

# **GERMAN WORLD WAR II ORGANIZATIONAL SERIES**

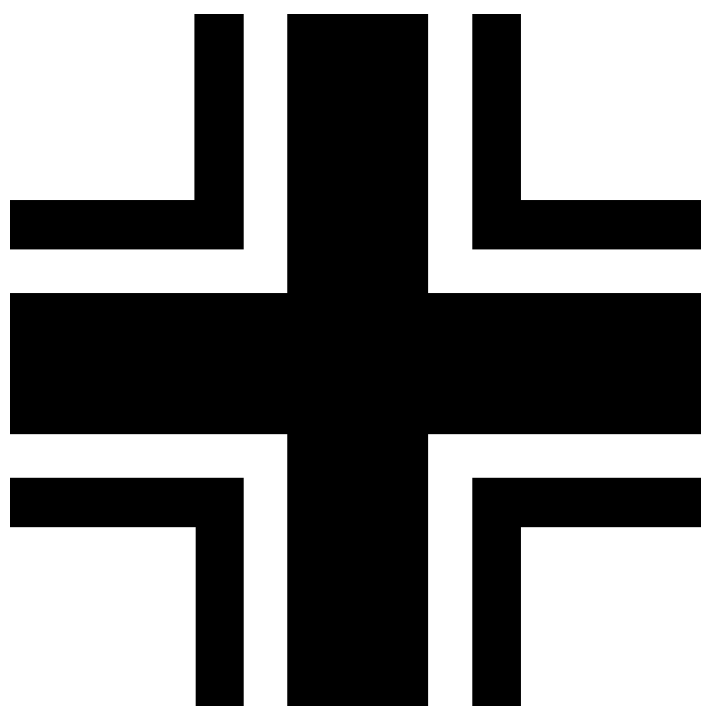

**Volume 5/I**

**MECHANIZED ARMY DIVISIONS  
(4th July 1943)**

## **THE GERMAN WORLD WAR II ORGANIZATIONAL SERIES**

1/I	01.09.39	Mechanized Army Formations and Waffen-SS Formations (3rd Revised Edition)
1/II-1	01.09.39	1 <sup>st</sup> and 2 <sup>nd</sup> Welle Army Infantry Divisions
1/II-2	01.09.39	3 <sup>rd</sup> and 4 <sup>th</sup> Welle Army Infantry Divisions
1/III	01.09.39	Higher Headquarters — Mechanized GHQ Units — Static Units (2nd Revised Edition)
2/I	10.05.40	Mechanized Army Formations and Waffen-SS Formations (2nd Revised Edition)
2/II	10.05.40	Higher Headquarters and Mechanized GHQ Units (2nd Revised Edition)
3/I	22.06.41	Mechanized Army Divisions - (2nd Revised Edition)
3/II	22.06.41	Higher Headquarters and Mechanized GHQ Units (2nd Revised Edition)
4/I	28.06.42	Mechanized Army Divisions - (2nd Revised Edition)
4/II	28.06.42	Mechanized GHQ Units and Waffen-SS Formations
5/I	04.07.43	Mechanized Army Formations
5/II	04.07.43	Higher Headquarters and Mechanized GHQ Units
5/III	04.07.43	Waffen-SS Higher Headquarters and Mechanized Formations

### **IN PREPARATION FOR PUBLICATION 2007/2008**

7/I	06.06.44	Mechanized Army Formations
2/III	10.05.40	Army Infantry Divisions
3/III	22.06.41	Army Infantry Divisions

### **IN PREPARATION FOR PUBLICATION**

01.09.39	Landwehr Division — Mountain Divisions — Cavalry Brigade
10.05.40	Non-Mechanized GHQ Units Static Units
22.06.41	Mechanized Waffen-SS Formations Static Units
28.06.42	Higher Headquarters Army Divisions Static Units
04.07.43	Army Divisions Static Units
01.11.43	Mechanized Army Formations Mechanized GHQ Units Mechanized Waffen-SS Formations Army Divisions Static Units Higher Headquarters
06.06.44	Mechanized GHQ Units Mechanized Waffen-SS Formations Army Divisions Static Units Higher Headquarters
16.12.44	Mechanized Army Formations Mechanized GHQ Units Mechanized Waffen-SS Formations Army Divisions Static Units Higher Headquarters
1939 – 45	Luftwaffen Ground Combat Forces
1944 – 45	The 1944 Brigades
1939 – 45	Organizational Handbook

# GERMAN WORLD WAR II ORGANIZATIONAL SERIES

*by Leo W.G. Niehorster*

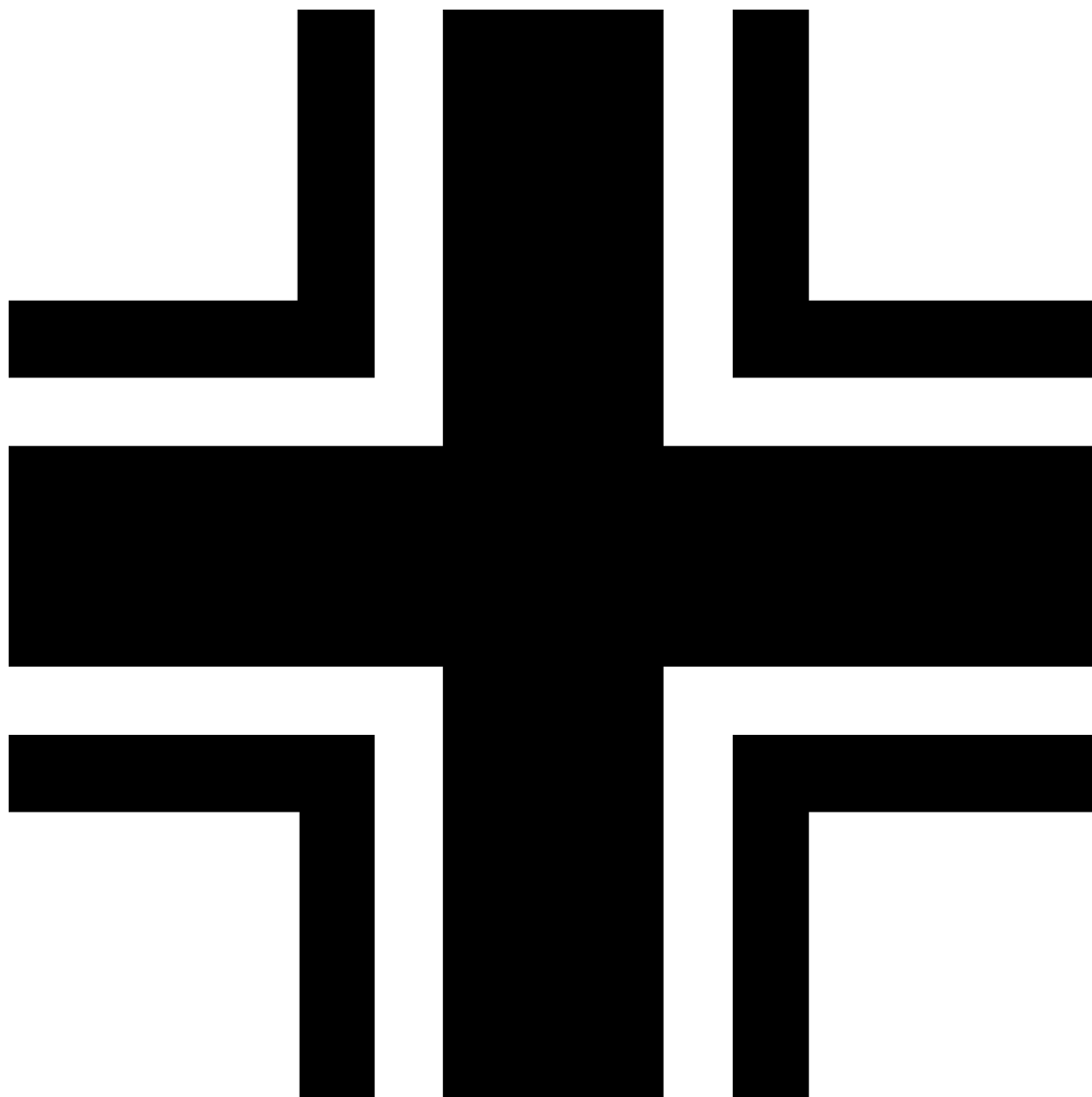

**Volume 5/I**

**MECHANIZED ARMY DIVISIONS  
(4th July 1943)**

**GERMAN WORLD WAR II ORGANIZATIONAL SERIES**

**Volume 5/I**

Mechanized Army Divisions

(4th July 1943)

First published by The Military Press in 2004

Reprinted by The Military Press in 2007

This and all previous editions © by Leo W.G. Niehorster

**THE MILITARY PRESS**

**1 Gallagher Close**

**Crownhill, Milton Keynes**

**Buckinghamshire MK8 OLQ**

**United Kingdom**

**Tel: +44 (190) 826-5095**

**Fax: +44 (870) 912-0908**

**email: [militarypress@bopenworld.com](mailto:militarypress@bopenworld.com)**

**<http://www.militarypress.co.uk>**

All rights reserved. Except for use in a review, no portion of this book may be reproduced, stored in a retrieval system or transmitted in any form or means, electronic, electrostatic, magnetic tape, mechanical, photocopying, or otherwise without the express prior, written permission of the publisher. Neither the author nor the publisher assumes any responsibility for the use or misuse of information contained in this book.

Printed in the United Kingdom

ISBN 978-0-85420-293-5 Hardback Edition  
ISBN 978-0-85420-298-0 Softback Edition

## CONTENTS

### Mechanized Army Divisions

<p>2 The Author</p> <p>3 General Introduction</p> <p>4 How to Read the Charts</p> <p>6 Organizational Symbols</p> <p>7 German Units and Symbols</p> <p>8 Terms and Abbreviations</p> <p>9 Order of Battle</p> <p>10 The 1943 Panzer Division, with all authorized changes</p> <p>11 The 1943 Panzergrenadier Division, with all authorized changes</p> <p>12 1. Panzer-Division</p> <p>13 2. Panzer-Division</p> <p>14 3. Panzer-Division</p> <p>15 4. Panzer-Division</p> <p>16 5. Panzer-Division</p> <p>17 6. Panzer-Division</p> <p>18 7. Panzer-Division</p> <p>19 8. Panzer-Division</p> <p>20 9. Panzer-Division</p> <p>21 11. Panzer-Division</p> <p>22 12. Panzer-Division</p> <p>23 13. Panzer-Division</p> <p>24 14. Panzer-Division</p> <p>25 16. Panzer-Division</p> <p>26 17. Panzer-Division</p> <p>27 18. Panzer-Division</p> <p>28 19. Panzer-Division</p> <p>29 20. Panzer-Division</p> <p>30 21. Panzer-Division</p> <p>31 23. Panzer-Division</p> <p>32 24. Panzer-Division</p> <p>33 25. Panzer-Division</p> <p>34 26. Panzer-Division</p> <p>35 Panzer-Grenadier-Division <i>Grossdeutschland</i></p> <p>36 3. Panzer-Grenadier-Division</p> <p>37 10. Panzer-Grenadier-Division</p>	<p>38 15. Panzer-(Grenadier-)Division</p> <p>39 16. Panzer-Grenadier-Division</p> <p>40 18. Panzer-Grenadier-Division</p> <p>41 20. Panzer-Grenadier-Division</p> <p>42 25. Panzer-Grenadier-Division</p> <p>43 29. Panzer-Grenadier-Division</p> <p>44 Panzer-Grenadier-Division <i>Feldherrnhalle</i></p> <p>45 Division <i>Sardinien</i></p> <p>46 Headquarters / Panzer &amp; Panzer-Grenadier Division</p> <p>47 Panzer-Regiment</p> <p>48 100. Panzer-Regiment (21. Panzer-Division)</p> <p>49 Panzer (Sturmgeschütz) Battalion &amp; Panzer Battalion</p> <p>50 Sturmgeschütz Battalions</p> <p>51 Panzer-Grenadier-Regiment (Panzer-Division)</p> <p>56 Panzer-Grenadier and Grenadier-Regiment (motorized)</p> <p>58 Panzer-Grenadier-Regiment (21. Panzer-Division)</p> <p>59 <i>Grossdeutschland</i> Regiment</p> <p>60 Panzer-Artillery Regiment</p> <p>62 Artillery Regiment (motorized)</p> <p>64 Anti-Aircraft Battalion</p> <p>65 Anti-Tank Battalion</p> <p>66 Armored Reconnaissance Battalion</p> <p>68 Armored Combat Engineer Battalion</p> <p>69 Motorized Combat Engineer Battalion</p> <p>70 Divisional Signal Battalion – Panzer-Division</p> <p>71 Divisional Signal Battalion – Panzergrenadier-Division</p> <p>72 Divisional Services</p> <p>74 Armored Fighting Vehicle Strengths</p> <p>75 Bibliography</p> <p style="padding-left: 20px;">i Introduction to Motor Vehicles</p> <p style="padding-left: 20px;">ii Numbered Motorized Softskin Vehicles</p> <p style="padding-left: 20px;">iv Special Motorized Vehicles</p> <p style="padding-left: 40px;">x Military Trailers and Special Military Trailers</p> <p>xiii Horse-Drawn Vehicles: Wagons, Carts, Sleds</p> <p>xv Ranks and Billet Groups of the German Army</p> <p>xvi German Military Personnel Job Descriptions</p>
--	--

## THE AUTHOR

Dr. Leo Niehorster was born in The Hague, Netherlands of an American mother and Dutch father. He has lived in Holland, Peru, England, Mexico, Canada, the United States, France, and Germany. His university education has been correspondingly diverse. The University of the Americas in 1964 to 1967, University of Maryland (correspondence courses while in the US Army) from 1968 to 1972, European Business School 1972 to 1976 (BA in Business Administration), Frankfurt Fachhochschule 1978 (Dipl. Kaufmann), Columbia Pacific University 1978 to 1980 (External MA in Business Administration), Columbia Pacific University 1980 to 1982 (External PhD in History). His vocational training includes a course resulting in the degree of Telecommunications Systems Developer. He is also a licensed Apple Service Technician.

The author did his military service in the US Army from 1968 to 1972, ending up in Germany, where he stayed.

His professional career started as night shift supervisor in an airline catering service, and has spanned such activities as pizza

baker at the local Italian in Barstow, California, to product manager for long haul travel in the world's largest tour operator in Hannover, Germany. He is presently spends most of his spare time involved in military history.

The author is a recognized authority on World War II German ground forces organization, and has put all of his expertise into the present series. Some of these books are a republishing of the original series, (which have been out of print for several years), and have been very much enhanced and augmented, encompassing a further fourteen years of research and study in the German, American, and British archives. The revised editions as well as the new volumes in the series will be highly welcomed by all interested in German military organization in World War II.

Dr. Niehorster's previously published works include the "The Royal Hungarian Army, 1920–1945", which was acclaimed as one of the Top Ten Books of 1999, and is considered by many experts to be the single most important English language history on the Hungarian Army.

## GENERAL INTRODUCTION

The 1942 Russian Campaign had ended disastrously for the Germans with the capitulation of the 6th Army in Stalingrad in February 1943, and the very narrow escape of the 4th Panzer Army from the Caucasus.

The 22. and 27. Panzer-Divisions lost at Stalingrad were not raised again. The 14., 16., and 24. Panzer-Divisions were, using approximately 3,000 to 4,000 troops of each of the old divisions, (comprising rear echelon units, personnel returning from leave and specialized training courses, as well as recovered wounded and sick). The rest came from existing reserve units, cadres from the 1. Panzer-Division before in was moved to the Balkans, and new personnel. Equipment was supplied slowly as it became available. The 3. and 29. Infantry Divisions (motorisiert) were also raised again, by redesignating the 386. and 345. Infanterie-Division (motorisiert), respectively. The 60. Infanterie-Division (motorisiert) was raised from its remnants and the 271. Grenadier-Regiment (mot). It was redesignated as Panzergrenadier-Division Feldherrnhalle on 14.06.1943. All Infanterie-Divisions (motorisiert) were redesignated as Panzergrenadier Divisions on 23.06.1943. In addition to the Stalingrad losses, the 13. and 18. Panzer Divisions had been severely mauled in the fighting, and were but shadows of their former selves.

The North African Campaign had also ended, but terminally for the Axis in May 1943. An additional seven German mechanized divisions were lost in Tunisia. The 15. Panzer, 21. Panzer, 90. Afrika and the Herman Göring Divisions were raised again. The 10. Panzer, 164. Afrika, and 999. Afrika Divisions were not. The Division Sizilien (raised 14.05.1943) and Division Sardinien (raised 23.04.1943) had been formed from personnel and units originally destined for the Axis forces which had been stranded in Italy when the Axis forces capitulated in North Africa. They were redesignated as the 15. Panzer-Division and 90. Panzergrenadier-Division on 1.07.1943 and 6.07.1943, respectively. The 15. Panzer-Division was again redesignated on 15.07.1943 as the 15. Panzer-Grenadier-Division. A completely new 21. Panzer-Division was raised from the *Schnelle Brigade West* (Mobile Brigade West). This had been a large armored, self-propelled formation almost exclusively equipped with French equipment and vehicles. It was beefed up by 100th Panzer Regiment and the 305th Army Anti-Aircraft Battalion. Contrary to all other formations being raised again, orders were issued specifically prohibiting the transfer of personnel of the (old) 21. Panzer-Division to the new division, so as to prevent the loss of experienced personnel from new formations being raised in Italy.

The 25. Panzer-Division was being brought up to strength in Norway. It was transferred to France during late July and August for completion and training, and was ready by October 1943.

The Germans had also formed the 26. Panzer-Division in September 1942 in France. This division was also brought up to strength, and was basically combat ready by early August 1943.

By mid-1943, a series of Army General Orders and amendments to the tables of organization (*Kriegstärkenachweisung* – *KStN*) had established a desired standard organization for the Panzer and Panzergrenadier Divisions. (See pages 10 and 11). The Panzer Divisions were supposed to have one battalion with four medium tank companies and one battalion with four Pz-V Panther companies. Every Panzer battalion was authorized a flame tank platoon. The Panzer Divisions were to have one armored infantry regiment with one armored infantry battalion. The infantry regiments were to be equipped throughout with heavy antitank guns. The heavy infantry gun companies were to be self-propelled. The artillery regiments were supposed to have one self-propelled artillery battalion. The antitank battalion was supposed to have three self-propelled antitank companies. The combat engineer battalion was to have two motorized and one armored engineer company, as well as a bridge column K. The armored reconnaissance battalions were supposed to have 1 wheeled armored car, 1 halftrack armored car, and 2 light reconnaissance (armored or motorized) companies. The heavy company was also supposed to be armored.

This was very much a theoretical exercise, as will be detailed in this book. The authorized and actual tank and self-propelled vehicle strengths have been indicated in the chart on page 74. Where it was possible to acquire exact company tank strength reports for the Panzer units, these have been noted on the divisional diagrams themselves.

Although in general the personnel situation could be mastered, equipment was and continued to be a major problem. Armored vehicles were in short supply. The divisions being raised in France were equipped for training largely with French equipment. Enough Pz-III and Pz-IV tanks, Sturmgeschütz, and armored self-propelled carriages to equip the forty odd mechanized divisions were just not available – or being produced – in sufficient numbers. The new Pz-V “Panther” was just coming off the production lines, and the first tank battalions so equipped did not reach their divisions until late August 1943. The heavy 75mm and 76.2mm, and even the medium 50mm antitank guns were in short supply. The medium armored halftrack was still unavailable in the desired numbers. Some Panzer divisions were equipped with a complete battalion, while others only had one armored infantry company, if at all. Besides the wheeled armored car company, the other companies in the armored reconnaissance battalion were supposed to be equipped with the light armored halftrack or Volkswagen Kübelwagen, but many companies were still equipped with motorcycles. The light, 4-wheel, armored car was supposed to be replaced by the new heavy, 8-wheel, version when it became available. Many heavy companies were still only motorized.

Soft-skinned motor vehicles were never produced in sufficient numbers to satisfy the needs of the *Kriegstärkenachweisung*. The lack of German equipment was compensated to a certain extent by the wholesale incorporation of captured Russian, Czech, British, and French, vehicles, guns, artillery, etc.

On 1.03.1943, General Heinz Guderian was appointed Inspector General of the Panzertruppen (Armored Forces). This meant that the organization of all mechanized formations, (including those of the Infantry Inspectorate, the Waffen-SS and the Luftwaffe) came under his control.

The Infanterie-Divisions (motorisiert) were redesignated as Panzer-Grenadier Divisions on 23.06.1943. All new motorized infantry regiments reformed or raised after this date were *supposed* to be designated as Panzergrenadier-Regiments, but not always were. [The Grenadier-Regiments (motorisiert) of the Panzergrenadier-Divisions in existence were not redesignated until 1.12.1944!] Hence, some Panzergrenadier-Divisions had one type of nomenclature for their regiments, while others carried another. The Infantry Inspectorate had had its own KStN. The infantry regiments (motorized) were supposed to be reorganized under the Panzertruppen Inspectorate KStN. But this took until November 1943. Confusingly, this meant that in July 1943 Panzer-Grenadier-Divisions had varying nomenclature and organizations for their infantry regiments.

The Grossdeutschland and Feldherrnhalle Panzergrenadier Divisions each had one Panzer-Grenadier and one Panzer-*Fusilier* Regiment. The latter was merely a traditional designation, and had no effect on organization. The elite Grossdeutschland Panzergrenadier-Division had been a strong Panzer Division in organization since 1942 anyway, although it continued to have – at least in parts – its own particular (Infantry Inspectorate) KStN for the motorized infantry units.

With the two types of Panzer Division armored infantry regiments, (1941 and 1943), there were five different authorized organizations for mechanized infantry in mid-1943.

I would like to mention the following for their time and assistance: Mijneer Piet Duits. Herr Kurt Gätzschmann. Mr. Thomas L. Jentz. Herr Brün Meyer. Herr Adolf Schönefeld. To all of them, my thanks.

The published material contained in the sources and references section indicates publications which were consulted, (although not necessarily used), and is basically meant to assist the reader in familiarizing himself with the subject of the German units and formations of the period.

This book draws primarily on German KStN and various orders of battle. The author apologizes for any mistakes that have happened during this process, (they are only my own), and welcomes critical comments and suggestions. Should any reader possess more founded information, or even the original documents thereto, I would appreciate hearing from them, so that in a future edition, the corresponding corrections can be inserted for the benefit of all.

## HOW TO READ THE CHARTS

Dates are indicated in the following manner: Day.Month.Year. (Thus 4.07.1943 is the 4th Day of July 1943).

The ordinator for numbers in German is the dot (“.”). Where German units are referred to in their original German designation, this practice has been followed. E.g. *14. Panzer-Division* is the German way of designating the 14th Armored Division.

The Germans normally referred to the large formations and the smallest units with an ordinator (i.e. armies, corps, divisions, brigades, and regimental battalions, as well as companies and platoons), whereas army groups, regiments and independent battalions were referred to in the reverse order. I.e. *Heeresgruppe Mitte, Artillerie-Regiment 103 (mot), or Panzer-Abteilung 33*. To facilitate the location of the various units and to present a uniform system of identification, all units have the identifying numbers indicated first in this work. Army groups, having names as opposed to numbers, have their designations indicated last.

Numbers in German can be confusing to Anglo-Saxons, as the decimal point becomes a decimal comma:

*German: 10,5*      English: 10.5 = (ten and a half)

Similarly, the comma used to separate thousands is also reversed:

*German: 10.000*      English: 10,000 = (ten thousand)

Where using German designations, the German practice has been followed (i.e.: *3,7cm Pak*). Otherwise, the English usage prevails: (i.e. 37mm antitank gun), using the millimeter system instead of the German WW II system based on centimeters.

Military motor vehicles and armored fighting vehicles (AFV) have a number behind them in brackets. This number refers to either the German model number (either *Kfz.* = *Kraftfahrzeug*, or to *Sd. Kfz.* = *Sonder Kraftfahrzeug*); or to the tonnage of the carrier. For civilian-type personnel and load carriers without a special number, the engine size or the weight classification is indicated instead.

E.g.: truck (3-ton) refers to a cross-country (all-wheel-drive) load-carrier with a 3-ton load factor. Truck (medium) refers to a civilian (rear-axle-driven) load carrier with a load factor of between 3 to 4.4 tons. Halftrack (7) refers to the 8-ton halftrack (*Zugkraftwagen*) with the *Sd.Kfz.* number 7. Car (2) refers to the light personnel carrier with the *Kfz.* number 2. Etc. Etc. The reader is referred to the sections on vehicles in the back of this book.

Van is a load carrier with a closed, hard body, (usually of wood), used for office, maintenance, and communications work. Truck is a load carrier having an open bed, which could be fitted with a tarpaulin stretched over tubular metal or wooden hoops.

The diagrams are based on reproductions of German organizational symbols of the period.

The text beneath each diagram has been used to clarify it, and to give details about composition and the amounts of subunits. It breaks down the KStN, giving numbers and date of issue. KStN that are no longer available are marked thus: \*)

The vehicles or items indicated behind the unit being described indicate the amounts in one of these units. E.g.:

3 Lt Tele Sect: 1 car (2), means that the three light telephone sections each have one light communications vehicle (*Kfz.* 2).

In some cases, sections do not have their own vehicles, or several sections share a vehicle. In these two cases, this is indicated in the text. E.g.:

1 Mortar Section: rides with one of the infantry squad's vehicles, or,  
2 Pack Radio Sect: ride together in one truck (2-ton).

The designation “Trains” includes all the administrative, supply, commissary, and baggage elements of the corresponding unit. Although maintenance sections and detachments were often included under this designation, they have been presented separately for clarity.

## TABLES OF ORGANIZATION – KRIEGSTÄRKENACHWEISUNGEN

German unit organizations were based on tables of organization, (*Kriegstärkenachweisungen* – KStN). Every unit raised had them, and all orders raising units indicated the corresponding KStN numbers and dates which applied for them. These orders also indicated any modifications that might apply at the time.

The Germans did not necessarily issue their KStN on the dates indicated on them, and it is highly unlikely that units conformed to the KStN on their issue dates. The KStN could be distributed before or after (retroactively to) the issue date. The issue date merely referred to a specific deadline upon which the KStN was to become effective. On 24.09.1943, for example, new organizations for all Panzer and Panzer-grenadier Divisions were ordered, although the new KStN were dated 1.11.1943 (and in a few cases 1.10.1943). Standard KStN were always dated on the 1st of the month. Provisional KStN were dated any other day of the month. These provisional KStN, (issued to test new organizations and changes to be promulgated), were then replaced by the official, standard KStN when ready. Sometimes, these provisional KStN remained in force and in effect became the standard KStN. In such cases, a ‘standard’ KStN (with an issue date on the 1st of the month), was not issued at all.

As new KStN appeared, the old ones were supposed to be destroyed in the field. The bombing and the ensuing fire caused the destruction of the Potsdam military archives in 1945, which means that only portions of the KStN remain today.

KStN could be modified (changed) by General Army Memorandums (AHM – *Allgemeine Heeresmitteilungen*) and also by orders issued by the various arms inspectorates or higher headquarters. These agencies continually changed and modified the KStN, adding a vehicle here, deleting a soldier or three there, or making other modifications.

The KStN are identified by their original issue date in this book. Such changes as made by the orders mentioned above have been incorporated, but the dates of and authorizations for these changes have not been indicated.

The Germans occasionally published lists with valid KStN at specific periods, approximately once a year. Some of the KStN indicated on these lists were never published, or they were issued, but with a remark that they were not to be implemented until further notification, (or specific orders), which, in some cases, was never forthcoming. Some KStN existed only a short time, never appearing on these validity lists, (either cancelled, never authorized, or superseded).

Other KStN were issued twice under the same date with minor modifications. The validity of the second one was indicated by underlining the date. Any KStN issued on that date had to have the date underlined to be valid.

KStN and changes became valid when authorized by higher headquarters and then applied immediately to unit strength reports. Internal reorganizations of the units were not made until the indicated units were able to implement them. This might mean having to wait until the units could be withdrawn from combat and having time for training and administrative matters. Units to be issued with new and particularly complicated equipment were withdrawn to training grounds, transferring most of their old equipment to other units upon departure. A new unit was normally raised, trained, and equipped at one of the training grounds and then sent to the front, where normally (but not always immediately) it joined its parent unit or formation.

The author has extrapolated the missing KStN from other KStN, which could be either contemporary and similar, or of the same KStN of later and/or earlier dates. The KStN number of the unit being defined in this case has an \*) behind it. These educated guesses are also based on what information could be gleaned from orders of battle, unit histories (where available), unit strength reports, and German tactical doctrine manuals of the period.

**It is important to emphasize that KStN indicated the maximum authorized organization. In many cases, they represented an ideal organization which in reality was not achieved.**



## GERMAN UNITS AND ORGANIZATIONAL SYMBOLS 1943

The symbols in this book are based on the official German handbook of military symbols (H.Dv. 272) of 23.05.1943, and on the actual symbols used in the organizational charts (Kriegsgliederungen des Feldheers, (1.07.43)). Where symbols in the latter are at variance with the former, the symbols of the organizational charts have been used.

The organizational unit symbols introduced in 1943 were simplified. E.g., anti-tank units now also used a representation of the basic anti-tank gun symbol itself; weapon symbols themselves were no longer modified, but had instead identifying information placed next to them, etc.

In German organizational charts (and, as reflected in this book), the headquarters symbol represents two purposes. First, it indicated the size, function, and mobility of the unit. And, second, it also indicated the headquarters of that echelon itself. I.e., there was no separate symbol for this echelon's headquarters. For all headquarters units with (and important units without) separate KStN, the corresponding symbols were placed to the right of the echelon's symbol. The same applied to those units that were directly assigned to the echelon's headquarters. For example, the signal and tank platoon of an armored regiment (although part of the Regiment Headquarters) were put next to the headquarters, but the independent tank maintenance platoon of a tank battalion was placed underneath it.

The different functions and mobility additions were used to enhance the echelon's symbol to indicate a specific purpose. Company-sized units and sub-units symbols were also modified in a similar fashion.

The Germans numbered their units on organizational charts from the right. I.e., the first company was on the far right, and the last company was on the far left.

An interesting feature of company and sub-unit symbols is that their size, shape, and dimensions could be altered to fit the diagram being depicted with them. Several infantry companies, for example, were placed side-by-side, elongated upwards, (so that all weapons symbols could fit within), and only the left-hand company had a thickened edge used to indicate its size (more of this below). The variations in size and shape followed the original configuration, and the basic symbol was still recognizable as such.

The symbols were intended to be mnemonic. The headquarters symbols reflected the units' pennants used on vehicles or the standards themselves. (These flags and pennants were of different colors to represent the various combat arms, and usually had a number, letter, and/or heraldic symbol superimposed upon them). Hence, any German looking at one of these symbols could immediately recognize the unit type being depicted. The colors in real life were substituted by the unit function and mobility modifiers above and below the symbols. In addition, a simplified version of the organizational symbols was, for example, painted on unit vehicles and used on maps.

The mobility of the unit was also quickly recognizable. For example, the two small circles ('wheels') underneath a symbols identified the unit as being motorized. In case these wheels were over the symbol (applied only to artillery-type units), this indicated that the unit was motorized by half-tracked prime movers. Elongated ovals ('tracks') applied underneath the symbol meant that the unit was either self-propelled or fully tracked.

The lozenge symbol represented armor. All tank-type units used this symbol, including assault artillery (Sturmgeschütz, Sturmhaubitze), as well as Sturmpanzer. It was shaped to reflect World War I tanks, and hence provided a good memory assist.

Aside from a very few specialized symbols, which were quickly memorized, all company-sized and smaller unit symbols tended to reflect the units' function or their main weapon. In most cases, a unit too difficult to depict easily was instead represented by a box with a corresponding abbreviation inside. In case it belonged to a particular arm, the arms symbol could be placed on top of or within this box. Where various modifiers applied, these were all added to the symbol.

Company-sized units had, somewhere within their symbol, a thickened part, usually a side.

Artillery Inspectorate firing batteries (tube, rocket-launcher, and Army anti-aircraft) batteries used the basic weapon symbols without thickening. A large weapon symbol (usually with the number of guns underneath) indicating a battery. (Firing artillery units smaller than battery size were depicted by smaller scale symbols). The caliber was indicated on the left of the symbol, (in centimeters or weight), and further identification, (if necessary), on the right. None-firing batteries followed the normal form of thickening a portion of the symbol to indicate their size.

The weapon symbols for the Infantry and Panzertruppen Inspectorate artillery-type companies (light and medium anti-aircraft, infantry gun) had the upright stems of the weapon symbols representing these types of companies thickened accordingly.

Where several columns, platoons, or detachments were gathered into a headquarters company or heavy company, these symbols were enclosed in a box with a thick side.

The units smaller than companies, whether independent or as sub-components, were usually depicted on organizational charts only if they had their own KStN. Exceptions occurred, particularly if the headquarters sub-units contained specialized equipment.

*Staffel* (Detachment) This was an elastic designation for several components under a headquarters section, these components being from section to platoon size. Often this was merely an administrative grouping, and the components were distributed to other sub-units in combat. It could either have its own small headquarters section, or one of the components' leaders could carry out a dual function.

*Kolonne* (Column) This was an independent transportation unit, varying from company to platoon size, transporting equipment or supplies such as a bridge column (which in fact did not actually built the bridge it was transporting), or even as an 'infantry' column (which consisted of a set number of horse-drawn vehicles capable of transporting a fixed tonnage).

*Zug* (Platoon) Independent unit or the typical main subdivision of companies and batteries. Usually, the 1st and 2nd platoons in each company-sized unit, and also of independent platoons, were lead by a lieutenant, while the other platoons were headed by a senior NCO.

*Trupp* (lit. Troop; Section) A small unit, equipped with specialized equipment; it could also function as a headquarters unit.

The units indicated below were not depicted as separate symbols.

*Halb-Zug* (lit.: Half-Platoon) Some platoons, for example HMG Platoons, could be divided into two parts.

*Gruppe* (Squad, Section) Normally the smallest sub-unit that existed in the German Army. In this book, the word "Squad" has only been used for infantry and reconnaissance infantry units. All other units of this size have been designated as "Sections".

*Halb-Gruppe* (lit. Half-Squad, i.e. Team) Infantry and reconnaissance squads could be broken down into two parts. Infantry and reconnaissance squads were built up around the squad LMG. Where only one LMG was provided, one team provided cover while the other team was the movement element. Where two LMG were available, the teams covered each other in turns. Reconnaissance teams, on the other hand, were trained to work independently, although they too could function as a squad.

GERMAN ORGANIZATIONAL SYMBOLS  
1943

SIZE, FUNCTION, MOBILITY

General Headquarters	Army Group Headquarters	Army Headquarters	Group Headquarters	Corps Headquarters	Military Commander	Division Headquarters	Brigade Headquarters	Regiment Headquarters	Battalion Headquarters	Company Headquarters	Band
Infantry	Reconnaissance	Signal	Engineer	Bridging Engineer	Railroad Engineer	Technical	Supply	Motor Transport	Maintenance	Medical	Veterinary
Infantry	Mountain	Bicycle	Semi-Motorized	Motorized	Motorcycle	Armored Infantry	Panzer Div. Tank	Anti-Tank	Construction	Military Police	Cavalry
Artillery	Mountain Artillery	Self-Propelled Artillery	Panzer Div. Artillery	Artillery Observation	Rocket Artillery	Recoilless Artillery	Assault Artillery	Infantry Anti-Aircraft	Army Anti-Aircraft	Luftwaffe Anti-Aircraft	Machine Gun
Foot / Horse-Drawn	Mountain	Ski or Sled	Bicycle	Mixed Mobility	Semi-Motorized	Motorized	Motorcycle	Halftrack Towed	Amphibious Motorized	Self-Propelled (Tracked)	Armored Halftrack

WEAPONS

Weapon Classification												
	Machine Gun	Anti-Tank Rifle	Infantry Gun	Mortar	Anti-Tank Gun	Rocket Launcher	Gun	Howitzer	Heavy Howitzer	Anti-Aircraft Gun	Flame Thrower	
light	<i>le</i>	with bipod	to 79mm	to 75mm	to 79mm	to 39mm	to 109mm	to 99mm	to 129mm		to 36mm	man-packed
medium	<i>m</i>				80 - 119mm	40 - 59mm	110 - 159mm				37 - 59mm	
heavy	<i>s</i>	with tripod	over 80mm	over 76mm	over 120mm	60 - 89mm	160 - 219mm	100 - 209mm	130 - 209mm	210 - 249mm	60 - 159mm	vehicle-borne
super heavy	<i>sw</i>	over 15mm				over 90mm	over 220mm	over 210mm	over 210mm	over 250mm	over 160mm	

INFANTRY INSPECTORATE UNITS













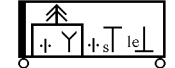



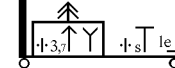







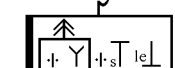







Infantry Platoon	Infantry Company	Infantry Mortar Company	Infantry Machine Gun Company	Infantry Engineer Platoon	Infantry Anti-Tank Platoon	Infantry Anti-Tank Company	Infantry Gun Platoon	Infantry Gun Company	Infantry Bicycle Platoon	Infantry Bicycle Company	Light Anti-Aircraft Co. (mot)
Mountain Infantry Platoon	Mountain Infantry Company	Mountain Mortar Platoon	Mountain Machine Gun Company	Mountain Engineer Platoon	Mountain Anti-Tank Platoon	Mountain Anti-Tank Company		Mountain Infantry Gun Company	Mountain Bicycle Inf. Plt.	Lt. Mountain Transport Column	Light Anti-Aircraft Co. (SP'd)
Cavalry Platoon	Cavalry Company	Cavalry Mortar Platoon	Cavalry Machine Gun Company	Cavalry Engineer Platoon	Cavalry Anti-Tank Platoon	Cavalry Inf. Gun Platoon	Infantry Mounted Recon. Plt.	Light Infantry Company (motorized)	Machine Gun Company (motorized)	Mortar Company (motorized)	Medium Anti-Aircraft Co. (SP'd)

ENGINEER INSPECTORATE UNITS





























































Engineer Platoon	Engineer Company	Mountain Engineer Company	Motorized Engineer Company	Armored Engineer Company	Engineer Goliath Company	Engineer Assault Boat Company	Bridge Construction Company	Construction Company	Road Construction Company	Engineer Equipment Plt. (mot)	Railroad Engineer Company
Bridge Column B (motorized)	Bridge Column K (motorized)	Bridge Column J (motorized)	Unit of Bridge Equipment H	Unit of Bridge Equipment leZ	Unit of Bridge Equipment sS	Bridge Unit with Escort Detachment	Bridge Column Unit & Escort Detachment	Engineer Snow-Clearing Plt. (mot)	Light Engineer Transport Column (mot)	Engineer Park	Railroad Engineer Park

GERMAN ORGANIZATIONAL SYMBOLS  
1943













PANZERTRUPPEN INSPECTORATE UNITS

 Motorized Infantry Platoon	 Motorized Infantry Company	 Motorized Heavy Company (typical example)	 Armored Infantry Platoon	 Armored Infantry Company	 Armored Flamethrower Platoon	 Armored Gun Platoon	 Armored Heavy Company (typical example)	 Motorized Inf. Gun Company	 Self-Propelled Inf. Gun Company		
 Motorcycle Recon. Platoon	 Motorcycle Recon. Company	 Kettenrad Recon. Company	 Volkswagen Recon. Company	 Armored Recon. Company	 Motorized Heavy Recon. Company (typical example)	 Armored Car Platoon	 Armored Car Company (wheeled)	 Armored Car Company (half-tracked)	 Armored Car Company (tracked)	 Light Recon. Transport Column	
 Tank Platoon	 Tank Company	 Radio-Controlled Tank Co.	 Tank (Sturmgeschütz) Company	 Assault Tank Company (Sturmpanzer)	 Armored Headquarters Company	 Tank Maintenance Platoon	 Tank Maintenance Company	 Flame Tank Platoon	 Motorized Anti-Tank Company	 Self-Propelled Anti-Tank Company	 Light Panzer Transport Column





































ARTILLERY INSPECTORATE UNITS

 Light Field Gun Battery	 75mm Mtn. Gun Battery (GK 15)	 75mm Field Gun Battery (FK 16nA)	 75mm Cav. Gun Battery (FK 16nA)	 75mm Field Gun Battery (FK 18)	 Assault Gun Battery (Sturmgeschütz)	 Light Field Howitzer Battery	 105mm Field Howitzer Bty. (le. FH 16)	 105mm Field Howitzer Bty. (le. FH 18)	 Heavy Field Howitzer Battery	 150mm Field Howitzer Bty. (s. lg. FH 13)	 150mm Field Howitzer Bty. (sFH 18)
 Heavy Gun Battery	 105mm Gun Battery (K 17)	 105mm Gun Battery (K 18)	 150mm Gun Battery (K 16)	 150mm Gun Battery (K 18)	 150mm Gun Battery (K 39)	 Mrs.Laf. 150mm Gun Battery (How. Base)	 Mrs.Laf. 170mm Gun Battery (How. Base)	 210mm Gun Battery (K 12)	 210mm Gun Battery (K 38)	 210mm Gun Battery (K 39)	 240mm Gun Battery (K 3)
 240mm Howitzer Bty. (H 39)	 210mm Howitzer Bty. (lange Mörser)	 210mm Howitzer Bty. (M 18)	 305mm Howitzer Battery	 355mm Howitzer Bty. (M 1)	 600mm Howitzer Bty. (Karl Gerät)	 75mm Recoiless Bty. (LG 1)	 105mm Recoiless Bty. (LG 2)	 Army AA Searchlight Battery	 20mm Flak Army AA Battery	 37mm Flak Army AA Battery	 88mm Flak Army AA Battery
 105mm Rocket Launcher Bty. (Nb. W. 40)	 150mm Rocket Launcher Bty. (Nb. W. 41)	 210mm Rocket Launcher Bty. (Nb. W. 42)	 280/320mm RL Bty. (Nb. W. 41)	 300mm Rocket Launcher Bty. (Nb. W. 42)	 Motorized Headquarters Battery	 Hqs. Bty. Self-Propelled Battalion	 Hqs. Bty. Assault Gun Battalion	 Hqs. Bty. Army AA Battalion	 Hqs. Bty. Rocket Battalion	 Hqs. Bty. Art. Obs. Battalion	 Artillery Park
 Motorized Calibration Detachment	 Mountain Calibration Detachment	 Calibration Platoon	 Calibration Battery	 Weather Detachment	 Motorized Weather Platoon	 Sound-Ranging Battery	 Flash-Ranging Battery	 Motorized Balloon Platoon	 Artillery Transport Column (mot)	 Army AA Transport Column (mot)	 Rocket Transport Column (mot)

SIGNAL INSPECTORATE UNITS

 Motorized Propaganda Company	 Motorized Signal Company	 Motorized Telephone Company	 Mountain Telephone Company	 Telephone Construction Company	 Wire Construction Company	 Telephone Operations Company	 Motorized Radio Company	 Motorized Interception Company	 Armored Signal Company	 Armored Radio Company	 Light Signal Transport Column (mot)
---	---	--	---	---	--	---	--	---	---	--	--

REAR ECHELON UNITS

 Horse-Drawn Transport Column (15t)	 Horse-Drawn Transport Column (30t)	 Horse-Drawn Transport Column (60t)	 Motorized Transport Column (30t)	 Motorized Transport Column (60t)	 Motorized Transport Company (90t)	 Motorized Transport Company (120t)	 Motorized Light Supply Company	 Motorized Heavy Supply Company	 Motorized P.O.L. Col. (25cbm)	 Motorized P.O.L. Col. (50cbm)	 Motorized Water Tanker Col. (60cbm)
 Motorized Bakery Company	 Motorized Butchery Company	 Mot. Rations Administration Detachment	 Motorized Field Post Detachment	 Motorized Military Police Platoon	 Motorized Military Police Company	 Motorized Trains	 Field Hospital	 Medical Company	 Motorized Ambulance Platoon	 Veterinary Company	 Mot. Horse Transport Column
 Motorcycle Messenger Platoon	 Motorized Maintenance Platoon	 Motorized Maintenance Company	 Motorized Armorer Company	 Motorized Spare Parts Detachment	 Motorized Spare Parts Column	 Motorized Recovery Platoon	 Tank Recovery Platoon	 Motorized Mapping Detachment	 Motorized Printing Detachment	 Motorized Printing Platoon	 Motorized Technical Company

<i>Abbr.</i>	<i>German</i>	<i>English</i>	<i>Abbr.</i>	<i>German</i>	<i>English</i>
AA	–	anti-aircraft	Li	Lichtmess	flash ranging
Abt	Abteilung	Battalion	LMG	–	light machine gun
AC	–	armored car	lt	–	light
AG	–	Army Group	Lw	Luftwaffe	German Air Force
Ammo	–	ammunition	M, Mörs	Mörser	howitzer
Armd	–	armored	m	mittler	medium
–	Armee	Army	MB	Militärbefehlshaber	Army Military Commander
–	Armeeabteilung	Army-sized Command	mcl	–	motorcycle
AT	–	anti-tank	mcl w/sc	–	motorcycle with side car
ATG	–	anti-tank gun	med	–	medium
ATR	–	anti-tank rifle	MG	Maschinengewehr	machine gun
Arko	Artillerie Kommandeur	Artillery Commander	mot	motorisiert	motorized
Battr	Batterie	Battery	mot S	mot. Selbstfahrlafette	self-propelled carriage
Befh	Befehlshaber	Commander	Nbl	Nebel	smoke
–	Befehlshaber rückwärtiges Heeresgebiet	Commander of Army Group Rear Area	Nbl W	Nebelwerfer	rocket launcher
Btl, Batl	Bataillon	Battalion	NCO	–	Non-Commissioned Officer
Bb, Beob	Beobachtung	observation	Ob.	Oberbefehlshaber	Commander-in-Chief
Bn	–	Battalion	Off	–	Officer
bo	bodenständig	static	OKH	Oberkommando des Heeres	Army High Command
Brig	Brigade	Brigade	OKW	Oberkommando der Wehrmacht	Armed Forces High Command
Bty	–	Battery	ops	–	operations
Bulg	–	Bulgarian	(p)	polnisch	Polish
cc	–	cross-country	Pak	Panzerabwehrkanone	anti-tank gun
CE	–	Combat Engineer	Pi, Pion	Pionier	(Combat) Engineer
Ch H Rüst	Chef Heeresrüstung und u. BdE	Chief of Army Equipment and Commander of the Reserve Army	Plt	–	Platoon
Co	–	Company	Pol	Polizei	police
Col	–	Column	P.O.L.	–	petrol, oil, lubricants
Det	–	Detachment	Prop	Propaganda	propaganda
Div	Division	Division	Pz, Panz	Panzer	tank, armor
EM	–	Enlisted Man	Pz-Bef	Panzerbefehlswagen	command tank
Engr	–	Engineer	PzGren	Panzergrenadier	motorized infantry
(f), (fr)	französisch	French	PzGren (gp)	Panzergrenadier (gp)	armored infantry
F.A.D.	Feldausbildungsdivision	Field Training Division	(r)	russisch	Russian
FEB	Feldersatz-Bataillon	field replacement battalion	Recon	–	reconnaissance
Fest.	Festung	Fortress	Res	Reserve	reserve
FH	Feldhaubitze	field howitzer	RF-SS	Reichsführer-SS	Reichs Leader of the SS
FK	Feldkanone	field gun	Rgt	Regiment	Regiment
Fla	Flugabwehr	anti-aircraft	RL	–	rocket launcher
Flak	Flugabwehrkanone	anti-aircraft gun	RSO	Raupenschlepper Ost	fully-tracked load carrier
Fkl	Funklenk	radio-controlled	Rum	–	Rumanian
FL	Feuerleit	artillery fire control	s, schw	schwer	heavy
Füs	Füsilier	Infantry	Sch	Schallmess	sound ranging
Fs	Fallschirm-	Parachute / Airborne	Schn	Schnelle	mobile
G, Gesch	Geschütz	gun, cannon	Sd	sonder	special
Geb.	Gebirgs-	mountain	Sd Kfz	Sonder-Kraftfahrzeug	special military vehicle
GHQ	–	General Headquarters	Sec	–	Security
GK	Gebirgskanone	mountain gun	Sect	–	Section
GSO	(Beamte)	Government Service Official	Sf	selbstfahrlafette	self-propelled
gp, gep	gepanzert	armored	Sfl	Selbstfahrlafette	self-propelled carriage
Gr	Gruppe	Group / Force	Sich	Sicherheits-	security
Gren	Grenadier	Infantry	Slov.	–	Slovakian
H, Haub	Haubitze	(gun-) howitzer	SMG	–	sub machine gun
Harko	Höhere Artillerie Kommandeur	Higher Artillery Commander	SP, SP'd	–	self-propelled
HMG	–	heavy machine gun	SPW	Schützenpanzerwagen	armored personnel carrier
Hqs	–	headquarters	Sdq	–	Squad
hvy	–	heavy	Sqdn	–	Squadron
–	Hun.	Hungarian	SS	Waffen-SS	Nazi Party military arm
IG	Infanterie-Geschütze	infantry gun	ss, sw	schwerste	super heavy
I, Inf	Infanterie	Infantry	St, Stb	Stab	headquarters
–	Ital.	Italian	–	Sturm-	assault
Jg	Jäger-	Light Infantry	StuGesch	Sturmgeschütz	assault gun (SP'd)
K, Kan	Kanone	gun	StuHaub	Sturmhaubitze	assault howitzer (SP'd)
KK	Kettenkrad	0.5-ton halftrack (aka: halftracked motorcycle)	StuPz	Sturmpanzer	assault tank (armored heavy IG)
kl	klein	small, light	(t)	tschechisch	Czechoslovakian
Kol	Kolonne	Column	tele	–	Telephone
Kp	Kompanie	Company	VW	Volkswagen	light cross-country car
KStN	Kriegstärkenachweisung	Table of Organization	Versorg	Versorgungs-	support
kz	kurz	short	w/	–	with
l, le, lei	leicht	light	w/o	–	without
LG	Leichtgeschütz	recoilless gun	WB	Wehrmachtbefehlshaber	Armed Forces Military Commander
lg	lang	long	Wfr	Werfer	(rocket-, grenade-) launcher
			WK	Wehrkreis	Military District
			zbV	zur besonderer Verwendung	for special (purposes / use)
			Zug	–	Platoon or railroad train

## ORDER OF BATTLE

<b>ARMY GROUP NORTH</b> 18. Pz-Gr. Div. 223. Inf. Div. 388. F.A.D.	16. Armee	<b>II. Korps</b>	331. Inf. Div. 12. Inf. Div. 218. Inf. Div. 123. Inf. Div. 93. Inf. Div.	<b>ARMY GROUP A</b> 13. Pz. Div.	<b>Befh. der Krim</b>	<b>Rum. Mountain Corps</b>	<i>Rum. 4 Mtn. Div.</i> <i>Rum. 2 Mtn. Div.</i>	<b>ARMY GROUP D</b> (Ob. West) 21. Pz. Div. 26. Pz. Div. 20. Brig. 30. Brig. 264. Inf. Div. 376. Inf. Div. 189. Res. Div. 159. Res. Div. 157. Res. Div. 165. Res. Div. 182. Res. Div. 148. Res. Div. 325. Sich. Div.	<b>WB Niederlande</b>	<b>LXXXVIII. Korps</b>	346. Inf. Div. 16. Lw.Feld-Div. 719. Inf. Div.					
		<b>Gruppe Höhe (VIII)</b>	21. Lw.Feld-Div. 122. Inf. Div. 32. Inf. Div.			<b>Kommando Auleb</b>	153. F.A.D. <i>Slov. Mobile Div.</i> 355. Inf. Div. 381. F.A.D.		<b>LXXXIX. Korps</b>	19. Lw.Feld-Div. 172. Inf. Div. 711. Res. Div.						
		<b>X. Korps</b>	5. Jg. Div. 30. Inf. Div. 8. Jg. Div. 126. Inf. Div. 329. Inf. Div.			<b>Befh. Straße Kertsch</b>	5. Lw.Feld-Div.		<b>LXXII. Korps</b>	18. Lw.Feld-Div. 156. Res. Div. 191. Res. Div.						
	18. Armee 121. Inf. Div. 28. Jg. Div.	<b>XXXVIII. Korps</b>	1. Lw.Feld-Div. 717. Inf. Div. SS Lett. Brig.		<b>17. Armee</b>	<b>Befh. Alpendinger</b>	<b>Gruppe Almendinger</b>		<i>Rum. 9 Cav. Div.</i> <i>Rum. 19 Inf. Div.</i> <i>Rum. 6 Cav. Div.</i> 4. Geb. Div. <i>Rum. 1 Mtn. Div.</i> 73. Inf. Div. 9. Inf. Div.	<b>XI. Flieger Korps</b> 1. Fs-Jg. Div. 2. Fs-Jg. Div. <b>LXXXVI. Res. Pz. Korps</b> <b>LXXVII. Res. Korps</b> <b>LXXVI. Res. Korps</b> <b>LXIV. Korps</b> <b>IV. Lw. Feld-Korps</b>	<b>7. Armee</b>	<b>LXXXIV. Korps</b>	716. Inf. Div. 709. Inf. Div. 319. Inf. Div.			
		<b>I. Korps</b>	13. Lw.Feld-Div. 227. Inf. Div.				<b>XXXIV. Korps</b>		97. Jg. Div. 70. Inf. Div. 101. Jg. Div. <i>Rum. 19 Inf. Div.</i> 79. Inf. Div. <i>Rum. 10 Inf. Div.</i> 98. Inf. Div. 125. Inf. Div.		<b>LXXXVII. Korps</b>	346. Inf. Div. 343. Inf. Div.				
		<b>XXVII. Korps</b>	96. Inf. Div. 61. Inf. Div. 81. Inf. Div. 12. Lw.Feld-Div. 225. Inf. Div. 132. Inf. Div.				<b>XXXXIX. Gebirgs-Korps</b>		370. Inf. Div. 50. Inf. Div. 125. Inf. Div. <i>Rum. 3 Mtn. Div.</i>		<b>XXV. Korps</b>	348. Inf. Div.				
		<b>XXVI. Korps</b>	212. Inf. Div. 1. Inf. Div. 11. Inf. Div. 69. Inf. Div. 290. Inf. Div. 23. Inf. Div. 5. Geb. Div.				<b>Befehlshaber rückwärtiges Heeresgebiet A</b>		<b>1. Armee</b>		<b>LXXX. Korps</b>	158. Res. Div. 708. Inf. Div.				
		<b>LIV. Korps</b>	21. Inf. Div. 24. Inf. Div. 254. Inf. Div. SS Polizei-Div. 58. Inf. Div.				<b>ARMY GROUP CENTER</b> Gr. Eisebeck 4. Pz. Div. 12. Pz. Div. 10. Pz-Gr. Div. 5. Pz. Div. 8.Pz. Div. 36. Inf. Div. 83. Inf. Div. 390. F.A.D. 391. F.A.D. 201. Sich. Div. <i>Hun 1 Lt. Div.</i>		<b>2. Armee</b>		<b>VII. Korps</b>	68. Inf. Div. 75. Inf. Div. 26. Inf. Div. 323. Inf. Div. 88. Inf. Div.	<b>LXXXVI. Korps</b>	334. Inf. Div. 14. Pz. Div. 10. SS-Div.	<b>LXXXVI. Korps</b>	344. Inf. Div.
		<b>L. Korps</b>	250. Inf. Div. 170. Inf. Div. 215. Inf. Div.								<b>XXIII. Korps</b>	327. Inf. Div. 340. Inf. Div. 377. Inf. Div. 82. Inf. Div.	<b>Armee-gruppe Felber</b>	<b>LXXXIII. Korps</b>	326. Inf. Div. 388. Inf. Div. 356. Inf. Div. 715. Inf. Div.	
	<b>III. Lw. Feldkorps</b>	9. Lw.Feld-Div. 10. Lw.Feld-Div.	<b>9. Armee</b>		<b>XX. Korps</b>	251. Inf. Div. 45. Inf. Div. 137. Inf. Div. 72. Inf. Div.				<b>Armeeniederlande</b>	<b>Befh. Kroatien</b>	100. Jg. Div. 114. Jg. Div. 118. Jg. Div. SS Eugen Div. 369. Inf. Div. 373. Inf. Div. 187. Res. Div.				
<b>Befehlshaber rückwärtiges Heeresgebiet Nord</b>			207. Sich. Div. 281. Sich. Div. 285. Sich. Div.	<b>XXXVI. Pz. Korps</b>	102. Inf. Div. 258. Inf. Div. Gr. Manteuffel 7. Inf. Div. 31. Inf. Div.	<b>Befh. Serbien</b>	297. Inf. Div. <i>Bulg. 7 Inf. Div.</i> <i>Bulg. 9 Inf. Div.</i> <i>Bulg. 21 Inf. Div.</i>	1. Geb. Div.								
<b>ARMY GROUP SOUTH</b> <i>Rum 24 Inf. Div.</i> 16. Pz-Gr. Div.	6. Armee	<b>XXIX. Korps</b>	111. Inf. Div. 15. Lw.Feld-Div. 17. Inf. Div. 336. Inf. Div.	<b>XXXVII. Pz. Korps</b>	20. Pz. Div. 2. Pz. Div. 6. Inf. Div. 9. Pz. Div.	<b>Befh. Saloniki-Ägäis</b>	11. Lw.Feld-Div. 104. Jg. Div.									
		<b>XVII. Korps</b>	294. Inf. Div. 306. Inf. Div. 302. Inf. Div.	<b>XXXXVII. Pz. Korps</b>	18. Pz. Div. 292. Inf. Div. 86. Inf. Div.	<b>Befh. Süd-griechenland</b>	1. Pz. Div. 117. Jg. Div.									
		<b>Gruppe Mieth (IV.)</b>	304. Inf. Div. 3. Geb. Div. 335. Inf. Div.	<b>XXXXI. Pz. Korps</b>	78. Sturm-Div. 216. Inf. Div. 383. Inf. Div.	<b>Festung Kreta</b>	Fest. Brig. Kreta 22. Inf. Div. (LL) <i>Ital. Sienna Div.</i>									
	1. Panzer-Armee	<b>XXX. Korps</b>	62. Inf. Div. 38. Inf. Div. 287. Inf. Div.	<b>XXXXV. Korps</b>	299. Inf. Div. 56. Inf. Div. 262. Inf. Div. 34. Inf. Div.	<b>Ob. Süd (Commando Supremo)</b>	<b>XIV. Pz. Korps</b>	Lw. HG Pz. Div. 16. Pz. Div. 29. Pz-Gr. Div. Brig. RF-SS 15. Pz. Div. 90. Pz-Gr. Div. 3. Pz-Gr. Div.								
		<b>XXXX. Pz. Korps</b>	333. Inf. Div. 46. Inf. Div. 257. Inf. Div.	<b>LIII. Korps</b>	208. Inf. Div. 25. Pz-Gr. Div. 211. Inf. Div. 293. Inf. Div.	<b>OKW Direct</b>	<b>XVIII. Geb. Korps</b>	SS Nord Div. 7. Geb. Div. 18. Geb. Pol. Rgt.								
		<b>LVII. Pz. Korps</b>	15. Inf. Div. 198. Inf. Div. 328. Inf. Div.	<b>LV. Korps</b>	134. Inf. Div. 110. Inf. Div. 296. Inf. Div. 339. Inf. Div.		<b>XXXVI. Geb. Korps</b>	169. Inf. Div. 163. Inf. Div.								
	<b>XXIV. Pz. Korps</b>	23. Pz. Div. 17. Pz. Div. SS W-Div.	<b>4. Armee</b>	<b>LVI. Pz. Korps</b>	131. Inf. Div. 14. Inf. Div. 321. Inf. Div.		<b>XIX. Geb. Korps</b>	2. Geb. Div. 388. Gren. Rgt. 6. Geb. Div. 139. Geb. Jg. Rgt. 210. Inf. Div. 503. Lw. Feld-Rgt. 193. Gren. Rgt.								
	Armee-abteilung Kempf	<b>XXXXII. Korps</b>	161. Inf. Div. 39. Inf. Div. 282. Inf. Div.	<b>XII. Korps</b>	267. Inf. Div. 260. Inf. Div. 268. Inf. Div.		<b>2. Panzer-Armee</b> 112. Inf. Div. 707. Inf. Div.	<b>Norwegen Armee (WB Norwegen)</b>	<b>LXXI. Korps</b>	230. Inf. Div. 270. Inf. Div. 199. Inf. Div.						
		<b>Gruppe Raus (XL)</b>	320. Inf. Div. 106. Inf. Div.	<b>IX. Korps</b>	342. Inf. Div. 252. Inf. Div. 35. Inf. Div.			<b>XXXIII. Korps</b>	14. Lw.Feld-Div. 702. Inf. Div. 181. Inf. Div.							
	<b>III. Pz. Korps</b>	7. Pz. Div. 19. Pz. Div. 6. Pz. Div. 168. Inf. Div.	<b>XXXXVIII. Pz. Korps</b>	167. Inf. Div. 11. Pz. Div. 3. Pz. Div. GD Pz-Gr. Div.	<b>XXXIX. Pz. Korps</b>			337. Inf. Div. 95. Inf. Div. 129. Inf. Div.	<b>LXX. Korps</b>	269. Inf. Div. 280. Inf. Div. 214. Inf. Div. 710. Inf. Div.						
4. Panzer-Armee	<b>II. SS-Pz. Korps</b>	SS T-Div. SS DR-Div. LSS AH-Div.	<b>LII. Korps</b>	246. Inf. Div. 197. Inf. Div. 256. Inf. Div. 52. Inf. Div.	<b>3. Panzer-Armee</b>		<b>Befh. Dänemark</b>	416. Inf. Div. 71. Inf. Div. 20. Lw.Feld-Div.								
	<b>XXXXVIII. Pz. Korps</b>	167. Inf. Div. 11. Pz. Div. 3. Pz. Div. GD Pz-Gr. Div.	<b>VI. Korps</b>	206. Inf. Div. 330. Inf. Div. 87. Inf. Div.	<b>II. Lw. Feldkorps</b>		<b>III. SS-Pz. Korps</b>	265. Inf. Div. 266. Inf. Div. 295. Inf. Div.								
	<b>LII. Korps</b>	332. Inf. Div. 255. Inf. Div. 57. Inf. Div.	<b>II. Lw. Feldkorps</b>	4. Lw.Feld-Div. 3. Lw.Feld-Div. 6. Lw.Feld-Div. 2. Lw.Feld-Div.	<b>LIX. Korps</b>		<b>WB Ukraine</b>	<b>LXII. Res. Kdo.</b>	143. Res. Div. 147. Res. Div.							
<b>Befehlshaber rückwärtiges Heeresgebiet Süd</b>			213. Sich. Div. 454. Sich. Div. 444. Sich. Div.	<b>XXXXIII. Korps</b>	20. Pz-Gr. Div. 205. Inf. Div.		<b>WB Ostland</b>	<b>LXI. Res. Kdo.</b>	141. Res. Div. 151. Res. Div.							
<b>Befehlshaber rückwärtiges Heeresgebiet Mitte</b>			286. Sich. Div. 221. Sich. Div. 203. Sich. Div.	<b>Befehlshaber rückwärtiges Heeresgebiet Mitte</b>		<b>VIIIth Hungarian Corps</b>	<i>Hun. 18 Lt. Div.</i> <i>Hun. 21 Lt. Div.</i> <i>Hun. 24 Lt. Div.</i> <i>Hun. 25 Lt. Div.</i>									
						<b>VIIIth Hungarian Corps</b>	<i>Hun. 2 Lt. Div.</i> <i>Hun. 5 Lt. Div.</i> <i>Hun. 8 Lt. Div.</i> <i>Hun. 201 Lt. Div.</i>									

The mid-1943 Panzer Division, including all changes and amendments, as authorized up to 30.06.1943. This is the ideal maximum strength, which was not achieved by any division.

1.07.1943

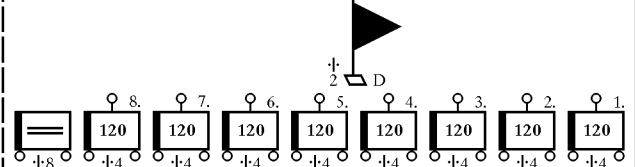
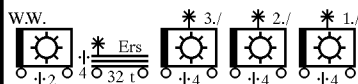
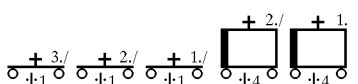
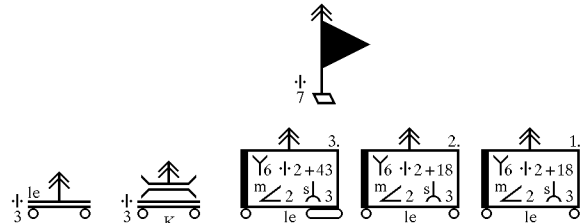
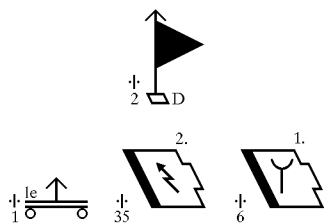
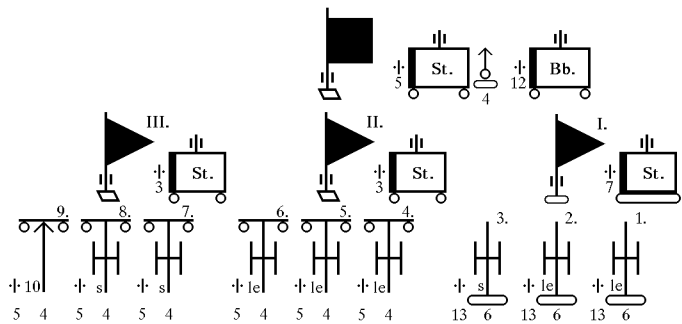
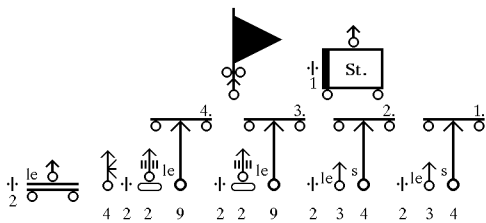
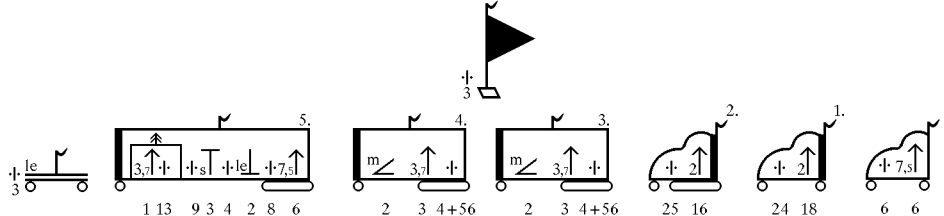
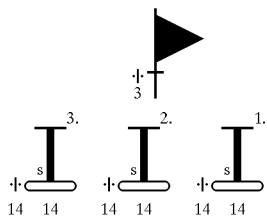
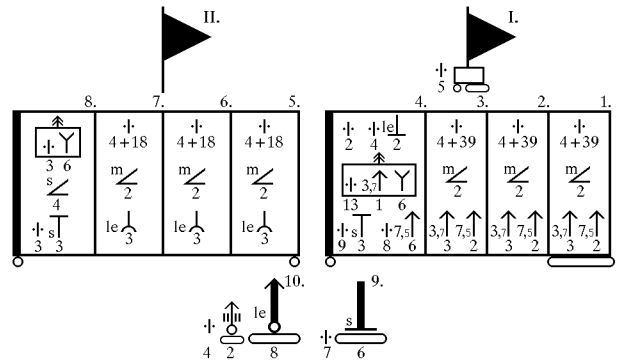
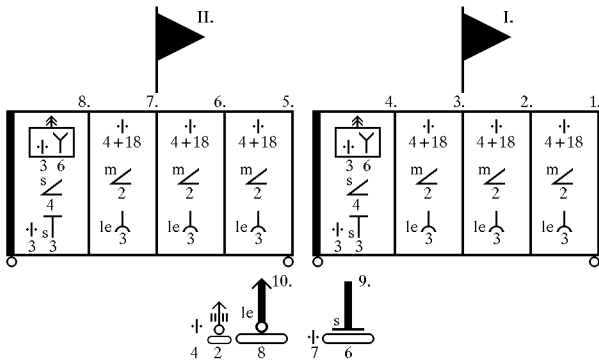
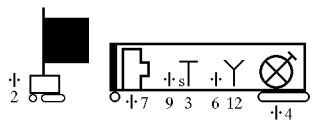
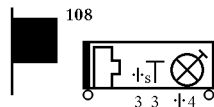
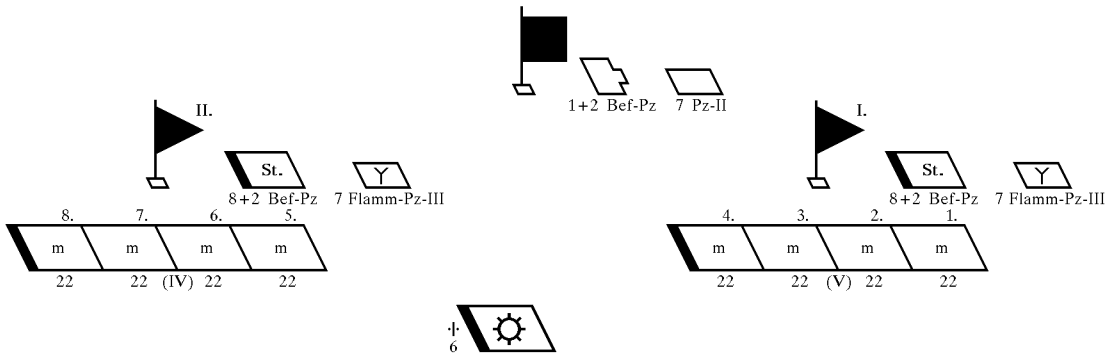
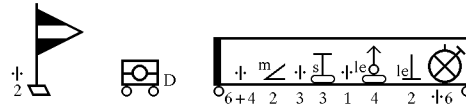

The mid-1943 Panzer-Grenadier Division, including all changes and amendments, as authorized up to 30.06.1943. This is the ideal maximum strength, which was not achieved by any division.

1.07.1943

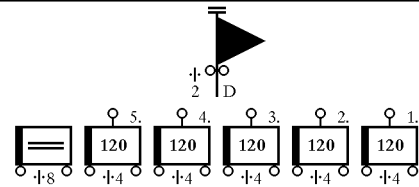
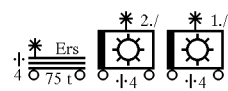
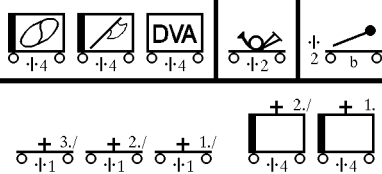
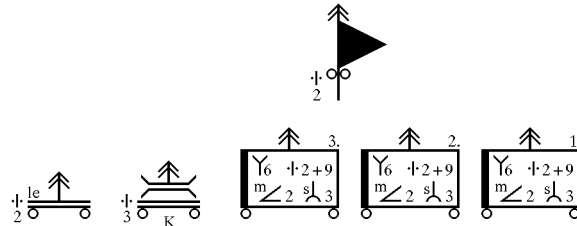
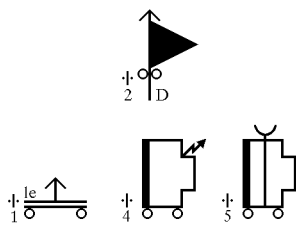
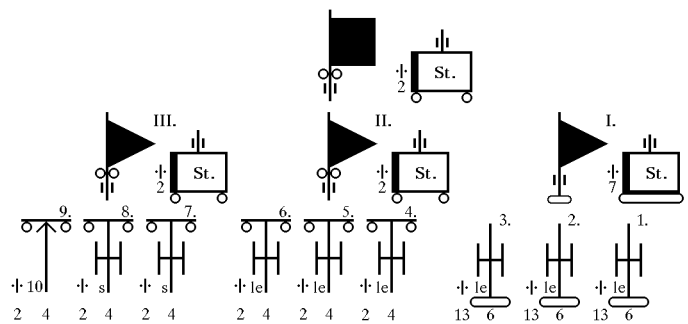
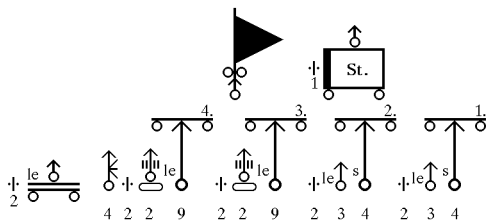
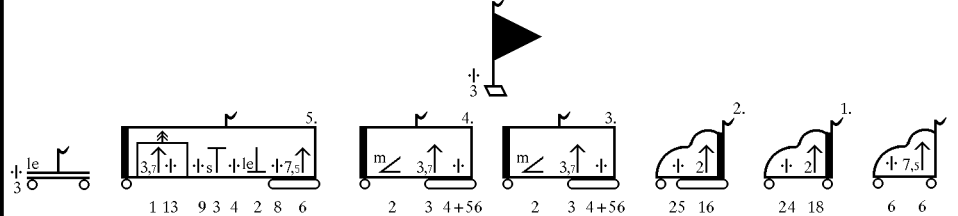
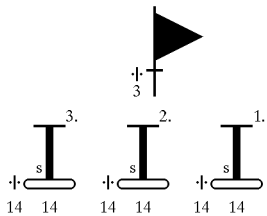
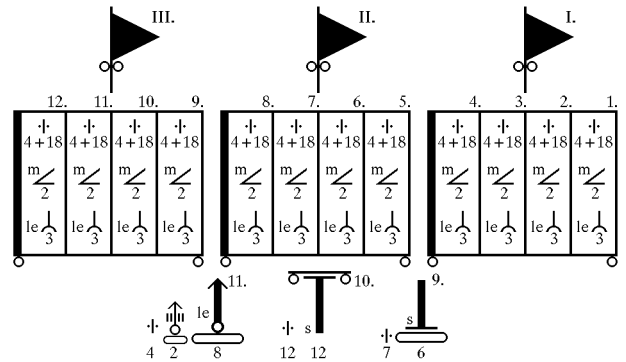
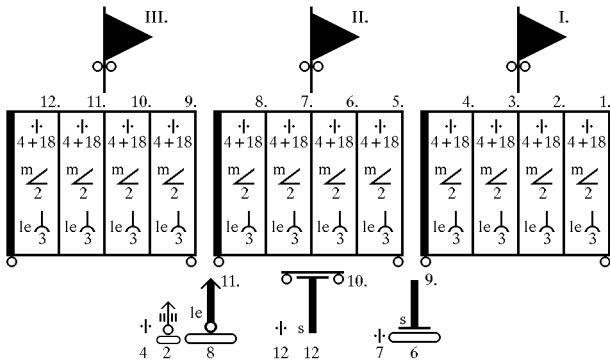
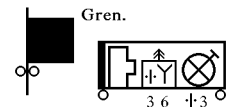
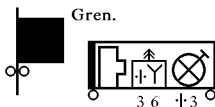
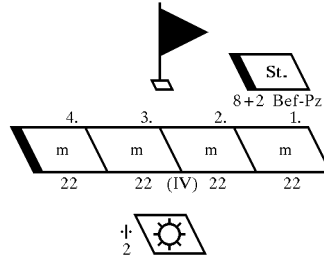
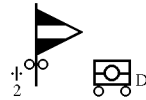

1.07.1943

 Non-standard, ad-hoc unit raised by the division. It was reported, but not counted as part of the normal establishment.

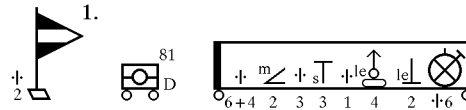

**I. Panzer Regiment tank strength:**  
 Rgt. Hqs: 2 BeF-Pz-IV+3 Pz-IV(lg)  
 Bn. Hqs: 2 BeF-Pz-IV+5 Pz-IV(lg)+7 Flamm-Pz-III  
 5. Co.: 14 Pz-IV(lg)  
 6. Co.: 14 Pz-IV(lg)  
 7. Co.: 14 Pz-IV(lg)  
 8. Co.: 14 Pz-IV(lg)

The I./I. Panzer-Regiment had not been assigned to the I. Panzer-Division since 5.03.1943. It was at Grafenwöhr Training Grounds in Germany converting to Pz-V Panzer tanks. On 11.07.1943 it was ordered to reconvert to medium Panzer-IV tanks.

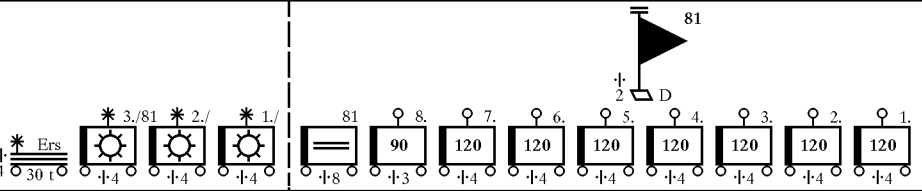
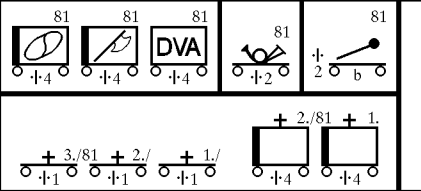
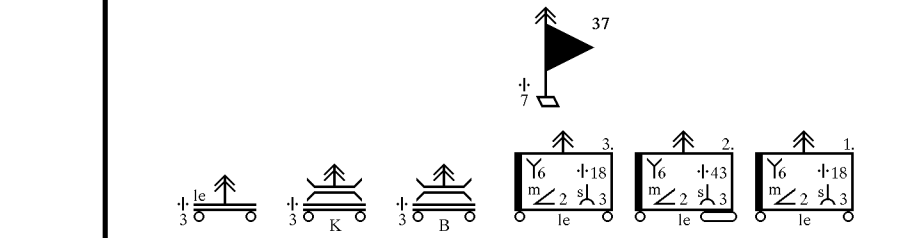
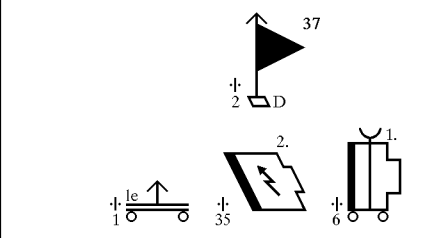
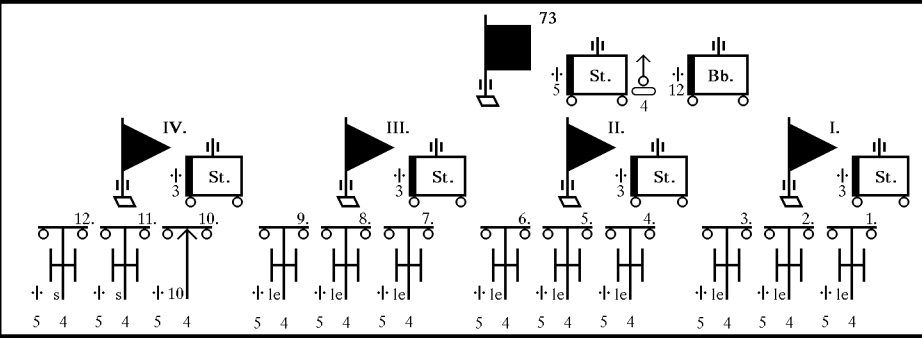
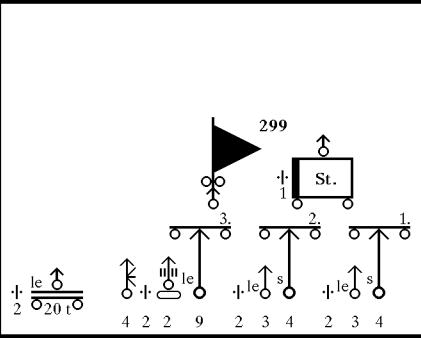
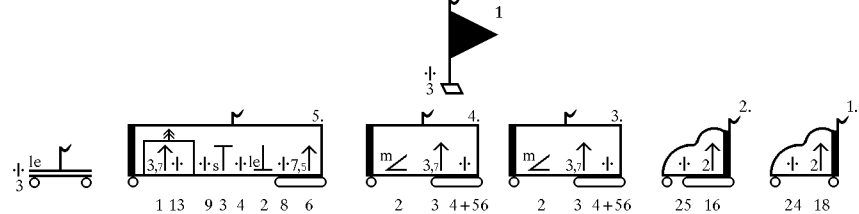
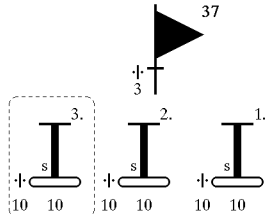
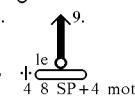
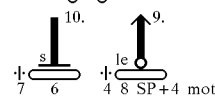
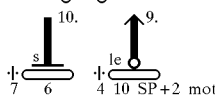
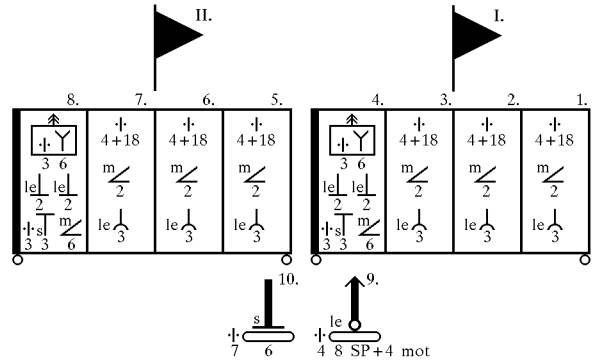
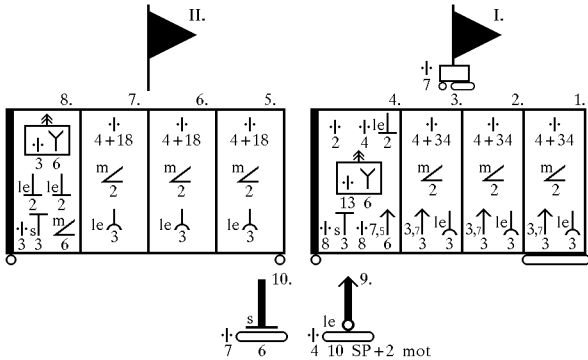
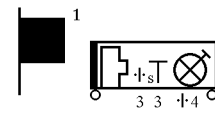
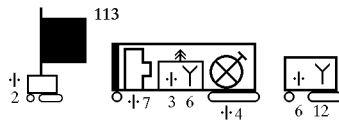
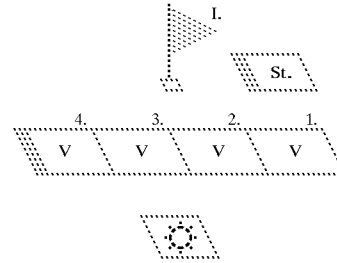
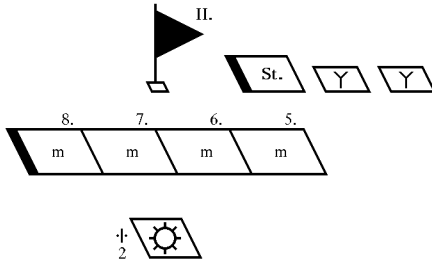



1.07.1943

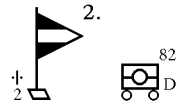

**3. Panzer Regiment tank strength:**

- Rgt. Hqs: 2 Bef-Pz-III+5 Pz-III(kz)
- Bn. Hqs: 3 Bef-Pz-III+5 Pz-III(75)+1 Pz-II
- 5. Co.: 16 Pz-IV(lg)+3 Pz-III(lg)+4 Pz-III(75)
- 6. Co.: 16 Pz-IV(lg)+3 Pz-III(lg)+3 Pz-III(75)
- 7. Co.: 15 Pz-IV(lg)+3 Pz-III(lg)+4 Pz-III(75)
- 8. Co.: 15 Pz-IV(lg)+3 Pz-III(lg)+4 Pz-III(75)

The I/3. Panzer-Regiment had not been assigned to the 2. Panzer Division since May 1943. It was at Mailly-le-Camp Training Grounds in France converting to Pz-V Panzer tanks.

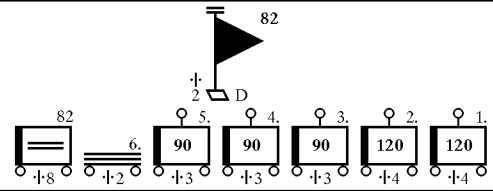
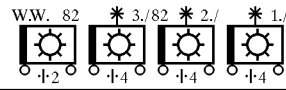
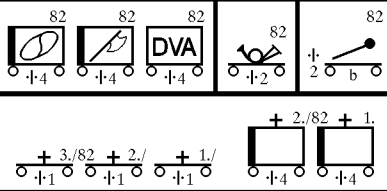
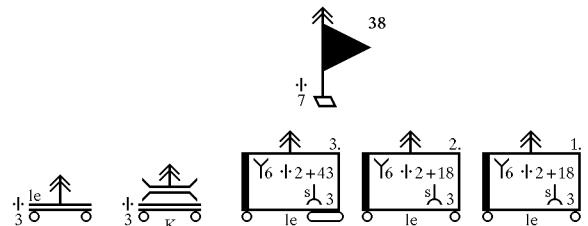
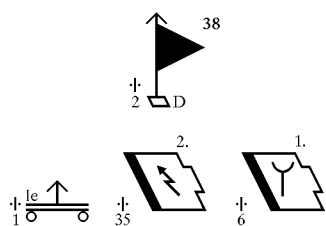
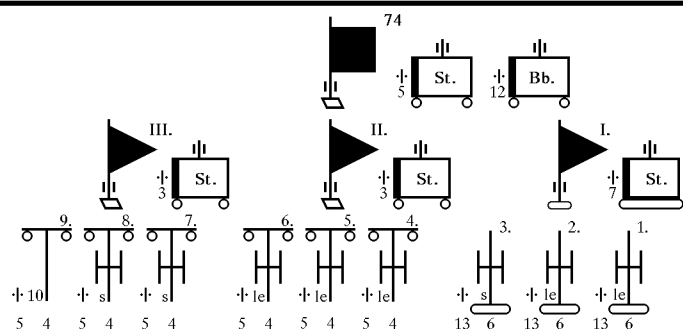
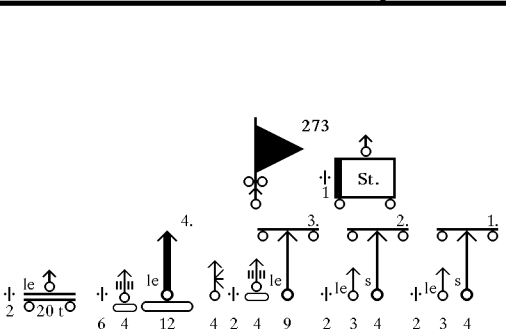
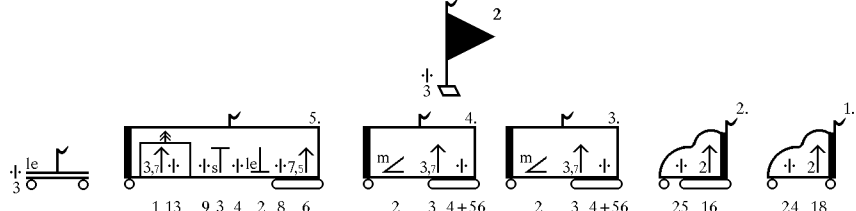
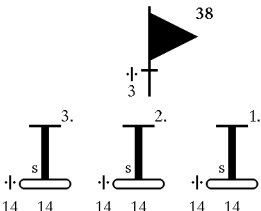
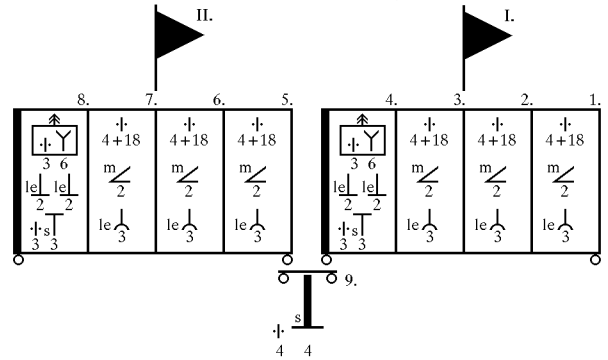
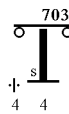
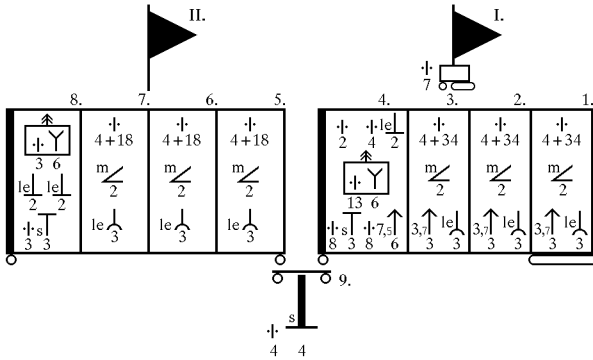
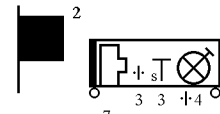
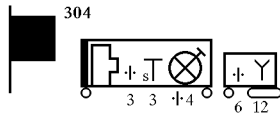
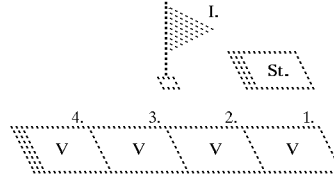
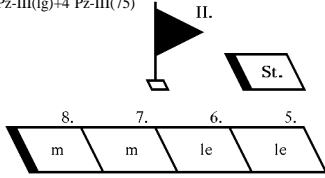

1.07.1943

3.

6

II. St.

I. St.

8. 7. 5.

m le le

4. 2. 1.

m le le

6

394

3

II.

I.

8. 7. 6. 5.

4+18 4+18 4+18

4. 3. 2. 1.

4+18 4+18 4+18

8. 7. 6. 5.

4+18 4+18 4+18

4. 3. 2. 1.

4+18 4+34 4+34

10.

9.

le s

4 12 4 4

543

2.

1.

s s

14 14 12 12

3

5.

4.

3.

2.

1.

le m s le le le

le le m s

le le m s

m s

24 18

314

4.

3.

2.

1.

le s

le s

le s

4 2 8 4 2 2 9 2 3 4 2 3 4

75

III.

II.

I.

9.

8.

7.

6.

5.

4.

3.

2.

1.

s le le

s le le

s le le

10.

le le le

5 4 5 4 5 4 5 4 5 4 5 4 5 4 5 4 5 4 5 4

39

2.

1.

le

s

1 35 6

39

3.

2.

1.

le

le

le

3 3 3

3 3 3

3 3 3

83

83

83

83

83

2./83

1.

3./83 2./ 1./

4 4

83

5.

4.

3.

2.

1.

6.

120 120 90 90 90

8 4 4 3 3 3

Non-standard, ad-hoc unit raised by the division. It was reported, but not counted as part of the normal establishment.

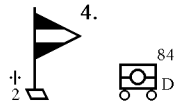

**I./35. Panzer Battalion tank strength:**

- Bn. Hqs: 2 Bef-Pz-III+6Pz-IV(lg)+1 Pz-IV(kz)
- 1. Co.: 17 Pz-IV(lg)+5 Pz-III(75)
- 2. Co.: 17 Pz-IV(lg)+5 Pz-III(75)
- 3. Co.: 17 Pz-IV(lg)+5 Pz-III(75)
- 4. Co.: 22 Pz-IV(lg)

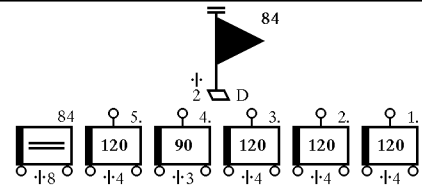
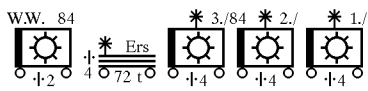
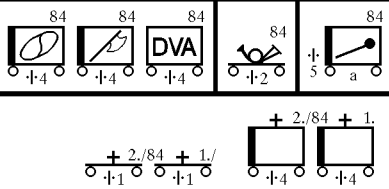
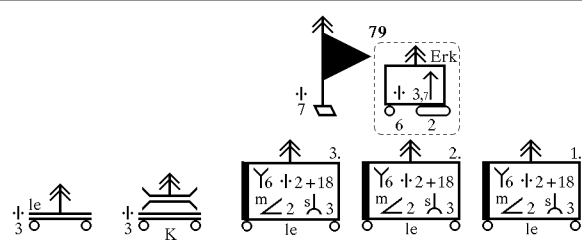
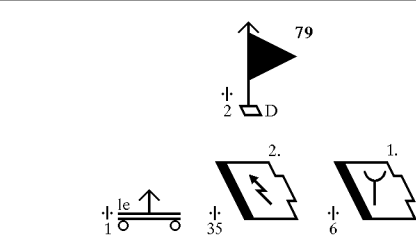
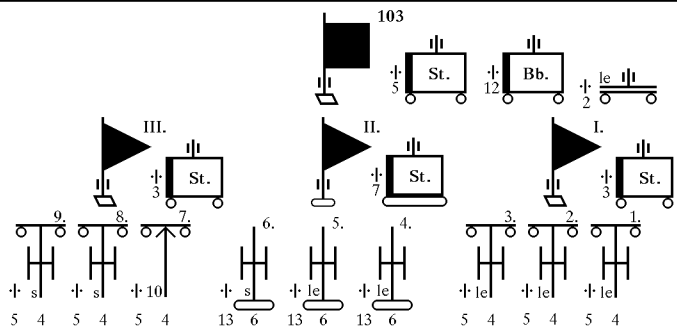
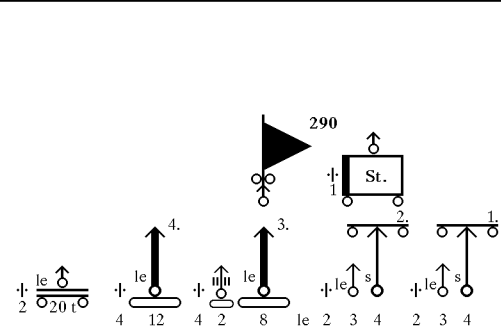
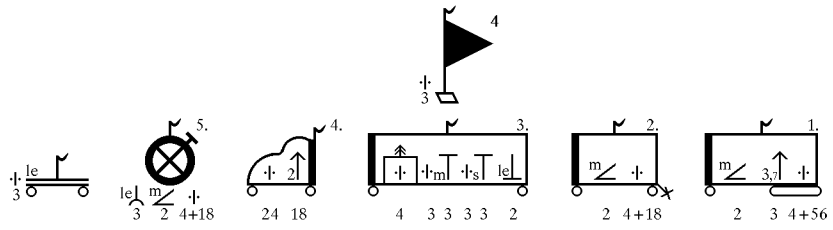
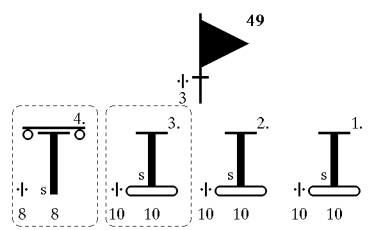
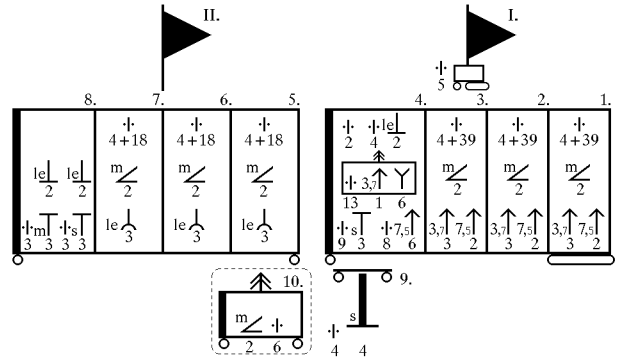
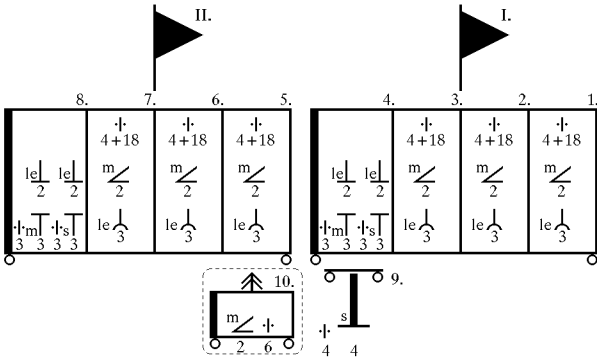
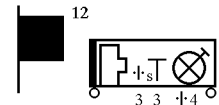
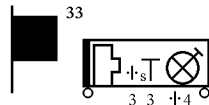
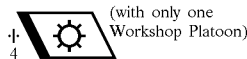
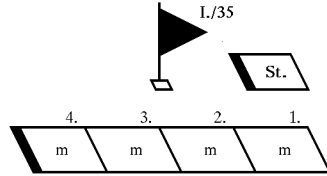

1.07.1943

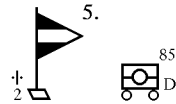

**31. Panzer Regiment tank strength:**

- Rgt. Hqs: 2 Bef-Pz-IV+6 Pz-IV(lg)
- Bn. Hqs: 2 Bef-Pz-IV+6 Pz-IV(lg)
- 5. Co.: 16 Pz-IV(lg)+4 Pz-IV(kz)
- 6. Co.: 16 Pz-IV(lg)+4 Pz-IV(kz)
- 7. Co.: 16 Pz-IV(lg)+4 Pz-IV(kz)
- 8. Co.: 16 Pz-IV(lg)+5 Pz-IV(kz)

The I/31. Panzer-Regiment had not been assigned to the 5. Panzer Division since 5.05.1943. It was in Wehrkreis VIII, Germany converting to Pz-V Panzer.

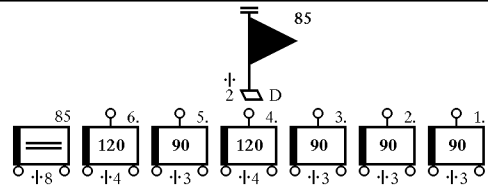
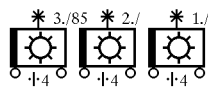
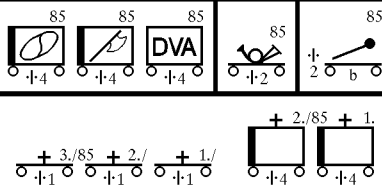
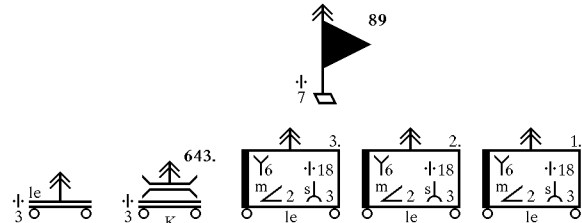
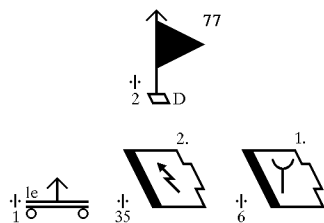
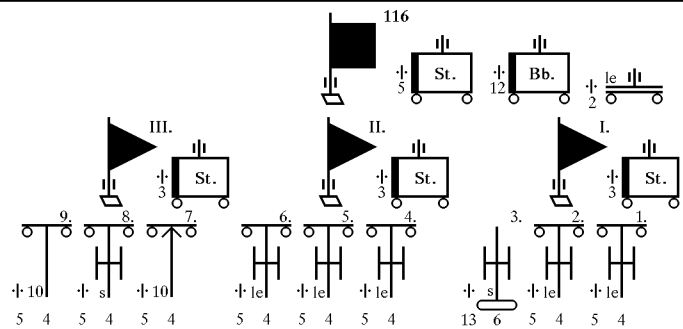
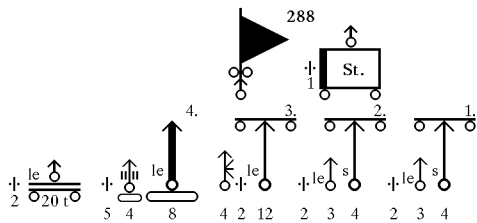
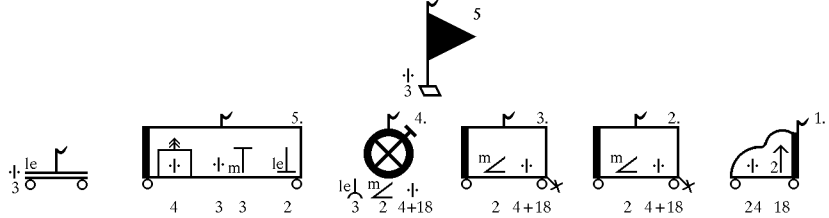
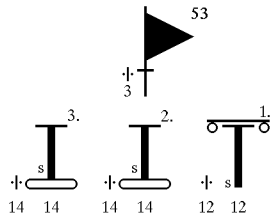
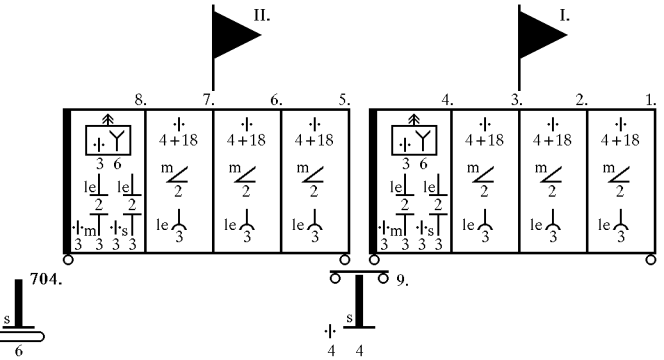
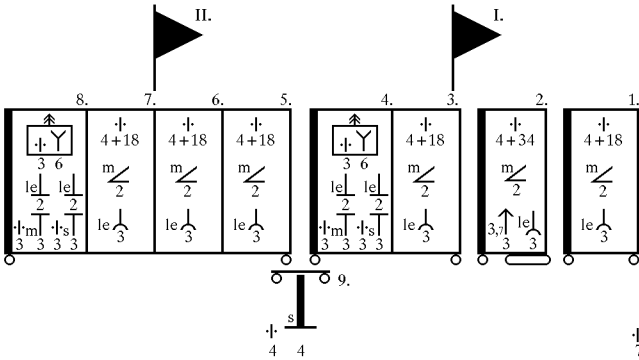
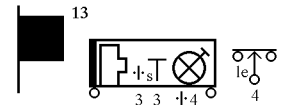
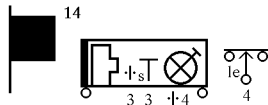
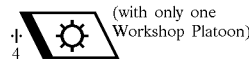
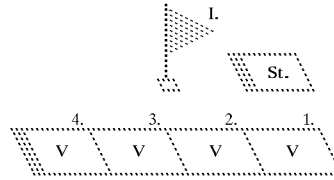
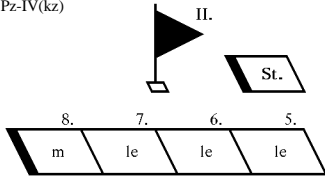

1.07.1943

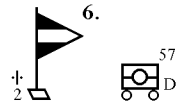

**II. Panzer Regiment tank strength:**

- Rgt. Hqs: 1 Bef-Pz-III+1 Pz-III(75)+6 Pz-II
- Bn. Hqs: 2 Bef-Pz-III+1 Pz-III(75)+7 Pz-II+14 Flamm-Pz-III
- 5. Co.: 8 Pz-IV(lg)+10 Pz-III(lg)+4 Pz-III(75)
- 6. Co.: 8 Pz-IV(lg)+8 Pz-III(lg)+4 Pz-III(75)
- 7. Co.: 8 Pz-IV(lg)+7 Pz-III(lg)+4 Pz-III(75)
- 8. Co.: 8 Pz-IV(lg)+9 Pz-III(lg)+4 Pz-III(75)

The I/11. Panzer-Regiment had not been assigned to the 6. Panzer Division since 5.05.1943. It was in Wehrkreis IX, Germany converting to Pz-V Panzer.

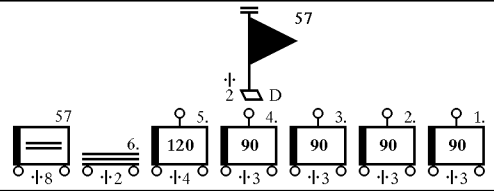
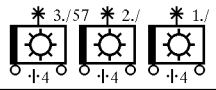
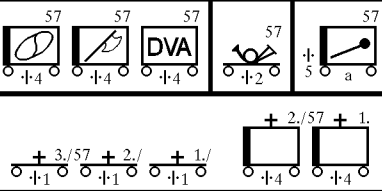
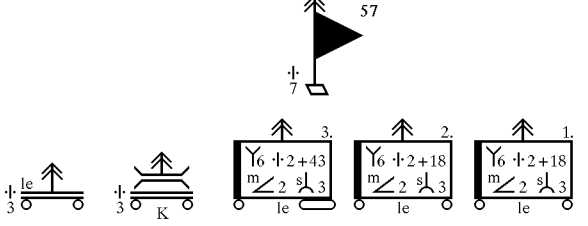
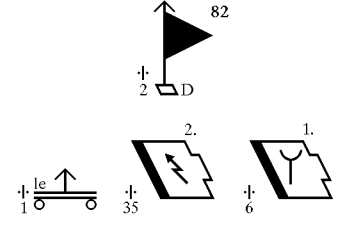
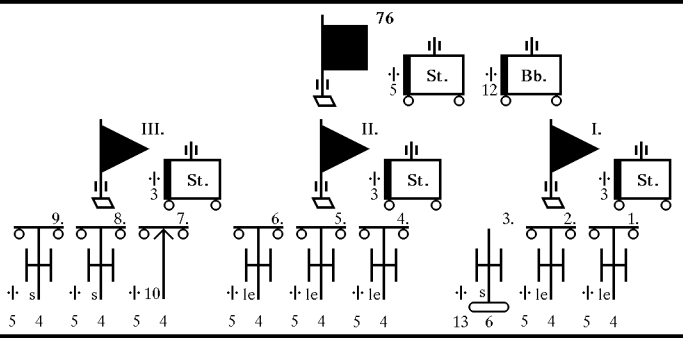
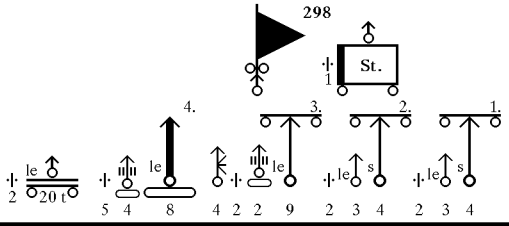
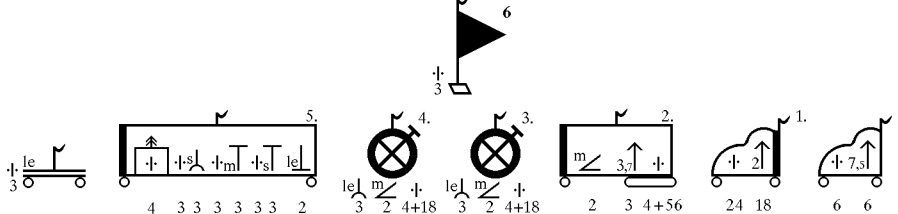
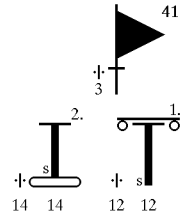
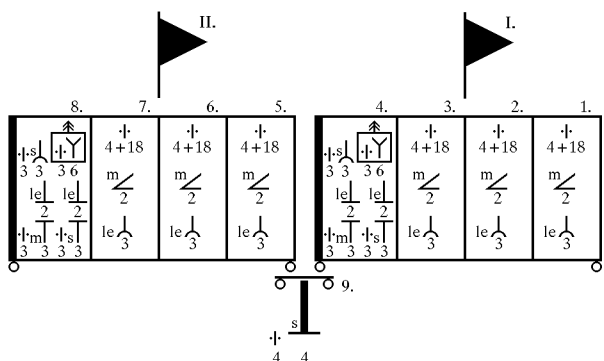
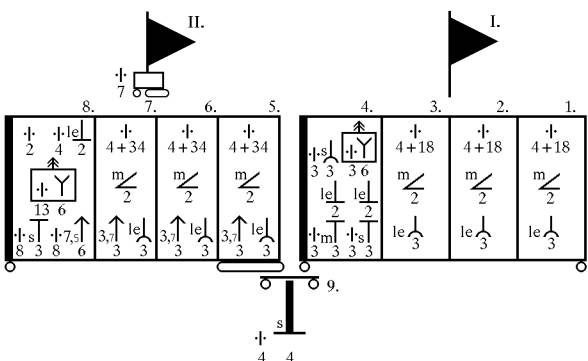
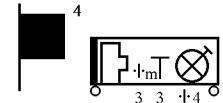
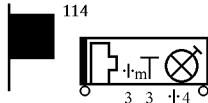
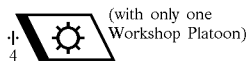
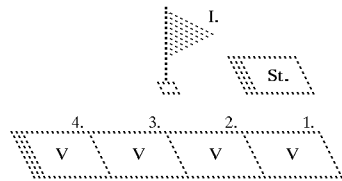
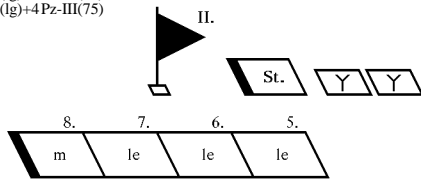

1.07.1943

25. Panzer Regiment tank strength:

- Rgt. Hqs: 3 Bef-Pz-III+4 Pz-II
- I. Bn. Hqs: 2 Bef-Pz-III+4 Pz-II
- 1. Co.: 2 Pz-IV+13 Pz-III
- 2. Co.: 2 Pz-IV+14 Pz-III
- 3. Co.: 15 Pz-IV
- II. Bn. Hqs: 2 Bef-Pz-III+4 Pz-II
- 4. Co.: 2 Pz-IV+14 Pz-III
- 5. Co.: 2 Pz-IV+14 Pz-III
- 6. Co.: 15 Pz-IV

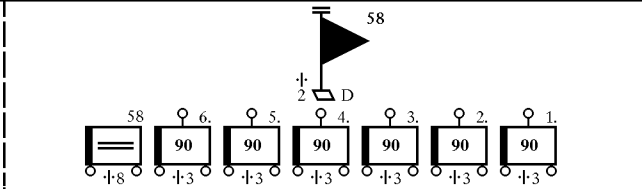
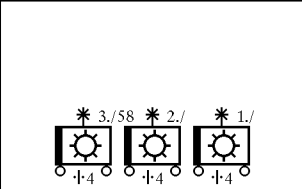
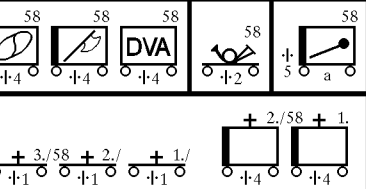
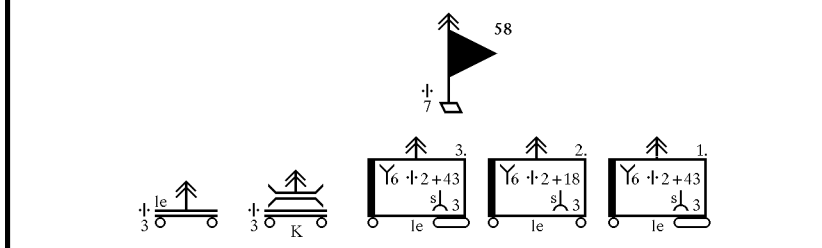
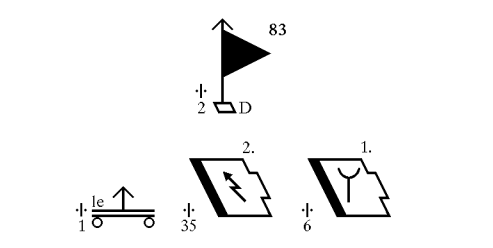
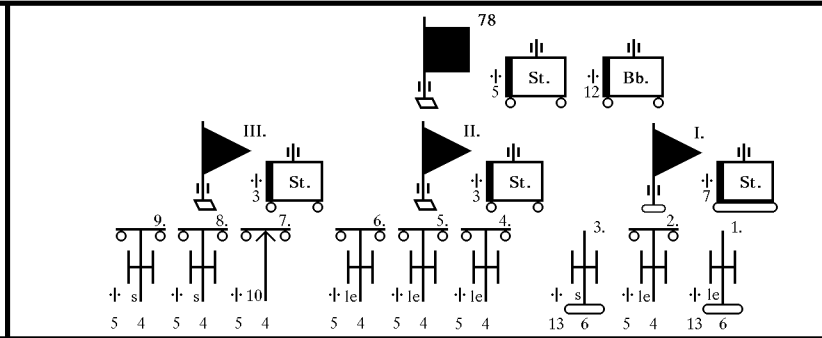
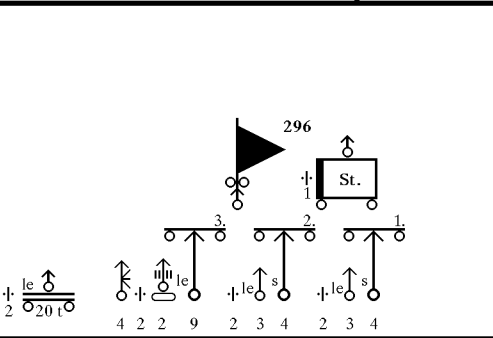
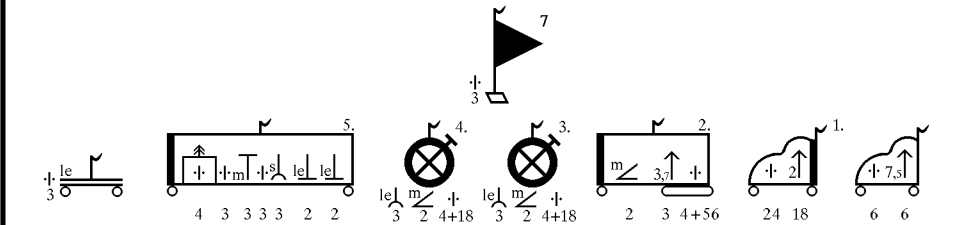
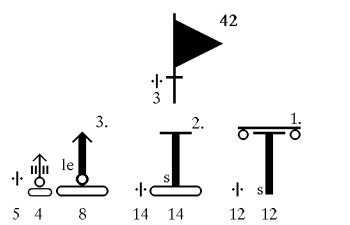
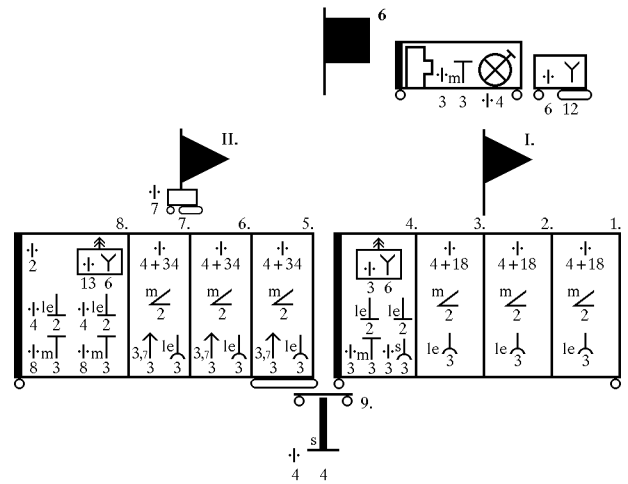
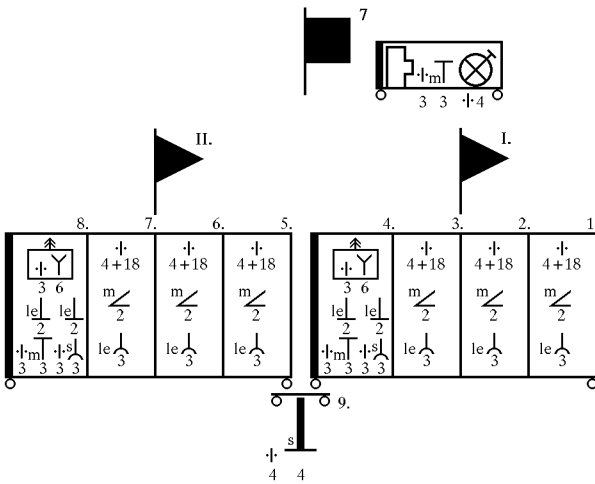
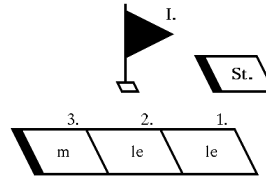
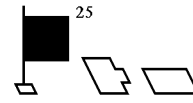
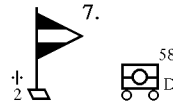
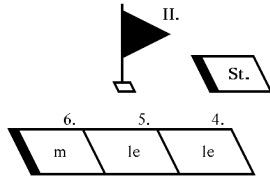

1.07.1943

Non-standard, ad-hoc unit raised by the division. It was reported, but not counted as part of the normal establishment.

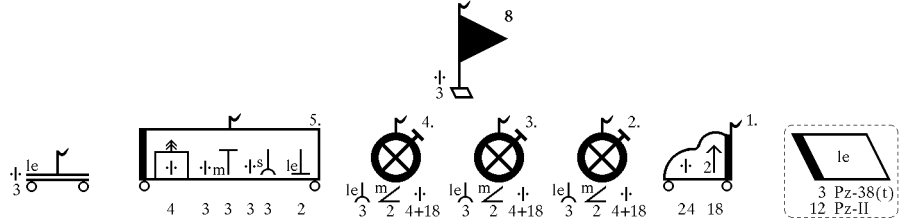
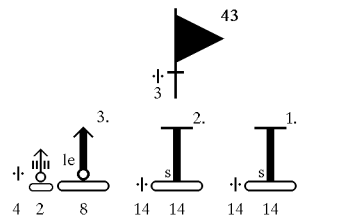
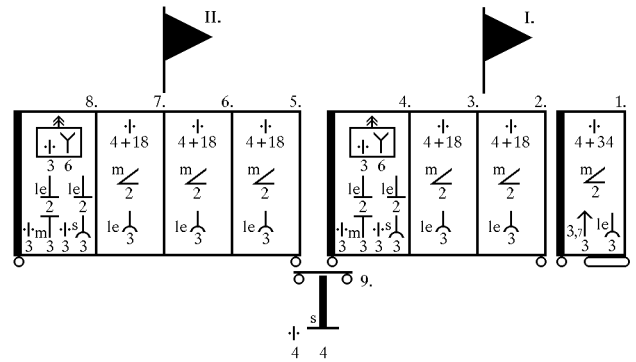
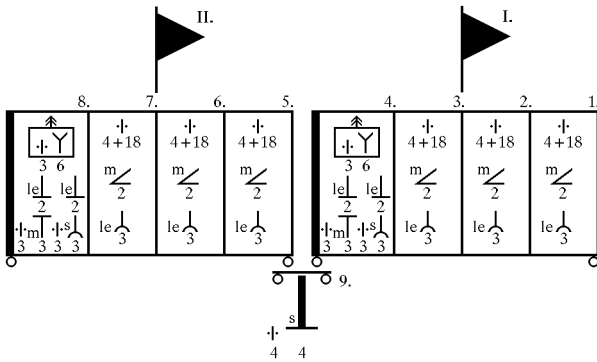
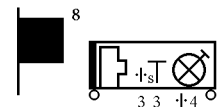
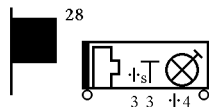
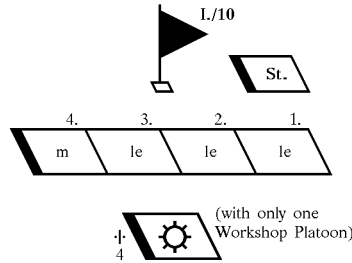
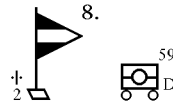

The 286. Heeres-Flak-Abteilung was en-route to the 8. Panzer Division on this date.

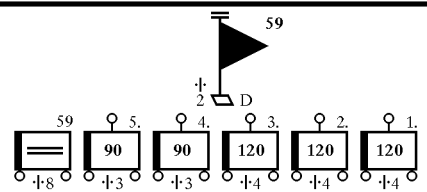
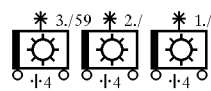
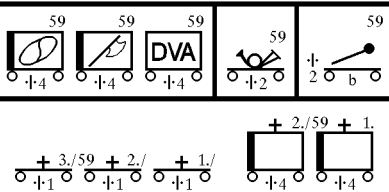
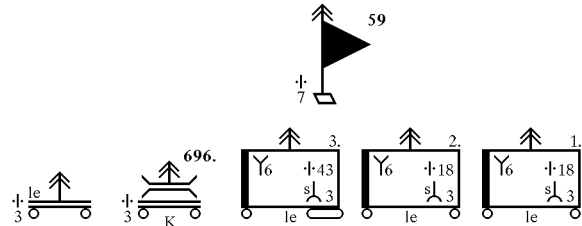
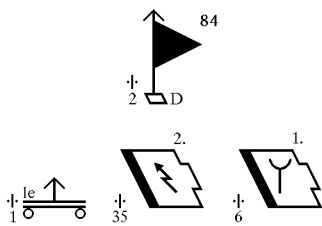
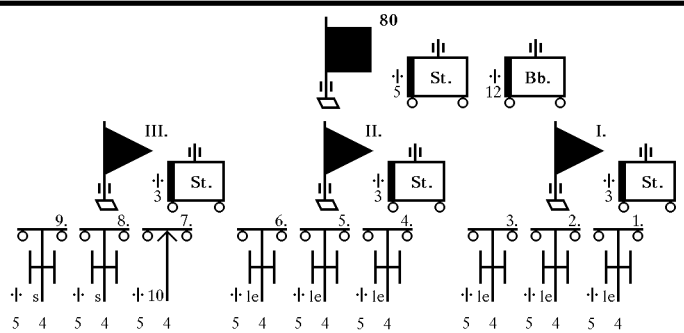
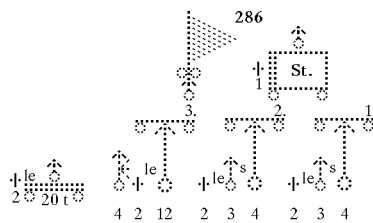

1.07.1943

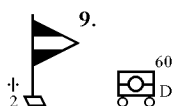

The II./33. Panzer-Regiment was not assigned to the 9. Panzer Division on this date. It operated as the 51. Panzer-Abteilung from 13.01.1943 through 3.01.1944 with Pz-V Panther.

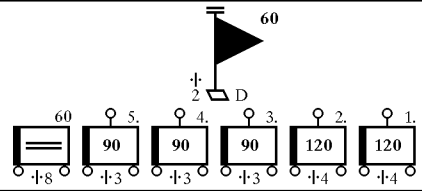
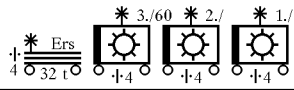
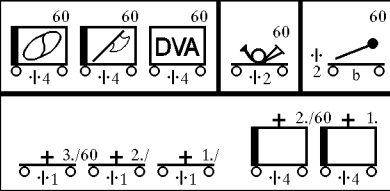
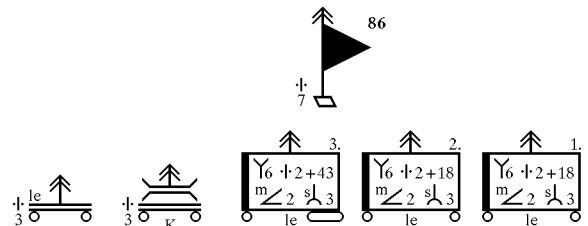
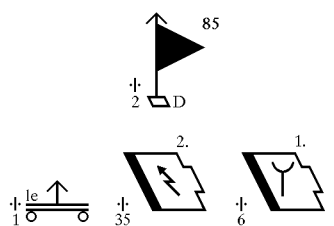
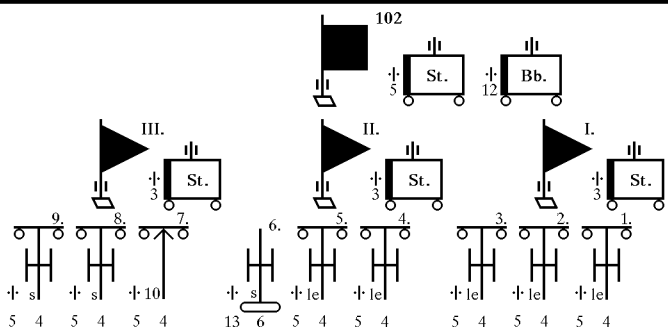
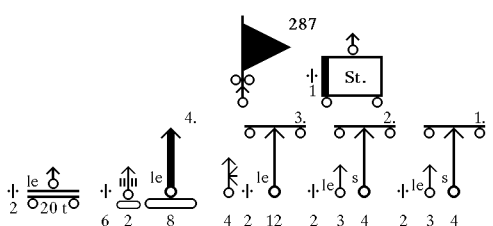
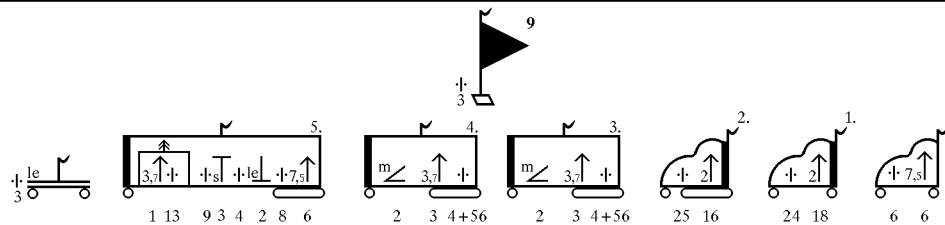
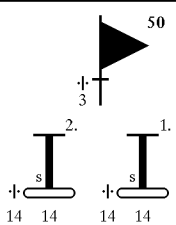
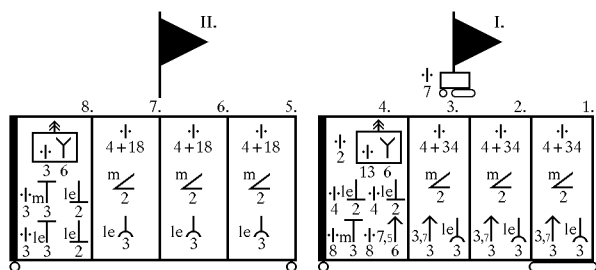
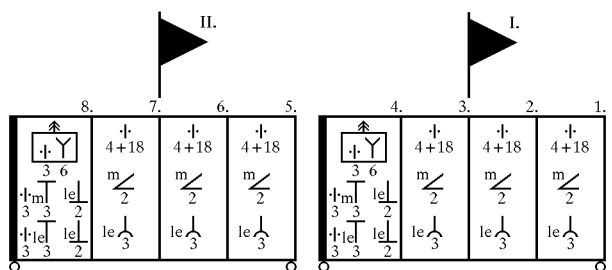
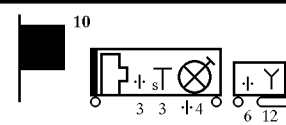
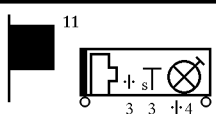
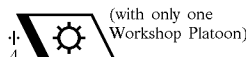
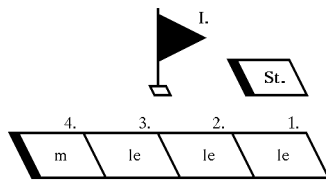
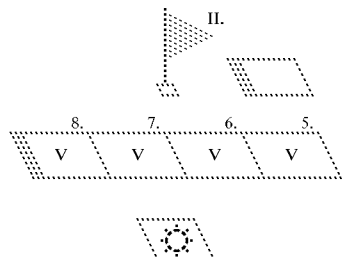
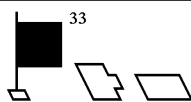



Non-standard, ad-hoc unit raised by the division. It was reported, but not counted as part of the normal establishment.

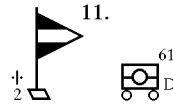

15. Panzer Regiment tank strength:

- Rgt. Hqs: 2 Bef-Pz-III+1 Pz-III(lg)+5 Pz-III(kz)
- II. Bn. Hqs: 1 Bef-Pz-III+1 Pz-III(lg)+3 Pz-III(kz)+3 Pz-II+7 Flamm-Pz-III
- 4. Co.: 12 Pz-III(lg)
- 5. Co.: 12 Pz-III(lg)
- 6. Co.: 13 Pz-IV(lg)+1 Pz-IV(kz)
- III. Bn. Hqs: 1 Bef-Pz-III+1 Pz-III(lg)+4 Pz-III(kz)+3 Pz-II+6 Flamm-Pz-III
- 7. Co.: 12 Pz-III(lg)
- 8. Co.: 12 Pz-III(lg)
- 9. Co.: 12 Pz-IV(lg)

The I./15. Panzer-Regiment was not assigned to the 11. Panzer Division on this date. It operated as the 52. Panzer-Abteilung from 16.02.1943 through 24.08.1943 with Pz-V Panther.

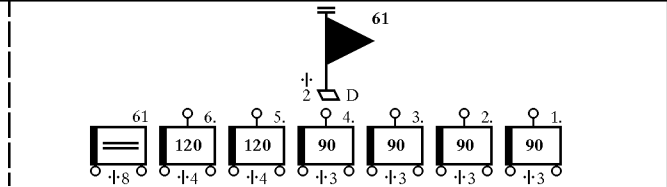
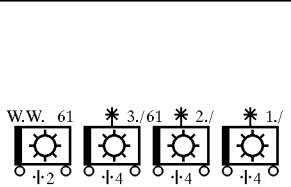
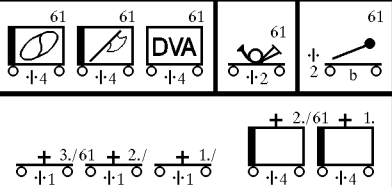
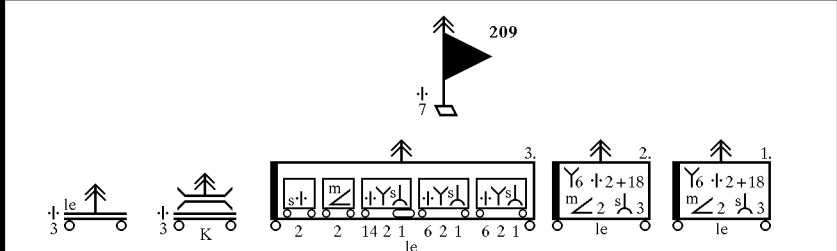
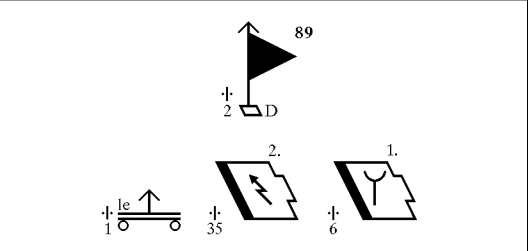
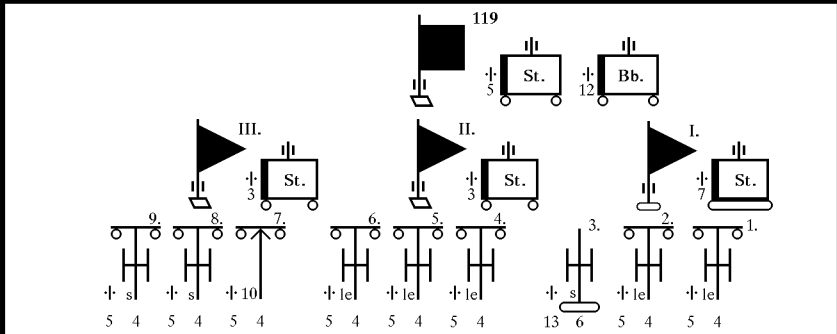
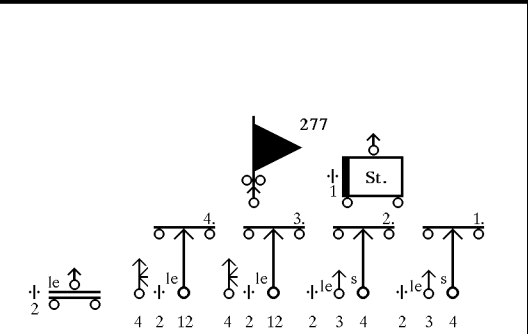
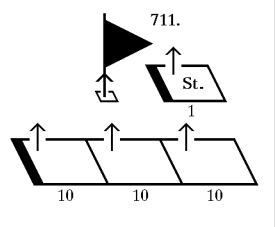
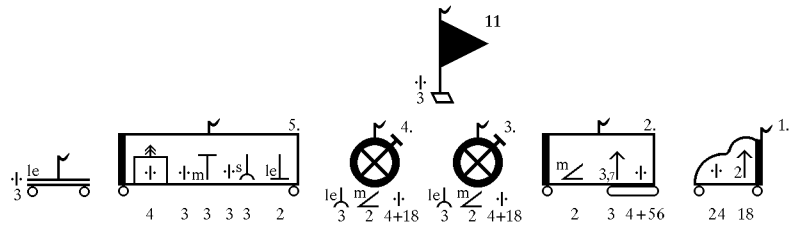
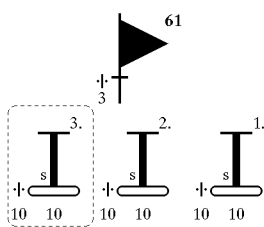
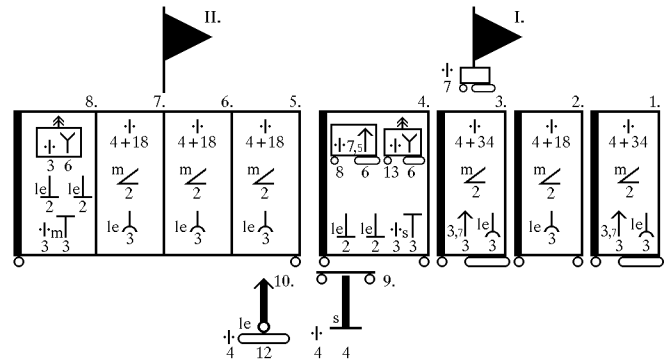
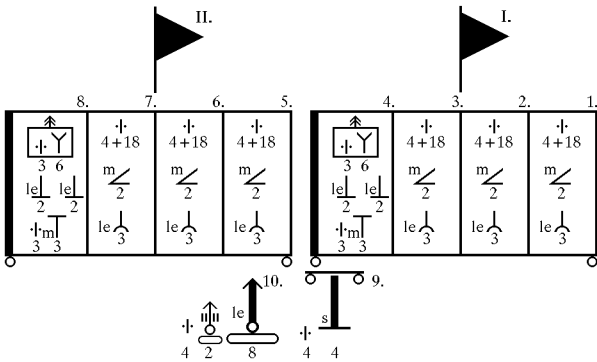
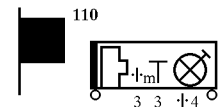
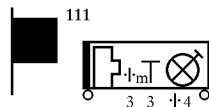
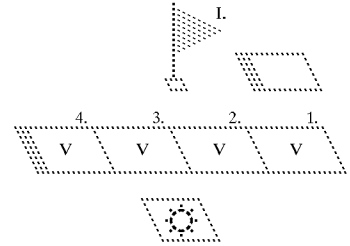
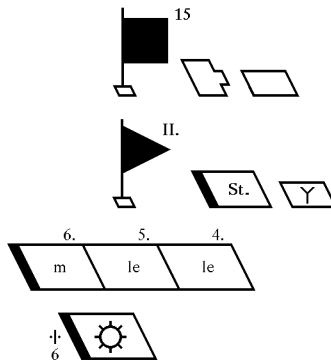
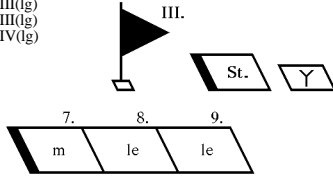

1.07.1943

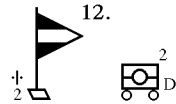

The I./29. Panzer-Regiment was not assigned to the 12. Panzer Division on this date. On 11.05.1943 it had been designated as the 508. Panzer-Abteilung (Tiger). But on 8.07.1943 it was again redesignated as I./29, and began training with Pz-V Panther at Putlos, Germany.

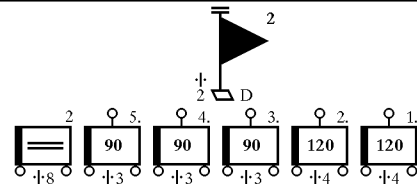
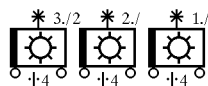
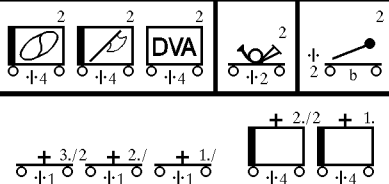
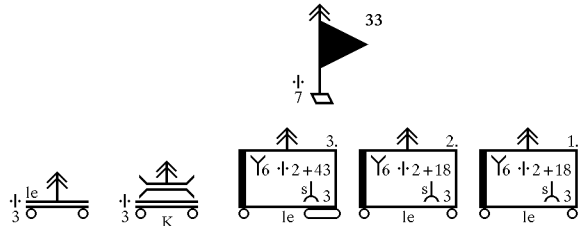
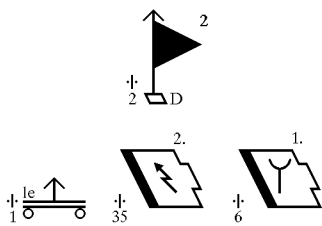
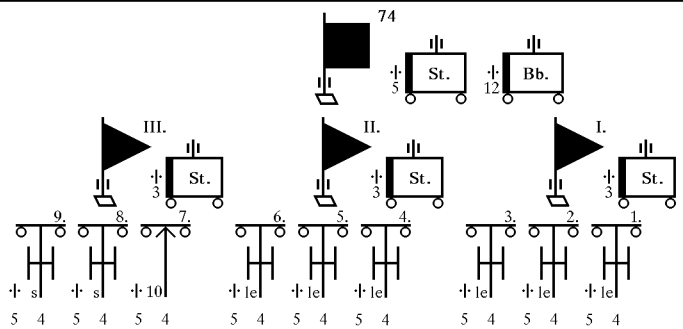
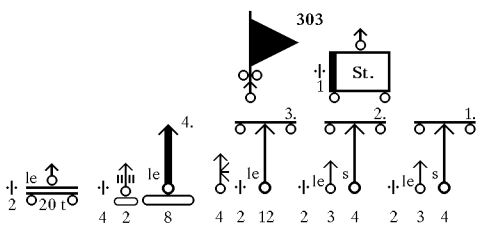
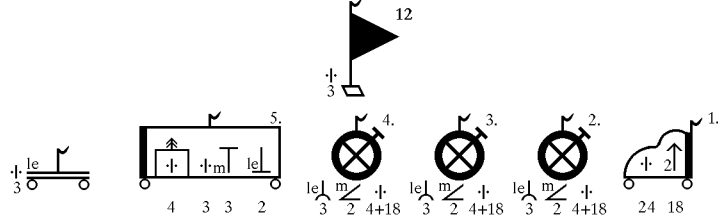
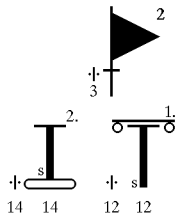
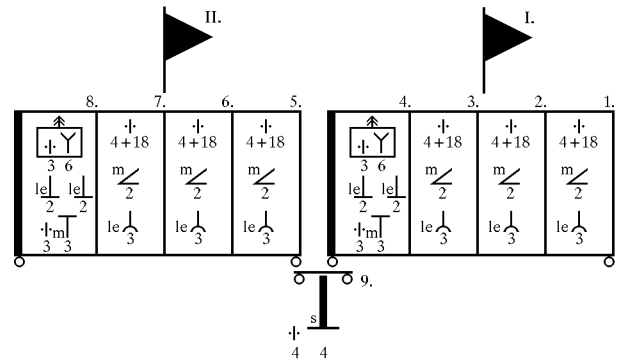
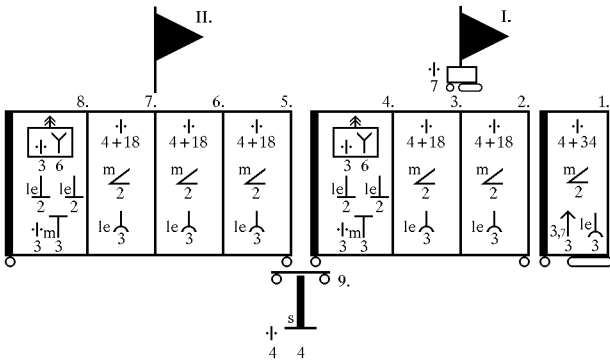
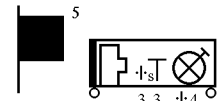
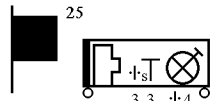
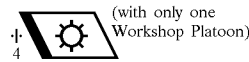
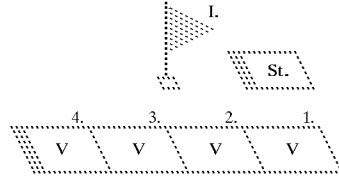
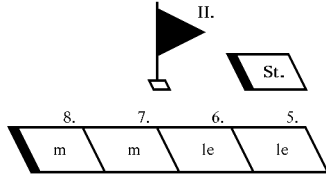

The 13. Panzer Division was still very much under strength after severe fighting on the Crimea. This is the proposed organization dated 30.06.1943, taking into consideration personnel, equipment and vehicles the division had been advised were en-route to it. But this organization had still not yet been achieved by August 1943.

30.06.1943

The units that were in existence on 30.06.1943 were:

**Kampfgruppe von Gaza:** (Crimea)

- 1./66. Headquarters, Armored Panzerregiment Battalion
- 1./13. Armored Car Company
- 2./13. Armored Light Reconnaissance Company
- 4./13. Motorcycle Reconnaissance Company
- 2./13. Motorized Combat Engineer Company
- 9./66. Motorized Infantry Gun Company
- II./13. Panzer Artillery Battalion (with 4., 5., & 8. Batteries)
- 1./4. Panzer Company
- 2./4. Panzer Company
- 1./13. Self-Propelled Panzerjäger Company
- 2./13. Motorized Ambulance Platoon

**Kampfgruppe Barth:** (Kuban Bridgehead)

- 93. Hqs. & Hqs. Company, Panzerregiment Regiment
- 1./93. Motorized Panzerregiment Battalion
- 9./93. Motorized Infantry Gun Company
- 10./93. Self-Propelled AA Company
- 3./4. Panzer Company
- 4./4. Panzer Company
- 2./13. Self-Propelled Panzerjäger Company

**Kampfgruppe Steinberg:** (Taman Peninsula)

- II./66. Panzerregiment Battalion
- 3./13. Self-Propelled Panzerjäger Company

**4. Panzer Regiment tank strength:**

- Rgt. Hqs: -
- Bn. Hqs: 2 Bef-Pz+5 Pz-II
- 5. Co.: 20Pz-IV(lg)
- 6. Co.: 2Pz-IV(lg)+10Pz-III(lg)+4Pz-III(kz)
- 7. Co.: 14Pz-IV(lg)
- 8. Co.: 14Pz-IV(lg)

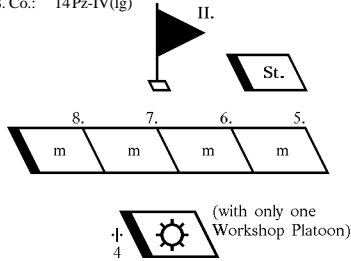

The I./4. Panzer-Regiment had not been assigned to the 13. Panzer Division since 5.05.1943. It was in France converting to Pz-V Panther.

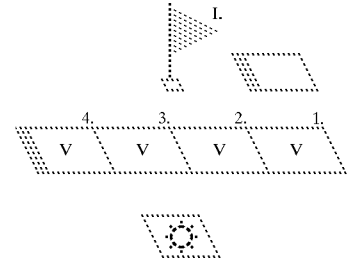

Full motorization of the II./66 and I./93. Panzerregiment Battalions was possible by using vehicles from the Motor Transport Companies.

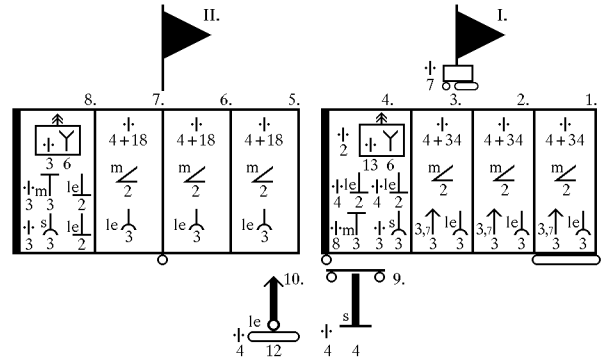
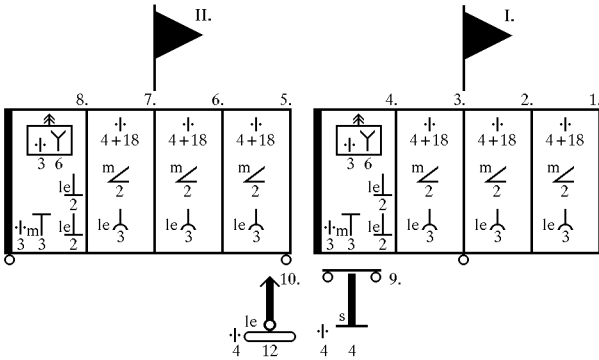
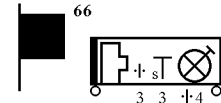
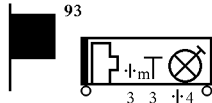

The 3./13 was a non-standard, ad-hoc unit raised by the division. It was reported, but not counted as part of the normal establishment.

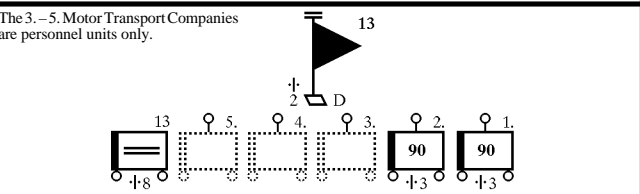
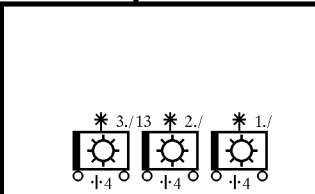
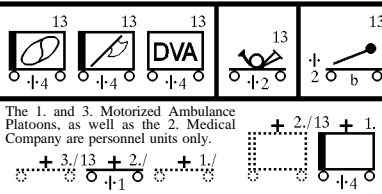
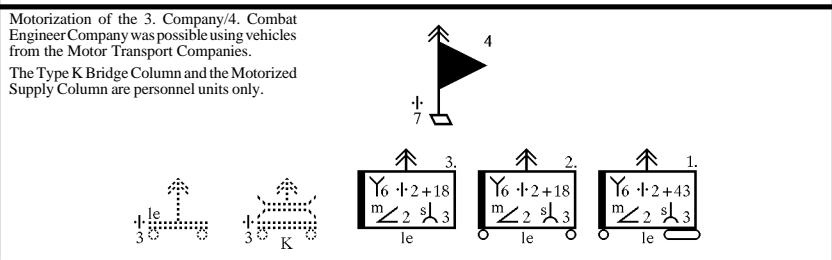
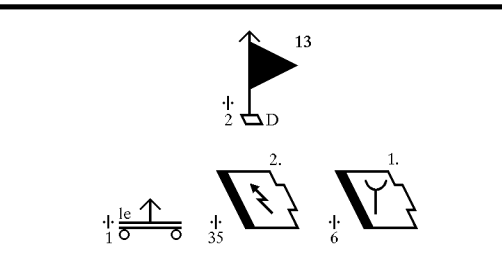
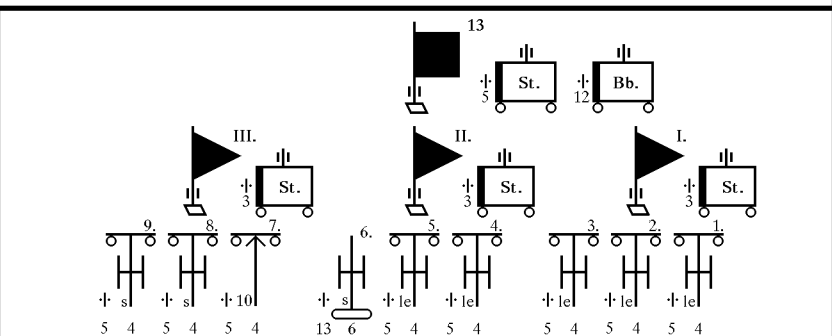
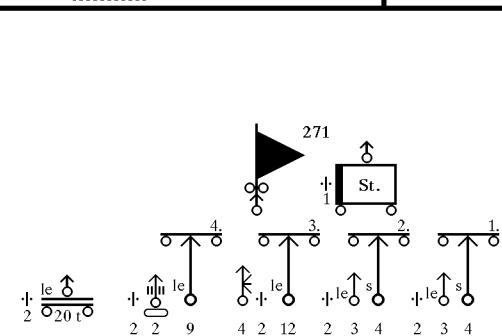
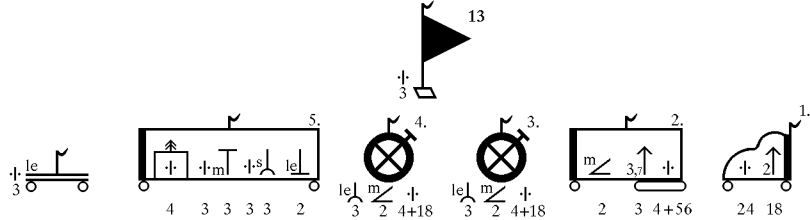
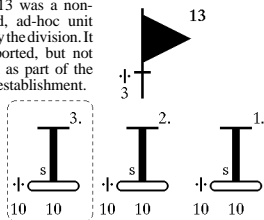

The 14. Panzer Division was still reforming after its destruction at Stalingrad. This is the proposed organization dated 30.06.1943. Most units were not filled up with personnel on this date, and equipment was mostly French

30.06.1943

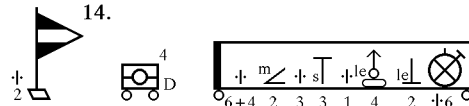

The II./36. Panzer-Regiment was planned, but never raised. The two medium tank companies were assigned to the III. Battalion as the 9. and 11. Companies.

The I./36 Panzer-Regiment was scheduled to be reorganized as a Pz-V Panther Battalion. On this date it still had a mixture of German medium and French tanks.

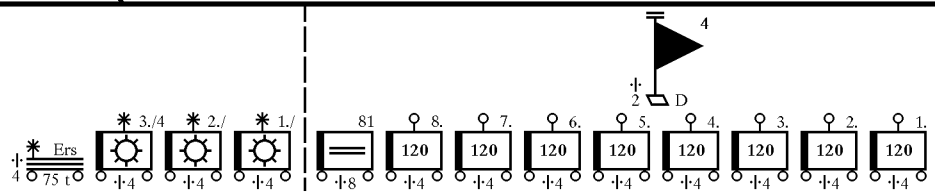
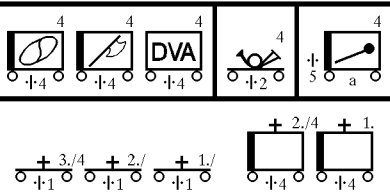
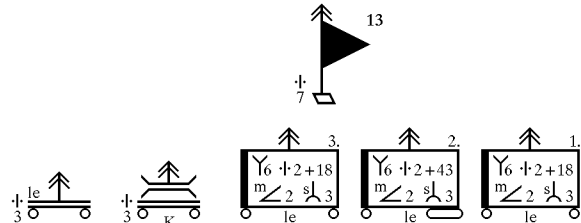
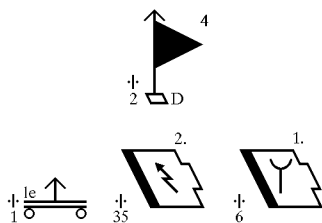
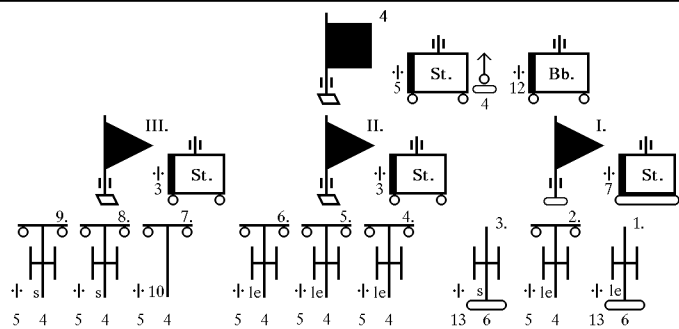
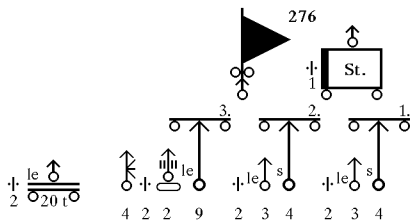
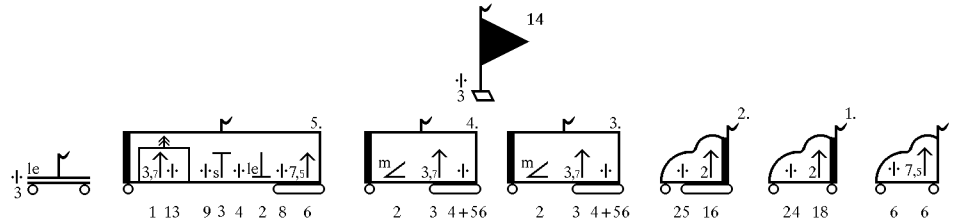
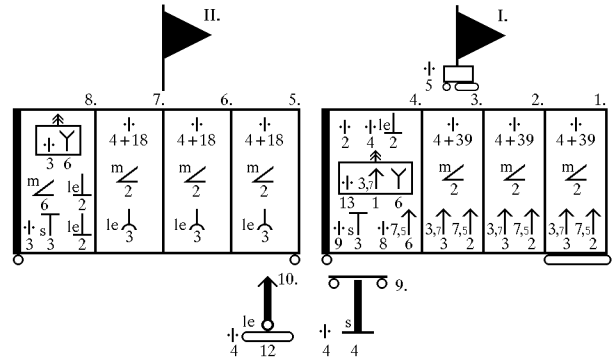
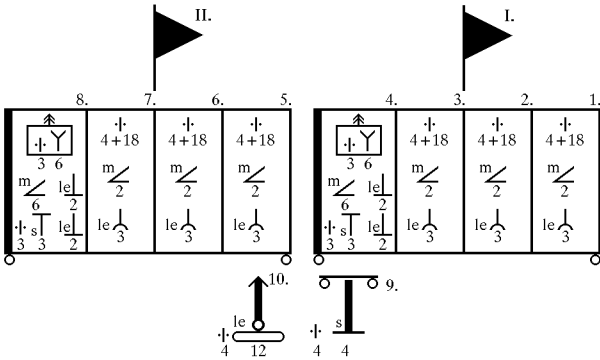
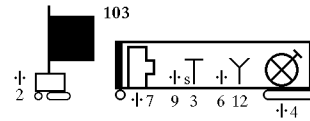
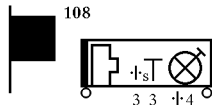
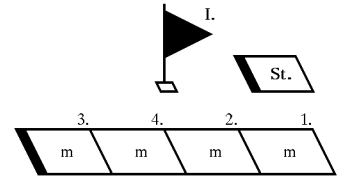
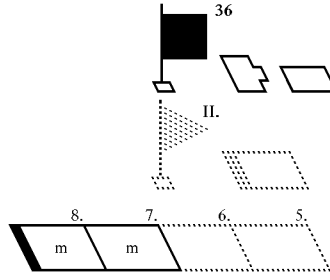
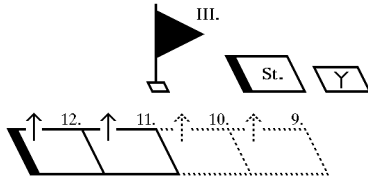

The 16. Panzer Division was still reforming after its destruction at Stalingrad. This is the proposed organization dated 30.06.1943. Most units were not filled up with personnel on this date, and equipment was mostly French. Full combat readiness was ordered by 1.09.1943.

30.06.1943

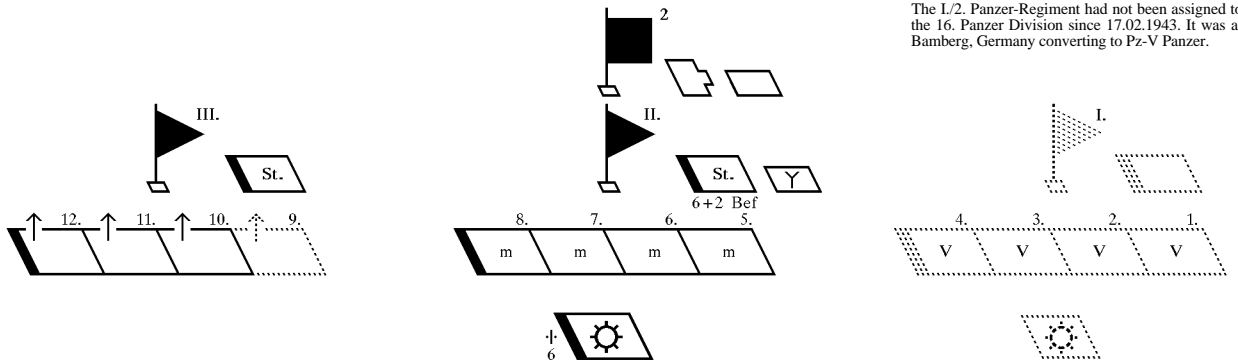
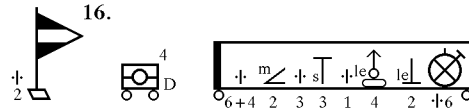

The I./2. Panzer-Regiment had not been assigned to the 16. Panzer Division since 17.02.1943. It was at Bamberg, Germany converting to Pz-V Panzer.

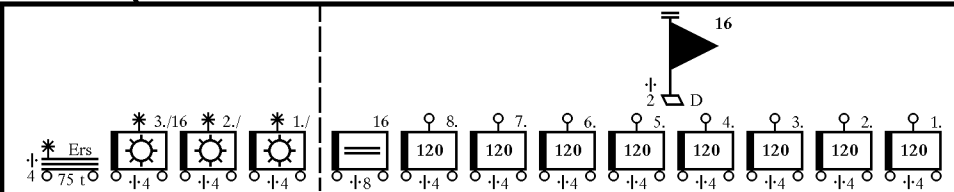
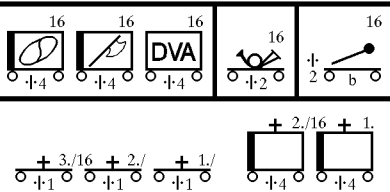
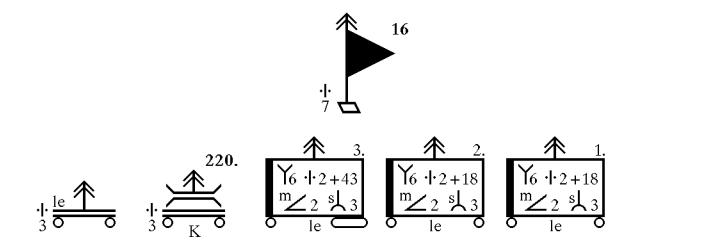
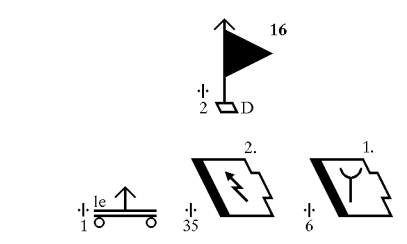
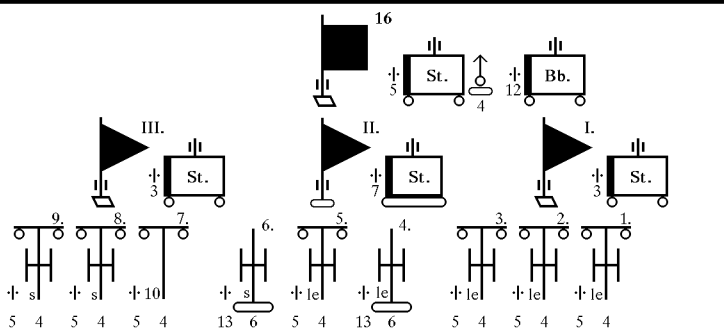
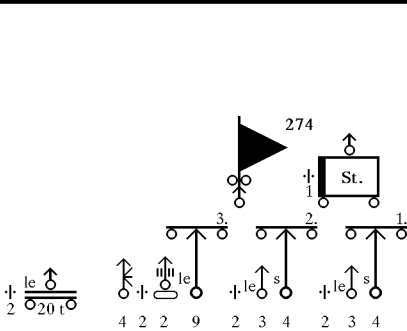
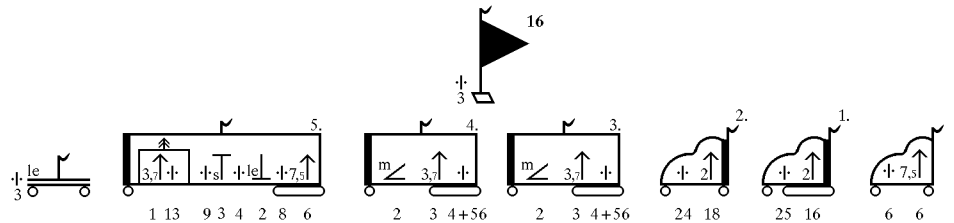
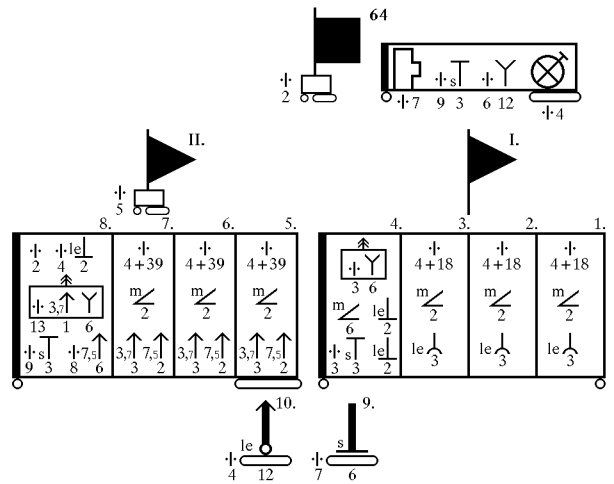
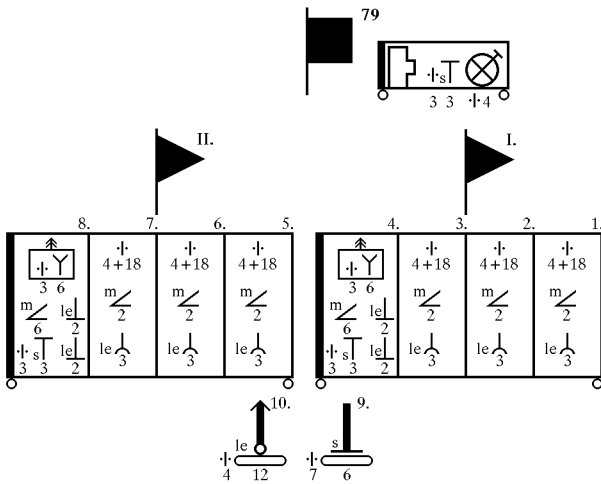

1.07.1943

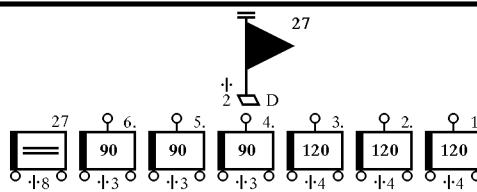
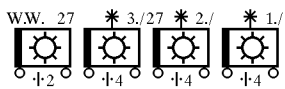
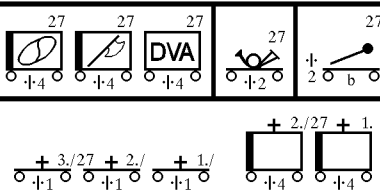
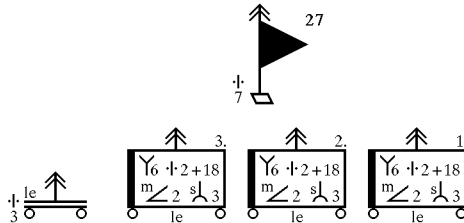
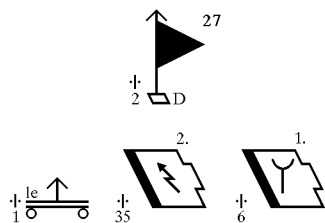
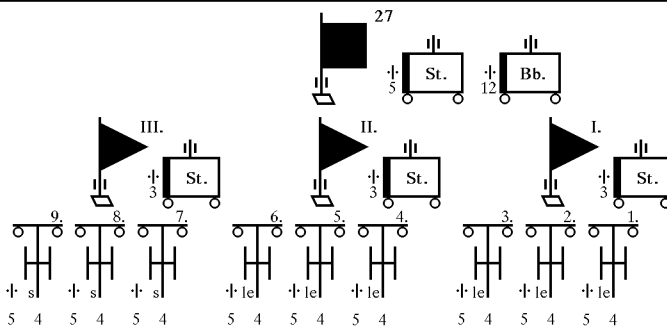
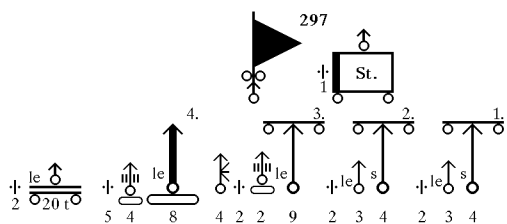
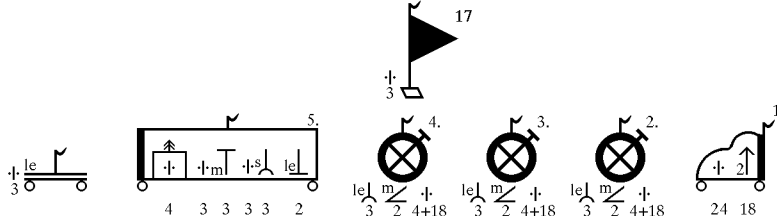
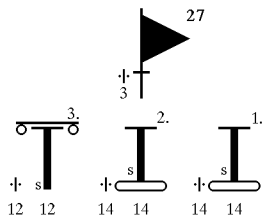
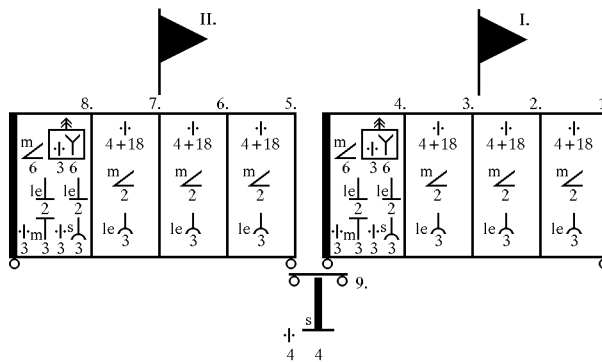
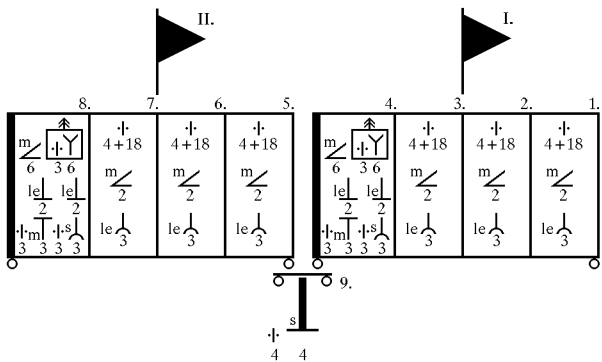
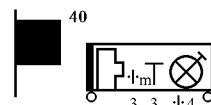
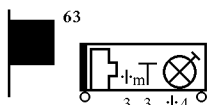
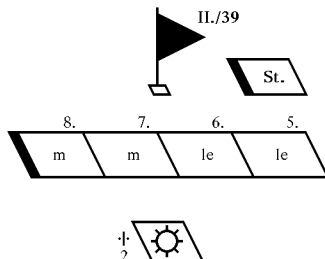
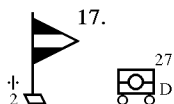

The 18. Panzer Division – having been heavily decimated in the Winter 1942/43 and Spring 1943 battles – had not been restored to full fighting strength. (It never would be, and was dissolved on 29.09.1943). The 18. Panzer Division was largely a foot and horse-drawn formation as it had few motor vehicles left. On 1.07.1943 it carried on its roles:  
 78 riding horses  
 130 heavy draft horses  
 2218 light draft horses

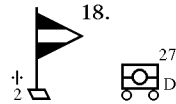

1.07.1943

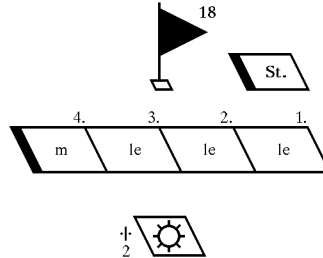

The 101. Panzergrenadier Regiment was not assigned to the 18. Panzer Division at this time. It had no motor vehicles at all, and was used as a foot infantry unit in the Battle of Kursk under the 292. Infanterie-Division.

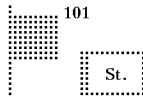

The 52. Panzergrenadier Regiment only had 63% of its authorized motor vehicles.

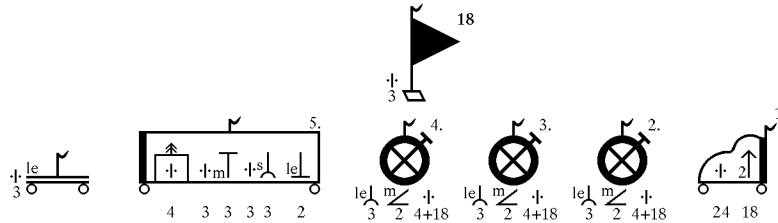
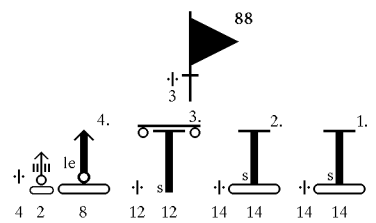
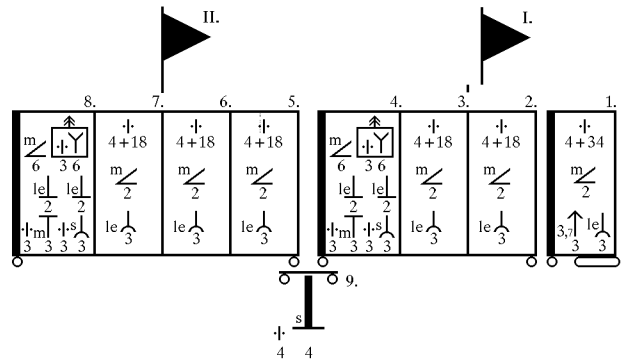
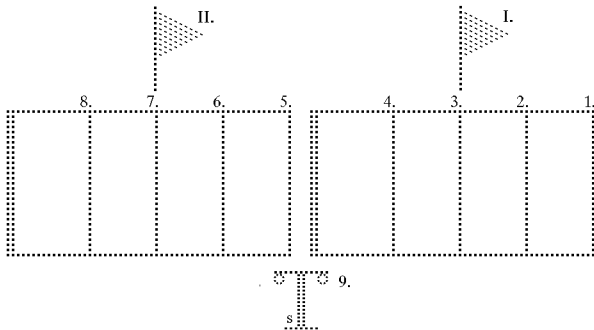
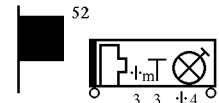

The 88. Panzer-Artillerie-Regiment had 51% of its prime movers.

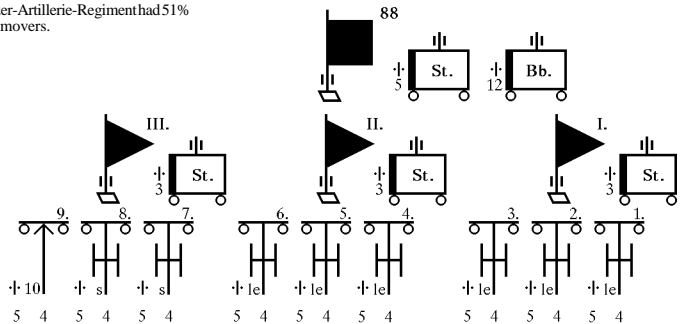

The 98. Panzer-Pionier-Bataillon had 34% of its authorized motor vehicles.

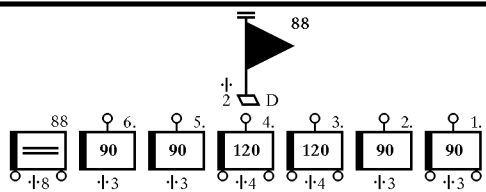
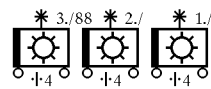
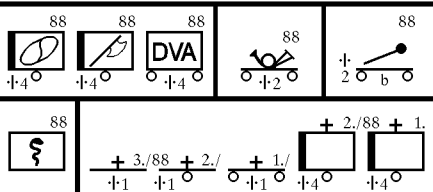
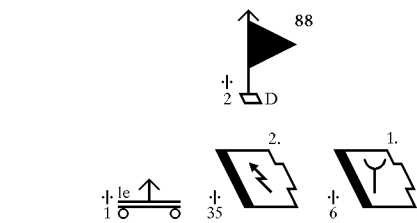
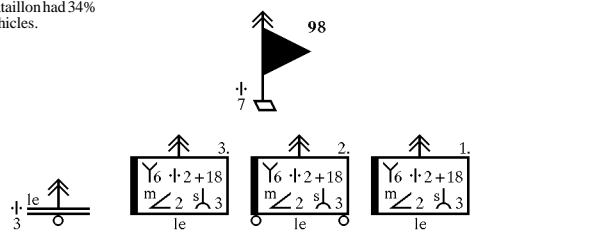

1.07.1943

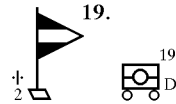

**27. Panzer Regiment tank strength:**  
 Rgt. Hqs: 1 Bef-Pz-III+1 Pz-III(lg)+1 Pz-III(75)  
 I. Bn. Hqs: 1 Pz-III(lg)+4 Pz-III(kz)+1 Pz-III(75)  
 1. Co.: 5 Pz-III(lg)+3 Pz-III(75)  
 2. Co.: 5 Pz-III(lg)+3 Pz-III(75)  
 3. Co.: 9 Pz-IV(lg)  
 4. Co.: 9 Pz-IV(lg)+2 Pz-IV(kz)  
 II. Bn. Hqs: 2 Bef-Pz-III+5 Pz-III(lg)+1 Pz-III(kz)  
 5. Co.: 5 Pz-III(lg)+3 Pz-III(75)  
 6. Co.: 9 Pz-IV(lg)  
 7. Co.: 9 Pz-IV(lg)

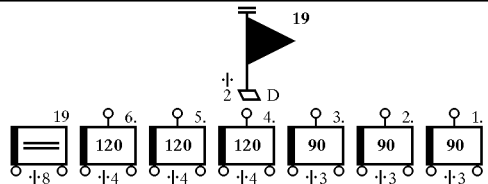
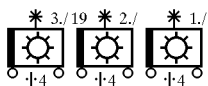
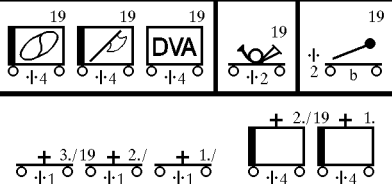
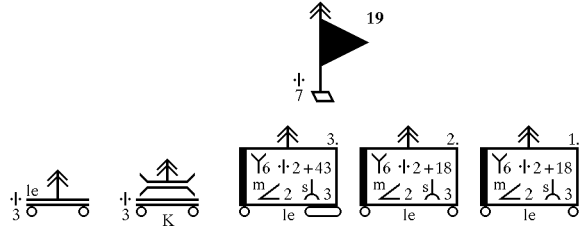
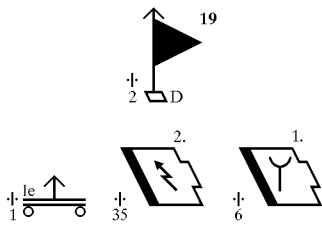
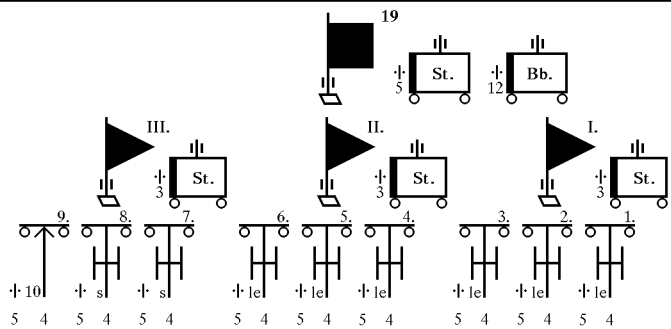
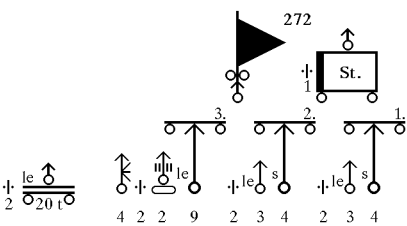
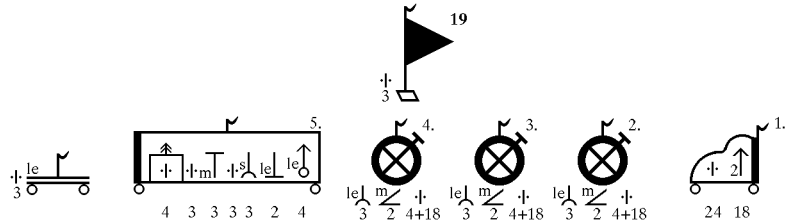
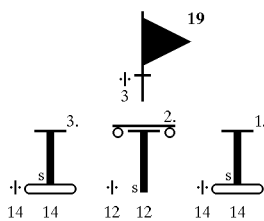
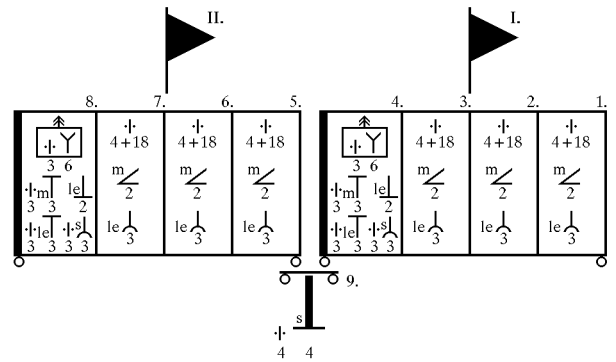
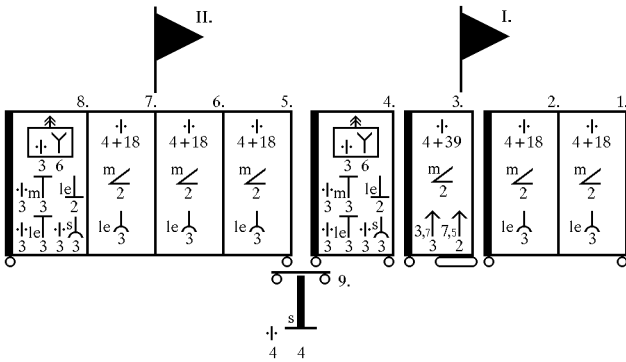
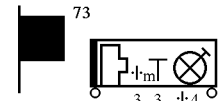
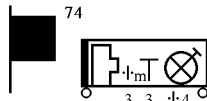
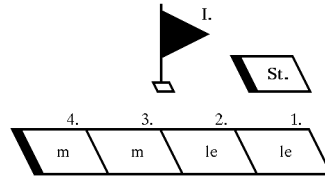
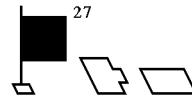
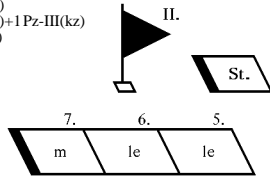



1.07.1943

Non-standard, ad-hoc unit raised by the division. It was reported, but not counted as part of the normal establishment.

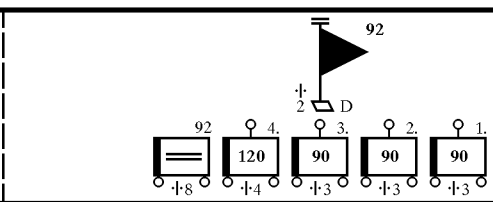
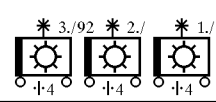
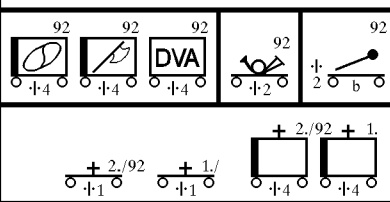
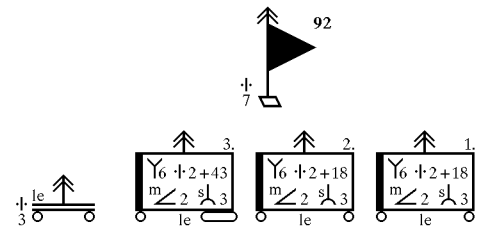
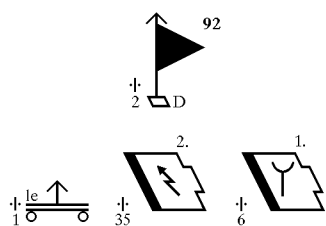
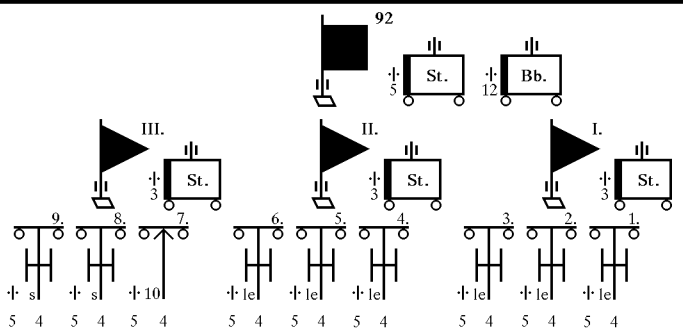
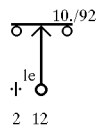
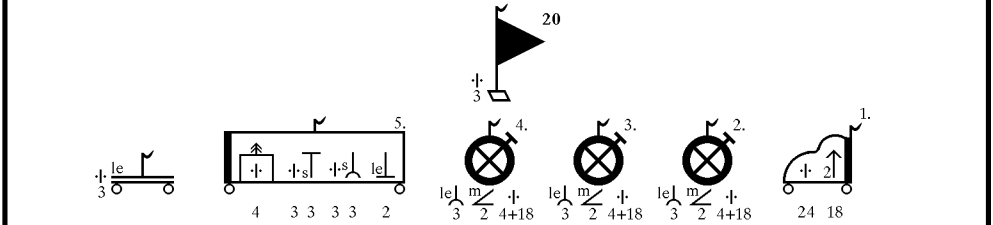
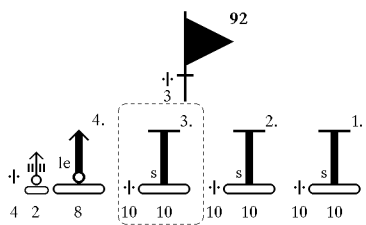
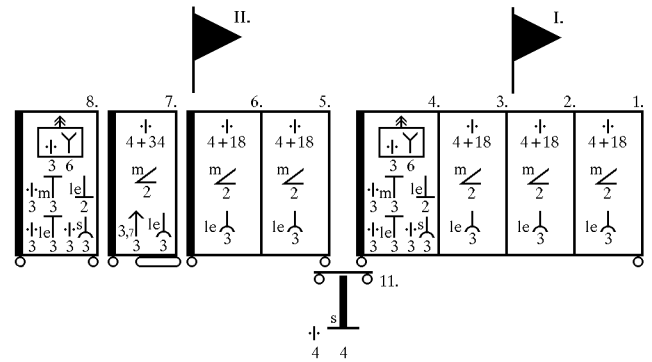
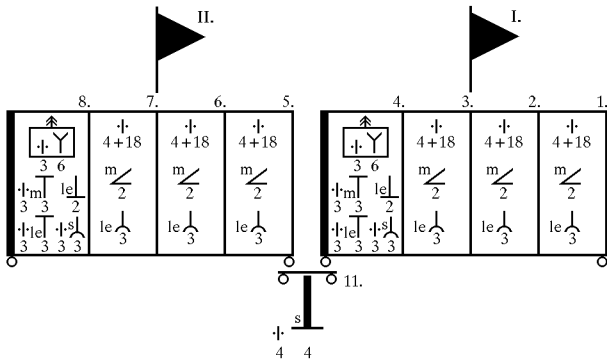
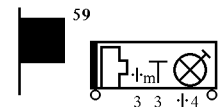
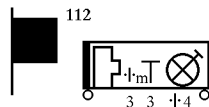
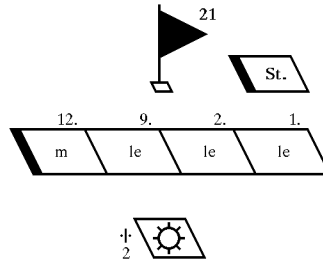
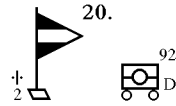

The 21. Panzer Division was a new division carrying an old designation. It was still in the process of formation. This is the proposed organization dated 30.06.1943. Most units were not filled up with personnel on this date, and equipment was overwhelmingly French. Many of the self-propelled weapons and halftracks were still in the process of being constructed and modified especially for the division.

30.06.1943

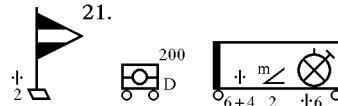

This symbol describes a halftrack with sixteen 81.4mm French mortars mounted in two rows of eight.

The light tanks are Somua Char 1935-S; the heavy tanks Hotchkiss Char 1938-S; and the flame tanks are Char Ibis.

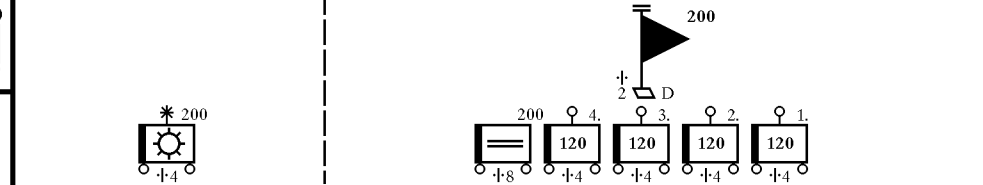
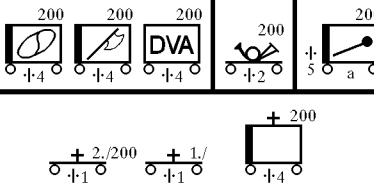
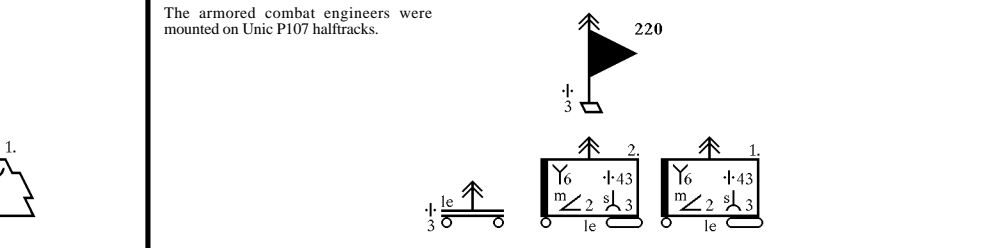
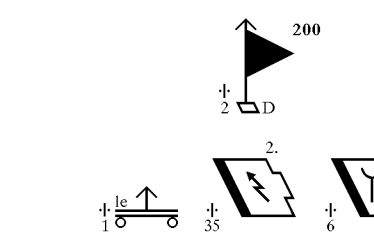
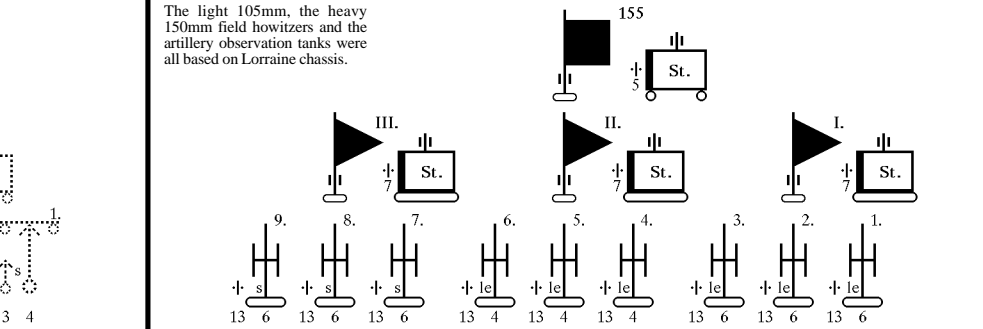
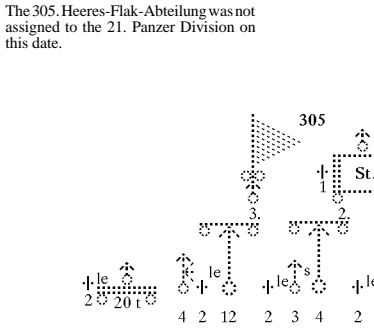
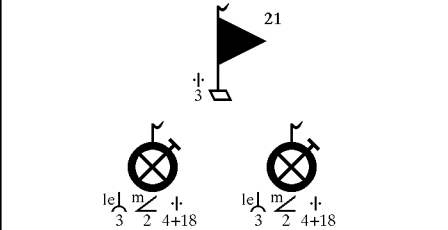
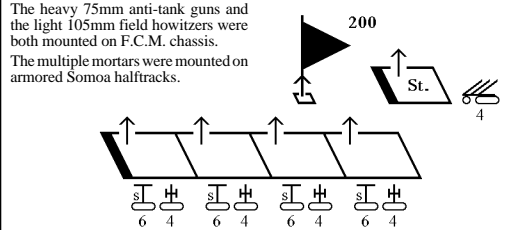
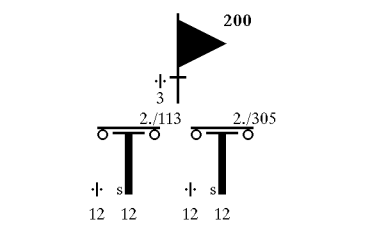
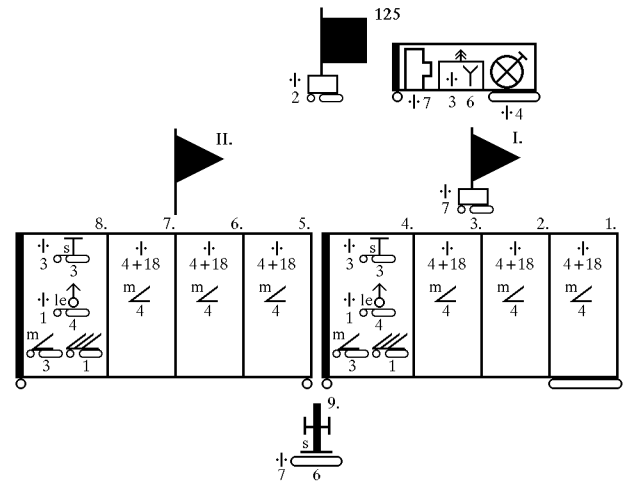
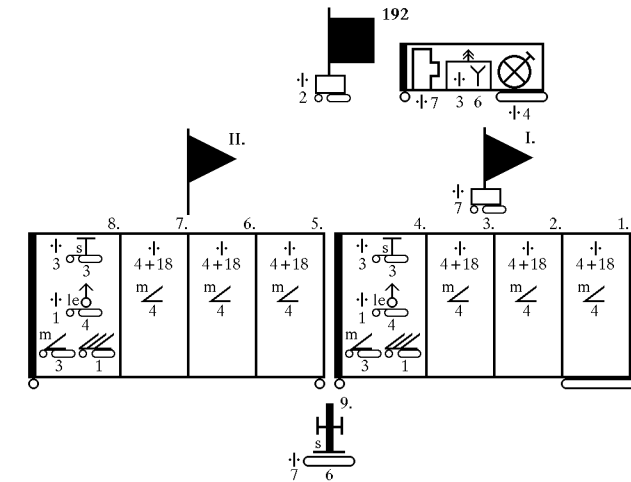
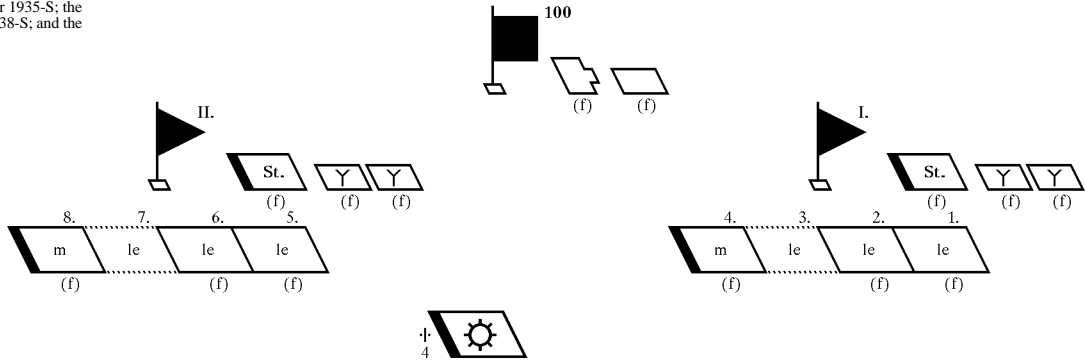

1.07.1943

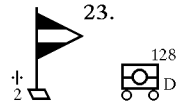

The II./201. Panzer-Regiment had not been assigned to the 23. Panzer Division since April 1943. It was at Erlangen, Germany converting to Pz-V Panzer.

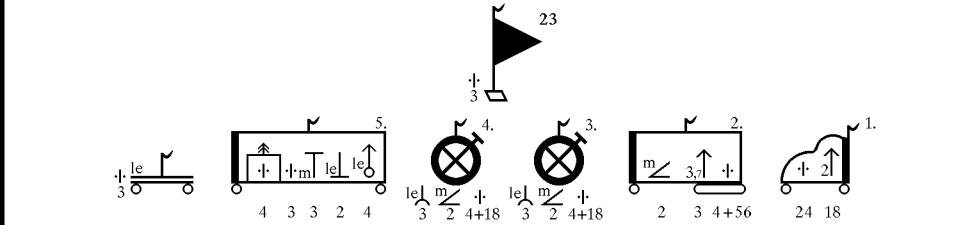
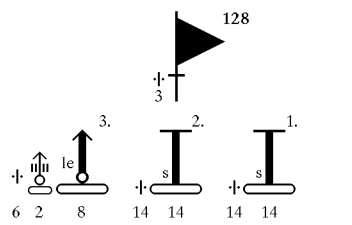
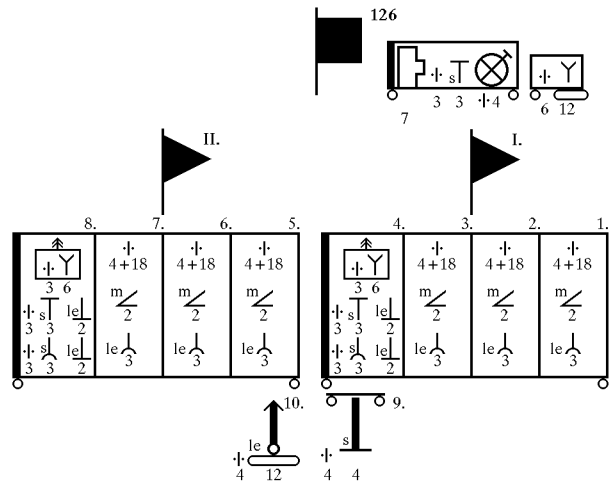
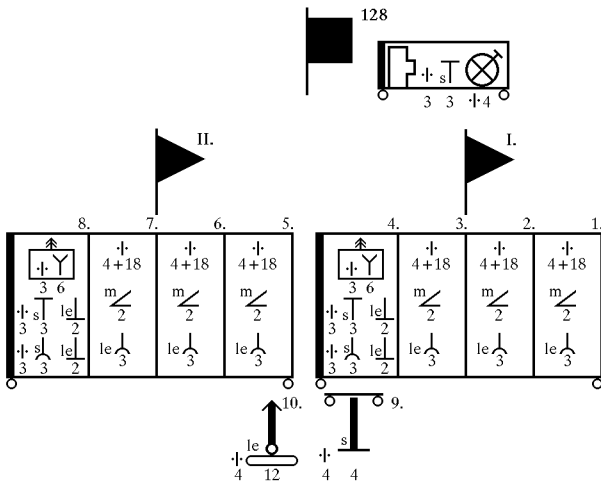
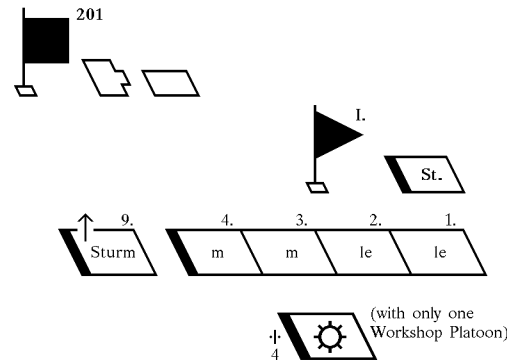
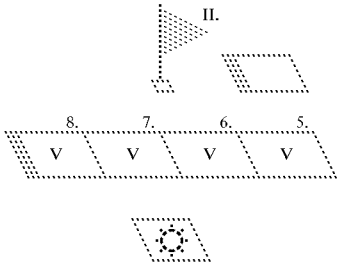

The 278. Heeres-Flak-Abteilung was not assigned to the 23. Panzer Division on this date.

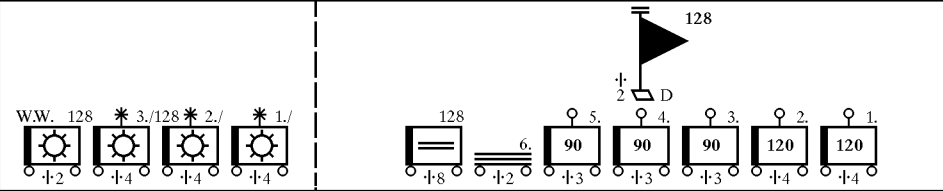
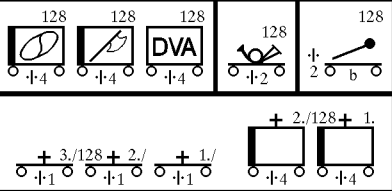
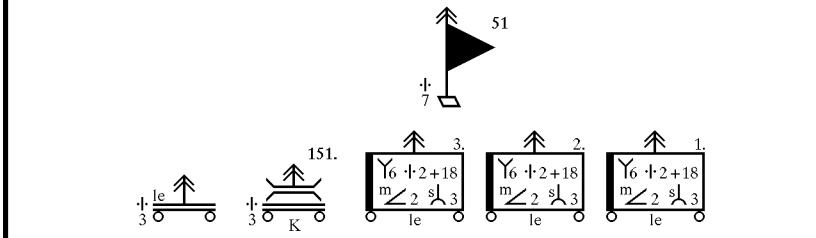
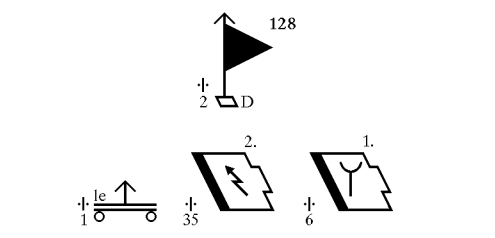
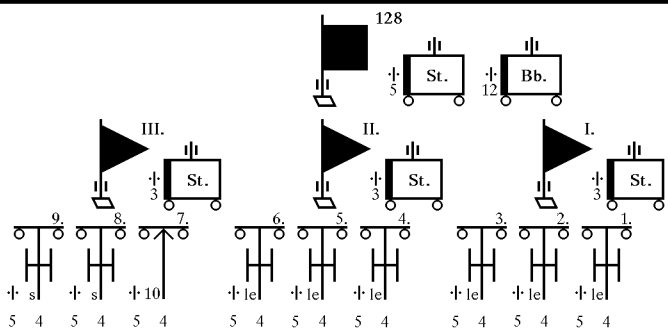
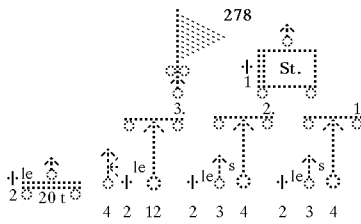

The 24. Panzer Division was still reforming after its destruction at Stalingrad. This is the proposed organization dated 30.06.1943. Most units were not filled up with personnel on this date, and equipment was mostly French

1.07.1943

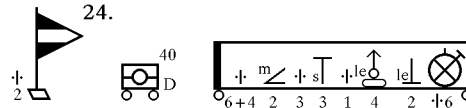

The II./24. Panzer-Regiment was planned, but it was never raised. The two medium tank companies were assigned to the III. Battalion as the 9. and 11. Companies, the two Sturmgeschütz companies were renumbered as the 10. and 12. companies.

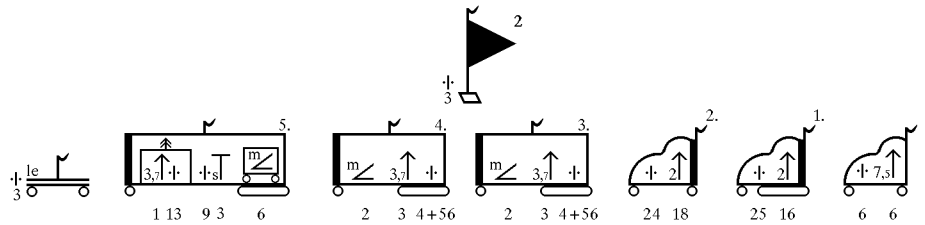
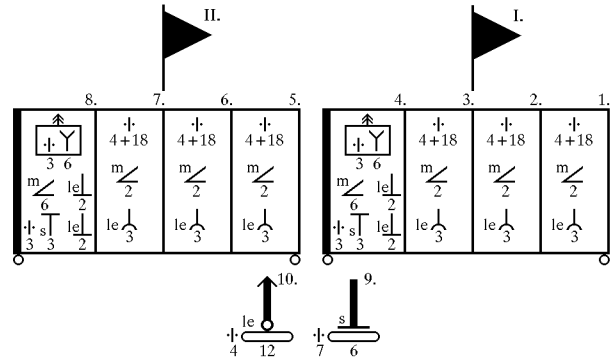
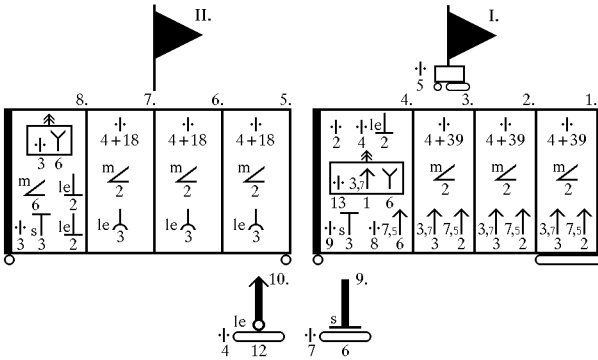
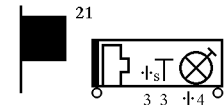
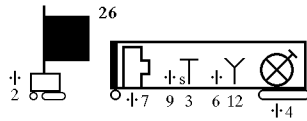
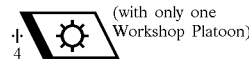
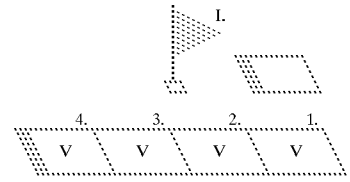
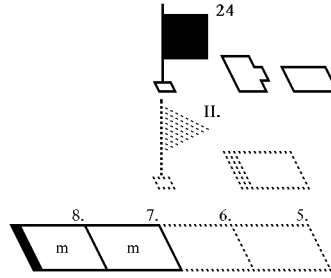
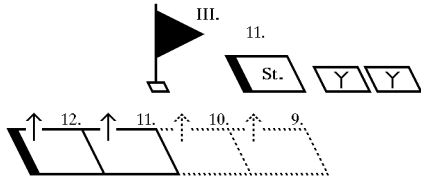

The I./24. Panzer-Regiment had not been assigned to the 24. Panzer Division since 17.02.1943. It was in Normandy, France converting to Pz-V Panzer.



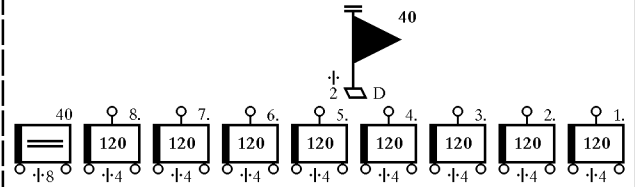
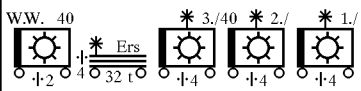
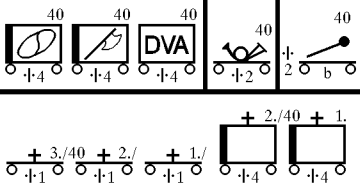
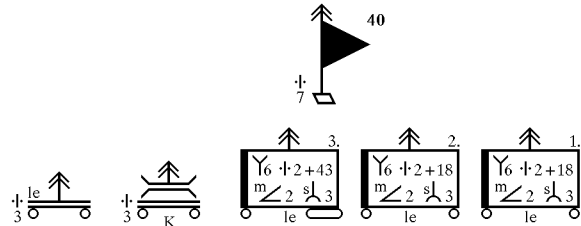
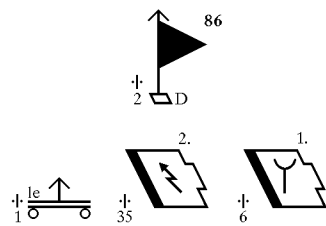
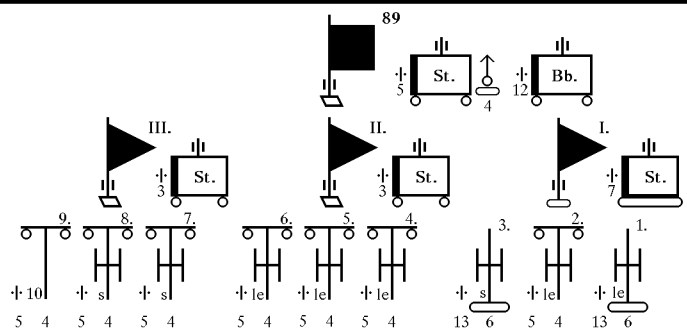
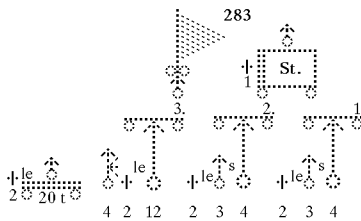



The 283. Heeres-Flak-Abteilung was not assigned to the 24. Panzer Division on this date.







1.07.1943

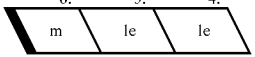

25.  

9.   

II.  



6. 5. 4.   

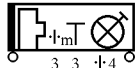

I.  

3. 2. 1.   





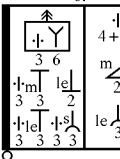
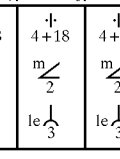
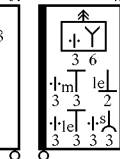
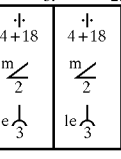
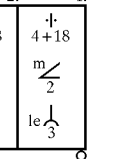

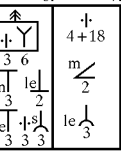
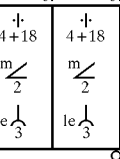
147.  

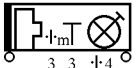

II.  

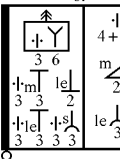
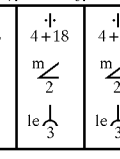
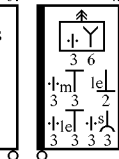
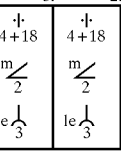
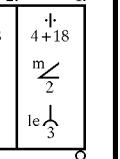

8. 7. 6. 5. 4. 3. 2. 1.        

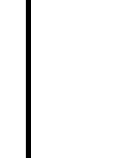
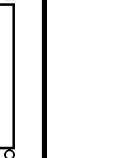



146.  



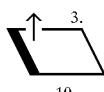

II.  





8. 7. 6. 5. 4. 3. 2. 1.        





9.  



87.   



10. 12. 12. 12. 12.     



25.     











5. 4. 3. 2. 1.     



4. 3. 3. 3. 2.     



le 1/2 4+18. le 1/3 2 4+18. le 1/3 2 4+18.  



272.  



3. 2. 1.   









le 2/20 1/0.          







91.   



III.  



II.  



I.  



9. 8. 7. 6. 5. 4. 3. 2. 1.         



sif. sif. sif. le. le. le.      



87.  







2. 1.  





le 1/3 35.   





87.  



123.  



3. 2. 1.   







Y6 1/18. Y6 1/18. Y6 1/18.      

87.     

3./87. 2./ 1./     

2./87. 1./  

87.  

5. 4. 3. 2. 1.      

1.07.1943

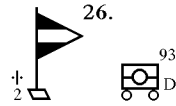

The I./26. Panzer-Regiment had not been assigned to the 26. Panzer Division since 31.05.1943. It was in Normandy, France converting to Pz-V Panzer.

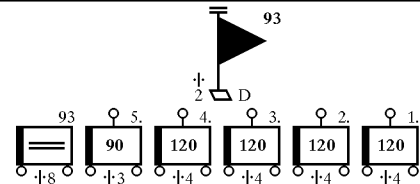
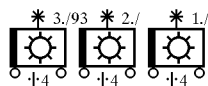
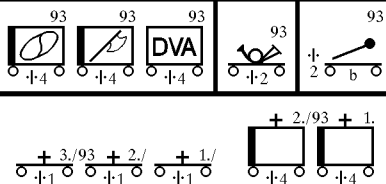
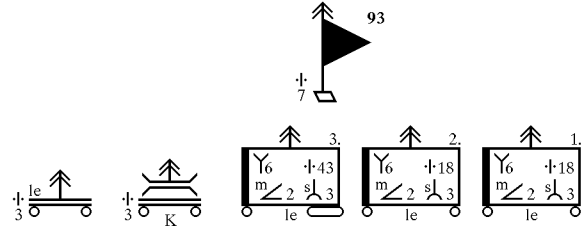
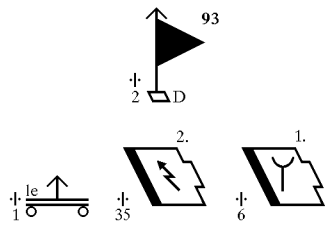
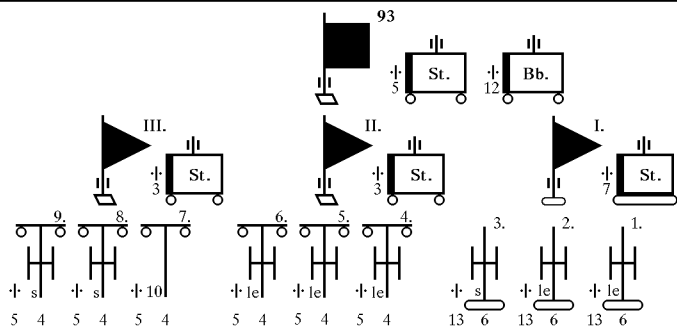
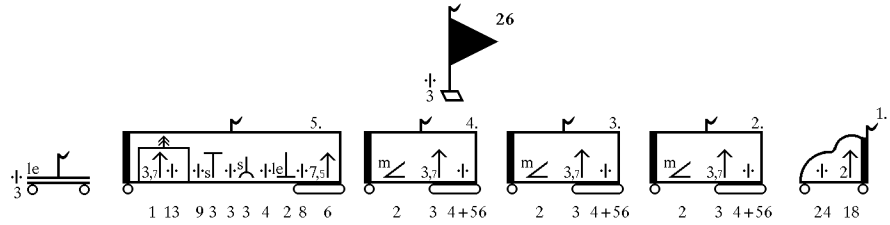
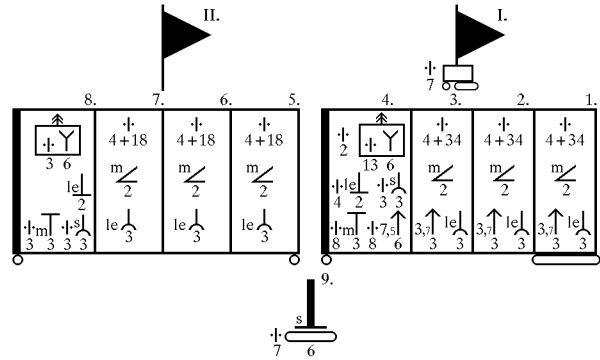
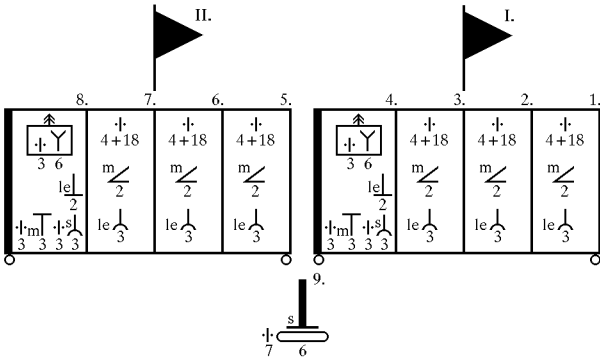
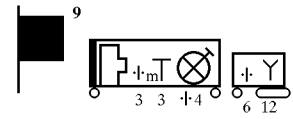
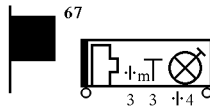
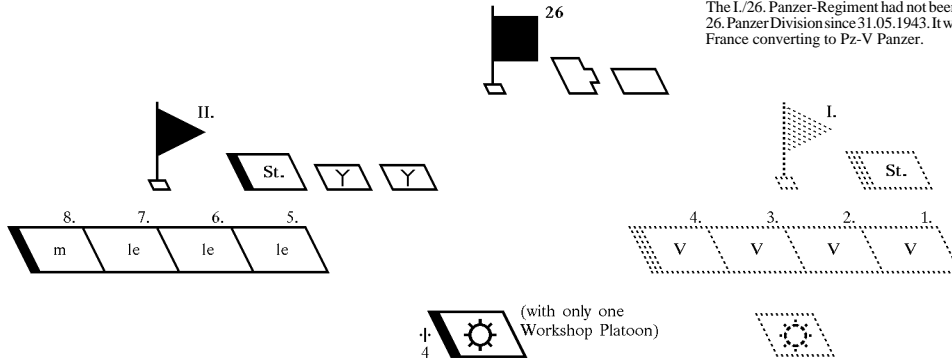



The 3. Panzergrenadier Division was still reforming after its destruction at Stalingrad. This is the proposed organization dated 5.07.1943. Most units were not filled up with personnel or equipment on this date.

5.07.1943

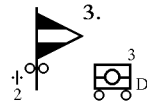

The 103. Panzer Battalion was ordered to convert to Sturmgeschütz on 15.07.1943.

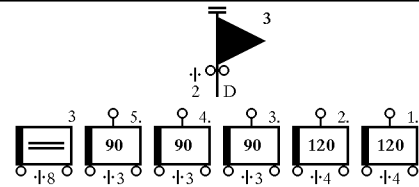
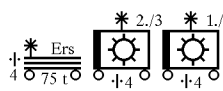
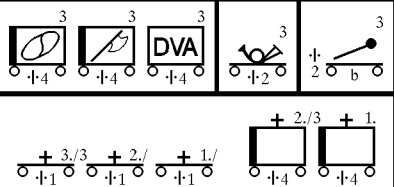
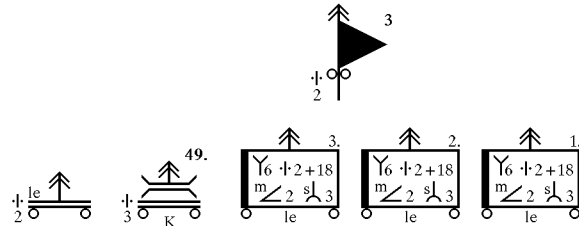
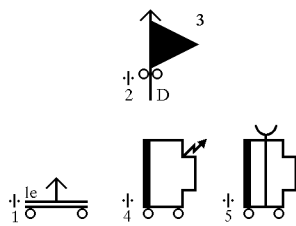
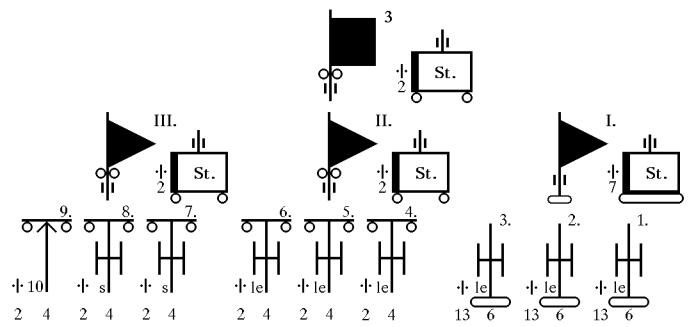
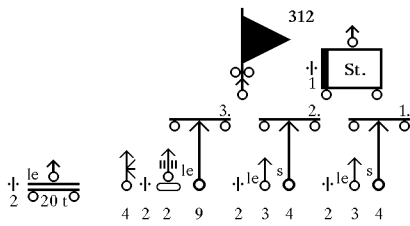
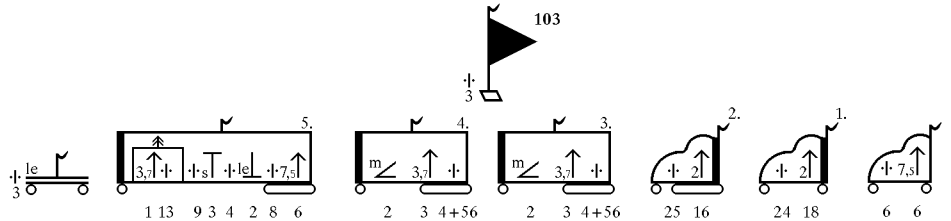
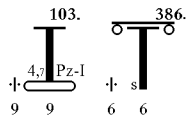
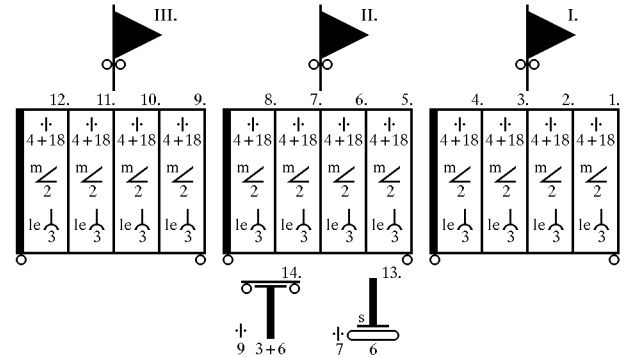
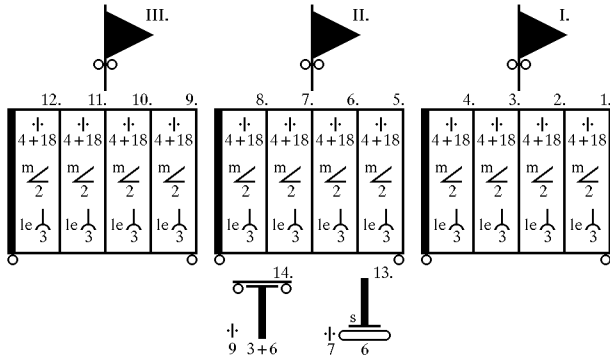
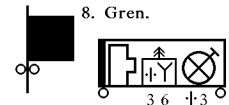
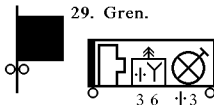
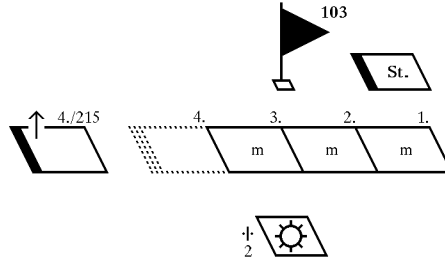



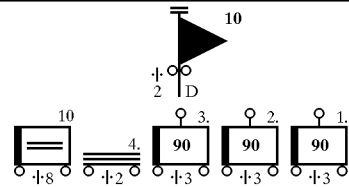
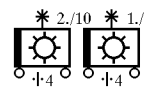
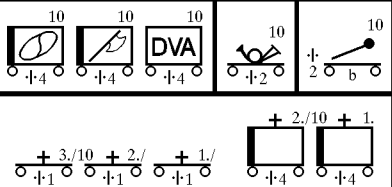
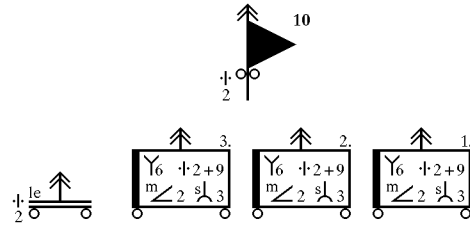
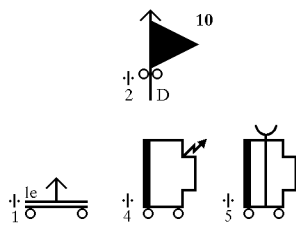
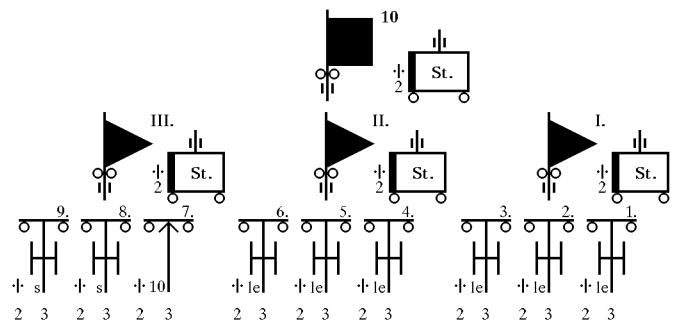
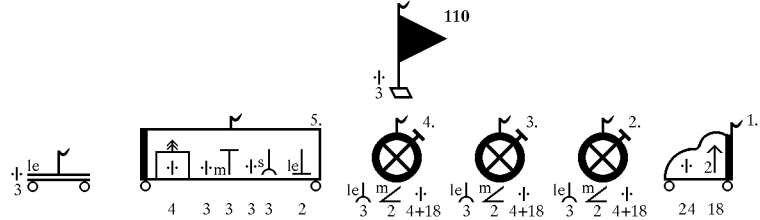
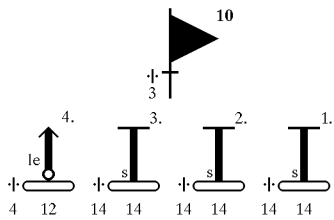
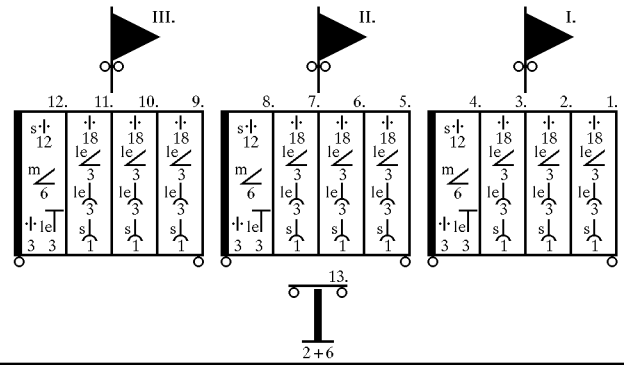
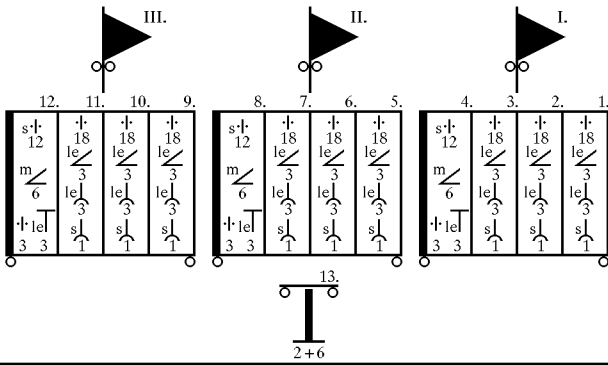
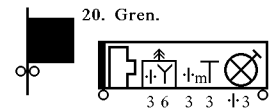
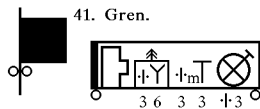
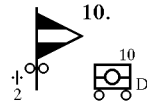

The 15. Panzer Division was a new division and was still forming.

The Division Sizilien (raised 14.05.1943) had been formed from personnel and units originally destined for the Axis forces which had been stranded in Italy when the Axis forces capitulated in North Africa. It was redesignated as the 15. Panzer Division on 1.07.1943 in memory of the former Afrika Korps formation. The 15. Panzer Division was again redesignated on 15.07.1943, this time as the 15. Panzer Grenadier Division.

This was the authorized organization on 1.07.1943. Motor vehicles were not available in the necessary numbers, and most battalions were only partially motorized. Heavy anti-tank guns were not available in the indicated numbers. The designations were changed as the division's units became established.

Unit	Date	Becomes
Pz. Gren. Regiment Sizilien 1	15.07.1943	104. Panzer-Grenadier-Regiment
Pz. Gren. Regiment Sizilien 2	15.07.1943	115. Panzer-Grenadier-Regiment
Pz. Gren. Regiment Sizilien 3	15.07.1943	129. Panzer-Grenadier-Regiment
215. Panzer Battalion	30.09.1943	115. Panzer Battalion
Flak Battalion Sizilien	6.07.1943	315. Flak Battalion
Artillery Regiment Sizilien (mot)	1.07.1943	33. Artillery Regiment (mot)
Hqs. / Supply Battalion Sizilien	24.07.1943	Hqs. / 33. Supply Battalion
33. Motor Maintenance Company new	10.07.1943	1./33. Motor Maintenance Company
33. Medical Company new	10.07.1943	2./33. Motor Maintenance Company
33. Medical Company new	10.07.1943	1./33. Medical Company
33. Ambulance Platoon	10.07.1943	2./33. Medical Company
643. Ambulance Platoon	10.07.1943	1./33. Ambulance Platoon
644. Ambulance Platoon	10.07.1943	2./33. Ambulance Platoon
	10.07.1943	3./33. Ambulance Platoon

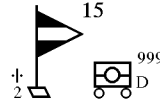

1.07.1943

The 215. Panzer Battalion was permanently assigned to the 15. Panzer-Division on 6.07.1943.

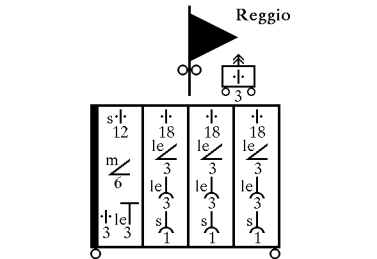
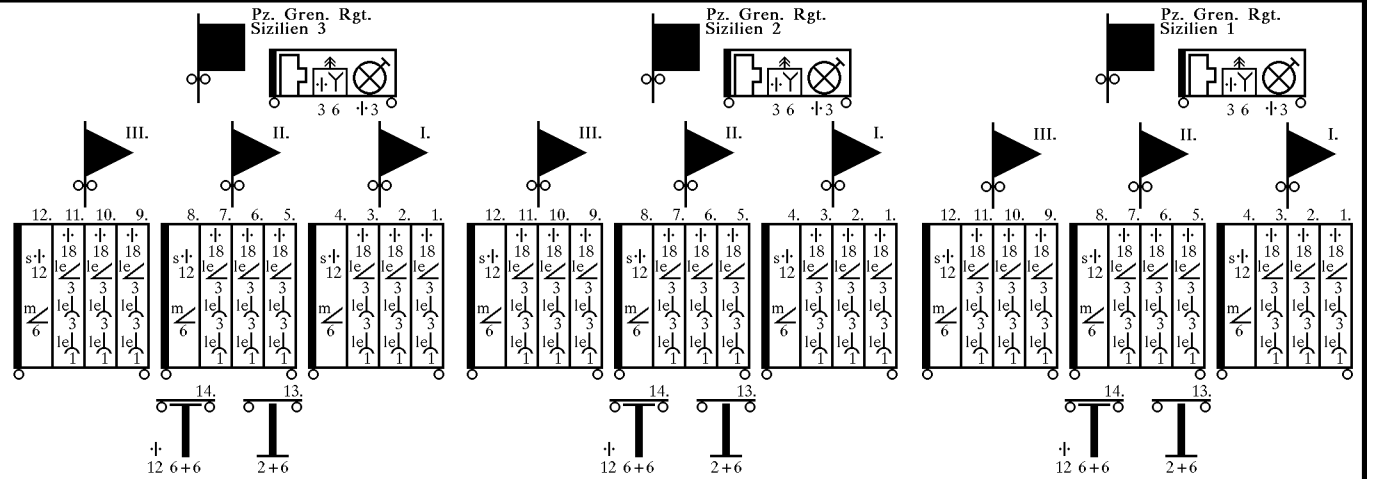
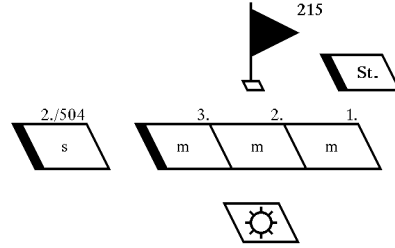

The "Schnelle Abteilung" (Mobile Battalion) Neapel was an ad-hoc unit created from various components of the division as well as GHQ Troops to perform reconnaissance missions.

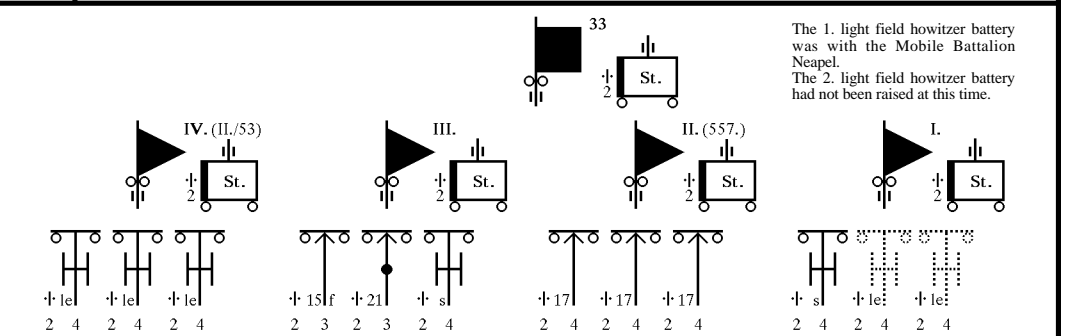
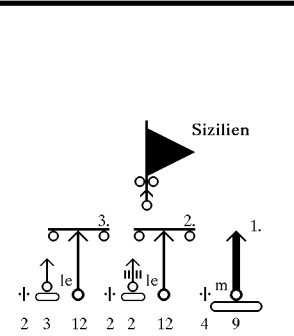
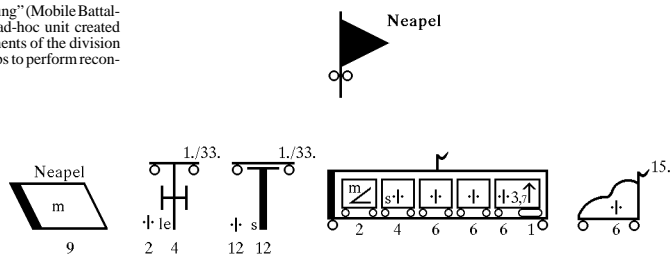

The 1. light field howitzer battery was with the Mobile Battalion Neapel. The 2. light field howitzer battery had not been raised at this time.

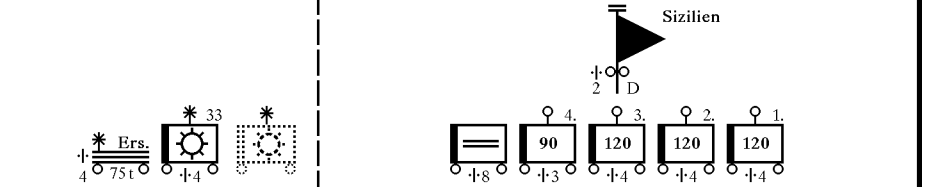
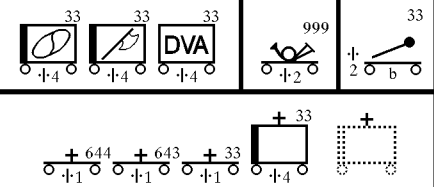
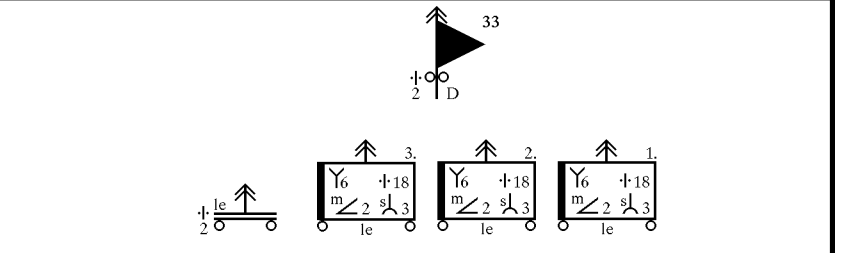
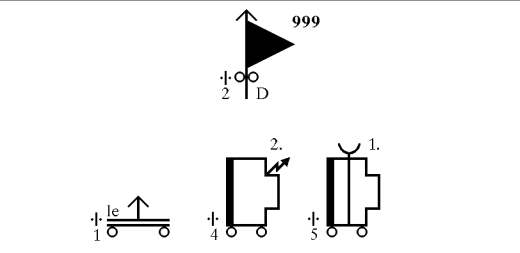

1.07.1943

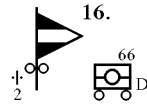

The 116. Panzer Battalion was ordered to convert to Sturmgeschütz on 15.07.1943.

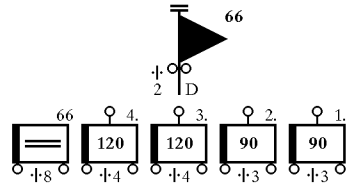
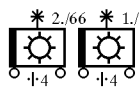
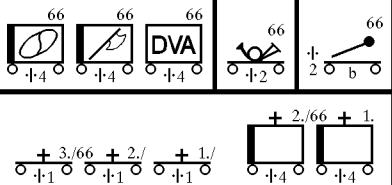
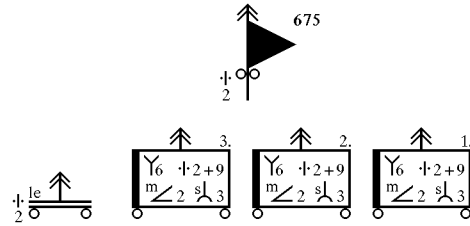
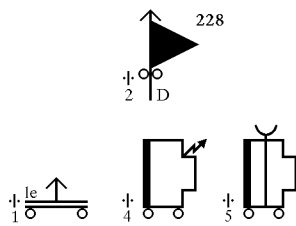
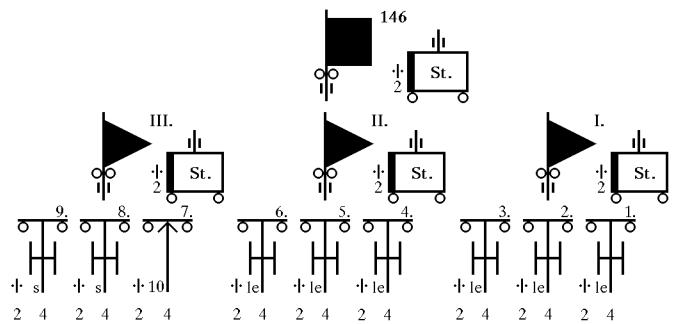
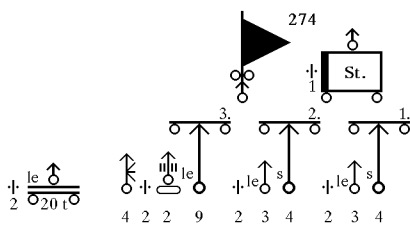
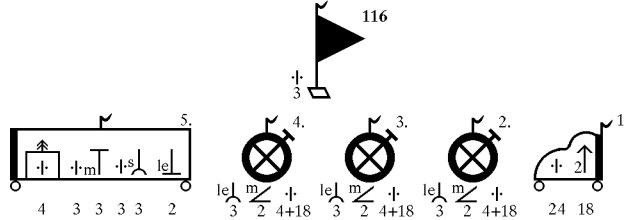
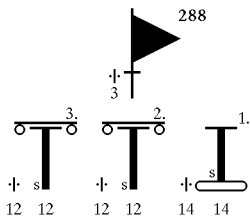
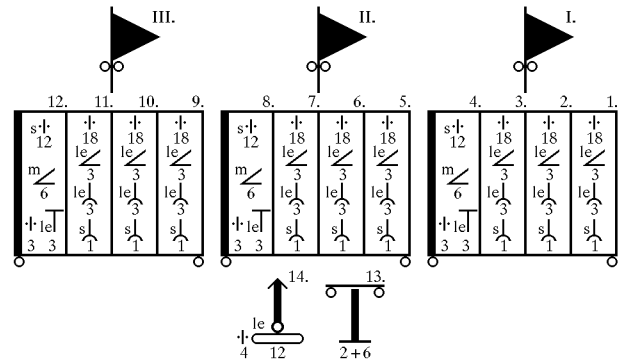
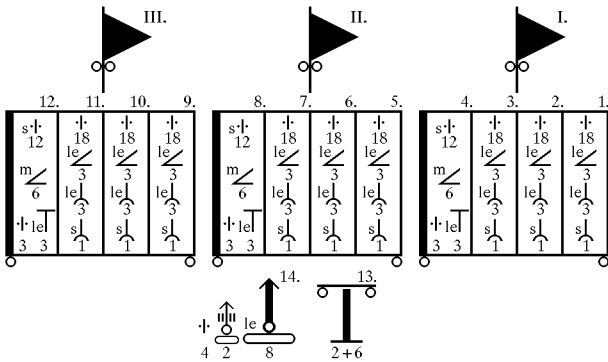
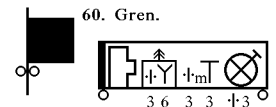
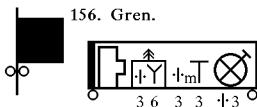
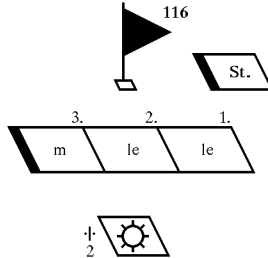

1.07.1943

Non-standard, ad-hoc unit raised by the division. It was reported, but not counted as part of the normal establishment.

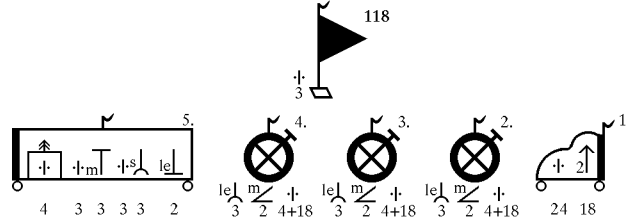
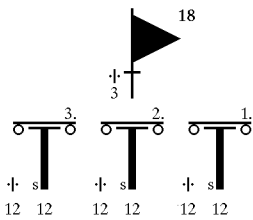
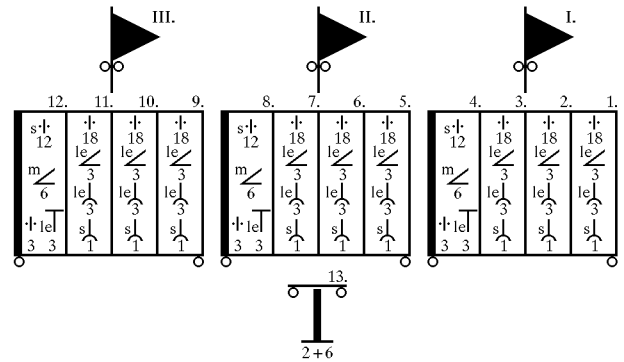
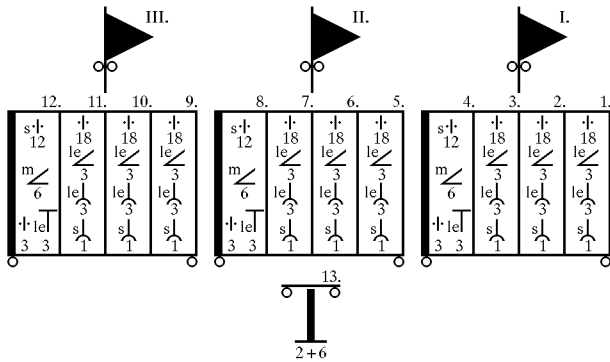
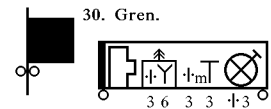
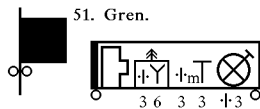
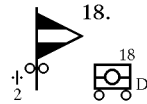

A non-standard, ad-hoc battery with 5 Polish 155mm howitzers was present in the I. Battalion.

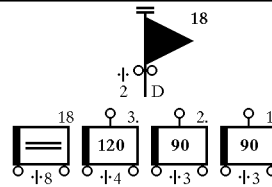
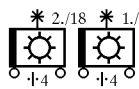
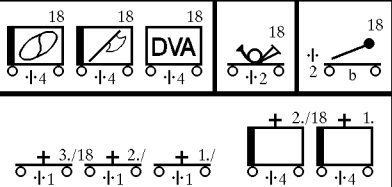
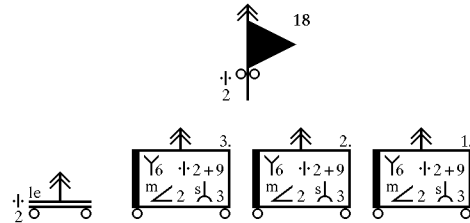
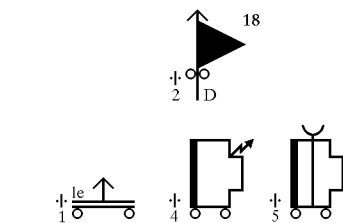
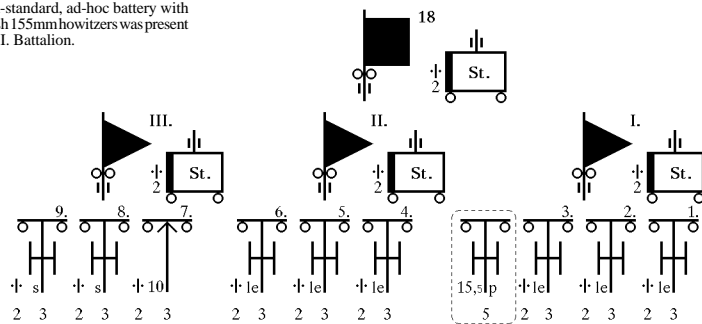

Non-standard, ad-hoc unit raised by the division. It was reported, but not counted as part of the normal establishment.

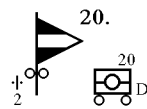

1.07.1943

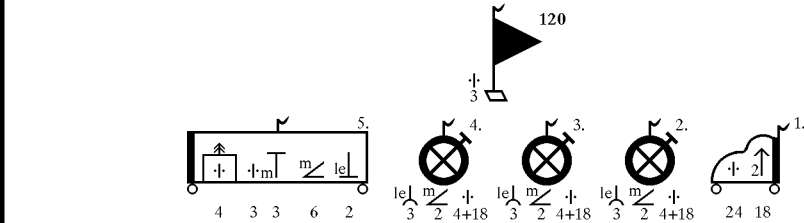
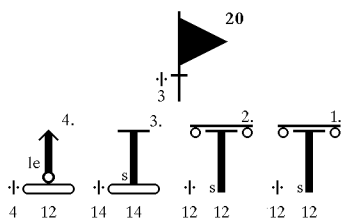
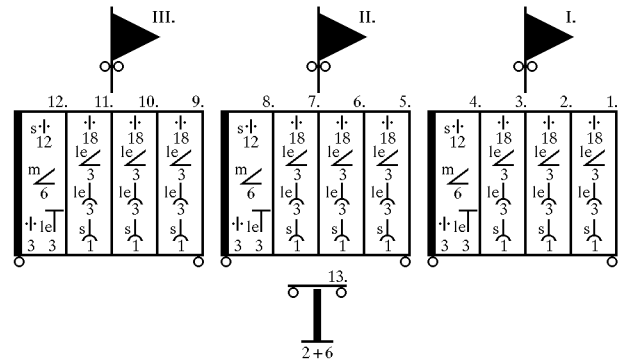
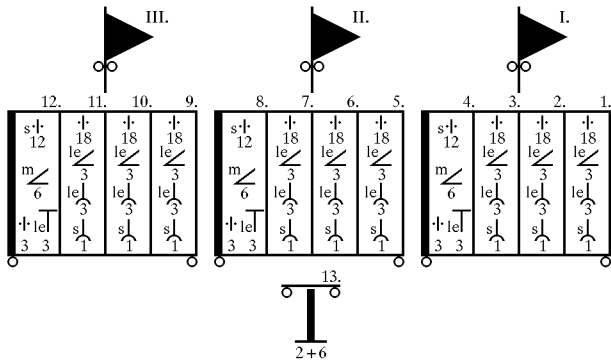
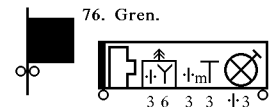
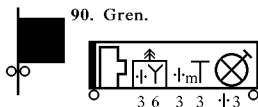

A non-standard, ad-hoc battery with 4 Russian 152mm howitzers was present in the III. Battalion.

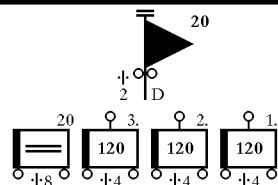
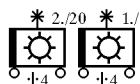
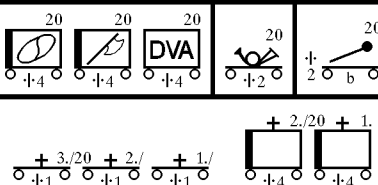
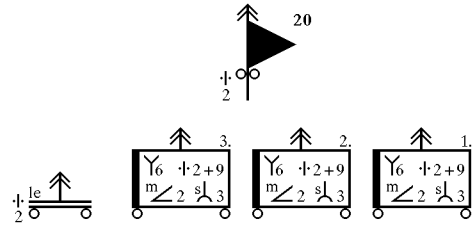
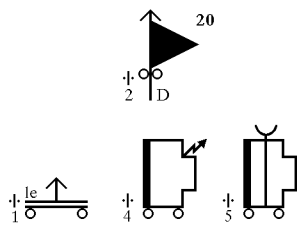
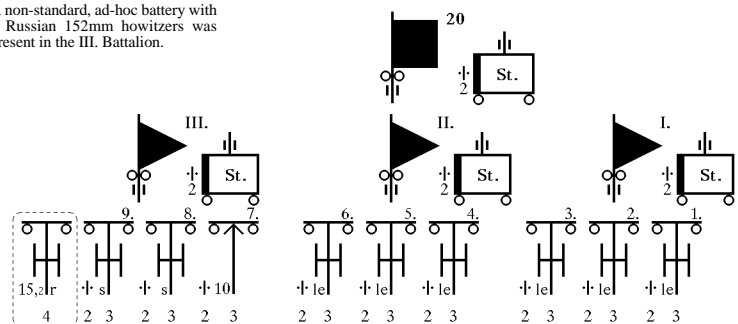

1.07.1943

Non-standard, ad-hoc unit raised by the division. It was reported, but not counted as part of the normal establishment.

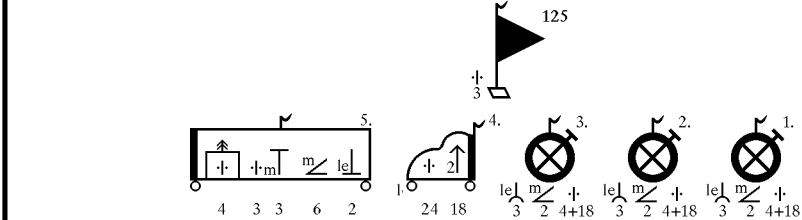
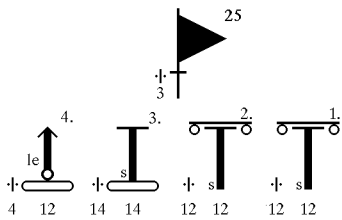
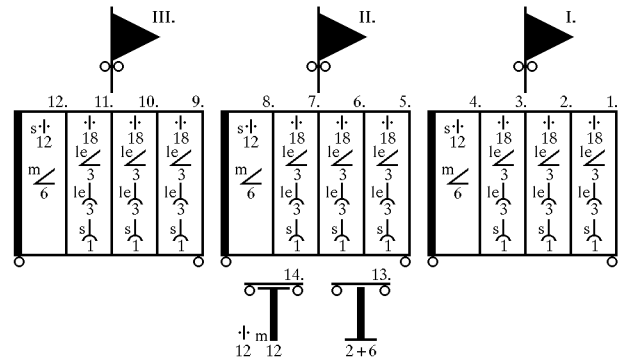
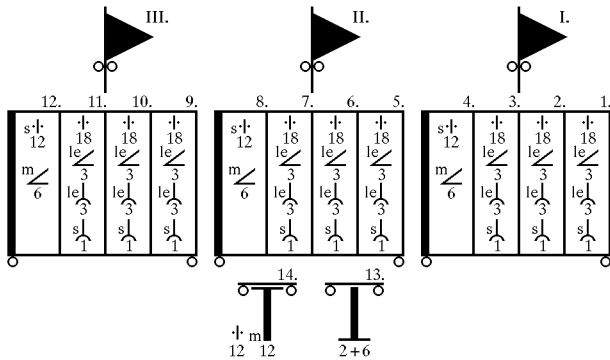
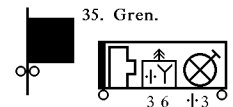
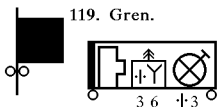
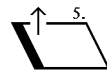
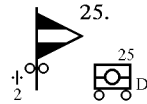

Two non-standard, ad-hoc batteries were present. One with 4 Russian 122mm howitzers in the I. Battalion and one with 3 Russian 152mm howitzers in the III. Battalion.

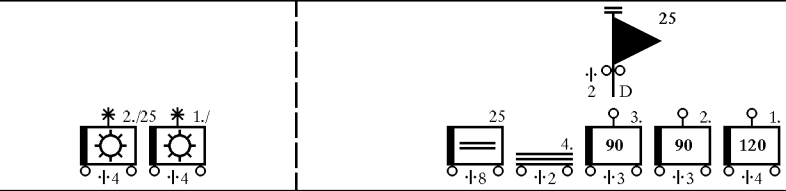
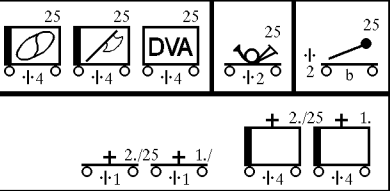
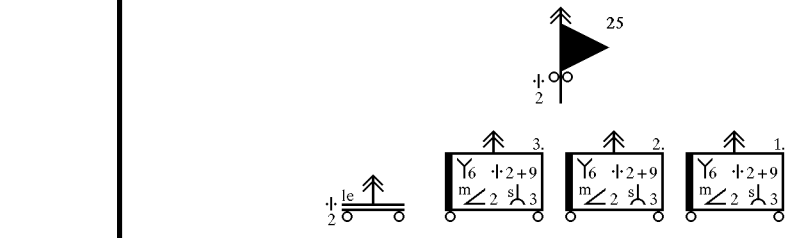
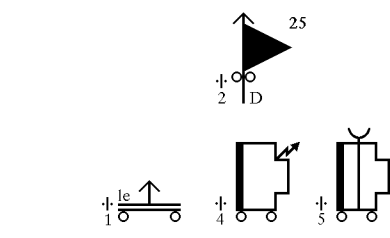
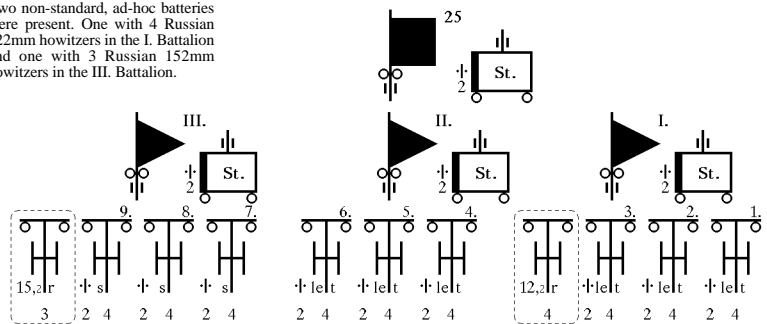

The 29. Panzergrenadier Division was still reforming after its destruction at Stalingrad. This is the proposed organization dated 5.07.1943. Most units were not filled up with personnel or equipment on this date.

5.07.1943

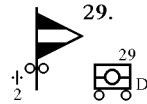

The 129. Panzer Battalion was ordered to convert to Sturmgeschütz on 15.07.1943.

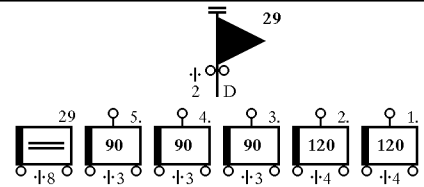
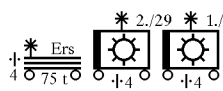
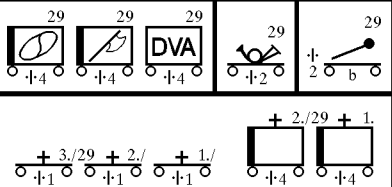
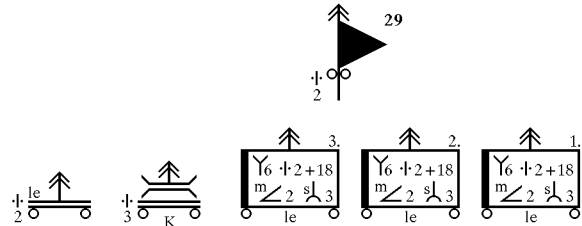
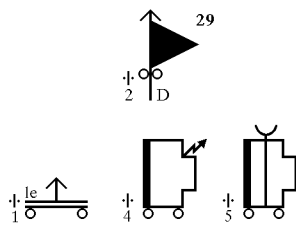
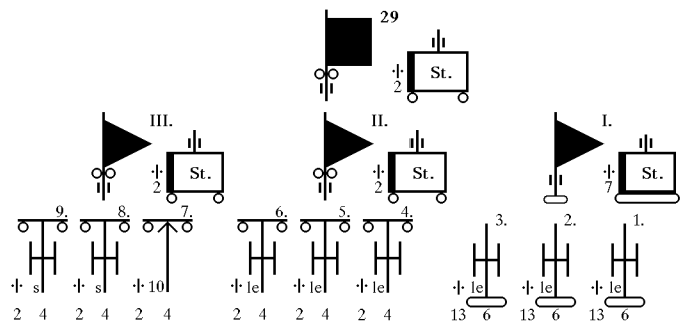
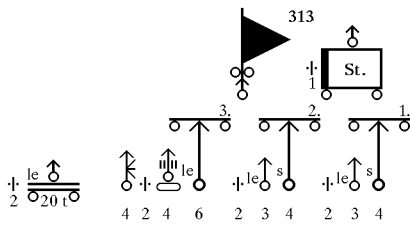
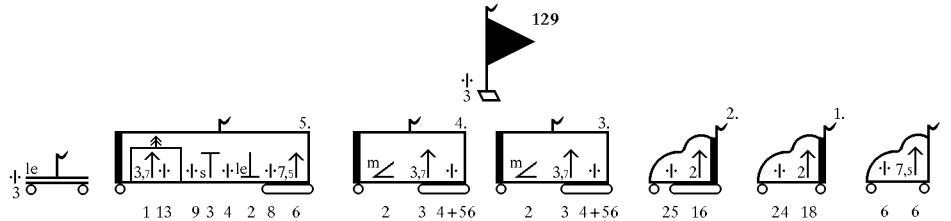
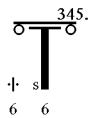
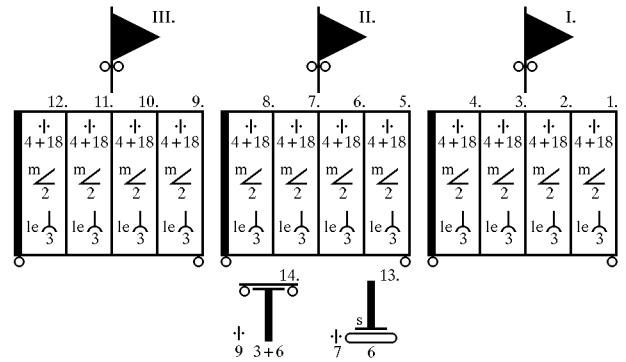
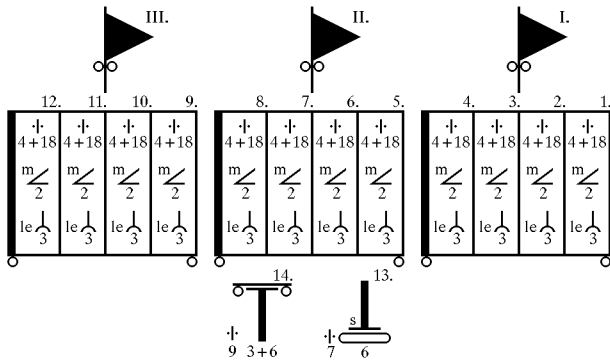
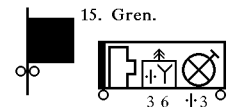
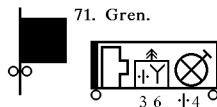
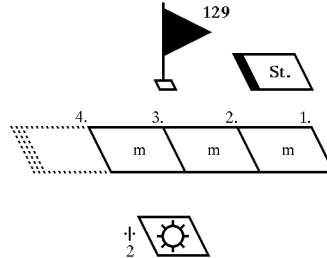

The Feldherrnhalle (FHH) Panzergrenadier Division was the former 60. Infanterie-Division (motorisiert), redesignated on 20.06.1943. It was still reforming after its destruction at Stalingrad. This is the proposed organization dated 5.07.1943. Most units were not filled up with personnel or equipment on this date.

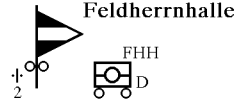

5.07.1943

The FHH Panzer Battalion was ordered to convert to Sturmgeschütz on 15.07.1943.

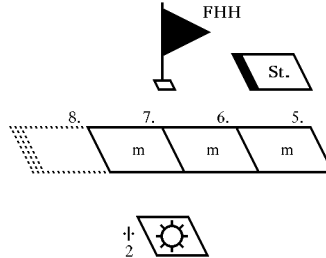

FHH Füs.

FHH Gren.

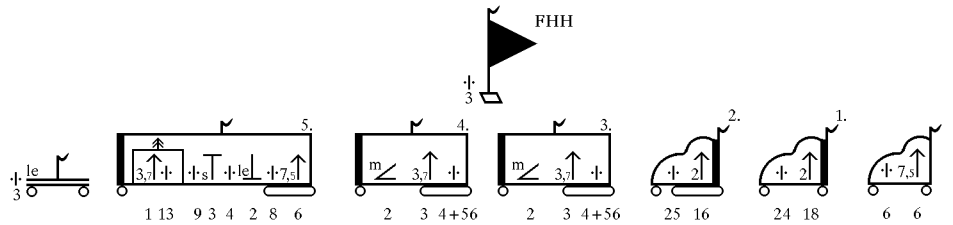
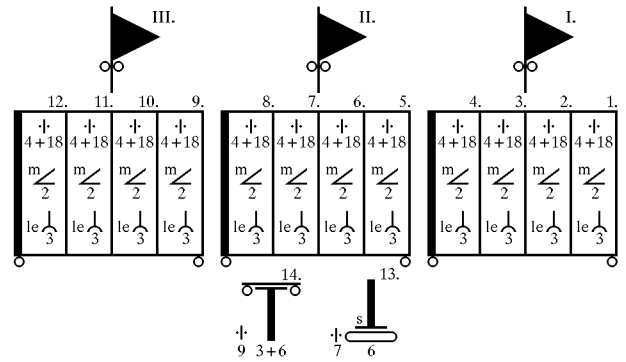
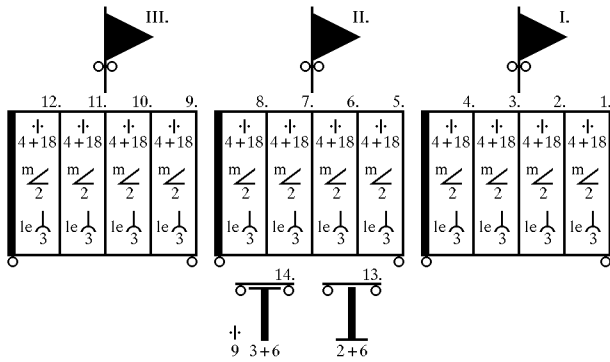

The 282. Heeres-Flak-Abteilung was redesignated as the FHH Flak Abteilung on 17.07.1943.

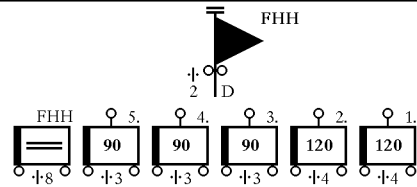
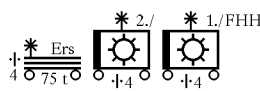
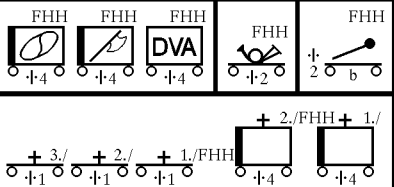
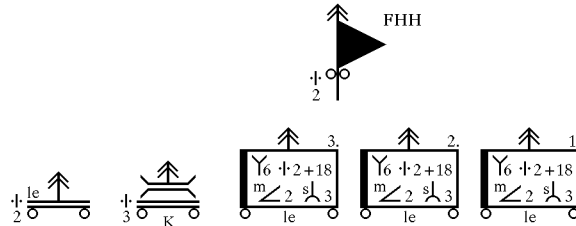
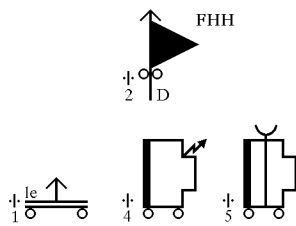
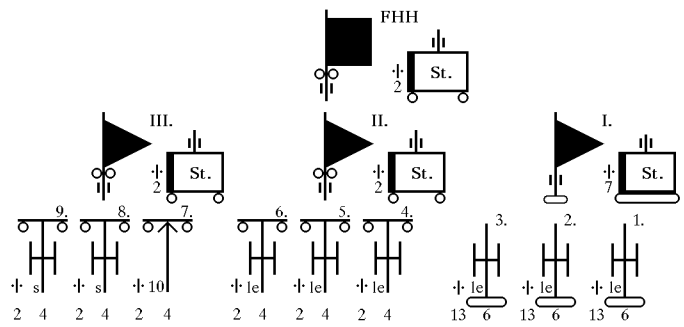
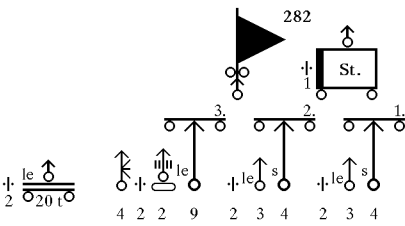



The Division Sardinien was redesignated on 6.07.1943 as the 90. Panzergrenadier Division in memory of the former Afrika Korps formation. It was a new division formed from personnel and units originally destined for the Axis forces which had been stranded in Italy when the Axis forces capitulated in North Africa.

This was the authorized organization on 1.07.1943. Motor vehicles were not available in the necessary numbers, and most battalions were only partially motorized. Heavy anti-tank guns were not available in the indicated numbers.

The designations were changed as the divisions' units became established.

Unit	Date	Becomes
Division Sardinien	6.07.1943	90. Pz. Gren. Division
Panzer Battalion Sardinien	12.07.1943	190. Panzer Battalion
Pz. Gren. Regiment Sardinien 1	6.07.1943	155. Panzer-Grenadier-Regiment
Pz. Gren. Regiment Sardinien 2	6.07.1943	200. Panzer-Grenadier-Regiment
853. Sturm Regiment (mot)	6.07.1943	361. Panzer-Grenadier-Regiment
61. Sturm Battalion (mot) new	6.07.1943	IL/361. Panzer-Grenadier-Regiment
Artillery Regiment Sardinien (mot)	6.07.1943	Hqs. / 190. Anti-Tank Battalion
Hqs. and 2. Radio Company new	1.07.1943	190. Artillery Regiment (mot)
190. Motor Maintenance Company new	6.07.1943	190. Signal Battalion
639. Field Post Detachment	10.07.1943	1./190. Motor Supply Battalion
190. Medical Company	10.07.1943	2./190. Motor Maintenance Company
2.999. Medical Company	7.07.1943	190. Field Post Detachment
190. Ambulance Platoon	10.07.1943	1./190. Medical Company
641. Ambulance Platoon	10.07.1943	2./190. Medical Company
642. Ambulance Platoon	10.07.1943	1./190. Ambulance Platoon
	10.07.1943	2./190. Ambulance Platoon
	10.07.1943	3./190. Ambulance Platoon

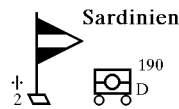

1.07.1943

The 3./190. Panzer Company was authorized on 24.07.1943. Sturmgeschütz-III were not issued until February 1944

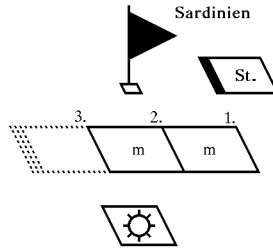

III. Battalions for all three regiments were planned at this time.

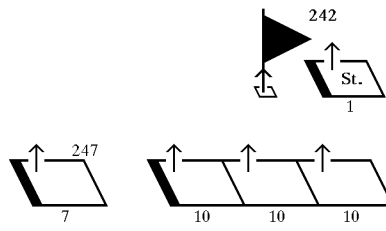
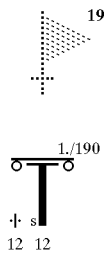
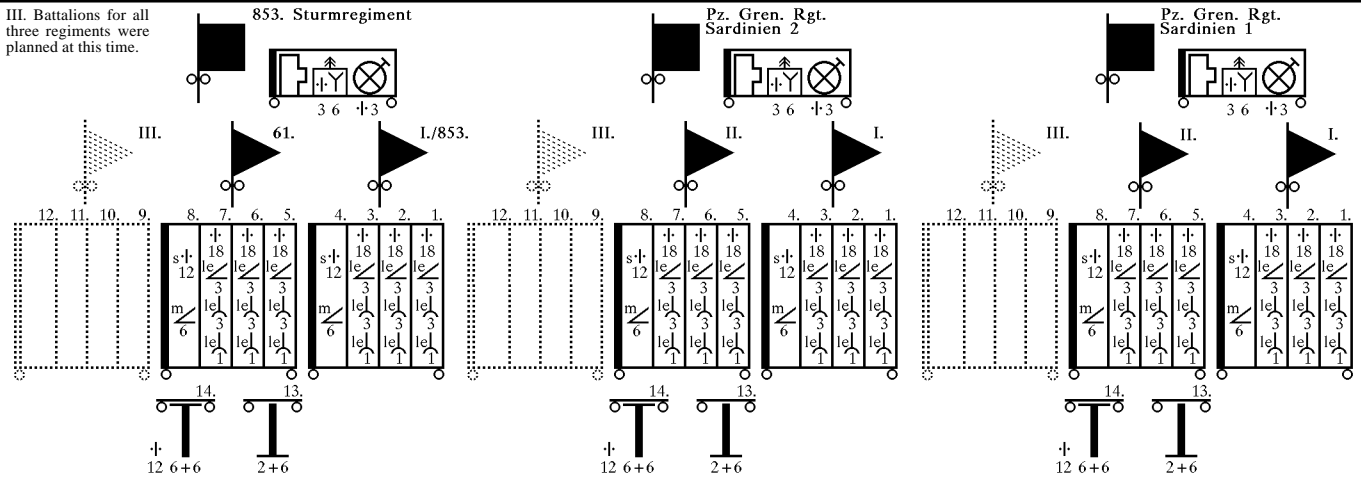

The II./5 Luftwaffe Flak Battalion was attached on this date. It had 3 heavy (88mm) batteries, 2 light (20mm) batteries, and a light column.

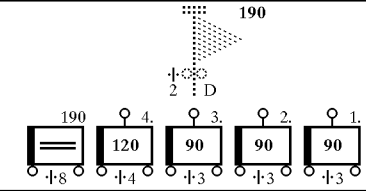
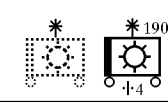
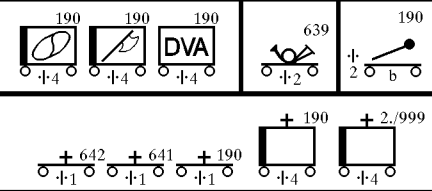
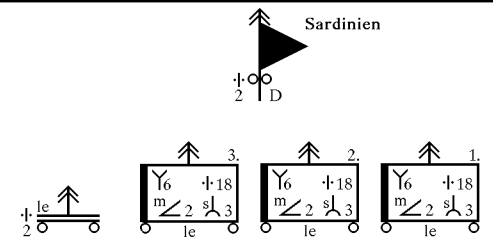
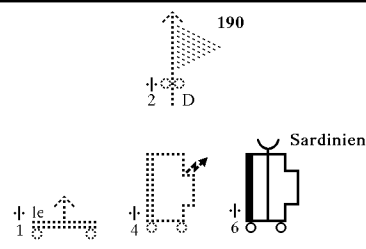
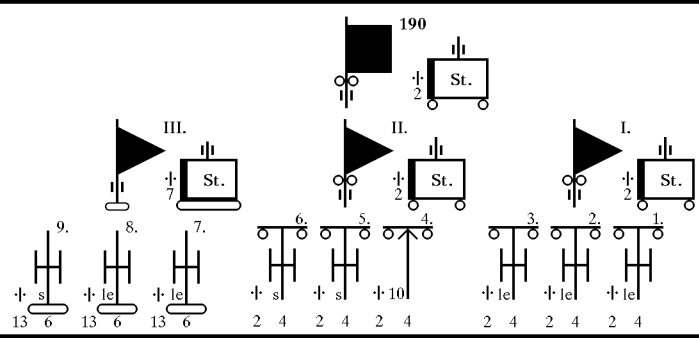

**STAB, PANZER- und PANZERGRENADIER-DIVISION**  
**Headquarters, Panzer and Panzer-Grenadier Division**

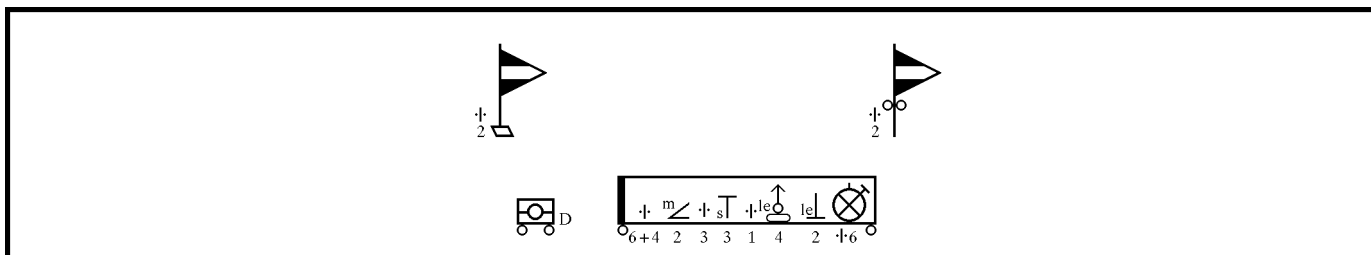

**KStN 51**  
1.11.1941

**Headquarters, Panzer and Panzer-Grenadier Division**

Div Hqs: (19 Off; 12 GSO; 29 NCO; 67 EM).  
 Div Gds: 1 truck (medium); 1 Infantry Squad with 2 LMG.  
 Mcl Det: 6 Sect: 5 mcl; 1 mcl w/sc.  
 Maint Sect: 1 mcl w/sc; 1 car (2/40).  
 Motor Pool: 3 mcl; 5 cars (light); 5 cars (medium); 4 cars (15); 1 car (21);  
 5 trucks (light); 6 trucks (medium); 2 buses (light); 1 bus (medium – converted to office use).

**KStN 2076**  
1.01.1942

**Motorized Divisional Mapping Detachment**

Det: 1 car (1); 1 bus (medium – converted to office use); 1 van (2-ton).

**KStN 126**  
12.01.1943

**Divisional Escort Company / Grossdeutschland**

Co Hqs: 5 mcl; 2 mcl w/sc; 1 car (15).  
 Inf Plt: Hqs Sect: 1 mcl; 1 car (15).  
 3 Inf Sqd: 2 trucks (70); 1 Infantry Squad w/ 2 LMG.  
 HMG Plt: Hqs Sect: 1 mcl; 1 mcl w/sc; 1 car (15).  
 3 HMG Sect: 2 trucks (70); 2 HMG.  
 1 Mortar Sect: 3 trucks (70); 2 mortars (81mm).  
 ATG Plt: Hqs Sect: 1 mcl; 1 mcl w/sc; 1 car (1); 2 Maultier (3).  
 Gun Sect: 3 Maultier; 3 ATG (76.2mm or 75mm – towed); 3 LMG.  
 AA Plt: Hqs Sect: 4 mcl; 1 car (15); 1 LMG.  
 Gun Sect: 2 halftracks (10/4 without guns); 4 halftracks (10/4 with 20mm Flak 38); 4 trailers (ammo).  
 lt IG Plt: Hqs Sect: 1 mcl; 1 mcl w/sc; 1 car (12).  
 Gun Sect: 6 cars (12); 2 lt IG (75mm – towed); 4 trailers (ammo).  
 Mcl Plt: Hqs Sect: 1 mcl; 2 cars (15).  
 3 Mcl Sect: 1 mcl; 4 mcl w/sc; 2 LMG.  
 1 Mcl Sect: 8 mcl.  
 Maint Sect: 1 mcl w/sc; 1 car (2/40).  
 Co Trains: 1 car (15); 2 trucks (2-ton); 2 trucks (medium); 2 trucks (3-ton).

**NOTES:**

Only the Grossdeutschland had a standard Escort Company with its own KStN. Other divisions had also been ordered to raise escort companies, but these were made up of various different KStN, or selected portions thereof. They had the

same components as KStN 126, it was just that there was no formalized KStN for Divisional Escort Companies as such until 1.11.1943. The 21. Panzer-Division Escort Company did not have AA and ATG Platoons.

Division	Escort Company	Activated	WK	Commanded by
1. Panzer	yes	15.10.35	IX	Gen.Lt. Walter Krüger
2. Panzer	–	15.10.35	XVII	Gen.Lt. Vollrath Lübbe
3. Panzer	–	15.10.35	III	Gen.Lt. Franz Westhoven
4. Panzer	–	10.11.38	XIII	Gen.Lt. Dietrich von Saucken
5. Panzer	–	24.11.38	VIII	Gen.Lt. Ernst Felix Faeckenstedt
6. Panzer	–	18.10.39	VI	Gen.Maj. Walther von Hünersdorff
7. Panzer	–	18.10.39	IX	Gen.Lt. Hans Fhr. von Funck
8. Panzer	–	16.10.39	III	Gen.Lt. Sebastian Fichtner
9. Panzer	–	3.01.40	XVII	Gen.Lt. Walter Scheller
11. Panzer	–	1.08.40	VIII	Gen.Maj. Johann Mickl
12. Panzer	–	5.10.40	II	Gen.Lt. Erpo Frh. von Bodenhausen
13. Panzer	–	11.10.40	XI	Gen.Lt. Hellmuth von der Chevallerie
14. Panzer	yes	1.04.43	IV	Gen.Maj. Friedrich Sieberg
16. Panzer	yes	5.03.43	VI	Gen.Maj. Rudolf Sieckenius
17. Panzer	–	1.11.40	VII	Gen.Lt. Walter Schilling
18. Panzer	–	26.10.40	IV	Gen.Maj. Karl-Wilhelm von Schlieben
19. Panzer	–	1.11.40	XI	Gen.Maj. Gustav Schmidt
20. Panzer	–	15.10.40	IX	Gen.Lt. Mortimer von Kessel
21. Panzer	yes	4.07.43	VI	Gen.Lt. Edgar Feuchtinger
23. Panzer	–	21.09.41	V	Gen.Lt. Nikolaus von Vormann
24. Panzer	yes	1.03.43	I	Gen.Lt. Maximilian Frh. von Edelsheim
25. Panzer	–	15.02.42	VI	Gen.Lt. Adolf von Schell
26. Panzer	–	14.09.42	III	Gen.Lt. Smilo Frh. von Lüttwitz
GD Panzer-Grenadier	yes	12.03.42	III	Gen.Maj. Walter Hoernlein
3. Panzer-Grenadier	–	23.06.43	III	Gen.Lt. Hubert-Fritz Graeser
10. Panzer-Grenadier	–	23.06.43	XIII	Gen.Lt. August Schmidt
15. Panzer	–	1.07.43	XII	Gen.Lt. Eberhard Rodt
16. Panzer-Grenadier	–	23.06.43	VI	Gen.Lt. Gerhard Graf von Schwerin
18. Panzer-Grenadier	–	23.06.43	VIII	Gen.Lt. Werner von Erdmannsdorf
20. Panzer-Grenadier	–	23.06.43	X	Gen.Lt. Georg Jauer
25. Panzer-Grenadier	–	23.06.43	V	Gen.Maj. Anton Grassler
29. Panzer-Grenadier	–	23.06.43	IX	Gen.Lt. Walter Fries
FHH Panzer-Grenadier	–	20.06.43	XX	Gen.Lt. Otto Kohlermann
Sardinien Panzer-Grenadier	–	12.05.43	III	Gen.Maj. Carl-Hans Lungershausen

Gen.Maj. = Generalmajor (US equivalent is Brigadier General)  
 Gen.Lt. = Generalleutnant (US equivalent is Major General)

**PANZER-REGIMENT**  
**Panzer Regiment**

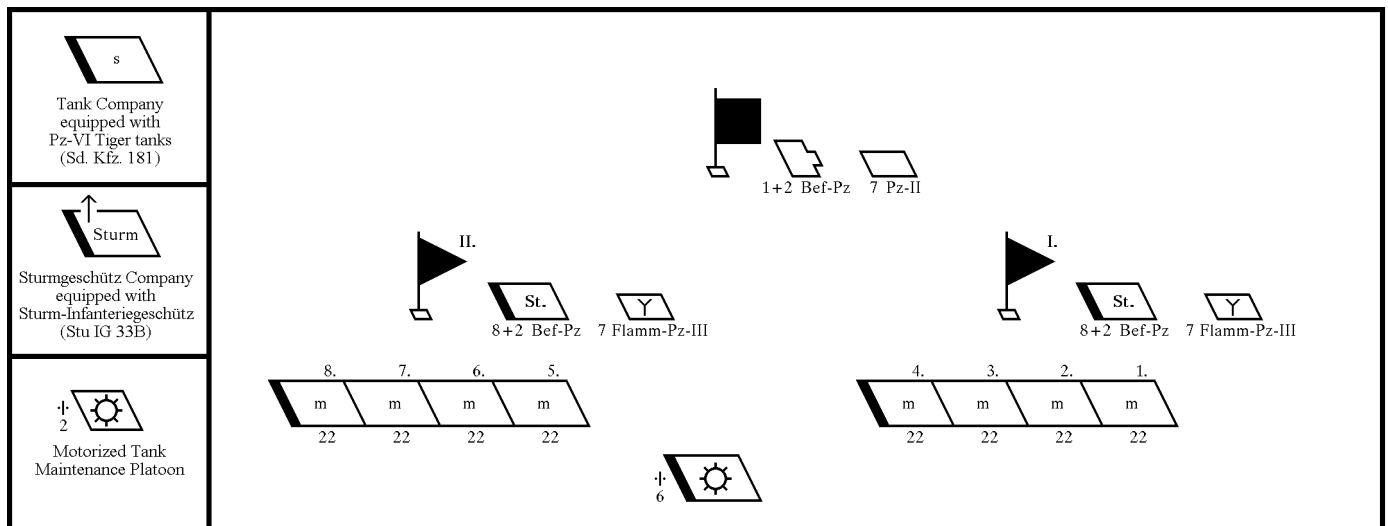

**KStN 1103**  
1.11.1941

**Headquarters, Tank Regiment**

Rgt Hqs: 4 mcl; 2mcl w/sc; 2 cars (15); 1 car (21).  
Recon Plt: 7 tanks.  
Signal Plt: 1 mcl w/sc; 1 car (15); 1 medium tank; 2 Bef-Pz (Pz-III or Pz-IV as command tanks).  
Maint Sect: 1 mcl w/sc; 1 car (2/40); 1 truck (3-ton).  
Rgt Trains: 2 mcl; 1 car (1); 2 trucks (light); 2 trucks (2-ton); 5 trucks (3-ton); 1 bus (medium/30 seats).

**KStN 1187**  
1.06.1942

**Motorized Tank Maintenance Company**

Co Hqs: 1 mcl; 1 mcl w/sc; 1 car (light); 1 car (1); 1 truck (medium); 1 AA car (4 w/ dual MG).  
2 Workshop Plt: 7 trucks (3-ton); 2 trucks (4.5-ton); 2 vans (4.5-ton); 1 bus (medium/22 seats); 1 trailer (tool); 1 trailer (welding); 2 LMG.  
Recovery Plt: 2 mcl w/sc; 1 car (1); 1 motor crane (100 – 3-ton); 1 halftrack crane (9/1 – 6-ton); 2 halftracks (7); 6 halftracks (9); 2 trailers (10-ton/light tank); 4 trailers (22-ton/medium tank).  
Armorer Sect: 1 mcl w/sc; 1 car (15); 4 trucks (medium).  
Signal Maint Sect: 1 truck (2-ton); 2 vans (42); 1 trailer (generator).  
Co Trains: 1 mcl w/sc; 1 car (light); 4 trucks (medium).

**KStN 1185**  
1.06.1942

**Motorized Tank Maintenance Platoon**

Plt Hqs: 1 mcl w/sc; 1 car (1).  
Workshop Det: 9 trucks (3-ton); 1 van (79); 1 bus (medium/22 seats); 1 trailer (tool); 1 trailer (welding); 2 LMG.  
Recovery Det: 1 mcl w/sc; 1 car (1); 1 halftrack (7); 3 halftracks (9); 1 halftrack crane (9/1 – 6-ton capacity); 1 trailer (10-ton/light tank); 1 trailer (22-ton/medium tank).  
Armorer Sect: 1 mcl w/sc; 1 car (15); 2 trucks (medium).  
Signal Maint Sect: 1 truck (light); 2 vans (42); 1 trailer (generator).  
Plt Trains: 1 mcl w/sc; 1 car (light); 3 trucks (medium).

**KStN 1107**  
1.04.1943

**Headquarters, Tank Battalion**

Bn Hqs: 2 mcl; 3 VW (1); 3 cars (15); 1 truck (2-ton).

**KStN 1150b**  
25.01.1943

**Headquarters Company, Medium Tank Battalion**

Co Hqs: 2 mcl; 1 car (15).  
Recon Plt: 7 medium tanks.  
Signal Plt: 1 mcl; 1 car (15); 1 medium tank; 2 Bef-Pz (Pz-III or Pz-IV as command tanks).  
Scout Plt: Hqs Sect: 3 mcl; 1 VW (1).  
4 Sect: 3 mcl; 1 VW (1); 1 LMG.  
*[These platoons were only present when authorized by special order for each battalion]*  
Engineer Plt: Hqs Sect: 1 mcl; 1 Schwimm-VW (1/20); 2 trucks (4.5-ton); 2 halftracks (10).  
3 Engineer Sect: ride in Headquarters Section trucks (4.5-ton); 1 Engineer Section w/ 1 LMG.  
Anti-Aircraft Plt: Hqs Sect: 2 mcl; 3 VW (1).  
Ammo Sect: 3 halftrack (10/4 w/o guns as ammo carriers).  
3 AA Sect: 2 halftracks (10/4 with 20mm Flak).  
Co Maint Sect: 1 VW (1); 1 car (2/40); 1 truck (3-ton); 1 truck (4.5-ton).  
Co Trains: 2 cars (1); 3 trucks (3-ton); 1 truck (4.5-ton); 1 LMG.  
Medic Sect: 1 VW (1); 1 truck (3-ton); 1 ambulance (31); 1 SPW (251/8).  
Bn Admin Det: 3 cars (1); 2 trucks (3-ton); 30 trucks (4.5-ton); 1 LMG.

**KStN 1190**  
25.01.1943

**Flame-Throwing Tank Platoon**

Plt: 7 Flamm-Pz-III (141).

**KStN 1175a**  
25.01.1943

**Medium Tank Company**

Co Hqs: 4 mcl; 1 car (15); 2 medium tanks.  
4 Tank Plt: 5 medium tanks.  
Maint Sect: 1 VW (1); 1 car (2/40); 1 truck (3-ton); 1 truck (4.5-ton); 2 halftracks (10).  
Co Trains: 3 VW (1); 2 trucks (medium); 2 trucks (3-ton); 2 trucks (4.5-ton).

**KStN 1176e**  
5.03.1943

**Heavy Tank Company (Tiger)**

Co Hqs: 3 mcl; 1 mcl w/sc; 1 car (15); 2 Pz-VI (181).  
3 Plt: 4 Pz-VI (181).  
Co Maint Sect: 3 VW (1); 1 car (2/40); 1 truck (3-ton); 1 truck (4.5-ton); 1 halftrack (10).  
Co Trains: 1 mcl w/sc; 2 VW (1); 2 trucks (3-ton); 6 trucks (4.5-ton); 1 LMG.

**NOTES:**

This organization applied officially as of 14.06.1943 for all Panzer units, although by no means all of them conformed to it on 30.06.1943. One tank battalion of all Panzer regiments was eventually to be equipped with Pz-IV. The other with Pz-V Panthers. Most of the latter battalions were already in Germany or France preparing for the conversion to Panther tanks.

The 25.01.1943 KStN eliminated light and medium tank companies. Medium companies originally were supposed to have 14 Pz-IV tanks, light companies 17 Pz-III. As of 15.03.1943 all authorized combat tanks were defined as being medium. In fact, many companies tended to have a mixed composition, although continuing with the old classifications. Medium tanks were Pz-III (short and long 50mm guns, as well as short 75mm guns) and Pz-IV (short and long 75mm guns). The regimental Pz-II were replaced by medium tanks when they were lost.

The Sturm-Infanterie-Geschütz-Kompanie in the 23. Panzer Division was equipped with armored Sturm-Infanteriegeschütz 33B on Sturmgeschütz chassis. It was organized under KStN 1159, Ausführung A. [See page 48.]

Battalion Headquarters Companies not authorized the armored Engineer and self-propelled 20mm Anti-Aircraft Platoons continued on with the motorized versions of the 1941 KStN.

The following Panzer battalions had flame tank platoons: 1. Pz.Div (2), 6. Pz.Div. (2), 11. Pz.Div. (2), 14. Pz.Div. (1), 16. Pz.Div. (1), 24. Pz.Div. (2), 26. Pz.Div. (2), GD Div. (2).

[A breakdown of the Panzer unit organizations and tank strengths is detailed on page 74.]

**PANZER-STURMGESCHÜTZ-ABTEILUNG**  
**Tank Battalion (Sturmgeschütz)**

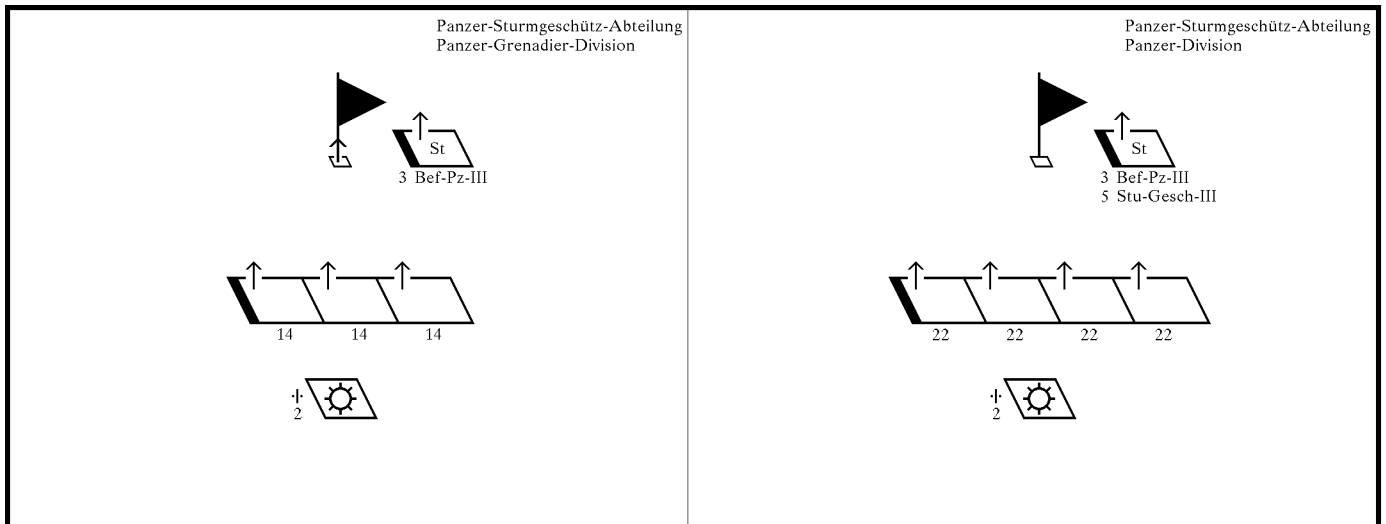

**KStN 1107**  
1.04.1943

**Headquarters, Tank Battalion / Panzer-Grenadier-Division**  
Bn Hqs: 2 mcl; 3 VW (1); 3 cars (15); 1 truck (2-ton).

**KStN 1157a**  
20.06.1943

**Headquarters Company, Tank Battalion (Sturmgeschütz)(45 Sturmgeschütz) / Panzer-Grenadier-Division**  
Bty Hqs: 2 mcl; 1 car (15).  
Signal Plt: 1 mcl; 1 car (15 with Lt Tele Sect); 3 Bef-Pz III (141 as command tank).  
Scout Plt: Hqs Sect: 3 mcl; 1 VW (1).  
3 Scout Sect: 1 mcl; 2 VW (1); 1 Scout Squad with 2 LMG.  
Engr Plt: Hqs Sect: 1 mcl; 1 VW (1/20); 2 trucks (4.5-ton); 2 SPW (250/1).  
3 Engr Sect: 1 Engineer Section with 1 LMG (ride in Headquarters Section vehicles).  
AA Plt: Hqs Sect: 1 mcl; 1 VW (1).  
3 AA Sect: 1 halftrack (7/1 with 20mm quad Flak); 1 Maultier (3).  
Co Maint Sect: 1 VW (1); 1 truck (1.5-ton as 2/40); 1 truck (3-ton); 1 truck (4.5-ton).  
Medic Sect: 1 VW (1); 1 truck (medium); 1 ambulance (31); 1 armored ambulance (251/8).  
Co Trains: 2 cars (light); 1 VW (1); 5 trucks (medium); 2 trucks (3-ton); 1 truck (4.5-ton); 1 LMG.  
Bn Admin Det: 2 mcl; 1 car (light); 1 VW (1); 1 truck (3-ton); 15 trucks (heavy); 15 trucks (4.5-ton); 1 LMG.

**KStN 1185**  
1.06.1942

**Motorized Tank Maintenance Platoon**  
Plt Hqs: 1 mcl w/sc; 1 car (1).  
Workshop Det: 9 trucks (3-ton); 1 van (79); 1 bus (medium/22 seats); 1 trailer (tool); 1 trailer (welding); 2 LMG.  
Recovery Det: 1 mcl w/sc; 1 car (1); 1 halftrack (7); 3 halftracks (9); 1 halftrack crane (9/1 – 6-ton capacity); 1 trailer (10-ton/light tank); 1 trailer (22-ton/medium tank).  
Armorer Sect: 1 mcl w/sc; 1 car (15); 2 trucks (medium).  
Signal Maint Sect: 1 truck (light); 2 vans (42); 1 trailer (generator).  
Plt Trains: 1 mcl w/sc; 1 car (light); 3 trucks (medium).

**KStN 1159 (A)**  
20.06.1943

**Tank (Sturmgeschütz) Company (14 Sturmgeschütz) / Panzer-Grenadier-Division**  
Co Hqs: 4 mcl; 1 car (15); 2 Sturmgeschütz III (142/1).  
3 StuG Plt: 4 Sturmgeschütz III (142/1).  
Co Maint Sect: 1 VW (1); 1 car (2/40); 2 trucks (medium); 2 halftracks (10).  
Co Trains: 1 car (light); 3 trucks (light); 3 trucks (medium); 5 trucks (4.5-ton); 2 LMG.

**KStN 1107**  
1.04.1943

**Headquarters, Tank Battalion / Panzer-Division**  
Bn Hqs: 2 mcl; 3 VW (1); 3 cars (15); 1 truck (2-ton).

**KStN 1157**  
10.04.1943

**Headquarters Company, Tank Battalion (Sturmgeschütz) / Panzer-Division**  
Co Hqs: 2 mcl; 1 car (15).  
Recon Plt: 5 Sturmgeschütz (141).  
Signal Plt: 1 mcl; 1 car (15 with Lt Tele Sect); 3 Bef-Pz-III (266).  
Scout Plt: Hqs Sect: 3 mcl; 1 VW (1).  
3 Sect: 1 mcl; 2 VW (1); 1 Scout Section with 2 LMG.  
Engr Plt: Hqs Sect: 1 mcl; 1 VW (1/20); 2 trucks (4.5-ton); 2 SPW (250/1).  
3 Engr Sect: 1 Engineer Section with 1 LMG (ride in Headquarters Section vehicles).  
AA Plt: Hqs Sect: 3 mcl; 1 car (15).  
3 AA Sect: 1 halftrack (7/1 with 20mm quad Flak); 1 halftrack (7/1 without gun, as ammo carrier).  
Maint Sect: 1 VW (1); 1 car (2/40); 1 truck (3-ton); 1 truck (heavy).  
Medic Sect: 1 VW (1); 1 truck (medium); 1 ambulance (31); 1 armored ambulance (251/8).  
Co Trains: 1 car (light); 1 VW (1); 4 trucks (medium); 1 truck (heavy); 1 LMG.  
Bn Admin & Supply Det: 2 mcl; 2 cars (light); 1 VW (1); 3 trucks (medium); 1 truck (3-ton); 15 trucks (heavy); 15 trucks (4.5-ton); 1 LMG.

**KStN 1185**  
1.06.1942

**Motorized Tank Maintenance Platoon**  
Plt Hqs: 1 mcl w/sc; 1 car (1).  
Workshop Det: 9 trucks (3-ton); 1 van (79); 1 bus (medium/22 seats); 1 trailer (tool); 1 trailer (welding); 2 LMG.  
Recovery Det: 1 mcl w/sc; 1 car (1); 1 halftrack (7); 3 halftracks (9); 1 halftrack crane (9/1 – 6-ton capacity); 1 trailer (10-ton/light tank); 1 trailer (22-ton/medium tank).  
Armorer Sect: 1 mcl w/sc; 1 car (15); 2 trucks (medium).  
Signal Maint Sect: 1 truck (light); 2 vans (42); 1 trailer (generator).  
Plt Trains: 1 mcl w/sc; 1 car (light); 3 trucks (medium).

**KStN 1158**  
10.04.1943

**Tank (Sturmgeschütz) Company (22 Sturmgeschütz) / Panzer-Division**  
Co Hqs: 4 mcl; 1 car (15); 2 Sturmgeschütz-III (142/1).  
4 StuG Plt: 5 Sturmgeschütz-III (142/1).  
Maint Sect: 1 VW (1); 1 car (2/40); 1 truck (3-ton); 1 truck (4.5-ton); 2 halftracks (10).  
Co Trains: 1 car (light); 2 VW (1); 1 trucks (medium); 3 trucks (3-ton); 5 trucks (4.5-ton); 2 LMG.

**NOTES:**

On 20.06.1943, the OKH ordered a special organization for the Panzer battalions of the Panzer-Grenadier-Divisions, authorizing 45 Sturmgeschütz III (Sd.Kfz. 141) and 3 Befehls-Panzer-III (Sd.Kfz. 266) each. This organization was not applied until after mid-July 1943.

The 14., 16., and 24. Panzer-Divisions were organized with a III. Battalion, each equipped with 93 Sturmgeschütz III (Sd.Kfz. 141) and 3 Befehls-Panzer-III (Sd.Kfz. 266).  
[A breakdown of the Panzer unit organizations and tanks strengths is detailed on page 74.]

**100. PANZER-REGIMENT**  
**100th Panzer Regiment**

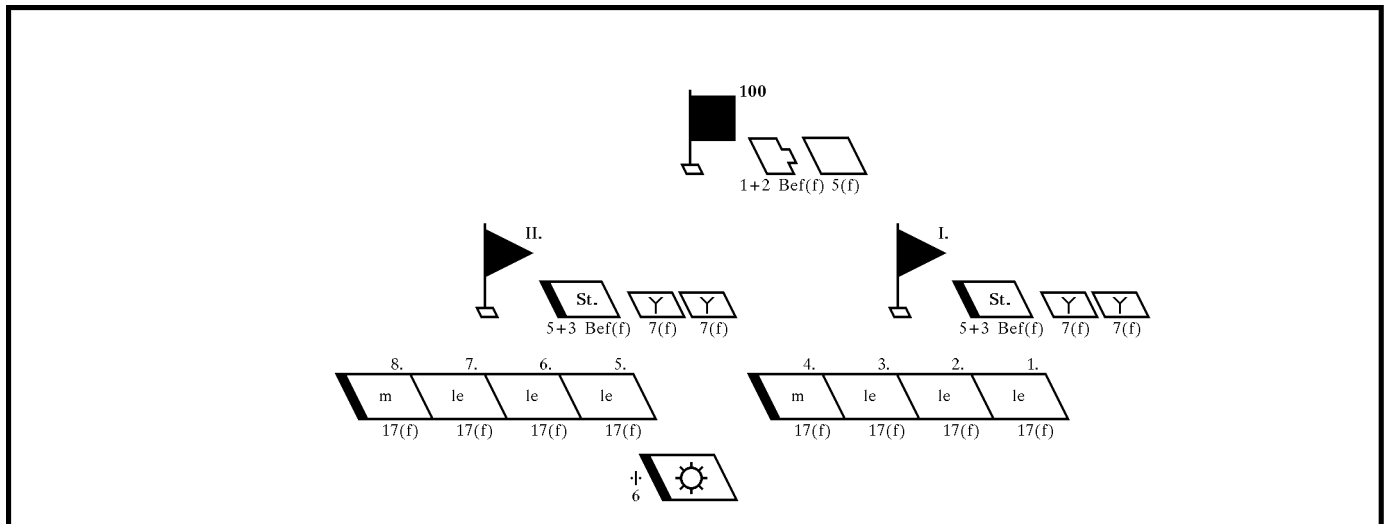

- KStN 1103c**  
1.11.1941  
**Headquarters, Tank Regiment (captured equipment)**  
Rgt Hqs: 4 mcl; 2 mcl w/sc; 3 cars (medium-cc); 1 car (heavy-cc).  
Signal Plt: Hqs Sect: 1 mcl w/sc; 1 car (light); 1 Pz-H38(f).  
2 Armd Radio Sect: 1 Bef-Pz-S35(f).  
1 Lt Tele Sect c: 1 car (medium-cc/telephone).  
2 Lt Radio Sect c: 1 car (medium-cc/radio).  
Recon Plt: 1 mcl w/sc; 4 Pz-H38(f); 1 Pz-S35(f).  
Maint Sect: 1 mcl w/sc; 1 car (light-cc, equipped as Kfz. 2/40); 1 truck (medium-cc).  
Rgt Hqs Trains: 1 car (light); 1 car (light-cc); 1 car (medium-cc); 4 trucks (light); 2 trucks (medium-cc).
- KStN 1107c**  
1.02.1941  
**Headquarters, Tank Battalion (captured equipment)**  
Bn Hqs: 2 mcl; 2 mcl w/sc; 1 car (light); 3 cars (medium-cc).  
Bn Admin Sect: 1 mcl; 1 car (light); 2 cars (medium-cc); 1 truck (light).
- KStN 1150c**  
1.02.1941  
**Headquarters Company, Tank Battalion (captured equipment)**  
Co Hqs: 3 mcl; 1 car (medium-cc); 1 truck (2-ton).  
Recon Plt: 1 mcl w/sc; 4 Pz-H38(f); 1 Pz-S35(f).  
Signal Plt: Hqs Sect: 1 mcl; 1 car (medium-cc); 1 car (15).  
2 Armd Radio Sect: 1 Bef-Pz-S35(f)  
1 Armd Radio Sect: 1 Bef-Pz-H38(f)  
2 Lt Radio Sect e: 1 van (17).  
Scout Plt: Hqs Sect: 3 mcl; 1 car (light-cc).  
4 Sect: 1 mcl; 2 mcl w/sc; 1 LMG.  
Co Maint Sect: 1 mcl w/sc; 1 car (light-cc, equipped as Kfz. 2/40); 1 truck (3-ton).  
Bn Trains: 1 mcl w/sc; 3 cars (light-cc); 11 trucks (medium-cc); 1 ambulance (31); 1 armored ambulance (French).
- KStN 1190**  
25.01.1943  
**Flame-Throwing Tank Platoon**  
Plt: 7 Flamm-Pz-B2(f).
- KStN 1187**  
1.06.1942  
**Motorized Tank Maintenance Company, Tank Battalion**  
Co Hqs: 1mcl; 1 mcl w/sc; 1 car (light); 1 car (1); 1 truck (medium); 1 AA car (equipped as Kfz. 4 w/ dual MG).  
2 Workshop Plt: 7 tucks (medium-cc); 2 trucks (heavy-cc); 2 vans (heavy-cc); 1 bus (medium/22 seats); 1 trailer (tool);  
1 trailer (welding); 2 LMG.  
Recovery Plt: 2 mcl w/sc; 1 car (1); 1 motor crane (3-ton); 1 halftrack w/ 6-ton crane; 8 halftracks;  
2 trailers (10-ton/light tank); 4 trailers (22-ton/medium tank).  
Armorer Sect: 1 mcl w/sc; 1 car (medium-cc); 4 trucks (medium).  
Signal Maint Sect: 1 truck (light-cc); 2 vans (medium-cc, equipped as Kfz. 42); 1 trailer (generator).  
Co Trains: 1 mcl w/sc; 1 car (light); 4 trucks (medium).
- KStN 1171c (A)**  
1.04.1941  
**Tank Company (light)(captured equipment)**  
Co Hqs: 2 mcl; 1 mcl/sc; 1 car (medium-cc); 2 Pz-S35(f); 2 trucks (light-cc).  
3 Tank Plt: 4 Pz-H38(f); 1 Pz-S35(f).  
Maint Sect: 4 mcl w/sc; 1 car (light-cc, equipped as Kfz. 2/40); 1 truck (medium-cc); 2 halftracks (10).  
Co Trains: 1 mcl w/sc; 1 car (light); 1 car (medium-cc); 1 truck (medium); 10 trucks (medium-cc).
- KStN 1171c (B)**  
1.04.1941  
**Tank Company (medium)(captured equipment)**  
Co Hqs: 2 mcl; 1 mcl/sc; 1 car (medium-cc); 2 Pz-B2(f); 2 trucks (light-cc).  
3 Plt: 5 Pz-B2(f).  
Maint Sect: 4 mcl w/sc; 1 car (light-cc, equipped as Kfz. 2/40); 1 truck (medium-cc); 2 halftracks.  
Co Trains: 1 mcl w/sc; 1 car (light); 1 car (medium-cc); 1 truck (medium); 10 trucks (medium-cc).

**NOTES:**

This organization applied to the 100. Panzer-Regiment (21. Panzer Division). The 3rd and 7th light tank companies were foreseen, but had not been raised at this time as equipment was lacking.

This organization also applied to most of the Panzer units being raised and refitted in France at this time, as they were – at least initially – equipped with French equipment. German equipment, besides a few examples for training purposes, was normally issued only to those units about to leave or leaving the Western Front for other theaters.

The cars and vehicles with a general weight classification are captured vehicles. The suffix "cc" indicates a cross-country vehicle. The armored vehicles are:  
Pz-S35(f) is a slightly modified French Somua Char 1935-S.  
Bef-Pz-S35(f) is the same vehicle converted to a command tank.  
Pz-H38(f) is a slightly modified French Hotchkiss Char 1938-H.  
Bef-Pz-H38(f) is the same vehicle converted to a command tank.  
Pz-H35(f) is a slightly modified French Hotchkiss Char 1935-H.  
Pz-B2(f) is a slightly modified French Char B1bis.  
Pz-B2(f) Flamm is a modified French Char B1bis equipped as a flame thrower.

## STURMGESCHÜTZ-ABTEILUNG Assault Gun Battalion

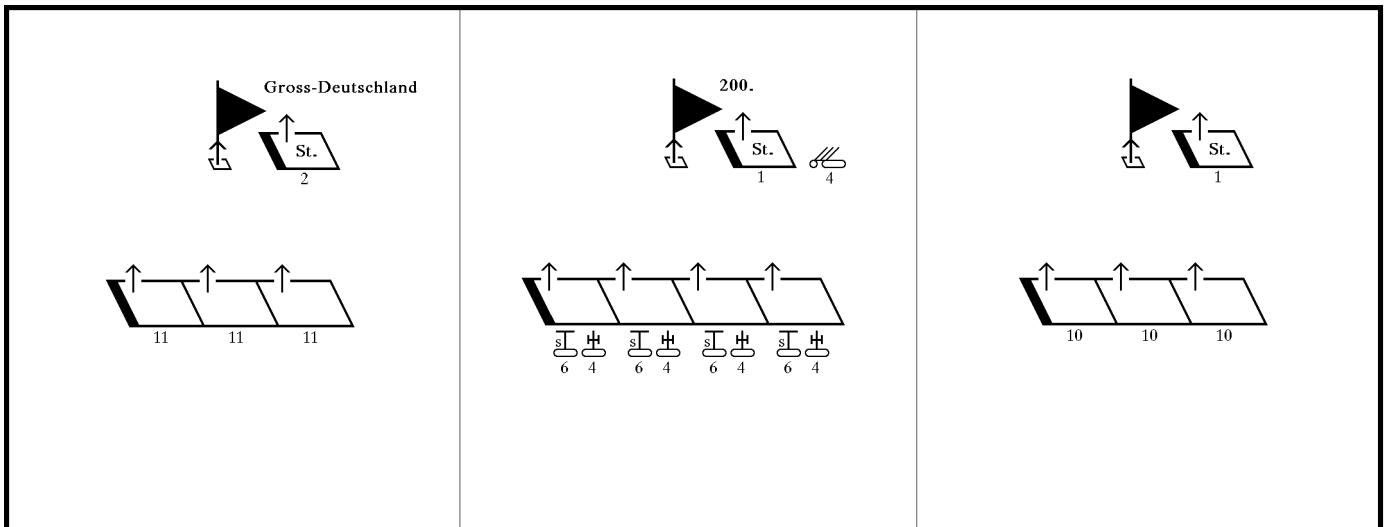

**KStN 416a \***  
1.12.1942

**Headquarters, Assault Gun Battalion / Grossdeutschland**

Bn Hqs: 4 mcl; 2 mcl w/sc; 2 cars (15); 2 Sturmgeschütz III (142/1).  
2 Lt Tele Sect c: 1 car (15).  
Lt Radio Sect b: 1 van (17).  
Bn Hqs Trains: 1 car (light); 2 trucks (light); 1 ambulance (31).

**KStN 588a**  
1.11.1942

**Headquarters Battery, Assault Gun Battalion / Grossdeutschland**

Bty Hqs: 1 mcl; 1 car (15).  
Bty Trains: 1 car (light); 1 AA car (4 w/dual MG); 5 trucks (medium).  
Bn Maintenance Det:  
Ordnance Maint Sect: 1 car (light); 2 trucks (3-ton).  
Motor Maint Sect: 1 mcl; 1 mcl w/sc; 1 car (medium); 1 bus (medium/22 seats); 8 trucks (3-ton); 1 van (79);  
1 trailer (tool); 1 trailer (welding).  
Recovery Sect: 2 halftracks (9); 1 motor crane (100 – 3-ton); 2 trailers (22-ton/medium tank).

**KStN 446a**  
1.11.1942

**Assault Gun Battery / Grossdeutschland**

Bty Hqs: 3 mcl; 1 mcl w/sc; 1 car (15); 2 Sturmgeschütz III (142/1).  
2 Lt Radio Sect b: 1 van (17).  
3 AG Plt: Hqs Sect: 2 mcl w/sc.  
Ammo Sect: 2 trucks (3-ton); 1 trailer (ammo).  
Gun Sect: 3 Sturmgeschütz III (142/1).  
Bty Maint Sect: 2 mcl w/sc; 2 trucks (medium).  
Bty Trains: 1 mcl; 1 AA car (4 w/ dual MG); 1 VW (1); 2 trucks (medium); 2 trailers (equipment / ammo).

**KStN 416**  
1.12.1942  
[modified]

**Headquarters, Assault Gun Battalion (200. Sturmgeschütz-Abteilung)**

Bn Hqs: 4 mcl; 2 mcl w/sc; 2 cars (15); 1 van (17); 1 ambulance (31); 1 SP'd 105mm field howitzer; 4 SP'd mortars (16x 81mm).

**KStN 588**  
1.04.1943

**Headquarters Battery, Assault Gun Battalion (200. Sturmgeschütz-Abteilung)**

Bty Hqs: 1 mcl; 1 car (15).  
Bty Trains: 1 car (light); 1 AA car (4 w/dual MG); 2 trucks (light); 3 trucks (medium).  
Bn Maintenance Det:  
Ordnance & Signal Maint Sect: 1 car (light); 1 truck (light); 1 truck (medium).  
Motor Maint Sect: 1 mcl; 1 mcl w/sc; 1 car (medium); 2 trucks (light); 4 trucks (medium); 1 van (79); 1 trailer (tool).  
Recovery Sect: 2 halftracks (9); 1 motor crane (100 – 3-ton); 2 trailers (22-ton/medium tank).

**KStN 446**  
1.11.1941  
[modified]

**Assault Gun Battery (200. Sturmgeschütz-Abteilung)**

Bty Hqs: 3 mcl; 1 mcl w/sc; 2 cars (15); 1 light SP'd 105mm field howitzer.  
2 AG Plt: Hqs Sect: 1 mcl w/sc.  
Ammo Sect: 1 armored ammunition carrier; 1 armored trailer (ammo).  
Gun Sect: 3 SP'd 75mm anti-tank guns  
1 AG Plt: Hqs Sect: 1 mcl w/sc.  
Ammo Sect: 1 armored ammunition carrier; 1 armored trailer (ammo).  
Gun Sect: 3 SP'd 105mm field howitzers.  
Bty Maint Sect: 2 mcl w/sc; 1 car (2/40); 1 truck (medium).  
Bty Trains: 1 mcl; 1 AA car (4 w/ dual MG); 3 trucks (light); 1 truck (2-ton); 3 trucks (medium); 5 trucks (3-ton).

**KStN 416**  
1.12.1942

**Headquarters, Assault Gun Battalion**

Bn Hqs: 4 mcl; 2 mcl w/sc; 2 cars (15); 1 van (17); 1 ambulance (31); 1 Sturmgeschütz III (142/1).

**KStN 588**  
1.04.1943

**Headquarters Battery, Assault Gun Battalion**

Bty Hqs: 1 mcl; 1 car (15).  
Bty Trains: 1 car (light); 1 AA car (4 w/dual MG); 2 trucks (light); 3 trucks (medium).  
Bn Maintenance Det:  
Ordnance & Signal Maint Sect: 1 car (light); 1 truck (light); 1 truck (medium).  
Motor Maint Sect: 1 mcl; 1 mcl w/sc; 1 car (medium); 2 trucks (light); 4 trucks (medium); 1 van (79); 1 trailer (tool).  
Recovery Sect: 2 halftracks (9); 1 motor crane (100 – 3-ton); 2 trailers (22-ton/medium tank).

**KStN 446**  
1.11.1941

**Assault Gun Battery**

Bty Hqs: 3 mcl; 1 mcl w/sc; 2 cars (15); 1 Sturmgeschütz III (142/1).  
2 AG Plt: Hqs Sect: 1 mcl w/sc.  
Ammo Sect: 1 armored ammunition carrier; 1 armored trailer (ammo).  
Gun Sect: 3 Sturmgeschütz III (142/1).  
1 AG Plt: Hqs Sect: 1 mcl w/sc.  
Ammo Sect: 1 armored ammunition carrier; 1 armored trailer (ammo).  
Gun Sect: 3 Sturmhaubitze III (142/2).  
Bty Maint Sect: 2 mcl w/sc; 1 car (2/40); 1 truck (medium).  
Bty Trains: 1 mcl; 1 AA car (4 w/ dual MG); 3 trucks (light); 1 truck (2-ton); 3 trucks (medium); 5 trucks (3-ton).

**NOTES:**

The 242. and 711. Sturmgeschütz-Abteilung were standard GHQ units assigned to Panzer-Divisions, and were not normally part of these formations. The 247. Sturmgeschütz-Batterie only had two platoons. The 200. Sturmgeschütz-Abteilung

with the 21. Panzer-Division had four batteries with French equipment, including modified self-propelled French tracked vehicles with French ordnance. The batteries used a modified KStN from those equipped with German weapons.

Order of Battle of the Panzer Division Panzergrenadier Regiments

Division	Panzergrenadier Regiment			Panzergrenadier Battalion						
	Headquarters	Companies		Hqs.	KStN	Infantry Cos.	Heavy Company Platoons			
1. Pz	1. PzG mot	9. AA Co (8 lt SP'd; 4 lt mot) Hqs Co: mot Commo + AT (hvy) + Scout Plt	10. IG SP'd Co (6 hvy)	I. mot 1941 3 mot II. mot 1941 3 mot			2 mot IG 2 mot IG	1 mot AT (75mm) 1 mot AT (75mm)	1 mot Engr 1 mot Engr	1 mot Mortar 1 mot Mortar
	113. PzG armd	9. AA Co (10 lt SP'd; 2 lt mot) Hqs Co: armd Commo + Engr + Scout + Flame Plt	10. IG SP'd (6 hvy)	I. armd 1941 3 armd II. mot 1941 3 mot			1 armd IG 2 mot IG	1 armd AT (75mm) 1 mot AT (75mm)	1 armd Engr 1 mot Engr	1 armd Gun 1 mot Mortar
2. Pz	2. PzG mot	9. IG Co mot (4 hvy) Hqs Co: mot Commo + AT (hvy) + Scout Plt	703. IG Co mot (4 hvy)	I. mot 1941 3 mot II. mot 1941 3 mot			2 mot IG 2 mot IG	1 mot AT (75mm) 1 mot AT (75mm)	1 mot Engr 1 mot Engr	– –
	304. PzG mot	9. IG Co armd (4 hvy) Hqs Co: mot Commo + AT (hvy) + Scout Plt & armd Flame Plt		I. armd 1941 3 armd II. mot 1941 3 mot			1 armd IG 2 mot IG	1 armd AT (75mm) 1 mot AT (75mm)	1 armd Engr 1 mot Engr	1 armd Gun –
3. Pz	3. PzG mot	9. IG Co mot (4 hvy) Hqs Co: mot Commo + AT (med) + Scout Plt	10. AA Co SP'd (12 lt)	I. armd 1941 2 armd+1 mot II. mot 1941 3 mot			2 mot IG 2 mot IG	2 mot AT (28 & 50mm) 2 mot AT (28 & 50mm)	1 mot Engr 1 mot Engr	1 armd Gun –
	394. PzG mot	9. IG Co mot (4 hvy) Hqs Co: mot Commo + AT (med) + Scout Plt & armd Flame Plt	10. AA Co SP'd (12 lt)	I. mot 1941 3 mot II. mot 1941 3 mot			2 mot IG 2 mot IG	2 mot AT (28 & 50mm) 2 mot AT (28 & 50mm)	1 mot Engr 1 mot Engr	– –
4. Pz	12. PzG mot	9. IG Co armd (4 hvy) Hqs Co: mot Commo + AT (med) + Scout Plt	10. Engineer Co (ad-hoc)	I. armd 1943 3 armd II. mot 1941 3 mot			1 armd IG 2 mot IG	1 armd AT (75mm) 1 mot AT (50 & 75mm)	1 armd Engr 1 mot Engr	1 armd Gun –
	33. PzG mot	9. IG Co mot (4 hvy) Hqs Co: mot Commo + AT (med) + Scout Plt	10. Engineer Co (ad-hoc)	I. mot 1941 3 mot II. mot 1941 3 mot			2 mot IG 2 mot IG	2 mot AT (50 & 75mm) 2 mot AT (50 & 75mm)	1 mot Engr 1 mot Engr	– –
5. Pz	13. PzG mot	9. IG Co mot (4 hvy) Hqs Co: mot Commo + AT (hvy) + Scout + AA Co Plt		I. mot 1941 3 mot II. mot 1941 3 mot			2 mot IG 2 mot IG	2 mot AT (50 & 75mm) 2 mot AT (50 & 75mm)	1 mot Engr 1 mot Engr	– –
	14. PzG mot	9. IG Co mot (4 hvy) Hqs Co: mot Commo + AT (hvy) + Scout + AA Co Plt	704. IG SP'd (6 hvy)	I. mot 1941 1 armd+2 mot II. mot 1941 3 mot			2 mot IG 2 mot IG	2 mot AT (50 & 75mm) 2 mot AT (50 & 75mm)	1 mot Engr 1 mot Engr	– –
6. Pz	4. PzG mot	9. IG Co armd (4 hvy) Hqs Co: mot Commo + AT (med) + Scout Plt		I. mot 1941 3 mot II. mot 1941 3 mot			2 mot IG 2 mot IG	3 mot AT (28/50/75mm) 1 mot AT (28/50/75mm)	1 mot Engr 1 mot Engr	– –
	114. PzG mot	9. IG Co mot (4 hvy) Hqs Co: mot Commo + AT (med) + Scout Plt		I. mot 1941 3 mot II. armd 1941 3 armd			2 mot IG 1 armd IG	3 mot AT (28/50/75mm) 1 armd AT (75mm)	1 mot Engr 1 armd Engr	– 1 armd Gun
7. Pz	6. PzG mot	9. IG Co armd (4 hvy) Hqs Co: mot Commo + AT (med) + Scout Plt & armd Flame Plt		I. mot 1941 3 mot II. armd 1941 3 armd			2 mot IG 2 armd IG	2 mot AT (28 & 50mm) 2 armd AT (50mm)	1 mot Engr 1 armd Engr	– –
	7. PzG mot	9. IG Co mot (4 hvy) Hqs Co: mot Commo + AT (med) + Scout Plt		I. mot 1941 3 mot II. mot 1941 3 mot			2 mot IG 2 mot IG	2 mot AT (28 & 50mm) 2 mot AT (28 & 50mm)	1 mot Engr 1 mot Engr	– –
8. Pz	8. PzG mot	9. IG Co mot (4 hvy) Hqs Co: mot Commo + AT (hvy) + Scout Plt		I. mot 1941 3 mot II. mot 1941 1 armd+2 mot			2 mot IG 2 mot IG	2 mot AT (28 & 50mm) 2 mot AT (28 & 50mm)	1 mot Engr 1 mot Engr	– –
	28. PzG mot	9. IG Co mot (4 hvy) Hqs Co: mot Commo + AT (hvy) + Scout Plt		I. mot 1941 3 mot II. mot 1941 3 mot			2 mot IG 2 mot IG	2 mot AT (28 & 50mm) 2 mot AT (28 & 50mm)	1 mot Engr 1 mot Engr	– –
9. Pz	10. PzG mot	9. IG Co armd (4 hvy) Hqs Co: mot Commo + AT (hvy) + Scout Plt & armd Flame Plt	10. AA Co SP'd (12 lt)	I. armd 1941 3 armd II. mot 1941 3 mot			2 armd IG 2 mot IG	1 armd (75mm) 1 mot AT (37 & 50mm)	1 armd Engr 1 mot Engr	1 armd Gun –
	11. PzG mot	9. IG Co mot (4 hvy) Hqs Co: mot Commo + AT (hvy) + Scout Plt	10. AA Co SP'd (12 lt) 701. IG SP'd (6 hvy)	I. mot 1941 3 mot II. mot 1941 3 mot			2 mot IG 2 mot IG	1 mot AT (37 & 50mm) 1 mot AT (37 & 50mm)	1 mot Engr 1 mot Engr	– –
11. Pz	110. PzG mot	9. IG Co mot (4 hvy) Hqs Co: mot Commo + AT (med) + Scout Plt	10. AA Co SP'd (12 lt)	I. armd 1941 2 armd+1 mot II. mot 1941 3 mot			2 mot IG 2 mot IG	1 mot AT (75mm) 1 mot AT (50mm)	1 armd Engr 1 mot Engr	1 armd Gun –
	111. PzG mot	9. IG Co mot (4 hvy) Hqs Co: mot Commo + AT (med) + Scout Plt	10. AA Co SP'd (8 lt & 2 quad)	I. mot 1941 3 mot II. mot 1941 3 mot			2 mot IG 2 mot IG	1 mot AT (50mm) 1 mot AT (50mm)	1 mot Engr 1 mot Engr	– –
12. Pz	5. PzG mot	9. IG Co mot (4 hvy) Hqs Co: mot Commo + AT (hvy) + Scout Plt		I. mot 1941 3 mot II. mot 1941 3 mot			2 mot IG 2 mot IG	1 mot AT (50mm) 1 mot AT (50mm)	1 mot Engr 1 mot Engr	– –
	25. PzG mot	9. IG Co mot (4 hvy) Hqs Co: mot Commo + AT (hvy) + Scout Plt		I. armd 1941 1 armd+2 mot II. mot 1941 3 mot			2 mot IG 2 mot IG	1 mot AT (50mm) 1 mot AT (50mm)	1 mot Engr 1 mot Engr	– –
13. Pz	66. PzG mot	9. IG Co mot (4 hvy) Hqs Co: mot Commo + AT (hvy) + Scout Plt	10. AA Co SP'd (12 lt)	I. armd 1941 3 armd II. mot 1941 3 mot			2 armd IG 2 mot IG	2 armd AT (28 & 50mm) 2 mot AT (28 & 50mm)	1 armd Engr 1 mot Engr	– –
	93. PzG mot	9. IG Co mot (4 hvy) Hqs Co: mot Commo + AT (hvy) + Scout Plt	10. AA Co SP'd (12 lt)	I. mot 1941 3 mot II. mot 1941 3 mot			2 mot IG 2 mot IG	1 mot AT (50mm) 1 mot AT (50mm)	1 mot Engr 1 mot Engr	– –
14. Pz	103. PzG armd	9. IG Co armd (4 hvy) Hqs Co: armd Commo + AT (hvy) + Scout + Flame Plt	10. AA Co SP'd (12 lt)	I. armd 1943 3 armd II. mot 1941 3 mot			1 armd IG 2 mot IG	1 armd AT (75mm) 1 mot AT (75mm)	1 armd Engr 1 mot Engr	1 armd Gun 1 mot Mortar
	108. PzG mot	9. IG Co mot (4 hvy) Hqs Co: Commo + AT (hvy) + Scout Plt	10. AA Co SP'd (12 lt)	I. mot 1941 3 mot II. mot 1941 3 mot			2 mot IG 2 mot IG	1 mot AT (75mm) 1 mot AT (75mm)	1 mot Engr 1 mot Engr	1 mot Mortar 1 mot Mortar
16. Pz	64. PzG armd	9. IG Co SP'd (6 hvy) Hqs Co: armd Commo + AT (hvy) + Scout + Flame Plt	10. AA Co SP'd (12 lt)	I. mot 1941 3 mot II. armd 1943 3 armd			2 mot IG 1 armd IG	1 mot AT (75mm) 1 armd (75mm)	1 mot Engr 1 armd Engr	1 mot Mortar 1 armd Gun
	79. PzG mot	9. IG Co SP'd (6 hvy) Hqs Co: mot Commo + AT (hvy) + Scout Plt	10. AA Co SP'd (12 lt)	I. mot 1941 3 mot II. mot 1941 3 mot			2 mot IG 2 mot IG	1 mot AT (75mm) 1 mot AT (75mm)	1 mot Engr 1 mot Engr	1 mot Mortar 1 mot Mortar
17. Pz	40. PzG mot	9. IG Co mot (4 hvy) Hqs Co: mot Commo + AT (med) + Scout Plt		I. mot 1941 3 mot II. mot 1941 3 mot			2 mot IG 2 mot IG	2 mot AT (28 & 50mm) 2 mot AT (28 & 50mm)	1 mot Engr 1 mot Engr	1 mot Mortar 1 mot Mortar
	63. PzG mot	9. IG Co mot (4 hvy) Hqs Co: mot Commo + AT (med) + Scout Plt		I. mot 1941 3 mot II. mot 1941 3 mot			2 mot IG 2 mot IG	2 mot AT (28 & 50mm) 2 mot AT (28 & 50mm)	1 mot Engr 1 mot Engr	1 mot Mortar 1 mot Mortar
18. Pz	52. PzG mot	9. IG Co mot (4 hvy) Hqs Co: mot Commo + AT (med) + Scout Plt		I. mot 1941 1 armd+ 2 mot II. mot 1941 3 mot			2 mot IG 2 mot IG	2 mot AT (28 & 50mm) 2 mot AT (28 & 50mm)	1 mot Engr 1 mot Engr	1 mot Mortar 1 mot Mortar
	101. PzG mot	9. IG Co mot (4 hvy) Hqs Co: mot Commo + AT (med) + Scout Plt		I. mot 1941 3 mot II. mot 1941 3 mot			2 mot IG 2 mot IG	2 mot AT (28 & 50mm) 2 mot AT (28 & 50mm)	1 mot Engr 1 mot Engr	1 mot Mortar 1 mot Mortar
19. Pz	73. PzG mot	9. IG Co mot (4 hvy) Hqs Co: mot Commo + AT (med) + Scout Plt		I. mot 1941 3 mot II. mot 1941 3 mot			1 mot IG 1 mot IG	3 mot AT (28/37/50mm) 3 mot AT (28/37/50mm)	1 mot Engr 1 mot Engr	– –
	74. PzG mot	9. IG Co mot (4 hvy) Hqs Co: mot Commo + AT (med) + Scout Plt		I. mot 1943 1 armd+2 mot II. mot 1941 3 mot			1 mot IG 1 mot IG	3 mot AT (28/37/50mm) 3 mot AT (28/37/50mm)	1 mot Engr 1 mot Engr	– –
20. Pz	59. PzG mot	11. IG mot (4 hvy) Hqs Co: mot Commo + AT (med) + Scout Plt		I. mot 1941 3 mot II. mot 1941 1 armd+2 mot			1 mot IG 1 mot IG	3 mot AT (28/37/50mm) 3 mot AT (28/37/50mm)	1 mot Engr 1 mot Engr	– –
	112. PzG mot	11. IG mot (4 hvy) Hqs Co: mot Commo + AT (med) + Scout Plt		I. mot 1941 3 mot II. mot 1941 3 mot			1 mot IG 1 mot IG	3 mot AT (28/37/50mm) 3 mot AT (28/37/50mm)	1 mot Engr 1 mot Engr	– –
23. Pz	126. PzG mot	9. IG Co mot (4 hvy) Hqs Co: mot Commo + AT (hvy) + Scout Plt & armd Flame Plt	10. AA Co SP'd (12 lt)	I. mot 1941 3 mot II. mot 1941 3 mot			2 mot IG 2 mot IG	2 mot AT (28 & 50mm) 2 mot AT (28 & 50mm)	1 mot Engr 1 mot Engr	– –
	128. PzG mot	9. IG Co mot (4 hvy) Hqs Co: mot Commo + AT (hvy) + Scout Plt	10. AA Co SP'd (12 lt)	I. mot 1941 3 mot II. mot 1941 3 mot			2 mot IG 2 mot IG	2 mot AT (28 & 50mm) 2 mot AT (28 & 50mm)	1 mot Engr 1 mot Engr	– –
24. Pz	21. PzG mot	9. IG Co SP'd (6 hvy) Hqs Co: mot Commo + AT (hvy) + Scout Plt	10. AA Co SP'd (12 lt)	I. mot 1941 3 mot II. mot 1941 3 mot			2 mot IG 2 mot IG	1 mot AT (75mm) 1 mot AT (75mm)	1 mot Engr 1 mot Engr	1 mot Mortar 1 mot Mortar
	26. PzG armd	9. IG Co SP'd (6 hvy) Hqs Co: armd Commo + AT (hvy) + Flame + Scout Plt	10. AA Co SP'd (12 lt)	I. armd 1943 3 armd II. mot 1941 3 mot			1 armd IG 2 mot IG	1 armd AT (75mm) 1 mot AT (75mm)	1 armd Engr 1 mot Engr	1 armd Gun 1 mot Mortar
25. Pz	146. PzG mot	9. IG Co mot (4 hvy) Hqs Co: mot Commo + AT (med) + Scout Plt	10. AA Co SP'd (12 lt)	I. mot 1941 3 mot II. mot 1941 3 mot			2 mot IG 2 mot IG	3 mot AT (28/50/75mm) 3 mot AT (28/50/75mm)	1 mot Engr 1 mot Engr	– –
	147. PzG mot	9. IG Co mot (4 hvy) Hqs Co: Commo + AT (med) + Scout Plt	10. AA Co SP'd (12 lt)	I. mot 1941 3 mot II. mot 1941 3 mot			2 mot IG 2 mot IG	3 mot AT (28/50/75mm) 3 mot AT (28/50/75mm)	1 mot Engr 1 mot Engr	– –
26. Pz	9. PzG mot	9. IG Co SP'd (6 hvy) Hqs Co: mot Commo + AT (med) + Scout Plt & armd Flame Plt		I. armd 1941 3 armd II. mot 1941 3 mot			1 armd IG 1 mot IG	2 armd AT (28 & 50mm) 2 mot AT (28 & 50mm)	1 armd Engr 1 mot Engr	1 armd Gun –
	67. PzG mot	9. IG Co SP'd (6 hvy) Hqs Co: mot Commo + AT (med) + Scout Plt		I. mot 1941 3 mot II. mot 1941 3 mot			1 mot IG 1 mot IG	2 mot AT (28 & 50mm) 2 mot AT (28 & 50mm)	1 mot Engr 1 mot Engr	– –

NOTES:

2. Panzer-Division

Although the 703. IG Co normally was a self-propelled infantry gun company, on this date it only had 4 motor-towed heavy infantry guns.

4. Panzer-Division:

The regimental engineer companies were ad-hoc units, formed from the engineer platoons of the battalions.

20. Panzer-Division

The heavy infantry gun companies retained their old numbering from the days when the battalions had 5 companies each.

The Panzergrenadier Regiments of the 21. Panzer Division as well as the Panzergrenadier and Panzerfusilier Regiments of the Gross Deutschland Division had their own organizations. (See pages 58 and 59) [Self-Propelled Heavy Infantry Gun strengths are listed on page 74.]

**1941 PANZERGRENADIER-REGIMENT**  
**1941 Panzergrenadier Regiment**

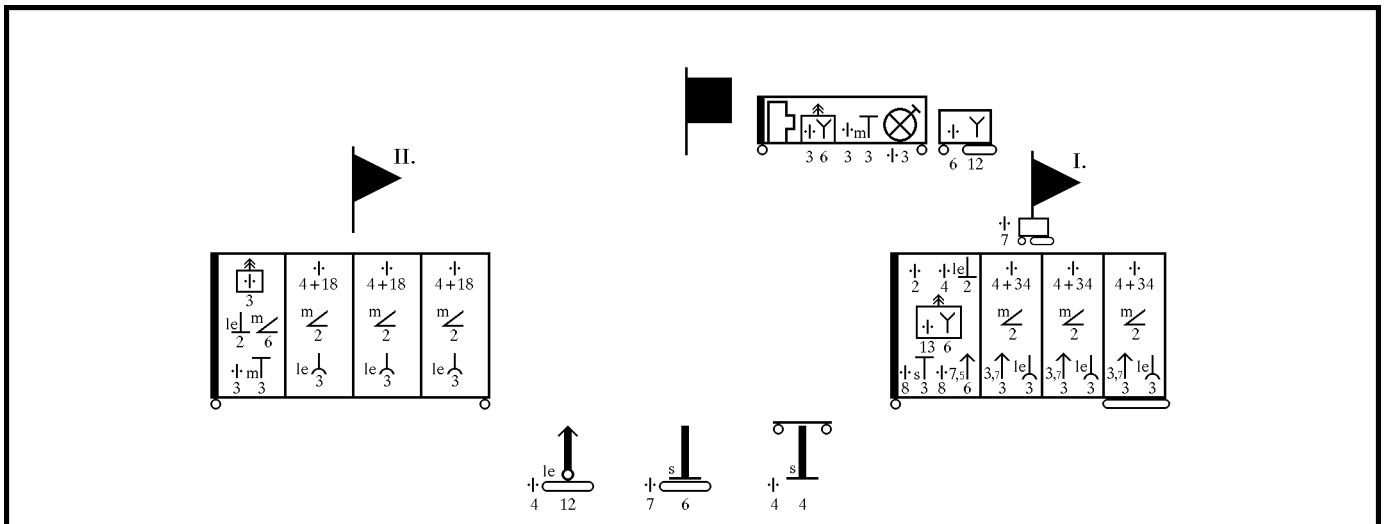

**KStN 1104**  
1.11.1941

**Headquarters, Motorized Infantry Regiment**  
Rgt Hqs: 4 mcl; 2 mcl w/sc; 2 cars (15).

**KStN 1153**  
1.11.1941

**Headquarters Company, Motorized Infantry Regiment**

Co Hqs: 2 mcl; 2 mcl w/sc; 1 car (15).

Motorcycle Plt: Hqs Sect: 3 mcl; 2 cars (15).

2 Sqd: 4 mcl w/sc; 1 Scout Squad w/ 2 LMG.

ATG Plt: Hqs Sect: 1 mcl; 1 mcl w/sc; 1 halftrack (10).

Gun Sect: 4 halftracks (10); 3 ATG (50 – towed); 1 trailer (ammo); 3 LMG.

Signal Plt: Hqs Sect: 1 mcl; 1 mcl w/sc; 1 car (15).

1 Lt Tele Sect *c*: 1 car (15).

4 Pack Radio Sect *b*: 1 car (2).

2 Lt Armd Radio Sect *d*: 1 AC (261).

Maint Sect: 1 mcl w/sc; 1 car (2/40); 1 car (light); 2 trucks (3-ton).

Co Trains: 1 mcl; 2 cars (light); 1 car (15); 2 trucks (light); 2 trucks (medium); 1 bus (medium/33 seats).

**KStN 1124**  
1.11.1941

Engineer Plt: Hqs Sect: 1 mcl; 1 mcl w/sc; 1 car (15); 2 trucks (2-ton).

4 Engr Sect: 1 truck (2-ton); 1 Engineer Section w/ 1 LMG.

**KStN 1130**  
20.01.1943

**Armored Flame Platoon**

Plt: 1 mcl w/sc; 6 SPW (251/16).

Plt Trains: 3 trucks (3-ton).

**KStN 1120**  
1.11.1941

**Motorized Infantry Gun Company**

Co Hqs: 3 mcl; 2 mcl w/sc; 2 halftracks (10).

Signal Det: 3 Lt Tele Sect *c*: ride in in one of the Company Headquarters halftracks.

Ammo Det: 2 halftracks (10); 2 trailers (ammo).

3 Lt IG Plt: Hqs Sect: 1 mcl; 1 mcl w/sc; 1 halftrack (10).

Gun Sect: 3 trucks (69); 2 lt IG (75mm – towed); 1 trailer (ammo).

1 Hvy IG Plt: Hqs Sect: 1 mcl; 1 mcl w/sc; 1 halftrack (10).

Gun Sect: 4 halftracks (10); 2 hvy IG (150mm – towed); 2 trailers (ammo).

Maint Sect: 1 mcl w/sc; 1 car (2/40).

Co Trains: 1 car (15); 1 truck (2-ton); 1 truck (medium); 1 truck (3-ton).

**KStN 1120a**  
1.05.1943

**Self-Propelled Heavy Infantry Gun Company**

Co Hqs: 4 mcl; 1 mcl w/sc; 1 SPW (251/1); 1 Maultier (3).

3 Hvy IG Plt: Hqs Sect: 1 mcl; 1 mcl w/sc; 1 SPW (251/3).

Gun Sect: 1 VW (1); 2 SP'd 150mm IG (138/1); 2 Maultier (3); 3 trailers (ammo); 1 LMG.

Ammo Det: 3 Maultier (3); 3 trailers (ammo).

Maint Sect: 1 car (2/40); 2 trucks (3-ton); 1 halftrack (8).

Co Trains: 1 VW (1); 1 truck (light); 1 truck (medium); 4 trucks (3-ton); 1 LMG.

**KStN 192(gek)**  
1.06.1943

**Mechanized Light Anti-Aircraft Company**

Co Hqs: 2 mcl; 1 car (15); 1 LMG.

Signal Det: Hqs Sect: 1 car (15).

1 Lt Tele Sect *c*: 1 car (15).

3 Pack Radio Sect *b*: 1 car (2).

Mono Mot Plt: Hqs Sect: 1 mcl; 2 cars (15); 1 LMG.

Ammo Sect: 2 trucks (81).

Gun Sect: 4 trucks (81); 4 AA guns (20mm – towed).

Mono SP'd Plt: Hqs Sect: 1 mcl; 2 cars (15); 1 LMG.

Ammo Sect: 2 halftracks (10/4 w/o guns).

Gun Sect: 4 halftracks (10/4 with 20mm Flak).

Quad SP'd Plt: Hqs Sect: 1 mcl; 2 cars (15); 1 LMG.

Ammo Sect: 2 halftracks (7/1 w/o guns).

Gun Sect: 2 halftracks (7/1 with 20mm Quad Flak).

Maint Sect: 1 car (2/40); 1 truck (medium).

Co Trains: 1 mcl w/sc; 1 car (15); 2 trucks (light); 2 trucks (1.5-ton); 2 trucks (3-ton).



**1941 PANZERGRENADIER-REGIMENT**  
**1941 Panzergrenadier Regiment**

<b>KStN 1108</b> 1.11.1941	<b>Headquarters, Motorized Infantry Battalion</b> Bn Hqs: 5 mcl; 2 mcl w/sc; 3 cars (15). Signal Det: Hqs Sect: 1 car (15). 1 Lt Tele Sect c: 1 car (15). 2 Pack Radio Sect d: 1 car (2). 2 Lt Radio Sect d: 1 van (17). Bn Hqs Trains: 1 mcl w/sc; 1 car (15); 1 truck (2-ton); 1 truck (medium); 1 truck (3-ton); 1 ambulance (31). Bn Maint Det: 1 mcl w/sc; 1 car (2/40); 1 car (light); 3 trucks (3-ton). Bn Trains: 1 mcl; 2 cars (light); 2 trucks (light); 1 truck (medium); 5 trucks (3-ton).
<b>KStN 1114</b> 1.11.1941	<b>Motorized Infantry Company</b> Co Hqs: 3 mcl; 2 mcl w/sc; 1 car (15). 3 Inf Plt: Hqs Sect: 1 mcl; 1 car (15); 1 ATR. 3 Inf Sqd: 2 trucks (70); 1 Infantry Squad w/ 2 LMG. 1 Hvy Plt: Hqs Sect: 1 mcl; 1 mcl w/sc; 1 car (15). 2 HMG Sect: 2 trucks (70); 2 HMG. 1 Mortar Sect: 3 trucks (70); 2 mortars (81mm). Maint Sect: 1 mcl w/sc; 1 car (2/40). Co Trains: 1 car (15); 1 truck (2-ton); 1 truck (medium); 1 truck (3-ton).
<b>KStN 1121</b> 1.11.1941	<b>Motorized Heavy Company</b> Co Hqs: 3 mcl; 2 mcl w/sc; 1 car (15). Lt Tele Sect c: 1 car (15). Maint Sect: 1 mcl w/sc; 1 car (2/40). Co Trains: 1 car (15); 1 truck (2-ton); 1 truck (medium); 1 truck (3-ton).
<b>KStN 1122a</b> 1.12.1941	ATG Plt: Hqs Sect: 1 mcl; 1 mcl w/sc; 1 car (15). Gun Sect: 5 halftracks (10); 3 ATG (50mm – towed); 2 trailers (ammo); 3 LMG.
<b>KStN 1123</b> 1.11.1941	IG Plt: Hqs Sect: 1 mcl; 1 mcl w/sc; 1 truck (69). Gun Sect: 3 trucks (69); 2 Lt IG (75mm – towed); 1 trailer (ammo).
<b>KStN 1124</b> 1.11.1941	Engr Plt: Hqs Sect: 1 mcl; 1 mcl w/sc; 1 car (15); 2 trucks (2-ton). 4 Engr Sect: 1 truck (2-ton); 1 Engineer Section w/ 1 LMG.
<b>KStN 1126</b> 1.10.1938	Mortar Plt: Hqs Sect: 1 mcl w/sc; 1 truck (11). 3 Mortar Sect: 3 trucks (70); 2 mortars (81mm).
<b>KStN 1127</b> 1.11.1941	ATG Sect: 1 mcl w/sc; 3 trucks (70); 3 ATG (28mm – towed); 3 LMG.
<b>KStN 1108(gp)</b> 1.11.1941	<b>Headquarters, Armored Infantry Battalion</b> Co Hqs: 5 mcl; 1 mcl w/sc; 2 cars (15); 2 SPW (250/3). Signal Det: Hqs Sect: 1 SPW (250/2). 1 Lt Armd Tele Sect c: 1 SPW (250/2). 2 Armd Pack Radio Sect d: ride together in one SPW (250/3). 2 Lt Armd Radio Sect d: 1 SPW (250/3). Bn Hqs Trains: 1 mcl w/sc; 1 car (15); 1 truck (2-ton); 1 truck (medium); truck (3-ton); 1 ambulance (31). Bn Maint Det: 1 mcl w/sc; 1 car (2/40); 1 car (light); 4 trucks (3-ton). Bn Trains: 1 mcl; 2 cars (light); 2 trucks (light); 1 truck (medium); 5 trucks (3-ton).
<b>KStN 1114(gp)</b> 1.11.1941	<b>Armored Infantry Company</b> Co Hqs: 3mcl; 1 mcl w/sc; 2 SPW (250/3). 3 Inf Plt: Hqs Sect: 1 mcl; 1 SPW (251/10 with 37mm ATG); 1 ATR. 3 Inf Sqd: 1 SPW (251/1); 1 Infantry Squad w/ 2 LMG. 1 Hvy Plt: Hqs Sect: 1 mcl; 1 mcl w/sc; 1 SPW (251/1). 2 HMG Sect: 1 SPW (251/1); 2 HMG. 1 Mortar Sect: 2 SPW (251/2 with 81mm mortar). Maint Sect: 1 mcl w/sc; 1 car (2/40). Co Trains: 1 car (15); 1 truck (2-ton); 1 truck (medium); 1 truck (3-ton).
<b>KStN 1121a(gp)</b> 1.11.1941	<b>Armored Heavy Company</b> Co Hqs: 2 mcl; 2 mcl w/sc; 1 SPW (250/3). Lt Armd Tele Sect c: 1 SPW (250/2). Maint Sect: 1 mcl w/sc; 1 car (2/40). Co Trains: 1 car (15); 1 truck (2-ton); 1 truck (medium); 1 truck (3-ton).
<b>KStN 1122a(gp)</b> 1.11.1941	ATG Plt: Hqs Sect: 1 mcl; 1 mcl w/sc; 1 SPW (250/1). Gun Sect: 4 SPW (251/1); 3 ATG (50mm – towed); 8 LMG.
<b>KStN 1123(gp)</b> 1.11.1941	IG Plt: Hqs Sect: 1 mcl; 1 mcl w/sc; 1 SPW (250/1). Gun Sect: 3 SPW (251/4); 2 Lt IG (75mm – towed).
<b>KStN 1124(gp)</b> 1.11.1941	Engr Plt: Hqs Sect: 1 mcl; 1 mcl w/sc; 1 SPW (250/1); 2 trucks (2-ton). 4 Engr Sect: 1 SPW (251/5); 1 Engineer Section w/ 1 LMG.
<b>KStN 1125(gp)</b> 21.12.1942	Gun Plt: Hqs Sect: 1 mcl w/sc; 1 SPW (251/4). Gun Sect: 6 SPW (250/9); 1 truck (3-ton)..
<b>KStN 1127</b> 1.11.1941	ATG Sect: 1 mcl w/sc; 3 SPW (250/11).
<b>KStN 1130</b> 20.01.1943	Flame Plt: Plt: 1 mcl w/sc; 6 SPW (251/16). Plt Trains: 3 trucks (3-ton).

**NOTES:**

All infantry assigned to Panzer Divisions were designated as *Panzer-Grenadier* (*Panzer* Infantry), indicating that they belonged to Panzer Divisions. Armored infantry had the suffix *gepanzert* (*gp*) added to their designations. The truck-equipped motorized Panzergrenadiers had no modifying suffix appended.

The KStN organization for the mechanized light anti-aircraft company was very versatile. Depending on the availability of equipment, it could be either self-propelled, motorized, or a combination of both. The towed 20mm Flak was often mounted on its prime-mover by the crews, resulting in these units becoming (unofficially) self-propelled, although the unit was still reported as towed. All light anti-aircraft companies were to supposed to be self-propelled. Some of the third

platoons were equipped with two quad 20mm Flak. It was planned eventually to issue all third platoons with these weapons.

It was also planned to replace the 81 mm mortars in the heavy companies with 120mm equipment as soon as these weapons became available. One Panzergrenadier Regiment per Panzer Division was authorized an armored flame platoon, but many did not have them. Heavy anti-tank guns were authorized for all anti-tank platoons when available. However, medium 50mm guns still counted.

[The table on page 51 shows which units were armored, i.e. equipped with SPW.]  
 [Self-Propelled Heavy Infantry Gun strengths are listed on page 74.]

**1943 PANZERGRENADIER-REGIMENT**  
**1943 Panzergrenadier Regiment**

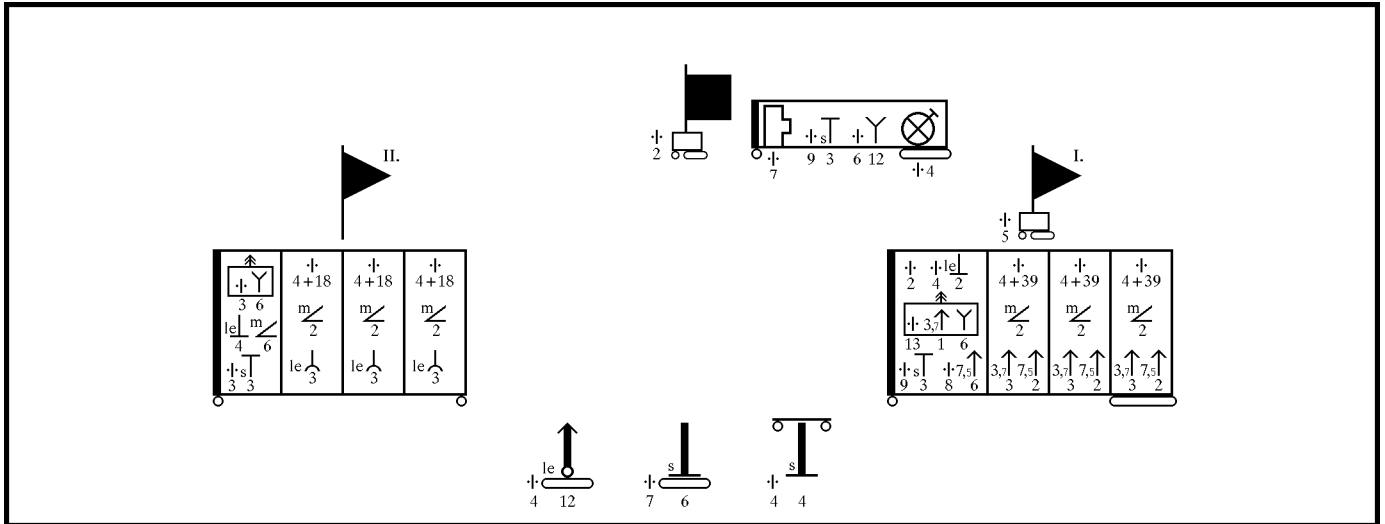

**KStN 1104a(gp) Headquarters, Armored Infantry Regiment**

1.06.1943 Rgt Hqs: 4 mcl; 1 mcl w/sc; 1 car (15); 2 SPW (250/3).

**KStN 1153a(gp) Headquarters Company, Armored Infantry Regiment**

1.04.1943

Co Hqs: 2 mcl; 2 mcl w/sc; 1 SPW (251/3).

Motorcycle Plt: Hqs Sect: 3 mcl; 3 mcl w/sc; 2 VW (1).

2 Sqd: 4 mcl w/sc; 1 Motorcycle Squad w/ 2 LMG.

Flame Plt: 1 mcl w/sc; 6 SPW (251/16); 3 trucks (3-ton).

ATG Plt: Hqs Sect: 2 mcl; 1 SPW (251/1).

Gun Sect: 5 SPW (251/4); 3 ATG (75mm – towed).

Signal Plt: Hqs Sect: 1 mcl; 1 mcl w/sc; 1 SPW (251/3).

3 Med Armd Tele Sect: 1 SPW (251/11).

3 Lt Armd Radio Sect *d*: 1 SPWE (251/3).

3 Pack Radio Sect *g*: one each rides in the SPW of the Light Armored Radio Sections *d*.

Maint Sect: 1 car (2/40); 2 trucks (3-ton); 1 halftrack (7).

Rgt Trains: 1 mcl w/sc; 4 VW (1); 1 trucks (light); 2 trucks (medium); 9 trucks (3-ton); 1 bus (medium/33 seats).

**KStN 1120 \*) Motorized Heavy Infantry Gun Company**

22.04.1943

Co Hqs: 3 mcl; 2 mcl w/sc; 2 cars (1); 1 LMG.

2 Lt Tele Sect *c*: 1 car (2).

2 Hvy IG Plt: Hqs Sect: 1 mcl; 1 mcl w/sc; 1 car (1).

Gun Sect: 3 halftracks (11); 2 Heavy Infantry Guns (150mm – towed); 1 trailer (ammo); 1 LMG.

Ammo Det: 2 trucks (3-ton); 2 trailers (ammo).

Co Maint Sect: 1 mcl w/sc; 1 car (2/40).

Co Trains: 1 car (light); 3 trucks (medium); 1 truck (3-ton); 1 LMG.

**KStN 1120(gp) Armored Infantry Gun Company**

1.02.1941

Co Hqs: 2 mcl; 2 mcl w/sc; 1 SPW (250/1); 1 SPW (250/3).

Signal Det: 3 Lt Tele Sect *c*: 1 SPW (250/2).

2 Hvy IG Plt: Hqs Sect: 4 mcl; 1 SPW (250/1); 1 SPW (250/2).

Gun Sect: 1 mcl w/sc; 4 SPW (251/4); 2 hvy IG (150mm – towed).

Maint Sect: 1 mcl w/sc; 1 car (2/40).

Co Trains: 1 car (15); 1 truck (2-ton); 1 truck (medium); 1 truck (3-ton).

**KStN 1120a Self-Propelled Heavy Infantry Gun Company**

1.05.1943

Co Hqs: 4 mcl; 1 mcl w/sc; 1 SPW (251/1); 1 Maultier (3).

3 Hvy IG Plt: Hqs Sect: 1 mcl; 1 mcl w/sc; 1 SPW (251/3).

Gun Sect: 1 VW (1); 2 SP'd 150mm IG (138/1); 2 Maultier (3); 3 trailers (ammo); 1 LMG.

Ammo Det: 3 Maultier (3); 3 trailers (ammo).

Maint Sect: 1 car (2/40); 2 trucks (3-ton); 1 halftrack (8).

Co Trains: 1 VW (1); 1 truck (light); 1 truck (medium); 4 trucks (3-ton); 1 LMG.

**KStN 192(gek) Mechanized Light Anti-Aircraft Company**

1.06.1943

Co Hqs: 2 mcl; 1 car (15); 1 LMG.

Signal Det: Hqs Sect: 1 car (15).

1 Lt Tele Sect *c*: 1 car (15).

3 Pack Radio Sect *b*: 1 car (2).

Mono Mot Plt: Hqs Sect: 1 mcl; 2 cars (15); 1 LMG.

Ammo Sect: 2 trucks (81).

Gun Sect: 4 trucks (81); 4 AA guns (20mm – towed).

Mono SP'd Plt: Hqs Sect: 1 mcl; 2 cars (15); 1 LMG.

Ammo Sect: 2 halftracks (10/4 w/o guns).

Gun Sect: 4 halftracks (10/4 with 20mm Flak).

Quad SP'd Plt: Hqs Sect: 1 mcl; 2 cars (15); 1 LMG.

Ammo Sect: 2 halftracks (7/1 w/o guns).

Gun Sect: 2 halftracks (7/1 with 20mm Quad Flak).

Maint Sect: 1 car (2/40); 1 truck (medium).

Co Trains: 1 mcl w/sc; 1 car (15); 2 trucks (light); 2 trucks (1.5-ton); 2 trucks (3-ton).

**1943 PANZERGRENADIER-REGIMENT**  
**1943 Panzergrenadier Regiment**

**KStN 1108a(gp) Headquarters, Armored Infantry Battalion**

1.04.1943 Bn Hqs: 5 mcl; 1 mcl w/sc; 3 VW (1); 2 SPW (251/3); 1 SPW (251/8).  
 Signal Det: Hqs Sect: 1 SPW (251/11).  
                   1 Med Armd Tele Sect: 1 SPW (251/11).  
                   2 Armd Pack Radio Sect *g*: ride together in one SPW (250/3).  
                   2 Armd Pack Radio Sect *g*: ride together in one SPW (250/3).  
 Bn Maint Det: 1 VW (2/40); 3 VW (1); 5 trucks (3-ton); 2 vans (3-ton); 1 halftrack (7); 1 trailer (generator); 1 trailer (tool).  
 Bn Trains: 1 mcl; 4 VW (1); 1 truck (medium); 9 trucks (3-ton); 1 ambulance (31).

**KStN 1114c(gp) Armored Infantry Company**

1.04.1943 Co Hqs: 3mcl; 1 mcl w/sc; 2 SPW (251/3).  
 3 Inf Plt: Hqs Sect: 1 mcl; 1 SPW (251/10 with 37mm ATG); 1 ATR.  
                   3 Inf Sqd: 1 SPW (251/1); 1 Infantry Squad w/ 2 LMG.  
 1 Hvy Plt: Hqs Sect: 1 mcl; 1 mcl w/sc; 1 SPW (251/1).  
                   2 HMG Sect: 1 SPW (251/1); 2 HMG.  
                   1 Mortar Sect: 2 SPW (251/2 with 81mm mortar).  
                   1 Gun Sect: 2 SPW (251/9)  
 Maint Sect: 1 VW (2/40); 1 truck (3-ton); 1 halftrack (7).  
 Co Trains: 1 VW (1); 1 truck (medium); 3 trucks (3-ton).

**Armored Heavy Company**

**KStN 1121a(gp)** Co Hqs: 2 mcl; 2 mcl w/sc; 1 SPW (251/3).  
 1.03.1943 Lt Armd Tele Sect *c*: 1 SPW (251/11).  
 Maint Sect: 1 VW (1); 2 trucks (3-ton); 1 halftrack (8).  
 Co Trains: 1 car (15); 1 truck (medium); 4 trucks (3-ton).

**KStN 1145(gp)** ATG Plt: Hqs Sect: 2 mcl; 1 SPW (251/1).  
 1.03.1943 Gun Sect: 5 SPW (251/4); 3 ATG (75mm – towed); 3 LMG.

**KStN 1124a (gp)** Engr Plt: Hqs Sect: 1 mcl; 1 mcl w/sc; 1 SPW (250/10).  
 1.03.1943 Equipment Sect: 3 trucks (3-ton).  
 3 Engr Sect: 2 SPW (251/7); 1 Engr. Section w/ 2 LMG.

**KStN 1123(gp)** IG Plt: Hqs Sect: 1 mcl; 1 mcl w/sc; 1 SPW (251/1).  
 1.03.1943 Gun Sect: 3 SPW (251/4); 2 Lt IG (75mm – towed).

**KStN 1125(gp)** Gun Plt: Hqs Sect: 1 mcl; 1 mcl w/sc.  
 1.05.1943 Gun Sect: 6 SPW (251/9); 1 SPW (251/1); 1 truck (3-ton).

**KStN 1108 Headquarters, Motorized Infantry Battalion**

1.11.1941 Bn Hqs: 5 mcl; 2 mcl w/sc; 3 cars (15).  
 Signal Det: Hqs Sect: 1 car (15).  
                   1 Lt Tele Sect *c*: 1 car (15).  
                   2 Pack Radio Sect *d*: 1 car (2).  
                   2 Lt Radio Sect *d*: 1 van (17).  
 Bn Maint Det: 1 mcl w/sc; 1 car (2/40); 1 car (light); 3 trucks (3-ton).  
 Bn Trains: 1 mcl; 1 mcl w/sc; 2 cars (light); 1 car (15); 2 trucks (light); 2 trucks (medium); 5 trucks (3-ton); 1 ambulance (31).

**Motorized Heavy Company**

**KStN 1121** Co Hqs: 3 mcl; 2 mcl w/sc; 1 car (15).  
 1.11.1941 Lt Tele Sect *c*: 1 car (15).  
 Maint Sect: 1 mcl w/sc; 1 car (2/40).  
 Co Trains: 1 car (15); 1 truck (2-ton); 1 truck (medium); 1 truck (3-ton).

**KStN 1122a** ATG Plt: Hqs Sect: 1 mcl; 1 mcl w/sc; 1 car (15).  
 1.12.1941 Gun Sect: 5 halftracks (10); 3 ATG (50mm – towed); 2 trailers (ammo); 3 LMG.

**KStN 1123** IG Plt: Hqs Sect: 1 mcl; 1 mcl w/sc; 1 truck (69).  
 1.11.1941 Gun Sect: 3 trucks (69); 2 Lt IG (75mm – towed); 1 trailer (ammo).

**KStN 1124** Engr Plt: Hqs Sect: 1 mcl; 1 mcl w/sc; 1 car (15); 2 trucks (2-ton).  
 1.11.1941 4 Engr Sect: 1 truck (2-ton); 1 Engineer Section w/ 1 LMG.

**KStN 1126** Mortar Plt: Hqs Sect: 1 mcl w/sc; 1 truck (11).  
 1.10.1938 3 Mortar Sect: 3 trucks (70); 2 mortars (81mm).

**KStN 1127** ATG Sect: 1 mcl w/sc; 3 trucks (70); 3 ATG (28mm – towed); 3 LMG.  
 1.11.1941

**NOTES:**

The few armored Panzergrenadier regimental headquarters units that existed were organized under the 1943 KStN. Regiment Headquarters and Headquarters Companies, when not armored, had the 1.11.1941 KStN.

One Panzergrenadier Regiment per Panzer Division was authorized an armored flame platoon, but many did not have them.

Heavy anti-tank guns were authorized for regimental headquarters companies and battalion heavy companies when available. However, medium 50mm guns continued to serve.

It was planned to replace the 81mm mortars in the heavy companies of the battalions with 120mm equipment as soon as these weapons became available.

There was no separate symbol for the armored – SPW-towed – heavy infantry gun companies. Only the various orders and reports concerning the division indicated this.

[The table on page 51 shows which units – including regimental headquarters – were armored, i.e. equipped with SPW.]  
 [Self-Propelled Heavy Infantry Gun strengths are listed on page 74.]

**GRENADIER-REGIMENT (motorisiert)**  
**Infantry Regiment (motorized)**

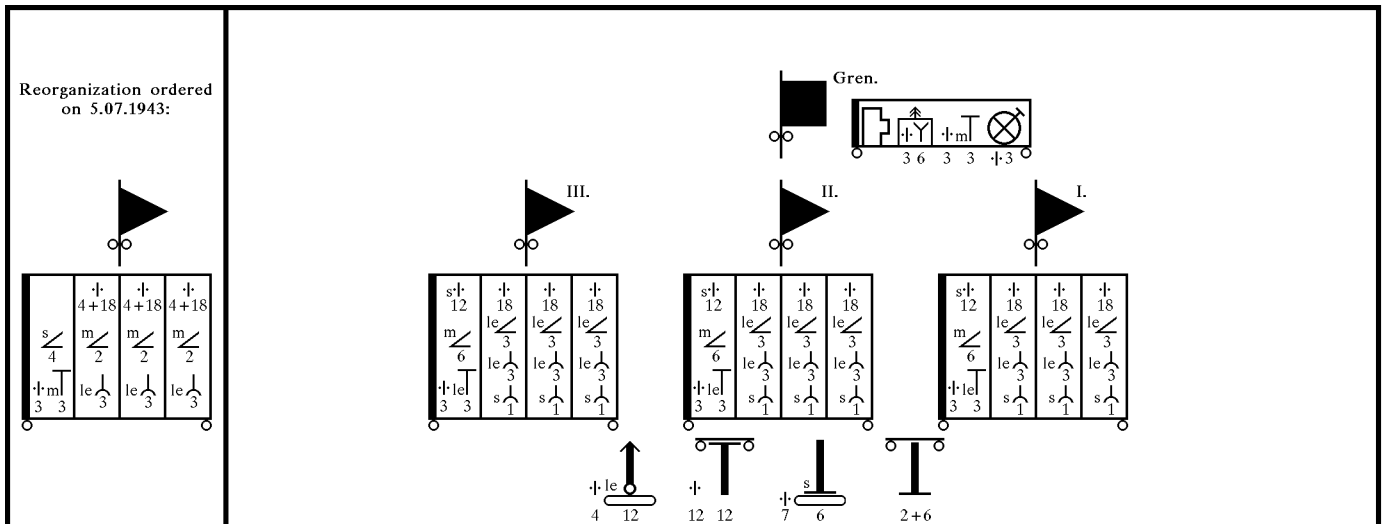
**KStN 103c**

1.11.1941

**Headquarters, Infantry Regiment (motorized)**

Rgt Hqs: 5 mcl; 2 mcl w/sc; 2 cars (12).

**KStN 129**

1.11.1941

**Headquarters Company, Infantry Regiment (motorized)**

Co Hqs: 2 mcl; 2 mcl w/sc; 1 car (12)

Motorcycle Plt: Hqs Sect: 1 mcl; 2 cars (15).

3 Recon Sqd: 1 mcl; 4 mcl w/sc; 1 Reconnaissance Squad with 1 LMG.  
1 Messenger Sect: 8 mcl.

Anti-Tank Plt: Hqs Sect: 1 mcl; 1 mcl w/sc; 1 halftrack (10); 3 LMG..

Gun Sect: 4 halftracks (10); 3 ATG (50mm – towed); 1 trailer (ammo).

Engr Plt: Hqs Sect: 1 mcl; 1 mcl w/sc; 1 car (15).

3 Engr Sect: 1 mcl; 2 trucks (2-ton); 1 Engineer Section with 1 LMG.

Signal Plt: Hqs Sect: 1 mcl; 1 mcl w/sc; 3 cars (15).

2 Lt Tele Sect *d*: 1 car (15).4 Pack Radio Sect *d*: ride in Headquarters Section vehicles.4 Lt Radio Sect *e*: 1 van (17).

Maint Sect: 1 mcl w/sc; 1 car (2/40).

Co Trains: 1 mcl; 2 cars (light); 4 trucks (light); 1 truck (medium); 1 bus (medium/33 seats).

**KStN 176**

1.11.1941

**Infantry Gun Company (motorized)**

Co Hqs: 5 mcl; 2 mcl w/sc; 2 cars (15).

Signal Det: 2 Lt Tele Sect *d*: 1 car (15).2 Pack Radio Sect *d*: 1 car (2).

3 Lt IG Plt: Hqs Sect: 1 mcl; 1 mcl w/sc; 1 car (12).

Gun Sect: 6 cars (12); 2 Lt IG (75mm – towed); 4 trailers (ammo).

1 Hvy IG Plt: Hqs Sect: 1 mcl; 1 mcl w/sc; 1 car (15).

Gun Sect: 4 halftracks (10); 2 hvy IG (150mm – towed).

Maint Sect: 1 mcl w/sc; 1 car (2/40).

Co Trains: 1 car (light); 1 truck (2-ton); 1 truck (medium); 1 truck (3-ton).

**KStN 1120a**

1.05.1943

**Self-Propelled Heavy Infantry Gun Company**

Co Hqs: 4 mcl; 1 mcl w/sc; 1 SPW (251/1); 1 Maultier (3).

3 Hvy IG Plt: Hqs Sect: 1 mcl; 1 mcl w/sc; 1 SPW (251/3).

Gun Sect: 1 VW (1); 2 SP'd 150mm IG (138/1);  
2 Maultier (3); 3 trailers (ammo); 2 LMG.

Ammo Det: 3 Maultier (3); 3 trailers (ammo).

Maint Sect: 1 car (2/40); 2 trucks (3-ton); 1 halftrack (8).

Co Trains: 1 VW (1); 1 truck (light); 1 truck (medium); 4 trucks (3-ton); 1 LMG.

**KStN 1140**

1.04.1943

**Motorized Anti-Tank Company**

Co Hqs: 3 mcl; 1 mcl w/sc; 1 car (15).

3/4 ATG Plt: Hqs Sect: 1 mcl; 1 mcl w/sc; 1 car (1).

Gun Sect: 6 halftracks (11); 3 ATG (towed); 1 trailer (ammo); 3 LMG.

Maint Sect: 1 mcl w/sc; 1 car (2/40).

Co Trains: 1 car (1); 1 truck (light); 4 trucks (1.5-ton); 1 truck (medium).

**KStN 192(gek)**

1.06.1943

**Mechanized Light Anti-Aircraft Company**

Co Hqs: 2 mcl; 1 car (15); 1 LMG.

Signal Det: Hqs Sect: 1 car (15).

1 Lt Tele Sect *c*: 1 car (15).3 Pack Radio Sect *b*: 1 car (2).

Mono Mot Plt: Hqs Sect: 1 mcl; 2 cars (15); 1 LMG.

Ammo Sect: 2 trucks (81).

Gun Sect: 4 trucks (81); 4 AA guns (20mm – towed).

Mono SP'd Plt: Hqs Sect: 1 mcl; 2 cars (15); 1 LMG.

Ammo Sect: 2 halftracks (10/4 w/o guns).

Gun Sect: 4 halftracks (10/4 with 20mm Flak).

Quad SP'd Plt: Hqs Sect: 1 mcl; 2 cars (15); 1 LMG.

Ammo Sect: 2 halftracks (7/1 w/o guns).

Gun Sect: 2 halftracks (7/1 with 20mm Quad Flak).

Maint Sect: 1 car (2/40); 1 truck (medium).

Co Trains: 1 mcl w/sc; 1 car (15); 2 trucks (light); 2 trucks (1.5-ton); 2 trucks (3-ton).

**NOTES:**

Grenadier-Regiments (motorisiert) of Panzergrenadier-Divisions, – the one-time Infanterie-Divisions (motorisiert) – were still organized under the Infantry Inspectorate KStN. An order dated 5.07.1943 authorized a series of reorganization measures modifying these KStN to some extent, and brought them more into line with the Panzer-Truppen Inspectorate KStN.

The Machine Gun Companies were ordered to convert from 6 medium (81mm) mortars to 4 heavy (120mm) mortars and to turn these medium mortars and their heavy machine guns over to the infantry companies. The light (37mm) anti-tank guns were to be exchanged for medium (50mm) weapons. The Infantry Companies were ordered to convert from their 3 light (50mm) mortars to 2 medium (81mm) mortars per company, and incorporate 4 heavy machine guns each from the machine the Gun Company. The 28mm anti-tank guns were eliminated.

The heavy mortars were obviously not instantly available everywhere. It was ordered that the regiments of those divisions of Army Group North, (the 16th and 18th Armies), were to be the first to be converted as heavy mortars became available.

Medium anti-tank guns had often already been incorporated – and in the case of the regimental headquarters companies, even heavy guns – as they had become available. The order merely made it official.

The 4 anti-tank platoons within the regiment were often gathered into a regimental company.

The 13., 29. and FHH Panzergrenadier Divisions were still forming at this time under Infantry Inspectorate KStN. Their Infantry Battalions had no Machine Gun Companies, and the four Infantry Companies were identical. The heavy weapons were concentrated in the regimental support companies. [Note that on 28.08.1943 orders were issued to reorganize the regiments of these three divisions under the Panzertruppen Inspectorate KStN].

**GRENADIER-REGIMENT (motorisiert)**  
**Infantry Regiment (motorized)**

**KStN 115c****Headquarters, Infantry Battalion (motorized)**

1.11.1941

Bn Hqs: 4 mcl; 2 mcl w/sc; 1 car (1); 2 cars (15).

Signal Det: Hqs Sect: 1 car (15); 1 truck (2-ton).

2 Lt Tele Sect *d*: ride in Headquarters Section truck (2-ton).2 Pack Radio Sect *d*: ride in Headquarters Section truck (2-ton).2 Pack Radio Sect *d*: 1 car (2).

Maint Det: 1 mcl w/sc; 1 car (2/40); 1 car (light); 1 truck (light); 2 trucks (3-ton).

Co Trains: 1 mcl; 1 mcl w/sc; 3 cars (light); 5 trucks (medium); 6 trucks (3-ton); 1 ambulance (31).

**KStN 138c****Infantry Company (motorized)**

1.11.1941

Co Hqs: 3 mcl; 2 mcl w/sc; 1 car (15); 1 truck (medium); 1 ATG (28mm – towed); 3 ATR.

3 Inf Plt: Hqs Sect: 1 mcl; 2 LMG (equipment reserve); personnel ride in Infantry Squad trucks.

4 Inf Sqd: 1 truck (medium); 1 Infantry Squad with 1 LMG.

1 Mortar Sect: 1 mortar (50mm); rides with an Infantry Squad.

Main Sect: 1 mcl w/sc; 1 car (2/40).

Co Trains: 1 car (light); 1 truck (light); 2 trucks (medium).

**KStN 161c****Machine Gun Company (motorized)**

1.11.1941

Co Hqs: 3 mcl; 2 mcl w/sc; 2 cars (15).

2 MG Plt: Hqs Sect: 1 mcl w/sc; 1 car (15).

3 MG Sect: 1 truck (medium); 2 HMG.

1 Mortar Plt: Hqs Sect: 1 mcl; 1 car (11).

3 Mortar Sect: 1 mcl; 2 trucks (medium); 2 mortars (81mm).

1 Anti-Tank Plt: Hqs Sect: 1 mcl; 1 mcl w/sc; 1 truck (69).

Gun Sect: 4 trucks (69); 3 ATG (37mm – towed); 1 LMG.

Main Sect: 1 mcl w/sc; 1 car (2/40).

Co Trains: 1 car (light); 1 truck (light); 2 trucks (medium).

**Order of Battle of the Panzer-Grenadier Divison Grenadier Regiments**

Division	Panzergrenadier Regiment and Grenadier Regiment (motorized)			Panzergrenadier Battalion and Grenadier Battalion (motorized)					
	Headquarters	Companies		Hqs.	KStN	Infantry Cos.	Heavy Company Platoons		
3. PzG	8. Gren mot	13. IG SP'd (6 hvy)	14. AT mot (3 hvy+6 med)	I. mot	1941	4 mot	–	–	–
		Hqs Co: mot Commo + Engr + Scout Plt		II. mot	1941	4 mot	–	–	–
	29. Gren mot	13. IG SP'd (6 hvy)	14. AT mot (3 hvy+6 med)	I. mot	1941	4 mot	–	–	–
		Hqs Co: mot Commo + Engr + Scout Plt		II. mot	1941	4 mot	–	–	–
10. PzG	20. Gren mot	13. IG mot (2 hvy+6 lt)		I. mot	1941	3 mot	1 mot HMG	1 mot Mortar	1 mot AT (37mm)
		Hqs Co: mot Commo + AT (med)+ Engr + Scout Plt		II. mot	1941	3 mot	1 mot HMG	1 mot Mortar	1 mot AT (37mm)
	41. Gren mot	13. IG mot (2 hvy+6 lt)		I. mot	1941	3 mot	1 mot HMG	1 mot Mortar	1 mot AT (37mm)
		Hqs Co: mot Commo + AT (med)+ Engr + Scout Plt		II. mot	1941	3 mot	1 mot HMG	1 mot Mortar	1 mot AT (37mm)
15. Pz	1. Sizilien PzGren mot	13. IG mot (2 hvy+6 lt)	14. AT mot (6 hvy+6 med)	I. mot	1941	3 mot	1 mot HMG	1 mot Mortar	
		Hqs Co: mot Commo + Engr + Scout Plt		II. mot	1941	3 mot	1 mot HMG	1 mot Mortar	
	2. Sizilien PzGren mot	13. IG mot (2 hvy+6 lt)	14. AT mot (6 hvy+6 med)	I. mot	1941	3 mot	1 mot HMG	1 mot Mortar	
		Hqs Co: mot Commo + Engr + Scout Plt		II. mot	1941	3 mot	1 mot HMG	1 mot Mortar	
	3. Sizilien PzGren mot	13. IG mot (2 hvy+6 lt)	14. AT mot (6 hvy+6 med)	I. mot	1941	3 mot	1 mot HMG	1 mot Mortar	
		Hqs Co: mot Commo + Engr + Scout Plt		II. mot	1941	3 mot	1 mot HMG	1 mot Mortar	
16. PzG	60. Gren mot	13. IG mot (2 hvy+6 lt)	14. AA SP'd (8 lt+2 lt quad)	I. mot	1941	3 mot	1 mot HMG	1 mot Mortar	1 mot (37mm)
		Hqs Co: mot Commo + AT (med)+ Engr + Scout Plt		II. mot	1941	3 mot	1 mot HMG	1 mot Mortar	1 mot (37mm)
	156. Gren mot	13. IG mot (2 hvy+6 lt)	14. AA SP'd (12 lt)	I. mot	1941	3 mot	1 mot HMG	1 mot Mortar	1 mot (37mm)
		Hqs Co: mot Commo + AT (med)+ Engr + Scout Plt		II. mot	1941	3 mot	1 mot HMG	1 mot Mortar	1 mot (37mm)
18. PzG	30. Gren mot	13. IG mot (2 hvy+6 lt)		I. mot	1941	3 mot	1 mot HMG	1 mot Mortar	1 mot (37mm)
		Hqs Co: mot Commo + AT (med)+ Engr + Scout Plt		II. mot	1941	3 mot	1 mot HMG	1 mot Mortar	1 mot (37mm)
	51. Gren mot	13. IG mot (2 hvy+6 lt)		I. mot	1941	3 mot	1 mot HMG	1 mot Mortar	1 mot (37mm)
		Hqs Co: mot Commo + AT (med)+ Engr + Scout Plt		II. mot	1941	3 mot	1 mot HMG	1 mot Mortar	1 mot (37mm)
20. PzG	76. Gren mot	13. IG mot (2 hvy+6 lt)		I. mot	1941	3 mot	1 mot HMG	1 mot Mortar	1 mot (37mm)
		Hqs Co: mot Commo + AT (med)+ Engr + Scout Plt		II. mot	1941	3 mot	1 mot HMG	1 mot Mortar	1 mot (37mm)
	90. Gren mot	13. IG mot (2 hvy+6 lt)		I. mot	1941	3 mot	1 mot HMG	1 mot Mortar	1 mot (37mm)
		Hqs Co: mot Commo + AT (med)+ Engr + Scout Plt		II. mot	1941	3 mot	1 mot HMG	1 mot Mortar	1 mot (37mm)
25. PzG	35. Gren mot	13. IG mot (2 hvy+6 lt)	14. AT mot (12 med)	I. mot	1941	3 mot	1 mot HMG	1 mot Mortar	
		Hqs Co: mot Commo + Engr + Scout Plt		II. mot	1941	3 mot	1 mot HMG	1 mot Mortar	
	119. Gren mot	13. IG mot (2 hvy+6 lt)	14. AT mot (12 med)	I. mot	1941	3 mot	1 mot HMG	1 mot Mortar	
		Hqs Co: mot Commo + Engr + Scout Plt		II. mot	1941	3 mot	1 mot HMG	1 mot Mortar	
29. PzG	15. Gren mot	13. IG SP'd (6 hvy)	14. AT mot (3 hvy+6 med)	I. mot	1941	4 mot	–	–	–
		Hqs Co: mot Commo + Engr + Scout Plt		II. mot	1941	4 mot	–	–	–
	71. Gren mot	13. IG SP'd (6 hvy)	14. AT mot (3 hvy+6 med)	I. mot	1941	4 mot	–	–	–
		Hqs Co: mot Commo + Engr + Scout Plt		II. mot	1941	4 mot	–	–	–
FHH PzG	FHH PzGren mot	13. IG SP'd (6 hvy)	10. AT mot (3 hvy+6 med)	I. mot	1941	4 mot	–	–	–
		Hqs Co: mot Commo + Engr + Scout Plt		II. mot	1941	4 mot	–	–	–
	FHH PzFüs mot	13. IG mot (2 hvy+6 lt)	10. AT mot (3 hvy+6 med)	I. mot	1941	4 mot	–	–	–
		Hqs Co: mot Commo + Engr + Scout Plt		II. mot	1941	4 mot	–	–	–
Sardinien	1. Sardinien PzGren mot	13. IG mot (2 hvy+6 lt)	14. AT mot (6 hvy+6 med)	I. mot	1941	3 mot	1 mot HMG	1 mot Mortar	
		Hqs Co: mot Commo + Engr + Scout Plt		II. mot	1941	3 mot	1 mot HMG	1 mot Mortar	
	2. Sardinien PzGren mot	13. IG mot (2 hvy+6 lt)	14. AT mot (6 hvy+6 med)	I. mot	1941	3 mot	1 mot HMG	1 mot Mortar	
		Hqs Co: mot Commo + Engr + Scout Plt		II. mot	1941	3 mot	1 mot HMG	1 mot Mortar	
	3. Sardinien PzGren mot	13. IG mot (2 hvy+6 lt)	14. AT mot (6 hvy+6 med)	I. mot	1941	3 mot	1 mot HMG	1 mot Mortar	
		Hqs Co: mot Commo + Engr + Scout Plt		II. mot	1941	3 mot	1 mot HMG	1 mot Mortar	

**NOTES:****15. Panzer-Division:**

The Infanterie-Battalion "Reggio" was a standard battalion with an engineer platoon using the regimental headquarters company KStN. The Panzergrenadier were organized under Infantry Inspectorate KStN.

[Self-Propelled Heavy Infantry Gun strengths are listed on page 74.]

**FHH Panzergrenadier Division:**

The Panzergrenadier and Panzerfüsilier were organized under Infantry Inspectorate KStN.

**Sardinien Division:**

The Panzergrenadier were organized under Infantry Inspectorate KStN.

**PANZERGRENADEI-REGIMENT (21. Panzer-Division)**  
**Panzer Grenadier Regiment (21st Panzer Division)**

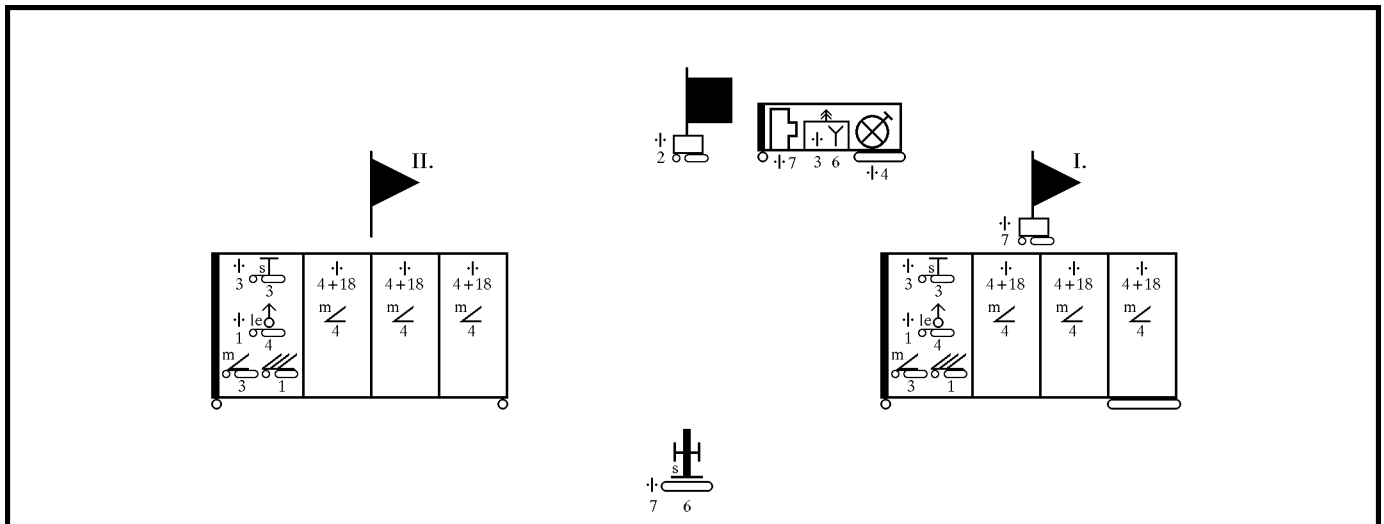

- KStN 1104a(gp)**  
1.06.1943  
**Headquarters, Armored Infantry Regiment**  
Rgt Hqs: 4 mcl; 1 mcl w/sc; 1 car (medium-cc); 2 armored halftracks.
- KStN 1153a(gp)**  
1.04.1943  
*[Special versions for 21. Pz. Div.]*  
**Headquarters Company, Armored Infantry Regiment**  
Co Hqs: 2 mcl; 2 mcl w/sc; 1 armored halftrack.  
Motorcycle Plt: Hqs Sect: 3 mcl; 3 mcl w/sc; 2 cars (light-cc).  
2 Sqd: 4 mcl w/sc; 1 Motorcycle Squad w/ 2 LMG.  
Engr Plt: Hqs Sect: 1 mcl; 1 mcl w/sc; 1 armored halftrack; 2 trucks (medium-cc).  
3 Engr Sect: 2 armored halftracks; 1 Engineer Section w/ 1 LMG.  
Signal Plt: Hqs Sect: 1 mcl; 1 mcl w/sc; 1 armored halftrack.  
3 Med Armd Tele Sect: 1 armored halftrack.  
3 Lt Armd Radio Sect *d*: armored halftrack.  
3 Pack Radio Sect *g*: one each rides in the armored halftrack of the Light Armored Radio Sections *d*.  
Maint Sect: 1 car (light-cc, equipped as Kfz. 2/40); 2 trucks (medium-cc); 1 halftrack.  
Rgt Trains: 1 mcl w/sc; 4 cars (light); 1 trucks (light); 2 trucks (medium); 9 trucks (medium-cc); 1 bus (medium/33 seats).
- KStN 461b**  
16.01.1943  
*[Special version for 21. Pz. Div.]*  
**Self-Propelled Heavy Field Howitzer Battery**  
Bty Hqs: 1 mcl; 1 mcl w/sc; 1 car (light-cc); 2 armored artillery observation vehicles.  
Signal Det: 1 Med Tele Sect *b*: 1 car (medium-cc); 1 van (medium-cc).  
2 Lt Tele Sect: 1 car (medium-cc).  
Gun Plt: Hqs Sect: 1 mcl w/sc; 1 VW (1); 3 cars (medium-cc).  
Gun Sect: 6 Lorraine SP *d* heavy field howitzers (135/1); 2 LMG.  
Ammo Det: 1 mcl w/sc; 4 trucks (medium-cc); 3 armored halftracks (ammo).  
Bty Maint Plt: 2 mcl w/sc; 1 car (light-cc, equipped as Kfz. 2/40); 3 trucks (medium-cc).  
Bty Trains: 4 trucks (medium); 2 trucks (medium-cc); 1 van (medium-cc).
- KStN 1108**  
1.11.1941  
*[Special version for 21. Pz. Div.]*  
**Headquarters, Motorized Infantry Battalion (with French equipment)**  
Bn Hqs: 5 mcl; 2 mcl w/sc; 3 cars (medium-cc).  
Signal Det: Hqs Sect: 1 car (medium-cc).  
1 Lt Tele Sect *c*: 1 car (medium-cc).  
2 Pack Radio Sect *d*: 1 car (light-cc).  
2 Lt Radio Sect *d*: 1 van (light-cc).  
Bn Hqs Trains: 1 mcl w/sc; 1 car (medium-cc); 1 truck (light-cc); 1 truck (medium); truck (3-ton); 1 ambulance (31).  
Bn Maint Det: 1 mcl w/sc; 1 car (light-cc, equipped as Kfz. 2/40); 1 car (light); 3 trucks (3-ton).  
Bn Trains: 1 mcl; 2 cars (light); 2 trucks (light); 1 truck (medium); 5 trucks (3-ton).
- KStN 1114**  
1.11.1941  
*[Special version for 21. Pz. Div.]*  
**Motorized Infantry Company (with French equipment)**  
Co Hqs: 3 mcl; 2 mcl w/sc; 1 car (medium-cc).  
3 Inf Plt: Hqs Sect: 1 mcl; 1 car (medium-cc).  
3 Inf Sqd: 2 trucks (light-cc); 1 Infantry Squad w/ 2 LMG.  
1 Hvy Plt: Hqs Sect: 1 mcl; 1 mcl w/sc; 1 car (medium-cc).  
2 HMG Sect: 2 trucks (light-cc); 2 HMG.  
1 Mortar Sect: 6 trucks (light-cc); 4 mortars.  
Maint Sect: 1 mcl w/sc; 1 car (light-cc, equipped as Kfz. 2/40).  
Co Trains: 1 car (medium-cc); 1 truck (light-cc); 1 truck (medium); 1 truck (medium-cc).
- KStN 1108a(gp)**  
1.04.1943  
*[Special version for 21. Pz. Div.]*  
**Headquarters, Armored Infantry Battalion (with French equipment)**  
Bn Hqs: 5 mcl; 1 mcl w/sc; 3 VW (1); 2 armored halftracks (radio); 1 armored halftrack (ambulance).  
Signal Det: Hqs Sect: 1 SPW (251/11).  
1 Med Armd Tele Sect: 1 armored halftrack.  
2 Armd Pack Radio Sect *g*: ride together in one armored halftrack.  
2 Armd Pack Radio Sect *g*: ride together in one armored halftrack.  
Bn Maint Det: 1 car (light-cc, equipped as Kfz. 2/40); 3 cars (light-cc); 5 trucks (medium-cc);  
2 vans (medium-cc); 1 halftrack; 1 trailer (generator); 1 trailer (tool).  
Bn Trains: 1 mcl; cars (light-cc); 1 truck (medium); 9 trucks (medium-cc); 1 ambulance.
- KStN 1114c(gp)**  
1.04.1943  
*[Special version for 21. Pz. Div.]*  
**Armored Infantry Company (with French equipment)**  
Co Hqs: 3mcl; 1 mcl w/sc; 2 armored halftracks (radio).  
3 Inf Plt: Hqs Sect: 1 mcl; 1 armored halftrack.  
3 Inf Sqd: 1 armored halftrack; 1 Infantry Squad w/ 2 LMG.  
1 Hvy Plt: Hqs Sect: 1 mcl; 1 mcl w/sc; 1 armored halftrack.  
2 HMG Sect: 1 armored halftrack; 2 HMG.  
1 Mortar Sect: 4 SP *d* 81mm mortars (on armored halftracks).  
Maint Sect: 1 car (light-cc, equipped as Kfz. 2/40); 1 truck (medium-cc); 1 halftrack.  
Co Trains: 1 car (light-cc); 1 truck (medium); 3 trucks (medium-cc).
- KStN 1121a(gp)**  
1.03.1943  
*[Special versions for 21. Pz. Div.]*  
**Armored Heavy Company (with French equipment)**  
Co Hqs: 2 mcl; 2 mcl w/sc; 1 armored halftrack (radio); 1 row-mortar (16x 81mm on 1 armored halftrack).  
Lt Armd Tele Sect *c*: 1 armored halftrack (telephone equipment).  
Maint Sect: 1 VW (1); 2 trucks (3-ton); 1 halftrack.  
Co Trains: 1 car (medium-cc); 1 truck (medium); 4 trucks (3-ton).  
SP *d* ATG Plt: Hqs Sect: 2 mcl; 1 armored halftrack.  
Gun Sect: 3 SP *d* 75mm ATG (on armored halftracks); 2 halftracks; 3 LMG.  
SP *d* AA Plt: Hqs Sect: 3 mcl; 2 cars (15); 1 LMG.  
Gun Sect: 4 SP *d* 20mm Flak (on armored halftracks); 2 halftracks; 2 trailers (ammo); 1 LMG.  
SP *d* Mortar Plt: Hqs Sect: 1 mcl w/sc; 1 halftrack.  
Mortar Sect: 1 mcl w/sc; 3 SP *d* 81mm mortars (on armored halftracks).

**NOTES:**

The 21st Panzer-Division had mainly French motor vehicles and equipment. All KStN were modified accordingly. Cars and vehicles with a general weight classification are French motor vehicles. The suffix "cc" indicates a cross-country vehicle.

The 75mm anti-tank guns and the multiple mortars were mounted on armored Somoa half-tracks.

The 20mm Flak and armored infantry were mounted on armored Unic P107 halftracks.

The heavy 150mm field howitzers were mounted on fully tracked Lorraine chassis.

The motorized units had trucks and unarmored Unic P107 halftracks.

**GROßDEUTSCHLAND-REGIMENT**  
**Motorized Grossdeutschland Regiment**

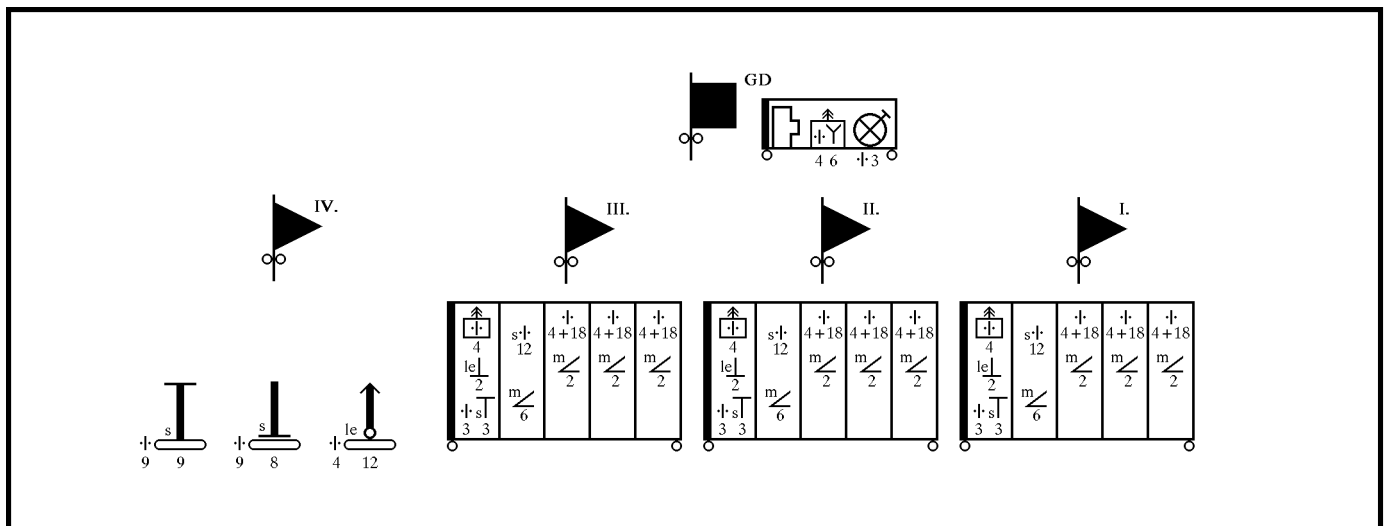

**KStN 103c**  
1.11.1941

**Headquarters, Infantry Regiment (motorized)**

Rgt Hqs: 5 mcl; 2 mcl w/sc; 2 cars (12); 1 car (medium).

**KStN 129**  
1.11.1941

**Headquarters Company, Infantry Regiment (motorized)**

Co Hqs: 2 mcl; 2 mcl w/sc; 1 car (12)

Mcl Plt: Hqs Sect: 1 mcl; 2 cars (15).

3 Recon Sqd: 1 mcl; 4 mcl w/sc; 1 Reconnaissance Squad with 1 LMG.  
1 Messenger Sect: 8 mcl.

Engr Plt: Hqs Sect: 1 mcl; 1 mcl w/sc; 1 car (15).

4 Engr Sect: 1 mcl; 2 trucks (2-ton); 1 Engineer Section with 1 LMG.

Signal Plt: Hqs Sect: 1 mcl; 1 mcl w/sc; 3 cars (15).

2 Lt Tele Sect *d*: 1 car (15).

4 Pack Radio Sect *d*: ride in Headquarters Section vehicles.

4 Lt Radio Sect *e*: 1 van (17).

Maint Sect: 1 mcl w/sc; 1 car (2/40).

Co Trains: 1 mcl; 2 cars (light); 1 car (medium); 4 trucks (light); 2 trucks (medium); 1 bus (medium/33 seats).

**KStN 115c**  
1.11.1941

**Headquarters, Infantry Battalion (motorized)**

Bn Hqs: 4 mcl; 2 mcl w/sc; 1 car (1); 3 cars (15).

Signal Det: Hqs Sect: 1 car (15); 1 truck (2-ton).

2 Lt Tele Sect *d*: ride in Headquarters Section truck (2-ton).

4 Pack Radio Sect *d*: 1 car (2).

Bn Maint Det: 1 mcl w/sc; 1 car (2/40); 1 car (light); 1 truck (light); 2 trucks (3-ton).

Bn Trains: 1 mcl; 1 mcl w/sc; 3 cars (light); 1 truck (light); 6 trucks (medium); 6 trucks (3-ton); 1 ambulance (31).

**KStN 1114**  
1.11.1941

**Motorized Infantry Company**

Co Hqs: 3 mcl; 2 mcl w/sc; 1 car (15).

3 Inf Plt: Hqs Sect: 1 mcl; 1 car (15).

3 Inf Sqd: 2 trucks (70); 1 Infantry Squad w/ 2 LMG.

1 Hvy Plt: Hqs Sect: 1 mcl; 1 mcl w/sc; 1 car (15).

2 HMG Sect: 2 trucks (70); 2 HMG.

1 Mortar Sect: 3 trucks (70); 2 mortars (81mm).

Maint Sect: 1 mcl w/sc; 1 car (2/40).

Co Trains: 1 car (15); 1 truck (2-ton); 1 truck (medium); 1 truck (3-ton).

**KStN 162**  
1.02.1941

**Machine Gun Company (motorized) / Grossdeutschland**

Co Hqs: 4 mcl; 3 cars (15).

3 MG Plt: Hqs Sect: 1 mcl w/sc; 2 cars (15).

2 MG Sect: 1 truck (medium); 2 HMG.

Mortar Plt: Hqs Sect: 1 mcl; 2 cars (11).

3 Mortar Sect: 1 car (11); 2 trucks (medium); 2 mortars (81mm).

Maint Sect: 1 mcl w/sc; 1 car (2/40).

Co Trains: 2 mcl; 1 mcl w/sc; 1 car (light); 3 trucks (light); 1 truck (medium).

**KStN 163**  
1.03.1943

**Heavy Company (motorized) / Grossdeutschland**

Co Hqs: 4 mcl; 1 mcl w/sc; 1 car (15).

Signal Det: 1 Lt Tele Sect *d*: 1 car (15).

2 Pack Radio Sect *d*: 1 car (2).

Engr Plt: Hqs Sect: 1 mcl; 1 mcl w/sc; 1 car (15); 1 truck (3-ton).

4 Engr Sect: 1 mcl; 2 trucks (1.5-ton); 1 Combat Engineer Section with 1 LMG.

ATG Plt: Hqs Sect: 1 mcl; 1 mcl w/sc; 1 car (12).

Gun Sect: 5 halftracks (11); 3 ATG (75mm – towed); 2 trailers (ammo); 3 LMG.

Lt IG Plt: Hqs Sect: 1 mcl; 1 mcl w/sc; 1 halftrack (10); 1 LMG.

Gun Sect: 3 halftracks (10); 2 lt IG (75mm – towed); 1 trailer (ammo).

Maint Sect: 1 mcl w/sc; 1 car (2/40).

Co Trains: 2 mcl; 1 mcl w/sc; 1 car (light); 1 truck (light); 3 trucks (medium); 1 truck (3-ton).

**KStN 192(gek)**  
1.06.1943

**Mechanized Light Anti-Aircraft Company**

Co Hqs: 2 mcl; 1 car (15); 1 LMG.

Signal Det: Hqs Sect: 1 car (15).

1 Lt Tele Sect *c*: 1 car (15).

3 Pack Radio Sect *b*: 1 car (2).

3 SP'd Plt: Hqs Sect: 1 mcl; 2 cars (15); 1 LMG.

Gun Sect: 6 halftracks (10/4 with 20mm Flak).

Maint Sect: 1 car (2/40); 1 truck (medium).

Co Trains: 1 mcl w/sc; 1 car (15); 2 trucks (light); 2 trucks (1.5-ton); 2 trucks (3-ton).

**KStN 1120a**  
1.05.1943

**Self-Propelled Heavy Infantry Gun Company**

Co Hqs: 4 mcl; 1 mcl w/sc; 1 SPW (251/1); 1 Maultier (3).

4 Hvy IG Plt: Hqs Sect: 1 mcl; 1 mcl w/sc; 1 SPW (251/3).

Gun Sect: 1 VW (1); 2 SP'd 150mm IG (138/1); 2 Maultier (3); 3 trailers (ammo); 2 LMG.

Ammo Det: 3 Maultier (3); 3 trailers (ammo).

Maint Sect: 1 car (2/40); 2 trucks (3-ton); 1 halftrack (8).

Co Trains: 1 VW (1); 1 truck (light); 1 truck (medium); 4 trucks (3-ton).

**KStN 1148a \***  
1.12.1942

**Self-Propelled Heavy Anti-Tank Company**

Co Hqs: 3 mcl; 1 mcl w/sc; 1 car (15); 1 Pz-I (101).

3 ATG Plt: Hqs Sect: 1 mcl; 1 mcl w/sc; 1 halftrack (10).

Gun Sect: 3 SP'd ATG (138 or 139); 3 LMG.

Maint Sect: 1 mcl w/sc; 1 car (2/40); 1 truck (3-ton); 1 halftrack (10); 1 halftrack (8); 1 trailer (10-ton/light tank).

Co Trains: 1 mcl; 1 mcl w/sc; 1 car (light); 1 truck (light); 3 trucks (2-ton); 10 trucks (3-ton).

**NOTES:**

Most of the companies of the Grossdeutschland Infantry Regiments still had their own – Infantry Inspectorate – KStN.

The headquarters of the IVth Battalions used the normal Infantry Battalion (motorized) organization.

The I. Bataillon/Grenadier-Regiment GD was a standard 1941 armored infantry unit.

**PANZER-ARTILLERIE-REGIMENT**  
**Artillery Regiment / Panzer Division**

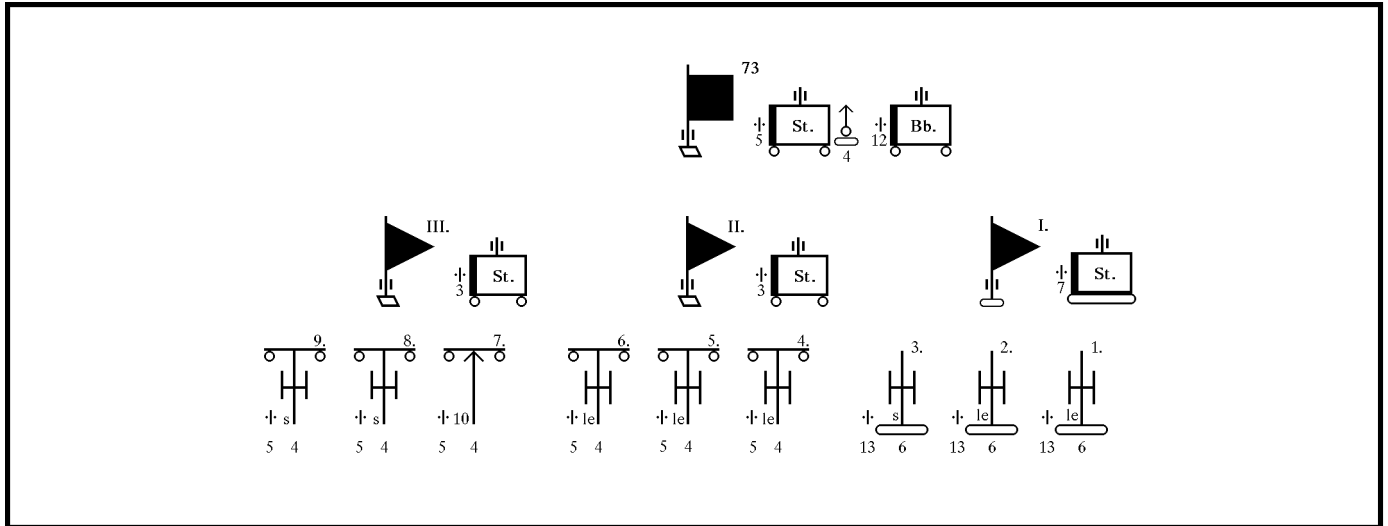

**KStN 410**  
1.11.1941 **Headquarters, Motorized Artillery Regiment**  
Rgt Hqs: 4 mcl; 1 car (1); 3 cars (15); 1 bus (medium).

**KStN 577**  
1.11.1941 **Headquarters Battery, Motorized Artillery Regiment / Panzer Division**  
Bty Hqs: 2 mcl; 1 car (15); 1 Artillery Observation Tank (143).  
Signal Plt: Hqs Sect: 1 mcl w/sc; 1 van (17/1).  
1 Hvy Tele Sect a: 1 car (2); 1 van (23).  
3 Lt Tele Sect c: 1 car (15).  
2 Lt Radio Sect b: 1 van (17).  
4 Pack Radio Sect b: 1 car (2).  
1 Lt Radio Sect c: 1 van (17/1).  
Maint Sect: 1 mcl w/sc; 1 car (2/40).  
Bty Trains: 3 cars (light); 1 car (4 w/dual MG); 1 truck (light); 3 trucks (medium); 1 bus (medium/33 seats).  
AA Plt: Hqs Sect: 1 mcl; 2 cars (15); 1 LMG.  
Ammo Sect: 2 halftracks (10/4 w/o guns).  
Gun Sect: 4 halftracks (10/4 with 20mm Flak).

**ex-KStN 192(gek)**  
1.06.1943

**KStN 545**  
1.11.1941 **Armored Artillery Observation Battery / Panzer Division**  
Bty Hqs: 3 mcl; 2 cars (3); 1 SPW (251/12).  
Flash Ranging Det: 6 SPW (251/12).  
Advance Warning Sect: 2 SPW (251/12).  
Sound Ranging Det: 4 cars (3); 4 SPW (251/12).  
Evaluation Det: 2 cars (3); 4 vans (62); 1 van (63).  
Printing Sect: 1 truck (medium); 1 van (62); 1 trailer (generator).  
Weather Sect: 1 mcl; 1 van (62).  
Maint Sect: 1 mcl w/sc; 1 car (2/40).  
Bty Trains: 1 mcl; 1 car (light); 1 car (4 w/ dual MG); 5 trucks (medium); 1 van (42); 1 bus (light/15 seats); 1 trailer (generator).  
**KStN 547**  
1.02.1941 Calibration Plt: Hqs Sect: 2 mcl; 1 car (16).  
2 Calibration Sect: 2 cars (16).  
1 Evaluation Sect: 1 van (62).

**Divisional Artillery Organization**

Division	Art Rgt	I. Battalion (batteries)	II. Battalion (batteries)	III. Battalion (batteries)	IV. Battalion (batteries)
1. Pz.	73+AA	3x 105FH (mot)	3x 105FH (mot)	3x 105FH (mot)	2x 150FH & 1x 105Gun (mot)
2. Pz.	74	2x 105FH & 1x 150FH (SP'd)	3x 105FH (mot)	2x 150FH & 1x 105Gun (mot)	—
3. Pz.	75	2x 105FH & 1x 105Gun (mot)	2x 105FH & 1x 150FH (mot)	2x 105FH & 1x 150FH (mot)	—
4. Pz.	103+Col	3x 105FH (mot)	2x 105FH & 1x 150FH (SP'd)	2x 150FH & 1x 105Gun (mot)	—
5. Pz.	116+Col	2x 105FH (mot); 1x 150FH (SP'd)	3x 105FH (mot)	1x 150FH & 2x 105Gun (mot)	—
6. Pz.	76	2x 105FH (mot); 1x 150FH (SP'd)	3x 105FH (mot)	2x 150FH & 1x 105Gun (mot)	—
7. Pz.	78	1x 105FH (mot); 1x 105FH & 1x 150FH (SP'd)	3x 105FH (mot)	2x 150FH & 1x 105Gun (mot)	—
8. Pz.	80	3x 105FH (mot)	3x 105FH (mot)	2x 150FH & 1x 105Gun (mot)	—
9. Pz.	102	3x 105FH (mot)	2x 105FH (mot); 1x 150FH (SP'd)	2x 150FH & 1x 105Gun (mot)	—
11. Pz.	119	2x 105FH (mot); 1x 150FH (SP'd)	3x 105FH (mot)	2x 150FH & 1x 105Gun (mot)	—
12. Pz.	2	3x 105FH (mot)	3x 105FH (mot)	2x 150FH & 1x 105Gun (mot)	—
13. Pz.	13	3x 105FH (mot)	2x 105FH (mot); 1x 150FH (SP'd)	2x 150FH & 1x 105Gun (mot)	—
14. Pz.	4+AA	1x 105FH (mot); 1x 105FH & 1x 150FH (SP'd)	3x 105FH (mot)	2x 150FH & 1x 105Gun (mot)	—
16. Pz.	16+AA	3x 105FH (mot)	1x 105FH (mot); 1x 105FH & 1x 150FH (SP'd)	2x 150FH & 1x 105Gun (mot)	—
17. Pz.	27	3x 105FH (mot)	3x 105FH (mot)	3x 150FH (mot)	—
18. Pz.	88	3x 105FH (mot)	3x 105FH (mot)	2x 150FH & 1x 105Gun (mot)	—
19. Pz.	19	3x 105FH (mot)	3x 105FH (mot)	2x 150FH & 1x 105Gun (mot)	—
20. Pz.	92	3x 105FH (mot)	3x 105FH (mot)	2x 150FH & 1x 105Gun (mot)	—
21. Pz.	155*	3x 105FH (SP'd)	3x 105FH (4 guns each)(SP'd)	3x 150FH (SP'd)	—
23. Pz.	128	3x 105FH (mot)	3x 105FH (mot)	2x 150FH & 1x 105Gun (mot)	—
24. Pz.	89+AA	1x 105FH (mot); 1x 105FH & 1x 150FH (SP'd)	3x 105FH (mot)	2x 150FH & 1x 105Gun (mot)	—
25. Pz.	91	2x 105FH (mot); 1x 150FH (SP'd)	3x 105FH (mot)	2x 150FH & 1x 105Gun (mot)	—
26. Pz.	23	2x 105FH & 1x 150FH (SP'd)	3x 105FH (mot)	2x 150FH & 1x 105Gun (mot)	—
GD	GD+AA	2x 105FH & 1x 150FH (mot)	2x 105FH & 1x 150FH (SP'd)	2x 105FH & 1x 105Gun (mot)	2x 105FH & 1x 150 Nbl (mot)
3. Pz.Gren.	3*	3x 105FH (SP'd)	3x 105FH (mot)	2x 150FH & 1x 105Gun (mot)	—
10. Pz.Gren.	10* ‡	3x 105FH (mot)	3x 105FH (mot)	2x 150FH & 1x 105Gun (mot)	—
15. Pz.	33*	1x 105FH & 1x 150FH (mot)	3x 170Gun (mot)	1x 150FH; 1x 210 How; 1x 150 Gun (mot)	3x 105FH (RSO)
16. Pz.Gren.	146*	3x 105FH (mot)	3x 105FH (mot)	2x 150FH & 1x 105Gun (mot)	—
18. Pz.Gren.	18* ‡	3x 105FH & 1x 155mm FH (mot)	3x 105FH (mot)	2x 150FH & 1x 105Gun (mot)	—
20. Pz.Gren.	20* ‡	3x 105FH (mot)	3x 105FH (mot)	2x 150FH; 1x 105Gun; 1x 152FH (mot)	—
25. Pz.Gren.	25*	3x 105FH & 1x 122FH (mot)	3x 105FH (mot)	3x 150FH & 1x 152FH (mot)	—
29. Pz.Gren.	29*	3x 105FH (SP'd)	3x 105FH (mot)	2x 150FH & 1x 105Gun (mot)	—
FHH Pz.Gren.	FHH*	3x 105FH (SP'd)	3x 105FH (mot)	2x 150FH & 1x 105Gun (mot)	—
Sardinien	190*	3x 105FH (mot)	2x 150FH & 1x 105Gun (mot)	2x 105FH & 1x 150FH (SP'd)	—

\* without an Armored Artillery Observation Battery  
‡ only 3 guns per battery

+AA with an Anti-Aircraft Platoon in the Regiment Headquarters  
+Col with a Light Artillery Column



**PANZER-ARTILLERIE-REGIMENT**  
**Artillery Regiment / Panzer Division**

KStN 511 1.03.1943	<b>Motorized Light Artillery Column</b> (The column capacity was achieved by varying the number of trucks authorized) Col: 2 mcl; 1 mcl w/sc; 2 trucks (light); 16 trucks (medium).
KStN 406 1.11.1941	<b>Headquarters, Motorized Artillery Battalion</b> Bn Hqs: 3 mcl; 1 mcl w/sc; 1 car (1); 3 cars (15); 1 truck (medium).
KStN 585 1.11.1941	<b>Headquarters Battery, Motorized Artillery Battalion / Panzer Division</b> Bty Hqs: 2 mcl; 1 car (15); 1 armored observation vehicle (253). SignalPlt: Hqs Sect: 1 mcl w/sc; 1 van (17/1). 1 Hvy Tele Sect a: 1 car (2); 1 van (23). 2 Lt Tele Sect c: 1 car (15). 4 Pack Radio Sect b: 1 car (2). 1 Lt Radio Sect c: 1 van (17/1). Calibration Sect: 1 mcl; 1 car (3); 1 truck (2-ton). Maint Sect: 1 mcl w/sc; 1 car (2/40). Bn Main Det: 1 car (light); 3 trucks (medium). Bn Trains: 4 mcl; 3 cars (light); 1 car (4 w/ dual MG); 4 trucks (light); 18 trucks (medium); 1 ambulance (31).
KStN 435 1.11.1941	<b>Motorized 105mm Light Field Howitzer Battery / Panzer Division</b> Bty Hqs: 3 mcl; 1 car (1); 1 car (2); 2 cars (15); 1 armored observation vehicle (253). SignalDet: Hqs Sect: 1 car (15); 1 van (17/1). 1 Med Tele Sect b: 1 car (15); 1 van (76). 1 Pack Radio Sect f: 1 car (2). Gun Plt: Hqs Sect: 1 mcl; 1 car (4 w/ dual MG); 2 cars (15); 1 halftrack (11). 2 Gun Sect: 2 halftracks (11); 2 lt field howitzers (105mm – towed). Ammo Det: 1 car (light); 4 trucks (3-ton). Maint Sect: 1 mcl w/sc; 1 car (2/40). Bty Trains: 1 truck (light); 3 trucks (medium).
KStN 457 1.11.1941	<b>Motorized 105mm Gun Battery / Panzer Division</b> Bty Hqs: 3 mcl; 1 car (1); 1 car (2); 2 cars (15); 1 armored observation vehicle (253). SignalDet: Hqs Sect: 1 car (15); 1 van (17/1). 1 Med Tele Sect b: 1 car (15); 1 van (76). 1 Pack Radio Sect f: 1 car (2). Gun Plt: Hqs Sect: 1 mcl; 1 car (4 w/ dual MG); 2 cars (15); 1 halftrack (7). 2 Gun Sect: 2 halftracks (7); 2 guns (105mm – towed). Ammo Det: 1 car (light); 4 trucks (3-ton). Maint Sect: 1 mcl w/sc; 1 car (2/40). Bty Trains: 1 truck (light); 3 trucks (medium).
KStN 463 1.11.1941	<b>Motorized 150mm Heavy Field Howitzer Battery / Panzer Division</b> Bty Hqs: 3 mcl; 1 car (1); 1 car (2); 2 cars (15); 1 armored observation vehicle (253). SignalDet: Hqs Sect: 1 car (15); 1 van (17/1). 1 Med Tele Sect b: 1 car (15); 1 van (76). 1 Pack Radio Sect f: 1 car (2). Gun Plt: Hqs Sect: 1 mcl; 1 car (4 w/ dual MG); 2 cars (15); 1 halftrack (7). 2 Gun Sect: 2 halftracks (7); 2 hvy field howitzers (150mm – towed). Ammo Det: 1 car (light); 4 trucks (3-ton). Maint Sect: 1 mcl w/sc; 1 car (2/49). Bty Trains: 1 truck (light); 3 trucks (medium).
KStN 407 16.01.1943	<b>Headquarters, Self-Propelled Artillery Battalion</b> Bn Hqs: 3 mcl; 1 mcl w/sc; 1 car (1); 2 cars (15); 2 Artillery Observation Tanks (143).
KStN 583 16.01.1943	<b>Headquarters Battery, Self-Propelled Artillery Battalion</b> Bty Hqs: 1 mcl; 1 car (15). SignalPlt: Hqs Sect: 1 car (15); 1 van (17). 1 Armd Air-Liaison Radio Sect: 1 AC (260). 1 Hvy Tele Sect a: 1 car (2); 1 van (23). 2 Lt Tele Sect: 1 car (15). Artillery Calibration Sect: 1 mcl; 1 car (3); 1 truck (3-ton). Bty Maint Sect: 1 mcl w/sc; 1 car (2/40). Bty Trains: 2 cars (1); 1 AA car (4 w/ dual MG); 1 car (15); 3 trucks (medium); 2 trucks (3-ton); 1 ambulance (31); 2 LMG. Bn Maint Det: 1 mcl; 1 mcl w/sc; 1 car (light); 6 trucks (3-ton); 1 halftrack (9); 1 halftrack crane (9/1 – 6-ton); 2 trailers (tank – 22-ton). Bn Admin Det: 1 mcl; 1 car (light); 12 trucks (medium).
KStN 431b 16.01.1943	<b>Self-Propelled Light Field Howitzer Battery</b> Bty Hqs: 1 mcl; 1 mcl w/sc; 1 VW (1); 2 Artillery Observation Tanks (143). SignalDet: Hqs Sect: 1 car (2). Med Tele Sect b: 1 car (15); 1 van (76). Lt Tele Sect: 1 car (15). Gun Plt: Hqs Sect: 1 mcl w/sc; 1 VW (1); 3 cars (15). Gun Sect: 6 Wespe SP'd light field howitzers (124); 2 LMG. Ammo Det: 1 mcl w/sc; 4 trucks (3-ton); 2 Wespe ammunition carriers (w/o howitzers). Bty Maint Plt: 2 mcl w/sc; 1 VW (2/40); 3 trucks (3-ton). Bty Trains: 4 trucks (medium); 2 trucks (3-ton); 1 van (3-ton).
KStN 461b 16.01.1943	<b>Self-Propelled Heavy Field Howitzer Battery</b> Bty Hqs: 1 mcl; 1 mcl w/sc; 1 VW (1); 2 Artillery Observation Tanks (143). SignalDet: Hqs Sect: 1 car (2). Med Tele Sect b: 1 car (15); 1 van (76). Lt Tele Sect: 1 car (15). Gun Plt: Hqs Sect: 1 mcl w/sc; 1 VW (1); 3 cars (15). Gun Sect: 6 Hummel SP'd heavy field howitzers (165); 2 LMG. Ammo Det: 1 mcl w/sc; 4 trucks (3-ton); 3 Hummel ammunition carriers (w/o howitzers). Bty Maint Plt: 2 mcl w/sc; 1 VW (2/40); 3 trucks (3-ton). Bty Trains: 4 trucks (medium); 2 trucks (3-ton); 1 van (3-ton).

**NOTES:**

The prefix "Panzer" to artillery unit designations merely indicated that they were assigned to Panzer Divisions. Self-propelled artillery had the suffix "Sfl" (for Selbstfahrlafette). Motorized artillery within the Panzer Divisions had the suffix "mot", (i.e. motorized).

The Panzergrenadier divisional artillery units' motorized regiment headquarters and battalions had their own KStN and used the suffix "motorized". (The Gross-Deutschland Artillery Regiment was also organized under the "motorized" KStN. [See page 62–63]). However, their self-propelled battalions had the same KStN as those of the Panzer Divisions.

One self-propelled artillery battalion was authorized for all Panzer and some Panzergrenadier Divisions. However, owing to a lack of self-propelled carriages, most divisions did not have a complete battalion, and a several had no self-propelled batteries at all.

All three battalions of the 21. Panzer Division were self-propelled using modified French tracked vehicles. The batteries used the same KStN as those equipped with German weapons. The batteries in the II. Battalion only had four guns each.

[ Self-Propelled Artillery strengths are listed on page 74.]

**ARTILLERIE-REGIMENT (motorisiert)**  
**Motorized Artillery Regiment**

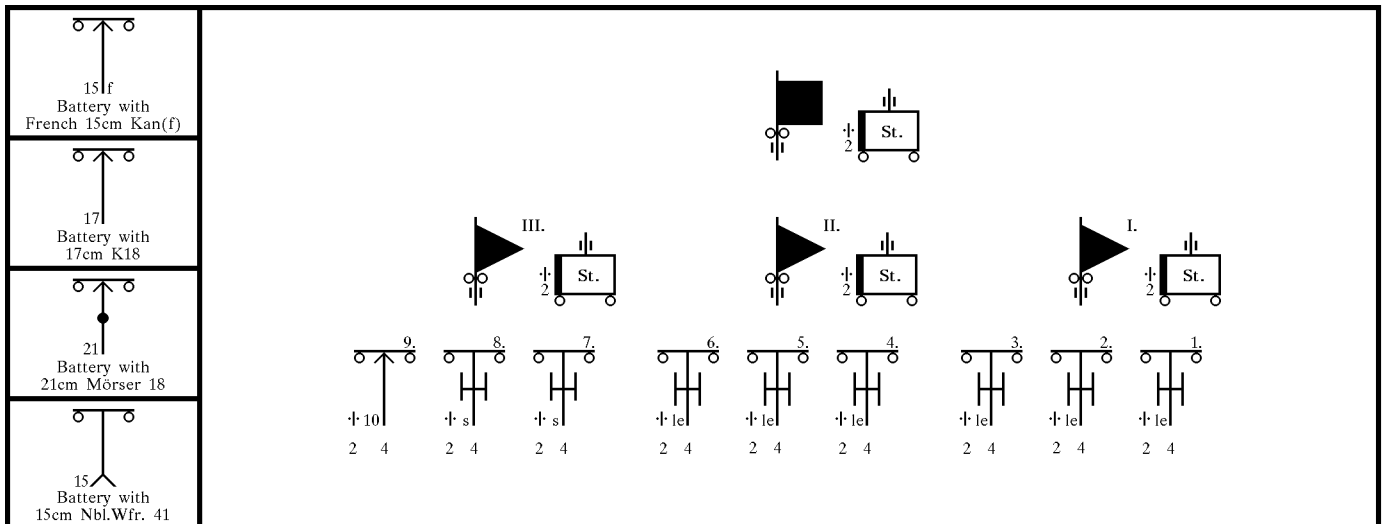
**KStN 410**

1.11.1941

**Headquarters, Motorized Artillery Regiment**

Rgt Hqs: 4 mcl; 1 car (1); 3 cars (15); 1 bus (medium).

**KStN 578**

1.11.1941

**Headquarters Battery, Motorized Artillery Regiment**

Bty Hqs: 2 mcl; 1 car (15).

Signal Plt: Hqs Sect: 1 mcl w/sc.

1 Hvy Tele Sect a: 1 car (2); 1 van (23).  
 1 Med tele Sect b: 1 car (15); 1 van (76).  
 3 Lt Tele Sect c: 1 car (15).  
 2 Lt Radio Sect b: 1 van (17).  
 4 Pack Radio Sect b: 1 car (2).  
 1 Lt Radio Sect c: 1 van (17/1).

Weather Sect: 1 mcl; 1 car (1); 1 van (76).

Printing Sect: 1 mcl; 1 car (light); 1 truck (medium); 1 van (62); 1 trailer (generator).

Maint Sect: 1 mcl w/sc; 1 car (2/40).

Bty Trains: 3 cars (light); 1 car (4 w/dual MG); 1 truck (light); 3 trucks (medium); 1 bus (medium/33 seats).

**KStN 406**

1.11.1941

**Headquarters, Motorized Artillery Battalion**

Bn Hqs: 3 mcl; 1 mcl w/sc; 1 car (1); 3 cars (15); 1 truck (medium).

**KStN 586**

1.11.1941

**Headquarters Battery, Motorized Artillery Battalion**

Bty Hqs: 2 mcl; 1 car (15).

Signal Plt: Hqs Sect: 1 mcl w/sc.

1 Med Tele Sect b: 1 car (15); 1 van (76).  
 3 Lt Tele Sect c: 1 car (15).  
 4 Pack Radio Sect b: 1 car (2).  
 1 Lt Radio Sect c: 1 van (17/1).

Calibration Sect: 1 mcl; 1 car (3); 1 truck (2-ton).

Bty Maint Sect: 1 mcl w/sc; 1 car (2/40).

Bn Main Det: 1 car (light); 3 trucks (medium).

Bn Trains: 4 mcl; 3 cars (light); 1 car (4 w/dual MG); 4 trucks (light); 18 trucks (medium); 1 ambulance (31).

**KStN 434**

1.11.1941

**Motorized 105mm Light Field Howitzer Battery**

Bty Hqs: 3 mcl; 3 cars (15).

Signal Det: Hqs Sect: 1 car (15).

1 Med Tele Sect b: 1 car (15); 1 van (76).  
 1 Lt Tele Sect c: 1 car (15).  
 1 Pack Radio Sect b: 1 car (2).

Gun Plt: Hqs Sect: 1 mcl; 1 car (1); 1 car (4 w/dual MG); 1 car (15); 1 halftrack (11).

Ammo Det: 1 car (light); 4 trucks (3-ton).

2 Gun Sect: 2 halftracks (11); 2 Lt Field Howitzers (105mm – towed).

Maint Sect: 1 mcl w/sc; 1 car (2/40).

Bty Trains: 1 truck (light); 3 trucks (medium).

**KStN 462 \*)**

1.11.1941

**Motorized 150mm Field-Howitzer Battery**

Bty Hqs: 3 mcl; 3 cars (15).

Signal Det: Hqs Sect: 1 car (15).

1 Med Tele Sect b: 1 car (15); 1 van (76).  
 1 Lt Tele Sect c: 1 car (15).  
 1 Pack Radio Sect f: 1 car (2).  
 1 Lt Radio Sect c: 1 van (17/1).

Gun Plt: Hqs Sect: 1 mcl; 1 car (1); 1 AA car (4 w/dual MG); 1 car (15); 1 halftrack (7).

Ammo Sect: 1 car (light); 4 trucks (3-ton).

2 Gun Sect: 2 halftracks (7); 2 hvy Field Howitzers (150mm – towed).

Maint Sect: 1 mcl w/sc; 1 car (2/40).

Bty Trains: 4 trucks (medium).

**KStN 454**

1.11.1941

**Motorized 105mm Gun Battery**

Bty Hqs: 3 mcl; 3 cars (15).

Signal Det: Hqs Sect: 1 car (15).

1 Med Tele Sect b: 1 car (15); 1 van (76).  
 1 Lt Tele Sect c: 1 car (15).  
 1 Pack Radio Sect f: 1 car (2).  
 1 Lt Radio Sect c: 1 van (17/1).

Gun Plt: Hqs Sect: 1 mcl; 1 car (1); 1 AA car (4 w/dual MG); 1 car (15); 1 halftrack (7).

Ammo Sect: 1 car (light); 4 trucks (3-ton).

2 Gun Sect: 2 halftracks (7); 2 Guns (105mm – towed).

Maint Sect: 1 mcl w/sc; 1 car (2/40).

Bty Trains: 4 trucks (medium).

**ARTILLERIE-REGIMENT (motorisiert)**  
**Motorized Artillery Regiment**

- KStN 473 \*)**  
1.11.1941  
**Motorized 150mm Gun Battery**  
Bty Hqs: 4 mcl; 2 cars (15).  
Signal Det: Hqs Sect: 1 car (15).  
1 Med Tele Sect *b*: 1 car (15); 1 van (23).  
1 Hvy Tele Sect *a*: 1 car (2); 1 van (76).  
3 Pack Radio Sect *f*: 1 car (2).  
Gun Plt: Hqs Sect: 4 mcl; 1 car (1); 1 AA car (4 w/ dual MG); 2 cars (15).  
2 Ammo Sect: 2 mcl; 1 car (1); 4 trucks (3-ton).  
3 Gun Sect: 2 halftracks (8); one 150mm Gun in two loads – towed (barrel & cradle).  
Support Sect: 5 trucks (4.5-ton).  
Maint Sect: 1 mcl w/sc; 1 car (2/40).  
Bty Trains: 4 trucks (medium).
- KStN 476 \*)**  
1.04.1942  
**Motorized 170mm Gun Battery**  
Bty Hqs: 4 mcl; 2 cars (15).  
Signal Det: Hqs Sect: 1 car (15).  
1 Med Tele Sect *b*: 1 car (15); 1 van (23).  
1 Hvy Tele Sect *a*: 1 car (2); 1 van (76).  
3 Pack Radio Sect *f*: 1 car (2).  
Gun Plt: Hqs Sect: 4 mcl; 1 car (1); 1 AA car (4 w/ dual MG); 2 cars (15).  
3 Gun Sect: 2 halftracks (8); one 170mm Gun in two loads – towed (barrel & cradle).  
Support Sect: 5 trucks (4.5-ton).  
Ammo Det: 2 mcl; 1 car (1); 4 trucks (3-ton).  
Maint Sect: 1 mcl w/sc; 1 car (2/40).  
Bty Trains: 4 trucks (medium).
- KStN 485 \*)**  
1.11.1941  
**Motorized 210mm Howitzer Battery**  
Bty Hqs: 4 mcl; 2 cars (15).  
Signal Det: Hqs Sect: 1 car (15).  
1 Med Tele Sect *b*: 1 car (15); 1 van (23).  
2 Lt Tele Sect *c*: 1 car (15).  
2 Pack Radio Sect *f*: 1 car (2).  
1 Pack Radio Sect *f*: rides in one of the other Signal Platoon vehicles.  
Gun Plt: Hqs Sect: 4 mcl; 1 car (1); 1 AA car (4 w/ dual MG); 2 cars (15).  
3 Gun Sect: 2 halftracks (8); one 210mm Howitzer in two loads – towed (barrel & cradle).  
Support Sect: 5 trucks (4.5-ton); 1 halftrack (8).  
1st Ammo Det: 2 mcl; 1 car (1); 4 trucks (4.5-ton).  
2nd Ammo Det: 1 mcl; 4 trucks (heavy).  
Maint Sect: 1 mcl w/sc; 1 car (2/40).  
Bty Trains: 1 mcl; 4 trucks (light); 2 trucks (medium).
- KStN 406b \*)**  
15.03.1943  
**Headquarters, Motorized Artillery Battalion (RSO)**  
Bn Hqs: 3 mcl; 1 mcl w/sc; 1 car (1); 3 cars (15); 1 RSO.
- KStN 584b \*)**  
15.03.1943  
**Headquarters Battery, Motorized Artillery Battalion (RSO)**  
Bty Hqs: 2 mcl; 2 cars (15).  
Signal Plt: Hqs Sect: 1 mcl w/sc.  
1 Med Tele Sect *b*: 1 car (15); 1 van (76).  
3 Lt Tele Sect *c*: 1 car (15).  
4 Pack Radio Sect *b*: 1 car (2).  
1 Lt Radio Sect *c*: 1 van (17).  
Calibration Sect: 1 mcl; 1 car (3); 1 truck (1.5-ton).  
Bty Maint Sect: 1 mcl w/sc; 1 car (2/40).  
Bn Maint Det: 1 car (1); 3 RSO; 3 trailers (equipment).  
Bn Trains: 4 mcl; 3 cars (light); 1 AA car (4 w/ dual MG); 8 RSO; 4 trailers (equipment).
- KStN 434b \*)**  
15.03.1943  
**Motorized 105mm Light Field Howitzer Battery (RSO)**  
Bty Hqs: 1 mcl; 3 cars (1).  
Signal Det: Hqs Sect: 1 car (15).  
1 Med Tele Sect *b*: 1 car (15); 1 van (76).  
1 Lt Tele Sect *c*: 1 car (15).  
3 Pack Radio Sect *b*: 1 car (2).  
Gun Plt: Hqs Sect: 1 mcl; 1 car (1); 1 car (4 w/ dual MG); 1 car (15); 2 RSO; 2 trailers (equipment).  
Ammo Det: 1 car (1); 4 RSO; 2 trailers (ammo).  
2 Gun Sect: 2 RSO; 2 Lt Field Howitzers (105mm – towed).  
Maint Sect: 1 mcl w/sc; 1 car (2/40).  
Bty Trains: 4 RSO.
- KStN 617**  
1.11.1941  
**Motorized Rocket Launcher Battery (150mm)**  
Bty Hqs: Hqs Sect: 2 car (1); 1 AA car (4 w/ dual MG).  
Signal Det: Hqs Sect: 1 car (15).  
2 Lt Tele Sect *c*: 1 car (15).  
2 Pack Radio Sect *f*: 1 car (2).  
1 Rocket Plt: Hqs Sect: 1 car (1).  
Launcher Sect: 3 halftracks (11/4); 3 launchers (150mm – towed).  
1 Rocket Plt: Hqs Sect: 1 halftrack (11/4); 1 ATG (50mm – towed).  
Launcher Sect: 3 halftracks (11/4); 3 launchers (150mm – towed).  
2 Ammo Det: 1 mcl w/sc; 3 halftracks (11/4); 3 trailers (ammo).  
Maint Sect: 1 mcl w/sc; 1 car (2/40).  
Bty Trains: 1 car (light); 4 trucks (light); 1 truck (medium).

**NOTES:**

The 15. Panzer-Division artillery was formed from personnel and GHQ heavy artillery units originally destined for the Axis forces in Tunisia which had been stranded in Italy when the Axis forces capitulated in North Africa. The I. Battalion was in the process of being raised. The 557. Motorized Heavy Artillery Battalion (elements of which had been lost in Tunisia), functioned as the II. Battalion and

was equipped with 170mm guns. The III. Battalion was a composite battalion consisting of one battery with heavy field howitzers, one battery with 210mm howitzers, and one battery with French 155mm Guns. The II/53. Artillery Battalion (equipped with light 105mm field howitzers towed by RSO – a fully-tracked truck) functioned as the IV. Battalion.

**HEERES-FLAKARTILLERIE-ABTEILUNG**  
**Motorized Army Anti-Aircraft Battalion**

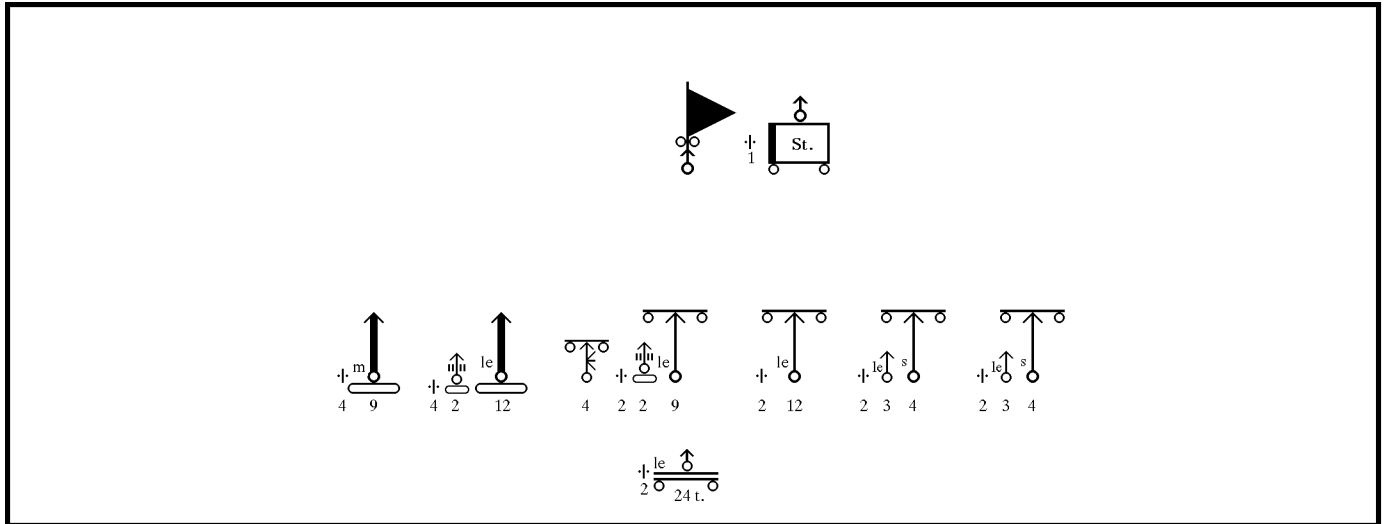

**KSStN 1705**  
1.11.1941

**Headquarters, Motorized Army Anti-Aircraft Battalion**  
Bn Hqs: 3 mcl; 1 car (light); 2 cars (15).

**KSStN 1709**  
1.04.1943

**Headquarters Battery, Motorized Army Anti-Aircraft Battalion**

Bty Hqs: 1 car (15).  
Signal Plt: Hqs Sect: 1 mcl; 1 mcl w/sc; 1 car (15); 1 LMG.  
1 Hvy Tele Sect *a*: 1 car (2); 1 van (23).  
3 Lt Tele Sect *c*: 1 car (15).  
1 Pack Radio Sect *b*: 1 car (2).  
1 Lt Radio Sect *a*: 1 van (17).  
1 Med Radio Sect *b*: 1 car (15); 1 van (17).

1 Weather Sect: 1 mcl; 1 van (61).  
1 Evaluation Sect: 1 truck (medium).  
Bty Maint Sect: 1 mcl w/sc; 1 car (2/40).  
Bn Maint Det: 1 car (light); 1 truck (medium); 3 trucks (3-ton).  
Bn Trains: 1 car (light); 1 car (1); 3 trucks (light); 3 trucks (medium); 1 ambulance (31).

**KSStN 511**  
1.03.1943

**Motorized Light Anti-Aircraft Column (24 ton)** (The column capacity was achieved by varying the number of trucks authorized)  
Col: 2 mcl; 1 mcl w/sc; 2 trucks (light); 8 trucks (medium); 2 LMG.

**KSStN 1711**  
1.03.1942

**Motorized Heavy 88mm Army Anti-Aircraft Battery**

Bty Hqs: 3 mcl; 2 cars (15).  
Calibration Det: Hqs Sect: 1 car (15).  
2 Calibration Sect: 1 van (74); 1 trailer (gun director).  
Signal Det: 1 Hvy Tele Sect *a*: 1 car (2); 1 van (23).  
1 Lt Radio Sect *b*: 1 van (17).  
Ammo Det: 4 trucks (3-ton).  
Lt AA Plt: 1 mcl w/sc; 3 trucks (81); 3 AA guns (20mm – towed).  
Hvy AA Plt: Hqs Sect: 1 mcl; 1 car (15); 1 halftrack (7); 1 trailer (w/o gun).  
Gun Sect: 4 halftracks (7); 4 AA guns (88mm – towed).  
Maint Sect: 1 mcl w/sc; 1 car (2/40).  
Bty Trains: 1 car (light); 3 trucks (light); 3 trucks (medium); 1 trailer (ammo).

**KSStN 1713**  
1.07.1942

**Motorized Light 20mm Army Anti-Aircraft Battery**

Bty Hqs: 3 mcl; 1 car (1); 1 car (15).  
Signal Det: Hqs Sect: 1 mcl w/sc.  
1 Hvy Tele Sect *a*: 1 car (2); 1 van (23).  
1 Lt Radio Sect *b*: 1 van (17).  
5 Pack Radio Sect *d*: 1 car (2).  
Ammo Det: 4 trucks (3-ton).  
2 Lt Mono Plt: Hqs Sect: 2 mcl; 1 car (1).  
Gun Sect: 3 trucks (81); 3 AA guns (20mm – towed); 1 LMG.  
2 Lt Mono Plt: Hqs Sect: 2 mcl; 1 car (1).  
Gun Sect: 3 trucks (81); 3 AA guns (20mm – towed).  
Maint Sect: 1 mcl w/sc; 1 car (2/40).  
Bty Trains: 1 car (light); 2 trucks (light); 3 trucks (medium).  
1 Lt Quad Plt: Hqs Sect: 1 mcl; 1 car (1).  
Gun Sect: 2 halftracks (8 w/ 20mm quad Flak 38).

**KSStN 1715**  
1.12.1942

**Motorized Searchlight Detachment**

Det: 1 mcl; 4 trucks (2-ton); 4 trailers (600mm searchlight – towed).

**KSStN 192(gek)**  
1.06.1943

**Mechanized Light Anti-Aircraft Company**

Co Hqs: 2 mcl; 1 car (15); 1 LMG.  
Signal Det: Hqs Sect: 1 car (15).  
1 Lt Tele Sect *c*: 1 car (15).  
3 Pack Radio Sect *b*: 1 car (2).  
Mono Mot Plt: Hqs Sect: 1 mcl; 2 cars (15); 1 LMG.  
Ammo Sect: 2 trucks (81).  
Gun Sect: 4 trucks (81); 4 AA guns (20mm – towed).  
Mono SP'd Plt: Hqs Sect: 1 mcl; 2 cars (15); 1 LMG.  
Ammo Sect: 2 halftracks (10/4 w/o guns).  
Gun Sect: 4 halftracks (10/4 with 20mm Flak).  
Quad SP'd Plt: Hqs Sect: 1 mcl; 2 cars (15); 1 LMG.  
Ammo Sect: 2 halftracks (7/1 w/o guns).  
Gun Sect: 2 halftracks (7/1 with 20mm Quad Flak).  
Maint Sect: 1 car (2/40); 1 truck (medium).  
Co Trains: 1 mcl w/sc; 1 car (15); 4 trucks (1.5-ton); 2 trucks (3-ton).

**KSStN 198**  
1.02.1941

**Self-Propelled Medium Anti-Aircraft Company**

Co Hqs: 2 mcl; 2 mcl w/sc; 1 car (medium); 1 car (12); 1 LMG.  
Signal Det: Hqs Sect: 1 car (2).  
1 Lt Tele Sect *c*: 1 car (15).  
1 Lt Radio Sect *b*: 1 van (17).  
4 Pack radio Sect *b*: 1 car (2).  
3 AA Plt: Hqs Sect: 3 mcl; 1 car (15); 1 LMG.  
Gun Sect: 3 halftracks (6/2 with 37mm Flak); 1 truck (3-ton).  
Ammo Det: 1 mcl; 3 trucks (3-ton).  
Maint Sect: 1 mcl w/sc; 1 car (2/40); 1 truck (medium).  
Co Trains: 5 mcl; 1 mcl w/sc; 1 car (15); 4 trucks (1.5-ton); 3 trucks (3-ton).

Divisional Army Anti-Aircraft Battalion Organization					
(indicating types and numbers of platoons for the light batteries and companies)					
Div.	Bn.	Hvy Army AA Bty	Lt Army AA Bty	Lt AA Co	Med AA Co
1. Pz	299	2	1 (3 mono/1 quad)	–	–
2. Pz	273	2	1 (3 mono/2 quad)	1 (3 mono/2 quad)	–
3. Pz	314	2	1 (3 mono/1 quad)	1 (2 mono/1 quad)	–
4. Pz	290	2	1 (3 mono/1 quad)	1 (3 mono)	–
5. Pz	288	2	1 (4 mono)	1 (2 mono/2 quad)	–
6. Pz	298	2	1 (3 mono/1 quad)	1 (2 mono/2 quad)	–
7. Pz	296	2	1 (3 mono/1 quad)	–	–
8. Pz	(286)	–	–	–	–
9. Pz	287	2	1 (4 mono)	1 (2 mono/1 quad)	–
11. Pz	277	2	2 (4 mono)	–	–
12. Pz	303	2	1 (4 mono)	1 (2 mono/1 quad)	–
13. Pz	271	2	1 (4 mono) & 1 (3 mono/1 quad)	–	–
14. Pz	276	2	1 (3 mono/1 quad)	–	–
16. Pz	274	2	1 (3 mono/1 quad)	–	–
17. Pz	297	2	1 (3 mono/1 quad)	1 (2 mono/2 quad)	–
18. Pz	–	–	–	–	–
19. Pz	272	2	1 (3 mono/1 quad)	–	–
20. Pz	–	–	1 (4 mono)	–	–
21. Pz	(305)	–	–	–	–
23. Pz	(278)	–	–	–	–
24. Pz	(283)	–	–	–	–
25. Pz	284	2	1 (3 mono/1 quad)	–	–
26. Pz	–	–	–	–	–
GD PzG	GD	3	1 (3 quad)	–	2
3. PzG	312.	2	1 (3 mono/1 quad)	–	–
10. PzG	–	–	–	–	–
15. Pz	Sizilien	–	1 (4 mono/1 quad) & 1 (5 mono)	–	1
16. PzG	281.	2	1 (3 mono/1 quad)	–	–
18. PzG	–	–	–	–	–
20. PzG	–	–	–	–	–
25. PzG	–	–	–	–	–
29. PzG	313.	2	1 (2 mono/2 quad)	–	–
FHH PzG	282.	2	1 (3 mono/1 quad)	–	–
Sardinien	– <sup>1)</sup>	–	–	–	–

1) The II/5 Luftwaffe Flak Battalion was only attached. An Army Anti-Aircraft Battalion was in the process of being formed. It would become the 315. Heeres-Flak-Artillerie-Abteilung (mot) on 6.07.1943.

## PANZERJÄGER-ABTEILUNG Mechanized Anti-Tank Battalion

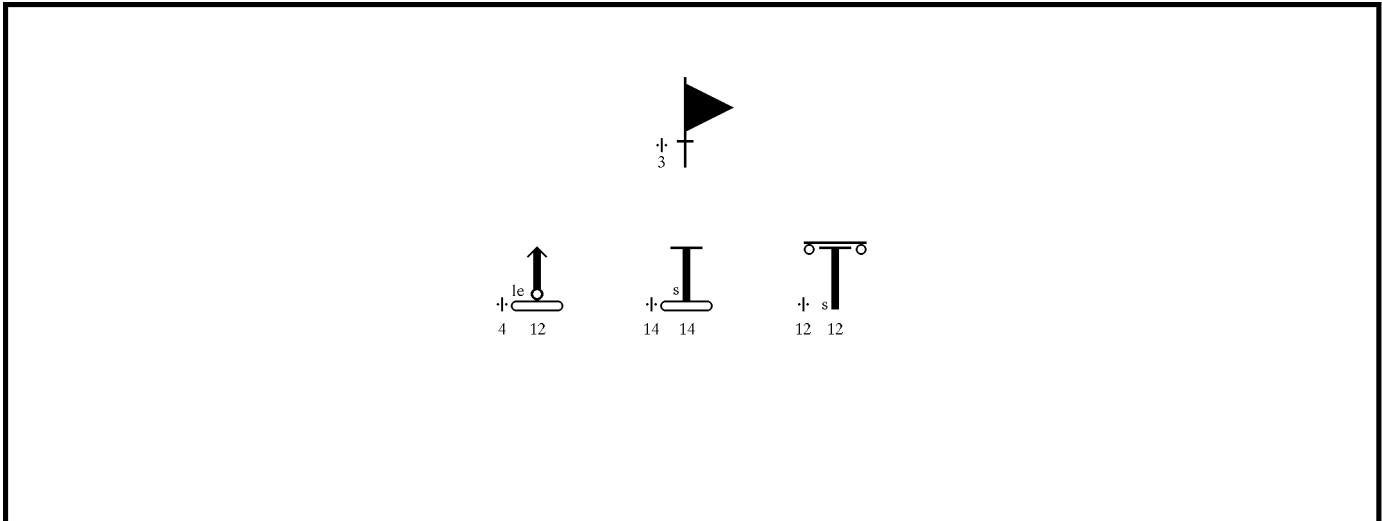

**KStN 1106**  
1.11.1941

**Headquarters, Motorized Anti-Tank Battalion**

Bn Hqs: 2 mcl; 1 mcl w/sc; 1 car (12); 1 car (15); 1 car (21).  
 Signal Det: 1 Lt Tele Sect *c*: 2 mcl; 1 car (15).  
 4 Pack Radio Sect *b*: 1 car (2).  
 2 Lt Armd Radio Sect *d*: 1 AC (261).  
 Hqs Maint Sect: 1 mcl w/sc; 1 car (2/40).  
 Bn Maint Det: 1 car (medium); 1 truck (light); 2 trucks (3-ton).  
 Bn Trains: 1 mcl w/sc; 2 cars (light); 2 trucks (light); 1 truck (2-ton); 1 truck (medium); 1 truck (3-ton); 1 ambulance (31).

**KStN 1140**  
1.04.1943

**Motorized Heavy Anti-Tank Company**

Co Hqs: 3 mcl; 1 mcl w/sc; 1 car (15).  
 3 ATG Plt: Hqs Sect: 1 mcl; 1 mcl w/sc; 1 car (15).  
 Gun Sect: 5 halftracks (11); 4 ATG (76.2mm or 75mm – towed); 1 trailer (ammo); 4 LMG.  
 Maint Det: 1 mcl w/sc; 1 car (2/40).  
 CoTrains: 1 car (1); 1 truck (light); 4 trucks (1.5-ton); 1 truck (medium).

**KStN 1148d**  
1.06.1943

**Self-Propelled Heavy Anti-Tank Company**

Co Hqs: 2 mcl; 1 VW (1); 1 car (15); 1 or 2 SP'd ATG (76.2mm or 75mm).  
 3 ATG Plt: Hqs Sect: 1 mcl; 1 mcl w/sc; 1 car (1); 2 Maultier (3).  
 Gun Sect: 3 or 4 SP'd ATG (76.2mm or 75mm); 4 LMG.  
 Maint Sect: 2 VW (1); 1 car (2/40); 2 trucks (3-ton); 1 halftrack (10).  
 CoTrains: 1 car (light); 1 VW (1); 1 truck (light); 1 truck (1.5-ton); 7 trucks (3-ton).

**KStN 192(gek)**  
1.06.1943

**Mechanized Light Anti-Aircraft Company**

Co Hqs: 2 mcl; 1 car (15); 1 LMG.  
 Signal Det: Hqs Sect: 1 car (15).  
 1 Lt Tele Sect *c*: 1 car (15).  
 3 Pack Radio Sect *b*: 1 car (2).  
 Mono SP'd Plt: Hqs Sect: 1 mcl; 2 cars (15); 1 LMG.  
 Ammo Sect: 2 halftracks (10/4 w/o guns).  
 Gun Sect: 4 halftracks (10/4 with 20mm Flak).  
 Quad SP'd Plt: Hqs Sect: 1 mcl; 2 cars (15); 1 LMG.  
 Ammo Sect: 2 halftracks (7/1 w/o guns).  
 Gun Sect: 2 halftracks (7/1 with 20mm Quad Flak).  
 Maint Sect: 1 car (2/40); 1 truck (medium).  
 CoTrains: 1 mcl w/sc; 1 car (15); 2 trucks (light); 2 trucks (1.5-ton); 2 trucks (3-ton).

Divisional Anti-Tank Battalion Organization					
Div.	Bn.	1st Company	2nd Company	3rd Company	4th Company
1. Pz	37	10x SP'd	10x SP'd	10x SP'd <sup>1)</sup>	–
2. Pz	38	14x SP'd	14x SP'd	14x SP'd	–
3. Pz	543	14x SP'd	12x mot	–	–
4. Pz	49	10x SP'd	10x SP'd	10x SP'd <sup>1)</sup>	12x mot
5. Pz	53	12x mot	14x SP'd	14x SP'd	–
6. Pz	41	12x mot	14x SP'd	–	–
7. Pz	42	12x mot	14x SP'd	–	–
8. Pz	43	14x SP'd	14x SP'd	8x lt Flak & 2x lt quad Flak SP'd	–
9. Pz	50	14x SP'd	14x SP'd	–	–
11. Pz	61	10x SP'd	10x SP'd	10x SP'd <sup>1)</sup>	–
12. Pz	2	14x SP'd	12x mot	–	–
13. Pz	13	10x SP'd	10x SP'd	10x SP'd <sup>1)</sup>	–
14. Pz	–	–	–	–	–
16. Pz	–	–	–	–	–
17. Pz	27	14x SP'd	14x SP'd	12x mot	–
18. Pz	88	14x SP'd	14x SP'd	12x mot	8x lt Flak & 2x lt quad Flak SP'd
19. Pz	19	14x SP'd	12x mot	14x SP'd	–
20. Pz	92	10x SP'd	10x SP'd	10x SP'd <sup>1)</sup>	8x lt Flak & 2x lt quad Flak SP'd
21. Pz	200	12x mot	12x mot	–	–
23. Pz	128	14x SP'd	14x SP'd	8x lt Flak & 2x lt quad Flak SP'd	–
24. Pz	–	–	–	–	–
25. Pz	87	12x mot	12x mot	10x StuG-III	–
26. Pz	–	–	–	–	–
GD PzG	GD	14x SP'd	9x mot	9x mot	–
3. PzG	–	6x mot	9x SP'd	–	–
10. PzG	10	14x SP'd	14x SP'd	14x SP'd	12x lt Flak SP'd
15. Pz	–	–	–	–	–
16. PzG	228	14x SP'd	12x mot	12x mot	–
18. PzG	18	12x mot	12x mot	12x mot	–
20. PzG	20	12x mot	12x mot	14x SP'd	12x lt Flak SP'd
25. PzG	25	12x mot	12x mot	14x SP'd	12x lt Flak SP'd
29. PzG	–	6x mot	–	–	–
FHH PzG	–	–	–	–	–
Sardinien	–	12x mot	–	–	–

**NOTES:**

The KStN for the self-propelled company allowed 1 or 2 self-propelled guns in the headquarters section, and for 2 or 3 platoons, each of 3 or 4 guns.

The KStN for the motor-ized company allowed for 3 or 4 guns per platoon. Standard caliber was 75mm or 76.2mm, but 50mm anti-tank guns were still used if the heavier calibers were not available.

Not all authorized equipment had as yet reached the troops, most companies were under-strength, and some were equipped with both motorized and self-propelled anti-tank guns.

Some divisions preferred to have an additional under-strength self-propelled company rather than two full strength ones.

The 3. Panzergrenadier Division had a company with 9 self-propelled 47mm ATG on Pz-I chassis.

[See page 74 for SP'd ATG strengths and types.]

1) A non-standard, ad-hoc unit raised by the division, using vehicles from other companies in the battalion.

**PANZER-AUFKLÄRUNGS-ABTEILUNG**  
**Reconnaissance Battalion**

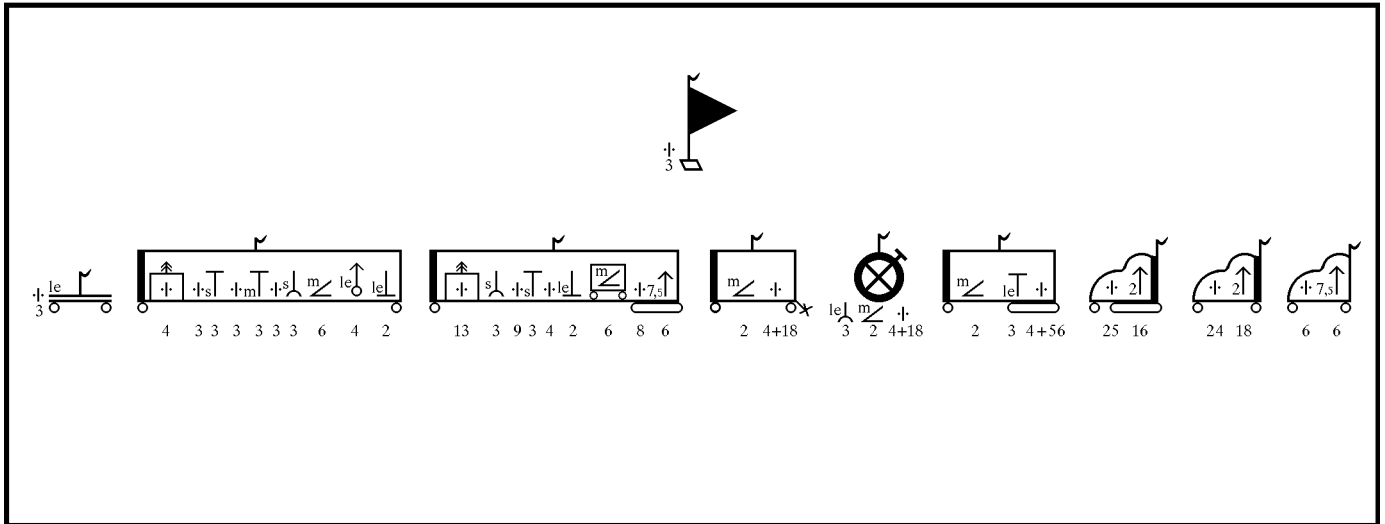

- KStN 1109 \*) Headquarters, Reconnaissance Battalion**  
16.01.1943  
Bn Hqs: 8 mcl; 2 mcl w/sc; 2 cars (15); 1 SPW (250/3).  
Signal Plt: Hqs Sect: 1 VW (1); 1 SPW (250/3).  
1 Lt Armd Tele Sect c: 1 SPW (251/11)  
1 Lt Armd Radio Sect b: 1 SPW (250/3).  
4 Lt Armd Radio Sect c: 1 AC (261).  
3 Med Armd Radio Sect b: 1 SPW (251/3).  
Maint Sect: 1 mcl w/sc; 1 car (2/40); 1 car (light); 3 trucks (3-ton); 1 halftrack (7).  
Bn Trains: 2 VW (1); 8 trucks (3-ton); 1 armored ambulance (251/8).
- KStN 1181 Motorized Light Reconnaissance Column**  
1.02.1941  
Col Hqs: 3 mcl; 4 mcl w/sc; 1 car (15); 3 LMG.  
2 Sect: 4 trucks (medium).  
Col Trains: 1 mcl w/sc; 2 trucks (medium).
- KStN 1138 Heavy Armored Car Platoon**  
1.12.1942  
Plt: 2 trucks (3-ton); 6 AC (233).
- KStN 1162 Armored Car Company (Wheeled)**  
1.11.1941  
Co Hqs: 2 mcl; 5 mcl w/sc; 1 car (15).  
1 Hvy AC Plt: 3 AC (231); 3 AC (232).  
3 Lt AC Plt: 4 AC (222); 2 AC (223).  
Maint Sect: 1 mcl w/sc; 1 car (2/40); 2 trucks (2-ton).  
Co Trains: 1 car (15); 3 trucks (2-ton); 1 truck (medium); 1 truck (3-ton).
- KStN 1162c \*) Armored Car Company (Half-tracked)**  
5.02.1943  
Co Hqs: 3 mcl; 7 KK (2); 1 car (15); 1 SPW (250/5).  
4 AC Plt: 2 SPW (250/5); 4 SPW (250/9).  
Maint Sect: 1 mcl w/sc; 1 car (2/40); 2 trucks (3-ton); 1 halftrack (11).  
Co Trains: 1 car (15); 5 trucks (3-ton).
- KStN 1113(gp) Armored Light Reconnaissance Company**  
1.03.1942  
Co Hqs: 4 mcl; 1 mcl w/sc; 2 SPW (250/3).  
3 Recon Plt: Hqs Sect: 1 SPW (250/1); 1 SPW (250/10 w/ 37mm ATG).  
3 Sqd: 2 SPW (250/1); 1 Reconnaissance Squad w/ 2 LMG.  
1 Hvy Plt: Hqs Sect: 1 mcl; 1 SPW (250/1).  
2 HMG Sect: 3 SPW (250/1); 2 HMG.  
1 Mortar Sect: 2 SPW (250/7 w/ 81mm mortars); 2 SPW (250/7 w/o mortars).  
Maint Sect: 1 mcl w/sc; 2 trucks (2-ton); 1 halftrack (10); 1 LMG.  
Co Trains: 1 car (15); 1 truck (2-ton); 1 truck (medium); 2 trucks (3-ton).
- KStN 1112 Motorcycle Reconnaissance Company**  
1.11.1941  
Co Hqs: 4 mcl; 2 mcl w/sc; 1 car (15).  
3 Mcl Plt: Hqs Sect: 1 mcl; 2 cars (15); 1 ATR.  
3 Mcl Sect: 4 mcl w/sc; 1 Infantry Squad with 2 LMG.  
1 Hvy Plt: Hqs Sect: 1 mcl; 1 mcl w/sc; 2 cars (15).  
2 HMG Sect: 8 mcl w/sc; 2 HMG.  
1 Mortar Sect: 3 trucks (70); 2 mortars (81mm).  
Maint Sect: 1 mcl w/sc; 1 car (2/40);.  
Co Trains: 1 car (15); 1 truck (2-ton); 1 truck (medium); 1 truck (3-ton).
- KStN 1113 Motorized Light Reconnaissance Company (Volkswagen)**  
18.03.1942  
Co Hqs: 4 mcl w/sc; 3 VW (1).  
3 Recon Plt: Hqs Sect: 1 mcl; 1 VW (1).  
3 Inf Sqd: 4 VW (1); 1 Reconnaissance Squad w/ 2 LMG.  
1 Hvy Plt: Hqs Sect: 1 mcl; 3 VW (1).  
2 HMG Sect: 7 VW; 2 HMG.  
1 Mortar Sect: 3 trucks (70); 2 mortars (81mm).  
Maint Sect: 1 VW (1); 1 VW (2/40).  
Co Trains: 1 VW (1); 1 truck (2-ton); 1 truck (medium); 1 truck (3-ton).

**PANZER-AUFKLÄRUNGS-ABTEILUNG**  
**Reconnaissance Battalion**

**Motorized Heavy Company**

<b>KStN 1121</b> 1.11.1941	Co Hqs: 3 mcl; 2 mcl w/sc; 1 car (15). Lt Tele Sect c: 1 car (15). Maint Sect: 1 mcl w/sc; 1 car (2/40). Co Trains: 1 car (15); 1 truck (2-ton); 1 truck (medium); 1 truck (3-ton).
<b>KStN 1123</b> 1.11.1941	IG Plt: Hqs Sect: 1 mcl; 1 mcl w/sc; 1 truck (69). Gun Sect: 3 trucks (69); 2 Lt IG (75mm – towed); 1 trailer (ammo).
<b>KStN 1127</b> 1.11.1941	ATG Sect: 1 mcl w/sc; 3 trucks (70); 3 ATG (28mm – towed); 3 LMG.
<b>KStN 1122a</b> 1.12.1941	Med ATG Plt: Hqs Sect: 1 mcl; 1 mcl w/sc; 1 car (15). Gun Sect: 3 halftracks (10); 3 ATG (50mm – towed); 3 LMG Ammo Sect: 2 halftracks (10); 2 trailers (ammo).
<b>KStN 1145</b> 1.04.1943	Hvy ATG Plt: Hqs Sect: 1 mcl; 1 mcl w/sc; 1 car (1). Gun Sect: 5 halftracks (11); 3 ATG (75mm – towed); 3 LMG.
<b>KStN 1124</b> 1.11.1941	Engr Plt: Hqs Sect: 1 mcl; 1 mcl w/sc; 1 car (15); 2 trucks (2-ton). 3 Engr Sect: 1 truck (2-ton); 1 Engineer Section w/ 1 LMG. 1 Engr Sect: 1 truck (2-ton); 1 Engineer Section.
<b>KStN 1126</b> 1.10.1938	Mortar Plt: Hqs Sect: 1 mcl w/sc; 1 truck (11). 3 Mortar Sect: 3 trucks (70); 2 mortars (81mm).
<b>ex-KStN 192(gek)</b> 1.03.1943	AA Plt: Hqs Sect: 1 mcl; 2 cars (15); 1 LMG. Ammo Sect: 2 halftracks (10/4 w/o guns). Gun Sect: 4 halftracks (10/4 with 20mm Flak).

**Armored Heavy Company**

<b>KStN 1121a(gp)</b> 1.03.1943	Co Hqs: 2 mcl; 2 mcl w/sc; 1 SPW (251/3). Lt Armd Tele Sect c: 1 SPW (251/11). Maint Sect: 1 VW (1); 2 trucks (3-ton); 1 halftrack (8). Co Trains: 1 car (15); 1 truck (medium); 4 trucks (3-ton).
<b>KStN 1123(gp)</b> 1.03.1943	IG Plt: Hqs Sect: 1 mcl; 1 mcl w/sc; 1 SPW (251/1). Gun Sect: 3 SPW (251/4); 2 Lt IG (75mm – towed).
<b>KStN 1127(gp)</b> 1.11.1941	ATG Sect: 1 mcl w/sc; 3 SPW (250/11).
<b>KStN 1145(gp)</b> 1.03.1943	ATG Plt: Hqs Sect: 2 mcl; 1 SPW (251/1). Gun Sect: 5 SPW (251/4); 3 ATG (75mm – towed).
<b>KStN 1124a (gp)</b> 1.03.1943	Engr Plt: Hqs Sect: 1 mcl; 1 mcl w/sc; 1 SPW (250/10). Equipment Sect: 3 trucks (3-ton). 3 Engr Sect: 2 SPW (251/7); 1 Engr. Section w/ 2 LMG.
<b>KStN 1125 (gp)</b> 1.05.1943	Gun Plt: Hqs Sect: 1 mcl; 1 mcl w/sc. Gun Sect: 6 SPW (251/9); 1 SPW (251/4); 1 truck (3-ton).
<b>KStN 1126</b> 1.10.1938	Mortar Plt: Hqs Sect: 1 mcl w/sc; 1 truck (11). 3 Mortar Sect: 3 trucks (70); 2 mortars (81mm).

**Divisional Reconnaissance Battalion Organization**

Division	Battalion	AC Gun Plt.	Reconnaissance Companies				Heavy Company				
			AC (wheeled)	AC (halftrack)	Armored light	Motorized light	Motor- cycle	Infantry Gun Plt.	Anti-Tank Gun Platoon	Engineer Platoon	misc. Platoons
1. Pz	1.	–	1	1	2	–	–	1 armd	1 armd (75mm)	1 armd	1 armd Gun
2. Pz	2.	1	1	1	2	–	–	1 armd	1 armd (75mm)	1 armd	1 armd Gun
3. Pz	3.	–	1	–	1	–	2	2 mot	2 mot (28 & 50mm)	1 mot	–
4. Pz	4.	–	1	–	1	1	1	2 mot	1 mot (50mm)	1 mot	–
5. Pz	5.	–	1	–	–	2	1	1 mot	1 mot (50mm)	1 mot	–
6. Pz	6.	1	1	–	1	–	2	1 armd	1 mot (28/50/75mm)	1 armd	1 armd Gun
7. Pz	7.	1	1	–	1	–	2	2 mot	2 mot (28 & 50mm)	1 mot	–
8. Pz	8.	–	1	1 <sup>b)</sup>	–	–	3	1 mot	2 mot (28 & 50mm)	1 mot	–
9. Pz	9.	1	1	1	2	–	–	1 armd	1 armd (75mm)	1 armd	1 armd Gun
11. Pz	11.	–	1	–	1	–	2	1 mot	2 mot (28 & 50mm)	1 mot	–
12. Pz	12.	–	1	–	–	–	3	1 mot	1 mot (50mm)	1 mot	–
13. Pz	13.	–	1	–	1	–	2	1 mot	2 mot (28 & 50mm)	1 mot	–
14. Pz	14.	1	1	1	2	–	–	1 armd	1 armd (75mm)	1 armd	1 armd Gun
16. Pz	16.	–	1	1	2	–	–	1 armd	1 armd (75mm)	1 armd	1 armd Gun
17. Pz	17.	–	1	–	–	–	3	1 mot	2 mot (28 & 50mm)	1 mot	–
18. Pz	18.	–	1	–	–	–	3	1 mot	2 mot (28 & 50mm)	1 mot	–
19. Pz	19.	–	1	–	–	–	3	1 mot	2 mot (28 & 50mm)	1 mot	1 mot AA
20. Pz	20.	–	1	–	–	–	3	1 mot	1 mot (28 & 75mm)	1 mot	–
21. Pz	21.	–	–	–	–	–	2	–	–	–	–
23. Pz	23.	–	1	–	1	–	2	1 mot	1 mot (50mm)	1 mot	1 mot AA
24. Pz	24.	1	1	1	2	–	–	–	1 armd (75mm)	1 armd	1 mot Mortar
25. Pz	25.	–	1	–	–	–	3	1 mot	1 mot (28 & 50mm)	1 mot	–
26. Pz	26.	–	1	–	3	–	–	1 armd	2 armd (28 & 75mm)	1 armd	1 armd Gun
GD PzG	GD	–	1	–	1	2	–	1 mot	1 mot (50mm)	1 mot	1 armd Gun
3. PzG	113.	1	1	1	2	–	–	1 armd	1 armd (75mm)	1 armd	1 armd Gun
10. PzG	110.	–	1	–	–	–	3	1 mot	2 mot (28 & 50mm)	1 mot	–
15. Pz	–	–	–	–	–	–	–	–	–	–	–
16. PzG	116.	–	1	–	–	–	3	1 mot	2 mot (28 & 50mm)	1 mot	–
18. PzG	118.	–	1	–	–	–	3	1 mot	2 mot (28 & 50mm)	1 mot	–
20. PzG	120.	–	1	–	–	–	3	1 mot	1 mot (50mm)	1 mot	1 mot Mortar
25. PzG	125.	–	1	–	–	–	3	1 mot	1 mot (50mm)	1 mot	1 mot Mortar
29. PzG	129.	1	1	1	2	–	–	1 armd	1 armd (75mm)	1 armd	1 armd Gun
FHH PzG	FHH	1	1	1	2	–	–	1 armd	1 armd (75mm)	1 armd	1 armd Gun
Sardinien	–	–	–	–	–	–	–	–	–	–	–

1) An Armored Car Company (half-tracked) equipped with 3 Pz-38(t) and 12 Pz-II for lack of light SPW.

**PANZER-PIONIER-BATAILLON**  
**Armored Combat Engineer Battalion**

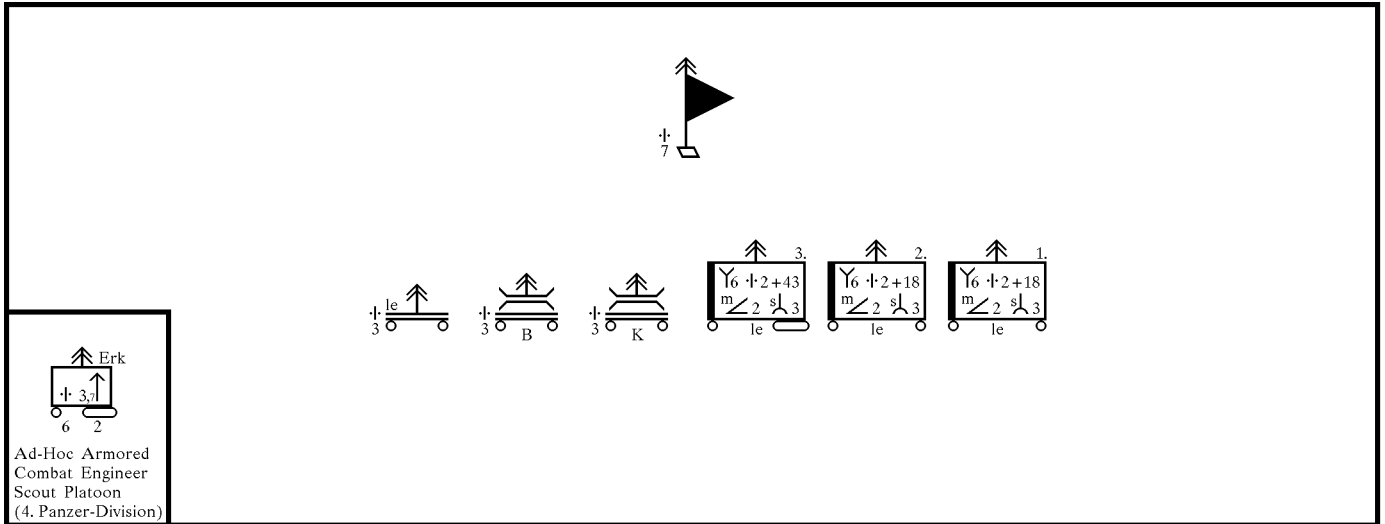

**KStN 703a Headquarters, Armored Combat Engineer Battalion**  
 1.03.1943  
 Bn Hqs: 2 mcl; 2 mcl w/sc; 2 cars (1); 3 cars (15); 2 SPW (250/3); 2 LMG.  
 1 Hvy Tele Sect *a*: 1 car (2); 1 van (1.5-ton).  
 Mcl Scout Det: Hqs Sect: 2 VW-Schwimm (1/20); 1 car (12).  
 3 Scout Sect: 2 mcl; 2 mcl w/sc; 1 Scout Section with 1 LMG.  
 Maint Det: 1 mcl w/sc; 1 car (2/40); 1 car (light); 2 trucks (3-ton).  
 Bn Trains: 1 mcl w/sc; 4 trucks (medium); 2 trucks (3-ton); 1 ambulance (31).

**Ad-hoc KStN**  
 (4. Panzer-Division)  
 Armd Scout Det: Hqs Sect: 1 mcl; 1 mcl w/sc; 2 SPW (250/10); 1 truck (2-ton).  
 3 Scout Sect: 2 SPW (251/7); 1 Scout Section with 1 LMG.

**KStN 714(A) Motorized Light Combat Engineer Company**  
 1.04.1943  
 Co Hqs: 3 mcl; 1 mcl w/sc; 1 car (15).  
 Support Sect: 1 truck (1.5-ton); 1 truck (3-ton).  
 Signal Det: Hqs Sect: 1 car (15).  
 2 Lt Radio Sect *b*: 1 van (2-ton).  
 3 CE Plt: Hqs Sect: 1 mcl; 1 mcl w/sc; 1 car (15); 1 truck (2-ton).  
 3 Sect: 2 truck (2-ton); 1 Combat Engineer Section w/ 2 LMG.  
 Maint Sect: 1 mcl w/sc; 1 car (2/40).  
 Co Trains: 1 mcl w/sc; 3 trucks (medium).  
 Mortar Sect: 2 trucks (medium); 2 mortars (81mm).

**KStN 726**  
 1.03.1943  
 Mortar Sect: 2 trucks (medium); 2 mortars (81mm).

**KStN 728**  
 9.02.1943  
 HMG Sect: 1 truck (2-ton); 2 HMG.

**KStN 714(gp) \* Armored Combat Engineer Company**  
 1.04.1943  
 Co Hqs: 3 mcl; 1 mcl w/sc; 1 SPW (250/3).  
 Support Det: 3 trucks (3-ton); 1 trailer (cargo).  
 Signal Det: Hqs Sect: 1 car (15).  
 2 Lt Armd Radio Sect *e*: 1 SPW (250/3).  
 3 CE Plt: Hqs Sect: 1 mcl; 1 mcl w/sc; 1 SPW (251/7); 1 truck (2-ton).  
 3 Engr Sect: 2 SPW (251/7);  
 1 Combat Engineer Section with 2 LMG.  
 Maint Sect: 1 mcl w/sc; 1 car (2/40); 2 truck (medium).  
 Co Trains: 1 mcl w/sc; 2 trucks (medium); 5 trucks (3-ton).  
 Mortar Sect: 2 SPW (251/2).

**KStN 726**  
 1.03.1943  
**KStN 728**  
 9.02.1943  
 HMG Sect: 1 SPW (251/7); 2 HMG.

**KStN 742 \*) Motorized Supply Column, Combat Engineer Battalion / Panzer Division**  
 1.04.1943  
 Col Hqs: 2 mcl; 1 mcl w/sc; 1 VW (1).  
 1 Plt: 1 mcl; 1 mcl w/sc; 1 car (light); 5 trucks (3-ton); 1 van (4.5-ton);  
 1 trailer (compressor); 1 trailer (cargo); 1 trailer (welding); 1 LMG.  
 2 Plt: 1 mcl; 1 VW (1); 5 trucks (3-ton); 1 trailer (tool);  
 1 trailer (8-ton – long); 1 LMG.  
 Col Trains: 1 mcl w/sc; 3 trucks (3-ton).

Divisional Combat Engineer Battalion Organization					
Div.	Bn.	Hqs.	Engineer Companies (indicating Mortar and HMG Sections)	Bridge Column	
1. Pz	37	armd	2 lt mot (Mort)	1 armd (Mort)	B + K
2. Pz	38	armd	2 lt mot (HMG)	1 armd (HMG)	K
3. Pz	39	armd	3 lt mot (Mort+HMG)	–	K
4. Pz	79	armd	3 lt mot (Mort+HMG)	1 armd (Mort+HMG)	K
5. Pz	89	armd	3 lt mot (HMG)	–	K
6. Pz	57	armd	2 lt mot (Mort+HMG)	1 armd (Mort+HMG)	K
7. Pz	58	armd	1 lt mot (HMG)	2 armd (HMG)	K
8. Pz	59	armd	2 lt mot	1 armd	K
9. Pz	86	armd	2 lt mot (Mort+HMG)	1 armd (Mort+HMG)	K
11. Pz	209	armd	2 lt mot (Mort+HMG)	1 mixed (Mort+HMG)	K
12. Pz	2	armd	2 lt mot (HMG)	1 armd (HMG)	K
13. Pz	4	armd	2 lt mot (Mort+HMG)	1 armd (Mort+HMG)	K
14. Pz	13	armd	2 lt mot (Mort+HMG)	1 armd (Mort+HMG)	K
16. Pz	16	armd	2 lt mot (Mort+HMG)	1 armd (Mort+HMG)	K
17. Pz	27	armd	3 lt mot (Mort+HMG)	–	–
18. Pz	98	armd	3 lt mot (Mort+HMG)	–	–
19. Pz	19	armd	2 lt mot (Mort+HMG)	1 armd (Mort+HMG)	K
20. Pz	92	armd	2 lt mot (Mort+HMG)	1 armd (Mort+HMG)	–
21. Pz	220	armd	–	2 armd (Mort)	K
23. Pz	51	armd	3 lt mot (Mort+HMG)	–	K
24. Pz	40	armd	2 lt mot (Mort+HMG)	1 armd (Mort+HMG)	K
25. Pz	87	armd	3 lt mot (Mort)	–	K
26. Pz	93	armd	2 lt mot (Mort)	1 armd (Mort)	K
GD PzG	GD	armd	3 mot	1 armd	K
3. PzG	3	mot	3 lt mot (Mort+HMG)	–	K
10. PzG	10	mot	3 mot (Mort+HMG)	–	–
15. Pz	33	mot	3 mot (Mort)	–	–
16. PzG	675	mot	3 mot (Mort+HMG)	–	–
18. PzG	18	mot	3 mot (Mort+HMG)	–	–
20. PzG	20	mot	3 mot (Mort+HMG)	–	–
25. PzG	25	mot	3 mot (Mort+HMG)	–	–
29. PzG	29	mot	3 lt mot (Mort+HMG)	–	K
FHH PzG	FHH	mot	3 lt mot (Mort+HMG)	–	K
Sardinien	Sardinien	mot	3 mot (Mort)	–	–

**NOTES:**  
 The 4. Panzer Division had some SPW, but not enough to form an armored company. It chose to utilize them in the scout section, as opposed to the 11. Panzer Division, which integrated the SPW into the third company.

Only the Gross Deutschland had an armored flame platoon.

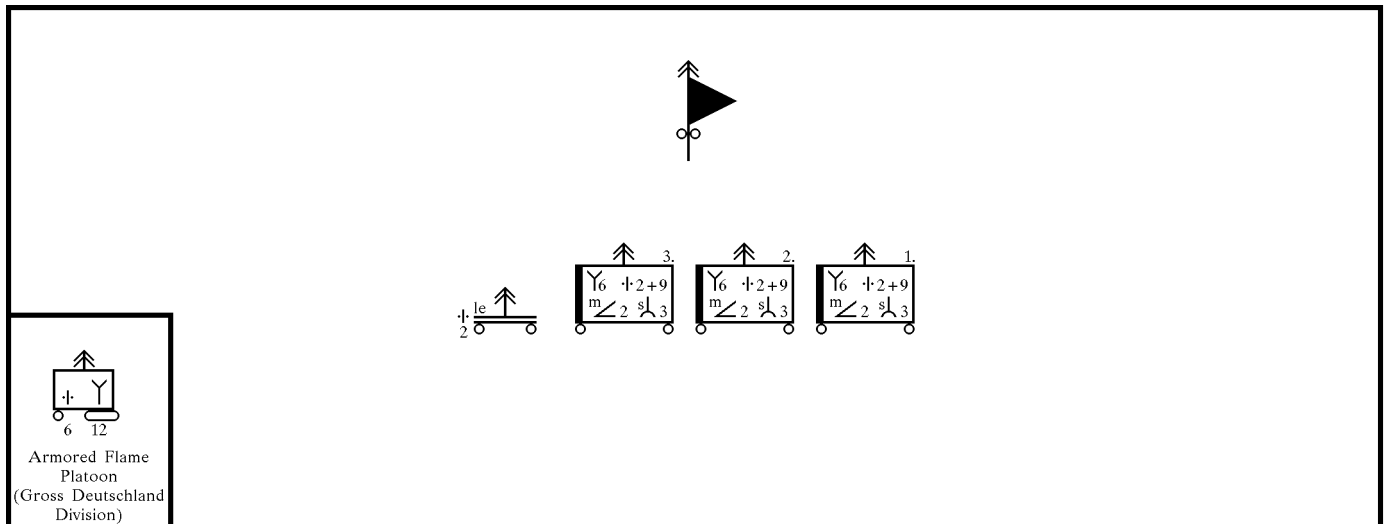

**PIONIER-BATAILLON (motorisiert)**  
**Motorized Combat Engineer Battalion**

**KStN 703**

1.04.1943

**Headquarters, Motorized Combat Engineer Battalion**

Bn Hqs: 2 mcl; 2 mcl w/sc; 2 cars (light); 3 cars (15); 2 LMG.

Signal Det: 4 Lt Radio Sect e: 1 car (2).

1 Hvy Tele Sect a: 1 car (2); 1 truck (3-ton).

Bn Maint Det: 1 mcl w/sc; 1 car (2/40); 1 car (light); 2 trucks (3-ton).

Bn Trains: 1 mcl w/sc; 4 trucks (medium); 2 trucks (3-ton); 1 ambulance (31).

**KStN 1130**

20.01.1943

**Armored Flame Platoon**

Plt: 1 mcl w/sc; 6 SPW (251/16).

Plt Trains: 3 trucks (3-ton).

**KStN 712 \*)**

1.04.1943

**Motorized Combat Engineer Company**

Co Hqs: 3 mcl; 1 mcl w/sc; 1 car (15).

Support Det: 3 trucks (3-ton); 2 trailers (compressor).

Signal Det: Hqs Set: 1 car (15).

2 Lt Radio Sect e: 1 van (17)

3 CE Plt: Hqs Sect: 1 mcl; 1 mcl w/sc; 1 car (15); 1 truck (medium); 1 ATR.

3 Engr Sect: 1 car (15); 1 truck (3-ton); 1 Combat Engineer Section with 1 LMG.

HMG Sect: 1 truck (2-ton); 2 HMG.

Maint Sect: 1 mcl w/sc; 1 car (2/40).

Co Trains: 1 mcl w/sc; 2 trucks (medium); 1 truck (3-ton).

Mortar Sect: 2 trucks (medium); 2 mortars (81mm).

**KStN 726**

1.03.1943

**KStN 728**

9.02.1943

HMG Sect: 1 truck (2-ton); 2 HMG.

**KStN 741**

1.03.1943

**Motorized Light Engineer Column**

Col Hqs: 2 mcl; 1 mcl w/sc; 1 car (light).

1 Equipment Plt: 1 mcl; 1 mcl w/sc; 1 car (light); 5 trucks (medium);

1 van (42); 1 trailer (compressor); 1 trailer (cargo);

1 trailer (tool); 1 trailer (8-ton – long); 1 LMG.

1 Support Plt: 1 mcl; 1 mcl w/sc; 5 trucks (medium); 1 trailer (pile driver); 1 trailer (8-ton); 1 LMG.

Col Trains: 1 mcl w/sc; 1 truck (medium).

**KStN 733 \*)**

1.03.1942

**Motorized Type B Bridge Column**

Col Hqs: 3 mcl; 1 car (light).

2 Bridge Plt: Hqs Sect: 1 mcl; 1 car (15); 1 LMG.

Pontoon Sect: 4 halftracks (7); 4 trailers (3 pontoons each).

Pontoon Sect: 4 trucks (4.5-ton); 4 trailers (3 pontoons each).

Trestle Sect: 2 trucks (4.5-ton); 2 trailers (trestles).

Transom Sect: 2 trucks (4.5-ton); 2 trailers (shore transoms).

Boat Sect: 1 truck (4.5-ton); 1 trailer.

1 Support Plt: Hqs Sect: 2 mcl w/sc.

Ramp Sect: 2 trucks (4.5-ton); 2 trailers (ramps).

Winch Sect: 1 truck (4.5-ton); 1 trailer (winch).

Col Trains: 1 truck (light); 2 trucks (medium); 1 LMG.

**KStN 737**

1.04.1943

**Motorized Type K Bridge Column**

Col Hqs: 3 mcl; 1 car (light).

2 Bridge Plt: Hqs Sect: 1 mcl; 1 mcl w/sc.

Pontoon Sect: 4 trucks (3-ton); 1 LMG.

Trestle Sect: 2 trucks (4.5-ton); 1 trailer (motor boat).

Transom Sect: 4 trucks (4.5-ton).

Tread Sect: 4 trucks (3-ton).

1 Support Plt: Hqs Sect: 2 mcl w/sc.

Rubber Raft Sect: 3 trucks (medium); 1 LMG.

Equipment Sect: 2 trucks (medium).

Support Sect: 1 truck (medium); 1 truck (4.5-ton).

Main Sect: 1 mcl w/sc; 1 car (2/40).

Col Trains: 1 truck (light).

**NACHRICHTEN-ABTEILUNG – PANZER-DIVISION**  
**Divisional Signal Battalion – Panzer Division**

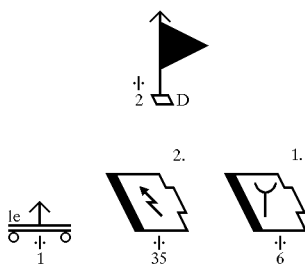

**KStN 805**  
1.03.1943

**Headquarters, Motorized Divisional Signal Battalion**

Bn Hqs: 2 mcl; 1 car (light); 3 cars (15); 2 trucks (1.5-ton); 2 LMG.  
 Maint Det: 1 mcl w/sc; 1 car (2/40); 1 car (light); 2 trucks (3-ton).

**KStN 976a**  
1.03.1943

**Armored Telephone Company / Panzer Division**

Co Hqs: 1 mcl; 1 mcl w/sc; 1 car (15); 1 truck (3-ton); 1 LMG.  
 2 Armd Plt: Hqs Sect: 2 mcl; 1 car (15); 1 KK (2/2); 1 trailer (for KK 2/2); 1 LMG.  
 1 Armd Tele Ops Sect: 1 SPW (251/11); 1 SPW (251/19).  
 3 Armd Hvy Tele Sect: 2 SPW (251/11).  
 1 Mot Plt: Hqs Sect: 2 mcl; 1 car (15); 1 KK (2/2); 1 trailer (for KK 2/2); 1 LMG.  
 1 Tele Ops Sect *a*: 1 car (15); 1 van (17).  
 4 Hvy Tele Sect *a*: 1 car (2); 1 van (23).  
 1 Mot Plt: Hqs Sect: 2 mcl; 1 car (15); 1 KK (2/2); 1 trailer (for KK 2/2); 1 LMG.  
 4 Hvy Tele Sect *a*: 1 car (2); 1 van (23).  
 Maint Sect: 1 mcl w/sc; 1 car (2/40).  
 Co Trains: 1 car (15); 5 trucks (medium).

**KStN 971 \*)**  
1.06.1942

**Armored Radio Company / Panzer Division**

Co Hqs: 1 mcl; 1 mcl w/sc; 1 car (15); 1 truck (3-ton); 1 LMG.  
 1st Plt: Hqs Sect: 2 mcl; 1 SPW (251/3).  
 1 Armd Radio Det: 3 Bef-Pz-III (141/2 equipped as command tanks).  
 2 Armd Command Sect: 1 SPW (251/3).  
 5 Armd Med Radio Sect *a*: 1 SPW (251/3).  
 2nd Plt: Hqs Sect: 2 mcl; 1 SPW (251/3).  
 6 Armd Med Radio Sect *a*: 1 SPW (251/3).  
 2 Armd Med Radio Sect *a/f*: 1 SPW (251/3).  
 3rd Plt: Hqs Sect: 2 mcl; 1 SPW (251/3).  
 8 Armd Med Radio Sect *a*: 1 SPW (251/3).  
 4th Plt: Hqs Sect: 2 mcl; 1 car (15); 1 truck (3-ton); 1 LMG.  
 2 Mot Med Radio Sect *b/f*: 1 truck (2-ton).  
 2 Mot Med Air Liaison Radio Sect: 1 van (2-ton).  
 2 Pack Radio Sect: 1 car (1).  
 1 Code Sect: 1 truck (3-ton).  
 1 Signal Intelligence Sect: 1 van (3-ton).  
 1 Replacement Tank Crew Sect: 1 truck (3-ton).  
 Maint Sect: 1 mcl w/sc; 1 car (2/40); 1 truck (3-ton); 1 halftrack (11).  
 Co Trains: 1 mcl; 1 car (1); 7 trucks (medium); 1 van (medium); 1 trailer (generator).

**KStN 991**  
1.03.1942

**Motorized Light Signal Transport Column a / Panzer Division**

Col: 1 mcl w/sc; 1 car (light); 5 trucks (light); 1 van (light);  
 3 trucks (medium); 2 vans (42); 1 trailer (generator); 1 LMG.

Divisional Signal Battalion Organization				
Div.	Bn.	Radio Co.	Tele Co.	Signal Column
1. Pz	37	armd	mot	1
2. Pz	38	armd	armd	1
3. Pz	39	armd	armd	1
4. Pz	79	armd	armd	1
5. Pz	77	armd	armd	1
6. Pz	82	armd	armd	1
7. Pz	83	armd	armd	1
8. Pz	84	armd	armd	1
9. Pz	85	armd	armd	1
11. Pz	89	armd	armd	1
12. Pz	2	armd	armd	1
13. Pz	13	armd	armd	1
14. Pz	4	armd	armd	1
16. Pz	16	armd	armd	1
17. Pz	27	armd	armd	1
18. Pz	88	armd	armd	1
19. Pz	19	armd	armd	1
20. Pz	92	armd	armd	1
21. Pz	200	armd	armd	1
23. Pz	128	armd	armd	1
24. Pz	86	armd	armd	1
25. Pz	87	armd	armd	1
26. Pz	93	armd	armd	1
GD PzG	GD	armd	armd	1
3. PzG	3	mot	mot	1
10. PzG	10	mot	mot	1
15. Pz	999	mot	mot	1
16. PzG	228	mot	mot	1
18. PzG	18	mot	mot	1
20. PzG	20	mot	mot	1
25. PzG	25	mot	mot	1
29. PzG	29	mot	mot	1
FHH PzG	FHH	mot	mot	1
Sardinien <sup>1)</sup>	–	armd	–	–

1) The Nachrichten-Kompanie Sardinien was redesignated as the 2nd (Armored Radio) Company/190th Armored Signal Battalion when this battalion was activated on 6.07.1943.

**NACHRICHTEN-ABTEILUNG – PANZERGRENADIER-DIVISION**  
**Divisional Signal Battalion – Panzergrenadier Division**

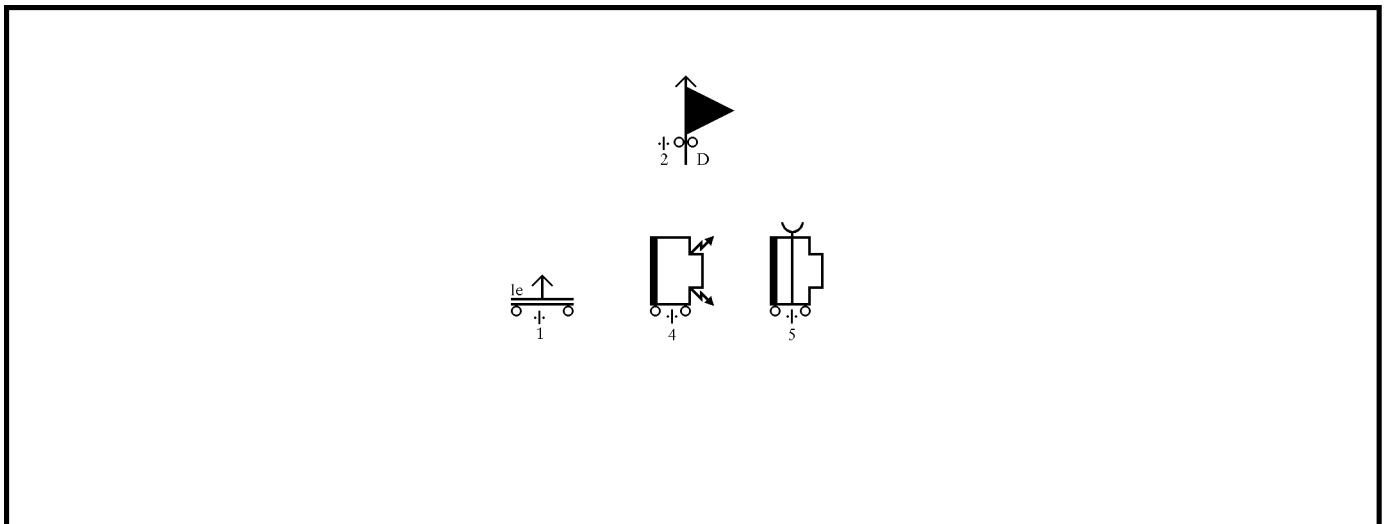

**KStN 805**  
1.03.1943

**Headquarters, Motorized Divisional Signal Battalion**

Bn Hqs: 2 mcl; 1 car (light); 3 cars (15); 2 trucks (1.5-ton); 2 LMG.  
 Maint Det: 1 mcl w/sc; 1 car (2/40); 1 car (light); 2 trucks (3-ton).

**KStN 832**  
1.03.1942

**Motorized Telephone Company / Panzergrenadier Division**

Co Hqs: 1 mcl; 1 mcl w/sc; 1 car (15); 1 truck (2-ton); 1 LMG.  
 1 Plt: Hqs Sect: 2 mcl; 1 car (15); 1 LMG.  
 3 Tele Ops Sect *a*: 1 car (15); 1 van (17).  
 4 Lt Tele Sect *b*: 1 car (15).  
 3 Plts: Hqs Sect: 2 mcl; 1 car (15); 1 LMG.  
 4 Hvy Tele Sect *a*: 1 car (2); 1 van (23).  
 Maint Sect: 1 mcl w/sc; 1 car (2/40).  
 Co Trains: 1 car (15); 3 trucks (light); 2 trucks (medium).

**KStN 858**  
1.03.1942

**Motorized Radio Company / Panzergrenadier Division**

Co Hqs: 1 mcl; 1 mcl w/sc; 1 car (15); 1 truck (2-ton); 1 LMG.  
 1st Plt: Hqs Sect: 2 mcl; 1 car (15); 1 LMG.  
 1 Armd Command Sect: 1 SPW (251/6).  
 6 Med Radio Sect *a*: 1 car (15); 1 van (17).  
 2nd Plt: Hqs Sect: 2 mcl; 1 car (15); 1 LMG.  
 6 Med Radio Sect *a*: 1 car (15); 1 van (17).  
 2 Med Radio Sect *a/f*: 2 vans (17).  
 3rd Plt: Hqs Sect: 2 mcl; 1 car (15); 1 LMG.  
 4 Med Radio Sect *b/f*: 2 cars (17).  
 2 Lt Armd Radio Sect *f*: 1 van (17/1).  
 1 Code Sect: 2 cars (15).  
 Maint Sect: 1 mcl w/sc; 1 car (2/40).  
 Co Trains: 1 car (15); 3 trucks (light); 2 trucks (3medium); 1 van (42); 1 trailer (generator).

**KStN 871**  
1.03.1942

**Motorized Light Signal Transport Column / Panzergrenadier Division**

Col: 1 mcl w/sc; 1 car (light); 1 truck (light); 4 trucks (medium); 2 vans (42); 1 trailer (generator); 1 LMG.

**DIVISIONS VERSORGUNGSDIENSTE**  
**Divisional Services**

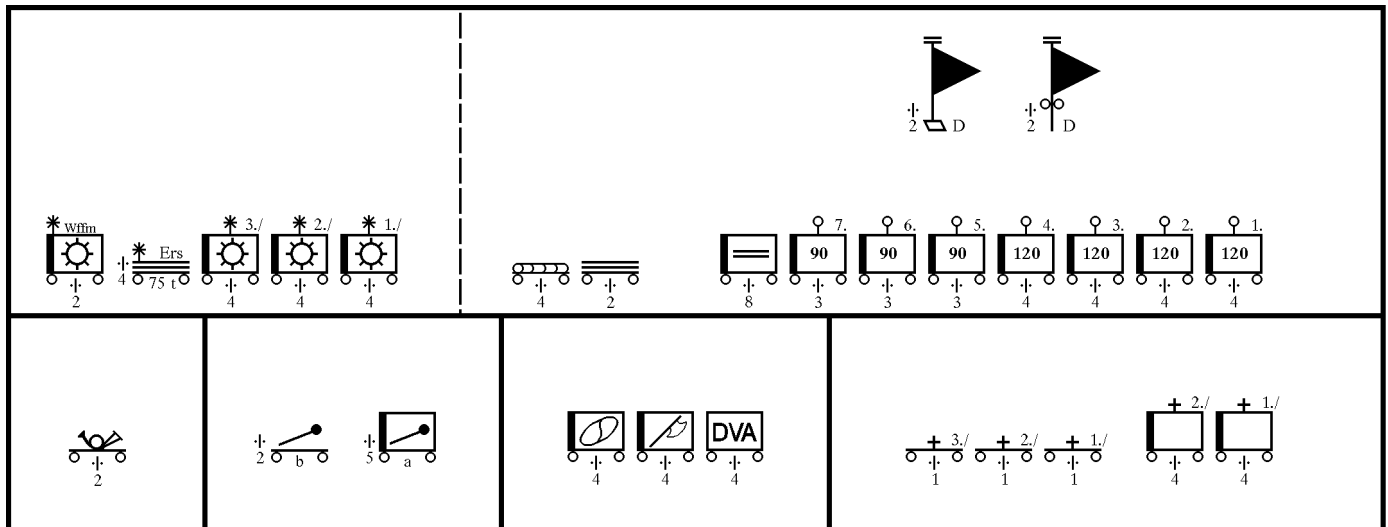

- KStN 1208 \*) Headquarters, Motorized Divisional Supply Battalion**  
1.03.1942  
Bn Hqs: 1 mcl; 4 mcl; 1 car (medium); 1 bus (light/11 seats); 2 LMG.  
Bn Trains: 1 truck (light).
- KStN 1231 \*) Motorized Transport Column (60 tons)**  
1.03.1942  
Col Hqs: 1 mcl; 1 mcl w/sc; 1 car (light).  
2 Sect: 5 trucks (medium); 1 LMG.  
2 Sect: 5 trucks (medium).  
Col. Trains: 1 mcl w/sc; 2 trucks (light).
- KStN 1217a \*) Motorized Transport Company (90 tons)**  
1.11.1942  
Co Hqs: 1 mcl; 1 mcl w/sc; 2 cars (light).  
3 Plt: 10 trucks (medium); 1 LMG.  
Col Trains: 1 mcl w/sc; 3 trucks (light).
- KStN 1217b \*) Motorized Transport Company (120 tons)**  
1.11.1942  
Co Hqs: 1 mcl; 1 mcl w/sc; 2 cars (light).  
4 Plt: 10 trucks (medium); 1 LMG.  
Col Trains: 1 mcl w/sc; 4 trucks (light).
- KStN 1232 \*) Motorized P.O.L. Transport Column (50 m<sup>3</sup>)**  
1.03.1942  
Col Hqs: 1 mcl; 1 mcl w/sc; 2 cars (light).  
4 Sect: 5 trucks (medium); 1 LMG.  
Col Trains: 1 mcl w/sc; 2 trucks (light).
- KStN 1255 \*) Motorized Supply Company**  
1.03.1942  
Co Hqs: 2 mcl w/sc; 1 car (light); 1 truck (light). [+ 8 LMG] <sup>(1)</sup>  
3 Supply Plt: 1 mcl w/sc; 3 trucks (medium).  
1 Technical Plt: 1 mcl w/sc; 3 trucks (medium).  
Co Trains: 1 mcl; 1 truck (light).
- KStN 1052 Motorized Motor Maintenance Company** <sup>(2)</sup>  
1.11.1941  
Co Hqs: 1 mcl; 1 car (light). [+4 LMG] <sup>(1)</sup>  
2 Workshop Plt: 1 mcl w/sc; 1 car (light); 1 truck (light); 1 truck (heavy); 1 bus (medium/31 seats); 1 van (79); 1 halftrack (7);  
1 trailer (generator); 1 trailer (tool).  
1 Armorer Plt: 2 mcl w/sc; 1 truck (light); 4 trucks (medium).  
Co Trains: 1 mcl; 1 car (light); 3 trucks (light).
- KStN 1231 \*) Motorized Transport Column (60 tons)(for spare parts)**  
1.03.1942  
Col Hqs: 1 mcl; 1 mcl w/sc; 1 car (light).  
2 Sect: 5 trucks (medium); 1 LMG.  
2 Sect: 5 trucks (medium).  
Col. Trains: 1 mcl w/sc; 2 trucks (light).
- KStN 1052 Motorized Weapons Maintenance Company** <sup>(2)</sup>  
1.11.1941  
Co Hqs: 1 mcl; 1 car (light). [+ 4 LMG] <sup>(1)</sup>  
2 Armorer Plt: 2 mcl w/sc; 1 truck (light); 4 trucks (medium).  
Co Trains: 1 mcl; 1 car (light); 3 trucks (light).
- KStN 2086 Motorized Divisional Commissary Detachment**  
1.02.1941  
Det: 1 mcl; 4 trucks (medium). [4 LMG] <sup>(1)</sup>
- KStN 1282 \*) Motorized Butcher Company**  
1.02.1941  
Co Hqs: 1 mcl; 1 mcl w/sc; 1 car (light). [+4 LMG] <sup>(1)</sup>  
2 Plt: 3 trucks (medium); 1 trailer (generator).  
Co Trains: 1 mcl w/sc; 1 car (light); 3 trucks (light).
- KStN 1277 \*) Motorized Baker Company**  
1.02.1943  
Co Hqs: 1 mcl; 1 car (light). [+ 4 LMG] <sup>(1)</sup>  
2 Plt: 3 trucks (heavy); 1 truck (heavy – water); 1 bus (medium/33 seats); 1 trailer (dough mixer); 2 trailers (oven).  
Co Trains: 1 mcl w/sc; 1 car (light); 3 trucks (light).

**DIVISIONS VERSORGUNGSDIENSTE**  
**Divisional Services**

- KStN 1314**      **Motorized Medical Company "b"**  
1.01.1943  
Co Hqs: 1 mcl; 1 car (light). [+2 LMG] <sup>(1)</sup>  
Lt Tele Sect 3: 1 car (15).  
Stretcher Bearer Plt: 1 car (light); 5 trucks (medium); 4 ambulance (31); 1 LMG.  
Clearing Station Plt: 1 mcl w/sc; 1 car (light); 3 cars (15); 5 trucks (medium); 1 trailer (generator); 1 trailer (decon); 1 LMG.  
Supplementary Plt: 1 mcl w/sc; 1 car (light); 3 trucks (medium).  
Maint Sect: 1 mcl w/sc; 1 car (2/40).  
Co Trains: 1 mcl; 4 trucks (medium).
- KStN 1365**      **Motorized Ambulance Platoon**  
1.11.1941  
Plt Hqs: 1 car (light); 2 trucks (light). [+1 LMG] <sup>(1)</sup>  
3 Sect: 5 ambulances (31).
- KStN 2033b**      **Motorized Military Police Detachment "b"** <sup>(3)</sup>  
1.03.1942  
Det Hqs: 4 mcl w/sc; 2 cars (light); 1 truck (light).  
2 MP Plt: 6 mcl; 5 cars (light); 1 LMG.
- KStN 2035**      **Mortorized Military Police Company "a"** <sup>(3)</sup>  
1.01.1943  
Co Hqs: 3 mcl; 3 cars (medium).  
2 Traffic Control Plt: Hqs Sect: 2 mcl; 1 mcl w/sc; 1 car (medium); 1 truck (light).  
1 Lt Tele Sect c: 1 car (15).  
2 Sect: 4 mcl; 3 mcl w/sc; 1 LMG.  
1 Sect: 4 mcl; 3 mcl w/sc.  
1 Support Plt: Hqs Sect: 2 mcl; 1 car (medium); 1 truck (light).  
1 Scout Sect: 3 mcl; 2 mcl w/sc.  
1 Traffic Sign Sect: 2 mcl w/sc; 1 car (medium).  
1 Engineer Sect: 1 mcl; 2 cars (15).  
Co Maint Sect: 1 mcl w/sc; 1 car (2/40).  
Co Trains: 1 mcl; 1 car (light); 3 trucks (light); 1 bus (medium/33 seats); 1 LMG.
- KStN 2251**      **Motorized Field Post Detachment** <sup>(3)</sup>  
1.02.1941  
Det: 1 car (medium); 1 motor bus (heavy/33 seats, used as office); 2 vans (light). [+ 2 LMG] <sup>(1)</sup>

**NOTES:**

- (1) Divisional organization diagrams often show more LMG in the service units than the original KStN authorized. Therefore they must have authorized at some time by General Army Orders (Allgemeine Heeresmitteilungen.) Where the exact location within the unit is unknown, these additional LMG are placed in square brackets at the end of the headquarters section.
- (2) The Motorized Maintenance Company authorized either two maintenance platoons or two armorer platoons.
- (3) The Field Post and the Military Police units were fully integrated into the Division (Brigade) Headquarters, and were attached to them for disciplinary matters, administration, and rations.

Divisional Services																
Divison	Supply Battalion	60-ton Column	90-ton Company	120-ton Company	P.O.L. Column	Supply Company	Maint. Company	Spare Parts Column	Armorer Company	Medical Company	Ambulance Platoon	Rations Detachment	Butchery Company	Bakery Company	Field Post	MP Unit
1. Pz	81.	-	1	7	-	1	3	30 t	-	2	3	2	1	1	1	Detachment
2. Pz	82.	1	3	2	-	1	3	-	1	2	3	1	1	1	1	Detachment
3. Pz	83.	-	3	2	1	1	3	-	-	2	3	1	1	1	1	Detachment
4. Pz	84.	-	1	4	-	1	3	72 t	1	2	2	1	1	1	1	Company
5. Pz	85.	-	4	2	-	1	3	-	-	2	3	1	1	1	1	Detachment
6. Pz	57.	1	4	1	-	1	3	-	-	2	3	1	1	1	1	Company
7. Pz	58.	-	6	-	-	1	3	-	-	2	3	1	1	1	1	Company
8. Pz	59.	-	2	3	-	1	3	-	-	2	3	1	1	1	1	Detachment
9. Pz	60.	-	3	2	-	1	3	32 t	-	2	3	1	1	1	1	Detachment
11. Pz	61.	-	4	2	-	1	3	-	1	2	3	1	1	1	1	Detachment
12. Pz	2.	-	3	2	-	1	3	-	-	2	3	1	1	1	1	Detachment
13. Pz	13.	-	2	-	-	1	3	-	-	1	1	1	1	1	1	Detachment
14. Pz	4.	-	-	8	-	1	3	75 t	-	2	3	1	1	1	1	Company
16. Pz	16.	-	-	8	-	1	3	75 t	-	2	3	1	1	1	1	Detachment
17. Pz	27.	-	3	3	-	1	3	-	1	2	3	1	1	1	1	Detachment
18. Pz	88.	-	4	1	-	1	3	-	-	2	3	1	1	1	1	Detachment
19. Pz	19.	-	3	3	-	1	3	-	-	2	3	1	1	1	1	Detachment
20. Pz	92.	-	3	1	-	1	3	-	-	2	3	1	1	1	1	Detachment
21. Pz	200.	-	-	4	-	1	1	-	-	1	2	1	1	1	1	Company
23. Pz	128.	1	3	2	-	1	3	-	1	2	3	1	1	1	1	Detachment
24. Pz	40.	-	-	8	-	1	3	32 t	1	2	3	1	1	1	1	Detachment
25. Pz	-	-	3	2	-	1	2	-	-	2	3	1	1	1	1	Detachment
26. Pz	-	-	1	4	-	1	3	-	-	2	3	1	1	1	1	Detachment
GD PzG	GD	-	3	5	-	1	4	60 t	-	2	3	1	1	1	1	Company
3. PzG	3.	-	3	2	-	1	2	75 t	-	2	3	1	1	1	1	Detachment
10. PzG	10.	1	3	-	-	1	2	-	-	2	3	1	1	1	1	Detachment
15. Pz	Sizilien*)	-	1	3	-	1	1	75 t	-	1	3	1	1	1	1	Detachment
16. PzG	66.	-	2	2	-	1	2	-	-	2	3	1	1	1	1	Detachment
18. PzG	18.	-	2	1	-	1	2	-	-	2	3	1	1	1	1	Detachment
20. PzG	20.	-	-	3	-	1	2	-	-	2	3	1	1	1	1	Detachment
25. PzG	25.	1	2	1	-	1	2	-	-	2	2	1	1	1	1	Detachment
29. PzG	29.	-	3	2	-	1	2	75 t	-	2	3	1	1	1	1	Detachment
FHH PzG	FHH	-	3	2	-	1	2	75 t	-	2	3	1	1	1	1	Detachment
Sardinien	**)	-	3	1	-	1	1	-	-	2	3	1	1	1	1	Detachment

**NOTES:**

\*) The Headquarters, Sizilien Motorized Divisional Supply Battalion for the 15. Panzer (Grenadier) Division was redesignated on 24.07.1943 as Headquarters, 33. Motorized Divisional Supply Battalion.

\*\*\*) The Headquarters, 190. Motorized Divisional Supply Battalion for the Sardinien (90.) Panzergrenadier Division was raised on 6.07.1943.

**DIVISIONAL AFV STRENGTHS ON 1.07.1943**  
(not including armored halftracks, armored cars, or training vehicles)

Division	Panzer Organization							Tanks, Sturmgeschütz, Command Tanks, and Artillery Tanks											Self-Propelled Anti-Tank Guns					other				
	Pz Rgt	Pz Bn	StuG Bn	Tank Maint.	Flame Plt	Bn. Hqs. Co. Engr. & AA Plts	Tank Companies	Pz I & II	StuG StuG	Pz-III Flame	medium tanks <<< >>>	Pz-III kz	Pz-III 75 <sup>mm</sup> lg	Pz-III Pz-IV kz	Pz-IV Pz-IV lg	Pz-VI	Bef. Pz	Beob. Pz	Total	75 <sup>mm</sup> Pz II	75 <sup>mm</sup> Lor-38(t)	75 <sup>mm</sup> Pz rainc	76.2 <sup>mm</sup> Pz II	76.2 <sup>mm</sup> Pz 38(t)	Total	SP <sup>d</sup> 105 le	SP <sup>d</sup> 150 s FH	SP <sup>d</sup> 150 s IG
1. Pz	1	II.	-	1 Plt	2	yes	- - 4 -	On Hand [En-route]	- -	7	- - - -	- -	- -	64	-	7	-	78	-	20	-	-	-	20	-	-	-	12
2. Pz	3	II.	-	1 Plt	-	-	- 2 2 -	On Hand [En-route]	12 <sup>1</sup>	-	5	20	12	1	62	-	9	127	-	24	-	-	6	30	12	6	-	
3. Pz	6	II.	-	1 Co	-	yes	- 5 2 -	On Hand [En-route]	7	2	8	17	34	2	21	-	2	94	-	14	-	-	-	14	-	-	-	
4. Pz	-	I/35	-	1 Co(-)	-	-	- - 4 -	On Hand [En-route]	- -	- -	- 15	-	1	79	-	6	9	110	25	-	-	1	-	26	12	6	-	
5. Pz	31	II.	-	1 Co(-)	-	-	- 3 1 -	On Hand [En-route]	- -	- -	- 17	-	-	-	76	-	9	102	14	-	-	-	-	14	-	6	2	
6. Pz	11	II.	-	1 Co(-)	2	-	- 3 1 -	On Hand [En-route]	13	-	14	-	18	34	-	6	-	117	5	-	-	1	-	6	-	6	-	
7. Pz	25	I., II.	-	1 Co	-	yes	- 4 2 -	On Hand [En-route]	12	-	-	12	43	1	37	-	7	112	-	-	-	6	-	6	6	6	-	
8. Pz	-	I/10	-	1 Co(-)	-	yes	- 3 1 -	On Hand [En-route]	14 <sup>2</sup>	-	25	4	33 <sup>3</sup>	8	14	-	6	104	-	6	-	-	12	18	-	-	-	
9. Pz	33	I.	-	1 Co(-)	-	yes	- 3 1 -	On Hand [En-route]	1	-	8	-	30	8	30	-	4	87	16	-	-	-	-	16	-	6	5	
11. Pz	15	II., III.	711.	1 Co	2	yes	3 4 2 -	On Hand [En-route]	8	31	13	11	51	-	25	-	4	148	11	-	-	-	-	11	-	6	-	
12. Pz	29	II.	-	1 Co(-)	-	yes	- 2 2 -	On Hand [En-route]	7 <sup>4</sup>	-	15	6	15	1	36	-	4	84	-	-	-	-	16	16	-	-	-	
13. Pz	4	II.	-	1 Co(-)	-	-	- - 4 -	On Hand [En-route]	5	-	4	-	10	-	50	-	2	71	25	-	-	-	-	25	-	-	-	
14. Pz	36	I., II.	III.	1 Co	1	yes	4 - 8 -	On Hand [En-route]	-	12	7	-	-	-	8	-	8	35	-	-	-	-	-	-	6	6	-	
16. Pz *	2	II.	III.	1 Co	1	yes	4 - 4 -	On Hand [En-route]	-	10	7	-	-	-	68	-	12	97	-	-	-	-	-	-	6	6	12	
17. Pz	-	II/39	-	1 Plt	-	yes	- 2 2 -	On Hand [En-route]	4	-	1	9	19	1	31	-	2	76	-	-	-	-	-	-	-	-	-	
18. Pz	-	18.	-	1 Plt	-	yes	- 3 1 -	On Hand [En-route]	5	-	10	20	-	7	29	-	3	74	5	3	-	-	-	8	-	-	-	
19. Pz	27	I., II.	-	1 Co	-	yes	- 4 3 -	On Hand [En-route]	2	-	5	11	22	2	36	-	3	85	-	-	-	-	14	14	-	-	-	
20. Pz	-	21.	-	1 Plt	-	yes	- 3 1 -	On Hand [En-route]	-	-	2	5	19 <sup>5</sup>	9	38	-	7	84	12	16	-	-	-	28	-	-	-	
21. Pz	100	I., II.	200.	1 Co	4	-	4 6 2 -	On Hand [En-route]	-	-	-	-	-	2	2	-	2	6	-	-	-	-	-	12	-	18	-	
23. Pz	201	I.	-	1 Co(-)	-	yes	1 <sup>6</sup> 2 2 -	On Hand [En-route]	1	7 <sup>6</sup>	7	3	17	-	30	-	1	61	1 <sup>7</sup>	15	-	-	-	16	-	-	-	
24. Pz	24	II.	III.	1 Co	2	yes	4 - 4 -	On Hand [En-route]	-	41	15	-	-	-	5	-	5	66	-	-	-	-	-	6	6	12	-	
25. Pz	9	I., II.	-	1 Co	-	yes	- 4 2 -	On Hand [En-route]	14	-	10	3	13	28	7	22	-	8	105	-	-	-	-	-	-	6	-	
26. Pz	26	II.	-	1 Co(-)	2	yes	- 3 1 -	On Hand [En-route]	10	-	14	-	16	24	17	-	10	100	-	-	-	-	-	12	6	12	-	
GD PzG	GD	I., II.	GD	1 Co	2	yes	3 - 6 1	On Hand [En-route]	4	34	14	1	2	20	5	63	15 <sup>8</sup>	9	175	20	-	-	-	20	12	6	16	
3. PzG	-	103.	-	1 Plt	-	-	1 - 3 -	On Hand [En-route]	1	22	-	-	-	-	-	-	5	28	9 <sup>10</sup>	-	-	-	-	9	18	12	-	
10. PzG	-	-	-	-	-	-	- - - -	On Hand [En-route]	-	-	-	-	-	-	-	-	-	-	39	-	-	-	-	39	-	-	-	
15. Pz	-	215.	-	1 Plt	-	-	- - 3 1	On Hand [En-route]	-	-	-	6	-	-	46	17	1	70	-	-	-	-	-	-	-	-	-	
16. PzG	-	116.	-	1 Plt	-	yes	- 2 1 -	On Hand [En-route]	4	-	-	5	32	11	-	-	1	53	14	-	-	-	-	14	-	-	-	
18. PzG	-	-	-	-	-	-	- - - -	On Hand [En-route]	-	-	-	-	-	-	-	-	-	-	-	-	-	-	-	-	-	-	-	
20. PzG	-	-	-	-	-	-	- - - -	On Hand [En-route]	-	-	-	-	-	-	-	-	-	-	-	-	-	-	6	6	-	-	-	
25. PzG	-	-	-	-	-	-	1 - - -	On Hand [En-route]	-	-	10	-	-	-	-	-	-	10	10	-	-	-	-	10	-	-	-	
29. PzG *	-	129.	-	1 Plt	-	yes	- - 3 -	On Hand [En-route]	-	-	-	-	-	-	-	-	4	4	-	-	-	-	-	-	18	12	-	
FHH PzG	-	FHH	-	1 Plt	-	-	- - 3 -	On Hand [En-route]	-	3	-	-	-	-	-	-	3	6	-	-	-	-	-	-	6	-	6	
Sardinien	-	Sardin.	242.	1 Plt	-	-	4 - 2 -	On Hand [En-route]	-	38	-	1	13	-	10	-	2	4	68	-	-	-	-	-	12	6	-	

## NOTES:

- Including 6 Pz-II without turrets
- Including 12 Pz-II in the Recon. Battalion
- Including 3 Pz-38(t) in the Recon. Battalion
- 1 Pz-I, Ausf. F (VK 1801); and 6 Pz-II, Ausf. J (VK 1601)
- Including 9 Pz-38(t)
- Self-propelled 150mm IG on StuG-III
- Self-propelled 50mm ATG on Pz-II
- Including 1 Befehls-Pz-VI
- Including 3 Befehls-Pz-VI
- Self-propelled 47mm ATG on Pz-I

\* Strength reports of the 16. Pz.-Div. and 29. Pz.-Gren.-Div. are from 10.06.1943.

- 1 Co (-) Maintenance Company without one Workshop Platoon.
- On Hand vehicles on 30.06.1943, including vehicles awaiting repair.
- [En-Route] vehicles allocated to the division on 30.06.1943. However, note that not all these vehicles arrived on time or even at their scheduled unit.
- kz (short) For Pz-III: 50mm L/42  
For Pz-IV: 75mm L/24
- lg (long) For Pz-III: 50mm L/60  
For Pz-IV: 75mm L/43 and L/48
- (75) For Pz-III: 75mm L/24

Strengths of Panzer units in the field had little to do with the Authorized (i.e., KStN) strengths. KStN were only adhered to when a unit was rebuilt or initially outfitted. Hence there was a only close relationship between the KStN and the On-Hand strengths when a unit was first sent into battle. Two days later, these KStN were not worth the paper they were written on. Thereafter, the periodic reports submitted by the divisions were used to gauge strength and to decide what replacements – but only in a very general sense – were to be sent to the unit. Until the next time the unit was completely refitted. They did not afford any rights to the unit in the field whatsoever to demand to be filled up to Authorized strength.

Just prior to Kursk, the OKH did attempt to achieve a field strength of approximately 85 medium tanks for each Panzer division, and only allocated tanks to the Panzer divisions on this basis.

Armored halftracks and armored cars were lumped together with other motor vehicles, and an accurate count was not submitted at this time. Foreign vehicles, such as French, Russian, and other tanks were not indicated in strength reports.

## SOURCES AND REFERENCES

## UNPUBLISHED

*Bundesarchiv-Militärarchiv (German Military Archives), Freiburg/Br.*

- RHD 4/273 "Muster für taktische Zeichen des Heeres"  
Heeresdienstvorschrift (H.Dv) 272, dated 23.05.1943
- RH 10/10 "Umgliederung und personelle Auffüllung des Pz.Rgt. 1"  
OKH/Ch H Rüst u B d E/AHA/Ia(I) Nr. 2348/43 g Kdos, dated 10.05.1943
- RH12-21/v. 56 "Ausbau der schnelle Brigade West zu einer Pz. Div."  
OKH/Ch H Rüst u B d E/AHA/Ia(I) Nr. 2130/43 g Kdos, dated 6.05.1943
- RH12-21/v. 56 "Ausbau der schnelle Brigade West zu einer Pz. Div."  
OKH/Ch H Rüst u B d E/AHA/Ia(I) Nr. 3515/43 g Kdos, dated 27.06.1943
- RH 10/132 to 133 "Kriegstagebuch General der Panzertruppen"
- RHD 11/1e "Gültigkeitsliste der Kriegstärke- und Ausrüstungsnachweisungen, Stand 1.4.1943"
- RHD 11/1 to 11/53 "Kriegstärkenachweisungen"
- RHD 18/63 "Kriegsgliederung des Feldheeres, Okt 42 bis Sommer 1943"

*U.S. National Archives, Washington, D.C.*

- H16/171 "Zustandsberichte Panzer-Divisionen, Stand 30.06.1943"  
I.Qu./Gruppe V(K)III/I. 31780/43 g Kdos, dated 11.07.1943
- H1/97 "Band II – Kriegsgliederung des Feldheeres (ohne Heerestruppen) – Sommer bis Sept. 1943"

## PUBLISHED

BEIERSDORF, H.

"KFZ-Anhänger der Wehrmacht 1935 – 1945"  
Podzun-Pallas, Friedberg, 1994.

BUCHNER, A.

"Das handbuch der deutschen Infanterie, 1939 – 1945"  
Podzun-Pallas, Friedberg, 1987.

–  
"Der Sanitätsdienst des Heeres"  
Nebel, Eggolsheim, 2002.

CHAMBERLAIN, P., DOYLE, H.C., JENTZ, T.  
"Encyclopedia of German Tanks of World War II"  
Arco Publishing, New York, 1978.

EMDE, J.

"Die Nebelwerfer"  
Podzun-Pallas, Friedberg, 1979.

DOYLE, H.C., and KLIMENT, C.K.

"Czechoslovak Armored Fighting Vehicles: 1918 – 1945"  
Bellona, Watford, Herts., 1979.

ENGELMANN, J.

"Das Buch der Artillerie, 1939 – 1945"  
Podzun-Pallas, Friedberg, 1983.

ENGLEMANN, J., and SCHEIBERT, H.

"Deutsche Artillerie, 1934 – 1945"  
Starke, Limburg/Lahn, 1974.

ERB, H.

"Kradschützen"  
Motorbuch, Stuttgart, 1981.

FRANK, R.

"Lastkraftwagen der Wehrmacht"  
Podzun-Pallas, Friedberg/H., 1992.

–  
"Personenkraftwagen der Wehrmacht"  
Podzun-Pallas, Friedberg/H., 1993.

GANDER, T.J.

"Field Rocket Equipment"  
Almark, London, 1972.

HAHN, J.

"Waffen und Geheimwaffen des deutschen Heeres, 1933 – 45"  
Bernhard und Graefe, Koblenz, 1986/87.

JENTZ, T.

"Panzertruppen 1933 – 1942"  
Schiffer Military History, Atglen, PA, 1996.

KEILIG, W.

"Das Deutsche Heer 1939-1945"  
[Loose-leaf collection, issued periodically]  
Podzun, Bad Neuheim, 1956 onwards.

KOCH, H.A.

"Flak"  
Podzun, Bad Nauheim, 1965.

KOSAR, F.

"Leichte Feldgeschütze"  
Lehmans, Munich, 1971.

–  
"Mittlere Feldgeschütze"  
Lehmans, Munich, 1973.

–  
"Schwere Geschütze und Eisenbahngeschütze"  
Bernard und Graefe, Munich, 1978.

–  
"Infanteriegeschütze und Rückstossfreie Leichgeschütze"  
Motorbuch, Stuttgart, 1979.

MEHNER, K.

"Die Deutsche Wehrmacht 1939 – 1945"  
= Führung und Truppen =  
Militair-Verlag Patzwall, Norderstedt, 1993.

Militärgeschichtliches Forschungsamt

"Das Deutsche Reich und der Zweiten Weltkrieg"  
Deutsches Verlags-Anstalt, Stuttgart, 1978 – 2001.

MUELLER-HILLEBRAND, B.

"Das Heer 1933-1945"  
E.S. Mittler, Darmstadt, 1954  
E.S. Mittler, Frankfurt/Main, 1965 – 1969.

NEHRING, W.

"Die Geschichte der deutsche Panzerwaffe 1916 – 1945"  
Motorbuch, Stuttgart, 1974.

–  
"Die deutschen gepanzerten Truppen bis 1945"  
Maximilian, Herford, 1965.

NIEHAUS, W.

"Die Nachrichtentruppen 1914 bis heute"  
Motorbuch, Stuttgart, 1980.

OSWALD, W.

"Kraftfahrzeuge und Panzer der Reichswehr, Wehrmacht und Bundeswehr"  
11th Edition  
Motorbuch, Stuttgart, 1982.

PAWLAS, K.L.

"Datenblätter für Heeres-Waffen, Fahrzeuge und Gerät 1944"  
(Dokumentenmtation W 127)  
Karl L. Pawlas, Nürnberg, 1976.

PETTER, D.P.

"Pioniere - Entwicklung einer deutsche Waffengattung"  
Wehr & Wissen, Darmstadt, 1963.

RICHTER, K. C.

"Die bespannten Truppen der Wehrmacht"  
Motorbuch, Stuttgart, 1997.

Von SENGER und ETTERLIN, F.M.

"Die Panzergrenadiere"  
Lehmans, Munich, 1961.

–  
"Die deutschen Geschütze 1939 – 1945"  
3rd Edition  
Bernard & Braede, Bonn, 1998.

SPIELBERGER, W.

"Die Panzerkampfwagen I und II und ihre Abarten"  
Motorbuch, Stuttgart, 1974.

–  
"Der Panzerkampfwagen III und seine Abarten"  
Motorbuch, Stuttgart, 1974.

–  
"Die gepanzerten Radfahrzeuge des Deutschen Heeres"  
Motorbuch, Stuttgart, 1974.

–  
"Der Panzerkampfwagen IV und seine Abarten"  
Motorbuch, Stuttgart, 1975.

–  
"Die Halbkettenfahrzeuge des Deutschen Heeres"  
Motorbuch, Stuttgart, 1976.

–  
"Die Motorisierung der Deutschen Reichswehr, 1920 – 1935"  
Motorbuch, Stuttgart, 1979.

–  
"Die Panzer-Kampfwagen 35(t) und 38(t) und ihre Abarten einschließlich der tschechoslowakischen Heeresmotorisierung, 1920 – 1945"  
Motorbuch, Stuttgart, 1980.

TESSIN, G.

"Verbände und Truppen der Deutschen Wehrmacht und Waffen-SS im Zweiten Weltkrieg"  
E.S. Mittler, Frankfurt/Main, 1965 – 1970.  
Biblio, Osnabrück, 1972 – 1988.

TM-E 30-451

"Handbook on German Military Forces"  
War Department, Washington, D.C., 15 March 1945.

Zentral Museum & Zentralarchiv der Pioniere

"Deutsche Pioniere 1939 – 1945"  
Kurt Vowinkel, Neckargemünd, 1976.

## INTRODUCTION TO GERMAN SOFT-SKINNED MOTOR VEHICLES

### Identification and Numbering System

The German Wehrmacht identified its motor vehicles by make, by type, by load, by mobility, by purpose, by number of seats, and/or by number. The latter, *Kraftfahrzeug (Kfz.)* and *Sonder Kraftfahrzeug (Sd.Kfz.)* numbers, indicated the purpose but not manufacturer of the vehicle. Early in the war, this series of numbers were reasonably well adhered to, although some vehicles were only classified by their load and mobility. As the war continued, the numbering system fell into disuse. The details of the numerical classifications are given on the next pages. The classifications were:

#### *Kfz. No. Nomenclature*

- 1 – 10 light personnel carriers (*le. PKW*)
- 11 – 20 medium personnel carriers (*m. PKW*)
- 21 – 30 heavy personnel carriers (*s. PKW*)
- 31 – 40 light load carriers (*le. LKW*)
- 41 – 50 medium load carriers (*m. LKW*)
- 51 – 60 heavy load carriers (*s. LKW*)
- 61 – 70 light cross-country load carriers (*le. gl. LKW*)
- 71 – 80 medium cross-country load carriers (*m. gl. LKW*)
- 81 – 90 heavy cross-country personnel carriers (*s. gl. PKW*),  
and, light cross-country load carriers (*le. gl. LKW*)

The heavy personnel carrier and the light load carrier had the same numbers. Same chassis, different bodies.

Classifications did not always correspond to the actual usage. Mobility for personnel and load carriers, whether military or commercial versions, was defined either as cross-country (indicated by the prefix “*geländegängig*”, abbreviated to “*gl.*”, i.e. cross-country), or road-bound, in which case either the suffix “*(o.)*” was added, or the suffix was omitted altogether.

Commercial vehicles could be directly purchased from the manufacturer, or, upon mobilization, requisitioned from the civilian economy. Indeed 63% of all motor vehicles in the German Army were requisitioned by September 1939.

### German Load Carriers

Load carriers came in two versions (truck, i.e. open/with a bed; and van, i.e. closed/with a body instead of a bed), and in two types (commercial and military). As indicated above, the Germans used both numbered and unnumbered series of load carriers. Load carriers with and without “*Kfz.*” numbers came in three different load classifications:

- Light up to 2-ton
- Medium 3-ton
- Heavy 4.5-ton and over.

Load carriers with over a 5-ton load factor were only bought in the commercial versions.

### German Commercial Load Carriers in Military Use

<b>up to 2-ton (light)</b>	Adler	W61
	Borgward	L1400
	Daimler-Benz	L1500, L1500S, L1500A
	Phanomen	Granit 25H; 1500S, 1500A
	Opel	Blitz 2,5-32
	Steyr (Ost. Daimler)	1500A/01, 1500A/02, 2000A
<b>3-ton (medium)</b>	Borgward	B3000S, B3000A
	Daimler-Benz	L3000, L3000S, L3000A
	Ford	G21T; V3000, V3000S
	KHD (Magirus)	3000S, 3000A
	MAN	E2; E3000
	Opel	Blitz 3,6-36S, Blitz 6700A
<b>4.5-ton (heavy)</b>	Büssing-NAG	4500S, 4500A
	Daimler-Benz	L4500S, L4500A
	Gräfe & Stift	V7DW
	MAN	ML4500S, ML4500A
<b>6.5-ton</b>	Büssing-NAG	6500
	Daimler-Benz	L6500
	Krupp	LD6,5
	MAN	F4
	Vomag	6LR-647, 6LR-652
	Tatra	6500A
<b>9-ton</b>	Büssing-NAG	801, 802
	Faun	L9000D567

### German Personnel Carriers

Personnel carriers, with or without numbers, were also classified according to their mobility and engine size:

- Light up to 1500cc
- Medium up to 3000cc
- Heavy over 3000cc

Personnel carriers were either civilian or military. Civilian and later also military vehicles were identified by the engine size – and sometimes the number of seats.

### German Motorcycles

There were a multitude of motorcycle types in the German Army, classified according to engine size:

- Light up to 350cc
- Medium up to 500cc
- Heavy over 500cc

Motorcycles came in solo and sidecar versions. For the heavy motorcycles with sidecars, the sidecar wheel was power-driven. Some motorcycles had a light machine-gun mounted on the sidecar. The side cars were also used to carry light mortars, ammunition, as well as personnel.

### The Einheits-Vehicle-Program

The Einheits Program was an attempt by the German Armed Forces in the 1930s to produce a series of standardized vehicles. They were based on complicated 4 x 2, 4 x 4, and 6 x 4 chassis, with varying bodies, each conceived for a specific role.

Four chassis were finally produced. They were designated the light (*le. E-PKW*), the medium (*m. E-PKW*), as well as the heavy (*s. E-PKW*) personnel carriers. The fourth was the light load carrier (*le. E-LKW*, also known as the “*Einheits-Diesel*”). This light load carrier, produced between 1937 and 1940, had a 6 x 6 chassis capable of transporting 2.5-tons, and was powered by a diesel engine, (one of the few WWII German vehicles so powered).

Early Einheits-PKW all had stub axles on both sides for the spare wheels, which were supposed to assist the vehicles in crossing rough terrain. This feature was dropped in later models.

Light load carrier chassis were also fitted with passenger bodies. A typical example of this was the *le. Einheits-LKW*, and later the Steyer 1500.

The Einheits Vehicle Program ran into considerable difficulties owing to production and maintenance complications. The design proved too sophisticated for field use, where maintenance and spare parts were in short supply. The complicated two-axle steering caused particular problems in maintenance. The *le. Einheits-LKW* proved the only one that was a successful design.

### The Schell Vehicle Program

The Einheits Program could not meet the motor vehicle needs of the German Armed Forces. In 1938, the Schell Program was initiated. It standardized the number of Einheits vehicles at four, (see paragraph above), and provided a limited number of alternative commercial vehicles with all-wheel drive. It reduced the large variety of models in both commercial and military production from 113 to 30 load carriers, from 52 to 10 personnel carriers, and from 150 to 30 motorcycles, which, as an added benefit, enabled the German Army to commandeer civilian vehicles in time of need without drastically complicating the replacement and spare parts situation. The Schell Program vehicles did not always have the engine performance required for military use.

Neither the Einheits nor the Schell Programs provided enough vehicles for the expanding German Armed Forces. However, no solution was ever found for this problem, and Germany was severely handicapped by a lack of motor vehicles in World War II. Even the incorporation of captured enemy vehicles and the production facilities of occupied countries was unable to remedy this problem.

### The Raupenschlepper Ost (RSO)

The Russian Campaign quickly demonstrated that German wheeled vehicles were totally inadequate when it came to moving through mud and snow. This lack of good cross-country mobility led to the development of the Raupenschlepper Ost, created to meet the needs of the infantry for a fully-tracked motor vehicle that could move in all terrain. It was ideal also because it did not move very much faster than the marching infantry. This family of vehicles was produced without the standard identifying numbers being allocated.

### The Maultier

The lack of good cross-country mobility also led to field improvisations. One of which was so successful that it was produced in large amounts by German industry. The Maultier was basically a truck with tracks and drive train components similar to that of a light tank instead of a rear axle and wheels. The Germans produced two weight classes, namely the Sd.Kfz. 3 based on the medium truck, (initially with a 2-ton payload, then increased to 3 tons) and the Sd.Kfz. 3/5, based on the 4.5-ton truck, (initially with a 4-ton payload, then increased to 4.5 tons).

### The Schwere Wehrmachtsschlepper

A simplified and standardized 6-ton halftrack began production in late 1943. Production was low, with only 1000 being produced during the war.



**GERMAN NUMBERED MOTORIZED SOFT-SKINNED VEHICLES**

<b>Kfz.</b>	<b>German Nomenclature</b>	<b>Description</b>	<b>Makes &amp; Models</b>
1	le gl PKW (‘Kübelwagen’)	light cc personnel carrier (3 and 4-seater)  Hanomag - all models	le. Einheits-PKW BMW 303, 309, 315, 319, 3/15, 4/20PS Daimler-Benz 170-V Dixie 3/15  Opel P-4 Skoda Popular 1100 Steyr 250 Volkswagen Type 82, 87, etc.
1/20	le gl schwimm-PKW	light amphibious cc personnel carrier (4-seater)	Volkswagen Type 128 and 166
2	le Nachrichten-Kw	light cc signals carrier	le. Einheits-PKW
2/1	le Fernsprech-Kw	light cc telephone carrier	BMW 309, 319, 3/15, 4/20
2/2	le Funk-Kw	light cc radio carrier	Hanomag - all models
2/40	le Instandsetzungs-Kw	light cc maintenance section carrier (all 2 seaters with equipment storage in the back)	Daimler-Benz 170-V Volkswagen Type 82, 87, etc.
3	le Messtrupp-Kw	light cc calibration section carrier	le. Einheits-PKW BMW 309 Daimler-Benz 170-V Steyr 250 Volkswagen Type 82, 87, etc.
4	le Truppen-Luftschutz-Kw	light cc anti-aircraft carrier (dual MG)	le. Einheits-PKW
5	m gl Kessel-Kw	medium cc tanker	m. Einheits-PKW
11	m gl PKW	medium cc personnel carrier	m. Einheits-PKW
12	m gl PKW mit Zughaken	medium cc personnel carrier with towing hook (for 37mm ATG, 75mm IG, ammo trailers)	Adler 12N, 3-Gd Daimler-Benz 200, 260, 290, 320 Phänomen Granit 25 Wanderer W-11, W-23S
13	m gl gp PKW (MG)	early armored medium cc car (with one MG)	Adler Standard 6
14	m gl gp PKW (Funk)	early armored medium cc radio car (no armament)	
15	m gl PKW	medium cc personnel carrier	m. Einheits-PKW
15	m gl PKW mit Gerätkasten	medium cc carrier with equipment boxes	Auto Union / Horch 830-R
15/1	m gl Nachrichten-Kw	medium cc signals carriers	Daimler-Benz 340-WK, L1500A
15/1	m gl Fernsprech-Kw	medium cc telephone carrier	Horch 830-R, 830-BL
15/2	m gl Funk-Kw	medium cc radio carrier	Steyr 250
15/4	m gl Funk-Kw	medium cc radio carrier	Stoewer M-12-RW
15/5	m gl Funk-Kw	medium cc radio carrier	
15/6	m gl Funk-Kw	medium cc radio carrier	
15/7	m gl Funk-Kw	medium cc radio carrier	
17	m gl Fernschreibe-Kw	medium cc telex carrier	
16	m gl Meßstelle-Kw	medium cc calibration station carrier	
16	m gl Meßtrupp-Kw	medium cc calibration section carrier	
16/1	m gl Vorwarner-Kw	medium cc advanced warning section carrier	
17	kl Verstärker-Kw	small cc amplifier van	m. Einheits-PKW
17	kl Kabelmess-Kw	small cc wire calibration van	Auto Union / Horch 830-R
17	kl Fernsprechbetriebs-Kw	small cc telephone operations van	
17/1	kl Funktrupp-Kw	small cc radio section van	
17/2	kl Fernsprechtrupp-Kw	small cc telephone section van	
17/3	kl Funk-Kw	small cc radio van	
18	s gl PKW	heavy cc personnel carrier	m. Einheits-PKW
18	Gefechts-Kw (mit Gerätkasten & Zughaken)	heavy cc carrier (combat) (with equipment boxes and towing hook)	s. Einheits-PKW Daimler-Benz 200, L1500A Wanderer W 11, W 14
19	Fernsprechbetriebs-Kw	cc telephone exchange van	Krupp L2H-43, Krupp L2H-143
	Fernsprech-Kw	cc telephone van	
	Funk-Kw	cc radio van	
21	s gl PKW (Kommandeurwagen)	heavy cc staff car (sedan or cabrio)	Daimler-Benz G-4 Krupp L2H-143 Cabrio Steyr 640, 1500A Praga Skoda
23	Fernsprech-Kw	cc telephone equipment van	s. Einheits-PKW
24	Verstärker-Kw	cc amplifier equipment van	
31	Sanitäts-Kw (‘Sanka’) [also: Kranken-Kw (‘KrKw’)]	cc ambulance van	s. Einheits-PKW Phänomen Granit 25H Steyr 640, 1500A Adler W-61K Daimler-Benz L1000, L1500E Ford G917, G987, 997, V3000S, V3000A
42	Sammler-Kw	generator / accumulator / battery van	Krupp L3-M42
	Sammlerwerkstatt-Kw	generator repair van	m. LKW (o.)
	Nachrichtenwerkstatt-Kw	signals repair van	
	Werkstatt-Kw	workshop van	
43	Flakauswert-Kw	anti-aircraft evaluation van	
44	Sauer- und Stickstoff-Erzeugungs-Kw	Oxygen and Nitrogen generation van	
51	Werkstatt-Kw	workshop van	m. LKW (o.) s. LKW (o.)

**NOTES:**

The early armored cars (*Kraftfahrzeug 13* and *14*) were obviously not soft-skinned vehicles. It is not clear why they were included within this listing and not in the special military motor vehicle (*Sonderkraftfahrzeug*) listing.

**GERMAN NUMBERED MOTORIZED SOFT-SKINNED VEHICLES**

<b>Kfz.</b>	<b>German Nomenclature</b>	<b>Description</b>	<b>Makes &amp; Models</b>
61	gr Nachrichten-Kw gr Schlüssel-Kw gr Funk-Kw gr Funkbetriebs-Kw gr Fernsprechbetriebs-Kw gr Fernschreib-Kw gr Verstärker-Kw gr Peil-Kw gr Meßtrupp-Kw	large cc signal van large cc code van large cc radio van large cc radio operations van large cc telephone operations van large cc telex van large cc amplifier van large cc sound-ranging equipment van large cc calibration section van	Einheits-Diesel Daimler-Benz G-3a, LG 3000 Büssing-NAG G-31, G500A, G500S, 4500S, 4500A Magirus M-206, M-30, S3000, A3000 Borgward G.W., B3000S, B3000A
61/1	gr Funk-Kw	large cc radio van	
62	gr Nachrichten-Kw gr Fernsprechbetriebs-Kw gr Funk-Kw gr Wetter-Kw gr Druckerei-Kw gr Schall-Aufnahme-Kw gr Schall-Auswertungs-Kw gr Vermessung-Auswertungs-Kw gr Licht-Auswertungs-Kw gr Stabs-Auswertungs-Kw	large cc signals van large cc telephone operations van large cc radio van large cc weather van large cc printing van large cc sound recording van large cc sound evaluation van large cc calibration evaluation van large cc flash evaluation van large cc evaluation command van	
63	gr Nachrichten-Kw gr Meß-Stellen- und Gerät-Kw gr Vermessungs-Gerät-Kw gr Lichtmeß-Stellen-Kw gr Lichtmeß-Gerät-Kw gr Schallmeß-Stellen-Kw gr Schallmeß-Gerät-Kw gr Vorwarner-Kw gr Vermessungsgerät-Kw	large cc signals van large cc calibration station and equipment van large cc calibration equipment van large cc flash ranging station van large cc flash ranging equipment van large cc sound ranging station van large cc sound ranging equipment van large cc advanced warning equipment van large cc calibration equipment van	
68	Funkmast-Kw Fernsprech-Kw	cc radio antenna van cc telephone carrier	Einheits-Diesel Krupp L2H-43, L2H-143 Magirus M-206 Opel Blitz A
68/1	Funkmast-Kw	cc radio antenna van	
69	Protz-Kw	cc prime-mover for light guns	s. Einheits-PKW
70	Mannschafts-Kw	cc personnel carrier	Krupp L2H-43, L2H-143
71	Truppen-Luftschutz-Kw s Truppenluftschutz-Kw	cc anti-aircraft carrier heavy cc anti-aircraft carrier	Mercedes-Benz L1500A
72	Fernsprechbetriebs-Kw Fernsprech-Vermittlungs-Kw Fernschreib-Kw Fernschreib-Vermittlungs-Kw Verstärker-Kw Funk-Kw (a & b) Funkbetriebs-Kw Funkhorch-Kw Befehls-Kw Druckerei-Kw m Wetter-Kw	cc telephone operations van cc telephone exchange van cc telex van cc telex exchange van cc amplifier van cc radio van cc radio operations van cc radio interception van cc command van cc printing van cc weather van	Henschel 33-D1 Magirus 33-G1 Krupp L3H-63, L3H-163 Büssing-NAG III GL6
72/1	Fernschreib-Kw	cc telex van	
74	Flak-Meßtrupp-Kw I & II	cc anti-aircraft calibration section van	
76	Beobachtungs-Kw	cc observation carrier	Daimler-Benz G-3a
77	Feldkabel-Kw Fernsprech-Kw Fernsprechbau-Kw	cc field cable carrier cc telephone carrier cc telephone construction carrier	Büssing-NAG G-31 Magirus M-206
79	Werkstatt-Kw	cc workshop van	Henschel 33-D1 Magirus 33-G1 Krupp L3H-63, L3H-163
81	le Flak-Kw	cc prime-mover for light anti-aircraft guns	s. Einheits-PKW
83	le Scheinwerfer-Kw I & II	cc prime-mover for light searchlights, with generator	Krupp L2H-42, L2H-143
92	Mannschaft-Entgiftungs-Kw	cc personnel decontamination van	Henschel 33-D1, 33-G1
93	Bekleidungs-Entgiftungs-Kw	cc clothing decontamination van	
94	Wasser-Kw (Kessel)	cc decontamination van (hot water shower)	
95	Kammer-Kw	unit stores van	m. LKW (o.)
100	Drehkran 3 – 5 ton	3 – 5-ton revolving crane on cc carrier	s. gl. LKW (4,5-ton)

**Abbreviations and Definitions:**

“Carrier”	indicates an open vehicle, covered by a canvas top.
“Truck”	indicates a cargo vehicle with an open payload area, covered by a canvas top.
“Van”	indicates a cargo vehicle with a fully or partially enclosed payload area (body).
“Prime-Mover”	indicates a vehicle for towing equipment, usually modified and adapted for that equipment.
“Sedan”	indicates a passenger vehicle (car) with a closed body.
“Cabrio”	indicates an open passenger vehicle (car) covered by a canvas top.
“cc”	indicates a vehicle with cross-country capability.

A	<i>Allrad</i> : all-wheel-drive version. (Makers identification).
S	<i>Steuerermässigt</i> : (taxed reduced) qualified for 33% motor vehicle tax reduction, introduced as incentive to increase demand for off-road capable trucks.
(o.)	<i>(ohne handelsüblich)</i> : commercial vehicle.
Kfz.	<i>Kraftfahrzeug</i> : commercially available chassis and drive train with military body.
Sd.Kfz.	<i>Sonderkraftfahrzeug</i> : specially military body and chassis.
le. / lei.	<i>leicht</i> : light
m.	<i>mittler</i> : medium
s.	<i>schwer</i> : heavy
LKW	<i>Lastkraftwagen</i> : load (cargo) motor vehicle (truck or van)
PKW	<i>Personenkraftwagen</i> : personnel (passenger) motor vehicle (car)
gl.	<i>geländegängig</i> : cross-country
Kw.	<i>Kraftwagen</i> : motor vehicle
kl.	<i>klein</i> : small/light
gr.	<i>gross</i> : large/heavy
gp.	<i>gepanzert</i> : armored
wg.	<i>wassergängig</i> : amphibious
schw.	<i>schwimmfähig</i> : amphibious (alternate)

## GERMAN SPECIAL MILITARY VEHICLES

Sd.Kfz. No.	German Designation « German Abbreviation »	Description Main Armament [Ammunition carried]
2	Kleines Kettenrad « KK »	0.5-ton light halftrack n/a
2/1	Kleines Kettenrad (Feldfern-kabel) « KK (FFK) »	0.5-ton halftrack with telephone cable n/a
2/2	Kleines Kettenrad (schwere Feldfern-kabel) « KK (s. FFK) »	0.5-ton halftrack with heavy telephone cable n/a
3	Gleisketten-Lastkraftwagen 2-ton (Maultier) « 2-ton Maultier »	halftracked 2-ton truck n/a
3/4	Gleisketten-Lastkraftwagen 2-ton (Maultier) (Krankenwagen) « 2-ton Maultier (KrKw) »	halftracked 2-ton ambulance n/a
3/5	Gleisketten-Lastkraftwagen 4.5-ton (Maultier) « 4.5-ton Maultier »	halftracked 4.5-ton truck n/a
4	Gleisketten-Lastkraftwagen 3-ton (Maultier) gepanzert (Munitionskraftwagen) « gep. Maultier (muni) »	armored halftracked truck for ammunition transport [transports 20 150mm rockets]
4/1	15cm Panzerwerfer 43 « Pz.Werf. 43 »	armored halftracked truck with rocket launcher 150mm rocket launcher (10 tubes) [20]
6	mittlerer Zugkraftwagen 5-ton (Pionier-Ausführung) « m. Zgkw. 5t (Pion. Ausf.) »	5-ton halftrack (engineer version) n/a
6/1	mittlerer Zugkraftwagen 5-ton (Artillerie-Ausführung) « m. Zgkw. 5t (Artl. Ausf.) »	5-ton halftrack (artillery version) n/a
6/2	3,7cm Flak 36 auf Fahrgestell m. Zugkraftwagen 5-ton « 3,7cm Flak (Sfl) auf lei. Zgkw. 5 t »	self-propelled medium antiaircraft gun on 5-ton halftrack 37mm Flak 18 or 36 [?]
7	mittlerer Zugkraftwagen 8-ton « m. Zgkw. 8t »	8-ton halftrack n/a
7/1	2cm Flakvierling auf Fahrgestell mittlerer Zugkraftwagen 8-ton « 2cm Flakvierl. (Sf) auf Zgkw. 8t »	self-propelled light quad antiaircraft gun on 8-ton halftrack 20mm quad Flak38 L/112.5 [600]
7/2	3,7cm Flak 36 /Sfl) auf Fahrgestell mittlerer Zugkraftwagen 8-ton « 2cm Flakvierl. (Sf) auf Zgkw. 8t »	self-propelled antiaircraft gun on 8-ton halftrack 37mm Flak 36 L/98 [?]
7/6	mittlerer Zugkraftwagen 8-ton (Flakmess) « Zgkw. 8t Flak-Mess »	8-ton halftrack for antiaircraft calibration equipment n/a
8	schwerer Zugkraftwagen 12-ton « s. Zgkw. 12t »	12-ton halftrack n/a
8	8,8cm Flak (Sf) auf gepanzertem Zugkraftwagen 12-ton « 8,8cm Flak (Sf) auf gep. Zgkw. 12t »	self-propelled heavy antiaircraft gun on armored halftrack 88mm Flak L/56 [40]
9	schwerer Zugkraftwagen 18-ton « Zgkw. 18t »	18-ton halftrack n/a
9/1	schwerer Drehkranwagen (Hebekraft 6 ton) « s. Drehkran (6 t) »	18-ton halftrack with 6-ton revolving crane (manufactured by Bilstein) n/a
9/2	schwerer Drehkranwagen (Hebekraft 10 ton) « s. Drehkran (10 t) »	18-ton halftrack with 10-ton revolving crane (manufactured by Demag) n/a
10	leichter Zugkraftwagen 1-ton « lei. Zgkw. 1t »	1-ton halftrack n/a
10/1	leichter Gasspürwagen « lei. Zgkw. (Gas-Spür) »	1-ton halftrack, light gas detection vehicle with sprinkler n/a
10/2	leichter Entgiftungskraftwagen « lei. Zgkw. (Entg.) »	1-ton halftrack, light decontamination vehicle n/a
10/3	leichter Sprühkraftwagen « lei. Zgkw. (Sprüh) »	1-ton halftrack, light bulk decontamination vehicle n/a
10/4	2cm Flak (Sf) auf Fahrgestell leichter Zugkraftwagen 1-ton « 2cm Flak (Sf) auf lei. Zgkw. 1t »	self-propelled light antiaircraft gun on 1-ton halftrack 20mm Flak 30 L/112.5 [280]
10/5	2cm Flak (Sf) auf gepanzertem Fahrgestell leichter Zugkraftwagen 1-ton « 2cm Flak (Sf) auf gp. lei. Zgkw. 1t »	self-propelled light antiaircraft gun on armored 1-ton halftrack 20mm Flak 38 L/112.5 [280]
11	leichter Zugkraftwagen 3-ton « lei. Zgkw. 3t »	3-ton halftrack n/a
11/1	Nebelkraftwagen « m. Zgkw. (Nebel) »	3-ton halftrack for towing rocket launchers n/a [10,5cm Nbl.W. 35: 80 rockets; 15cm Nbl.W. 41: 36 rockets; 28/32cm Nebelwerfer 41: 12 rockets plus launching frames]
11/2	mittlerer Entgiftungskraftwagen « m. Zgkw. (Entg.) »	3-ton halftrack, medium decontamination vehicle n/a
11/3	mittlerer Sprühkraftwagen « m. Zgkw. (Sprüh) »	3-ton halftrack, medium chemical spraying vehicle (bulk decontamination) n/a

## GERMAN SPECIAL MILITARY VEHICLES

Sd.Kfz. No.	---German Designation « German Abbreviation »	Description Main Armament [Ammunition carried]
11 /4	Nebelkraftwagen « m. Zgkw. (Nebel) »	3-ton halftrack for towing 15cm rocket launchers n/a [15cm Nbl.W. 41: 36 rockets; 21cm Nbl.W. 42: 10 rockets; 28/32cm Nebelwerfer 41: 4 rockets]
11 /5	Nebelkraftwagen « m. Zgkw. (Nebel) »	3-ton halftrack for towing 21cm rocket launchers n/a [15cm Nbl.W. 41: 36 rockets; 21cm Nbl.W. 42: 10 rockets]
35	Bergepanzer « Berge-Pz. »	armored recovery vehicle (T-34 or KV-I w/o turret) n/a
101	Panzerkampfwagen I « Pz. I »	light tank 2 MG 13 [1525 – 2250]
–	Panzerkampfwagen I, Ausf. F (n.A. verstärkt) « Pz. I, n.A. »	light tank, reinforced armor, Model F 2 MG 34 [2250]
–	4,7cm Pak(t)(Sf) auf Fahrgestell Panzerkampfwagen I « 4,7cm Pak(t) auf Pz-I; [also 4,7cm(t) (mot S)] »	self-propelled antitank gun on Pz-I chassis 47mm Pak(t) L/43.4 [86]
–	15cm sIG 33 auf Panzerkampfwagen I, Ausf. B « 15cm sIG33 auf Pz-I; [also 15cm sIG (mot S)] »	self-propelled heavy infantry gun on Pz-I chassis 150mm L/43.4 [?]
–	Pionier-Panzerwagen I « Pion-Pz. I »	Engineer vehicle (without turret) on Pz-I chassis n/a
111	Munitionsschlepper auf Fahrgestell Panzerkampfwagen I « Muni-Schlepper auf Pz-I »	armored ammunition carrier based on Pz-I chassis varied, depending upon ammunition type carried
121	Panzerkampfwagen II « Pz. II »	light tank 20mm KwK 30 L/55 [180]
122	Flamm-Panzer-II « Fl.Pz. II »	flame throwing tank on Pz-II basis [320 liters flame oil]
123	Panzerspähwagen II (Luchs 2cm) « lei. Pz-Späh. Wg. Luchs »	light, fully tracked recon tank on Pz-II basis 20mm KwK 38 L/55 [330]
123	Panzerspähwagen II (Luchs 5cm) « lei. Pz-Späh. Wg. Luchs »	light, fully tracked recon tank on Pz-II basis 50mm KwK L/60 [33]
124	lei. FH 18/2 Selbstfahrlafette auf Pz-II (Wespe) « Wespe »	self-propelled light field howitzer on Pz-II basis 105mm le FH 18/2 [32]
–	Munitions-Selbstfahrlafette auf Pz-II (Wespe) « Muni. Wespe »	armored ammunition carrier for Wespe on same chassis [transports 90 light field howitzer rounds]
–	Geschützwagen II für 15cm sIG « 15cm sIG (sfl) »	self-propelled heavy infantry gun 150mm L/43.4 [30]
–	Pionier-Panzerwagen II « Pion-Pz. II »	Engineer vehicle (without turret) on Pz-II chassis n/a
131	Panzer-Selbstfahrlafette für 7,5cm Pak 40/2 auf Fahrgestell Panzerkampfwagen II « Marder II; [also 7,5cm Pak 40 (Sf) auf Pz-II; also Pz Sf 2] »	self-propelled antitank gun on Pz-II chassis 75mm Pak L/43 [37]
132	Panzer-Selbstfahrlafette für 7,62cm Pak 36(r) auf Fahrgestell Panzerkampfwagen II « Marder II; [also 7,62cm Pak 36(r)(Sf) auf Pz-II; also Pz Sf 1] »	self-propelled antitank gun on Pz-II chassis (Models D and E) 76.2mm Pak(r) L/51.5 [30]
135	75mm Pak auf Lorraine-Schlepper (Marder I) « Marder I »	self-propelled heavy antitank gun on Lorraine basis 75mm s FH Pak 40/1 [?]
135 /1	s. FH 13/1 Selbstfahrlafette auf Lorraine-Schlepper « s.FH (sfl) auf Lorraine »	self-propelled heavy field howitzer on Lorraine basis 150mm s FH 13/1 [8]
–	Panzerkampfwagen 35 (t) « Pz-35(t) »	Czech medium tank (designation changed from LTM 35 on 16.01.40) 37mm A33 L/42 [72]
–	Panzerbefehlswagen 35 (t) « Pz-Bef-Wg 35(t) »	Czech medium command tank 37mm A33 L/42 [?]
–	Mörserwagen 35 (t) « Mörs.Wg. 35(t) »	tracked prime mover for heavy mortar on Czech medium tank basis n/a
–	Zugkraftwagen 35 (t) « Zgkw. 35(t) »	tracked prime mover based on Czech medium tank n/a
–	Panzerkampfwagen 38(t), Ausführung A – G « Pz-38(t) »	Czech medium tank (designation changed from LTM 38 on 16.01.40) 37mm A7 L/42 [90]
–	Panzerbefehlswagen 38(t) « Pz-Bef-Wg 38(t) »	Czech medium command tank 37mm A7 L/42 [?]
138	Panzerjäger 38(t), Ausf. H für 7,5cm Pak « Marder III »	self-propelled antitank gun on Pz-38(t) chassis 75mm Pak 40/3 L/48 [38]
138	Panzerjäger 38(t), Ausf. M für 7,5cm Pak « Marder III »	self-propelled antitank gun on Pz-38(t) chassis 75mm Pak 40/3 L/48 [27]
138	Munitionsfahrzeug für 15cm s.IG selbstfahrlafette « Muni. Fahrzeug für 15cm s.IG Sfl »	armored ammunition carrier for Bison on same chassis [transports 40 infantry gun rounds]

## GERMAN SPECIAL MILITARY VEHICLES

Sd.Kfz. No.	German Designation « German Abbreviation »	Description Main Armament [Ammunition carried]
138/1	s.IG auf Selbstfahrlafette 38(t) « s.IG (sfl) <i>Grille</i> »	self-propelled heavy infantry gun on Pz-38(t) chassis 150 sIG 33/1 L/11 [15]
138/2	Jagdpanzer 38 « <i>Hetzer</i> »	light tank destroyer on Pz-38(t) basis 75mm Pak 39 L/48 [41]
–	Flammpanzer 38 « Flamm-Pz 38 »	flame tank based on <i>Hetzer</i> hull [700 liters flame oil]
–	Bergepanzer 38 « Berge-Pz 38 »	recovery tank based on <i>Hetzer</i> hull n/a
–	15cm schwerer Infanteriegeschütz 33/2 auf Jagdpanzer 38 « 15cm sIG 33/2 auf PzJg 38(t) »	self-propelled heavy infantry gun based on <i>Hetzer</i> hull 150mm sIG 33/2 [?]
139	Panzerjäger 38(t) für 7,62cm Pak 36(r) « <i>Marder III</i> »	self-propelled antitank gun on Pz-38(t) chassis 76.2mm Pak(r) L/51.5 [30]
140	Flakpanzer 38 « Flak-Pz-38 »	Self-propelled anti-aircraft gun based on Czech Pz-38(t) 20mm Flak 38 [540]
140/1	Aufklärungspanzer 38(t) (2cm) « Aufkl-Pz-38(t) (2cm) »	Czech reconnaissance tank based on Pz-38(t) 20mm KwK 38 [108]
140/1	Aufklärungspanzer 38(t) (7,5cm) « Aufkl-Pz-38(t) (7,5cm) »	Czech reconnaissance support tank based on Pz-38(t) 75mm KwK 37 L/24 [?]
141	Panzerkampfwagen III, Ausführung A – G « Pz. III (3,7cm) »	medium tank, Models A – G 37mm KwK 35/36 L/45 [120]
141	Panzerkampfwagen III, Ausführung H – J « Pz. III (5cm); [also Pz-III (kz)] »	medium tank, Models H – J 50mm KwK L/42 [99]
141/1	Panzerkampfwagen III, Ausführung J – L « Pz. III (5cm); [also Pz-III (lg)] »	medium tank, Model J – L 50mm KwK L/60 [84 – 78]
141/2	Panzerkampfwagen III, Ausf. M – N « Pz. III (7,5cm) »	medium tank, Models M – N 75mm KwK 37 L/24 [84 – 64]
141/3	Flammpanzer III « Flamm-Pz. III »	medium flame-throwing tank [1020 liters flame oil]; MG [3750]
–	SturmInfanteriegeschütz 33B « St. Inf. Gesch. 33 »	self-propelled, armored heavy infantry gun on Sturmgeschütz basis 150mm Stu IG L/11 [30]
142	7,5cm Sturmgeschütz 40, Ausführung A – D « Sturmgeschütz III [also: Stu. Gesch. III] »	assault gun, Model A – D 75mm StuK 37 L/24 [44]
142	7,5cm Sturmgeschütz 40, Ausführung E « Sturmgeschütz III [also: Stu. Gesch. III] »	assault gun, Model E 75mm StuK 37 L/24 [50]
142	7,5cm Sturmgeschütz 40, Ausführung F « Sturmgeschütz III [also: Stu. Gesch. III] »	assault gun, Model F 75mm StuK 37 L/24 [44]
142/1	7,5cm Sturmgeschütz 40, Ausführung F8 – G « Sturmgeschütz III [also: Stu. Gesch. III] »	assault gun, Model F8 – G 75mm StuK40 L/43 [54]
142/2	7,5cm Sturmhaubitze, Ausführung F – G « Sturmhaubitze III [also: Stu. Haub. III] »	assault howitzer, Model F – G 105mm StuH 42 L/28 [36]
143	Panzer-Beobachtungswagen III « Pz. Beob. Pz. III »	armored artillery observation tank MG [2100]
161	Panzerkampfwagen IV, Ausführung A – F <sub>1</sub> « Pz. IV [also: Pz-IV(kz)] »	medium tank, Models A – F <sub>1</sub> 75mm KwK 37 L/24 [80]
161/1	Panzerkampfwagen IV, Ausführung F <sub>2</sub> – G « Pz. IV [also: Pz-IV(lg)] »	medium tank, Models F <sub>2</sub> – G 75mm KwK 40 L/43 [87]
161/2	Panzerkampfwagen IV, Ausführung H – J « Pz. IV [also: Pz-IV(lg)] »	medium tank, Models H – J 75mm KwK 40 L/48 [87]
161/3	Flakpanzer-IV « Flak-Pz 3,7cm [ <i>Ostwind</i> ] »	anti-aircraft tank 37mm Flak 43 L/98 [400]
161/4	Flakpanzer-IV « Flak-Pz 2cm-Vierling [ <i>Wirbelwind</i> ] »	anti-aircraft tank 20mm quad Flak 38 [1000]
–	Panzer-Flak Sfl IV « Pz-Flak IV [ <i>Möbelwagen</i> ] »	anti-aircraft tank 37mm Flak 43 L/98 [416]
162	7,5cm Pak 39 auf Fahrgestell Panzerkampfwagen IV « Jagdpanzer IV »	self-propelled heavy antitank gun on Pz-IV basis 75mm Pak 39 L/48 [79]
162/1	7,5cm StuK 42 auf Fahrgestell Panzerkampfwagen IV, Ausführung A « Panzer-IV/70 (A) »	tank destroyer on Pz-IV basis 75mm StuK 42 L/70 [55]
162/1	7,5cm StuK 42 auf Fahrgestell Panzerkampfwagen IV, Ausführung V « Panzer-IV/70 (V) »	tank destroyer on Pz-IV basis 75mm StuK 42 L/70 [55]

## GERMAN SPECIAL MILITARY VEHICLES

Sd.Kfz. No.	German Designation « German Abbreviation »	Description Main Armament [Ammunition carried]
163	7,5cm Sturmgeschütz IV « Sturmgeschütz IV [also: StuG IV] »	assault gun based on Pz-IV 75mm StuK40 L/48 [63]
164	8,8cm Pak 43/1 auf Fahrgestell Panzerkampfwagen III/IV (Hornisse) « Hornisse; [as of 1944: Nashorn] »	self-propelled heavy antitank gun on mixed Pz-III/IV basis 88mm Pak 43/1 L/71 [40]
165	s. Panzerhaubitze 18/1 auf Fahrgestell III/IV (Hummel) « Hummel »	self-propelled heavy field howitzer on mixed Pz-III/IV basis 150mm sFH 18/1 [18]
–	Munitionsfahrzeug für 15cm s.IG selbstfahrlafette « Muni. Fahrzeug für 15cm s.IG Sfl »	armored ammunition carrier for Hummel on same chassis [transports 60 heavy field howitzer rounds]
165 /1	leichte Feldhaubitze (Sfl)/Geschützwagen IVb « leFH (sfl) »	self-propelled light field howitzer on Pz-IV basis 105mm leFH 18/1 [60]
166	s.IG auf Panzerkampfwagen-IV Fahrgestell (Sturmpanzer) « Stu-Pz IV [aka <i>Brummbär</i> ] »	armored, self-propelled heavy infantry gun on Pz-IV chassis 150mm StuH 43 L/12 [38]
–	10,5cm Kanone 18 auf Panzer-Selbstfahrlafette IVa « 10,5cm K18 auf Pz-Sfl IVa »	self-propelled gun on Pz-IV chassis 105mm StuK 18/1 L/52 [25]
171	Panzerkampfwagen V (Panther), Ausführung D, A « Panther »	medium tank, Models D and A 75mm KwK 42 L/70 [79]
171	Panzerkampfwagen V (Panther), Ausführung G « Panther »	medium tank, Models G 75mm KwK 42 L/70 [82]
173	Jagdpanzer V « Jagdpanther »	tank destroyer on Panther basis 88mm Pak 43/3 L/71 [57]
179	Bergepanther « Berge-Pz-V »	armored recovery vehicle on Panther basis 20mm KwK 38 [?]
181	Panzerkampfwagen VI (Tiger I), Ausführung E « Tiger I »	heavy tank, Model E 88mm KwK 36 L/56 [92]
–	Panzer-Mörser 38cm auf VI (Tiger) « Sturmtiger »	self-propelled heavy rocket launcher on Pz-VI(I) chassis 380mm rocket launcher [12]
182	Panzerkampfwagen VI (Tiger II), Ausführung B « Tiger II [aka <i>Königstiger</i> ] »	heavy tank 88mm KwK 43 L/71 [72–84]
184	Panzerjäger Tiger (P) für 8,8cm Pak 43 (Ferdinand) « Ferdinand; [later <i>Elefant</i> ] »	self-propelled, heavy antitank gun on prototype Pz-VI chassis 88mm StuK 43/1 L/71 [55]
186	schwere Panzerjäger, Ausführung B « Jagdtiger »	heavy tank destroyer 128mm Pak 44 L/55 [40]
221	leichter Panzerspähwagen (MG) « le. Pz-Späh. Wg. (MG) »	light armored car (4x4) MG [1020]
221	leichter Panzerspähwagen (schwere Panzerbüchse 41) « le. Pz-Späh. Wg. (sPzBü 41) »	light armored car (4x4) 28mm sPzBü 41 [180]
222	leichter Panzerspähwagen (2cm) « le. Pz-Späh. Wg. (2cm) »	light armored car (4x4) 20mm KwK 38 L/55 [180]
223	leichter Panzerspähwagen (Funk) « le. Pz-Späh. Wg. (Fu) »	light armored radio car (4x4) MG [1050]
231	schwerer Panzerspähwagen (2cm)(6-Rad) « s. Pz-Späh. Wg. (2cm) »	heavy armored car (6x4) 20mm KwK 30 L/55 [200]
232	schwerer Panzerspähwagen (Funk)(6-Rad) « s. Pz-Späh. Wg. (Fu) »	heavy armored radio car (6x4) 20mm KwK 30 L/55 [200]
231	schwerer Panzerspähwagen (2cm)(8-Rad) « s. Pz-Späh. Wg. (2cm) 8-Rad »	heavy armored car (8x8) 20mm KwK 30 L/55 [180]
232	schwerer Panzerspähwagen (Funk)(8-Rad) « s. Pz-Späh. Wg. (Fu) 8-Rad »	heavy armored radio car (8x8) 20mm KwK 30 L/55 [180]
233	schwerer Panzerspähwagen (7,5cm)(8-Rad) « s. Pz-Späh. Wg. (7,5cm) 8-Rad »	heavy armored radio car (8x8) 75mm StuK 37 L/24 [32]
234 /1	schwerer Panzerspähwagen (2cm) « Pz-Späh. Wg. (2cm) »	heavy armored car (8x8) 20mm KwK 30 L/55 [250]
234 /2	schwerer Panzerspähwagen (5cm) « Pz-Späh. Wg. (2cm) [aka <i>Puma</i> ] »	heavy armored car (8x8) 50mm KwK 39/1 L/60 [55]
234 /3	schwerer Panzerspähwagen (7,5cm) « Pz-Späh. Wg. (7,5cm) »	heavy armored car (8x8) 75mm K-51 L/24 [50]
234 /4	schwerer Panzerspähwagen (7,5cm Pak) « Pz-Späh. Wg. (7,5cm Pak) »	heavy armored car (8x8) 75mm Pak 40 [12]
247	schwerer geländegängiger gepanzerter Personenkraftwagen (4-Rad) « s. gl. gep. PKW »	heavy armored staff car (4x4) n/a
247	schwerer geländegängiger gepanzerter Personenkraftwagen (6-Rad) « s. gl. gep. PKW »	heavy armored staff car (6x4) n/a

## GERMAN SPECIAL MILITARY VEHICLES

Sd.Kfz. No.	German Designation « German Abbreviation »	Description Main Armament [Ammunition carried]
250 /1	leichter Schützenpanzerwagen « le. SPW »	light armored halftrack, personnel carrier MG [2010]
250 /1	leichter Schützenpanzerwagen « le. SPW »	light armored halftrack, heavy machine gun section carrier MG [2010]
250 /2	leichter Fernsprechpanzerwagen « le. Fe. Pzgw. »	light armored halftrack, telephone & wire carrier MG [1100]
250 /3	leichter Funkpanzerwagen « le. Fu. Pzgw. »	light armored halftrack, radio carrier MG [1100]
250 /4	leichter Beobachtungs-Panzerwagen « le. Beob. Pzgw. »	light armored halftrack, observation vehicle MG [1100]
250 /5	leichter Beobachtungspanzerwagen « le. Beob. Pzgw. »	light armored halftrack, observation vehicle MG [2010]
250 /5	leichter Aufklärungspanzerwagen « le. Beob. Pzgw. »	light armored halftrack, reconnaissance vehicle MG [2010]
250 /6	leichter Munitionspanzerwagen « le. Muni. Pzgw. »	light armored halftrack, ammunition carrier MG [1100] [transports 70 L/24 or 60 L/43 rounds]
250 /7(I)	leichter Schützenpanzerwagen (schwere Granatwerfer) « le. SPW (Gr Wfr) »	light armored halftrack, mortar carrier 81mm mortar [42]
250 /7(II)	leichter Schützenpanzerwagen (Munitionsfahrzeug) « le. SPW (Muni) »	light armored halftrack, 81mm mortar ammunition carrier MG [2010] [transports 66 mortar rounds]
250 /8	leichter Kanonenpanzerwagen (7,5cm) « le. SPW (2cm) »	light armored halftrack, support vehicle 75mm KwK 51 L/24 [20]
250 /9	leichter Schützenpanzerwagen (2cm) « le. SPW (2cm) »	light armored halftrack, reconnaissance vehicle 20mm KwK 38 [100]
250 /10	leichter Schützenpanzerwagen (3,7cm Pak) « le. SPW (3,7cm) »	light armored halftrack, Platoon Leader vehicle 37mm Pak L/45 [216]
250 /11	leichter Schützenpanzerwagen (schwere Panzerbüchse 41) « le. SPW (sPzBü 41) »	light armored halftrack, Platoon Leader vehicle 28mm PzBü 41 [168]
250 /11	leichter Messtrupp-Auswertungs-Panzerwagen « le. Mess-Trupp-Pzgw. »	light armored halftrack, Calibration Section vehicle MG [1040]
251 /1	mittlerer Schützenpanzerwagen « m. SPW »	medium armored halftrack, personnel carrier MG [2010]
251 /2	mittlerer Schützenpanzerwagen (Granatwerfer) « m. SPW (Gr Wfr) »	medium armored halftrack, mortar carrier 81mm mortar [66]
251 /3	mittlerer Funkpanzerwagen « m. Fu. Pzgw. »	medium armored halftrack, radio carrier MG [2010]
251 /4	mittlerer Schützenpanzerwagen (Infanteriegeschütz) « m. SPW (IG) »	medium armored halftrack, light IG prime-mover MG [1100] [transports 120 rounds of 75mm ammo]
251 /5	mittlerer Pionierpanzerwagen « m. Pion. Pzgw. »	medium armored halftrack, engineer vehicle MG [4800]
251 /6	mittlerer Kommandopanzerwagen « m. Pion. Pzgw. »	medium armored halftrack, command vehicle MG [1100]
251 /7	mittlerer Pionierpanzerwagen « m. Pion. Pzgw. »	medium armored halftrack, engineer vehicle MG [4800]
251 /8	mittlerer Krankenpanzerwagen « m. Kranken-Pzgw. »	medium armored halftrack, ambulance n/a
251 /9	mittlerer Schützenpanzerwagen (7,5cm) « m. SPW (7,5cm) »	medium armored halftrack, self-propelled light gun 75mm KwK 37 L/24 [32]
251 /10	mittlerer Schützenpanzerwagen (3,7cm Pak) « m. SPW (3,7cm) »	medium armored halftrack, Platoon Leader vehicle 37mm Pak L/45 [168]
251 /10	mittlerer Schützenpanzerwagen (sPzBü) « m. SPW (sPzBü) »	medium armored halftrack, Platoon Leader vehicle 28mm sPzBü 41 L/28/20 [168]
251 /11	mittlerer Fernsprech-Panzerwagen « m. SPW (Fe) »	medium armored halftrack, telephone cable-laying vehicle MG [1100]
251 /12	mittlerer Meßtrupp- und Gerät-Panzerwagen « m. Meßtrupp Pzgw. »	medium armored halftrack, Calibration Section equipment vehicle MG [1100]
251 /13	mittlerer Schallaufnahme-Panzerwagen « m. Schall-Aufnahme-Pzgw. »	medium armored halftrack, sound recording vehicle MG [1100]
251 /14	mittlerer Schallauswerte-Panzerwagen « m. Schall-Auswerte-Pzgw. »	medium armored halftrack, sound ranging vehicle MG [1100]

## GERMAN SPECIAL MILITARY VEHICLES

Sd.Kfz. No.	German Designation « German Abbreviation »	Description Main Armament [Ammunition carried]
251 /15	mittlerer Lichtauswerte-Panzerwagen « m. Licht-Auswerte-Pzwg. »	medium armored halftrack, sound flash ranging vehicle MG [1100]
251 /16	mittlerer Flamm-Panzerwagen « m. SPW (Flamm) »	medium armored halftrack, with 2 pivoted flame throwers 80 bursts of 2 – 3 seconds (700 liters flame oil); MG [2100]
251 /17	mittlerer Flak-Panzerwagen « m. SPW (2cm) »	medium armored halftrack, self-propelled light anti-aircraft gun 20mm Flak 38 [600]
251 /18	mittlerer Beobachtungs-Panzerwagen « m. Beob-Pzgw. »	medium armored halftrack, observation vehicle MG [1100]
251 /19	mittlerer Fernsprech-Betriebs-Panzerwagen « m. Fs.Betr.-Pzgw. »	medium armored halftrack, telephone operations vehicle MG [1100]
251 /20(I)	mittlerer Panzerwagen (Uhu) « m. Pzgw. (Uhu) »	medium armored halftrack, infrared projector vehicle MG [1100]
251 /20(II)	mittlerer Panzerwagen (Falke) « m. Pzgw. (Falke) »	medium armored halftrack, infrared viewer vehicle MG [1100]
251 /21	mittlerer Panzerwagen (MG 151/15 Drilling) « m. SPW (MG 1,5cm) »	medium armored halftrack, self-propelled light anti-aircraft gun 15mm triple MG 151/15 [3000]
251 /21	mittlerer Panzerwagen (MG 151/20 Drilling) « m. SPW (MG 2cm) »	medium armored halftrack, self-propelled light anti-aircraft gun 20mm triple MG 151/20 [3000]
251 /22	mittlerer Panzerwagen (7,5cm Pak) « m. SPW (7,5cm Pak) »	medium armored halftrack, self-propelled anti-tank gun 75mm Pak 40 L/48 [22]
251 /23	mittlerer Panzerwagen (2cm Flak) « m. SPW (2cm Flak) »	medium armored halftrack, self-propelled light anti-aircraft gun 20mm KwK 38 L/55 [180]
252	leichter gepanzerter Munitionswagen « le. gep. Muni-Wg. »	light armored halftrack, ammunition carrier MG [1020]
253	leichter gepanzerter Beobachtungswagen « le. gep. Beob. Wg. »	light armored halftrack, observation vehicle MG [1100]
254	mittlerer gepanzerter Beobachtungswagen « m. gep. Beob. Wg. »	medium armored wheeled/tracked observation vehicle MG [1100]
260	kleiner Panzerfunkwagen « kl. Pz. Fu. Wg. »	light armored radio car (4x4) n/a
261	kleiner Panzerfunkwagen « kl. Pz. Fu. Wg. »	light armored radio car (4x4) n/a
263	schwerer Panzerfunkwagen « s. Pz. Fu. Wg. »	heavy armored radio car (6x4) MG [1020]
266	Panzerbefehlswagen « gr. Pz-Bef-Wg. »	command tank based on Pz-III, Pz-IV, Pz-V, or Pz-VI MG [1500]
267	Panzerbefehlswagen « gr. Pz-Bef-Wg. »	command tank based on Pz-III, Pz-IV, Pz-V, or Pz-VI MG [1500]
268	Panzerbefehlswagen « gr. Pz-Bef-Wg. »	command tank based on Pz-III, Pz-IV, Pz-V, or Pz-VI MG [1500]
300	Minenräumwagen B-I & B-II « Minenräum-Wg. »	tracked mineclearing vehicle, Model B-I & B-II n/a
301	schwere Ladungsträger B-IV « B-IV »	tracked, remote-controlled demolition vehicle, Model B-IV n/a
302	Leichte Ladungsträger Goliath, Ausf. A « Goliath »	tracked, remote-controlled demolition vehicle, Model A (electric) n/a
303	Leichte Ladungsträger Goliath, Auf. B « Goliath »	tracked, remote-controlled demolition vehicle, Model B (gasoline) n/a
304	mittlere Ladungsträger « Springer »	tracked, remote-controlled demolition vehicle n/a

### Notes:

For the sake of completeness, this list includes the unnumbered vehicles belonging to the same family of vehicles.



## GERMAN SPECIAL MILITARY TRAILERS AND MILITARY TRAILERS

### German Trailers

Besides the numbered trailers listed below, there were also trailers without numbers. These were identified by load factor, number of axles, open or covered, and/or purpose. Furthermore, upon mobilization, the German military requisitioned trailers from the civilian sector. These trailers were strictly for use by road-bound units, and only found in rear-echelon units where they provided a valuable increase in transportation capacity. There were even trailers built specifically for towing horse drawn equipment with motor vehicles.

A few military horse-drawn vehicles (wagons and carts) were modified for towing by motor vehicles by the addition of wheel and parking brakes, rubber-rimmed or even pneumatic tires, rear lights, and towing arrangements.

Some horse-drawn wagon and carts were issued with towing bars allowing them to be towed by motor vehicles.

It was not unusual, specially in the non-motorized units, that unmodified horse-drawn vehicles be towed by motor vehicles. Naturally at comparatively low speeds.

Although many combat units had trailers for guns, ammunition, components of heavy guns, generators, bridging equipment, etc., convoy speed of all vehicles was reduced when towing trailer, and maneuverability was hampered off-road. However, the expense of motor vehicles made the use of trailers an attractive alternative.

<i>Sd.Anh.-Sonder Anhänger</i>	<i>Special Trailers with numbers</i>
Sd.Anh. 1 (1 Achsig) für kleines Kettenkrad	trailer (1 axle) for Kettenkrad
Sd.Anh. 1/1 (1 Achsig) für kleines Kettenkrad	trailer (1 axle) for Kettenkrad
Sd.Anh. 1/2 (1 Achsig) für kleines Kettenkrad für schweres Feldkabel	trailer (1 axle) for Kettenkrad, with heavy telephone field cable.
Sd.Anh. 3 (1 Achsig) für leichte Lasten	trailer (1 axle) for transporting light artillery guns (7,5cm leFK 16 and 10,5cm leFH 16)
Sd.Anh. 4 (1 Achsig) für mittlere und schwere Lasten	trailer (1 axle) for transporting medium and heavy artillery guns (15cm sFH 13)
Sd.Anh. 5 (1 Achsig) für Artilleriemunition	trailer (1 axle) for artillery ammunition
Sd.Anh. 7 (1 Achsig) für Munition (Nbl. Wfr.)	trailer (1 axle) for Nebelwerfer ammunition
Sd.Anh. 8 (1 Achsig) für Veterinärgerät	trailer (1 axle) for veterinary equipment
Sd.Anh. 11 (1 Achsig) für Entseuchung mit Brausevorrichtung	trailer (1 axle) for decontamination with showers
Sd.Anh. 13 (1 Achsig) für M-Boot (100 PS MB 41)	trailer (1 axle) for motorboat (100 HP Type MB 41)
Sd.Anh. 14 (1 Achsig) für Abschleppzwecke	trailer (1 axle) for motor vehicle towing and recovery
Sd.Anh. 15 (1 Achsig) für Fährseil	trailer (1 axle) for winch
Sd.Anh. 20 (1 Achsig) für Erdkabel	trailer (1 axle) for underground telephone cable
Sd.Anh. 21 (2 Achsig) für Fernsprechbau	trailer (1 axle) for telephone construction
Sd.Anh. 22 (1 Achsig) Azetylen-Erzeugeranhängen	trailer (1 axle) for generator for Acetylene gas
Sd.Anh. 23 (1 Achsig) für Sammlerladegerät D	trailer (1 axle) for Generator Type D for recharging batteries
Sd.Anh. 23/1 (1 Achsig) für Maschinensatz 220/65V; 4,5/1,3 Kw	trailer (1 axle) for Generator 220/65 Volt, 4.5/1.3 Kw
Sd.Anh. 24 (1 Achsig) für Maschinensatz I	trailer (1 axle) for Generator Type I
Sd.Anh. 24 (1 Achsig) für Maschinensatz A (Drehstrom 15k VA)	trailer (1 axle) for Generator Type A for 15k AC
Sd.Anh. 25 (1 Achsig) für Feldfernkabel	trailer (1 axle) for heavy telephone field cable
Sd.Anh. 25/1 (1 Achsig) für Maschinensatz F	trailer (1 axle) for Generator Type F
Sd.Anh. 25/2 (1 Achsig) für Nachrichtengerät	trailer (1 axle) for signal equipment
Sd.Anh. 25/3 (1 Achsig) Beleuchtungsanhänger N	trailer (1 axle) for Lighting Equipment Type N
Sd.Anh. 25/4 (1 Achsig) Nachschubanhänger	trailer (1 axle) for supply
Sd.Anh. 25/3 (1 Achsig) Beleuchtungsanhänger N	trailer (1 axle) for lighting equipment
Sd.Anh. 26 (1 Achsig) für Führungsfernkabel	trailer (1 axle) for command telephone heavy cable
Sd.Anh. 28 (1 Achsig) für Peilanhänger (für Peiltrupp (LMW))	trailer (1 axle) for direction finder of a Direction Finding Section
Sd.Anh. 29 (1 Achsig) für gepanzerten Munitionsschlepper	trailer (1 axle) for ammunition (for armored ammunition carrier)
Sd.Anh. 30 (1 Achsig) Wassertankanhänger	trailer (1 axle) for water tank
Sd.Anh. 31 (1 Achsig) für Munition Type A	trailer (1 axle) for ammunition Type A
Sd.Anh. 31/1 (1 Achsig) für Munition (7,5cm Stuk 40)	trailer (1 axle) for ammunition for 7.5cm Assault Gun Model 40
Sd.Anh. 32 (1 Achsig) für Munition (3,7cm Pak)	trailer (1 axle) for ammunition for 3,7cm Antitank Gun
Sd.Anh. 32/1 (1 Achsig) für Munition (7,5cm)	trailer (1 axle) for ammunition for 7,5cm
Sd.Anh. 32/2 (1 Achsig) für Munition (s. Pz Bü 41)	trailer (1 axle) for ammunition for heavy antitank rifle Model 41
Sd.Anh. 32/3 (1 Achsig) für s. Pz Bü 41 auf leichte Feldlafette	trailer (1 axle) for heavy antitank rifle Model 41 on light field carriage
Sd.Anh. 33 (1 Achsig) für Nebelwerfermunition	trailer (1 axle) for ammunition (rocket launcher)
Sd.Anh. 34 (1 Achsig) für Entgiftungsanhänger	trailer (1 axle) for decontamination
Sd.Anh. 35 (1 Achsig) für Teigknetanhänger	trailer (1 axle) for dough mixer
Sd.Anh. 36 (1 Achsig) für leichten Ladungsschlepper	trailer (1 axle) for remote control vehicle (Goliath)
Sd.Anh. 40 (1 Achsig) Panzerbergeanker als Anhänger	trailer (1 axle) for tank recovery anchor
Sd.Anh. 46 (1 Achsig) schmalspurig	trailer (1 axle) with narrow wheel spacing
Sd.Anh. 51 (1 Achsig) Beleuchtungsanhänger (Vermessungstrupp (mot))	trailer (1 axle) for electricity generator in enclosed body for Calibration Detachment
Sd.Anh. 51 (1 Achsig) für 2cm Geschütz 30 mit Munition- und Zubehörkasten	trailer (1 axle) for 2cm antiaircraft gun Model 30 with ammo and equipment boxes
Sd.Anh. 51 (1 Achsig) für Scheinwerfer 60cm mit Zubehörkasten	trailer (1 axle) for 60cm antiaircraft searchlight with equipment boxes
Sd.Anh. 51 (1 Achsig) für 2cm Flak 38 mit Munition- und Zubehörkasten	trailer (1 axle) for 20mm antiaircraft gun Model 38 with ammo and equipment boxes
Sd.Anh. 52 (1 Achsig) für 2cm Flak Vierling 38/1 mit Munition- und Zubehörkasten	trailer (1 axle) for 2cm quad antiaircraft gun Model 38/1 with ammo and equipment boxes
Sd.Anh. 52 (1 Achsig) für 3,7cm Flak 36/37 mit Munition- und Zubehörkasten	trailer (1 axle) for 3.7cm antiaircraft gun Model 36/37 with ammo and equipment boxes
Sd.Anh. 52 (1 Achsig) für Kommando-Gerät 40	trailer (1 axle) for antiaircraft fire direction computer Model 40
Sd.Anh. 53 (1 Achsig) für Kommando-Hilfsgerät 35	trailer (1 axle) for antiaircraft auxiliary fire direction computer Model 35
Sd.Anh. 54 (1 Achsig) für Kinotheodolit für Flakmess-Auswerte-Zug	trailer (1 axle) for antiaircraft optical tracking computer for Calibration Evaluation Platoon
Sd.Anh. 55 (1 Achsig) für V <sup>o</sup> -Messgerät Flak	trailer (1 axle) for antiaircraft muzzle velocity calibration equipment
Sd.Anh. 56 (1 Achsig) für 2cm Flak mit Munition- und Zubehörkasten	trailer (1 axle) for 2cm quad antiaircraft gun with ammo and equipment boxes
Sd.Anh. 56 (1 Achsig) für 2cm Flakvierling 38/1 mit Munition- und Zubehörkasten	trailer (1 axle) for 2cm quad antiaircraft gun Model 38/1 with ammo and equipment boxes
Sd.Anh. 57 (1 Achsig) für 3,7cm Flak mit Munition- und Zubehörkasten	trailer (1 axle) for 3.7cm antiaircraft gun with ammo and equipment boxes
Sd.Anh. 58 (1 Achsig) für 3,7cm Flak 43 mit Munition- und Zubehörkasten	trailer (1 axle) for 3.7cm antiaircraft gun Model 43 with ammo and equipment boxes
Sd.Anh. 58 (1 Achsig) für 3,7cm Flak 43/1 mit Munition- und Zubehörkasten	trailer (1 axle) for 3.7cm antiaircraft gun Model 43/1 with ammo and equipment boxes
Sd.Anh. 101 (2 Achsig) für Flakhorchgerät	trailer (2 axle) for antiaircraft sound tracking equipment
Sd.Anh. 101 (2 Achsig) für mittleren Flak-Maschinensatz	trailer (2 axle) for antiaircraft generator for sound tracking equipment
Sd.Anh. 102 (2 Achsig) für Flak-Scheinwerfer 110cm	trailer (2 axle) for antiaircraft searchlight (110cm)
Sd.Anh. 102 (2 Achsig) für Flak-Maschinensatz	trailer (2 axle) for antiaircraft generator for searchlight (110cm)
Sd.Anh. 103 (2 Achsig) für mittlere und schwere Lasten	trailer (2 axle) for medium and heavy cargo
Sd.Anh. 104 (2 Achsig) für 150cm Flak-Scheinwerfer	trailer (2 axle) for 150cm antiaircraft searchlight
Sd.Anh. 104 (2 Achsig) für Maschinensatz 24 Kw für 150cm Flak-Scheinwerfer	trailer (2 axle) for generator Model 24Kw for 150cm antiaircraft searchlight
Sd.Anh. 104 (2 Achsig) für Sperrballonwinde	trailer (2 axle) for winch for antiaircraft barrage ballon
Sd.Anh. 104 (2 Achsig) für Funkmessgerät 39 TD	trailer (2 axle) for antiaircraft radar Model 39TD
Sd.Anh. 104 (2 Achsig) für 3,7cm Flak 18	trailer (2 axle) for 3.7cm antiaircraft gun Model 18
Sd.Anh. 104 (2 Achsig) für Kommandogerät 36	trailer (2 axle) for antiaircraft fire direction computer Model 36
Sd.Anh. 104 (2 Achsig) für Richtung-Richtungshörer (RRH)	trailer (2 axle) for antiaircraft sound tracking equipment
Sd.Anh. 105 (2 Achsig) Backanhänger	trailer (2 axle) for baking oven
Sd.Anh. 106 (2 Achsig) Backanhänger	trailer (2 axle) for baking oven
Sd.Anh. 107 (2 Achsig) Grosskühlbehälteranhänger	trailer (2 axle) for refrigeration
Sd.Anh. 108 (2 Achsig) für S-Boot (Pionier-Strumboot 39)	trailer (2 axle) for three assault boats (Engineer Assault Boat Model 39)

## GERMAN SPECIAL MILITARY TRAILERS AND MILITARY TRAILERS

Sd.Anh. 109	(2 Achsig) leichter Vermessungsanhänger .....	trailer (2 axle) for light calibration equipment
Sd.Anh. 111	(2 Achsig) schwerer Vermessungsanhänger .....	trailer (2 axle) for heavy calibration equipment
Sd.Anh. 113	(3 Achsig) für Langerät (8 ton) .....	trailer (3 axle) for cargo, long (8ton)
Sd.Anh. 115	Tiefhladeanhänger für PzKfpWg 10-12 ton .....	trailer (2 axle) low boy (also: low bed) for armored vehicles (10 – 12 ton)
Sd.Anh. 116	Tiefhladeanhänger für PzKfpWg 22 ton .....	trailer (4 axle) low boy (also: low bed) for armored vehicles (22 ton)
Sd.Anh. 119	(2 Achsig) für 100 PS-Motorboot .....	trailer (2 axle) for motorboat (100 HP Type MB 41)
Sd.Anh. 120	(2 Achsig) für 250 PS-Motorboot .....	trailer (2 axle) for motorboat (250 HP Type MB 42)
Sd.Anh. 121	Tiefhladeanhänger für PzKfpWg 65 ton .....	trailer (6 axle) low boy (also: low bed) for armored vehicles (65 ton)
Sd.Anh. 127	(2 Achsig) Mastanhänger .....	trailer (2 axle) for mast antenna
Sd.Anh. 141	(2 Achsig) für Pionier-Landungs-Fahrzeug 20-ton .....	trailer (2 axle) for engineer landing vehicle (20ton)
Sd.Anh. 201	(2 Achsig) für 8,8cm Flak .....	trailer (2 axle) for 8.8cm antiaircraft gun
Sd.Anh. 202	(2 Achsig) für 8,8cm Flak 37/37 .....	trailer (2 axle) for 8.8cm antiaircraft gun Model 36/38
Sd.Anh. 202	(2 Achsig) für 8,8cm Flak 41 .....	trailer (2 axle) for 8.8cm antiaircraft gun Model 41
Sd.Anh. 203	(2 Achsig) für 10,5cm Flak 38/39 .....	trailer (2 axle) for 10.5cm antiaircraft gun Model 38/39
Sd.Anh. 203	(2 Achsig) für Fahrgerüst für schwere 12,8cm Flak (o) .....	trailer (2 axle) for mobilizing the static, heavy 12.8cm antiaircraft gun
Sd.Anh. 203	(2 Achsig) Transportbrücke für 12,8cm Flak-Zwilling .....	trailer (2 axle) for 12.8cm twin antiaircraft gun
Sd.Anh. 204	(2 Achsig) für 5cm Flak 41 .....	trailer (2 axle) for 5cm antiaircraft gun Model 41
Sd.Anh. 204	(2 Achsig) für 200cm Flak-Scheinwerfer .....	trailer (2 axle) for 200cm antiaircraft searchlight
Sd.Anh. 204	(2 Achsig) für Maschinensatz für 200cm Flak-Scheinwerfer .....	trailer (2 axle) for generator for 200cm antiaircraft searchlight
Sd.Anh. 204	(2 Achsig) für Maschinensatz 60 kW .....	trailer (2 axle) for generator Model 60Kw
Sd.Anh. 204	(2 Achsig) für Sperrballonwinde .....	trailer (2 axle) for winch for barrage balloon
Sd.Anh. 205	(2 Achsig) Rohrwagen für 10,5cm Flak .....	trailer (2 axle) for barrel wagon for 10.5cm antiaircraft gun
Sd.Anh. 206	(2 Achsig) für 5,5cm Flak 58 .....	trailer (2 axle) for 5.5cm antiaircraft gun Model 58
Sd.Anh. 206	(2 Achsig) für 3,7cm Flak-Zwilling 43 .....	trailer (2 axle) for 3.7cm dual antiaircraft gun Model 43
Sd.Anh. 206	(2 Achsig) für 200cm Flak-Scheinwerfer 44 .....	trailer (2 axle) for 200cm antiaircraft searchlight Model 44
Sd.Anh. 206	(2 Achsig) für Maschinensatz 120 kW .....	trailer (2 axle) for generator Model 120Kw
Sd.Anh. 206	(2 Achsig) für Funkmessgerät .....	trailer (2 axle) for antiaircraft radar
Sd.Anh. 206	(2 Achsig) für Flakrakete H3 117 "Schmetterling" .....	trailer (2 axle) for antiaircraft rocket Model Hs 117 "Schmetterling" (Butterfly)
Sd.Anh. 220	(4 Achsig) für Funkmessgerät .....	trailer (4 axle) for radar system
Sd.Anh. 220	(4 Achsig) für 12,8cm Flak 40/1 .....	trailer (4 axle) for 12.8cm antiaircraft gun Model 40/1
Sd.Anh. 301	(1 Achsig) für Tankspritze .....	trailer (1 axle) for fire engine equipment (auxiliary for the fire engine)
Sd.Anh. 302	(1 Achsig) für Schlauchtender .....	trailer (1 axle) for mobile fire fighting (for independent operation)
Sd.Anh. 319	für Fla-Rakete "Wasserfall" .....	trailer for antiaircraft rocket "Wasserfall" (Waterfall)
Sd.Anh. 322	für A2 (o) 7,5-ton mit geschlossenem Aufbau .....	trailer for rocket A2 (o) with enclosed body (7.5 ton)
Sd.Anh. 322/2	für Landescheinwerfer (Gl 1500) .....	trailer for 1500cm landing searchlight Model Gl 1500
Sd.Anh. 322/3	für Landescheinwerfer (HgLL 1500) .....	trailer for 1500cm landing searchlight Model Hg LL 150
Sd.Anh. 350	für B2 (3-ton) (o) mit geschlossenem Aufbau .....	trailer B2 with enclosed body (civilian type)(3-ton)
Sd.Anh. 350/7	Fernsprechvermittlungs-Anhänger .....	telephone exchange trailer
Sd.Anh. 350/32	Leuchtfeueranhänger .....	generator trailer for airfield beacons
Sd.Anh. 350/33	Leuchtfeueranhänger .....	generator trailer for airfield beacons
Sd.Anh. 350/32	Prüf- und Wartungs-Anhänger für Bordfunk- und Peilgerät .....	trailer for maintenance and testing of aircraft radio and radar equipment
Sd.Anh. 350/43	Prüf- und Wartungs-Anhänger für Bordfunk- und Peilgerät .....	trailer for maintenance and testing of aircraft radio and radar equipment
Sd.Anh. 350/?	Anhänger B2 für Ladestation FR .....	trailer B2 with enclosed body (civilian type)(3-ton) for battery charger for V2 rocket units
Sd.Anh. 363	für B3 (4,5-ton) (o) mit geschlossenem Aufbau .....	trailer B3 with enclosed body (civilian type)(4.5-ton)
Sd.Anh. 363/1	für B3 (4,5-ton) (o) für Bildbearbeitung .....	trailer B3 with enclosed body (civilian type)(4.5-ton) for photograph production Type I
Sd.Anh. 363/2	für B3 (4,5-ton) (o) für Bildbearbeitung .....	trailer B3 with enclosed body (civilian type)(4.5-ton) for photograph production Type II
Sd.Anh. 401	(1 Achsig) Feldküche als Anhänger .....	trailer (1 axle) mobile field kitchen ("Gulaschkanone")
Sd.Anh. 422	(1 Achsig) Navigations-Funkpeilanhänger .....	trailer (1 axle) for direction finding equipment for navigation
Sd.Anh. 447	(2 Achsig) Navigations-Funkpeilanhänger .....	trailer (2 axle) for direction finding equipment for navigation
Sd.Anh. 450	(2 Achsig) Tragflächen 6 Meter .....	trailer (2 axle) for transporting wings (6 meters)
Sd.Anh. 451	(2 Achsig) Tragflächen 10 Meter .....	trailer (2 axle) for transporting wings (10 meters)
Sd.Anh. 450	(2 Achsig) Tragflächen 6 Meter .....	trailer (2 axle) for wings (6 meters)
Sd.Anh. 454	(2 Achsig) Flugbetriebsstoffkessel-Anhänger .....	trailer (2 axle) bowser for aircraft fuel
Sd.Anh. 458	(2 Achsig) Waffenabwurfgerät-Anhänger .....	trailer (2 axle) for bomb transport
Sd.Anh. 459	(2 Achsig) Waffenabwurfgerät-Anhänger .....	trailer (2 axle) for bomb transport
Sd.Anh. 469	(2 Achsig) Fernschreib-Anschlussanhänger .....	trailer (2 axle) with enclosed body for telephone switchboard
Sd.Anh. 470	(2 Achsig) Funkanhänger (Kurz- /Langwelle) .....	trailer (2 axle) with enclosed body for short and medium wave radio station
Sd.Anh. 471	(2 Achsig) Betriebs-Funkempfängeranhänger .....	trailer (2 axle) with enclosed body for radio receiver operation station
Sd.Anh. 472	(2 Achsig) leichter Leuchtfeueranhänger .....	trailer (2 axle) with enclosed body light generator for airfield beacons
Sd.Anh. 473	(2 Achsig) mittlerer Leuchtfeueranhänger .....	trailer (2 axle) with enclosed body medium generator for airfield beacons
<b>Vsah. = Versuchsanhänger</b> .....	<b>Experimental Trailers</b>	
Vsah. 642	Tiefhladeanhänger für Panzerkampfwagen .....	medium tank transport trailer
Vsah. 654	Tiefhladeanhänger für Panzerkampfwagen .....	light tank transport trailer
<b>Anhänger</b> .....	<b>Trailers without numbers</b>	
(1 Achsig) Anhänger-Fahrgestell 900 kg .....	trailer (1 axle) chassis (900 kilos)	
(1 Achsig) Anhänger-Fahrgestell 1500 kg Baumuster 41 .....	trailer (1500 axle) chassis Model 41 (1500 kilos)	
(1 Achsig) Anhänger-Fahrgestell 1900 kg .....	trailer (1 axle) chassis (1900 kilos)	
(1 Achsig) Anhänger-Fahrgestell gl. 500 kg .....	trailer (1 axle) chassis cross-country capable (500 kilos)	
(1 Achsig) Anhänger-Fahrgestell gl. 900 kg .....	trailer (1 axle) chassis cross-country capable (900 kilos)	
(1 Achsig) Anhänger-Fahrgestell gl. 1500 kg .....	trailer (1 axle) chassis cross-country capable (1500 kilos)	
(1 Achsig) Anhänger-Fahrgestell gl. 2200 kg .....	trailer (1 axle) chassis cross-country capable (2200 kilos)	
(1 Achsig) Anhänger A1 (0,5 t), offen (o) .....	trailer (1 axle) Model A1, civilian type, open (500 kilos)	
(1 Achsig) Anhänger A1 (0,5 t), offen (o) als Schlauchhaspel für Kfz. 346 .....	trailer (1 axle) Model A1, civilian type, open (500 kilos), for hoses, towed by Kfz. 346	
(1 Achsig) Anhänger mit geschlossenem Aufbau (o) für Eisenbahn-Pionier .....	trailer (1 axle) civilian type, enclosed, for Railroad Engineers	
(1 Achsig) Anhänger mit geschlossenem Aufbau (o) für Kraftfahrzeug-Parkes .....	trailer (1 axle) civilian type, enclosed, for Motor Vehicle Parks	
(1 Achsig) Anhänger gl. für Einheitsbehälter für Kraftstoff .....	trailer (1 axle) cross-country capable, for standard fuel cans ("Jerry cans")	
(1 Achsig) Anhänger für 200-Liter Kraftstoff-Fass .....	trailer (1 axle) fuel barrel (200 liters)	
(1 Achsig) Anhänger für 2x 200-Liter Kraftstoff-Fass .....	trailer (1 axle) 2 fuel barrels (each 200 liters)	
(1 Achsig) Anhänger für Ladungswerfer .....	trailer (1 axle) for heavy spigot mortar of the engineers	
(1 Achsig) Anhänger für M.S. Boot (handelsüblichen Gerät) der Pioniere .....	trailer (1 axle) for civilian motor boat used by the engineers	
(1 Achsig) Anhänger mit Notstromaggregat 12kVA "Carfais" Diesel der Marine .....	trailer (1 axle) for diesel power generator "Carfais" for the Navy	
(1 Achsig) Anhänger mit Notstromaggregat 12kVA "Fimag" Bezin der Marine .....	trailer (1 axle) for gasoline power generator "Fimag" for the Navy	
(1 Achsig) Anhänger für schwere Panzerbüchse 41 .....	trailer (1 axle) for heavy antitank rifle (PzBü 41)	

## GERMAN SPECIAL MILITARY TRAILERS AND MILITARY TRAILERS

(1 Achsig) Anhänger für Räudegaszellen .....	trailer (1 axle) for gas bottles (gas used against mangle)
(1 Achsig) Anhänger für Verschluss-Sachen der Vermessungs- und Karten-Einheiten .....	trailer (1 axle) enclosed, lockable, for confidential material of the surveying and mapping units
(1 Achsig) Anhänger offen (o) für Veterinärgerät für Pferdelažarett .....	trailer (1 axle) civilian type, open, for veterinary equipment for veterinary hospital
(1 Achsig) Anhänger für V2.Abschussplattform .....	trailer (1 axle) for firing platform for V2 rocket units
(1 Achsig) Diesel-Eisbereiter als Anhänger .....	trailer (1 axle) for diesel powered ice maker
(1 Achsig) Brennschluss-Antennen-Anhänger für schiess Fernraketen-Batterien .....	trailer (1 axle) for antenna for establishing rocket-cut-off for V2 rocket units
(1 Achsig) Grosser Druckluftzerzeuger als Anhänger .....	trailer (1 axle) with large air compressor
(1 Achsig) Fallschirmjägerkarren als Anhänger für das Kettenkrad .....	cart (1 axle) for Kettenkrad for Fallschirmjäger (Parachute Infantry)
(1 Achsig) Grosse Feldküche als Anhänger .....	trailer (1 axle) for mobile large field kitchen range
(1 Achsig) Festungskabeltötkarren .....	cart (1 axle) for Fortress Signal Troops, with sodering and other equipment
(1 Achsig) Festungskabelmesskarren .....	cart (1 axle) for Fortress Signal Troops, with calibration and other equipment
(1 Achsig) schweren Grabenpflug (Entgiftungspflug) als Anhänger .....	trailer (1 axle) heavy plow, originally for decontamination, but also used for entrenching
(1 Achsig) Handkarren für leichten Ladungswerfer der Pioniere .....	hand cart (1 axle) for light spigot mortar of the engineers
(1 Achsig) kleiner Kabeltrommel-Anhänger für Fernraketen-Einheit .....	trailer (1 axle) for light cable drums for V2 rocket units
(1 Achsig) Leitstrahl-Antennen-Anhänger für FR-Einheit .....	trailer (1 axle) for guiding beam antenna for V2 rocket units
(1 Achsig) Leitstrahl-Kontroll-Anhänger für FR-Einheit .....	trailer (1 axle) for guiding beam instrumentation for V2 rocket units
(1 Achsig) Lichtbogen-Schweissmaschinensatz auf Anhängerfahrgestell 1500 t .....	trailer (1 axle) arch welding equipment on chassis Model 41 (1500 kilos)
(1 Achsig) Maschinensatz 110/220 V 24 Kw als Anhänger fahrbar .....	trailer (1 axle) generator (110/220 Volts, 24 kW)
(1 Achsig) Maschinensatz 220 V 6,5 Kw als Anhänger fahrbar .....	trailer (1 axle) generator (220 Volts, 6.5 kW)
(1 Achsig) Maschinensatz 220 V (Wechselstrom) 15/18 KVA der Sanitätstruppe .....	trailer (1 axle) generator (220 Volts, AC, 15 kVA) for the Medical Troops
(1 Achsig) Maschinensatz 220/380 (Drehstrom) 30 Kw als Anhänger fahrbar .....	trailer (1 axle) generator (220/380 Volts, DC, 30 kVA)
(1 Achsig) Motorspritze als Anhänger fahrbar (o) .....	trailer (1 axle) motor water pump (civilian type)
(1 Achsig) Anhänger leichter Sprühanhänger .....	trailer (1 axle) light decontamination spray unit
(1 Achsig) Tragkraftspritzen-Anhänger (Tsga 8)(Bauart 1937) .....	trailer (1 axle) fire fighting equipment, including a portable water pump Type Tsga 8/37
(1 Achsig) Tragkraftspritzen-Anhänger (Tsga 8)(Bauart 1939) .....	trailer (1 axle) fire fighting equipment, including a portable water pump Type Tsga 8/39
(1 Achsig) Tragkraftspritzen-Anhänger (o) .....	trailer (1 axle) fire fighting equipment, civilian type, including a portable water pump
(1 Achsig) Troganhänger fürEntgiftungskraftwagen (Kfz. 305/112) des S.H.D. ....	trailer (1 axle) for decontamination van of the S.H.D. ("Sicherheits- und Hilfedienst")
(1 Achsig) T-Stoff-Vorwärmer-Anhänger für FR-Einheit .....	trailer (1 axle) for warming fuel (T-Staff = Hydrogensuperoxyd) for the V2 rocket units
(1 Achsig) Wasser-Anhänger 100 liter .....	trailer (1 axle) bowser for water (1000 liters)
(2 Achsig) Anhänger A2 Einheits-Anhänger 1 t offen (o) .....	trailer (2 axle) Standard Model A2, civilian type, open (1 ton)
(2 Achsig) Anhänger A2 als Schlauchhaspel für Schlauchkraftwagen (Kfz. 346) .....	trailer (2 axle) Standard Model A2, civilian type, open (1 ton), for hoses, towed by Kfz. 346
(2 Achsig) Anhänger B2 Einheits-Anhänger 3 t offen (o) .....	trailer (2 axle) Standard Model B2, civilian type, open (3 ton)
(2 Achsig) Anhänger B2 mit Maschinensatz 220/380 V Drehstrom 60 Kw .....	trailer (2 axle) Standard Model B2, for generator (220/380 Volts, DC, 60 kVA)
(2 Achsig) Anhänger B3 Einheits-Anhänger 4,5 t offen (o) .....	trailer (2 axle) Standard Model B3, civilian type, open (4.5 ton)
(2 Achsig) Anhänger E5 Einheits-Anhänger 5 t offen (o) .....	trailer (2 axle) Standard Model E5, civilian type, open, (5 ton)
(2 Achsig) Anhänger E8 Einheits-Anhänger 8 t offen (o) .....	trailer (2 axle) Standard Model E8, civilian type, open, (8 ton)
(2 Achsig) Anhänger mit Anlage zum Nachfüllen des Sauerstoffbedarf von Kampfflugzeuge .....	trailer (2 axle) for filling Oxygen into fighter planes
(2 Achsig) Anhänger (Langholz) für 6 Auffahrtsschienen Brückengerät I.Z. ....	trailer (2 axle) for 6 ramps of Type I.Z. bridge (long pole equipment)
(2 Achsig) Anhänger mit mittlerer Betriebsstoffkesselanlage (o) der Luftwaffe .....	trailer (2 axle) with medium boiler tank for aviation fuel
(2 Achsig) Anhänger mit schwererBetriebsstoffkesselanlage (o) der Luftwaffe .....	trailer (2 axle) with heavy boiler tank for aviation fuel
(2 Achsig) Anhänger mit Feldballonwinde 40 der Artillerie .....	trailer (2 axle) with winch for observation ballon Model 40 of the artillery
(2 Achsig) Anhänger mit Flakkommandogerät Hazemeyer der Marine .....	trailer (2 axle) with antiaircraft fire direction computer Model Hazemeyer
(2 Achsig) Anhänger mit 2cm-Flak auf Socketlafette .....	trailer (2 axle) for 2 cm antiaircraft gun Model 30 on pedestal base
(2 Achsig) Anhänger mit Kessel für Flüssigsauerstoff für Fernraketen .....	trailer (2 axle) with tank for Liquid Oxygen for V2 rocket units
(2 Achsig) Anhänger mit Kurbelmast 30m der Nachrichtentruppen .....	trailer (2 axle) with extendable antenna (30 meters) for the Signal Troops
(2 Achsig) Anhänger 1,5 t für Raupenschlepper Ost .....	trailer (2 axle) for Raupenschlepper Ost (1.5 ton)
(2 Achsig) Anhänger für Schleppboot 200 PS der Pioniere .....	trailer (2 axle) for towing boat (200 HP) of the Engineers
(2 Achsig) Anhänger schwimmfähig für Land-Wasser-Schlepper (Kässbohrer) .....	trailer (2 axle) for the amphibious truck ("LWS")(made by Kässbohrer)
(2 Achsig) Entgiftungsgeräte-Anhänger für den Entgiftungsgerätek. (Kfz. 305/12) .....	trailer (2 axle) for the decontamination equipment truck (Kfz. 305/12)
(2 Achsig) Kabeltrommel-Anhänger für FR-Einheiten .....	trailer (2 axle) for cable drums for V2 rocket units
(2 Achsig) Kfz. Werkstatt-Kessel für FR-Einheiten .....	trailer (2 axle) with motor maintenance shop for V2 rocket units
(2 Achsig) Landebahn-Leuchtanhänger .....	trailer (2 axle) for runway lighting
(2 Achsig) Luftverdichter-Anhänger für FR-Einheiten .....	trailer (2 axle) for air compressor for V2 rockets
(2 Achsig) Omnibus-Anhänger (Kässebohrer Type P4 1939) .....	trailer (2 axle) for motor bus (bus Model P4 1939)(made by Kässebohrer)
(2 Achsig) Rohrwagen 40 für 12,8cm Flak 40 .....	trailer (2 axle) for 12,8cm antiaircraft gun barrel
(2 Achsig) Sägevollgater auf Anhänger .....	trailer (2 axle) for mobile buzzsaw
(2 Achsig) Scheinwerfer-Transportwagen für Scheinwerfer G150 (alter Art) .....	trailer (2 axle) for 150cm searchlight Model G150 (old type)
(2 Achsig) Scheinwerfer-Transportwagen für Scheinwerfer G110 .....	trailer (2 axle) for 110cm searchlight Model G110
(2 Achsig) Strabo-Kran 16t als Anhänger .....	trailer (2 axle) for 16 ton collapsible crane (made by Strabo)
(2 Achsig) Tragflächen-Transportanhänger a & b (Bauart 39) .....	trailer (2 axle) for transport of aircraft wings Type a and b, Model 39
(2 Achsig) V2 Transport-Anhänger Vidal .....	trailer (2 axle) for transporting a V2 rocket (made by Vidal)
(2 Achsig) Wasserstoffverdichter-Anhänger 41+42 .....	trailer (2 axle) for Hydrogen compression Model 41+42
(2 Achsig) Wasserstoffentwickler-Anhänger 40+41 .....	trailer (2 axle) for Hydrogen developing Model 40+41
(3 Achsig) Anhänger 8 t für 800 PS Motorboot 43 .....	trailer (3 axle) (8 ton) for motor boat Model 53 (800 HP)
(3 Achsig) Anhänger offen (o) mit Nutzlast 11.000 kg .....	trailer (3 axle) cargo, civilian type, open (11 ton)
(3 Achsig) Anhänger mit 30-t Kran .....	trailer (3 axle) for 30-ton collapsible crane
(3 Achsig) Anhänger schwimmfähig mit Nutzlast von 10 t .....	trailer (3 axle) amphibious (10 ton)
(3 Achsig) Anhänger schwimmfähig mit Nutzlast von 20 t .....	trailer (3 axle) amphibious (20 ton)
(3 Achsig) Anhänger für die Fernrakete A4 (V2) Fabrikat Meiller .....	trailer (3 axle) for transporting a V2 rocket (made by Meiller)
(4 Achsig) Anhänger für schwere Lasten Culemeyer .....	trailer (4 axle) for heavy cargo (made by Culemeyer)
(6 Achsig) Anhänger für schwere Lasten Culemeyer bis 60 t .....	trailer (6 axle) for heavy cargo (60 ton) (made by Culemeyer)
(6 Achsig) Anhänger für schwere Lasten Gothaer Waggonfabrik bis 60 t .....	trailer (6 axle) for heavy cargo (60 ton) (made by Gothaer Waggonfabrik)
(Mehrachts) Anhänger für schwere Lasten bis 110 t .....	trailer (multi-axle) for heavy cargo (110 ton)
(Mehrachts) Anhänger für schwere Lasten bis 150 t .....	trailer (multi-axle) for heavy cargo (150 ton)
(Mehrachts) Anhänger mit geschlossenem Aufbau für Zinkdruckrotationspresse .....	trailers (multi-axle) with enclosed body for zincograph rotating printing press

<b>Pf. = Pionierfahrzeuge .....</b>	<b>Engineer Vehicles</b>
Pf. 10 (2 Achsig) Bockwagen .....	trailer (2 axle) for bridge tressels
Pf. 11 (2 Achsig) Pontonwagen .....	trailer (2 axle) for bridge pontoons
Pf. 12 (2 Achsig) Rampenwagen .....	trailer (2 axle) for bridge ramps
Pf. 13 (1 Achsig) für M-Boot (100 PS MB 41) .....	trailer (1 axle) for motorboat (100 HP Type MB 41)

### Note:

The designation of these four engineer trailers was a holdover from an earlier period; the old nomenclature was maintained, except that Pf. 13 is mentioned also as Sd.Anh. 13.

## GERMAN HORSE-DRAWN VEHICLES: WAGONS – CARTS — SLEDS

<b>Af = Artilleriefahrzeuge</b> .....	<b>Artillerie Vehicles</b>
Af 3 Munitionswagen 96 n.A. ....	ammunition limber Type 96 n.A.
Af ? Munitionshinterwagen 96 n.A. ....	ammunition rear limber Type 96 n.A.
Af 4 Feldhaubitzen-Munitionswagen .....	field howitzer ammunition wagon 98
Af 5 schwerer Munitionswagen 02 .....	heavy ammunition wagon 02
Af 7 Rohrwagen für 10cm K17 .....	barrel wagon – 10cm Gun (K17)
Af 8 Rohrwagen für 15cm K16 .....	barrel wagon – 15cm Gun (K16)
Af 12 Beobachtungswagen .....	artillery observation wagon
Af 14 Munitionswagen .....	ammunition wagon
Af 19 Rohrwagen für 10cm K18 oder sFH 18 .....	barrel wagon – 10cm Gun or 15cm sFH
Af ? Feldhaubitze .....	limber for field howitzer
Af ? Munitionshunterwagen 98 .....	ammunition rear limber Type 98
Af ? Munitionswagen 38 für 7,5cm Feldkanone 38 .....	ammunition limber for 7,5cm field gun
Af ? Feldkanonenprotze für 7,5cm Feldkanone 38 .....	limber for 7,5cm field gun 38
Af ? leichte Feldhaubitze 98E .....	limber for light field howitzer 98E
Af ? leichte Feldhaubitze 18 .....	limber for light field howitzer 18
Af ? leichte Feldhaubitze 18/40 .....	limber for light field howitzer 18/40
Af ? schwerer Feldhaubitzen-Munitionswagen .....	heavy field howitzer ammunition wagon

<b>EF = Ersatzfeldwagen</b> .....	<b>Replacement Field Wagon</b>
EF40 Wirtschaftswagen .....	supply wagon

<b>Hf = Heeresfahrzeug</b> .....	<b>Army Vehicles</b>
Hf 1 leichter Feldwagen (gefedert) .....	light field wagon (sprung)
used as Verpflegungswagen .....	rations wagon
Sanitätsträgerwagen .....	stretcher bearer wagon
Packwagen .....	baggage wagon
Veterinärmitelwagen .....	veterinary equipment wagon
Schanzzeugwagen .....	entrenching equipment wagon
Hf 1/1 grosser Gefechtswagen .....	large combat wagon
used as Nachrichtengerätwagen (gefedert) .....	signal equipment wagon (sprung)
Pioniergerätwagen (gefedert) .....	engineer equipment wagon (sprung)
Vermessungsgerätwagen (gefedert) .....	survey equipment wagon (sprung)
Hf 1/2 Handscheinwerferwagen (M) .....	hand held searchlight wagon
Hf 1/3 Handscheinwerferwagen (S)(gefedert) .....	hand held searchlight wagon (sprung)
Hf 1/4 Beobachtungs-Gerätwagen .....	observation equipment wagon
Hf 1/11 grosser Gefechtswagen .....	large combat wagon
used as Nachrichtengerätwagen .....	signal equipment wagon
Hf 1/13 grosser Fahnschmiedwagen .....	large farrier wagon
Hf 1/14 Packwagen für Feldschmiede .....	field forge wagon
Hf 1/14 Waffenmeisterwagen .....	armorer wagon
Hf 1/16 Bäckereigerät-Wagen .....	bakery equipment wagon
Hf 1/18 Truppensanitäts-Wagen .....	medical equipment wagon
Hf 2 schwere Feldwagen .....	heavy field wagon
used as Gerätwagen .....	equipment wagon
schwerer Gefechtswagen .....	heavy combat wagon
Lastwagen .....	cargo wagon
Munitionswagen .....	ammunition wagon
Packwagen .....	baggage wagon
Verpflegungswagen .....	rations wagon
Vorratswagen .....	stores wagon
Hf 3 kleiner Feldwagen .....	small field wagon (600 kilo)
Hf 3/1 Nachrichtengerätwagen (gefedert) .....	signal wagon (sprung)
Hf 3/2 leichter Frenspchswagen (gefedert) .....	ligh telephone wagon (sprung)
Hf 3/11 kleiner Gefechtswagen .....	small combat wagon
Hf 3/12 kleiner Fahnschmiedwagen .....	small farrier wagon
Hf 4 Gebirgskarren .....	mountain cart
Hf 7 Stahlfeldwagen (gefedert) .....	field wagon (steel)(sprung)
Hf 7/11 grosser Gefechtswagen (Stahlfeldwagen) .....	large combat wagon (steel)
Hf 7/13 grosser Fahnschmiedwagen (Stahlfeldwagen) .....	large farrier wagon (steel)
Hf 7/14 Waffenmeisterwagen (Stahlfeldwagen) .....	armorer wagon (steel)
Hf 8 Bockwagen .....	tressel transport wagon
Hf 9 Pontonwagen .....	pontoon transport wagon
Hf 11 grosser Feldküche .....	large field kitchen
Hf 12 kleiner Feldküche .....	small field kitchen
Hf 13 grosser Feldküche .....	large field kitchen
Hf 14 kleiner Feldküche .....	small field kitchen
Hf ? Munitionswagen .....	ammunition wagon
Hf ? Vorratswagen .....	supply wagon
Hf ? Sanitätswagen .....	medic wagon
Hf ? Veterinärvorratswagen .....	veterinary supply wagon

## GERMAN HORSE-DRAWN VEHICLES: WAGONS – CARTS — SLEDS

<b>If</b>	<b>= Infanteriefahrzeuge</b>	<b>Infantry Vehicles</b>
If 3	Maschinengewehr-Wagen (s) (2 sMG)	heavy machine gun wagon (2 HMG)
If 4	Maschinengewehr-Wagen (1) (2 sMG)	light machine gun wagon (2 HMG)
If 4	Gebirgskarre	mountain cart
If 5	Maschinengewehrwagen (Zwillingssockel)	machine gun wagon (with pedestal for dual MG)
If 6	Gefechtskarre für s Gr.Wfr. /m. Gr.Wfr.	medium & heavy mortar wagon
If 7	Maschinengewehrwagen (1 sMG)	machine gun wagon (1 HMG)
If 7/24	Maschinengewehrwagen (MG7/24 Schwarzlose)	machine gun wagon (for HMG 7/24 Scharzloser)
If 8	Tornister-Funktrupp-Wagen	pack radio wagon
If 9	Gefechtskarre	combat cart
If 9/1	Gefechtskarre für 8cm Granatwerfer	combat cart for 8cm mortar
If 9/1	Munitionskarre für 8cm Granatwerfer	ammunition cart for 8cm mortar
If 12	Beobachtungswagen	observation wagon
If 12/1	leichte Infantriegeschützprotze	limber for light infantry gun
If 14	Munitionswagen	ammunition wagon
If 15	Beobachtungswagen	observation wagon
If ?	Gebirgskarre für 3,7cm Pak	mountain cart for 3,7cm antitank gun
If ?	Granatwerferkarre mit Rahmen M.24/25	mortar cart with frames

<b>Nf</b>	<b>= Nachrichtenfahrzeuge</b>	<b>Signal Vehicles</b>
Nf 1	schwerer Fernsprechwagen	heavy telephone wagon
Nf 2	leichter Fernsprechwagen	light telephone wagon
Nf 4	kleiner Funkwagen	small radio wagon
Nf 5	kleinfunkwagen	small radio wagon
Nf 6	Funkwagen	radio wagon
Nf 7	Infanterie-Nachrichtenwagen	infantry signal wagon
Nf ?	Bauwagen 13	construction equipment wagon
Nf ?	Leiterwagen für Fernsprechrupp	ladder wagon for telephone section
Nf ?	Kastenwagen für Fernsprechrupp	equipment wagon for telephone section

<b>Pf</b>	<b>= Pionierfahrzeuge</b>	<b>Engineer Vehicles</b>
Pf 21	Flammenwerfer-Füllwagen	flamethrower refill wagon
Pf 22	Pionierhandkarren	engineer hand cart
Pf 25	Handkarren für leichten Landungswerfer	hand cart for light spigot mortar

<b>Sf</b>	<b>= Sanitätsfeldwagen</b>	<b>Medical Field Wagons</b>
Sf 1	Krankenwagen	ambulance wagon
Sf 2	Krankenwagen	ambulance wagon

<b>Vf</b>	<b>= Fahrzeuge der Veterinärtruppen</b>	<b>Wagons for Veterinary Troops</b>
Vf 1	Pferdetransportwagen	horse transport wagon

<b>Vwf</b>	<b>= Fahrzeuge der Verwaltungstruppen</b>	<b>Wagons for Administration Troops</b>
Vwf 1	Backofentransportwagen	oven transport wagon
Vwf 2	Teigknetwagen	dough mixer wagon
Vwf 3	Kraftquellenwagen	water pump wagon

<b>Fahrzeuge ohne Numerierung</b>	<b>Wagons without Numbers</b>
— Pleskau-Wagen I	Pleskau I (359 kilo) (1 horse team)
— Pleskau-Wagen II	Pleskau II (700 kilo) (2 horse team)
— Kutschwagen	carriage / coach
— grosser Feldwagen (t)	large Czech field wagon
— kleiner Feldwagen (t)	small Czech field wagon
— grosser Feldküche (t)	large Czech field kitchen
— kleiner Feldküche (t)	small Czech field kitchen
— Gebirgskarren M15 für Munition (t)	Czech mountain cart for ammunition

<b>Hs</b>	<b>= Heeresschlitten</b>	<b>Army Sleds</b>
Hs 1	Schlitten (300 Kg)	sled (300 Kilo) (single or tandem)
Hs 3	Schlitten (500 Kg)	sled (500 Kilo) (single or tandem)
Hs 3/1	Krankenschlitten	stretcher sled (single or tandem)
Hs 5	Schlitten (1000 Kg)	sled (1000 Kilo) (single or tandem)
Hs 41	zweispännige Schlitten	sled (dual)
Hs 42	zweispännige Schlitten	sled (dual)
Hs 43	zweispännige Schlitten	sled (dual)
Hs 61	einspännige Schlitten	sled (single)
Hs 62	einspännige Schlitten	sled (single)

## GERMAN ARMY RANKS AND *STELLEGRUPPEN* (BILLET GROUPS)

This is only a simplified account of the German military personnel structure and hierarchy. Readers are warned that, as in all armies, they were in actual fact more complicated, with important differentiations being made between designations of rank, billet, function, and skill.

'Billet' indicates an appointment to (staffing of) a position – also called a 'slot' – like Squad Leader, Platoon Commander, Divisional Commander, Executive Officer, Supply Sergeant, etc. Confusingly, in some cases, the billet has the same designation as a rank, such as Hauptfeldwebel.

The equivalent Ranks given in English are neither completely World War II British nor American, and is not going to satisfy any specialist. (However a specialist would probably not be reading this anyway). Nearly all German officer ranks correspond to US Army ranks, although their terminology differs, a *Generalmajor* being the equivalent of a brigadier general. Modern US Army rank equivalents have some differences. There is one more enlisted rank (Command Sergeant Major), and one more Warrant Officer rank (Warrant Officer 3rd Class). US Army Warrant Officers are counted as officers, not enlisted men. In the German WWII Army, all ranks below 2nd Lieutenant were enlisted men.

The German Army divided officers billets into eight groups, depending on the function to be carried out. German wartime officer ranks were permanent, which often made it impossible for German officers to be promoted to the higher rank which their wartime billet would actually have warranted. For example, although a Captain normally staffed the billet of Company Commander, this was not always a rule. If there were not enough Captains then a senior member of a lower rank was assigned to that billet. Conversely, if there were too many of a higher rank than one or more might be assigned a lower ranking billet. Many Divisions were commanded by a Brigadier General - and even an occasional Colonel - instead of a Major General. Conversely, if a billet was particularly critical, a higher-ranking person might be assigned to that billet than would normally be the case. Skill was preferred to rank. Promotion was achieved by serving time. The function or billet filled as such was not a ground for promotion.

The enlisted men were divided into three billet groups: Senior Sergeants (Unteroffiziere mit Portepee) ("O" Group), Junior Sergeants (Unteroffiziere ohne Portepee) ("G" Group), and Other Ranks (Mannschaften) ("M" Group).

Enlisted members of the German Army had an 'Occupation' (Laufbahn), i.e. a career or field of specialty, like Infantry, Supply, Finance and so on. The occupation might be incorporated into the rank designation, such as *Beschlagschmiedobergefreiter*, a farrier (horseshoe smith) corporal; or even be used instead of the rank designations, such as *Beschlagmeister*, ('Farrier Master'), who was an expert farrier sergeant.

The highest combat leader position held by an enlisted man was that of platoon leader. However, this usually applied only to the third and fourth platoons. All other combat command positions were held by officers. Sergeants and Warrant Officers were in charge of logistics and administration, freeing the officers for their primary function of leading men into combat. It was not unusual for senior enlisted men to become involved in combat when the need arose, although the German Army considered it a waste of skilled manpower to use these highly trained and experienced men for this purpose.

German Tables of Organization (KStN – *Kriegsstärkenachweisungen*) had many notes indicating which billets and specialist slots were to be filled with what ranks and specialists, listing which billets had priority over others, which could alternatively be filled by a person with specialized knowledge or skill, and which billets should by preference be filled with regular army personnel.

Although it was expected to have rank and billet corresponding to each other, this was far from the case. Specialist personnel was rare and many units were raised in a hurry, not having enough time to acquire all its correct personnel. And once a unit entered combat, the chances of acquiring the exact, highly-skilled soldier for the correct position often became merely a matter of luck.

The German Wehrmacht also had a unique category of personnel within its ranks, namely the *Wehrmachtbeamten*, which can be loosely translated as Armed Forces Civil Servants or as Government Service Officials. They were found in administrative, legal, and technical service positions. They were civilians performing functions within the Armed Forces. Although they were not classified as soldiers, they wore uniforms identical with those of the Service branch they were serving with, albeit with different insignia. Their duties, at least at field and company level, could lead to armed encounters with enemy forces, and they were all armed with pistols.

### Generals

#### Billet Group "A"

Commander-in-Chief / General Officer in an "A" Group  
*Oberbefehlshaber / General in A-Stelle*  
 Generalfeldmarschall ..... General of the Army (Field Marshal)  
 Generaloberst ..... General

#### Billet Group "F"

Commanding General / General Officer in an "F" Group  
*Kommandierender General / General in F-Stelle*  
 General ..... Lieutenant General  
 der Infanterie ..... of the Cavalry  
 der Kavallerie ..... of the Infantry  
 der Artillerie ..... of the Artillery  
 der ... ..... of the ...

#### Billet Group "D"

Divisional Commander / General Officer in a "D" Group  
*Divisionskommandeur / General in D-Stelle*  
 Generalleutnant ..... Major General  
 Generalstabsarzt ..... Major General (Medical Corps)  
 Generalstabs- ..... Major General ( ... )

#### Billet Group "I"

Infantry, Artillery, or Brigade Commander / General Officer in an "I" Group  
*Infanterie-, Artillerie-, Brigadekommandeur / Offizier in I-Stelle*  
 Generalmajor ..... Brigadier General  
 Generalarzt ..... Brigadier General (Medical Corps)  
 General- ..... Brigadier General ( ... )

### Officers

#### Billet Group "R"

Regimental Commander / Officer in an "R" Group  
*Regimentskommandeur / Offizier in R-Stelle*  
 Oberst ..... Colonel  
 Oberstarzt ..... Colonel (Medical Corps)  
 Oberst- ..... Colonel ( ... )

#### Billet Group "B"

Battalion Commander / Officer in a "B" Group  
*Abteilungs- bzw. Bataillonskommandeur / Offizier in B-Stelle*  
 Oberstleutnant ..... Lieutenant Colonel  
 Oberfeldarzt ..... Lieutenant Colonel (Medical Corps)  
 Oberfeld- ..... Lieutenant Colonel ( ... )  
 Major ..... Major  
 Oberstabsarzt ..... Major (Medical Corps)  
 Oberstabs- ..... Major ( ... )

#### Billet Group "K"

Battery, Squadron, or Company Commander / Officer in a "K" Group  
*Batterie-, Schwadron- bzw. Kompanieführer / Offizier in K-Stelle*  
 Hauptmann ..... Captain  
 Rittmeister ..... Captain (Cavalry Corps)  
 Stabsarzt ..... Captain (Medical Corps)  
 Stabsveterinär ..... Captain (Veterinary Corps)  
 Stabsmusikmeister ..... Captain (Band)  
 Stabs- ..... Captain ( ... )

#### Billet Group "Z"

Platoon Leader / Officer in a "Z" Group  
*Zugführer / Offizier in Z-Stelle*  
 Oberleutnant ..... First Lieutenant  
 Oberarzt ..... First Lieutenant (Medical Corps)  
 Obermusikmeister ..... First Lieutenant (Band)  
 Oberzahlmeister ..... First Lieutenant (Paymaster Corps)  
 Ober- ..... First Lieutenant ( ... )  
 Leutnant ..... Second Lieutenant  
 Assistenzarzt ..... Second Lieutenant (Medical Corps)  
 Musikmeister ..... Second Lieutenant (Band)  
 Assistenzzahlmeister ..... Second Lieutenant (Paymaster Corps)  
 Assistenz- ..... Second Lieutenant ( ... )

### Enlisted Men

#### Billet Group "O"

Senior Non-Commissioned Officer in an "O" Group  
*Oberfeldwebel (Unteroffiziere mit Portepee)*  
 Stabsfeldwebel ..... Warrant Officer First Class  
 Obermeister ..... Warrant Officer 1st Class of a Technical Establishment  
 Hauptfeldwebel ..... Warrant Officer 2nd Class  
 Hauptwachtmeister ..... Warrant Officer 2nd Class (Cavalry, Artillery, AA, etc.)  
 Oberfeldwebel ..... Sergeant Major  
 Oberwachtmeister ..... Sergeant Major (Cavalry, Artillery, AA, etc.)  
 Musikleiter ..... Sergeant Major (Band)  
 etc. ....  
 Feldwebel ..... First Sergeant  
 Wachtmeister ..... First Sergeant (Cavalry, Artillery, AA, etc.)  
 Beschlagmeister ..... Farrier First Sergeant  
 Feuerwerker ..... Ordnance First Sergeant  
 Brieffaubenmeister ..... Pigeon Postmaster  
 etc. ....

#### Billet Group "G"

Non-Commissioned Officer in a "G" Group  
*Gruppenführer (Unteroffiziere ohne Portepee)*  
 Unterfeldwebel ..... Staff Sergeant  
 Unterwachtmeister ..... Staff Sergeant (Cavalry, Artillery, AA, etc.)  
 etc. ....  
 Unteroffizier ..... Sergeant  
 Sanitätsunteroffizier ..... Sergeant (Medical Corps)  
 etc. ....  
 Obergefreiter ..... Corporal  
 Sanitätsobergefreiter ..... Corporal (Medical Corps)  
 etc. ....

#### Billet Group "M"

Other Rank in an "M" Group  
*Mannschaft*  
 Gefreiter ..... Private First Class  
 Oberschütze ..... Private 2  
 Oberreiter ..... Trooper First Class  
 etc. ....  
 Schütze ..... Private 1 (infantryman)  
 Grenadier ..... Private (alternate designation for infantryman)  
 Jäger ..... Private (Mountain or Light Infantry)  
 Pionier ..... Engineer / Pioneer (Engineers)  
 Fahrer ..... Driver (usually of a horse-drawn vehicle)  
 Kraftfahrer ..... Driver (motor vehicle)  
 Beschlagschmiedschütze ..... Farrier (horse smith)  
 Spielman ..... Bandsman / Bugler  
 etc. ....

## GERMAN MILITARY PERSONNEL JOB DESCRIPTIONS

Abteilungsarzt	Battalion Physician	Melder	Messenger / Runner
Abteilungskommandeur	Battalion Commander	Meldereiter	Messenger (horse-mounted)
Abteilungsschreiber	Battalion Headquarters Clerk	Mitarbeiter	Assistant Clerk
Abteilungsveterinär	Battalion Veterinary Doctor	Motorschlosser	Motor Mechanic
Adjutant	Adjutant	Munitionskanonier	Ammunition Handler
Arzt	Physician	Munitionsschütze	Ammunition Handler
Auswerter	Plotter / Evaluator	Musiker	Bandsman
Autoschlosser	Motor Vehicle Mechanic	Musikmeister	Band Leader
Bataillonsarzt	Battalion Physician	Nachrichtenmechaniker	Signals Technician
Bataillonskommandeur	Battalion Commander	Nachrichtenoﬃzler	Signal Officer
Bataillonsveterinär	Battalion Veterinary Doctor	Nachrichtenunteroﬃzler	Signal NCO
Batterieführer	Battery Commander	Oﬃzler	Officer
Batterieoﬃzler	Firing Battery Commander	Ordnanzoﬃzler	Aid (-de-Camp) (officer)
Batterieschreiber	Battery Headquarters Clerk	Ordnanz	Orderly (enlisted)
Beamte	Armed Forces Civil Servant / Government Service Official / Civilian Employee in Military Service	Panzerbüchenschütze	Antitank Rifleman
Beobachter	Observer	Panzerelktromechaniker	Armored Vehicle Electrician
Beobachtungsoﬃzler	Observation Officer	Panzerelktroschweisser	Armored Vehicle Arc Welder
Beschlagschmied	Farrier / Horseshoe Smith	Panzerführer	Armored Vehicle Commander
Betreuungsoﬃzler	Entertainment Officer	Panzerfunkwart	Armored Vehicle Radio Repairman
Bootsmann	Boat Operator	Panzergetriebenschlosser	Armored Vehicle Drive Train Mechanic
Chef des Stabes	Chief of Staff	Panzerjägerführer	Antitank Vehicle Commander
Divisionionsarzt	Division Physician	Panzermotorschlosser	Armored Vehicle Motor Mechanic
Divisionskommandeur	Division Commander	Panzerschlosser	Armored Vehicle Mechanic
Dolmetscher	Interpreter	Panzerschützen	Infantryman in an Armored Vehicle
Dreher	Lathe Operator	Panzerwart	Armored Vehicle Mechanic
Drucker	Printer	Peiler	Direction Finder
Elektriker	Electrician	Pferdeführer	Horse Leader. Driver on foot of a horse-drawn wagon
Elektromechaniker	Electro Mechanic	Pferdehalter	Horse Holder (Groom)
Entfernungsmesser	Rangefinder / Distance Measurer	Pferdewärter	Groom (Horse Holder)
Erkunder	Scout	Pionier	Pioneer / Engineer / Sapper
Erkundungsoﬃzler	Observation Officer	Planoffizier	Triangulation Officer
Facharbeiter	Specialist	Postfachkraft	Postal Worker
Fahnenschmied	Farrier NCO	Prüfer	Accounts Controller
Fahrer	Driver	Quartiermeister	Quartermaster
Fahrer vom Bock	Wagoner. (Driver of a horse-drawn vehicle sitting on the driver's box)	Rechner	Calculator
Fahrer vom Sattel	Horse Team Leaders. (Drivers of a horse-drawn vehicle sitting on the horses)	Rechnungsführer	Accountant
Feinmechaniker	Optics Technician	Regimentsadjutant	Regiment Adjutant
Feldfunksprecher	Field Radio Operator	Regimentsarzt	Regiment Physician
Feldgendarm	Military Policeman	Regimentskommandeur	Regiment Commander
Feldkoch	Cook	Regimentskraftfahreroﬃzler	Regiment Motor Officer
Feldkochunteroﬃzler	Cook NCO	Regimentschreiber	Regiment Headquarters Clerk
Feldwebel	Sergeant	Regimentsveterinär	Regiment Veterinary Doctor
Fernsprecher	Telephonist	Richter	Judge
Feuerwerker	Ordnance NCO	Richtkreisuﬃzler	Gun Layer NCO / Gun Director NCO
Flakwaffenwart	Antiaircraft Weapon Armorer	Richtmeister	Master Fitter
Flugmeldeauswerter	Air Observation Evaluator	Richtschütze	Gunner
Flugmelder	Air Observer	Sachbearbeiter	Clerk
Führer	Leader	Sanitätssoﬃzler	Medical Officer
Führer der Gefechtsfahrzeuge	Leader of the Company/Battery Vehicles	Sanitätsunteroﬃzler	Medical NCO
Funker	Radio Operator	Sattelpferd	Near Horse
Funkmeister	Senior Radio Operator	Sattler	Saddler / Harness Maker
Funkwart	Radio Repairman	Scharenfernrohrunteroﬃzler	Scissors Telescope NCO
Futtermeister	Fodder NCO	Schirmmeister	Foreman / Harness Keeper / Storekeeper NCO / Maintenance Technical Sergeant
Gaschützunteroﬃzler	Chemical Warfare NCO	Schleifer	Polisher
Gefechtschreiber	Headquarters Clerk	Schlosser	Mechanic
Gerätverwalter	Equipment Administrator	Schmied	Smith
Gerätwart	Equipment Repairman	Schneider	Tailor
Geschützbedienung	Gun Crew	Schreiber	Clerk
Geschützführer	Gun Layer / Gun Captain / Gun Commander	Schumacher / Schuster	Shoemaker / Cobbler
Getriebeschlosser	Drive Train Mechanic	Schwadronführer	Company Commander (cavalry arm)
Gruppenführer	Section Leader	Schwadrontruppführer	Company Headquarters Section Leader (cavalry arm)
Handwerker	Craftsman	Schweisser	Welder
Hauptfeldwebel	Senior Company NCO / Company First Sergeant	Spähtruppführer	Scout Section Leader
Hauptwachmeister	Senior Battery NCO / Battery First Sergeant	Staffelführer	Detachment Leader
Hilfsbeobachter	Assistant Observer	Stellmacher	Cartwright / Wheelwright
Hilfsprüfer	Assistant Controller	Stellungsunteroﬃzler	Gun Position NCO
Hiwi (Hilfswilliger)	Foreign Volunteer for Military Service	Steuermann	Helmsman (driver of a boat)
Holzarbeiter	Wood Worker	Tankwart	Fuel Handler
Intendant	Commissary Officer	Tischler	Joiner / Cabinet Maker
Kanonier	Gunner	Trossführer	Trains Leader
Kartenzeichner	Cartographer	Truppenarzt	Troop Doctor
Kettenkraftradfahrer	Kettenrad Driver	Truppführer	Team Leader
Klempner	Plumber	Unteroﬃzler	NCO (Non-Commissioned Officer)
Koch	Cook	Urkundsbeamter	Document Clerk
Kommandant	Commandant	Verbindungssoﬃzler	Liaison Officer
Kommandeur	Commander	Vermessungsdienst	Measuring Service
Kompanieführer	Company Commander	Verpflegungsmann	Rations Handler
Kompanietrossführer	Company Trains Leader	Verpflegungsunteroﬃzler	Rations NCO
Kompanietruppführer	Company Headquarters Section Leader	Veterinärsoﬃzler	Veterinary Officer
Kradmelder	Motorcycle Messenger	Vorgeschobener Beobachter	Forward Observer
Kraftfahrzeugelektriker	Motor Vehicle Electrician	Vorhandwerker	Leading Craftsman
Kraftfahrzeugmotorschlosser	Motor Vehicle Motor Mechanic	Vorreiter	Outrider. Escort on horse-back of a horse-drawn vehicle.
Kraftfahrzeugschlosser	Motor Vehicle Mechanic	Vorwamer	Advance Warning Man
Kraftwagenbeifahrer	Motor Vehicle Codriver	Waffenmeister	Armorer
Kraftwagenfahrer	Motor Vehicle Driver	Waffenmeisterhilfe	Assistant Armorer
Krankenträger	Stretcher Bearer	Waffenmeisterunteroﬃzler	Master Armorer NCO
Ladeschütze	Loader	Waffenunteroﬃzler	Armorer NCO
Laufwerkschlosser	Running Gear Mechanic	Wagenbegleiter	Wagon Escort. Escort of a horse-drawn vehicle on foot
Leiter	Chief Leader	Wagenführer	Leader of the vehicles in the trains
Lichtpauser	Photographer	Werferführer	Launcher or Mortar Gunner
Maler	Painter	Werkmeister	Foreman / Chief Technician
Mann	(Enlisted) Man	Zahlmeister	Paymaster / Finance Officer
Mannschaft	Privat / Other Rank / (Enlisted) Man	Zeichner	Draftsman
Maschinengewehrschütze	Machine Gunner	Zimmermann	Carpenter
Meldefahrer	Motor Vehicle Messenger	Zugführer	Platoon Leader
Meldefahrer	Messenger (motor vehicle)	Zugtruppführer	Platoon Headquarters Section Leader