



RTO AGARDograph 300
Flight Test Techniques Series – Volume 14

SCI-FT3

Introduction to Flight Test Engineering

(Introduction aux techniques des essais en vol)

This AGARDograph has been sponsored by SCI-172,
the Flight Test Technical Team (FT3) of the Systems
Concepts and Integration Panel (SCI) of the RTO.

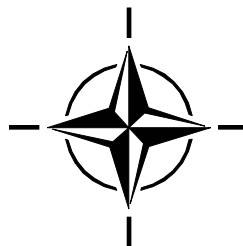

Published July 2005



NORTH ATLANTIC TREATY
ORGANISATION



AC/323(SCI-FT3)TP/74

RESEARCH AND TECHNOLOGY
ORGANISATION



www.rta.nato.int

RTO AGARDograph 300
Flight Test Techniques Series – Volume 14

SCI-FT3

Introduction to Flight Test Engineering

(Introduction aux techniques des essais en vol)

This AGARDograph has been sponsored by SCI-172,
the Flight Test Technical Team (FT3) of the Systems
Concepts and Integration Panel (SCI) of the RTO.

by

F.N. Stoliker

The Research and Technology Organisation (RTO) of NATO

RTO is the single focus in NATO for Defence Research and Technology activities. Its mission is to conduct and promote co-operative research and information exchange. The objective is to support the development and effective use of national defence research and technology and to meet the military needs of the Alliance, to maintain a technological lead, and to provide advice to NATO and national decision makers. The RTO performs its mission with the support of an extensive network of national experts. It also ensures effective co-ordination with other NATO bodies involved in R&T activities.

RTO reports both to the Military Committee of NATO and to the Conference of National Armament Directors. It comprises a Research and Technology Board (RTB) as the highest level of national representation and the Research and Technology Agency (RTA), a dedicated staff with its headquarters in Neuilly, near Paris, France. In order to facilitate contacts with the military users and other NATO activities, a small part of the RTA staff is located in NATO Headquarters in Brussels. The Brussels staff also co-ordinates RTO's co-operation with nations in Middle and Eastern Europe, to which RTO attaches particular importance especially as working together in the field of research is one of the more promising areas of co-operation.

The total spectrum of R&T activities is covered by the following 7 bodies:

- AVT Applied Vehicle Technology Panel
- HFM Human Factors and Medicine Panel
- IST Information Systems Technology Panel
- NMSG NATO Modelling and Simulation Group
- SAS Studies, Analysis and Simulation Panel
- SCI Systems Concepts and Integration Panel
- SET Sensors and Electronics Technology Panel

These bodies are made up of national representatives as well as generally recognised 'world class' scientists. They also provide a communication link to military users and other NATO bodies. RTO's scientific and technological work is carried out by Technical Teams, created for specific activities and with a specific duration. Such Technical Teams can organise workshops, symposia, field trials, lecture series and training courses. An important function of these Technical Teams is to ensure the continuity of the expert networks.

RTO builds upon earlier co-operation in defence research and technology as set-up under the Advisory Group for Aerospace Research and Development (AGARD) and the Defence Research Group (DRG). AGARD and the DRG share common roots in that they were both established at the initiative of Dr Theodore von Kármán, a leading aerospace scientist, who early on recognised the importance of scientific support for the Allied Armed Forces. RTO is capitalising on these common roots in order to provide the Alliance and the NATO nations with a strong scientific and technological basis that will guarantee a solid base for the future.

The content of this publication has been reproduced directly from material supplied by RTO or the authors.

Published July 2005

Copyright © RTO/NATO 2005
All Rights Reserved

ISBN 92-837-1126-2

Single copies of this publication or of a part of it may be made for individual use only. The approval of the RTA Information Management Systems Branch is required for more than one copy to be made or an extract included in another publication. Requests to do so should be sent to the address on the back cover.

AGARDograph Series 160 and 300

The Systems Concepts and Integration (SCI) Panel has a mission to distribute knowledge concerning advanced systems, concepts, integration, engineering techniques, and technologies across the spectrum of platforms and operating environments to assure cost-effective mission area capabilities. Integrated defence systems, including air, land, sea, and space systems (manned and unmanned) and associated weapon and countermeasure integration are covered. Panel activities focus on NATO and national mid- to long-term system level operational needs. The scope of the Panel covers a multidisciplinary range of theoretical concepts, design, development, and evaluation methods applied to integrated defence systems.

One of the teams formed under the SCI Panel is dedicated to Flight Test Technology. Its mission is to disseminate information through publication of monographs on flight test technology derived from best practices which support the development of concepts and systems critical to maintaining NATO's technological and operational superiority. It also serves as the focal point for flight test subjects and issues within the SCI Panel and ensures continued vitality of the network of flight test experts within NATO.

These tasks were recognized and addressed by the former AGARD organisation of NATO in the form of two AGARDograph series. The team continues this important activity by adding to the series described below.

In 1968, as a result of developments in the field of flight test instrumentation, it was decided that monographs should be published to document best practices in the NATO community. The monographs in this series are being published as individually numbered volumes of the AGARDograph 160 Flight Test Instrumentation Series.

In 1981, it was further decided that specialist monographs should be published covering aspects of Volume 1 and 2 of the original Flight Test Manual, including the flight testing of aircraft systems. The monographs in this series (with the exception of AG 237, which was separately numbered) are being published as individually numbered volumes of the AGARDograph 300 Flight Test Techniques Series.

At the end of each AGARDograph 160 Flight Test Instrumentation Series and AGARDograph 300 Flight Test Techniques Series volume is an annex listing all of the monographs published in both series.

Introduction to Flight Test Engineering

(RTO-AG-300-V14)

Executive Summary

Flight test is at the core of what organizations must do in order to validate the operation and systems on an aircraft. While the AGARDograph series 300 and 160 series deal with aspects of this testing, this volume pulls it all together as an introduction to the process required to do effective flight test engineering.

This volume was originally published in 1995. Its utility has been proven in that many flight test organizations and universities have requested copies for their engineers and students. It was felt that re-issuing it in a new format designed for electronic publication would be valuable to the community. This second 'printing' changes none of the text, but rather reformats it. All the original references to AGARD (instead of RTO) are left in place so that none of the flavor of the original publication is lost.

This is the Introductory Volume to the Flight Test Techniques Series. It is a general introduction to the various activities and aspects of Flight Test Engineering that must be considered when planning, conducting, and reporting a flight test program. Its main intent is to provide a broad overview to the novice engineer or to other people who have a need to interface with specialists within the flight test community. The first two Sections provide some insight into the question of why flight test and give a short history of flight test engineering. Sections 3 through 10 deal with the preparation for flight testing. They provide guidance on the preliminary factors that must be considered; the composition of the test team; the logistic support requirements; the instrumentation and data processing requirements; the flight test plan; the associated preliminary ground tests; and last, but by no means least, discuss safety aspects. Sections 11 through 27 describe the various types of flight tests that are usually conducted during the development and certification of a new or modified aircraft type. Each Section offers a brief introduction to the topic under consideration, and the nature and the objectives of the tests to be conducted. It lists the test instrumentation (and, where appropriate, other test equipment and facilities) required, describes the test maneuvers to be executed, and indicates the way in which the test data is selected, analyzed, and presented. The various activities that should take place between test flights are presented next. Items that are covered are: who to debrief; what type of reports to send where; types of data analysis required for next flight; review of test data to make a comparison to predicted data and some courses of action if there is not good agreement; and comments on selecting the next test flight. The activities that must take place upon completion of the test program are presented. The types of reports and briefings that should take place and a discussion of some of the uses of the flight test data are covered. A brief forecast is presented of where present trends may be leading.

Introduction aux techniques des essais en vol

(RTO-AG-300-V14)

Synthèse

Les essais en vol sont au cœur des préoccupations des organisations responsables de la validation du fonctionnement des aéronefs et des systèmes aéronautiques. Si les AGARDographies des séries 300 et 160 ont traité de certains aspects de ces essais, le présent volume résume les connaissances en la matière, en fournissant une introduction au processus qui permet de réaliser des essais en vol efficaces.

Ce volume a été publié pour la première fois en 1995. Son utilité n'est plus à démontrer, de nombreuses organisations d'essais en vol et d'universités l'ayant demandé pour diffusion à leurs ingénieurs et étudiants. La Commission SCI de la RTO a considéré que sa réédition, dans un nouveau format, compatible avec l'édition électronique, serait appréciée par les spécialistes du domaine. Le texte n'a subi aucun changement lors de cette deuxième « édition », il a simplement été reformaté. L'ensemble des références à l'AGARD (au lieu de la RTO) sont maintenues, afin de conserver le style de l'original.

Cet ouvrage constitue l'introduction à la série de publications RTO sur les techniques des essais en vol. Il s'agit d'une introduction générale aux différentes activités ainsi qu'aux différents aspects des techniques des essais en vol qui sont à considérer lors de la planification, la réalisation et la rédaction de rapports sur les programmes d'essais en vol. Elle a pour objectif principal de fournir un aperçu général du domaine aux jeunes ingénieurs, ainsi qu'à toute autre personne appelée à collaborer avec des spécialistes des essais en vol. Les deux premières sections, qui résument l'historique des essais en vol, définissent leur raison d'être. Les sections 3 à 10 traitent des travaux préparatoires aux essais. Elles donnent des directives concernant les facteurs préliminaires qui sont à prendre en compte, la composition de l'équipe d'essais, le soutien logistique, l'instrumentation, l'informatique, le plan des essais en vol, les essais au sol préliminaires associés et la sécurité. Les sections 11 à 27 présentent les différents types d'essais en vol qui sont généralement réalisés lors du développement et de la certification de tout type d'aéronef nouveau ou modifié. Chaque section propose une introduction sommaire au sujet à l'étude, ainsi qu'à la nature et aux objectifs des essais à réaliser. L'instrumentation d'essais est répertoriée (avec, le cas échéant, les autres appareils et installations d'essai), les manœuvres d'essai à exécuter sont décrites, et le choix, l'analyse et la présentation des données d'essais sont indiqués. Ensuite, les différentes activités qui ont lieu entre les vols d'essai sont présentées. Les sujets traités sont les suivants : les personnes à débriefer, les types de rapports à rédiger et leurs destinataires : les types d'analyses de données demandées pour le prochain vol, l'examen des données d'essais pour faire la comparaison avec les prévisions, quelques propositions d'actions à prendre en cas de non-concordance, et des conseils pour le choix du prochain essai en vol. Les activités qui ont lieu à l'achèvement du programme d'essais sont présentées. Les types de rapports et les briefings qui sont à organiser sont couverts, avec une discussion de quelques applications des données d'essais en vol. Enfin, quelques indications sont données des applications possibles des tendances actuelles.

Preface

Soon after its founding in 1952, the Advisory Group for Aerospace Research and Development (AGARD) recognized the need for a comprehensive publication on flight test techniques and the associated instrumentation. Under the direction of the Flight Test Panel (now the Flight Vehicle Integration Panel) a Flight Test Manual was published in the years 1954 to 1956. This original Manual was prepared as four volumes: 1. Performance, 2. Stability and Control, 3. Instrumentation Catalog, and 4. Instrumentation Systems.

As a result of the advances in the field of flight test instrumentation, the Flight Test Instrumentation Group was formed in 1968 to update Volumes 3 and 4 of the Flight Test Manual by publication of the Flight Test Instrumentation Series, AGARDograph 160. In its published volumes AGARDograph 160 has covered recent developments in flight test instrumentation.

In 1978, it was decided that further specialist monographs should be published covering aspects of Volumes 1 and 2 of the original Flight Test Manual, including the flight testing of aircraft systems. In March 1981, the Flight Test Techniques Group was established to carry out this task. The monographs of this latter series (with the exception of AG 237 which was separately numbered) are being published as individually numbered volumes in AGARDograph 300. In 1993, the Flight Test Techniques Group was transformed into the Flight Test Editorial Committee, thereby better reflecting its actual status within AGARD. Fortunately, the work on volumes could continue without being affected by this change.

An Annex at the end of each volume of both AGARDograph 160 and AGARDograph 300 lists the volumes that have been published in the Flight Test Instrumentation Series (AG 160) and the Flight Test Techniques Series (AG 300) plus the volumes that were in preparation when this volume was published.

In 1987 when several volumes in the Flight Test Techniques Series had already been published, it was decided that it was an omission not to have an introductory volume to the Flight Test Techniques Series. This volume was to provide an overview of the field of flight test engineering for the novice engineer engaged in this field. It took some time before an editor was found who would work closely with over fifty lead authors and contributing authors. Mr. F.N. Stoliker, former Technical Director of the US Air Force Flight Test Center at Edwards Air Force Base in California, was willing to undertake this heavy task and he started his preparations in 1989. The first authors started writing in 1991.

In 1995 the Volume has now been published and AGARD is convinced that it is a significant volume that will be met with great appreciation in the flight test community.

Préface

Peu de temps après sa création en 1952, le Groupe consultatif pour la recherche et les réalisations aérospatiales (AGARD), a pris conscience de la nécessité d'une publication très complète sur les techniques d'essais en vol et l'instrumentation y associée. Sous l'égide du Panel des essais en vol (l'actuel Panel conception intégrée des véhicules aérospatiaux) un manuel d'essais en vol a été publié au cours des années 1954 à 1956. Ce manuel unique comportait quatre volumes à savoir: Vol. 1: Performances, Vol. 2: Stabilité et contrôle, Vol. 3: Catalogue des appareils de mesure, Vol. 4: Systèmes de mesure.

Les novations dans le domaine des appareils de mesure pour les essais en vol ont conduit à créer, en 1968, le Groupe de travail sur les appareils de mesure pour les essais en vol, afin de permettre la remise à jour des volumes 3 et 4 du manuel sous la forme d'une série de publications appelées l'AGARDographie 160. Les différents volumes de l'AGARDographie 160 publiés jusqu'à ce jour couvrent les derniers développements dans le domaine.

En 1978, le Panel de la mécanique de vol a signalé l'intérêt de monographies supplémentaires sur certains aspects des volumes I et II du manuel initial et notamment les essais en vol des systèmes avioniques. Ainsi, au mois de mars 1981, le Groupe de travail sur les techniques d'essais en vol a été créé pour mener à bien cette tâche. Les monographies dans cette série (à l'exception de l'AG 237 qui fait partie d'une série distincte) sont publiées sous forme de volumes individuels de l'AGARDographie 300. En 1993, le Groupe est devenu le Comité de rédaction des techniques d'essais en vol pour mieux traduire sa nouvelle position au sein de l'AGARD. Heureusement, le travail en cours sur les différents volumes a pu continuer sans être perturbé par ce changement.

A la fin de chacun des volumes de l'AGARDographie 160 et de l'AGARDographie 300 figure une annexe donnant la liste des volumes publiés dans la série «Appareils de mesure pour les essais en vol» (AG 160) et dans la série «Techniques d'essais en vol» (AG 300), ainsi que les volumes en cours de rédaction au moment de la publication du présent volume.

En 1987, un certain nombre de volumes dans la série techniques d'essais en vol avaient déjà été publiés lorsque le groupe a décidé qu'il serait souhaitable de l'étoffer d'un volume liminaire. Ce volume devait fournir un panorama du domaine des techniques d'essais en vol pour le jeune ingénieur travaillant dans ce secteur d'activité. Il a fallu un certain temps pour trouver un rédacteur en chef à même d'assurer la collaboration étroite demandée avec plus d'une cinquantaine d'auteurs. M. F.N. Stoliker, ancien Directeur technique de l'Edwards Air Force Base en Californie, a bien voulu accepter d'assumer cette lourde tâche et il a entamé les travaux préparatoires des 1989. Les premiers auteurs ont commencé la rédaction en 1991.

Aujourd'hui, nous sommes en 1995 et le premier volume vient de paraître. Le Panel FVP de l'AGARD est persuadé qu'il s'agit d'un ouvrage d'importance qui sera accueilli avec un grand intérêt par la communauté de essais en vol.

Foreword

The volumes that currently exist in the Flight Test Techniques Series are quite specific in their focus and are generally aimed at the engineer who has some knowledge in the field of flight test engineering. Even though these volumes meet a strong need for this type of information it was felt that there was a need to provide information to the novice engineer or to other people who have a need to interface with the flight test community. This volume is intended to lightly touch all those areas that must be considered when planning, establishing, conducting, closing out, and reporting on a flight test program. This volume is NOT intended to be a complete guide as to how to conduct a flight test program. Rather, it is a primer and contains references to additional material that will provide greater detail. The serious reader is encouraged to do further reading in the various volumes of the AGARD Flight Test Techniques series and the Flight Test Instrumentation series, AGARDographs 300 and 160, respectively, and other documents which are referenced in each Section of this volume.

The first two Sections are the Introduction and Historical Perspective. They provide some insight into the question of why flight test and give a short history of flight test engineering.

Sections 3 through 10 deal with the preparation for flight testing. They provide guidance on the preliminary factors that must be considered, such as the technical, commercial, and political background to the tests, and any relevant existing data or considerations (Section 3); the composition of the test team (Section 4), the logistic support requirements (Section 5); the instrumentation and data processing requirements (Sections 6 and 7); the overall flight test plan and the associated preliminary ground tests (Sections 8 and 9); and last, but by no means least, Section 10 discusses safety aspects.

Sections 11 through 27 describe the various types of flight tests that are usually conducted during the development and certification of a new or modified aircraft type. Each Section offers a brief introduction to the topic under consideration, and the nature and the objectives of the tests to be made. It lists the test instrumentation (and, where appropriate, other test equipment and facilities) required, describes the test maneuvers to be executed, and indicates the way in which the test data is selected, analyzed, and presented.

Section 28 "Post-flight Operations" discusses the various activities that should take place between test flights. Items that are covered include who to debrief, what type of reports to send where, types of data analysis required for the next flight, review of test data to make a comparison to predicted data, some courses of action if there is not good agreement, and comments on selecting the next test flight.

Section 29 "Post Test Operations" covers the activities that must take place upon completion of the test program. Briefly discussed are the types of reports and briefings that should take place and a discussion of some of the uses of the flight test data.

Section 30 "Future Trends" gives a brief forecast of where present trends may be leading.

The material presented in the Volume reflects the experience of the prime author and any contributing author(s) for each Section. The Sections will normally be typical of the procedures and practices of the author's home station; however, they are representative of those used by many organizations. As such, an individual Section may or may not include comments about civil and/or rotary wing aircraft. Wherever possible the authors and reviewers have provided bibliographic entries that would be useful to those who desire to test other than fixed wing military aircraft. The users of this Volume are reminded that they should interpret the advice given in the context of the rules, processes, and procedures of their parent/home organization.

Also, the reader must be aware that terms such as "project" are used in the context of the Section author's home base and experience. The same term could have an entirely different meaning at another base or another country. For example, in the US, "project" normally means a given set of tests whereas in the UK "project" usually means "aircraft type" such that "AV-8B Project" would encompass all aspects of that aircraft type's development.

Acknowledgements

ACKNOWLEDGEMENTS BY THE EDITOR

The Editor is deeply grateful to the many authors and contributing authors for their diligence in preparing the various Sections of this Volume. Obviously, this Volume could never have been completed without their dedication, perseverance, technical knowledge, and writing skills.

The support and cooperation of the Flight Test Editorial Committee (FTEC) was invaluable throughout this whole process. They identified the various authors and reviewed and provided valuable comment on each of the various sections. In particular, the Editor would like to acknowledge the support of FTEC Members Messrs. J.K. Appleford (UK), R.R. Hildebrand (US), R.A. Russell (US), and R.L. van der Velde (NE).

F.N. Stoliker
Camarillo, CA, US
March 1995

ACKNOWLEDGEMENT to FLIGHT TEST EDITORIAL COMMITTEE MEMBERS

The Flight Test Editorial Committee, formerly the Flight Test Techniques Working Group 11, was fortunate to have one of its past members and former chairman take on the difficult task of Editor for this AGARDograph. The committee is most grateful for the hard work and persistence of the Editor, Mr. Fred Stoliker, in bringing this volume into existence.

Besides the Editor, the following current and past members of the Flight Test Editorial Committee have taken an active part in the preparation of this Volume:

Appleford, J.K.	A&A/AEE/UK
Bever, G.	NASA/US
Bothe, H.	DLR/Germany
Campos, L.M.B.	IST/Portugal
Hildebrand, R.R.	AFFTC/US
Krijn, R.	NLR/Netherlands
van der Velde, R.L.	NLR/Netherlands
Van Norman, C.	AFFTC/US
Zundel, Y.	CEV/France

R.A. Russell
Member, Flight Vehicle Integration Panel
Chairman, Flight Test Editorial Committee

ACKNOWLEDGEMENT to RTO FLIGHT TEST TECHNICAL TEAM EDITOR

The editor would like to express appreciation to Mr. Glenn Bever, who undertook to update the original volume to this current edition. The work included converting old text files to current word processor files, reformatting the entire volume to current RTO standards, reworking all the figures, and correcting some errors. This makes the volume much more readable both electronically and in printed form. The effort was significant and is much appreciated.

Table of Contents

	Page
AGARDograph Series 160 and 300	iii
Executive Summary	iv
Synthèse	v
Preface	vi
Préface	vii
Foreword	viii
Acknowledgements	ix
List of Figures	xxi
List of Tables	xxiii
Chapter 1 – Introduction	1-1
by J.K. Appleford	
1.0 Introduction	1-1
1.1 Definitions	1-1
1.2 Background	1-1
1.3 Why Flight Test?	1-2
1.4 Development and Certification Flight Testing	1-2
1.5 Scope of Volume	1-4
1.6 Concluding Remarks	1-4
1.7 Bibliography	1-4
Chapter 2 – Historical Perspective, One Hundred Years of Flight Testing	2-1
by R.L. van der Velde	
2.0 Introduction	2-1
2.1 Short History of Flight	2-1
2.2 The Evolution of Flight Test Engineering through the Decades	2-5
2.3 Future Trends	2-10
2.4 Concluding Remarks	2-11
2.5 Acknowledgements	2-12
2.6 References	2-12
2.7 Bibliography	2-14
Chapter 3 – Background Considerations	3-1
by J.K. Appleford	
3.0 Introduction	3-1
3.1 Organisational Issues	3-1
3.2 Programme Issues	3-3

3.3	Review of Technical Data	3-4
3.4	Concluding Remarks	3-5
3.5	References	3-5
3.6	Bibliography	3-6
Chapter 4 – Establishing the Test Team		4-1
by R.J. Oblen		
4.0	Introduction	4-1
4.1	Test Team Selection	4-1
4.2	Qualifications Required for Test Team	4-2
4.3	Test Team Tasking	4-2
4.4	Special Considerations	4-2
4.5	Concluding Remarks	4-3
4.6	Bibliography	4-3
Chapter 5 – Logistics Support Considerations		5-1
by H.G. Kolwey		
5.0	Introduction	5-1
5.1	Typical Logistics Support Considerations	5-1
5.2	Objectives	5-2
5.3	Provisioning Considerations	5-2
5.4	Communications Requirements	5-3
5.5	Typical Products of Test Planning	5-3
5.6	Special Considerations	5-3
5.7	Concluding Remarks	5-3
5.8	Bibliography	5-4
Chapter 6 – Flight Test Instrumentation		6-1
by D.R. Crouse		
6.0	Introduction	6-1
6.1	The Instrumentation Specification	6-1
6.2	Introduction to Instrumentation Systems	6-1
6.3	Instrumentation Systems Management	6-5
6.4	Design Considerations	6-7
6.5	Operational Considerations	6-9
6.6	Concluding Remarks	6-10
6.7	Acknowledgements	6-10
6.8	References	6-10
6.9	Bibliography	6-12
Chapter 7 – Data Processing		7-1
by R.L. van der Velde		
7.0	Introduction	7-1
7.1	Objectives	7-2
7.2	Preparations for Data Processing	7-2

7.3	Data Processing Operations	7-4
7.4	Data Processing Environment	7-5
7.5	Some Advice to the Flight Test Engineer	7-5
7.6	Special Considerations	7-6
7.7	Concluding Remarks	7-7
7.8	Acknowledgements	7-7
7.9	References	7-7
7.10	Bibliography	7-8

Chapter 8 – Preparation of the Flight Test Plan **8-1**

by R.J. Harney

8.0	Introduction	8-1
8.1	Objectives of the Test Plan	8-1
8.2	Contents of the Test Plan	8-2
8.3	Testing of Civil Aircraft	8-8
8.4	Concluding Remarks	8-8
8.5	Acknowledgements	8-9
8.6	References	8-9
8.7	Bibliography	8-9

Chapter 9 – Pre-Flight Tests **9-1**

by P.W. Kirsten

9.0	Introduction	9-1
9.1	Wind Tunnel Tests	9-2
9.2	Simulation Tests	9-4
9.3	Propulsion Tests	9-7
9.4	Weight and Balance Tests	9-10
9.5	Ground Vibration Tests	9-12
9.6	Structural Loads Tests	9-13
9.7	Gain Margin Tests	9-15
9.8	Verification and Calibration Tests	9-17
9.9	Taxi Tests	9-19
9.10	Concluding Remarks	9-21
9.11	Acknowledgements	9-21
9.12	References	9-21
9.13	Bibliography	9-22

Chapter 10 – Safety Aspects **10-1**

by J.K. Appleford

10.0	Introduction	10-1
10.1	Organisational Matters	10-1
10.2	Facilities Required	10-2
10.3	Crewing Considerations	10-5
10.4	Test Planning	10-6

10.5	Test Operations	10-7
10.6	Concluding Remarks	10-8
10.7	References	10-8
10.8	Bibliography	10-9

Chapter 11 – Airdata Measurement and Calibration **11-1**

by E.A. Haering, Jr.

11.0	Introduction	11-1
11.1	Test Objectives	11-2
11.2	Measurement and Calibration of Airdata Quantities	11-2
11.3	Parameters Required for Airdata Calibration	11-6
11.4	Typical Calibration Techniques	11-7
11.5	Data Processing and Analysis	11-10
11.6	Special Cases	11-12
11.7	Concluding Remarks	11-14
11.8	References	11-14
11.9	Bibliography	11-17

Chapter 12 – Flight Envelope **12-1**

by H. Walgemoed

12.0	Introduction	12-1
12.1	Airworthiness Requirements	12-2
12.2	Limitations	12-3
12.3	Design Loads	12-5
12.4	The Flight Envelope	12-7
12.5	Test Objectives	12-7
12.6	Typical Measurands, Sampling Rates, and Frequency Requirements	12-7
12.7	Typical Test Maneuvers	12-8
12.8	Data Analysis Considerations	12-10
12.9	Products of Testing	12-11
12.10	Special Considerations	12-11
12.11	Concluding Remarks	12-12
12.12	References	12-12
12.13	Bibliography	12-12

Chapter 12A – Rotorcraft Flight Envelope Unique Considerations **12A-1**

by M.W. Mosher

12A.0	Introduction	12A-1
12A.1	Test Objectives	12A-1
12A.2	Types of Tests	12A-1
12A.3	Test Instrumentation	12A-2
12A.4	Special Rotorcraft Envelope Considerations	12A-3
12A.5	Products of Testing	12A-7
12A.6	Special Considerations	12A-7

12A.7	Concluding Remarks	12A-8
12A.8	Acknowledgements	12A-8
12A.9	References	12A-8
12A.10	Bibliography	12A-8

Chapter 13 – Performance **13-1**
by J.P.K. Vlegghert

13.0	Introduction	13-1
13.1	General Considerations	13-1
13.2	Take-Off and Landing Tests	13-4
13.3	Climb Tests	13-6
13.4	Cruise Tests	13-9
13.5	Combat Performance	13-10
13.6	Descent Tests	13-12
13.7	Concluding Remarks	13-12
13.8	References	13-13
13.9	Bibliography	13-13

Chapter 14 – Aeroelasticity **14-1**
by J.J. Meijer

14.0	Introduction	14-1
14.1	Requirements	14-3
14.2	Test Objectives	14-4
14.3	Typical Measurements	14-4
14.4	Typical Maneuvers	14-5
14.5	Flight Test Procedures	14-7
14.6	Data Acquisition and Analysis	14-9
14.7	Typical Products	14-12
14.8	Special Considerations	14-12
14.9	Concluding Remarks	14-12
14.10	Acknowledgement	14-13
14.11	References	14-13
14.12	Bibliography	14-13

Chapter 15 – Handling Qualities **15-1**
by R.E. Lee, Jr.

15.0	Introduction	15-1
15.1	General Considerations	15-1
15.2	Stability and Control Tests	15-4
15.3	Handling Qualities Tests	15-8
15.4	High Angle of Attack Tests	15-11
15.5	Parameter Identification	15-12
15.6	Special Considerations	15-14
15.7	Concluding Remarks	15-14

15.8	References	15-14
15.9	Bibliography	15-16

Chapter 16 – Aircraft External Noise **16-1**

by H. Heller

16.0	Introduction	16-1
16.1	Aircraft Noise Certification	16-2
16.2	Testing Procedures	16-2
16.3	Data Acquisition and Evaluation	16-3
16.4	Special Problems	16-7
16.5	Concluding Remarks	16-9
16.6	References	16-10
16.7	Bibliography	16-10

Chapter 17 – Airframe Tests **17-1**

by J.K. Appleford

17.0	Introduction	17-1
17.1	General Considerations	17-2
17.2	Anti/De-Icing	17-4
17.3	Electrical System	17-8
17.4	Engine Installation	17-11
17.5	Environmental Control Systems	17-13
17.6	Escape System	17-15
17.7	Flying Controls	17-19
17.8	Fuel System	17-22
17.9	Hydraulic System	17-25
17.10	Oxygen System	17-27
17.11	Secondary Power System	17-30
17.12	Undercarriage, Wheels, and Brakes	17-32
17.13	Concluding Remarks	17-35
17.14	Acknowledgements	17-35
17.15	References	17-36

Chapter 18 – Testing under Environmental Extremes **18-1**

by J.A. Ford

18.0	Introduction	18-1
18.1	Typical Test Objectives	18-1
18.2	Typical Instrumentation, Measurands, and Data Rates	18-2
18.3	Typical Tests	18-3
18.4	Data Analysis Considerations	18-3
18.5	Typical Products of Testing	18-4
18.6	Special Considerations	18-4
18.7	Concluding Remarks	18-4
18.8	References	18-5

Chapter 19A – Radar Cross Section	19A-1
by R.W. Borek	
19A.0 Introduction	19A-1
19A.1 The Radar Cross Section Concept	19A-1
19A.2 Types of RCS Measurements	19A-3
19A.3 The RCS Test Range	19A-5
19A.4 Data Collection, Reduction, and Presentation	19A-7
19A.5 Concluding Remarks	19A-9
19A.6 References	19A-9
19A.7 Bibliography	19A-10
Appendix 19A.A – Radar Cross Section Reduction	19A-13
19A.A.0 Introduction	19A-13
19A.A.1 The Four Basic Methods of RCSR	19A-13
Chapter 19B – Antenna Radiation Patterns	19B-1
by H. Bothe	
19B.0 Introduction	19B-1
19B.1 Test Objectives	19B-2
19B.2 Measurement Requirements	19B-3
19B.3 The Determination of the ARP by Static Methods	19B-8
19B.4 The Determination of ARP of Full-Size Aircraft in Flight	19B-9
19B.5 Data Analysis	19B-12
19B.6 Dynamic Radar Cross Section (RCS) Measurements	19B-15
19B.7 Concluding Remarks	19B-15
19B.8 References	19B-15
19B.9 Bibliography	19B-16
Appendix 19B.A – LRP Determination of a Glide Slope Antenna	19B-17
Appendix 19B.B – Examples of Measurement Results	19B-20
Chapter 20 – Human Factors	20-1
by P.A.A. Verbaarschot	
20.0 Introduction	20-1
20.1 Test Objectives	20-2
20.2 Test Techniques	20-5
20.3 Test Preparations	20-7
20.4 Ground Test Program	20-7
20.5 Flight Test Program	20-10
20.6 Data Analysis	20-11
20.7 Test Results	20-12
20.8 New Developments	20-12
20.9 Concluding Remarks	20-14
20.10 Acknowledgements	20-15
20.11 References	20-15
20.12 Bibliography	20-16

Chapter 21 – Avionics	21-1
by R. Mahlum	
21.0 Introduction	21-1
21.1 General Considerations	21-2
21.2 Autopilot System	21-5
21.3 Navigation and Communication Systems	21-8
21.4 Offensive Sensor Systems	21-11
21.5 Defensive Systems	21-14
21.6 System Integration	21-15
21.7 Concluding Remarks	21-17
21.8 Acknowledgements	21-17
21.9 References	21-17
21.10 Bibliography	21-17
Chapter 22 – Reliability and Maintainability	22-1
by J.M. Howell	
22.0 Introduction	22-1
22.1 R&M Test Objectives	22-2
22.2 Test Planning	22-3
22.3 Test Conduct	22-7
22.4 Concluding Remarks	22-9
22.5 References	22-9
22.6 Bibliography	22-9
Chapter 23 – Logistics Test and Evaluation	23-1
by F.W. Baxley	
23.0 Introduction	23-1
23.1 Personnel, Training, and Training Equipment	23-1
23.2 Technical Data	23-3
23.3 Support Equipment	23-4
23.4 Spares and Repair Parts	23-5
23.5 Facilities	23-7
23.6 Packaging, Handling, Storage, and Transportation	23-7
23.7 Data Collection/Reduction	23-8
23.8 Special Considerations	23-8
23.9 Concluding Remarks	23-8
23.10 Bibliography	23-9
Chapter 24 – Propulsion	24-1
by L.A. Thomas	
24.0 Introduction	24-1
24.1 Test Objectives	24-3
24.2 Instrumentation	24-5
24.3 Typical Test Techniques	24-5

24.4	Application of Test Techniques	24-8
24.5	Data Analysis	24-10
24.6	Product of Testing	24-11
24.7	Special Considerations	24-11
24.8	Concluding Remarks	24-13
24.9	Acknowledgements	24-13
24.10	References	24-13
24.11	Bibliography	24-13

Chapter 25 – Armament Testing and Stores Separation **25-1**

by R.E. Mosher

25.0	Introduction	25-1
25.1	Aircraft Armament Control System	25-1
25.2	Flutter	25-2
25.3	Aircraft and Store Loads	25-2
25.4	Stability and Control	25-2
25.5	Flying Qualities	25-3
25.6	Performance	25-3
25.7	Vibration	25-3
25.8	Aeroacoustic	25-3
25.9	Thermal	25-3
25.10	Safe Separation	25-4
25.11	Gunfire	25-4
25.12	Special Considerations	25-4
25.13	Concluding Remarks	25-4
25.14	References	25-5
25.15	Bibliography	25-5

Chapter 26 – Software Test and Evaluation **26-1**

by K. Rodger

26.0	Introduction	26-1
26.1	The Nature of Software	26-1
26.2	The Design and Development of Software	26-3
26.3	Software Test Techniques	26-4
26.4	Hardware/Software Integration	26-6
26.5	Future Developments	26-7
26.6	The Role of the Flight Test Engineer	26-7
26.7	Concluding Remarks	26-8
26.8	References	26-9
Appendix 26-1 – Glossary		26-10

Chapter 26A – Software Test and Evaluation: A View from the US **26A-1**

by L.O. Campbell

26A.0	Introduction	26A-1
26A.1	Software Development, Test, and Evaluation Phases	26A-2

26A.2	The Role of “Tools” in the Software Development Process	26A-4
26A.3	Test Objectives	26A-6
26A.4	Typical Measurands and Data Rates	26A-7
26A.5	Typical Test Techniques	26A-7
26A.6	Data Analysis Considerations	26A-8
26A.7	Typical Products of Testing	26A-9
26A.8	Special Considerations	26A-9
26A.9	Concluding Remarks	26A-9
26A.10	References	26A-10
26A.11	Bibliography	26A-11
	Appendix 26A-1 – List of Acronyms	26A-12

Chapter 27 – Electromagnetic Interference/Electromagnetic Compatibility **27-1**

by R.W. Borek

27.0	Introduction	27-1
27.1	The Philosophy of Standards and Specifications	27-1
27.2	The Role of the Flight Test Engineer	27-2
27.3	Typical EMI/EMC Test Objectives	27-2
27.4	Sources of EMI	27-3
27.5	Testing for EMI	27-9
27.6	Measurement Error Analysis Considerations	27-13
27.7	Some Guidelines for Design	27-13
27.8	Concluding Remarks	27-15
27.9	References	27-15
27.10	Bibliography	27-16

Chapter 28 – Post Flight Operations **28-1**

by Y. Zundel

28.0	Introduction	28-1
28.1	Post Flight Debrief (PFD)	28-2
28.2	Reports	28-3
28.3	Data Reduction	28-4
28.4	Data Analysis	28-5
28.5	Planning the Next Flight	28-7
28.6	Special Considerations	28-8
28.7	Concluding Remarks	28-9
28.8	Acknowledgements	28-9
28.9	Bibliography	28-9

Chapter 29 – Post-Test Operations **29-1**

by R.J. Oblen

29.0	Introduction	29-1
29.1	Post-Test Briefings	29-1
29.2	Preparation for Reporting	29-1

29.3	Reporting	29-3
29.4	Special Considerations	29-6
29.5	Concluding Remarks	29-7
29.6	Acknowledgement	29-7
29.7	References	29-7
29.8	Bibliography	29-7
Chapter 30 – Future Trends		30-1
	by R.R. Hildebrand	
30.0	Introduction	30-1
30.1	Near-Future Environment	30-1
30.2	Impacts on the Flight Test Engineers' Tasks	30-3
30.3	Concluding Remarks	30-4
Epilogue		E-1
Annex – AGARD and RTO Flight Test Instrumentation and Flight Test Techniques Series		A-1

List of Figures

Figure		Page
Figure 11-1	Airflow Around an Airplane Wing	11-2
Figure 11-2	Flight Test Noseboom for Measuring Pitot-Static Pressures and Flow Angles	11-3
Figure 11-3	Subsonic Static Pressure Distribution	11-3
Figure 11-4	Total Temperature Calibration	11-5
Figure 11-5	Tower-Flyby Calibration Method	11-8
Figure 11-6	Trailing Cone and Pacer Aircraft Calibration Methods	11-9
Figure 11-7	Radar-Tracking Calibration Method	11-10
Figure 11-8	Flush Airdata Sensor Hardware	11-14
Figure 12-1	Typical Civil Aircraft Maneuvering Envelope for a Given Weight and Altitude	12-6
Figure 12-2	Typical Military Aircraft Maneuvering Envelope for a Given Weight and Altitude	12-6
Figure 12A-1	Blade Stall Boundary	12A-5
Figure 14-1	Flutter Investigation During Development Stage of a New Aircraft	14-2
Figure 14-2a	Minimum Required Flutter Margin	14-3
Figure 14-2b	Required Damping	14-4
Figure 14-3	Identification of Dynamic Characteristics	14-6
Figure 14-4	Flutter Test Procedures	14-8
Figure 14-5	Typical Flutter Data Acquisition and Analysis System	14-10
Figure 14-6	Typical Results Obtained from Flight Tests	14-11
Figure 14-7	Current Stability Determination for Most Airframe Companies/Government Agencies	14-11
Figure 16-1	Basic Measurement Equipment Needed in the Field for Noise Certification Testing	16-4
Figure 16-2	Block Diagram of Noise Measuring System for Acoustic Calibration, Data Acquisition and Reduction	16-4
Figure 16-3	Schematic Representation of Ground Reflection Interference Problem	16-8
Figure 16-4	Comparison of Time-History of Propeller Rotational Harmonic as Measured with a Ground Surface Microphone and One 1.2 m Above Ground (“Elevated”)	16-8
Figure 19A-1	Logarithmic Comparison of RCS Square Meter and Dbsm	19A-12
Figure 19B-1	Aspect Angle and Vehicle Coordinate System	19B-4
Figure 19B-2	Determination of the Horizontal Aspect Angle	19B-5

Figure 19B-3	Determination of the Vertical Aspect Angle	19B-6
Figure 19B-4	Straight Flight Test Trajectories for ARP Measurement, d = Distance; h = Altitude	19B-11
Figure 19B-5	Curved Flight Test Trajectories for ARP Measurement, Fixed Altitude d = Distance	19B-11
Figure 19B-6	Curved Flight Test Trajectories for ARP Measurement, Variable Altitude	19B-11
Figure 19B-7	True Airspeed with Respect to Rate and Radius of Turn, Bank Angle as a Parameter	19B-14
Figure 19B.A-1	Multipath Gain of the Reflecting Ground Calculated after Reference 19B-1	19B-19
Figure 19B.A-2	Radiation Pattern of a Glide Slope Antenna, Frequency 335.5 MHz, Polarization Horizontal, Test Flight Left Circle, LRP 44 dB	19B-19
Figure 19B.B-1	Radiation Pattern of VOR/LOC Antenna, Trajectory Left-hand Circle, Bank Angle 5 Degrees, Frequency 111.1 MHz	19B-21
Figure 19B.B-2	Radiation Pattern of Marker Antenna, Trajectory Fly Over, Frequency 75 MHz	19B-21
Figure 19B.B-3	Radiation Pattern of Telemetry Antenna, Trajectory Right-hand Circle, Bank Angle 15 Degrees, Frequency 2401 MHz	19B-22
Figure 19B.B-4	Horizontal Radiation Pattern of a Waveguide Slot Antenna, Bank Angle 0 Degrees	19B-22
Figure 19B.B-5	In-Flight Measured RCS of Small Twin Jet Aircraft, Trajectory Right-hand Circle, Bank Angle 10 Degrees, Frequency 5 GHz, 0dB=1m ²	19B-23
Figure 19B.B-6	RCS of Scaled Model of Test Object from Figure 19B.B-5, Bank Angle 0 Degrees, RCS Averaged over Angular Area of 5 Degrees, 0dB=1m ²	19B-23
Figure 21-1	OFP Flight Test Process	21-4
Figure 21-2	Regression Test Points	21-4
Figure 24-1	Factors Which Affect Propulsion System O&C	24-2
Figure 24-2	Causes and Influences of Propulsion System Flight Test Variables	24-4
Figure 24-3	Potential Propulsion System Instrumentation Parameter	24-5

List of Tables

Table		Page
Table 7-I	Data Processing Elements	7-9
Table 8-I	Test Matrix	8-3
Table 8-II	Test Envelope	8-3
Table 8-III	Test Loadings	8-4
Table 8-IV	Test Configurations	8-4
Table 8-V	Instrumentation Requirements	8-5
Table 8-VI	Hazard Analysis - Flight Profile	8-6
Table 8-VII	Hazard Analysis - Project Equipment	8-7
Table 19A-I	Radar and ECM Bands	19A-12
Table 19B-I	Available Field Power Densities and Minimum Required Value of Receiver Input Voltage	19B-3
Table 19B-II	Parameters Required for ARP Determination	19B-12
Table 20-I	Typical Test Areas	20-2
Table 20-II	Evaluation of Flight Deck Design	20-6
Table 21-I	Autopilot Tests	21-6
Table 21-II	Navigation System Parameters	21-9
Table 21-III	Communication System Parameters	21-9
Table 29-I	Data Collection and Monitoring	29-2



Chapter 1 – INTRODUCTION

J.K. Appleford

Aeroplane & Armament Evaluation Establishment
Boscombe Down, Salisbury, Wilts, SP4 0JF
UK

1.0 INTRODUCTION

This AGARDograph is intended, as the title and Foreword indicate, to provide an **introduction** to flight test engineering. It is aimed at personnel entering the field with little or no prior experience of the subject, and those whose work in other branches of aeronautics requires them to have an appreciation of the issues involved. Hence, it concentrates on the more universally applicable aspects of the subject which will be encountered during the development and certification of any new aircraft design. This Section "sets the scene" by offering some background on, and justification for, flight testing and outlining the differences between "development" and "certification" testing.

1.1 DEFINITIONS

Perhaps it would be helpful, at the outset, to define what is meant by the terms "flight test engineering" and "Flight Test Engineer (FTE)".

Flight test engineering can be summarised as the engineering associated with the testing, in flight, of an aircraft or item(s) of aircraft equipment. The aims of that testing can be very diverse: they may be to investigate new concepts, to provide empirical data to substantiate design assumptions, or to demonstrate that an aircraft and/or its equipment achieve specified levels of performance, etc. Thus flight testing covers a broad spectrum of topics, the common feature of which is that there is a degree of novelty in the aircraft, its equipment or its intended usage which requires assessment **in flight**. (Flight testing is, of course, usually preceded by appropriate ground testing as discussed in Section 9 below.)

Reflecting the wide range of topics involved, the term "Flight Test Engineer" is often applied loosely (as occurs in other branches of engineering). However, it is generally accepted that an FTE is a person responsible for so coordinating and managing all the various activities involved that the objectives of a particular series of flight tests are met. Thus he/she is responsible (in cooperation with the "customer" and the extended flight test team of test pilots, technical specialists, instrumentation engineers, data processing specialists, maintenance engineers, etc.) for the definition, planning, and execution of flight tests, and the analysis and presentation of the results obtained.

1.2 BACKGROUND

Flight testing is not a new activity but, by definition, is as old as man's attempts to fly. An outline of the history of flight testing is given in Section 2 of this Volume. Although the technology of current military aircraft is far removed from that of the first primitive gliders, the objective of flight testing remains much the same - to prove that the man/machine combination can achieve the desired "performance" (in its widest sense).

Clearly, the "performance" required of current aircraft is of a different order from that sought originally, when success was judged mainly by absence of injury to the pilot or damage to the machine. As aviation progressed to become, perhaps, **the** technology driver of the 20th century, the "performance" required of

INTRODUCTION

aircraft expanded. While the history of aircraft development is a topic in its own right, it will be appreciated that from the earliest days of powered flight designers have striven to improve such aspects as speed, range, manoeuvrability, and payload. In addition to seeking improvements in the air vehicle itself (e.g., in flying qualities, strength, performance, reliability, and maintainability), a variety of "systems" have been developed to permit all-weather operation and, in the case of military aircraft, to provide offensive/defensive weapons capabilities.

This expansion in the "performance" expected of aircraft reflects (and prompted) an exponential growth in the related technologies which, at the start of the century, could only have been foreseen by the prophetic. As these technologies were developed and incorporated into the aircraft design process, formal codes of Requirements or Specifications were drawn up to provide universal yardsticks against which new aircraft could be designed and assessed. At the same time, the purpose and practice of flight testing evolved and matured to become the discipline outlined in this Volume.

1.3 WHY FLIGHT TEST?

Over the years since the Wright brothers' first controlled powered flight in 1903, extensive databases covering all the basic building blocks of aeronautics (e.g., aerodynamics, materials, and structures) have been accumulated. It might be argued that all aspects of a new aircraft's design can now be investigated on the ground via wind tunnels, propulsion test stands, systems test rigs (e.g., "iron birds", avionics "hot benches", etc.), and by mathematical modelling/simulation by computer. Thus it may be wondered why flight testing is required at all.

Many reasons could be advanced, but perhaps the principal ones are that:

- Adequate replication on the ground of flight conditions is often impracticable, if not impossible (e.g., it would not be possible, on the ground, to subject a fuel system to the range of acceleration forces (g) with which it must cope in flight)
- Particular flight conditions may be insufficiently well defined to be simulated (e.g., the flow field round an aircraft carrier may be unknown, or too complex to model)
- All but the simplest of aircraft incorporate many systems whose interactions are complex: the only practicable way of investigating those interactions is through flight testing of the complete aircraft
- Despite man's best endeavours, significant discrepancies between actual flight behaviour and that predicted from calculation and ground-based testing are all too common (even in cases where the changes in design or required operating conditions are small) and, as a corollary, flight test data is essential to improve the accuracy of the models and simulations which are becoming increasingly important in the development and certification processes.

Thus flight testing under operationally representative conditions (when potentially limiting conditions can be approached in a controlled, incremental manner with salient parameters monitored via appropriate test instrumentation) remains the only safe and convincing means of proving, in the "real world", that the man/machine combination can achieve the "performance" required.

1.4 DEVELOPMENT AND CERTIFICATION FLIGHT TESTING

The flight testing of any new aircraft (or significant improvement to an existing aircraft) destined for commercial or military use is conducted in two phases: a "development" phase, and a "certification" phase. (Subsequently, the "customer/user" may conduct his own flight tests to refine his operating procedures, using his intimate knowledge of his intended missions and aircrew capabilities: as the type and scope of such "operational" testing are highly dependent on individual circumstances, it will not be

discussed further.) In many countries and military services the development flight test programme is conducted by the manufacturer, and the certification flight tests conducted by an official government agency: in others, both phases are conducted jointly.

The aims and objectives of the development and certification phases are different. The development flight tests are aimed at developing the aircraft to the stage where the manufacturer can claim that he has satisfied the contract by meeting all applicable specifications, and should therefore be paid. The certification phase is aimed at confirming formally that the aircraft does indeed meet those specifications, particularly in respect of qualitative matters which are the subject of pilot judgement. In the case of military aircraft, the "certifying agency" is usually charged also with making value judgements on behalf of the customer, such as:

- Even though the aircraft meets its Specification, will it prove to be effective in the role(s) for which it is being procured? (Note: It is virtually impossible to write a specification that will **guarantee** that an aircraft will be satisfactory in all respects because such aspects as pilot workload and the impact of the pilot himself on the aircraft and its systems cannot be defined in quantitative terms, and the operational requirement may change after the specification is written.)
- Are any modifications needed or desirable?
- What are the optimum operating techniques, bearing in mind the capabilities of Service aircrew?
- What is the "performance" that can be assumed for mission planning purposes?

Ignoring construction, the design and development of an aircraft by a manufacturer can be regarded as having three main stages, namely:

- **Design** during which data from previous experience and dedicated research is used to formulate an aircraft whose characteristics and capabilities are predicted to satisfy the specified requirements
- **Ground testing** during which aspects such as flying qualities are investigated using modelling and simulation techniques, and individual elements of the aircraft (or even the complete aircraft) are tested, as far as is practicable, using appropriate test rigs
- **Flight testing** during which all aspects of the complete aircraft and of the man/machine interface are tested under conditions nominally representative of the intended service usage.

It will be appreciated that, in practice, the distinction between the three stages is not clear-cut. Ground and flight testing invariably reveal deficiencies which require re-design to overcome, imparting to the development phase a large element of "test and fix". For this reason the proposed flight test programme (based on the capabilities required, design features incorporated, and experience of previous similar projects) can only be a "best guess", and will be subject to ad hoc amendment as events dictate.

On the other hand, the certification flight test programme can usually be predicted with a fair degree of confidence because it is conducted on a "known product" (in theory, at least). It is customary with military aircraft for official assessments to be made by the "certifying agency" at pre-defined stages during development, so that the customer can be assured that the project is proceeding satisfactorily or be warned of any significant deficiencies. As indicated above, these "official" tests concentrate on aspects which depend on subjective judgement and/or thorough familiarity with current operational practice. (Note: In neither case can the views of the manufacturer's pilots be relied upon without corroboration - in the first instance they could be subject to an intolerable conflict of interests, and in the second they are very unlikely to be conversant with the current standards of training and competence of Service pilots, or with the current operational role(s) and tactics.)

1.5 SCOPE OF VOLUME

Clearly, the nature and scope of the flight tests conducted by the manufacturer and "certifying agency" will depend on such factors as the aircraft's role(s), equipment and characteristics, and the problems encountered during development. Thus the testing required for a highly manoeuvrable combat aircraft fitted with a suite of offensive/defensive systems and intended to operate in all weather/visibility conditions from a variety of bases (including, perhaps, off-runway and carriers) will be considerably more extensive than that required for a primary trainer. Further, certain types of testing are very specialised and it would be inappropriate to include them in a primer such as this.

However, the general principles of flight test engineering described in this Volume will always apply, irrespective of the type of aircraft under consideration. The main elements involved are introduced (in logical sequence) in the Foreword, and amplified by the List of Contents, and need not be repeated here. Adequate guidance is given for a neophyte FTE to embark, with confidence, on a typical flight test programme of a new aircraft type, but the operating rules, regulations, and procedures of his home base must, of course, take precedence over any advice given in this Volume.

1.6 CONCLUDING REMARKS

The discipline of flight test engineering covers a broad spectrum. It is expensive, often time-consuming (the prevailing conditions rarely seem to match those sought!) and can be potentially hazardous. As with any other complex activity, the eventual success and value of any flight test programme is critically dependent on the quality of the preparatory work: In particular, the overall aims and objectives must be clearly defined (and agreed by the "customer"!) and the scope of (or, indeed, need for) each individual test identified in the light of all relevant existing information. The contents of this Volume cover the main elements of flight test planning and execution, but readers should be aware that more specific guidance may well be needed in particular instances (as offered in the References) together, perhaps, with some innovative thinking!

As a corollary, FTEs must be something of a "jack of all trades". They must have the technical competence and management skills to plan and execute a test programme which will achieve the desired objectives safely and efficiently and, whilst so doing, they must deploy the diplomacy needed to weld many disparate occupations (technical specialists, test pilots, mechanics, etc.) into an effective team. Those skills, as in other professions, can only be acquired through practice. However, if this Volume assists in guiding the neophyte to a more rapid acquisition of those skills it will have achieved its objective.

1.7 BIBLIOGRAPHY

Appleford, J.K., "Performance Division Clearance Philosophies for Fixed-Wing Aircraft", A&AEE Note 2111, dated 5 December 1978.

Norris, E.J. (Editor), "Handbook of Test Methods for Assessing the Flying Qualities and Performance of Military Aircraft", A&AEE, dated 1979 with later amendments.

Chapter 2 – HISTORICAL PERSPECTIVE, ONE HUNDRED YEARS OF FLIGHT TESTING

Robert L. van der Velde
Instrumentation Department
National Aerospace Laboratory NLR
Anthony Fokkerweg 2
1059 CM Amsterdam
THE NETHERLANDS

2.0 INTRODUCTION

In less than a century the airplane has undergone a spectacular evolution. This evolution was marked by recurring cycles of research, ground testing, production, flight testing, improved products, and it stemmed from man's constant striving for better, more capable, more effective, more economical airplanes. The early pioneers in aviation combined many disciplines: they were aerodynamicist, materials specialist, researcher, designer, airframe manufacturer and sometimes, like the Wright brothers, engine-manufacturer too. They were also test pilot, flight test engineer (FTE) and data analyst, all in one person. As time progressed, technology advanced and the complexity of airplanes increased, it was no longer possible for one person to remain ahead of the developments in all fields. Specialist disciplines started to develop and the former "one-man" job dissolved into many specialist functions. The function of FTE was one of those specialist functions. In itself the profession of FTE has changed quite a bit over the years, as a consequence of further specialization.

It is interesting to seek an answer to the question: "Who can be regarded as the first Flight Test Engineer?". Starting from the definition of an FTE, as given in the previous Section, it still is not very easy. Some say the Wright brothers, others mention Lilienthal. The fact remains that they were not FTEs only, they embodied numerous other disciplines. The first pure FTE must have emerged during the late twenties.

This Section will briefly discuss the history of flight, the evolution of aircraft and its systems and the evolution of the profession of the FTE in the light of the aeronautical developments that have taken place since man's first flight. It will give some insight in the tools and the facilities the FTE has used in his work. Furthermore, it will try to unveil what the future has in store for the FTE.

2.1 SHORT HISTORY OF FLIGHT

2.1.1 Developments in Aircraft and Its Subsystems

When does the history of flight start? With the myth of Icarus? With the Benedictine monk who made a short gliding flight from Malmesbury Abbey in Wiltshire, UK about 1000 A.D.? [2-1] With Leonardo da Vinci, who was the first to quantify the theory of flight and who produced workable engineering designs of flying machines and a helicopter rotor around the year 1500? With the first flight in 1783 of a hot-air balloon built by the Montgolfier brothers? Or perhaps in the UK in the beginning of the nineteenth century, with the boy who flew in an experimental glider designed by Sir George Cayley? [2-2] Cayley had earned the title "Father of Aerodynamics", he was the first to think of an airplane configuration with wings, fuselage and tail group as we know it today. He found that curved surfaces give better lift than flat ones and that a better lateral stability could be obtained by giving the wing a dihedral angle.

The German mechanical engineer Otto Lilienthal is often regarded as the man who triggered the chain of aeronautical events that took place in the last one hundred years. He certainly is the first to take a scientific approach to tackle the problem of human flight. He investigated the lift, drag, and stability of crude airfoils and reported the results in a book "The Flight of Birds as the Basis for the Art of Aviation", which was published in 1889. [2-3] In the years from 1891 until 1896 he and his brother executed about 2000 gliding flights. In the end he could cover a distance of 350 meters. In the meantime the German Daimler and the Frenchman Levasseur had developed a light internal-combustion engine which Lilienthal built into his glider. The power was used to flap the wing tips up and down in a bird-like fashion. He paid with his life for his experiments. On the 9th of October 1896 his flight ended in disaster, he broke his spine and he died the next day.

Lilienthal's work directly influenced Orville and Wilbur Wright, who made the first powered flight on the 17th of December 1903. [2-2] [2-4] [2-5] [2-6]

The Wright brothers had approached their project in a scientific way and they had solved all problems of aerodynamics, structure, materials, stability, control, and propulsion. The first flight followed an intensive program of research, engineering and testing. On that day of the first powered flight each of the brothers made two flights, after which the "Flyer" was severely damaged by a gust of wind. After this success they worked for several more years to perfect their design. Only after having completed licensing agreements in the US and Europe were they prepared to show their airplane in public. Wilbur made a series of demonstration flights at Avours near Le Mans in France in August 1908 during which flights he could stay in the air for 2 hours and 20 minutes and attain an altitude of 400 feet. A few days later Orville gave a demonstration at Fort Myer, Va, USA. After this period they contributed little to the further development of aircraft, but their achievements in the period from 1899 to 1908 mark them as great pioneers.

And yet Wilbur Wright was not the first (and not even the second) aviator to fly in France. This honor was due to the Brazilian Santos-Dumont who had already flown near Paris in October and November 1906. The second was the Englishman Henri Farman in January 1908. In 1909 the Frenchman Louis Blériot crossed the English Channel. The operation of an airplane from the deck of a ship was demonstrated by Eugene Ely in the USA in 1910 and 1911.

In several European countries there appeared national aviators, some of them with self-built airplanes, others with airplanes bought from a number of rapidly emerging airplane manufacturers. The first airplanes were made of wood, wire and fabric, some with metal tube frames. In 1910 the French Army ordered some reconnaissance planes. Anthony Fokker of the Netherlands flew his first aircraft, the "Spin" (Spider) in 1911. On the 1st of January 1914 the first commercial air transportation service in the US started.

Aviation was officially recognized by Governments of several nations about 1909. The UK formed the Advisory Committee for Aeronautics in April 1909 "for the superintendence of the investigations at the National Physical Laboratory, and for general advice on the scientific problems arising in connection with the work of the Admiralty and War Office in aerial construction and navigation". In the USA the National Advisory Committee for Aeronautics (NACA) was founded in 1915.

The first World War gave a very strong impulse to the use and further development of the airplane. In total 200,000 airplanes were built during the war, in Germany alone some 48,000. The military aircraft had only a limited effect on the outcome of the war, although it proved very valuable for reconnaissance purposes. After the war these airplanes came available for other purposes and it is no coincidence that quite a few, now major airlines, were founded in the post-war years.

Anthony Fokker, who had helped the Germans by building airplanes during the war, managed to escape from Germany with several train loads full of aircraft parts and engines and started a factory in the Netherlands in 1919. This was the foundation of the present Fokker Aircraft Company.

In the same year, Lt. Commander Read in a Navy-Curtis NC flying boat and Alcock and Whitten-Brown in a modified Vickers Vimy bomber made the first flights across the Atlantic Ocean.

The twenties saw a steady development of the airplane. At the start of this decade airplanes had three cockpit instruments, a tachometer, an air speed indicator and an altimeter, instead of just a tachometer as in 1910. For test flights a temperature gauge and a barograph were added. Later cockpits had some 10 instruments. [2-7], [2-8], [2-9] Radio communication was introduced, as were the metal, variable-pitch propellers. The first experiments in blind flying were executed, using an artificial horizon stabilized by a gyroscope, a heading gyroscope and a sensitive barometric altimeter. [2-10]

In 1927 Charles Lindbergh made the first non-stop trans-Atlantic flight from continent to continent. [2-11]

In the thirties the first all-metal aircraft with enclosed cockpits, and somewhat later, pressurized cabins emerged. De-icing and anti-icing systems made their appearance. The retractable landing gear was introduced, as well as wing flaps, and hydraulic systems to operate them. Some aircraft types were equipped with a relatively simple, hydraulic or pneumatic automatic pilot and fixed antennas for radio communication. The initial method of actuating control surfaces, by means of steel cables or pushrods connected to the pilot's controls, was abandoned. The new control systems had hydraulically powered, fully irreversible control servos. These servos were, however, still operated by cables or rods. Radial, air-cooled engines with drag-reducing NACA-cowlings and engine-driven electrical generators came into operation. [2-12]

Just before the end of the decade a major milestone was reached in the development of aircraft propulsion technology. In August 1939 the world's first jet flight took place in Germany with a Heinkel He 178 Technology Demonstrator. The German physicist Von Ohain was the inventor of this engine. In the UK Frank Whittle was the major figure in gas turbine research; his design made its first flight in May 1941 in a Gloster E28/39. [2-1]

The forties with the second World War (WWII) saw the further development of the jet engine. To the great concern of the Allies the Germans were leading this race. In 1945 Germany had 13 types of jet aircraft flying, but not in large quantities.

In this period several electronic navigation systems, as well as radar were developed and used. These systems were the predecessors of similar systems, such as Loran (Long Range Navigation) and ILS (Instrument Landing System), later used in military and civil aviation. Again a war had a tremendous impact on the speed of development of aircraft. Fighters and long range bombers in numerous varieties were developed. However, it took two more years after the end of WWII, before the first supersonic flight was made by Chuck Yeager in a Bell X-1 from Edwards Air Force Base on 14 October 1947.

Long range passenger aircraft were introduced, built with the experience derived from long-range bomber operations, at first still powered by piston engines. The first passenger airplane with jet-propulsion was the UK De Havilland D.H.106 Comet, which made its first flight on 27 July 1949. The first scheduled passenger flight was made on 2 May 1952. Several early Comets suffered fatal structural damage as a consequence of metal fatigue, a new notion in aviation. These problems were eventually overcome. [2-13]

In January 1969 the first supersonic passenger airplane, the Tupolev Tu-144, made its first flight, to be followed, within two months, on 2 March 1969, by the British Aerospace/French Aerospatiale Concorde.

The manufacturers that would start to dominate the market for civil transport aircraft were Boeing, McDonnell Douglas and Lockheed. They were joined in the early seventies by Airbus, a European consortium of French, German, British and Spanish aircraft manufacturers.

During the past twenty years electronics, computer and software technology have contributed more to the development of aircraft subsystems than any other technology.

2.1.2 The Electronics and Software Age

At first gradually, but from the beginning of the seventies at an ever increasing rate, electronics started to fulfil functions previously unheard of or previously performed by electro-mechanical, pneumatic, or hydraulic devices. Each new generation of aircraft had more on-board electronics for communication, navigation and other functions. Weather radar was introduced. The cockpit instruments that, in the thirties, had become electro-mechanical instruments, were replaced by an Electronic Flight Instruments System (EFIS) and an Engine Indicating and Crew Alerting System (EICAS). The vacuum-tube electronics became transistor electronics, the transistor was soon replaced by integrated circuits. The birth of digital electronics and the associated digital computer marked the beginning of a new period in aviation in which we would experience an increased growth in aircraft system capabilities. The rapid development of electronics and software-intensive systems contributed considerably to the development of aviation. The miniaturization of the electronic modules enabled more functions to be installed in less space, with less weight and consuming less electrical power.

Electronic systems were no longer for communication and navigation only. Systems with new functions were developed, such as the EFIS and EICAS mentioned above. These systems could only be developed thanks to the availability of modern airborne computer technology and complex software packages. Examples of other systems in this category are:

- Inertial Navigation Systems
- Automatic Flight Control Systems
- Electronic Engine Control Systems
- Aircraft Integrated Monitoring Systems, used in conjunction with the Digital Flight Data Recorder for accident investigation
- Traffic Alert and Collision Avoidance Systems
- Ground Proximity Warning Systems
- ARINC Communication Addressing Reporting System.

In military aviation, radar became widely used for navigation, target detection, weapon aiming and delivery. Later infra-red and laser tracking and designator systems were added to the inventory for similar purposes. Special systems were designed to detect and jam radio and radar emissions, and thus electronic warfare emerged. Radar decoys, such as "chaff" and infra-red decoys, such as flares, were designed for use against hostile homing missiles. The latest development to avoid detection by enemy radar is the "stealth" technology. Stealth aircraft have a special, sometimes bizarre, shape to minimize the radar echo. They are built of composite materials, such as carbon fibre or glass fibre, and have a special surface finish to absorb radar energy.

Automatic Flight Control systems took over the classical autopilot functions, but they were also put to work for automatic landings and stability augmentation or even to provide artificial stability in aircraft with inherent instability.

The hydro-mechanical method of control surface actuation was, in some modern aircraft, replaced by a new method. These aircraft, such as the military General Dynamics F-16 fighter and the civil Airbus 320 passenger transport, feature Fly-By-Wire technology. The command inputs from the pilot are no longer mechanically transferred to the control servos but electrically by a simple pair of electrical wires. In the future these wires will be replaced by fibre-optic data links, i.e., the Fly-By-Light concept.

In the late eighties the Global Positioning System (GPS) was introduced which permitted very accurate navigation worldwide.

Modern electronics are required to perform many complex functions in a very short or near-real time. To achieve this, present day electronic circuitry has to work with very low energy levels which makes it sensitive to interference from outside sources generating electrical or electromagnetic fields. This phenomenon is called Electro-Magnetic Interference (EMI). EMI testing has become an important and integral part of a flight test program. Techniques had to be developed to counteract EMI, such as screening, bonding, grounding, and filtering. In aircraft made of composite material this problem is more serious than in conventional aircraft as there is no longer a "Cage of Faraday" in the form of an all-metal aircraft structure around the precious electronics, to protect it from unwanted, incoming radiation. The development of on-board fibre-optic sensors and data transmission lines, which are immune to EMI, will relieve but not entirely solve this problem in the near future. (See Section 27).

Today's modern aircraft have numerous electronic systems for numerous functions, all of which have to be tested in flight. It is no wonder that the job of the FTE has changed considerably over the years.

2.2 THE EVOLUTION OF FLIGHT TEST ENGINEERING THROUGH THE DECADES

2.2.1 Overview

In the beginning of flight testing the major issues were: How long can I stay in the air? How high? What speed can I reach?

There was no such specialist as the FTE we know today. One man often performed many functions, sometimes he was designer, manufacturer, mechanic, pilot, tester, FTE, etc., all at the same time. In the first three decades of aviation, flight testing was almost entirely aimed at performance, stability and control. There were hardly any "aircraft subsystems" to be tested besides those for propulsion and control. The exceptions were the machine-guns and the cameras in the military aircraft. The forward firing machine-guns were firing through the propeller plane and, therefore, had to be properly synchronized to the propeller position, or else....

Aeronautical development up to World War I (WWI) proceeded initially through the efforts of a few individuals. They could identify and "understand" (more or less) the deficiencies of their aircraft, which they rectified by empirical modification. However, when (comparatively) vast numbers of aircraft were deployed during WWI, flown by pilots who had little or no aeronautical training, the deficiencies in contemporary designs became embarrassing. As a result, there was considerable pressure to find solutions.

This prompted a variety of investigations into the problems encountered, conducted by men with more formal scientific (but not necessarily aeronautical) background. From that period and through the twenties and thirties there appears to have been a huge increase in scientific interest in aeronautical matters and in attempts to describe aerodynamic phenomena (e.g., flow fields, lift/drag characteristics, boundary layers, etc.) in mathematical terms. In particular, the theory of aircraft stability and control was developed by many contributors (e.g., Gates and Lyon in the UK). [2-18]

It is hard to tell when the FTE function emerged. Was it somewhere in the late twenties? The driving forces behind the emergence of flight test engineering as a discipline, were probably the development of the theory of flight, particularly that of stability and control, and the development of a scientific/mathematical basis for predicting the flight behavior of a given aircraft design.

While many of the theories of aerodynamic phenomena could be validated via wind tunnel testing, validation of overall aircraft behavior required full-scale flight testing. The development of underlying theories and, later, specific requirements, demanded testing that could not be undertaken, unaided, by the pilot. A new breed of engineer - the FTE - arose who understood the theories, and could undertake the necessary measurements in flight (aided by primitive "flight test instrumentation"). Thus the FTE acted as the interface between theory and practice, working in very close cooperation with the designer(s). He took over many of the technical and scientific functions but worked closely with the pilot who was responsible for the actual flying and the flight safety. The pilot was also responsible for providing a subjective evaluation of the aircraft flying qualities, system operation, and operational utility.

The function of FTE was probably further re-enforced by the introduction of quantitative general requirements in respect of flying qualities (MIL-SPECs in the USA, AvP 970 in the UK), and the introduction of Federal Aviation Regulations (FAR) [2-14] and Joint Airworthiness Requirements (JAR, Europe) [2-15] and the need to demonstrate that they were satisfied. Moreover, by identifying specific criteria to be met, those requirements must have strongly influenced the nature of the flight test programs conducted.

The many developments in aircraft and aircraft equipment design and the increasing scope and sophistication of predictive techniques modified the scope of flight testing and the role of the FTE. For testing the performance of new subsystems, new methods had to be developed which required close cooperation with the system experts involved. It was the input from these specialists that forced the FTE to develop new flight test methods and techniques.

This was the beginning of a period in which the testing of subsystems would gradually start to take a great percentage of the total testing time. Especially when electronic systems for various purposes made their appearance the scope of flight testing started changing drastically again.

In-flight assessment of structural and electronic system performance introduced new disciplines, and theoretical treatment of the traditional disciplines of stability and control and performance became more and more complicated. As a result, the FTE could no longer remain an expert in all matters being tested and he started to depend on expertise from specialist departments or organizations.

The FTE became more of a technical manager of the flight test program with responsibility for detailed specification of test points and analysis/interpretation of the results being disseminated to specialists in each discipline. As new technologies were incorporated, and the technical bases of design became ever more diverse and complicated, the FTE became less of an airborne expert and more of a person responsible for coordinating and managing all the various activities involved so that the objectives of a particular series of flight tests are met.

Around 1909 the first reports on aeronautical theory were published. The Advisory Committee for Aeronautics in the UK (which became the Aeronautical Research Committee in 1920, and Aeronautical Research Council in 1946) produced a series of Reports & Memoranda (R&M) covering all aspects of the new science of aeronautics and written by theoretical and practical workers in the field, especially those at the National Physical Laboratory and the Royal Aircraft Factory (later Royal Aircraft Establishment). One of the first reports (R&M 18, dated October 1909) was a "Summary of papers relating to the stability of airships and aeroplanes" compiled by the Secretary, quoting work by (inter alia) Bryan, Feber, Lanchester and Soreau. [2-16] R&M 154 by Bairstow and Nayler, published in October 1914, includes a "general mathematical investigation of the stability of the motion of an aeroplane", [2-17] and the output of work on similar topics continued steadily through the twenties, thirties and forties, prominent authors including such as Bryant, Gates and Lyon. Typical examples are R&M 2027 and 2028 [2-18] which covered, respectively, the general theory and interpretation of flight tests of longitudinal stability and control, and R&M 2557 (Lush, K.J., 1948) [2-19] which proposed a new climb technique for high-performance aircraft, subsequently universally adopted for turbine-powered combat aircraft. The R&M's (which total some 4000) were readily available through His Majesty's Stationary Office and were used extensively by authors as source material to produce text books on aeronautical matters. An example is "Aerodynamics" by N.A.V. Piercy, published in 1937, which was intended to "present the modern science of Aerodynamics and its immediate application to aircraft". [2-20]

In the USA, one of the early books regarding certain aspects of flight test engineering was "Notes on Practical Airplane Performance Testing" by G.B. Patterson of the Air Service Engineering Division, Dayton, Ohio, published in 1919. [2-21] It was an attempt to define standardized procedures for performance flight testing. Another book in the same year was NACA Report No. 70, "Preliminary Report on Free Flight Tests" by E.P. Warner and F.H. Norton. [2-22] Other early books were "Flight Testing of Aircraft", by E.H. Barksdale, of the Air Service Engineering School, Dayton, Ohio, published in 1926 [2-23], and "A Manual of Flight Test Procedure", by W.F. Gerhardt and L.V. Kerber of the University of Michigan, Department of Engineering Research in 1927. [2-24] The latter book defined standardized procedures for performance flight testing. E.L. Pratt of the Air Corps Material Division, Dayton, Ohio, wrote "Flight Test Manual" in 1928. [2-25]

Through such books, and the introduction of courses in aeronautical engineering in universities a cadre of engineers was educated to understand the theories underlying flight. Many of those recruited by industry and government organizations were assigned to flight test work, leading to the establishment and development of flight test engineering as a specific discipline.

The development of flight test engineering received its major impetus during and immediately after WWII. A significant breakthrough was the publication of the NACA treatise by William Phillips, "Application and Prediction of Flying Qualities", published in the late forties. [2-26] This was the first recognized attempt to express aircraft flying qualities in quantitative terms. Prior to this date, aircraft designers and developers had to rely on the test pilot's qualitative comments to relate actual flying qualities to those predicted by design and wind tunnel data. Following the publication of Phillips' work, several aerodynamic text books were published which presented aerodynamics in terms usable by the FTE (i.e., related to the real aircraft). These include "Airplane Performance Stability and Control" by Perkins and Hage [2-27] and "Aerodynamics of the Helicopter" by Gessow and Myers. [2-28]

The first text book devoted entirely to the field of flight test engineering was "Flight Testing" by Benson Hamlin, published in 1946. [2-29]

Perhaps the first specialized flight test organizations were those established in the UK at Royal Aircraft Factory (later Establishment) at Farnborough in April 1911, and the Experimental Flight of the RFC Central Flying School formed at Upavon in 1914. Following a move to Martlesham Heath in 1917, the Experimental Flight evolved into the Aeroplane and Armament Experimental Establishment and moved to

Boscombe Down at the outbreak of WWII, where it has remained ever since. A similar capability was established at Göttingen, Germany, at about the same time period. The first formal flight test organization in the US was established by the US Army Airplane Engineering Department at McCook Field near Dayton, Ohio on 4 December 1917. By the end of WWI, this organization had a military and civilian staff of over 2300 personnel. The US Navy received approval to use the Anacostia Naval Air Station as a test site in January 1918. The US NACA facility at Langley was dedicated in June 1927. The McCook site was succeeded by Wright Field, Ohio, and the two sites continued to serve as a flight test site throughout the years up to and including WWII. Other capabilities were subsequently established at a variety of sites such as Edwards Air Force Base, USA, Boscombe Down, UK, Brétigny, France, and other facilities throughout Europe. Besides these mainly military institutions, virtually all aircraft manufacturers had created their own flight test departments.

During WWII the need arose to give the pilots and engineers who were closely engaged in the execution of flight test programs, a formal, specialized training in flight test techniques and procedures. In the UK the "Test Pilot's School" was founded at Boscombe Down in 1943. It was to "provide suitably trained pilots for test flying duties in Aeronautical R&D Establishments within the Service and the Industry". It was later renamed "Empire Test Pilot School" (ETPS). The ETPS was soon followed by the US Army Air Force's Flight Test Training Unit in September, 1944, and then by the US Navy. The US Air Force school at the re-named Wright-Patterson Air Force Base (AFB), Ohio, was moved to Edwards AFB in 1951. In France the "Ecole du Personnel Navigant d'Essais et de Réception" (E.P.N.E.R.) was opened in Istres. Although these schools were called Test Pilot's Schools, they all adapted courses for FTEs. The first "fixed wing" course for FTEs started in February 1973 at Edwards AFB and was soon followed by the ETPS in 1974. The first class for rotary aircraft was offered by the ETPS in 1975. Flight test engineering became recognized as a distinct academic discipline. By 1970 it was included in the aeronautical engineering departments in several universities.

An important observation is that over the past decade aircraft subsystem testing has taken up about 70 percent of all flight test time. [2-30] In current flight test programs only 30 percent of the total flight test time is devoted to performance, stability and control testing. However, the Test Pilot Schools still dedicate about 70 percent of their training time to this subject, which illustrates the fact that it remains of utmost importance.

The changes in technology, requirements and test philosophy mentioned above have brought about drastic changes in flight test methods and the scope of the work of the FTE during the past few decades. The FTE, as we know him today, has become the central figure in any flight test program. He is responsible for the preparation, coordination, organization, and execution of the program and for reporting the results.

2.2.2 Data Acquisition Methods

In the beginning of flight testing the main source of flight test information was the flight test pilot's subjective judgement. At best the pilot had some basic instruments the readings of which he could jot down on his kneepad if the maneuver permitted that.

NACA, in 1930, was probably the first to use special flight instruments to record measurands of interest during flight tests for the determination of aircraft handling qualities. [2-31] At a later stage cameras were used to photograph or film the pilot's instrument panel or other panels specially installed in the test aircraft for the purpose of the flight test and provided with special instruments and warning or indicator lights. These were the so-called "Automatic Observers" or Photo Panel Recorders.

After WWII special flight test instruments became available in which a small mirror could be deflected under the influence of an electrical current, an air pressure, an acceleration or another physical phenomenon. By reflecting a sharp light beam onto photo-sensitive paper, signals could be recorded.

These were the early trace recorders or oscillographs. In this period the development of transducers or sensors began which could convert a physical phenomenon into an electrical output. These outputs could be used in conjunction with the early "mirror galvanometers" or with magnetic tape recorders, which made their appearance in flight testing in the fifties.

From the early fifties, Frequency Modulation (FM) techniques were used for recording these electrical signals on magnetic tape. Later, in the sixties, Pulse Code Modulation (PCM) became the major recording standard. [2-32] This digital technique had the advantage of a better accuracy, a bigger dynamic range, and more data could be packed into the same space on the tape. Moreover, it facilitated the direct interfacing with the digital data processing computer. However, FM techniques are still being used at some flight test facilities for high frequency recording. In this period the use of telemetry became more widespread. It had the big advantage of providing real-time results, which could reduce the time needed to complete a flight test program.

In the sixties the combination of digital techniques and the micro-miniaturization of electronic components triggered the development of high-capacity data acquisition, telemetry and data processing systems. These were necessary as the number of parameters to be recorded and analyzed during flight tests increased sharply from a few tens just after WWII to some tens of thousands for the flight testing of present-day aircraft. Not only the total number of parameters increased enormously during this period but also the number of parameters with a high sampling rate for high frequency signals, resulting in enormous figures for the total system sampling rate. Nowadays, data systems which can cope with several millions of measurement values per second are not uncommon. [2-33]

This increase in capacity of flight test data systems has only been made possible by the great advances in electronic technology during the past few decades.

A further increase in data rates can be expected from video and radar data rates for reconnaissance and remote sensing applications. For the near future there hardly seems to be a limitation in the capabilities of modern electronics. Since magnetic tape recorders can still handle the required data rates it will probably take quite some time before other recording techniques, such as solid state and optical techniques will start to get the lead in high capacity recording applications.

2.2.3 Data Processing and Analysis Methods

The first tools that were used to reduce flight test data to standard conditions and other calculations were the hand-cranked mechanical calculator and the slide rule. Data reduction was a tedious process, involving a lot of manpower and time. The error rate was high and equations had to be simplified to avoid complex, time consuming calculations. It was not until the advent of digital computers in the late fifties that this situation improved. The rapidly increasing capabilities of the digital computer were easily absorbed by the now growing demand for computing power, generated by the then new PCM data acquisition systems.

The computer also became an invaluable tool for the storage of flight test data, results of calculations, administrative data, aircraft and data system configuration data, and calibration data. Large relational data base management systems were introduced for the storage and retrieval of such data, the main advantage being that all data is stored in an orderly, known fashion and is accessible to many users of various disciplines. Computer networks and commercial data transmission facilities enabled users to transmit their flight test data from and to virtually any place in the world and provided access to their data bases from wherever they choose to do their flight tests.

2.2.4 Simulators and Testrigs

Over the past 40 years the engineering simulator has become an indispensable tool for the FTE. Its most important use is the prediction of safe flight envelopes during the flight test program. Furthermore, it supports flight test preparation and crew training, the development of safe and efficient test methods and maneuvers, and final data analysis. In addition, it is an effective means for communication between pilots and FTEs. [2-34] Another important use of simulators is to enable the man-machine interface to be checked or refined prior to flight. In short, the engineering simulator has well demonstrated that it enhances safety and improves the efficiency of a flight test program. However, the FTE must always bear in mind that the fidelity of the simulation is only as good as the data utilized, and much of that data still comes from wind tunnels, Computational Fluid Dynamics (CFD), etc. While the simulator will be updated from the flight test results as the program progresses, the assessment of what constitutes acceptable aircraft behavior and the decision to progress to the next stage in the planned program will be based on the results obtained in flight, **not** on the simulator.

Before simulators became available, the engineer had to rely entirely on wind tunnel data in setting up his test program. Wind tunnel data, however, could be erroneous or misleading because of scaling factors (Reynold's number effects), simplifying assumptions made, instrumentation effects, fidelity of the tunnel, estimations made in interpreting how separately tested aircraft assemblies interacted, etc. Simulator technology and CFD are nowadays essential in the design and development of aircraft and they both have improved the ability of the FTE to predict potential problem areas in the flight envelope. They also allow pilots and engineers to familiarize themselves with the predicted aircraft characteristics (and thus, allow evaluation of some of the man-machine interfaces). However, fidelity of simulators and the accuracy of the CFD are no better than the data that is input and the assumptions made in programming. Consequently, the simulator/CFD outputs are at best approximations of the actual aircraft.

As the flight test program progresses the simulator must be updated with actual flight test data to improve its fidelity and, with that, its usefulness in envelope expansion.

The marriage of simulators and flight test data results in a simulation that has become of great importance in the flight test development and in envelope expansion. Furthermore, it provides the basis for operational flight trainers that accurately reflect the operational aircraft.

Much of what has been said here about simulators is also valid for test rigs, test beds and "iron birds". These devices are used for (ground) testing of aircraft components, complete subsystems or even a cluster of subsystems in a realistic environment and under controlled, standard or extreme conditions. They simulate "airborne" situations for realistic testing, and range from very simple test stations for aircraft component parts to, for example, very sophisticated integrated avionics test facilities. Investigations and checks can be performed and possible corrective actions taken before the equipment is actually installed in the aircraft.

Simulators and test rigs have given the FTE the possibility of improving the safety and efficiency of his flight test program. Their proper use can save valuable flight test time.

2.3 FUTURE TRENDS

What new developments can be expected that can affect the FTE's work?

During the past decade environmental issues have brought about new developments in the fields of aircraft noise and pollution. More stringent government regulations will stimulate the development of engine and acoustics technology, new take-off and landing aids and procedures, and new test techniques.

Technological advances can be expected in the fields of laminar flow airframes, propfan and unducted-fan engines and high-agility marginal stability control systems. These are considered to be the primary drivers for the evolution of flight test techniques. [2-35]

It is hard to predict how the development of future aircraft, such as the National Aerospace Plane, half aircraft, half spacecraft, will influence the FTE's work. One thing is for sure: the FTE will have to add several other disciplines to his list of contacts with specialists.

Even though state-of-the-art data acquisition and processing systems can satisfy the requirements of the majority of flight test programs, some current and future programs will require an expansion in capability to handle higher data rates for a larger number of measurands. This will dictate that development of both data acquisition and processing systems will continue. In fact, the US Navy has the lead responsibility for the US armed forces for developing a new airborne data acquisition system with increased number of channels of data and a capability to vastly increase sampling rates. A further penetration of computing power in airborne data systems can be expected, but it remains to be seen whether important data processing tasks will be transferred to the aircraft. Yet, the capabilities of modern on-board computers will be able to deal with the most sophisticated demands for real-time presentation of flight test information to pilot or on-board flight test crew. Telemetry will undoubtedly go on to play an important role, as will on-board recording, whenever space permits, of all available raw data.

The maturing of GPS will drastically change current methods for obtaining high precision time and space position and aircraft trajectory information. Simulators and test rigs will play an ever increasing role in the future; their use can significantly reduce flight test time in an environment with a steadily growing demand for test data as a consequence of the greater complexity of modern aircraft.

More detailed thoughts on the future trends in flight testing are contained in Section 30.

2.4 CONCLUDING REMARKS

This Section has given a short overview of the history of flight, the evolution of aircraft and its subsystems, the evolution of the FTE's work and his tools, such as data acquisition and processing systems and simulators. Furthermore, it has ventured to unveil what the future has in store for the FTE.

Looking back it can be said that the evolution of aviation, since that memorable event of the first powered flight in 1903, has been enormous. So has been the evolution of the profession of FTE. Being an FTE is an interesting, challenging and rewarding job. The somewhat older FTEs have witnessed a big evolution in flight test tools, techniques and capabilities. And maybe the younger FTEs are in for an even more interesting period to come.

For those younger engineers a word of caution: Never become so enamored with the sophisticated, fully automated and computerized data acquisition, processing and analysis systems that you allow yourself to be relegated to the roles of observer and computer operator. Intelligent engineering analysis, as can be provided only by a knowledgeable FTE, always will be essential in the test and evaluation of aircraft systems.

2.5 ACKNOWLEDGEMENTS

Special thanks are due to Jim Young, Chief Historian of the Air Force Flight Test Center, Edwards AFB, CA, USA, Dean Carico and Ralph Siegel (deceased 1992), Naval Air Warfare Center, Patuxent River, Md, USA, and John Appleford, Aeroplane and Armament Evaluation Establishment, Boscombe Down, UK.

2.6 REFERENCES

- [2-1] Hallion, R.P., "Flight Testing and Flight Research: From the Age of the Tower Jumper to the Age of the Astronaut", Proceedings of the AGARD Symposium "Flight Test Techniques", 1988 Edwards AFB, CA, USA.
- [2-2] Culick, F.E.C., "The Origins of the First Powered, Man-carrying Airplane", in: Scientific American, July 1979, pp 86-100.
- [2-3] Lilienthal, Otto, "Der Vogelflug als Grundlage der Fliegekunst", (The Flight of Birds as the Basis for the Art of Aviation), 1889.
- [2-4] Ritchie, M.L., "The Research and Development Methods of Wilbur and Orville Wright", Report No. HFE 76-12, Aug.1976, Wright State University, Human Factors Engineering, Dayton, Ohio.
- [2-5] McFarland, M.W. (Ed.), "The Papers of Wilbur and Orville Wright", Vol. 1 and 2, McGraw Hill 1953. Reprinted by Arno Press, New York, 1972.
- [2-6] Wright, O., "How We Made the First Flight", Flying and the Aero Club of America Bulletin, December 1913.
- [2-7] Edmonds, I.G., "Flight Testing Then and Now", in: Flight Test Center Review, May 1960, Volume 2, Number 11, AFFTC, CA, USA.
- [2-8] Chorley, R.A., "Seventy Years of Flight Instruments and Displays", The Aeronautical Journal, August 1976.
- [2-9] Niklas, D.R., "A History of Cockpit Instrumentation 1903-1946", Wright Air Development Center Technical Report 57-301, April 1958.
- [2-10] Doolittle, J.H., "Flying an Airplane in Fog", SAE Journal, Vol. XXVI, March 1930.
- [2-11] Lindbergh, Charles A., "The Spirit of Saint Louis", Hamilton & Co. (Stafford) Ltd, London, 1957.
- [2-12] Douglas, D.W., "The Development and Reliability of the Modern Multi-engine Airliner", The Journal of the Royal Aeronautical Society, November 1935.
- [2-13] Jane's Encyclopedia of Aviation, 2nd ed. 1989, published by Bracken Books, Bestseller Publications Ltd., Princess House, 50 Eastcastle Street, London W1N 7AP, ISBN 1 85170 324 1.
- [2-14] Federal Aviation Regulations (FARs), Department of Transportation, Federal Aviation Administration, Washington DC, USA.
- [2-15] Joint Airworthiness Requirements (JARs), Airworthiness Authority Committee.

- "Reports & Memoranda" (R&M) of the following UK-organizations:
Advisory Committee for Aeronautics, 1909,
Aeronautical Research Committee, 1920,
Aeronautical Research Council, 1946.
- [2-16] R&M 18, Bryan, Feber, Lanchester and Soreau, "Summary of Papers relating to the Stability of Airships and Aeroplanes", October 1909.
- [2-17] R&M 154, Bairstow and Nayler, "General Mathematical Investigation of the Stability of the Motion of an Aeroplane", October 1914.
- [2-18] R&M 2027/2028, Gates and Lyon, "General Theory and Interpretation of Flight Tests of Longitudinal Stability and Control".
- [2-19] R&M 2557, Lush, K.J., "Climb Technique for High-Performance Aircraft", 1948.
- [2-20] Piercy, N.A.V., "Aerodynamics", UK, 1937.
- [2-21] Patterson, G.B., "Notes on Practical Airplane Performance Testing", Dayton, Ohio, Air Service Engineering Division, June 1919.
- [2-22] Warner, E.P. and Norton, F.H., "Preliminary Report on Free Flight Tests", NACA Report No. 70, 1919.
- [2-23] Barksdale, E.H., "Flight Testing of Aircraft", Dayton, Ohio, Air Service Engineering School, May 1926.
- [2-24] Gerhardt, W.F. and Kerber, L.V., "A Manual of Flight Test Procedure", Ann Arbor, Michigan: University of Michigan, Department of Engineering Research, 1927.
- [2-25] Pratt, E.L., "Flight Test Manual", Dayton, OH, Air Corps Material Division, 1928.
- [2-26] Phillips, W., "Appreciation and Prediction of Flying Qualities", NACA treatise, late 1940's.
- [2-27] Perkins, C.D. and Hage, R.E., "Airplane Performance Stability and Control", John Wiley and Sons, Inc., New York, 1949.
- [2-28] Gessow, A. and Myers, G.C. Jr., "Aerodynamics of the Helicopter", fifth edition, Frederick Unger Publishing Co., NY, 1978.
- [2-29] Hamlin, B., "Flight Testing Conventional and Jet-propelled Airplanes", New York, The Macmillan Co., 1946.
- [2-30] Smith, C., "Avionics System Training", in "World Aerospace Technology 1992", publ. by Sterling Publications Ltd, P.O. Box 799, Brunei House, 57 North Wharf Road, London W2 1XR, UK.
- [2-31] Dearborn, C.H. and Kirschbaum, H.W., "Maneuverability Investigation of the F6C-3 Airplane with Special Flight Instruments", NACA Report No. 369, 1930.
- [2-32] IRIG Standard 106-86, 1986 (and later revisions), "Telemetry Standards", Telemetry Group, Inter-Range Instrumentation Group, Range Commanders Council, White Sands Missile Range, New Mexico 88002, USA.

- [2-33] AGARDograph No. 160, AGARD Flight Test Instrumentation Series.
- [2-34] Hoey, R.G., "Simulation in Support of Flight Test: In Retrospect", AIAA Paper 88-2130, AIAA 4th Flight Test Conference, San Diego, 1988.
- [2-35] Siddiqi, S. and Robson, R., "Flight Testing Keeps Pace", Aerospace America, Vol. 26, February 1988, pp 14-16.

2.7 BIBLIOGRAPHY

AGARD Publications

Some of these documents provide brief historical overviews; all of them at least provide a glimpse at the state of the art of the profession at the time of their publication. The following types of AGARD Publications exist:

- Conference Proceedings
- Lecture Series
- AGARDographs
- AGARD Reports

AGARDograph No. 300, AGARD Flight Test Techniques Series.

"A&AEE Handbook on Methods of Making Set Tests on Performance and Handling of Aircraft", Boscombe Down, UK 1943.

"Performance Flight Test Techniques", Report No. FTC 64-2006, 1964, USAF Aerospace Research Pilot School, Edwards AFB, California, USA.

Anderson, D.A., "Progress in Aircraft Design since 1903", Washington, DC, NASA, 1974.

Bikle, P.F., "Performance Flight Testing, Methods in use by the Flight Section", Dayton, OH, Army Air Forces Technical Report No. 5069, 15 January 1944.

Bonté, L., "L'Histoire des Essais en Vol", (The History of Flight Testing).

Vol. III of Collection Docavia, Paris, Editions Larivière, 1974.

Chanute, Octave, "Progress in Flying Machines", New York, Forney, 1894.

Republished by Lorenz and Herwig, Long Beach, California, 1976.

Chanute, Octave, "Recent Experiments in Gliding", in J.Means (Ed.), The Aeronautical Annual 1897. Boston: W.B. Clarks, 1897.

Gast, R. de, "Pax River: the Naval Air Test Center", US Naval Institute Proceedings, Dec. 1969.

Gibbs-Smith, C.H., "The Aeroplane: An Historical Survey of Its Origin and Development", London, HMSO, 1960.

- Gibbs-Smith, C.H., "The Invention of the Aeroplane 1799-1909", New York: Toplinger, 1965.
- Gilruth, R.R., "Requirements for Satisfactory Flying Qualities of Airplanes", NACA Report 755, 1943.
- Green, W., "The War Planes of the Third Reich", Garden City, NY, Doubleday and Co., 1970.
- Hallion, R.P., "Test Pilots, the Frontiersmen of Flight", Smithsonian Institution Press, Washington, D.C., London, rev. ed. 1988, ISBN 0-87474-549-7.
- Hallion, R.P., "Legacy of Flight: The Guggenheim Contribution to American Aviation", Seattle, Washington: University of Washington Press, 1977.
- Herrington, R.M. and Shoemaker, P.E., "Flight Test Engineering Manual", USAF Technical Report No. 6273, Air Research and Development Command, W-PAFB, Dayton, Ohio, 1951.
- Lean, D., "The Art and Science of Modern Flight Testing - A Personal View", ICAS Paper 76 45, The Tenth Congress of the International Council of the Aeronautical Sciences, October 1976.
- Lewis, G.W., "The Wright Brothers as Researchers", Aviation, Aug. 1939, vol. 38 no.7.
- Miller, R. and Sawers, D., "The Technical Development of Modern Aviation", New York: Praeger, 1970.
- Pelt, L.G. van, "The Evolution of Flight Test Concepts", History Office, US Air Force Flight Test Center, June 1982.
- Perkins, C.D. and Dommasch, D.O., AGARD Flight Test Manual, 3 vols., Princeton, NJ: Advisory Group for Aeronautical Research and Development of NATO and the Aeronautical Engineering Department, Princeton University, n.d.
- (The predecessor of the present AGARDograph 160 and 300 Series, "Flight Test Instrumentation" and "Flight Test Techniques", respectively).
- Polve, J.H., "Performance Flight Testing", AF Technical Report No. AFFTC 53-5, August 1953, USAF Experimental Flight Test Pilot School, Air Force Flight Test Center, Edwards AFB, California, USA.
- Rounds, B., "Commercial Flight Testing", XIXth National Aeronautics Meeting, Society of Automotive Engineers, Detroit, April 15-16, 1931.



Chapter 3 – BACKGROUND CONSIDERATIONS

J.K. Appleford

Aeroplane & Armament Evaluation Establishment
Boscombe Down, Salisbury, Wilts, SP4 0JF
UK

3.0 INTRODUCTION

Before describing (in Sections 4 to 10) the many preparatory activities involved in flight testing, it is appropriate to introduce here some general background considerations which bear on the Flight Test Engineer's (FTE's) task. Clearly, most of the FTE's concern is with technical matters and, if the trials are to be conducted in a safe, efficient and economic manner, he must obtain (and consider carefully) the types of technical data discussed in paragraph 3.3 below. However, there are also wider issues of which he must be aware.

All flight testing is instigated at the request of some form of "sponsor" or "customer", whose stated requirements, priorities and timescales the FTE must always endeavour to satisfy. Yet the FTE's freedom of action to formulate and conduct a successful test programme will depend on such factors as his relationship with that customer, the customer's overall programme, the resources available for the tests and the "rules" of the FTE's organisation. In keeping with the aims of this volume, this Section offers an outline of some of these wider organisational and programme issues which may affect the FTE's freedom to define and control the flight test programme.

3.1 ORGANISATIONAL ISSUES

The FTE's responsibilities and freedom of action depend crucially on whether or not he is part of the same organisation as his sponsor/customer. Thus an FTE employed within an aeronautical research laboratory will often be required to conduct tests whose purpose and scope is controlled closely by the leader of a research project, and the work of an FTE employed by an aircraft manufacturer will be directed by staff of one or more of the technical design departments (Structures, Systems, Aerodynamics, etc.). In both cases the FTE will be responsible for interpreting the sponsor's requirements to achieve safe and effective use of the flight test resources, but may have little influence on the scope of the testing or on the analysis and interpretation of the results.

A completely different situation prevails in the case of FTEs responsible for civil certification or military assessment/clearance testing. The FTE employed by a national civil certification authority normally works to a published mandatory set of airworthiness requirements in respect of flying qualities, performance, and systems operation. For each new aircraft design the authority will discuss with the manufacturer the evidence the latter must provide in order to obtain certification, which will usually include evidence from calculation, rig tests, and simulation as well as flight test. In negotiating the nature and extent of the flight test evidence required, the authority is usually represented by one or more senior FTEs and pilots, who will also rule on the tests that they require to conduct themselves to form their own judgements in respect of subjective handling aspects and, perhaps, flight-safety-critical performance. As they will be the main arbiters of the manufacturer's compliance with the requirements in these respects, and will thus influence directly whether or not his design is certificated (with the concomitant implications for further development/delay in introduction into service), they have a very powerful bargaining position: clearly, this must not be abused.

BACKGROUND CONSIDERATIONS

The situation in respect of the FTE working in a military flight test assessment organisation or Official Test Centre (OTC, UK terminology) is less clear-cut. Typically, military aircraft programmes are managed by an Aircraft Project Director (APD, UK terminology) who is responsible for all aspects of an aircraft's procurement. In earlier times, it was customary for the APD to require the OTC to conduct and report on a series of Official flight test assessments which were independent (but took account) of the manufacturer's tests. One or more Preview(s) was/were conducted at an early stage of development to provide an independent Official assessment of progress to date and likely final capability. Extensive Official tests were then conducted on a production standard aircraft immediately prior to initial entry into Service in order to assess overall suitability for Service use, identify deficiencies requiring rectification action, recommend operating limitations, and confirm (or otherwise) the manufacturer's performance claims. Similar tests were subsequently made at intervals throughout the aircraft's service life to cover later enhancements of equipment and/or capability.

In recent years the situation has changed (in the UK, at least). In a drive to reduce the timescale and cost of aircraft development programmes, and to reduce what is seen as "unnecessary duplication of flight testing", there is a move to minimise independent OTC flight test assessments. Aircraft procurement is becoming increasingly reliant on competitive tender against a specification which defines not only the required "cardinal point performance" (in all senses) but the development and demonstration process as well. Thus, when evaluating tenders, the APD may well seek the FTE's comments on each manufacturer's proposals for demonstrating compliance with the specification. Similarly, during contractor development there are usually a number of deliverables (called the Contract Data Requirements List (CDRL) in the US) that the contracting agency must review and approve. In many instances the FTE will be required to play a key role in the assessment of these items.

Reflecting this greater reliance on specifications and manufacturers' evidence of compliance with them, Official assessment in the UK is becoming increasingly based on oversight of, and (limited) participation in, the manufacturer's rig and flight test activity. Likewise, with US military programmes there is a continuing trend towards involvement of military test pilots and FTEs in the contractor's development efforts. To conserve funding and to reduce the length of time required to field a new aircraft, the contractor is often required to perform his development and integration work at the government test site (called "principal site testing"). This provides the government FTE with the opportunity to observe/participate in early contractor development efforts, when he/she can become familiar with the new aircraft and aircraft systems and (hopefully) influence system development, where desirable.

The overall extent of the flight test programme, the division of that programme between the manufacturer and the Official test organisation, and the "ground rules" governing Official participation in the manufacturer's programme are all matters likely to be debated with the APD at a seniority level well above that of the FTE. However, the engineer should be aware of the potential difficulties associated with participation in manufacturer's testing, when the objectives, operating procedures, test and analysis methods, etc., of the two organisations may differ significantly. The FTE should make an honest and realistic appraisal of the proposed test programme and, if he/she deems that it will not provide the OTC with adequate scope to form an authoritative independent judgement, the APD should be warned accordingly.

As well as these issues arising from the FTE's relationship with the customer he/she must, of course, always operate in accordance with the rules and practices of his/her particular organisation. It is usual for these to be promulgated through formal "Standing Instructions" (updated as/when necessary) which define, for one or more aspects of the flight test work undertaken by the organisation, the responsibilities assigned to each post and the procedures to be followed, etc. Clearly, the FTE must be familiar with all such documents which bear on his/her work (and, indeed, may be required to sign that he/she has read them!). However, in addition to these formal "rules", each organisation will evolve its own "accepted working practices", and one of the major tasks facing a new FTE is to become acquainted with these

practices (and the personnel who exercise them) as soon as possible. Indeed, it is perhaps apposite here to remind the neophyte FTE that his/her work will **always** involve orchestrating the efforts of personnel with a very wide spectrum of backgrounds, skills and personalities, and diplomacy will, at times, be a priceless asset!

3.2 PROGRAMME ISSUES

Although the FTE is, naturally, most concerned with flight test matters he must recognise that, for a new project, this is merely one stage in the aircraft's development (albeit a very important one). However, it is invariably the most unpredictable stage, such that a major element of the FTE's task is likely to be the "management of uncertainty". This uncertainty arises from the following major influences:

- Being virtually the last element in the development process, the timing of the flight test programme is invariably subject to the cumulative effects of slippages in the preceding stages resulting from funding or technical difficulties. This often results in the flight tests starting many months (or even years) later than originally planned, which complicates considerably the marshalling of the necessary resources (manpower, facilities and material). Even slippages of a month or two can be critical if they result in essential test conditions being missed (e.g., particular climatic conditions which only occur on an annual basis), or access to facilities being lost (e.g., "missing the slot" in an aircraft carrier's programme).
- Flight testing is dependent on a great many separate factors, all of which must be favourable simultaneously for the tests to be successful. For example, the aircraft and its equipments under test must remain serviceable, as must the test equipments and instrumentation, including the relevant ground installations: the weather conditions must be suitable, and the required access to the test ranges or operating areas must be available. While some shortfalls can be accommodated by providing appropriate alternative flight briefs, a realistic programme must allow for some contingency (each case must be considered on its merits but, in the author's experience, about 20 percent has proved reasonable for handling qualities test programmes of up to 50 flights).
- Despite the improvements in predictive methods, and the extensive precursor ground tests and simulations which are undertaken as a matter of routine nowadays, "surprises" during flight tests (especially in respect of flying qualities) are not uncommon. (Hence the general acceptance, as discussed in Section 1, that flight testing alone can prove that the required performance has been achieved - even if the extent of the flight testing needed is often a matter of hot debate!). An (almost) inevitable corollary of such "surprises" is that the flight test programme must be extended beyond that originally planned, particularly if a "show-stopper" is encountered which requires significant design changes. Needless to say, this possibility can induce an ambivalent attitude towards flight testing in both the manufacturer and the customer and, at times, the FTE can be subjected to considerable pressure to "take a positive view" of the results!

While the above factors are largely out of the FTE's control, they reinforce the need for the FTE to be completely familiar with the customer's objectives, priorities and timescales to ensure that the flight test programme is as "narrowly focussed" as possible. Thus the FTE must consider such aspects of the customer's stated requirements and intended overall programme as:

- The overall development plan and (in particular) the test and evaluation plans, as defined in the appropriate high level documents (e.g., the Test and Evaluation Master Plan (TEMP) in the US), and the priorities, budget, and timescale associated with those tests which the FTE is to manage.
- The general and specific requirements that the aircraft/equipment is designed to meet, as expressed in such documents as the Operational Requirement, overall "Weapons Systems Specification" and referenced general specifications such as the (US) Military Standards (MIL-SPECs) or (European) Joint Airworthiness Requirements (JARs). For example, if takeoff and

BACKGROUND CONSIDERATIONS

landing tests are to be conducted of a civil aircraft acquired for military use, the FTE must know whether the customer wishes the tests to be conducted in accordance with civilian or military procedures and standards. Similarly, if a naval aircraft that was originally procured for operation from aircraft carriers is now being procured for use while operating only from runways, the FTE must know what airfield performance standards the customer wishes to apply. [3-1, 3-2, 3-3, 3-4]

- The nature of the data that the customer expects from the flight tests, the purpose to which he intends to put it, and the form and timescale in which he wishes it to be provided.
- The standard of aircraft/equipment available for assessment, and the differences (if any) from the eventual production standard. Thus a request for an assessment of an aircraft's handling qualities will lead to markedly different test programmes depending on whether that aircraft is a prototype with a severely restricted flight envelope, a pre-production vehicle (perhaps lacking pylons for external stores, or fitted with engines of limited thrust, etc.), or an aircraft fully representative of the production standard in all respects.
- The facilities and capabilities available at the test site (e.g., for a weapon aiming test programme, the range instrumentation must be capable of measuring aircraft position to a high degree of accuracy against a common timebase).

Having considered these factors, the FTE will find it helpful to prepare an informal checklist which details all the customer's requirements, "deliverables" and timescales, explicit and implicit. When drafting the test programme (which will also reflect the review of the relevant technical data, as discussed in paragraph 3.3, below) he/she should use this checklist to ensure that the facilities, technical content and timescales allotted to each stage (e.g., preliminary ground tests, test flights, data returns, analysis periods and reporting) are compatible with the customer's objectives. If not, the programme must be adjusted accordingly or, if this is impossible within the applicable constraints, the customer warned and appropriate relaxations of his objectives negotiated. Once the FTE has refined and defined the draft programme in this manner, it will constitute a valuable tool for monitoring trials progress and technical achievement.

3.3 REVIEW OF TECHNICAL DATA

Before embarking on the (invariably expensive, and often time-consuming) process of flight testing, it behoves the FTE to study the background material which can help him to optimise his programme. A first step is to review general documents with a bearing on the intended tests. Thus the pertinent MIL-STDs/SPECs will often provide valuable information on both the type of tests required and the types of data presentation required. For example, MIL-STD-1797A "Flying Qualities of Piloted Aircraft" would be a prime source document in identifying test objectives for a handling qualities program, while MIL-STD-1763A "Aircraft/Stores Certification Program" would be a prime source when assessing stores carriage. [3-4, 3-5] The choice of reference material should also reflect the specifications in effect at the time the aircraft was procured: while MIL-STD-1797A will be pertinent to new aircraft, an older aircraft being modified to perform a new role may have to be evaluated against MIL-F-8785C, "Flying Qualities of Piloted Airplanes" [3-6]. Further details can be found in the references and bibliography given below and, of course, Sections 11 to 27 of this Volume introduce most of the tests and test techniques involved. Similarly, it is usually possible to find, either in the public domain or within the FTE's own test organisation, reports of comparable tests on analogous aircraft types which offer useful guidance on the various techniques involved (and, perhaps, the potential pitfalls to avoid!).

There will often be a wealth of data available specific to the particular aircraft or equipment (although on occasion, such as when a foreign item of equipment is to be procured, the data may be sparse), which should prompt the FTE to be selective and seek the most directly relevant (or "downstream") material. For example, when planning an Official assessment of a new military aircraft, the FTE should turn first to the most recent flight test reports submitted by the manufacturer. However, reports of tests on earlier

standards of the aircraft, including prototypes and pre-prototypes, may also yield vital data (e.g., a significant proportion of the manufacturer's evidence in respect of flying qualities and performance is often derived from early tests on a pre-series aircraft which, although fitted with immature and/or incomplete mission equipment, was aerodynamically representative of the production standard).

Further, data from the manufacturer's (and his sub-contractors') simulator, rig, and component tests may provide the best (perhaps the only) empirical evidence of such aspects as the effects of simulated systems failures, especially those deemed too difficult (or too risky) to test in flight. Similarly, the only empirical engine performance data available may be that measured by the engine manufacturer using a sea-level testbed and/or altitude chamber. However, in the majority of cases, technical data from earlier sources (such as wind tunnel tests and calculation) is likely to be too remote (and may also have been rendered inaccurate by design changes during development) to be of much practical use to the FTE.

Finally, the FTE must ensure that all the technical documentation required by the various members of the flight test team is provided by the manufacturer in sufficient time to allow full assimilation of its contents, and the implementation of any necessary changes to the planned test programme. This documentation must be directly applicable to the standard of the aircraft to be tested (which may well be immature and significantly different, in detail, from the intended production standard) and must be complete, current, and in a readily-understood form (e.g., it should reflect the normal aeronautical conventions in respect of terminology, definition of axes systems, etc.). As a minimum it will include:

- Flying Limitations (which will be subject to review/approval at an appropriately senior level within the FTE's organisation)
- Aircrew Manual (providing an overview of the test aircraft's features and characteristics, and describing the recommended operating techniques under both normal and emergency conditions)
- Maintenance Manual
- Instrumentation Manual (describing the test instrumentation, its characteristics, maintenance, calibration, and operation)
- Test Equipment Manual (describing characteristics and operation of any special items of test equipment fitted, such as an autopilot "runaway box").

3.4 CONCLUDING REMARKS

This section offers an insight into some of the considerations that the FTE must bear in mind when planning his flight test programme. While organisational and programme issues will vary, depending on particular circumstances, the FTE will always need to assemble and review thoroughly all relevant available technical data if he is to achieve a safe, efficient and economic solution to his sponsor/customer's objectives.

3.5 REFERENCES

- [3-1] MIL-M-7700D, "Manuals, Flight", USAF, Aeronautical Systems Center, 1990.
- [3-2] Federal Aviation Regulations (FAR) Part 25 - "Airworthiness Standards: Transport Category Airplanes", U.S. Department of Transportation, Federal Aviation Administration (FAA).
- [3-3] Joint Aviation Requirements (JAR)-25 - "Large Aeroplanes", (European) Joint Aviation Authorities.
- [3-4] MIL-STD-1797, "Flying Qualities of Piloted Airplanes".

BACKGROUND CONSIDERATIONS

[3-5] MIL-STD-1763A Change Notice 1, "Aircraft/Store Certification Procedures", USAF Seek Eagle Office, 1992.

[3-6] MIL-F-8785C, "Flying Qualities of Piloted Airplanes", Naval Air Systems Command, 1980.

3.6 BIBLIOGRAPHY

U.S. Standard Atmosphere, Superintendent of Documents, US Government Printing Office, Washington, D.C., 20402.

MIL-STD-1793, "Flight Performance, Air Vehicle", Dec 1985.

MIL-A-8861B, "Airplane and Rigidity Flight Loads", Naval Air Systems Command, 1986.

MIL-A-8870C, "Airplane Strength and Rigidity Vibration, Flutter, and Divergence", Naval Air Systems Command, 1993.

MIL-A-87221, "Airplane Strength and Rigidity Flight and Ground Operations Tests".

MIL-A-8591H, "Airborne Stores, Suspension Equipment and Aircraft/Store Interface (Carriage Phase): General Design Criteria for", Naval Air Systems Command, 1990.

MIL-B-81006B, "Bombs, Free-fall, Demonstration of Dispersion Requirements for", Naval Air Systems Command, 1968. Valid Notice 1, 1987.

MIL-C-005011B, "Standard Aircraft Characteristics, Piloted Aircraft (Fixed Wing)", Jun 1977.

MIL-D-8708C, "Demonstration, Aircraft Weapon Systems, General Specification for", Naval Air Systems Command, 1991.

MIL-D-23222A, "Demonstration Requirements for Helicopters", Naval Air Systems Command, 1971. Valid Notice 1, 1983.

MIL-H-8501A, "Helicopter Flying and Ground Qualities, General Requirements for", AV-Army-Aviation and Troop Command", 1961.

MIL-P-22203, "Performance Data Report for Standard Aircraft Characteristics Charts for Piloted Aircraft", Naval Air Systems Command, 1959.

MIL-HDBK-244, "Guide to Aircraft/Stores Compatibility", Naval Air Systems Command, 1990.

Appleford, J.K., A&AEE Note 2111, "Performance Division Clearance Philosophies for Fixed-Wing Aircraft", Dec 1978.

"A&AEE Handbook of Test Methods for Assessing the Flying Qualities and Performance of Military Aircraft", Dec 1979 with later amendments.

Federal Air Regulations (FAR) 23, "Normal, Utility, Aerobatic, and Commuter Category Aeroplanes".

US Department of Transportation, Federal Aviation Agency (FAA) Circular AC 25-7, "Flight Test Guide for Certification of Transport Category Airplanes".

British Civil Airworthiness Requirements (BCAR) 23, "Light Aeroplanes".

DEF-STAN 00-970, "Design and Airworthiness Requirements for Service Aircraft, Volume 1 - Aeroplanes and Volume 2 - Rotorcraft".

Ecole du Personnel Navigant D'Essais et de Reception (EPNER)

- Pratique des Essais en Vol Helicopteres (2 Vol), ref EPNER 25.
- Pratique des Essais en Vol Avions (3 Vol), ref EPNER 24.
- Pratique de la Reception (1 Vol), ref EPNER 27.

BACKGROUND CONSIDERATIONS



Chapter 4 – ESTABLISHING THE TEST TEAM

Ronald J. Oblen

Naval Air Warfare Center Aircraft Division
Patuxent River, MD 20670-5304
USA

4.0 INTRODUCTION

Test and evaluation (T&E) is performed to provide information to reduce acquisition risk, provide early and continuing estimates of a system's operational effectiveness and suitability, verify technical performance and objectives, and support programmatic decision making. Test activities must be fully integrated early into the overall development process to ensure a cohesive and seamless acquisition program. The test authority must therefore be alert to the evolution of new programs so that they can assign a dedicated test team to each new program at the earliest practicable stage with consideration as to the availability of funding and other resources. Involvement of the team from the earliest stages will enhance their understanding of the aircraft/system's mission and design features, and thus enhance their ability to contribute to the project's success. However, while T&E will be required throughout the project's life (commonly called "cradle-to-grave" support), the aspects of interest will change and appropriate changes to the size and composition of the test team will also be needed.

The procedures and practices contained herein are typical of those found at a large military test center; however, they contain all the elements that must be considered in the selection of flight test team members. The process may vary considerably depending on the organization, the resources available, and whether it is a military or civilian program.

4.1 TEST TEAM SELECTION

The test program task elements drive personnel requirements. The team leader, once identified, must be generally familiar with the scope of the test effort. Once rough task elements are identified, the team leader can start to form the team since the team leader knows what major test disciplines are required. For example, if a new radio is being tested in an aircraft, a Microwaves Engineer and an Electromagnetic Compatibility Engineer will likely be required. As the team develops, further team refinement can be made (i.e., further refining the task elements and bringing on appropriate personnel). Local requirements (e.g., flight clearance, instrumentation, aircraft maintenance, etc.) further drive what type of disciplines are required.

Experienced engineers should lead the test effort (on large scope programs). The staff could be comprised of mid-level and junior engineers. Flight test is more than getting a job done, it's also grooming/developing and training inexperienced team members. This not only builds self esteem but prepares the organization for future programs.

The team leader needs to determine how program functions can be fulfilled. Sometimes dedicated technical support (full-time) is required; other times part-time support may suffice. This is usually driven by the length, scope, and complexity of the test program. Also, the team leader needs to determine the mix of direct reporting staff versus matrix support. Some organizations may not allow much leeway regarding support structure especially where the organization operates on a matrix principle, so the team leader must coordinate

ESTABLISHING THE TEST TEAM

closely with organization managers to ensure all personnel requirements are adequately addressed. The team leader must also consider how to accomplish non-technical functions (e.g., secretarial, administrative support, contract support, financial management support, etc.).

4.2 QUALIFICATIONS REQUIRED FOR TEST TEAM

The team leader should determine flight crew qualifications (e.g., past specific operational experience, test pilot school (TPS) graduate, etc.) and ensure the organization has access to people with those specific qualifications for the duration of the program. The leaders of long-term programs may need to provide input to Test Pilot School (TPS) selection boards stating specific test personnel requirements and to military assignment and civilian recruitment activities such that the proper mix of qualified test personnel are continually available.

Once people with the requisite education, training, and experience have been selected, the team leader needs to ensure each team member understands the mission/operational environment of the system under test. Knowing the scope and breadth of required tests and the capabilities of the team members will help define the test specific training requirements for the team members. (See also paragraph 10.3.3).

4.3 TEST TEAM TASKING

To ensure a total understanding of the aircraft/system under test, each team member should be familiar with the proposed operational environment and operational utility of the aircraft/system under test. Further, each team member should be familiar with the test program objectives and goals and with the particular operating practices and procedures of the test establishment prior to starting any work toward test preparation. The team leader is responsible for briefing the entire team regarding the program big picture (schedule, cost, performance), team expectations, deliverables, roles, and responsibilities.

Team member roles and responsibilities should be clearly defined and agreed upon by all team members. This will ensure all test aspects get adequate attention and also will help prevent duplication of effort. An effective method of ensuring adequate team tasking is for the leader to conduct a kick-off meeting which discusses and defines the roles/responsibilities of each team member. The most important part of a kick-off meeting is thorough preparation by the team leader. The team leader needs to propose a role summary (i.e., determine what role and responsibility each team member will have), but each team member needs to provide input to the roles and responsibilities and ultimately come to consensus.

The test team should begin monitoring program efforts as early in the program as possible (concept exploration, early demonstration/validation, prototyping, etc.) consistent with the test establishment procedures and the resources that are available. The team should be proactive and should not have to wait for specific sponsor tasking to monitor early efforts. Early effective involvement means fewer surprises and problems in the future. It also enhances the possibility that an adequate test program is planned/budgeted.

4.4 SPECIAL CONSIDERATIONS

Early contact with program sponsors is necessary to ensure that the sponsor understands the need for an adequate test program and allocates sufficient time and resources for the conduct of an appropriate test program. It is very important that team members keep their suppliers/customers informed as the test planning

and the actual tests are conducted (See Section 28). The team should tap into programs/teams that have performed similar work to avoid "reinventing the wheel" and be able to judiciously capitalize on "lessons learned". Corporate knowledge of experienced test engineers and organization managers should be tapped to ensure that the most efficient/effective test program team is established. The team leader should document who the test members were and what their responsibilities were so that appropriate contact can be made in the event of similar tests or to help resolve problems that may arise at a later date.

4.5 CONCLUDING REMARKS

The test team must get involved early in the program. The entire team needs to know the big picture so each team member understands their importance to a successful test effort, and more importantly to a successful acquisition and subsequent operational employment. The team leader must ensure correct engineering, flight crew, and support disciplines are involved such that a successful test program can be executed on time and within budget.

4.6 BIBLIOGRAPHY

"Naval Air Training and Operating Procedures Standardization (NATOPS)", Force Warfare Aircraft Test Directorate, Naval Air Warfare Center, Aircraft Division, Flight Test and Engineering Group, Patuxent River, MD, 1992.

"Technical Support Assignments to Naval Air Systems Command Field Activities and Space and Naval Warfare Systems Command Research and Development Centers", Naval Air Systems Command Instruction (NAVAIRINST) 5451.87B, 6 June 1989.

"Test and Evaluation", Change 1, NAVAIRINST 3960.2B, 27 December 1989.

"Preparation, Review, and Implementation of Project Test Plans", Naval Air Test Center Instruction (NAVAIRTESTCENINST) 3960.10D, 3 June 1990.

"Defense Acquisition Management Policies and Procedures", Department of Defense Instruction (DODINST) 5000.2, 23 February 1991.

Peters, T. J. and Waterman, R. H., "In Search of Excellence, Lessons from America's Best-Run Companies", New York, NY, Warner Books, 1982 (ISBN 0-446-38281-7 (pbk.) (USA), ISBN 0-446-38282-5 (pbk.) (Canada)).

Deming, W. E., "Out of the Crisis", Cambridge, MA, Massachusetts Institute of Technology, Center for Advanced Engineering Study, 1989 (ISBN 0-911379-01-0).

Lacy, J. A., "Systems Engineering Management, Achieving Total Quality", New York, NY, McGraw-Hill, Inc., 1992 (ISBN 0-8306-2304-3).

Booz, Allen & Hamilton Inc. under contract MDA 903-85-C-0171, directed by Defense Systems Management College (DSMC), "Defense Systems Management College Systems Engineering Management Guide", 2nd edition, Chapter 13, DSMC, Fort Belvoir, VA, Dec 1986.



Chapter 5 – LOGISTICS SUPPORT CONSIDERATIONS

Herman G. Kolwey

Naval Air Warfare Center Aircraft Division
Patuxent River, MD 20670-5304
USA

5.0 INTRODUCTION

When preparing for the conduct of a Test and Evaluation (T&E) program it is vital that the Flight Test Engineer (FTE) ensure that adequate arrangements are being made for the logistics support of the test program. The FTE must understand the type of tests that will be conducted and then communicate the peculiar needs of his test project to the logistics support community. Logistics support is required to keep the test aircraft flying in the required test configuration, while a logistics test evaluates the support system required for the intended user to operate the aircraft. The logistic support system includes support equipment, technical orders, facilities, and manning. Test support requirements may vary drastically depending on status of the aircraft (new aircraft such as C-17, or old aircraft such as F-14D), environmental conditions (cold/hot, salt water/sand, electromagnetic environment, altitude, aircraft carrier, etc.), or repetitive nature of the test (takeoff/landing, accelerations/decelerations, or repetitive high time at specific test conditions). Perhaps the most important point to make is that the FTE should locate the logistics experts at their facility, explain the tests that are to be conducted, and task them to provide the support that is required. The FTE cannot arrange the logistics support without expert help. However, these logistics experts may well be able to provide information on spares, training and timing of support so that the FTE can rearrange his planned schedule of tests more efficiently to better match the availability of support. This Section will provide an overview of the types of logistic planning that must be conducted in preparation for such tests and the role of the FTE in defining these support requirements. The conduct of the Logistics T&E program is discussed in Section 23.

5.1 TYPICAL LOGISTICS SUPPORT CONSIDERATIONS

Each T&E program will have its own peculiar logistics support requirements - without exception. If there is a well established logistic support capability manned by knowledgeable personnel, it may be sufficient to just communicate the type of T&E being conducted in order to ensure that adequate logistic support for the aircraft, special instrumentation, and new/peculiar support equipment is available, with back-up, at the test site when needed. However, the FTE must evaluate the peculiar circumstances of the test program and then take appropriate action to provide the support that his test will need.

For example, if the aircraft is a new series such as a C-17 the FTE must ensure that engine spares are available to support repetitive tests at high power settings such as takeoffs, numerous climbs to high altitude, level accelerations to determine excess thrust, etc. The engines will proportionally use much higher thrust settings than those experienced during a similar time span in an operational environment. Similarly, the T&E program will utilize proportionally much more braking during tests to determine short field performance than is to be expected during normal service operations, and thus more brake spares will be required. Aircraft carrier evaluations may require greater spares support of equipment that is sensitive to the high accelerations that will occur during the accelerated launch and recovery sequences. Certain equipments/hardware may fail prematurely because of operations in the shipboard electromagnetic or salt water environment.

Also, the support of new aircraft may require maintenance skills that are not currently available through normal training courses and may require contractor support. Repetitive removals/replacements to check and/or repair test components or instrumentation may far exceed the typical operational requirement for the aircraft. It is incumbent upon the FTE to urge the early training of personnel and try to acquire maintenance resources at a higher level of manning than will normally be used to support an operational version of the test aircraft.

It is vital that T&E peculiar support requirements be communicated to the logistics support community and put in place for the test. Special emphasis is required for long lead-time items such as peculiar support equipment and technical orders.

5.2 OBJECTIVES

With proper test planning and communication, the FTE can alleviate delays to the test program that are caused by the unusually high use of specific logistics support and/or arrange his planned order of tests to match logistics support availability. The FTE must understand the implications of the tests that are being designed and the impact on the logistic support system that is primarily oriented to providing support to operational aircraft (after all, the prime provisioning organization is responsible for thousands of operational aircraft and the special needs of the T&E community are an aberration that they must endure). When conducting tests or qualifying a new aircraft, it is valuable to involve the logistics support community in the test results, because early reliability/maintainability/supportability data will be useful in identifying problems that may be easily corrected early in the program. (See Section 22).

5.3 PROVISIONING CONSIDERATIONS

Provisioning for T&E, especially of a new aircraft, requires thoughtful consideration of the requirements to provide support for an aircraft that may exist as a one-of-a-kind vehicle with none of the logistics "tail" that will exist for a vehicle that has been in production for several years. The FTEs must ensure that they precisely and exactly communicate the reasons why this particular test program departs from the needs of a "normal" operational aircraft - why do you need twice the normal number of engines for a given number of flight hours, why must you have three times as many sets of brake parts, why do you need four times as many electronic warfare "black boxes" and a dedicated set of support equipment for one aircraft when one set is normally used to support a whole squadron, etc.

The FTE should consider the need for special supply chain requirements, especially for programs with unique equipment under test. These requirements may include a "bonded" storeroom for spare parts support or inventory of special consumables. Further, if there are special maintenance requirements, the FTE may want to set up unique arrangements to expedite maintenance of parts. For instance, a system/part may require special handling, or transportation may need to be expedited to a repair facility or to the component manufacturer for engineering analysis, rather than using normal supply methods. The FTE needs to ensure that a unique/specialized piece of equipment under test doesn't get lost in the supply system. This will be applicable to systems that require maintenance at the intermediate or depot level.

5.4 COMMUNICATIONS REQUIREMENTS

It is incumbent upon the FTEs to communicate their special needs for support to the local logistics organization at the planning meetings and provide them with the information that they will require to convince a test sponsor to provide unusual quantities or amounts of logistic support.

5.5 TYPICAL PRODUCTS OF TEST PLANNING

By successfully communicating their peculiar test support requirements to the local test support activity, and then in turn supporting their efforts with the test sponsor, the FTEs will achieve a test program that will experience a minimal number of delays because of logistics support considerations since all test support requirements will be clearly outlined in the test planning document.

5.6 SPECIAL CONSIDERATIONS

The following are specific areas that the FTE should give increased emphasis in the planning of the flight test program to ensure its success:

- Logistics support needs to be planned right up front in a program. Special logistic requirements will take a relatively long time to identify and implement (successfully). Logistics support will be especially critical for tests conducted at remote sites such as those required for climatic and all weather tests or carrier suitability trials. (See Section 18). It will be extremely difficult to play "catch up".
- The organization performing logistics T&E should be familiar with the specific program as well as generic logistics requirements. The FTE can use this organization to assist logistics support planning.
- The FTE should work closely with the logistics sponsor (e.g., the Assistant Program Manager for Logistics) to ensure the program needs can be met. This sponsor is normally the person who can help in the early planning and execution of the program to ensure that long-lead items are available during the flight test execution phase.
- The novice FTE should understand "normal" operational logistics (at a high level) in order to comprehend how/why specific unique program requirements may be different.
- There may also be logistics support requirements for special test instrumentation, unique diagnostic equipment, etc., that must be considered.

5.7 CONCLUDING REMARKS

Proper logistic support can make the difference between a timely, effective T&E program and one that fails to provide information in a timely fashion. It is the FTEs' responsibility to identify logistic support requirements in a timely fashion and then to communicate these needs to their local logistic support organization. The FTEs must then stand ready (and volunteer their support) to assist the local logistics organization in acquiring the logistic support that will assure the successful conduct of the T&E program.

5.8 BIBLIOGRAPHY

US Air Force Regulation (AFR) 800-8, "Integrated Logistics Support Program", June 1986.

MIL-D-23222(AS), "Demonstration Requirements", 18 Mar 1971 with Amendment 1 of 30 Jun 1983.

MIL-D-8708A(WEP), "Demonstration Requirements for Airplanes", 13 Sep 1960.

DoD Directive (DoDD) 5000.3, "Test and Evaluation", 26 Dec 1979.

DoDD 5000.40, "Reliability and Maintainability", 11 Dec 1992.

MIL-STD-1388.1A, "Logistic Support Analysis", Rev A, Change 4 of 21 Jan 1993.

Strike Aircraft Flight Test Manual (SAFTM-01), "Carrier Suitability Testing Manual", 3 Apr 91.

Naval Air Warfare Center, Flight Test Engineering Group Instruction (FTEGINST) 3120.1 "FTEG Shipboard and Off-Site Shorebased Test Operations", 28 Jul 1992.

Chapter 6 – FLIGHT TEST INSTRUMENTATION

David R. Crouse

US Air Force Flight Test Center
Edwards AFB, CA 93524-6630
USA

6.0 INTRODUCTION

The purpose of a flight test instrumentation system is to acquire data about the operation of the test vehicle and provide the data to the data processing group. As a flight test engineer (FTE), no matter what discipline, the FTE needs to define the measurands needed for the assigned tasks to the instrumentation engineer. In general, a test article will support multiple discipline testing. Many measurands are requested by more than one user and the FTE needs to coordinate with engineers from other disciplines to define those measurands. Other measurands are exclusively the lead FTE's. All must be defined in detail.

A great deal of detailed information is required to prepare and implement an adequate instrumentation specification. This section will provide some general information on the elements that make up an instrumentation system and provide guidance on where to find additional information. AGARDograph 160, the Flight Test Instrumentation Series of volumes, provides a wealth of information equally useful to the neophyte or journeyman engineer. [6-1]

6.1 THE INSTRUMENTATION SPECIFICATION

The instrumentation specification describes the measurands that the FTE requires to successfully evaluate and report on the performance or specification compliance of the vehicle and the solution to those requirements as installed in the test vehicle. For the most part, the specification will consist of bits and pieces of information passed to the designer through meetings, memos, and verbal communications, while the solution will be in the form of drawings, installation instructions, operating procedures, and various configuration lists. Seldom is a single comprehensive document prepared. In researching data for this chapter, the author queried many organizations for standards they used for the specification. While at first glance there appeared to be many, a deeper look discovered that, almost always, the standard was violated for the particular program involved. The reason was that the particular program involved significant differences that necessitated addition of new material or deletion of old. Paragraph 6.3 shows one approach. The FTE is advised to contact the instrumentation group early in the program to see exactly what data they need to successfully design a system for their program.

6.2 INTRODUCTION TO INSTRUMENTATION SYSTEMS

Instrumentation Systems can be classified in two areas: airborne and ground.

6.2.1 Airborne Systems

The purpose of an airborne instrumentation system is to acquire data about the operation or environment of a test object and store and/or transmit that data for future use. The system can be broken down to five to six basic components:

- A **transducer** that senses the phenomenon of interest
- A **signal conditioner** that converts the transducer output into a standardized signal, usually electrical (several successive conditioners may be needed)

- A **multiplexer** to allow multiple signals to share time or space
- An **analog-to-digital converter** (in the case of a digital system)
- A **modulator** that converts the standardized signal so that it can be recorded
- A **recorder** that stores data for future retrieval.

The modulator often includes a multiplexer that allows multiple signals to share time or space. The signal to the recorder is often fed to a telemetry (TM) link that allows real-time, ground display of data and/or ground recording. Large systems in large aircraft also often include airborne data processors to convert the sensed information to engineering units. Ancillary items include power supplies, control/display panels, etc.

The systems run from very simple to very complex. Examples of very simple systems include: production aircraft sensors for transducers, production cockpit instruments for the signal conditioning, an FTE reading several indicators as the multiplexer, the FTE's eyeball to hand-motion reflex as the modulator, and paper on the FTE's knee-board and a pencil for the recorder. Another simple system is a video camera positioned to view the instrument panel and video recorder. A complex system may have hundreds or even thousands of both production and special transducers; racks of signal conditioners; programmable multiplexers that allow in-flight selection of a subset of the total available transducer suite; programmable signal conditioners or modulators that allow range changes on the data depending on a particular flight condition; multiple or very powerful computers that not only convert data to engineering units but also can provide analysis and visual presentation of data. The majority of installed data systems fall between these two extremes.

6.2.1.1 Transducers. Transducers can be purchased or custom designed and built to measure almost any physical phenomenon, to almost any range, and to almost any accuracy. Cost and availability separate the low end items from the high end ones. Various AGARDograph Flight Test Instrumentation Series Volumes describe detailed use of many transducers. [6-2] Most transducer manufacturers will provide technical documents describing their devices. Sources for finding manufacturers include (in the US) Vendor Catalog Service, [6-3] Electronic Engineers Master (EEM) catalog and Thomas Register. [6-4, 6-5] These documents also apply to other system components as described later.

6.2.1.2 Signal Conditioning. Equipment for signal conditioning can also be purchased or custom designed. Fewer types are normally required than transducer types as widely different transducer inputs have identical outputs. One function of signal conditioning the FTE must know about and sometimes specify is filtering. Description of detailed signal conditioning design can be found in AGARDograph 160 Volumes 1 and 19. [6-6, 6-7] NASA publication 1159 also contains much information on analog conditioning. [6-8] Manufacturers of signal conditioning and of integrated circuits for signal conditioning often include details in their literature.

6.2.1.3 Modulators. The modulators currently in use include Frequency Modulation (FM) systems and Pulse Code Modulation (PCM) Systems. The Range Commanders Council (RCC) has prepared standards for both these approaches. Their Inter-Range Instrumentation Group (IRIG) standards are used throughout the world. [6-9] Due to the large investment for all the possible combinations, particularly in FM, not all data processing facilities have all the necessary equipment. Use of any facility, other than the facility the designers are familiar with, requires coordination.

In the multiplexing portion of PCM encoding, measurands are normally sampled sequentially. The designer must know if the FTE needs simultaneous samples of specific measurands. While FM systems appear to be continuous, most data processing systems eventually sample the data just as a PCM system does. The FTEs should ensure that the data is processed in the way they need.

6.2.1.4 Aircraft Avionics Data Buses. Besides the measurands acquired by the previously described classical flight test transducer/signal conditioner/multiplexor/modulator chains, many measurands are now available on aircraft avionics buses. In modern flight test programs of some significance, the number of digital data bus measurands is usually much bigger than the number of classical flight test measurands. The data on these buses is already in a digital format. The desired data are extracted from the data buses and are often multiplexed into the data streams with the other PCM data. As the digital words on these avionics buses are much longer than the 10-, 11-, or 12-bit words of the classical PCM words, special precautions must be taken to enable later decoding. The data bus systems used in the civil aviation community are described in ARINC-429 and ARINC-629, while the military data bus standard is described in MIL-STD-1553. [6-10, 6-11, 6-12] More modern versions of the military bus standard are in preparation, i.e., a 10 MHz version and a fiber-optic version for even higher frequencies.

6.2.1.5 Recorders. Most modern recorders use magnetic tape. Size of the recorders and complexity tend to be related to data rates and, to a lesser extent, recording time desired. Since the tape becomes an interface with the ground processing system, coordination is essential. As above, the instrumentation design function normally will assure that the local facility can handle the tape but if the FTE plans to use other facilities, coordination with them is an additional task. Again, IRIG standards exist for most recording approaches. [6-13] A detailed description of recording approaches is available in an AGARDograph. [6-14] In addition to tape recorders, some applications require on-board, real-time data and stripchart recorders are often used. They provide a time history of data by writing a continuous line on moving paper.

While not usually considered as a classical transducer, film cameras and/or video cameras often are used to record data. Many test programs are conducted using cockpit instruments recorded with over-the-shoulder cameras. A common use for video cameras is flow visualization. Recorders for video cameras are also used, normally based on industry standards, i.e., VHS, HI-8, etc. Systems to mix PCM data with video and then record using standard video recorders are now available. [6-15]

6.2.1.6 Telemetry. TM systems are used either in conjunction with airborne recorders to transmit portions of the entire data stream to the ground or with only ground recorders when the entire data stream is transmitted such as tests of air-to-air or air-to-ground missiles. Telemetry without on-board recording may also be necessary for cost, safety, or space reasons.

For most military testing, encryption of any transmitted PCM data is required. This requires additional equipment both on the vehicle to randomize the PCM bit stream and on the ground to recover the original data. Availability of special encryption equipment for both the vehicle and more particularly, ground play-back, is often a problem; also, the more items or procedures that are inserted between the measurand and the FTE, the more possibility of failure or a misunderstanding. The delay in receiving processed data from a recorder must be balanced against total data loss if an encryption failure occurs (all TM) and the ability to monitor system health, safety, and security requirements for an encrypted vehicle.

Another TM consideration is transmitted bandwidth. The more data transmitted, the wider the bandwidth required. A project will normally share the allocated bandwidth. If a program is not the top priority project, scheduling may be a problem. The FTE must be sure to identify any remote testing. While local facilities may be able to handle test TM requirements, the FTE must be sure that any remote sites also have the necessary equipment.

Video signals are sometimes desirable for real-time viewing. The TM bandwidth, particularly for color, is very large. Digital encoding for encryption purposes is also possible. TM bandwidth can be made lower if lower resolution and/or frame rates are acceptable. [6-16]

6.2.1.7 Ancillary. Ancillary items are those associated with but not strictly part of the instrumentation system. They are often designed and installed by the instrumentation department. They include items like systems to excite the vehicle's flutter modes. [6-17] Another ancillary item is the instrumentation ground support cart.

The ground support cart provides test equipment for operational and pre/post flight checks (paragraphs 6.4.3.4 and 6.5.2). Such items as signal simulators, tape recorders, oscilloscopes, etc. are installed in a mobile cart that can be moved near the aircraft. The instrumentation department often has standard carts available but for some projects, a custom cart must be designed and manufactured.

If the project includes remote site testing, the FTE must specify the location and schedule in the instrumentation specification. Often ground support items are shared among many vehicles or programs. Planning must occur to acquire (or borrow) items to support the remote testing. Remote testing also affects the basic system design. Often for a small system, telemetry will be the choice for recording. Knowledge of any off-range testing where there are no receiving facilities could change the choice.

On-board computational capabilities, particularly for large aircraft, grow each year. It can provide the pilot or airborne FTE with higher resolution displays of flight conditions or displays of data not normally available in the recent past. Additionally with TM, the ground-based FTE can have access to engineering unit data without ground processing delays.

TM uplink of control data or pilot advisory data is possible, particularly in single seat vehicles. It allows the flight controller to off-load non-flying tasks from the pilot and, as above, to present flight data to the pilot or FTE that is not available in production instruments. Other airborne items are often considered as part of the instrumentation system. Radar tracking beacons, on-board space positioning systems, etc., need to be considered and specified.

6.2.2 Ground Systems

Ground instrumentation systems in general are used by many separate programs and require relatively large capital investment. These systems include tracking radars, optical tracking systems, electronic warfare threat simulators, ground vibration simulators, anechoic chambers, weather measuring systems, and data processing. The emphasis of this section is the airborne system but the FTE must also consider the requirement for and the need for compatibility with ground systems.

A special item of ground instrumentation is the telemetry ground station. In this station the telemetry signal is received and processed to present data to the FTE and other ground-based personnel during flight. This system can be sophisticated, with specialized computers and graphical workstations giving engineering units or can be very simple with strip chart recorders. Magnetic tapes recorded during flight can also be processed by the ground station.

Often a test bench will be used to integrate various airborne system components and provide for ground maintenance by simulating an aircraft installation. Both generic benches and aircraft specific benches are used. Interoperability of components can be observed early in the design and problems can be found and solved well before the actual installation. As software becomes more and more part of the instrumentation system, it too can be checked on the bench and if a recorder or aircraft TM transmitter is included, testing of the data processing for the project is possible.

6.3 INSTRUMENTATION SYSTEMS MANAGEMENT

To ensure a successful execution of the intended flight tests (including the data processing and interpretation afterwards) it is essential to have a good configuration management system. At least the following documents are needed.

6.3.1 Measurand List

The measurand list contains the complete set of measurands that have to be recorded during the intended flight tests and their associated characteristics. It includes measurands from standard production aircraft systems as well as special flight test sensors.

Typical information present in the measurand list is:

- Measurand title
- Abbreviated title
- Measurand description
- Engineering unit
- Range (minimum/maximum)
- Accuracy
- Resolution
- Frequency response (in Hertz) (from which sample rate (PCM) or bandwidth (FM) are derived)
- Data processing information (e.g., spectrum or time series)

This list represents the needs of the FTE, other data users, and the instrumentation engineers (IEs). In larger instrumentation systems an instrumentation coordinator will have the task of guiding this specification process. The IEs must be able to assess the requirements and add measurands if they feel there are omissions or housekeeping measurands (instrumentation system health) needed. On the other hand, he has to ensure that the system is not growing out of bounds because of excessive demands. Therefore, the IE has to be convinced of the need for the measurands and their specifications (especially accuracy and sample rate).

6.3.2 Instrumentation List

The instrumentation list contains the list of the equipment needed as derived from the measurand list by the IE and the instrumentation designer. It describes transducers, signal conditioners, multiplexers, and recorders needed.

Typical information in the instrumentation list includes:

- Abbreviated title for the measurand
- Range (as realized)
- Accuracy (as realized)
- Resolution (as realized)
- Calibration table references
- If applicable, avionics bus reference (ARINC or MIL-STD-1553)
- Registration method (FM, PCM, etc.)

Optionally the information in the measurand list can be updated to show the realized configuration. The FTE must understand any variances between their requirements and what is realistically available. The IE needs to apprise the FTE of the cost, impact on data processing and analysis, etc., of the FTE's requirements.

6.3.3 Flight Test Equipment List

The flight test equipment list describes all the provisions needed in the aircraft to perform the tests. Besides the mechanical and electrical provisions needed for the measurands it also specifies the provisions for the execution of the flight tests (e.g., special intercom systems, cockpit instrument display repeaters, ballast provisions, etc.). Also included are cockpit or flight test equipment panel switches and indicators.

6.3.4 Configuration Descriptions

The configuration descriptions contain the actual realization of the measurand system. Together with the instrumentation list it is needed for the data processing and telemetry. In the descriptions the following is typically available:

- Description of the PCM frames
- Description of avionics bus data streams
- Description of the FM channels
- Description of tape recorders track assignments

In the case that the total measurand requirement is greater than the measuring system capacity, several configurations may have to be defined, related to particular test types. Each configuration then contains a subset of the instrumentation list.

6.3.5 Instrumentation Report

To have a complete description of the measurand system and the involved flight test equipment an instrumentation report is compiled. This report contains information about the measurands available in the system. This is done by giving information about the measurand in text and sketches with references to installation and wiring drawings. If the measurand system will be installed for a long time, information relating to changes (paragraph 6.3.6) should be added.

6.3.6 Measurand System Change Proposals

In order to control changes to measurand systems, change proposals need to be centrally controlled. Since any changes affect the IE, FTE, system designers, and potentially the data processing, a review process that involves all is required. The process needs to look at added costs and feasibility as well as capacity of the installed system. After approval of the change, the previously mentioned lists need to be updated to reflect the new configuration.

6.4 DESIGN CONSIDERATIONS

6.4.1 System Performance

As can be seen from the previous sections, many variables drive system performance. Many compromises will need to be negotiated between the FTE and the designer to reach an acceptable, feasible, cost effective system within the time allotted. Many measurands at high data rates require a high speed data system, high data rate recorder, and/or wide bandwidth telemetry system. Depending on the type of recorder selected, the high data rate will shorten record time. Data tapes can often be replaced in flight, a chore in a single seat vehicle but very feasible in a large aircraft. For a very few measurands that are available on flight instruments the FTE should consider either the over-the-shoulder camera or even hand-recorded data.

Another system performance issue is the environment where the vehicle will operate or be maintained. Climatic testing is particularly harsh and special consideration must be paid to heating or cooling equipment and for the human interface for calibrations, etc. (See Section 18) [6-18] The instrumentation system itself should be environmentally tested according to the appropriate civil or military standard. [6-19, 6-20]

6.4.2 Time Synchronization

One other design consideration not mentioned before is time synchronization. Recorded data requires time to allow searches of the tape for specific events and to allow reruns of sections of the tape at a later time. Time can be in the form of elapsed time from some specific event such as engine start but more often is time-of-day, usually Greenwich Mean Time. If there are other data sources such as other aircraft flying as targets or ground sources, such as photographic or radar trackers, the FTE must analyze the synchronization that is required between sources. The designers need knowledge of any special timing correlation so appropriate error budgets can be considered. Timing formats are also the subject of an IRIG standard. [6-21]

With the increasing availability of Global Positioning System (GPS) satellites and airborne components, an independent source for very accurate time is available and should be considered. [6-22]

6.4.3 Design Phases

The following sections briefly describe some of the tasks that occur to translate the FTE's measurand requirements into an operational system. While the phases are easy to define, schedules often require overlapping them. Overlap and system installation during vehicle manufacture have an advantage over sequential phases. Feedback on the success of the design is immediate and if changes are necessary, the design strategy will be fresh. Sequential design accommodates optimization of space usage for components as nothing is installed until the design is finished. Simultaneous instrumentation installation with vehicle manufacture requires constant coordination with the aircraft designers on space, power, and systems used. The FTE often can help the instrumentation designers with this as often the FTEs are the first consulted on production systems.

6.4.3.1 Initial Design. The process of instrumenting a vehicle often starts with rough order of magnitude (ROM) estimates. This ROM process allows the designers to size the system, analyze the power and space requirements, and estimate installation time and costs. At this point, the FTE will provide estimates of measurand quantities and sample rates; specific measurands, accuracies, etc., are not needed. Once the detailed measurand requirements are defined, the initial design can occur.

During the initial design, the designer uses the measurand list to verify the appropriate basic system design approach, hopefully the same as any earlier estimate. Large, relatively low response systems will normally utilize PCM while small, relatively high response systems will utilize FM. Large combined low and high response systems will be a combination. Transducers will be selected for the majority of the measurands and signal conditioning approaches will be defined. The system block diagram is prepared to allow all involved to easily see the end product. The lists of paragraph 6.3 are skeletal at this point, with information filled in as the design proceeds. The design team will also evaluate the parts requirements and order long-lead items.

Data reduction issues begin to be evaluated in coordination with the reduction facility. Such items as data formats, time correlation, TM frequencies and other TM characteristics, tape recorder characteristics, etc., need coordination to assure that the facility can receive or play back airborne data and provide the FTE with flight test data. Organizations that have integrated airborne instrumentation and data reduction groups will usually coordinate programs. Where the airborne instrumentation function is separated from the data processing function, operational problems often occur. The FTE must be sure that coordination occurs so the data from each system plays with the other systems.

A word of caution - realism in measurand requirements and definition is essential. In general, each measurand costs money, consumes space, requires electrical power, and adds to both installation and preflight/post-flight maintenance time. Over-defining measurand definitions (accuracy, sampling rates, etc.) can add significantly to these areas. When a development action is needed to acquire a new device, schedules can additionally suffer. The FTE should be ready to defend the measurand requirements. If the designers are following the instructions in AGARD Instrumentation Series, Vol I, they will question each measurand. Is it needed? Is the accuracy appropriate? While the discussion may become heated, it is necessary. [6-23] The FTE must understand the impact of his requirements. The IE can play an invaluable role by apprising the FTE of the impact of his requirements, what the impact on the final data product is when the FTE agrees to a restriction, the time and availability impact of reducing his requirements, etc. There must be a clear understanding between "what is nice to have" and "what is mandatory" to satisfy test requirements.

6.4.3.2 Detailed Design. After the preliminary design is finished, the "grunt-work" of detailed design occurs. Custom signal conditioning is designed, bread-boarded and fabricated; point-to-point wiring diagrams are drafted; locations for transducers and other components are selected; mounting structures are designed, analyzed, drafted, and fabricated; and routine parts are ordered. Design reviews of the details are normally conducted before releasing the drawings for fabrication. The FTE should be involved in reviews, questioning if the design meets the measurand list requirements. At this point major changes become very expensive. Most designers will allow for addition of measurands during design, installation, and even operation of the system. Changes that add additional signal conditioning, transducers, or change the basic design, i.e., PCM to FM, will significantly add to the cost and adversely impact the schedule.

The plan for the acceptance test (paragraph. 6.4.3.4) will be written during the final part of the design phase. The FTE needs to review the plan to assure that it will define whether the system meets his requirements.

6.4.3.3 Installation. The culmination of all the design efforts occurs with the installation of the system in the vehicle. Often this is the first time the designers/IEs have had contact with the actual test article. Design changes can be forced by undocumented prior modifications or production changes where documentation has not caught up. Various brackets, transducers and components are installed. Wire is installed and connected to the components. Electrical continuity and power checks are performed.

6.4.3.4 Verification. After the system is installed, an acceptance test will be conducted to verify that the design performs as intended. Transducers measuring vehicle functions (positions, etc.) are exercised over

their full range. Often other measurands (pressure, temperature, etc.) are checked with portable calibration standards. Those that can't be checked are simulated. Custom fixtures may be needed for position measurements or to connect standards to the vehicle. Their requirements must be considered early with design and manufacture finished for this phase. Very important verifications, especially in this age of all-electric aircraft, are Electromagnetic Interference and Electromagnetic Compatibility tests on the installed instrumentation system (See Section 27). If necessary, one or several flight tests are conducted to assure system operation. The FTE needs to monitor the results to assure that his needs are met.

6.5 OPERATIONAL CONSIDERATIONS

Numerous operational aspects must be considered as part of the system design. The environment and off-site issues were mentioned earlier.

6.5.1 Calibration

Calibration, the determination of the over-all transfer function of each measurand from the sensor to the encoder, must be carefully thought out. Special fixtures are often required for on-vehicle measurands and must be fabricated and certified. Normally those required for verification (paragraph 6.4.3.4 above) are used. On-vehicle calibrations usually do not provide for error determination of environmental effects. Checks for this in a laboratory may be needed. Occasionally special spot-check items are designed, particularly when verification item availability is limited, or handling, special hanger, etc., preclude operational access.

Removable transducers can be calibrated in a laboratory and environmental effects can usually be determined. Effects of interfacing the transducer with the next item in the system, signal conditioning for instance, need to be determined at some point.

If loads testing is planned, calibration of any strain gaged structures must be considered. Most flight test facilities will have the ability to handle smaller components such as drag links, tail hooks, etc., but external facilities may be needed for complete landing gear, wings, or fuselages.

6.5.2 Pre/Post-flight

Pre/post-flight operations involve checking measurands for reasonableness; a complete calibration involving multiple points over the full range, is normally not done. Checks can be performed with the ground cart or with TM transmission. Each approach has advantages and disadvantages. Ease of ground cart scheduling and TM transmission scheduling may drive a solution. The weather and ability to utilize a hanger may also drive to more limited checks, forcing more reliance on in-flight data to ascertain system health. Other activities include loading tape recorders, encryption codes, etc.

6.5.3 In Flight

In-flight monitoring by instrumentation personnel, if TM is used, can provide quicker analysis of system health than post-flight checks. Special instrumentation maneuvers, conducted between flight test data points, that exercise measurands not required at that time, can allow early diagnosis of potential problems.

6.5.4 Record Keeping

As mentioned in paragraph 6.3, the day-to-day configuration of the system must be tracked. While many components of a system have no effect on the resultant data, others such as transducers, signal conditioning, etc., do. Any format changes and calibration changes must be inserted into the data

reduction system. Failure to do so will produce incorrect data for FTE analysis. In most instances, erroneous data will be easily seen, but usually after data processing, resulting in a costly re-run. Subtle changes are harder to spot and may result in many flights needing data reprocessing.

6.6 CONCLUDING REMARKS

Many factors must be considered in the design and installation of an instrumentation system. The FTE must define the measurands and the operational environment of the program early with reasonable goals, and be able to compromise. The biggest concern voiced by instrumentation designers throughout the years has been COORDINATION. An FTE with minimal knowledge of what an instrumentation system can do, who coordinates with the designers will have a successful program. Those who assume that their wishes will be absorbed by osmosis will have unsuccessful programs.

6.7 ACKNOWLEDGEMENTS

The author would like to acknowledge the contributions of Paul Harney, NASA Dryden Flight Research Center, and Michiel van Loon, Fokker Aircraft B.V. Without their suggestions and editing this section would not exist.

6.8 REFERENCES

- [6-1] AGARDograph No 160, Vols 1 - 19, "Flight Test Instrumentation Series". (Note: AGARDograph 160, Vol 1, "Basic Principles of Flight Test Instrumentation Engineering" was originally published in 1974. Issue 2 of Vol 1 was published in 1993).
- [6-2] AGARDograph No 160, Volumes 2, 3, 4, 6, 7, 8, 11, and 15 contain information relating to various transducers.
- [6-3] Vendor Service Catalog. Available on microfilm, Visual Search Microfilm File (VSMF) or CD ROM from Information Handling Services Inc, Englewood, CO.
- [6-4] Electronic Engineers Master Catalog, published annually by Hearst Business Communications Inc., Garden City, NY.
- [6-5] Thomas Register of American Manufacturers, published annually by Thomas Publishing Co., New York, NY.
- [6-6] "Basic Principles of Flight Test Instrumentation Engineering", AGARDograph No 160, Volume 1, 1974, pp. 5.1 - 6.13.
- [6-7] Bever, G.A., "Digital Signal Conditioning for Flight Test", AGARDograph No 160, Volume 19, 1991.
- [6-8] Veatch, D.W. and Bogue, R.W., "Analog Signal Conditioning for Flight Test Instrumentation", NASA Reference Publication 1159, January 1986. (also published as AGARDograph No 160, Volume 17)
- [6-9] "Telemetry Standards", Inter-Range Instrumentation Group (IRIG) Standard 106-93. Secretariat, Range Commanders Council, White Sands Missile Range, New Mexico, chapters 3 and 4.

- [6-10] ARINC Specification 429 (including revisions and supplements), "Mark 33 Digital Information Transfer System (DITS)", Aeronautical Radio, Inc., Annapolis, MA, USA.
- [6-11] ARINC Specification 629 (including revisions and supplements), Multi-Transfer Data Bus", Aeronautical Radio, Inc., Annapolis, MA, USA.
- [6-12] MIL-STD-1553, "Aircraft Internal Time Division Command/Response Multiplex Data Bus".
- [6-13] "Telemetry Standards", Inter-Range Instrumentation Group (IRIG) Standard 106-93. Secretariat, Range Commanders Council, White Sands Missile Range, New Mexico, chapter 6.
- [6-14] Bennett, G.E., "Magnetic Recording of Flight Test Data", AGARDograph No 160, Volume 5, 1974.
- [6-15] Comeau, C.P. and Fischer, J.F., "System for Multiplexing PCM Data with Video Data", International Telemetry Conference Proceedings, Vol XXVI, 1990, Paper 90-724 and Jensen, P., "A Data to Video Encoding and Decoding System", International Telemetry Conference Proceedings, Vol XXVIII, 1992, Paper 92-0505, and Kailawai, George, Capt., and McQuillan, Richard, "Flight Test and Evaluation of a Prototype Airborne Video and Pulse Code Modulation Multiplexing System", Proceedings of the Society of Flight Test Engineers, 15th Annual symposium, 1986.
- [6-16] Gattis, S.L and Rieger, J.L., "Color Extension for HORACE TV Compression Protocol", International Telemetry Conference Proceedings, Vol XXVI, 1990, Paper 90-725.
- [6-17] van Nunen, J.W.G. and Piazzoli, G., "Aeroelastic Flight Test Techniques and Instrumentation", AGARDograph No 160, Volume 9, 1979.
- [6-18] Hendrickson, C.L., "Flight Testing under Extreme Environmental Conditions", AGARDograph No 300, Volume 8, 1988.
- [6-19] Radio Technical Commission for Aeronautics (RTCA)/DO-160C, "Environmental Conditions and Test Procedures for Airborne Electronic Equipment", RTCA, Washington, D.C. 20005, USA.
- [6-20] MIL-STD-810, "Environmental Test Methods".
- [6-21] "Time Code Formats", IRIG Standard 200-89. Secretariat, Range Commanders Council, White Sands Missile Range, New Mexico.
- [6-22] SS-GPS-300B, "System Specification for the Navstar Global Positioning System", US DoD Program Specification, 28 Jan 1987.
- [6-23] "Basic Principles of Flight Test Instrumentation Engineering", AGARDograph No 160, Vol 1, 1974, p. 2.3.

6.9 BIBLIOGRAPHY

Strock, O.J., "Telemetry Computer Systems: The New Generation", Instrument Society of America, 1988, ISBN 1-55617-098-X.

van Doorn, J., et al., "MVRS, A System for Measuring, Recording, and Processing Flight Test Data", NLR MP 88034 U, National Aerospace Laboratory (NLR), The Netherlands, 1988.

US Air Force Systems Command (AFSC) Regulation 80-33, "Class II Modification of Aerospace Vehicles Research and Development".

US Navy Flight Test and Engineering Group Instruction (FTEGINST) 13050.3, "Procedures for Planning and Coordination of Aircraft Instrumentation Installation", 26 July 1994.

Storm van Leeuwen, S. and Voskes, A., "The Data Acquisition System for the Fokker 100 Test Aircraft", Proceedings of the 18th Symposium of the Society of Flight Test Engineers, Amsterdam, 1987.

Strock, O.J., "Introduction to Telemetry", Instrument Society of America, 1987, ISBN 0-87664-980-0.

"Telemetry Applications Handbook", IRIG Document 119-88, Telemetry Group, Range Commanders Council, White Sands Missile Range, NM 88002, USA, 1988.

Chapter 7 – DATA PROCESSING

Robert L. van der Velde
Instrumentation Department
National Aerospace Laboratory NLR
Anthony Fokkerweg 2
1059 CM Amsterdam
THE NETHERLANDS

7.0 INTRODUCTION

Data requirements are directly dictated by the program and its reporting requirements. After all, the entire purpose of a flight test program is to provide data to facilitate system development, evaluation, certification, and ultimately, use. Definition of data requirements is a multiple step process that includes specifying the tests and test conditions, identification of the parameters that must be measured, the rate and accuracy needed, definition of data turn-around time and data reduction and/or analysis methods, and the data presentation formats required. (See Section 6).

In the sequence of events that make up a flight test program data processing comes between data acquisition and data analysis. It typically starts with the receipt of the flight test data, whether recorded on tape or received in realtime by telemetry link, and it ends with the delivery of the processed data to the end user, the data analyst.

There are many kinds of "data processing" that occur and the Flight Test Engineer (FTE) must ensure that he/she understands what these various processes are and which data that he/she can expect from each step. Some examples of these data processing steps are:

- Conversion of raw binary data into Engineering Unit (EU) data
- Presentation of EU data as numerical values (tables) or graphical time histories, x-y plots, bar charts, etc.
- Pictorial presentation of the flight path and aircraft attitude and other flight or aircraft parameters
- Calculations in the frequency domain (Fast Fourier Transform)
- Data analysis with dedicated software for:
 - Signal analysis
 - Signal filtering
 - Determination of transfer functions
 - Parameter identification
 - "Image processing" of video and radar data

This section will describe the responsibilities and involvement of the FTE in the process of setting-up a data processing facility and obtaining flight test data that is ready for final analysis. It will provide some guidance to the novice engineer on how to proceed in this process and will identify some of the personnel with whom interfaces are required.

It will not describe how data processing is done. Table 7-I contains a summary of elements that, together, constitute "Data Processing". Many, if not all, of these elements are subject of discussion between the FTE and the home-base instrumentation and data processing engineers to ensure that the desired/required data is received in time in the format that is acceptable for analysis and reporting.

The "How" of data processing is discussed in some detail in Chapter 10 of AGARDograph 160, Volume 1 (Issue 2) "Basic Principles of Flight Test Instrumentation Engineering". [7-1] Additional information can be found in reference 7-2.

7.1 OBJECTIVES

Quantitative data obtained by an instrumentation system during a flight test program are almost never in a form that is directly usable by the FTE or the agency that has requested the test. Therefore it is necessary to convert this data into a more usable form. The conversion of this data, be it by means of manual computation or full use of powerful computers, is called "data processing".

The data processing requirements must be spelled out as early as possible during the planning for a test. This planning is an iterative process that starts with a generalized idea of the information needed and progresses ultimately to the preparation of the detailed data processing plan. The FTE must be prepared to specify in great detail how the data that is measured and recorded (See Sections 6 and 8) is to be processed, to specify what data products will be required, and the format in which they are to be presented. He/she must understand the inter-relationships between the instrumentation system, its capabilities and limitations, and the overall capabilities of the data processing system.

The objective of the data processing requirements planning, therefore, is to describe the data products that will satisfy test objectives without over-specifying needs for accuracy, sampling rates, etc.

7.2 PREPARATIONS FOR DATA PROCESSING

In small programs and in some organizations the FTE, data analyst, and report writer functions will be combined in one person. In other organizations, the FTE's responsibilities are to define what data is required in terms of parameters, range, accuracy, sampling rate, output format, etc. Then selection of the best means of data sensing, recording, processing and presentation is left to the expertise of the instrumentation and data processing groups. In somewhat larger programs several FTE's may have to work with the data analysts and engineers in several specialist-departments who use the data to prepare their final reports.

During the preparation stage of a larger flight test program, the FTE must have numerous meetings with the data users of the specialist departments, instrumentation engineers, and data processing specialists in order to prepare the data processing facilities and procedures. The FTE is responsible for the coordination of the work of these people, irrespective of whether it concerns the inception of a new data processing system or the day-to-day operations of an existing system during a flight test program.

Perhaps the most important responsibility of the FTE in this area is to communicate accurately and precisely what the program needs and requirements are. Of course, communication is both "sending" and "receiving", so he/she also needs to listen carefully and understand what he/she is told in terms of how well the combined capabilities of the instrumentation and data processing systems can meet the requirements. The FTE must be willing to consider compromises caused by equipment capabilities and then understand the impact of these compromises on the desired and/or required end data products.

The first item of importance in the process of setting up a flight test program is the drafting of a document with the data user's requirements.

If the program is of such a scope that the FTE will be the coordinator rather than the data analyst/data user, he/she will generally start with interviewing the data users. A good approach is for the FTE to put ideas on paper, together with a preliminary parameter list containing, per parameter, the envisaged range, accuracy, resolution, and bandwidth. He/she then adds a list of questions for the data users to answer and sends the document to the data users prior to the interview so that they know its contents before the interview and, hopefully, have their answers ready at that time. It is effective to conduct these interviews in conjunction with the instrumentation and data processing specialists. In the beginning these discussions will have a brainstorming accent, but later on they must converge to tangible concepts, the costs of which must also be considered. The questions asked during these interviews are:

- Are all the parameters you need in the preliminary parameter list? If so, are the envisaged range, accuracy, resolution, and sampling rate or bandwidth correct? If not, please state your additional requirements.
- Have you found parameters in the list that are superfluous?
- Can you state a priority figure for each parameter, i.e.: 1=essential, 2=not essential but important for various reasons, 3=nice to have?
- What types of flight tests are you thinking of for your discipline?
- Can you specify parameter selections per type of tests (such as take-offs, climbs, dynamic performance testing, static stability measurements, sensor system evaluation, etc.)?
- What is the duration of a measurement run in each test type?
- Do you need data that will be found on an avionics data bus (See paragraph 6.2.1.4)?
- What is the number of measurement runs per test type?
- Do you need quick-look presentation?
- Do you need real-time presentation on board the aircraft or on the ground? Which parameters? (With today's telemetry systems and the emphasis on monitoring during high risk maneuvers such as flutter testing, spin testing, simulated flame-out approaches, and high angle of attack tests, there have to be many early decisions as to what parameters, accuracy, scaling, etc., are needed to reduce the risk and collect the necessary information. Also see Section 10).
- Can you indicate what kind of presentation media and formats you need on board the aircraft and on the ground?
- Can you specify calculations, data manipulations, or data correction or reduction algorithms that have to be performed, real-time and/or post-flight?

The FTE must specify the following information which the data processing specialist needs for the definition of the data processing facility:

- The amount of data, i.e., the number of data samples (determined by the number of parameters and the sampling rate per parameter) to be processed per test flight
- What functions must be available for processing the gathered data
- Within what typical time span those functions are to be performed
- The time period after the test during which it must be possible to repeat data processing operations, i.e., the storage time and storage capacity of the raw test data itself and all associated auxiliary and administrative data such as calibrations, configuration of aircraft and data systems, etc.

With the outcome of these interviews the instrumentation and data processing specialists can make their preliminary system designs and assess the costs for implementing these systems. Between the moment that the requirements of the data users have been formulated and the moment that the data is delivered to them lies a complex process. Before a final system set-up is chosen several iterations will undoubtedly have taken place. It is of prime importance that the process of design, development, integration, test, and evaluation of the data acquisition and processing system is an integrated effort of the representatives of all disciplines mentioned. During this process all questions referred to above, will have to be answered.

The FTE and the other participants need to determine how they intend to keep track of all flight test data, configuration data of aircraft and data system, calibrations, administrative data, etc., and how they intend to exchange this information between the various disciplines before, during and after the test program. Even in a very small, one-or-two-man program a personal computer is indispensable. At the somewhat larger flight test facilities with a continuous flow of test programs there usually is a well-established method of filing, retrieving and dissemination of this information. The more sophisticated facilities use a centralized computer database which serves all participants involved in the preparation and execution of the flight test program and in the analysis and reporting. Examples of such database systems are given in references 7-3 and 7-4.

The outcome of this user's requirements study determines the amount of sophistication required of the envisaged data processing and storage facilities. The FTE needs to consider whether the existing facilities meet these requirements. If the existing capabilities are insufficient specifications could be relaxed. This often results in more primitive ways of obtaining the required data and longer turn-around times and, hence, a longer duration of the flight test program. If this is not acceptable the FTE has to go back to management with the requirement for a more powerful data processing and storage facility. The lead times for the latter solution are long and therefore the preparations for a large and intensive flight test program, which is beyond the capabilities of the existing facilities, must begin at a very early stage.

7.3 DATA PROCESSING OPERATIONS

During the flight test program the FTE must specify per flight:

- The choice of tape, (high speed) film, photo, and video recordings
- The data selections, i.e., which media and which parameters must be processed and during which time periods of the test, for quick-look, real-time and post-flight processing
- The use of special, non-standard aircraft, range or other ground instrumentation
- The processing facilities, depending on which aircraft, range, or other ground instrumentation has been specified for the test
- The accuracy per parameter if that deviates from a previously agreed standard value
- The "processing" rate per parameter (equal to or less than the sampling rate)
- Which functions must be performed on the requested parameters
- The presentation facilities and their location
- The presentation formats of the selected parameters
- The required data turn-around time if this deviates from the standard time.

In order to cope with the requests of the FTE, the data processing specialists need the following information from the instrumentation engineers:

- Information where the requested parameters can be found on the flight recorder media
- The current overall (end-to-end) calibration or component calibrations per parameter.

With this information the instrumentation and data specialists can set up their systems for the coming test flight.

Typically, after each flight, the FTE will specify the start and stop times for each test conducted and identify, where appropriate, any special features or processing requirement. The instrumentation engineer will review the recorded data to identify any anomalies. The data engineer will then collate copies of the data records with the comments from the FTE and the instrumentation engineer and process the data using the agreed equipment and procedures. The processing plan must also include information as to how problems or anomalies are to be reported and to whom processed data are to be returned (normally, a log will be kept to track what is happening to the data, when it was received from whom and to whom forwarded, who was notified of problems, what the problems were, etc.). After each flight the FTE must see to it that the data is adequately validated and made available to the data analysts at the agreed time.

In principle, the end product of the data processing process is such that the data analyst does not have to do any further major processing and that he/she can start analysis right away. In practice the last part of the data processing process is often interactively controlled by the data analyst, especially the part which formats the test results in a suitable way for inclusion in his final report.

7.4 DATA PROCESSING ENVIRONMENT

Each mature test agency, and indeed often each major test project, will have its own data processing environment and its own procedures and requirements as to the way that the data processing environment is utilized. For example, there may be a sophisticated data base management system to store instrumentation calibrations or even previously-acquired data. A beginning FTE does not usually have to start with a clean sheet of paper.

However, the data environment will often offer a wide variety of options to the FTE. He/she must review and select those options which are the most cost and time effective for the program. For example, if the test aircraft contains a telemetry system and real-time display and processing is available, the engineer certainly should utilize of this capability if there is any question of safety of flight. On the other hand, the FTE needs to weigh the relative advantages of this capability in terms of determining "goodness" of data during routine performance or system tests against the cost of acquiring and displaying real-time data.

7.5 SOME ADVICE TO THE FLIGHT TEST ENGINEER

The FTE must always be careful to distinguish between the accuracy and the precision of the final data presentation. A number followed by six significant numbers, i.e., 127.623411 meters, is very precise but it is not very accurate if the basic measuring device is only capable of measuring to +/- 10 meters. For discussions with instrumentation and data processing engineers the FTE must be familiar with the definitions of such notions as accuracy, resolution, sensitivity, and linearity.

The FTE should be aware of the relationship between accuracy, sampling rate and the bandwidth of the available signal as well as the bandwidth required for the test. It is up to the FTE and the representative of the specialist department to determine the required bandwidth of each parameter and the required accuracy. It is up to the instrumentation engineer to assess the occurring signal bandwidth and the

desirability and specification of presample filters, and to establish the sampling rate. If this is not done properly the resulting accuracy might be much worse than anticipated, without anybody knowing it. This issue is addressed in Chapter 6 of the original issue of reference 7-1 and in Chapter 7 of Issue 2 of that same Volume. If the FTE chooses an accuracy or bandwidth which is unnecessarily high, both processing time and money are being wasted.

Airborne instrumentation technology has enabled the measurement and recording of huge amounts of data. Although this permits a greater assurance of not missing the information required to evaluate the vehicle, it often results in much more data being recorded than is necessary for the engineering analysis of the specific test results. While it is good practice to record this data it is not economically feasible nor desirable to process it all. The FTE can quickly be buried in an avalanche of data that would require exorbitant amounts of time to sort out the specific information that is really needed.

It is therefore necessary that the FTE work closely with both the instrumentation engineer and the data engineer to ensure that the selected measurements, sampling rates, accuracies, etc., will meet the needs and not unnecessarily burden the entire data process. The FTE must select only what is needed and not blindly accept what the system can provide. He/she must also be prepared to compromise between what would really be liked and what the system can provide, or what can be afforded, and then understand the impact of each individual compromise.

Modern systems utilizing interactive "smart terminals" capable of presenting both tabular and graphical data on a display screen permit the FTE to scan for events of interest more efficiently than reviewing printed materials. However, this capability does not obviate the need for careful up-front selection of data to be converted to engineering units, or further processed, to avoid excessive and costly use of equipment and time.

An important area where savings can be obtained is in the design stage of the instrumentation and data processing facilities. Often the design of the instrumentation leads the way and the data processing system designers have to cope with what the instrumentation designers have decided. What might be a very cost-effective solution for some isolated instrumentation problem may result in an overall solution which is not cost-effective at all. The bottom-line is that the design process should be a well-coordinated effort. The FTE must play an important role in this process as he/she is generally the person who is held responsible for schedule and costs.

7.6 SPECIAL CONSIDERATIONS

In addition to the cautions noted above on the need to control data volume and the need for compromise, there are several additional items that should be considered.

7.6.1 Perfect Data

There is no such thing as perfect data from flight testing, regardless of the sophistication of the data processing system. Dropped or transposed bits, breaks in transmission or recording, and anomalies within the hardware or software all work to produce imperfect data. A software program that requires perfect data can work for hours and then a parity error or data gap will lose everything. Data can often be salvaged by a skilled operator but it can never be manufactured. The entire data system from transducer to final data products must be considered as an entity. The FTE, instrumentation engineer, and the data engineer must understand this and be prepared to implement procedures to minimize data loss. A small compromise in requested needs can often yield major benefits.

7.6.2 Software Anomalies

The use of "canned" software routines offers the FTE both flexibility and the reduction of labor in developing a set of instructions to produce the required output. However, the more general the application of the software, the more likely will be the existence of unwanted branches lurking in storage recesses to trap the unwary bit or byte and produce a nonsense answer. Small program changes, which seem insignificant at first glance, and made as "quick fixes" to get data out or to streamline a process often ricochet throughout the program causing it to produce nonsense, if it produces anything at all. The more careful the definitions and instructions at the early stages, the more likely is success. Preproduction testing of software by using known inputs for all cases of interest will significantly lower the risks. The FTE should not try to control every aspect of the software preparation and use but once the production version has been established, he/she should insist upon rigid configuration control of both the software and instrumentation system and its calibrations.

7.6.3 Hardware Limitations

Today's modern computer systems appear so overwhelming that little notice is taken of the equipment limitations. Advances in speed and internal self-checking capability have been impressive, but it is still possible to saturate a system with inefficient or faulty software. Word size, storage capacity, and ancillary equipment will always have finite limitations that must be recognized and accommodated. The computer may be capable of marvelous performances but it is still a literal machine which will follow its instructions whether good or bad. The FTE will rely heavily on the knowledge and the advice of the data engineer to describe and mitigate the compromises from some of these limitations.

7.7 CONCLUDING REMARKS

Data processing is expensive and often time consuming. However, proper planning, coordination, and understanding of overall data system capabilities can reduce the cost and increase the responsiveness of the overall process. Conversely, ill-considered requests for data in terms of excessive sampling rates or for data that is "nice" but not required can easily saturate a data processing system, increase costs, and unnecessarily delay final reporting. The FTE holds the key to economical data processing by truly understanding what is needed, what the combined instrumentation and data processing systems can realistically produce, and by being able to accept necessary compromises and understanding the impact of these compromises.

Good early planning and communication will greatly aid the FTEs in ensuring that they understand what is happening to their data and that the data truly represents the test results.

7.8 ACKNOWLEDGEMENTS

Mr. Richard R. Hildebrand, Executive Director of the US Air Force Flight Test Center, and Mr. Frederick N. Stoliker, the Editor of this Volume, made substantial contributions to this Section.

7.9 REFERENCES

- [7-1] Borek, R.W. and Pool, A., Editors, "Basic Principles of Flight Test Instrumentation Engineering", AGARDograph 160 Flight Test Instrumentation Series, Volume 1, original publication in 1974. Issue 2 of Vol. 1 was published in March 1994.

- [7-2] Smith, L.J. and Matthews, N.O., "Aircraft Flight Test Data Processing A Review of State of the Art", AGARDograph 160 Flight Test Instrumentation Series, Volume 12, November 1980.
- [7-3] Oosthoek, P.B., "A Database System Concept to Support Flight Test Measurement System Design and Operation", Proceedings of the 29th Annual International Telemetry Conference, Las Vegas, NV, 25-28 October 1993.
- [7-4] van Teunenbroek, O. and Heerema, F.J., "A Database Oriented System for the Support of Flight Tests", NLR MP 87008 U, National Aerospace Laboratory NLR, Amsterdam, The Netherlands, 1987.

7.10 BIBLIOGRAPHY

van Doorn, J.T.M., et al, "MRVS, a System for Measuring, Recording and Processing Flight Test Data", NLR MP 88034 U, National Aerospace Laboratory NLR, Amsterdam, The Netherlands, 1988.

Johnson, G.G., "Meeting Real-Time Telemetry Processing Requirements of the 1990's", Proceedings of the International Telemetry Conference, Vol. XXV, October 1989.

Rhea, D.C., Moore, A.L., and Scardello, M.A., "An Advanced Distributed Architecture for Real-Time Processing and Display of Telemetry and Space Positioning Data", Proceedings of the International Telemetry Conference, Vol. XXVI, Las Vegas, NV, October/November 1990.

Coonce, K.G. and Schumacher, G.A., "Design and Implementation of a Total Flight Test System", Proceedings of the International Telemetry Conference, Vol. XXVI, Las Vegas, NV, October/November 1990.

Cardinal, R.W., "Data Reduction and Processing System for Flight Test of Next Generation Boeing Airplanes", Proceedings of the 29th Annual International Telemetry Conference, Las Vegas, NV, 25-28 October 1993.

Porter, R.E. and Armour, M.F., "Flight Test Instrumentation and Data Processing at British Aerospace, Warton, UK", AGARD-CP-452: Flight Test Techniques, AGARD Flight Mechanics Panel Symposium, Edwards AFB, California, USA, 17-20 October 1988.

Table 7-1 Data Processing Elements

PREPROCESSING

Data format

- PCM
- PCM with asynchronous subframes
- PCM with embedded MIL-STD-1553 or ARINC 429/629 or custom data formats

Replay of flight and telemetry tapes

- Bit, frame, and word synchronization

Data selection

- Selection of processing periods
- Selection of parameters
- Redundancy removal

Conversion to computer compatible format

Application of calibrations

- Approximation method
 - Best fit straight line
 - Multi-section linear fit (linear interpolation between calibration points)
 - Table look-up
 - Polynomials (nth order)
 - Splines
- Type of calibration
 - Over-all (end-to-end) (in-situ) calibrations
 - Aggregate calibrations
 - Component calibrations
 - Discrete

Application of corrections

Time

- Synchronization
- Correlation
- Tagging

Dealing with delay times

- Pitot-static lines
- Filter delays
- Processing delays

Ident tagging

Instrumentation checking

- Parameter quick-look
- Presentation of raw data

Standard calculations

- Computation of standard derived parameters: Mach, indicated airspeed, altitude, position error correction
- Computation of other simply derived parameters
- Correction of systematic errors

Data validation

Delivery of data to post-processing environment

POSTPROCESSING AND ANALYSIS (real-time and/or post-mission)

Interactive processing/batch processing

Curve fitting

DATA PROCESSING

Data smoothing or filtering
Data compression
Reduction to standard atmosphere
Standard routine calculations
Custom algorithms
Calculations specific to the type of test

- Trajectory
 - Aircraft
 - Stores
- Performance
- Stability and control
- Thrust
- Air data
- Loads
- Wind
- Fly-over noise
- Engine inlet distortion
- Etc.

Coordinate conversions
Standard algorithm library
Signal filtering
Image processing of video and radar data
Parameter identification
Statistical analysis
Power spectral density
Fast Fourier Transform
Transfer function analysis
Frequency response analysis
Etc.

PRESENTATION

Color/black & white
Display screen
Hard copy
Post-flight/quick-look/real-time
Time histories

- Numerical tables
- Graphical plots

X-y cross plots
3D-plots
Bar charts
Annunciator panel
Limit failure
Pictorial display

- Flight path
- Aircraft attitude
- HUD display
- System schematic
- Spin
- Aircraft stores
- Take-off/landing performance

- Predicted threshold
- Positional map
- Other flight or aircraft parameters

DATA PROCESSING FACILITIES

Telemetry (preprocessing) ground station

Tracking antenna, single or dual axis

Preprocessing stations

IRIG-PCM computer front-ends

- Bit- and frame-synchronizers
- Time code translators

Data processing computers

Operating system

Throughput capacity

Storage capacity

Data communication network

Workstations

Printers

Plotters

Equipment for processing and analyzing trace, photo, film, and videorecordings

DATA BASE FOR AUXILIARY DATA

Aircraft identification

Test flight number, date and time

Aircraft configuration

- Mass
- Center of Gravity
- Modification standard
- Equipment suite

Configuration of stores

Configuration of avionics data buses

Configuration of data acquisition system

- PCM formats
- Location of measured physical quantities
- Programming information
- Transducers and signal conditioners
- Aircraft signal sources

Parameter info, definition, technical data

Calibrations

DATA BASE FOR FLIGHT TEST DATA AND RESULTS

On-line data and results files for flight test data users

(Historical) archiving of flight test data and results



Chapter 8 – PREPARATION OF THE FLIGHT TEST PLAN

Ronald J. Harney

Naval Air Warfare Center Aircraft Division
Patuxent River, MD 20670-5304
USA

8.0 INTRODUCTION

Test plans are written for all aspects of airplane testing such as airframe structural tests, flying qualities and performance tests, avionics tests, simulator validation, systems software tests, and engine tests. It is a written document of the duties and responsibilities of those concerned with planning and conducting assigned projects. Thorough and timely reviews of the test plan can aid in ensuring that the test is conducted safely. All members of the test team should be familiar with the test plan prior to conducting test flights.

The knowledge gained from previous tests similar to the tests to be conducted is always of importance. References to previous reports, discussions with experienced test teams, and reference to any flight safety data bases should be included.

This Section provides guidance to the Flight Test Engineer regarding the type of information that should be included in the test plan. The following paragraphs are typical of comprehensive test plans. [8-1]

It should be noted that some organizations separate documentation of safety planning, definition of instrumentation, etc., but all of these elements must be included in the totality of the test preparation documentation. There are some significant differences in the planning tests for commercial aircraft. Some of these differences are noted in paragraph 8.3.

8.1 OBJECTIVES OF THE TEST PLAN

The test plan gives project personnel a systematic approach to the effective, efficient, and safe conduct of the test program. The test plan defines the purpose of the test, the scope of the test, the test methods used, the risks involved with the test, and the risk reduction techniques to be used. (Refer to Section 10 for information on the safety aspects). In this light, it is also a document in which management can obtain a clear and concise description of the objectives of the test and the risks involved in obtaining these objectives. The test plan also provides a means by which management can ensure that adequate planning and preparation have been done, to verify that the test is within the charter or capabilities of the organization, and to ensure that the correct personnel are being used.

8.2 CONTENTS OF THE TEST PLAN

8.2.1 Background

This portion of the test plan introduces the project to the reader. It should include any pertinent information regarding the origin of the requirements for the test program. Reference should also be made as to who is requesting the tests and why. Include previously related tests, operational problems, or any other material which may pertain to the origin of the tests. Generally, this section will include a description of the test article including comments as to how well it represents the article to be deployed for operational service.

8.2.2 Purpose of the Tests

This section provides a clear and concise statement as to the overall purpose of the tests.

The test plan first must define the objectives of the test program so that the test team and management have a clear understanding as to **why** the tests are being conducted. Background material can be included to provide the team with a historical perspective into the program. Test objectives can include the following:

- Develop the system and subsystem
- Determine Compliance with Specified Goals: The most significant portion of flight tests is spent ensuring compliance with the goals specified of the airplane design. The test program should provide essential information for assessment of acquisition risk and for decision making.
- Determine Mission Suitability: The airplane must also be evaluated in the mission environment for which it was designed. Measures of effectiveness in the planned operational scenarios should be evaluated and presented.
- Document Enhancing Characteristics: The test program should allow the project engineer to determine the enhancing characteristics of the system. These would be things such as improvements over original systems or the ability of the system to drastically exceed the minimum requirements.
- Document Deficiencies: The test program should provide the project engineer the means to adequately determine the deficiencies of the system. The deficiencies of the system being tested can be identified as shortcomings of the equipment or system that adversely affect airworthiness of the aircraft, the ability of the aircraft to accomplish its mission, the effectiveness of the crew as an essential subsystem, the safety of the crew or the integrity of an essential subsystem, the ability of the system to meet the contract specifications, and maintainability and reliability of the system.

8.2.3 Scope of Tests

Once the objectives are stated the test plan must next define **what** the test team is going to do. The scope of tests section defines the exact test program that will be required to satisfy the objectives of the test. Typically found in the scope of tests paragraphs are a definition of the tests, the conditions under which the test will be conducted, the test envelope, test aircraft loadings, test aircraft configurations, and a definition of the standards under which the test results will be evaluated.

8.2.3.1 Tests and Test Conditions. A summary of the testing is presented in this section. Include the number of phases, tasks/subtasks, number of flights, and the number of flight and ground test hours required to accomplish the tests. Items such as weather, runway conditions (wet or dry), external loadings and aircraft configuration (gear up or down, flaps up or down, one or more engines inoperative, etc.)

should be included. Weather requirements for one block of test points may be very stringent such as high angle-of-attack tests or performance tests. Other blocks of test points may require less stringent weather conditions such as an Inertial Navigation System test. Also specify both terminal (field) weather requirements and operating area weather requirements.

A detailed matrix that includes the specific tests is included in the body of the test plan or referenced as an appendix to the test plan. The matrix should include each specific test to be conducted and include as a minimum the task title, specific test objective, loading, configuration, airspeed, and altitude. Other items that can be included are applicable specification paragraphs, data required, time to conduct test, and handling qualities task and tolerances. A typical matrix is presented in Table 8-I. The test matrix is also the base from which one builds the data cards.

Table 8-I Test Matrix

Event	Test	Loading	Configuration	Airspeed (KIAS)	Altitude (FT)	Specification	Task/Tolerance	Remarks
1	Taxi	A	TX	As required	On deck	---	Maintain centerline ±5 ft	• Nose wheel steering OFF

8.2.3.2 Test Envelope. In this portion state the flight envelope or test limits for the conduct of tests and the source of the limits. Limits typically can include structural limits, performance airplane limits, and system operating limits. Special note should be made of areas that differ from the usual limits defined in the flight or operator's manual. A typical table for the test envelope is presented in Table 8-II.

Table 8-II Test Envelope

Parameter	Limit
Indicated Airspeed	0 to 300 KIAS
Indicated Altitude	0 to 30,000 ft
CG Normal Acceleration	-1 to +6 g

8.2.3.3 Flight Clearance. A flight clearance is sometimes required if the governing agency responsible for determining aircraft limits is not the testing agency. The flight clearance is a formal document authorizing the testing agency to conduct envelope expansion tests, carry or release non-standard stores, or fly with aircraft structural, flight control, or electrical/mechanical system modifications. If a flight clearance is required, it should be stated in this section. If possible include the flight clearance as an appendix to the test plan. Include the issuing agency, the date the flight clearance is expected to be issued, and when the flight clearance will expire.

8.2.3.4 Test Loadings. This is usually a table of the various external store loadings to be tested. Variables such as gross weight, center of gravity (cg) position, drag index, and external store loading, which may have a significant effect on the tests being conducted, should be included. A typical table of test loadings is presented in Table 8-III. Any asymmetric loading should also be denoted.

PREPARATION OF THE FLIGHT TEST PLAN

Table 8-III Test Loadings

Loading	Description	Store Station				Gross Weight (lb)	CG (% MAC)
		1	2	3	4		
A	Clean wing	-	-	-	-	10,000 - 12,000	23.5 - 23.8
B	Drop tanks on each wing	Drop Tank	-	-	Drop Tank	12,000 - 15,000	23.0 - 24.0

8.2.3.5 Test Configurations. The airplane test configurations should be listed and described. Variables such as configuration, landing gear position, flap position, speedbrake position and thrust, should be included. A typical table is presented in Table 8-IV.

Table 8-IV Test Configurations

Configuration	Gear	Flaps	Spoilers	Thrust
Taxi - TX	Down	Up	Down	As required
Takeoff - TO	Down	20°	Down	MAX
Cruise - CR	Up	Up	Down	TLF(1)
Descent - D1 - D2	Up	Up	Down	85%
	Up	Up	Up	85%
Power Approach - PA	Down	20°	Down	TNA(2)
Landing - L	Down	40°	Down	Idle

Notes: (1) Thrust for level flight
(2) Thrust for normal approach

8.2.3.6 Test Standards. The test standards portion is of extreme importance as the standards ultimately determine the necessary test maneuvers, tolerances, and data requirements. The test standards to be used should be stated in terms of mission, applicable specifications, demonstration criteria, guarantees, etc.

8.2.4 Method of Tests

Most importantly, the test plan must define **how** the test will be performed. Test methods and procedures, airplane's instrumentation, data analysis, and use of check lists should be discussed.

8.2.4.1 Test Methods and Procedures. Test methods, tactics to be used, environment for tests, and equipment required for the test program should be thoroughly described. Include set procedures and buildups in the test methods. Accepted test manuals may be referenced for methods and procedures. Any non-standard tests, however, cannot be referenced and must be described in detail. Reference to operator's manuals, tactics manuals, and approved standard operating procedures is also appropriate. Where applicable, the test matrix can be referenced.

8.2.4.2 Instrumentation and Data Processing. Test instrumentation should be outlined to include the type of instrumentation required and what recording methods will be used. The list should include external instrumentation requirements such as cameras, signal sources, radar and theodolite ranges, laser trackers, telemetry processing facilities, etc. A detailed listing of parameters to be measured, the measurement characteristics, and what parameters will be critical for safety of flight should also be listed. (See also Sections 6 and 10.) A typical table is presented in Table 8-V. Data processing support should be stated in terms of support requirements, who will do the processing and analysis and whether or not special software applicable programs are necessary. The required turn-around times for the various data products should be specified. (See Section 7.)

Table 8-V Instrumentation Requirements

MEASUREMENT	MEASUREMENT RANGE	FREQUENCY RESPONSE	ACCURACY	SIGNAL SOURCE	DATA COLLECTION	OUTPUT DESIRED	REMARKS

8.2.4.3 Data Analysis. Data analysis techniques should be discussed. Techniques could include trend analysis, comparison with previous tests, statistical analysis, etc.

8.2.4.4 Support Requirements. Support requirements should be listed to cover the following:

- Any specialized support laboratories or shops to include metal and machine shops, photography services, or instrumentation laboratories.
- Facilities that require special scheduling such as restricted or operating areas, target tracking ranges, surface or airborne targets, other test facilities, satellite time, and military services.
- Special aircraft requirements such as chase, target, electronic warfare, formation lead, or tanker.
- Special engineering or computer laboratory support.
- Estimated time frame in which the resources/assistance will be required.

8.2.5 Determine Exit Criteria

The test plan takes the system specifications and requirements and evolves them into tangible test limits or exit criteria that need to be met or exceeded. (Note: Exit criteria, for US military systems, are typically defined as the test objectives that have to be met to proceed from technical tests to operational tests). By passing this exit criteria, the test team has verified that the system has met the minimum requirements. The test method and procedures must be established to ensure that the team can test to the exit criteria. For military applications, the exit criteria are typically defined in a Test and Evaluation Master Plan to meet the requirements stated in an Operational Requirements Document.

8.2.6 Management

The management section should cover all items that will be of concern to test management. Items should be included, or excluded, per home base procedures.

8.2.6.1 Funding and Resource Requirements. Funds allotted, their source, and expiration date should be described. The overall manpower and cost estimate should be included as well as any comment as to the adequacy of funds provided. Detailed cost estimates showing labor, material, contract, computer, special support, travel, and flight hour costs may be included.

Test planning must define the required funding level as well as test personnel, flight crew, aircraft, and other test support asset requirements (i.e., special resources such as telemetry ground stations, tracking ranges, etc.). The required resources may be directly impacted by the time scale of the test program, i.e., if the time frame for tests is severely limited by an operational requirement, additional aircraft and the associated maintenance and test resources may have to be allocated.

8.2.6.2 Schedule and Milestones. A schedule/milestone chart showing the project milestones should be presented in this section or as an appendix. Milestones should include contract deadlines, instrumentation dates, test dates, report dates, and project completion. This chart can also be used as a progress chart by plotting actual progress and achieved milestones. Additionally, schedule drivers may also be shown such as test range availability or aircraft availability (test or support), or ship at-sea dates for shipboard testing.

PREPARATION OF THE FLIGHT TEST PLAN

8.2.6.3 Personnel Assignment. List the personnel assigned to the program along with their project function, organizational codes, and telephone numbers. (See Section 4.)

8.2.6.4 Reports. The final product of the test program is the test report. Describe how the test results will be reported, the frequency of interim reports (if required for long duration test programs), and who will receive the reports. The test plan often specifies the types of reports to be prepared and to whom the reports will be distributed. (See Sections 28 and 29.)

8.2.7 Safety Plan

As all testing assumes some risk, particular attention must be paid to first identify the risks, then show how the risks are minimized. (See Section 10.) Management must be able to ascertain that safety is given utmost attention and determine if the objectives of the test are worth the assumed risks.

The most important function of the safety plan is a comprehensive evaluation of the hazards involved in the test and a detailed presentation of the procedures and precautions that will be used to minimize the risk inherent in flight test. Of most importance is the hazard analysis which should include all of the foreseen hazards that could be encountered. A general outline for safety planning is presented in the following paragraphs.

8.2.7.1 Special Precautions. The hazard analysis is a detailed evaluation of the problem areas that may be encountered in the testing process. Test hazards may include those expected in the particular flight region or those caused by new or modified equipment in the airplane. (See Section 10.) The object of the hazard analysis is to first identify hazards that could occur, identify the cause of the hazard, determine the probability of that hazard occurring, assess the risk should the hazard be encountered, and establish precautionary measures to eliminate or reduce the hazard. An example of a flight profile hazard analysis is shown in Table 8-VI. An example of a project equipment hazard analysis is shown in Table 8-VII.

Table 8-VI Hazard Analysis - Flight Profile

Hazard	Cause	Precautionary Measures	Probability of Occurrence (POC)	Risk Assessment (RA)
Lateral drift on VL causing excessive sideloads on outrigger landing gear	<ul style="list-style-type: none"> • crosswind/turbulence • jet exhaust impingement on wing due to bank angle when close to deck • insufficient lateral control authority due to airplane dynamics • excessive lateral weight asymmetries • poor pilot scan 	<ul style="list-style-type: none"> • buildup in crosswind, lateral asymmetry • no excessive lateral inputs when close to deck • LSO will waveoff any unsafe approach • FCLP will be accomplished for pilot proficiency prior to detachment 	Low	Mod

Legend:

Low POC: The hazard is unlikely to occur.
 Moderate POC: The hazard may occur.
 High POC: The hazard is likely to occur.

Low RA: Minor damage to aircraft is likely to occur.
 Moderate RA: Moderate damage to aircraft is likely to occur.
 High RA: Loss of aircraft and aircrew is likely to occur.

Table 8-VII Hazard Analysis - Project Equipment

Hazard	Cause	Precautionary Measures	Probability of Occurrence (POC)	Risk Assessment (RA)
Asymmetric dumping of water tanks creating asymmetric moment beyond airborne limits resulting in aircraft impact with water	<p>For asymmetric dump:</p> <ul style="list-style-type: none"> • faulty dump valve • faulty wiring • "popped" circuit breaker for one tank and not the other (they are on separate circuit breakers) <p>For not being able to secure asymmetric dump:</p> <ul style="list-style-type: none"> • after detecting asymmetric dump, power is lost to the "good" tank which would leave the valve in its position at power loss (open) • after detecting asymmetric dump, valve fails (sticks open) on the "good" tank 	<ul style="list-style-type: none"> • Valves are approximately 2 years old and have been reworked for this project. • All electrical wiring in tanks have been replaced with new wiring • LSO will visually monitor water tank dump after each launch and confirm "both tanks dumping" via radio. If asymmetric dump is detected, LSO will declare "secure dump, secure dump" via radio. If asymmetric dump detected, attempt to secure dump immediately and BINGO to shore. If asymmetric dump continues, jettison tanks. • Jettison circuits will be checked daily • Fresh water vice salt water will be used in the tanks to aid in preventing corrosion. 	Low	High

Legend:

Low POC: The hazard is unlikely to occur.
 Moderate POC: The hazard may occur.
 High POC: The hazard is likely to occur.

Low RA: Minor damage to aircraft is likely to occur.
 Moderate RA: Moderate damage to aircraft is likely to occur.
 High RA: Loss of aircraft and aircrew is likely to occur.

8.2.7.2 High Risk/Workload Data Points. High risk/workload data points should be identified and procedures for safely accomplishing the task should be written.

8.2.7.3 Checklists. The application and use of checklists during flight tests helps eliminate the errors that can be made in an intense high workload flight test environment. These checklists should be developed and presented in the test plan.

8.2.7.4 Data Management. The data management techniques to ensure safety should be specifically addressed so that there is a clear understanding of what the critical safety of flight instrumentation parameters are, who will be monitoring these parameters, and what special techniques will be used such as trend analysis for structural testing or gain and phase margin computation for flight controls tests. A clear understanding must be presented as to whom, or what functional tile, can authorize continuing hazardous flights or call for a test halt. Any special techniques to manipulate the data or use trend analysis should be identified in this section.

8.2.7.5 Miscellaneous Items. The following items also need to be addressed and documented during the test planning process:

- Aircraft Downing Discrepancies
- Required Ground Checks for Project Equipment.
- Special Maintenance or Handling Procedures
- Locally Manufactured Parts
- Aircraft Discrepancy Review Procedures
- Go-No Go Criteria
- Pre-flight and Postflight Briefings. (See Section 28.)

8.2.8 Operational Security Considerations

Although most testing of sensitive classified nature is conducted with encrypted data, care should also be taken in the planning and conduct of any project in which important information can be transmitted in one form or another. Test plans with detailed test matrices, test schedules showing type of support, and radio communication discussions with the project team can be used by competitive or non-friendly parties to obtain information as to the capabilities and faults of the test aircraft. The overall security classification of the project as well as the classification of data and test results should be stated. If any components are classified, define the procedures established for storing, utilizing, and/or handling. If data are classified, state how it will be protected. If classified equipment or ordnance is to be delivered to or shipped from the organization, define the arrangements and procedures to be followed. Relevant Operational Security guides/instructions should be followed.

8.3 TESTING OF CIVIL AIRCRAFT

Any testing with the objective of obtaining a civilian Certificate of Airworthiness must be based upon the rules and regulations set forth in the JAR/FAR regulatory framework. [8-2, 8-3] The first action is to establish a Certification Base. This base is the agreement between the authorities and the manufacturer in which the applicable Amendments for the new aircraft design are spelled out.

Once this agreement has been reached the pertinent requirements from the different JAR/FARs are translated into a Compliance Matrix. This matrix shows how the manufacturer will comply with every article of the certification base. Compliance can be based upon math models, similarity with existing certified products, and use of simulators, scale models, full-size mock-ups, and complete aircraft in ground or flight tests. The contents of the matrix will be discussed with the authorities to agree how each item in the matrix will be satisfied. Those items requiring flight tests will them singled out and then appropriate test plans will be prepared.

In general, the test plans will follow the outlines noted above with the notable exception that the civil test maneuvers are spelled out in an "Acceptable Means of Compliance" document prepared by the authorities. It is possible to deviate from the compliance document but to do so the manufacturer must convince the authorities that his approach will lead to at least the equivalent level of safety.

Once the manufacturer has determined that the aircraft meets the certification requirements, the certification authorities will be notified and will send their test crew(s). These test crews will then fly the aircraft using the requirements of the JAR/FAR. If this crew accepts the manufacturer's claim of compliance the Certificate of Compliance can be obtained.

8.4 CONCLUDING REMARKS

It is very important that a comprehensive test plan be prepared and coordinated with appropriate authorities well in advance of any planned testing. This test plan and the checking/coordinating process will then ensure that proper test planning has been accomplished and that the potential test crew understands what is to be done, how it is to be done, the potential hazards that exist, and the necessary steps and procedures to be taken to alleviate the test hazards. However, the test plan is a living document - it must be utilized on a daily basis and it must be updated and re-coordinated as test progress dictates.

A well prepared test plan that is utilized on a continuing basis is a must for a safe and efficient test program.

8.5 ACKNOWLEDGEMENTS

Mr. J. Nicolaes, Fokker Aircraft Company, contributed information regarding test planning for civil aircraft.

8.6 REFERENCES

- [8-1] US Navy, Flight Test Engineering Group Instruction (FTEGINST) 3960.1, "Preparation, Review, and Implementation of Project Test Plans", 14 July 1992.
- [8-2] US Government Publications
- Code of Federal Regulations, Title 14, Chapter 1, Part 25 (for large aircraft)
 - Federal Aviation Authority (FAA) Advisory Circulars
- [8-3] Joint Aviation Requirements, Joint Aviation Authorities.

8.7 BIBLIOGRAPHY

DOD 5000.2, "Defense Acquisition Management Policies and Procedures," 23 February 1991.

US Navy Test Pilot School (USNTPS) FTM-104, "Fixed Wing Performance Test Manual", July 1977.

USNTPS FTM-103, "Fixed Wing Stability and Control Manual", 1 Jan 1975.

US Air Force Test Pilot School (USAFTPS) Volume I, "Aircraft Performance".

USAFTPS Volume II, "Flying Qualities".

Twisk, J. van, "The Fokker 50 and 100 Flight Test Program", Proceedings of the 18th Symposium of the Society of Flight Test Engineers, Amsterdam, 1987.



Chapter 9 – PRE-FLIGHT TESTS

Paul W. Kirsten

US Air Force Flight Test Center
Edwards AFB CA 93524-6841
USA

9.0 INTRODUCTION

Pre-flight testing is critical to the success of any flight test program. Pre-flight tests are performed to measure and evaluate the characteristics of an aircraft in a non-flying environment and to verify that these characteristics are as desired. Since aircraft systems are becoming more and more complex, conducting proper pre-flight testing to help identify system characteristics and deficiencies prior to flight is more important now than ever before. Much flight test time has been lost fixing problems that should have been found and corrected prior to flight. Accidents have occurred because pre-flight tests and verification procedures were not conducted thoroughly enough to identify the aircraft's characteristics properly or to find system discrepancies. Proper pre-flight testing helps ensure that the aircraft is ready to fly and contributes toward an efficient, productive, and safe flight test program.

The reader should be aware that this Section is dedicated to the testing that should take place prior to the first flight. There are other "pre-flight" tests that take place prior to each individual flight. These latter tests are not discussed in this Section.

The following paragraphs of this Section describe significant tests that are usually accomplished prior to flying a new or highly modified aircraft. Test objectives, descriptions, products, and requirements are provided in the following subsections:

- 9.1 Wind tunnel tests
- 9.2 Simulation tests
- 9.3 Propulsion tests
- 9.4 Weight and balance tests
- 9.5 Ground vibration tests
- 9.6 Structural loads tests
- 9.7 Gain margin tests
- 9.8 Verification and calibration tests
- 9.9 Taxi tests

The specific examples given and the test facilities mentioned in this Section will illustrate the approach taken and the techniques used by the US Air Force; however, they are typical of those used by other test organizations.

9.1 WIND TUNNEL TESTS

9.1.1 Objectives

The results of wind tunnel tests are used, as part of the design and development process, to enhance confidence in theoretical estimates of the aircraft's aerodynamic characteristics. They are also used to refine predictions of the aircraft's flying qualities and performance and, when necessary, to guide modifications to the aircraft's external configuration or flight control system. Wind tunnel data are also the prime initial source for the aerodynamic data base required for a variety of analytical programs used in the design process, and for man-in-the-loop simulators.

9.1.2 Test Description

9.1.2.1 Static Force and Moment. Static force and moment aerodynamic data along and about the three orthogonal axes are obtained from wind tunnels which blow air over scale models of aircraft positioned on a fixed mounting system. The model is either mounted on struts on its bottom surface or on a sting at the aft end of the model. The mounting system contains gauges which measure static forces and moments produced by the air flowing over the model. Wind tunnel facilities in the United States are numerous and can generate airspeeds ranging from subsonic to hypersonic.

Static force and moment wind tunnel tests are conducted at a matrix of test conditions. Test variables include Mach number, altitude, orientation of the model to the airflow (angle of attack and angle of sideslip), and control surface deflection angle. Force and moment data are obtained at each test condition. If the model and mounting system are automated, control surface deflections and orientation angles can be set quickly from outside the tunnel chamber without shutting down the air flow.

9.1.2.2 Rotary Balance. In rotary balance wind tunnels the aircraft model is mounted on a sting and rotated in the tunnel. Aerodynamic rotary data are obtained as a function of rotation rate. The aerodynamic data obtained in these tunnels is a total pitch, roll, or yaw coefficient as opposed to individual stability or control derivatives which are obtained in a static force and moment tunnel test.

9.1.2.3 Captive Model. In these test the aircraft model is flown inside the wind tunnel by pilots who sit outside the chamber and view the model through windows. The model is controlled by a flexible cable extending from its upper surface which transmits the command signals from the pilot's station outside the tunnel chamber. The model is maneuvered in the pitch, roll, and yaw axes. The walls of the tunnel are netted to capture the model if an out of control condition occurs. These low-speed tests are conducted to determine aircraft departure characteristics.

9.1.2.4 Vertical Spin Tunnel. Aircraft models are thrown into these large vertical tunnels at the top of the tunnel and allowed to free fall to the bottom. The models are thrown at different orientation angles, rotation rates, and rotation directions to simulate out of control flight which might occur at high angles of attack. The model is either allowed to recover to stabilized flight on its own, if possible, or it can be remotely commanded to deflect its control surfaces to attempt a recovery. The model can also be designed with a spin chute which can be remotely activated and deployed to assess its ability to recover the model from a spin. These tests provide information on spin modes, proper control actions to effect recovery, and recovery characteristics.

9.1.3 Test Product

The product obtained from static wind tunnel tests is aerodynamic force and moment data. The data obtained are either in coefficient or derivative form. Coefficient data are the non-dimensional pitching, rolling, and yawing moments and normal, side, and axial forces obtained at each tunnel test condition.

Derivative data are the coefficient data per unit of orientation angle or control surface deflection angle. For example, the longitudinal stability derivative is the amount of pitching moment coefficient change obtained for a one-degree (or one radian) change in angle of attack at a particular test condition.

Aerodynamic force and moment data obtained from wind tunnels are used to build the predicted aerodynamic models of aircraft. These predicted aerodynamic models are used in computer analysis programs and man-in-the-loop simulators to predict and evaluate the aircraft's flying qualities. The models are also essential for designing the aircraft's flight control system. The same analytical programs and man-in-the-loop simulators are used to perform this function.

Rotary balance, captive model, and vertical spin tunnels tests are performed primarily to obtain predicted high angle of attack characteristics of an aircraft. The tests evaluate the model aircraft's high angle of attack flying qualities, its control system performance, its resistance to departure from controlled flight, and its recovery characteristics after it has departed from controlled flight. The tests also determine what type of oscillatory and spin modes the model has if it does depart from controlled flight and what the proper pilot recovery procedures are; i.e., which control surfaces should be deflected and in which direction. This type of information is very valuable when the actual high angle of attack flight test program is conducted on the aircraft.

9.1.4 Test Requirements

Model fidelity is essential to obtaining accurate wind tunnel data. External contours, protuberances, cavities, and surface roughness must be scaled and modeled accurately if representative aerodynamic data is to be obtained.

Aircraft aerodynamics are often a strong function of Reynolds number. Therefore, wind tunnel tests for the scaled model should be conducted as close as possible to the flight Reynolds number expected for the actual aircraft. Since wind tunnels cannot always duplicate flight Reynolds numbers because of tunnel limitations, it is useful to conduct wind tunnel tests at several different Reynolds numbers so that trend information can be obtained and extrapolation to flight Reynolds numbers can be made. A range of Reynolds numbers can be achieved by using different size models to alter scale length and/or pressurized tunnels to increase air density. Extrapolation to higher Reynolds numbers can have risks. If, for example, the wind tunnel test is conducted below a critical Reynolds number for transition from laminar to turbulent flow and the actual flight is above that number, the flow could be attached in the tunnel and separated in flight. This could lead, for example, to different values of aerodynamic or stability parameters. However, if the real flight Reynolds number cannot be reached in a tunnel, there is no alternative but to extrapolate; however, the Flight Test Engineer (FTE) must bear in mind that predicted results could be misleading and/or wrong.

One aspect of wind tunnel testing that is often overlooked is the suitability of the test matrix. Tunnel testing must be conducted at the conditions and aircraft configurations that will occur during flight testing. For example, if the aircraft will usually fly at sideslip angles of less than five degrees, which is most often the case, aerodynamic data should be obtained in the wind tunnel at small sideslip angles around zero degrees to define possible nonlinear effects rather than at gross increments of five degrees or more which is often done. The same holds true for control surface deflection angles. Not testing at the proper conditions is the primary cause for errors in the predicted aerodynamic data bases of new aircraft. However, the wind tunnel tests must include some "off-design" conditions of high incidence, sideslip, and control deflection in order to predict aircraft behavior during departure and recovery. Unreliable as this data can be it's still better than calculations and is essential for the simulator and early flight program. The choices and extent of wind tunnel testing may well devolve to a question of balancing priorities.

Control surface trim positions can have a significant effect on the aircraft's aerodynamics. For example, the longitudinal trim deflection angle of a canard can effect the longitudinal pitch stability as well as the lateral-directional stability of an aircraft. It is, therefore, necessary to test all control surfaces over their range of trim deflection angles which might occur in flight.

9.2 SIMULATION TESTS

9.2.1 Objectives

Simulators are an essential element in the pre-flight test process. The engineer who builds and uses the simulator is generally the one who knows the most about the aircraft's characteristics. Simulators are used to assist the design process by enabling subsystems and systems to be operated in a representative, interactive manner, with or without the "man-in-the-loop, with relevant flight conditions and overall response, etc., being simulated via appropriate computer programs. They are particularly useful for conducting sensitivity analyses (e.g., the effect on predicted flying qualities of errors in determining individual aerodynamic parameters) or investigating the effects of possible system malfunctions. Simulators are also used to conduct flight test programs. Hardware-in-the-loop and "iron bird" simulators are used to evaluate the aircraft's subsystem characteristics such as control surface actuators, hydraulic systems, computers, electrical systems, and landing gear. Man-in-the-loop simulators are used by pilots and engineers to evaluate the aircraft's flying qualities and performance characteristics. Simulators are also used to design flight control systems and to evaluate avionics systems. Virtually all new aircraft programs make extensive use of simulators and conduct numerous simulator studies prior to first flight. The purpose of pre-flight simulator studies is to verify that the aircraft's characteristics appear to be as designed and desired, and to provide confidence that it is safe to begin flight testing. The FTE must always bear in mind that you can never know how good the simulator is until the test aircraft has been flown.

9.2.2 Test Description

9.2.2.1 Man-In-The-Loop. Simulations which are flown in real time from a cockpit are referred to as man-in-the-loop simulators. These types of simulators give the best predicted evaluations of aircraft performance and flying qualities. Man-in-the-loop simulators have a replica of the cockpit and control devices, the aircraft's flight control system and the aircraft's aerodynamic data. Many man-in-the-loop simulations nowadays contain actual control system computer hardware and software. Man-in-the-loop simulators usually have a good visual system that displays the world outside the cockpit. They can have motion systems to simulate aircraft dynamics. However, because of the complexity, expense, and inaccuracies associated with motion systems, most man-in-the-loop simulators are fixed base.

9.2.2.2 Iron Bird. "Iron bird" simulations contain most of the aircraft's actual hardware components except for the structure. They are used to conduct aircraft subsystem tests such as hydraulic system evaluations. Hydraulic lines and hardware are sized and positioned as they are in the actual aircraft. Subsystems are cycled through many hours of operational tests to ensure proper operation and endurance. Because of the expense involved in operating them, iron bird simulators are usually not used to conduct man-in-the-loop evaluations except when it is critical to include the actual aircraft hardware in the evaluation.

9.2.2.3 Hot Bench. These simulations test individual aircraft components such as actuators, control sticks, flight control computers, etc. They are used to test and evaluate individual aircraft components prior to installing them in more complete simulations such as an iron bird.

9.2.2.4 Hardware-in-the-Loop. Hardware-in-the-loop simulators are used to conduct man-in-the-loop performance and flying qualities evaluations. They usually contain actual flight control computer hardware and software and avionics computers. They do not contain all of the other subsystem components that an iron bird does, and are therefore, cheaper to operate and can be used for man-in-the-loop studies. The simulations are usually set up so that they can use the actual flight control and avionics computers or a simulation of these computers. In this setup, the actual computers can be removed from the simulation and used in the aircraft, and vice versa, if required.

9.2.2.5 Avionics. These simulations contain avionics hardware and software. They usually do not contain all of the other aircraft subsystems that an iron bird does. Most avionics simulations contain duplicates of the aircraft's cockpit, including switches and displays. Avionics simulations are used to conduct software verification testing and evaluation which is so critical on today's modern aircraft. Avionics facilities such as the Integration Facility for Avionics System Test (IFAST) at Edwards AFB can and have saved many hours of valuable flight test time by conducting proper avionics ground tests that identify and resolve many avionics system problems prior to flight. It is worth noting here that many avionic systems, such as radars, are often developed and therefore can be checked out using a flying test bed.

9.2.2.6 In Flight. In-flight simulators are actual aircraft which are used to simulate the performance and flying qualities of another aircraft. They are flying simulators. In-flight simulators have computers on board which use model following or response feedback techniques to simulate the dynamic response of another aircraft. The advantage of in-flight simulators is that the pilot is in an actual flight environment and experiencing the visual and motion cues of that environment. The obvious limitation of in-flight simulators is that, even when the simulated model of the aircraft is perfect, it can only fly within the envelope of the in-flight simulator. The envelope of the simulator may (and often is) more limited than that of the simulated aircraft. Therefore, the simulator may not be able to reproduce the high agility maneuvers of the new aircraft which may have a larger envelope than the simulator. In-flight simulators are most useful for simulating the critical landing phase of flight since they are more likely to raise a pilot's gain (anxiety level) to realistic flight values than a ground-based simulator.

9.2.3 Test Product

If designed and used properly, simulators are the best tool available for educating pilots and engineers on the flight and subsystem characteristics of an aircraft. Man-in-the-loop simulators are used to evaluate the performance and flying qualities of an aircraft. They are used to design and evaluate flight control systems. They are also used to design effective, efficient, and safe mission plans. Man-in-the-loop simulators are used extensively prior to the first flight of a new aircraft. When properly used, a good simulation can be invaluable in uncovering aircraft deficiencies such as control system anomalies, poor stability, and pilot-induced oscillation (PIO) tendencies. If these deficiencies are uncovered during pre-flight simulator studies, they can be fixed or avoided through proper test planning without sacrificing the safety of the pilot and aircraft.

An important study to conduct prior to flight in a man-in-the-loop simulator is an aerodynamic uncertainty study. History has shown that the actual flight aerodynamics of an aircraft can be 25-percent different than the predicted aerodynamic model of the aircraft; not necessarily because of tunnel deficiencies per se, but primarily because of other factors such as model inaccuracies and incomplete testing in the wind tunnel. It is, therefore, necessary to conduct uncertainty studies which evaluate 25-percent errors in two or three aerodynamic derivatives at a time. The aircraft's control system should provide acceptable flying qualities with these errors applied. If not, it should be changed.

It is important to note that when trying to uncover aircraft deficiencies such as PIOs on a simulator, tasks which elevate the pilot's gain, or anxiety level, should be used. A pilot's gain is likely to be two or three

times lower on a ground-based simulator than it is while flying an actual aircraft during critical flight phases. Since PIOs are more likely under these high pilot gain conditions, the pilot's gain on the simulator should be elevated to values more representative of actual in-flight values. An effective method of doing this is to conduct high-gain tracking tasks on the simulator in which the pilot aggressively tries to track a target such as a visual representation of another aircraft. If the pilot aggressively tries to keep the pipper of the simulated aircraft on a point on the target aircraft, any control system deficiencies such as PIOs should be uncovered.

Hot bench, iron bird, and hardware-in-the-loop simulators are effective means of evaluating an aircraft's subsystem characteristics prior to flight. They can be extremely cost effective if subsystem problems are found and fixed before the flight test program begins. They obviously also enhance flight safety by uncovering problems on the ground rather than in flight. An iron bird simulation which contains most of the aircraft's subsystems can verify proper total integrated system operation on the ground. Hardware-in-the-loop simulations provide an evaluation of aircraft flight characteristics with actual hardware and software components. They also are used to provide an evaluation of failures of these system components. If component failures are artificially inserted in the simulation while being flown by a pilot, the effect of these failures on the aircraft's flying qualities can be evaluated. These tests are referred to as Failure Modes and Effects Tests (FMET).

Pre-flight testing in avionics simulators is essential for verifying that the aircraft's total integrated avionics hardware and software system works as designed. Avionics simulators provide a final verification of actual aircraft hardware and software operation in a fully integrated environment with other aircraft components. Complete checkouts of the avionics system are conducted including extensive functionality checks from the simulated cockpit and thorough verification of primary mode and submode operation. The avionics system is evaluated during simulated aircraft missions and environments. If problems are found, they are fixed prior to flight. Pre-flight testing has proven to be a very productive and cost-effective way of evaluating and verifying avionics systems. It should be noted that there may be limits to the checks that can be made on the ground. For example, laser system ground checks may be limited by safety considerations.

9.2.4 Test Requirements

Man-in-the-loop simulators should contain an accurate model of the aircraft's aerodynamics and flight control system. If actual control system software is not used, all gains, filters, and time lags must be simulated accurately. Actuator frequency response characteristics, including non-linear characteristics, should also be modeled accurately. If man-in-the-loop simulators are used for performance and flying qualities evaluations, the cockpit need only contain the switches and displays necessary for these evaluations. If used as pilot trainers, all cockpit elements are required. In either case, the switches and displays in the simulation cockpit should have the same physical characteristics and be in the same location as in the actual aircraft cockpit. The cockpit control devices should have the same force, displacement, and damping characteristics as those in the aircraft. Man-in-the-loop simulators should have good visual display systems. It is important to minimize the time lag associated with the visual system. Excessive time lags in visual systems can produce unrealistic characteristics such as PIO tendencies during closed loop flying qualities evaluations.

Most simulators used to conduct flying qualities evaluations nowadays are fixed base; i.e., the cockpit does not move to simulate aircraft motion cues. The reason for this is that moving-base systems are costly to build, expensive to maintain, and contain provisions to start washing out cockpit motion after relatively small displacements are achieved so that the cockpit (and pilot) are not slammed into the walls of the simulation facility. This washout system employs filtering which may produce unrealistic and inaccurate motion cues. For this reason there are only a few good motion-based simulations in the United States. Two good ones are the large amplitude Vertical Motion Simulator (VMS) at NASA Ames Research

Center, CA and the Large Amplitude Multi-Axis Research Simulator (LAMARS) at Wright-Patterson AFB, OH.

Iron bird and avionics simulators should use aircraft hardware and software. The software should be the current version of the aircraft's software. This requirement is necessary since pre-flight tests done on these simulations are conducted to verify flight software prior to using it in the actual aircraft.

9.3 PROPULSION TESTS

9.3.1 Objectives

Prior to the flight testing of new or modified propulsion systems, current accepted practice dictates that the system be subjected to several types of ground tests. In general, these include inlet testing, altitude operability and performance testing, durability testing, and installed thrust tests. The overall objectives of these tests are to measure the thrust of the engine, both uninstalled and installed; to assess the airflow distortion caused by the engine inlet; to evaluate engine operability, both with and without inlet distortion; and to evaluate the durability of the engine. These types of testing would normally occur after more developmental preliminary tests such as engine component structural and aero-mechanical tests such as compressors, fans, combustors, etc. (See Section 24 for a discussion of propulsion flight tests).

9.3.2 Test Description

9.3.2.1 Inlet Distortion. This testing is accomplished on the inlets of new or highly modified aircraft. The objective of these tests is to measure and characterize the airflow distortion patterns that are generated at high angles of attack and sideslip. A scale model of the aircraft inlet is constructed, including the parts of the aircraft forebody that could affect the flow field. The inlet model is then placed in a wind tunnel oriented at a large number of different angle of attack and angle of sideslip combinations. Airflow and Mach number are also varied at each condition. Pressure pickups in the inlet model record the pressure pattern for each condition at a location corresponding to where the engine face would be in the actual installation. Usually approximately 40 pressure probes are used to measure the pressure pattern. The resulting patterns are analyzed and compared to analytic predictions for the inlet. The "worst case" distortion patterns are determined. These patterns are scaled up to a full size inlet by building blockage screens which duplicate the distortion patterns. The engine is operated behind these screens during the ground operability tests. In this way the most adverse effects of the inlet on the engine during maneuvering flight is simulated.

In some cases a new or modified inlet is to be used with a previously ground-tested engine. In these cases a scale model would be tested as above, and the resulting worst distortion patterns would be compared to those patterns used in the original operability ground testing for the engine. If analysis shows that the engine will be subjected to worse distortion than previously, it would usually be desirable to repeat the operability testing with the new patterns. It is often the case that the thrust of an engine is substantially increased, or even that an entirely new engine is incorporated into an aircraft. In these cases, it would be highly desirable to repeat the above testing, using the known worst case distortion patterns with the higher thrust engine. This is particularly true if analysis shows the new or modified engine may have lower fan or compressor stall margins in some portions of the flight envelope.

9.3.2.2 Operability and Performance Testing. The objective of these tests is to evaluate the operability and performance of the engine at simulated flight conditions throughout the planned flight envelope of the aircraft. The engine is operated, usually uninstalled, (i.e., bare engine) in a test cell. Conditioned air is introduced to the engine at temperatures, pressures, and velocities corresponding to desired flight conditions. All aspects of engine operation are evaluated during these tests, including steady state

operation, thrust transients, including afterburning if the engine is so equipped, and airstarts. The engine is carefully monitored using extensive special instrumentation, to ensure the engine operates as intended and within established operating limits. The occurrence of compressor stalls, afterburner blowouts, airstart no-lights, and other detrimental operation is recorded and analyzed to determine cause. Intentional compressor stalls are accomplished to determine the engine's susceptibility to non-recoverable stalls. During steady state tests, engine thrust is measured and compared to the thrust required by the engine specification. Inlet compatibility tests are accomplished to simulate maneuvering flight conditions. These tests consist of operating the engine at a variety of flight conditions behind the "worst case" airflow distortion screens described above under 9.3.2.1.

9.3.2.3 Durability Testing. The objective of this phase of testing is to determine whether the engine has the service life required by the engine specification. This phase of testing is usually accomplished at approximately sea level conditions, with the engine uninstalled. To determine service life, the engine is put through "Accelerated Mission Testing" (AMT) which is designed to simulate the usage an engine would receive during its operational lifetime prior to being returned for an overhaul. This AMT consists of repeated cycling of the engine between low power and high power settings. This repeated cycling over a relatively short period is roughly equivalent to the wear and tear an operational engine would receive during a much longer period of in-service use. The most often-used measure of durability is Total Accumulated Cycles, or "TACs". One TAC is equivalent to operating the engine from shutoff, up to military thrust, and back to shutoff.

9.3.2.4 Ice, Water, and Bird Ingestion Testing. Ice, water, and bird ingestion tests are normally conducted on "bare" engines prior to first flight as a part of the overall qualification process for new engines. Occasionally these types of testing are not conducted before flight testing begins. However, they **must** be accomplished before the engine is released for operational service. Ice ingestion testing is conducted to evaluate both the ability of engine anti-icing provisions to prevent ice accumulation at the front of the engine, as well as to evaluate the ability of the engine to withstand damage from ice chunks which might in actual flight be flushed from inlets and other surfaces. This type of testing can be conducted uninstalled in an engine test cell. It is also conducted installed, during both in-flight icing tests and ground climatic chamber tests. Water ingestion testing is typically conducted on installed engines to evaluate the engines' reaction to heavy rain. This type of testing can be done in a ground climatic chamber and is sometimes done as a part of in-flight tests. Bird ingestion testing is accomplished to determine the ability of the engine to withstand damage and to evaluate the ability to continue operating after bird ingestion. Another test conducted is to deliberately sever a fan/compressor blade using an explosive charge with the engine operating. This test is to simulate mechanical failure of the turbo-machinery and demonstrate that the debris is contained within the engine casing or the external containment shield and does not pose any further hazard to the aircraft.

9.3.2.5 Installed Thrust. Installed engine ground tests are accomplished to determine the thrust provided by the engine as installed in the airframe. This is done to compare the installed thrust to engine specification values and to that calculated by the in-flight thrust computer program to be used during flight testing. The installed thrust could be different than the thrust measured during uninstalled test cell performance testing for several reasons. The inlet could have the effect of reducing the total air pressure available at the engine face, which would reduce thrust. The bleed air extracted from the engine for the environmental control system could reduce thrust. Also, horsepower extraction for accessories could affect thrust. To measure thrust, the aircraft is fixed to a load measuring device such as load cells or strain gages. A Horizontal Thrust Stand with this capability is available at Edwards AFB, CA. The engine is operated on the thrust stand at several steady conditions from idle to maximum thrust. Engine bleed is varied from none to full available bleed. Horsepower extraction is usually as is normal to provide the required accessories.

9.3.3 Test Product

A wide variety of test products are provided for each type of ground tests conducted. The required test products can vary dependent on contract requirements, degree of technical risk of the engine development program, previous test results, and other factors. The products mentioned here are not intended to be an all-inclusive list, but are rather suggestions to be considered.

The results generally produced for the engine ground operability include the susceptibility of the engine to compressor stall, afterburner rumble or instability, or other detrimental operation as a function of flight condition. The stall margin for each simulated flight condition is determined from the intentional compressor stall tests. Any tendency for nonrecoverability following compressor stalls is noted. Airstart results at simulated flight conditions tested include success rate and time required for the airstart. Time histories of pertinent engine parameters are analyzed to determine the cause of any anomalies noted. This cause could include control malfunction, control scheduling errors, or inherent design shortcomings. If anomalies are detrimental to operational use of the engine, the cause of the problems must generally be corrected before testing can be completed and the engine released for flight testing. The results of inlet distortion testing are generally the distortion patterns, in terms of isobar lines, that the inlet introduces into the face of the engine. Various indices of distortion, both circumferential and radial, are also determined for each pattern.

The thrust data obtained from both the uninstalled and the installed thrust tests are usually plotted, along with fuel flow at the various thrust levels, and compared to thrust and fuel flow required by the engine specification. The actual measured thrust from either the test cell or the horizontal thrust stand can be plotted versus both the thrust calculated by the thrust calculation computer programs and the predicted thrust based on ambient conditions.

9.3.4 Test Requirements

9.3.4.1 Test Matrix. The number of variables which need to be considered in developing ground test matrices is very large. For inlet testing, they include airflow rate and Mach number as well as angle of attack and sideslip. For operability testing, variables include altitude and Mach number, power setting or type of transient and degree of inlet distortion applied, if any. For airstarts, variables include flight conditions as well as type of airstart and start method. In fact, the number of variables for all types of pre-flight propulsion testing is so large that to test every possible condition would easily consume several years. In a typical pre-flight ground test program, only 2 to 4 months is usually available to evaluate operability and performance prior to first flight.

For these reasons, in developing test matrices for both inlet and operability ground testing, it is essential to keep in mind the planned operating envelope of the aircraft. Also, regions where historically more problems are encountered, such as the upper left-hand corner of the flight envelope, should get a more detailed look than more benign areas. Pre-test predictions and analysis should be used to the maximum extent possible in defining the matrix. Test point intervals in regions of the flight envelope which are less critical could be relatively large (up to approximately 10,000 feet and 0.2 Mach number) while those in more critical areas would be small (2,000 feet and 0.05 Mach number). It takes a great deal of experience to plan a propulsion ground test matrix which adequately explores the flight envelope but does not take an inordinate amount of test time.

9.3.4.2 Instrumentation and Data Processing. Due to the developmental nature of propulsion ground tests, the engines and inlets used tend to be highly instrumented. The typical standard for inlet testing is approximately 40 pressure probes arranged in rakes in the inlet, while engines can often be instrumented for over 100 parameters. Frequently, the contractors supply their own data analysis software. Arnold Engineering Development Center, which accomplishes much inlet testing for the Air Force, provides

software for processing the pressure probe data from inlet testing. For performance testing, a "cycle deck" is normally provided by the engine contractor. This computer program can generate predicted steady state performance for the engine under test, which is then compared to measured performance. This deck is also used to standardize measured performance. In some cases, a transient deck is also provided which can simulate engine operation during throttle transients and airstarts. Predicted operation during these types of tests can then be compared to the actual observed operation.

9.4 WEIGHT AND BALANCE TESTS

9.4.1 Objectives

The objective of these tests is to obtain the weight, centers of gravity, and moments of inertia of the aircraft. Weight and balance data should be obtained for various aircraft configurations, fuel loadings, and store loadings.

9.4.2 Test Description

Weight and balance data is initially obtained by the airframe contractor through analytical "bookkeeping" techniques. The weight and location of each component of the aircraft is determined and stored into an analytical program that calculates total aircraft weight, moments of inertia, and centers of gravity based on the contribution of all the individual components. Total aircraft weight and balance characteristics can be accurately determined by this method if considerable care is taken in accounting for all individual components. It is essential to also physically measure the aircraft's weight and balance characteristics to obtain actual values of weight and center of gravity, and to provide a final check of the analytically predicted bookkeeping values.

Weight and center of gravity measurements of aircraft can be accomplished at ground facilities such as the Weight and Balance Facility at Edwards AFB, CA. By using a combination of eight large scales, the largest of which measures 27 by 15 feet, arranged in a cross pattern in the floor of this facility, a wide range of aircraft from small to large size and from light weight to approximately two-million pounds can be measured. The accuracy of the scales, and hence the measured weight, is quite good; 0.07 percent of 300,000 pounds or more. (Other scales may have better or worse accuracy. The FTE should determine the accuracy of the system used).

The aircraft is positioned with its gear resting on the scales and total weight is obtained simply by adding the measurements of the individual scales. Longitudinal and lateral centers of gravity can be obtained with the aircraft level from the individual weight measurements at known distances from some reference location. Center of gravity is the point at which the individual weight measurement times their moment arms equal zero. Center of gravity in each axis is therefore, the sum of the individual moments divided by the gross weight of the aircraft. The vertical center of gravity can be obtained by tilting the aircraft in the vertical direction and summing the weight components in the vertical axis times their moment arms and then dividing by total weight in the vertical axis. The aircraft can be leveled or tilted by raising or lowering the scale on which the nose gear rests. Weight and center of gravity measurements are easy to obtain and take as little as 30 minutes for one configuration in the Edwards AFB facility.

Weight and center of gravity measurements can also be made with the aircraft mounted on jacks containing load cells. In this process, the aircraft is easier to level and tilt in all axes. The disadvantages are that more equipment and setup time is required, and the tests are more hazardous due to the possibility of the aircraft falling off of the jacks.

To measure moments of inertia, the aircraft must be suspended and oscillated in some manner so that frequencies of oscillation can be determined. This is difficult to do, and obviously more so for larger aircraft. Hence, there currently is no facility in the United States that routinely measures aircraft moments of inertia. Moments of inertia must be obtained by analytical bookkeeping methods as described previously.

Weight and center of gravity measurements can be taken for the baseline aircraft with no stores or fuel, for configurations with store loadings, and for various fuel loadings. If weighings are taken for several fuel loadings between zero and full, the incremental weight measurements can be used to calibrate the aircraft's fuel measuring system. If the aircraft is also tilted during these measurements, a fuel system calibration for non-zero aircraft attitudes during flight can be obtained. If the fuel tanks are partially full, center of gravity change due to fuel movement in the tank when the aircraft is tilted can also be measured. Longitudinal center of gravity location in particular has a strong influence on aircraft stability and control characteristics and all aircraft have a center of gravity range that they must stay within. Therefore, knowing the center of gravity movement due to fuel usage is critical. These effects can be obtained by measuring center of gravity locations as a function of fuel tank loadings.

9.4.3 Test Product

Accurate weight and balance data are required for modeling the aircraft through the use of simulations and analysis programs. These simulations and analysis programs are used to evaluate the performance and flying qualities of the aircraft. Aircraft weight, moments of inertia, and centers of gravity are integral terms in the aerodynamic equations of motion used in the simulations and analysis programs. If the weight and balance data used in these equations are inaccurate the predicted flight characteristics of the aircraft will also be inaccurate.

A second important use for weight and balance data is in acquiring the aerodynamic data of the aircraft from flight. Performance data (lift and drag) and stability and control derivatives are now routinely obtained for the aircraft while in its flight environment. The computer programs and analysis routines which obtain aerodynamic flight data for the aircraft use the aerodynamic equations of motion which contain weight, moments of inertia, and centers of gravity terms. Hence, if the weight and balance data contained in these programs and routines are inaccurate the lift, drag, and stability and control derivatives obtained from the flight test will also be inaccurate.

9.4.4 Test Requirements

Weight and balance data should be obtained for the baseline aircraft configuration with no fuel and no external or internal stores. The effects of moving the landing gear and opening doors on aircraft centers of gravity and moments of inertia should also be obtained. Finally, the effects of adding fuel and stores, on aircraft weight centers of gravity, and moments of inertia should be obtained.

9.5 GROUND VIBRATION TESTS

9.5.1 Objectives

Ground vibration testing (GVT) is an essential preliminary ground test that must be conducted prior to the beginning of flight testing. The objective of the GVT is to obtain aircraft structural mode characteristics such as frequencies, mode shapes and damping. It is done to verify and update the aircraft analytical flutter model as well as provide a means of identifying modes from the frequencies found in flight test data. A GVT is not only required for new aircraft designs but also when extensive changes are made to existing aircraft or when new store configurations are added.

9.5.2 Test Description

A basic GVT consists of vibrating the aircraft at a number of different frequencies and measuring the response at various locations on the aircraft. Usually several hundred response stations are monitored in order to fully define the aircraft's modal characteristics. The response signals are processed through signal conditioning amplifiers and passed on to high speed computers for data manipulation and analysis.

The structural responses are most often sensed with accelerometers attached to the surface of the aircraft. The accelerometers are generally evenly distributed over one side of each aerodynamic surface (i.e., wings, horizontal and vertical tails, and control surfaces), and are also located at critical stations on the fuselage, engine nacelles, and pylon or stores.

The excitation of the aircraft is generally produced by electrodynamic shakers. These are essentially electric motors which cause a center armature to translate up and down as a function of applied current. The armature of the shaker is attached to the structure of the aircraft by a sting. A force link is usually attached to the sting to measure input vibration force data for use in transfer function analysis. Generally more than one shaker is used and they are attached to the aircraft at its extremities such as the wing tips, vertical and horizontal tail tips and on the fuselage nose or tail. The shakers can be operated in and out of phase with each other to generate symmetric and antisymmetric inputs, respectively, using either random or sinusoidal wave forms.

It is generally necessary to suspend the aircraft from a soft support system in order to separate the rigid body modes from the elastic vibration modes. This is done by suspending the aircraft on vibration isolators such as air bags or soft springs. In some cases sufficient suspension can be provided with the aircraft resting on its landing gear by simply reducing the pressure in the tires and gear struts. This generally can only be done if the landing gear is attached to the fuselage and not to the wing.

A number of different excitation techniques are used during a GVT. Swept sine waves or random excitations are used to determine broad band frequency response characteristics. Based on these characteristics, discrete frequencies are selected and a sine dwell excitation is performed at each frequency to generate mode shape data. Often the sine dwell is stopped abruptly and the decay of the resulting transient response is measured to obtain damping. Current modern data processing frequently allows obtaining modal frequencies, mode shapes, and damping all from a single random excitation by simultaneously processing multiple input forces and output responses.

9.5.3 Test Product

The products produced from GVT's include structural response frequencies, mode shapes and damping values. The data is presented in the form of frequency response plots (amplitude and phase versus frequency), animated mode shapes and a listing of damping values for each mode. Information as to the validity of the modal data is also presented in the form of orthogonality and reciprocity checks and

coherency plots. This data is used to update the vibration, flutter and aeroservoelastic predictions necessary to support flight testing. Typical information provided by a GVT is given in reference 9-1.

9.5.4 Test Requirements

The aircraft should be as close structurally to the final flight-ready configuration as is practical otherwise the modal data obtained will be misleading. The soft suspension system must be capable of not only supporting the weight of the aircraft but must reduce the value of the highest rigid body frequency to less than one third of the lowest elastic frequency. Generally the aircraft hydraulic system must be on to activate the control actuators or the control surfaces must be locked in place. The excitation system typically must be capable of input force ranges of from 5 to 250 pounds and in some cases, where exciting control surfaces is involved, forces as low as 1 pound. The accelerometers and force cells must be sized for the level of responses expected and yet be small enough not to add appreciable mass to the structure or shaker armature. There should be a sufficient number of strategically placed accelerometers on the aircraft to accurately map the mode shape for each structural mode. The response stations where the accelerometers are located must correspond to the node points used in the analytical vibration or flutter model in order to correlate GVT results with analysis.

9.6 STRUCTURAL LOADS TESTS

9.6.1 Objectives

Structural loads ground testing is conducted on structural test airframes (usually a bare hull) and not on a flight article. This structural testing is not a simple "pre-flight" test as are most others in this Section, but is a parallel activity which continues, in respect to fatigue tests, often throughout the entire aircraft life. The objective of this testing is to verify the structural load capability of the aircraft.

9.6.2 Test Description

The structural loads ground testing is divided into two major categories: 1) static loads tests and 2) durability tests and are usually conducted on separate airframes. The static loads tests are conducted to ensure that the aircraft structure has adequate strength to withstand the anticipated operational loads. Durability tests are done to verify the fatigue life of the aircraft. Damage tolerance tests are often considered part of the durability tests and are done to verify that the aircraft has sufficient structural redundancy in the event of battle damage.

For both the static loads and durability tests the assembled aircraft is usually mounted in a rigid test jig and the loads are applied with hydraulic rams. For the static tests the loads are applied in an incremental build up fashion with the structural strains being monitored at each load increment. For the durability tests the loads are applied in a cyclic fashion for an extended period of time. For pressurized structures, such as fuselage hulls, static pressure tests are also required. In addition, pressurized hulls are also subjected to fatigue tests by repeatedly simulating the pressure cycles that will be experienced in operational flight profiles.

In both the static loads and durability testing the data measurements of interest are the load inputs and the response strains, where strain is the change in size (i.e., elongation or compression) of the structural component. The hydraulic load inputs are measured with load cells attached between the rams and the structure. The response strains are measured with strain gages mounted on the critical structural components. In addition to the strains and loads, structural deflections, (i.e., movement of a point on the structure relative to the initial unloaded position) are measured during static loads testing and the number of load cycles are recorded during durability testing. During both types of testing the structure is inspected frequently for potential damage and local failures.

9.6.3 Test Product

The ultimate product of the static loads tests is the verification that the aircraft has adequate strength to withstand projected maximum operational loads, i.e., design limit loads (DLL), without deformation. The data from these tests are usually presented in the form of strains as a function of applied loads. The strain responses from the gages are often converted to stresses through the use of computers for comparison with analytical predictions.

As part of the static loads testing the aircraft flight loads strain gages are calibrated for later use in flight testing. The calibration data is usually presented in terms of strain voltages versus applied loads. Often the voltage output from several gages is combined in a single calibration equation relating the voltages to the applied load. The calibration equations are used in monitoring aircraft loads during envelope expansion flight testing and in gathering flight loads data to verify analytical structural models.

Fatigue tests are run continuously to ensure that the fatigue specimen has an adequate margin of demonstrated life over the fleet leader, and the results are used to guide fleet structural inspection programs. The ultimate product of the durability testing is the verification that the aircraft has adequate fatigue life and damage tolerance capability to be serviceable for the expected life of the airframe under operational conditions. Strain and stress data from these tests are also used to update the durability models and provide information which can be used to extend the life of the aircraft if needed.

9.6.4 Test Requirements

Static loads tests require that the structure be loaded up to design ultimate load which is 150 percent of DLL. This is to ensure that the structure will not deform at DLL. Often the structure is tested to failure in order to determine actual strength margins. Note that the failure **must** be beyond the design ultimate load or the required strength margins have not been met. Ultimate load static testing must be done before flight testing to the design limit load conditions can be attempted but is not always done before first flight of the aircraft. In this event, static load proof tests to 100 percent of DLL must be done on critical flight control surfaces and their associated backup structure before first flight. The aircraft is also limited to 80-percent DLL maneuvers until the ultimate static load tests are done. Static loads calibration tests must be done before loads flight testing can begin and static pressure tests to 133 percent of maximum pressurization level must be done before first flight with pressurization. The 100-percent proof tests, the initial limitation to 80-percent DLL, and the 133 percent pressure tests criteria are specific to testing military aircraft in the United States and the criteria may be different in other countries. [9-2 and 9-3]

Durability tests must demonstrate that the actual airframe life is twice the expected service life. These tests use typical mission loading profiles and are usually done on accelerated schedules over a period of months.

9.7 GAIN MARGIN TESTS

9.7.1 Objectives

With the advent of high gain flight control systems, gain margin tests are becoming more and more important. The objective of these tests is to determine the predicted gain margins for instabilities involving the aircraft's aerodynamics, control system, and structure. If the closed-loop gain of the network composed of these elements is high enough, an instability such as limit cycling or structural resonance can occur. The amplitudes of these instabilities can be sufficient to be destructive in high gain systems. It is therefore, important to ensure that the aircraft has adequate gain margin to prevent limit cycling or structural resonance from occurring in flight. Pre-flight gain margin tests, if conducted properly and on flight hardware, can help satisfy this objective.

9.7.2 Test Description

9.7.2.1 Limit Cycles. Limit cycle oscillations are closed-loop oscillations involving the aircraft's flight control system and rigid body aerodynamics. No structural deformation is involved. Limit cycles are caused by aircraft motion being sensed by the control system sensors (gyros, accelerometers, etc.) and fed back through the control system to the control surface actuators to form the loop closure. If the phase lag of the loop is sufficient, the feedback signals will be in phase with the aircraft motion and reinforce it rather than out of phase and damp it which is desired in normal stability augmentation system operation. If the loop gain is high enough, a self-sustained oscillation will develop. Limit cycles occur when the total loop gain (control system plus aerodynamic) is equal to unity and the phase lag is 180 degrees. Limit cycles usually have a frequency of between two and four Hertz. It should be made clear that limit cycles are self-sustaining oscillations that do not require a forcing function to keep them going.

Limit cycle ground tests should be conducted on either an iron bird simulation or on the aircraft so that the actual gain and phase characteristics, time lags, and nonlinearities of the flight control system and control surface actuators are included. The aerodynamic model of the aircraft must be included in either case. If the tests are conducted on the actual aircraft, a computer containing the aerodynamic simulation must be connected to the aircraft. The input to the aerodynamic simulation in the computer is the position measurements of the aircraft's control surfaces. The output of the computer is the simulated aircraft aerodynamic response to control surface deflection. The simulated responses out of the computer are sent back into the aircraft in place of the flight control system sensor feedback signals (gyro, accelerometer, etc). In this manner the closed loop involving the aircraft's flight control system and aerodynamic characteristics is formed.

Limit cycle ground tests are simple and easy to conduct. The aircraft's control system gains and aerodynamics are set to and tested at a few of the more critical conditions (highest gain, lowest predicted gain margin) in the flight envelope. At each of these conditions the total loop gain in each axis (pitch, roll and yaw) is increased until a limit cycle oscillation is attained. The limit cycle gain margin is the difference between the gain required to achieve a limit cycle oscillation and the total loop gain (control system plus aerodynamic) at the condition tested.

9.7.2.2 Structural Resonance. Structural resonance is a closed-loop oscillation involving the aircraft's flight control system and the aircraft's structure. Rigid body aerodynamics are not involved. Structural resonance is caused by the aircraft's control surfaces producing structural vibrations which are sensed by the control system gyros and accelerometers and fed back through the control system to the surface actuators to form the loop closure. If the phase lag of the loop is sufficient, the feedback signals will be in phase with the structural vibrations and reinforce them. If the loop gain is high enough, a structural resonance will occur. Structural resonance occurs when the total loop gain (control system plus structure) is equal to unity and the phase lag is 180 degrees. Structural resonance usually occurs in the frequency range between 10 and 15 Hertz and is also a self-sustaining oscillation.

Structural resonance ground tests must be conducted on the actual aircraft so that the structure is involved. These tests are sometimes referred to as structural coupling tests. The tests are very simple and easy to conduct. The aircraft's control system gains are set to and tested at a few of the more critical conditions in the flight envelope. At each of these conditions the control system feedback gains in each axis are increased until a structural resonance is attained. The structural resonance gain margin is the difference between the gain required to achieve a structural resonance and the actual control system gain to be used in flight at the condition tested. The gain increases are accomplished by using a software patch in a digital system or making a component modification (such as a resistor change) in an analog system. In either case, the gains must be returned to the design standard values after the tests to obtain the desired control system characteristics for flight testing.

9.7.3 Test Product

Limit cycle and structural resonance ground tests provide predicted gain margins for closed-loop instabilities. They enhance flight safety and mission planning by identifying which areas in the flight envelope will be most susceptible to having limit cycle or structural resonance oscillations occur. If the ground tests predict low gain margins in certain portions of the envelope, these areas can be approached with caution during the flight test program or avoided completely. If higher gain margins are desired, control system changes such as decreasing the feedback gains or adding notch filters can be made to achieve this end.

Limit cycle and structural resonance ground tests are also used to verify analytical models which predict aeroservoelastic instabilities. For example, structural resonance ground tests are conducted at zero dynamic pressure. Airloads may have an effect on the damping of the structure. To predict this effect, we must rely on analytical models which contain aerodynamic effects. These models are used to predict structural resonance characteristics over the entire flight envelope of the aircraft. But the analytical model can be verified at zero dynamic pressure by comparing its predicted structural resonance characteristics at this condition to those achieved from the structural resonance ground tests. If the model does not match the ground test results it should be updated to do so.

9.7.4 Test Requirements

Limit tests must be conducted on either the actual aircraft or an iron bird simulation so that the hydraulic system, actuator, and control system characteristics are included. Structural resonance tests must be conducted on the actual aircraft so that its structural characteristics are included. The aircraft should be in a flight-ready configuration with all panels and structural elements that are load bearing intact.

Both tests should be conducted at the most critical conditions expected in flight. For limit cycle tests this means the highest control system times aerodynamic loop gain. For structural resonance this means the highest flight control system gain.

The standard requirement is to demonstrate six db gain margins throughout the flight envelope for both limit cycle and structural resonance oscillations. This gain margin is required prior to flight to guard against uncertainties in aerodynamics, structural damping effects due to airloads, changes in structural characteristics due to fuel loading, etc. The loop gain in each axis should be increased until an oscillation is achieved, even if this gain value is in excess of six db. The reason for doing this is if control system gain changes are made in the future the gain value at which an oscillation occurs will be known and adequate gain margins can be maintained.

If the tests are done on the actual aircraft, the aircraft should be placed on a soft suspension system or the tires should be deflated. This is done to decrease the frequency of the aircraft rocking on its gear to as low of a value as possible so that these gear frequencies do not interact with the limit cycle or structural resonance frequencies and contaminate the test results.

During closed loop limit cycle testing, the aircraft should be excited with both small and large sharp pulses. Large pulses are required to test if the system can sustain actuator rate limited limit cycle oscillations. Actuator rate limited limit cycle oscillations can be very large amplitude oscillations which can occur at a much lower gain value than non-rate limited limit cycle oscillations. Since they can be large in amplitude, these oscillations can be destructive. They, therefore, should be properly tested for on the ground prior to flight by applying sharp, large amplitude inputs during limit cycle ground tests.

9.8 VERIFICATION AND CALIBRATION TESTS

9.8.1 Objectives

Verification and calibration tests are conducted to ensure that the aircraft's software, subsystems, and instrumentation systems (both the special flight test instrumentation and the standard ship systems) operate as designed. Pre-flight verification and calibration tests are critical to the success of the flight test program. Software and subsystems should be checked in the most thorough manner possible and practical prior to flight so that surprises are minimized during the flight test program. It costs dearly in terms of both schedule slippage and monetary expense to spend flight test time correcting discrepancies that should have been found pre-flight. Even more important, it is critical that accidents do not occur during the flight test program that were caused by discrepancies that should have been caught during pre-flight tests.

9.8.2 Test Description

Software verification is conducted in several steps. Component, functional, integration, and man-in-the-loop simulation tests are usually conducted for new or highly modified aircraft. Component verification tests are detailed checks of all software elements such as gain schedules, computations, filters, rate limits, discretizes, and logic statements. Every individual gain value of each component is verified. It is essentially a bit by bit check of the software. These are the initial software verification tests accomplished and are usually performed by the company that codes the software. Functional software tests provide verification of the software code. Using the flight control system software as an example, these tests would involve end-to-end static and dynamic checks of each path in the control system, both individually and collectively. These tests ensure that the individual components of the software are integrated properly into the control law design and the software logic is properly programmed. The tests verify all calculations and logic for the entire flight control system and check that the control laws are implemented as designed. In other words, they verify that the proper output is achieved for a given input or combination of inputs. Functional tests also are usually performed by the company that codes the software. At this point, the software is sent to the aircraft manufacturer who combines the software for all aircraft subsystems (flight controls, avionics, displays, engine, etc.) in an integration ground test facility and performs software integration testing. The software integration facility is a simulation of the aircraft's

complete software system. Integration testing verifies that the software for all aircraft subsystems interact properly with each other and pass the appropriate information between each other. The software integration simulator usually uses automated flight profiles to simulate the aircraft's flight mission and to verify that the software operates properly throughout the entire envelope of the aircraft for all modes of operation. In conjunction with the verification that is accomplished on the software integration simulator, the overall software operation is also verified during the man-in-the-loop simulator studies that are conducted, on a different simulation facility, to evaluate the aircraft's flying qualities. In addition to verifying the overall operation of the software throughout the flight envelope, these studies verify that the software operates properly for all types of pilot inputs. For example, an important verification that is done on the man-in-the-loop simulator is to ensure that the software does not exceed throughput or frame time limits while maneuvering throughout the flight envelope. Even though the software verification tests described in this paragraph are reasonably comprehensive, it is impossible to verify that the proper output is achieved for all possible inputs or combination of inputs. (See Sections 26 and 26A for further information on software tests).

Proper verification and calibration of the aircraft's flight test instrumentation system is required to ensure that the aircraft's in-flight characteristics are measured accurately. Individual transducers which measure such quantities as control surface deflections, aircraft motion, environmental conditions, and engine and subsystem operation must be calibrated both statically and dynamically over their full range of operation. End-to-end static and dynamic checks of the entire instrumentation system, after it is installed in the aircraft, should also be conducted. Special fixtures are required and must be fabricated to calibrate on-vehicle measurands such as control surface deflections, and angle of attack and angle of sideslip vane deflections. Verification and calibration of the aircraft's instrumentation system is a non-trivial task which requires considerable attention. It is also a good idea to calibrate the aircraft's normal instrumentation during pre-flight tests. A description of the design and calibration of flight test instrumentation systems is contained in Section 6 of this document.

Aircraft subsystems are numerous and the pre-flight testing required to verify their proper operation is extensive. A thorough discussion of subsystem pre-flight testing is contained in Section 17 of this document.

9.8.3 Test Product

Pre-flight software verification tests should produce flight control system and avionics software that has been checked to the fullest extent possible and is ready to install in the aircraft. Subsystem verification tests provide assurance that the aircraft's mechanical systems operate as designed. Pre-flight calibration tests provide the aircraft with a calibrated instrumentation system that can be used to obtain accurate data from flight. In essence, pre-flight verification and calibration tests should produce an aircraft system that is ready for first flight.

9.8.4 Test Requirements

The most important requirement for verification tests is that they are thorough and complete. Using flight control system software verification as an example, this means that all gain values, limits, and logic statements are checked in all flight control system modes and submodes. It also means that transfer functions contained in the control system are dynamically checked over their entire frequency range of operation. All individual software components must be tested in an integration facility to ensure that they interact with each other properly. It is important that the actual flight software and hardware components be tested in these integration facilities or in man-in-the-loop simulators to ensure that the components that will be used on the aircraft in flight, and not some emulation thereof, are verified. It is also important that end-to-end static and dynamic flight control system checks be conducted on the actual aircraft prior to first flight. Static checks are required to verify that the software which is integrated with the aircraft's

hardware produces the proper sign and magnitude of control surface deflection for a given flight control system sensor input signal. Dynamic checks are required to obtain end-to-end transfer functions for the actual, installed aircraft hardware and software. These transfer functions are required for man-in-the-loop and analytical simulations.

Verification capability for software changes is something that is required most during the flight test program, but is still appropriate to mention in this Section. Software changes will always be required during the flight test program to fix discrepancies that occur in the actual flight environment. If these changes take many months to verify before they can be flown on the aircraft, they can have a devastating effect on the flight test program, especially if the change is required for flight safety. If quick verification procedures for software changes are agreed upon by all parties early on in the program, it can save considerable time, money, and consternation. Effective modular design of the software can be useful in acquiring quick verification capability. This type of design tries to ensure that changes made to one module of the software do not affect software contained in other modules. If changes can indeed be isolated to one module, software verification time and expense can be minimized by verifying only the module in which the change was made.

9.9 TAXI TESTS

9.9.1 Objectives

Taxi tests are conducted primarily to verify the aircraft's braking system, landing gear shimmy characteristics, and ground handling characteristics. These tests are usually the last ground tests done prior to flight. They provide final verification that the aircraft, with all systems fully operational, is ready for first flight.

9.9.2 Test Description

Braking tests are conducted in a build-up fashion by first accelerating the aircraft to low speeds at a light aircraft weight and applying light, moderate, and heavy braking. The process is repeated in increasing increments of target ground speed and aircraft weight until maximum conditions of near take-off speed and heavy weight are reached. Usually about three or four target ground speeds at which brakes are applied are used during the tests. The tests are conducted with the brake anti-skid system operational, although some build up testing with the anti-skid system off may be desirable. Periods of cooling will probably be required between the higher speed and heavy braking runs to ensure that brake and tire temperature design limits are not exceeded.

Landing gear shimmy tests are conducted concurrently with braking system and ground handling tests. Gear shimmy tests should also be conducted in a build up fashion from low to high speeds since shimmy will be more severe at high speeds. The landing gear's shimmy characteristics are assessed by use of real-time telemetry in the control room monitoring landing gear accelerometer data. Landing gear damping can be measured as the aircraft rolls over rough spots on the runway or after the ground steering system has been pulsed by inputs from the pilot. Light damping at low speeds is an indication that sustained shimmy may occur at higher speeds. Any significant level of shimmy will of course also be felt by the pilot.

The aircraft's ground steering capability can be assessed by conducting closed-loop tracking tasks such as aggressively trying to track the runway centerline during acceleration and deceleration. In these tests, the pilot evaluates the capability to maneuver the aircraft about, and to capture, the runway centerline by using nose wheel steering, differential braking, rudders, and ailerons. Since the effectiveness and sensitivity of nose wheel steering, differential braking, and aerodynamic control surfaces varies with speed, the tracking tasks should be accomplished throughout the range of ground speeds expected for the aircraft.

Nose rotation capability should be evaluated as a part of the ground handling taxi tests prior to first flight. Nose rotation capability can be safely assessed by the pilot applying aft stick during ground acceleration below the predicted nose rotation speed, and well below the predicted aircraft liftoff speed. As the aircraft accelerates with aft stick applied, and the nose begins to rotate off the ground, the pilot should carefully control the rotation rate until the target rotation angle (usually about five degrees or less) is reached. The pilot should lower the nose back onto the runway and reduce engine thrust at a ground speed which is far enough below aircraft liftoff speed so that the aircraft does not become airborne during these taxi tests. If the predicted nose rotation speed is close to the predicted aircraft liftoff speed, it is not desirable to lift the nose off the ground during these tests. Instead, aft stick should be applied well below the predicted nose rotation speed and held until the nose gear strut starts to extend. Strut position can be monitored by the use of real-time telemetry to aid the pilot if required. When the nose gear strut starts to extend, aft stick should be released and engine thrust reduced. The ground speed at which to start applying aft stick in both cases can be obtained from simulator studies. Since there is a good deal of uncertainty associated with control surface effectiveness in ground effects, the simulator studies should be conducted with at least 25-percent uncertainty applied to elevator control effectiveness to ensure there is plenty of margin between the speed for aft stick application and aircraft liftoff speed.

9.9.3 Test Product

Braking tests verify that the aircraft's brake and anti-skid system operate and perform as desired. Desired system operation means the deceleration characteristics are smooth and free of chatter, and there is no tendency for the brake and anti-skid system to grab or lock. Brake forces should be acceptable to the pilot. Desired system performance means the brakes are capable of stopping the aircraft within the design requirements without excessive wear, damage, or overheating. Brake system overheating can cause hydraulic system fires; hence, it obviously should be avoided.

Landing gear shimmy tests verify the aircraft is free of undesirable shimmy during runway operations. Shimmy levels that produce unacceptable ride qualities to the pilot or have the potential of causing structural damage are undesirable. If this level of shimmy does occur, mechanical damping will have to be added to the landing gear system to eliminate it.

Ground steering tests provide an evaluation of the aircraft's steering system from low taxi speeds to high takeoff and landing speeds. Good ground steering capability is required to maneuver and control the aircraft on the runway during takeoff and landing, especially in high crosswinds.

Nose rotation evaluations are performed during taxi tests to assess the aircraft's longitudinal control power in ground effects so that, on the first flight, the pilot will be familiar with the ground speed required for rotation and the rotation rate is achieved. (When the aircraft is on or close to the ground, its lift, drag, and pitching moment characteristics at a given airspeed and incidence differ from those in free air. This effect, termed "ground effect", reduces rapidly as the aircraft climbs to become negligible once the wing is more than about a semi-span above the ground. This effect is difficult to estimate, or to measure in a wind tunnel).

Successful completion of the taxi tests is the final step in the pre-flight test process. If the braking system, landing gear shimmy characteristics, and ground handling characteristics are acceptable, the aircraft is ready for first flight.

9.9.4 Test Requirements

The aircraft should be in a flight ready configuration. A flyable configuration is required in the event the aircraft unintentionally becomes airborne during the high speed taxi tests.

Brake temperatures must be closely monitored during taxi tests to ensure that design limits are not exceeded and a hydraulic system fire does not occur. Cooling will probably be required between high speed or heavy braking runs.

Taxi tests should be conducted in a buildup fashion so that testing proceeds incrementally from the least critical to the most critical conditions. Parameters that require a buildup are ground speed, braking levels, aircraft weight, and control input levels.

Runway length requirements for high speed taxi tests should be carefully determined. Plenty of margin for error should be included. Required distances to accelerate, coast, and decelerate the aircraft, which include adequate margins for uncertainties, should be calculated. Factors which may produce uncertainties in runway length requirements are overshooting target ground speed, pilot reaction time for brake application at high speeds, lower than expected braking performance, lower than predicted rolling friction characteristics, and test day wind conditions.

The need for brake cooling fans/blowers and "cages" to contain wheel/tire fragments in the event of explosion caused by overheating (although this is usually protected against by the use of fusible plugs) should be evaluated.

A control room should be used for real-time-monitoring during taxi tests. The control room can be used to monitor gear shimmy characteristics and calculate damping, monitor brake temperatures, monitor ground speeds, and monitor aircraft system integrity by ensuring that all subsystems are operating properly and without failure.

9.10 CONCLUDING REMARKS

This Section has presented an overview of pre-flight testing that is required to ensure that the aircraft is ready for first flight. The complex nature of today's advanced aircraft systems make it essential that pre-flight tests are performed thoroughly and meticulously so that a productive and safe flight test program can be accomplished. The goal of pre-flight testing should be to catch and correct system deficiencies to the fullest extent possible so that valuable flight test time is not lost doing so. After proper pre-flight testing is accomplished, the aircraft is ready for first flight.

9.11 ACKNOWLEDGEMENTS

Mr. L. Tracy Redd and Mr. Allan T. Webb of the US Air Force Flight Test Center made substantial contributions to this Section. Mr. Redd wrote the "Ground Vibration Tests" and "Structural Loads Tests" subsections, and Mr. Webb wrote the "Propulsion Tests" subsection.

9.12 REFERENCES

- [9-1] Lenzi, David C., Cogburn, Lowell T., "AFTI/F-111 Mission Adaptive Wing Ground Vibration Test", AFFTC-TR-85-1, February, 1985.
- [9-2] Military Specification, "Airplane Strength and Rigidity - Ground Tests", MIL-A-8867B.
- [9-3] Military Specification, "Airplane Strength and Rigidity - Flight and Ground Operation Tests", MIL-A-8871A.

9.13 BIBLIOGRAPHY

Norton, W. J., Captain, USAF, "Structures Flight Test Handbook", AFFTC-TIH-90-001, November 1990.

Air Force Guide Specification, "General Specifications For Aircraft Structures", AFGS-87221 (USAF), 28 February 1985.

Dole, C.E., "Fundamentals of Aircraft Material Factors", University of Southern California, Los Angeles, California, 1987.

Military Standard, "Aircraft Structural Integrity Program, Airplane Requirements", MIL-STD-1530A.

Military Specification, "Airplane Strength and Rigidity - General Specification", MIL-A-8860.

Military Specification, "Airplane Strength and Rigidity - Flight Loads", MIL-A-8861.

Military Specification, "Airplane Strength and Rigidity - Reliability Requirements, Repeated Loads, and Fatigue", MIL-A-8866.

Skopinski, T.H., Aiken, W.S. Jr., and Huston, W.B., "Calibration of Strain-Gage Installations in Aircraft Structures for the Measurement of Flight Loads", NACA Report 1178, 1954.

Kottkamp, E., Wilhelm, H., and Kohl, D., "Strain Gauge Measurements on Aircraft", Agard Flight Test Instrumentation Series, AGARDograph 160, Vol. 7, 1976.

Manning, S.D., et. al., "Durability Methods Development", Volume I, AFFDL-TR-79-3118, September 1979.

Mahlum, R.W., "AFFTC Aircraft Horizontal Thrust Stand Evaluation and Operation Update", AFFTC-TIH-76-05, AFFTC, Edwards AFB, CA, August 1977.

Pihlgren, W.D., "Aircraft Vertical Center of Gravity Determination Using the Ground Inclination Method", AFFTC, Edwards AFB, CA, December 1975.

Wiles, J.A., "Aircraft Brake Systems Testing Handbook", Addendum 1 to AFFTC-TIH-81-01, AFFTC, Edwards AFB, CA, July 1982.

Danek, G., "Vertical Motion Simulator Familiarization Guide", NASA TM 103923, May 1993.

"Test Facilities Handbook", Thirteenth Edition, Arnold Engineering Development Center (AEDC), TN, May 1992.

Muse, W.W., "AEDC Analysis and Evaluation Program Synopses (FY91) Propulsion Projects", AEDC-TR-91-27, AEDC, Arnold AFS, TN, October, 1992.

Kirsten, P.W., "Flight Control System Structural Resonance and Limit Cycle Results", AGARD Symposium on Flight Test Techniques, Conference Proceedings No. 223, DFVLR, Porz Wahn, Germany.

Chapter 10 – SAFETY ASPECTS

J.K. Appleford

Aeroplane & Armament Evaluation Establishment
Boscombe Down, Salisbury, Wilts, SP4 0JF
UK

10.0 INTRODUCTION

It is considered self-evident that flight testing should be conducted "safely", i.e., without hazarding the aircraft, its crew, or persons or property on the ground. It is equally obvious that not all flight tests incur the same degree of risk: for example, the risks incurred in testing the departure (stalling and spinning) characteristics of a new aircraft type can be expected to be an order (or even orders) higher than those associated with range measurements on a new radio.

However, it must be recognized that there is an (accepted) element of risk in **any** flight operation, and "safe" is a relative term. In devising his test programme the Flight Test Engineer (FTE) can rarely quantify, let alone guarantee, the actual level of risk involved. But what he can and must do is to so plan and execute the test programme that, within the constraints imposed by the nature of the tests themselves and the resources available, the risks incurred are always kept within what are judged to be acceptable limits.

This section confines itself to safety-related matters peculiar to flight testing, and it is assumed that readers will be aware of those applicable to all flight operations (e.g., the need to ensure that the aircraft is serviceable, and always operated within its permitted limits and in accordance with the approved procedures). It discusses responsibilities for flight test safety, the safety-related aspects of trials facilities, and crew constitution and training. It then outlines the principles of test planning and conduct, and concludes with a summary of the main points to be borne in mind.

10.1 ORGANISATIONAL MATTERS

The structure of each flight test organisation will reflect its origins, terms of reference and the nature of the tasks it undertakes. Each will develop working practices that suit its particular circumstances, and significant variations can be expected. However, the chain of command must ensure that, when necessary, safety-related decisions are taken at the highest level. Typically, flight test safety will be addressed at the planning stage via a procedure similar to the following.

The test programme and the associated test procedures to be followed (see Section 8) will be drawn up by the flight test team, led by the lead FTE and project pilot. Usually the former will take the lead in technical matters (assisted, where necessary, by the appropriate specialists) and the latter will take prime responsibility for the operational aspects of the trials. While the test programme will be aimed primarily at achieving the trials objectives, a balance must be struck between the "worth" of those objectives and the "risks" involved in achieving them. To allow the overall risks to be weighed against the value of the data expected from the trials, it is necessary to identify for each set of tests and test conditions:

- The individual hazards that could arise, and their cause(s)
- The probability of each hazard occurring, and its consequences
- Possible means of eliminating or reducing those hazards.

SAFETY ASPECTS

In the US, this risk assessment is conducted via a formal hazard analysis, designed to identify and evaluate all potential problems arising from the aircraft and/or equipment under assessment (e.g., possible failure modes), or the (demanding) flight conditions to be investigated (e.g., aircraft departure during high angle of attack testing). [10-1, 10-2, 10-3]

Once the flight test team are agreed that their proposals represent a sound means of achieving the test objectives, they should be submitted for independent review to confirm that they are indeed acceptably "safe", in that:

- Due account has been taken of all relevant existing evidence (from calculation, wind tunnel tests, simulation and earlier flight tests, etc.)
- The test organisation's normal safety criteria are being applied
- No potential hazards have been missed through ignorance or oversight
- The risks incurred are justified by the expected return.

Responsibility for this safety review, and approval of the proposed flight test programme and test procedures, may rest with the supervisory chains for each discipline (typical of UK practice) or be assigned to a "Review Board" on which the various disciplines are represented (typical of US practice). In either case the personnel involved should consist of senior practitioners with (between them) extensive experience of all aspects of the proposed tests, and the authority to rule on the acceptable levels of risk.

10.2 FACILITIES REQUIRED

10.2.1 Trials Aircraft

The test team must satisfy themselves that the build standard, equipment fit, serviceability, and test instrumentation of the trials aircraft meet both the technical and safety requirements of the planned trials, and that the applicable flight limitations and operating procedures are fully documented in an appropriate form. They should also consider whether non-standard items of equipment should be fitted for the specific purpose of enhancing flight test safety.

In the case of trials such as stalling, spinning and aggressive air combat manoeuvring (traditionally classified as "high-risk" because they incur a high risk of loss of control and, possibly, pilot disorientation), it is common practice to provide such equipment as:

- Additional and/or repositioned cockpit instruments to enable the pilot to recognise the onset of potentially dangerous flight conditions in time to avoid them (e.g., expanded scale airspeed indicator, single pointer altimeter with visual or audio warning, yaw indicator, structural load indicators, etc.), or to assist him in recovery following loss of control (e.g., control position indicators, pitch and roll attitude indicators, etc.)
- Telemetry to enable a ground-based "safety pilot" and trials specialist(s) to assist the pilot in monitoring critical parameters, or to recover should he become disorientated following a loss of control
- A recovery device (e.g., rocket or parachute) to assist in restoring the aircraft to a flying attitude should it attain a condition in which the aerodynamic moments provided by the flying controls are inadequate
- Emergency power supplies to provide alternative sources of hydraulic and electrical power in the event of malfunction or failure of the engine(s)
- An accident data recorder, supplied by the emergency electrical power source and protected against the effects of a crash, providing sufficient data to offer a high probability of identifying the cause(s) in the event of a crash.

Such equipment is likely to incur a significant lead time (and, possibly, a maintenance penalty) and hence its need should be considered at the earliest possible stage of trials planning. Further, its presence may well affect the trials programme. For example, telemetry, if extended to cover the appropriate parameters, can enable "success" at one flight condition to be confirmed in real time, allowing immediate progression to the next condition. Thus equipment installed primarily for safety reasons may assist trials progress. On the other hand, a stall/spin recovery device which affects the aircraft's inertial or aerodynamic characteristics significantly can require tests to be repeated with the device removed. In deciding whether or not to install safety-enhancing equipment the flight test team must consider each case on its merits, weighing the likely gain in safety against the effect on the flight test programme. Needless to say, safety considerations should always outweigh trials convenience.

It should also be noted that relatively simple items can offer worthwhile improvements in flight test safety. For example, for UK air-to-air refuelling tests (probe and drogue) which incurred frequent rapid throttle movements in the receiver, a temporary hinged throttle baulk was fitted to prevent inadvertent excursions to throttle settings at which "pop" surges occurred.

Cargo and passenger transport aircraft call for special consideration, especially if advantage is taken of the large fuselage volume to carry extensive flight test equipment and several flight test observers to monitor/operate it. For example, it is unlikely that escape facilities will be "built-in", and it will be necessary to provide such items as:

- Parachutes and parachute-compatible seating
- Door(s) and/or hatch(es) which can be opened in flight, and an emergency de-pressurisation system
- Means of guiding/assisting crew escape (for one UK trials programme a handrail consisting of a knotted rope was installed from the cockpit to the rear door).

However, to minimise the crew requirements during "high-risk" flights (see paragraph 10.3.2 below), it should be possible to operate all essential test equipment (flight test instrumentation, flutter excitation system, autopilot "runaway box", etc.) from the flight deck crew positions. Particular care must be taken over "house-keeping" to ensure that, before any tests involving significant manoeuvres are undertaken, all test equipment is secure and there are no loose items (such as clipboards or calculators) to cause injury or damage.

10.2.2 Trials Site

It must be assumed that the "home" site at which the flight test team operates is judged to be adequate for the flight trials normally undertaken there, and hence there is little point in providing a general check-list of desirable/undesirable features for a flight test site. Nevertheless, the suitability of the "home" test site must always be considered when planning trials of an unfamiliar or unusual nature. As a simple example, if takeoff performance tests are to be conducted at abnormally high values of aircraft mass, the suitability of the airfield geometry must be reviewed by assessing the available takeoff, landing, and emergency distances and obstacle clearance surfaces in the light of the predicted aircraft performance (see paragraph 10.4 below).

In some cases it may be recognised that the "home" site is unsuitable for certain types of test, and that they must be conducted at an alternative test venue. Thus Edwards Air Force Base is often used for tests involving high incidence, stalling, spinning, and engine handling of turbojet-engined aircraft (in each of which there is a high risk of engine flame-out) because it offers both very long runways and extensive areas of dry lake bed on which "dead-stick" landings can be made safely. When (as with Edwards Air Force Base) the alternative test venue is an established flight test centre, the facilities available are likely

SAFETY ASPECTS

to meet all the normal requirements for trials safety and efficiency. However, it remains the responsibility of the test team to confirm that this is so, or to negotiate the provision of any special facilities necessary for their particular aircraft and/or trial.

Certain types of trials require, by their very nature, ground and flight tests to be conducted at a site quite unlike the "home" site with which the test team is familiar. Typical examples might be:

- "Austere site" testing, to assess operation of the aircraft from semi-prepared or unprepared surfaces
- Climatic testing (hot or cold) (See Section 18)
- Operation from aircraft carriers.

In the first two cases, the potential options can vary considerably. The proposed test site may be an airfield equipped with all the facilities required for routine aircraft operations, a little-used or disused airfield, or even a "green-field" site. Thus preliminary site visits are essential to enable the test team to familiarise themselves with the facilities available and the likely operating constraints. The active co-operation of the site "owners" should be enlisted to identify the facilities available, particularly in respect of rescue and recovery and medical treatment or evacuation, so that the suitability of the site and the nature and extent of any additional facilities needed can be determined. In the case of "green-field" sites, the logistics of providing adequate safety facilities in respect of rescue, fire, and medical cover may be formidable.

While operation from aircraft carriers may seem straightforward, similar site visits are also essential to:

- Confirm compatibility of the test aircraft with the ship's supplies (e.g., in respect of fuel and oil, electrical supply, etc.)
- Negotiate any special facilities or operating practices required for the tests
- Identify any potentially adverse features of the ship's environment (e.g., the possibility of interference by the ship's radar with the aircraft's electronic systems and vice versa).

Clearly, such preliminary investigations are even more important if the trials (e.g., of a helicopter) are to be conducted from a ship which does not normally support flying operations.

10.2.3 Other

For all trials other than those involving minor changes to internal equipment it is prudent to provide a chase aircraft whose pilot can monitor the progress of the trials from close range and, if necessary, advise the test pilot of the external configuration of the test aircraft (e.g., stores remaining, undercarriage position, etc.) or warn of anomalies (e.g., insecure panels, signs of leakage or fire, etc.). Ideally, the chase aircraft should permit a photographer to be carried to enable still and/or video records to be taken as required. Its performance should allow it to formate with the test aircraft although, if the test aircraft is significantly faster than the chase, the latter can "pre-position" for tests at high speed/Mach number. Clearly, care must be taken to ensure that there is no risk of collision between test aircraft and chase. For stalling and spinning tests the chase aircraft should "stand-off" at a safe range. Prior to weapon delivery tests, both aircraft should rehearse the manoeuvres involved to ensure that the chase can obtain the coverage required without risk of collision, or infringement of the "bomb fall line".

Similarly, appropriate ground facilities should be provided and/or utilised to enhance flight test safety, such as:

- Air Traffic Control, to assist the pilot in remaining within the test "range", and to avoid conflicts with other traffic

- Range kinetheodolites, to monitor the height lost/minimum terrain clearances incurred during ground attack dive testing
- (When operating away from the "home" site) portable flight test instrumentation replay facilities, to permit the post-flight analysis necessary to conduct the test programme in a progressive manner.

10.3 CREWING CONSIDERATIONS

10.3.1 Crew Qualification

It is assumed that the flight test crew will satisfy the criteria discussed in Section 4, i.e., that they will be professionally qualified test pilot(s) and flight test observers and, (where appropriate) flight engineers, missions systems operators, etc. As such they must be medically fit and, where the test venue so requires, be given the appropriate inoculations. They must have been trained in all relevant flight safety procedures, especially those specific to the test aircraft (e.g., use of doors and/or hatches for emergency egress on the ground and in the air). Their personal flying clothing and safety and survival equipment must, of course, always be appropriate to the test aircraft and test venue. Finally, the pilots, engineers and operators should be thoroughly familiar with the Service role(s) for which the aircraft under test is destined.

10.3.2 Crew Constitution

Except where the tests are clearly "non-hazardous" (e.g., they involve minor equipment changes to a well-proven aircraft type, and routine flight profiles), the crew should be restricted to the minimum number, which will depend on the type of aircraft and the nature of the tests to be made. For "high-risk" trials (e.g., those which involve a risk of departure from controlled flight), the crew complement must be kept to the minimum **essential**, even if this results in less efficient use of flight time by preventing other (less hazardous) tests from being conducted during that sortie. In deciding the minimum crew complement, consideration should be given to the feasibility of re-assigning the normal crew duties, including devolving tasks to the flight test observer (or vice-versa).

10.3.3 Crew Training

The extent of the preliminary crew training required will depend on such factors as the:

- Status of the test aircraft (which can range from a new design prior to first flight, to a long established type in which only minor changes have been incorporated)
- Nature of the tests to be made
- Crew members' previous experience and currency.

With new or unfamiliar aircraft types the crew must be briefed fully on the aircraft's design features and systems, handling and performance characteristics, and recommended operating procedures. The briefing will normally be given via ground schools run by the airframe, engine, and equipment manufacturers. Wherever possible, ground rigs and/or flight simulators should be used to provide "hands-on" training in the operation of the aircraft and its equipment, and to familiarise the pilot(s) with its handling and performance characteristics, under both normal conditions and those abnormal conditions which may arise in the event of failure. Where practicable, this training should be supplemented by training flights in the test aircraft, conducted under the direction of an experienced crew. Appropriate training should also be given in the operation of the flight test instrumentation, and in the use of any special test equipment fitted (e.g., autopilot "runaway box").

SAFETY ASPECTS

In addition to the above training on features specific to the test aircraft, it is essential that the flight deck crew be current in the operational techniques applicable to the tests to be conducted. For instance, before undertaking tests which involve a risk of departure from controlled flight, the pilot(s) should be in current spin recovery practice: if possible, this should be acquired using an aircraft whose departure/spin characteristics are similar to those predicted for the test aircraft. Similarly, before undertaking aircraft carrier trials the pilots should be current in deck landings, preferably by undertaking deck landings with a (similar) Service type, and practicing with the test aircraft on an airfield equipped with a painted "dummy deck" and the relevant carrier approach aids. Where other members of the flight deck crew are involved directly in the tests (e.g., Air-to-Air Refuelling testing of a tanker, which involves the flight engineer and/or a boom operator), the "hands-on" training should include those crew members.

10.4 TEST PLANNING

As introduced in paragraph 10.1 above, the FTE must so plan the flight test programme, and the flight test procedures to be followed, that the risks are reduced to the minimum practicable. Using his and the project pilot's experience (and, where appropriate, that of specialists outside the immediate flight test team) he must consider such factors as the:

- Nature of (and risks inherent in) the various tests involved
- Design features and the known or predicted characteristics of the test aircraft
- Likely variability in factors outside his direct control
- Facilities available for monitoring interim test results to ensure that the overall test programme provides a progressive and "safe" approach to the desired end conditions. While the detail will vary from case to case, the following examples illustrate the thought processes involved.

Taking the example of paragraph 10.2.2 above, if engine failure is to be simulated during takeoff at abnormally high values of aircraft mass, the FTE must first consider the risks inherent in the test and form judgements as to whether they are acceptable, or can be made so by adopting appropriate experimental procedures. Thus the probability of a second (real) engine failure occurring should be considered and, if it cannot be discounted, the consequences and options remaining, namely:

- Is the power available from the remaining engine(s) adequate to continue, and can a safe emergency landing be made at near takeoff mass?
- Can adequate power be re-established sufficiently rapidly on the (simulated) "failed" engine?
- Could the second (real) engine failure result in a double-engine failure due to the proximity of intakes or inadequate containment?
- If adequate power to continue cannot be assured, is the runway and/or emergency distance available adequate in all respects to abandon the takeoff safely?
- Should the situation be irretrievable, can the aircrew eject safely with acceptably low risk to persons/property on the ground?

If he judges the inherent risks to be acceptable, he must then consider what pre-cursor tests are needed (e.g., tests to determine V_s , V_{mcg} and V_{mca} , the datum speeds on which the takeoff reference speeds are based), what increments in aircraft weight and/or decrements in engine "failure" speed represent a suitably progressive approach to limiting conditions, and what "go/no-go" criteria will be used to monitor test safety as the trials progress.

The cardinal principle in planning a test programme must be to start from known "safe" conditions, and to progress to increasingly more demanding conditions in appropriate increments, monitoring the results obtained at each condition before progressing to the next.

Thus assessment of a particular aspect of an aircraft's flying qualities should be initiated under loading and flight conditions predicted to be benign. The extremes of aircraft centre of gravity (cg) position and/or of the flight envelope should then be approached incrementally, confirming satisfactory behaviour at each set of conditions before progressing to the next. Similarly, the different types of test should be conducted in a logical, progressive sequence. For instance, before embarking on an assessment of air combat manoeuvring, where inadvertent departures from controlled flight can be expected, pre-cursor tests must have been completed to determine:

- The general flying qualities of the aircraft, especially of its departure (stalling and spinning) characteristics, the associated piloting techniques for recovery and the height losses incurred
- Engine behaviour, handling, and relighting, especially under conditions of high incidence and/or large sideslip angles.

It is appropriate to note here that, as stated in paragraph 10.0, the level of risk associated with particular tests and test conditions often cannot be quantified, but must be a matter of "engineering judgement". Experience suggests that the safety standards applied tend to differ between flight test agencies and, even within the same agency, to depend on the type of testing or the "political pressures" involved. Thus the FTE must base the judgement of the risks involved in a particular test against the standards normally applied by his test agency. However, any pressure to "cut corners" for economic reasons should be resisted (supported by the "Review Board") and, in many cases, it may well be possible to demonstrate that the progressive approach necessary for safety reasons offers technical advantages. Thus the resulting larger data base will improve the fidelity of interpolation and reduce the risks of unforeseen anomalies being missed. Further, any "rare events" arising (say) from particular combinations of flight conditions and piloting technique are more likely to be encountered, enhancing confidence that the test results, conclusions, and recommendations are sound.

Finally, when the draft test matrix has been constructed in accordance with the guidelines above, it should be reviewed to see whether any adjustments would result in improved trials effectiveness without compromising flight test safety.

It should be stressed that it is only possible to offer **general** guidance on flight test planning. Each flight test programme is (almost by definition) unique, and thus, the FTE **must** consider **in detail** the specific characteristics of the test aircraft, the tests to be made and the prevailing circumstances to ensure that, as far as is humanly possible, all contingencies have been covered. In particular, he must **never** allow familiarity with the aircraft and/or type of testing to lull him into a false sense of security - "old" aircraft can bite too!

10.5 TEST OPERATIONS

The physical safety aspects of test operation are very similar to those encountered with any aircraft operations, and it is assumed that **all** personnel involved (especially any visiting specialists who are not familiar with the operational environment) will be briefed as necessary on the relevant hazards and required procedures. This is particularly important when conducting climatic tests and/or operating from unfamiliar sites, when the potential hazards may differ from those normally encountered.

In addition to the flying limitations, operating procedures and allowable deficiency list applicable to the aircraft and its equipment, a clear set of "go/no-go" criteria should be established to cover such aspects as:

- Test location (e.g., to avoid airways, built-up areas or High Intensity Radio Transmission Areas which could interfere with the aircraft's electronic systems)
- Weather/visual conditions (e.g., to allow the pilot to remain well-orientated, "a well-defined horizon, with no significant cloud cover beneath the aircraft" is specified in the UK for tests involving a risk of departure)

SAFETY ASPECTS

- Minimum altitudes (again, for tests involving a risk of departure, the minimum altitudes for initiating the tests and, if necessary, activating the recovery device and/or abandoning the aircraft must be specified).

With regard to the conduct of the testing, it will be appreciated from the foregoing paragraphs that intelligent test planning is the key to successful test operations. In principle, if the planning is sound no undue "surprises" should arise during the actual execution of the tests. That said, the FTE must remain fully alert throughout the test phase. As testing proceeds, the results obtained must be monitored continuously to confirm that they are as expected. This will usually be accomplished by comparing the test results with data derived from earlier flights, from simulation, or from calculation. The facilities available should be used to the full, and the temptation to "check later when the data comes back" resisted. If the test data appears to diverge from the predictions, or the validity of the results is in doubt, the reason(s) should be established before proceeding: in particular, the pilot should **never** repeat a test which resulted in unexpected behaviour until the reason(s) has/have been established by appropriate data analysis.

This monitoring should cover **all** aspects of the flight, and not just the topic of immediate interest. During an assessment of air combat manoeuvring in the UK, the aircraft's flying qualities were entirely as predicted but, quite unexpectedly, the engine suffered "fan rubbing" due to flexure of the shaft. Thus, the flight test team must remain alert for **any** signs of distress or shortfalls in "performance", especially where they may have safety implications. In the limit, it may be judged imprudent to proceed any further with a particular test, resulting in a recommendation that the aircraft be modified and/or acceptance of limitation(s) in the aircraft's capabilities.

The decision to proceed with a series of tests will normally be made jointly by the team leader and the project pilot. However, if they have any reason to suspect that the safety of future tests might fall below that originally presented to the "Review Board", they should alert the Board and offer appropriately amended test proposals for their approval.

10.6 CONCLUDING REMARKS

It is imperative that all flight testing be conducted "safely" and the associated risks be kept within acceptable bounds. While there are no "golden rules" which can guarantee safety, the cardinal principle of test planning and execution must be to proceed from "known, safe" conditions to more critical ones in a progressive and controlled fashion.

Throughout this process, the FTE must apply intelligent engineering judgement, utilising the expertise of all involved (pilots, specialists, ground crew, site "hosts", etc.) to ensure that, as far as is humanly possible, all contingencies have been foreseen and appropriate counter-measures planned. The FTE must guard against complacency (especially when conducting tests on well-established aircraft), remain alert to **any** signs of impending trouble, and be as certain as possible of the validity of interim test results and their significance before continuing to more demanding conditions.

While experience is a great help (as is luck, in some cases!), an informed, common-sense approach to flight trials should result in both safe and effective testing. If in doubt, **DON'T**, but debate the problem within the flight test team (and/or with experienced colleagues) until an acceptable solution (which satisfies the Review Board) has been found.

10.7 REFERENCES

- [10-1] Air Force Material Command (AFMC) Pamphlet (AFMCP) 127-2, "Flight Safety Planning Guide for Flight Testing".

[10-2] Air Force Flight Test Center Regulation (AFFTCR) 127-3, "Safety planning for AFFTC Projects".

[10-3] AFMC Regulation (AFMCR) 127-8, "Test Safety Review Process".

10.8 BIBLIOGRAPHY

Norris, E.J., "Test methods and flight safety procedures for aircraft trials which may lead to departures from controlled flight", A&AEE Note 2111, July 1979.

US Air Force Regulation (AFR) 800-16, "USAF Systems Safety Programs".

US AFR 127-6, "US Air Force Systems Safety Engineering Analysis (SSEA) Process".

OPNAV INSTRUCTION (OPNAVINST) 3750.6Q, "Naval Aviation Safety Program", Change 2, 8 July 1993.

OPNAVINST 3710.7P, "Naval Aviation Training and Operating Procedures Standardization (NATOPS) General Flight and Operating Instructions", 1 Dec 1992.

US Naval Air Systems Command Instruction (NAVAIRINST) 13034.1, "Flight Clearance Policies", 10 Feb 1987.

US Naval Air Systems Command, Flight Test and Engineering Group Instruction (FTEGINST) 3710.1A, "Flight Test and Engineering Group General Flight and Operating Instructions", Patuxent MD, 10 Mar 1994.



Chapter 11 – AIRDATA MEASUREMENT AND CALIBRATION

Edward A. Haering, Jr.
NASA Dryden Flight Research Center
Edwards, California 93523-0273
USA

11.0 INTRODUCTION

This Section provides a brief introduction to airdata measurement and calibration. Readers will learn about typical test objectives, quantities to measure, and flight maneuvers and operations for calibration. The Section informs readers about tower-flyby, trailing cone, pacer, radar-tracking, and dynamic airdata calibration maneuvers. Readers will also begin to understand how some data analysis considerations and special airdata cases, including high-angle-of-attack flight, high-speed flight, and nonobtrusive sensors are handled. This section is not intended to be all inclusive; readers should review AGARDograph 300, Volume 1, "Calibration of Airdata Systems and Flow Direction Sensors" for more detailed information. [11-1] References 11-2, 11-3, and 11-4 also supply pertinent information to better understand airdata measurement and calibration and related terminology.

Airdata are vital to successfully complete an aircraft's mission and are derived from the air surrounding the aircraft. These airdata encompass indicated and true airspeed, pressure altitude, ambient air temperature, angles of attack and sideslip, Mach number, and rate of climb. Typically, pitot and static pressures are sensed and converted (by mechanical means in the instruments themselves) into indications on the altimeter, vertical speed indicator, airspeed indicator, and Machmeter. Similarly, measured local flow angles establish angles of attack and sideslip, and the outside air temperature is measured and indicated in the cockpit. (Instruments that can perform the conversion, such as airspeed indicators, altimeters, and Machmeters, do not correct for errors in the input values.) These measured parameters are commonly input to the airdata computer which, using appropriate algorithms and correction factors (or calibrations, as discussed later), can provide other parameters, such as true airspeed, required by the aircraft's avionics or flight control system.

The presence of the aircraft in the airstream causes input errors to the measuring instruments - the aircraft disturbs the air that it flies through, thereby also disturbing the airdata measurements. Figure 11-1 shows the airflow around an airplane wing. The air above the wing has lower pressure than the ambient air, while the pressure below the wing is higher than the ambient air. Compressibility and shock waves also disturb the air and affect the measurements. Compressibility effects become important above approximately Mach number 0.3. As a result the static pressure around an airplane varies considerably with location. Local flow angles also differ from the free-stream flow direction. In straight-and-level flight the airflow rises to the wing leading edge and falls below the trailing edge, causing errors in flow direction measurements. To some extent these errors can be studied in wind tunnels, but wind-tunnel measurements cannot replace in-flight measurements.

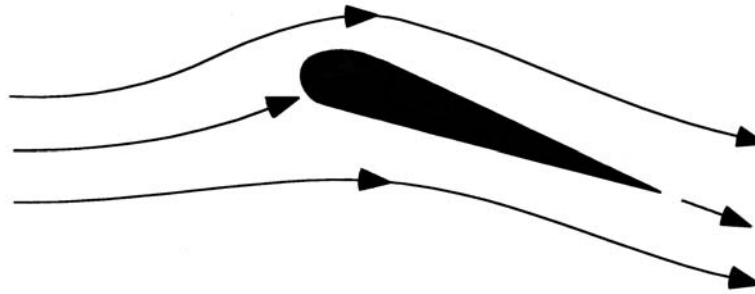

Figure 11-1. Airflow Around an Airplane Wing.

Accurate airdata are necessary for many purposes and applications. Obviously, the pilot cannot safely fly the aircraft without knowing airspeed and pressure altitude. In civil aviation the small vertical separation between flight levels assigned by air traffic controllers is based on accurate knowledge of pressure altitude. Numerous systems, such as autoflight controls, engine controls, cockpit and cabin environmental control, weapons delivery, navigation, and air traffic control, depend on accurate airdata. When an unproven airplane undergoes envelope expansion, careful attention must be paid to flight limits of equivalent airspeed to ensure flight safety. In flight research, most measurands are referenced to airdata quantities, and many parameters are normalized to dynamic pressure. The accuracy needed for a particular application dictates how airdata should be measured and dictates the amount of calibration effort required. References 11-5 and 11-6 specify the accuracy levels required of the pitot-static system by civil and military organizations. Flight research activities may require higher accuracies.

11.1 TEST OBJECTIVES

If the location of the static ports has not already been identified, then the first objective must be to determine the best location for the static ports, that is, where the smallest or most constant position errors occur. Once this location is established, the calibrations of the total and static pressures, angles of attack and sideslip, and air temperature should be determined to account for the disturbing presence of the aircraft in the flow field. The calibrations must be performed under various flight conditions of airspeeds and altitude as well as aircraft attitudes and configurations (combinations of flaps, gear, and external stores).

11.2 MEASUREMENT AND CALIBRATION OF AIRDATA QUANTITIES

11.2.1 Pitot Pressures

The pitot, or total, pressure is the sum of the static pressure and the pressure rise resulting from stagnation of the airflow (dynamic pressure) in the pitot tube. Total pressure is generally easy to measure accurately; the location of the pitot tube is not critical as long as the tube opening is outside the aircraft's boundary layer and is oriented to the incoming flow. For well-sited or aligned probes the total pressure error is usually negligible. (This assumption can be checked by comparison with a venturi pitot or by flying in formation with a calibrated pacer aircraft.) The shape of the pitot tube opening dictates the flow angles at which the pitot tube works well. For supersonic flight pitot tubes that are forward of aircraft shocks, such as those on nosebooms [11-7], will not have aircraft shock losses. [11-2] Figure 11-2 shows a typical flight test noseboom that measures pitot-static pressures as well as local flow angles.

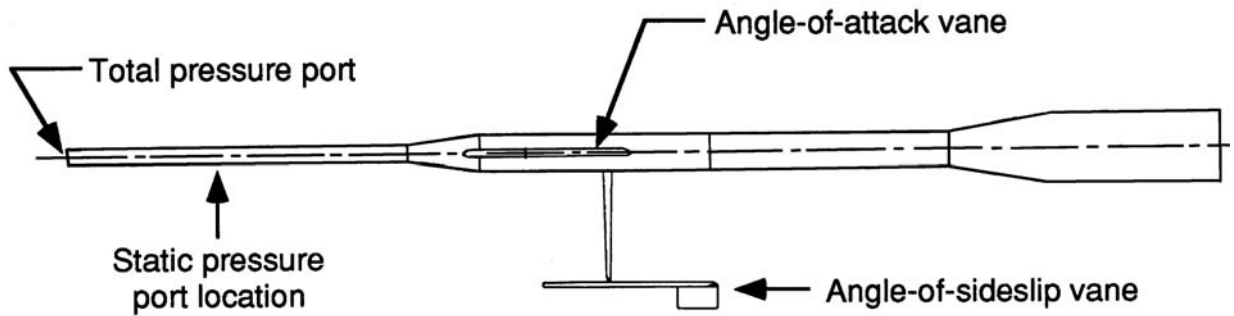

Figure 11-2. Flight Test Noseboom for Measuring Pitot-Static Pressures and Flow Angles [11-7].

11.2.2 Static Pressures

Static pressure can be measured with a pitot-static tube or a flush-mounted port on the fuselage. Figure 11-3 shows a typical subsonic static pressure distribution on an aircraft fuselage. [11-2] The measured minus true static pressure, ΔP , normalized to compressible dynamic pressure, q_c , is plotted as a function of fuselage position. Zero static pressure error on the fuselage exists at locations 2 through 5. One of these locations is chosen for the static port. To keep pneumatic lag small, the static port is normally located as near the airdata instruments as possible (or the other way around). (To determine this location precisely, several static ports are made in this area. The optimum location is then selected as a result of comparing the various ports with a reference source, such as a trailing cone.) This pressure distribution changes with flight condition; so a calibration over the flight envelope may still be necessary.

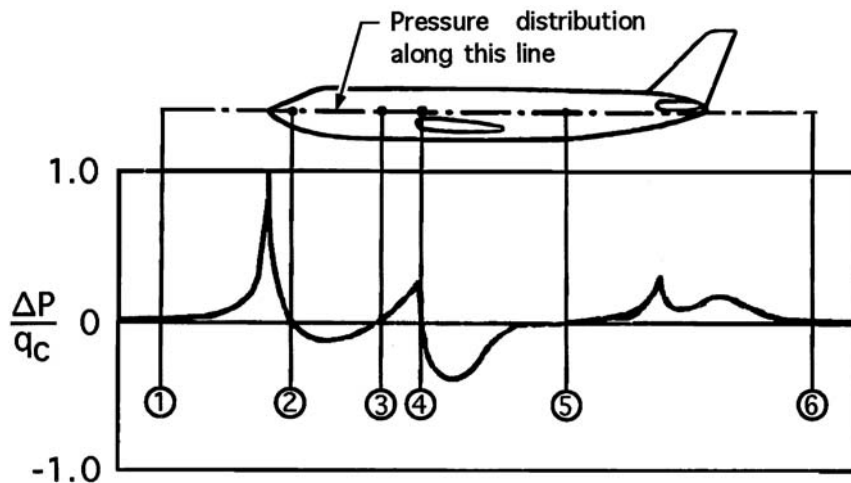

Figure 11-3. Subsonic Static Pressure Distribution [11-2].

Location 1 in Figure 11-3 also has zero static pressure error. A noseboom can be used to place a static-pressure source toward this region. Structural considerations prevent a noseboom from being long enough to have identically zero static pressure error. Some static pressure errors remain and need to be calibrated. Some nosebooms and pitot-static probes have contours designed to compensate the measured static pressure for the position error induced by the specific airplane (or probe for a supersonic noseboom). [11-2]

Even with the selection of the best static port position, some pressure errors will remain, and these errors must be determined in flight. The difference between the locally measured static pressure and the ambient static pressure, which is dependent upon angle of attack, airspeed, and aircraft configuration, is called position error.

Three calibration types are generally used to determine position error: direct comparison, altimetry, and velocimetry. The direct-comparison calibration type involves measuring the true static pressure from a known source. The result is then compared with the static pressure of the airplane being calibrated. Direct comparisons are completed using the trailing cone and pacer methods described in paragraphs 11.4.2 and 11.4.3. The altimetry type adds one level of complexity by first determining the true pressure altitude. This altitude is then converted to static pressure. The tower-flyby and radar-tracking methods, described in paragraphs 11.4.1 and 11.4.4, use altimetry. The velocimetry type uses the ground speed of the airplane and windspeed to determine true airspeed. If test maneuvers are conducted in opposite directions, wind errors can be minimized. Temperature errors affect this calibration type. After the pitot and static pressure system is calibrated, the flow angles and temperature may be calibrated.

11.2.3 Temperature

The undisturbed ambient outside air temperature (OAT) can only be directly measured on board the aircraft at very low speeds. At the low speeds, temperature is typically measured mechanically using a bimetallic strip that moves a needle indicator. At higher speeds the stagnation or total air temperature (TAT) is measured and then corrected to ambient conditions to provide better accuracy of OAT measurement. TAT is the sum of the OAT and the adiabatic temperature rise resulting from the stagnation of the airflow. Because there is not 100 percent stagnation (some airflow past the sensing element is required), a correction, termed the recovery factor, has to be determined. OAT can be readily determined by the methods in reference 11-1 once the true TAT and Mach number are known.

The location for the TAT is not critical as long as the probe inlet openings are outside the boundary layer and are aligned with the airflow when the aircraft is in its normal flight attitude. A favorable location is on the aircraft nose, in the area where the flow is still attached.

Most modern aircraft use TAT probes with electrical resistance elements or thermistors [11-8] with a mechanical design that prevents liquid, ice, or dirt particles from affecting the sensing element. Most probes also have housings that are electrically heated to prevent icing; the sensor results must be corrected for this heating. TAT measurements must also be corrected for self-heating (resulting from the electrical excitation of the heating element), radiation, and the previously mentioned recovery factor.

The combination of these errors is often termed the recovery factor, which must be determined from indicated temperature to TAT. The easiest way to determine this factor is to compare the readings with a reference TAT probe that has been calibrated in a wind tunnel. Another method is to compare the indicated temperature readings with those obtained on another aircraft in which the temperature system has been calibrated.

Figure 11-4 shows a typical temperature calibration for the case in which a reference probe is not available. Plotting total temperature as a function of Mach number squared yields a linear trend. The ordinate intercept is the ambient temperature. The slope and ambient temperature are used to determine the recovery factor. [11-1] The data for one plot must be gathered in a short time-and-distance interval and at a constant altitude so that the ambient temperature remains constant.

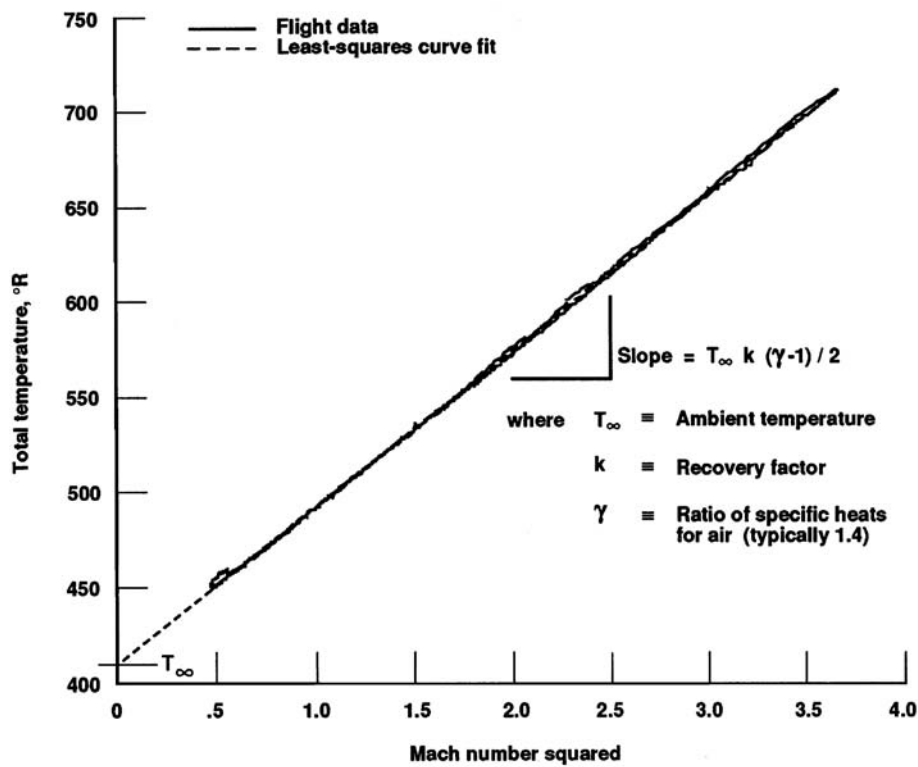

Figure 11-4. Total Temperature Calibration [11-12].

Another method for determining the recovery factor uses a direct measurement of ambient temperature. This temperature is obtained using a thermometer in a tower for low-altitude flight. Still another method uses meteorological data and true Mach number to calculate true total temperature and, thereby, the recovery factor. [11-1]

11.2.4 Measurement of Flow Angles

The locations of the flow angle sensors greatly affect their measurement. At subsonic speeds the local angle of attack is affected by flow around the body and wing of the airplane, which is termed upwash. Upwash affects the sensors near a lifting surface much more than it affects sensors on a noseboom. Wingtip-mounted sensors are greatly influenced by upwash and sidewash; thus, they are rarely used. Flow angles are typically measured with one of three sensors: flow vanes, fixed differential pressure probes, and null-seeking servoactuated differential pressure probes. [11-1, 11-2] Flow vanes resemble small weather vanes and are connected to a potentiometer or other angle-measuring transducers. These vanes should be mass-balanced to remove biases and to improve precision in dynamic maneuvers. Flow vanes tend to be more sensitive than the other two sensors, especially at low speeds. On the other hand these vanes are more susceptible to damage than are the other sensors.

Fixed differential pressure probes generally are hemispherically or pyramidally headed probes with two pressure ports for measuring the flow angle in each axis. When the two pressures are equal, the probe is aligned with the flow. A nonzero differential pressure can be converted to the angle of the flow to the probe.

The null-seeking probe is similar to the fixed probe, except that a servo rotates the probe to achieve zero differential pressure. The angle to which the probe is rotated measures the local flow direction relative to the aircraft body datum.

11.2.5 Angle-of-Attack Calibration

True angle of attack can be determined during steady flight as the difference between the pitch attitude angle and flightpath climb angle of the airplane. [11-1] (Measurement methods for these quantities will be discussed in paragraph 11.3.1.) This analysis requires minimum effort, but the result may not be valid during unsteady flight.

To obtain true angle of attack for unsteady flight, the winds aloft, airplane ground speed, and true airspeed - for which the position error must be known - are combined. This combination is known as trajectory or state reconstruction. [11-9, 11-10, 11-11, 11-12, 11-13] Assuming that the vertical winds are zero usually is valid for a nonturbulent atmosphere. Dynamic effects on the sensors must also be considered, including the bending of the airplane structure and the effects on accelerometers and flow vanes from angular rate and acceleration. [11-12]

Typically, production angle-of-attack sensors are mounted on the side of the fuselage forward of the wing. Upwash caused by wing lift should not affect the sensor in supersonic flow; however, the sensor may be affected by other local shock waves. [11-12]

11.2.6 Angle of Sideslip Calibration

In theory, angle of sideslip can be calibrated in the same manner as angle of attack. In practice, however, wind variability makes steady flight angle-of-sideslip calibration difficult because calculated true angle of sideslip is very sensitive to lateral winds. [11-1] Obtaining bias errors for angle of sideslip through trajectory reconstruction presents similar difficulties. [11-12] This problem increases in difficulty as aircraft speed decreases. In a similar way that upwash affects angle of attack, sidewash affects angle of sideslip. Sidewash and shock wave effects can be determined through trajectory reconstruction.

11.3 PARAMETERS REQUIRED FOR AIRDATA CALIBRATION

Quantities used to calibrate airdata parameters include velocity, attitude, angular rates, angular and linear accelerations and atmospheric data. During steady-state flight most of these quantities can be recorded using pencil and paper. For greater accuracy, however, especially during dynamic maneuvers, digital recording is used.

11.3.1 Position, Velocity, and Attitude

Several of the calibration calculations require earth-relative position or velocity components. These data can be determined by an inertial navigation system (INS), ground-based radar, laser, or optical tracker; or global positioning system (GPS). Euler angles for aircraft attitude (roll, pitch, and yaw) can be measured using INS and some GPS units. [11-14]

An INS generally provides a complete Earth-relative data set, self-contained in the airplane, but these data are subject to drift errors. These drift errors are aggravated by maneuvering flight. An INS that uses ring-laser gyroscopes generally has less drift than one that uses mechanical gyroscopes. Altitude from an INS typically uses airdata to stabilize its integration loop. Some INS units have significant transport delays or lags because of filtering, or both, that should be taken into account.

Ground-based radar, laser, or optical trackers can be used to determine aircraft position and velocity. These trackers are not subject to the kinds of drift that INS experience, but they are susceptible to errors, such as atmospheric refraction. [11-15] Where an INS determines velocity from integrated acceleration, systems using radar, laser, and optical trackers determine velocity from differentiated position. Radars can track aircraft to much greater distances than laser or optical trackers.

A GPS receiver can determine the time, position, and velocity of an airplane without drift errors. Position data from a GPS receiver may be degraded by selective availability when a nonmilitary receiver is used. Velocities are not affected by this problem. Using differential GPS greatly increases position accuracy, but a reference ground receiver is needed. These GPS data are typically received on the order of 1 sample per second. The Euler angles of the airplane can be measured using multiple GPS antennae on the airplane and the carrier phase of the GPS signal.

Another type of inertial reference blends INS and GPS. This reference has all the benefits of an INS with GPS used to remove the drift error associated with INS.

11.3.2 Rates and Accelerations

The angular rates, angular accelerations, and linear accelerations of the airplane are used in the calibration analyses of dynamic maneuvers. Linear accelerometers can also be used in steady flight to measure the pitch and roll attitude of the airplane. [11-1]

An angular rate may be measured by a rate gyroscope. Angular accelerations can be determined by differentiating the angular rate data. Direct measurement of angular acceleration data is possible but generally difficult. The location of an angular rate gyroscope is unimportant if the airplane is inflexible and the location is subject to experience only minor vibration.

Linear accelerometers should be located as near the center of gravity as possible. If a significant offset exists between the accelerometer location and the center of gravity, then angular rates and angular accelerations will affect the linear acceleration data. These effects can be subtracted if the moment arm, angular rates, and angular accelerations are known. Linear accelerometers are affected by gravity and may also be affected by aircraft bending. [11-12]

11.3.3 Atmospheric Data

To convert the earth-referenced data from such sources as INS or radar into airdata, the state of the atmosphere must be known. Measurements of the atmosphere can be made from ground-based devices, upper-air weather balloons, and satellite data. If direct atmospheric measurements cannot be made, for example, for a vehicle flying in near-space, a first-order approximation can be made using a standard atmosphere. [11-16]

Weather balloons employ radio tracking for wind measurements by the rawinsonde method. The balloon carries an instrumentation package and telemeters the data to a ground station that also tracks the location of the balloon to determine the wind. The processed data include temperature, humidity, pressure, and windspeed and direction as a function of altitude. These balloons are released from many locations around the world at least twice a day. Data from a single balloon may have significant errors, so an atmospheric analysis may be required. [11-17] Refer to paragraph 11.5.2 for additional information.

11.4 TYPICAL CALIBRATION TECHNIQUES

The following paragraphs describe typical maneuvers and methods for most airdata calibrations. Tower flyby, trailing static or trailing cone, pacer aircraft, radar tracking, and dynamic maneuvers are included.

11.4.1 Tower Flyby

The tower-flyby method is the most accurate of the altimetry type of calibrations; however, only subsonic data can be taken. In addition only a few calibration points can be flown during one flight. Figure 11-5

illustrates the tower-flyby method. [11-1, 11-4, 11-12] The airplane is flown at a steady airspeed and altitude near the flyby tower. Passes by the tower are flown at various subsonic Mach numbers. At the same time the airplane is sighted from the tower through an eyepiece or camera and grid, and the true geometric altitude of the airplane is determined by geometry. Then, the hydrostatic equation is used to adjust the pressure at the tower for the height of the airplane above the tower. This new pressure is the free-stream static pressure at the altitude of the airplane. The total pressure is assumed to be correct.

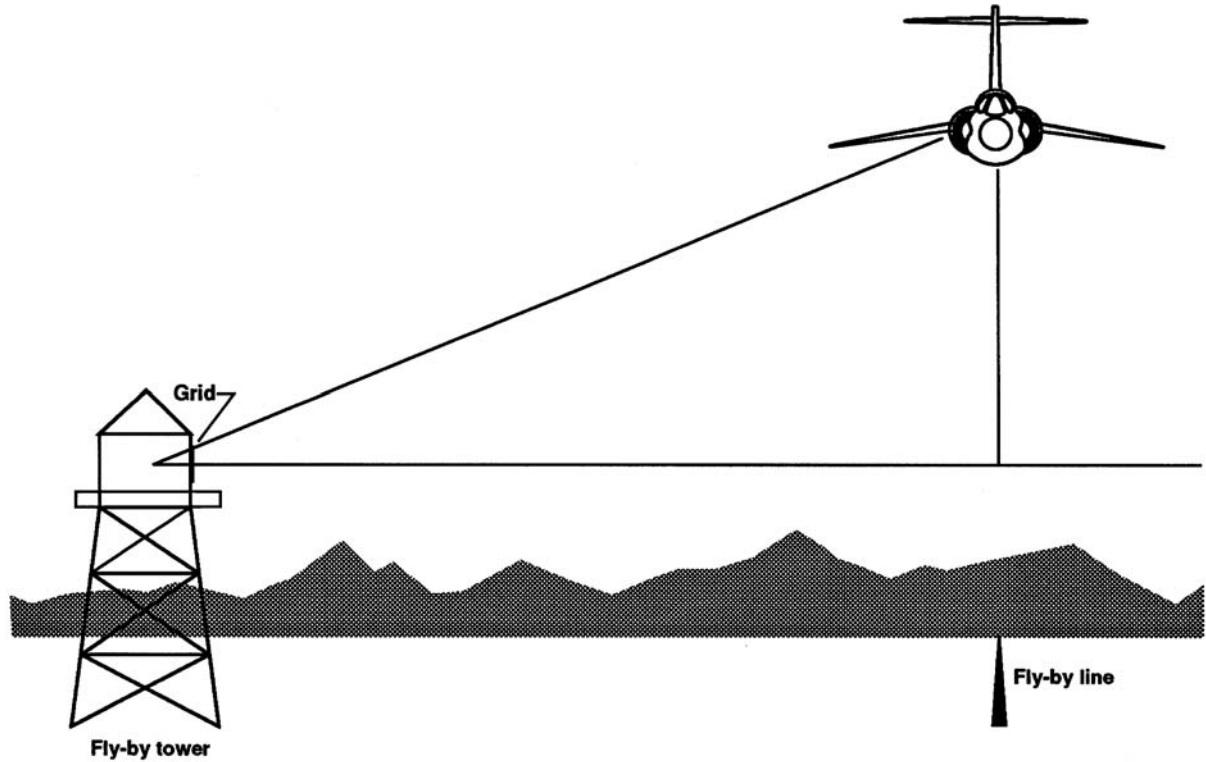

Figure 11-5. Tower-Flyby Calibration Method [11-12].

11.4.2 Trailing Static or Trailing Cone

A direct-comparison type of calibration is the trailing static or trailing cone method. [11-1, 11-2, 11-18] Location 6 in Figure 11-3 shows a region of nearly zero static pressure error. By trailing a long tube behind the airplane, a nearly free-stream static pressure measurement can be taken (Figure 11-6). A perforated cone at the end of the tube acts as a drag device to keep the tube stable. Because of the long tube length, only steady level calibration points are possible. A differential pressure measurement between the trailing tube and airdata system static source measures position error directly. Some trailing cones have pressure transducers within them; these do not have pneumatic lag problems.

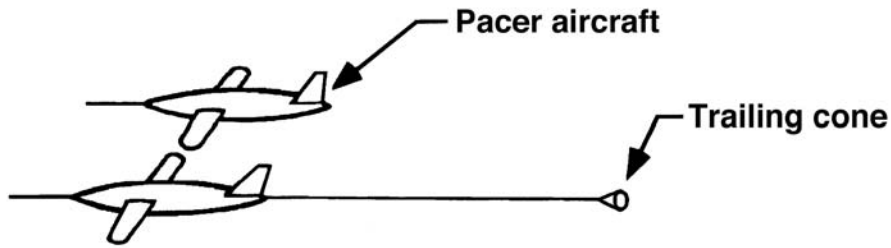

Figure 11-6. Trailing Cone and Pacer Aircraft Calibration Methods [11-3].

Although in principle a trailing cone may be used throughout the envelope of an airplane, its trailing tube may have some regions of dynamic instability. A method to extend and retract the tube is preferred to prevent damage of the apparatus during takeoff and landing and to adjust the length and thereby ensure stability of the tube. The optimum extension length varies with aircraft and speed but may typically be two wingspans.

11.4.3 Pacer Aircraft

Another direct-comparison calibration method involves a second airplane, known as a pacer airplane. [11-1, 11-4] An accurately calibrated airdata system aboard the pacer is used to calibrate the test airplane. Both aircraft fly at nearly the same altitude, so the calibrated static pressure, or pressure altitude, from a pacer airplane is the free-stream static pressure, or pressure altitude, for a test airplane (Figure 11-6). In this way, a direct-comparison calibration is done. If some altitude difference exists between the two aircraft, an altimetry calibration can be performed using optical measurements of the altitude difference.

Although it is desirable for a pacer airplane to have performance similar to a test airplane, test aircraft can perform flybys in the same fashion as tower flybys. Position error is determined by the difference in static pressure, or pressure altitude, between the two aircraft. The accuracy of the resulting calibration cannot be better than the accuracy of the airdata system of the pacer airplane.

11.4.4 Radar Tracking

Figure 11-7 shows the radar-tracking method. As in the tower-flyby method, free-stream static pressure is calculated for the airplane. [11-1, 11-4, 11-12] For a calibration run, the airplane flies with wings level, on a constant heading, and at a constant geometric altitude. The airplane begins the run at a low airspeed and accelerates at a slow rate to its peak speed. The pilot then begins to decelerate slowly back to the original airspeed. The entire maneuver is completed at radar elevation angles above 10 degrees to minimize radar refraction errors and below 80 degrees to avoid high radar antennae slew rates. Time-coded radar data are processed to give geometric altitude. Weather data from balloons and other sources are analyzed to determine the true static pressure as a function of balloon altitude and lateral distance from the balloon location. These data are combined to give the true static pressure at the airplane during the entire maneuver.

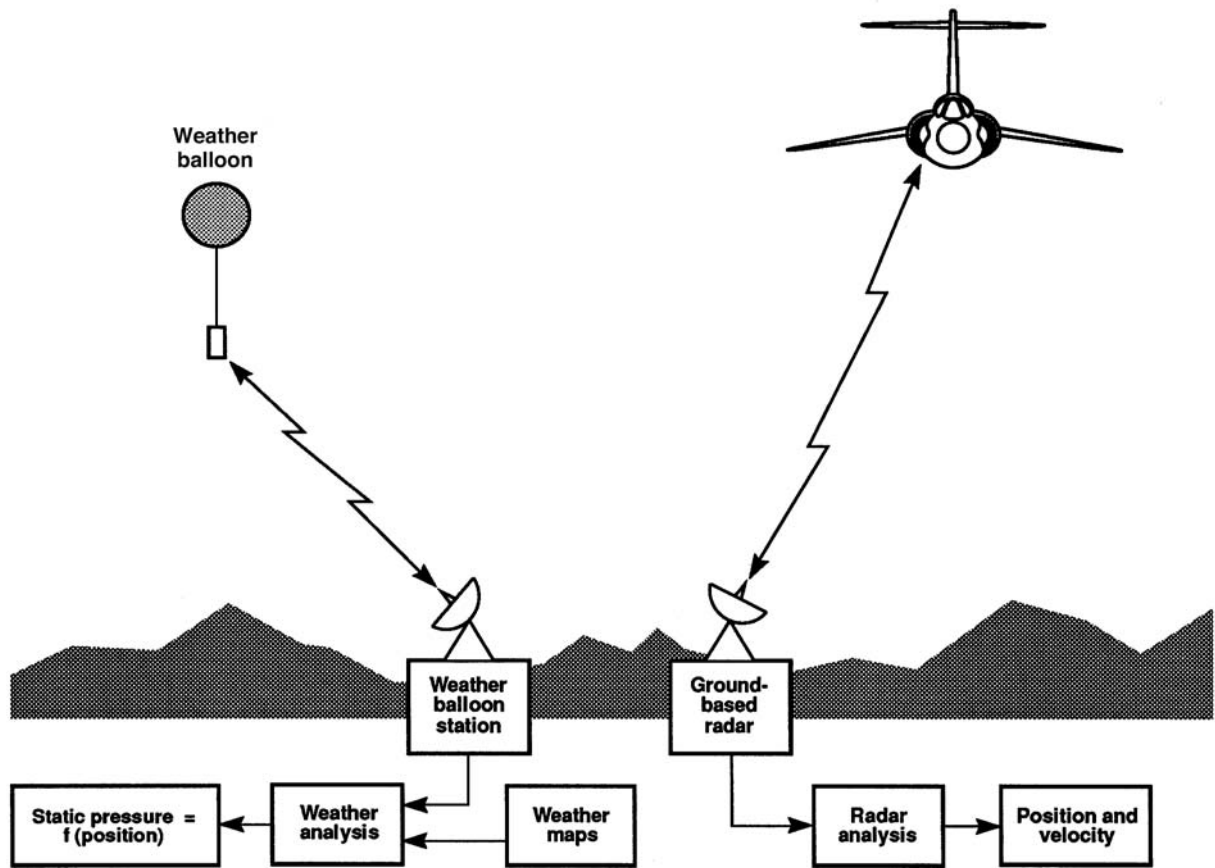

Figure 11-7. Radar-Tracking Calibration Method [11-12].

This radar-tracking method is of the altimetry type and has the advantage of being able to handle large amounts of data at all speeds. This method is less accurate than the tower-flyby method because meteorological and radar errors propagate into the analysis.

11.4.5 Dynamic Maneuvers

An extension of the radar-tracking method uses radar, or another earth-relative data source, during dynamic maneuvers to perform a trajectory reconstruction. Typical flight maneuvers include windup turns, climbs, descents, roller coasters, pushover-pullups, and rudder sweeps. [11-1, 11-12] Windup turns can be used to get data at elevated normal force or angles of attack. Roller coaster and pushover-pullup maneuvers are used for angle-of-attack calibration. Rudder sweeps are used for angle-of-sideslip calibration. One benefit of dynamic maneuver analysis is that any maneuver done with sufficient data collection can be analyzed for airdata calibration. Note, however, that keeping the varying quantities to a minimum number is desirable because it simplifies interpretation of the results.

11.5 DATA PROCESSING AND ANALYSIS

Items of concern for airdata calibrations include data tares, atmospheric references, trajectory reconstruction, and pneumatic lag and attenuation.

11.5.1 Data Tares

The use of data tares, or zeros, greatly improves the quality of a calibration. These readings should be taken while the airplane is stationary, and no personnel are climbing around it. Readings of all the instruments and transducers are taken before and after the flight. The resulting data can be used to determine if the transducers have drifted and to adjust the flight data if a change has occurred. Some designs of differential pressure transducers can measure tares while in flight and then be returned to a data-gathering mode for the test maneuver. This capability can give highly accurate readings of small differential pressures.

Collecting data during stabilized flight before and after a dynamic maneuver is also a form of a tare. For trajectory reconstruction efforts where accurate wind data are needed, the airplane can perform slow stabilized turns. Ground speed, true airspeed, and heading are used to measure the winds in flight. Often an airplane will perform calibration maneuvers along a track in opposite directions. A wind tare can be gathered while putting the airplane on a reciprocal heading on the original track.

An airdata calibration can be no more accurate than the sensors used to measure airdata and other calibration parameters. End-to-end calibration of all transducers is highly desirable. This procedure involves calibrating the sensor, signal conditioning, analog-to-digital conversion, data telemetry, and recording systems as a whole unit. Some transducers need accurate placement or alignment, such as accelerometers, INS units, nosebooms, and flow vanes. On flexible aircraft with nosebooms or bendable flow vanes, the alignment should be checked periodically.

11.5.2 Atmospheric References

Climatological data must sometimes be used instead of measured weather data. Common examples include situations in which the airplane is flown great distances from any weather station or at altitudes above those in which measurements are taken. Using monthly climatological data instead of collocated measurements will degrade the quality of the calibration, but that is preferable to simply using the standard atmosphere or other annual reference statistics.

Atmospheric data may be needed for a calibration, but data from a single weather balloon may have significant errors. See paragraph 11.3.3. An atmospheric reference analysis may be required. [11-17] For this analysis data from multiple balloons are collected at different locations and times. Then, these data are merged with satellite and weather map data. The resulting data are checked for consistency and are interpolated to the flight time and location of the airplane.

11.5.3 Trajectory Reconstruction

The simplest way to reconstruct a trajectory is to use one measurement of each needed input parameter. A more complicated method that increases accuracy is to combine all available data sources and then blend them. This method assumes that each data source has some random error, and these errors cancel each other out when blended with similar data from an independent source. [11-9, 11-10, 11-11, 11-12]

Blending multiple data sources can be accomplished with a multiple-state linear Kalman filter. This filter blends data from multiple sources to estimate the minimum variance of the trajectory of the airplane. The observations and dynamics equations are selectively weighted using a matrix determined by physical intuition about the system. The linear Kalman-filter algorithm consists of prediction and correction steps. The prediction step extrapolates the measured data to the next time point using the dynamics equations. The correction step adjusts the extrapolated state using measured data at that point to give the minimum variance estimate. [11-12]

By necessity or for a lack of resources, some aircraft have no airdata sensors. In these cases, trajectories must be reconstructed for every data flight. Such reconstruction provides a basis for inferring the airdata parameters of the airplane. [11-13]

11.5.4 Pneumatic Lag and Attenuation

During unsteady flight, pneumatic lag and attenuation may affect pressure measurements. Pressure variations propagate as waves through the pneumatic tubing to the pressure transducer. The wave propagation is damped by frictional attenuation along the walls of the tubing and fluid viscosity. This damping produces a magnitude attenuation and a phase lag. After the wave reaches the transducer, it is reflected back up the tube. Depending upon frequency distribution of the incoming wave energy and tubing length, the reflected wave may cancel or reinforce incoming pressure wave. If the waves cancel each other out, further spectral attenuation occurs. If the waves reinforce each other, the power of the incoming wave is amplified and resonance occurs.

The response of a pneumatic system can be approximated by a second-order model whose time response lag and natural frequency are functions of tube length, tube diameter, entrapped volume, local pressure, and local temperature. [11-19, 11-20, 11-21, 11-22, 11-23] The classic treatment of pneumatic lag assumes a first-order model as well as a very large entrapped volume. [11-1, 11-24, 11-25] These assumptions are only valid for step pressure inputs in an overdamped system. Then, the classical lag calculations agree with the second-order calculations.

Lag and attenuation can be estimated or measured experimentally. Criteria can be set for how quickly pressure can change in the pneumatic system without affecting the airdata. Such calibration methods as the trailing cone may have very large pneumatic lags and may have to be used in steady flight.

11.6 SPECIAL CASES

Airdata measurement and calibration for three special cases are discussed next. These cases are high-angle-of-attack flight, high-speed flight, and nonobtrusive sensors. The measurements and calibration techniques previously described were developed for aircraft flying at low angles of attack and low-to-moderate speeds. As aircraft envelopes expand into previously unknown regions, some of the initial assumptions made for the typical methods are no longer valid.

11.6.1 High Angle of Attack

High-angle-of-attack flight, which is arguably above 30 degrees angle of attack, complicates the measurement and calibration of airdata. [11-26] The typical assumption about total pressure being measured correctly without calibration may not hold. Some total pressure sensors are more suited for high-angle-of-attack flight, such as Kiel or self-aligning probes. [11-27, 11-28] Typical total temperature sensors also suffer because of the high angularity of the flow.

The characteristics of the nose of an airplane become very important at high angles of attack, and flight characteristics can be adversely affected by use of a noseboom. Wingtip-mounted booms suffer from a great deal of upwash and sidewash. A flush airdata sensing (FADS) system can be used over a large range of flow angles without disturbing the flow about the nose of an airplane. Paragraph 11.6.3 discusses FADS systems in more detail.

At high angles of attack or in any extreme of the flight envelope, the equations being used should apply to that flight regime. Many aerodynamic equations may have simplifications that assume small angles. As a result such equations are inappropriate to high-angle-of-attack flight.

11.6.2 High Speed

Sensor location in relation to shock waves becomes important during high-speed flight. A pitot tube located behind an airplane shock results in a total pressure measurement that is too low. Flow angle measurements can be affected by nonsymmetrical nosebooms. [11-12] Because high-speed aircraft also tend to fly at high altitudes, where the absolute pressure is much lower than at sea level, static pressure measurements are particularly sensitive to pneumatic lag and attenuation. See paragraph 11.5.4. The higher pressures help total pressure lag and attenuation. Particular techniques for calibrating high-speed aircraft have been previously reported. [11-29, 11-30, 11-31]

In relation to slower aircraft, high-speed aircraft use more airspace or have shorter test times for a given airspace. These larger airspaces may present a problem when tracking with radar or other sensors with limited range. Trackers may be used in series as the airplane flies from region to region. Large test regions also require increased atmospheric analysis. For very high Mach-number flight, aerodynamic heating becomes a problem on airdata sensors. For Mach numbers greater than 10, variable gas constant and other real gas effects must be considered.

11.6.3 Nonobtrusive Sensors

Typically, a probe sticking out of the airplane is used to measure airdata parameters. For hypersonic, stealth, and some research aircraft, having nonobtrusive airdata sensors is desirable. This requirement can be met by using a FADS system. [11-23, 11-32, 11-33, 11-34, 11-35] In the future, an optical airdata system may be used.

A FADS system consists of multiple flush pressure ports. These ports are usually located on the nose of an airplane. Figure 11-8 shows a schematic of FADS hardware. [11-34] These pressures can be analyzed to give such airdata parameters as Mach number, altitude, and angles of attack and sideslip. This analysis can be done by using the equations for potential flow around a sphere and by adjusting for nonpotential and nonspherical flow with calibration coefficients. One benefit of a FADS system is that it is an overdetermined system; that is, it measures more pressures than are minimally needed for the airdata state. Inaccurate pressure readings can be excluded from the calculation, thereby improving its robustness. In addition, the effect of the remaining small pressure errors on the airdata state can be minimized. Some FADS algorithms are time-recursive and iterative, further increasing robustness. Other FADS systems have been calibrated to high-angle-of-attack and to low supersonic speeds.

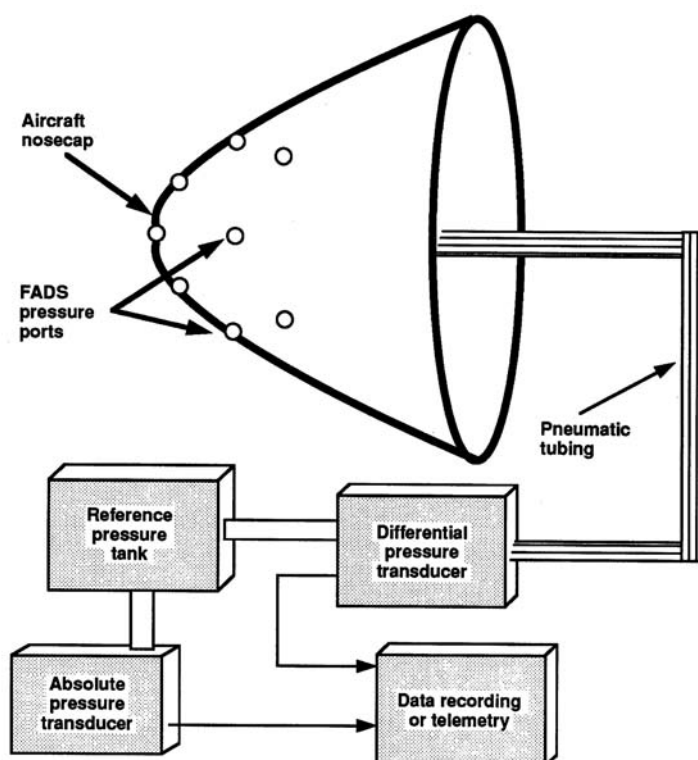

Figure 11-8. Flush Airdata Sensor Hardware [11-34].

Another class of nonintrusive sensors in the developmental stage includes optical airdata sensors. These sensors use lasers to measure the speed, flow angles, and temperature of the air. These lasers can be shone through a flush window in the airplane.

11.7 CONCLUDING REMARKS

Airdata quantities are needed for a multitude of tasks including flight safety, control, navigation, weapons delivery, flight test, and flight research. These quantities generally need to be measured and then calibrated to remove errors. The techniques and procedures have been only briefly described here; numerous references should be studied, notably reference 11-1, if airdata values are to be measured and calibrated.

11.8 REFERENCES

- [11-1] Lawford, J. A. and Nippres, K. R., "Calibration of Air-Data Systems and Flow Direction Sensors", AGARD-AG-300, Vol. 1, Sept. 1983.
- [11-2] Wuest, W., et al., "Pressure and Flow Measurement", AGARD-AG-160, Vol. 11, July 1980.
- [11-3] Gracey, W., "Measurement of Aircraft Speed and Altitude", NASA RP-1046, May 1980.
- [11-4] DeAnda, A. G., "AFFTC Standard Airspeed Calibration Procedures", AFFTC-TIH-81-5, June 1981.

- [11-5] Federal Aviation Administration, Federal Aviation Regulations, Volume 3, Transmittal 11, Part 25, "Airworthiness Standards: Transport Category Airplanes", U. S. Government Printing Office, Washington, DC, June 1974.
- [11-6] U.S. Navy, Bureau of Aeronautics, "Instrument Systems, Pitot Tube and Flush Static Port Operated, Installation of", MIL-I-6115A, March 1951.
- [11-7] Richardson, N. R. and Pearson, A. O., "Wind-Tunnel Calibrations of a Combined Pitot-Static Tube, Vane-Type Flow-Direction Transmitter, and Stagnation-Temperature Element at Mach Numbers From 0.60 to 2.87", NASA TN D-122, Oct. 1959.
- [11-8] Holman, J. P. and Gajda, W. J., Jr., "Experimental Methods for Engineers", 4th Ed., McGraw-Hill, New York, 1984.
- [11-9] Whitmore, S. A., "Reconstruction of the Shuttle Reentry Air Data Parameters Using a Linearized Kalman Filter", AIAA 83-2097S, Aug. 1983.
- [11-10] Whitmore, S. A., et al., "Air Data Position-Error Calibration Using State Reconstruction Techniques", NASA TM-86029, Sept. 1984.
- [11-11] Whitmore, S. A., "Formulation and Implementation of a Nonstationary Adaptive Estimation Algorithm With Applications to Air-Data Reconstruction", NASA TM-86727, May 1985.
- [11-12] Haering, E. A., Jr., "Airdata Calibration of a High-Performance Aircraft for Measuring Atmospheric Wind Profiles", NASA TM-101714, Jan. 1990.
- [11-13] Noffz, G. K., et al., "Aerothermal Test Results From the First Flight of the Pegasus Air-Launched Space Booster", NASA TM-4330, Oct. 1991.
- [11-14] Cohen, C. E., et al., "Flight Tests of Attitude Determination Using GPS Compared Against an Inertial Navigation Unit", presented at the ION National Technical Meeting, San Francisco, California, Jan. 20–22, 1993.
- [11-15] Haering, E. A., Jr., and Whitmore, S. A., "A FORTRAN Program for the Analysis of Ground-Based Radar Data—Usage and Derivations, Version 6.2", NASA TP-3430, 1994.
- [11-16] National Oceanic and Atmospheric Administration, National Aeronautics and Space Administration, and United States Air Force, "U. S. Standard Atmosphere, 1976", NOAA-S/T 76-1562, U. S. Government Printing Office, Washington DC, 1976.
- [11-17] Ehernberger, L. J., et al., "Atmospheric Analysis for Airdata Calibration on Research Aircraft", AIAA-92-0293, Jan. 1992.
- [11-18] Brown, E. N., "Position Error Calibration of a Pressure Survey Aircraft Using a Trailing Cone", NCAR TN-313-STR, July 1988.
- [11-19] Stephens, R. W. B., "Acoustics and Vibrational Physics", 2d ed., Edward Arnold, London, 1966.
- [11-20] Schlichting, H., "Boundary-Layer Theory", 7th ed., McGraw-Hill, New York, 1979.
- [11-21] Schuder, C. B. and Binder, R. C., "The Response of Pneumatic Transmission Lines to Step Inputs", Transactions of the American Society of Mechanical Engineers, Dec. 1959.

- [11-22] Hougen, J. O., et al., "Dynamics of Pneumatic Transmission Lines", J. Control Engineering, Sept. 1963.
- [11-23] Whitmore, S. A. and Moes, T. R., "The Effects of Pressure Sensor Acoustics on Airdata Derived from a High-Angle-of-Attack Flush Airdata Sensing (HI-FADS) System", NASA TM-101736, Feb. 1991.
- [11-24] Irwin, K. S., "Lag in Aircraft Altitude Measuring Systems", AFFTC-TDR-63-26, 1963.
- [11-25] Whitmore, S. A., "Formulation of a General Technique for Predicting Pneumatic Attenuation Errors in Airborne Pressure Sensing Devices", NASA TM-100430, May 1988.
- [11-26] Moes, T. R. and Whitmore, S. A., "A Preliminary Look at Techniques Used to Obtain Airdata From Flight at High Angles of Attack", NASA TM-101729, Dec. 1990.
- [11-27] Gracey, W., "Wind-Tunnel Investigation of a Number of Total-Pressure Tubes at High Angles of Attack: Subsonic, Transonic, and Supersonic Speeds", 43rd Annual Report of the National Advisory Committee for Aeronautics, NACA TR-1303, 1957, pp. 495+.
- [11-28] Geenen, R. J., et al., "A System for Testing Airdata Probes at High Angles of Attack Using a Ground Vehicle", AIAA 91-0088, Jan. 1991.
- [11-29] Larson, T. J. and Ehernberger, L. J., "Techniques Used for Determination of Static Source Position Error of a High Altitude Supersonic Airplane", NASA TM X-3152, Feb. 1975.
- [11-30] Larson, T. J., "Compensated and Uncompensated Nose Boom Static Pressures Measured from Two Airdata Systems on a Supersonic Airplane", NASA TM X-3132, Nov. 1974.
- [11-31] Webb, L. D. and Washington, H. P., "Flight Calibration of Compensated and Uncompensated Pitot-Static Airspeed Probes and Application of the Probes to Supersonic Cruise Vehicles", NASA TN D-6827, May 1972.
- [11-32] Larson, T. J., et al., "Qualitative Evaluation of a Flush Air Data System at Transonic Speeds and High Angles of Attack", NASA TP-2716, Apr. 1987.
- [11-33] Siemers, P.M., III, et al., "Shuttle Entry Airdata System (SEADS) - Flight Verification of an Advanced Airdata System Concept", AIAA-88-2104, May 1988.
- [11-34] Whitmore, S. A., et al., "Preliminary Results From a Subsonic High Angle-of-Attack Flush Airdata Sensing (Hi-FADS) System: Design, Calibration, and Flight Test Evaluation", NASA TM-101713, Jan. 1990.
- [11-35] Whitmore, S. A., et al., "Development of a Pneumatic High-Angle-of-Attack Flush Airdata Sensing (HI-FADS) System", Control and Dynamic Systems: Advances in Theory and Application, Vol. 52, Academic Press, San Diego, 1992.

11.9 BIBLIOGRAPHY

Trenkle, F. and Reinhardt, M., "In-Flight Temperature Measurements", AGARDograph 160, Vol 2, 1973.

Breeman, J.H., "Method for Determining the Time Delay of the Pitot-Static Tubing System of Aircraft", NLR Technical Report TR 83075 U, National Aerospace Laboratory/NLR, Amsterdam, The Netherlands, 1983.

Storm van Leeuwen, S., "A Simple and Low-cost System to Measure Delay Times in Pneumatic Systems", NLR Technical Publication TP 90174 U, National Aerospace Laboratory/NLR, Amsterdam, The Netherlands, 1990.

Jentink, H.W., Stieglmeier, M., and Tropea, C., "In-Flight Velocity Measurements Using Laser Doppler Anemometry", NLR Technical Publication TP 93561 U, National Aerospace Laboratory/NLR, Amsterdam, The Netherlands, 1993.



Chapter 12 – FLIGHT ENVELOPE

H. Walgemoed

Fokker Aircraft B.V.
1117 ZJ Schiphol-Oost
THE NETHERLANDS

12.0 INTRODUCTION

The term "flight envelope" is used to refer to the boundaries of aircraft loading and flight conditions within which operation of the aircraft is satisfactory, and beyond which some aspect becomes unacceptable. This flight envelope represents, in fact, the limiting conditions arising from a matrix of inter-related flight envelopes covering the appropriate variables. Thus, for each loading (i.e., external stores configuration and its associated range of weight and center of gravity (c.g.) position) and aircraft configuration (i.e., position of undercarriage (u/c), flaps, slats, etc.), the envelopes of airspeed versus altitude, airspeed versus load factor, angle of attack versus angle of sideslip, etc., must be investigated to establish the limits within which all aspects such as handling qualities, engine behavior, structural loads, etc., remain acceptable.

Flight testing of new or derivative aircraft models is carried out with the initial purpose of defining a flight envelope which is, first and foremost, safe and secondarily, which enables the effective use of the vehicle for its intended purpose. Flight testing occurs only after numerous reviews of the design and review of results from ground tests and predictions of flight characteristics in such areas as structures, aerodynamics, stability and control, flight controls (particularly fly-by-wire control systems, propulsion, etc.). Accordingly, opening and expanding the envelope is a task that must be approached cautiously, systematically, and with coordination and cooperation of the many disciplines involved in the design and test of an airplane. (Sections 8 and 10 cover test planning and safety of flight considerations, respectively).

The fundamental tenet in establishing a flight envelope via flight test is risk reduction. This is reflected in the typical sequence of events leading to initial flight test - design reviews (both hardware and software), then ground test involving singular disciplines (windtunnel tests for aerodynamics, structurally loading the wing/fuselage/nacelle on a ground test article with loads anticipated to occur in flight, flight control system control law checkout, propulsion test cell runs and/or flying test bed tests, etc.), and then ground tests involving multi-disciplines (See Section 9). Only after these have been accomplished will an initial, limited, low-risk, flight envelope be established. The limited envelope will typically be in the middle of the projected final flight envelope. Subsequent flight tests will then be devoted to expanding the initial envelope by operating the airplane at increasing ranges - representing increasing risk - of engine operation, airspeeds both fast and slow, altitude, load factor both above and below 1g, centers of gravity (fore and aft), and with system/subsystem failures. Whether flight tests are to define a flight envelope on a new model airplane with the attendant new airframe, new engine(s), and new subsystems (hydraulics, pressurization, etc.), or on an airplane involving only a few of these areas such as new engines in an old airframe, the fundamental approach to establishing an envelope is the same.

Before planning the flight test program, the Flight Test Engineers (FTEs) tasked with establishing a flight envelope must be aware of design goals and ground test results to understand the capabilities and anticipated limitations of the vehicle. (While it is important to have the results of many of these tests in hand, the FTE cannot wait until all results are in before planning the tests. The test plan must be established using best information available and modified when additional test results become available). Once flight tests start, it is imperative that there be an on-going dialogue between the FTE and the

designers and ground test team so that adjustments in the goals of each result in a safe and efficient test program. Also, the FTE must work with designers, ground testers, and instrumentation engineers to ensure that the right instrumentation is installed at the right places to ensure valid comparisons of ground and flight data so that confidence in projected flight vehicle characteristics is gained in areas not yet explored in flight test. Sections 28 and 29 cover the reporting requirements both during and after testing.

This Section concentrates on the influence of structural strength on the flight envelope. However, as noted above, parts of the flight envelope may be determined by the onset of unsatisfactory characteristics such as flutter or vibration, an unacceptable deterioration in the aircraft's flying qualities, or in engine or other subsystem behavior.

Section 12A examines flight envelope expansion for rotary wing aircraft.

12.1 AIRWORTHINESS REQUIREMENTS

Flight testing of a new or derivative aircraft type has as one of the main purposes the objective of establishing a safe flight envelope in which the aircraft can operate. The governmental type certification is the manifestation that the goal has been achieved. The type certificate can be regarded as a statement of the certifying authority that some standard version of the subject aircraft type fulfills the applicable airworthiness requirements. Each individual aircraft of the type can subsequently obtain a certificate of airworthiness, after consideration of the differences from the standard aircraft. For civil aircraft the certificates are issued by the Airworthiness Authority of the country of registration. Military aircraft have to be approved by a designated Agency which normally is a part of the Armed Forces of the country which owns and operates the aircraft.

Specific airworthiness requirements exist for civil and rotary wing aircraft. However, the present section is, as far as civil aircraft are concerned, primarily based on the requirements of FAR Part 25 and JAR-25. [12-1, 12-2] These codes are updated relatively frequently. Which version is applicable for a given aircraft type depends on when certification was requested and on whether or not the subject aircraft is a derivative of an older one. For a specific aircraft type the certification basis may include some Special Conditions, imposed by the Authorities, describing additions to and deviations from the basic code. In principle, each airworthiness authority may impose its own set of requirements.

For military aircraft the procuring agency may validate the aircraft against a set of Military Specifications (MIL SPECs), issued by the US Air Force or the US Navy but used by a number of other countries, including the members of NATO. Of course, the complete set of MIL SPECs applicable for a certain aircraft type must be well-defined in the contract or a comparable document, but in general will be the version in effect at the time of the contract.

It should be noted that civil certification authorities are concerned solely with airworthiness (i.e., "safety") as defined by the applicable requirements. In clearing the envelope, they will ensure that the aircraft meets all of those requirements but will not attempt to assess whether the aircraft is well suited to its intended purpose: that is a matter for the user(s) to decide. On the other hand, military certification authorities are normally the agents of the user and, hence, are also concerned with the effectiveness in its intended role(s). Thus, in addition to defining the envelope(s) within which all airworthiness requirements are met and the aircraft is "safe" they may define more restrictive flight envelopes, particularly in respect to flying qualities, within which those qualities are sufficiently good to enable more demanding operational tasks to be conducted satisfactorily.

12.2 LIMITATIONS

12.2.1 Weight and Loading Limits

The aircraft mass must be within limits defined by the so-called design weights, including:

- Maximum zero-fuel weight (MZFW), the maximum weight of the aircraft above which the aircraft weight may only be increased with fuel (or payload) in the wings or, in some cases, stores under the wings
- Maximum ramp weight (MRW), the highest weight at which the aircraft may operate on the ground
- Maximum take-off weight (MTOW), the highest weight at which flight is permitted
- Minimum weight, the lowest gross weight at which flight is permitted
- Maximum landing weight (MLW), the highest weight at which the aircraft is allowed to land in normal operations. Landing at a higher weight is permitted in emergency conditions and may also be permitted for certain flight test purposes.

Limits on the distribution of mass are generally applicable as well, such as:

- Limits on the distribution of payload in the fuselage of a transport aircraft, e.g., maxima for the loading per unit of length or per unit of area on the main deck and in the belly cargo holds
- The order in which the fuel tanks are emptied may be prescribed
- Maxima for the weights with external stores and asymmetric rolling moments created by fuel asymmetry or by combinations of stores to be installed at hard points.

Also, care must be taken that the center of gravity (cg) of the aircraft is always within the prescribed limits. For civil transport aircraft usually two cg-weight diagrams are applicable: one for undercarriage (u/c) down conditions and a slightly wider one (to enable movement of crew members and passengers) for u/c up conditions.

It should be noted that there may be angle of attack limitations due to cg location and/or external stores. There also may be additional limitations on maximum asymmetric store loading as a function of flight conditions (e.g., angle of attack and Mach number).

12.2.2 Altitudes

Aircraft may be flown from sea level up to the maximum operating altitude which is normally defined by the performance capability of the airplane/engine combination (i.e., service cruise, or combat ceiling), but could be defined by other considerations such as pressure differential limitation. If the aircraft is pressurized, the specified maximum pressure differential must never be exceeded in flight. In certain configurations (e.g., flaps down) the maximum allowed altitude may be lower than in the clean configuration. Since cabin pressurization is physiologically essential at altitudes above 45,000 feet, the crew of a military aircraft (which may lose pressurization due to combat damage) operating at these altitudes must wear pressure suits.

12.2.3 Airspeeds in the "Clean" (Flaps, Slats, and Gear Retracted) Configuration

The following speeds, where V is the equivalent or calibrated airspeed measured in knots and M is the Mach number, are of importance in a flight test program. Some of these are related to the structural capabilities and are termed "design" speeds, being those used in calculating structural loads, flight control

requirements, etc. (It should be noted that the definitions given below are not rigorous, and there are often differences between those used by the various airworthiness authorities).

- V_S , the stall speed. Currently, this is interpreted as the minimum speed at which steady horizontal flight ($n_z = 1$) is possible.
- V_A , the design maneuvering speed. V_A may not be less than $\sqrt{n_z} \cdot V_S$, where n_z is the design maneuvering load factor of the airplane. V_A is the highest speed at which maximum elevator displacement is allowed.
- V_B , the design speed for maximum gust intensity
- V_C/M_C , the design cruising speed
- V_D/M_D , the design dive speed
- V_H , the stall speed in inverted flight
- V_{RA} , the rough-air speed. V_{RA} is the airspeed to be selected when heavy turbulence is encountered.
- V_{MO}/M_{MO} , the maximum operating speed. V_{MO}/M_{MO} may not be greater than V_C/M_C (see FAR/JAR 25.1505) and may not be deliberately exceeded unless a higher speed is authorized (e.g., for certain flight tests). If, in normal operations, V_{MO}/M_{MO} is exceeded unintentionally, the speed must be reduced as soon as practical.

For military aircraft designed in accordance with US Military Specifications, V_{RA} , V_C and V_D are replaced by V_G (the slow-down speed for gust), V_H (level-flight maximum speed) and V_L (limit speed), respectively, which have more or less the same definition.

12.2.4 Airspeeds in "Dirty" (Flaps, Slats, and/or U/C Extended) Configurations

In the dirty configuration, e.g., with some combinations of high-lift devices and/or u/c extended, some relevant airspeeds are:

- V_{MC} , the minimum control speed. V_{MC} is the minimum speed at which controlled operation is possible with the critical engine inoperative. V_{MCG} is the minimum control speed on or near the ground in the takeoff configuration, V_{MCA} minimum speed in the air in the takeoff configuration, and V_{MCL} the minimum control speed in the air in the landing configuration.
- V_F , the design wing-flap speed. V_F depends on the flap setting. The corresponding design speed for military aircraft is V_{LF} , the landing, approach, and takeoff limit speed.
- V_{FE} , the flap extended speed. V_{FE} is the maximum speed at which flight with a certain flap setting is allowed. V_{FE} , which is the speed the pilot uses, may not be greater than V_F .
- V_{LO} , the landing gear operating speed
- V_{LE} , the landing gear extended speed
- V_{DD} , the design drag device speed. V_{DD} is the design speed for a drag device such as an airbrake.

V_{MC} tests should be conducted under near-ISA/sea level conditions where the engine thrust is greatest and the resulting V_{MC} is highest. For the airborne tests (V_{MCA} and V_{MCL}) it is customary to establish the minimum control speed, sometimes called the critical speed, under static conditions (i.e., by reducing speed with simulated engine failure established until directional control is lost). A large margin, typically 30 knots, is then added to the critical speed for the first tests accomplished under dynamic conditions (i.e., with simulated sudden engine failure) and with, typically, a two-second delay before the pilot takes any corrective action. The speed for simulated engine failure is then progressively reduced on successive tests

until V_{MCA} has been established. It should be noted that these tests may be very difficult to execute accurately for aircraft which have high thrust to weight ratios due to the high levels of acceleration (or rates of climb) involved.

12.3 DESIGN LOADS

At the time of design inception, the design operating conditions of the operational flight envelope must be defined. The types of elements that must be considered are noted below while defining the flight envelope and the test maneuvers that must be conducted to demonstrate that the flight envelope can be safely utilized are specified in paragraphs 12.4 and 12.7, respectively.

12.3.1 Load Factors

The load factor n (or n_z) is defined as the ratio between the total external normal forces on the aircraft and its weight. Normal forces refer to forces along the "z" axis (which lies in the plane of symmetry) such that they would be oriented "up" when the airplane is upright in wings-level steady flight. The external forces are primarily aerodynamic forces, but vertical components of engine thrust and/or u/c reaction may be included as well. The aircraft structure is designed for limit loads corresponding with load factors given in so-called n - V diagrams and with a number of other limit design conditions which are specified in the applicable airworthiness requirements and design documents. Limit loads must be withstood by the airplane structure without permanent deformation. They may not be deliberately exceeded in flight, neither in normal operation nor in flight tests. However, accidental exceedance of the limit load cannot be excluded. Therefore it is required that ultimate loads are specified which may not lead to structural failure (to be shown by ground tests and/or analysis), but permanent deformation is allowed beyond limit load. Ultimate loads are obtained by multiplication of the limit loads by a safety factor, j . In most cases, $j = 1.5$, but for some military prototype aircraft or experimental aircraft a higher safety factor may be specified to avoid limitations in the flight test program resulting from uncertainties in the predicted stress distributions.

12.3.2 Maneuvering Diagram

A typical maneuvering diagram, at a given altitude and weight, for civil transport aircraft is presented in Figure 12-1 (based on FAR/JAR 25.333(b)). According to FAR/JAR 25.337(b) the maximum value of n is at least 2.5, but for aircraft with a design take-off weight less than 22,680 kg (50,000 lbs) n_{max} is higher, viz., $n_{max} = 2.1 + 10886/(W + 4536)$, where W is the design take-off weight in kg. However, n_{max} need not be greater than 3.8.

For a particular aircraft type the maneuvering diagram depends on aircraft weight and altitude, as these parameters determine the position of the positive and negative C_{Nmax} curves and the design speeds V_A and V_H . It is one of the purposes of the flight test program to determine the buffeting and stall limits.

For military airplanes the n - V diagrams and the design airspeeds are defined in a somewhat different way. An example of an n - V diagram is given in Figure 12-2 (based on figure 1 of reference 12-3 or figure 2 of reference 12-4).

A number of parameters determining the actual maneuvering diagrams for a certain aircraft type depend on the classification of the aircraft (such as fighter, attack aircraft, trainer, transport, bomber, etc.). The maximum and minimum load factors for which the aircraft is designed can be found in the appropriate documentation. Military aircraft may be capable of carrying external stores. In principle, each external stores configuration may lead to some flight envelope restrictions due to performance limitations caused by increased drag, aeroelastic limitations (e.g., reduced flutter speeds) or limitations due to available strength.

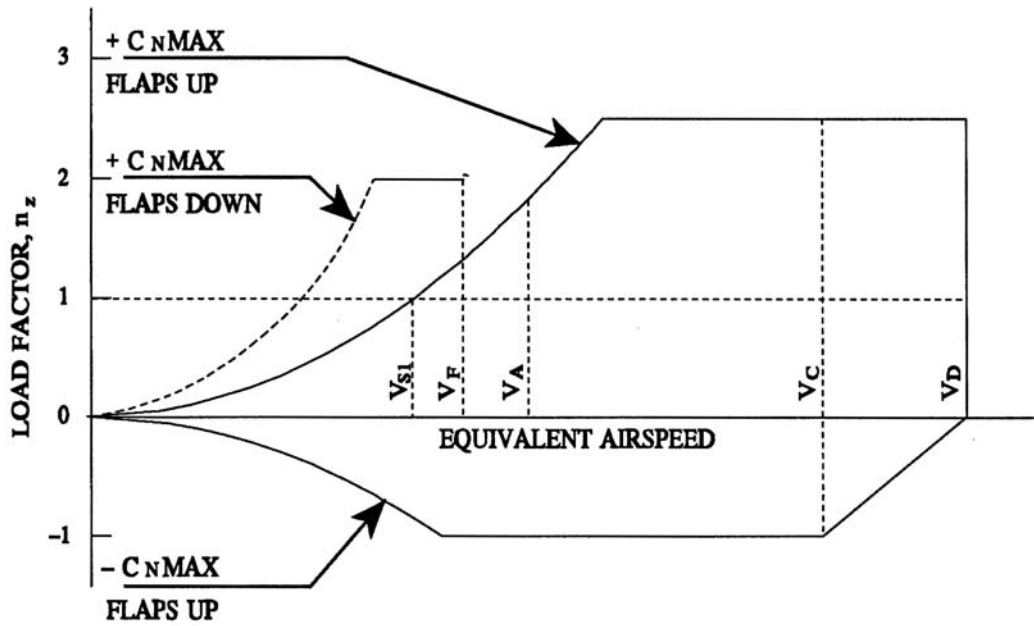

Figure 12-1. Typical Civil Aircraft Maneuvering Envelope for a Given Weight and Altitude.

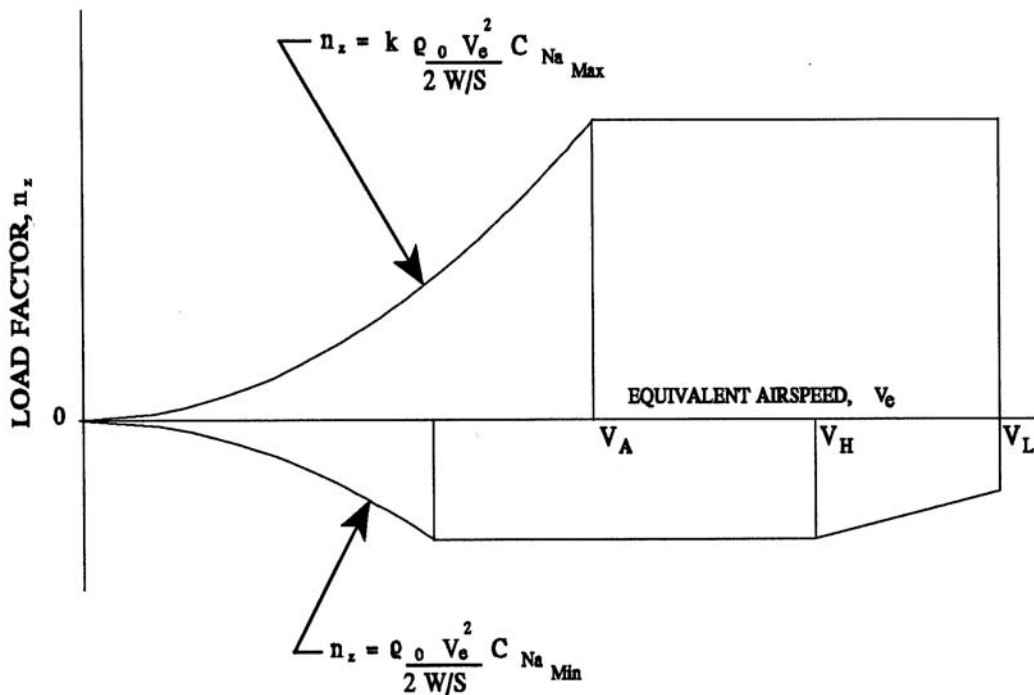

Figure 12-2. Typical Military Aircraft Maneuvering Envelope for a Given Weight and Altitude.

12.3.3 Gusts

For many aircraft, in particular transport aircraft, a significant part of the structure is critically loaded by gusts. However, unlike maneuver and landing conditions, gust load calculation procedures cannot be validated through in-flight load measurements. The reason is that the input gust signal is difficult to determine unless special measuring equipment is installed. Also, the actual gust input will differ from the idealized gusts used for calculating the design gust loads. Therefore, the measurement of gust loads will not normally be a part of the flight test program and/or the certification process.

12.4 THE FLIGHT ENVELOPE

As noted above, the flight envelope is defined as the range of airspeeds, altitudes and normal load factors at which the aircraft can (safely) operate. For military aircraft some specific flight envelopes are defined in references 12-5 and 12-6. These are the following:

- Operational Flight Envelope. This is the envelope in which the airplane must be capable of operating in order to accomplish its operational mission. It depends on the mission concerned and on the external aerodynamic configuration of the aircraft. For example, if the mission is delivery of a certain type of weapon, the operational flight envelope depends on the characteristics and limitations of the weapon as well.
- Service Flight Envelope. This envelope is based on the limits of the airplane concerned, such as structural or performance limits. The service flight envelope must encompass the operational flight envelope.
- Permissible Flight Envelope. It is required that from all points in the permissible flight envelope it shall be readily and safely possible to return to the service flight envelope without exceptional pilot skill or technique. However, degraded flight handling qualities are acceptable to a certain extent.

12.5 TEST OBJECTIVES

The objective of these tests is to provide a flight envelope that will allow the pilot/flight crew to safely utilize the full design capabilities of the aircraft. This prime objective must continuously be kept in mind while setting up the various specific tests such as determining stresses that exist on various critical parts of the structure under a given set of airspeed, altitude, Mach number, and normal acceleration. For military airplanes one of the objectives of flight testing may be to show compliance with some of the demonstration requirements of reference 12-7. For flight testing of other aircraft reference 12-7 may contain valuable background material.

12.6 TYPICAL MEASURANDS, SAMPLING RATES, AND FREQUENCY REQUIREMENTS

Once the specific test points are established, the FTEs must work with the instrumentation engineers to ensure that the installed instrumentation will provide the necessary data. If it will not, then modifications will have to be made to ensure correct and timely data are received. (See Section 6).

Normally, the instrumentation required for structural envelope expansion is built into the aircraft during the construction process. Therefore, it is necessary for the FTE to begin liaison with the manufacturer's engineers early in the final design phase in order to ensure that the instrumentation and the sensor locations selected will provide the data that is necessary. The data processing engineer also needs to be brought into the picture at about this same time so that he can ensure that data processing equipment is

adequate to the processing task, initiate actions to modify the equipment, and/or notify the FTE that his data processing requirements cannot be met so that alternative courses of support can be evaluated. Sections 6 and 7 contain information on establishing instrumentation and data processing requirements/support.

Structural loads such as shears, bending moments, and torques are mostly measured by means of strain gauges at appropriate locations. See reference 12-8 for more information. The strain gauges must be calibrated and the relationships between loads and strains must be established experimentally prior to flight. This should be done by applying loads in steps up to approximately the highest load to be expected in flight testing. However, this may not always be possible. For example, applying calibration loads to the wing of a relatively large aircraft such that the limit wing root bending moment is approached may be beyond the capabilities of the available equipment.

In cases where aerodynamic forces are the major contributors to the critical structural loads it may be appropriate to measure the airloads directly, e.g., by means of pressure belts located at a few spanwise locations on the wing and/or tailplanes. With such pressure measurements, the spanwise and chordwise airload distributions can be checked. Where dynamic loads are predominant, the use of accelerometers may be useful.

The highest frequency with which a certain structural component may significantly respond to any excitation (e.g., maneuvers, turbulence, landing and taxiing, and buffeting) should be estimated analytically or on the basis of previous experience. In order to avoid any data aliasing, the sampling rate should be at least twice the expected frequency of the measurement.

The selection of parameters to be monitored in real time depends on the characteristics of the aircraft concerned, but loads on tailplanes, engine supports (e.g., pylons), and flaps may be included.

12.7 TYPICAL TEST MANEUVERS

Opening the flight envelope should be done carefully and must be well-planned. The full flight envelope can only be explored if it has been shown by analysis supported by ground tests that the test aircraft can safely operate in the entire flight envelope. But this is not a sufficient condition. The aircraft may have unforeseen or unknown characteristics which restrict the safe part of the flight envelope. It is evident that some risk is involved in exploring the flight envelope, especially its boundaries. But these risks must be minimized as much as possible. Therefore, a clear picture must be obtained of the nature and the severity of the risks before the start of the flight test program. All relevant disciplines should contribute to such a risk assessment. (See Sections 8 and 10).

In order to expedite test conduct, the FTE should be monitoring selected data in real time. He can then clear the aircraft to the next test point or call a halt while the data is reviewed in greater detail. The data must be compared to predictions. If there are any deviations (beyond a pre-determined amount that was established to account for instrument accuracy, etc.) from the predicted data the test must be halted until the deviation is explained and, if necessary, the structural model is modified to reflect test data. This comparison is an on-going process throughout the flight test program.

In the first flight no boundaries of the flight envelope should be approached, i.e., the speeds should be limited, no heavy maneuvering should be done, areas of severe turbulence should be avoided, potentially risky failure conditions should not be simulated, on landing only a limited crosswind is acceptable, and no extreme weights and/or cg positions should be allowed. Several flight parameters should be monitored, the most critical ones in real time by telemetering to the ground, in order to compare the aircraft's behavior with predictions. If this comparison is satisfactory, i.e., no adverse behavior is observed, the limitations can be relaxed for the next flight.

As far as the speed range is concerned, it is obvious that the lower and upper speed limits are of special interest. On the low-speed side V_S and V_{MC} are the critical speeds which have to be determined experimentally. Stall tests must be carried out for a number of aerodynamic configurations, including every position of the high-lift devices, for high and low engine power or thrust, and at both forward and aft cg positions. If deep stall is a potential problem, appropriate recovery means must be provided. The flow separation associated with wing stall produces a wake which may hit the empennage, possibly resulting in high, fluctuating empennage loads and/or even resulting in a nose-up pitching tendency. Theoretical prediction of these loads is difficult or even impossible, so it is advised to monitor them during flight testing by means of calibrated strain gauges.

At the high-speed range a number of aeroelastic properties, including flutter, have to be investigated (see Section 14). As the carriage of external stores may significantly decrease the flutter boundary (i.e., the lowest speed at which an aeroelastic vibration mode becomes unstable), all possible combinations of external stores (or at least the most critical ones) have to be tested. In flutter testing the critical combination of speed and altitude, mostly the combination of highest Mach number and highest dynamic pressure, must be approached carefully. It must be established that, on the basis of damping measurements at previous test points, positive damping is expected before permission can be given to proceed to the next test point. Absence of other adverse aeroelastic phenomena, such as divergence, control reversal, or buzz, must also be demonstrated.

For modern aircraft equipped with an electronic flight control system the loads and other parameters may depend on the system parameters. Consequently, the influence of modifications to the flight control system should be checked when necessary.

In addition, the buffet boundary must be established. High-speed buffet is associated with shock waves and flow separation in the transonic flight regime which produce vibration with a pseudo-random character. It is therefore necessary to establish that adequate maneuver capability is available before the onset of heavy buffet when operating at high altitude/high speed.

The following paragraphs illustrate typical test maneuvers.

12.7.1 Symmetrical Maneuvers

In the flight test program it must be shown that the aircraft can safely execute a number of prescribed maneuvers. As far as the symmetrical, or longitudinal, maneuvers are concerned, the test program may include the following types:

- (Quasi-)steady maneuvers in which the load factor to be demonstrated is reached relatively slowly, usually in wind-up turns. In this maneuver the pitching velocity is low and is proportional to the load factor achieved. Due to the slow elevator displacement rate the pitching acceleration is almost zero.
- Unchecked pitching maneuvers as described in FAR/JAR 25.331(c)(1). It should be noted here that these maneuvers are intended for structural design purposes only and not for flight testing. Trying to execute such an (artificial) maneuver may be dangerous, because it may lead to stall and/or overstressing of the horizontal tailplane. However, it may be appropriate to perform a similar maneuver with less elevator displacement during a limited period of time, in order to check the load calculations.
- Checked pitching maneuvers described in the MIL SPECS, where the longitudinal cockpit control displacement is a triangular or trapezoidal function of time. Alternatively, if the airplane is designed for the maneuvers described in ACJ 25.331(c)(2) of reference 12-2, it is more appropriate to approximate a 3/4 sine application of the cockpit pitch control.

- Other longitudinal maneuvers may be specified, depending on the type of aircraft and the applicable requirements.

12.7.2 Rolling Maneuvers

The rolling conditions specified in FAR/JAR 25.349 are artificial conditions intended for structural design purposes, and cannot be executed in flight (at least not by transport type airplanes). It should be made sure that any rolling maneuvers to be performed in flight testing do not lead to structural overloading and/or controllability problems. The rolling conditions mentioned in the MIL SPECS may also be difficult to execute, e.g., where zero sideslip throughout the maneuver is specified. A more realistic maneuver is the rolling pull-out maneuver which should be part of the flight test program if this maneuver is a design condition for the aircraft. For some aircraft (viz. fighters, attack aircraft, and trainers) a 360-degree roll has to be demonstrated as well.

12.7.3 Yawing Maneuvers

Unlike pitching maneuvers, which are limited by n_z according to the maneuvering diagram, yawing maneuvers are not limited by n_y or yaw rate. However, they may be limited by sideslip angle. The critical sideslip angle may be structural loading, engine/inlet compatibility, or dynamic stability at high angles of attack or high airspeeds. The critical values of these parameters depend on control (pedal) forces, as specified in the requirements, and the properties of the flight control system. Some critical yawing conditions, to be considered between V_{MC} and V_D/M_D are:

- At zero yaw the rudder is deflected suddenly to the position corresponding with the prescribed pedal force, the characteristics of the flight control system, and the aerodynamic rudder hinge moment
- Starting from the above mentioned condition, the pedal force is maintained, resulting in a high (overswing) angle of sideslip
- A steady sideslip condition consistent with the specified pedal force. Normally this condition is associated with a larger rudder deflection than the zero sideslip condition, due to the fact that the rudder hinge moment per degree of rudder deflection decreases with increasing angle of sideslip.
- Return from steady sideslip.

Often, these yawing conditions are critical for stressing the vertical tailplane and the rear fuselage. It should be noted here that if an oscillatory rudder displacement is not in the structural design requirements, such a maneuver should not be executed in flight, because it may lead to structural failure.

12.7.4 Failure Conditions

Some failure conditions, e.g., trim runaways, engine failure conditions, or inadvertent thrust reverser deployment, may also be critical. Caution is strongly recommended when these conditions are simulated in-flight.

12.8 DATA ANALYSIS CONSIDERATIONS

Real-time data analysis should be selected to provide only information essential to ensure safe flight and allow tests to proceed to the next test condition. For a quick and efficient flight test program it is desirable to decide quickly whether or not to proceed. This decision should preferably be based on a simple but effective quick-look assessment of a few essential parameters. Usually, this is done by plotting the data points in a graph such that trends can be discovered and comparisons with the structural limits can be

made. The parameters should be selected carefully and it may be advantageous to consider combinations of structural load parameters as well as these parameters themselves, e.g., combinations of shear and torque or bending and torque at certain spanwise locations on a lifting surface. Needless to say that a thorough pre-flight preparation is essential.

Post-flight data analysis must be carried out to check the aircraft's behavior, the aerodynamic data, and the design loads. Generally, flight test measurements do not agree completely with predictions. Aerodynamic predictions are based on Computational Fluid Dynamics (CFD) calculations and on windtunnel measurements, each having its advantages and drawbacks. But the final and most reliable set of aerodynamic data is the flight test results. Since most data to be analyzed (e.g., trimmed flight conditions, maneuvers, and loads) depend on several basic aerodynamic coefficients, improving the aerodynamic database is often a cumbersome process, requiring a lot of expertise. It is essential that the measured data are sufficiently complete to make this task possible, i.e., no "missing links" may exist. Again, careful preparation is needed regarding the parameters to be measured.

12.9 PRODUCTS OF TESTING

The end product of the testing process will be the report specifying the flight envelope in which the aircraft can operate. Other products will include the feedback to research organizations that will allow them to modify/correct/update the processes whereby they predict structural capabilities and prepare models.

In many cases, flight testing is part of a certification process. If successful, the results of flight testing can be used as part of the proof that the aircraft meets the certification requirements. If flight testing reveals that the aircraft does not meet some of the requirements, the aircraft has to be modified or, if possible, the requirements have to be relaxed. Modifications will increase costs and may cause a delay. Therefore, any required modifications should be identified as early as possible, so that they can be incorporated in the flight test aircraft early and flight testing with the modified aircraft can resume.

12.10 SPECIAL CONSIDERATIONS

It must be reiterated that opening the flight envelope involves some risk and that safety considerations must be the predominant criteria when planning and executing flight tests. Safety is more important than schedule! Special caution is required when simulating failure conditions.

The initial part of flight testing (shake-down flights) should be carried out only in a limited part of the flight envelope in order to check the systems, to ascertain that the aircraft behaves more or less as predicted, and to gain confidence in the aircraft. The next part is the gradual and careful opening of the entire envelope, starting with either the low-speed part (stalls) or the high-speed part (flutter).

An adequate instrumentation and data processing system, consisting of reliable hardware and software, to support generating and analyzing flight test data, is indispensable. But computers can only support, not replace, competent engineers.

12.11 CONCLUDING REMARKS

In this section some background information has been given which may be useful for the FTE in order to better understand the concept of a flight envelope and the airworthiness requirements and to improve his ability to communicate with the design engineers. Such communication is essential, because flight testing is a multi-disciplinary activity.

Special emphasis is given to the maneuvers that may be conducted and to instrumentation and data analysis. Also, some guidelines for a safe and efficient execution of flight tests have been given.

12.12 REFERENCES

- [12-1] Federal Aviation Regulations Part 25 - "Airworthiness Standards: Transport Category Airplanes", U.S. Department of Transportation, Federal Aviation Administration (FAA).
- [12-2] Joint Aviation Requirements JAR-25 - "Large Aeroplanes", Joint Aviation Authorities (of several European countries).
- [12-3] Military Specification MIL-A-008861A(USAF), "Airplane Strength and Rigidity - Flight Loads", United States Air Force, 31 March 1971.
- [12-4] Military Specification MIL-A-8861B(AS), "Airplane Strength and Rigidity - Flight Loads", Naval Air Systems Command, 1986.
- [12-5] Military Specification MIL-F-8785C, "Flying Qualities of Piloted Airplanes", United States Department of Defense", 5 November 1980.
- [12-6] Military Standard MIL-STD-1797A, "Flying Qualities of Piloted Aircraft", US Department of Defense, January 1990.
- [12-7] Military Specification MIL-D-8708B(AS), "Demonstration Requirements for Airplanes", United States Navy, 31 January 1969, incl. Amendment 1, 3 June 1982.
- [12-8] Kottkamp, E., Wilhelm, H., and Kohl, D., "Strain Gauge Measurements on Aircraft", AGARDograph 160, Vol. 7, AGARD Flight Test Instrumentation Series, 1976.

12.13 BIBLIOGRAPHY

Various, "AGARD Flight Test Instrumentation Series", AGARDograph 160.

Various, "AGARD Flight Test Techniques Series", AGARDograph 300.

Ecole du Personnel Navigant D'Essais et de Reception

- Pratique des Essais en Vol Helicopteres (2 Vol), ref EPNER 25.
- Pratique des Essais en Vol Avions (3 Vol), ref EPNER 24.
- Pratique de la Reception (1 Vol), ref EPNER 27.

McDonell, J.D., AFFDL-TR-68-76, "Pilot Rating Techniques for the Estimation and Evaluation of Handling Qualities", December 1986.

Cooper, C.R. and Harper, R.P. Jr., "The Use of Pilot Ratings in the Evaluation of Aircraft Handling Qualities", NASA TN D-5153, April 1969.

MIL-A-8870C, "Airplane Strength and Rigidity - Vibration, Flutter, and Divergence", Naval Air Systems Command, 1993.

MIL-A-87221, "Airplane Strength and Rigidity - Flight and Ground Operations Tests", Naval Air Systems Command.



Chapter 12A – ROTORCRAFT FLIGHT ENVELOPE UNIQUE CONSIDERATIONS

Michael W. Mosher
US Naval Test Pilot School
Patuxent River, MD 20670-5304
USA

12A.0 INTRODUCTION

As noted in Section 12, the term flight envelope is used to refer to the boundaries of aircraft loading and flight conditions within which operation of the aircraft is satisfactory, and beyond which some aspect becomes unacceptable. Each aircraft has its own peculiar set of operating conditions and limitations, and this is particularly true of rotorcraft. In addition to the concerns of the fixed wing aircraft test engineer, the helicopter test engineer has to be concerned with dynamic components such as main and tail rotors and their associated control components, transmissions, noise, vibrations, and environmental factors such as swirling particulates which can cause visual obscuration and/or aircraft erosion when operating in unprepared areas like desert, snow, or over salt water. Operation in the hover/low speed regime is a unique capability and is therefore the forte of the helicopter. This "new" regime has its own envelope concerns.

This Section provides a brief overview of some of the considerations when establishing/expanding the flight envelope of a rotorcraft. Types of tests and maneuvers, instrumentation, and special considerations will be discussed. However, the reader must be aware that this Section is far from a complete description of all the factors which must be considered in establishing a rotorcraft flight envelope. Much of the material presented in Section 12 is pertinent to rotorcraft envelope definition.

12A.1 TEST OBJECTIVES

The prime objective of these tests is to determine the overall flight envelope that will allow the pilot/crew to safely perform the design mission including the carriage, utilization, and/or jettison of external stores, and carriage of external sling loads. This prime objective must continuously be kept in mind while setting up the various specific tests such as determining stresses that exist on various critical parts of the structure or on some of the dynamic components under a given set of airspeed, altitude, blade-tip Mach number, and normal acceleration. Safety of flight is always a key objective for each test point and test flight. The prior establishment of do-not-exceed (DNE) limits for each instrumentation parameter to be monitored by telemetry is critical to the "knock it off" call and the safe conduct of the test.

12A.2 TYPES OF TESTS

Other than pure envelope expansion testing whose purpose is so stated, many different flight tests types involve some definition or exploration of rotorcraft flight envelope. Among them are:

- Structural Demonstrations - to verify the maximum strength, rigidity, and operation restrictions of US Navy/Marine Corps helicopters. This test involves government witnessing of specific compliance maneuvers flown by aircraft manufacturer pilots. The maneuvers and their sequence are designed to stress the whole aircraft including dynamic components, engines, and transmissions. The required tests are described in MIL-D-23222. [12A-2]
- Loads Survey - to define the flight loads experienced in the airframe during mission representative maneuvers that may or may not be at the edge of an envelope. The data, when coupled with

ROTORCRAFT FLIGHT ENVELOPE UNIQUE CONSIDERATIONS

component fatigue data and the mission spectrum, are used to compute component replacement times and overhaul intervals for life limited components.

- Dynamic Interface - for shipboard operated aircraft, to define in terms of wind over deck and ship motion, the envelopes for rotor engagement, takeoff and recovery. This is closely related to Critical Azimuth testing (over land) in which the low speed envelope of wind speed and direction are explored to determine maximum sideward and rearward flight speeds, and critical wind azimuths for control margins flying qualities, vibrations, and hot gas reingestion.
- External Load Tests - to define the helicopter operating limitations when carrying a specific sling/load combination, including other airplanes and helicopters. Often the load, not the helicopter, is the envelope limiter.

12A.3 TEST INSTRUMENTATION

Helicopter instrumentation often must operate in a more severe environment than in fixed wing aircraft because of the relatively high vibration levels associated with helicopter flight. As with any instrumentation package, physical space, Electromagnetic Interference, proper transducer choice and location, cockpit controls/displays, and choice of recording device are but a few of the considerations to be made. [12A-1]

For rotorcraft envelope (expansion) testing, the parameters that would be considered essential are given below:

PERFORMANCE

- Calibrated Airspeed (i.e., Airspeed Calibration Test Complete)
- Calibrated Pressure Altitude
- Engine Turbine Temperatures
- Transmission Torque
- Rotor Speed

STABILITY AND CONTROL

- Cockpit Control Positions
- Main and Tail Rotor Blade Pitch Angles
- Sideslip Angle
- Cabin Angle of Attack
- Aircraft Attitudes
- Body Angular Rates
- Automatic Flight Control System Servo Positions

STRUCTURAL LOADS AND MOTIONS

- Blade Flapping Angles (Main and Tail Rotor)
- Blade Torsional, Chordwise, and Edgewise Bending Moments (Multiple Locations)
- Main/Tail Rotor Mast Torque and Bending
- Main/Tail Rotor Hub Loads

- Main Rotor Pitch Change Rod Loads
- Swashplate Loads
- Main/Tail Rotor Servo Loads
- Fuselage/Tailboom/Tail Structural Loads (Multiple Locations)
- Cockpit Vibrations

MISCELLANEOUS

- Chase Aircraft
- Cockpit Voice
- Event Marker
- Record Number
- Fuel Quantity
- Cargo Hook Load(s)

The parameters for which telemetry would be required are dictated by the specific aircraft limitations and characteristics. Installation of the test instrumentation can be accomplished by the aircraft manufacturer during aircraft construction, but is just as often installed later by the manufacturer or testing activity. The unique aspect of many of the required rotorcraft parameters is that the transducers are located in a rotating system while the power supply, signal conditioning, and recording/transmitting equipment are in the fuselage. This fact provides great challenge to the instrumentation engineer and Flight Test Engineer (FTE) as well as increases the cost and duration of the instrumentation phase. In a typical structural instrumentation package, power and signals are sent back and forth between the rotating and fixed system through slip rings. Miniature telemetry equipment is also used to transmit signals from rotating to fixed systems. Both have capacity limitations and can be costly. This should be factored in to all time and cost estimates of the test program. Ensuring the proper number of slip ring channels takes planning. Transducers in the rotor environment typically do not survive for extended periods. For this reason, backup transducers are usually installed during the instrumentation phase.

Recording and telemetry equipment for rotorcraft structural data is also unique in that the nominal sample rates required are much higher than those required by fixed wing airplanes. The frequency of interest for structural phenomena can be as high as 100 Hz (tail rotor blade passage frequency) which would require a sample rate of 500 hz to satisfactorily capture. For this reason some structural parameters are recorded/transmitted in Frequency Modulated (FM) rather than the more standard Pulse Code Modulated (PCM) format. This can create problems at the ground station in that a separate piece of hardware is required for each parameter and each must be tuned before the flight.

As discussed in Section 12, telemetry of critical parameters is essential in envelope testing so as to allow for FTE management of safe test progression from the known to the unknown. If the test is a structural demonstration, the engineer must ensure that the parameters required for maneuver compliance are also telemetered.

12A.4 SPECIAL ROTORCRAFT ENVELOPE CONSIDERATIONS

12A.4.1 Hover/Low Speed Envelope

As mentioned earlier the unique capability that rotorcraft possess is the ability to takeoff and land vertically and to remain in a stationary hover for a useful amount of time. The following are a few of the special considerations pertinent to the helicopter's hover and low speed envelope.

12A.4.1.1 Hover Ceiling. A rotorcraft can maintain a stabilized hover as long as the engine power available is greater than the power required by the main rotor, tail rotor, transmission, and accessory losses. In most approximations, the losses are a constant while the rotor power required increases with increased density altitude, gross weight, and rotor speed. The power available decreases with increased ambient temperature and pressure altitude. The hover ceiling is defined as the maximum pressure altitude at which the helicopter can hover at the given conditions (i.e., temperature, gross weight, rotor speed, etc.). Hover performance testing is usually not done as an envelope test, but rather this element of the envelope is extrapolated from generalized power required and power available data obtained away from the "edges". The limits on those extrapolations, for example on maximum allowable engine turbine inlet temperature, are obtained from other envelope related testing and analysis.

12A.4.1.2 Tail Rotor Authority. The tail rotor on a single main rotor/tail rotor configured helicopter has two main functions. One is to provide the anti-torque against the main rotor while also providing the pilot with the directional control of the vehicle. For an American main rotor rotation sense (advancing blade to the right) right sideward flight speed can become limited by "running out of left pedal". The torque required in low speed flight is in general higher than cruise flight causing the anti-torque requirement to be highest in this regime. As right sideward airspeed is increased, a minimum of two effects are increasing left pedal requirements. The directional stability (weathercock stability) of the aircraft, provided by any vertical fin, will generate an additional right yaw moment which must be countered with left yaw moment from application of left pedal. As right sideward speed is increased the tail rotor blade angle of attack is reduced requiring still further left pedal.

For similar causes, the control margins in the remaining axes may also become limited with low airspeeds along azimuths other than the cardinals (0, 90, 180, and 270 degrees). An aircraft is said to have a Critical Azimuth if this is the case. Aircraft can also have critical azimuths because of vibrations, workload, and/or hot (engine exhaust) gas reingestion which can significantly lower the power available in the hover/low speed regime.

12A.4.2 High Speed Envelope

The maximum airspeed for a conventional helicopter is limited by two primary and additive phenomena; retreating blade stall and advancing blade compressibility. Approaching these limitations typically results in an increase in vibrations, reduction of controllability, and a marked increase in power required. The increase in power required is directly due to the increases in drag on blade elements that are stalled and/or suffering from drag divergence. The increase in vibrations is a result of the large blade torsional moment changes as the blade sections enter and leave the stalled and transonic regimes. A pilot cue to this condition occasionally noted is control feedback where the aircraft control boost system (if present) is overcome by the large torsional blade moments and these moments are fed back to the pilot control as an oscillatory force in the cyclic stick. In extreme cases, control lock up or "jack stall" can be encountered in which the pilot controls lock and he loses all control of the vehicle until the loads are alleviated. The test engineer in the ground station is cued to the onset of stall/compressibility with a sharp increase in rotating component oscillatory loads. The working diagram for prediction and analysis of retreating blade stall is shown in Figure 12A-1.

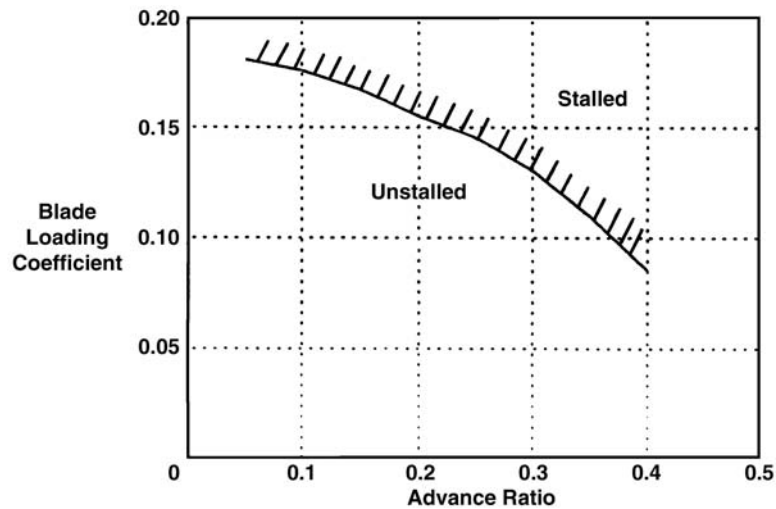

Figure 12A-1. Blade Stall Boundary.

The plot is a predicted boundary of Blade Loading Coefficient vs. Advance Ratio. For a given helicopter, Blade Loading Coefficient increases with weight, load factor, and density altitude while Advance Ratio increases with forward speed. Using this diagram (perhaps generated by the manufacturer) the test engineer can do a point by point prediction of blade stall potential. Similar prediction boundaries are used for advancing blade compressibility. The diagram can be updated as real flight data becomes available in the envelope expansion process.

12A.4.3 Maneuvering Envelope

The rotorcraft maneuvering envelope can be regarded as having more "degrees of freedom" than a fixed-wing airplane. In the latter, a V-n diagram is the major consideration and all-attitude, relatively care-free handling (at least in the up and away phase of flight) is afforded the pilot, with few limits on control motion, rates or attitude. The following paragraphs outline the envelope restriction parameters unique to rotorcraft and some discussion on how they could be approached.

12A.4.3.1 Load Factor. The maximum positive load factor (N_z) of a helicopter is typically lower than the maximum N_z for the fixed-wing aircraft. One reason for this is that the same turn rate can be achieved at a lower N_z at the lower speeds of the helicopter. In forward flight, the lift generating capability of the helicopter is typically less than the fixed wing and reduces as speed increases because of the retreating blade stall phenomenon introduced previously in paragraph 12A.4.2. As load factor is increased the blade loading is increased. Enough load factor (blade loading) can also drive the main rotor into blade stall even at moderate forward speed. The cues (to pilot and engineer) as well as the results can be identical to those discussed in the maximum forward speed paragraph 12A.4.2.

The static strength concerns of the helicopter under increased load factor are similar in nature to fixed wing concerns.

The minimum load factor boundary of the envelope is also more restrictive than that of the fixed wing aircraft. The primary reason for this is that the control of the helicopter is directly related to the load factor, and at $N_z = 0$, the pilot of the teetering-rotor helicopter has zero cyclic control effectiveness. The same loss of cyclic control effectiveness occurs at a negative N_z value for helicopters with flapping-hinge offset. To avoid this loss of control the N_z envelope is established at some margin above the value where loss of control would occur. Approximate values of this lower load factor limit for the helicopter is somewhere between -1 and +0.5.

ROTORCRAFT FLIGHT ENVELOPE UNIQUE CONSIDERATIONS

Further minimum load factor limits can arise from aircraft systems (i.e., fuel system) which are not designed for negative load factor.

12A.4.3.2 Body Rates and Control Motion. In addition to the load factor envelope described above there are other variables (or additional dimensions of the "envelope") that must be considered which cause the maneuverability of a helicopter to be more restricted than that of fixed wing aircraft. For example, the maneuverability of a helicopter must be limited to avoid blade flapping. Excessive blade flapping can result in the blades contacting parts of the airframe, or cause the blade to contact the rotor mast producing what is called "mast bumping". The results of the rotor-airframe contact or mast bumping are typically catastrophic and must be avoided. Many variables affect blade flapping during maneuvering flight but aircraft pitch and roll rates and, cyclic control position, are the most influential. Mast bumping envelopes defined in terms of these variables should be established, especially for an aircraft whose mission requires aggressive maneuvering. A relatively accurate first cut on what the envelope will look like can be obtained through the use of high fidelity simulation. The net envelope is a multiple dimensional surface in many variables other than the actual variables that define the envelope.

12A.4.3.3 Aircraft Attitudes. For example, rather than placing limits on load factor, pitch rate, control positions, etc., the limits are often placed on pitch and roll attitude. The thought is that since fleet (vs. test) aircraft all have attitude information displayed to the pilot, this is a convenient way of limiting the rotorcraft with a parameter the pilot already has available to him. In general, in remaining within relatively low attitude limits (typically ± 45 degrees in both pitch and roll), the pilot then remains within the limits of all the other parameters mentioned earlier. The danger of this is that it is a generalization and therefore it is quite possible to exceed the other envelope parameters while staying within the attitude limits. At the same time, the fleet pilot may be prohibited from exploiting perfectly safe performance regimes of the aircraft. An example of the former would be the case where because of high ambient temperature, density altitude, and gross weight the helicopter may be performance limited (power required higher than available) from sustaining a level turn at the Handbook angle of bank. Performing a turn at the "limit" angle of bank would necessitate either a decrease in airspeed or a descent rate. If the maneuver was flown at low altitude (above ground), the descent rate could become large and cause the crew to fly into the ground while never exceeding the handbook angle of bank.

12A.4.4 Miscellaneous

12A.4.4.1 Rotor Speed. Helicopters are designed with a nominal operating rotor speed in mind. Excursions above this design speed are allowed to a certain extent (typically to 110-115 percent). The major consideration for preventing rotor overspeeding is the increase in blade centrifugal loads at higher rotor speeds. Allowable speeds are typically determined in analyses and ground whirl stand tests, but are often verified in flight. Other considerations include loads on driveshaft bearings and supports and critical speeds for the driveshafts themselves.

The low rotor speed envelope can be limited in hover through tail rotor authority. At lower rotor speeds, more torque is required for the equivalent conditions. The tail rotor thrust producing capability is reduced with lower rotor speed (in single main rotor/tail rotor designs the main and tail rotors are usually geared together). These two effects are additive making directional control in hover a primary concern at low rotor speeds. The low rotor speed envelope in forward flight can be limited by such factors as blade stall and limit operating speeds for drive train-driven generators and pumps.

12A.4.4.2 Frequency Management. A major consideration in the design and test of a rotorcraft is the dynamic interaction of several lightly damped modes of motion. They include the main rotor lead-lag modes, external sling/loads combinations, large fuselage structural modes, and some rigid body modes. This notion is complicated by the fact that there are large excitation forces present in the rotorcraft at multiple characteristic frequencies. These frequencies are determined by the number of revolutions per second of the main and tail rotors, the number of blades per each rotor, and the engine speeds. Helicopter

manufacturers must be aware of the characteristic frequencies of the excitation source as well as the lightly-damped dynamic modes that they could potentially excite. A resonance involving a rotor mode and fuselage mode could be catastrophic and difficult to alleviate once started. The rule of thumb that is generally accepted in the helicopter dynamics field is to design the helicopter such that any excitation mode frequency is at least 10 percent away from all the lightly damped dynamic modes' natural frequencies. This issue can be encountered in some types of test programs including frequency domain handling qualities testing, testing of modified lead-lag dampers, testing of new external loads or slings, or even the removal or installation of relatively heavy mission equipment, the latter changing the modes and frequencies of the fuselage. To remain safe during these types of flight tests, this characteristic frequency information from the design phase would be useful in ensuring that the test bed aircraft is free from resonance. Obtaining this information as an FTE preparing to do one of these tests may be difficult as it may involve proprietary data from the original helicopter manufacturer. Every effort must be made to research and obtain these data so that the engineer may "fight smart".

12A.5 PRODUCTS OF TESTING

The end product of the testing process will be the report or reports specifying the flight envelope within which the helicopter can operate. Reasons and rationale for limitations resulting from the test program should be carefully spelled out. The report should also note any potentially dangerous or hazardous conditions that could be encountered when operating near the extremes of the established envelope.

Other products will include the feedback to design and research organizations that will allow them to modify/correct/update the processes whereby they predict structural and other envelope impacting capabilities.

The results of successful flight testing establish the operational envelope and can be used as part of the proof that the helicopter meets the certification requirements. If flight testing reveals that it does not satisfy some of the requirements, the helicopter may have to be modified or, when reasonable, the requirements have to be relaxed. Modifications will increase costs and may cause a delay in initial operating capability. Therefore, any required modifications should be identified as early as possible, so that they can be incorporated in the flight test vehicle early and flight testing with the modified helicopter can resume.

12A.6 SPECIAL CONSIDERATIONS

As noted in paragraph 12.10, establishing/expanding the flight envelope involves risks. Therefore, safety considerations must be the predominant criteria when planning and executing flight tests - Safety is more important than schedule! Special caution must be exercised when simulating failure conditions. The initial flight tests should always be carried out in a portion of the flight envelope that analysis indicates is free of problems. These initial tests are to check the systems, to determine that the aircraft behaves more or less as predicted, and to gain confidence in the aircraft. The next part is the gradual and careful opening of the entire envelope in carefully considered steps that will permit a reasoned expansion of the envelope from all aspects of the test helicopter's proposed mission.

An instrumentation and data processing system, consisting of reliable hardware and tested software, to support generating and analyzing flight test data, is indispensable. However, experienced and competent engineers are required to apply judgements to the data produced.

The following are some of the items that are peculiar to and/or important to helicopter testing:

- Transmissions and drive systems must be closely monitored, especially during the first 50 hours of testing. The pressures and temperatures as well as the chip detectors should be recorded/monitored and evaluated for any signs of wear and/or impending failure.

ROTORCRAFT FLIGHT ENVELOPE UNIQUE CONSIDERATIONS

- Care must be taken to ensure that data recordings for stabilized flight conditions are of sufficient duration to cover enough rotor rotations to permit identification of any harmonic phenomena with respect to rotor natural frequencies to be identified.
- Maintenance data must be gathered and analyzed to detect any early signs of malfunctions and/or "wear-out" tendencies of vibration sensitive equipment.

The development of an autopilot is not specifically a part of a flight envelope definition unless it features control laws designed to minimize/alleviate potentially damaging airframe and dynamic system loads. However, a functioning autopilot could be helpful to the pilot during tests.

12A.7 CONCLUDING REMARKS

In embarking on a helicopter envelope expansion effort it is generally a good practice to remember that there is more to a helicopter than "meets the eye". Ask a lot of questions if any helicopter flight test program involves:

- Modifications which change stiffness or mass significantly
- Anything being modified in the rotating system
- New external loads or slings
- Proposed sudden or sinusoidal control inputs
- Sudden power changes
- Ordnance firing
- The aircraft being operated in a manner much different than the fleet.

Although proper preparation is essential, in envelope-related testing, no amount of pre-flight analysis and planning can substitute for careful, thorough buildup.

12A.8 ACKNOWLEDGEMENTS

Mr. Pierluige Piccinini, recently retired from AGUSTA Flight Test Engineering, Cascina Costa di Samarate, Italy, provided valuable information used in Chapters 12A.1 Test Objectives, 12A.5 Products of Testing, and 12A.6 Special Considerations. Mr. Robert V. Miller, US Naval Test Pilot School, was a major contributor to all other Chapters.

12A.9 REFERENCES

[12A-1] Ferrell, K.R., "Helicopter Flight Test Instrumentation", Vol.10, AGARDograph 160, Flight Test Instrumentation Series, July 1980.

[12A-2] Military Specification MIL-D-23222(AS), "Demonstration Requirements of Helicopters", 18 Mar 1971 with Amendment 1, 30 June 1983.

12A.10 BIBLIOGRAPHY

Kolwey, H.G. and Allison, W.A., "Navy Structural Demonstrations", American Helicopter Society Specialists' Meeting, 15 and 16 March 1988.

Gregory, J.D.L., "Principles of Flight Test Assessment of Flight Test Safety Critical Systems in Helicopters", Vol 12, AGARDograph 300, Flight Test Techniques Series, August 1994.

Hofman, C.F.M.G. and Fang, R., "Determinations of Limitations for Helicopter-Shipborne Operations", NLR Report MP 84072 U, National Aerospace Laboratory/NLR, Amsterdam, The Netherlands, 1984.

NAVAIR Instruction 13.100.5, "Military Specification MIL-D-8708, Demonstration Requirements for Airplanes, and MIL-D-23222, Demonstration Requirements for Helicopters; the Administration of", 20 Feb 1968.

MIL-D-23222A, "Demonstration Requirements for Helicopters", Naval Air Systems Command, 1971. Valid Notice 1, 1983.

MIL-H-8501A, "General Requirements for Helicopter Flying and Ground Handling Qualities", AV Army Aviation and Troop Command, 1961.

U.S. Naval Test Pilot School (USNTPS) "Helicopter Stability and Control", Classroom Notes, unpublished.

Kracinovich, S., "Structural Flight Testing", Classroom Notes for USNTPS, unpublished.

USNTPS-FTM-No. 107, "Rotary Wing Stability and Control", U.S. Naval Test Pilot School Flight Test Manual, Patuxent River, MD, 30 June 1991.

USNTPS-FTM-No. 106, "Rotary Wing Performance", U.S. Naval Test Pilot School Flight Test Manual, Patuxent River, MD, 31 Dec 1987.

Empire Test Pilot School (ETPS), "Rotary Wing Ground School Notes," England, undated.

DEF-STAN 00-970, "Design and Airworthiness Requirements for Service Aircraft, Volume 1 - Rotorcraft", Issue 1 dated 31 July 1984, to AL 8, UK.

British Civil Air Requirements (BCAR) Section G, "Rotorcraft", published and distributed by the Civil Aviation Authorities (CAA), Cheltenham, UK.

Federal Air Regulation 29, Chapter 1, "Flight Characteristics".

Federal Aviation Regulations, "Part 27, Airworthiness Standards: Normal Category Helicopters", Revised 1 January 1986.

Joint Airworthiness Requirements (JAR) 27, "Small Rotorcraft", published by the (European) Joint Aviation Authority (JAA), Hoofddorp, The Netherlands.

JAR 29, "Large Rotorcraft", published by the JAA, Hoofddorp, The Netherlands.

AMCP 706-203, "EDH, Helicopter Engineering Part Three, Qualification Assurance".

Ecole du Personnel Navigant D'Essais et de Reception (EPNER), Pratique des Essais en Vol Helicopteres (2 Vol), ref EPNER 25.

Gessow, A. and Myers, G.C. Jr., "Aerodynamics of the Helicopter", fifth printing, Frederick Unger Publishing Co., NY, 1978.

ROTORCRAFT FLIGHT ENVELOPE UNIQUE CONSIDERATIONS

Prouty, P.R., "Practical Helicopter Aerodynamics", PJS Publications, Inc., 1982.

Bramwell, A.R.S., "Helicopter Dynamics", Edward Arnold (Publishers) Ltd., London, England, 1976.

Kaplita, et al, "Helicopter Simulation Development by Correlation with Frequency Sweep Flight Test Data", Sikorsky Aircraft Division of United Technologies, undated.

Chapter 13 – PERFORMANCE

J.P.K. Vleghert
Parkietstraat 36
1171 HV Badhoevedorp
THE NETHERLANDS

13.0 INTRODUCTION

This Section will set forth the types of tests, procedures, instrumentation requirements, data analysis and presentation, and the purposes for conducting performance tests. In general, performance tests are conducted to:

- Determine those elements of the aircraft's performance which are critical from flight safety considerations, i.e., the weight/altitude/temperature limits at which the applicable performance requirements with respect to the take-off and landing distances and climb gradients are met
- Acquire data to quantify the capabilities of an aircraft, to verify and/or establish the aircraft's performance model, and to provide information for the Aircraft Operation Manual (AOM)
- Determine if an aircraft meets specifications/guarantees.

There are a number of sources of detailed information on conducting performance tests, and analyzing and presenting data. A few of these sources are listed as references and a selected few are contained as bibliographic entries. [13-1, 13-2, 13-3] This Section offers a broad introduction to the topic: although based principally on typical civil practice, a similar approach is applied to military aircraft, and aspects specific to military aircraft, such as combat, are covered.

13.1 GENERAL CONSIDERATIONS

Test planning depends on the type of aircraft and the purpose of the tests. Traditionally, climb performance and cruise performance for "low"-performance aircraft and for civil aircraft that require a lot of One-Engine-Inoperative (OEI) performance to be established, have been determined in steady-state tests. In steady-state tests it is possible to faithfully reproduce the conditions that ultimately have to be met. However, for high-performance aircraft which generally have shorter endurance, steady-state tests require too much flying time. Therefore, performance is usually determined over a range of conditions in non-steady maneuvers. This type of testing requires more sophisticated instrumentation and processing, which take more time and money to prepare. For purposes of this discussion, high-performance aircraft are typified by military fighters and/or fighter-bombers. (It is worthy of note that high performance aircraft become low-performance aircraft after the failure of an engine.)

13.1.1 Test Objectives

The scope of the flight testing is dependent on the stage of development of the aircraft under consideration. On a prototype aircraft initial testing will be exploratory, with limited performance evaluation, directed to find possible critical items for later detailed testing.

Depending on the extent of performance information required and whether models are available for aircraft lift and drag and engine performance, tests may be directed to determining the required range and verify, establish, or update the model. This model can then be used to calculate performance under any desired conditions. An alternative is to test just the points necessary to show compliance with contract (or

other) specifications. In that case, performance will only be reduced to standard conditions of temperature, pressure, and weight. As the number of test points increases it becomes more advantageous to use the model approach because this is the only way to find out if the results are mutually consistent.

A third test objective would be analysis of discrepancies which are found. This may lead to more, and dedicated, testing.

13.1.2 Test Aircraft

The test aircraft should be in the standard external configuration of the production model. Any change requires additional testing - or convincing the authorities that the effect of the change is negligible. The test engine should be representative of the production engine. If it is not, then tests should be limited until a production engine is available. Then future tests with a production engine should be conducted to ensure that correct information is available for the Aircraft Operations Manual (AOM). In the case of military aircraft, capable of carrying a large number of external stores in many combinations, "drag indices" are generally used to minimize the number of test cases required.

For performance considerations it is desirable to trim the engine(s) to the thrust/power standard assumed in the AOM and/or specification, that is, typically, Average Power (or Thrust) or to the minimum value that the engine manufacturer expects or guarantees to obtain in service (Normally, "thrust" refers to jet powered aircraft while "power" refers to propeller-driven aircraft). It is worth noting that a new engine can often perform significantly better than this guaranteed value. Usually, minimum engine thrust is set 2 percent below Average New. For a turboprop a Minimum Power value of 4 percent below Average New can be used, unless there are indications that another - usually even lower - value must be used. The setting must be determined from an extensive bench test, which should be repeated after the test program. It is possible that in the course of the test program, which involves more full power operation than during normal operation, power or thrust has deteriorated significantly, causing discrepancies in the measured aircraft performance. For this reason, it is highly desirable to duplicate an early test in order to determine if the engine output has deteriorated.

13.1.3 Test Instrumentation

The instrumentation depends on the test objective. For a simple test, such as determining the take-off distance or maximum speed resulting from increased engine thrust, only the standard aircraft and engine instruments are required, i.e., altitude, airspeed, total air temperature, and fuel on board or fuel used and for a simple engine, RPM, fuel flow, turbine gas temperature and engine pressure ratio (EPR) or torquemeter indication for the case of a turboprop. These data could be manually recorded or the pilot's panel could be photographed. If this approach is taken, the instruments must be calibrated and the engineer must be aware of the inherent accuracy limitations.

For most tests - and especially for high performance aircraft - an automated, multi-channel digital data recording system is used to aid data processing and analysis, especially where non-steady state tests are performed. Airspeed, altitude, air temperature, fuel used, fuel flow rates, time, and engine parameters must all be recorded at rates sufficient to allow correct determination of performance. (See Sections 6 and 7 for information on preparing instrumentation and data processing requirements).

Needs for more specific instrumentation are discussed below under the appropriate heading.

Both airspeed and altitude measurements may be affected by pneumatic lag and attenuation. This is especially true of aircraft operating at rapid rates of change of altitude or speed and at very high altitudes. It may be necessary to conduct ground and flight tests to determine calibration factors that can be used during data correction. (See reference 13-4 and paragraph 11.5.4.)

13.1.4 Nature and Scope of Tests

In general, each test will reproduce the condition for which performance information is desired, but in some cases the parameter of interest will be determined by indirect means. For example, climb performance (rate of climb) can be measured over a speed range by flying a level acceleration at a constant engine power setting. The climb performance can be readily calculated from the excess thrust obtained from the measured flight path acceleration or equivalent level acceleration. This takes less flying time than a series of steady climbs at constant values of the airspeed over the range required to define peak rate of climb, but requires more effort in instrumentation and data analysis (see 13.3.4 for more details).

If point performance, such as a guarantee on maximum speed, is to be determined, the aircraft weight, center of gravity position, engine power or thrust, and atmospheric temperature must usually be within certain tolerances. For verifying the performance model, tests are conducted over a range of conditions, usually at high and low weights for a number of altitudes. Performance tests such as take-off and landing tests, are sometimes conducted at the extremes of ambient temperatures associated with desert environments. Performance tests under arctic conditions are not required if the engine maximum power is reached under near-ISA conditions and does not increase as temperature is further reduced. These conditions usually require off-base expeditions which are very expensive but, apart from performance model verification, serve to bring out possible handling or hardware difficulties or to prove that there are none. (See Section 18). Not all combinations of the above conditions need to be covered but there usually are requirements that must be satisfied. Typically, a sample of about six runs is made at each condition to establish a reasonable estimate of the mean value, but fewer tests at each condition may be acceptable where the test results are "mutually supportive", i.e., where there is sufficient coverage of the independent variable(s) to allow the mean trend to be established with a reasonable confidence. It must be borne in mind that even if more than one airplane is tested, it requires "engineering judgement" to arrive at an estimate of Fleet Average Performance.

13.1.5 Analysis and Presentation of Results

Data reduction covers the calculation of standard day values, and/or the calculation of performance model data such as lift and drag coefficients, from the recordings. However, before calculations begin the recorded values have to be corrected for instrument errors and then the position error correction of the pitot-static system. (The position error must be established separately as discussed in Section 11). From the corrected values, pressure altitude, true airspeed, Mach number and static air temperature are calculated. (The computational procedure is the same as that used in the aircraft's Air Data Computer). [13-1, 13-2]

Excess thrust and aircraft weight are calculated and used with the previous data to determine the lift and drag characteristics of the aircraft.

Further analysis covers comparison of similar measurements to check repeatability, e.g., determination of rate of climb as a function of airspeed. Possible outliers ("wild points") must be analyzed. They should be discarded only if a good technical reason can be found; they may otherwise indicate errors in the set-up or the execution of the test.

The reduced data are then presented in a form suitable for analysis for a particular test set, i.e., take-off roll versus weight for various lift-off speeds and/or flap settings for a series of weights, lift coefficient versus drag coefficient, etc.

Point performance can be deduced better from a number of measurements over a range of airspeeds than from attempting to repeat the same condition. It is usually not possible to repeat measurements at exactly the same conditions of airspeed, altitude, weight, engine performance, etc. Therefore, in order to establish

a mean value with confidence a "reasonable" sample size is required. The range enables corrections to be made for discrepancies and optimum climb speed, for example, to be determined. The value of rate of climb can be deduced at any speed from a curve fit. The engine instruments serve to check whether the engine is indeed flown at the desired thrust level. The observed aircraft performance must be corrected for any discrepancies in thrust level. The absolute value of engine thrust need not be known.

From the above procedure it is only a small step to the performance model, which enables a large number of measurements to be coordinated. In that case the absolute level of engine thrust must be known and it is no small task to establish the validity of the measured/calculated engine thrust. Once the model is validated by measurements taken over as wide a range of conditions as feasible, performance can be calculated for any set of conditions within this range. Limited extrapolation is allowed. The results may then be given or presented in tabular or graphic form for incorporation in the AOM.

13.2 TAKE-OFF AND LANDING TESTS

13.2.1 Description of the Tests

Take-off tests are conducted to define the time, distance, and airspeed to rotation, lift-off, and minimum barrier or screen height for a range of weights and flap settings. The important take-off speeds, such as V_1 (decision speed), V_R (rotation speed), and V_2 (take-off safety speed or initial climb speed) are chosen to give specified margins over V_S (stalling speed) and $VMCG/VMCA$ (minimum control speed on the ground/in the air) as defined in the appropriate requirements documents. Landing tests are maneuvers conducted to determine the distance from a barrier/screen height to touchdown and then to a full stop. Rejected take-off tests define the distance to accelerate to a refusal speed and to come to a standstill from there. [13-5, 13-6, 13-7]

Each take-off test should be considered complete when the aircraft is out of ground effect, approximately one wingspan above the ground, but for certification purposes specific values are often chosen, e.g., 50 or 35 feet for military and civil aircraft, respectively. For both military and civilian aircraft, failure of one engine is assumed during acceleration. If not enough runway is available to stop, the aircraft continues until rotation speed is attained. The aircraft then climbs out at V_2 which is chosen to provide the specified speed margins over the stall speed V_S and the minimum control speeds $VMCG$ and $VMCA$ (See paragraph 12.2.3). Below that speed take-off must be rejected if an engine fails. Aircraft weight, and therefore payload, must be chosen such that the required runway length can be satisfied within the available distance.

It is important to establish that enough elevator/stabilizer authority is available to permit the aircraft to rotate at the desired speeds. If elevator/stabilator authority is very strong, it is also important not to rotate at too low a speed and get into a situation where the aircraft may not have enough thrust to continue the take-off. (Also, see paragraph 9.9).

13.2.2 Test Instrumentation Parameters

There are no special airborne instrumentation requirements other than the need to correlate time between airborne and ground-based instrumentation. There are many different methods to measure distance along the runway, speed attained, lift-off point, and height above the ground such as kinetheodolite tracking, laser tracking, airborne camera, and inertial systems. These methods all differ in ease of operation, data reduction difficulty, and the ability to synchronize ground and on-board equipment. The ground instrumentation must also measure the atmospheric conditions such as temperature and pressure plus wind velocity and direction. In the interest of brevity, none of this ground based instrumentation is discussed here. For a complete review the reader is directed to AG-160-Vol.16. [13-8]

13.2.3 Test Maneuvers

The typical maneuver for a take-off is to set the desired power with the brakes locked, release the brakes, and start rolling. For a continuous take-off the aircraft is rotated at VR, which is chosen such that climb-out occurs at take-off safety speed (V2) which is defined as 1.2 times the stalling speed (VS) for jets and twin turboprops. For short take-off and landing (STOL) propeller aircraft, rotation for the shortest ground roll can be at VS (determined with engines idling) if pitch control power allows, because the propeller slipstream provides the necessary stall margin. Usually a minimum VR is also determined.

In a rejected take-off test, the pilot/co-pilot simulates engine failure by retarding the critical engine's throttle/power lever (see 12.2.3) to the idle position at a pre-determined airspeed. After power reduction, the pilot is required to wait three seconds before taking any corrective action, such as utilizing nose wheel steering, reducing power to any additional operating engines, applying brakes, and activating lift dumpers/"spoilers", if available, to provide maximum aircraft weight on the wheels for maximum braking power. Especially at heavy weight the brakes should be released just before standstill to keep rolling, otherwise the brakes may lock, with considerable damage resulting. If the take-off is continued the speed must be above VMCG. VMCG is determined with the elevator positioned for full aircraft nose-down to provide maximum weight on the nose wheel for best control. Sometimes speeds are center-of-gravity dependent because of limited pitch control. In those cases where engine failure is simulated, realistic pilot delay times must be allowed between the simulated failure and any pilot corrective activities.

For some military aircraft, tests must be conducted to determine the "ferry" take-off capability with one engine totally inoperative and with and without the "failure" of a second engine. Also, military requirements may dispense with safety regulations essential for civil aircraft, e.g., discount the failure of an engine and/or accept lower reference speeds to reduce the required take-off distances while accepting the handling control implications. Needless to say, these tests have to be carefully planned and executed using a very conservative approach while ensuring that realistic response times are allowed between successive piloting actions.

Engine brochure power is determined on the test bench with a stabilization period of about four minutes to "set" tip and seal clearances. This means that in the first minute after setting Power Lever Angle (PLA) both the indications and the engine output change appreciably; in practice the whole take-off run is executed with the engine not stabilized. Also, in a rejected take-off, it is not reasonable to cut engine power by shutting off its fuel supply. The sudden decrease of internal temperatures could cause turbine seizure and consequent damage. Also, by only cutting the engine to idle, power may be brought back up to help control the aircraft in the event of unexpected control problems. When PLA is closed to idle, the maximum speed in the rejected take-off run will be substantially above the value which would result from a true engine failure.

Landings are performed from stabilized conditions in the final approach configuration, utilizing power as required to attain the desired approach speed and angle. Power-off normally tends to result in a high vertical velocity which makes the flare maneuver critical. Usually the approach speed is 1.3 VS, unless additional requirements are imposed due to the phenomenon of speed instability, which is characteristic of "flight at the back side of the power curve". This means that additional thrust/power is required to maintain the flight path at decreasing speed. Lower speeds may be utilized after analyzing data and detailed discussions with the pilot regarding the feasibility and desirability of operating at lower speeds. High performance aircraft often enter the final approach with excess speed, which is bled off before touch-down. This tends to give a rather large variation of performance because this maneuver is difficult to reproduce. Civil aircraft are required to perform five landings consecutively with the same tires and brakes to provide an average value and to prove that tires and brakes are not overstressed. Only in the "maximum kinetic energy accelerate-stop" tests may the brakes be expended in one test run.

13.2.4 Data Analysis and Presentation

Take-off and landing data are reduced to standard weights and atmospheric conditions using the techniques set forth, for example in references 13-1 and 13-2, and are presented as plots of velocity or total energy versus distance. For take-offs, the distance is shown to lift-off and to a height of 50 feet for various weights and, if appropriate, flap positions with indicated airspeeds noted on the plots. Landing data are presented as distance from 50 feet to a complete stop versus velocity or total energy. It is also possible to model acceleration and deceleration as a function of atmospheric conditions, aircraft configuration, speed, and engine power and derive distances from that. [13-8]

13.3 CLIMB TESTS

13.3.1 Description of the Tests

Knowledge of climb performance is required to determine climb speeds, time to climb to a given height, fuel used, and distance covered for flight planning. In addition, there is the safety aspect; after failure of one engine, the remaining aircraft performance must be sufficient to continue safely. This means that the aircraft must be able to clear obstacles with a certain margin and reach a height from which a landing pattern can be initiated if an engine failure occurs during take-off. Or the aircraft must be able to continue to climb to a cruise altitude that will permit completion of a mission. Of course, this does not hold for single-engine aircraft, which are generally military or light. In the latter case a forced landing straight ahead is feasible or the pilot must eject from the aircraft. For aircraft with three or more engines, the possibility of a second failure later in the flight must be considered. [13-5, 13-6, 13-7]

13.3.2 Test Instrumentation Parameters

The instrumentation noted in paragraph 13.1.3, above, is often supplemented with a flight path accelerometer (FPA) and/or an inertial navigation system in order to measure acceleration along a flight path or acceleration components along all three axes. Angles of attack and sideslip, and roll should also be recorded. The use of the accelerometers is noted in paragraph 13.3.4, below.

13.3.3 Test Maneuvers

The test maneuvers to acquire climb data must be tailored to the end use of the data. Different tests are utilized for determining the speed for best rate of climb as opposed to determining time to climb through an altitude increment.

The simplest case of measuring climb performance is that of determining rate of climb (RoC) through an altitude increment at a constant indicated airspeed. (These climbs are often referred to as "saw-tooth" climbs because that is the shape of a plot of altitude versus time). The climbs are conducted over a range of speeds to determine the speed for best climb angle for obstacle clearance and a higher speed for best RoC. Engine power should be stabilized before entering the timed altitude increment. Duration of a single sawtooth climb test is usually less than five minutes.

These classical climb tests consist of a stabilization period for engine and aircraft of at least one minute, followed by three minutes of recording at a sampling rate of one sample per five seconds. With One-Engine-Inoperative (OEI) there are several different techniques to fly the tests which influence the end result. Optimum performance usually results from holding the "live"/operative engine low (approximately 5 degrees of bank) and flying with little side-slip. The possibilities range from maximum sideslip into the "live" engine and minimum rudder force to maximum rudder deflection (easier to hold against the stop), generally with the "live" engine high. Propeller-driven aircraft may require considerable aileron angle in OEI-flight to counteract asymmetric lift generated by the propeller slipstream. At higher airspeed, much

smaller control deflections are required for equilibrium. The asymmetry of the slipstream in a propeller aircraft gives rise to the concept of "critical engine". Usually both propellers turn in the same direction. If this is clockwise, viewed in the direction of flight, the vertical fin experiences a force to the right, requiring more rudder deflection if the left (critical) engine is made inoperative than the other way round. The concept of a "critical" engine also holds true for turbo-jet/fan engines.

At this point, it is appropriate to introduce the concept of Specific Excess Power (SEP) as a means of defining and determining the performance of high performance aircraft. Simply stated, SEP represents the difference between power available and that required for steady straight and level flight at the same speed and altitude, and is a measure of the aircraft's ability to accelerate, climb, or maneuver (i.e., overcome the increased induced drag in a turn). It is defined as the rate of change of energy height (h_e) which, in turn, is the sum of the specific potential and kinetic energy (i.e., the total energy of the aircraft per unit mass). Thus it can be written:

$$SEP = dh_e/dt = d/dt(h + V^2/2g) = dh/dt + V/g \times dV/dt$$

where the last two terms represent the "tape measure" rate of climb and the longitudinal acceleration, respectively, and g is the normal acceleration.

SEP is usually determined from non-steady flight maneuvers, such as performing a level acceleration at constant PLA and measuring the acceleration along the flight path. As can be seen from the above equation, the measured accelerations in level flight, i.e., with $dh/dt = 0$, is a direct measure of SEP, which may be converted into rate of climb at constant speed, i.e., with $dV/dt = 0$. This concept is developed in Ryland's method in which, with PLA fixed, a straight and level acceleration over a chosen Mach range, followed by a smooth increase in normal acceleration to decelerate the aircraft back to the initial speed is used to provide data from which the variation of SEP with Mach number at the test altitude and aircraft mass can be derived. [13-9] It should be noted that while the concept of SEP is simple, its determination calls for very accurate flying and considerable data reduction effort in allowing for the changes in Position Error Correction (PEC) with speed and inadvertent variations in the salient variables.

For high performance aircraft, level accelerations at constant PLA, and minimum sideslip, are used to determine climb performance for a range of airspeeds. Level acceleration tests are often performed by accelerating and/or decelerating parallel to a condensation or smoke trail laid down by a calibrated aircraft. This trail provides a constant altitude so that the test pilot does not have to try to judge a constant altitude from his altimeter readings. This procedure will help minimize corrections to test data. (This same data will provide airspeed system calibration information when the pressure altitude of the trail is defined by using a pacer aircraft or by tracking the contrail-creating aircraft by radar). When initiating horizontal accelerated flight it is desirable to start off with an engine stabilization period in steady climb of at least one minute. The changing altitude makes no difference in the engine stabilization, it is the internal temperatures that must be stabilized to obtain reliable power indications. It is common practice to utilize the speed brake, if available, to slow climb/acceleration while the engine is stabilizing. Even so, the step from stable climb at minimum airspeed to horizontal acceleration may be excessive, upsetting the first few seconds of recording so pilot technique becomes critical. However, the test data of real interest is usually in the mid-range of the speed envelope so the loss of data at low and very high speeds is usually not critical. These tests are usually repeated at a series of altitudes, e.g., every 5,000 or 10,000 ft. The airspeed/Mach number at maximum SEP which is calculated from each level acceleration is the airspeed for maximum rate of climb at that altitude. The line through the peaks of the SEP curves at different altitudes denotes the optimum climb schedule. Normal acceleration should be kept to approximately one g , however, corrections can be applied in the data analysis for small discrepancies. Sampling rate is 5 to 10 samples per second (sps).

One or more continuous climbs are then executed, sometimes with different airspeed schedules, to check the results, especially time, distance, and fuel required to reach a given altitude. If there is more than one external configuration, such as external tanks or stores, then climbs should be flown at each configuration.

13.3.4 Data Analysis and Presentation

Data analysis is different whether the result wanted is a number of point performances, e.g., for contract purposes, or preparation/verification of a performance model for subsequent calculation of an AOM.

Climb performance over a range of airspeeds can be determined in a single maneuver, such as a level acceleration or deceleration. In this case, however, the demand for instrument accuracy is much more stringent, as the differentiation process has to be executed over a much shorter time interval. The sampling rate should be at least five sps. The static pressure and Position Error Correction (PEC) have to be known exactly as a discrepancy has a cumulative effect on the rate of climb, e.g., a single error, can result in both pressure altitude and airspeed deviating in the same direction.

Performance can be measured without differentiating if accelerations along the aircraft axes are measured and transformed to flight path axes utilizing angle of attack, the so-called Flight Path Acceleration technique. A recording rate of 5-10 sps should be used, with adequate filtering of the accelerometer output, say a one Hz low pass filter.

Especially for low performance aircraft the angle of attack has to be calibrated accurately in-flight. Vane angle may be influenced by upflow ahead of the wing or by inflow to an engine or by control deflection. It is also influenced by aircraft rotation in pitch. An error of one milliradian, or about 0.05 degree, can give an error of 0.1 percent in climb gradient, which cannot be neglected. This angle-of-attack calibration has to be repeated for each flap angle, as the fuselage attitude for constant lift coefficient varies with flap angle.

Performance can also be measured by earth-bound accelerometers, i.e., an Inertial Navigation System (INS) without the necessity of an angle-of-attack calibration. In this case, however, the accuracy of the vertical acceleration is critical as a discrepancy which through integration would result in a vertical speed which implies performance that does not exist. Computer programs exist which reconstruct the flight path accurately from the combination of accelerometers and altitude/airspeed measurement; subsequently, this flight path-time history can be used to determine performance. [13-10] Small errors in vertical accelerometers accumulate through integration in an INS. This leads to significant errors in altitude and altitude rate over a period of time. These errors are primarily due to changes in acceleration of gravity as a function of latitude, accelerometer bias, changes in the atmosphere such as wind gradients or up/downdrafts. Using an external altitude reference (air data computer's altitude output), these errors can be corrected. This is a so-called baro-damped loop. This loop is closed for most maneuvers; however, it is "open" for maneuvers such as climbs and descents).

13.3.4.1 Point Performance. In the simple Rate of Climb (RoC) test, the measured RoC is corrected for variations from standard day and standard weight and presented as plots of RoC versus airspeed. Comparison of this RoC to that obtained during level acceleration must include corrections for the changing absolute speed, experienced during a steady climb at either constant indicated airspeed or constant Mach number.

The thrust and drag corrections required for the correction of the point performance can be derived from generalized data for aircraft and engine. As long as the correction is less than, say, 10 percent, a correction accuracy of 10 percent is sufficient to get a final accuracy within 1 percent; the absolute values of thrust and drag are not required. Corrections can be made in a linearized differential form. For contract purposes it is recommended not to rely on a single test, but on the average of, say, five tests at the same

airspeed or over a range of airspeeds or engine settings. In the latter case a computer curve fit can be calculated, which is then read at the desired value; the accuracy can be evaluated from the Random Error Limit of Curve Fit.

The above quoted accuracy does not include bias errors, which can occur in climb tests because of atmospheric phenomena like vertical speed or horizontal wind speed or pressure gradients. These may occur over a surprisingly wide area, and can cause errors in RoC of 100 feet per minute or more, which cannot be neglected in a low-performance aircraft. Usually only one or two tests out of a series are affected, they can be found by vetting (i.e., eliminating outliers or bogus data by using expert knowledge of the shape or characteristic of the data) the results for outliers. Do not execute all tests in the same area and use reciprocal headings to show up differences, if any.

Stable air for conducting performance tests is best found over water early in the morning before significant convection from the surface develops. Tests performed near mountains can have substantial atmospheric disturbances, i.e., updrafts and downdrafts, which should be avoided.

13.3.4.2 Performance Model. If a performance model is to be verified, thrust and drag must be separated and known in absolute value. For the larger engines, thrust is determined by the engine manufacturer and given as a computer file, which can be adapted by the aircraft manufacturer to include installation effects. (However, the Flight Test Engineer should be aware that there is a great deal of effort to determine the installation effects such as ground calibration of engines fitted with flight tail pipes.) For the simpler cases thrust and specific fuel consumption can be given in non-dimensional or quasi-non-dimensional form as a function of Engine Pressure Ratio or fan RPM for different flight Mach numbers. Corrections for Reynold's Number effects must be considered but they are beyond the scope of this volume.

Aircraft drag is usually computed as drag coefficient versus lift coefficient for different Mach Numbers.

For one-engine-inoperative flight an asymmetric drag coefficient must be included, which can usually be expressed as a quadratic function of the asymmetric thrust coefficient. It is commonly established empirically. Also pitch trim drag can be evaluated separately; it is a function of center of gravity position.

13.4 CRUISE TESTS

13.4.1 Description of the Tests

Cruise tests are used to obtain data from which best cruise conditions can be determined. For low performance aircraft, tests are often conducted using quasi-stabilized conditions, allowing very small variations in speed or altitude, at various combinations of weight and external configuration. For high performance aircraft, data is obtained from non-steady maneuvers.

13.4.2 Test Instrumentation Parameters

The instrumentation required is the same as that required for climb performance determination.

13.4.3 Test Maneuvers

For developing AOM and/or model data, more detailed information must be obtained through quasi-stable tests or non-steady tests, or from both sources. Quasi-steady tests require considerable time to establish the necessary test conditions at various combinations of velocity, altitude, weight, and external configuration. The pilot establishes a throttle setting at a given altitude-weight-configuration and then holds a constant altitude while waiting for speed to stabilize. This technique is repeated at airspeed

PERFORMANCE

intervals until adequate data has been obtained to define a power required-velocity curve at that altitude. It is highly desirable for low performance aircraft to obtain a range of speeds from the "back side of the power curve" to near maximum speed for normal rated power to ensure that the lift-drag relationships are defined and that the best cruise speed can be defined. An alternate method of obtaining cruise data for turbo-jet/fan engines is to establish engine setting required versus Mach Number at several constant values of "Weight-over-delta", where delta is the static pressure at altitude divided by the standard sea level pressure. At constant throttle setting, the pilot attempts to hold constant Mach, i.e., a change in airspeed less than one knot in two minutes, as the aircraft settles into a "cruise climb" which is held steady for five minutes while records are taken. (See also paragraph 13.4.4).

For the high performance aircraft, data can be obtained during non-steady maneuvers such as level accelerations/decelerations at a near constant altitude and turns where the normal acceleration is gradually increased (a "wind-up" turn) at various altitudes and weights. The PLA should be fixed (auto-throttle off) for each run. Runs should be accomplished at different fixed PLA settings to obtain engine mapping data as well as the effects of power on the lift-drag relationships (Note that data from the non-steady climb and sustained turn tests can be used in defining cruise performance).

13.4.4 Data Analysis and Presentation

Cruise performance determined by quasi-steady state tests could be recorded by hand if it was not for the problem of evaluating stability, i.e., residual acceleration. For this reason the last minute of a cruise test should be recorded and the increment of drag resulting from the derived acceleration should be calculated.

Cruise drag is primarily a function of lift coefficient and Mach Number and should be evaluated as such. (The influence of Reynold's number effects on both drag and the engine must be considered but are beyond the scope of this volume.) In the AOM, cruise performance is usually given as engine setting and fuel flow versus aircraft weight for a limited number of cruise schedules and diverse heights, including Reynold's number effects. For reference, other engine parameters can also be included.

Another way of presenting cruise performance is to evaluate the range factor as a function of Mach Number and aircraft weight divided by atmospheric pressure ("Weight-over-delta"). These values determine the lift coefficient for optimum cruise. The engine setting required is also a function of Mach Number and "Weight-over-delta". This presentation allows the finding of optimum cruise height as a function of aircraft weight and desired Mach number. This is defined by the value of "Weight-over-delta" for maximum Range Factor (best nautical air miles traveled per pound of fuel consumed at the weight and altitude). Range factor versus Mach number is constant for a given "Weight-over-delta", except for the Reynold's number (skin friction drag effect) mentioned above.

The data from the non-steady maneuvers is reduced to lift and drag coefficients and presented as plots of lift coefficient versus drag coefficient, fuel flow over pressure ratio versus Mach number for various power conditions (i.e., EPR, RPM, etc.). These plots are then the basis for forming or evaluating the aircraft and engine models.

13.5 COMBAT PERFORMANCE

13.5.1 Description of the Tests

For military aircraft, combat performance can be defined as maximum speed, turn rate (both instantaneous and sustained), excess thrust (which gives accelerating performance and/or rate of climb), and minimum usable speeds. (Handling qualities also involve combat performance and are discussed in Section 15).

13.5.2 Test Instrumentation Parameters

In principle, the determination of Combat Performance demands the same instrumentation and data analysis as climb performance, but the maneuvering requirement goes up to 9 g and the very high thrust-to-weight ratio aircraft usually demands high data sample rates. On the other hand, the absolute data accuracy can be less and still give a good relative accuracy.

13.5.3 Test Maneuvers

The excess thrust of the vehicle is measured in high-g maneuvers, performed to the normal positive and negative acceleration limits of the aircraft, stability considerations permitting. Apart from acceleration performance, deceleration can also be evaluated along with the effect of deceleration devices like speed brakes.

Even though high performance aircraft usually have a low aspect ratio, and therefore, high drag at low speed, the initial acceleration for aircraft with a thrust to weight ratio of one or greater is still high enough to make the maneuver difficult to perform.

On the other hand, the Maximum Sustained Turn Rate demands the utmost from pilot, airframe, and instrumentation. The test is usually started from high speed in a horizontal wind-up turn, in which speed decreases at high g. Tests are flown at maximum power (full afterburning) and at different g levels. Sustained turn rate is found by interpolation. Besides performance, important aspects are controllability, buffet boundary, post-stall behavior and engine tolerance to high angle-of-attack and sideslip.

In modern engines the control system is often adaptive and can include parameters like Mach Number, angle of attack, and sideslip angle. It is possible to run the afterburner in closed loop control ("buzz riding"). With a full authority Digital Electronic Engine Control, surge margins can be varied with Mach number, angle of attack, and angle of sideslip. This allows better performance in low angle of attack flight and the best possible performance during turning maneuvers.

13.5.4 Data Analysis and Presentation

Determination of excess power/thrust demands the evaluation of changes in speed and altitude with either pressure instruments or with the Flight Path Acceleration technique. It should be recognized that SEP can be either a positive or a negative value.

Combat Performance is difficult to establish accurately. When employing the Flight Path Acceleration technique at high g, fuselage bending - and that of the boom carrying the angle-of-attack sensor - can have a large influence on the measurement results. Also air loads on the boom can be significant.

The variation of Energy Height (the imaginary height at which the potential energy is equivalent to the total energy of the aircraft, i.e., the sum of its potential (height) and kinetic (speed) energy) gives only the effective acceleration in flight path direction. Aircraft axis-orientated accelerometers transformed to the flight path axes using the angle of attack give the acceleration in the direction of the flight path and normal to the flight path, due to the resultant thrust, lift and drag. The determination is irrespective of aircraft attitude, and therefore independent of the test maneuver.

The flight path acceleration is given by coordinate transformation from the body axes to the earth axes. The normal component of the flight path acceleration determines pitch rate. The maneuver performed can have a different pitch rate from the desired case, which may be a pull-up in the vertical plane or turning in the horizontal plane, or anything else. Therefore a correction to the measured flight path acceleration may be necessary. For that it is desirable to add pitch rate to the measurands.

13.6 DESCENT TESTS

13.6.1 Description of the Tests

"Normal" descent tests are accomplished to determine time, distance, and fuel used to descend from one altitude to another, and determine fuel used and distance covered while emergency descents (utilizing speed brakes, steep nose down attitude, and, if possible, gear and flaps extended), are conducted to determine the maximum possible rate of descent following emergency conditions such as loss of cabin pressure.

Rate of Descent at constant airspeed is a function of engine setting and external configuration (which could include extension of flaps and gear). Engine setting has to satisfy requirements for accessory drive, possible flame-out or die-out and acceleration time to high power in case of a go-around. Unless idle RPM is closed-loop controlled it varies with airspeed. Sometimes separate values exist for ground and flight idle. It may be possible to utilize the lower ground idle value in descent to increase rate of descent. The flight idle condition must then be restored in the approach for better acceleration.

13.6.2 Test Instrumentation Parameters

The instrumentation defined for climb and cruise performance determination will satisfy requirements for determination of descent performance.

13.6.3 Test Maneuvers

In a previous paragraph deceleration performance has been mentioned as a logical by-product of measuring excess power/thrust. This measurement can be performed in nominally horizontal flight and then corrected to steady descent or, more directly, descents can be accomplished at various combinations of speed and configuration.

13.6.4 Data Analysis and Presentation

Test data must be corrected to standard day conditions and standard weight for presentation of distance covered, elapsed time, and fuel used. Additional plots should be prepared showing altitude required to recover from descents/dives of varying dive angle and speed to allow for the case of dive bombing or an escape maneuver.

Descent performance can be calculated from a performance model, which has been verified for conditions as close as practical to the actual maneuver.

13.7 CONCLUDING REMARKS

This section has presented procedures to determine aircraft performance, both for isolated tests and for verification of a performance model. Calculations are not worked out in detail; this has to be obtained from the indicated references, but most aspects have been discussed.

13.8 REFERENCES

- [13-1] US Air Force Test Pilot School, Volume 1, "Performance Manual".
- [13-2] US Naval Test Pilot School (USNTPS) FTM-104, "Fixed Wing Performance Test Manual", July 1977.
- [13-3] USNTPS FTM-106, "Rotary Wing Performance", December 1987.
- [13-4] Lawford, J.A. and Nipress, K.R., "Calibration of Air-Data Systems and Flow Direction Sensors", AGARDograph 300 "AGARD Flight Test Techniques Series", Volume 1, 1983.
- [13-5] UK Ministry of Defense, Defense Standard 00-970, "Design and Airworthiness Requirements for Service Aircraft"
- Volume 1 Aeroplanes: Issue 1 dated 12 December 1993, to amendment 12 dated October 1992
 - Volume 2 Rotorcraft: Issue 1 dated 31 July 1984, to amendment 8 dated 8 December 1990."
- [13-6] Federal Aviation Regulations Part 25 - "Airworthiness Standards: Transport Category Airplanes", U.S. Department of Transportation, Federal Aviation Administration (FAA).
- [13-7] Joint Aviation Requirements (JAR)-25 - "Large Aeroplanes", (European) Joint Aviation Authorities.
- [13-8] de Benque d'Agut, P., Riebeek, H., and Pool, A., "Trajectory Measurements for Take-off and Landing and Other Short-Range Applications", AGARDograph 160 "AGARD Flight Test Instrumentation Series", Volume 16, 1985.
- [13-9] Norris (Ed.), E.J., "Handbook of Test Methods for Assessing the Flying Qualities and Performance of Military Aircraft, Vol 1 Aeroplanes", A&AEE, Boscombe Down, UK.
- [13-10] Gerlach, O.H., "The Determination of Stability Derivatives and Performance Characteristics from Dynamic Maneuvers", AGARD FMP Symposium, May 1971.

13.9 BIBLIOGRAPHY

- USNTPS FTM-106, "Rotary Wing Performance", USNTPS Flight Test Manual, Patuxent River, MD, US, 31 Dec 1987.
- Cohen, H., Rogers, G.F.C., and Saravanamuttoo, H.I.H., "Gas Turbine Theory", Longman, 1987.
- Perkins, C.D. and Hage, R.E., "Airplane Performance, Stability and Control", Wiley, 1950.
- Herrington, R.M., and Shoemaker, P.E., "Flight Test Engineering Manual", USAF Technical Report No. 6273, Air Research and Development Command, W-PAFB, Ohio, 1951.
- Various Volumes in AGARDograph 160, "Flight Test Instrumentation Series".
- Various Volumes in AGARDograph 300, "Flight Test Techniques Series".
- Kohlman, D.L. and Schweikhard, W.G., "Flight Test Principles and Practices", The University of Kansas, USA, 26 April 1991.

PERFORMANCE

Lan, C.E. and Roskam, J., "Airplane Aerodynamics and Performance", The University of Kansas, USA, first printing 1981.

Roskam, J., "Airplane Flight Dynamics and Automatic Flight Controls", Part I and Part II, The University of Kansas, USA, second printing 1982.

Ruygrok, J., "Elements of Airplane Performance", Technical University Delft, the Netherlands, Delft University Press, 1990.

Austyn Mair, W. and Birdsall, D.L., "Aircraft Performance", Cambridge Aerospace Series 5, Cambridge University Press, UK, Cambridge, New York, 1992.

Ecole du Personnel Navigant D'Essais et de Reception

- Pratique des Essais en Vol Helicopteres (2 Vol), ref EPNER 25.
- Pratique des Essais en Vol Avions (3 Vol), ref EPNER 24.
- Pratique de la Reception (1 Vol), ref EPNER 27.

Chapter 14 – AEROELASTICITY

J.J. Meijer

National Aerospace Laboratory (NLR)
Anthony Fokkerweg 2
1059 CM Amsterdam
THE NETHERLANDS

14.0 INTRODUCTION

Flutter is an aeroelastic phenomenon in which aerodynamic, elastic and inertia forces couple unfavorably at a sufficiently high speed to produce an unstable oscillation which may grow without limit and so result in a structural failure. Flutter is, unfortunately, not a problem that will just "go away": modern aircraft, in particular, are progressively more flexible, fly faster, and are highly control configured, more maneuverable and more system dependent. The development of active control systems for flutter suppression will actually complicate the problem by introducing a fourth "servo" dimension into the aeroelastic scene and will at best only defer flutter to higher speeds.

Clearly, an important problem during the design of new aircraft is to make sure that the proposed and actual structure is free from flutter within the proposed flight envelope. This requirement is essential since flutter involves a structural instability and as such will cause damage to the structure when it occurs. Flutter can only be prevented by a proper design of the structure and, as a consequence, the study of flutter must start at an early stage of the development of a new aircraft. It will continue along with this development up to and into the early flight test stage. For modified aircraft, structural modifications or flight control modifications require that the flutter stability has to be re-established. It must be remembered that even a minor structural modification could have major implications for flutter stability. For military aircraft which are to be equipped with a large variety of external stores, the study of the flutter problem will often extend well beyond the first stage of flight testing. This is caused by the fact that variations in the external loading of an aircraft, due to new requirements, may change its flutter characteristics appreciably and by the fact that "intermediate" configurations (after release of stores and with fuel tank partial loadings or fuel transfer failures) must also be considered.

Flutter was recognized as a problem even in the early days of flying and although considerable effort has been made towards the understanding of the problem, flutter still remains a major consideration when designing new aircraft. This is due in part to the fact that newer construction materials and more sophisticated construction techniques have led to an ever decreasing relative thickness of the aircraft's lifting surfaces. The stiffness of these structures has, however, hardly increased and, therefore the sensitivity to flutter has increased accordingly. On the other hand flying speeds have also increased considerably from subsonic to transonic and supersonic speeds and, as a consequence, the aerodynamic loads related to flutter have not only grown but have also changed their character due to encountering shock waves.

Because of the direct impact flutter may have on the design of a new aircraft, the eventuality of flutter is considered from the beginning of a new design. During the development phase this investigation will pass various stages as indicated in figure 14-1 obtained from reference 14-1.

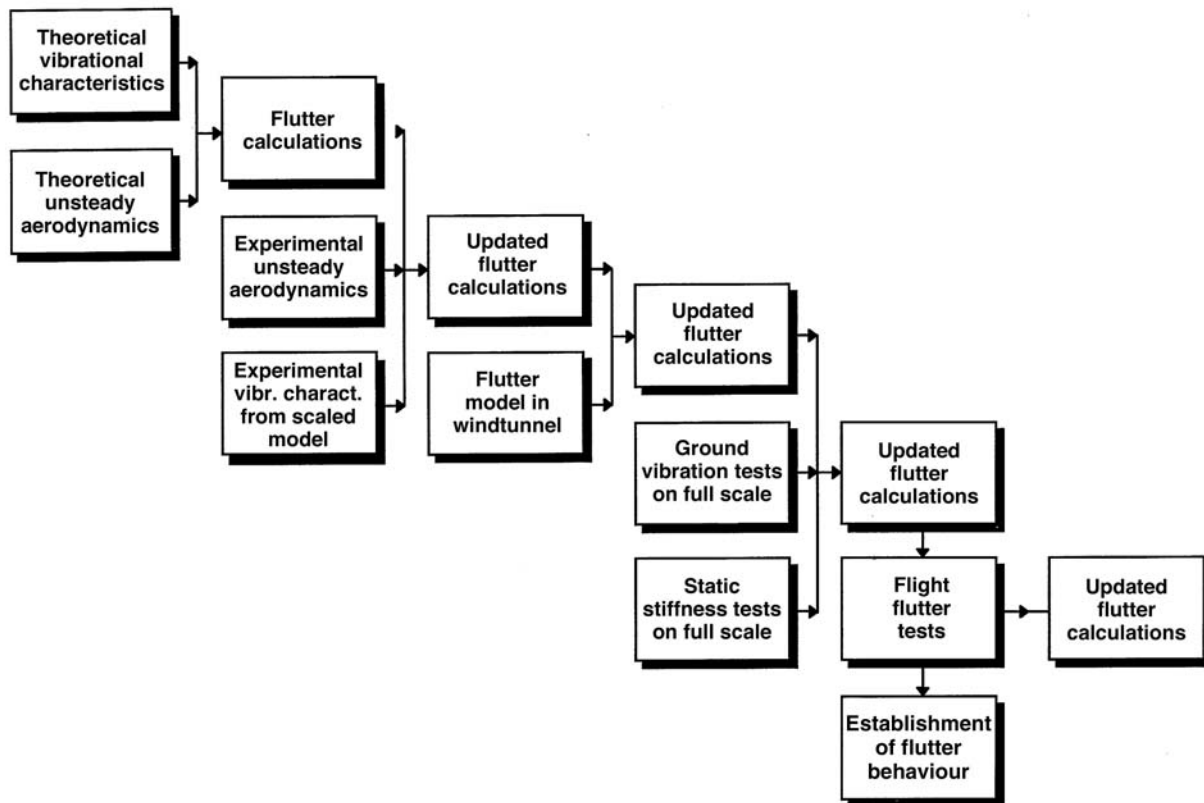

Figure 14-1. Flutter Investigation During Development Stage of a New Aircraft.

Flight flutter tests are conducted to demonstrate freedom from flutter for critical aircraft conditions. The stability results derived from those tests are used to validate the flutter analysis. Both test results and calculated results are used to demonstrate compliance with the airworthiness requirements. Active control systems (ride control, gust load alleviation, flutter suppression, etc.) add to the scope and complexity of these tests in that control system instability due to aeroelastic interactions must also be considered. Wind tunnel tests usually form part of the validation process and flutter in this environment can result in costly damage or loss to the wind tunnel.

Reliable flight and wind tunnel test procedures are therefore required to minimize the hazard of these tests. This requires that effective methods be used for exciting the aircraft or model and that reliable, on-line and off-line methods be used for estimating the stability from the measured structural and control system responses (parameter estimation). In addition, effective procedures for preventing damage must be available in the event that an instability is experienced. In some instances this has led to the use of active flutter suppression systems on wind tunnel models.

The principal impediments to achieving reliable estimates for stability parameters are the short test time on condition and the high noise levels in the data collected. A number of methods have been developed or are being proposed to address these problems and will be discussed below.

Nonlinear aerodynamics, structural dynamic, or control system characteristics provide further impediments to reliable stability parameter estimates because a larger data base is required to identify and characterize the nonlinear behavior and because estimation methods generally used assume linear processes. It is therefore important to determine what parameter estimation methods have been used and how successful those methods have been particularly in the presence of nonlinear conditions.

This section will spell out the airworthiness requirements, the subcritical clearance philosophy, typical test objectives and procedures, denote excitation devices used and excitation signal types, instrumentation/recording required, and touch upon data analysis techniques and typical products of the test conduct. Finally, some practical problems and future needs will be considered. More details can be found in references 14-1, 14-2 and 14-3.

14.1 REQUIREMENTS

Analyses, wind tunnel and laboratory tests, and aircraft ground and flight tests shall demonstrate that flutter, divergence, and other related aeroelastic or aeroservoelastic instability boundaries occur outside the 1.15 times design limit speed envelope. The aircraft shall meet the following stability design requirements for both normal and emergency conditions:

- Flutter margin: Fifteen percent equivalent airspeed margin on the applicable design limit speed envelope, both at constant altitude and constant Mach number as indicated in Figure 14-2a obtained from reference 14-4.
- Damping: The damping coefficient, g , for any critical flutter mode or for any significant dynamic response mode shall be at least three percent (0.03) for all altitudes on flight speeds up to the design limit speed as indicated in Figure 14-2b , also obtained from reference 14-4.

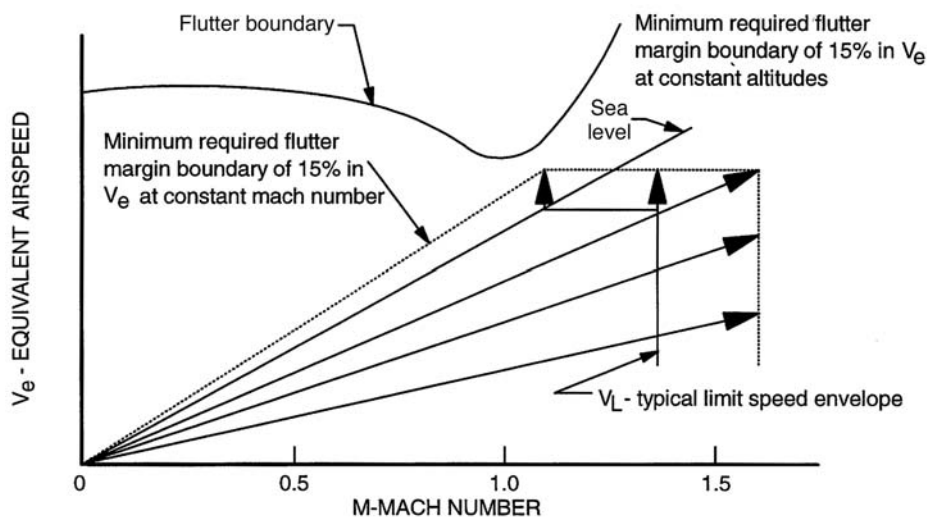

Figure 14-2a. Minimum Required Flutter Margin.

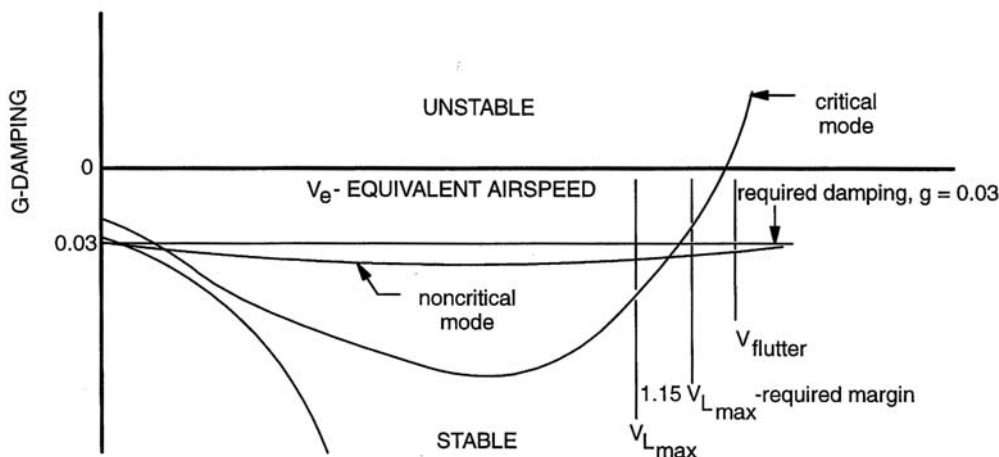

Figure 14-2b. Required Damping.

14.2 TEST OBJECTIVES

The prime objective must always be to provide flutter free operation in the intended envelope of the test aircraft in a safe and economical fashion. This objective must be reflected in all subsequent flutter test activities.

The preliminary flight test plan should always be prepared by experienced flutter engineers based upon their analysis of flutter calculations and wind tunnel tests. They will determine where, in the planned flight envelope, it is safe to fly without flutter testing and where flutter testing is required. Where it is required they will specify the vibration sensors (accelerometers, preferably, and/or strain gage bridges, mostly available for other purposes), and their location in the aircraft. Using the same analysis and information they will specify the type of vibration exciters and where they are to be located. At this point the flight test and instrumentation engineers will participate in the detailed design of the instrumentation system and the excitation system.

Next, the flutter and flight test engineers must prepare a detailed flight test plan showing the combinations of speed and altitude that must be flown to demonstrate the freedom from flutter. Then a detailed sequence of testing must be prepared wherein tests are first flown at the conditions where analysis indicates that there are no predicted flutter problems. As each test point is flown, the test results are reviewed to ensure flight safety and compared to the predicted results. If the test results and the predictions disagree to a significant degree in the view of either the flutter or flight test engineer, the tests are halted until the cause of the variance is explained.

The test plan must clearly specify the duties and responsibilities of all the test participants to include who has the specific responsibility for calling a halt to or proceeding on with a test series. In all cases, the test pilot has the authority to stop any test series if he detects any items that indicate any type of a departure from anticipated results.

14.3 TYPICAL MEASUREMENTS

Flight flutter testing comprises three steps: structural excitation, structural response measurements, and stability analysis. Accordingly, the data to be collected during the flight flutter tests can be divided into two groups: those for measuring the excitation force and those for measuring the response of the aircraft.

In the first group, for measuring excitation forces, the sensor used will depend entirely upon the type of exciter used. For example, an electromagnetic exciter will require the measurement of a current while a strain gage bridge will be required for measuring the vane excitation force.

In the second group, the most commonly used transducers are accelerometers and strain gage bridges. If amplitude accuracy is not critical, there is no clear preference between the two types. Strain gages are normally used only on new aircraft as they need to be installed during assembly of the aircraft since they are generally located in areas which are inaccessible once the aircraft has been assembled. On the other hand, accelerometers can be installed in many cases after the aircraft has been assembled. If the flutter tests are to be conducted on an existing vehicle, which is being equipped with new external stores, for example, the use of accelerometers may be dictated by the relative ease of installation. The two different types of sensor require quite different placement. In a wing, for example, the strain gage bridge will generally be applied near the wing root where the structural loads are large, whereas the accelerometer would be placed near the wing tip where the displacements are large. In the case of "classical" flutter, amplitude accuracy is not very critical since the engineer will be concerned with damping ratios rather than absolute amplitude. Good linearity is required for this case and it is essential that the phase relationship between the various sensors is of good quality. However, if nonlinear phenomena, such as transonic aerodynamics and nonlinear control system characteristics are present, absolute displacement amplitude sizes become important as well. Consequently, a preference for accelerometers is becoming more common.

The selection of sampling rates for digitized data is critical. The consequence of sampling a fluctuating signal at too low a rate can be that high frequency signal components are interpreted as low signal components. To avoid this problem which is called data aliasing, the sampling rate for digitized signals should be at least twice the maximum frequency present in the original signal. It should be noted that the frequencies encountered in flight tests normally range up to about 50 Hz for transport type aircraft and 50 to 100 Hz for fighter type aircraft.

Despite the considerable improvements in test/analysis techniques that have been made in recent years, flutter testing is still a hazardous exercise. It is therefore important that the test aircraft not significantly overshoot the test points as it progressively clears the envelope. Therefore, airspeed and altitude must be controlled very accurately. As the testing approaches the boundaries of the envelope the airspeed tolerances usually become even more restricted with no positive tolerance allowed. In order to achieve these tight tolerances special airspeed and pressure instrumentation is generally required such as a trailing cone or special instrumentation mounted in a flight test nose boom.

14.4 TYPICAL MANEUVERS

It will be necessary to excite an aircraft in order to obtain the resonance frequencies and the corresponding damping coefficients of all required structural vibration modes to establish the flutter characteristics of the aircraft (see figure 14-3 obtained from reference 14-2). The means of excitation of the aircraft may be "natural" or "deliberate". Natural in this context means that the aircraft response to the naturally occurring atmospheric turbulence is used so that no excitation equipment is required. Whilst this option may appear attractive it is not ideal as will become clear later on. Several means of "deliberate" excitation have been developed and applied that appear to be quite different from each other. However, a detailed examination reveals that they are based on a limited number of basic principles, such as aerodynamic, moving mass, and pyrotechnic exciters. A brief description of each and their relative advantages and disadvantages are listed below. More detailed descriptions, factors involved in the choice of excitation device, and discussion are contained in references 14-1 and 14-2.

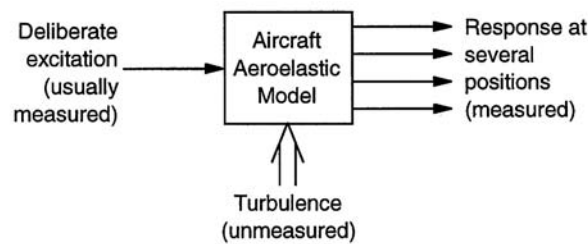

(a) Deliberate excitation

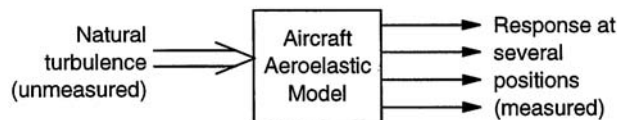

(b) Natural excitation

Figure 14-3. Identification of Dynamic Characteristics.

14.4.1 Aerodynamic Excitation

There are basically three types of aerodynamic excitation sources used in flutter testing. These are the aircraft control surfaces, special oscillating vanes attached to the tips of the lifting surfaces or to external stores, and atmospheric turbulence. The advantages of these excitation sources are that they add very little mass to the structure and that they can be used to provide a wide range of input frequencies.

In case of the control surface and oscillating vane excitation sources, the oscillating input force to the aircraft structure comes from changes in the aerodynamic lift on the oscillating surface. Such changes in aerodynamic lift can also be obtained by a rotating slotted cylinder along the trailing edge of a fixed vane, as described in reference 14-5. These sources can be used to provide either frequency sweep inputs (i.e., sweeping from low to high frequencies or vice-versa), constant frequency burst inputs, or random frequency inputs. In addition, control surfaces are also used for pulse or rap inputs which simulate impulse inputs to the structure. A further advantage is that it is usually possible to arrange aerodynamic excitation to be symmetric or asymmetric about the centerline of the aircraft, so aiding the process of separating out the structural vibration modes.

Atmospheric turbulence provides a random input to the structure which generally encompasses a spectrum of frequencies up to about 10 Hz. Even though the input is not generally felt by the pilot, there is always some energy content transferred to the structure from the air mass. However, the amount of input from this source is generally very small, which results in slow, unreliable, poor quality test data, compared to the other types of "deliberate" aerodynamic excitation sources and therefore is less satisfactory as pointed out in references 14-2 and 14-6.

14.4.2 Moving Mass Excitation

There are basically two types of moving mass excitation sources: inertia exciters and electrodynamic exciters. These exciters impart a force into the structure via reacting the inertia of a moving mass attached to the aircraft structure. They are generally mounted inside the aircraft and therefore do not present any aerodynamic interference. These can provide frequency sweep, frequency burst and, in some cases, random inputs similar to the aerodynamic exciters.

Inertia exciters generally consist of a rotating out-of-balance mass mounted on a shaft which can be driven through the frequency range of interest. In some cases a "wand" is used which consists of a mass placed at the end of a pivoted arm attached to a shaft located at the tip of a wing or tail surface. One disadvantage of this system is that larger masses are needed to excite the lower frequencies and the overall system weight may become prohibitive.

Electrodynamic exciters are akin to the electrodynamic shakers used in ground vibration tests (GVTs) as presented in paragraph 9.5. In this case the force is generated by a mass excited by an electromagnetic field. The mass is suspended by springs and consists of a permanent magnet with coil windings attached. When an alternating current is sent through another set of coils in close proximity, the mass can be made to move within the electric field. The frequency of movement is proportional to the electric signal. This system has the same advantages and disadvantages as the inertia exciter.

14.4.3 Pyrotechnic Excitation

The pyrotechnic excitation source which is sometimes called a "bonker" consists of a very small explosive charge that is typically placed externally on the aircraft structure and detonated electrically. The tiny explosion produces an excitation of short duration. The actual time history of this force and, thus the frequency content, can be controlled by the design of the exciter. Some of the advantages of this type of exciter are that the short duration of the excitation makes it useful for short flight maneuvers such as dives, and since the exciter is small, a number of them can be mounted almost anywhere on the aircraft without disturbing its vibrational characteristics. The disadvantage of this excitation source is the limited number of excitations (one per exciter) that can be produced during a given flight.

14.5 FLIGHT TEST PROCEDURES

In the conduct of flutter tests, a subcritical envelope expansion procedure is used whereby less critical points are flown prior to the more critical ones. The aircraft structural response data and flight parameters are also monitored in real time. This procedure provides the test engineer an opportunity to determine damping and frequency trends as dynamic pressure and airspeed increased during the test.

Generally, the buildup will consist of points of incrementally increasing airspeeds or Mach number which are flown at either a constant altitude or along a constant dynamic pressure line. If the buildup is flown at a constant altitude then it usually begins at a high altitude where the dynamic pressure will be the lowest. The airspeed increments between points will depend upon the proximity to the predicted flutter boundary and the confidence in the flutter analysis. Smaller steps are required when close to a flutter condition or when a rapid decrease in damping is observed. Some practical initial airspeed must be selected to begin the buildup sequence since the aircraft must take off and climb to the first test altitude. The choice of the initial test airspeed and altitude is based on a conservative review of the predicted flutter modes and flutter margin.

Clearly, the test program will differ according to whether the aircraft is to be cleared for low subsonic, high subsonic or transonic/supersonic speed regimes. In all cases a part of the flight envelope is cleared by calculations for initial flying, obviously allowing a good margin of safety. Typical procedures for testing of these speed regimes are shown in figure 14-4, obtained from reference 14-1.

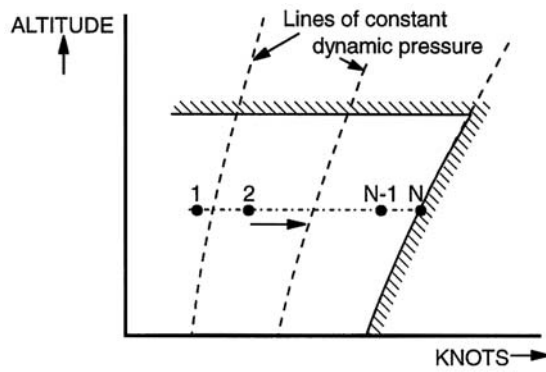

(a) Low Subsonic Speed Regime.

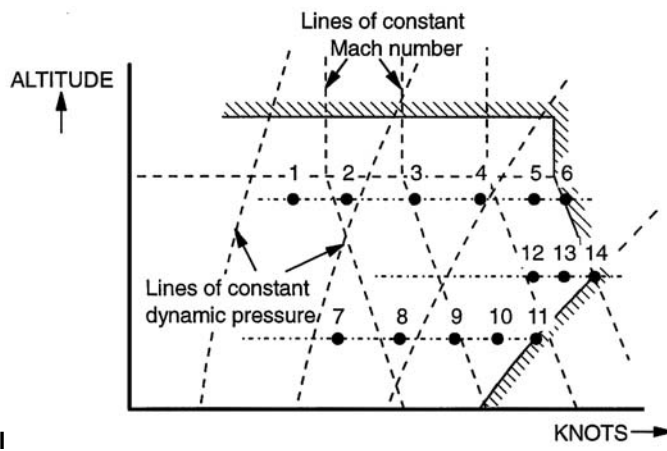

(b) High Subsonic and Transonic Speed Regime

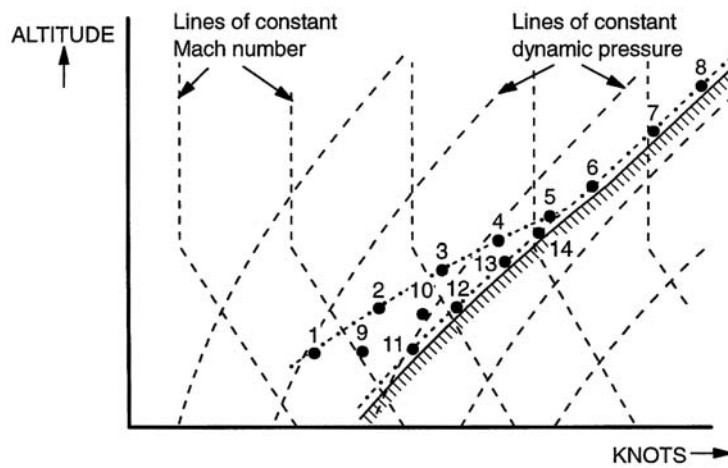

(c) Transonic and Supersonic Speed Regime.

Figure 14-4. Flutter Test Procedures.

The maneuvers used in flutter testing depend upon the type of aircraft structural excitation available and the data to be collected. If sweep, burst, or random data is to be required, the aircraft will stabilize on condition (i.e., fly at a constant airspeed and altitude) for the time required to do the excitation. Generally, when dive test points have to be flown, the aircraft will reach a target airspeed, and the excitation data will be taken between a band of altitudes to prevent significant changes in the dynamic pressure during the maneuver. Sometimes, windup turns are carried out to determine the effect of g-forces on the aircraft flutter characteristics.

14.6 DATA ACQUISITION AND ANALYSIS

Until relatively recently, the measured signals were handled manually all the way to analysis in an analog format. This meant that only simple procedures could be applied unless time lapse did not play a significant role. In fact, trace recordings of time histories, particularly those of decaying oscillations, were processed manually and further evaluations in the frequency range domain were seldom performed. This process is still used, along with more sophisticated methods, for aircraft that are expected to exhibit one predominate critical modal response such as with aircraft with external stores or large transport type aircraft.

With the advent of computers, plus improved data acquisition systems and the development of Fast Fourier Transform techniques, more complex analysis procedures involving two signals simultaneously in both the time and frequency domain have been developed. It is now possible to produce real-time quantities such as auto spectra of input or output and transfer functions in the frequency domain and auto correlations of input or output, cross correlations, and impulse responses in the time domain as discussed in chapter 11 of reference 14-3. In addition, new near real-time curve fitting techniques in both the frequency and time domains help expedite damping and frequency calculations.

Signals from the sensors often contain components of no interest to the flutter investigation and the data is subject to filtering before recording and/or analysis. Data from the sensors are normally always recorded on board the aircraft utilizing magnetic tape recorders and selected parameters are usually sent to the ground for "quick look" and intermaneuver analysis by suitable specialists (Large transport/cargo aircraft will often have equipment on board for analysis in flight). This not only reduces risk but permits more test points per flight. In figure 14-5 a block diagram of a typical data acquisition and analysis system is shown. The analysis system is normally part of telemetry ground station. Data analysis can be done in real time using the data coming in via a telemetry link, or postflight, using data recorded on board the aircraft or on the ground station itself.

There is no need to process much of the data past the "quick look" stage. Data that is required to be processed further must be judiciously selected by the flutter engineer to avoid saturation of the data processing facilities. Typical results during flight tests are shown in figure 14-6 and the final result of flutter stability in figure 14-7.

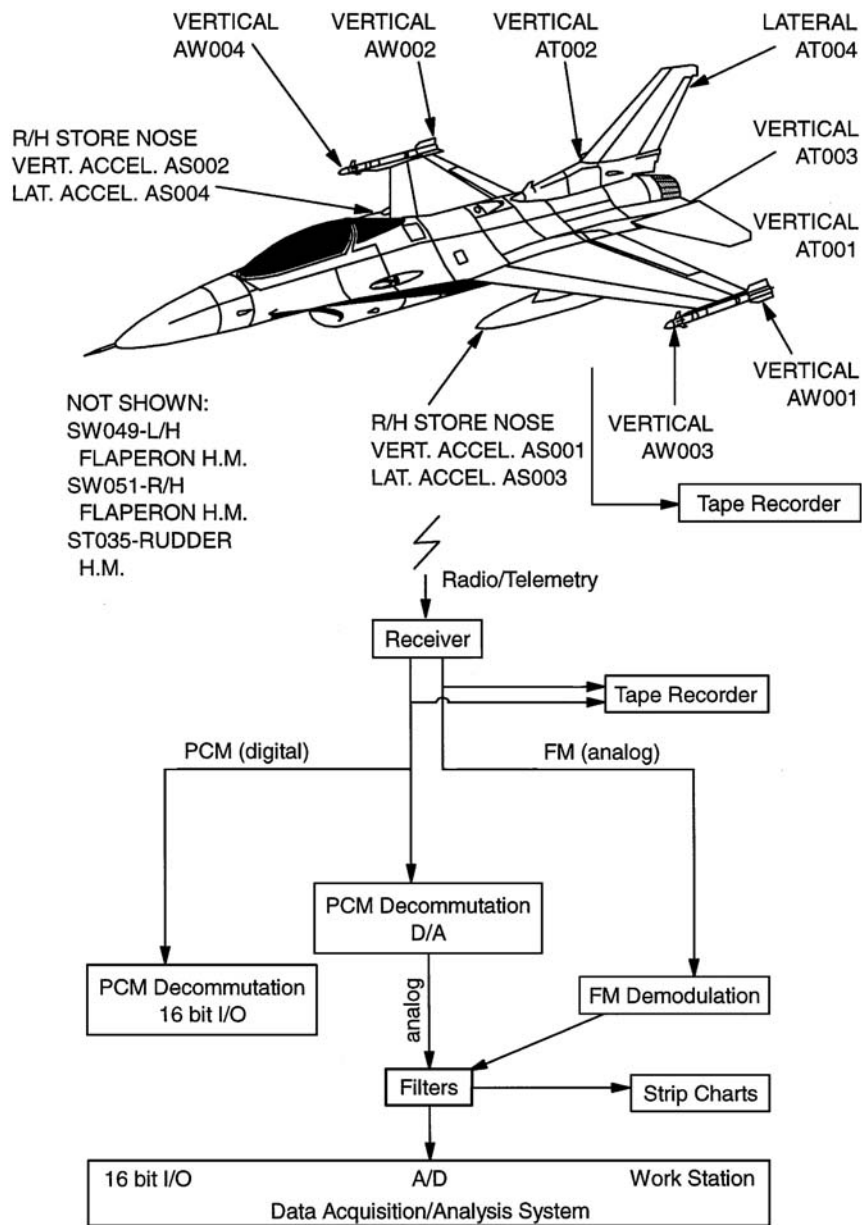

Figure 14-5. Typical Flutter Data Acquisition and Analysis System.

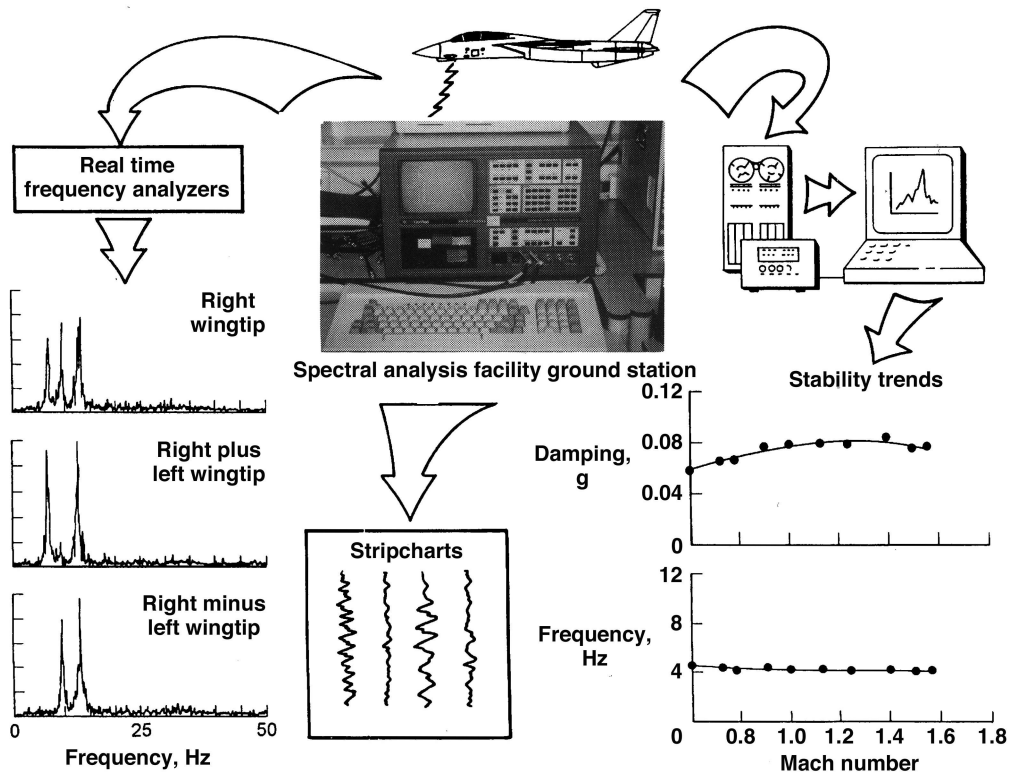

Figure 14-6. Typical Results Obtained from Flight Tests.

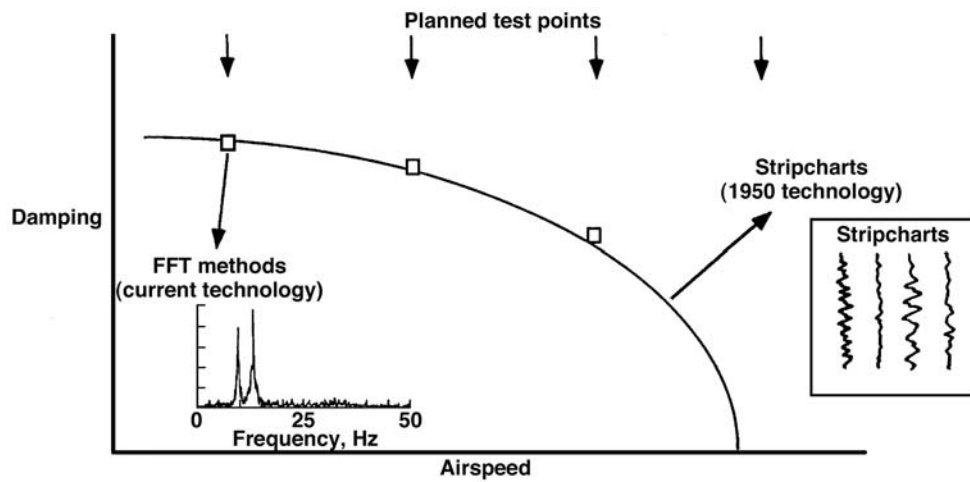

Figure 14-7. Current Stability Determination for Most Airframe Companies/Government Agencies.

14.7 TYPICAL PRODUCTS

The most important product resulting from the flutter test is the report providing clearances/limitations/special operating procedures as derived from test and data analysis.

Other products of importance to the flutter community are the quantities such as (in the frequency domain) autospectra of input or output, cross transfer and transfer functions and (in the time domain) autocorrelations of input or output, cross-correlations, and impulse responses.

Another very important product is the validation or updating, as appropriate, of the flutter model developed as a result of the wind tunnel testing and data analysis.

14.8 SPECIAL CONSIDERATIONS

Safety of flight must be the prime consideration when conducting flutter tests. Tests should not be continued, if in the opinion of the test pilot or the flutter engineer, unexpected results are encountered. Procedures must be clearly spelled out as to who has the authority to interrupt any given set of data points of the specified flight test program in order to conduct an inserted detailed data analysis.

All flutter tests should begin in that part of the flight envelope where wind tunnel data and data analysis unambiguously indicate freedom of flutter. Further tests should progress toward the anticipated edges of the envelope in carefully calculated increments that get smaller as less safe conditions are expected. Flight test data that show differences from predicted flutter and/or damping characteristics should result in a stand-down until the differences are explained and/or rectified.

The flight test engineer and the flutter engineer should carefully debrief the test pilot after each flight. Special attention should be given to pilot comments about any vibrations or oscillations experienced during each test point. These comments could provide valuable clues of which data to further process or of items to look for when processing data.

During real-time testing the flight test engineer should be continually on the look-out for trends in the damping and frequency that indicate that flutter could be imminent. This is performed primarily by monitoring the time signals or the processed data frequency and damping of the critical modes as a function of airspeed and/or dynamic pressure. If the damping starts to decrease at a faster rate than anticipated, then testing should be done at smaller increments or terminated. If the structural time history response starts to become more sinusoidal, with less relative noise, as the test progresses from point to point then the tests should proceed with extreme caution since flutter may occur. In any event, the damping coefficient should not be allowed to go below three percent as specified in figure 14-2b.

14.9 CONCLUDING REMARKS

Flutter can destroy or seriously damage an aircraft. Therefore, flutter considerations must be addressed early in the design process and the concern for flutter problems must be addressed at every stage of the aircraft's development and as early as reasonable in the flight test program. However, a vehicle representative of the production version must still be tested to provide representative data, especially if the aircraft is designed to carry a variety of stores.

Rapid strides are being made in flutter analysis and suppression techniques. The entire subject of flutter is being addressed by a planned AGARD Structure and Materials Panel Specialist's Meeting to review the state-of-the-art and consider future directions (to be held in the spring, 1995).

14.10 ACKNOWLEDGEMENT

Mr. L. Tracy Redd of the US Air Force Flight Test Center made substantial contributions to the preparation of this Section.

14.11 REFERENCES

- [14-1] Nunen, J.W.G.van and Piazzoli, G., "Aeroelastic Flight Test Techniques and Instrumentation", AGARD-AG-160, Flight Test Instrumentation Series Volume 9, 1979.
- [14-2] Wright, J.R., "Introduction to Flutter of Winged Aircraft: Flight Flutter Testing", Lecture Series 1992-01, von Karman Institute for Fluid Dynamics, Chaussee de Waterloo 72, B-1640 Rhode Saint Genese, Belgium.
- [14-3] Norton, W.J., Captain, USAF, "Structures Flight Test Handbook", AFFTC-TIH-90-001, November 1990.
- [14-4] Military Specification, MIL-A-8870C, "Airplane Strength and Rigidity, Vibration, Flutter, and Divergence", 25 Mar 1993.
- [14-5] Reed III, W.H., "Development and Flight Application of the DEI Flutter Exciter", Aerospace Flutter and Dynamics Council Meeting, Orlando, Florida, October 1989.
- [14-6] Norton, W.J., Captain, USAF, "Random Air Turbulence as a Flutter Test Excitation Source", Society of Flight Test Engineers 20th Annual Symposium Proceedings, September 1989.

14.12 BIBLIOGRAPHY

- Mazet, R., "Some Aspects of Ground and Flight Vibration Tests", AGARD Report 40-T, April 1956.
- "Several Techniques for Flight Flutter Testing", AGARDograph 56, 1960.
- Piazzoli, G., "Aeroelastic Test Methods, Experimental Techniques", AGARD Report, 1970.
- Skingle, C.W. and Baldock, J.C.A., "Flutter Techniques in the UK - a Survey", AIAA 73-330, March 1973.
- Dat, R., "The Theoretical and Experimental Methods used in France for Flutter Prediction", AIAA 73-329, March 1973.
- Larue, P., Millet, M., and Piazzoli, G., "Pyrotechnic Bonkers for Structural Tests in Flight", La Recherche Aeronautique, May-June 1974, pp. 137-146.
- Rosenbaum, R., "Survey of Aircraft Subcritical Flight Flutter Testing Methods", NASA CR 132479, August 1974.
- Nash, D.E., Katz, H., and Noody, W.C., "F-15 Flight Flutter Testing: Aircraft Systems and Test Operations", AIAA Aircraft Systems and Technology Meeting, Los Angeles, CA, August 1975.
- "Flight Flutter Testing Symposium", New printing of 1958 Symposium NASA SP-285, 1975.

"Flutter Testing Techniques" Proceedings of Conference in 1975, NASA SP-415, 1975.

Collar, A.R., "The First Fifty Years of Aeroelasticity", Aerospace 545, (publication of the Royal Aeronautical Society), February 1978.

Koenig, K., "Experience from Flight Flutter Testing with Tip-Vanes on Airbus", International Symposium on Aeroelasticity, Nuremberg, Germany, October 1981.

Zimmermann, H. and Destuynder, R., "Flight Flutter Testing with Emphasis on the Tip Vane Method", AGARD-CP-339, October 1982.

Garrick, I.E. and Reed III, W.H., "Historical Development of Aircraft Flutter", Journal of Aircraft, Vol.8, No.11, November 1982.

Kehoe, M.W., "Aircraft Flight Flutter Testing at the NASA Ames-Dryden Flight Research Facility", NASA TM-100417, May 1988.

Reed III, W.H., "A New Flight Flutter Excitation System", Society of Flight Test Engineers 19th Annual Symposium Proceedings, August 1988.

Auwerker, H. van der, Leuridan, J., Pintelon, R., and Schoukens, J., "A Frequency Domain Maximum Likelihood Identification Scheme with Application to Flight Flutter Data Analysis", 8th International Modal Analysis Conference Proceedings, Kissimmee, FL, January-February 1990.

Ricketts, R.H., "Experimental Aeroelasticity, History, Status and Future in Brief", AIAA-90-0978, April 1990.

Bucharles, A., Cassan, H., and Roubertier, J., "Advanced Parameter Identification Techniques for Near Real Time Flight Flutter Test Analysis", 5th Biannual Flight Test Conference Proceedings, Ontario, CA, May 1990.

Air Force Guide Specifications, "General Specifications For Aircraft Structures", AFGS-87221a, 8 June 1990.

Norton, W.J., "Limit Cycle Oscillation and Flight Flutter Testing", Society of Flight Test Engineers 21th Annual Symposium Proceedings, August 1990.

Guillaume, P., Pintelon, R., and Schoukens, J., "Description of a Parametric Maximum Likelihood Estimator in the Frequency Domain for Multi-input, Multi-Output Systems and its Application to Flight Flutter Analysis", Mechanical Systems and Signal Processing, Vol.4, September 1990.

Cooper, J.E., "Model Parameter Identification Techniques for Flight Flutter Testing", 71st AGARD SMP Proceedings, Povoá de Varzim, Portugal, October 1990.

Nissim, E., "The Effectiveness of Vane-Aileron Excitation in the Experimental Determination of Flutter Speed by Parameter Identification", NASA TP-2971, 1990.

Buckley, W.R. and Poland, J.B., "Modal Analysis in the Certification of a Commercial Aircraft", 9th International Modal Analysis Conference Proceedings, Florence, Italy, April 1991.

Marshall, M.A., "Determination of In-Flight Modal Characteristics of a Fighter Type Aircraft", 9th International Modal Analysis Conference, Florence Proceedings, Italy, April 1991.

Shibata, K. and Matsuzaki, K., "Preliminary Study of Algorithm for Real-Time Flutter Monitoring", 29th International Pacific Air and Space Technology Conference and Aircraft Symposium Proceedings, Gifu, Japan, October 1991.

Meijer, J.J., "NLR Investigations of Flutter Behaviour of Fighter Aircraft with External Stores", NLR TP 91134 U, National Aerospace Laboratory/NLR, Amsterdam, 1991.

Girone, M. and Jones, W., "Increasing the Lethality and Combat Mission Flexibility of the F-111 Through Flight Test and an Enhanced Flutter Computer Program", Society of Experimental Test Pilots 36th Symposium Proceedings, September 1992.

Lee, B.H.K. and Ben-Neticha, Z., "Analysis of Flight Flutter Test Data", Canadian Aeronautics and Space Journal, Vol.38, No.4, December 1992.

Cooper, J.E., Emmet, P.R., Wright, J.R., and Schofield, M., "Envelope Function - A Tool for Analyzing Flutter Data", Journal of Aircraft, Vol.30, No.5, September-October 1993, p. 785-790.

Hodson, C.H., Dobbs, K., Brosnan, M.J., and Chen, J.B., "X-31A Flight Flutter Test Excitation by Control Surfaces", AIAA 93-1538, 1993.

Pinkelman, J.K., Batill, S.M., Vernon, L.E., and Kehoe, M.W., "An Evaluation of Excitation Techniques for Time Domain Based Flutter Data Processing", AIAA 93-1602, 1993.

Vernon, L., "In-flight Investigation of a Rotating Cylinder-Based Structural Excitation System for Flutter Testing", NASA TM-4512, 1993.

Nissim, E., "Improvement of Method for Experimental Determination of Flutter Speed by Parameter Identification", NASA CR-193555, 1993.

Farrell, P.A. and Ryall, T.G., "Flight Flutter Test Techniques at ARL", ARL-STRUC-TM-569, Aeronautical Research Labs., Melbourne, Australia.

JAR 25.629, "Joint Airworthiness Requirements".

FAR 25.629, "Federal Airworthiness Requirements".



Chapter 15 – HANDLING QUALITIES

Robert E. Lee, Jr.

U. S. Air Force Flight Test Center
412 OG/DOEF
Edwards Air Force Base, CA 93524-6824
USA

15.0 INTRODUCTION

This section will set forth the types of tests, procedures, instrumentation requirements, data analysis and presentation, and the purposes for conducting the various tests required to define an aircraft's handling qualities. In general, handling qualities tests are conducted to define the basic stability and control characteristics of the aircraft, define how the aircraft responds to pilot or other inputs, and to define techniques to maintain safe flight in the operational envelope. The terms handling qualities and flying qualities are often used synonymously; however, a distinction is sometimes made between the two notions. Flying qualities generally refers to a set of attributes determined by an aircraft's stability and control characteristics. Handling qualities reflect the ease with which a pilot can carry out a mission task using an aircraft that possesses a particular set of flying qualities.

There are a number of sources of detailed information regarding test conduct, analysis, presentation, and evaluation of handling qualities. A few of these sources are listed as references and several more are shown as bibliographic entries.

15.1 GENERAL CONSIDERATIONS

Handling qualities tie together the studies of complex dynamic systems and capabilities, and the likes and dislikes of the humans which must operate these systems. Practitioners of the art of flying qualities must understand aircraft aerodynamics, control systems, dynamics, and abilities of the human operator. By nature flying qualities requirements are subjective because they describe how a pilot would like an aircraft to behave when he attempts to accomplish some task. Subjective requirements are stated in general qualitative terms. Unfortunately, when it comes to testing an aircraft for compliance with subjective requirements we are faced with varying interpretations of the qualitative terms. Over the years flying qualities specifications have tended to evolve into a set of predominately objective criteria for stability and control of the aircraft itself (open loop-criteria) which can be used as design guidance and can be measured directly from flight test for verification. The basis for these objective criteria have been experiments and flight experience which have correlated qualitative ratings for handling qualities with quantitative values for the criteria. History has shown, however, that satisfying open-loop criteria does not always ensure acceptable pilot-in-the-loop (closed-loop) handling qualities. Therefore, a complete flying qualities test program includes both evaluation of open-loop criteria and closed-loop tasks representative of the aircraft's mission.

As with other testing disciplines, test planning, instrumentation and data analysis for flying qualities depend on the type of aircraft and purpose of the tests. The purpose of testing can range from assessing modifications made to an existing airplane, e.g., addition/removal of radome, change in radome shape, change of flight control/control laws, addition of new stores or change in store mix, to development of a new aircraft model. The scope of the testing can range from simply gathering pilot opinions of aircraft suitability for specific piloting tasks using an uninstrumented aircraft, to extensively instrumenting an aircraft and collecting large amounts of data, both open-loop and closed-loop, to document overall flight characteristics and update stability and control models.

15.1.1 Test Objectives

General objectives of flying qualities tests are to:

- Determine if the aircraft is safe to fly throughout the envelope
- Evaluate the suitability of the aircraft's handling qualities for the intended mission
- Determine if an aircraft meets specifications
- Provide information for the aircraft operating manual
- Acquire data to substantiate, derive, and/or update analytical predictions/models of the aircraft and control system characteristics
- Identify characteristics which are sufficiently good/bad to incorporate/avoid in future designs.

The source for many specific test requirements are the flying qualities specifications such as the military specification MIL-STD-1797A, and civil specifications such as FAR parts 23 and 25. [15-1, 15-2, 15-3] The primary difference between civil and military specifications is that the civil specifications are oriented to safe operation and are much less detailed with respect to quantitative requirements while the military specifications are mission/performance oriented and much more detailed. Flight test requirements for flying qualities usually include evaluations of static and dynamic stability, control power, control forces and deflections, maneuverability, and mission oriented tasks. More extensive test programs may also evaluate flight at high angle of attack, the effects of failure modes on flying qualities, and estimation of aerodynamic data to update analytical models.

15.1.2 Test Aircraft

It is desirable to have the test aircraft represent the production aircraft as closely as possible in terms of external configuration, weight, inertia, and center of gravity (cg) range. In many cases flying qualities test data can be adjusted and standardized for slight variations in weight, inertia, or cg. Changes to flying qualities due to external configuration differences may be hard to accurately predict and it may be necessary to retest the aircraft in the production configuration if external differences are significant or if there is a major change in engine thrust/power. For example, developmental flying qualities test aircraft are often equipped with a noseboom for measuring angle of attack and sideslip. Past experience has shown that the shape of the nose can have a significant effect on flight characteristics at high angle of attack. Also, external stores such as missiles, bombs, rockets, and fuel tanks can significantly affect the flying qualities of the basic aircraft. Therefore, each configuration of external stores may have to be tested individually. It should be noted that, in addition to the trim changes that can result from changes in engine output, the pilot's overall view of handling qualities is crucially dependent upon engine response in demanding tasks such as air-to-air refueling.

The control system in a developmental aircraft may often undergo changes to correct for flying qualities deficiencies. This is almost guaranteed to occur if the flight control system has electronic augmentation. Consideration should be given to designing the electronic control system for testability. Such considerations include a programmable gain changer to allow control system gain changes in flight, a programmable test input generator to allow precise, repeatable inputs into the control system, and a "data pump" to extract information internal to the flight control computer. [15-4] It should be noted that any use of programmable gain changers, is strictly a developmental activity. Any certification assessment must be conducted on the production vehicle and the production control system configuration.

15.1.3 Test Instrumentation

The type of instrumentation required to support this testing obviously depends upon the stage of the aircraft development and the type of tests to be accomplished. If the aircraft handling qualities have previously been well defined, no instrumentation other than a hand-held control force gage and perhaps a camera photographing the pilot's instrument panel may be needed to evaluate the effects of a change such as adding a new type of external store.

However, the typical airborne data requirements for a prototype or new production aircraft includes measurement of all controller positions and control surfaces, control forces, attitude about all three axes, rate of change of attitude and the resulting accelerations, airspeed, altitude, free air temperature, angles of attack and sideslip, aircraft weight and fuel quantities, and propulsion system parameters. These data are recorded utilizing a multi-channel, digital data recording system. Data rates to be recorded are typically a minimum of 10 samples per second (sps), but may be much higher (50 to 100 sps) if the data are to be processed by computer to obtain aerodynamic stability derivative or frequency domain data. Data are often telemetered to a ground station so that a test director and team can monitor the progress of a flight and determine that the data being acquired are valid and to ensure that no safety of flight parameters are nearing or exceeding their predetermined limits.

15.1.4 Nature and Scope of Tests

For a developmental aircraft the flying qualities testing will proceed in a build-up fashion in order to establish a safe envelope in which to fly the aircraft in terms of airspeed, dynamic pressure, altitude, Mach number, angle-of-attack, angle of sideslip, load factor, weight and center of gravity. Testing begins at some point in the middle of this complex envelope and proceeds toward the extremes as data are gathered and compared with predictions. If data diverge far from prediction or indicate undesirable trends it may be necessary to restrict the flight envelope or even stop testing until deficiencies can be corrected or the discrepancy can be resolved. As flight testing progresses, the test data should be used to update analytical models so that more reliable predictions can be made. This process should continue throughout the test program. Eventually the flying qualities must be evaluated through a range of conditions which represent the operational service and the permissible flight envelopes of the aircraft. This involves all maneuvers and configurations which will be flown by the operational aircraft. It may also be necessary to assess the flying qualities in certain failure states which may be encountered such as the loss of an engine or hydraulic system or a failure of a part of the control system. The major task in planning a flying qualities test program on a complex aircraft is deciding which points need to be examined from the very large array of possible test conditions. MIL-STD-1797A contains guidance on critical test conditions for test planning purposes. [15-1] When all changes to the aircraft and its control system are finalized it may be necessary to repeat some of the flying qualities tests with the production representative aircraft for verification of data acquired on the heavily instrumented aircraft and the aircraft's adequacy to perform its intended mission(s). Also, testing may be required under adverse weather conditions, such as rain, sleet, and snow.

15.1.5 Analysis and Presentation of Results

Quantitative data reduction usually involves calculation of quantities such as weight, cg, and inertia from fuel distribution, corrections to measured airspeed and altitude for position error, derivation of calibrated, equivalent, and/or true airspeed, and the correction, if necessary, of measured values of angles, rates, and accelerations to a common reference point. Data from static or slowly varying maneuvers are often analyzed as crossplots of key parameters such as stick force versus normal acceleration or rudder position versus sideslip angle. Data from dynamic maneuvers are often analyzed in the form of time histories of key parameters versus time. Dynamic data may also be analyzed in the frequency domain by Fourier transform or by system identification in the time or frequency domain. Metrics such as damping,

frequency, maximum rate, or time to achieve a change in aircraft state are then summarized and presented in a format that will allow comparison with the requirements of the flying qualities specification. MIL-STD-1797A shows typical data presentations for many specification requirements. [15-1] The mechanical control characteristics, such as friction, breakout forces, trim speed band, control displacements (actual versus predicted), hysteresis, etc., must be quantitatively determined and presented.

Qualitative data in the form of pilot comments are an important source of data for all handling qualities evaluations. Qualitative comments are usually summarized to paint an overall picture of how well the aircraft flies and to describe the flight characteristics in the aircraft operating manual. Pilot comments can help pinpoint the source of a particular flying qualities deficiency, as well as indicate the factors impacting the quality of an individual test which may not otherwise be evident from the instrumentation, e.g., weather conditions and system settings/failures. It is extremely important that pilot comments be recorded immediately following the test flight while flight events and subjective evaluations are fresh. It is to be noted that the pilot qualitative assessment is, in the end, the ultimate criterion of acceptability. The crucial element of this assessment is the acceptability of the workload involved and the skill levels required to achieve the required performance. However, the pilot should not be allowed to decide, purely qualitatively, how well he has done. The required criteria for performance must be defined and the degree to which he has met the criteria must be measured. He must use accepted rating methodology such as the Cooper-Harper scale when assessing handling tasks. [15-5]

15.2 STABILITY AND CONTROL TESTS

These tests are the classical open-loop tests flown to define the flying qualities of an aircraft in terms of objective metrics contained in the flying qualities specification. These tests are open loop in the sense that the pilot makes specific inputs to obtain a desired response but he does not act as a feedback loop (closed loop) and alter the control inputs in order to accomplish a specific task such as tracking another aircraft. (Closed-loop flying qualities tests are described in paragraph 15.3). There are several categories of stability and control tests (e.g. static stability, maneuverability, controllability, modal characteristics, dynamic response, transient response) that follow the requirements outlined in the flying qualities specifications. The requirements are generally separated into longitudinal and lateral-directional axes.

15.2.1 Description of the Tests

The following listing is not all inclusive but is typical of the open loop flying qualities tests commonly flown on most test programs.

Static longitudinal stability tests evaluate the tendency of an aircraft to return to its trim condition when disturbed. Longitudinal control position and force variation are measured with respect to changes in airspeed from a trimmed condition. An aircraft with positive static stability will require an increase in nose up elevator at a speed slower than trim.

Flightpath stability tests should be conducted to determine if the aircraft in the approach or landing configuration is operating on the "backside of the power curve", i.e., an increase in power is required to maintain altitude as the speed decreases.

Maneuvering stability tests measure the capability to control load factor from a trimmed condition at a constant airspeed. Elevator angle and stick force per unit of normal acceleration are measured during steady pull-ups, push-overs, or in constant airspeed turns with slowly increasing load factor (called "wind-up turns"). If maneuvering force gradients are too light the pilot may fly the aircraft beyond the structural limits while if they are too heavy they may require too much physical exertion to maneuver the aircraft.

Dynamic longitudinal stability tests measure the oscillatory characteristics of the two major longitudinal modes of motion of the aircraft, the phugoid and the short period. The phugoid motion is a long-period variation in airspeed at nearly constant angle of attack and if the aircraft complies with other longitudinal requirements the phugoid motion will generally not be objectionable. Damping of the phugoid is the main characteristic of interest. The short period motion is more important since its period can be as short as a few seconds and the pilots reaction time becomes a factor. The damping and frequency of the short period are measured from aircraft response to momentary, sharp inputs of the longitudinal control from a trimmed condition.

Longitudinal control power tests measure the amount of longitudinal control displacement and control force required for specific maneuvers including takeoff, landing, diving flight, and flight during sideslip.

Static lateral-directional tests are performed to measure lateral and directional control positions and forces, and bank angle during steady sideslips to characterize directional and lateral stability. Variation of rudder and aileron positions, rudder pedal position and force, lateral control deflection and force, and bank angle with changing sideslip are measured during zero-yaw-rate sideslip maneuvers. Requirements are generally in terms of linearity of response, correct sense of response to control input, and limits and/or sensitivity on the amount of control required. Data from these tests are also used to establish takeoff and landing capabilities in cross winds.

Dynamic lateral-directional stability tests measure the three major lateral-directional modes of free motion of an aircraft. The mode of primary interest is the Dutch roll mode, a coupled motion involving the yaw and roll axes. Damping and frequency are measured from aircraft response to a rapid rudder or lateral control input. The second mode, the roll mode, is usually characterized as a single degree of freedom response and is an indication of how quickly an aircraft can achieve a steady roll rate. The roll mode is measured from the roll response to a step input of the lateral control with no rudder pedal inputs. Several other specification requirements for roll rate oscillations and sideslip executions can be evaluated from the same lateral step input tests. The third motion, the spiral mode, indicates the tendency for an aircraft to diverge in bank angle when bank angle is disturbed. Roll performance tests measure how rapidly the aircraft can change bank angle. Requirements are different for various classes of aircraft. Fighter/acrobatic aircraft will generally demonstrate these requirements by performing 360-degree rolls while less maneuverable aircraft will establish a bank angle and then roll through wings level to the same bank angle in the opposite direction.

An evaluation of minimum control speeds should be conducted for multi-engined aircraft, both on the ground (V_{MCG}) and in the air (V_{MCA}).

15.2.2 Test Instrumentation Parameters

The primary parameters of interest in the longitudinal axis are longitudinal control force and control position, normal load factor, pitch attitude, pitch rate, and angle of attack. Parameters of secondary interest include pitch control surface positions, and pitch trim position. For the lateral-directional axes the primary parameters are lateral control force and position, yaw control force and position, roll rate, bank angle, yaw rate, lateral acceleration, sideslip angle, lateral control surface positions, yaw control surface positions, and position of trimming devices. Other parameters commonly recorded, in addition to time, are the positions of the secondary controls such as flaps and gear (to establish aircraft configuration), fuel tank contents (to derive mass, cg position, and moments of inertia), airspeed, and altitude.

Only a few of these parameters are required for the analysis of most open-loop maneuvers. For the quasi-steady tests covering aspects such as longitudinal trim and steady sideslips it may be possible to record the data by hand. However, when dynamic maneuvers such as Dutch rolls or roll performance are involved, a sampling rate of at least 10 sps is required. For closed-loop tests, it is important to record engine parameters because of the engine's impact on handling qualities.

15.2.3 Test Maneuvers

Stability and control tests are most efficiently performed as a block of maneuvers at a specific test condition. Each maneuver is performed from a trimmed condition of airspeed, altitude, and load factor or angle of attack. It is important to note that, for the block maneuvers specified below, the engine power should not be changed from the trim setting so that the stability characteristics are documented for the specific trim condition. Airspeed is controlled by varying the rate of climb or descent. A typical maneuver block might consist of the following maneuvers:

- Trimmed flight
- Pitch doublet
- Slow acceleration/deceleration (accel/decel) using longitudinal control
- Wind-up turn
- Steady heading sideslip
- Yaw doublet
- Roll doublet
- Bank to bank roll

The pitch doublet is performed by a symmetric fore/aft application of longitudinal control. The intent is to excite a symmetric perturbation about the trim angle of attack at the short period frequency. The aircraft is then allowed to respond freely without further control inputs. In this way, the phugoid characteristics as well as the short-period characteristics can be evaluated.

The slow acceleration/deceleration (accel/decel) is also called the longitudinal static stability or speed stability test. From a trimmed condition the aircraft is accelerated slowly at a rate of about 1 knot per second by pushing slowly forward on the longitudinal control and allowing the aircraft to descend. The aircraft is accelerated to some increment of speed above trim and then returned to the trim condition by reversing the procedure. Similarly the aircraft is decelerated to a slower speed by climbing the aircraft using aft longitudinal control.

The wind-up turn is conducted by slowly increasing load factor to a target value while banking the aircraft and descending as required to maintain constant speed with a fixed throttle position. The rate of load factor buildup may vary depending on the capability of the aircraft but typically ranges from 0.1 to 0.5 g's per second. During envelope expansion testing wind-up turns are typically repeated as build-up maneuvers with increasing values for the target load factor on subsequent tests.

Steady-heading sideslips are performed by sideslipping the aircraft using rudder control and banking the aircraft as necessary with lateral control to maintain heading. Sideslip is increased slowly and is usually allowed to stabilize momentarily at increments of several degrees until maximum rudder, maximum lateral control, or maximum sideslip limits are achieved. The maneuver will also be terminated if rudder pedal force lightens noticeably as sideslip increases, indicating a directional instability. The maneuver can be performed to the left and right to check for symmetry.

Yaw doublets or roll doublets are performed to excite Dutch roll motion about the trim condition with symmetrical left/right inputs to the rudder or lateral control. The aircraft is allowed to respond freely without further control inputs.

Bank-to-bank rolls are performed by stabilizing the aircraft in a steady turn at a specified bank angle (usually 30, 45, or 60 degrees) and then rolling through wings level to the opposite bank angle using a step lateral control input. During development testing the maneuver is repeated with increasing magnitudes of

lateral control until full lateral inputs are used. The build-ups are necessary to evaluate any tendency to overshoot of bank angle, angle of attack, sideslip, or load limits.

The above maneuvers are the most commonly performed in stability and control testing. A number of other maneuvers such as symmetrical pull-ups, 360-degree rolls, and bank angle upsets can provide additional or alternate means of obtaining data. Both the US Air Force and Navy Test Pilot School Handbooks for flying qualities contain details on accomplishing all of the test maneuvers mentioned above as well as analyzing the data. [15-6, 15-7] FAR Advisory Circulars 23-8 and 25-7 provide guidance for stability and control flight testing for certification of civil aircraft. [15-8, 15-9]

15.2.4 Data Analysis and Presentation

The analysis of data from open loop tests is mostly graphical in the form of time histories or crossplots of key parameters. Data may also be summarized in tabular form. The following are typical of the types of open loop stability and control data analyzed and presented in flight test reports.

Longitudinal static stability is typically shown as crossplots of elevator position, longitudinal control position and control force versus airspeed or Mach number obtained from slow accel/decel maneuvers when trimmed for a set airspeed. Data may be presented for a range of cg location but the most aft cg is the critical case.

Maneuvering stability is typically shown as crossplots of elevator position, longitudinal control position, and control force versus normal load factor obtained from wind-up turns or steady pull-ups or pushovers. Data from the most forward and most aft cg position define the maximum and minimum control force gradients. Control force gradients from a number of flight conditions may be summarized on a single plot.

Dynamic longitudinal stability is analyzed from time histories of pitch rate, normal acceleration, or angle of attack from pitch doublet maneuvers. One of several methods can be used to estimate frequency and damping of the short period. [15-6] Data from a number of flight conditions is summarized in one of several formats consistent with specification requirements. Data analysis and presentation for some of the newer short-term pitch response criteria which are applicable to highly augmented aircraft can be found in reference material listed in the applicable paragraphs of MIL-STD-1797A, Appendix A. [15-1]

Static lateral-directional stability is typically shown as crossplots of rudder position, rudder force, lateral control, lateral control force or position, and bank angle versus sideslip angle from steady heading sideslip maneuvers. The gradients of rudder per unit sideslip, lateral control per unit sideslip, and bank angle per unit sideslip can be summarized on a single plot for a range of flight conditions.

Dynamic lateral-directional stability is analyzed from time histories of roll rate, yaw rate, sideslip angle, and/or bank angle from yaw and roll doublet maneuvers. Damping and frequency of the Dutch Roll mode are estimated with the same methods used to analyze longitudinal dynamic stability. [15-6] Data may be presented on summary plots of damping and frequency versus flight condition or as frequency versus damping for a range of flight conditions.

Roll performance is analyzed from time histories of roll rate, bank angle, and sideslip from bank to bank or 360-degree roll maneuvers. Typically, time to achieve bank angle change, maximum roll rate, and maximum sideslip excursion are determined and plotted versus flight condition airspeed or Mach number.

Spiral mode characteristics are determined from a time history of bank angle. Typically the time to double amplitude (unstable/divergent) or half amplitude (stable/convergent) is measured from an initial bank angle perturbation (usually from 5 to 20 degrees). The data are plotted or tabulated for a range of airspeed and altitude conditions.

15.3 HANDLING QUALITIES TESTS

Handling qualities tests are evaluations of those pilot-in-the-loop tasks that will verify that the handling qualities of the vehicle are sufficient to perform its intended mission. For example a fighter aircraft may perform tracking tests to evaluate the ability of the pilot-aircraft combination to track a target and successfully utilize its weapons. The types of tasks evaluated usually require some sort of precision control and can often be specified in terms of acceptable levels of performance in accomplishing the task. The results of these tests are in the form of pilot comments and where appropriate a numerical pilot rating. Unfortunately, there are not a lot of available reference sources with detailed information to guide in the selection of suitable tasks for handling qualities tests. The most comprehensive guidance is contained in Appendix A of MIL-STD-1797A and a recently published report, "Aircraft Maneuvers for the Evaluation of Flying Qualities and Agility, Vol II: Maneuver Descriptions and Selection Guide". [15-1, 15-10] It remains to the collective imagination of the test pilots and test engineers to design demanding tasks that are suited to the aircraft and its mission, and the test pilots and engineers can always check with the end-users or the people who originally set-up the requirements for inputs.

15.3.1 Description of the Tests

A number of closed-loop tasks have been used for handling qualities evaluations in the past. Some recommended tasks include air-to-air and air-to-ground tracking of targets, aerial refueling, close formation flying, and precision landings and takeoffs. It should be noted that aerial refueling and formation tasks are heavily biased by engine response characteristics while air-to-air and air-to-ground tracking tasks seldom are.

Air-to-air tracking evaluates the ability to point to and capture a target aircraft (gross acquisition) and then continuously track the target (fine tracking). This requires a cooperative target aircraft or a target generated on a Head-up Display to execute a sequence of maneuvers. Performance objectives for gross acquisition are in terms of time to acquire the target and the number and magnitude of overshoots. The performance objective for fine tracking is to keep the aiming reticle within a certain radius of the target point for a large percentage of the tracking time. Air-to-ground tracking is similar except that the aircraft flies a specified glideslope and airspeed toward targets on the ground. The targets are captured and tracked in sequence. Performance objectives are the same as for air-to-air tracking.

For aerial refueling using a boom the most frequently used task is to track the boom from the pre-contact position. The boom is either stationary or translated slowly. The performance objective is to keep the aim point within a certain radius of the boom nozzle for a large percentage of tracking time. Probe-and-drogue refueling uses actual hook ups as evaluation tasks. The performance objective is to obtain a certain percentage of successful hookups/plugs with an acceptable workload.

Close formation consists of maintaining a specific position relative to another maneuvering aircraft. This task places emphasis on flight path control and is useful for evaluating the approach and landing configuration. However, it is difficult to measure excursions in relative position of the two aircraft. Therefore, performance objectives may not be as quantifiable as for other target tracking tasks.

Precision landings from an offset approach have been frequently used as evaluation tasks for the landing phase. Attempting to land the aircraft at a precise location on the runway increases the pilot's gain and may show deficiencies in attitude and flight path response. The offset approach requires the pilot to make aggressive flight path corrections late in the approach. Performance objectives include flight path and airspeed control within limits during approach and then touching down at the designed landing speed and sink rate within a designated touchdown zone. Because of the proximity to the ground, precision offset approaches should not be flown until other testing has shown a low probability for dangerous handling qualities in the landing configuration. Other variations of this task include precision landing during cross

winds and from an ILS approach. Especially for carrier-based aircraft, precision landings from an off-set approach should be conducted and should include combinations of slow/fast and high/low approaches, i.e., offsets in airspeed and glideslope (altitude).

For takeoff the usual task is to aggressively rotate to and capture a specified pitch attitude. Performance objectives include ability to capture attitude in terms of overshoots and the ability to control target attitude within a specified tolerance.

A closed loop test technique known as Handling Qualities During Tracking (HQDT) has been used to expose handling qualities deficiencies of an aircraft which might otherwise escape notice. [15-11] The concept behind HQDT is to increase the pilot's gain in performing a tracking task by aggressively maneuvering the aircraft to eliminate any residual error in tracking a precision aim point. This differs from the "operational" technique in the previously described tests where the pilot adopts a control strategy which attempts to satisfy performance objectives. The idea is to identify poor handling characteristics by removing the pilot's natural tendency to compensate in order to achieve a level of performance. Just about any tracking task using a precision aiming point can be used with the HQDT technique. HQDT is particularly useful for investigating the potential for pilot induced oscillations. [15-1]

The success of HQDT led to research to develop a series of demonstration maneuvers for a variety of tasks. This research produced a set of some twenty maneuvers called Standard Evaluation Maneuvers (STEMS). STEMS are designed to require dynamics similar to those needed during operational missions. The reference noted provides information on selecting, conducting, and analyzing STEMS maneuvers. [15-10] Some STEMS are already in use in the flight test community and have been very beneficial in evaluating handling qualities. Others require more development of data analysis techniques before they can be gainfully employed in conventional handling qualities analysis.

15.3.2 Test Instrumentation Parameters

Even though qualitative pilot comments are a primary source of data for closed-loop handling qualities tests, his performance must be measured and compared to criteria established earlier. Qualitative comments alone are not sufficient for a clear understanding of handling qualities or to pinpoint the cause of deficiencies, particularly for an aircraft under development. The parameters of interest for closed loop testing are the same as for open loop testing (paragraph 15.2) and consist of aircraft state information and control system information. In addition, instrumentation to record the objective performance information is highly desirable. For example, a camera recording the Head-up Display can be used to measure tracking deviation between the pipper and the target.

15.3.3 Test Maneuvers

For air-to-air tracking of another aircraft the most commonly used maneuver is an S-turn. The test and target aircraft begin in level flight with about 1500 feet of separation. The target aircraft initiates a turn at a specified load factor and after a period of time (20-30 seconds) reverses and begins a turn in the opposite direction. The test aircraft begins his maneuver to acquire the aircraft after a certain amount of angular displacement to the target has developed and attempts to maintain his pipper at a reference point on the target (e.g., tailpipe, fuselage wing junction, etc.) until the target reverses. The test aircraft should maintain about 1500 feet of range to the target aircraft.

Another air-to-air target maneuver is the wind-up turn. Here the target begins a turn and slowly increases load factor to a specified maximum value. After allowing the target some initial angular displacement the test aircraft acquires the target and then continues to track the aim point until maximum load factor is reached.

HANDLING QUALITIES

For air-to-ground tracking the test aircraft establishes a dive along a specified glideslope at a specified speed at a group of targets spaced perpendicular and parallel to the flight path. The pilot aggressively captures and then tracks the first target for a specified time and then switches to succeeding targets. As range to the targets closes, switching occurs between targets which are closer together. The sequence is briefed in advance or can be programmed into the test set-up if a special facility such as the Deutsche Forschungsanstalt für Luft und Raumfahrt (DLR) Ground Attack Test Equipment or NASA's Adaptable Target Lighting Array System is used. [15-12, 15-13, 15-14]

For boom tracking during aerial refueling the test aircraft is established at the pre-contact position about 50 feet aft and 30 degrees down from the tanker in level flight. The boom is held stationary or translated slowly (< 1 -degree per second) while the test aircraft attempts to maintain an aim point on the boom nozzle. Two to 4 minutes of tracking time is recommended. An alternate tracking approach which doesn't require an aiming point in the test aircraft is to keep the tanker boom visually aligned with some reference point on the tanker with the boom held stationary.

Close formation maneuvers can be flown with the test aircraft either in a wing or trail formation with the target aircraft. When in close trail position the test aircraft should be slightly low to avoid lead's jet wake. Separation of the aircraft is a matter for pilot judgment and comfort. When the two aircraft are in formation position the target aircraft begins to maneuver gently in pitch and/or roll and the test aircraft attempts to maintain position precisely by reference to points on the lead aircraft.

The offset precision landing is set up about a mile out on final approach with a lateral offset from centerline on the order of 150 to 300 feet and/or a vertical offset from the glideslope of about 100 to 200 feet. The evaluation pilot maintains flight path angle and airspeed up to the offset correction point (which moves progressively closer toward the threshold as confidence is gained). The pilot should make aggressive corrections in order to be wings level by 50 feet above ground level. The pilot then attempts to put the main wheels down inside the designated landing zone at the specified landing speed.

The US Navy requires more demanding criteria due to the limited landing area aboard a carrier. The landing task begins when the aircraft rolls wings level, on glide slope and centerline, three-fourths of a mile aft of the ship. The task is to maintain the aircraft on glide slope within ± 0.2 degrees, on attack angle ± 0.5 degrees, and on centerline, ± 1.0 feet, throughout the approach and until touchdown on the angled deck throughout. These levels of performance are expected for both nominal and off-nominal approaches. Off-nominal conditions, such as high/low and overshooting/undershooting, are conducted to define the pilot's ability to acquire nominal conditions. Off-nominal conditions are evaluated at one-half and one-quarter miles to evaluate the recovery from conditions such as pilot technique, surface wind, or ship structure induced turbulence.

15.3.4 Data Analysis and Presentation

Analysis of closed loop handling qualities tests consists primarily of correlating subjective pilot comments with handling qualities ratings, and with supporting data in the form of objective performance data and time histories of measured aircraft responses and control system activity. The most frequently used pilot rating scale for performance oriented closed loop handling qualities is the Cooper-Harper rating scale. [15-5] The reference cited contains a lot of useful information, including a briefing guide, on conducting handling qualities experiments.

Because pilot rating and opinion are subject to variability, it is highly desirable to have more than one pilot evaluate the same task. Experience has shown that at least three pilots is the minimum desired to achieve some consistency in pilot opinion. If there is a significant variation, more than ± 2 in the Cooper-Harper ratings, then an investigation should be conducted to determine the cause of the variations. Another method to reduce variability is to have the pilot repeat the task several times until he is confident of his

evaluation before assigning a rating. Of course the hard work comes in understanding and explaining significant variations in pilot opinion for a specific task.

15.4 HIGH ANGLE OF ATTACK TESTS

High Angle-of-Attack (AOA) testing is a category of flying qualities testing at airspeeds and angles of attack normally outside the standard operational envelope of the aircraft. However, for fighter aircraft that may have to use the entire AOA regime that is available, the testing may well be conducted to determine what the high AOA envelope may be. These tests are flown to determine stall characteristics, stall warning cues, susceptibility to departure from controlled flight and for some aircraft post-stall, spin, recovery and related characteristics. The objectives of high AOA flight test demonstration are to evaluate aircraft characteristics for critical store loadings, gross weights, and centers of gravity and inertias as a function of angle of attack, sideslip, Mach number, attitude, attitude rate and control inputs.

Because of the potential for loss of control, high AOA tests are among the most hazardous kinds of flight testing. A great deal of planning and preparation using analysis, simulation and a careful buildup approach are necessary to minimize the risks associated with high AOA flight test. MIL-F-83691B contains flight test demonstration requirements for high AOA flight characteristics for piloted military aircraft. [15-15] This specification includes requirements for emergency recovery devices for out-of-control situations, emergency power systems and flight test instrumentation. Similarly, FAR Advisory Circulars 23-8 and 25-7 provide some guidance in flight testing civil aircraft for stalls and spins for certification. [15-8, 15-9]

15.4.1 Description of Tests

MIL-F-83691B describes a structured test progression of four test phases, A through D, in a build-up fashion from the most docile post-stall maneuvers to deliberate attempts to spin the aircraft. The phases are structured so there is a higher probability of arresting out-of-control motions in the early phases. Phase A begins with one-g stalls at a slow airspeed bleed rate and progresses to accelerated stalls at a more abrupt angle of attack rate. In all cases recovery is initiated at the first indication of a stall or loss of control. In phase B the same maneuvers are performed but the flight controls are briefly "misapplied" before recovery in an attempt to aggravate the stall. Phase C is similar to phase B except that misapplied controls are held for up to three seconds to evaluate the effects of delays in applying proper recovery controls. If no out of control motions have developed during phases A, B, or C the testing proceeds into phase D where attempts are made to force the aircraft into a spin, deep stall, or some post-stall out-of-control motion.

Of course not all aircraft are required to demonstrate all four test phases. Transport aircraft are typically required only to demonstrate phase A stalls with a slow airspeed bleed rate.

15.4.2 Test Instrumentation Parameters

Parameters of interest for high AOA testing are the same as for other stability and control testing (paragraph 15.1.3). In addition, sufficient engine instrumentation to document engine characteristics at high AOA should be available. For some high AOA testing it may be necessary to include parameters to measure structural loads if these could be a limiting factor.

Stall tests of light aircraft have been accomplished with only hand-recorded data such as indicated stall speed and descriptive data from the pilot. However, high AOA flight testing which may result in out-of-control situations requires adequate quantitative information. Post-stall and spin maneuvers can be quite disorienting and experience has shown that a pilot's qualitative perception of events can be quite wrong

when compared to quantitative data. The full complement of stability and control parameters should be included for any deliberate out-of-control flight testing. Special consideration should be given to parameter ranges to measure the full performance capability of the aircraft. For example, angles of attack and sideslip should have full 360-degree measurement range. An over-the-shoulder video camera with continuous audio from the pilot and with a view of the horizon is very helpful in post-flight debriefing and analysis of post-stall events. External video coverage from a chase aircraft and/or ground based photo-theodolite system can also be very useful in visualizing events.

15.4.3 Test Maneuvers

The primary test maneuvers for high AOA testing are wings-level stalls, accelerated stalls from turning flight, and then if required, stalls with various combinations of control inputs designed to characterize the tendency of the aircraft to depart from controlled flight and subsequently recover to controlled flight. In addition, tactical aircraft may evaluate operationally representative maneuvers, such as maximum load factor rolls, near the AOA limit to assess the susceptibility to depart controlled flight while maneuvering in the operational envelope.

One-g stalls are started from trimmed level flight at a speed usually 1.2 to 1.4 times the expected stall speed. The aircraft is decelerated using longitudinal control at a steady rate until the wing stalls or full aft longitudinal control is reached or the aircraft begins uncommanded motion due to loss of stability, or the aerodynamic buffeting becomes "intolerable". The rate at which stall is approached can vary from 1/2 knot per second for the initial stall testing to several degrees per second of AOA for the abrupt entries. Accelerated stalls are usually started from trimmed level flight at a speed consistent with achieving the intended load factor at stall. The aircraft is then decelerated in a constant altitude turn or the AOA may be increased while maintaining speed in a wind-up turn until one of the conditions defining a stall occurs. Rate at which AOA is increased varies from 1/2 degree per second to several degrees per second.

The same series of one-g and accelerated stalls using increasingly abrupt entry rates is repeated, if required, through all four test phases. In phases B, C and D the longitudinal, lateral and directional controls are input, at the indication of stall, in various combinations to represent misapplied controls. The magnitude and sequencing of controls is selected so that each subsequent maneuver is more likely to result in loss of control. If out-of-control motions develop from any of these maneuvers, then an additional test matrix may be constructed to look at various combinations of recovery controls in order to develop an acceptable recovery procedure.

15.4.4 Data Analysis and Presentation

Data analysis for high AOA testing is mostly in the form of time histories of aircraft motions, control inputs, and aircraft systems operation. Analysis of video is often helpful in visualizing events in out-of-control situations which are difficult to interpret directly from time histories. The final report should include time histories of significant events which illustrate the high AOA characteristics of the aircraft. It is helpful to clearly annotate key events on time histories presented in a report. Summary tables or plots of key characteristics such as stall warning speeds, stall speeds, maximum angular rates and altitude lost may be included. A well made video presentation showing characteristic aircraft motion during high AOA flight can be a valuable addition to a test report.

15.5 PARAMETER IDENTIFICATION

Many of today's complex aircraft rely extensively on modeling and simulation for design, evaluation and in some cases verification of aircraft flying qualities. Mathematical models for these analyses include aerodynamics and applicable aircraft control systems and are initially based on theoretical estimates, wind

tunnel data and design data which are validated and updated from ground and flight tests. Much of the validation of aircraft control systems can be accomplished by ground tests of the hardware and software but the validation of aerodynamic data can only be accomplished through flight test. One of the primary techniques for extracting numerical values for aerodynamic stability and control data from flight test is parameter identification. The references noted contain substantial background material on the use of parameter identification as it applies to aircraft flight testing. [15-16, 15-17, 15-18]

15.5.1 Description of Tests

The general problem of systems identification is to determine certain physical characteristics of a system by measuring its output response to external inputs. In flight test the usual approach is to assume a form for the model of the aircraft aerodynamic forces and moments and use one of several parameter estimation techniques to estimate the parameters of this model from the dynamic response of the aircraft. Typically, test maneuvers are flown to excite an aircraft response with a specific set of test inputs. A computer algorithm is used to adjust the parameters of the aerodynamic model in order to minimize the differences between computed aircraft response to the test inputs and the flight test measured response. One of the most widely used parameter estimation methods is the maximum likelihood estimator which applies to linear models. [15-16] An example of a non-linear parameter estimation method is given in reference 15-17.

15.5.2 Test Instrumentation Parameters

Typically the parameters of interest include control positions, angular rates, linear accelerations, Euler angles, flow angles (AOA and sideslip), air data, and time. These same parameters are used for other flying qualities testing but the instrumentation must be of high quality for parameter identification. "Noise" in the instrumentation system is (usually) an unmodelled input in the parameter estimation process and can degrade the accuracy of the estimates. Noise comes from several sources including electrical noise, vibration, sensor dynamics, filtering, and calibration errors. Reference 15-16 contains considerations for instrumentation.

15.5.3 Test Maneuvers

The test input must excite the principle response modes which depend on the parameters to be estimated. In principal almost any maneuver which excites a response could be analyzed but in practice certain maneuvers provide less uncertainty (i.e., more accuracy) in the parameter estimates. The most often used test maneuvers are small perturbation maneuvers which are naturally suited to linearized aerodynamic models. The aircraft is trimmed at a flight condition and then perturbed about the trim condition using a sharp control input sequence such as doublets which usually excites the predominant oscillatory modes. Typically a sharp elevator doublet is used to excite the short period response while a sharp rudder doublet followed a few seconds later by a sharp aileron doublet is used to excite the Dutch roll response. The size of the doublets should be large enough to provide adequate aircraft response relative to noise in the instrumentation and small enough to preserve linearity. Some experimentation by trial and error is usually necessary to determine the appropriate timing and magnitude of the test inputs to achieve the best results.

15.5.4 Data Analysis and Presentation

Data analysis for parameter identification is rather complex and is covered in detail in the reference material. [15-16, 15-18, 15-19] In general the analyst must select an appropriate mathematical model of the aircraft's aerodynamics and dynamics, obtain predictive data (usually wind tunnel) with which to start the estimation process, and select a computational algorithm to perform the estimation. Computer programs such as MMLE3 are available to do the numerical computations for aircraft parameter identification. [15-20] The analyst usually has numerous options for controlling the estimation process

including constraints on parameter estimates and weighting the relative importance in matching the set of computed and measured responses. The goodness of the results is judged in terms of how well the computed responses in the time or frequency domain match the flight test measured responses, the relative scatter in the parameter estimates from similar maneuvers, and comparison with predicted data. It obviously requires experience on the part of the analyst to effectively accomplish parameter identification.

15.6 SPECIAL CONSIDERATIONS

The FTE should note that the Military Specifications are a guide to control system design that should lead to good handling qualities, but there is no guarantee that this will happen. It is possible to design a control system which meets all the specifications but which provides poor handling qualities. The purpose of flight testing is look beyond specification compliance and determine if the aircraft has acceptable flying and handling qualities with which to perform its intended operational missions.

15.7 CONCLUDING REMARKS

Determining the stability and control characteristics and assessing the pilot's ability to safely accomplish all the operational tasks without incurring an excessive workload or displaying exceptional skill are both important aspects of evaluating aircraft flying qualities. This section has presented an overview of the testing required including test objectives, procedures, and data requirements. The reader is referred to the reference material for details.

Flying qualities is a broad topic and while most test programs will contain many of the elements described here no two test programs are alike. Aircraft configuration, aircraft mission, schedule, and money will all influence the extent of a flying qualities evaluation. The ultimate goal of any flying qualities test program is to ensure that an aircraft is safe to fly and, for a military aircraft, capable of executing all operational maneuvers required by its role(s). It is generally not possible to test all the conditions which could occur in flight. Therefore, the evaluation of flying qualities is as much art as science since subjective judgment plays a large part in both deciding what to test and interpreting the results of those tests. There is no substitute for experience when it comes to practicing this art.

15.8 REFERENCES

- [15-1] MIL-STD-1797A, "Flying Qualities of Piloted Vehicles", January, 1990.
- [15-2] Federal Aviation Regulations, Part 23, "Airworthiness Standards: Normal, Utility, and Acrobatic Category Airplanes".
- [15-3] Federal Aviation Regulations, Part 25, "Airworthiness Standards: Transport Category Airplanes".
- [15-4] AFFTC-TIH-9101, "Configuration for Improved Flying Qualities Testing", July, 1991.
- [15-5] Cooper, G., and Harper, R., NASA TN D-5153, "The Use of Pilot Rating in the Evaluation of Aircraft Handling Qualities", April, 1969.
- [15-6] FTC-TIH-79-2, US Air Force Test Pilot School, "Flying Qualities Handbook, Flying Qualities Theory and Flight Test Techniques", November, 1979.

- [15-7] USNTPS-FTM-103, "Fixed Wing Stability and Control, Theory and Flight Techniques", 1 November 1981.
- [15-8] FAA Advisory Circular 23-8, "Flight Test Guide for Certification of Normal, Utility and Acrobatic Category Airplanes", 20 October 1987.
- [15-9] FAA Advisory Circular 25-7, "Flight Test Guide for Certification of Transport Category Airplanes", 9 April 1986.
- [15-10] Wilson, D.J., "Aircraft Maneuvers for the Evaluation of Flying Qualities and Agility, Vol II: Maneuver Descriptions and Selection Guide", WL-TR-93-3082, August 1993.
- [15-11] Twisdale, T., and Franklin, D., AFFTC-TD-75-1, "Tracking Test Techniques for Handling Qualities Evaluation", May, 1975.
- [15-12] Koehler, R., and Buchacker, E., "A Flight Test Method for Pilot/Aircraft Analysis", in NASA CP 2428, pp. 35.1 to 35.14, 1986.
- [15-13] Koehler, R., and Buchacker, E., "GRATE - A New Flight Test Tool for Flying Qualities Evaluations", in AGARD CP-452, pp 8-1 to 8-12, 1989.
- [15-14] Shafer, M., et al, NASA TM 101700, "Initial Flight Test of a Ground Deployed System for Flying Qualities Assessment", August, 1989.
- [15-15] MIL-F-83691B (USAF), Military Specification, "Flight Test Demonstration Requirements for Departure Resistance and Post-Departure Characteristics of Piloted Airplanes", 1 March 1991.
- [15-16] Maine, R., and Iliff, K., "Identification of Dynamic Systems -- Applications to Aircraft Part 1; The Output Error Approach", AGARDograph No. 300 Flight Test Techniques Series, Volume 3, December, 1986.
- [15-17] Mulder, J.A., Shridhar, J.K., and Breeman, J.H., "Identification of Dynamic Systems - Applications to Aircraft, Part 2: Nonlinear Model Analysis and Maneuver Design", AGARDograph 300 Flight Test Techniques Series, Vol. 3-2, May, 1994.
- [15-18] NASA TND-7647, "Parameter Estimation Techniques and Applications in Aircraft Flight Testing", April, 1974.
- [15-19] AGARD-CP-172, "Methods for Aircraft State and Parameter Identification", May, 1975.
- [15-20] Maine, R., and Iliff, K., NASA TP-1563, "Users Manual for MMLE3 A General FORTRAN Program for Maximum Likelihood Parameter Estimation", 1980.

15.9 BIBLIOGRAPHY

MIL-F-8785C, "Flying Qualities of Piloted Airplanes", US Naval Air Systems Command, 1980.

AGARD CP-333, "Criteria for Handling Qualities of Military Aircraft", April 1982.

McRuer, D., Ashkenas, I., and Graham, D., "Aircraft Dynamics and Automated Control", Princeton University Press, 1973.

McLean, D., "Automated Flight Control Systems", Prentice Hall, 1990.

Neal, T.P., and Smith, R.E., "An In-flight Investigation to Develop Control System Design Criteria for Fighter Airplanes", AFFDL-TR-70-74, Vol 1, December 1970.

Mooij, H.A., "Criteria for Low-speed Longitudinal Handling Qualities of Transport Aircraft with Closed-loop Flight Control Systems", National Aerospace Laboratory/NLR, Amsterdam, September, 1984.

Weingarten, N.C., Berthe, C.J., and Rynaski, E.G., "Flared Landing Approach Flying Qualities", Vol. 1, "Experiment Design and Analysis", NASA CR 178188, December, 1986.

Hoh, R.H., "Concepts and Criteria for a Mission Oriented Flying Qualities Specification", AGARD LS-157, May 1988.

Mulder, J.A., et al, "Determination of the Mathematical model for the New Dutch Government Civil Aviation Flying School Flight Simulator", Proceedings of the 18th Symposium of the Society of Flight Test Engineers, 1987.

Ecole du Personnel Navigant D'Essais et de Reception

- Pratique des Essais en Vol Helicopteres (2 Vol), ref EPNER 25.
- Pratique des Essais en Vol Avions (3 Vol), ref EPNER 24.
- Pratique de la Reception

Chapter 16 – AIRCRAFT EXTERNAL NOISE

Dr. Hanno Heller

Institute for Design Aerodynamics
German Aerospace Research Establishment (DLR)
Postfach 3267
D-38022 Braunschweig
FEDERAL REPUBLIC OF GERMANY

16.0 INTRODUCTION

This Section presents, in summary form, the typical elements required to conduct noise testing and to evaluate the data derived from this testing. Review of this Section will enable the test engineers to familiarize themselves with the necessary steps leading to the final indisputable noise level certification for the aircraft in question. AGARDograph 300, Volume 9 "Aircraft Exterior Noise Measurement and Analysis Techniques" presents, in detail, the information that is summarized here and should be consulted by those requiring detailed information. [16-1] The following paragraphs will acquaint the reader with the purpose of noise testing of civil aircraft, how the test vehicle is evaluated, and what the products of this type of testing are. (At the moment there are no legal aircraft noise limits levied on military aircraft.)

Aircraft generate noise which has become a major source of public concern; it is - next to traffic noise - the number one environmental acoustic problem. To control this type of noise, legislation has been established - and is being enforced - which requires both the manufacturer and the operator to adhere to certain, sometimes very stringent, noise rules. In order to fulfil such requirements the manufacturer continuously strives to develop a quieter product (certainly also to better compete on the market) and the operator is forced - frequently by local airports - to fly the craft in the quietest possible manner (or not to fly at all!)

Hence, there are two aspects of the problem: The manufacturer who attempts to develop an ever less-noisy product on the one hand, and the operator who must operate/fly the aircraft so as not to generate excessive noise, on the other hand; both need to prove the acoustic quality of their product and their manner of operation, respectively. This then requires somebody to determine the acoustic characteristics of an aircraft in operation following established testing and analysis techniques. This somebody, of course, would be the acoustic test engineer who (together with his highly qualified staff) will have to undertake the effort of acquiring flyover noise data, of analyzing and interpreting such data and reporting it to, say, a manufacturer or an operator, or - more frequently - to some aviation authorities.

In this Section, the very basic - though necessarily fairly compressed, yet still comprehensive - information will be provided which will allow the test engineer to start drawing up the framework of his own test plan. More specifically, in the following paragraph (16.1) a brief account of aircraft noise certification along the lines of the internationally agreed upon procedure as delineated in ICAO Annex 16, Volume 1 will be given, followed in paragraph 16.2 by a somewhat more specific discussion of testing procedures for the various types of aircraft. [16-2] In paragraph 16.3, then, the actual data acquisition and data reduction will be treated; here acoustic instrumentation (microphones, signal-conditioning, recording and analyzing equipment) and non-acoustic instrumentation (tracking, meteorological, time-synchronization, on-board equipment) is discussed, followed by an elaboration on test site selection criteria, considerations on test execution and data evaluation. Paragraph 16.4 is devoted to special problems in conducting flyover noise measurements such as those arising from using microphones some distance above the ground surface, and a brief discussion on the need to establish the validity of test results in view of the very small number of test data required in noise certification. Finally, paragraph 16.5

provides some pertinent concluding remarks and gives an outlook on the future direction of aircraft noise certification in an international context based on the recent ICAO CAEP/2-meeting (1991).

16.1 AIRCRAFT NOISE CERTIFICATION

16.1.1 Purpose

Noise certification has but one objective: to determine an aircraft specific **noise certification level** to be assessed against a given noise limit. For this purpose, the aircraft flies over one or several microphones positioned directly under the flight path or to the side of the flight track. The craft must execute a number (either 4 or 6) of horizontal (\cong "level") flyovers at a specified flight height or takeoffs or landing approaches (or all of these) at precisely defined operational conditions. The measured flyover noise is corrected for deviations from the reference flight path or reference operational and atmospheric conditions. For each of these flight procedures, the corrected flyover noise levels are then averaged over all valid test-flyovers, to yield the final "certification level" within certain statistical confidence limits.

16.1.2 ICAO ANNEX 16, VOLUME 1 (1988 EDITION)

The flight test and analysis procedures for aircraft noise certification have been developed by the International Civil Aviation Organization (ICAO) with headquarters in Montreal/Canada and documented in the (well-known blue colored) "ICAO ANNEX 16, Volume 1. [16-2] In this document, Part II, there are special Chapters (describing the evaluation methods in detail) devoted to certain types of aircraft, namely:

- Chapter 3 -> Subsonic Jet Aeroplanes and Heavy Propeller-driven Aeroplanes
- Chapter 6 -> Light Propeller-driven Aeroplanes (this Chapter is to be phased out soon, but it is still valid as of 1992)
- Chapter 10 -> Light Propeller-driven Aeroplanes
- Chapter 8 -> Helicopters

ANNEX 16 also contains special Appendices where the test environment, instrumentation, and certain computation procedures are dealt with.

16.2 TESTING PROCEDURES

16.2.1 Subsonic Jet Aeroplanes and Heavy (> 9000 kg) Propeller-driven Aeroplanes

Following ANNEX 16 Chapter 3 such aircraft must conduct several actual (or simulated) **takeoffs** and **landing approaches** under precisely specified operational conditions. During the takeoff test procedure (a minimum of six valid test flights are necessary) the aircraft flies over one microphone positioned at the "flyover reference point" (located 6500 m past brake release). During at least six more takeoffs, the maximum noise at the "lateral reference point" 450 m to the side of the ground track is measured (to determine this "point" a number of microphones must be positioned at this side-line to capture the maximum). The measuring microphones are located 1.2 m (\cong 4 ft) above ground level. At each of these (minimum 18) test flights the noise is measured and evaluated in terms of Effective Perceived Noise Levels (EPNL). For an explanation of noise metrics see paragraph 16.2.4.

16.2.2 Light (< 9000 kg) Propeller-driven Aeroplanes

Following ICAO ANNEX 16 Chapter 10 the aircraft must conduct at least six actual or simulated **takeoffs** under takeoff power conditions, where the noise is measured at a microphone located 2500 m past brake

release. Now however the microphone is positioned near the ground in an inverted manner above a small round metal plate (for an assessment of the problems arising from positioning microphones at some height - e.g., 1.2 m - above ground, see paragraph 16.4). Noise is evaluated in terms of Maximum Overall A-weighted Noise Level ((L(A)). For an explanation of noise metrics see paragraph 16.2.4.

16.2.3 Helicopters

Following ICAO ANNEX 16 Chapter 8 helicopters must conduct at least six test flights each under precisely specified operational conditions for the test procedures (1) takeoff, (2) level flyover and (3) landing approach. In each case the aircraft must fly over a laterally extended array of 3 microphones - one at a center location, one each 150 m to the left and the right from the flight track. The microphones are positioned 1.2 m above ground and noise is evaluated in terms of Effective Perceived Noise Levels (EPNL). For an explanation of noise metrics see paragraph 16.2.4.

16.2.4 Noise Limits and Noise Metrics

Each of the ANNEX Chapters - corresponding to a certain type of aircraft - specifies noise limits not to be exceeded by an aircraft when tested according to regulations. The noise limits are defined as function of aircraft mass, usually the maximum permitted takeoff mass for takeoff and flyover test procedures, and the maximum permitted landing mass for approach test procedures. Noise limits become less stringent with a decrease in weight (a much disputed regulation!).

The pertinent **Noise Metric** for Subsonic Jet Aeroplanes, Heavy Propeller-driven Aeroplanes and for Helicopters is the Effective Perceived Noise Level (EPNL). This unit has been specifically developed for aircraft noise evaluation. Computation of the EPNL requires the determination of sound pressure level 1/3-octave band spectra over an extended frequency range (25 Hz to 10 kHz) at 1/2-second fixed time intervals over a time span where the aircraft's flyover noise is within 10 to 15 dB below the maximum. Each of these spectra (typically 30 to 60 for each flyover event) is subjected to a level-dependent weighting (low and very high frequencies are weighted less than those in a mid-frequency range). Each spectrum is further individually corrected for distance effects (since the aircraft-to-observer distance changes continuously) and for atmospheric absorption. Finally an adjustment is made for the presence of pronounced tones. Obviously EPNL cannot be read from an instrument, but requires data storage and off-line computer analysis.

The pertinent noise metric for light propeller-driven aeroplanes is the Maximum Overall A-weighted Noise Level, L(A). Determination of an A-weighted noise level only requires a precision sound level meter with internal A-weighting circuit; the maximum A-weighted level during a flyover event can then be read directly from the instrument. The (now level-independent) A-weighting curve is precisely defined, de-emphasizing low frequencies quite strongly and very high frequencies less strongly to simulate the human auditory systems's behavior.

16.3 DATA ACQUISITION AND EVALUATION

The basic equipment needed in the field for noise certification testing is shown in a block-diagram in Figure 16-1. Accordingly, there will be the noise measuring system, another one to acquire and monitor meteorological data, and equipment to trace the aircraft trajectory. In addition, time synchronization equipment is necessary. All of these should be controlled from a central "Master Measurement Station", often housed in a mobile Control Van. Some data also need to be acquired on board the aircraft such as aircraft operational parameters and to some extent meteorological information aloft.

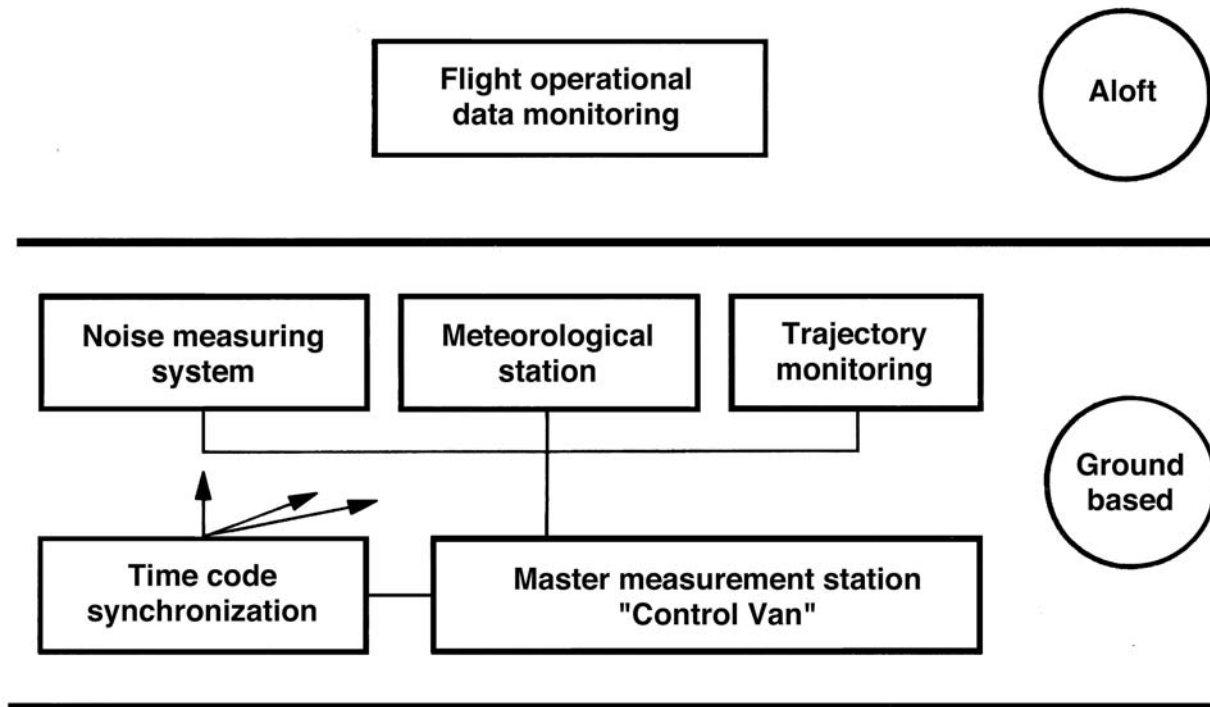

Figure 16-1. Basic Measurement Equipment Needed in the Field for Noise Certification Testing.

Referring more specifically to the noise monitoring system (as depicted in Figure 16-2) there are two major groups: calibration equipment and data acquisition and reduction equipment. In the following paragraphs the necessary "acoustic" and "non-acoustic" instrumentation will be described, followed by a discussion on test execution and data analysis.

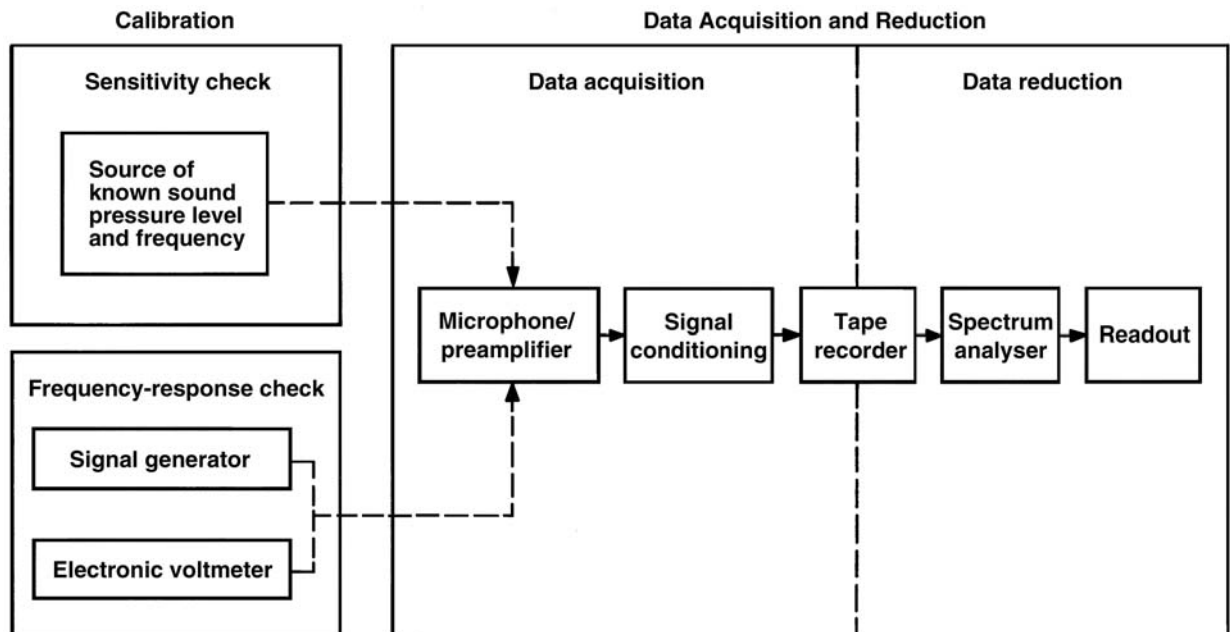

Figure 16-2. Block Diagram of Noise Measuring System for Acoustic Calibration, Data Acquisition and Reduction (reproduced from Reference [16-2]).

16.3.1 Instrumentation

16.3.1.1 Acoustic Instrumentation. Microphones are used to measure noise. In noise certification these will be of the condenser type. ANNEX 16 specifies the use of a "pressure type"-microphone; such microphones have a flat frequency response (within ± 1 dB) and - if positioned such that sound arrives at grazing incidence (i.e., in parallel to the microphone diaphragm) - then no further angle-of-incidence corrections are needed up to a highest frequency, which itself depends on microphone size. One-half-inch or 1-inch diameter microphones are most commonly used having a large dynamic range (typically from 10 dB to 140 dB re 20 μ Pa)¹.

Often there is a need for further "signal conditioning". The signal, as it comes from the microphone, may, in fact, have to be both amplified and spectrally shaped before it can be recorded on a tape recorder of limited dynamic range (analog tape recorders often have no more than 40 to 50 dB dynamic range!). If the signal to be recorded spans a large dynamic range (as is often the case for a helicopter acoustic signal) then one may want to pre-shape the signal (e.g., de-emphasize its low frequency content) before recording. On the other hand, modern digital recorders have a very large dynamic range (in the order of 90 dB!) such that no elaborate signal conditioning is required. Still, in the practice of noise certification, analog recorders are widely used.

Prior to and during actual testing it is necessary to calibrate the entire acoustic measurement chain, both for frequency response and for sensitivity. Frequency response calibration serves to determine deviations from an ideal uniform frequency response. Usually, a 1/3-octave-filtered broadband noise signal sweep is used, since in noise certification testing 1/3-octave band levels must be determined. Sensitivity need only be determined at one, or very few, select frequencies, e.g., at 250 Hz or at 1000 Hz, using for example a pistonphone. In more elaborate field testing, insert voltage calibration is often used which can be done remotely, eliminating the need to individually check-calibrate each microphone at its site.

The necessary 1/3-octave-band spectral analysis (every 1/2-second interval during a flyover) can be performed by means of real-time frequency analyzers, specifically developed for flyover noise measurements. These compute 1/3-octave band spectra in the appropriate frequency range (e.g., from 1.6 Hz up to 20 kHz) in near real time.

If only the maximum A-weighted overall noise level needs to be determined then a Precision Sound Level Meter (SLM) with internal A-weighting network can be used in the field. Such SLMs have a stepwise adjustable dynamic range, e.g., from 24 dB to 130 dB in 10 dB intervals. They feature several detector time constants ("slow", "fast" and "impulse"), allowing tailoring the response to the expected signal. However, in noise certification, the detector time constant "slow" is specified. This somewhat "smoothes" periodic-impulse sounds from overflying aircraft. Modern SLM's have digital displays. Their output can also be fed into tape-recorders, if need be.

16.3.1.2 Non-acoustic Instrumentation. Since all measured acoustic data need to be corrected toward flight operational and meteorological reference conditions, some fairly elaborate non-acoustic instrumentation is required in noise certification testing.

Tracking instrumentation - usually, but not necessarily ground based - serves to follow the flight trajectory of the aircraft under test. ICAO ANNEX 16 Chapter 6 testing requires only a height determination above the measurement station. Hence, often one (sometimes two) camera(s) facing straight up is (are) employed. The photograph(s) can then be used for height determination based on optical scaling.

¹ 20 μ Pa (corresponding to 0 dB is the human hearing threshold pressure).

All other ANNEX Chapters require a continuous monitoring of the aircraft trajectory. Hence, optical (e.g., movie-cameras, kinetheodolites, laser emitting/receiving equipment) or radio tracking means (radar, microwave positioning systems, radio altimeter and the like) must be employed.

Ambient temperature and humidity affect the "atmospheric absorption" the sound signal suffers on its way from the aircraft to the ground. Temperature in addition affects the strength of aeroacoustic sources (for example, propeller noise very much depends on the helical blade tip Mach-number which, in turn, is a function of ambient temperature). Hence, such atmospheric parameters must be determined all along the sound propagation path, i.e., from the aircraft all the way down to the receiver. As sound is also attenuated through spherical spreading ($1/r^2$ law) there is a need to know the actual distance of the aircraft from the microphone at the time the sound signal leaves the aircraft. Wind is also an important parameter to be accounted for in measuring aircraft noise. In fact, the ANNEX specifies wind speed limits near the ground, which must not be exceeded during data taking. Ambient air pressure, close to the test aircraft and close to the measurement site, needs to be known, as this parameter affects the engine power on the one hand and the microphone sensitivity on the other.

Such meteorological parameters may be determined through equipment attached on the test aircraft or - often in more sophisticated testing - by means of an additional dedicated "meteorological aircraft". Sometimes weather balloons or tethered radio-sondes are used. This way, information is gathered along the entire sound transmission path. Such data is sometimes also available from a nearby airport tower.

Time synchronization between acoustic and flight-trajectory recordings is of great importance. To correct for deviation of the actual flight path from a reference flight path the exact distance of the aircraft at the time when the signal for the maximum noise is emitted, must be known. In addition, flight-operational and engine parameters at that same "instant in time" should be available. In practice a time synchronization pulse (from some electronic clock) must be recorded both on the tracking system and the acoustic recording system. In "simple" certification tests it often suffices to record the exposure click of the camera which is used for optical height determination on the acoustic tape recorder.

Important on-board equipment would be an airspeed and "wind vector" indicator, since true airspeed of the aircraft must be known very precisely, especially for source noise correction.

16.3.2 Test Execution and Data Reduction

16.3.2.1 Test Site and Equipment Setup. Selecting an appropriate test site is very important. If actual takeoffs and landings are planned then the test site must be close to an airport. This could complicate noise certification testing, as regular air traffic has preference. If simulated takeoffs and landing approaches can be employed, or if only level flyovers are required then a smaller, preferably abandoned airport has distinct advantages. The runway provides a visual clue to the test pilot for finding and passing over the central acoustic measurement station, provided the runway is parallel to, and to the side, of the microphone array. Prior to testing, the test site needs to be surveyed, the location of the microphone(s), of the camera(s), and/or other tracking equipment (kinetheodolite, laser transmitter/receiver, radar tracking antenna, transponder locations, etc.) need to be determined to within one meter, or so. For landing approaches (especially in testing helicopters) the location of a Precision Approach Path Indicator (PAPI) must be especially carefully established.

16.3.2.2 Test Conduct and Data Analysis. Hence, in conducting a noise certification test the following data needs to be acquired: (1) acoustic, (2) aircraft operational, (3) aircraft time-space-position information, and (4) meteorological. Prior to testing a well thought out and sufficiently detailed test plan and test matrix must be established and distributed to all concerned. The ground test crew (in charge of the acoustic, meteorological and tracking data acquisition) and the test pilot and observer pilot must be thoroughly informed. If several autonomous recorder stations are to be individually manned then the

responsible test engineer will brief each member of the ground crew about the sequence of events prior, during and after each flyover. It should be made clear particularly how the approaching aircraft will be announced, how recording equipment gains must be set, and when to switch equipment on and off. Also, it must be clear what kind of immediate response is expected right after each flight. The pilot must know the required settings of the engine parameters and the flight trajectory to be followed. The observer pilot must be prepared to note on-board information; sometimes it is helpful to monitor/photograph cockpit display instrumentation during the test to record on-board information.

Radio communication links must be established from the master measurement station (e.g., the Control Van) to the test aircraft (and ,if used, to the meteorological aircraft), to the acoustic, tracking and the meteorological ground stations, and to the air-traffic control tower.

While some noise certification tests allow for a near real-time analysis of data (such as ANNEX 16 Chapter 6), most others require elaborate post-test analysis. Tracking information (other than through laser tracking) is processed off-line. Computation of the final EPN-Level requires each of the 1/3-octave band spectra to be corrected for distance and atmospheric absorption before further processing in terms of the subjective weighting and accounting for the presence of pronounced tones. Source noise corrections might be necessary (especially in testing propeller-driven aeroplanes and helicopters) where temperature-dependent rotational Mach numbers have a strong effect on the source noise.

16.4 SPECIAL PROBLEMS

16.4.1 Ground Reflection Effects

ICAO ANNEX 16 specifies the position of the measuring microphone as 1.2 m above ground level. Only ANNEX 16 Chapter 10 specifies use of a ground plane microphone. Since all noise data from an aircraft in flyover are adversely affected by ground reflection interference effects when microphones elevated above ground are used, the pertinent problems will be briefly discussed in the following, to alert the test engineer to potential, sometimes grave, errors in determining flyover noise levels with microphones at 1.2 m above ground. Errors are to be expected when propeller aircraft with strong tonal spectra are tested.

The general problem of interference between directly incident and ground-reflected sound waves as radiated from an aircraft in flight is illustrated in Figure 16-3. If direct and reflected sinusoidal pressure waves with path length difference Δr and wavelength λ interfere, the acoustic pressures at the microphone show frequency-dependent differences from those of the directly incident wave. Pressure doubling, corresponding to an increase of 6 dB, will occur at certain values of $\Delta r/\lambda$ while at other values a complete cancellation with a decrease of up to $-\infty$ may occur - and anything in between! The periodicity of this interference depends on (i) the microphone height above ground, (ii) the ambient temperature, and (iii) the sound incident-angle.

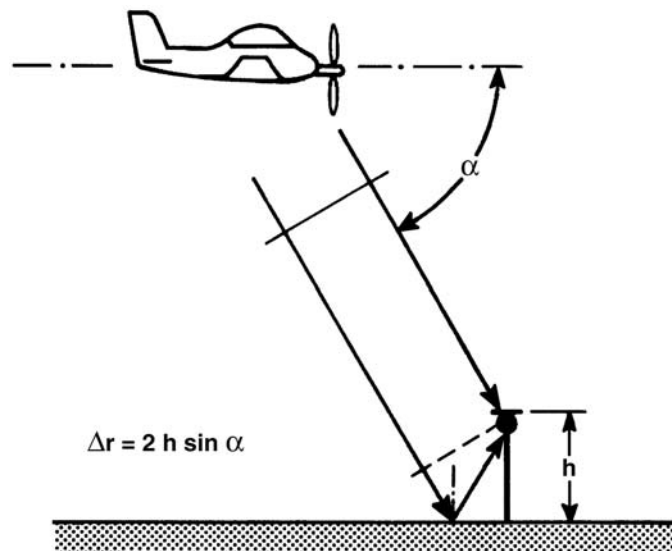

Figure 16-3. Schematic Representation of Ground Reflection Interference Problem.

An example of the "devastating" effect of such ground reflections appears in Figure 16-4 where the flyover time history of a 4th harmonic of the propeller- sound from an aircraft was measured both with a microphone 1.2 m above ground (with obvious strong interference dips) and with a microphone very close to the ground with a smooth increase towards a maximum and a steady decrease thereafter. The reader is referred to the pertinent literature. [16-3, 16-4, 16-5, 16-6]

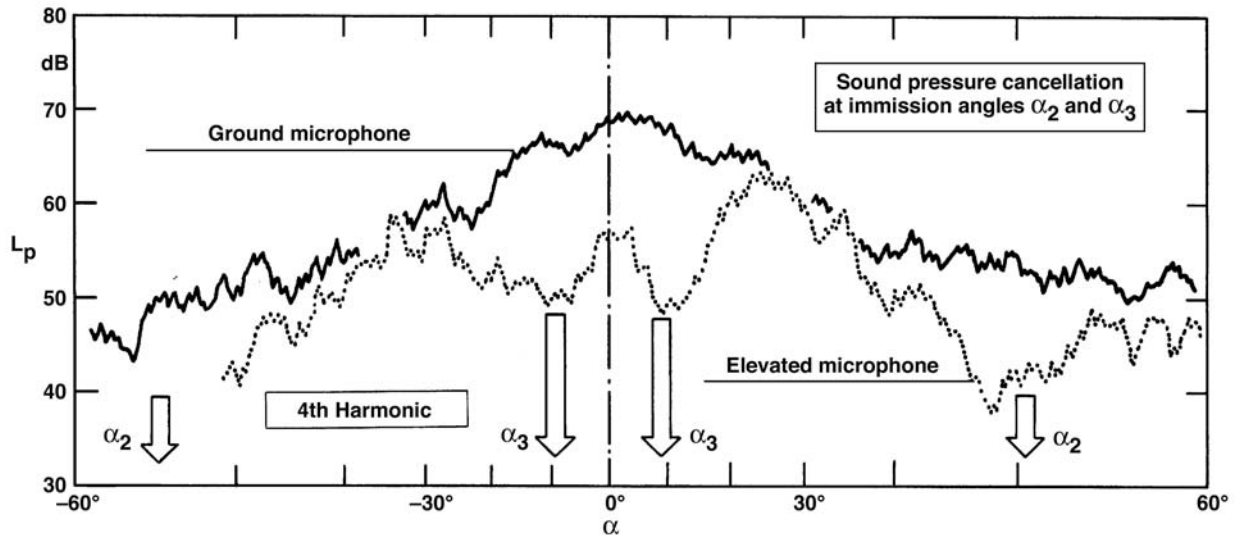

Figure 16-4. Comparison of Time-History of Propeller Rotational Harmonic as Measured with a Ground Surface Microphone and One 1.2 m Above Ground ("Elevated").

16.4.2 Establishing Validity of Test Results

Evaluation of noise certification data from flyovers of subsonic jet-aeroplanes, heavy propeller-driven aeroplanes and helicopters involves the averaging of the (final, and corrected) EPN-levels as obtained during repeated test-flights. A minimum of six valid test-flights is specified. The sample-size (of the

acoustic data) must be large enough to establish a confidence-limit not to exceed ± 1.5 EPNdB at a 90% confidence level. Clearly, a sample size of only 6 is very small for any statistical reasoning. Therefore, "small sample size" statistical considerations apply in noise certification.

Statistical techniques are not discussed herein. The necessary information for such analysis can be found in reference 16-7 or in most text books on statistical analysis.

16.5 CONCLUDING REMARKS

The material presented in this "Introductory Volume" on the aspect of Aircraft External Noise, or more specifically on conducting a noise certification test, should enable the responsible flight test engineer to familiarize himself with the basics of conducting such a test. This will not replace the study of the relevant AGARDograph No. 300, Volume 9, where testing and analysis techniques to measure aircraft noise in the context of noise certification as specified by ICAO are discussed in great detail. There, the relevant noise certification Standards and Recommended Practices for propeller-driven aeroplanes, for jet-propelled aircraft and for helicopters are described in depth. The characteristics and requirements of the necessary instrumentation for data acquisition and data processing are discussed, as are the procedures to determine the special noise measures EPNL and L(A). This AGARDograph also contains an extensive discussion of test and analysis procedures for aircraft noise studies not connected to noise certification. Here in particular the test engineer will find valuable information and "hints" on the practical execution of measuring and interpreting aircraft noise.

It should be understood that the testing and evaluation procedures for aircraft noise certification are in a continuous process of development by the appropriate ICAO Committees, as new experience and knowledge is gathered. Thus, periodically (perhaps once or twice per decade) new improved, updated and extended editions of the ICAO ANNEX 16 appear. Recently, during the 1991 meeting of the ICAO Committee on Aviation Environmental Protection (CAEP) a new - much simplified - noise certification procedure for light helicopters was instituted as a new Chapter 11 and a Sub-chapter on "Ultralight Aeroplanes" might be introduced in the ANNEX. In the future, noise certification rules and regulations for supersonic aircraft and for aeroplanes equipped with propfan-engines will be established. Hence, the flight noise test engineer is encouraged to inquire about the latest status of noise certification by contacting:

Document Sales Unit ICAO 1000 Sherbrooke Street West, Suite 400 Montreal, Quebec Canada H3A 2R2

Much useful information in the general area of aircraft noise may also be obtained in studying the Proceedings of the AIAA Aeroacoustics Conferences. Information may be obtained from the

American Institute for Aeronautics and Astronautics (AIAA) The Aerospace Center 370 L'Enfant Promenade SW Washington, DC 20024-2518, USA
--

16.6 REFERENCES

- [16-1] Heller, H., "Aircraft Exterior Noise Measurement and Analysis Techniques", AGARD-AG-300 Volume 9, April 1991.
- [16-2] International Standards and Recommended Practices "ENVIRONMENTAL PROTECTION", ANNEX 16 to the Convention on International Civil Aviation, Volume I Aircraft Noise, Second Edition, 1988. (Editor's Note: The third edition was issued in 1993 after this Section was prepared.)
- [16-3] SAE AIR 1672B (1983), "Practical Methods to obtain Free-field Sound Pressure Levels from Acoustical Measurements over Ground Surfaces".
- [16-4] Dobrzynski, W., "Interferenzwirkung durch Bodenreflexion bei Fluglärmessungen an Propellerflugzeugen", DFVLR-Forschungsbericht, FB 81-28, 1981.
- [16-5] Chapkis, R. and Marsh, A., "Investigation of Ground Reflection and Impedance from Flyover Noise Measurements", NASA Contractor Report CR-145302.
- [16-6] Dobrzynski, W., "The Effect of Ground Reflections on the Propeller Aircraft Noise Measures LAmax and EPNL", Paper 8th Symposium FASE'89, Zaragoza, Spain, 1989.
- [16-7] Linder, A. and Berchtold, W., "Elementare statistische Methoden", Birkhäuser Verlag Basel, Boston, Stuttgart, Uni-Taschenbücher ISBN 3-7643-0905-9, 1979.

16.7 BIBLIOGRAPHY

Klijn, J.M. and Rademaker, E.R., "Instrumentation for In-Flight Acoustic Measurements in an Engine Inlet Duct of a Fokker 100 Aircraft", NLR Technical Publication TP 91200 U, National Aerospace Laboratory/NLR, Amsterdam, The Netherlands, 1991, Presented at the 22nd Annual Symposium of the Society of Flight Test Engineers in St. Louis, Missouri, USA, 5-9 August 1991.

Chapter 17 – AIRFRAME TESTS

J.K. Appleford

Engineering Systems Division
Aeroplane & Armament Evaluation Establishment
Boscombe Down, Salisbury, Wilts SP4 0JF
UK

17.0 INTRODUCTION

This Section outlines the flight testing required to demonstrate that each of the systems installed in an aircraft is suitable for its operational role(s). It is primarily written from the perspective of a military Flight Test Engineer (FTE) but most of the contents are applicable to civil aircraft. Reflecting the introductory nature of this Volume, its scope is limited to systems normally found in all aircraft, e.g., fuel, hydraulic, electrical, etc., systems. The tests described below are usually made under the prevailing ambient conditions and, to assess behaviour under climatic extremes and in all weathers, further testing is conducted as described in Section 18. Tests of the propulsion system are covered separately in Section 23, but for systems associated with specific roles the reader should consult appropriate specialized sources (e.g., references 17-1 and 17-2 for Airdrop and Arresting Systems, respectively).

While the scope of the tests required in any particular case will depend on the details of the aircraft's design, and on the intended operational usage, the aim is to offer sufficient guidance to enable the reader to appreciate and apply the general principles involved. Chapter 17.1 describes (in suitably broad terms) those aspects which are common to the testing of any aircraft system, the subsequent Chapters cover aspects relevant to particular systems, namely:

- 17.2 Anti/De-icing
- 17.3 Electrical
- 17.4 Engine Installation
- 17.5 Environmental Control
- 17.6 Escape
- 17.7 Flying Control
- 17.8 Fuel
- 17.9 Hydraulic
- 17.10 Oxygen
- 17.11 Secondary Power
- 17.12 Undercarriage, Wheels, and Brakes

and some concluding remarks are offered in Chapter 17.13.

To assist the reader with limited knowledge of aircraft systems, these latter Chapters each commence with a brief generic description of the system covered. Depending on the topic involved the format of subsequent paragraphs differ slightly but, typically, each Chapter covers the following aspects:

- Paragraph 1 Description of System
- Paragraph 2 Test Instrumentation Parameters
- Paragraph 3 Preliminary Rig and Ground Tests
- Paragraph 4 Flight Tests

17.1 GENERAL CONSIDERATIONS

17.1.1 Test Objectives

In broad terms, the main objective of aircraft system testing is to determine whether or not each system is likely to prove satisfactory when the aircraft is operated in its intended role(s). The term "satisfactory" implies that, with the aircraft being operated anywhere within its required environmental and flight envelopes, the system fully meets its design requirements and will not:

- Hazard the aircraft
- Prevent it from fulfilling any aspect of its missions
- Require undue maintenance effort, either in terms of "turn-round" time between sorties or long-term "cost of ownership".

Important secondary objectives are to define the capabilities of each system, in both normal and emergency (system failed) operation, to identify any need for modification action and to provide appropriate systems operating procedures for inclusion in the Aircrew Manual.

Civil and military aircraft are subject to formal general airworthiness requirements (which also define the acceptable means of demonstrating compliance with them), as exemplified in the UK by references 17-3 and 17-4, respectively. The FTE should therefore always consult the applicable requirements as an essential preliminary step in planning the test programme. However, it should be noted that civil (and many military) design and test requirements are concerned only with airworthiness (or "safety") aspects, and it will often be necessary for the FTE (particularly one working for a military "certifying agency") to ensure that appropriate additional testing is conducted to assess the aircraft's "effectiveness" (i.e., its ability to fulfil all aspects of its missions without incurring an unacceptable aircrew workload or maintenance effort, etc.).

17.1.2 Overall Test Programme

This volume is concerned specifically with **flight** testing, but it should be appreciated that, as far as aircraft systems testing is concerned, flight testing is usually the last link in a long chain. Typically, each individual system is subjected to extensive preliminary ground testing on the bench (component tests) and on a suitable rig (sub-system and complete system tests), categorised in the UK as "Stage A" testing. When all the various systems have been installed in the aircraft, ground tests of each are conducted using ground power ("Stage B" tests) and then with power provided by the aircraft's engine(s) ("Stage C" tests). As the individual systems then form part of the complete aircraft, the interactions between them should be fully representative.

It should be noted that the ground tests (particularly the Stage A tests) offer the opportunity to undertake testing of a type or depth which would be too difficult, risky or expensive to conduct in flight. For example, the effects of jamming of a non-return valve in a fluid control circuit can, sensibly, only be studied via ground tests on a bench or rig. For this reason, much of the detailed evidence required to establish confidence in system design and performance is, in fact, derived from ground rather than flight tests.

Once each system has successfully completed the Stage C tests, the aircraft is cleared for flight testing. Clearly, as flight involves simultaneous use of most, if not all, systems it is sensible (and cost-effective) to so structure the flight test programme that data relevant to several systems (and/or to the aircraft performance and handling qualities tests of Sections 13 and 15, respectively) is obtained from the same test points. While some pointers are offered in the following paragraphs, the flight test engineer should always consider this aspect when constructing his flight test programme.

17.1.3 Test Aircraft

The systems installed in the test aircraft should be fully representative, in all material respects, of the production standard. In this context it should be noted that the performance of one system can be affected by the performance of another with which it interacts, so that it is important that **all** systems, and their interfaces, be of the production standard. If one or more system(s) is/are immature (as is often the case), the need for "repeat" testing must be given careful consideration.

Where malfunction or failure degradation of a system can have an adverse effect on the aircraft's flying qualities or performance, it may be necessary to simulate such failures in flight via special test equipments (e.g., autopilot "runaway box", non-standard fuel cut-off valve, etc.). Where such equipments are installed, their interfaces with the normal aircraft systems must be such that there is no risk of unwanted interactions with the latter.

17.1.4 Test Instrumentation

In general, most of the flight testing described in this Section will be conducted in conjunction with that in respect of Performance (Section 13) and Handling Qualities (Section 15), and many of the parameters of interest (such as flight conditions, aircraft configuration and pilot inputs) will be common. As advice in respect of those parameters is readily available (e.g., reference 17-5 identifies parameter types, ranges, accuracy and sampling rates), Paragraph 2 of each chapter below lists only those parameters (such as temperatures, pressures, flow rates, etc.) which are typically needed to quantify the performance of the particular system under consideration. However, it is emphasised that, in practice, the choice of parameters and sensor locations (and of ranges and sampling rates, etc.) must be based on intimate knowledge of the architecture of each system, its mode of operation, and the results obtained during the preliminary bench, rig and ground tests. More general advice on test instrumentation topics may be found in reference 17-6.

17.1.5 Nature and Scope of Tests

While the ergonomics of system operation must be considered, aircraft systems testing is less dependent on aircrew subjective judgement than is, say, the assessment of flying qualities. In cases where assessment can be based solely on analysis of quantitative data, the manufacturer's development programme may well satisfy many of the certifying agency's needs provided that, where matters of "engineering judgement" are involved, the latter's FTEs have adequate first-hand access to it. In meeting the overall objectives outlined in paragraph 17.1.1 above, both "normal" and "abnormal" operation of the system must be considered.

"Normal" operation implies that the system is fully serviceable and being operated in accordance with the specified procedures. The nature of the flight tests undertaken will depend on the system under investigation, and the results of the preliminary ground tests. The ease of operating the system should be assessed in the context of the workload imposed by other mission-related tasks, and system performance should be monitored via the appropriate flight test instrumentation. In accordance with the guidance on flight test safety given in Section 10, the approach to potentially demanding conditions should be progressive to permit any deterioration in system performance to be identified before it constitutes a flight safety hazard. If any significant shortfalls become apparent before the design operating conditions are reached, modification action should be considered (and, if taken, the bench and/or rig tests repeated as necessary before resuming the flight trials).

"Abnormal" operation includes any system malfunction or failure whose probability of occurrence is insufficiently remote for it to be discounted, the use of any stand-by or emergency systems that are provided to cover such eventualities, and the effects of aircrew error in operating the (serviceable)

systems. Particular attention should be paid to the warning cues available to the aircrew and the required aircrew actions, and to the effects on mission capability.

17.1.6 Analysis and Presentation of Results

To fulfil the objectives of paragraph 17.1.1 above, both qualitative and quantitative evidence is required: evidence that a system is easy to maintain, and has functioned satisfactorily without showing signs of distress (mechanical, thermal, electrical, etc.) must be based mainly on "engineering judgement", whereas appropriate quantitative evidence must be assembled to prove that the relevant specified "performance" has been achieved.

Although reliability and maintainability are covered in Section 22, the FTE should consider these aspects when conducting the systems tests; the observations and comments of maintenance staff undertaking routine servicing can be invaluable in this respect.

The FTE should also be satisfied (with the co-operation of the appropriate technical specialists) that the system has indeed proved to be "up to the job" (or not, as the case may be). Post-test inspections should be made, the depth of which will depend on the detailed features of the system under consideration, and on any anomalies noted during the tests. In some cases a general external inspection of salient areas may suffice (e.g., a survey of the primary flight control surfaces and actuators for signs of fouls or hydraulic leaks): in others, a "tear-down" inspection may be needed. It is not possible to lay down "hard and fast" rules for these inspections and, in general, it must be left to the engineering judgement of the FTE and technical colleagues to decide what to inspect and the criteria of acceptability to apply (e.g., in respect to fluid "weeps", brake pack wear, etc.).

Where the required system "performance" is defined in the aircraft or general specifications (e.g., rate of fuel transfer from a tanker to a receiver, cockpit temperature/humidity in a given ambient condition, etc.), the data recorded by the test instrumentation should be used to derive the achieved performance for comparison with that required. As the methods of analysis and presentation adopted will depend on the type (and design features) of the system being considered, it is not possible to define recommended procedures and the FTE must use judgement to select methods appropriate to each particular case. However, it should be noted that in many cases little more is required than graphs or time histories comparing the measured values of salient parameters with the applicable requirements and/or operating limitations.

In consultation with the extended flight test team, the FTE should consider the general acceptability of the system for Service use. If it poses any potential hazard to flight safety, or limits mission capability, the nature of and reasons for those hazards/limitations should be identified. The need for any rectification/modification action should be identified (and its importance categorized) and, if considered helpful, proposals for such action may be offered (avoiding specific advice which might place undue constraints on the manufacturer). Finally, the adequacy of the procedures for systems operation given in the Aircrew Manual (in respect of both "normal" and "abnormal" operation) should be considered in the light of test experience and, if necessary, appropriate amendments recommended.

17.2 ANTI/DE-ICING

17.2.1 Description of System

The specifications for most military aircraft call for the ability to operate for defined period(s) of time in atmospheric conditions in which ice accretion may occur, such as:

- (Defined) Continuous Maximum, or Intermittent Maximum icing conditions
- Ice crystal (or mixed) cloud conditions
- Freezing fog, rain or drizzle
- Continuous or intermittent falling snow.

Similarly, operation is often required from and to runways contaminated with ice, snow (and in the presence of blown or recirculating snow) or slush. Civilian aircraft can either be certificated for flight "in known icing conditions", or their certification may preclude flight in known icing conditions.

Atmospheric icing is a complex phenomenon influenced by many interdependent factors, the most significant of which are:

- Ambient temperature (icing can occur in ambient temperatures as low as -80°C when the ice crystal cloud is partially melted on contact with a airframe warmed above 0°C by kinetic heating, down to -40°C with supercooled water, and at more than $+5^{\circ}\text{C}$ when the airframe has been cold-soaked, or adiabatic cooling of the airflow occurs, as in engine intakes or carburetor venturies)
- Liquid water content (a range of 0.15 to 5 grams per cubic meter (g/m^3)) is normally considered, the higher concentrations typically being associated with convective, or cumuliform, clouds which tend to be of limited horizontal extent: the liquid water content in layer, or stratiform, cloud seldom exceeds $1 \text{ g}/\text{m}^3$) and droplet size (which ranges from about 10 microns in fog to 5,000 microns in freezing rain), or
- Ice crystal content (clouds containing ice crystals can occur at temperatures from 0°C down to -80°C , and at altitudes up to 60,000 ft: at temperatures down to about -20°C the ice crystals usually occur in combination with supercooled water)
- Pressure altitude (the altitude ranges in which icing can occur depend considerably on the condition: freezing fog usually only extends up to about 300 ft above ground level, whereas the severe icing associated with the "Intermittent Maximum" condition, normally associated with cumuliform cloud, is most likely to be experienced between 4000 and 40,000 ft).

In addition to these factors, the distribution, type and rate of formation of the resulting ice accretion depend on airspeed and on the local shape, size, and attitude relative to the airflow of the airframe, and its surface temperature and conductivity.

At the lowest temperatures in the icing range (-40°C) supercooled water freezes on impact with a cold surface to form rime ice which is usually opaque and sharply pointed. Typically, rime ice forms on the wings as a narrow band running spanwise along the leading edge, centred on the stagnation point. At the highest temperatures in the icing range (close to 0°C), the supercooled water does not freeze immediately on impact but runs back, losing heat by evaporation, conduction, and adiabatic cooling until glaze ice forms which may be smooth and fairly transparent. Since the run-back of the impinging water occurs on both sides of the stagnation point, the chord-wise profile of the ice formation develops to resemble two "horns", which may be separated by a relatively ice-free area. At intermediate temperatures in the icing range the extent and type of ice accretion lie between those described above. The ice may take on an arrowhead or mushroom shape, and the ice texture may range from rime through glime (or cloudy ice) to glaze, depending on the temperature.

Ice accretion can be potentially hazardous in many respects. The resulting modification of aerofoil profiles can result in a very marked increase in drag and reduction in lift, and a reduction in control power. (With earlier generations of aircraft, the deterioration in aerodynamic efficiency combined with the mass of the ice accretion could require very high power settings to counter.) Ice accretion can also constrict

engine intakes with a resultant loss of power and, in the case of gas turbines, it can pose a risk to engine integrity if shed. It can block externally mounted probes and vents, jam angle of attack vanes and, should run-back enter control gaps and then freeze, prevent deployment of airbrakes or flaps. Most modern military aircraft have the capability of either flying out of icing conditions or of accelerating to an "ice-free speed" where the airframe surface temperature is raised above 0°C such that no ice accumulates. However, this option may be precluded by mission or air traffic control considerations, and is not available during the circuit and landing. Thus the design of the aircraft must reflect the required capability for operation in icing conditions and incorporate, where necessary, an appropriate anti- or de-icing system. (It should be noted that even if deliberate operation in icing conditions is **not** required, it will still be necessary to consider the implications of inadvertent entry into icing conditions.)

An anti-icing system is designed to prevent the formation of ice on critical parts of the aircraft, usually by using electrical power or engine bleed air to provide continuous heating of the relevant parts when icing conditions are encountered (although, in some cases, the system is based on the use of a freezing point depressant fluid). The level of protection provided must be sufficient to cover the full range of icing conditions anticipated, and to prevent any problems resulting from re-freezing of run-back, and it should incorporate suitable margins to cover errors in estimating the heating or fluid quantities required. The system design should avoid any risk of asymmetric ice accretion and/or shedding and, where failure of the system could lead to hazardous flight conditions, a back-up system should be provided. Because extensive anti-icing systems invariably impose a considerable operational penalty, their use is often restricted to the minimum that can be tolerated (e.g., to areas such as engine intakes where the intermittent ice shedding resulting from the use of a de-icing system could result in engine damage).

De-icing systems are designed to remove ice accretion from the aircraft periodically, before it reaches an extent that could cause unacceptable aircraft or system performance, or cause a hazard to the aircraft as the ice is shed. They are usually based on the intermittent application of heat (provided electrically, or by engine bleed air), or on mechanical disruption (i.e., pneumatically inflatable de-icing boots fitted to the leading edge of aerofoils). In each case the ON/OFF ratio of the de-icing system must be chosen to provide the desired compromise between de-icing performance and the power required.

The systems fitted in military aircraft incorporate an ice detector designed to provide accurate and timely indication of the onset of icing over the full range of icing conditions. The detector provides a warning to the pilot, and automatically activates the protection system (cancelling the warning and deactivating the protection system when the aircraft is no longer subject to icing conditions). For civilian aircraft, an ice detector is not a standard item. The activation of anti-ice or de-ice systems may be decided by observing actual ice formation on wing leading edges, wind frames, windshield wipers, or on the basis of outside air temperature.

17.2.2 Test Instrumentation

In addition to those normally recorded (as noted in paragraph 17.1.4), the following parameters are considered essential to define the atmospheric (icing) conditions in which the aircraft is operating, and the behaviour of the aircraft's ice protection system:

- Liquid water content
- Mean water droplet diameter
- Ice detector function
- Aircraft skin temperature in areas subject to ice accretion
- Ice thickness

- Ice protection heater function for all sensors (e.g., pitot head, AoA vane, etc.)
- Electrical power consumption of the ice protection system(s), and/or engine bleed air temperature at the ice protection positions.

17.2.3 Preliminary Rig and Ground Tests

At an early stage of design the likely forms of ice accretion are assessed, using appropriate wind tunnel facilities and techniques, to determine the characteristics of the ice protection required. (If no ice protection is to be fitted, a study must be made of the implications for the aircraft's handling qualities and performance. This may lead to flight tests being conducted with the predicted ice accretion simulated by fitting appropriately shaped rigid foam panels.) The various ice protection sub-systems are subjected to rig testing of individual components during the development phase, but testing of the complete system is usually impracticable. Similarly, pending the Environmental Tests of Section 18, tests of the complete system installed in the aircraft serve only to check power consumption and component/structural temperatures in "normal" ambient temperatures. However, facilities exist which enable parts of a complete installation to be assessed under reasonably realistic conditions.

In the UK, the A&AEE (open jet) Blower Tunnel is used to provide an icing airstream to immerse, in turn, areas of interest on an aircraft positioned in front of it. (Clearly, these tests are best conducted in low ambient temperatures with the airframe cold-soaked to about 0°C: in higher ambient temperatures pre-cooling of the airframe can be achieved by injecting liquid nitrogen into the airstream.) The severity of the icing conditions provided (airspeed, temperature of the airstream, liquid water content and droplet size) can be varied to give a gradual approach to the required worst icing conditions, and the nature of the installation allows many of the aircraft's utilities to be operated for the tests. Thus engines can be run to investigate protection from icing of intakes and/or propellers and, with de-icing systems, the consequences of ice shedding. Similarly, assessments can be made of the ability of the protection systems to maintain the cockpit transparencies, air data sensors and auxiliary intakes, etc., clear of ice. Where no ice protection is provided (e.g., on radomes, or externally-mounted weapons, drop tanks, etc.) the Blower Tunnel tests provide a useful basis for an initial assessment of the likely operational significance of ice accretion.

Finally, it should be recognised that the difficulties of finding suitable icing conditions in flight (and the virtual impossibility of adjusting icing encounters to give a safe, progressive approach to limiting conditions) render such ground tests invaluable and, unlike the "precursor" ground tests of other systems, they may well provide the best available evidence on which to base assessment of the ice protection system(s).

17.2.4 Flight Tests

Assessment of operation to and from runways contaminated with ice, snow or slush can only be conducted at a site where these conditions occur naturally, and will usually be made in conjunction with the Environmental Testing of Section 18. While a significant part of this assessment will be concerned with the effects of the contamination on aircraft handling qualities and (reduced) performance, aspects pertaining to airframe tests include:

- The tendency for standing snow, ice, slush or water to be thrown up and adhere to the airframe, including the interiors of the wheelbays
- The effects of any such contamination on the functioning of air data sensors, AoA vanes, anti-skid system, etc.

AIRFRAME TESTS

Similarly, the airborne icing tests are usually conducted at a site which offers a reasonably high probability of encountering the required conditions. However, achieving suitable natural icing conditions is notoriously difficult (and the aircraft never seems to be serviceable when those conditions are found!). For this reason, icing tests are conducted more conveniently and controllably using an airborne icing spray rake fitted to a suitably equipped tanker aircraft (although it is believed that such a facility is currently available only in the USA). Such a facility enables the required icing conditions (i.e., liquid water content and droplet size) to be provided at will within a benign environment (i.e., over a well defined area, albeit of limited extent, within otherwise clear air), so that the tests can be conducted in a progressive manner and, if necessary, readily terminated.

The airborne icing tests are usually designed to cover "Continuous Maximum" icing conditions, the most likely (if not the most severe) case expected to be encountered in Service use. For tests to be conducted in natural icing conditions, particular consideration should be given to the likely rate of ice accretion (assuming, conservatively, half the kinetic temperature rise appropriate to dry air conditions) so that a suitable strategy for avoiding dangerous conditions can be devised. Tests should then be conducted to confirm that:

- The ice detector detects and responds rapidly to icing conditions
- The automatic controls function satisfactorily when flying into and out of icing conditions, and do not operate under conditions where this might hazard the aircraft or system
- Sufficient ice protection is provided for the icing conditions and durations required by the specification
- Adequate clear vision for the pilot(s) and crew is maintained for safe and effective operation of the aircraft
- Significant failures of the protection system are indicated to the pilot and any back-up systems operate satisfactorily at such times.

Finally, it should be noted that there is no clear relationship between the icing conditions defined in aircraft specifications (which are expressed in terms of ambient temperature and liquid water content) and the terms used by weather forecasters although, as an approximate guide, their term "light icing" covers a liquid water content up to about 0.5 g/m^3 , "moderate icing" from 0.5 to 1.0 g/m^3 , and "severe icing" from 1.0 to 4.0 g/m^3 . When presenting the test results the limitations recommended for flight in icing conditions should be expressed in those (simple) terms because the pilot will only have the forecasters' information, the indication of the ice detector/system controller (i.e., ON or OFF), the outside air temperature reading and his own observation of the airframe state to judge the severity of the icing conditions being experienced.

17.3 ELECTRICAL SYSTEM

17.3.1 Description of System

A typical aircraft electrical system consists of a primary (main) power source, emergency power source, secondary power conversion equipment, system control and protection devices, interconnection network, and power distribution system.

Primary power may be AC and/or DC and is provided during flight by the main engine-driven generator(s). In the event of a primary power source failure, emergency power is usually provided from independent auxiliary power unit (APU)-driven generator(s), ram air or hydraulically-driven generator(s), or batteries. Secondary power may also be AC and/or DC and is normally derived from transformers, transformer rectifier units, inverters, or frequency converters, as appropriate.

A typical modern electrical system in military aircraft employs two or more engine-driven 115V/200V, 400Hz, 3-phase AC, oil cooled, constant frequency generators which supply essential and non-essential (main) AC busbars via generator contactors, the total aircraft load being shared. Each generator may be driven by either a separate or integral constant speed drive (CSD) system, or it may be a variable speed constant frequency (VSCF) type as used on a number of recent military aircraft designs. Each generator channel operates independently, and in the event of a single failure condition the faulty generator is isolated from its busbar and its loads are automatically transferred to other channels. Provision is made for automatically or manually shedding certain non-essential loads in the event of failures. Limited emergency AC and/or DC power supplies are provided by an APU-driven generator. Where required by the overall system design (e.g., for aircraft employing fly-by-wire flight control systems, where even transient interruption of the electrical supply to their control computers cannot be tolerated), parallel operation of generator channels may be achieved by the use of bus-tie contactors. Secondary 28VDC power supplies are provided from transformer rectifier units which supply essential and non-essential (main) DC busbars. Limited emergency DC/AC power supplies are provided by batteries/inverter, as appropriate.

All control, switching, and protection functions are normally fully automatic, in order to reduce crew workload and prevent incorrect manual selections. Each generator channel has its own control and protection circuits which include built-in test circuits that compute generator serviceability before applying excitation. Providing the generator is serviceable and the drive speed is correct, excitation is applied and the voltage regulator maintains the generator output voltage at the correct level. At this point the generator control unit (GCU) signals the central bus control unit (CBCU) that the generator is ready to bring on line. The CBCU decides the pattern of contactor operations which must take place on the basis of information fed from other generator control circuits and busbar protection circuits. Each GCU oversees the operation of its particular generator and monitors signals from protection units indicating over- or under-voltage, over- or under-frequency, overtemperature, overcurrent, differential current or line faults, as appropriate.

All faults, with the exception of underfrequency and overtemperature, will result in de-excitation of the generator concerned and the removal of the generator "ready" signal to the system control circuit, which isolates the faulty generator from the busbars and resets the appropriate bus-tie contactors to maintain supplies. The generator cannot be re-excited until the fault is corrected and appropriate "reset" action is taken. Signals from the busbar protection circuits indicate busbar short circuits and earth faults to the system control circuit which will result in the affected part of the busbar system being isolated. System malfunctions are categorised and communicated to the crew, using visual or aural means, by the aircraft failure warning system.

17.3.2 Test Instrumentation

The following electrical system parameters are typical of those needed to establish system performance:

- Voltage, AC and DC, essential and non-essential (main) busbars
- Voltage, frequency, current and wattage AC, generator(s) output
- Voltage and current DC, generator(s) output
- Voltage and current DC, battery
- Voltage and current DC, engine/APU starter motor
- Speed, AC and DC generator input shaft
- Temperature, engine/APU starter motor windings and negative brush
- Temperature, internal battery

AIRFRAME TESTS

- Temperature, equipment bay
- Temperature, generator(s) including cooling oil/air inlet and outlet
- Pressure, generator(s) cooling oil inlet
- Generator and bus-tie contactors status
- Transient voltages and currents, as required.

17.3.3 Preliminary Rig and Ground Tests

(NOTE: references 17-7 to 17-9 illustrate typical specifications for electrical systems, and references 17-10 and 17-11 describe some of the test techniques used.)

Following component tests, comprehensive rig testing of a fully configured electrical system (Stage A tests) should be conducted to prove that the concepts, functioning, and performance of the system design are generally satisfactory. On-aircraft ground tests may then be undertaken using ground power supplies (Stage B tests) and the aircraft power supplies with the engines running (Stage C tests) to confirm correct functioning and satisfactory interfacing with other aircraft systems. These tests, when the electrical system should be operated in accordance with the specified normal and emergency operating procedures, should include measurements of:

- The voltage characteristics under steady state conditions, throughout the full range of electrical load conditions, at the AC busbar (i.e., RMS value, average value, crest factor, harmonic content, and frequency and amplitude modulation) and at the DC busbar (i.e., average voltage, and ripple amplitude and frequency)
- The transient voltage surges, spikes, and interrupts at the AC and DC busbars during load switching, engine/gearbox speed transients, and failure simulations (which must include primary and emergency generators, secondary power sources, batteries and busbars)
- Generator temperatures, including cooling oil/air inlets and outlets (where applicable), throughout a range of typical electrical load conditions and engine/gearbox speeds.

Checks should also be conducted to establish that:

- The manual and automatic controls (system logic) function correctly and provide correct indications
- Generator load sharing (where applicable) is within limits
- The charging characteristics of the aircraft battery(ies), and the specified nominal capacity when charged, are adequate to support essential services for the required duration following total primary power source failure
- Battery performance with respect to repeated engine or APU ground starting requirements following a cold soak at specified minimum ambient operating temperature is satisfactory
- The thermal characteristics of the battery during high charge/discharge current conditions following a hot soak at specified maximum ambient operating temperature is satisfactory.

17.3.4 Flight Tests

The main objectives of the flight tests are to confirm the results of the ground testing, demonstrate satisfactory system operation and stability over the full flight envelope and manoeuvre range of the aircraft, and explore in-flight effects that cannot be reproduced on the ground. Particular attention should be paid to:

- The operating temperatures of all primary and secondary power sources and other temperature sensitive items, especially during low level high speed flight, to ensure that design limits are not exceeded
- The effect of positive, zero and negative 'g' manoeuvres and vibration on the correct functioning of CSD systems, contactors, and other mechanical devices
- The effect of in-flight engine/gearbox speed transients on power supply quality
- The effect of a shut down or temporary failure at high altitude, followed by an emergency descent, on the performance of CSD system, and oil cooled generators (if applicable)
- APU in-flight starting and operation throughout the specified envelope(s)
- Assessment of the emergency generator(s) which can only be operated in flight, such as those driven by ram air turbines
- Insofar as is practicable, the effects of simulated failures of the power sources and busbars.

17.4 ENGINE INSTALLATION

17.4.1 Description of System

Because they can readily constitute a source of ignition, and are in close proximity to significant quantities of combustible fluids (fuel, engine oil, and hydraulic fluid), aircraft engines are installed in areas designated as fire zones. These fire zones are designed to prevent any fire from spreading, and are usually fitted with fire detection ("fire-wire") and suppression (one or two-shot fire extinguisher) equipment. Engines embedded in the aircraft structure (typical of most combat aircraft, trainer aircraft and some larger aircraft) are a greater risk in terms of fire spread than pylon-mounted, podded engines which, being very much self-contained units, are more easily dealt with. In general, embedded engines are isolated from each other by a fireproof bulkhead running longitudinally between them, and the spread of fire or (highly combustible) fuel vapour to the remainder of the aircraft structure is prevented by fireproof bulkheads at the forward end of the engine bays and (typically) titanium inner skins extending over the entire length of the bays to protect the top and side bays. Similarly, fire seals at the aft end of the engine bay are provided to prevent the spread of fire or fuel vapour into the nozzle/jet pipe area.

To avoid any build-up of fuel vapour, the engine bay is usually ventilated by introducing main engine intake duct air via non-return valves or by air introduced through nacelle inlet scoops, the air being exhausted through clearance areas around the nozzle/jet pipe and through the bay drains (which also remove any fluids) located at the front and rear of the lower surfaces of the engine bay.

Other considerations involved in the engine installation include the provision of adequate clearance between the engine and its accessories within the engine bay (which must allow for expansion and movement of the engine relative to the airframe), suitable access to those accessories and the engine/airframe connections for maintenance and/or replacement operations, and the possibility of ingestion of water or other runway contaminants thrown up by the wheels during ground manoeuvres.

17.4.2 Test Instrumentation

The only instrumentation normally required for the engine installation assessment is a suite of temperature sensors which should be positioned to survey the whole bay, especially any temperature sensitive material or unit that may be situated within the fire zone. However, civil aircraft testing usually includes actual activation of the fire extinguisher system, when a system of suction pipes is provided to lead samples of the foam produced in the engine bay to a density measuring device (Steatham Equipment) in the cabin.

AIRFRAME TESTS

(NOTE: This test may be conducted on the ground, with airflow through the engine bay simulated using equipment such as the A&AEE Blower Tunnel, and/or it may be conducted in flight.)

17.4.3 Preliminary Rig and Ground Tests

Inspections should be made to check that any pipes and electrical cables within the fire zones are not susceptible to chafing due to their routes within the zones. Sources of contamination of the fire zone due to spillage (e.g., of fuel or oil) during uncoupling and coupling of the engine/airframe connections should be identified, and checks made to ensure that the location of drainage holes relative to the source of contamination is satisfactory. It should also be established that the fireproofing of components and the sealing of the fire zones will not be degraded by any of the actions involved in removal and replacement of the engine.

Ground tests should be conducted to demonstrate throughout the required environmental temperature range of the aircraft, that the:

- Temperatures of the fire zone structure, fire zone components, and any temperature sensitive components adjacent to the outer surfaces of the fireproof bulkheads and wall are satisfactory during and after ground engine running, including the temperatures at any localised hot spots within the fire zones
- Position of the fire zone drains ensures that fluid cannot accumulate in any part of the fire zones due to fluid spillage or as a result of aircraft operations
- Sealing of the fireproof bulkheads is not degraded by aircraft operations
- Fireproofing of the fire zones and components within the zones are not degraded by aircraft operations or servicing activity.

If the engine layout chosen makes the engine(s) inherently prone to the ingestion of water or other runway contaminants/debris thrown up by the landing gear (common with a nose gear just ahead of chin or side-mounted intakes), it will be necessary to undertake tests to assess the extent of the problem and the effectiveness of any palliatives (e.g., chined tyres, or mudguards). Such tests are normally conducted during the taxiing and takeoff handling tests described in Section 15. [17-12]

17.4.4 Flight Tests

No dedicated flight tests of the engine installation are normally required (apart from any fire extinguisher tests required by the civil authorities) but, during the course of testing other systems, it should be demonstrated throughout the environmental temperature range of the aircraft that the:

- Temperatures of the fire zone structure, the fire zone components and the temperature sensitive equipments adjacent to the outer surfaces of the fireproof bulkheads are satisfactory throughout the flight envelope of the aircraft, including during and after a low level high speed flight after a prolonged hot soak
- Fire zones and adjacent bays remain free from fluid contamination: should post-flight examination show that such contamination has occurred, the source of the contaminant must be identified and its significance assessed.

However, dedicated flights may be required to evaluate specific compatibility problems determined during testing. For example, a fighter aircraft was found to be having considerable foreign object damage during carrier landings. The cause was determined to be significant relative motion between the engine and the airframe causing damage to the inlet mating ring. Another example involved a re-engined fighter aircraft where interference was found between the engine gearbox accessories and the aircraft structure, again caused by the relative motion of the engine and the airframe.

17.5 ENVIRONMENTAL CONTROL SYSTEMS

17.5.1 Description of System

As the name indicates, the purpose of an environmental control system (ECS) is to so condition the pressure, temperature, and humidity of the air in the cockpit/cabin that the crew (and passengers) are provided with a benign operating environment and protected against the adverse effects of high altitude flight. Additionally, electrical and avionics equipment compartments are maintained at a suitable working temperature by using the conditioned air after it has passed through the cockpit/cabin (or, sometimes, via a dedicated conditioning system).

The need to provide a comfortable level of temperature and humidity in the cockpit/cabin (bearing in mind that the ambient temperature falls by about 2°C for every 1000-foot increase in altitude) is self-evident. With increasing altitude, the partial pressure of the oxygen in the atmosphere decreases in direct proportion to the decrease in absolute pressure and, as altitude increases above 10,000 ft, supplementary oxygen must be supplied to avoid hypoxia and anoxia and their attendant adverse effects. The ECS of all civil and most military multi-seat aircraft is designed to maintain the cabin altitude below 8000 ft to avoid the need, under normal conditions, to use oxygen masks (see Chapter 17.10) but, to ease the structural design, the cockpit altitude of high performance single/twin-seat combat aircraft (in which the aircrew always wear oxygen masks) usually ranges between 8000 and 20,000 ft. Further, the ECS must ensure that the rate of change of cabin/cockpit altitude during climbs and (especially) descents does not cause otitic barotrauma: for civilian passengers the rate of descent of cabin altitude is restricted to about 300 feet per minute (fpm), while a rate as high as about 2000 fpm can be accepted for Service aircrew.

Air conditioning may be provided by several means, but the most commonly used is the air cycle system. Hot air bled from the engine compressor is first cooled by an air/air heat exchanger (the "pre-cooler", which utilises ram air as the cooling medium) before entering a conditioning package. This package usually consists of an intercooler heat exchanger, temperature control valve (TCV), cold air unit (CAU) turbine, frost guard at exit from CAU and a water extractor. The main airflow is compressed in the compressor portion of the CAU, passed through the intercooler secondary heat exchanger, and then expanded through the turbine of the CAU to produce sub zero temperatures, and this discharge air is then mixed with warm air (directed to bypass the CAU by the TCV) to avoid formation of ice in the air distribution ducting. At low altitude, excess free water is extracted by the water extractor and the conditioned air is delivered to the cockpit/cabin distribution system. (The extracted water can be used to provide extra cooling within the ECS by injecting it into the cooling air flow, or sprayed over the face of the secondary heat exchanger to improve efficiency of the heat exchanger during low-altitude, high-speed flight.) Conversely, during prolonged flight at high altitude, water may be injected into the air outlet of the conditioning pack in order to maintain an acceptable level of humidity. The air temperature within the cockpit/cabin is selectable by the pilot, and is maintained at the desired level by a temperature control system sensitive to the cockpit/cabin air inlet and outlet temperatures.

Pressurisation is obtained by imposing a variable restriction on the discharge to atmosphere of the air entering the cabin/cockpit from the conditioning unit. (NOTE: The air flow rate required is governed by the requirements for ventilation and cooling rather than that for pressurisation.) A pressure controller, which is sensitive to both the absolute pressure in the cabin and the differential pressure between the cabin and ambient pressure, is used to control the action of one or more discharge valves. Various devices to vary the pressure datum, to limit surges, or to take over control in the event of equipment failure are usually incorporated in the system: in particular, safety devices must be installed to safeguard the aircraft structure in the event of an uncontrolled rise of cabin pressure, and to limit to a safe value any negative differential pressure which may occur.

In addition, the conditioned air supply may be utilised to provide air for cockpit canopy seal inflation, anti-'g' garments, rain dispersal from the windscreen, hot air for windscreen demisting, on-board oxygen generating system (OBOGS), micro-climate chemical/biological/nuclear (CBN) suits, and wing anti-icing. The air discharged from the cockpit is normally utilised for equipment conditioning and, in some cases, this air is also used to extract heat from a liquid cooling system for the radar installation. To cater for air conditioning failure, a ram air inlet valve is fitted to provide fresh air ventilation and limited cooling (which is supplemented by cooling fans). (NOTE: Activation of the ram air valve results in loss of pressurisation.)

17.5.2 Test Instrumentation

In addition to the normal flight parameters (see para 17.1.4), Dew Point should be recorded. Typically, the air conditioning system parameters required are:

- Cold air unit delivery temperature
- Cockpit air inlet and outlet temperatures
- Cockpit humidity
- Air temperature at pilot's head, hands and feet and black body temperature adjacent to head
- Air temperature adjacent to key components in equipment bays
- Air massflow through both sides of the air/air heat exchangers
- Air massflow delivered to the cockpit
- Air mass flow delivered to the avionics bays
- Temperature at passenger seats
- Temperatures around galleys.

For testing at the extremes of the operational environment as described in Section 18 it is also desirable to monitor the following parameters on the pilot using man-mounted sensors and miniature data recorders fitted and monitored under medical supervision:

- Deep body and mean skin temperatures
- Pulse and respiration rates
- Pre/post flight nude body weight (to determine the body fluid lost through sweating).

17.5.3 Preliminary Rig and Ground Tests

Initial testing of the ECS is carried out by the aircraft manufacturer using rigs incorporating production aircraft components assembled to represent the aircraft system layout. These tests are aimed at ensuring that the airflows and temperatures throughout each element of the system achieve the design values. They enable appropriate minor adjustments to individual inlets and outlets to be made as necessary, and require considerably more detailed test instrumentation than that listed above.

Subsequent on-aircraft testing is often confined to determining the delivery conditions of air supplied to various parts of the cockpit and to the equipment areas. Ground tests with the engine(s) at idle power setting are performed in a range of ground ambient temperatures to establish the cockpit cool-down/warm-up characteristics and assess the adequacy (or otherwise) of equipment cooling/heating during periods of ground operation within the design specification. (Typically, operation is required in a hot/dry climate of +40/45°C, in a hot/humid climate of +30/35°C with a maximum dewpoint at about + 30°C, and in a cold climate of -30/40°C. These tests represent a major element of the climatic tests described in Section 18.)

17.5.4 Flight Tests

ECS performance tests should be carried out progressively over the entire flight envelope of the aircraft to demonstrate that, under the specified temperature and humidity conditions, and with the engine power settings required to achieve the specified flight profiles, the system is satisfactory in respect of:

- Temperature, pressure, flow and distribution throughout the system (NOTE: For transport-type aircraft, it is very difficult to provide a fully representative cabin mock-up for the ground tests and hence more reliance must be placed on in-flight flow measurements.)
- Stabilised temperature and temperature distribution within the cockpit(s)/cabin, and stabilised temperatures of directly-cooled equipments and equipments in conditioned bays, including when the aircraft is flown to the most adverse flight profile for the conditioning system following prolonged soak at maximum and minimum ground level ambient temperatures. (NOTE: For combat aircraft, these tests should include monitoring of the pilot's deep body temperature, skin temperature, pulse rate and respiration rate.)
- Performance of the air conditioning system after a simulated single engine failure
- Adequacy of ventilation of occupied and equipment compartments, including checks for contaminants (e.g., carbon monoxide) in the air supply
- Functioning and stability of the cockpit pressurisation system throughout the flight envelope of the aircraft particularly during rapid climbs and descents
- Cabin air leak rate following a pressurisation failure at maximum altitude
- Effectiveness of the cockpit inward venting system during a maximum rate descent
- Adequacy of the demisting system during a maximum rate descent after a prolonged cold soak at altitude into a hot, humid environment
- Adequacy of the demisting system (and/or electrical heating of the windscreen) during night operation (i.e., with no solar heat input to the cockpit) in the high relative humidities associated with a ground level ambient temperature of +10/25°C
- Provision of satisfactory clear vision via the demisting system and rain dispersal system (where fitted) under all conditions (including icing conditions), especially during taxiing, take-off and landing
- Noise levels that may inhibit communications, damage hearing, or increase crew fatigue
- Providing an adequate air supply for On Board Oxygen Generating System (OBOGS) operation (where fitted).

Further advice on the testing of environmental conditioning systems is contained in reference 17-13.

17.6 ESCAPE SYSTEM

17.6.1 Description of System

Many facets of military aviation incur an inherently high degree of risk due to the consequences of enemy action, or loss of control when manoeuvring aggressively at low altitude. For this reason it is normal for combat and most training aircraft to be fitted with some form of system to assist crew escape (and, indeed, about 10 percent of all ejection seats manufactured by Martin-Baker have been used "in anger"!). While certain aircraft (particularly in the US) are fitted with escape capsules, the (individual) ejection seat is much more common and, for the purposes of this introductory volume, only the latter will be considered.

AIRFRAME TESTS

With an ejection seat escape system, the seats at the normal aircrew stations are equipped with a gun (and, usually, a rocket sustainer motor) which is designed to remove the occupant from the aircraft as quickly as possible, when necessary. The escape path is first cleared by jettisoning the canopy (or hatch, for rear crew), or by disrupting the transparency via an explosive cord. (Ejection through the canopy, where the transparency is broken by "canopy-breakers" fitted to the ejection seat, is now considered acceptable only as a back-up because of the risk of injury to the occupant.)

Following ejection (which takes about 0.5 second (sec), and subjects the occupant to a maximum acceleration of about 17 'g'), a drogue is deployed for 1-2 sec to decelerate the seat and achieve a suitable attitude before the main parachute is released. The deceleration produced by the drogue increases with airspeed and, typically, can be up to about 25 'g'.

The main parachute is usually released when the airspeed has fallen to a maximum of about 250 knots (kts) and, in most ejection seats, the seat restraint harness is released at the same time to become the parachute harness, the seat then falling away from the occupant. The parachute inflates, stabilises, and reduces the vertical rate of descent to about 7 meters per second (mps). The design peak deceleration is limited to about 25 'g' to avoid excessive physiological stress and canopy inflation forces and, to achieve this, parachute release is usually subject to time delays above 6000 ft and inhibited above 10,000 ft. The total time taken from initiation of ejection to vertical descent beneath the main parachute is between 3 and 4 sec.

In multi-seat aircraft "Command Ejection" is usually provided whereby, if one crew member ejects, the others are ejected in an automatically controlled sequence which avoids collisions between ejection seats or between one seat and the jettisoned/fragmented canopy from another crew station. (Such a command system can be initiated by any crew member, and also provides for individual ejections.)

The escape system must cater for the physical variations in aircrew (e.g., an equipped weight range of 65 to 135 kg in the UK) and, in combination with the aircrew personal equipment, provide suitable aids to enhance survival in the operating environment. The ejection seat carries an emergency oxygen supply, regulator, and controls (which are available until seat separation occurs at a safe altitude of 10,000 ft or below), and a personal survival pack (which remains attached to the main parachute harness after seat separation) containing a single-seat life raft, rations and survival aids.

17.6.2 Test Instrumentation

An integral element of the test instrumentation used for escape system testing (in the UK) is the Alderson dummy, available in three sizes to represent the minimum, median and maximum size of aircrew. It consists of a steel "skeleton" covered with "rubber" soft tissue and is anthropomorphic (i.e., the hollow torso can accommodate ballast weights and instrumentation to give representative mass distribution). It is not anthropodynamic (the torso is rigid, and the limbs have simple pin joints), but the dummy has been "calibrated" by comparison with subsequent "real" ejections and, apart from some doubts over arm restraint, it is considered to yield reliable data.

The dummy-mounted instrumentation parameters, which are usually relayed by telemetry to a ground station to reduce the risk of loss of data in the event of catastrophic failure of the test article, consist of the following:

- Linear acceleration at torso (fore/aft, lateral, vertical), head (fore/aft, lateral) and seat (vertical, fore/aft)
- Angular velocity at torso (pitch, roll, yaw)
- Static and dynamic pressure (where a speed and/or altitude sensing system is fitted)
- Force in parachute harness.

The behaviour of the ejection seats, parachutes and (particularly) escape path clearance systems is monitored using, typically, cine photography (at up to 4000 frames per second (fps)), and 400 fps video systems which provide an immediate replay facility and simplify motion analysis. The tests are usually conducted on or over a range equipped with tracking kinetheodolites to enable trajectory data to be obtained.

17.6.3 Ground and Flight Tests

It will be readily appreciated that escape system testing, which involves a significant degree of "destructive test", is not cheap. The specialised aircraft required to conduct flight tests are expensive to provide and maintain (only one remains in the UK). Moreover, their flight envelope is often well within that of the aircraft for which a clearance is sought (e.g., the converted Phantom F-4 used by the USN can only achieve test airspeeds of about 550 kts/1.2 M). Thus the testing of escape systems is more dependent on ground testing (using a variety of facilities) than is the case for other systems, and it is therefore more appropriate to consider ground and flight testing together, as in this paragraph.

It is usual to approach the testing of escape systems in the following three stages (although, to reduce costs, tests appropriate to the three stages are combined wherever possible):

- Ejection seat qualification, during which the performance of the production standard ejection seat is demonstrated following completion of development by the manufacturer
- Escape path clearance, to confirm that the initial trajectories of the seat(s) and canopy are compatible
- Escape system qualification, in which full "end-to-end" tests of the complete escape system are made.

(It should be noted that all escape system testing is normally carried out under conditions representative of 1'g' straight and level flight. This has become a de facto standard which is reasonably representative of most real ejections and permits comparisons to be made between different types of ejection seat.)

17.6.3.1 Ejection Seat Qualification. For speeds up to about 70 kts, test firings may be made from an open test rig mounted on the flat bed of a lorry. In the UK, a converted Meteor aircraft operated by Martin-Baker can be used for airborne tests between 130 kts and 450 kts/0.8 M, and runway level tests at about 90 kts. For higher speeds, rocket-propelled sleds running on special test tracks are used (indeed, the UK has always used this ground-based technique for airspeeds greater than 450 kts). The sled does not need to be representative of the aircraft cockpit, and it is usually slab-sided with the seat being enclosed by a hatch which is jettisoned just before the seat is fired. However, the high longitudinal acceleration (up to 17 'g') required to achieve the test speed in the distance available can make it difficult to ensure that the dummy's limbs remain in the desired position.

17.6.3.2 Escape Path Clearance. In the UK, the A&AEE Blower Tunnel is used extensively for escape path clearance testing. This is an open-jet wind tunnel capable of generating an airspeed of up to 235 kts across a working section of 1.8 meter (m) diameter, with a large open-air working area in which test rigs (or even complete aircraft) can be positioned. It can be adjusted in pitch to provide the desired angle of incidence, but sideslip must be represented by appropriate positioning of the test rig or aircraft. A catch net system is used to salvage both the seat and canopy.

It is common practice to use a special "crew escape" test rig for escape path clearance testing (and for subsequent full escape system qualification testing). This consists of a cockpit section with representative structural stiffness, windscreen, canopy, ejection seat(s) and internal furnishing.

Having conducted appropriate component/sub-system tests, the manufacturer usually conducts a canopy jettison at zero airspeed to prove that the ground emergency egress mode is satisfactory (i.e., the canopy falls clear of the aircraft). With a fixed time interval between canopy jettison and seat ejection this is also the worst case for escape path clearance, and this test offers early evidence of the suitability of the time interval chosen. Where canopy jettison is provided by rocket motors (one in each canopy side rail), the system performance should provide adequate escape path clearance in the presence of a tail wind: this may be tested by mounting the test rig (facing backwards) on the flat bed of a lorry, and firing it at a speed of (say) 30 kts.

Canopy jettison tests are then conducted in the Blower Tunnel at an airspeed of 235 kts, using the crew escape test rig with ejection seats and dummy aircrew installed and a representative sequencing system. This test is intended to demonstrate satisfactory operation of the sequencing system (although the seat gun is not fired), the ability of the jettison system to overcome moderate aerodynamic loads and freedom from adverse physiological effects on the crew. In the case of rocket-powered canopy jettison systems, the Blower Tunnel is also used to assess the performance of the jettison system with only one rocket motor operating (although, it should be noted, there is no evidence to date that such a failure has occurred in practice).

The Blower Tunnel is particularly useful for testing canopy disruption systems because it is practicable to operate both the disruption system and the ejection seat. (NOTE: Canopy disruption may be provided by a fragmentation system, where the transparency is broken into fragments via Miniature Detonating Cord (MDC), or by a segmentation system where a Line Cutting Charge (LCC) breaks the canopy into segments.) Although only the gun is fired, the acceleration and trajectory of the ejection seat are fully representative during the period when interaction with canopy fragments/segments might be encountered.

The tests usually start with a zero airspeed firing, which is often the most critical case for a disruption system as there is no airflow to sweep the debris clear of the escape path and satisfactory operation depends on the kinetic energy imparted to the fragments/segments by the MDC/LCC. (As with canopy jettison, this test is also representative of the ground emergency egress mode.) It is then customary to proceed directly to a test airspeed of more than 200 kts, since "scavenging" of fragments is usually satisfactory and does not require intermediate test points, and the (potentially adverse) effects of aerodynamic loads on segments increase with airspeed.

For tests of canopy jettison or disruption at higher speeds a rocket-propelled sled must be used, as for the high-speed ejection seat qualification tests described in para 17.6.3.1 above, and it is thus customary to combine high-speed jettison/disruption testing with the escape system qualification tests described below.

17.6.3.3 Escape System Qualification Testing. The escape system qualification tests are designed to demonstrate satisfactory end-to-end integration and performance of the qualified ejection seat and escape path clearance system. The tests usually cover the full range of airspeed required (typically, zero to 600 kts). In the UK the tests are made using a representative cockpit section as described in paragraph 17.6.3.2 above, mounted on a rocket-propelled sled which can accelerate to 650 kts and sustain this speed for the one second required for canopy jettison followed by a double, commanded, ejection before being decelerated to rest using a water brake system.

In addition to the those conducted at zero and 600 kts, tests are made at intermediate speeds approximating to those used during the earlier test phases so that comparative data is available should any anomalies arise (i.e., at about 250 kts, close to the maximum used during the escape path testing in the Blower Tunnel, and at 450 kts, the maximum speed for the airborne qualification testing of the ejection seat).

17.6.4 Analysis of Results

A very important element of the analysis of the trials results is the physical examination of all items of equipment immediately after each test, to identify any potential anomalies for further investigation. Whether or not anomalies are detected, it is customary for the manufacturer to undertake a thorough strip-down assessment of all sub-systems to identify any signs of distress. However, it must be recognised that escape systems are "one-shot" items, and minor damage (e.g., pulled stitching in a harness that has sustained maximum loading during parachute inflation) is often judged acceptable.

The forces imposed on the instrumented dummy are compared with the criteria published in references 17-14, 17-15, and 17-16 to estimate the risk of injury incurred. It is acknowledged that these criteria are imperfect (the survivable loadings far exceed the levels at which volunteer testing can be conducted, and the dynamic response of the human body is both non-linear and very variable), but they correlate reasonably well with real-life survival. Further, the uncertainties of injury are tolerable when compared with the inevitable results of equipment failure!

Comparison of the measured trajectories of the canopy and ejection seat(s), either from the results of the escape system qualification tests or by superposition of data from separate tests, is usually sufficient to confirm that the escape path is satisfactory. The assessment of canopy disruption systems is more difficult because the motion of larger remnants (the sides of the canopy in a fragmentation system, or the segments in a segmentation system), with the greater potential for inflicting injury, can be very susceptible to minor changes in airflow. While the cine/video records of the disruption characteristics can be compared with those from "through canopy" testing (taken as the worst case), the acceptability of observed motions of the canopy remnants remains a matter for "engineering judgement".

With command ejection systems, data from individual ejection seat trajectories as well that from full command system demonstrations is used to examine the worst case (usually ejection of maximum mass followed by ejection of minimum mass) and the effects of tolerances in the timing sequence, and to identify the effect of airspeed on the separation distances throughout the escape sequence.

17.7 FLYING CONTROLS

17.7.1 Description of System

The flying controls of an aircraft can be regarded as being comprised of two sub-systems, namely the:

- Primary flight control system (PFCS) which enables the attitude and angular rate about each axis to be controlled, and consists of the elevator, ailerons, and rudder (or their equivalents, such as the elevons on a delta aircraft, or the foreplanes with a canard configuration)
- Secondary flight control system (SFCS), which permits the aerodynamic configuration to be optimised for particular flight conditions, and consists of such features as variable wing sweep (to cover the Mach number range), flaps and slats (to enhance lift and thereby improve manoeuvre capability and/or reduce takeoff and landing speeds), and airbrakes (to increase deceleration or rate of descent).

While the control surfaces of early aircraft were operated by direct mechanical linkages (composed of levers, cables and rods, etc.) from the pilot's controls, the difficulties of providing acceptable levels of control force and movement as airspeeds and aircraft mass increased led to the near-universal adoption of hydraulically powered systems, with the pilot's inputs being transmitted mechanically or electrically to a hydraulic actuator at each control surface.

Similarly, to improve manoeuvrability and enhance air vehicle performance (by reducing longitudinal trim drag), it has become commonplace for military (and many commercial transport) aircraft to have reduced natural stability, such that some form of artificial stability must be provided to yield acceptable flying qualities. This artificial stability (and other related control functions) is typically provided by a digital flight control computer which continuously senses the aircraft state (attitude and rate about each axis, etc.), compares it with that demanded by the pilot through his controls (or inceptors), and drives the control surfaces (motivators) in such a way as to achieve the demanded aircraft state. Such a system is commonly referred to as a "fly-by-wire" (or, where data transmission by optical fibre is employed, "fly-by light") system. The resulting stability and control characteristics perceived by the pilot must, of course, satisfy the criteria discussed in Section 15. Because the vital nature of the PFCS demands that the probability of failure be extremely remote, the computing elements are multiplexed (typically, quadruplex) and their architecture, and that of the sensing and actuation elements, is designed to be robust with graceful degradation in the event of malfunction.

This chapter will consider a generic flight control system (PFCS and SFCS) typical of current practice which, for assessment and testing purpose, it is convenient to consider as consisting of four functional areas, namely:

- Cockpit (e.g, pilot's controls and indicators)
- Sensor systems (e.g., air data)
- Computing system
- Actuation system.

The pilot's PFCS controls (inceptors) remain traditional, with a control column or side-stick controller for demands in pitch and roll, rudder pedals for yaw demands, and trim switches for each axis on the stick top. All controls are compliant (although the range of movement tends to be very small with side-stick controllers) and feel is usually provided by a (damped) spring system. The input demands are detected as displacement of (or, occasionally, force applied to) the pilot's inceptor by quadruplex analogue sensors and converted to digital signals for processing within the flight control computer. (In earlier systems a conventional mechanical backup was also provided, at least for the pitch and roll axes but, as confidence in the reliability of fly-by-wire systems has grown, this is now unusual.) The SFCS inceptors are also usually traditional (e.g., flap and undercarriage selectors, etc.), but the SFCS elements are often subject to some form of automatic control also (e.g., flap and slat angle scheduled as a function of angle of attack and Mach number). Controls and indicators are provided in the cockpit for the Built-in-Test (BIT) system, and warning of failures is given via the central warning panel (see below).

A comprehensive suite of sensors is required to define the aircraft's configuration (in respect of both the PFCS and SFCS), flight conditions, and motions about the body axes, typical parameters in those categories being, respectively:

- Positions of all motivators (elevator, ailerons and rudder, or their equivalents), and status of weight-on-wheels switch, undercarriage position, flap position, slat position, etc.
- Air data system giving speed, altitude, outside air temperature, angle of attack, angle of sideslip
- Attitudes, rates and accelerations relative to each body axis.

As noted above, the heart of the flight control system is a suite of four flight control computers which perform the control law computations in accordance with algorithms developed to provide the required flying qualities. However, from the perspective of airframe testing, the subject of this Section, testing of the flight control computers themselves is often limited to confirming that their environmental conditioning is satisfactory (see Chapter 17.5). (Development of the control algorithms is conducted principally through ground-based simulation, and subsequent flight assessment (and, where necessary,

refinement) of them is covered by the activities described in Section 15. Similarly, the development and validation of the implementation of the intended algorithms, and the strategies adopted to ensure a robust architecture are introduced in Sections 26 and 26A.) Thus, the computing system will not be described in any greater depth other than to note that the BIT system normally checks the serviceability of the computer software as well as that of the sensor suite and control actuators, and provides for pre-flight check out, continuous in-flight monitoring and subsequent maintenance diagnostic checks.

Typically, each elevator/aileron/rudder (or equivalent) actuator of the PFCS consists of four electro-hydraulic servo valves, a monitoring system and a power stage with two hydraulic power supplies and electrical and/or mechanical feedbacks. Each spoiler actuator consists of one double-fed electro/hydraulic servo valve, two feed back potentiometers and a power control unit, with failures in the spoiler actuators being detected by electrical monitors. Each axis is provided with a trim system whose method of operation can vary widely: it may be by a parallel trim actuator containing two electric motors (one motor for auto trim, and one for manual trim) or, on more sophisticated systems, via a trim motor sensor feeding directly into the integrated flight control computing system. The main SFCS surfaces (i.e., flaps and slats) are usually extended and retracted by screwjack actuators via a series of transmission shafts, gear boxes and universal joints, driven by a unit which incorporates two interconnected hydraulic motors with duplex hydraulic power supply and a torque limiter. Feedback systems are provided for both systems, and position transducers connected to the screwjacks in each wing feed to comparator units: should an asymmetry be detected in either system, its position will be "frozen" and appropriate warning given to the pilot.

17.7.2 Test Instrumentation

Clearly, the test instrumentation required in each case will depend crucially on the details of the flight control system under investigation. However, in broad terms, it will be necessary to record:

- All pilot inputs (i.e., PFCS inceptor positions and forces, and SFCS services selected, such as flap and undercarriage position) and related displays (e.g., failure warning on central warning panel)
- Position of all actuators and/or aerodynamic control surfaces and services on both the PFCS and the SFCS
- Parameters appropriate to all interfacing systems, such as hydraulic pressure and oil temperature, and electrical voltage
- Where possible, appropriate elements of the digital data stream, especially those relating to operating status such as channel(s) in use, failure detection, etc.

Many of these requirements overlap/duplicate the instrumentation required for flying qualities testing (Section 15).

17.7.3 Preliminary Rig and Ground Tests

It is usual for all components of a flight control system to have been subjected to extensive bench testing before incorporation into a system rig, or "iron bird", which enables the whole system to be exercised using aircraft components and with simulated air loads applied to the various control surfaces. The "iron bird" will be operated in conjunction with a flight simulator to allow pilot assessment of "flying" the rig/simulator under all flight conditions appropriate to the intended missions. As well as confirming satisfactory operation of the system itself, this testing enables the pilots to familiarize themselves with (and conduct initial assessments of) system behaviour. In particular, the rig can be used to test progressively failure conditions of increasing severity (and the adequacy of the associated cockpit warnings), including combinations of failures of the flight control system and/or its interfaces with other systems whose effects are expected to be too adverse to simulate in flight.

Some ground tests with engines running (Stage C tests) must be undertaken to confirm that, as installed in the aircraft, correct functioning and satisfactory interfacing of the flight control system with other related systems (e.g., hydraulic and electrical systems) is achieved when the flight control system is operated in accordance with the specified normal and emergency operating procedures. This testing, which will mostly be undertaken in association with the hydraulic system tests (Chapter 17.9) and, later, the environmental tests (Section 18), should include extensive use of the BIT system to ensure that all relevant failures are detected, and that spurious failure indications are to an acceptable minimum.

17.7.4 Flight Tests

Flight testing of the flight control system will inevitably be undertaken in conjunction with the Handling Qualities test programme (Section 15), and must cover the entire flight envelope of the aircraft. Overall system performance should be monitored to confirm that the PFCS and SFCS function correctly under normal operating conditions throughout the aircraft's flight envelope. The ease of system management and the suitability of its status displays (including those of the BIT) should be assessed from start-up and throughout flight to shut-down, and the ability of the maintenance diagnostic checks to identify any anomalies that may have occurred investigated. Where required, appropriate measurements may be made to determine system "performance" in the presence of air loads, such as undercarriage or flap extension and retraction times.

Once satisfactory operation has been demonstrated throughout the required flight envelopes, and in all required configurations, flight assessment of relevant failure cases should be made. Clearly, the types of failure to be investigated depend intimately on the architecture of the system, but the cardinal principle to be followed is that **all** failures whose probability of occurrence in Service use cannot be discounted should be assessed. The purpose of this assessment, made under controlled conditions with appropriate safety precautions in place, is to validate the failure characteristics and associated aircraft motion/flying qualities implications identified during the rig/simulator tests in order to establish procedures and advice for the Aircrew Manual. (NOTE: Should a failure mode result in unacceptable characteristics which cannot be avoided by a tolerable restriction in the permitted operating conditions, re-design will be necessary.)

17.8 FUEL SYSTEM

17.8.1 Description of System

In general, a fuel system comprises internal tanks situated in the fuselage and wings, together with appropriate fuel control, gauging and jettison systems. Military aircraft often have provision for the carriage of external tanks (normally jettisonable) and/or in-flight refuelling (via a probe or receptacle), and additional auxiliary fuel tanks may be fitted in the cabin or freight hold of cargo/passenger aircraft to extend ferry range. In addition, the fuel is used in some aircraft as a heat sink for cooling other system fluids such as hydraulic and gearbox oils.

Normally each engine is fed from its own dedicated tank, which incorporates a collector box containing two booster pumps feeding the main (engine-mounted) high pressure pump. On multi-engined aircraft the booster pumps can also feed other engines via a cross-feed valve, if required. Fuel is transferred from the wing/fuselage tanks into each collector tank using electrical transfer pumps or air pressure. On some aircraft, fuel-powered motive flow pumps (jet pumps) are utilized to transfer fuel. All tanks are usually pressurised to prevent fuel boiling at altitude (using ram air or engine bleed air) with the pressure being maintained and controlled by duplicated vent valves. Typically, a gauging system is provided to display the contents of each tank and total fuel contents, and flowmeters indicate fuel flow to each engine. If fitted, a jettison system allows fuel to be jettisoned from each main collector tank via a master jettison valve. When an in-flight refuelling system is provided, the aircraft is fitted with a probe (fixed or

retractable) or receptacle, and fuel from a tanker aircraft is fed via the probe or receptacle into the main refuel gallery via a non-return valve.

17.8.2 Test Instrumentation

Typically the following fuel system parameters must be measured:

- Fuel contents in each tank, and total fuel remaining
- Fuel pressure in the refuel gallery, and at the inlet to each refuel valve
- Fuel pressure at the outlet from each transfer pump and each booster pump
- Air pressure in each tank vent system
- Fuel flow to each engine
- Fuel temperature in each tank and at each booster pump outlet

17.8.3 Preliminary Rig and Ground Tests

The preliminary bench and rig tests (Stage A tests) will normally include an "iron bird" representation of the fuel system, mounted on a multiple degree-of-freedom suspension system, so that the effects of fuel state, aircraft attitude and fuel flow paths and rates can be investigated prior to flight. On-aircraft ground tests with the engine(s) running (Stage C tests) should then be undertaken to confirm correct functioning of the whole fuel system, and satisfactory interfacing with other related aircraft systems (e.g., electrical system), when the fuel system is operated in accordance with the specified normal and emergency operating procedures. The ground tests (during which correct functioning of the flight test instrumentation may be checked) should cover the following specific tests of fuel capacity and refuelling/defuelling.

It should be confirmed that the tank capacities, unusable fuel levels, and undrainable fuel levels determined from the rig tests are valid for production aircraft. The tank capacities and the accuracy of the fuel gauging system may be measured by filling each from the drained condition in sequence, using a calibrated fuel truck and/or weighing the fuel truck and/or the aircraft. The accuracy of the fuel gauging system should be checked both with the aircraft in the normal ground attitude and with it jacked to a pitch attitude typical of cruising flight conditions. The low level warning system performance and the unusable fuel levels may then be determined by emptying the tanks from full, using the booster pumps, and measuring the quantities of fuel removed when the booster pump delivery pressure drops. Appropriate test procedures will be needed to remove and measure the undrainable fuel. It should also be confirmed (during the environmental trials of Section 18) that the expansion spaces are adequate to accommodate the volumetric change in the fuel when the aircraft, filled with 'cold' fuel, is hot soaked in the highest required ground level ambient temperature (i.e., that no venting occurs).

It should also be confirmed that the flow rates, total time to full and surge pressures at shut off are satisfactory during gravity and pressure refuelling when using a Service fuel truck, and similar to those obtained on the rig. Similarly, it should be confirmed that the flows, pressures and the control of the contents remaining are satisfactory during defuelling using Service equipment and procedures.

17.8.4 Flight Tests

Tests covering the various aspects of fuel system performance should be carried out progressively over the entire flight envelope of the aircraft, as described below.

Tests should be conducted to show that transfer of fuel, in the correct sequence, from internal and external tanks to the collector tanks (or to other tanks as required for the centre of gravity to be maintained within

AIRFRAME TESTS

limits) can be achieved under all flight conditions permitted by the aircraft's manoeuvre envelope (e.g., under positive and negative 'g', including sustained turns, in steep dives and climbs, and under high longitudinal acceleration and deceleration). These tests should be repeated for any alternative transfer modes (e.g., following simulation of transfer valve failure, where appropriate). An assessment should also be made of other fuel management features within the system such as:

- Tank interconnect (i.e., the rate of transfer, both ways, between interconnected tanks)
- Cross feed (the selective use of booster pumps with cross feed open).

The fuel gauging should be monitored throughout these tests to assess gauging stability (e.g., 'g' compensation), and the consistency of the contents and totaliser indications.

The behaviour of the pressurisation and vent system should be assessed to verify that, under all flight conditions, sufficient constant pressure supply is available from the engine bleed air and/or inward ram air sources, and that the vent system controls the tank pressurisation within the specified limits. The principal test conditions that need to be investigated are:

- Maximum rate climb from sea level to high altitude
- Rapid descent, with engines at idle, from high to low altitude
- High angle of attack and yaw manoeuvres (to assess the performance of the ram air intake)
- Subsonic, transonic and supersonic flight conditions (to assess vent system pressures).

The capability of the fuel system to deliver sufficient fuel at the correct pressure to sustain the engine should be confirmed throughout the flight envelope, particularly during dynamic flight manoeuvres with high power settings (where collector tank capacity and the resultant 'g' vector lead to the most critical conditions for fuel supply), such as:

- Maximum performance takeoff, followed by maximum rate climb from sea level to maximum altitude
- Dive from maximum to low altitude with maximum nose down attitude, accelerated and decelerated
- High speed at low level in the maximum obtainable ambient temperature
- Rolls through 360 degrees to the left and right
- High angle of attack manoeuvres with engines at maximum power
- Combat manoeuvres at low fuel contents and high power settings.

In addition, representative conditions should be repeated for each type of fuel with which the aircraft is to operate.

Each fuel group/engine combination should also be tested independently, in dry and reheat power, in negative 'g' pushovers, zero 'g' pushovers, and in inverted flight, working up progressively to the specified time limit for zero 'g' and inverted flight.

The behaviour of the low fuel contents and booster pump low pressure warning systems should be assessed throughout the above manoeuvres and, finally, the suction feed capability in both dry and reheat power (i.e., booster pumps selected OFF to simulate pump failure) should be evaluated.

The fuel/oil cooling system should be assessed to verify that the fuel and (gearbox and /or hydraulic) oil temperatures and pressures in the system remain within limits under all conditions, particularly at low fuel

contents. These tests should cover normal flight conditions, sustained periods at ground idle (including taxiing) and (in conjunction with the Environmental Testing of Section 18) sustained high subsonic speed in dry power at low level following a high temperature ground soak.

Assessment of the jettison system should aim to verify that it performs correctly and does not adversely affect any other system. Thus the tests should confirm that:

- The fuel supply to the engines is satisfactory during fuel jettisoning, no fuel contamination of the aircraft occurs and no fire hazard is created
- Fuel jettison has no adverse effect on control of the aircraft's centre of gravity
- The jettison rate achieved meets the specified requirement.

For virtually all combat aircraft, and many (if not most) military cargo and transport aircraft, flight refuelling operations will be required against a number of different tanker aircraft. While reference 17-17 provides a full description of the testing involved, the general principles may be summarised as follows. Preliminary ground tests should be conducted to confirm probe/drogue or boom/receptacle compatibility, and to verify satisfactory flow rates and acceptable surge pressures in the refuelling galleries at refuel valve closure. Prior to attempting fuel transfer in flight, "dry" contacts should be made to assess aircraft and engine handling in the standoff position, during the approach to contact, when in contact and during normal and emergency disconnects, with any "bow wave" effects on the reception basket being noted. These "dry" contacts should be carried out over a range of speed and altitude to establish the limiting and optimum flight conditions from tanker and receiver handling considerations. A series of wet contacts should then be made, starting at the optimum conditions, to evaluate:

- The refuel pressures in the refuelling galleries during steady state refuelling, and the surge pressures developed during refuel valve closure as tanks become full
- The total refuelling time required
- Any tendency of the aircraft to vent fuel during refuelling or on completion of refuelling
- The cg movement (to ensure that the limits are not exceeded)
- Normal and emergency disconnection from the drogue/receptacle, ensuring with a drogue that any fuel spray does not contaminate the canopy or cause any system malfunction (e.g., engine surge due to fuel ingestion).

Further reading on fuel system testing is provided by references 17-18 and 17-19.

17.9 HYDRAULIC SYSTEM

17.9.1 Description of System

In general, hydraulic systems provide power for the actuation of other aircraft systems (such as primary and secondary flying control actuators, undercarriage lowering/raising, brakes, nose wheel steering, canopy and cargo door opening/closing, etc.), many of which incur large operating forces.

On multi-engined aircraft, each engine normally drives a completely separate and independent hydraulic system via an hydraulic pump mounted on its auxiliary gearbox, and there is usually provision to duplicate the motive power source of each system either hydraulically, electrically, or pneumatically. On twin-engined aircraft there may be provision to drive a failed engine's gearbox from the live engine, thus maintaining operation of both hydraulic systems. On some single-engined aircraft two separate hydraulic systems are powered from pumps mounted on an auxiliary gearbox.

AIRFRAME TESTS

The hydraulic pump of each system draws fluid from its reservoir and delivers fluid to the sub-system actuators at high pressure (up to 4000 psi) via a filter and an accumulator (which is generally pressurised using nitrogen gas). Fluid returning to the reservoir passes through another filter and, on some aircraft, a cooler (generally a fuel-cooled heat exchanger) to prevent overheating of the fluid during periods of high demand. Downstream of the accumulator the delivery lines divide into the various services with, typically, one branch serving the flight controls and a second one the utilities (i.e., undercarriage, brakes, canopy, nose wheel steering, etc.). The systems provide fully duplicated power supplies to all actuators in the flight control system and, should a system fail, priority is given to the flight control system at the expense of the utilities system.

Some aircraft have a Ram Air Turbine which can be deployed into the airstream to provide hydraulic power in emergency (see Chapter 17.11, below), and/or an auxiliary power system which can drive one of the hydraulic pumps for ground operation and in emergency situations. Additionally, the accumulator(s), which is/are pressurised with gaseous nitrogen, offer(s) a limited source of hydraulic power should all other sources fail.

17.9.2 Test Instrumentation

Typical parameters required to assess the performance of a hydraulic system are:

- Hydraulic fluid pressure at the outlet from each pump, at the input and return lines to selected flight control system and utilities actuators, and to the brake line
- Hydraulic fluid temperature at the outlet from each pump, the return line from selected flight control and utilities actuators, and the cooler inlet and outlet (if fitted)
- Hydraulic fluid content in each reservoir
- Hydraulic fluid flow outlet from each pump
- Nitrogen pressure in each accumulator.

17.9.3 Preliminary Rig and Ground Tests

Following the satisfactory completion of the bench and rig testing (Stage A tests), on-aircraft ground tests with the engines running (Stage C tests) should be undertaken to confirm correct functioning of the whole hydraulic system, and satisfactory interfacing with other related aircraft systems (e.g., flying control and secondary power systems), when the hydraulic system is operated in accordance with the specified normal and emergency operating procedures.

With the aircraft on jacks, it should be demonstrated that the pressures and temperatures throughout the hydraulic system are in agreement with those obtained on the rig, and that the operating times of all actuators are satisfactory, during both normal and emergency (i.e., single system failed) operation of all services (especially during operation of the undercarriage which imposes a large load on the hydraulic system). A test is sometimes made of the capacity of the accumulator to provide for "last-ditch" operation of the primary flying controls for a controlled escape in the event of total failure of the hydraulic pumps (as could occur following seizure of the engine(s) due to multiple bird strikes). With the accumulator fully charged, and all engines shut down, representative conservative control inputs are made about all axes and the time available before all hydraulic pressure is lost (and the flight control actuators "freeze") is measured.

It should also be verified that the stabilised temperatures throughout the system do not exceed the fluid or system component temperature limits during simulated taxi and hold prior to take off and, if required, during standby conditions. Such tests are an important element of the climatic tests described in Section

18, when a prolonged soak in high temperatures can result in exceedance of the permitted maximum fluid or component temperatures, and a prolonged soak in cold temperatures can result in fluid leaks due to reduced compliance in the various seals.

17.9.4 Flight Tests

The following hydraulic system performance tests should be carried out progressively over the entire flight envelope of the aircraft: in most cases they can be combined with tests of associated systems (e.g., flying control system, undercarriage system, etc.).

Initially, tests of single service operation (i.e., primary flying control inputs only, flaps only, undercarriage only, etc.) should be made in steady state flight conditions, checking that pressures, flows and operating times are in accordance with those found during rig and ground tests. Once confidence in their performance has been gained, services should be operated simultaneously to check that the system provides adequate flow and pressure during high hydraulic demands.

The above testing should then be repeated with the engines at flight idle to check that adequate flow and pressure is still available. Further tests should also be undertaken by operating the services under positive, negative and zero 'g' conditions and, if required, in inverted flight (where a particular watch should be kept for any pressure fluctuations, or total loss, due to air in the system).

The testing must build up to the worst case conditions which, for the hydraulic system, normally arise during approach and landing when the engine power settings are low and the hydraulic demand tends to be high (i.e., large primary flying control inputs due to the low speed coupled with operation of flaps, slats, and undercarriage).

The tests above should be repeated with single hydraulic system failure simulated by switching one system off, or by closing one engine down.

As noted in para 17.9.3 above, environmental testing of the hydraulic system is an important element of the climatic tests described in Section 18 and, following a prolonged soak in the prevailing hot or cold temperature extreme, the aircraft should be flown immediately in the appropriate "worst-case" conditions (high speed/low level and maximum altitude, respectively) to confirm that the performance of the hydraulic system remains satisfactory.

Further advice on the testing of hydraulic systems is offered in reference 17-20.

17.10 OXYGEN SYSTEM

17.10.1 Description of System

The oxygen content of the atmosphere decreases with altitude such that, to avoid adverse physiological effects, it must be supplemented above 10,000 ft (3,000 ft to avoid a deterioration in night vision). In civil and multi-seat military aircraft it is normal for the Environmental Control System (see Chapter 17.5) to maintain the cabin altitude at about 5,000 ft, so that supplementary oxygen is only required in the (unlikely) event of loss of pressurisation or contamination of the cabin air. The emergency system provided (based on bottled oxygen with continuous flow/"drop-out" masks for the passengers and masks with full regulator demand and pressure breathing for the aircrew) is intended only to permit (rapid) safe return to low altitude. This chapter therefore deals only with oxygen systems more typical of combat aircraft where, to ease structural design and to allow mission completion in the event of loss of cabin pressure (e.g., due to enemy action), each crew member is provided with an oxygen mask for continuous use throughout the sortie.

AIRFRAME TESTS

Typically, each mask is supplied with breathing gas which is either a mixture of cabin air and oxygen (airmix) or 100-percent oxygen. When selected to airmix, oxygen is mixed with cabin air in proportion to the cabin altitude, 100-percent oxygen being supplied when the cabin altitude is 32,000 ft or above. At low altitude, breathing gas is supplied in response to a breathing demand, but at cabin altitudes above 15,000 ft it is supplied at a slight positive pressure (safety pressure) and at cabin altitudes between 38,000 ft and 50,000 ft it is supplied at a pressure proportional to the cabin altitude to provide pressure breathing. With 100-percent oxygen selected, safety pressure is available from ground level to counter possible contamination of the cabin air, and above 15,000 ft the delivery characteristics are the same as with airmix selected. A separate emergency oxygen system provides 100-percent oxygen for 10 minutes to each crew member should the main oxygen system fail, or during an ejected escape from the aircraft.

The oxygen supply source may be:

- Storage bottles containing gaseous oxygen under high pressure (as these are now largely superseded because of their mass and volume, they will not be discussed further)
- A liquid oxygen converter
- An on-board oxygen concentration system.

Liquid oxygen is stored in fully stabilised 10-litre spherical containers, or converters, designed to be readily removable from the aircraft during routine servicing. They are fitted with a capacity gauging system and a warming coil to provide gaseous oxygen at a temperature suitable for breathing. The oxygen is delivered to each crew station service unit (which contains a shut off valve, a flow sensor and a low pressure warning switch), and then passes via a flexible hose to a regulator assembly fitted to the ejection seat adjacent to the personal equipment connector. The regulator assembly consists of both an airmix demand regulator and a 100-percent oxygen demand regulator, selectable by means of a switch, and a compensated dump valve controlled by the pressure in the reference chamber of the regulator in use which ensures that the pressure in the mask cavity does not exceed the acceptable value. From the regulator assembly the selected breathing gas passes via the personal equipment connector to the oxygen mask.

Although used successfully over the past few decades, liquid oxygen systems pose obvious significant logistical problems and several systems of on-board oxygen generation are in use or under development, e.g., the On Board Oxygen Generation System (OBOGS) fitted to the Harrier II family. Typically, bleed air from the engine compressor is cooled and its pressure reduced before it is passed through an oxygen concentrator, or molecular sieve, based on a bed of zeolite crystals. The pore size of the zeolite retains nitrogen molecules, resulting in enrichment of the oxygen content of the breathing gas. When the zeolite is saturated with nitrogen molecules, it is purged for re-use by a reverse flow of oxygen. The use of two or three beds of crystals allows simultaneous enrichment and purging, and hence a continuous flow of breathing gas, with the gas flows being controlled to achieve the required oxygen level. The oxygen content of the breathing gas supplied to the crew is monitored continuously, and if/when the partial pressure of the oxygen falls below the limit appropriate to the cabin altitude a warning is given, the output from the concentrator package shut down, and oxygen supplied from an emergency gaseous storage bottle carried on each ejection seat. The emergency supply can provide 100-percent oxygen for 10 minutes to allow descent to a lower altitude where the output from the concentrator package is acceptable or, in the event of system failure, below 10,000 ft.

17.10.2 Test Instrumentation

No special test instrumentation is usually required because that provided for normal operation by the aircrew gives adequate indication of the performance of the system. Typically, the oxygen system is provided with the following features:

- Gaseous oxygen flow indicators. For two-seat aircraft, the flow sensor in each service unit provides a signal to both crew members so that each crew member can monitor that the other is breathing normally.
- Warning of low supply pressure. Normally displayed on the aircraft's central warning panel, and based on sensors monitoring the pressure in each service unit.
- Contents indication. Emergency oxygen content is displayed on a gauge on the ejection seat and, where liquid or gaseous oxygen is carried, the oxygen content is shown in the cockpit and at the converter or bottles.
- Press-to-test facilities. Situated on the regulator assembly bodies so that an oxygen flow can be obtained to test the fit of the oxygen mask as part of the pre-flight checks and, where appropriate, adjacent to the contents gauges to test the contents indication.

17.10.3 Ground Tests

Following an initial theoretical assessment, and appropriate component bench tests and system rig tests, aircraft ground tests are conducted to assess the:

- Integration of the oxygen system into the aircraft
- Accessibility of the system components
- Functioning of the oxygen system throughout the ground level ambient temperature range for the aircraft.

The last item must, of course, be conducted over the extremes of environmental conditions for which the aircraft is to be cleared. It is normal to make an initial assessment in the prevailing "temperate" conditions (say -20°C to $+35^{\circ}\text{C}$), and then to explore the full temperature ranges required when operating (e.g., -40°C to $+50^{\circ}\text{C}$) and under "soak", non-operating, conditions (e.g., -60°C and $+90^{\circ}\text{C}$) as part of the Environmental Trials (see Section 18).

17.10.4 Flight Tests

Flight tests are usually conducted in conjunction with other testing to assess the functioning of the oxygen system throughout the flight envelope of the aircraft. Most of these tests consist of qualitative assessment by the various aircrew members of system performance and ease of use. (However, it should be noted that the advent of miniaturised data logging instrumentation has led to the development of self-contained man-mounted data acquisition systems which enable a supervising aeromedical doctor to instrument individual crew members with sensors appropriate to a number of key physiological parameters, and to correlate aircrew "performance" with oxygen system function.) These qualitative assessments are principally aimed at ensuring that:

- The supply of oxygen to crew members is satisfactory under all flight conditions, especially during conditions of high psychological stress (e.g., takeoff and landing) when there may be a tendency to hyperventilate, and under conditions of high physical stress (e.g., during aerobatics and air combat manoeuvres)
- Use and control of the system is straightforward under all operational conditions, and all system status indications (especially warnings) are always readily interpreted
- The noise levels of the oxygen system are satisfactory under all flight conditions
- Passenger oxygen masks are presented, as appropriate.

While these assessments will, of course, be initiated on early development aircraft, it is not unusual for the oxygen system and the masks provided with the Aircrew Equipment Assembly to be unrepresentative at that stage of the production standard. Further tests will therefore be required on a representative production aircraft to confirm the validity of system characteristics established on earlier standards.

Further reading on the testing of aircraft oxygen systems is included in reference 17-13.

17.11 SECONDARY POWER SYSTEM

17.11.1 Description of System

The Secondary Power System consists of the sources of power (electric, hydraulic, pneumatic, etc.) required to operate the aircraft's utilities and systems. These are normally driven by power transfer from the main engine(s) but may also be driven by power transfer from one system to another and, in many cases, by one or more independent sources of motive power. Clearly, the architecture of the secondary power system must be such that loss of a secondary power source does not adversely affect safe and effective operation of the aircraft.

The main source of secondary power is by means of power transfer from the engine(s) via an auxiliaries gearbox on which are mounted the electrical generator(s) and hydraulic pump(s), etc. In the case of turbine powered aircraft, air bleed from the engine compressor is also used as a source of secondary power (e.g., to power the Environmental Control System, see Chapter 17.6). Redundancy is provided by fitting an auxiliaries gearbox to each engine which can be cross-driven by the other engine, either by bleed air or (where the engines are in close proximity in twin-engined aircraft) by a shaft. Alternative means of transferring secondary power may also be incorporated, e.g., hydraulic power may be maintained by "back-to-back" pumps in adjacent hydraulic circuits, or by electrically driven pumps.

To maintain secondary power in the event of failure of the main engine(s), or of the engine-mounted generators, pumps and drive systems, it is usual to provide one or more forms of independent motive power. In its simplest form this may be a battery, but other forms of providing pneumatic, hydraulic and electrical power include:

- Auxiliary Power Unit (APU), a small gas turbine used to provide high pressure air both to start the main engines and (often) to drive the auxiliaries gearbox(es) of the main engine(s) via an air motor and/or provided with an independent hydraulic pump and electric generator
- Ram Air Turbine (RAT), a small turbine which can be deployed in the airstream to drive a hydraulic pump and/or electric generator, etc.
- Emergency Power Unit (EPU), a "one-shot" source of emergency hydraulic and electrical power of limited duration (e.g., a turbine motor driven by a hypergolic mixture) usually fitted only where there is a risk of total loss of engine power combined with low dynamic pressure (rendering a RAT ineffective), such as may be encountered during high incidence testing.

The main sources of secondary power (by power transfer) are discussed in the appropriate chapters dealing with the electrical and hydraulic systems, and therefore this chapter is restricted to independent sources of secondary power (auxiliary power sources) such as APU, RAT and EPU.

17.11.2 Test Instrumentation

The standard of instrumentation should be such that the performance of the auxiliary power source under consideration, and its interaction with the aircraft's systems, can be monitored continuously. Clearly, the parameters required will depend on the type of installation to be tested. In the case of a RAT, its input

(which will depend on aircraft speed and altitude) might be defined by turbine blade pitch and rotational speed, and its outputs to the aircraft systems defined by frequency, voltage and current (electrical generator), and flow rate and pressure (hydraulic pump). For a gas turbine powered APU, the instrumentation required to assess its performance will be very similar to that for the main power plant(s). If the auxiliary power source is selected by an automatic system, the criteria which trigger the system should also be recorded. (NOTE: For test purposes, it may be necessary to provide manual control of the auxiliary power source.)

17.11.3 Preliminary Rig and Ground Tests

The types of tests required will depend on the architecture of the aircraft's secondary power system and the type of auxiliary power source under consideration. They will invariably include some form of preliminary rig tests followed by ground tests on the complete aircraft ("Stage B" tests) where the interfaces between the auxiliary power source and the other aircraft systems are, of course, fully representative. Indeed, in the case of an APU designed as the primary means of starting the main engine(s), extensive ground tests (many of which will be conducted as part of the Environmental Tests, see Section 18) will be necessary to demonstrate that:

- The APU can be started (and restarted when hot) and operated over the specified range of ambient conditions (i.e., altitude, temperature, wind strength, and direction), using each specified type of fuel
- Ventilation and drainage of the installation is satisfactory for the maximum required period of operation, and exhaust gas impingement on the aircraft structure has no unacceptable effects
- The APU achieves the required level of performance in all respects (e.g., in starting the main engines, driving the hydraulic and electrical systems, etc., and, where applicable, in exercising the correct priorities).

Similarly, appropriate ground tests should be made of the installed performance of any other auxiliary power sources, such as:

- Using a motor to drive a RAT at the rotational speed expected at a given airspeed to enable its power output(s) and interfacing with the relevant aircraft systems (electrical, hydraulic, etc.) to be assessed or
- Measuring the endurance of the batteries when operating as the sole source of secondary power. (In the case of a UK maritime patrol aircraft, the batteries were required to drive the hydraulic pumps to power the flying control system throughout a descent and controlled ditching in the (admittedly very unlikely) event of failure of all four engines: this was simulated on the ground, with the flying controls being exercised for 20 minutes in what was judged to be a representative manner, to confirm that the battery capacity was adequate.)

17.11.4 Flight Tests

The purpose of the flight tests is to define or confirm the flight envelope over which the behaviour of each type of auxiliary power source is satisfactory. The tests must be conducted under conditions representative of the intended Service operations. In the case of an APU they should cover the full range of climatic conditions and each type of fuel (including the extremes of specific gravity) for which clearance is required.

The tests must establish the flight envelopes over which the APU can be started, or the RAT deployed and operated, and should define the flight envelopes over which the performance remains satisfactory, particularly in the case of the RAT. The details of the test configurations will reflect the architecture of

AIRFRAME TESTS

the secondary power system (and thus, the circumstances under which the auxiliary power source is likely to be used), any automatic control features, safety or interlock switches, and the results of the preliminary rig and ground tests. In the case of an APU or RAT, where the auxiliary power available is sensibly of unlimited duration (although the operating time of an APU may be limited by oil capacity, or the rise in bay temperature), the ability of the auxiliary power source to supply on a continuous basis hydraulic or electric power following failure of the engine(s), or engine-mounted pump(s) and generator(s) should be measured.

The tests should also determine, as far as is practicable from flight safety considerations, how well each auxiliary power source or combination of sources provides for:

- The aircraft to be maintained under full control until the engine(s) can be relit (including the worst case of a flame-out at the service ceiling followed by a descent to the engine relight altitude)
- The aircraft to be controlled for sufficient time to permit a safe evacuation to be carried out (this test is less severe, and would not be required if the previous one yielded satisfactory results)
- An emergency descent and landing to be completed with the engine(s) at idle to simulate failure and, where appropriate, normal sources of secondary power "off line".

(In the case of certain "one-shot" devices of limited duration, such as an EPU, the risks of conducting representative tests in flight may be considered unacceptably high. In such cases particular care should be made to obtain valid data from rig testing.)

Reference 17-21, although primarily concerned with propulsion aspects, offers some advice on the testing of the engine-driven secondary power system.

17.12 UNDERCARRIAGE, WHEELS, AND BRAKES

17.12.1 Description of System

As is self-evident, all land-based, fixed-wing aircraft require some form of undercarriage to permit ground movement for positioning (taxying), takeoff, and landing. The undercarriage must cushion the residual rate of descent at touch down, and absorb the effects of irregularities in the operating surface (particularly important when operating from unprepared surfaces such as grass or temporary taxiways/runways formed, for example, of Pre-fabricated Surface Aluminium (PSA)). Clearly, the tyres must be suitable for the loads/speeds involved, and some form of steering and braking must be provided.

Most current aircraft are equipped with a retractable tricycle undercarriage, which is raised and lowered by hydraulic power. When retracted, the wheel wells are closed by doors (usually operated by mechanical linkages from the actuating mechanism). Dictated mainly by ground loading and/or stowage requirements, the main undercarriage may be fitted with a single wheel (e.g., combat aircraft) or multiple wheels with or without bogies (e.g., large aircraft). Typically, shock absorption on all legs is provided by an oleo-pneumatic suspension in which high pressure gas or nitrogen provides the spring, and restriction of oil movement by metering valves provides compression and rebound damping. Steering may be by differential mainwheel braking in association with a castoring nose/tail wheel or, more commonly, by a steerable nose leg.

Brakes are usually fitted to the main wheels only, and are generally of the multiple disc type, i.e., a series of rotors and stators lined with friction material forced into contact by hydraulic pressure. The brakes must have sufficient capacity to cope with the worst case (rejected take-off at high mass/speed) and provide satisfactory lining life in normal use. To protect the tyres and avoid incidents on low-friction surfaces or due to pilot error, an anti-skid system is normally provided in which the applied brake pressure is relaxed automatically if an excessive rate of wheel deceleration is detected.

Dissipation of the aircraft's kinetic energy via the brakes can result in large inputs of heat to the wheels and thence to the tyres. To guard against the risk of explosive failure of the tyres following a rejected takeoff or landing at high mass, the wheels are often provided with fusible plugs which deflate the tyres before a dangerous temperature is reached, and may be fitted with brake cooling fans. The tyres, which may be of cross-ply or radial construction, tend to run with considerably higher deflections than is the case in the automotive world. This results in an appreciable rise in carcass and bead temperature when rolling, and can impose limitations on the total ground movement distance allowed, particularly for operation in high ambient temperatures.

17.12.2 Test Instrumentation

For ground and flight tests of the complete aircraft, the test instrumentation parameters required are usually limited to:

- Oleo closure on all undercarriage legs
- Applied brake pressure (both legs with single main wheels, representative left and right wheels for multiple wheel/bogie arrangements)
- Brake pack temperature (as for brake pressure)
- Tyre bead temperature (as for brake temperature)
- Rotation of undercarriage leg (for shimmy tests, if required).

(NOTE: Tyre bead temperature is usually measured by a hand-held probe inserted into a hole pre-drilled through the tyre wall, but it is preferable to provide a suitable sensor attached to the wheel so that tyre temperature can be measured continuously and the danger to the person taking the measurements minimised.)

17.12.3 Preliminary Rig Tests

A series of preliminary rig tests are conducted by the relevant component manufacturers to qualify individual components for flight. For example, the undercarriage is subjected to drop tests to validate the design assumptions and to confirm that its energy absorbing capabilities and rebound characteristics, etc., are satisfactory. These tests normally cover the design case (maximum landing mass and vertical velocity), the ultimate load case (to confirm that failure occurs in the manner and at the conditions predicted) and the effects of variations in nominal conditions, e.g., in tyre and oleo pressure, or oil contents and temperature, etc. Similarly, the capabilities of the tyres and brakes are demonstrated by their respective manufacturers using appropriate dynamometer equipment.

Where the aircraft is required to operate from other than a smooth, paved runway, i.e., from unprepared or semi-prepared surfaces, over slab or mat-repaired runways, or from carriers, it is highly desirable that the manufacturer prepare appropriate mathematical models of the response of the aircraft/undercarriage to assist in test planning and monitoring.

17.12.4 Ground Tests

This Section deals with the engineering tests of the undercarriage system. All are conducted on the ground, but many will be made in conjunction with the aircraft performance and handling tests of Sections 13 and 15. However, dedicated tests may be necessary to investigate such aspects as trampling of arrestor gear cables, undercarriage behaviour on semi-prepared surfaces and tyre temperature rise (especially in high ambient temperatures; see Section 18).

AIRFRAME TESTS

Before commencing flight trials, the aircraft should be mounted on jacks and satisfactory retraction and extension of the undercarriage demonstrated using both the normal and emergency systems, e.g., extension by "freefall", and/or "blow-down". Ideally, these tests should be repeated at the required extremes of ambient temperature to confirm that the operating times and the fit and clearance of the locks and undercarriage doors remain acceptable.

The behaviour of the undercarriage during taxiing and ground manoeuvring should be monitored, and the minimum radii of turn achieved using the available methods of steering (including reverse thrust, where applicable) measured. The oleo closures incurred during taxi, takeoff, and landing at the appropriate maximum permitted values of aircraft mass should be recorded to ensure that adequate travel remains under all conditions likely to be met in Service use. The ability of the aircraft to trample rigged and rigged/tensioned arrestor cables without sustaining damage should be assessed on each type of arresting system likely to be encountered in Service use, and the appropriate maximum trampling speeds determined for promulgation in the Aircrew Manual. [17-22, 17-23]

Where operation on and from/to semi-prepared surfaces, or from/to carriers is required, particular care is needed to monitor oleo closures (especially, in the latter case, in the presence of ship pitch). During operation on semi-prepared surfaces, or on snow or slush covered runways, the undercarriage and its fittings (hydraulic brake lines, etc.) should be inspected for any signs of damage, or interference with the functioning of operating mechanisms and indication systems.

Dedicated tests may be required in respect of shimmy (a lateral and/or rotational oscillation of an undercarriage leg, usually the nose leg) whose characteristics depend on the undercarriage design. If there is any concern that the damping of this mode (which decreases with increase in groundspeed) could fall below an acceptable level, an oscillation of the leg may be provoked by running the wheel over a small obstacle fastened to the runway, and the damping of the oscillations determined from analysis of records of leg rotation. The test should be repeated at increasing groundspeed until it is confirmed (or otherwise) that the damping remains acceptable up to the maximum groundspeed that will be encountered in Service.

Several rejected takeoffs should be simulated to confirm that the kinetic energy absorption capability of the brakes is as predicted from the manufacturer's dynamometer tests, and to check that no untoward characteristics are encountered. These tests must be conducted progressively, i.e., by increasing aircraft mass and/or brakes-on speed for successive tests, with the brake pack being subjected to a "tear-down" inspection after each to check for any signs of damage, and to judge whether replacement of the brake pack is necessary before proceeding to the next. Subject to satisfactory results at lower values, the tests should be continued until the kinetic energy input to the brakes is 90-95 percent of the design value. In addition to these tests of brake capacity, the brake performance and operating characteristics should be monitored throughout the flight test phase (with physical inspections being made whenever judged necessary) to confirm that they are satisfactory under all conditions encountered, and to judge the brake life likely to be achieved in Service use.

The tyre operating characteristics will have been determined by the manufacturer from his dynamometer tests, and he will have declared such parameters as the maximum tyre bead temperatures and the estimated ground roll distance, dependent on aircraft mass, at which they will be reached. The accuracy of these estimates should be assessed by measuring the tyre temperature rise after a known ground roll distance, e.g., following landing and return to dispersal, and, in some cases, it may be desirable to conduct prolonged taxi tests for this purpose. These tests are particularly important when operating in high ambient temperatures especially at elevated airfields, when the groundspeeds associated with takeoff and landing can be significantly greater than normal. Further, the rates at which the tyres cool once the aircraft is at rest, with and without the use of any installed or ground equipment brake cooling fans, should be measured to determine the effect on turn-round times. Finally, the tyres should be frequently inspected for any signs of damage, particularly when operating on semi-prepared surfaces.

Further reading on undercarriage and brake testing is provided by references 17-24 and 17-25.

17.13 CONCLUDING REMARKS

While readers will appreciate that the introductory nature of this Volume has permitted only the most "broad brush" treatment of the principal systems covered by airframe testing, it is hoped that the general overview provided in this Section will prove of interest and value to those less familiar with the systems involved, or of their assessment.

It is re-emphasised that systems testing is crucially dependent on design detail in a way that other testing is not. For example, for aspects such as handling qualities, or electromagnetic compatibility, the test programme conducted and instrumentation suite employed are largely independent of the aircraft's design (even if the results obtained are not!). On the other hand, for the airframe tests the details of the test procedures, and of the test instrumentation sensor characteristics and locations, must be chosen to reflect the specific design features of the systems involved which, in turn, requires an intimate knowledge of system function and architecture.

The criteria of acceptability applicable to the Airframe Tests fall into two classes:

- Quantitative criteria which are defined in general specifications (such as Military Specifications in the US, and Defence Standards in the UK) and/or in the Aircraft Specification itself
- Qualitative criteria, or "engineering judgements", which are based on assessment of the likely significance of the observed system "performance" under the anticipated circumstances of Service use.

In principle, criteria belonging to the first class are readily applied (although, in practice, it may prove difficult to establish the exact conditions required for test purposes). Criteria of the second class are much more dependent on the judgements of the assessor, and those judgements will only be reliable if he/she has sufficient relevant experience on which to base them. The neophyte FTE should therefore actively seek and encourage assistance from those more experienced than him/herself, and should recognise that the observations and opinions of technicians and mechanics who have "seen it all before" (or, at least, something very similar) can be invaluable.

Finally, it must be recognised that, in the never-ending search for greater capability and efficiency, the systems of each successive aircraft design are likely to be more complex than those of its predecessors. In particular, there is a marked (and irreversible?) trend towards greater integration of the systems covered by this Section, controlled by digital computer, with an associated reliance on software. While the individual disciplines, e.g., in respect of electric, hydraulic, oxygen, etc., systems, will remain, the FTE of the (near) future will also have to pay considerable attention to the overall control system (known, in the case of the EF 2000 project, as the Utilities Control System).

17.14 ACKNOWLEDGEMENTS

This Section is based mainly on expert advice from the following contributing authors:

<u>Name</u>	<u>Chapter</u>
D.A. Grocott	17.2, 17.5 & 17.10
A.J. Horner	17.4, 17.7, 17.8 & 17.9
V.C. Hibbert	17.6
R.J. Kilford	17.11 & 17.12
T.J. Martin	17.3

17.15 REFERENCES

- [17-1] Hunter, H.J., "Developmental Airdrop Testing Techniques and Devices", AGARDograph 300 Flight Test Techniques Series, Vol 6, 1987.
- [17-2] Tracy, W.V. Jr., "Aircraft Arresting Gear Testing", 6520th Test Group, Airframe Systems Division, Subsystems Branch Handbook, undated.
- [17-3] "Joint Airworthiness Requirements (JAR) - 25, Large Aeroplanes", Change 13, 5 October 1989, published and distributed by the CAA on behalf of the Joint Aviation Authorities' Committee.
- [17-4] DEF-STAN 00-970, "Design and Airworthiness Requirements for Service Aircraft, Volume 1, Aeroplanes".
- [17-5] Norris, E.J.(editor) et al., "Performance Division Handbook of Test Methods for Assessing the Flying Qualities and Performance of Military Aircraft", Volume 1 Aeroplanes to Amendment List (AL)9, A&AEE, May 1989.
- [17-6] "Basic Principles of Flight Test Instrumentation Engineering", AGARDograph No 160 Flight Test Instrumentation Series, Vol 1 (Issues 1 and 2).
- [17-7] MIL-STD-704, "Electrical Power, Aircraft, Characteristics and Utilization".
- [17-8] BS 3G100, Part 3, "Characteristics of Aircraft Electrical Power Supplies".
- [17-9] EUROCAE ED-14B/RTCA DO-160B, "Environmental Conditions and Test Procedures for Airborne Equipments".
- [17-10] DEF-STAN 00-970, "Design and Airworthiness Requirements for Service Aircraft, Volume 1 Aeroplanes", Chapters 707 & 1001.
- [17-11] Lush, K.J., "Electrical Subsystems Flight Test Handbook", AFFTC-TIH- 84-1, January 1984.
- [17-12] Tracy, W.V. Jr., "Engine Inlet/Nose Tire Water Ingestion", AFFTC Systems Engineering Branch Handbook, Vol II, Chapter 5, September 1979.
- [17-13] Lush, K.J., "Environmental Control Subsystems Flight Test Handbook", AFFTC-TIH-82-1, December 1982.
- [17-14] "Human Tolerance to Parachute Opening Shock", Air Standard Coordinating Committee (ASCC) Advisory Publication 61/42A, 20 September 1990.
- [17-15] "Ejection Acceleration Limits", ASCC Air Standard 61/1A.
- [17-16] "Escape System Test Methods", Draft ASCC Air Standard 61/3B.
- [17-17] Bradley, J. and Emerson, K., "The Testing of Fixed-Wing Tanker and Receiver Aircraft to Establish their Air-to-Air Refuelling Capabilities", AGARDograph No 300 Flight Test Techniques Series, Vol 11, December 1992.
- [17-18] MIL-F-17847B, "Fuel Systems: Aircraft, Installation and Test of".

- [17-19] Lush, K.J., "Fuel Subsystems Flight Test Handbook", AFFTC-TIH-81-6, December, 1981.
- [17-20] Lush, K.J., "Hydraulic Subsystems Flight Test Handbook", AFFTC-TIH-83-2, August 1983.
- [17-21] "Propulsion", 6520th Test Group, Flight Dynamics Division Handbook, Vol II.
- [17-22] Grant, W.A.K., "Arrester Wire Trampling - Recommendations for RAF Aircraft", A&AEE Report No Tech/396/Eng, 17 March 1969.
- [17-23] Cook, I.R., "Evaluation of 'Super Disc' Arrester Cable Supports", A&AEE Report No E1128, January 1995.
- [17-24] Tracy, W.V. Jr., "Landing Gear Subsystem Testing", 6520th Test Group, Airframe Systems Division Handbook, undated.
- [17-25] Plews, L.A. and Mandt, G.A., 1 Lt, "Aircraft Brake Systems Testing Handbook", AFFTC-TIH-81-1, May 1981.



Chapter 18 – TESTING UNDER ENVIRONMENTAL EXTREMES

James A. Ford

US Air Force Flight Test Center
412 Test Wing/TSSS
Edwards Air Force Base, CA 93524-6841
USA

18.0 INTRODUCTION

This section presents the typical elements of the test conduct phase of all-weather flight and ground testing. The following paragraphs will familiarize the reader with the purpose of all-weather testing, how the test vehicle is evaluated, and what the products of this type of testing are. The specific examples given in this Section will illustrate the approach taken and the tools used by the United States Air Force; however, they are exemplary of those used by other test organizations.

18.1 TYPICAL TEST OBJECTIVES

An all-weather test program consists of climatic and adverse weather tests. The climatic tests are performed under artificially controlled conditions and at selected remote sites. Adverse weather testing is conducted in extreme natural environments which are detrimental to the system under evaluation.

Separate qualification of individual components is not normally considered a part of climatic testing. It is assumed that this qualification testing has been conducted previously by the equipment manufacturer in response to acquisition program management. Past experience has shown that qualification testing at a subsystem level is not adequate to define operational capabilities, procedures, and limitations of the complete system, primarily because the interface between systems has not been evaluated. Qualification test data can be used to supplement total system data to determine proper performance during climatic extremes. [18-1]

18.1.1 All-Weather

The general objective of all-weather testing is to determine to what extent a weapon system, including its essential support equipment, maintenance personnel and aircrews can accomplish the design mission in world-wide climatic extremes. Specific objectives include evaluation of the effects of the particular environment on the integrated system, initiation of corrective actions (including design changes and problem work-around procedures), assessing operational impacts such as system effectiveness, safety, and operating/maintenance costs, and initiation of changes at an early stage in the production of the weapon system. [18-2]

18.1.2 Climatic

Climatic tests of US Air Force systems and equipment are accomplished first in the McKinley Climatic Laboratory at Eglin AFB, FL. The Laboratory is a large hangar in which the complete aircraft can be tested, with or without the engines running. (An abbreviated description of this laboratory is contained in reference 18-1. Detailed descriptions are contained in references 11 and 12 of reference 18-1). As noted in reference 18-1, the United Kingdom also has a climatic laboratory. In most other countries, artificially controlled conditions are usually limited to equipment testing and qualification. The aircraft themselves are usually tested in natural environments.

The test objective here is to determine if the system or equipment can perform its mission under world-wide climatic extremes under controlled laboratory conditions. Required extremes are spelled out in the manufacturers' Systems Specifications or Prime Item Development Specifications, which are derived from MIL-STD-210. [18-3] Testing in the laboratory allows the engineer to conduct evaluations at the most extreme conditions called for by the specification or standard, which may not be possible to attain in any given season in a natural environment. In addition, any problem areas discovered which might pose a flight safety hazard can be evaluated on the ground in a static condition and corrected as necessary prior to flight.

Climatic tests also include deployments to seasonal extreme weather sites for adverse, cold, hot, or tropical weather evaluation of weapon systems and equipment. These tests are usually done after the climatic laboratory evaluation. The test objectives are to determine the capabilities and limitations of the test vehicle under static and dynamic conditions in natural environmental extremes. The results of testing at these sites are compared with those of laboratory tests under similar conditions to verify the findings.

18.1.3 Simulated Environments

Simulated environmental tests include in-flight icing and rain, where the appropriate conditions are created by a water spray system such as used on KC-135 Serial Number 55-0128 at Edwards AFB, CA. [18-2 and 18-4] This water spray tanker is a dual-role aircraft which can quickly be converted from an uninstrumented refueling tanker to an instrumented test system for creation of a specified icing or rain cloud. The water sprays aft through a boom nozzle or array in a small conical pattern. The small pattern allows the pilot to expose only a section of the test vehicle to the icing cloud or rain such as an engine inlet or half of the windshield. This method gives him maximum control of his aircraft during exposure to hazardous conditions. The water used for in-flight icing tests contains sea marker dye to enhance visibility of ice buildup from the chase plane and in the color photographs or video records of tests.

The objectives of in-flight artificial icing tests are to determine the effects of accreted ice on the exposed surfaces of the test vehicle, such as engine inlets and first stages of the engine fan or compressor, wing leading edges, windshield, etc., and to evaluate the test vehicle's de-icing systems. What the engineer should try to find out is how much ice can be accreted without causing damage to the test vehicle or becoming a flight safety hazard.

The objectives of in-flight simulated rain tests are to evaluate the capability of windshield rain removal systems, determine the effects of water erosion on surfaces such as windshields and radomes, determine if water penetrates access areas (examples are avionics bays and compartments with mechanical components such as flight control servoactuators which may accumulate water and subsequently freeze), and how much water (up to the manufacturers' specification limits) can be ingested by an engine without causing compressor stalling or flameout. [18-2 and 18-4]

18.2 TYPICAL INSTRUMENTATION, MEASURANDS, AND DATA RATES

18.2.1 Airborne Test Instrumentation System

A basic state-of-the-art airborne instrumentation system is utilized. [18-1] Sample rate of the pulse code modulation data system varies, depending on the bit rate, number of measurands, and individual measurand sample rate requirements. Two hundred samples per second is usually the highest data rate required for climatic testing. The system may be installed internally, or in an external pod, depending on space availability. For a first-time test on a new air vehicle, the manufacturer will normally perform the installation on the assembly line. For follow-on or repeat testing on an existing air vehicle, the instrumentation system may be installed by a contractor or by the test organization. The unit size and

power requirements are determined by the number and type of measurands. In the climatic laboratory, the system control unit and tape recorder are removed from the air vehicle and placed in a conditioned booth nearby. Remote control of the instrumentation and a separate power source are provided for ground testing at the extreme weather test sites. The specifications for installation of airborne test instrumentation used by the United States Air Force are contained in AFSC Regulation 80-33. [18-5]

18.2.2 Typical Measurands and Data rates

The number of subsystem measurands may vary from 20 to over 300 depending on the complexity of the test vehicle. Typical measurands for climatic evaluation are auxiliary power unit (APU) start system pressures and fluid/gas temperatures, engine oil pressure and temperature, engine operating parameters, hydraulic system pressures and temperatures, fuel system temperatures, environmental control system temperatures and flow, and air temperatures in the various crew and avionics compartments. [18-1] The number and specific type depend on past experience with similar systems and specific engineering requirements of the weapon system under test. Typical data rates vary from one to five samples per second (sps) for near steady-state conditions such as air temperatures in crew and avionics compartments, to 200 sps for rapidly changing or dynamic conditions such as in hydraulic systems (pump inlet and outlet fluid pressure) or flight control surface movement rates.

18.3 TYPICAL TESTS

18.3.1 Climatic Laboratory

Aircraft testing in the climatic laboratory typically involves APU and engine operation and getting the subsystems and avionics on line and warmed up for flight. Aircrew and ground crew checklists are used to construct test run sheets, with modifications made as necessary to allow for the tiedown configuration on jacks in the main chamber. [18-1 and 18-2] The nose wheel can be turned and the landing gear cycled to simulate taxi and flight conditions with the test vehicle on jacks. Testing is generally patterned after a normal engine start and a selected mission profile, but the starting procedure can be varied to evaluate other modes, such as alert profiles and preflight operations involving avionics warmup using air conditioning ground carts. All of the aircraft subsystems are operated to the extent possible in the laboratory. Human factors evaluations of maintenance tasks and crew operations are performed at all environmental extremes. (See Section 20).

18.3.2 Extreme Weather Test Sites

Flight testing in extreme weather conditions should be accomplished using selected mission profiles which will most fully exercise all of the test vehicle subsystems [18-2] The same tests which were accomplished in the climatic laboratory should be reaccomplished at the extreme weather test sites using the same instrumentation. This will allow accurate comparison of data. Specific tests such as environmental control system (ECS) response to changes in control settings or full up operation of the avionics to evaluate overheat potential are integrated at appropriate points in the profiles. Typical test sites used by the US Air Force for extreme weather testing are Eielson AFB, Alaska for cold weather, Howard AFB, Panama for tropical weather, El Centro Naval Air Facility, Ca or Yuma Marine Corps Air Station, AR for hot weather testing, and Wright-Patterson AFB, OH for adverse weather.

18.4 DATA ANALYSIS CONSIDERATIONS

General areas of consideration for data analysis are APU and engine starting, hydraulic system pressurization, flight controls warmup, and ECS capacity. In cold weather, hydraulic accumulators or gas pressure bottles used for starting an APU or jet fuel starter (JFS) lose pressure and sometimes do not have

enough energy to sustain lightoff. [18-6] Time histories of fluid pressures and temperatures (and sometimes flow) must be analyzed to determine if the start system is operating as designed in cold weather. Hydraulic pump inlet and outlet pressures should be analyzed during engine start for evidence of pump cavitation or abnormal pressure oscillations. [18-10] Flight controls, nose wheel steering and other hydraulically-powered systems should be monitored during operation at extreme cold temperature to determine if movement rates are adversely affected by increased hydraulic fluid viscosity. [18-7, 18-8, 18-9, and 18-10] Time histories of ECS pack supply air and distribution system temperatures should be reviewed to determine if specification requirements for crew and avionics environments are being met. [18-11 and 18-12]

18.5 TYPICAL PRODUCTS OF TESTING

Design changes or problem workaround procedures are nearly always the end result of testing a new or highly modified weapon system in extreme environments. Operating limitations may have to be placed on certain subsystems such as an APU or jet fuel starter in extreme low temperature conditions if it is not cost effective to redesign or if workaround procedures are not practical. In many cases, component failures will be more likely in extreme environments. One example is avionics operation in hot or humid weather. A product of the testing would be to determine the increase in number of black box spares necessary to properly support the weapon system in these environments. Flight certification is also a product of all-weather testing. For example, in-flight icing tests behind a water spray tanker are done in buildup fashion on engine inlets, windshields, and wing and tail leading edges, which allows the engineer to determine limits of exposure time for safe flight. A certification might then be issued to allow limited flight in light or moderate icing conditions. [18-4]

18.6 SPECIAL CONSIDERATIONS

Whenever possible, climatic laboratory testing should be accomplished first to identify and correct any flight safety problems before flight in extreme weather conditions. Emphasis should be placed on human factors and support equipment evaluations as an integral part of all-weather testing. The manufacturer of a new aircraft should be placed under contract to install instrumentation in the all-weather test vehicle on the assembly line, using components which will withstand the environmental test temperatures that range from -54 to +49 degrees C. Provisions should always be made to allow removal of the system or format control unit and tape recorder for placement in a heated and air conditioned booth for climatic laboratory testing. The instrumentation system should also be designed for alternate use with external controls and a separate power source to permit remote operation at hot and cold weather sites. The engineer can then operate the instrumentation system on the ground without biasing the temperature soak condition of the test vehicle, and rapidly convert back to onboard controls and aircraft electrical power for flight.

18.7 CONCLUDING REMARKS

An overview of the engineering aspects of all-weather testing has been presented in the preceding paragraphs. Typical test objectives, instrumentation requirements, types of tests and data analysis considerations, and products of testing were briefly discussed. The new climatic engineer or one who must interface with climatic testing should now have a better understanding of the type of technical planning needed for this effort. It should be pointed out that the planning phase of an all-weather test program is most important. Climatic testing is very time-intensive because of tight schedules in the climatic laboratory and limited, or seasonal, weather at the remote test sites. The climatic engineer usually gets only one chance at conducting successful testing in each phase, and must be well-prepared with alternate schedules, fall-back tests, spares support, and any other backup support which will ensure timely completion.

18.8 REFERENCES

- [18-1] Hendrickson, C. L., "Flight Testing Under Extreme Environmental Conditions", AGARDograph 300, Vol 8, Flight Test Techniques Series, June 1988.
- [18-2] Tompkins, C. D. and Ford, J. A., "The USAF Approach to All-Weather Testing", AGARD 74th Symposium of the Flight Mechanics Panel, May 1989.
- [18-3] MIL-STD-210C, "Climatic Information to Determine Design and Test Requirements for Military Systems and Equipment", Department of Defense, Washington, D.C., 9 January 1987.
- [18-4] Tracy, W. V. Jr., "Natural and Artificial Icing/Rain Testing", Air Force Flight Test Center (AFFTC) Systems Engineering Branch Handbook Volume II, Chapter V, Section II, Part I, January 1980.
- [18-5] Air Force Systems Command (AFSC) Regulation 80-33, "Class II Modification of Aerospace Vehicles Research and Development".
- [18-6] Ford, J. A. and Boucher, L. M. Second Lieutenant, USAF, "F-15 Reevaluation In The Climatic Laboratory", AFFTC-TR-77-37, AFFTC, Edwards AFB, CA, December 1977.
- [18-7] Ford, J. A. and Kelly, B. R., Second Lieutenant, USAF, "E-3A MIL-H-83282 Hydraulic Fluid Low Temperature Evaluation in the Climatic Laboratory", AFFTC-TR-83-24, AFFTC, Edwards AFB, CA, July 1983.
- [18-8] Velasco, K. D., et. al., "B-52G MIL-H-83282 Hydraulic Fluid Climatic Laboratory Evaluation", AFFTC-TR-82-20, AFFTC, Edwards AFB, CA, December 1982.
- [18-9] Kelly, B. R., Second Lieutenant, USAF, "FB-111A MIL-H-83282 Hydraulic Fluid and Limited Shale Fuel Low Temperature Climatic Laboratory Evaluation", AFFTC-TR-84-7, AFFTC, Edwards AFB, CA, June 1984.
- [18-10] Tills, A. D., "KC-135R Climatic Laboratory Subsystems, Engine Vortex Induced Icing, and Limited Human Factors Low Temperature Evaluation", AFFTC-TR-84-8, AFFTC, Edwards AFB, CA, June 1984.
- [18-11] Davis, D. P., and Tompkins, C. D., et. al., "MC-130H Combat Talon II Climatic Laboratory Evaluation", AFFTC-89-18, AFFTC, Edwards AFB, CA, July 1989.
- [18-12] Davis, D. P., "Combat Talon II All Weather Assessment", AFFTC-90-33, AFFTC, Edwards AFB, CA, August 1991.



Chapter 19A – RADAR CROSS SECTION

Robert W. Borek
Principal Engineer
SPARTA, Inc.
Lancaster, CA 93535
USA

19A.0 INTRODUCTION

The material in this Section will provide the novice Flight Test Engineer (FTE) with a brief overview of the radar cross section (RCS) concept. Brief details of radar range descriptions, operations, target calibrations, and data reduction are included. It is noted that these range operations concentrate on the "static" test range rather than the much more sophisticated "dynamic" test range. The dynamic test range is what the FTE will probably work with.

Radar reflectivity measurement has developed over the last two decades from a relatively simple endeavor involving the measurement of target RCS amplitude statistics to involving wide band, coherent systems that can measure high resolution images of targets as well as, in many cases, the polarization and phasing properties. This rapid growth in RCS technology has occurred because of the increased use of radar in today's commercial and military systems. In general, the goal for commercial systems is to enhance radar reflectivity, whereas the military goal is to reduce radar reflectivity. Also, classification and identification are important for military purposes because in adverse weather radar may be the only system that may be capable of separating enemy targets from friendly ones.

This Section will discuss the fundamentals of RCS. Since the flight test techniques associated with RCS measurements are very similar to those of antenna pattern measurements, both will be presented at the same time in Section 19B Antenna Radiation Pattern Measurements.

19A.1 THE RADAR CROSS SECTION CONCEPT

The measurement of the RCS of targets, both simple and complex, is a difficult and challenging electromagnetic problem that has existed since radar was invented. Although the principles of electromagnetic theory are well developed, the application of those principles for predicting RCS often result in complex and extensive computations. Thus, there is always the need to test theory or verify predictions and these actions can usually be accomplished by test range measurements.

Stated in fundamental terms, the RCS of a target is the projected area of an **electrically large** and perfectly conducting metal sphere that would scatter the same power in the same direction as that of the target. The term electrically large is meant to mean a sphere at least several wavelengths in diameter producing a projected area of πa^2 , where a is the radius of the sphere. The echoes of most targets vary considerably with changing aspect angle and frequency but the echo of a large sphere changes very little. Although not a rigorous concept, using a sphere does generate the idea.

When a target is illuminated by an electromagnetic wave, energy is dispersed in all directions. The spatial distribution of this energy depends on the size, shape and composition of the target, and on the frequency and nature of the incident wave. This distribution of energy is called **scattering**, and the target itself is often referred to as a **scatterer**.

RADAR CROSS SECTION

Bistatic scattering is the name given to the situation when the scattering direction is not back toward the source of the radiation, thus **forward scattering** occurs when the bistatic angle is 180 degrees. It is called **monostatic scattering** when the receiver and the source are located at the same point, as is the case for a single radar. [19A-1]

Probably as an outgrowth of antenna research and design, this spatial distribution of scattered energy or scattered power is characterized by a **cross section**, a fictitious area property of the target. An antenna is often regarded as having an "aperture of effective area" which extracts energy from a passing radio wave. The power available at the terminals of the receiving antenna can be represented as the product of the incident power density and an effective area exposed to that power. [19A-2] The power reflected or scattered by a radar target can be expressed as the product of an effective area and an incident power density. In general, that area is called the **scattering cross section**. For directions other than back toward the radar, it is called the **bistatic cross section**, and when the direction is back toward the radar, it is called the **back scattering cross section** or the **radar cross section**. In the pioneer days of radar research, the term **echo area** was common and occasionally researchers defined "effective areas" that could be identified with the geometry of a flat plate. [19A-3]

In general, the target can be considered to consist of many individual "scatterers". These scatterers can be added vectorially to give the total scattered field. Since the scattered fields depend on the attitude at which the target is presented to the incident wave, the scattering cross section fluctuates. Therefore, it can be seen that the scattering cross section is **not** a constant, but is strongly dependent on the angular properties of the target and the direction from which the target is viewed.

19A.1.1 The Radar Range Equation

The radar range equation provides a very useful mathematical relationship for assessing both the need for and the effectiveness of efforts to alter radar target cross section. In its various forms, the radar range equation accounts for:

- Radar system parameters
- Target parameters
- Background effects (clutter, noise, interference, and jamming)
- Propagation effects (reflection, refraction, and diffraction)
- Propagation medium (absorption and scatter) [19A-4]

The radar range equation shows that the received power is a direct function of the transmitted power, the gains of the transmitting and receiving transmitters, the frequency (wavelength), and the RCS, and is indirectly proportional to the fourth power of the distance from the target to the receiving antenna. [19A-5]

A thorough knowledge of the radar range equation and its implications are quite important to the understanding of RCS and RCS alteration. Luckily, the fundamental form of the equation is based on simple geometric principles. The parameters show that the maximum free space detection range varies as the fourth root of the RCS. Thus, a factor of 16 reduction in RCS will be required to halve the maximum detection range, and a factor of 10,000 reduction in RCS will be required to cut the detection range by a factor of ten.

For detection in clutter or multipath, the relationship between RCS and maximum detection range becomes more complicated.

19A.1.2 Use of the Decibel

The RCS variables often consist of many orders of magnitude; transmitted powers may be in megawatts and received power may be in picowatts. Because of the wide range of variables involved, parameters are conveniently converted to logarithmic values. Typically, transmitted power, antenna gain, and RCS values are provided in dB. (RCS values are often expressed in dBsm - decibels relative to a square meter - where dBsm is a direct function of the logarithm to the base ten of the RCS of a target expressed in square meters.) A comparison of the square meter and dBsm is shown in Figure 19A-1. Wavelength and range are usually given in linear units and must be converted to dB. (Regardless of whether they are dBm, dB, dBsm, "dB"s may be arithmetically added.)

19A.2 TYPES OF RCS MEASUREMENTS

The purpose of an RCS measurement range is to collect radar target scattering data. Usually, the range user requires far-field data, corresponding to the case where the target is located far enough from the instrumentation radar that the incident phase fronts are acceptably flat. Many times this dictates the use of an outdoor range. However, depending on the target and the nature of the research program many tests are conducted indoors in an anechoic chamber. Whether outdoors or indoors, an RCS measurements facility must have, as a minimum, these five features:

- An instrumentation radar capable of launching and receiving a microwave signal of sufficient intensity,
- Recording instruments, either analog or digital or both, for saving the information,
- A controllable target rotator or turn table,
- A low background signal environment, including "invisible" target support structures, to minimize contamination of the desired signals,
- A test target suitable for the measurements.

After the decision has been made to conduct a measurement program, a suitable facility must be found. Negotiations usually involve the specification of a set of test conditions and a test matrix, and the prospective range will submit a bid. This bid should be carefully evaluated to ensure that the facility can actually produce the data required and to determine if the range is able to offer a differing set of test conditions that could produce the desired data in a more cost effective fashion based upon the experience of the facility personnel.

Free-flight measurements of air vehicles are accomplished primarily to ascertain the RCS, determine the contributions of "dynamic" components such as engines and control surfaces, validate and/or define problems with the ground measurements, and determine RCS under combat conditions such as maneuvering flight and the modification to RCS at the time of chaff release.

A complex target, such as an aircraft, contains several dozen significant scattering centers and dozens of other less significant scatterers. Because of this multiplicity of scatterers, the net RCS pattern exhibits a rapid scintillation with aspect angle due to the mutual interference as the various contributors go in and out of phase with each other. The larger the target in terms of wave-length, the more rapid these scintillations become. Major sources of nose-on reflections on a commercial transport are the flat bulkhead on which the weather radar is mounted, the large cockpit cavity, and the interaction between the engine fan faces and the very short, wide engine inlet ducts.

19A.2.1 The Far-field Requirement

The formal definition of RCS states that the distance r between the target and the radar must become infinite. The reason for this is to eliminate any distance dependence in the RCS characteristics. The limiting process essentially requires that the target be illuminated by a plane wave, yet in practical measurement situations the wave is almost always somewhat spherical, due to finite separation. The question then is: how "spherical" can the incident waveform be and yet be a reasonably good approximation of a plane wave? One way to resolve this question is to assume the radar to be a point source and examine the deviation of the incident phase fronts from perfect uniformity over an aperture having the same width as the target.

In some cases the radar sensitivity is not good enough for the target to be measured in the farfield distance, and a shorter range may have to be selected to ensure adequate received signal strengths.

19A.2.2 Measurements

The effects of measuring rather complex targets at less than the standard farfield distance are often difficult to recognize. At high frequencies, each feature of the target scatters energy more or less independent of other target features. These features are significantly smaller than the overall target. These features, which may be tail fins, engine intakes, nose tips, or external stores, could each be in the farfield with respect to its own size, although the overall composite target may not be. Thus, the amplitude of the scattering from each feature, as well as the locations of peaks and nulls in its own pattern, are less sensitive to the measurement range. The primary effect of a near-field measurement in this case is the slight shifting of the lobes and nulls of the composite pattern as compared with the true far-field pattern. This being the case, measurements performed at less than the farfield distance can often be justified.

Further, high accuracy in RCS measurements is often unnecessary. Quite often, users of test data require only median values, which are statistically representative of the signal return over an angle window that is moved across the RCS pattern. Therefore, the end use of the data should be considered when deciding how important nearfield effects may be.

19A.2.3 The Type of Pattern Cut

One of the decisions required of the test range user is whether to specify spherical or conical "cuts" (patterns). A cut refers to the RCS pattern recorded for a complete revolution of the target. Whether or not this cut is spherical or a cone trajectory depends on the tilt angle of the axis of rotation.

With the target mounted on a support column in a level flight attitude and in a nose-on viewing position, the radar line-of-sight remains in the target yaw plane as the turntable is rotated through 360 degrees. If the axis of rotation is now tilted toward the radar, the radar line-of-sight maintains a constant angle with respect to the axis of rotation. As a result, the line-of-sight traces out a cone centered on the yaw axis as the target is rotated. This is the conical cut. Reference 19A-6 provides several figures that illustrate the geometry of these types of patterns.

The conical cut is usually the favored method of target rotation for RCS measurements because more data can be obtained in much less time at less cost; even though the spherical cut can obtain high-elevation angles not possible with the conical cut. However, the test engineer should discuss this issue with the range personnel to ensure that he gets usable data.

19A.2.4 RCS and Radar Frequency Bands

Generally, radars fall within the frequency bands shown in Table 19A-I. These bands include frequencies that range from 3 MHz to 300 GHz with the majority of them using microwave frequency bands designated as L, S, C, X and Ku. It is interesting to observe that with the development of "stealth" technology the radars that use the UHF and VHF bands have somewhat reversed the trend toward the use of higher frequency radar systems. Vehicles with low RCS values will generally show an RCS response proportional to the radar wavelength squared. This wavelength dependence, driven by the target shaping that must be used if very low RCS values are to be obtained, has renewed the interest in these lower frequency radars. These frequency band distinctions are important when establishing a flight test program. In fact, it is this very distinction that usually dictates what frequencies to use for a given test program. That is, the target RCS will be evaluated at those radar frequencies most generally used by the adversary.

The IEEE Standard 521-1976, Table 19A-I(a), illustrates that the standard radar bands are not consistent with the electronic countermeasures (ECM) frequency band designations listed in AFR 55-4, Table 19A-I(b). [19A-7, 19A-8] Thus, anyone requiring the use of radar absorber material, for example, must be frequency specific rather than use an overall Band designator. Notice the difference in the L-Band frequency ranges, radar vs ECM.

19A.3 THE RCS TEST RANGE

The RCS range provides a valuable tool for testing the performance of various design approaches or simply accruing a database for targets, target conditions, and various absorber materials.

RCS ranges have their advantages and disadvantages and they exist in a variety of shapes and sizes. Early RCS measurement facilities were indoor anechoic chambers, although currently, a large number of both indoor and outdoor ranges are in operation throughout the United States.

- Indoor ranges suffer limitations in the size of the targets that can be measured, whereas outdoor ranges suffer down time problems due to weather conditions. Although the indoor ranges offer protection against the weather and intruders, outdoor ranges can often measure full-scale targets under far-field conditions.
- Probably the single most important disadvantage of outdoor measurements is the long-term effects of weather. Measurements cannot be made in the rain because of moisture collection on targets and target support columns and the backscatter from raindrops in the measurement zone. When rain is not a problem the wind usually is.
- Outdoor measurement ranges are subject to overhead observation by aircraft and/or satellite, an important problem when working with sensitive targets. Although the test sites are usually located in controlled airspace areas and satellite schedules are accurately known, the problems of continually removing the target to prevent observation severely limits measurement time. Night operations do very little to prevent observation due to light amplification techniques.
- A problem common to both indoor and outdoor ranges is how to expose the target to the incident radar beam on an "invisible" target support. Certainly there are no invisible target support mechanisms, but recent improvements in absorber material have produced acceptable configurations.

19A.3.1 Outdoor Ranges

Outdoor ranges generally use pulsed radar instrumentation, whereas indoor ranges use continuous wave and frequency modulation/continuous wave systems. The measured patterns are essentially the same in both cases, provided that the pulse width of the outdoor system is long enough to bracket the target.

RADAR CROSS SECTION

The instrumentation for an outdoor range is relatively simple for conventional RCS measurements, but can be much more complex if coherent data (i.e., measurement of the relative phase of the signal return in addition to the amplitude) are required. For diagnostic isolation of flare spots for example, a chirped pulse must be used. The quality, quantity, and complexity of radar instrumentation varies considerably from range to range. For detailed information on this subject refer to Skolnik's "Radar Handbook". [19A-9]

Most of the world's large outdoor ranges (non-dynamic) are located in the United States. The oldest dates back to the '60s and the newest was completed in the early '90s. All are static RCS ranges, i.e., the test target is exposed to the instrumentation radar on a controllable support fixture. Although the target may be rotated in aspect during measurements, it remains static in that it never leaves the ground and the radar points to it in a fixed direction. The contrast is the dynamic test range, and targets may fly courses several miles long. This requires that the instrumentation radars track the target in both angle and range.

An example of a modern free-flight range is the dynamic RCS measurement capability that exists at the US Naval Air Warfare Center at Patuxent River, Maryland. This capability exists within the Chesapeake Test Range and utilizes that range to provide time-space position information, aircraft telemetry data, and the electronic warfare measurements, such as RCS and jam-to-signal ratios, all operating in a real-time environment. The RCS measurement system operates on a pulse transmission, time delay, amplitude measurement concept. The system is capable of obtaining dynamic in-flight RCS measurements of single, multiple, or extended targets including aircraft, chaff, and jammers. The system collects up to eight simultaneous measurements on a pulse-to-pulse basis. This latter feature allows single flight data acquisition at multiple frequency/polarization combinations, and allows proper determination of target scattering Probability Density Functions. From this radar performance data, calculations of an aircraft's mission effectiveness and survivability can be determined.

Future enhancements to the dynamic range include a high resolution imagery (inverse synthetic aperture radar) to be used to coherently measure RCS. The system will allow dynamic air vehicle measurements such as Doppler signature, jet engine modulation, and propeller/rotor modulation. Measurements could also be performed to locate scattering centers and changes in RCS due to maintenance practices or environmental factors. These coherent measurements can then be used to provide a baseline for data comparison to measurements performed by other RCS facilities.

There are a number of rather complex items that affect measurements, such as:

- **Ground Plane Effect.** The proximity of the ground to the antenna and the target is hard to avoid and one solution is to exploit the ground reflections. The exploitation requires precise knowledge of the reflecting surface and in many cases asphalt or concrete is used although a carefully graded and level soil is quite satisfactory. (See reference 19A-10 for the detailed geometry).
- **Antenna Considerations.** Whether or not the ground plane effect is used in RCS measurements, one of the first things to decide is the antenna size. The antenna beamwidth must be broad enough to adequately illuminate the target, implying that there is an upper limit to the antenna size that may be used. On the other hand, system sensitivity imposes a lower limit on the size.
- **Ground Reflections, Clutter and Multipath.** The reflection from the ground depends on the type of soil, its dampness, and its roughness. The surface roughness diffuses energy in all directions with the diffusion being greater for greater roughness. The diffused energy reduces the amount of energy reflected in the specular direction, thus the ground plane enhancement becomes less significant the rougher the ground. Vegetation can increase the apparent roughness and absorb some of the incident energy. [19A-10]

These items should be discussed with the range engineering staff in order to understand their impact on the test data.

19A.3.2 Indoor Ranges

Although a large building is required to house an indoor range, much less ground area is required than for an outdoor range. However, the indoor range does have its problems such as undesired reflected signals from chamber walls.

To a lesser extent facility screen rooms are often required to meet radio frequency interference (RFI) and security requirements which in turn lead to lighting, heating, and cooling complications.

Often, even though the convenience, economy, and security of an indoor test range are preferred, most targets are just too big. For example, a target as small as 1.5 meters (5 feet) should be measured at a range of not less than 154.0 meters (about 500 feet) for a test frequency of 10 GHz if the far-field criterion is to be satisfied. Thus, even the largest indoor ranges may fall short of being useful even for small targets.

The compact indoor range represents a successful approach to significantly increasing target size for a given chamber size. In fact, compact ranges can now provide some farfield equivalent measurements that even the largest outdoor ranges cannot. The compact range concept is based on the premise that devices can be constructed which will collimate (i.e., make straight) a spherical or cylindrical wave to produce a plane wave. Two different types of collimators are available: lenses and reflectors. Within certain limitations these devices straighten out the incident phase fronts making it possible to conduct measurements indoors with a fraction of the distance normally required. [19A-11, 19A-12, 19A-13]

The EMI Electronics, Limited, has developed a radar modeling capability at the UK National Radio Modeling Facility. Emphasis at this facility is on the development of instrumentation systems and the collection and interpretation of radar scattering data at frequencies up to 2 GHz. Virtually all of the measurements and testing are performed on scale models from missiles and artillery shells to ships and aircraft. The EMI Electronics, Limited, has also developed state of the art components such as RF sources and detection systems. All measurements are conducted indoors. As of 1978, nine different radar systems were operable in conjunction with seven different model support systems. Unlike most indoor facilities, this one makes limited use of radar absorbing material and relies instead on range gating to eliminate background reflections. [19A-14]

Once experimenters learned the importance of reducing extraneous reflections, true anechoic chambers were constructed. At first these chambers were rectangular, simply because the room was this shape to start with. Later, the concept of a tapered chamber was introduced to suppress the specular wall reflections. The taper effectively removes the sidewall regions where specular reflections can occur. This tapered concept was first described by Emerson and Sefton, and King et al. [19A-15, 19A-16] Tapered chambers are superior to rectangular chambers for RCS measurements, especially if the measurements must be made at low frequencies for which high gain antennas (to reduce sidewall illumination) cannot be used. At millimeter wavelengths (one-eighth inch at 93 Ghz), the sharp tips on the pyramidal absorbing material must be maintained, otherwise the effectiveness of the design is degraded. Further, at these frequencies the absorber must not be painted.

19A.4 DATA COLLECTION, REDUCTION, AND PRESENTATION [19A-17]

19A.4.1 Data Collection

Raw data collected for a typical test program are obtained from perhaps several targets or target configurations for spherical or conical cuts, frequencies, and polarizations. Each raw data set is in the form of data pairs (angle, RCS), typically obtained every 0.1 to 0.5 degrees. Data reduction includes not only each raw data set, but also summaries for each target in the test matrix.

19A.4.2 Data Reduction

Data reduction takes many forms, and the discussion of these techniques is covered quite well elsewhere. [19A-18, 19A-19] However, it is of some interest to discuss how data are smoothed. Typically, most targets have a large number of scattering elements, and it is apparent from the RCS pattern that even relatively few elements produce rapid scintillation as the aspect angle changes. At the higher frequencies, the individual lobes in the pattern may be as close as 0.1 degree and a measured pattern will consist of what appears as a band of ink and a specialist may be interested in this data. Program personnel need better data characterization. In general, averages, medians, and standard deviations of individual test runs are more meaningful to test personnel.

In forming an average or median, it must be decided how many contiguous data points will be used. Because the RCS pattern is usually sampled at a fixed angular rate, the decision amounts to selecting an angular "window" over which the averaging will be performed. This window can vary from 0.1 to 10 degrees depending on the RCS fluctuations.

After the selection of the angular window has been made, a "slide" must be chosen. The slide is the amount by which the window will be indexed across the RCS pattern. The slide is never greater than the width of the window since this will result in gaps in the pattern over which no averaging is made, although the slide can be as large as the window. Smaller slides make for finer patterns, but require more processing time. Slides of 1 or 2 degrees are average and slides set to the window width are often chosen to generate preliminary "quick-look" data. Each data run may take one of several forms: smoothed data over a specified window and slide for (three) percentile levels; sector data over (three) specified angular regions for median, mean, and standard deviation in dB; mean and standard deviation in square meter; and probability density functions and cumulative distribution function for each of the sectors.

19A.4.3 Data Presentation

The most common format for RCS data is the polar and rectangular presentation. The polar plot has the advantage of illustrating a "physical feel" to scattering as the target plot is viewed throughout the complete azimuths of recorded data. Further, the polar plot emphasizes the dynamic variations in RCS values. The rectangular plot does not lend a physical feel to the scattering process. Its major virtue is that it is easier to pick off or read selected values regardless of level as low values are not compressed.

When pattern overlays are done, polar plots have fewer parameters to keep constant than rectangular plots. Polar plots need to keep only radial length and decade scale constant compared to rectangular plots that have two sets of axes to compare, abscissa and ordinate lengths, and respective decade scales.

With rectangular plots it is also initially important to verify that the "start and stop" dBsm values are the same to ensure accuracy of the complete rotation.

Another innovation is the global range plot. For this plot, the frequency data for an aspect angle are converted by fast Fourier transform to color-coded amplitude data. The typical one-tenth degree data are transformed and plotted and a representation of the test vehicle is put in the center of the plot so that its center of rotation matches the plot center. This allows the vertex of the curvature of the colored data lines to be the location of the scatterer of the vehicle.

The test matrix summary may have the following forms:

- A matrix showing run number, pitch, roll, frequency, polarization, operator comments, and the front sector median, mean, and standard deviation
- A data file for use in plotting a target response as a function of the test matrix variables such as RCS vs pitch angle, frequency, polarization, and roll angle.

The RCS of an airborne target is typically of interest over a limited sector or cone in space for which a threat is possible. For aircraft, this threat sector is a forward-opening cone in the yaw and pitch planes of the target. Targets can be characterized over a given threat sector by median data or RCS distribution function which include medians, averages, and standard deviations. The average median is defined as the average over the test matrix (frequency, polarization, pitch, and roll) of each sector median.

19A.5 CONCLUDING REMARKS

The subject of RCS, its concept, objective usefulness, and how it is measured has been briefly discussed. The intent is to provide a nominal understanding of this measurement design tool for the novice flight test engineer who on occasion is responsible for implementing full scale RCS flight test measurements. Since the flight test techniques associated with RCS measurements are very similar to those of antenna pattern measurements, both will be discussed at the same time in Section 19B Antenna Radiation Patterns.

The novice engineer must fully understand that he cannot solely rely on the RCS data obtained from static ranges, but rather should utilize in-flight (dynamic range) information whenever it is available.

19A.6 REFERENCES

- [19A-1] Knott, E.F., "Radar Cross Section", Artech House, Inc., 1985, p.155.
- [19A-2] Kraus, J.D., "Antennas", McGraw-Hill, 1950, p. 41.
- [19A-3] Stratton, J.A., "Electromagnetic Theory", McGraw-Hill, 1941, p. 281.
- [19A-4] Bechtel, M.E., "Applications of Geometric Diffraction Theory to Scattering from Cones and Disks", IEEE Transactions. Antennas Propagation, Vol AP-17, March 1969, pp 244-246.
- [19A-5] Blore, W.E., "The Radar Cross Section of Spherically Blunted 8° Right Circular Cones," IEEE Proceedings, Antennas Propagation, Vol AP-12, March 1973, pp. 252-253.
- [19A-6] Freeny, C.C., "Target Support Parameters Associated with Radar Reflectivity Measurements", Proceedings, IEEE Vol 53, August 1965, pp. 929-936.
- [19A-7] IEEE Standard 521-1976, 30 November 1976.
- [19A-8] AFR 55-44 (AR105-86, OPNAVIST 3430.9B, MEO 3430.1), 27 October 1964.
- [19A-9] Skolnik, M.I., "Radar Handbook," 2nd ed., McGraw-Hill, New York, 1990.
- [19A-10] Bush, T.F., ed., "Evaluation of the RATSCAT Ground Plane Range", Report No. PE00911, Physical Science Laboratory, New Mexico State University, Las Cruces, NM, August 1978.
- [19A-11] Burke, H.S., Dalby, T.G., Hansen, W.P. Jr., and Vincent, M.C., "A Millimeter Wave Scattering Facility", 1980 Radar Camouflage Symposium, Orlando, FL, 18-20 November 1980; Technical Report No. AFWAL-TR-81-1015, Avionics Laboratory, Wright-Patterson AFB, OH, pp.327-336.
- [19A-12] Johnson, R.C., Ecker, H.A., and Moore, R.A., "Compact Range Techniques and Measurements", IEEE Transactions, Antennas Propagation, Vol. AP-17, September 1969, pp. 568-576.

- [19A-13] Cram, L.A. and Woolcock, S.C., "Review of Two Decades of Experience Between 30 Ghz and 900 Ghz in the Development of Model Radar Systems", Millimeter and Sub-millimeter Wave Propagation and Circuits, AGARD Conference Proceedings No. 245, September 1978.
- [19A-14] Bothe, H. and McDonald, D., "Determination of Antenna Patterns and Radar Reflection Characteristics of Aircraft", AGARD Flight Test Techniques Series, AGARDograph 300, Volume 4, 1986.
- [19A-15] Emerson, W.H. and Sefton, H.B. Jr., "An Improved Design for Indoor Ranges", Proc. IEEE, Vol. 53, August 1965, pp 1079-1081.
- [19A-16] King, H.E., Shimabukuro, F.I., and Wong, J.L., "Characteristics of a Tapered Anechoic Chamber", IEEE Transactions. Antennas Propagation, Vol. AP-15, May 1967, pp 488-490.
- [19A-17] Knott, E.F. and Senior, T.B.A., "How Far is Far?", IEEE Trans. on Antennas Propagation, Vol. AP-22, September 1974.
- [19A-18] Knott, E.F., Shaeffer, J.F., and Tuley, M.T., "Radar Cross Section, Its Prediction, Measurement and Reduction", Artech House, Inc. Dedham, MA, 1985, pp 413-442.
- [19A-19] Shaeffer, J.F., "Radar Reflectivity Measurement: Techniques and Applications", 2nd ed., N. Currie (ed.), Artech House, Norwood, MA.

19A.7 BIBLIOGRAPHY

Bethke, K.H., "Investigation of Signal Degradation by Scattered Fields and its Suppression in Near-Ground Radar-Backscattering Maneuvers", DFVLR-FB 85-42, Institut für Hochfrequenztechnik der DFVLR, Oberpfaffenhofen, Germany, 1985.

Bethke, K.H., "Global and High Resolution Radar Cross Section Measurements and Two-Dimensional Microwave Images of a Scaled Aircraft Model from the Type Airbus A310", DLR-Mittellungen 91-10, DLR Institut für Hochfrequenztechnik der DFVLR, Oberpfaffenhofen, Germany, 1991.

Blake, L.V., "Radar Range Performance Analysis", Artech House, Inc., Norwood MA, 1986.

Burke, H.S., Dalby, T.G., Hansen, W.P. Jr., and Vincent, M.C., "A Millimeter Wave Scattering Facility", 1980 Radar Camouflage Symposium, Orlando, FL, 18-20 November 1980; Technical Report No. AFWAL-TR-81-1015, Avionics Laboratory, Wright-Patterson AFB, OH, pp.327-336.

Burnside, W.D. and Peters, L. Jr., "Radar Cross Section of Finite Cones by the Equivalent Current Concept with Higher Order Diffraction", Radio Science, Vol. 7, No. 10, October 1972, pp 943-948.

Currie, R.C., "Radar Reflectivity Measurement", Artech House, Inc., Morwood, MA, 1989.

Emerson, W.H. and Sefton, H.B. Jr., "An Improved Design for Indoor Ranges", Proc. IEEE, Vol. 53, August 1965, pp 1079-1081.

Howell, N.A., "Design of Pulse Gated Compact Radar Cross Section Range", 1970 G-AP International Program and Digest, IEEE Publication 70c 36-AP, September 1970, pp. 187-195.

Johnson, R.C., Ecker, H.A., and Moore, R.A., "Compact Range Techniques and Measurements", IEEE Transactions, Antennas Propagation, Vol. AP-17, September 1969, pp. 568-576.

Keller, J.B., "Backscattering from a Finite Cone", IRE Transactions. Antennas Propagation, Vol. AP-8, March 1960, pp 175-182.

Keller, J.B., "Backscattering from a Finite Cone - Comparison of Theory and Experiment," IRE Transactions. Antennas Propagation, Vol AP-9, July 1961, pp. 411-412.

Kouyoumjian, R.G. and L. Peters, Jr., "Range Requirements in Radar Cross Section Measurements," Proc. IEEE, Vol. 53, August 1965.

Maffett, A.L., "Topics for a Statistical Description of Radar Cross Section", John Wiley and Sons, New York, 1989.

Phelan, H.R., "Model 1640 - The Harris Large Compact Range", Antenna Measurements Techniques Assoc. Symposium Proceedings, 1987, pp. 33-38.

"RATSCAT Facilities and Capabilities", brochure published by the 6585th Test Group, Air Force Systems Command, Holloman AFB, NM. (The brochure is not dated but was probably initially published in 1978).

Ruck, G.T., Barrick, D.E., Stuart, W.D., Krichbaum, C.K., "Radar Cross Section Handbook", Vol 1, Plenum Press, New York, 1970.

Solomon, L., "Radar Cross Section Measurements: How Accurate Are They?", Electronics, Vol. 35, July 20, 1962, pp. 48-52.

Sweetman, B. and Goodall, J., "Lockheed F-117A", Motorbooks International, Osceola, WI, 1990.

"Target Signatures", AGARD Conference Report No. 364, London, UK, 8-12 October 1984.

Van Bladel, J., "Electromagnetic Fields", Hemisphere Publishing, New York, 1985.

RADAR CROSS SECTION

Table 19A-I Radar and ECM Bands

(a)		(b)	
Standard radar bands [19A-8]		Electronic countermeasures bands [19A-9]	
Band designation	Frequency range (MHz)	Band designation	Frequency range (MHz)
HF	3 – 30	A	0 – 250
VHF (2)	30 – 300	B	250 – 500
UHF (2)	300 – 1000	C	500 – 1000
L	1000 – 2000	D	1000 – 2000
S	2000 – 4000	E	2000 – 3000
C	4000 – 8000	F	3000 – 4000
X	8000 – 12,000	G	4000 – 6000
K _u	12,000 – 18,000	H	6000 – 8000
K	18,000 – 27,000	I	8000 – 10,000
K _a	27,000 – 40,000	J	10,000 – 20,000
Millimeter (3)	40,000 – 300,000	K	20,000 – 40,000
		L	40,000 – 60,000
		M	60,000 – 100,000

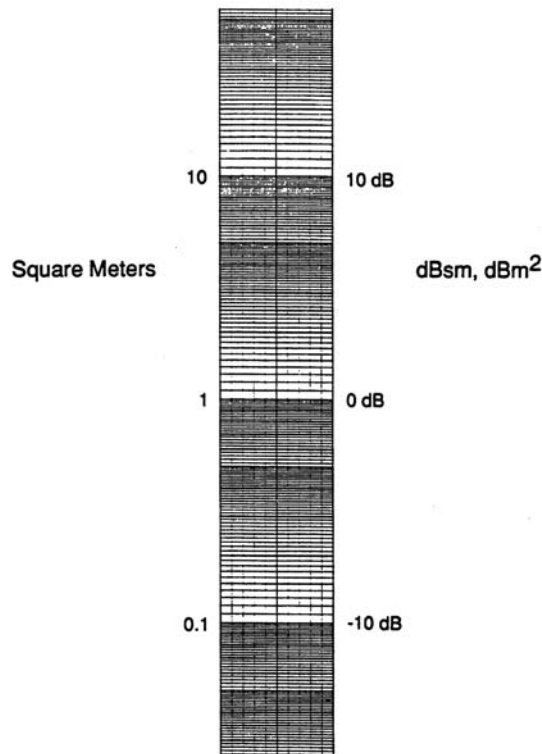

Figure 19A-1. Logarithmic Comparison of RCS Square Meter and Dbsm.

APPENDIX 19A.A – RADAR CROSS SECTION REDUCTION

19A.A.0 INTRODUCTION

Radar Cross Section Reduction (RCSR) is a study of compromises in which advantages are balanced against disadvantages. A reduction in RCSR at one viewing angle is usually offset by an enhancement at another when target surfaces are reoriented to achieve the initial reduction. However, if radar absorbing materials are used, the reduction is obtained by the dissipation of energy within the material, therefore leaving the RCS levels relatively unchanged in the other aspect angles. However, the absorber is a compromise paid for with added weight, volume, surface maintenance problems, and cost.

No matter what the cost may be, each improvement in RCS reduction is obtained at higher cost. In general, the first 50 percent of reduction is fairly inexpensive, while the next 10 percent is more costly, the next even more so until a level of 90-95 percent may be excessively costly and not practical.

19A.A.1 THE FOUR BASIC METHODS OF RCSR

There are generally only four basic techniques used for reducing RCS. They are:

- Shaping
- Radar absorbing materials
- Passive cancellation
- Active cancellation

Each of these methods have their advantages and disadvantages.

The goal of shaping is to orient the target surfaces and edges so as to deflect the radar return energy away from the radar receiver. This is not possible for all viewing angles within the entire sphere of the target because there will always be viewing angles at which surfaces are "seen" at normal incidence and there the echoes will be observable. The success of shaping depends on the existence of angular sectors over which low radar cross section is less important than others.

A forward-opening cone is of primary interest and large cross sections can be "shifted" out of this forward sector toward the broadside sectors. This is done by sweeping airfoils back at sharper angles. The forward sector includes the elevation plane as well as the azimuth plane, and if a target is rarely seen from above, echo sources such as engine intakes can be placed on the top side of the target where they are hidden by the forward portion of the body when viewed from below. In addition to the flat "underbelly" and top side engine inlets there are the added advantages of the inward canted vertical fins that reduce broadside reflections, and rounded corners and wing tips. Incidentally, outward canted vertical fins can have similar effects to those of the inward canted vertical fins, that is, reflected energy is directed away from the tracking radar.

RADAR CROSS SECTION



Chapter 19B – ANTENNA RADIATION PATTERNS

Dr. Helmut Bothe

DLR Institute of Flight Guidance
38022 Braunschweig
GERMANY

19B.0 INTRODUCTION

Modern civil and military aircraft are equipped with a variety of communication devices, radio navigation equipment, and air traffic control systems. For all of these devices appropriate antennas must be available to transmit and receive the signals. As a result, as many as 30 antennas, and sometimes even more, are mounted around today's aircraft. For this reason, it is necessary to know the capabilities of the receiving/transmitting equipment on board. These capabilities are driven by the antenna characteristics. Therefore, coverage, shading, and beam pointing pattern data are necessary for optimum electronic coverage. The aircraft antenna has to convert the available power density of the electromagnetic field to an electric voltage at its connector. This voltage level must be sufficiently high to operate the connected equipment. The reciprocity principle states that it makes no difference if the antenna is receiving or transmitting. For the certification of the aircraft antennas it must be proven that the antennas are at least generating the minimum receiver input voltage which is required for each radio service. The prime condition is, of course, that the specified field power densities of the different radio navigation and communication services are available.

An important property of a radio frequency link is the electro-magnetic field intensity at every point in space for a given output power of the antenna. As the propagation of radio frequency waves in free space is well known, the spatial distribution of the field intensity needs only be measured at one spatial sphere around the antenna. The information is usually given as distributions along the circumference of flat sections through this sphere: each of these is called an ARP. Several ARPs are usually required to describe the complete spatial antenna pattern of an antenna.

In addition to mathematical modeling, measurements on sub-scale models, and static measurements on full size models or aircraft on the ground, dynamic measurements on aircraft in flight play the most important role in the aircraft antenna testing and certification. [19B-1] The shape of an ARP, for one given frequency, is determined by the shape of the antenna and the shape and material of the surface it is mounted on. As the directly transmitted waves interfere with waves reflected by the aircraft skin with its complex geometry, and the surface material parameters are only roughly known, it is not possible to predict the ARP with the required accuracy. In ground measurements the earth's surface also acts as a reflector thereby causing the ground ARP to be different from the in-flight ARP. As the in-flight ARP is the ARP we are actually interested in it becomes clear that it is necessary to conduct in-flight ARP measurements.

The Flight Test Engineer must be aware of the needs of the specialists who are establishing the test program for measuring antenna patterns and radar cross sections. These tests will require special test equipment and dedicated flights to obtain the data that they require.

This Section provides an introduction to the principles of determining antenna patterns and the flight techniques for determining both antenna patterns and radar cross section. Reference 19B-1 provides detailed information.

19B.1 TEST OBJECTIVES

19B.1.1 Antenna Radiation Pattern

The objective of ARP tests is to determine whether reliable radio communication, and other electronic, links can be established in the required azimuth and elevation angles as seen from the aircraft. The following parameters play a role in this process: The output power of the transmitter; cable losses between the transmitter and the transmitting antenna; the gain and ARP of the transmitting antenna; attenuation in free space (which is dependent on the frequency and distance); the gain and ARP of the receiving antenna; cable losses between the receiving antenna and the receiver; and the sensitivity of the receiver. If, for any reason, the receiving antenna cannot supply the required input voltage to the receiver the communication link cannot be established.

For the usual radio navigation and communication systems the transmitter and receiver parameters and the resulting available electro-magnetic field power densities at a certain distance are known. The field power densities are specified in Reference 19B-2. The minimum required input voltage for each type of receiver is published in a series of ARINC publications. [19B-3, 19B-4, 19B-5, 19B-6, and 19B-7]

The available field power densities and the minimum value of the required receiver input voltages are listed in Table 19B-I which summarizes the requirements given in these references.

It has to be proven that each aircraft antenna is at least generating the minimum receiver input voltages given in Table 19B-I if the power densities listed there are available. This is determined by measuring the ARP within certain required angular coverage areas which depend on the radio system the antenna is serving.

19B.1.2 Lowest Required Power (LRP) Level

For each individual radiation pattern a lowest required power level (LRP) has to be calculated in order to assess whether the ARP is satisfactory. The lowest required power level (LRP) in the appropriate polar antenna pattern is a circle which is equal to the Maximum Power Level (MPL) of the antenna pattern under consideration minus the gain margin which is the difference between the actual gain of the receiver antenna (the antenna under test) and the minimal required gain of this antenna.

As described in detail in Appendix 19B.A the minimal required gain can be determined from the available power density, which is given in Table 19B-1. This table also gives the minimum required input power for the receiver. The actual gain of the receiver antenna can be calculated by utilizing the "gain-loss" equation given in Appendix 19B.A and reference 19B-1.

Table 19B-I Available Field Power Densities and Minimum Required Value of Receiver Input Voltage

Service	DME	ILS		VOR		VHF COM	ATC		UHF COM
		LOC	GS	VOR	MARK.		AC	GROUND	
available field power density in dBW/m ² ¹⁾	-83	-114	-95	-107	-82	-109	-50 ²⁾	-41,4 ²⁾	see VHF
minimum required receiver input voltage in μ V ³⁾	7 (17,8)	2,5 (15)	10 (20)	0,75 (10)	100	1	31,6	(12,6)	see VHF
minimum required receiver input power in dBm	-90 (-82)	-99 (-83,4)	-87 (-81)	-109,5 (-87)	-67	-107	-77	(-85)	see VHF

() - values depicted from Reference 19 B-2 (ICAO Aeronautical Telecommunications Annex 10, Vol. I)

¹⁾ secured values within specified coverage of the system

²⁾ distance 200 NM

³⁾ across 50 OHM input resistance

An example of the determination of the LRP-circle in the radiation pattern of a glide slope antenna is given in Appendix 19B.A.

19B.2 MEASUREMENT REQUIREMENTS

19B.2.1 Aspect Angle and Coordinate Systems

The radiation direction of an aircraft antenna with respect to a receiving station (on the ground or in a second aircraft) is defined by the aspect angle Φ . This is the angle between the roll axis and the line of sight (Figure 19B.1). In order to cover the whole sphere, the aspect angle is resolved into two parts, the horizontal aspect angle Φ_A and the vertical aspect angle Φ_E . The horizontal aspect angle is measured in the yaw plane between the roll axis and the projection of the line of sight perpendicular to the yaw plane. The vertical aspect angle is the angle between the line of sight and its projection perpendicular to the yaw plane. In polar ARP plots one of these angles is usually taken as the independent variable, while radiated power is the dependent variable. For static measurements of models or full-sized aircraft, the aspect angle is readily obtained from the angle readouts of the pedestal. As will be shown later, in-flight measurements are more complex because the aspect angle depends on the relative locations of the ground station and the aircraft, as well as on the attitude of the aircraft.

Spherical coordinates for general use in antenna pattern measurements are defined by IEEE standards published in reference 19B-8.

In addition, the Inter-Range Instrumentation Group (IRIG) has published recommendations on how the orientation of an antenna-bearing vehicle should be described in the IEEE standardized system. [19B-9]

A detailed description of the orientation of aircraft to these systems in dynamic ARP measurements is found in Reference 19B-1. In this field of application it is common practice to denote the horizontal aspect angle by Φ_A , and to measure Φ_A from the nose of aircraft (positive roll axis) so that the right wing coincides with $\Phi_A = 90^\circ$. The vertical aspect angle defined in Figure 19B-1 is usually denoted by Φ_E .

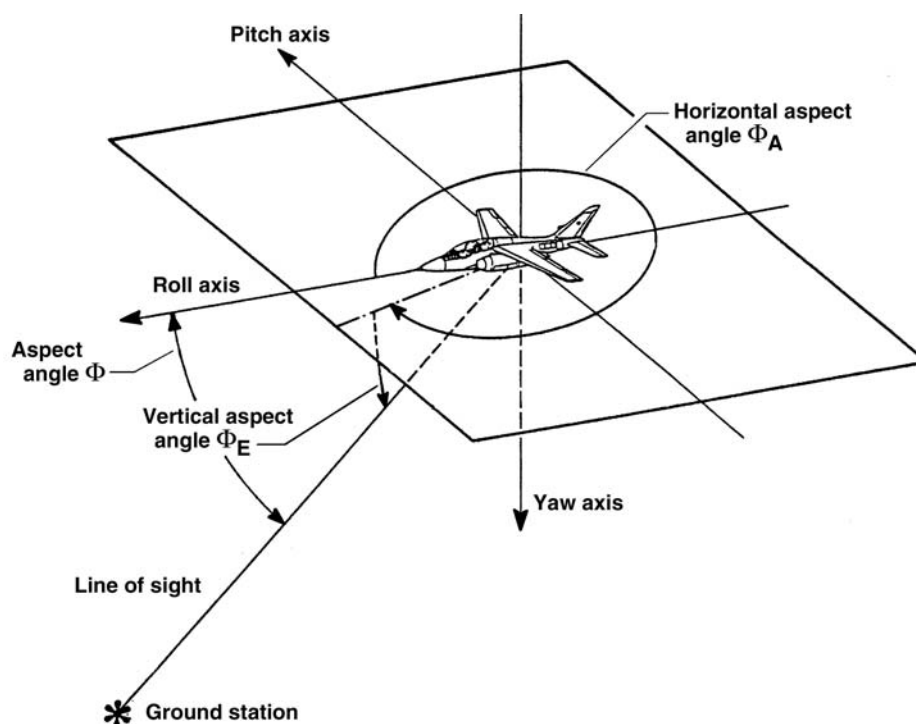

Figure 19B-1. Aspect Angle and Vehicle Coordinate System.

In order to achieve easy comparisons between dynamic and static measurements, the same coordinate system and notations should also be used for static measurements of models or full sized aircraft.

Aircraft antenna patterns are often presented in polar diagrams. Horizontal patterns are conveniently recorded by a continuous variation of the horizontal aspect angle while the vertical aspect angle Φ_E is stepped as a parameter. This leads to a movement of models under test on a cone, and the recorded patterns are conic section patterns. Due to the limited maneuverability of a full-sized aircraft in flight, conic section patterns cannot be measured during a complete continuous flight pattern. Nevertheless this type of mapping is frequently applied to model measurements.

The usual polar patterns for in-flight measurements are great circle patterns, which are recorded as the aircraft moves in a complete horizontal circle. If the circle is flown with different angles of roll, radiation patterns in the corresponding inclined planes through the aircraft roll axis are obtained. This means that the vertical aspect angle also changes and true parametric plots are thus not achieved.

A "matrix" plot in the form of a spherical surface projection provides radiation intensity at increments of Φ_A and Φ_E over the entire sphere. Radiation intensity appears as a plotted number in each element of the matrix or as contour lines of equal radiation intensity. The first representation allows only a rough angular resolution. The second one suffers from poor resolution of radiation intensity.

19B.2.2 Aspect Angle Determination

As mentioned in the preceding chapter the radiation direction of an aircraft antenna with respect to a receiving station is defined by the aspect angle illustrated in Figure 19B-1. To determine the aspect angle during tests, the following parameters have to be considered:

- Location of the ground station
- Location of the aircraft

- Attitude (pitch, roll and heading) of the aircraft
- Earth curvature

In a plane system, where the earth curvature is neglected, the aircraft and ground antennas are supposed to be at almost the same elevation and the pitch and roll angles of the aircraft are small, the determination of the horizontal aspect angle is very simple. As shown in Figure 19B-2, the horizontal aspect angle Φ_A becomes

$$\Phi_A = 180^\circ - \beta_A + \Psi$$

if Ψ is the heading angle of the aircraft under test and $\beta_A = 360^\circ$ minus the azimuth angle of the aircraft as seen from the ground system. If the aircraft is tracked from the ground system, β_A can be measured directly. If no such tracking equipment is available at the ground station, β_A must be calculated from the outputs of radio navigation or inertial systems on board the aircraft. [19B-10]

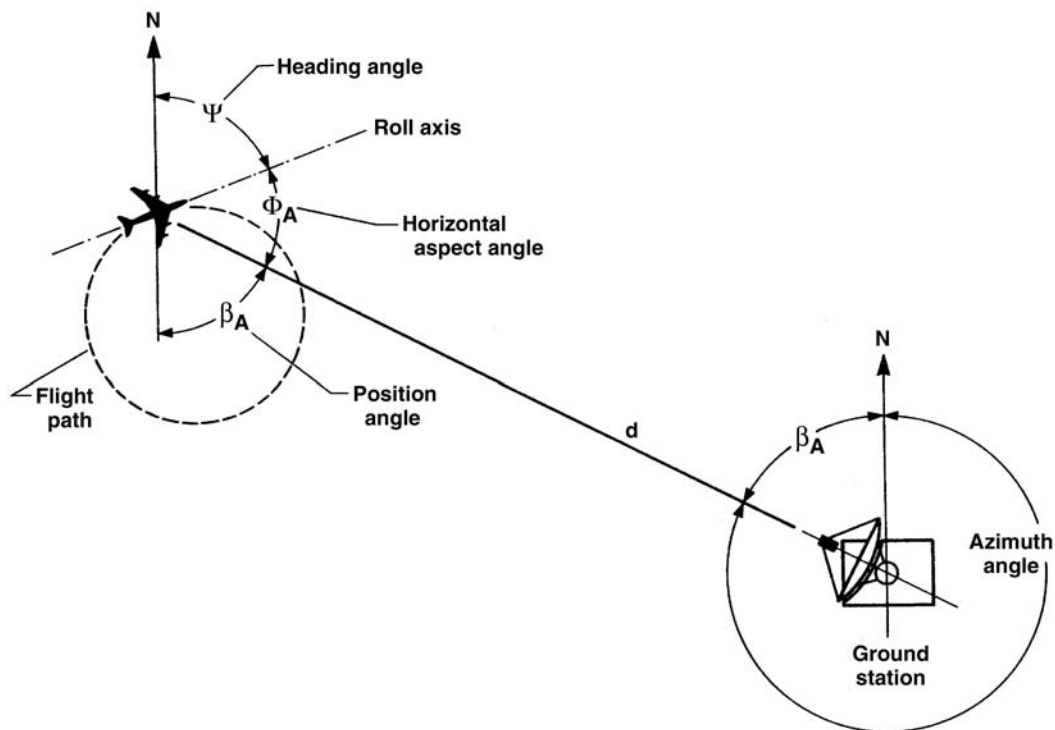

Figure 19B-2. Determination of the Horizontal Aspect Angle.

The determination of the vertical aspect angle Φ_E is very simple if the test flight is conducted in a vertical plane which also intersects the ground station (Figure 19B-3). The vertical aspect angle Φ_E then becomes

$$\Phi_E = \beta_E + \theta$$

where θ is the pitch angle of the aircraft. The position-dependent angle β_E equals the elevation tracking angle of the ground system. Again β_E can also be computed from available on-board information, derived from radio or inertial navigation equipment and altitude combined with distance measurement. [19B-10]

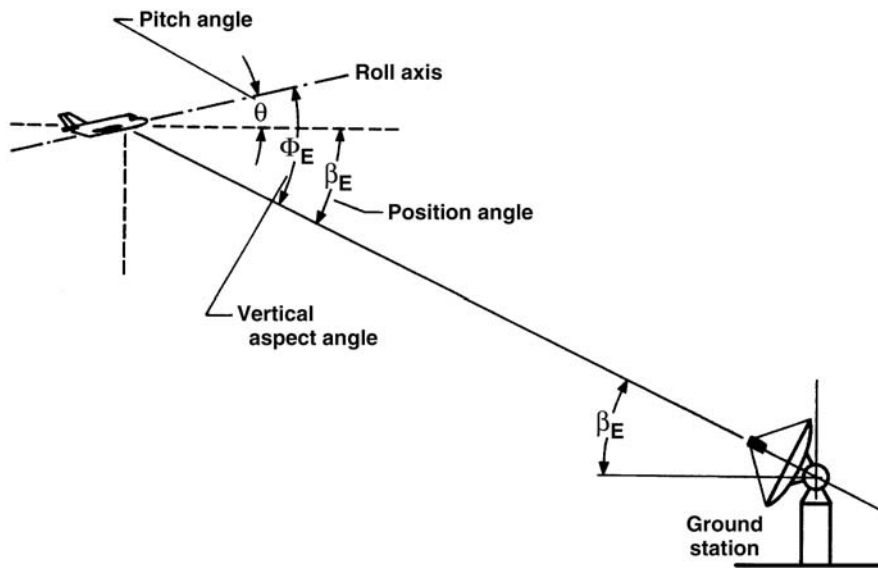

Figure 19B-3. Determination of the Vertical Aspect Angle.

If the above mentioned restrictions apply, the indicated equations are useful for the determination of the horizontal and vertical aspect angle. However, in many of the flight profiles discussed below, the horizontal and vertical position angle vary simultaneously. Also many flight profiles require changes of the angle of roll which influence the horizontal aspect angle.

A universal equation, which takes account of all parameters necessary to compute the two components of the aspect angle Φ_A and Φ_E in the general case, is given in Reference 19B-1.

In many applications the following simplified equation is used for on-line data processing and quick-look possibilities or to save computing time. [19B-1]

$$\Phi_A = \tan^{-1} (\tan (\Psi - \delta) \cos \Phi)$$

where δ is the azimuth angle of the ground tracking system and Φ the bank (roll) angle of the aircraft.

19B.2.3 Distance Determination

Another important parameter in antenna measurements is the distance d of the antenna under test from the ground facility involved in the measurements. Distance variations during test flights cannot be helped if the antenna carrier is a fixed wing aircraft. In consequence the distance sensitive parameters have to be corrected. These parameters are the received power in the radio link (see gain-loss discussion in paragraph 19B.2.5) and the aspect angle, depending on which method is used for determination.

Direct measurements of the distance are possible by radar equipment or laser tracker devices. Other methods which make use of a telemetry data link are reported in reference 19B-11.

Indirect measurements utilize the outputs of inertial or radio frequency navigation equipment. The actual distance is then calculated by on-line computation if the geographical coordinates of the ground facility are known.

19B.2.4 Received Power Level for ARP

As mentioned above, the ARP is determined from the output signal of the receiver in the radio link set up for the test. Because the dynamic range of the received signal is large, the receiver must have a logarithmic characteristic, or an automatic gain control circuit. The ARP is usually recorded within a dynamic range of 40 dB. It is convenient to take advantage of, if possible, a receiver dynamic range of 60 to 80 dB. By this, adjustments of a pre-attenuator during measurements of patterns with unknown dynamic range can be avoided. Otherwise these adjustments are necessary to prevent overriding of the receiver. In order to record calibrated (absolute) patterns the receiver has to be calibrated over its total dynamic range prior to a series of pattern measurements.

As a consequence of the reciprocity theorem of antennas, the transmitting and receiving patterns of an antenna are the same. It, therefore, makes no difference whether the antenna under test is the transmitting or receiving antenna in the radio link set up for pattern measurements. Up to frequencies of several GHz the transmitter is usually smaller and weighs less than the receiver. Therefore it is convenient to mount the transmitter in the aircraft. At much higher frequencies the transmitting equipment becomes heavy and voluminous. Then the receiver is usually mounted in the aircraft, and either on-board pattern recording is used, or a telemetry system must transmit the measured signal to a ground processor, along with the other parameters necessary for the aspect angle calculation and distance correction.

19B.2.5 Propagation Problems

In a radio link set up for ARP measurements and characterized by the "gain-loss" equation presented in paragraph 19B.1.2, two parameters usually alter the recorded antenna signal and therefore have to be compensated by computation.

- The variation of the received signal due to a change of the distance r of the aircraft to the ground station has to be compensated by multiplying the losses by r^2
- The ground reflection multipath gain has to be considered.

The ground reflection multipath gain is investigated in more detail in reference 19B-1. If possible, distance, flight level, and receiving antenna height should be chosen such that the ground reflection multipath gain remains nearly constant during the test flight profile and only small corrections are necessary. The example outlined in Figure 19B.A-1 illustrates that a distance of more than 20 km is necessary for that application in order to cut off large multipath gain variations up to 20 dB. More examples which also illustrate the influence of soil wetness and sea water are given in reference 19B-1.

During vertical ARP measurements several deep attenuation nulls may be met in the course of a test flight (see paragraph 19B.4 and Figure 19B.A-1). At frequencies of about 1 GHz and higher a highly directive ground antenna can reduce this problem considerably. An alternative, also helpful at low frequencies, is to make use of the ground as a reflector for the receiving antenna. In order to obtain well-defined conditions, the surroundings of the ground antenna to a distance of several wavelengths are covered with a metallic mesh. This antenna arrangement has only one lobe, which covers the whole test flight, but corrections must be applied for the variations of gain within that lobe. The large distance variations during the test flight require additional corrections for the received power level.

In dynamic ARP measurements an important parameter is the range at which the measurements are made. Phase and amplitude variations over the illuminated test aperture have to be kept within certain limits in order to record correct ARP's. This is achieved by making the measurements in the "Far Zone". The accepted criterion as discussed in reference 19B-1 is

$$r \geq 2 D^2 / \lambda$$

with r = distance between on-board and ground antenna, D = maximum dimensions of the antennas and λ = wavelength. It is important to notice that the dimension of the on-board antenna can comprise the total aircraft due to possible reflections on parts of the metal structure. Compared to that the dimensions of the ground antenna are usually much smaller, e.g., the diameter of a parabolic dish at high test frequencies.

19B.3 THE DETERMINATION OF THE ARP BY STATIC METHODS

Section 19B basically deals with the flight test techniques for the purpose of aircraft ARP measurements. To be complete the other methods mainly applied in the early development stage of an aircraft are briefly covered here. More details on these methods can be found in reference 19B-1.

19B.3.1 The Determination of the ARP by Mathematical Modeling

Modern high-speed computers with large storage capacity have made possible the theoretical calculation of the ARP of antennas mounted on complex structures such as aircraft or helicopters. The main advantage of this mathematical method is that, once the shape of the vehicle has been represented in the computer, the influence of different positions of the individual antennas can be easily evaluated. If the position of an antenna has been selected on the basis of a computer evaluation, the number of measurements can be cut down to a minimum.

Disadvantages are that the shape of the vehicle can only be approximately modeled and that surface parameters such as conductivity and susceptibility are only roughly known. Therefore, the calculated results may contain errors and can only be considered as approximate patterns which usually have to be supplemented by full-scale measurements, either statically on ground ranges or by in-flight measurements.

Two different theoretical ARP-computation methods have been developed: the integral equation method and the geometrical theory of diffraction method. Which method must be used will depend on the size of the vehicle compared to the wavelength of the antenna under consideration. [19B-1]

19B.3.2 The Determination of ARP by Sub-Scale Model Measurements

In sub-scale modeling for determination of an ARP the device to be tested is scaled down in size to a ratio between 1:5 and 1:50, depending on the size of the original aircraft and the available measurement facilities. Modeling is usually done in two steps. First the antenna itself is scaled down, and its radiation characteristics measured and compared with the characteristics of the original full sized antenna. If, for this purpose, a counterpoise, e.g., a ground plane, is used the same scale factor has to be used. Thereafter the antenna model is integrated into the aircraft model and the ARPs are measured.

Sub-scale modeling has a number of advantages:

- The main advantage is the complete free mobility of the model in space, which allows a coverage of the whole sphere, so that true conic section or great circle patterns can be recorded
- Due to the small scale, measurements are frequently made indoors so that the effects of weather are eliminated
- Once a model has been manufactured, it can be used repeatedly for all kinds of antenna and radar cross section measurements, even if later additional antennas or structural modifications of the carrier are planned
- The small dimensions also allow reflecting walls or other obstacles to be screened by absorbing materials to create a clean electromagnetic environment for the measurements
- Model measurements do not require expensive aircraft flying hours and can be conducted by one or two persons.

The disadvantages of sub-scale model measurements are:

- A precision model must be manufactured. For high-frequency measurements the simulation of the cabin-roof, windows, and surface discontinuities, such as doors, access panels, etc., is especially difficult.
- The model laws can not be performed completely. Measurements conducted in free space do not require transformation of the permeability and permittivity, but frequency and conductivity have to be increased by the factor of reduction. The frequency requirement can be fulfilled in most cases, whereas the conductivity requirement is usually violated.
- Sub scaling of the antenna elements requires much experience about where a certain degree of definition can be neglected and where not.

19B.3.3 The Determination of ARP of Full Size Aircraft on the Ground

Military aircraft often fly in several configurations with different weapon systems, ECM pods, or fuel tanks at different store points below the wings or fuselage. The effect of the different configurations on antenna radiation patterns must be investigated. If all these patterns were measured in flight, it would require a large number of expensive flying hours. To avoid this, static ARP tests can be executed on full-scale airframes, mockups or airframe sections mounted atop heavy 3-axis positioners on outdoor antenna test ranges.

The advantages of this method are:

- Measurements are made on full-scale aircraft, no constraints due to model laws have to be considered and no up-translation of frequency is necessary. All measurements are made at the correct frequencies.
- The "test aircraft" need not be fully equipped, especially inside the airframe. In many cases a mock-up is adequate and modifications in the configuration can be realized by makeshift or temporary arrangements in which only the radio frequency aspects need be taken into account. This, in conjunction with the saving of many flying hours, speeds up the measurements and increases the economy of ARP recording.
- Since the aircraft can be inverted, antenna-to-antenna isolation measurements of two or more antennas mounted on the same airframe can be made without the influence of ground-coupling on antennas below the fuselage and wings.

The following disadvantages have to be considered:

- Due to the large weight of the airframes under test, the pedestals have to be rugged enough to carry up to 25 tons
- The large dimensions of the device under test require a large quiet zone for the illuminating field which leads to high towers and - in conjunction with the far-field condition requirements - to very large test areas
- If reflections of the illuminating RF-signals by ground and other obstacles are present, additional measures must be taken to attain the desired accuracy of the measurements.

19B.4 THE DETERMINATION OF ARP OF FULL-SIZE AIRCRAFT IN FLIGHT

During in-flight measurements of ARP the aircraft antenna under test is part of an air-to-ground radio link. The aircraft flies selected maneuvers in front of the ground antenna, whereby the following parameters are recorded:

ANTENNA RADIATION PATTERNS

- If the transmitter is on board the aircraft, the transmitted power, if the receiver is on board, the received power
- The (transmitted or received) power at the ground station
- The position of the aircraft relative to the ground station
- The attitude angles of the aircraft.

The gain of the aircraft antenna must then be calculated from the "gain-loss" considerations noted in paragraph 19B.1.2 and Appendix 19B.A. The flight trajectory for these tests must be chosen carefully to ensure that the other parameters in the equation remain as constant as possible and can be calculated with the maximum accuracy. The optimum trajectories are discussed later on in this chapter.

The advantage of this method is that the antenna gain is measured under actual conditions, without any errors due to modeling imperfections. The effect of moving parts, such as propellers, helicopter rotors and stabilizing rotors is fully taken into account. Measurements of this kind are necessary for the certification of new aircraft types, even if model calculations and model measurements have been carried out.

The main disadvantage of this method is the high cost of the flying hours that are required. For that reason the flight tests usually are the final stage of a long process of static testing. Problems of in-flight measurements are:

- The flight characteristics of the aircraft limit the choice of aspect angles (see paragraph 19B 2.2) at which measurements can be made
- The effect of ground reflections may vary considerably during the flight tests and it is difficult to eliminate these effects (however, with proper processing, these effects can be eliminated from the ARP especially if all reflections occur over water or reflecting ranges)
- Delays due to weather conditions and aircraft availability
- Increased processing requirements to remove the dynamic perturbations and range tracking errors.

The effects of many of these disadvantages can be reduced by careful planning of the trajectories flown during the tests, as described below.

When measuring an ARP it is not usually necessary to cover the whole sphere above and below the antenna under test. The aspect angle zone of interest depends very much on the maneuverability of the aircraft and on the kind of radio aid under consideration. Once the angular range to be covered by the measurements is defined, the flight profiles can be selected. Continuous flight trajectories which allow complete continuous radiation pattern recordings are very efficient with respect to flying time and data processing. Unfortunately, certain angular areas of the sphere cannot be covered by continuous flight trajectories, and measuring requirements may call for additional discontinuous flight trajectories, e.g., straight trajectories, usually with constant attitude and altitude (Figure 19B-4).

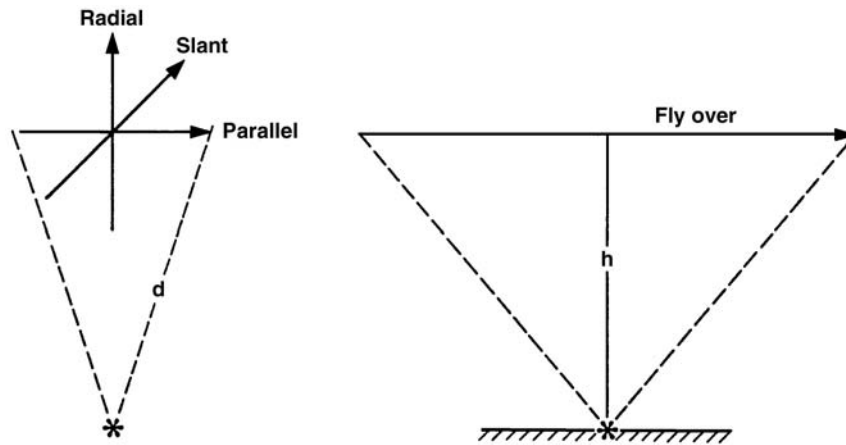

Figure 19B-4. Straight Flight Test Trajectories for ARP Measurement, $d = \text{Distance}$; $h = \text{Altitude}$.

While radial, slant, and parallel flights are suitable and qualified for horizontal antenna pattern measurements, the fly-over trajectory is better suited to vertical antenna patterns, at least for those below the fuselage of the aircraft. Refer to Figures 19B-5 and 19B-6.

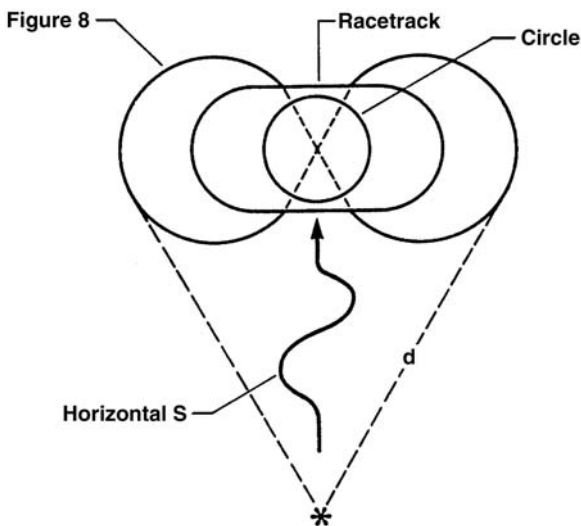

Figure 19B-5. Curved Flight Test Trajectories for ARP Measurement, Fixed Altitude $d = \text{Distance}$.

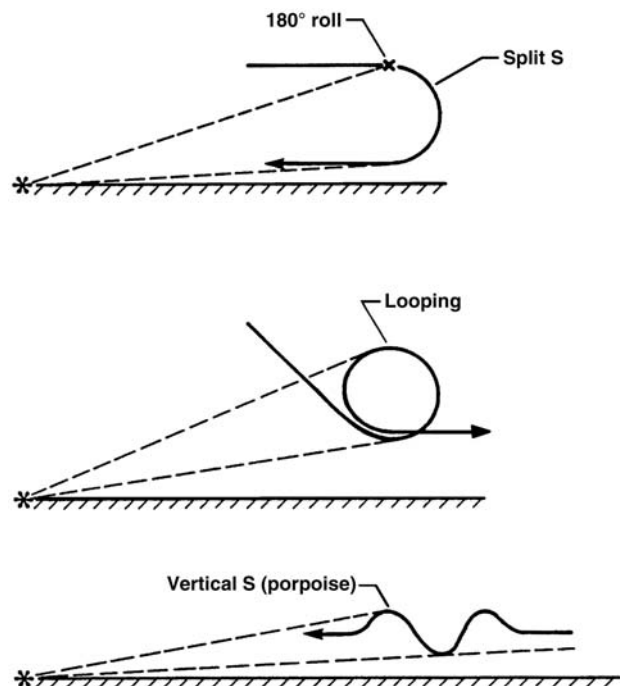

Figure 19B-6. Curved Flight Test Trajectories for ARP Measurement, Variable Altitude.

Curved flight test trajectories for ARP measurement, usually flown at a fixed altitude, are shown in Figure 19B-5. The circle or orbit trajectory is very easy to fly, the aircraft circles in a skidding turn or at a constant bank angle, each turn covering a complete 360-degree great circle antenna radiation pattern. Therefore this trajectory is one of the most efficient profiles for ARP measurements as far as flight time is concerned. In a flight at great distance and at low altitude, the coverage of the depression angle in the

ANTENNA RADIATION PATTERNS

nose and tail area of the aircraft is poor. The coverage of the depression angle can be improved by flying the aircraft at higher altitudes. The race track trajectory, very similar to the circle pattern, allows a gyro realignment during the straight course runs connecting the semicircles. The figure eight trajectory of Figure 19B-5 allows the aircraft to fly left- and right-hand turns during the same maneuver. In the dashed section of this figure no measurements are recommended because the roll rate of the aircraft is very high. To complete a 360-degree antenna pattern, the maneuver has to be repeated under conditions where the figure eight is turned 90 degrees with respect to the ground station. If only the nose and tail horizontal patterns of an aircraft antenna need to be measured, the horizontal "S" flight trajectory is convenient. Also, descents pointing at the ground station and climbs away from the ground station are useful for getting nose-on and tail-on data.

The candidate curved flight trajectories for ARP measurements in the vertical plane are shown in Figure 19B-6. For a split S trajectory the aircraft starts from straight horizontal flight, then performs a 180-degree roll and finally reverses its flight direction diving to a lower flight level. This maneuver gives nearly 180 degrees of coverage of the nose-tail elevation cut but can be performed only by highly agile aircraft. The looping trajectory, where the aircraft performs a 360-degree vertical turn, extends the coverage to a complete 360-degree vertical radiation pattern. The vertical "S" or porpoise trajectory, during which the aircraft alternately dives and climbs, gives a limited coverage of the depression angle in the nose and tail area. If the distance is large it can even provide data on small negative depression angles.

In many cases a combination of the previously mentioned trajectories is used to achieve a rational and economic flight test program.

19B.5 DATA ANALYSIS

From the above mentioned requirements for the determination of aircraft antenna patterns, a listing of required parameters can be generated. Table 19B-II provides a list of parameters required for ARP determination. As this list indicates, there are generally two locations of data sources, one on-board the aircraft and one on the ground.

Table 19B-II Parameters Required for ARP Determination

Parameter	Sensor	Tolerance Error
On-Board		
Roll Angle	Inertial Reference System	< 1 degree
Pitch Angle	Inertial Reference System	< 1 degree
Heading Angle	Inertial Reference System	< 1 degree
Altitude	Air Data Computer	100 m
Present Position/ Longitude, Latitude	Radio Navigation/ Inertial Navigation	100 m
Field Intensity	Special Equipment	1 to 3 dB
Ground		
Azimuth Angle	Tracking System	< 1 degree
Elevation Angle	Telemetry/Radar	< 1 degree
Distance	Telemetry/Radar/(On-Board Navigation System)	100 to 200m
Field Intensity	Special Equipment	1 to 3 dB

For data computation and analysis it is important that all parameters are available at a computing facility at the same time. There are three ways to accomplish this. If the data processing takes place on board, the ground data has to be transmitted on-line to the device under test. If the data processing facility is on the ground, a down link is necessary for data transmission. Both methods allow on-line data processing and analysis. A third method is to record on-board and ground data separately in conjunction with time signals and let the computing system synchronize the two data streams in a post-flight analysis. The main disadvantage of this method is that no quick-look analysis is possible during the flight tests.

The data processing facility must compute the aspect angle and make the necessary corrections of the measured field strength due to variable distances, ground reflections and ground antenna characteristics. The computed data thereafter has to be processed for pattern recording, e.g., for the presentation of polar patterns.

In this processing process it is important to pay attention to the sampling theorem. In this case it means that a minimum of 5 sets of data points have to be calculated to display one lobe of the pattern. At high frequencies, in the order of 5 GHz, one pattern lobe may be observed in a 1-degree aspect angle area. A turn rate of 3 degrees per second therefore requires 15 complete calculated data sets on-line processing presumed. At this turn rate and a 60-degree banked turn the speed of the aircraft under test must be 600 knots (see Figure 19B-7). This figure illustrates that angle and speed must be carefully adjusted to an acceptable turn rate of the aircraft under test. Another dependent parameter also given in Figure 19B-7 is the turn radius, which causes distance and field strength variations.

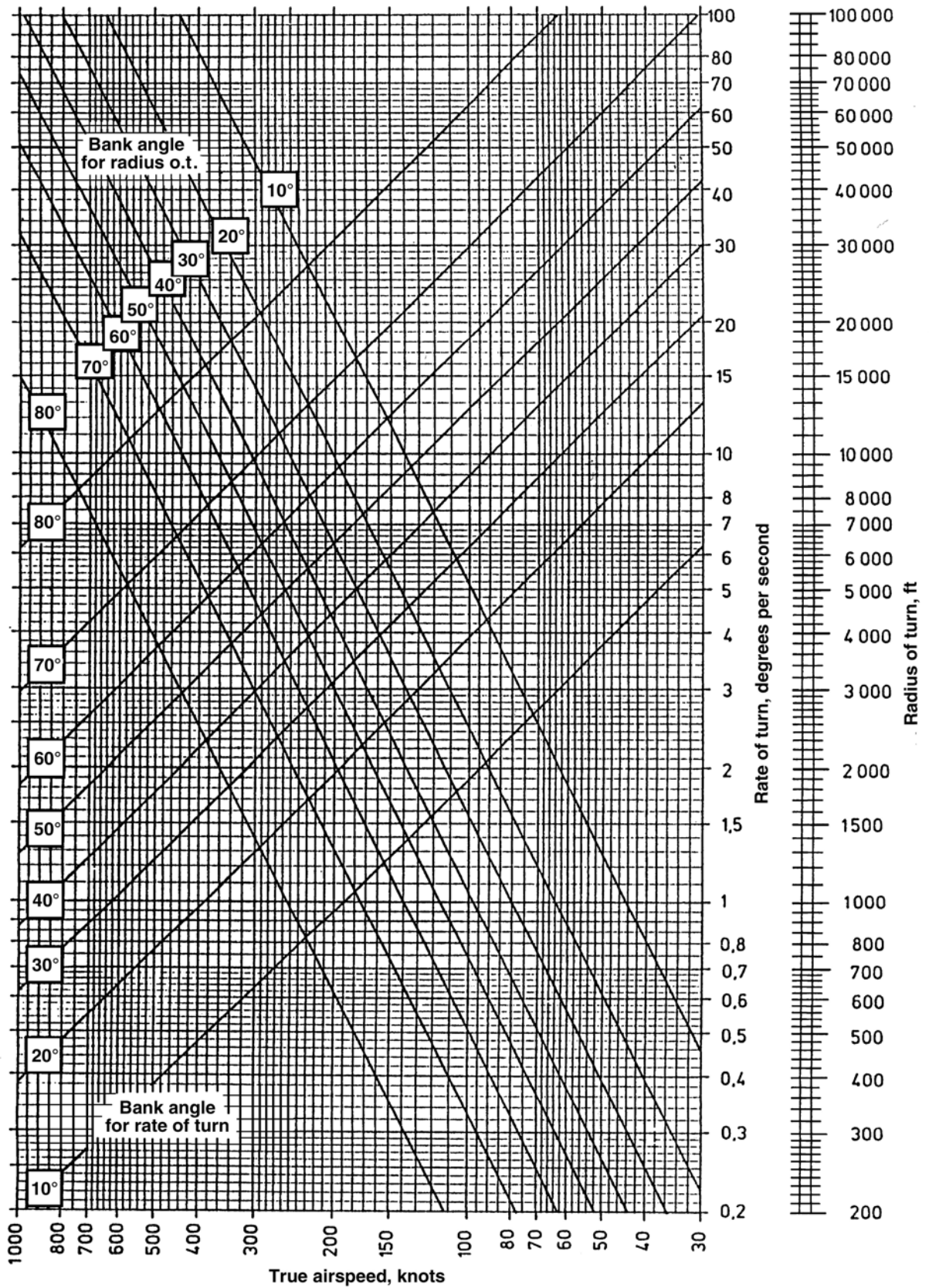

Figure 19B-7. True Airspeed with Respect to Rate and Radius of Turn, Bank Angle as a Parameter.

19B.6 DYNAMIC RADAR CROSS SECTION (RCS) MEASUREMENTS

A brief overview of radar reflectivity measurements generally conducted in anechoic chambers and outdoor test ranges is given in Section 19A.

The determination of RCS of real aircraft in flight is treated here because from a flight test point of view there is a great similarity in procedures and methods for dynamic RCS measurements and the described ARP measurements. The major advantage of such dynamic RCS measurements is that data is obtained in the normal operating environment of an aircraft. All target details and effects of target motion are included. For the RCS measurement system, the antenna radio link receiver must be replaced by the receiver of the test radar. For this the automatic gain control (AGC) output voltage or the intermediate frequency (IF) output signal of the radar receiver has to be adapted to the data acquisition system. Generally, this signal has a poor long-term stability. Therefore, just before or after the measurements the characteristic of the receiver output voltage has to be calibrated to the RCS. This is usually done by launching a balloon carrying a sphere with well known RCS being completely independent from the angle of incidence. This sphere is tracked by the radar and the distance variation serves for a complete sweep of the receiver output voltage down to the noise level. More information on system considerations and examples of existing measurement facilities are given in Reference 19B-1. Appendix 19B.B includes some results of dynamic RCS measurements.

19B.7 CONCLUDING REMARKS

In this Section the need, requirements, methods, and test techniques for dynamic in-flight measurements of aircraft antenna radiation patterns have been outlined. It has been shown that the application of modern data acquisition and processing systems, in conjunction with telemetry, can speed up the expensive flight tests considerably. However, problems in connection with wave propagation in the radio frequency link have to be considered carefully in order to avoid incorrect measurements. Various flight profiles and their advantages and disadvantages have been discussed.

19B.8 REFERENCES

- [19B-1] Bothe, H., and Macdonald, D., "Determination of Antennae Patterns and Radar Reflection Characteristics of Aircraft", AGARD-AG 300, Vol. 4 (1986), 138 pages (ISBN 92-835-1530-7).
- [19B-2] ICAO, "Aeronautical Telecommunications Annex 10, Vol I", International Civil Aviation Organization, Montreal, Canada, 1985.
- [19B-3] ARINC, "Mark 5 Airborne Distance Measuring Equipment (DME)", ARINC Characteristic 709-5, Aeronautical Radio Inc., Annapolis, USA, 1982.
- [19B-4] ARINC, "Mark 2 Airborne ILS-Receiver", ARINC Characteristic 710-8, Aeronautical Radio Inc., Annapolis, USA, 1985.
- [19B-5] ARINC, "Mark 2 Airborne VOR Receiver", ARINC Characteristic 711-6, Aeronautical Radio Inc., Annapolis, USA, 1983.
- [19B-6] ARINC, "Airborne VHF Communications Transceiver", ARINC Characteristic 716-5, Aeronautical Radio Inc., Annapolis, USA, 1983.
- [19B-7] ARINC, "Mark 3 Air Traffic Control Transponder (ATCRBS/DABS)", ARINC Characteristic 718-3, Aeronautical Radio Inc., Annapolis, USA, 1981.

- [19B-8] IEEE, "IEEE Standard Test Procedures for Antennas", IEEE Standard 149, 1979.
- [19B-9] IRIG, "Standard Coordinate System and Data Formats for Antenna Patterns", Electronic Trajectory Measurements Working Group, Inter-Range Instrumentation Group, Range Commanders Council, United States National Ranges, IRIG, Document AD 637 189, May 1966.
- [19B-10] Bothe, H., "In-Flight Measurement of Aircraft Antenna Radiation Patterns", AGARD CP 139 (1973).
- [19B-11] Bothe, H., "Distance Measurements - a By-Product of Telemetry Data Links", Proc. ETC 1992 (1992), 11 pages, 12 figs., 1 table, 5 refs., European Telemetry Conference ETC 1992, Garmisch-Partenkirchen, Germany, 12-14 May 1992.
- [19B-12] Bothe, H., "A Telemetry Computer System for Radio Frequency Flight Test Applications", 10th European Telemetry Conference ETC 90, 15-18 May 1990, Garmisch-Partenkirchen, Germany. Proc.(1990), 14 pages, 13 figs., 1 table, 3 refs.
- [19B-13] Tetzlaff, J., "In-Flight Radiation Pattern Measurement of an Airborne Directional Antenna for Wide Band Microwave Data Transmission", Proceedings of the 10th European Telemetry Conference ETC 90, Garmisch-Partenkirchen, Germany, 15-18 May 1990 (1990), 10 pages, 11 figs., 2 refs.

19B.9 BIBLIOGRAPHY

- Kraus, J.D., "Antennas", Second Edition, McGraw-Hill, NY, 1988, ISBN 0-07-035422-7.
- Jasik, H., "Antenna Engineering Handbook", McGraw-Hill, NY, 1961.
- Reed, H.R., Russel, C.M., "Ultra High Frequency Propagation", Chapman A. Hall LTD, London, 1966.

APPENDIX 19B.A – LRP DETERMINATION OF A GLIDE SLOPE ANTENNA

The determination of the lowest required power level LRP in a measured antenna pattern is discussed in paragraph 19B.1.2. In the following example a glide slope antenna is examined. The utilized gain-loss equation is derived in reference 19B-1. The term 32.54 includes all constant factors within this equation and the dimension constants. It is also mentioned that the power given in dBW is referenced to 1 Watt and in dBm to 1 mWatt. During the test flight for the pattern measurement the transmitter power P_T was 5 dBW, the gain of the ground (transmitting) antenna G_T was 7.3 dBi, the multipath gain G_M was calculated to be 2.5 dB (see Fig 19B.A-1), the input power P_R of the receiver was measured by -105 dBW, line losses L were estimated by 2 dB, the distance d was 55 km and the frequency f was 335.5 MHz. As given by the mentioned gain-loss equation, the actual gain G_R of the glide slope antenna becomes

$$\begin{aligned}
 G_R &= -P_{T(\text{dBW})} - G_{T(\text{dBi})} - G_{M(\text{dB})} + P_{R(\text{dBW})} + L_{(\text{dB})} + 20\log d_{(\text{km})} + 20\log f_{(\text{MHz})} + 32.54 \text{ dB} \\
 &= -5 \quad -7.3 \quad -2.5 \quad -105 \quad +2 \quad +34.8 \quad +50.5 \quad +32.54 \text{ dB} \\
 &= 0.04 \text{ dB}
 \end{aligned}$$

The minimum required gain G_{min} of the glide slope antenna is derived from the relation

$$\frac{A}{G} = \frac{\lambda^2}{4\pi}$$

which applies to all antennas [19B-1]. A is the effective area, G the gain of the antenna and λ the wavelength. For an isotropic antenna with no preferred direction of radiation, G is 1 and A_i becomes

$$A_i = \frac{\lambda^2}{4\pi}$$

The received power P_R in the case of an isotropic antenna is then

$$P_R = S_R A_i = S_R \frac{\lambda^2}{4\pi}$$

where S_R is the power per unit area, and in logarithmic units of measure

$$P_R = S_R + 10\log \frac{\lambda^2}{4\pi}$$

with S_R in dBW/m² and λ in m.

Now the minimal required gain G_{min} of the antenna is given by

$$G_{\text{min}} = P_{R\text{min}} - (S_R + 10\log \frac{\lambda^2}{4\pi})$$

As can be seen in Table 19B-I the power density S_R for a glide slope antenna is -95 dBW/m² and the minimum receiver input power is -87 dBm, which is -117 dBW. A frequency of 335.5 MHz presumed now G_{min} becomes

ANTENNA RADIATION PATTERNS

$$\begin{aligned}G_{\min} &= -117 - (-95 - 11.96) \text{ dB} \\ &= -10.04 \text{ dB}\end{aligned}$$

The gain margin G_m already mentioned in section 19B.1.2 is the difference between the actual gain G_R and the minimum required gain G_{\min}

$$G_m = G_R - G_{\min}$$

which is

$$\begin{aligned}G_m &= 0.04 \text{ dB} + 10.04 \text{ dB} \\ &= 10.08 \text{ dB}\end{aligned}$$

In Fig 19B.A-2, the maximum power level MPL is observed between 360 and 10 degrees at 54 dB. Then the LRP circle becomes

$$\begin{aligned}\text{LRP} &= \text{MPL} - G_m \\ &= 54 - 10.08 \text{ dB} \\ &= 43.92 \text{ dB}\end{aligned}$$

It is noticed, that the lowest required power level is not achieved in the angular areas from 80 to 135 and 220 to 285 degrees. But these are areas, where the glide slope system is out of use anyway.

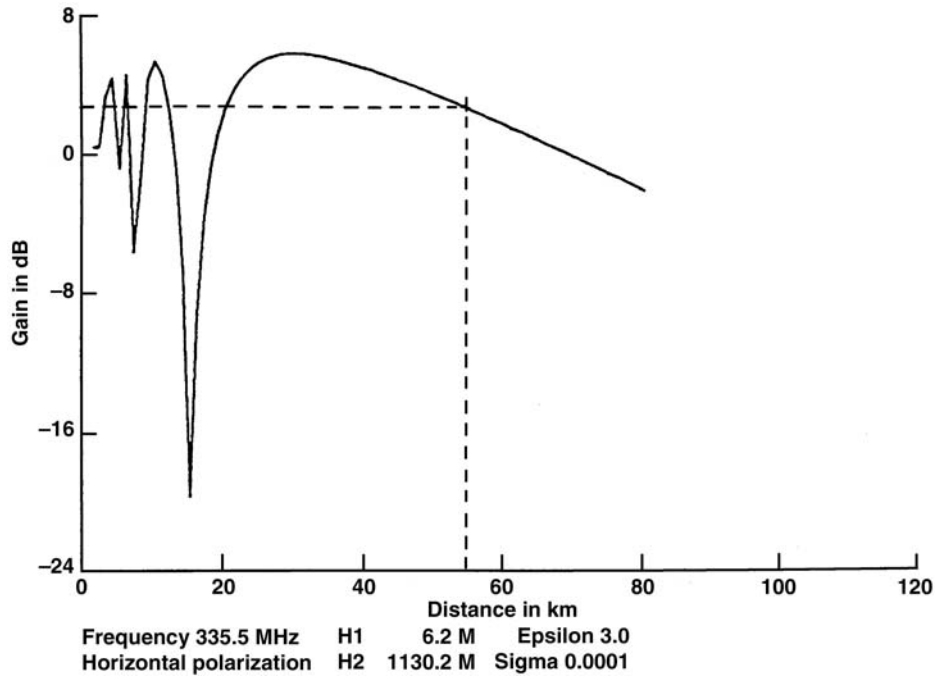

Figure 19B.A-1. Multipath Gain of the Reflecting Ground Calculated after Reference 19B-1.

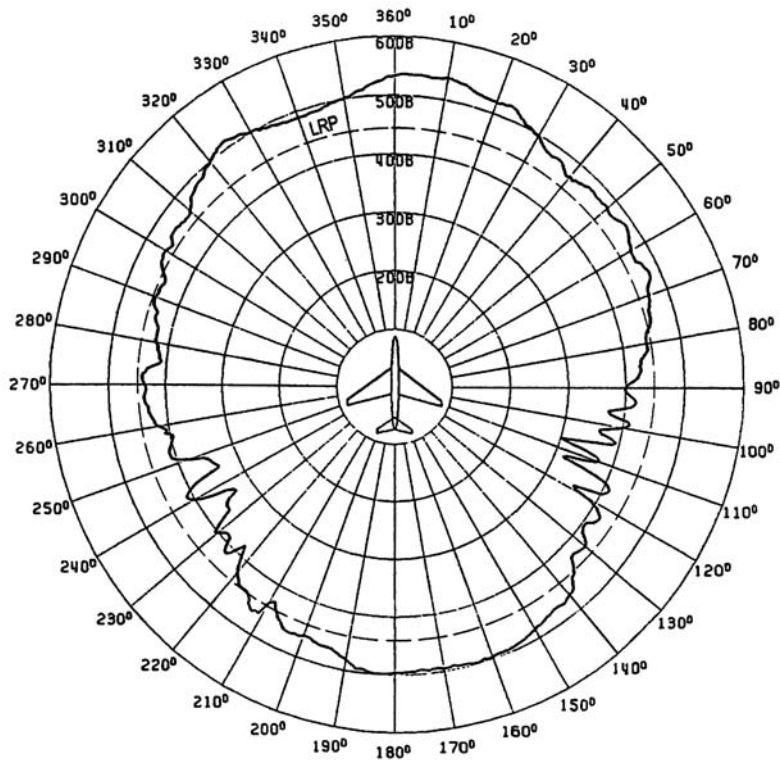

Figure 19B.A-2. Radiation Pattern of a Glide Slope Antenna, Frequency 335.5 MHz, Polarization Horizontal, Test Flight Left Circle, LRP 44 dB.

APPENDIX 19B.B – EXAMPLES OF MEASUREMENT RESULTS

The measurement results given in this section have been recorded by an automatic measurement system with on-line data processing capabilities, operated by the German Aerospace Research Establishment (DLR) in Braunschweig. [19B-12, 19B-13] The radiation pattern of a VOR/Localizer navigation antenna measured in flight is shown in Figure 19B.B-1. This antenna is built into the nose of a flight inspection aircraft Cessna Citation. The pattern shows small interferences in the tail section due to shadowing effects of the fuselage. The pattern has been recorded during a low banked circle flight.

Another example taken from the same aircraft during a fly-over trajectory is illustrated in Figure 19B.B-2. The pattern of a marker antenna mounted below the fuselage is nearly undisturbed in the angular area of operation.

If frequencies increase, the departure of the radiation pattern from circularity usually becomes much worse as the next example illustrates (Figure 19B.B-3).

The radiation pattern of a telemetry antenna mounted on top of the vertical stabilizer of a Dornier DO 228 aircraft is shown in Figure 19B.B-3. During the right-circle flight the left wing elevates and disturbs propagation in the angular area of 280 to 350 degrees. In addition the vertical stabilizer is deflected for guidance of the aircraft during the 15-degree coordinated turn. This deflection deteriorates radiation in the areas around 155 and 210 degrees.

The Dornier DO 228 test aircraft of the DLR carries a directional waveguide slot antenna below its fuselage. This antenna serves for picture data transmission in the 15 GHz frequency band. The 5-degree beamwidth in the horizontal plane asks for directional control in this plane, while the vertical beamwidth of 35 degrees requires no further control. The horizontal radiation pattern of this antenna is illustrated in Figure 19B.B-4. During the pattern measurement the main beam was fixed to a horizontal aspect angle of 90 degrees. It is observed that a high number of smaller lobes are generated by additional rays reflected and diffracted from the structure of the aircraft.

Figures 19B.B-5 and 19B.B-6 illustrate results of RCS measurements taken from the same type of aircraft by in-flight measurements and by scaled model measurements. The scaled model measurement results are averaged over an area of 5 degrees. The difference of 24dB to 6dB in the nose area of the model results from a radar antenna, first aligned in the roll axis and then turned aside. Though the scaled model results are available in limited sectional angular areas only a fairly good agreement with the dynamic results can be observed.

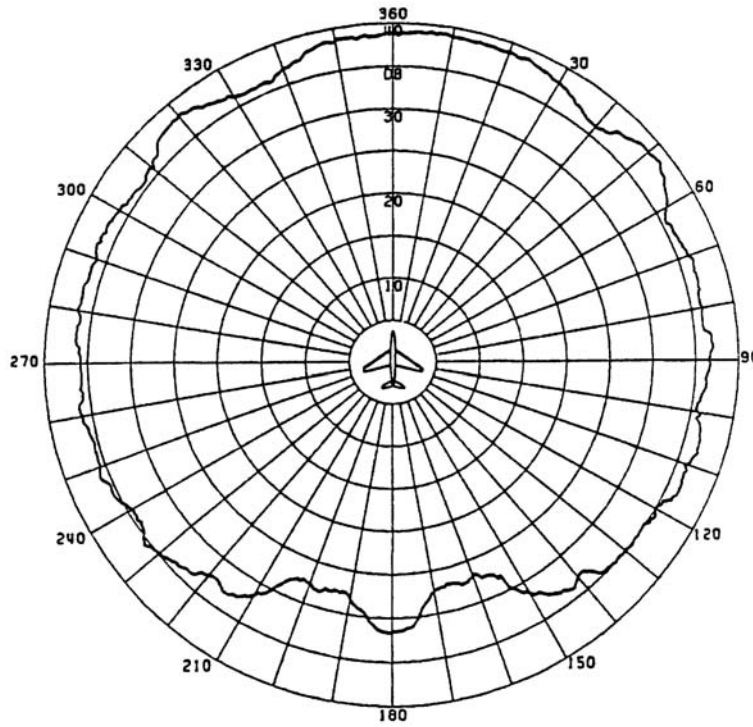

Figure 19B.B-1. Radiation Pattern of VOR/LOC Antenna, Trajectory Left-hand Circle, Bank Angle 5 Degrees, Frequency 111.1 MHz.

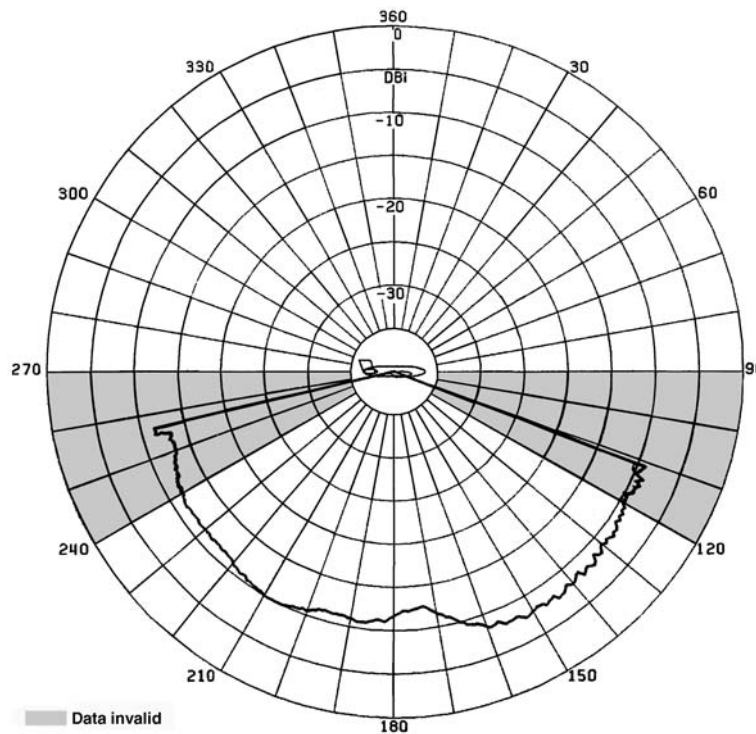

Figure 19B.B-2. Radiation Pattern of Marker Antenna, Trajectory Fly Over, Frequency 75 MHz.

ANTENNA RADIATION PATTERNS

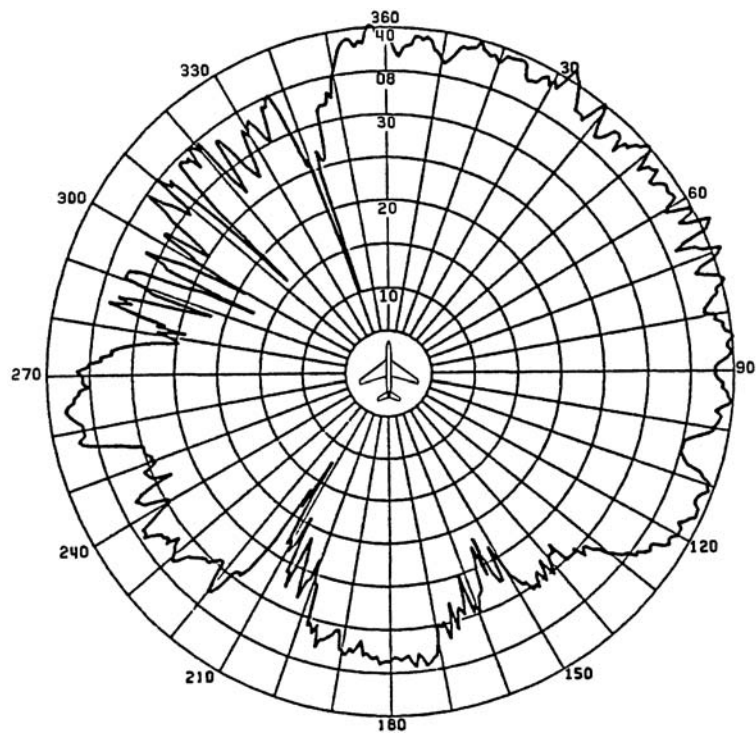

Figure 19B.B-3. Radiation Pattern of Telemetry Antenna, Trajectory Right-hand Circle, Bank Angle 15 Degrees, Frequency 2401 MHz.

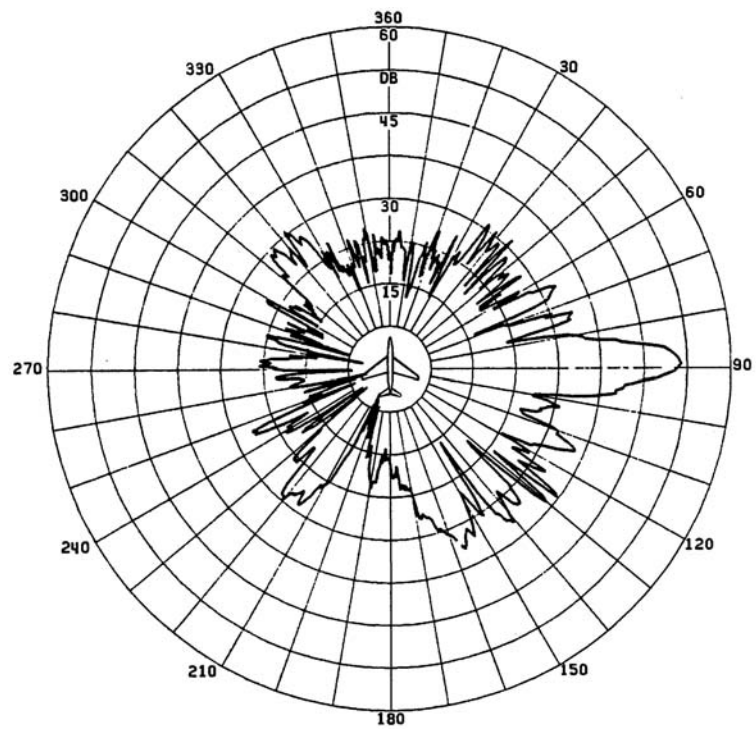

Figure 19B.B-4. Horizontal Radiation Pattern of a Waveguide Slot Antenna, Bank Angle 0 Degrees.

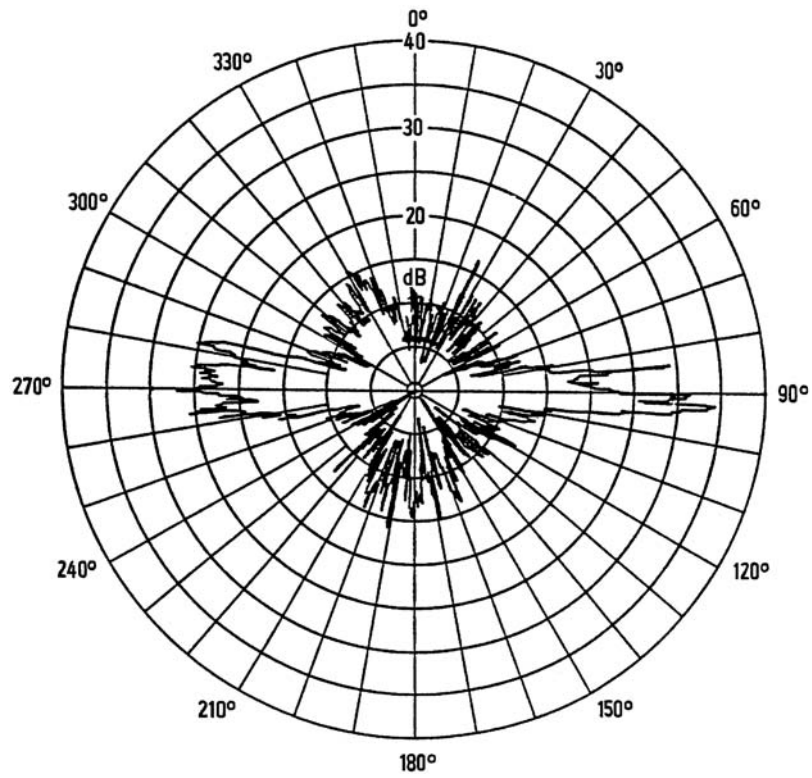

Figure 19B.B-5. In-Flight Measured RCS of Small Twin Jet Aircraft, Trajectory Right-hand Circle, Bank Angle 10 Degrees, Frequency 5 GHz, 0dB=1m².

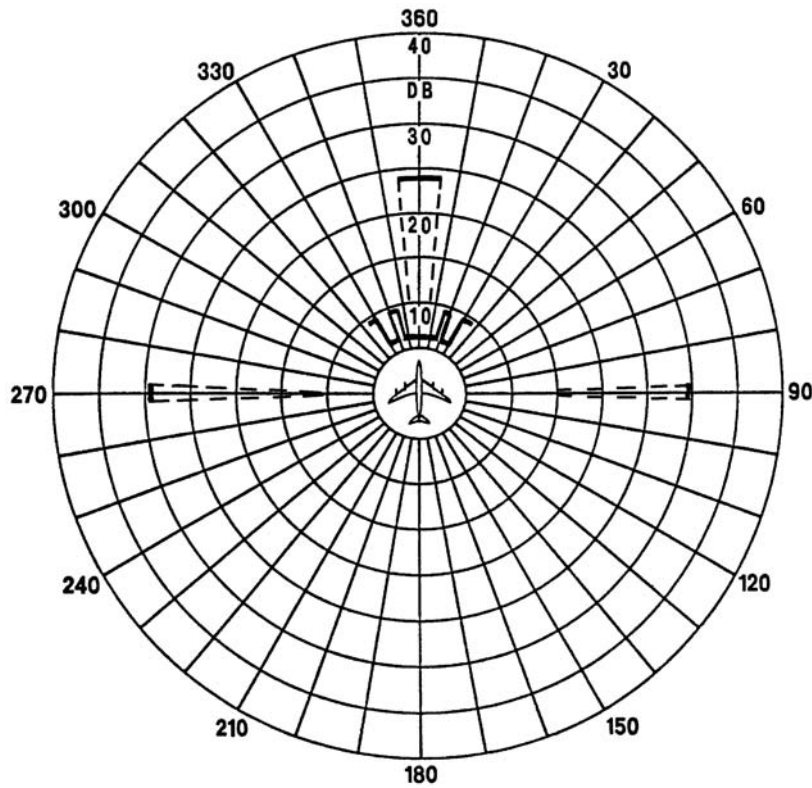

Figure 19B.B-6. RCS of Scaled Model of Test Object from Figure 19B.B-5, Bank Angle 0 Degrees, RCS Averaged over Angular Area of 5 Degrees, 0dB=1m².



Chapter 20 – HUMAN FACTORS

P.A.A. Verbaarschot¹
Department EDAV-FDS
Fokker Aircraft Company
P.O. Box 7600
1117 ZJ Schiphol-Oost
THE NETHERLANDS

20.0 INTRODUCTION

This section presents information that can be used as a general guideline for performing a comprehensive human engineering (human factors(HF)/ergonomics) assessment during a flight test program of either a new air vehicle or a systems upgrade to an existing vehicle. In general, a comprehensive HF assessment covers all person-machine interface aspects. That is, tests deal with the suitability of the aircraft and its equipment for supporting, and being operated by, the aircrew and ground crew members required to execute the aircraft's mission(s).

From the perspective of the aircrew or system operator, a comprehensive HF assessment includes:

- All controls (for instance, type versus function, activation forces and directions, layout, operation of keyboards in flight, etc.) and displays (i.e., symbology, alphanumerics, font size/type, warnings, cautions and advisories, etc.)
- All communication devices (radios, intercom) - speech intelligibility
- Crew station geometry - functional reach and internal field of view
- Crew station configuration and miscellaneous furnishings, personal protective equipment, lighting, oxygen generating and distributing systems, seat geometry and aircrew comfort, the climatic conditions, noise and vibration levels, and ride quality in crew and passenger compartments, etc.
- Windshield and canopies (external field of view, optical qualities, etc.)
- Ingress/egress (normal and emergency, including rescue)
- Aircrew workload and performance, including measurement of physiological, psychological, and mission related stressors on mission accomplishment.

It follows that HF is a fundamental aspect of the design of any manned aircraft and that the assessment of HF is a major element of many tests involved in a typical flight test program. Since many of the HF assessments will be made during the course of tests for other purposes (e.g., the assessment of flying qualities), it is important the Flight Test Engineer (FTE) ensures that there is a close liaison between the HF engineer, the test aircrew, and other specialists involved. In addition, comprehensive assessment should include a review of all aircrew training devices to insure that the design of the hardware and software supports fast and efficient skill acquisition.

From the perspective of the maintainer, comprehensive HF testing includes an assessment of the maintainability aspects of the air vehicle design and the maintenance training devices.

¹ Mr. Verbaarschot was killed in an accident in December 1992.

HUMAN FACTORS

The material in this Section has been prepared under the assumption that HF Engineering has been an integral part of the design process and that the tests described herein are performed on a design that is relatively "complete".

In order to keep these guidelines as generic as possible, specific (system unique) design related aspects are not discussed in any detail. Representative examples of past or current HF test programs are used for clarification purposes only. For instance, some examples from the evaluation and certification of the Fokker 100 flight deck are included. Due to space constraints, the following information does not represent an exhaustive treatise on HF testing.

20.1 TEST OBJECTIVES

In general, there are three distinct but related overall HF test objectives. The first is to determine if human engineering requirements and criteria have been incorporated in the system design such that the design accommodates the full range of personnel representative of the user population when operating, controlling, and maintaining the aircraft in the intended operational environment, i.e., does it provide a benign and user friendly environment such that the aircrew and/or ground crew will be able to safely and efficiently execute all associated tasks while operating the aircraft in accordance with the recommended operating procedures. The next objective is to determine if the system provides for efficient human performance in the intended operational environment and to identify any undesirable design or procedural features or discrepancies between required and actual performance and provide recommendations for corrective actions. The third is to identify significant areas of operation or maintenance that are conducive to human error and provide recommendations for corrective action.

20.1.1 Human Engineering

HF engineering and testing should (ideally) start in the preliminary design phase of any project. All design decisions made throughout the various design phases are subject to human engineering verification and validation tests beginning with rapid prototyping and mockups, extending through partial and full simulations, and continuing through on-aircraft ground and flight test missions in operationally representative conditions and environments. Typical test areas include, but are not limited to, those shown in Table 20-I.

Table 20-I Typical Test Areas

- Flight operations clearances
 - Aircraft subsystems operation
 - Performance during flight tasks and mission segments
- Evaluation/certification of:
 - Crew performance on flight tasks
 - Controls and displays
 - Methods of control actuation
 - Guards against inadvertent control actuation
 - Design for blind operation of controls
 - Control Mechanization/switchology for task accomplishment
 - Control/actuation/response delays
 - Control panel design and placement
 - Control panel legends and labeling
 - Display colors, lighting, and compatibility
 - Display information content, format, and clutter
 - Display symbology

- Display image quality
- Display scale design, pointer accuracy, and pointer parallax
- Communication systems
- Crew station geometry
 - Accessibility/reachability of controls
 - Crew station (ejection) seats
 - Clearances between aircrew/personal equipment and the flight deck/cockpit structures, canopy/windscreen, and controls
 - Physical accommodation of small to large crews
 - Internal and external visibility
 - Canopy/windscreen quality
 - Field of view
 - Optical qualities
 - Miscellaneous furnishings
- Lighting (internal and external)
 - Night Vision Goggles ()
 - Aerial refueling lights
 - Taxi/landing lights
- Aircrew workload and performance
- Aircrew life support and aircraft environment
 - Noise
 - Cockpit/flight deck comfort
 - Temperature control and head/foot temperature differentials
 - Ride quality
 - Noise levels
 - Vibration levels
 - Oxygen generating and distributing systems
 - Personal protective equipment
 - Passive Thermal Protection Shields
 - Lead Lanthanum-modified Zirconate Titanite (PLZT) Goggles
 - Fit
 - Performance during normal operations
 - Performance in the post egress/ejection environment
 - Compatibility with flight deck/crew station controls, displays, and seats
- Warning, caution, and advisory system
 - Integration of aural and visual indications
 - Intelligibility
 - Location
- Aircrew training devices
- Ingress/egress
 - Normal and emergency
 - Rescue
- Aircraft maintainability and support
 - Noise
 - Near (within 100 feet) field
 - Far (in excess of 100 feet) field
 - Suitability of tools and support equipment
 - Special test equipment
- Accuracy and adequacy of technical manuals
 - Maintainer system-specific training devices

For each of these test areas shown in Table 20-I (and any others unique to the particular system under test), specific test objectives and success criteria should be established prior to test. Success criteria should specify required degree of compliance with various program, system or mission requirements documents, as well as specific contract-mandated design specifications and regulations. Samples of airworthiness authority requirements pertaining to flight deck design can be found in FAR/JAR 25, paragraphs 771, 773, 1301, 1309, 1321, 1381 and 1523. [20-1, 20-2] The US Department of Defense has a military standard entitled "Human Engineering Design Criteria for Military Systems, Equipment and Facilities" that establishes general human engineering criteria for design and development of military systems, equipment and facilities. [20-3] This document is often referenced in weapon system contracts as being the general human engineering design guidance, and as a result, is referenced often in HF test and evaluation of military systems. However, such requirements cannot be fully comprehensive and the acceptability of a particular design will depend upon a host of detailed interactions for which it is impossible to legislate.

To avoid the need for a major re-design at a later date, the HF aspects of the design should be monitored continuously as it matures by means of ground testing on appropriate rigs and/or mockups prior to ground and flight testing of the production vehicle. For example, HF testing is often initiated with simulation tests in partial and full mockups (simulators) and should precede or be conducted in conjunction with on-aircraft ground and flight tests. Based on customer needs, HF testing can be iterative commensurate with modifications to the overall system design. Often HF testing culminates in dedicated flight test of complete or partial mission scenarios, in operationally representative flight regimes. This allows validation of pilot-in-the-loop total system design in terms of potential for mission success. This is sometimes referred to as "systems integration testing" and has been successfully employed in several US Air Force flight test programs (e.g., F-16/Low Altitude Navigation Targeting Infrared for Night (LANTIRN) System tests, Phase I and Phase II).

While systems integration tests are being conducted, the air vehicle system should be as representative as possible of the production (final) configuration to allow an acceptable degree of generalization of the test results to the operational use of the system in the actual environment. The air vehicle system acquisition agency, the prime integrating system designer and manufacturer (as well as critical subcontractors), ground and flight test agencies, and to a certain extent, the system users, must all agree as to test philosophy, basis for certification, and required specification compliance demonstration.

20.1.2 Human Performance

Typically, human engineering and subsystem performance is assessed through the use of:

- Subjective assessments (via questionnaires and rating scales) obtained from qualified test (aircrew and maintainer) subjects
- Psychophysiological and other qualitative and quantitative measurements of actual test subject performance
- Analysis of crew station or maintenance activities videotape recordings made during test conditions
- Physical inspection/measurement of aircraft structure and other on- and off-aircraft components for adherence to design guidelines involving such aspects as layout, dimensions, travel (direction of movement), rotation, weight, resistance, visual, auditory and tactile feedback, labeling, and lighting
- Photographic, photometric, and acoustic measurements
- Observation of test subject performance during actual task performance or staged demonstrations
- Anthropometric measures of test subjects.

20.1.3 Operations and Maintenance

During most HF testing, particularly actual on-aircraft ground or flight test, generally no attempt is made to introduce real or simulated aircraft malfunctions or to specify test conditions which would place the air vehicle at risk. If authentic emergency situations exist, data is obtained on a non-intrusive basis only.

A comprehensive HF assessment in the maintenance area includes:

- Assessment of the maintainability aspects of the air vehicle design in terms of how efficiently and successfully the maintainers can service the air vehicle using the available tools, support equipment, and related documentation
- A review of all system unique test equipment and related documentation to ensure safe and efficient use
- An assessment of training devices to ensure fast and effective skill acquisition
- Measurement of the noise environment around the air vehicle during various engine settings (near and far field) in order to evaluate the impact on the ground crew and to assess the effectiveness of noise abatement equipment.

20.2 TEST TECHNIQUES

HF test techniques usually are comprised of, but are not limited to, subjective assessments performed by multiple flight/ground crew. The test can be supported by video/audio recordings, which can prove useful to review and clarify test scenarios, and data recording. All test subjects should be briefed before the start of the program on general elements such as de-briefing procedures, video recordings, and ratings and comments forms/questionnaires to be completed.

Aircrew workload and performance can be evaluated subjectively and/or objectively. It would be desirable for the evaluation to conclude with dedicated workload and systems integration test sortie(s) during which operational realism would be maintained to the highest degree possible. The evaluation of workload and performance would assess the extent to which aircraft flying qualities, cockpit layout, control mechanization, display representation, subsystem performance, and overall systems integration support a level of aircrew workload which permits the aircrew to successfully perform mission-required tasks without inducing excessive psychological stress, mental effort, physical fatigue, and/or error. The assessment tool should be as unobtrusive as possible so as not to add to the aircrew workload. [20-3]

On the spot measurements of safe operation during the flight would be most desirable; a practical way to realize this would be subjective ratings given by the pilot, first officer, and/or a flight safety observer (FSO). After each flight the crew would also be requested to comment in writing if any of the factors mentioned in Table 20-II impacted the safe and effective completion of the mission. Often a structured interview is used by the HF engineer to debrief the aircrew.

Table 20-II Evaluation of Flight Deck Design

FAR/JAR 25 PARA		
771	a c e	Flight crew must be able to perform duties without unreasonable concentration or fatigue. The airplane must be controlled from either pilot seat with equal safety (for a two crew aircraft). Vibration and noise of cockpit equipment may not interfere with safe operation.
1309	c	Warning information must be provided to alert the crew to unsafe operating conditions and enable them to take appropriate corrective action. Warning means must be designed to minimize crew errors which could create additional hazards.
1523	a b c	The minimum flight crew must be stabilized sufficient for safe operation considering: Workload on individual crew members. (Visual) accessibility, conspicuity and ease of operation of necessary controls. Kind of operation authorized.

There are many subjective workload rating tools available for use in flight test. Among them are Subjective Workload Assessment Technique (SWAT), NASA Task Load Index (TLX), United States Air Force School of Aerospace Medicine (USAFSAM) Rating Scale, and Subjective Workload Dominance (SWORD) Technique. [20-4, 20-5, 20-6]

Methods for objective workload assessment have also been investigated. [20-7, 20-8, 20-9] Physiological metrics have been used with varying degrees of success as objective measures of workload. Some examples of these metrics are: electrocardiographs, heart rate variability, electro-oculogram, and electroencephalogram.

Noise may be aerodynamically related or caused by systems operations such as compressors, hydraulic pumps, air conditioning flow, auxiliary power unit, engines, etc. Spectral sound measurements at various locations on the flight deck should uncover frequencies and levels that may have an adverse effect on the effectiveness of operation of the flight crew. The issue of cumulative noise exposure, especially on long duration flights should be investigated. Air Force Regulation (AFR) 161-35 and Military Standard (MIL-STD) 88060 can be used as guides. [20-10, 20-11]

For example, to establish the required level of the aural warnings generated by the integrated flight warning system, subjective listening tests under high, medium, and low noise conditions were performed by multiple flight crew including authority pilots on the Fokker 100 program. The subjective results obtained were correlated with spectral recordings of warning sounds under ambient noise conditions. Recordings of aircraft parameters such as speed and altitude could be correlated to flight deck noise levels. This made it possible to design a warning system that adapts the level of the aural warnings to the actual flight deck noise level.

Evaluations will be conducted of controls and displays, crew station configuration, miscellaneous furnishings, and lighting. A typical data collection procedure would have the aircrew complete a questionnaire that pertains to the specific area being assessed. This is usually accomplished post-flight or after the debrief.

Performing a flight test program during twilight/night conditions should reveal any flight deck lighting problems. The flight test program should include the use of exterior lighting systems such as anti-

collision lights and landing/taxi lights that may cause glare effects interfering with crew operation during operation in clouds or reflections on fuselage parts. Aerial refueling lights and formation lights must be evaluated to determine their suitability and usability under adverse weather conditions and during night operations under varying conditions of phases of the moon, cloud cover, etc. [20-12, 20-13, 20-14]

20.3 TEST PREPARATIONS

The HF engineer must prepare a test plan which utilizes the most appropriate form of testing for each area of interest appropriate to the system under test. Experience has shown that HF testing, like all other discipline testing, must begin with a rigorous test plan that identifies any appropriate test constraints and limitations, required air vehicle configuration(s), and is detailed in an appropriate test (either ground or flight) card. The test plan must also address special test equipment, if needed, and specify the need for parameter recordings. (See Section 8). (In case of certification, agreement with the authority is required prior to start of the test).

Appropriate test cards, either ground or flight, must be prepared that detail the objectives, constraints and limitations, and air vehicle configuration. Test cards should also denote specific aircrew (or maintainer) activities (if required), and areas of concern, such as potential hazards or a particular control or display, on which aircrew or maintainers need to focus their attention and subjective assessment. The test cards can be prepared for each individual test or for an entire flight. It is useful to leave room on the card so the flight crew can record notes while performing the test.

Some HF tests must precede other forms of testing to insure initial safety of flight and ground operations. For instance, emergency egress testing should precede first flight (by definition, "flight" begins with any movement of the air vehicle) of any new air vehicle. (See paragraph 17.6). This test will insure that the aircrew can safely and expeditiously exit the air vehicle in the time required with a minimum of obstructions and delays. Ground test of crew station internal lighting as well as air vehicle external lighting, to verify safe operating conditions during taxi, takeoff/landing, aerial refueling operations and/or formation flight (of military aircraft), needs to be completed prior to operations in twilight or night conditions.

20.4 GROUND TEST PROGRAM

Ground testing should be accomplished with qualified air vehicle and ground crew personnel (depending upon the type and goal(s) of the test, it is not always necessary to have certified aircrew and maintainers as test subjects) in communication with the HF engineer via appropriate communication links. In some cases, testing will require the participation of qualified aircrew and maintainers to serve as test subjects. The following areas are normally tested on the ground and ideally (although not always) tested before first flight (test) of a new air vehicle.

20.4.1 Controls and Displays

Flight deck control and display systems have the primary function of providing information (visual, aural and tactile) and system control to the aircrew. Examples of such systems are Electronic Flight Instrument System, throttles, side stick controller, a Flight Warning System, and a weather system. Functional performance of these systems is not usually the domain of HF; however, the degree to which the human efficiently and effectively interfaces with them is a matter of concern to the HF engineers.

20.4.2 Crew Station Configuration

Assessment of functional reach, ease of operation and proper functioning (relative to stereotypes, i.e., "switch up" connotes "on"; "switch down" connotes "off") of all flight critical and ground critical control devices, preferably under different seat safety harness configurations (for instance, simulating locked and unlocked harnesses) is conducted. This testing seeks to determine if there is adequate hand and foot access (to the appropriate controls) for the full range of potential system users and also assesses critical crew station displays in terms of visual accessibility. [20-3] Such tests must include considerations for cold weather gear and/or chemical/biological/nuclear (CBN) protective equipment.

Crew station testing also includes an assessment of crew seats (non-ejection and ejection) in terms of comfort and control, ease of ingress/egress, operator-seat separation interfaces and safety devices, and maintainability. Aircrew comfort in military ejection seats has been an issue for a long time, especially in aircraft with long duration flights. Aircrew seating comfort is a serious concern to HF testing, as it is well known that seating discomfort can jeopardize overall mission success.

Miscellaneous furnishings (i.e., axes, emergency ejection and evacuation systems, survival equipment, galleys, toilets, storage boxes, etc.) must also be assessed under the aegis of crew station configuration testing to ensure that the equipment performs as intended and that aircrew (or maintainers) can easily and expeditiously access, use, or service the equipment as required. Mock emergency trials or functional demonstrations should be accomplished that allow this type of analysis and assessment.

20.4.3 Lighting (Internal and External)

Ground tests for evaluation of flight deck internal lighting are intended to verify the lighting aspects of panels, indicators, floodlights, portable emergency lights, annunciators, and utility lights under various ambient lighting conditions. [20-12, 20-13, 20-14] This testing is usually conducted via subjective assessment using system experts as test subjects. However, photometric measures of interior and exterior lighting systems are sometimes taken to verify that they meet system specifications or to determine if there is adequate illumination at predetermined distances. Photometric measurements are also taken when deficiencies are found to exist (i.e., light leakages). With respect to internal lights, the following performance characteristics are addressed during this testing:

- Brightness/intensity
- Chromaticity
- Contrast
- Stray light
- Light leakage
- Reflections/glare
- Uniformity (color, luminance, illuminance)
- Interference
- Mechanization/stowage/location of utility and emergency lights
- Color shift
- Labeling
- False illumination
- Control (range, response, tracking)
- Distribution
- Legibility

Depending upon the mission of the air vehicle, subjectively-based surveys of the interior crew station lighting system are conducted with and without additional equipment. This can include helmet visors (clear, dark, and gradient), night vision goggles (NVGs), and passive thermal protection shields (PTPS) used either in conjunction with polarized lanthanum-modified lead zirconate titanate (PLZT) goggles or each system used alone. On one test program, the interior lighting tests were conducted with PTPS only and PLZT only. Windshield tests were conducted with PTPS alone and with PLZT. These tests are conducted in both daytime ambient and reduced ambient (nighttime) lighting conditions.

Ground tests are also conducted of all external lighting systems. This includes taxi/landing lights, position (navigation) lights as well as aerial refueling lights (for military aircraft). With respect to the aerial refueling lights, ground tests are also conducted from the perspective of the boom operator to insure the potential for safe twilight and nighttime aerial refueling operations.

20.4.4 Evaluation of Maintainability Aspects

Maintainability requirements of aircraft and systems must be included as design requirements and verified during the development process of the aircraft. Such requirements may comprise aspects such as size and weight of Line Replaceable Units, easy access to equipment, equipment removal and installation procedures, times (with and without bulky cold weather clothing or Chemical, Biological, and Nuclear (CBN) protective clothing), personnel required, maximum allowable time to identify faulty equipment, etc. The purpose of test programs performed on prototype aircraft is to verify the aircraft and systems maintainability design on a complete aircraft. Modern, state-of-the-art electronic designs usually include Built-In-Test capabilities or self-diagnostics, either automatically or manually initiated, and may involve automatic reconfiguration in a fault tolerant design. Important HF aspects relate to unambiguous and clear indication of maintenance actions required such as identification and replacement of faulty equipment. The technical documentation should be complete, i.e., all maintenance steps are included in the documentation, and describe any variations to maintenance actions when they are performed in extremely cold or hot conditions, i.e., taking into consideration limitations imposed by the clothing worn by maintainers. Maintenance actions should be performed without removing unnecessary units, i.e., can a radio be accessed without removing an ejection seat. Access areas should be sufficiently large to accommodate the tools and personnel required to perform a maintenance action, e.g., will a tool with a six-inch handle fit into an area that is full of other equipment, or does a unit to be removed weigh so much that three people are required to lift it but only two people can reach it. It has been found to be very useful to make a video recording of maintenance actions so that the actions can be analyzed without undue interruption of the maintenance activities.

An evaluation of the Minimum Equipment List is essential. The list may allow the aircraft to be dispatched with one or more system failures. The justification being that for dual or multiply redundant systems it may be perfectly safe to allow an aircraft to be operated for a limited amount of time. To allow dispatch under those conditions, operational or maintenance procedures may be affected and should be identified as such. It is therefore very important that the flight crew is presented with clear and unambiguous indications of system failures so that they can establish whether the next test is affected or that maintenance should be called in. (See Section 10).

20.4.5 Emergency Evacuation

Prior to the start of a flight test program the subject of safe evacuation of the flight/cabin crew must be addressed to ensure safe and timely evacuation of the aircraft both on the ground and in flight. Any standard equipment must be evaluated and tested to ensure that it operates as designed and that it can be used by the flight crew without undue risk under the worst conditions anticipated on the ground or in flight. If there is no emergency egress equipment or if the test aircraft will operate in conditions in which the equipment may not function or is unusable, then other provisions must be designed, tested, and installed, procedures established, and the crew trained in its use.

There are many different types of aircraft with different provisions and procedures. (See paragraph 17.6). Two generic aircraft types, with and without ejection seats, will be addressed.

20.4.5.1 Aircraft Equipped with Ejection Seats. When previously qualified equipment is to be used on new aircraft, a review must be conducted of previous ground and flight tests to ensure that the existing equipment will interface satisfactorily with the new aircraft. It is assumed that the equipment itself will work and has been tested in mock-ups, on sled tracks, etc., and may have been utilized in other aircraft. The emphasis here is to assure that there are no HF issues, i.e., the new cockpit does not contain projections that will prohibit the crew from reaching seat operating switches and levers, there are no projections or control stick placements that will interfere with the seat as it leaves the aircraft, flight test panels and displays do not protrude into the ejection envelope, and the crew will not be injured or maimed when the seat is operated, that are related to the installation in the new aircraft. The weight and center of gravity of aircrew mounted devices, such as helmet-mounted displays, should not produce injuries from the acceleration forces experienced during ejection.

When new ejection seats are to be utilized, the HF engineer must ensure that HF engineering has played a major role during the design phase of the new equipment and that laboratory tests have established that the new equipment meets its design specification. In this case, the emphasis has to be two-fold: Will the seat work properly in this aircraft and are the HF considerations safely met?

20.4.5.2 Aircraft Not Equipped With Ejection Seats. Depending on the nature of the flight test program, e.g., a new aircraft starting with a restricted flight envelope, flutter testing, deep stall testing, etc., it may be necessary to design specific provisions on a prototype aircraft, such as slides or chutes, knotted ropes from crew positions to egress hatches, emergency lighting, etc., to allow a parachute-equipped flight crew member to evacuate the aircraft in case of an emergency. (A provision not normally found on civil passenger aircraft or a military aircraft designed to carry passengers or cargo). The HF engineer must ensure that emergency equipment such as parachutes, fire extinguishers, oxygen masks, emergency egress equipment, etc., are located where they can be utilized under the expected emergency conditions. The emergency egress procedures need to be derived and documented so that crew members can be properly trained and briefed prior to each high risk test.

For passenger aircraft, emergency ground evacuation tests are required for all representative crew/passenger combinations. Passengers should not be selected and placed in the aircraft randomly. Passengers should represent the typical mix of gender and size to be expected during normal operations. For aircraft with an aeromedical evacuation mission, emergency evacuation from typical configurations of litter stations and ambulatory passengers should be evaluated. Evacuation instructions provided to the passengers should be the same as those briefed before normal flights. Random exits (unknown to the passengers) should be blocked from the outside to simulate aircraft damage or obstructions. The goal is to identify how well the evacuation instructions describe the proper evacuation procedure, to identify what type of passengers may have difficulty in operating emergency evacuation exits, and how fast all passengers and litter patients can depart from the aircraft.

20.5 FLIGHT TEST PROGRAM

In order to establish safe operation of the aircraft a flight test program must be performed with emphasis on HF and crew performance. [20-3, 20-15] In order to validate the results obtained during the program, the items tested, up to the entire flight deck or crew station configuration, needs to be as close to the final production configuration as possible, or even be performed on the first production aircraft itself. In the Fokker 100 test program many situations on the flight deck were simulated that could have been encountered during airline operation with the aircraft including abnormal and emergency situations.

20.5.1 Crew Composition

Except for flight tests deemed to be of potentially high risk when the minimum crew is carried, it is often possible to accommodate an HF specialist in transport and cargo aircraft. The crew composition used during the Fokker 100 program consisted of:

- 2 pilots
- 1 flight safety officer/observer
- 1 HF engineer
- 1 second observer
- 2 flight test instrumentation engineers
- 1 flight test engineer

Other aircraft (i.e., fighter aircraft, B-2 bomber) are limited in crew composition by the size/configuration of the aircraft. On some F-16 developmental testing two-seat aircraft were used and the rear cockpit was occupied by a discipline engineer. The B-2 bomber testing is limited to the right- and left-seat pilots. The crew composition used during the C-17 flight test program typically consists of:

- 2 pilots
- 1 flight safety observer
- 1 flight test engineer
- 1 discipline engineer (i.e., HF, avionics, flight controls, etc.)

20.5.2 Flight Test Scenarios

The flight test scenarios should be a composition of system integration flights which as closely as possible represent an actual operational mission. On the Fokker 100 test program, it was desirable to include simulated abnormal and/or emergency situations. The simulated failures could be initiated by pulling circuit breakers or initiating system test sequences. The scenarios chosen should resemble realistic normal and abnormal situations that may be encountered during operation with the aircraft, including flight at night and under adverse weather conditions.

All crew members are to be briefed before the start of the program on general elements such as de-briefing procedures, video recordings, ratings and comment forms to be completed. If any training is required on the metrics to be used to gather subjective data, it must be conducted prior to the start of the flight test program. The crew should follow normal company/test facility procedures such as signing of fuel, load sheets, flight plans, flight logs, etc.

20.6 DATA ANALYSIS

Data gathered via questionnaires, structured interview, on-board recordings, and flight reports will be consolidated and analyzed. Analysis will generally consist of the comparison and/or verification of each in a comprehensive list of component design and performance characteristics against provisions contained in cited human engineering guidelines and contractual specifications. The HF engineer will then assess the extent to which the various subsystems meet the needs of the aircrew.

On the Fokker 100 program, the results of the test program were primarily obtained from verbal crew comments during the debriefing. The FSO was able to pinpoint the highlights encountered during the flight in the debriefing. The ratings were not part of the formal certification program. The primary

function of the recorded ratings was to assist the pilot in determining his thoughts with respect to the verbal comments during the debriefing. In general the ratings of FSO and pilots were comparable. In some cases, however, a noticeable difference was found. These differences were discussed during the debriefings.

The flight parameters were not analyzed but were merely recorded as a safeguard should it become necessary at a later stage to obtain additional information about the aircraft condition or position.

20.7 TEST RESULTS

Where HF requirements are expressed in quantitative terms (e.g., the required field of view from the design eye position) demonstration of compliance with those requirements is a straightforward matter of measurements which may sometimes be delegated to the manufacturer. Where the assessment of HF involves subjective judgement, those judgements must be the responsibility of the certifying agency. For all but trivial matters such judgements should be based upon the views of at least three pilots with current experience in the vehicle type whose physiques cover the anthropomorphic range. Each pilot should wear the aircrew equipment appropriate to the aircraft's mission(s).

The formulation and reporting of subjective assessments is best achieved by narrative reports in which the assessors describe the tests conducted, the results obtained, and the conclusions drawn, i.e., the suitability of the particular item for service use plus any enhancing features or improvements needed. Quantitative values should be given where relevant, e.g., the force required to operate a control, indicating whether the value is measured or estimated. In some cases it may be helpful and convenient to present qualitative judgements via a qualitative scaling system but it must be appreciated that such scales are a means of providing an overall summary, and that explanatory detail for the reasoning behind selecting the value assigned is always essential.

After each Fokker 100 test flight, problems that were identified were highlighted during the debriefing. A Test Result Summary with the highlights and relevant information needed to retrieve recorded information was produced as a feed back to the design specialist. In case of a certification test a Test Certification Form was completed that formally stated that the tests were performed in accordance with the test specification and listed the observations or deviations from the expected or specified results.

The latter document was an input to the final JAR/FAR Certification Results Report that addresses the observations and deviations. Supporting evidence to explain observations may consist of video and audio recordings and aircraft parameter recordings. Sometimes the sequence was repeated if a system redesign was required as a result of the observations during the tests or unacceptable deviations from the specified results.

20.8 NEW DEVELOPMENTS

The following paragraphs contain comments on several new developments that will be applied to future HF evaluations.

20.8.1 Test and Evaluation of "Glass" Cockpits

The advent of the "glass" cockpit in aviation systems offers a new challenge for the Crew Systems Integration test and evaluation.

The traditional cockpit is characterized by the use of "knobs and dials" to convey information to the aircrew. Generally in this type of cockpit, data are conveyed directly from the source in an analog format.

Flight control, aircraft systems, and mission data are typically provided via single purpose, dedicated indicators. Conventional instruments provide raw data that the operator integrates to obtain information about the aircraft, the environment, and the mission. The data formats in this cockpit are inherently standardized/consistent between crew stations. Displays and controls for data, when placed consistently within crew stations allow aircrew to develop a spatial orientation to information. Aircrew can develop a scan pattern "habit" that is well defined and practiced so that data are transferred consistently and efficiently from the controls and displays for aircrew to accomplish their mission safely and effectively. This inherent standardization also aids the crew in the coordination of tasks and responsibilities to manage mission workload. The traditional cockpit, however, is extremely limited in the amount of information that can be conveyed: knobs and dials require crew station "real estate". The integration of new mission systems requires new controls and displays - and these controls and displays require space and power in what are typically overcrowded and cluttered cockpit instrument panels.

The glass cockpit is characterized by the use of multifunction displays (MFDs) to provide **information** to the aircrew. Use of these displays gives the aircrew more information - from sensor imagery and sophisticated flight control/guidance cues to "notification by exception" warning/caution/advisory systems - than ever imaginable in a traditional cockpit. The use of MFDs allows significantly more information to be presented in a minimal amount of crew station real estate. With these advantages, however, came an increase in the complexity of the system an operator must use. In a glass cockpit, aircrew must develop a conceptual orientation to information. Information is located in multiple "layers" of formats accessible via a single display. Furthermore, information in the glass cockpit is not inherently standardized between crew station or aircraft. Problems arise with control over subsystem configuration and data entry, display clutter, symbology cues, and access logic that does not flow in accordance with the operator decision process, latency between the response of the aircraft or subsystem, and the depiction of that information to the pilot, crew coordination, and communication.

Test and evaluation of a traditional cockpit focuses on the knobs and dials. The physical attributes of the controls and displays, such as key size, actuation force, symbol size, character height, etc., can be specified to support optimal human performance. But this approach does not address the provision of information for mission tasks or more importantly, the equations, control laws, and logic that defines this information. The glass cockpit requires crew systems engineers to go beyond the knobs and dials.

Glass cockpits have added complexity to the HF evaluations. Since MFDs replace many dedicated instruments not all of the information available from the replaced instruments are available to the flight crew all of the time. This poses the question of whether the MFDs can display all of the appropriate information at the appropriate times during the flight/mission. In order to access the information, the menu logic is evaluated. For the individual display pages, there are issues of display information coding, format, and clutter. Malfunction displays are no longer tied directly to the sensors or systems generating the data as dedicated instruments are. Also, the data links from ground stations or other airborne platforms can provide data to the aircraft. This provides the opportunity for the on-board computers to integrate the raw data from several aircraft, sensors, and/or systems to provide tailored information to the aircrew. The complexity of the HF evaluation is truly realized when trying to assess how inaccurate data from these sources affects the data integration and the resulting information displayed to the aircrew.

The Netherlands National Aerospace Laboratory (NLR) is working on uniform procedures to accommodate the rapid development of glass cockpits in both civil and military applications. To support the evaluations, NLR has developed a standardized Cockpit Operability and Design Evaluation Procedure (CODEP) with special attention directed toward the information integration aspects. [20-16] The CODEP was prepared to be systematic and standardized and includes objective and replicable "operability tests". All cockpit instruments and their related controls are reviewed and test procedures and conditions are described in detail. Execution of the procedure results in both qualitative and quantitative data.

In developing the procedure, NLR used a well accepted pilot model that represents the major components and interactions involved in human information processing. The model serves as the human-centered guideline for the systematic cockpit evaluation. Performance in the cockpit will not only depend on single items like readability of displays or reachability of controls but emphasizes their interactions and relationships to assess realistic task demands including the particular environmental (working) conditions and the capabilities of the pilot population concerned, items such as subject characteristics (glasses, age, etc.), training, and practice levels. Since even a well designed instrument can be misread under stress and/or time pressure, the aforementioned factors are represented in the procedure by tailored "operability tests" that allow a replicable cockpit evaluation.

A prototype version of CODEP was utilized to evaluate military glass cockpits for helicopters. The results indicate that the dialogue with the manufacturer were clearly enhanced by the fact that the HF aspects were addressed systematically and recorded under standardized circumstances. The quantitative background information provided a good basis for design improvements.

20.8.2 Subjective Workload Measurements

A notable improvement in subjective workload measurement is the use of paired-comparisons to explicitly identify the workload between several phases of flight. Methods published to date include the Analytic Hierarchy Process (AHP) and the Subjective Workload Dominance (SWORD) techniques. [20-17, 20-6] When these paired-comparison methods have been used in conjunction with more traditional subjective measures such as the NASA Task Load Index (NASA-TLX) and the subjective Workload Assessment Technique (SWAT), the paired-comparison methods were able to identify statistically different levels of workload between flight phases or flight tasks when the other methods did not. [20-6, 20-5, 20-4]

20.8.3 Structured Test Procedures

The US Air Force is developing structured test procedures (STPs) which coordinate the methods used by the laboratories, procuring offices, and the test agencies in testing the HF aspects of aircraft. [20-18] The major topics addressed by these STPs are listed in Table 20-I. The benefits provided by these STPs are improved communication between the agencies involved in HF test and evaluation, more accurate information about the costs of performing these tests, and test and evaluation results are collected within a common framework throughout the life cycle of the aircraft so that results collected at the initial stages of the aircraft development can be compared to results from the final phases of aircraft checkout and operational evaluations.

20.9 CONCLUDING REMARKS

An overview has been presented, in the preceding paragraphs, of the HF aspects associated with a ground and flight test program. Examples have been given of past programs intended as guidelines for new FTEs or other people becoming involved with human factor programs. It should be pointed out that HF engineering should be an integral part of the design and development phase of a new aircraft. Laboratory, hot mock-up, and flight simulator tests should be used to make and review important design decisions. The HF evaluation and pilot workload program conducted on a new aircraft should be to evaluate the completed design, not to make design decisions.

20.10 ACKNOWLEDGEMENTS

The following contributing authors provided valuable information as noted:

<u>Name:</u>	<u>Organization:</u>	<u>Area:</u>
Mr. Y. Zundel	CEV/France	Emergency egress
Ms. Gina Papa	AFFTC/US	Ground Test
Ms. Janice R. Tomeny	AFFTC/US	Flight Test
Capt. Aric Turner	AFFTC/US	New Developments
Lt. James Cleet	AFFTC/US	Noise measurements
Ms. Brenda Leonard	AFFTC-CSC/US	Lighting evaluation
Mr. Harrie Bohnen	NLR/Netherlands	New Developments
Mrs. Rebecca A. Morgan	NAWC-WD/US	New Developments

20.11 REFERENCES

- [20-1] "Joint Airworthiness Requirements (JAR)", Airworthiness Authority Committee.
- [20-2] "Federal Aviation Regulations (FAR)", Department of Transportation, Federal Aviation Administration, Washington DC, USA.
- [20-3] MIL-STD-1472, "Human Engineering Design Criteria for Military Systems, Equipment, and Facilities".
- [20-4] Reid, Gary B., Eggemeirer, F. T., and Nygren, T.E., "An Individual Differences Approach to SWAT Scale Development", Proceedings of the Human Factors Society, 26th Annual Meeting, 1982. (Also, Reid, G.B. and Nygren, "The Subjective Workload Assessment Technique: A Scaling Procedure for Measuring Mental Workload", in "Human Mental Workload" (pp. 185-218), Hancock, P.A. and Meshkate, N. (Eds.), Amsterdam, North Holland, 1988).
- [20-5] Hart, S.G. and Sreveland, L.E., "Development of NASA-TLX (Task Load Index): Results of Experimental and Theoretical Research", in "Human Mental Workload", Hancock, P.A. and Meshkate, N. (Eds.), Amsterdam, North Holland, 1988.
- [20-6] Vidulich, M.A., "The Use of Judgement Matrices in Subjective Workload Assessment: The Subjective Workload Dominance (SWORD) Technique", Proceedings of the Human Factors and Ergonomics Society, 33rd Annual Meeting (pp 1406-1410), Santa Monica, CA, 1989.
- [20-7] Burgess, D.W., Chillery, J.A., Jensen, S., and Hall, A., "Optimisation of Operational Workload Levels Using Neurophysiological and Cognitive Techniques" Report of the RAE, R132 Building, Farnborough, Hants, England, 1990.
- [20-8] Roscoe, Alan H., "Assessing Pilot Workload in Flight", AGARD Conference Proceedings No. 373, Portugal, 1984.
- [20-9] Jex, H.R., "Measuring Mental Workload: Problems, Progress, and Promises", in Human Mental Workload (Chapter 2), Hancock, P.A. and Meshkati, N. (Eds.), Elsevier Science, North-Holland, 1989.
- [20-10] AFR 161-35, "Aerospace Medicine Hazardous Noise Exposure".

- [20-11] MIL-STD-8806B, "Military Specification, Sound Pressure Levels in Aircraft, General Specification for", Dec 1966.
- [20-12] MIL-L-6703, "Lighting Equipment: Exterior, Installation of Aircraft".
- [20-13] MIL-L-18276, "Lighting, Aircraft Interior, Installation of".
- [20-14] NAWC TM 92-37 SY, "Exterior Lighting Inspection Criteria and Guidelines".
- [20-15] FAA, Advisory Circular AC-25.1523-1, "Minimum Flight Crew", Feb 1993.
- [20-16] Jorna, P.G.A.M., et al, "CODEP, Cockpit Operability and Design Evaluation Procedure: a Systematic Approach to Cockpit Effectiveness", NLR Technical Report TR 95089 L, National Aerospace Laboratory NLR, Amsterdam, 1995.
- [20-17] Saaty, T.L., "The Analytic Hierarchy Process", McGraw-Hill, New York , 1980.
- [20-18] (Structured Test Procedures are under development for AL/CFA (CCCD), Wright-Patterson AFB, OH 45433-6573, by Arvin/Calspan Advanced Technology Center, P.O. Box 400, Buffalo, NY 14225).

20.12 BIBLIOGRAPHY

- Billings, C.E., "Human-Centered Aircraft Automation: A Concept and Guidelines", NASA Technical Memorandum 103885, Ames Research Center, 1991.
- Boff, K.R., Kaufman, L., and Thomas, J.P., "Handbook of Perception and Human Performance", Wiley, NY, 1986.
- Bolton, C.B., "An Anthropometric Survey of 2000 Royal Air Force Aircrew 1970/71", AGARD-AG-181, Dec. 1974.
- Corwin, W.H., "Autoflight Mode Annunciation: Complex Codes for Complex Modes", Seventh International Aviation Psychology Symposium, 1993.
- Damos, D.L., "Multiple Task Performance", Taylor and Francis, London, 1992.
- Dorp, A.L.C. van, "Pilot Opinions on the Use of Flight Management Systems", Report TP 91076 U, National Aerospace Laboratory/NLR, Amsterdam, The Netherlands, 1991.
- Frazier, M.L., and Crombie, R. B., AFFTC-TR-82-5 "Proceedings of the Workshop on Testing to Identify Pilot Workload and Pilot Dynamics", May 1982.
- Hart, S.G., "Research Papers and Publications (1981-1987): Workload Research Program", NASA Ames Research Center, Moffett Field, CA, circa 1988.
- Meister, D., "Behavioral Analysis and Measurement Methods", John Wiley and Sons, New York, 1985.
- Norman, D.A., "The 'Problem' with Automation: Inappropriate Feedback and Interaction", Philosophical Transactions of the Royal Society of London, B327, 1990.

Nunnerly, S.A. and Stribley, R.F., SAM-TR-78-33 "Fighter Index of Thermal Stress: Relation to Weather Conditions at ATC and TAC Bases", USAF School of Aerospace Medicine, Brooks AFB, TX, circa 1978.

Sanders, M.S. and McCormick, E.J., "Human Factors in Engineering and Design", McGraw-Hill, Inc., New York, 1993.

Stoliker, J. R. and Higginbotham, W.N., AFFTC-TR-88-14 "Limited Evaluation of Prototype Vision Restriction Device for F-16", Air Force Flight Test Center, Edwards AFB, CA, July 1988.

Wickens, C.D., "Engineering Psychology and Human Performance", Merrill, Columbus, Ohio, 1992.

Wiener, E.L. and Nagel, D.C., "Human Factors in Aviation", Academic Press, Inc., New York, 1988.

"Crew Station Evaluation", prepared for US Navy Test Pilot School, Systems Engineering Test Directorate, US Naval Air Warfare Center, Patuxent River, MD, undated.

Various publications from the Crew System Ergonomics Information Analysis Center, AL/CFH/CSERIAC Bldg. 248, 2255 H Street, Wright-Patterson AFB, OH 45433-7022.

US Navy Naval Air Engineering Center (NAEC) ACEL Report No. 533, "Anthropometry of Naval Aviators, 1964".

NAVAIRINST 4355.8B, "Inspection of Mockups of Naval Aircraft (Configuration)".

NAVAIRINST 4355.7B, "Inspection of Lighting Mockups of Naval Aircraft".

US Military Standards (MIL-STD) and Federal Standards (FED-STD)

MIL-STD-210	"Climatic Information to Determine Design and Test Requirements for Military Systems and Requirements".
MIL-STD-721	"Definitions of Terms for Reliability, Maintainability, Human Factors, and Safety".
DOD-HDBK-763	"Human Engineering Procedures Guide".
MIL-STD-850	"Aircrew Station Vision Requirements for Military Aircraft".
MIL-STD-882	"System Safety Program Requirements".
MIL-STD-1800	"Human Engineering".

US Military Specifications

MIL-D-8706	"Data and Tests, Engineering, Contract Requirements".
MIL-D-8708	"Demonstration Requirements for Airplanes".
MIL-H-46855	"Human Engineering Requirements for Military Systems, Equipment, and Facilities".



Chapter 21 – AVIONICS

Ron Mahlum

US Air Force Flight Test Center
AFFTC/CAST
Edwards AFB, CA 93524-6842
USA

21.0 INTRODUCTION

This Section presents general guidance for flight testing of avionics systems. Due to the complex and ever changing nature of avionics systems, specific detailed test methods and analysis techniques are left to current and future system specific AGARDographs such as references 21-1 and 21-2. This section will provide descriptions of test methods which are generic to most current and future avionics systems. The field of avionics systems was divided into four general categories (autopilot, navigation and communication, offensive, and defensive) and a fifth overall test category of integration. This was accomplished only for the convenience in presenting the material. These categories are not meant to encompass all avionics systems but are intended to be sufficiently general to enable a systematic discussion of the testing of the basic types of avionics systems.

21.0.1 Scope

This Section will address some of the basic test methods, data analysis techniques, and unique test support required for flight testing of modern avionics systems. Unique test assets are required for testing many of the new systems and will be addressed where applicable. The test and evaluation of the software that drives many of these systems are discussed in Sections 26 and 26A.

Flight control systems are not covered in this section. The integration of the flight control system with the autopilot, data busses, and other systems is part of avionics integration testing and is, therefore, discussed in this Section. The primary tests for flight control systems are flying quality related and are discussed in Section 15.

21.0.2 Role of the Flight Test Engineer

In order to properly plan and conduct avionics systems tests, the Flight Test Engineer (FTE) will have to understand, in detail, what role each system is to play in the overall aircraft, how it affects the aircraft's operational requirements, and the mission suitability. The FTE must also be aware of the underlying requirements to which the system was designed, what the performance criteria are, how the various systems interface, and what test data is available from ground testing and/or testing in-flight in test bed aircraft. This knowledge and information must then be blended into a coherent set of tests that will satisfy the performance criteria and provide meaningful information for operating manuals.

One of the most time consuming aspects of avionics systems testing is functional testing which includes evaluating combinations of switch action and mode changes for the system under test. The FTE must give special attention to these tests in order to minimize the time required.

21.1 GENERAL CONSIDERATIONS

21.1.1 Test Approach

The development of current avionics subsystem architecture requires a thorough understanding of the user's operational mission requirements. Once defined, a structured, building block approach can be initiated by following a disciplined test process that will enable an efficient, cost-effective execution of the test program. The test process begins by developing the program's test objectives, establishing the test's success criteria and preparing a detailed test plan. (See Section 8.) The next step is to conduct a pre-test analysis to predict the performance of the system under test. This primarily involves the application of modeling and simulation analysis. The use of statistical tools to gain an early assessment of the systems capability will significantly reduce the number of test points required to conduct the test. Following pre-test analysis will be the actual test conduct where data is collected and test events documented. Post-test analysis consists of converting the raw data collected into a format suitable for analysis. The data is compared to the evaluation criteria established in the test plan. Deficiencies in either the test article or test procedure are also identified and documented. The final step in the test process is to report the results of the test effort. (See Section 29.) This step provides the essential feedback needed by the decision makers to determine if further testing is warranted.

21.1.2 Test Objectives

The overall test objective for all avionics systems testing is system performance and mission suitability. This could include system performance for specification compliance, certification, mission utility, subsystem integration, or mission enhancement. Additional objectives would be to define deficiencies - those that should be corrected or those that do not meet requirements/specifications but do not impact mission accomplishment - or to define areas for future improvements that meet specifications but impair the full use of the system.

21.1.3 Resources

Successful execution of the test process during the avionics systems' development requires the utilization of the appropriate test resources at the proper time. As the system matures from a conceptual design to a fielded system, the following test resources will be required during applicable portions of the system's development: Models and simulations; measurement facilities; system integration laboratories; hardware-in-the-loop facilities; installed system test facilities; and open environment ranges.

To the maximum extent possible, the test aircraft should be representative of the "production" configuration, including all software that operates or interfaces with any of the avionics subsystems that are under test. The less representative the test aircraft is of the final configuration the more likely the test results will be incomplete.

21.1.4 Test Instrumentation

Due to the ever-changing designs, implementations, and technology of avionics systems the data types, data sources, and data collection rates are constantly changing. The most important concept is to collect the type of data appropriate to the system and complexity of the test at a rate ideally at three times the rate of change of the fastest changing parameter. Due to data rate issues, this may not be possible. This includes the whole range from hand-recorded data to high speed data recording devices.

As stated before, careful consideration should be given to what should be measured. It is important not only to measure the primary parameter of interest, but also those that will enable sufficient analysis of what is going on. When determining what to measure it is important to consider the scope of the program.

If it concerns a relatively simple, small budget, verification program measurements should be limited to a few essentials. If, on the other hand, it concerns a large, time-critical program, it is prudent to do some "overkill", in other words record more than would normally be needed. It is important to allow sufficient time in the program schedule to install essential measuring and recording equipment because some unexpected phenomenon may have to be analyzed that could adversely impact the test programs.

There are a number of basic parameters that are common to all avionics testing such as airspeed, altitude, vertical velocity, and Mach number; heading; angles of pitch, roll, sideslip, yaw, and attack; accelerations along body axes; engine power parameters; and aircraft weight, center of gravity, and external configuration (flaps, gear, stores, etc.). Needs for additional specific instrumentation are discussed below in the appropriate paragraph.

21.1.5 Nature and Scope of Test

In general testing of avionics systems is for one of the following five reasons:

- Systems Performance - measurement of capability
- Specification Compliance - meeting minimum performance
- System Utility - aircrew or mission benefit
- System Certification - authorization for general use
- System Safety - safety of flight.

The objectives of the test depend not only on the systems being tested but also on the criticality of the system and stage in system development. The testing of these systems can be as simple as testing functional characteristics to testing of complex systems using modeling, laboratory, and test range support.

Planning for tests of avionics systems must always consider the effects of changes in the system operational flight program (OFP), i.e., the avionics system software, during the test program. Ideally by the time the software is in the flight test phase it would not require changes. This rarely happens. During flight test, deficiencies, both minor and major, will be found which will require some degree of software changes. The more complex the OFP and avionics suite, the more changes will be required with increasing complexity. As such, the test program should be designed to be compatible with changing configurations and the final configuration of avionics and OFP delivered to the customer must be thoroughly and satisfactorily tested.

One way to accomplish this is to design in hardware and software change points in the test plan. This can be accomplished by using a three-phase test plan as represented in Figure 21-1.

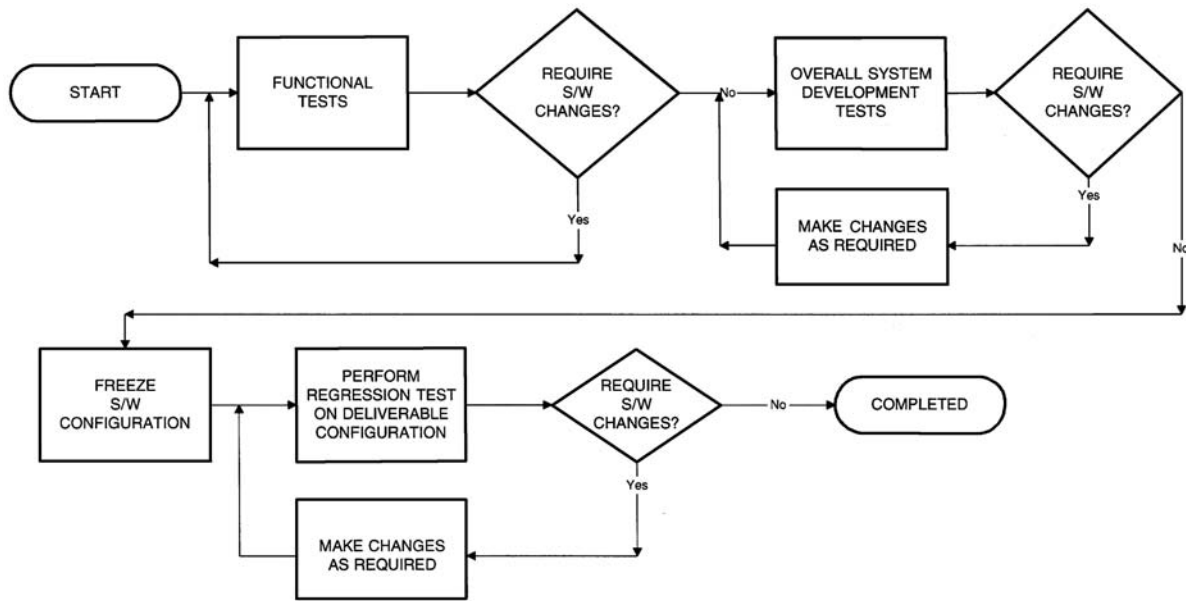

Figure 21-1. OFP Flight Test Process.

The first phase would be a quick overall test of the systems to insure major deficiencies do not exist which would prevent any useful result from the test. If major deficiencies are found, corrections are made before flight testing is continued. The second phase is the complete test program with no changes permitted in the system unless significant deficiencies are found which would preclude completion of the test program. The third phase involves implementing required changes and performing selective regression tests (selective repeat of previously completed test points) with the configuration frozen. If the test results are satisfactory the system is delivered to the customer. If more changes are required, regression tests are repeated.

A key to successful test planning is design of regression test points which will enable appropriate test points to be repeated after changes are made to hardware or software during testing. This is of primary importance for safety of flight issues. An example of regression test planning for flight safety issues is shown in Figure 21-2 for terrain following tests. This example is only a subset of a larger test plan and is shown only to illustrate the regression test planning concept.

SCP (feet)	Maneuver Type	Terrain	Test Points
1000	Straight	Level	1 2
750	Straight	Level	3 4
1000	Straight	Iso Obstl	5 6
750	Straight	Iso Obstl	7 8
1000	Straight	Rolling	9 10
750	Straight	Rolling	11 12
1000	Straight	Rough	13 14
750	Straight	Rough	15 16

Figure 21-2. Regression Test Points.

This type of waterfall chart is used to associate the test risk with the test points to be completed. Charts of this type are useful for test planning and can be valuable during regression testing to identify which test points should be repeated. The chart is constructed by listing the test points on the left. In this figure set-clearance-plane (SCP) (minimum height above the terrain), aircraft maneuver type (straight), and terrain type (level, isolated obstacles, rolling, or rough). The test are arranged with the least dangerous at the top to the most dangerous at the bottom. The test blocks are arranged to relate sequence of test. Tests in one block can not be started until blocks to the left have been completed. If the system is changed during the test sequence, the test points affected are identified and regression test are completed for test points in all block to the left prior to continuing the test sequence.

21.1.6 Presentation of Results

In general data may be presented in three different ways:

- Time plot: Each parameter may be presented as a time plot, i.e., the value of the measured parameter along the vertical axis and the time along the horizontal axis. This is the most common and straight-forward method.
- Cross plot: One parameter is plotted along the horizontal axis, the other along the vertical. This method may be helpful to check on the relationship between two parameters.
- Statistical plot: Statistical presentation of data is used in various forms. Not only because it may be convenient to present the data in a certain way, e.g., a bar chart presentation, but some statistical techniques may require some sort of special presentation of the data, e.g., to test a hypothesis a plot with accept and reject boundaries may be required.

21.2 AUTOPILOT SYSTEM

21.2.1 Description of System

The autopilot system is a system typically coupled with the mission computer, navigation avionics system, flight control system, propulsion system, and aircraft displays.

21.2.2 Test Objectives

The primary objective of autopilot system testing is to verify satisfactory operation of various modes of the autopilot and auto-throttle system with the aircraft flight control system. Evaluations will include determining the accuracy and capture capability of the various modes (altitude hold, heading hold, airspeed hold, Mach hold, etc.).

21.2.3 Test Instrumentation

For autopilot systems the basic aircraft parameters shown in paragraph 21.1.4 will be required plus additional aircraft parameters and a number of specific autopilot parameters shown in Table 21-I.

Table 21-I Autopilot Tests

Additional Basic Aircraft Parameters

Baro correction
Radio altitude
Flight path angle
Wind speed and direction
Ground speed
Control surface positions
Throttle position
Air/ground discrete
Touchdown event discrete
Specific autopilot parameters:
Selected altitude
Selected vertical speed
Selected speed
Selected Mach number
Selected heading
Selected mode (longitudinal, lateral and speed)
Internal mode/status discretets
Flight director roll, pitch, and speed commands
Autopilot (AP) servo/actuator engage clutch current and drive current or voltage, and actuator position
Internal system mode control loop data
Glide slope and localizer deviation
Touch-down position relative to runway threshold and centerline
Vertical speed at touchdown

21.2.4 Test Approach

21.2.4.1 Functional System Testing. The goal of functional and system integration testing is to check that the system functions as intended (this may not be the same as what is in the specification). The interrelation between the units that make up the autopilot system and the interfaces with the sensor systems are evaluated and any interface problems identified are corrected. Functional and system integration testing should primarily be done at a simulation facility that includes the capability to couple the actual aircraft system hardware to the simulation computer. However, such a facility is not always available, or the fidelity of the simulation may be insufficient for some flight conditions resulting in the requirement for expanded flight test evaluations.

21.2.4.2 Flight Test. The best approach is to carefully design test profiles which exercise the system in all possible modes and mode transitions from take-off through landing. This testing must be done in a methodical build-up approach in accordance with the approved test plan. Failure to do this may prevent successful duplication of system errors.

The flight test goal is to verify that the system meets its specified performance in each mode of operation (e.g., will the autopilot hold altitude within 50 feet and/or meet the certification criteria, assuming there are no faults in the system). The objective is to gather hard numerical evidence. The tests should be designed to identify the system's behavior and to group the various tests according to the phases of flight (i.e., take-off, cruise, approach, landing, and go-around).

It is important to carefully consider the parameters to be recorded. Primary parameters and related parameters should all be recorded. For tests such as altitude hold, parameters such as airspeed, pitch attitude, elevator deflection, and stabilizer position should be recorded.

Should the aircraft unexpectedly deviate from the selected altitude, there must be verification as to whether the airspeed changed or whether there was an elevator or stabilizer trim action. Other important things to consider are accuracy, resolution, data range, and the relation between parameters.

21.2.4.3 Performance with Faults. The objective of testing system performance with system faults is similar to fault free performance testing. The difference is that one or more failures are intentionally introduced into the autopilot or its sensors, and system performance with these failures present is verified. It may also be that to test autopilot behavior at the moment the failure occurs, i.e., the transient behavior at the moment of failure and shortly thereafter. If the system is supposed to degrade gracefully, this should be verified. It should be noted that this type of testing should be accomplished in a simulator before free-flight testing. The failures which should be introduced depend on the probability that the failure occurs. However, simulator testing should not replace free-flight, full-scale testing unless such testing would violate flight safety.

Another factor to consider is whether a certain failure is a grounding case or not. If it is allowable for a certain failure to exist for a longer time, i.e., the aircraft may fly with the failure, the occurrence of a second failure must be considered. In the case of performance with faults, it may be allowable to have a degraded performance, however, it may also be that the performance should be the same as in the fault free case. Suppose the autopilot uses triple redundant attitude sensors for approach and landing. If one attitude source fails, the performance on the two remaining sources should essentially be the same. On the other hand, if a total air data failure occurs, the Go-Around mode probably reverts to a fixed pitch angle guidance mode.

21.2.4.4 Testing of Failure Effects. The reason for failure effect testing is to demonstrate that the effect of a certain failure is relatively benign. Paragraph 25.11309, "Equipment, Systems, and Installations", of FAR/JAR 25 includes a regulatory relationship between the probability of a failure and the failure effect. [21-3, 21-4] Failures that may occur with a probability higher than one in one million flight hours (10E-6/hour) should have a limited effect on the aircraft that can be easily coped with by the crew. For a failure of this nature it may be necessary to demonstrate this ability. A well known case is a single channel autopilot. The probability of an autopilot runaway or hard-over is higher than 10E-5/hour. To limit the failure effect, torque of the servo motors is usually limited. Most probably it will be required to demonstrate that this torque limit results in a runaway behavior that can easily be controlled by the pilot. The reverse case is an autopilot slow-over, the catch here is that it occurs so slowly the pilot may not notice the failure right away.

Human factors testing of failure modes should be accomplished in a simulator and prior to flight test. These types of tests often require a number of pilots to go through some flight scenario, and the objective then is to perform work load or other assessments as to how well they perform under a certain set of conditions. Additionally, it may be necessary to demonstrate performance to a certification authority or a customer under actual flight conditions.

21.2.5 Data Presentation

Time plots are commonly used for general performance analysis and troubleshooting. Statistical methods are used to prove that the probability of exceeding some value is below some (very low) value. This is the case when compliance must be shown with the approach and auto-land airworthiness requirements. These stipulate certain probabilistic requirements for the touchdown point on the runway. Certification of load alleviation devices require statistical data to show that the probability of mechanical loads in extreme turbulence will not exceed an acceptable value.

An example of where cross plots may be used is the analysis of the transfer function of the mechanical control system. Backlash or hysteresis in the aircraft mechanical control system may impair autopilot performance. Insight into the properties of the mechanical control system can be gained by making a plot of control surface deflection versus autopilot servo rotation.

21.3 NAVIGATION AND COMMUNICATION SYSTEMS

The primary objective of testing navigation systems is to evaluate: system accuracy (latitude/longitude, range, bearing, glide slope, etc.), system error rates (latitude error rate, longitude error rate), system functionality (modes and displays perform as designed), system utility (systems ability to provide acceptable navigation capabilities), and the systems' resistance to jamming (noise and mode dependent).

Testing of communication systems normally consists of three primary objectives:

- Evaluate maximum range performance
- Evaluate system intelligibility
- Evaluate Electromagnetic Interference/Electromagnetic Compatibility (EMI/EMC)

Since communication systems transmitters have the potential to interfere with data busses and on-board computers, testing for potential EMI issues is a primary objective for new aircraft with digital flight control systems. (See Section 27.)

21.3.1 Description of Systems

The aircraft's navigation system may consist of a combination of inertial navigation or reference systems and radio navigation systems, utilizing navigational aids such as the Global Positioning System (GPS), VHF Omni Range (VOR), Distance Measuring Equipment (DME), Tactical Air Navigation (TACAN), Instrument Landing System (ILS), and Microwave Landing System (MLS).

21.3.2 Test Objectives

The objective of testing these systems is to determine the accuracy of the aircraft's navigation system and its compatibility with the avionics suite.

21.3.3 Test Instrumentation

The basic aircraft parameters are the same as denoted in paragraph 21.1.4. The system peculiar parameters are noted in Tables 21-II and 21-III.

Table 21-II Navigation System Parameters

Baro correction
Vertical speed
Ground speed (Wind speed and direction can be determined from airspeed and ground speed)
Aircraft position in Lat/Long
Aircraft position in Lat/Long from reference system
Desired track
Track angle error
Flight plan vertical flight path and flight path error
Roll and pitch steering commands
Throttle command
System Mode/Status discrettes
Internal system mode data
Internal system control data

Table 21-III Communication System Parameters

Aircraft roll, pitch, yaw
Aircraft altitude, latitude, longitude
Signal strength received at the ground test site

21.3.4 Test Approach

21.3.4.1 Communication Systems. Usually the flight performance of a communication system is evaluated by verifying that it performs adequately over the specified range. This test may be a simple verification that intelligible voice communication is possible until the radio horizon, or a signal-to-noise ratio measurement, or a data error rate measurement over the range. It is possible to measure voice intelligibility by sending a special synthetic signal and analyzing the spectrum of the received signal. When checking the range performance of communication systems a couple of factors should be considered.

The signal propagation characteristic of the test frequency should be understood. When testing "line-of-sight" communication, e.g., VHF or UHF communication, the field strength as a function of distance, aircraft altitude, and the height of the transmitter antenna should be considered. The range of these systems is usually noise limited when close to the radio horizon. The antenna pattern is also a factor in radio performance. To check this, the aircraft is flown through 360-degree turns at different bank angles and at different pitch angles around a point at various locations from the receiver site. (See Section 19B.) The antenna pattern which is most useful in evaluating the system's maximum range performance is the one at a -3 degree elevation angle. Care should be taken to position the aircraft (altitude and range) such that the aircraft is not flying in a point of multipath cancellation.

The performance of HF systems is more difficult to verify due to the more complicated propagation characteristics of HF signals. Interference from other stations and fading due to propagation characteristics play an important factor here. Because of the particular propagation characteristics of HF, time of day is a factor to take into account when checking the range of HF systems.

An additional test that is often done is to check for mutual interference between communication systems. This is of interest for systems that operate in the same frequency range because interference may occur if the receiving system picks up a harmonic signal or if the transmitting systems radiate signals that are directly picked up by the IF stage of the receiver or if signals are radiated on the mirror frequency of the receiver. When dealing with two or more systems that are the same or that operate on the same frequency,

it is usual to determine the minimum frequency separation between the systems that allows reception on one system while transmitting on the other.

Besides mutual interference between communication systems, interference from and on other aircraft systems should also be considered. The harmonic of a computer clock frequency may for instance coincide with a HF communication receive frequency. The harmonic of an aircraft's 400 Hz 115 VAC generator is known to have caused problems with Omega navigation receivers. Aircraft transmitters are primary sources of interference on other aircraft avionics systems.

Some navigation and communication systems may require testing for susceptibility to jamming. For military aircraft most systems are tested and commercial aircraft may require this for key navigation and landing systems.

Most aircraft antenna patterns are measured on full size mock up or on small size model mounted on pedestals. Pedestals allow all aspect and elevation angles to be measured. Measurements made in flight are restricted by the aircraft's ability to maneuver. To measure an antenna pattern one may perform a 360-degree turn with wings level in an area where the field strength of the transmitted signal is almost constant. This will be in the outer multipath reinforced region. (See Section 19B.)

In general, the same functional/system integration testing as for autopilot testing also applies here. Also, navigation system functional and system integration testing preferably should be done in simulators. The simulator should have the proper models to do a good navigation simulation, e.g., the simulator should contain a navigation data base providing simulated VOR/DME data as a function of position.

21.3.4.2 Navigation Systems. The assessment of navigation system performance generally is divided into two parts, navigation accuracy and guidance accuracy, both laterally and vertically. Full-up performance in this case is similar to fault free performance, it means all system inputs are available. Loss of an input need not be due to a failure, but could result from loss or degradation of a radio navigation sensor due to propagation conditions.

The objective of navigation accuracy testing is to measure how well the navigation system determines the actual aircraft position. This need not always be a complicated test. It may be a simple verification of a system that has been used many times before. In that case it may be sufficient to fly over a couple of clearly distinguishable landmarks and compare the position as given by the system with the known position of the landmark.

In case of the certification/qualification of a new system some statistical proof is usually required. The basic idea is to gather a statistically sufficient number of position samples together with the same amount of samples from a reference navigation system. This could be a special system on board the aircraft but it may also be a ground based radar or laser tracking system. The drawback of these latter systems is that a ground facility is required. The facility must be setup or booked in advance and the tests are confined to a certain area. If a self-contained system on board the aircraft is available, the test can be conducted during other tests.

The objective of guidance accuracy testing is to measure how well the system brings the aircraft on the desired track and how well it keeps on track. The emphasis is on the qualities of the steering signals the navigation system provides to the autopilot. Parameters to look for are: overshoot as a function of intercept angle and ground speed, possible oscillations around the track after the intercept, offset from the track as a function of cross wind, and quality of the aircraft roll and pitch movements (smooth or abrupt?).

Essentially degraded performance tests are the same as for full-up performance. The difference, of course, is that the system is degraded either due to failure(s) or due to loss or degradation of one or more sensor

inputs (not necessarily failures). The effect is that the navigation accuracy is degraded. An example is a navigation system that uses an Inertial Reference System (IRS) position mixed with multiple DME distance data. When the VOR/DME signal is lost the position accuracy will degrade with time. Because of the degraded navigation accuracy, there may be operational restrictions to the use of the navigation system and appropriate warnings to the crew should be generated.

21.3.5 Data Presentation

21.3.5.1 Communication Systems. The plots of interest for communication systems could be a function of distance at a given altitude, or as a function of attitude at a given distance and altitude, or as a function of bearing angle to the ground station at a given distance and altitude. To make an antenna radiation pattern, simply make an azimuth plot of the received signal as a function of the bearing to the ground station. (See Section 19B.) This bearing may be obtained by inserting the coordinates of the ground station as a way point into your NAV system and making a recording of the desired track to that way point.

21.3.5.2 Navigation Systems. To show the radio navigational accuracy, system errors are plotted as a function of range or aircraft azimuth. These plots should include average error and a confidence interval (either 95 percent or 2 sigma). It may be desired to analyze the navigation accuracy as a function of the distance from a navigation (NAV)-aid. This could be the case when analyzing degraded performance. In this case the average error and the 2-sigma error are plotted as a function of the distance from the NAV-aid.

To show the guidance accuracy you may plot the actual track relative to the desired track, average, and 2-sigma deviation. To get a first feel whether things are right or not, plot the results of a few runs directly and do not apply statistics right away.

21.4 OFFENSIVE SENSOR SYSTEMS

21.4.1 Description of System

Offensive sensor systems consist primarily of those sensors, controls and displays used to detect, acquire identify and attack both airborne and ground based targets. The major systems that comprise the offensive sensor suite include Radar and Electro-Optical (EO) sensors. Each of these systems offer certain tactical advantages depending on the operating environment. The combination of both radar and EO systems in one aircraft provides a formidable offensive capability.

Modern air-to-air radars in fighter and attack aircraft are typically multi-mode, pulse Doppler systems that are capable of detecting, acquiring, identifying, and tracking single or multiple small targets in a beyond visual range (BVR) environment. They typically operate in the X (8-12.5 Ghz) and K_u (12.5-18 Ghz) frequency bands and are integrated with other aircraft systems to enable effective weapons delivery. In the air-to-ground modes, the radar is used to detect fixed and moving targets as well as generate high resolution ground map displays. Other air-to-ground applications performed by a radar system includes terrain following, and terrain avoidance. Additionally, weather radars are also used to provide weather avoidance.

Electro-Optical (EO) sensors can provide some advantages over radar due to the range of operating wavelengths ranging from the visible through infrared (IR). Low-light-level television (LLTV) is a common passive system that utilizes the light reflected from a target area of interest and displays the information on a multifunction display in the cockpit. IR is also a passive system and primarily uses thermal or photon detectors to detect targets of interest. Lasers utilize the process of stimulated emission

of radiation to produce a highly directional laser beam that can be detected by a remote receiver such as a laser-guided bomb or missile for extremely precise weapons delivery. Because of the narrow beam width characteristics of an EO sensor, interception and jamming is very difficult. On the other hand, one of the disadvantages of an EO sensor is the influence of atmospheric absorption which can significantly reduce the systems effective range.

21.4.2 Test Objectives

The primary objective in testing an air-to-air radar is to determine its ability to detect an airborne target in all air-to-air radar modes in a variety of test conditions including: low, medium and high altitudes; look-up/look-down setups; head-on; tail-on; and all aspect runs. Other objectives include determining the adequacy of automatic and manual acquisition modes as well as evaluating single and multiple target track performance throughout a variety of dynamic fighter/target test conditions.

Weather avoidance radar objectives include an assessment of the radars ability to accurately display the range and intensity of the weather return. The capability of the radar to distinguish between the clouds and the actual raindrops is also a related objective.

Terrain following/terrain avoidance radar objectives include determining the systems ability to follow terrain contours at a preselected terrain clearance while maintaining satisfactory clearance from horizontal obstructions.

In the air-to-ground modes, the radar must be capable of detecting fixed or moving targets in a variety of ground clutter and terrain conditions. The capability of the radar to generate high resolution ground maps is another item that needs to be investigated.

The primary objective for EO systems testing involves system resolution, maximum usable range, and pointing accuracy. These test objectives can generally be accomplished at facilities equipped with a variety of infrared targets. These target boards can be electronically controlled to the desired temperature required to support the test conditions.

21.4.3 Test Instrumentation

A sophisticated on-board instrumentation system is required to capture the data necessary to evaluate airborne sensor systems. This includes on-board recording of the video and head-up display data, internal sensor data, selected aircraft parameter data, and pilot voice. The capability to transmit telemetry data of critical parameters to a ground station for real time display may also be required. Due to the large variety of systems and the extremely large numbers of parameters associated with each system, a table of parameters to record is not provided in this document. For each particular test, the key parameters of the system must be determined based on the system design and the data recording list prepared based on these key parameters and the capability of the instrumentation recording system.

21.4.4 Test Approach

Testing radar and EO systems typically begins with modeling and simulation where initial design studies are conducted followed by initial system development. Measurement facilities are then used to perform an early performance evaluation of various components of the radar or EO system. For radar systems this would include RF antenna characterization facilities, signature measurement facilities, and airborne radar testbeds. EO measurement facilities include signature measurement/characterization capabilities; optical, Laser, and receiver research labs; and flying testbed aircraft. System integration laboratories are facilities where hardware and software components are integrated at a subsystem level. Typical tests include sensor/display interface evaluations, software module tests, and end-to-end tests of subsystem

components. This testing is followed by hardware-in-the-loop tests where actual radar and EO subsystem hardware is evaluated in a closed-loop indoor lab environment. These facilities are generally more sophisticated than system integration laboratories and are capable of performing in-depth subsystem level evaluations including sensor functional tests, component/subsystem life-cycle endurance tests, failure modes and effects testing, and electronic countermeasures techniques using manned threat simulators. The offensive sensors are then installed on the testbed aircraft where they are evaluated at installed system test facilities such as anechoic test facilities and climatic laboratories. Primary tests conducted in these facilities include electromagnetic compatibility/electromagnetic interference (EMC/EMI), simulated threat assessments, ECM technique development, and full scale climatic tests. Final evaluations of radar and EO systems are conducted over open air ranges that are capable of providing controlled, instrumented ranges in real world environments. System performance measurements as well as operational assessments are performed during open air range testing. Results of these tests provide vital feedback for subsequent system upgrades or modifications.

21.4.5 Flight Test

21.4.5.1 Radar Systems. During performance testing target detection capability is evaluated against both airborne targets and ground targets. For ground target resolution, there is usually a ground array of targets at varying, but known, distances from each other in various geometric arrangements. The aircraft's radar system then is evaluated on how well it can discern these ground targets. To evaluate airborne target resolution, aircraft are used as targets for the airborne radar system under test. These target aircraft are flown in different geometric patterns to determine at what range the test radar can discern the targets. For example, four target aircraft are flown in a diamond pattern at the same altitude, and the ability of the test radar attempting to separate out these four aircraft into four distinct targets is assessed.

The full systems test of sensors involves a total spectrum of test capabilities and support systems. This could include everything from spread bench laboratories, system integration laboratories, test bed aircraft, anechoic facilities, and test aircraft. As systems become more integrated and complex, flight test of these systems will become more dependent on integration laboratories and anechoic facilities to effectively evaluate the sensor systems total performance. A typical scenario for flight testing a new, integrated sensor would be to run the equivalent flight test in a full integration laboratory, run an equivalent test on the test vehicle in an anechoic facility, and finally conduct overall system verification in flight test with operationally significant scenarios. The following test methods are directed at the flight test phase, but the test conditions and data analysis are similar regardless of the test facility.

Testing of radar systems (air-to-air, air-to-ground, weather) can be grouped into three classes: 1) Performance test, 2) Environmental, and 3) System integration-displays-human factors. The performance test consists of flying the aircraft in controlled conditions while measuring the minimum and maximum performance limits on each of the radar's operating modes. The environmental tests consists of placing the aircraft in a unique atmospheric, electromagnetic, ECM, or operational condition and evaluate system performance.

More of the modern radar systems have been using synthetic aperture radar technology. To lessen the overall vulnerability of the aircraft, some of these modern radar system use frequency agility and power management to have a Low Probability of Intercept system.

21.4.5.2 EO Systems. In-flight resolution evaluations typically utilize an infrared target board that consists of thermally controlled panels that can be arranged to satisfy desired contrast patterns. Precise aircraft position data is required to determine aircraft position relative to the target which is then used to determine slant range. Testing begins with the aircraft positioned beyond the resolution range of the sensor. While varying the target board temperature between runs or sets of runs, various combinations of aircraft range and altitude conditions are performed perpendicular to the target. Target detection and

resolution are the primary parameters recorded during each run. In order to determine the atmospheric transmission during the test, meteorological data is recorded throughout the mission. Tactical evaluations can be accomplished by performing runs against a convoy of tactical sized vehicles including tanks, trucks, and armored personnel carriers that are arranged in a pre-determined configuration. The objective of this test is to determine not only the detection range but also the range at which the type and orientation of the target can be recognized. Following each run, the vehicles should change positions and orientation. In addition to the quantitative data acquired during these tests, pilot questionnaires should be generated to supplement the evaluations.

21.4.6 Data Presentation

For offensive-type systems a number of key data analysis tools are used. For tracking systems, plots of tracking errors as a function of target range are a useful tool. These errors are normally range, elevation, azimuth, range rate, elevation rate, and azimuth rate. For radar systems, statistical calculation for the maximum detection range and probability of false alarm are usually conducted.

For IR systems, resolution is shown as Delta Temperature vs. Spatial Frequency. These charts are created by using the range at which the IR target board temperature bands can be resolved to compute the resolution angle. This angle in radians is plotted vs. Delta Temperature.

21.5 DEFENSIVE SYSTEMS

For the purpose of this Section, defensive avionics systems are systems used for the detection or disruption of aircraft tracking systems. These may be either active jamming (countermeasures and counter-countermeasures) or passive (warning or countermeasures) systems. The active systems use real-time processing to determine their response to stimuli. The passive systems rely on predetermined system characteristics to be effective such as sensor response to chaff or flare systems.

The issues to be addressed are items such as threat angle measurement errors, responsiveness to threats, identification of threat, effective system range, and most important, for active systems, degradation of the victim threat system. Testing of defensive systems will not only address the performance issues of system accuracy and sensitivity, system usable range, system limitations, and system utility but will also include a key issue of compatibility with on-board systems.

21.5.1 Description of System

The major active systems used for detection of threats are radar and missile launch warning systems. These systems are primarily used to detect active tracking radar on the aircraft and to detect the launching of missiles. Both of these systems are used to provide the aircrew with warning of hostile events and to indicate the relative direction of the threat. The major active threat countermeasures systems are selective radar mode jamming and optical tracker jamming. Both systems require detailed knowledge of the threat systems to induce tracking errors and break lock.

21.5.2 Test Objectives

The objectives of testing defensive systems are to determine system performance, system compatibility, and operational utility. These objectives can be further defined for each system being tested. The active jamming systems will require testing threat radar classification accuracy, jamming techniques selection, and effective ranges. The warning systems will include tests for probability of false alarms and quadrant identification.

21.5.3 Test Instrumentation

Other than the normal aircraft parameters, these tests will require high-speed defensive system bus data and threat system data. Data from the threat system will include information such as tracking and track lock. For passive systems, such as flare and chaff, external photography is important to determine correct distribution of the components in flight. One of the key elements of testing these systems is full knowledge of the operating environment. This requires measurement of all radiation systems. In free space this is nearing impossible, so shielded, anechoic chambers are often used in ground tests. Like the offensive systems, a table of parameters to record is not provided in this document. Each test must be reviewed for the key parameters of the system based on the system design and the data recording capability. With current technology, system data rates can easily overwhelm data recording and data processing capability.

21.5.4 Test Approach

In general, testing of defensive systems proceed from the most controlled conditions to the least controlled. This is normally from laboratory spread benches, to ground tests, to flight tests. In the laboratory the initial checkout can be conducted using signal injection techniques and monitoring system responses. These types of tests can determine the basic system performance. But since airframe effects are not present and free space radiation is not used, overall system performance can not be tested.

To get the next level of system testing, anechoic facilities are used. Only in a radio-frequency shielded anechoic facility can the aircraft and systems be exposed to a dense RF environment in a highly controlled repeatable test. During this test phase, the aircraft and crew are placed in an environment with known threat signals and the aircraft's systems responses to these signals are recorded.

Final testing of any defensive system and the only method of fully testing dispensing-type systems is in flight on instrumented test ranges. These tests are conducted with captive missiles or with missiles fired from the target aircraft while out of intercept range and while being tracked by the multiple threat radars. The missile may either be captive on an aircraft or captive on a ground cable run. For on aircraft captive tests, an instrumented missile is attached to an aircraft and flown to a position to actively track the target. Range instrumentation and sensor performance data are used to determine the effectiveness of the countermeasure. For missile warning tests, a missile connected to a suspended cable can be fired with the aircraft positioned such that the aircraft missile warning system will detect the missile.

21.5.5 Data Presentation

For most warning systems, the primary data presentation is error in threat signal angle of arrival measurement vs. aircraft azimuth angle. This plot is used to determine the azimuth angle where the warning systems may be experiencing antenna installation problems. These may be antenna directivity issues or aircraft skin reflection problems. These problems will be indicated by large angle of arrival errors which may be linear with azimuth angle.

For jamming type systems video recording of system displays are typically used to correlate on-board system activity with threat system responses. Digital messages from the aircraft data busses are recorded to track specific responses.

21.6 SYSTEM INTEGRATION

Overall, the objectives of avionics system integration testing are to verify satisfactory interoperability of all avionics systems during all modes of operation. The final test of system integration is always with a fully equipped aircraft, but numerous modes and system components can be tested in a full-up systems

integration laboratory. System integration testing is only complete when a high probability of correct system interaction is achieved.

In reality, software-intensive, highly-integrated systems may never be 100- percent correctly integrated. The goal of the tester is to reduce to an absolute minimum the probability of a system integration error affecting safety or mission performance and reduce to an acceptable level any other integration error.

21.6.1 Description of System Integration

System integration is the successful combining of systems, displays, and software such that they all work as required to fulfill the mission of the aircraft. This consists of systems coexisting in the electromagnetic environment, data busses, power lines, and physical environments.

21.6.2 Test Objectives

The overall objective of system integration testing is to verify the aircraft systems, as installed in the aircraft, do not produce adverse effects on each other and function correctly. Key types of test are free space electromagnetic radiation compatibility, data bus compatibility, electromagnetic compatibility, and systems effectiveness.

21.6.3 Test Instrumentation

Although test instrumentation for system integration testing is similar to systems testing, one major difference is test facilities. Large anechoic facilities are used to isolate the test from extraneous RF signals and to provide a controlled electromagnetic environment to conduct the tests.

21.6.4 Test Approach

There are four basic test classifications for systems integration tests. The first is a full-up integration laboratory where the initial tests may be conducted to verify correct system operation. This may be in a ground lab or in flight in a flying test bed aircraft. The second is in an anechoic facility so that full-up systems can be operated and tested in a highly controlled environment. Third is test with the systems operating in the aircraft on the ground to verify as many modes and system operations as possible. The last and final test type is test in flight. This is the last and most complete system integration test. The modes which can only be tested in flight are reserved for the final tests.

21.6.5 Data Presentation

Analysis of system integration test results is unique to each system and its functions. The final presentation is usually a plot or photograph showing system performance which deviates from the required performance.

21.6.6 Success Criteria

System integration is only successful after all modes and conditions of flight have been demonstrated with acceptable performance.

21.7 CONCLUDING REMARKS

This Section has provided an introduction to methods and procedures for conducting tests of aircraft avionics systems. Typical test objectives, test methods, instrumentation requirements, and data analysis and presentation considerations have been covered. The testing of aircraft avionics system is a very broad subject and the FTE is cautioned that no two programs are ever alike. Also, the FTE must be aware that software is now a major part of avionics systems, but requirements for testing software were not incorporated in this Section but are discussed in Sections 26 and 26A.

21.8 ACKNOWLEDGEMENTS

The following people contributed to the following paragraphs:

Sam Jackson Air Force Flight Test Center 21.1, 21.4
Coen de Vries Fokker Aircraft, The Netherlands 21.2, 21.3

21.9 REFERENCES

- [21-1] Scott, R.E., "Air-to-Air Radar Testing", AGARDograph 300, Flight Test Techniques Series, Volume 7, 1986.
- [21-2] Bothe, H. and McDonald, D., "Determination of Antenna Patterns and Radar Reflection Characteristics of Aircraft", AGARDograph 300, Flight Test Techniques Series, Volume 4, 1986.
- [21-3] FAR 25, Federal Aviation Regulations, Part 25, "Airworthiness Standards: Transport Category Airplanes", U.S. Department of Transportation, Federal Aviation Authority (FAA), Washington, D.C.
- [21-4] Joint Airworthiness Requirements, JAR 25, "Large Aeroplanes", issued by the (European) Joint Aviation Authorities (JAA).

21.10 BIBLIOGRAPHY

Stimson, G.W., "Introduction to Airborne Radar", Hughes Aircraft Company, 1983.

Bogers, C.J.M. and Manders, P.J.H.M., "A Flight Test Avionics Data Acquisition System for Future Fokker Aircraft", NLR Technical Publication TP 94011 U, National Aerospace Laboratory/NLR, Amsterdam, The Netherlands, 1994.

Underwood, J.M. Jr., "Technology Considerations for Avionics Flight Test Support Facilities", 18th Annual Symposium Proceedings of the Society of Flight Test Engineers, Amsterdam, The Netherlands, 28 September-2 October 1987.



Chapter 22 – RELIABILITY AND MAINTAINABILITY

Jan M. Howell

US Air Force Flight Test Center
452d Flight Test Squadron/DOE
Edwards Air Force Base, CA 93524-6435
USA

22.0 INTRODUCTION

The purpose of this Section is to provide an overview of reliability and maintainability (R&M) evaluations conducted during initial flight test. For purposes of this Section reliability is defined as the probability that an item will perform its intended function for a specified interval under stated conditions. Maintainability is a characteristic of design and installation which is expressed as the probability that an item will be retained in or restored to a specified condition within a given period of time, when maintenance is performed in accordance with prescribed procedures and resources. Flight test R&M evaluations are essential because R&M characteristics cannot be predicted with any degree of success. Initial reliability for newly designed equipment, during bench and laboratory testing, is normally 10 to 20 percent of the predicted value. Considerable laboratory and flight test is required before the actual reliability begins to approach the original prediction. Therefore, it is essential that the R&M engineer be involved during the design and early production stages. Otherwise the improvement in R&M during the flight test phase may be insufficient to obtain the desired minimum R&M level without initiating a new design and production schedule.

The R&M engineer faces a constant battle to justify his evaluation. It obviously takes time and costs money to run the complete R&M evaluation but the results of a good evaluation may not really be evident until the aircraft is in service use. He must be prepared to utilize data from prototype system and bench tests to provide indicators of potential problem areas and/or validate good characteristics.

This Section will concentrate on the flight test portion of the R&M process. However, there are many activities such as ground laboratory and bench tests, studies, maintainability demonstrations, etc., that constitute invaluable portions of this overall evaluation that cannot be ignored and must be considered/utilized when establishing the flight test program. [22-1]

Statistical treatments of R&M data are important and essential to flight test data. The numbers of flight hours normally collected in a flight test program vary but are never at levels to provide certainty of the distribution. This is a very important tool for the R&M engineer and its relevance is critical to data evaluation. However, this section will not repeat the usual statistical treatment found in many textbooks. Instead, the focus will be to discuss the objectives of an R&M evaluation and give an overview of test planning and conduct. A textbook that is pertinent is listed in the Bibliography.

The specific examples given in this Section illustrate the approach taken and the tools used by the United States Air Force; however, they are representative of those used by other test organizations and/or countries. It is noted, for example, that in the UK the R&M determination is made by an organization separate from the test organization, and their assessment is largely based on data obtained when the aircraft is in its Service phase.

Detailed information on R&M test and evaluation procedures can be found in reference 22-1.

22.1 R&M TEST OBJECTIVES

22.1.1 Develop/Mature Reliability

The most important objective of any R&M evaluation is to increase system reliability. The reliability test effort is really a reliability maturation program because initial designs normally start with 10 to 20 percent of the planned reliability. A common misconception is that R&M evaluations are to measure R&M values. Measurement for measurement's sake is a sterile exercise; the real value is in getting the information needed to improve the product. This point cannot be over emphasized. In the world environment today, quality is the most important characteristic of any product. The nation, the manufacturer, and the ultimate consumer who fail to understand this are destined for extinction.

The R&M process is simply to identify and eliminate the root cause of failures which occur during flight test. Experience shows that the vast majority of failures do not require a design change to eliminate the failure cause. Instead, fixing the manufacturing process eliminates over 90 percent of the failure modes.

Changing suppliers and increasing component quality do not require design changes, but do require time and money.

Equipment design changes are the most expensive. Initial designs unsuited to the actual operating environment are a common cause of redesign. Temperature and vibration cause the majority of environmental problems. When environmental problems are suspected, it is often necessary to instrument the aircraft to discover the severity of the problem. The instrumentation installation, data acquisition/analysis, and eventual redesign are long and costly processes.

22.1.2 Develop/Mature Maintainability

The concept of maintainability "growth" is not as accepted or well studied as reliability growth. However, maintainability will improve if sufficient resources, such as maintainability demonstrations, are correctly applied to that objective. While the improvement will not be an order of magnitude (as sometimes happens in reliability), the improvement can be worthwhile. The two components of a repair task most amenable to improvement are fault isolation and fault correction. The fault isolation time can be decreased by improved troubleshooting procedures (which at the time of the R&M testing may be incomplete, incorrect, or even not available), test equipment, and built-in-test capability. The use of trained maintenance personnel in evaluating procedures cannot be overemphasized. The fault correction segment of repair time is somewhat fixed by the physical design of equipment, but changes to procedures, special tools, and training can decrease the actual repair time. In some cases the task may be difficult enough to warrant design changes.

22.1.3 Lower Duty Cycle

A high value evaluation objective is to assure that all equipment has the lowest possible duty cycle. That is, to make certain that vehicle subsystems are operated or stressed only when needed. While this is a seemingly obvious objective, experience shows that almost all aircraft have some components that operate more than required.

22.1.4 Verify Contractor Performance

R&M performance requirements should be included in every aircraft contract just as other requirements such as payload, range, and weight are. The contract should also clearly state how achievement of R&M requirements is to be verified. Because R&M performance improves during the development phase it is not possible to demonstrate mature R&M characteristics during test. But, it is possible to demonstrate that satisfactory progress is being made toward achieving mature R&M values.

22.1.5 Identification of Deficiencies

One of the major results of an R&M evaluation is the identification of problem areas where corrective action must be taken before the system is produced in quantity. Once a difficulty is encountered, enough evidence must be gathered to prove or disprove the problem. A deficiency tracking and reporting system must be established and utilized when evaluating major procurements. The evidence must be clear and convincing and the seriousness of the problem must be apparent. Further, enough data must be available to allow the manufacturer to identify causes and correct the problem.

22.1.6 Mature System Capability

Prediction or estimation of the R&M driven capabilities of the weapons system is a valuable result of the flight test program. The problem of predicting maximum sortie rate in an operational environment from flight test data is nontrivial. A simulation model of some complexity must be used to translate flight test measures such as repair/service times and frequencies into operationally oriented measures such as sortie rate.

22.2 TEST PLANNING

22.2.1 Personnel

Appropriate numbers of correctly trained people from several backgrounds are required to conduct a flight test R&M evaluation. Ideally, these individuals should have participated in the design review process. Such participation will provide detailed knowledge of the aircraft to be tested and some feeling for potential trouble areas.

Trained R&M engineering personnel are essential to a flight test R&M evaluation. The engineers should have a strong background in aircraft systems in addition to training and experience in R&M. The number of engineering personnel needed is a direct function of the complexity of the system being tested. For small systems, such as a primary trainer with minimal avionics, one engineer should suffice. Complex aircraft, such as a modern fighter, bomber or large cargo carrier, might require as many as five engineers.

Staffing a test program with maintenance personnel poses a dilemma. From one viewpoint it is desirable to have senior maintenance personnel available to gain from their experience with other aircraft. In contrast, it is necessary to determine how well the aircraft can be repaired and serviced by the average maintainer. An acceptable compromise is to have junior people do the actual work while the senior people observe and judge. The actual number of maintenance personnel needed varies greatly with the complexity of the system. As a minimum, each technical specialty (such as engine mechanics and avionics technicians) should be represented by at least one experienced individual. During early development testing, it is often necessary to use contractor maintenance personnel and their use will impact the value of the early R&M data. The early training of military maintenance personnel is often accomplished by the manufacturer and this training must be spelled out in the contract.

Experienced flight crew personnel are also needed during an R&M evaluation. The complete observance and accurate reporting of in-flight difficulties is essential to finding and correcting problems. In many ways the ability to observe and report differentiates the test pilot from the operational or line pilot. The flight crew must also help in determining if the anomaly had any implications for flight safety or prevented completion of the aircraft mission.

22.2.2 Test Assets Requirement

The number of flight hours required to accomplish an effective R&M evaluation varies in direct proportion to the complexity of the aircraft being tested. A simple aircraft such as the US Air Force T-46 can be well characterized, and a majority of the R&M problems identified in about 700 flight hours. In contrast, a large aircraft with complex avionics, such as the B-1 bomber, may require several thousand flight hours to test. Avionics components with a 2,000-hour mean time between failure (MTBF) cannot be measured with any statistical significance. However, for subsystems and components, the accuracy of the predictions can be improved by utilizing data from accelerated bench tests conducted in simulated flight environments. But, an avionics system, such as a 100-hour MTBF radar, can be measured. Even in the case of the 2,000-hour MTBF component, the initial reliability will be much lower (200-400 hours typically). The flight test program can measure the lower numbers and identify some of the corrections needed to achieve the desired 2,000-hour MTBF. Normally, no flight test time is dedicated to R&M evaluations. Instead, the test program is structured around the flights required to test the vehicle and subsystem performance characteristics. Then, as a result of stressing the vehicle during test, much failure and repair data are available. There are several considerations that can maximize the resulting R&M data. First, all installed subsystems should be operated every flight regardless if it is needed for any given test. This operation must include turning the subsystems on and periodically testing those equipments during the mission. This is done by including the appropriate directions in the flight crew checklists and flight cards.

While little or no flight time is dedicated to R&M evaluations, much ground time is required for maintainability demonstrations and logistics evaluations. Although much maintainability information can be obtained from normal maintenance, most flight test programs do not last long enough for all (or even a significant sample) of maintenance tasks to arise. For this reason a block of ground time (maintenance demonstrations) should be set aside to demonstrate those interesting tasks that have not naturally occurred during the test program and to verify contractor fixes that have been developed during development testing. The tasks of the most interest are the long duration, complex efforts. This dedicated block of ground time varies in duration as a function of the aircraft complexity.

22.2.3 Reliability and Maintainability Data

The purpose of collecting R&M data is to know the cumulative stress that the system has undergone and to measure the effort required to keep the system in the initial condition. For aircraft systems, the simplest approach is to assume that the stress suffered in flight is much greater than ground non-operating time. However, other aeronautical systems such as munitions and missiles might spend much of their existence in storage. For systems such as this, the strict use of flight time is a poor measure of stress and other metrics must be sought.

For avionics, temperature and vibration are the primary causes of failure with changing levels of thermal and vibratory stress causing different failure rates. For Naval aircraft, the R&M engineer must be aware that the salt water environment is very corrosive and could even be one of the major causes of system failure.

Because of the high cost of instrumentation, R&M test engineers seldom, if ever, get all of the measurands that they want. The problem then becomes an allocation process. The rule of thumb is to instrument the

most critical from a safety of flight standpoint. Less obvious is the approach of instrumenting the system to verify the design predictions. Many aircraft temperature predictions are made based on results of a large computer model of the system. Instrumentation should be designed to verify and perhaps improve the model.

Vibration sensing instrumentation is difficult to plan. The only guidelines are to consider all vibration inducing sources and place sensors around those producing sufficient energy to be potentially troublesome. Aircraft-mounted guns are always good candidates because of the very high energy generated. Engine and accessory power unit equipment may produce considerable energy.

In all cases, optimal selection of instrumentation requires considerable engineering judgment. It is relatively easy to place instrumentation after thermal or vibration problems arise; the difficulty comes in predicting needs during the aircraft design phase.

22.2.4 Flight Data

The most readily obtainable stress data are aircrew debriefing information (flight hours). Because of the relative ease of use, many test programs rely solely on this data as stress measurement. The aircrew must also record any anomalies reported by the aircraft built-in-test system and note whether any related symptom was observed. Since the crew cannot be expected to detect all subtle failures, the R&M engineer should be aware that additional data may be available from the maintenance data recorders and/or the accident data recorders.

As the program progresses through the design review phases, the R&M test engineers should continuously refine their requirements and plans for operations and stress data. Instrumentation requirements should be agreed upon by R&M engineers, and thermal and vibration specialists. Aircrew debriefing forms should be developed jointly by aircrew and engineers.

22.2.5 Maintenance Data

Aircraft maintenance can be considered in two broad general categories; scheduled and unscheduled. Scheduled maintenance is that maintenance whose need can be foreseen. Aircraft servicing and inspections comprise the bulk of this type maintenance. Data on scheduled maintenance are needed to measure the resource requirements for such efforts and to determine the time the aircraft is not available for service.

Unscheduled maintenance is that maintenance required to restore the aircraft to operating condition after an anomaly. Data on unscheduled maintenance are needed to again measure resource requirements, to determine aircraft nonavailability and also to find the exact cause of the anomaly. Besides the on-aircraft work done, this data must include the "off-aircraft" work. That is, all work necessary to isolate the exact cause of the anomaly and restore normal operation must be included. During test programs the acquiring service often cannot repair new equipment and failed equipment must be returned to the prime contractor. Then the prime contractor may return the failed item to a vendor or even lower tier supplier. Considerable planning is needed to insure that, regardless of the complex repair path, the needed information is available to the flight test engineers.

Development of paper forms needed for maintenance data collection is also a complex issue. Customer, contractor and program unique requirements must be considered. Reference 22-1 contains more detail.

Another type of information that must be obtained from the contractor is the detailed analysis describing the root cause of failure (sometimes called physics of failure). This type of analysis is essential. Both contractor and customer should plan to perform such analysis for every failure that occurs during the flight

test program. This includes failures of nonrepairable items. Without knowledge of the causes of failure it is impossible to prevent reoccurrence.

History shows that the best way to ensure that the needed data are available is to specify the requirement in the original contract and state that the requirement is to be levied on all vendors and lower tier suppliers. Some experienced contractors regard this process as simply good commercial practice. This is not always the case.

22.2.6 Data Reduction Requirements

The three primary types of R&M data (operations, maintenance, and instrumentation) all require differing types of data reduction tools.

22.2.6.1 Operations Data. Operations Data (normally debriefing data from aircrews) are the simplest information to convert to usable form. These data are normally a single sheet or two per attempted sortie. As mentioned previously, the easiest way to aggregate and summarize this data is with the use of desk top computers and a commercial data base management system. The most commonly used data summary lists the accumulated stress (flight hours or cycles) per unit time (often months).

22.2.6.2 Maintenance Data. The reduction of maintenance data is a much more challenging task because of the greater relative volume, more sophisticated data base creation, and complex data analysis requirements. The volume of maintenance data is such that desk top computers are suitable for the small test programs only. A large "mainframe" computer is needed to store and process the maintenance data for large test programs. The C-5A maintenance data base was 200 million bits of information at the end of the test program. Complex software is required to maintain and analyze this amount of data.

The software needed varies depending on the information and format of the raw data, but certain general requirements exist. For example, as part of the data base maintenance process, the times that aircraft maintenance started and stopped must be converted into man-hours, active hours, and elapsed hours. All individual maintenance actions (such as troubleshooting, actual repair, and cleanup) must be linked together into a single maintenance event. Further, all levels of repair (on-aircraft, off-aircraft, and depot) must be linked together. This complex linkage is needed because the various actions within a single maintenance event often occur at different times and different places. When all the smaller actions are properly linked, the total repair cost, both time and material, are visible. When properly done, the data base should provide an audit trail that begins with a description of the aircraft problem and concludes with action taken to prevent recurrence of that problem.

Maintenance data analysis computer reports vary from the trivial to the esoteric. Generally, the value of these reports is inversely proportional to the complexity. A most usable report simply lists the most frequently occurring failures in descending order of frequency. A report of similar type for the highest maintenance man-hour consumers is also of utility. Other computer reports present the various R&M metrics such as Mean Time Between Failure, Mean Time To Repair, and Maintenance Man-hours per Flying Hour.

22.2.6.3 Instrumentation Data. Complex tools are also needed to reduce special instrumentation data to usable form. Much has been written, in AGARD volumes and elsewhere, on the process of converting raw instrumentation data into engineering units and presenting the results. This treatise will rely on that work. [22-2]

22.2.7 Joint Reliability and Maintainability Evaluation Teams (JRMET)

A final planning effort should include establishment of a group to participate in classification of R&M data, review of results, arrive at a consensus on deficiencies, and to evaluate proposed fixes for previously defined problems. The basic nature of R&M data drives the need for such a group.

In many respects, R&M data are more subjective than data from other engineering disciplines. Often, it is not clear that an anomaly is an inherent defect or was somehow induced. Similarly, there is often disagreement as to the criticality of failures. Further, contracts often contain definitions of failure that are significantly different than those normally used by the operating command. Adding more confusion is the often large difference between the flight test environment and the eventual usage environment. Considerable engineering judgment is needed to translate flight test results to expected fleet results.

Establishing a team is a way to obtain consensus and increase understanding of the somewhat subjective results. If agreement cannot be reached on all issues, at least points of disagreement can be isolated and order-of-magnitude disparities eliminated. Acceptance of R&M results is maximized if all program participating agencies are represented on the JRMET (sometimes called a scoring conference). This includes government program management, contractors, test agencies, independent oversight agencies, and support agencies (repair depots).

This group should be formed before test planning is complete in order that the test can be structured such that all participants' objectives can be met. JRMETs can be formally chartered.

Once flight testing begins, the group should meet periodically (perhaps monthly) to classify new data and review results. The details of the classification process are discussed in the following test conduct section.

22.3 TEST CONDUCT

22.3.1 Scheduled Maintenance/Serviceing

Frequently performed tasks such as pre-/post-flight inspections often consume 50 percent of the maintenance labor hours on military aircraft. For reliable transport type vehicles, the figure is even higher. During the fleet life of these vehicles, frequent actions may be performed millions of times. Because of this high number, even the slightest labor and time savings can be important over the service life of the vehicle.

Early in the test program, engineers and experienced maintenance personnel should carefully scrutinize these commonly occurring tasks. Videotape recordings can show where task flow might be improved and time saved. Desktop computers with process flow analysis software can also help. Difficult tasks might be improved with more training or different tools. One recent analysis showed a noticeable improvement in task times when the maintenance technicians were simply provided a better quality flashlight to perform aircraft interior inspections.

22.3.2 Unscheduled Maintenance

Analysis of unscheduled maintenance data starts with the first flight. Through the test program, the engineer must actively search for problems and track trends. Periodically, the contractual and operational measures should be calculated and compared to requirements and expectations.

One objective of a reliability evaluation should be to analyze and fix every failure mode which occurs. But practical limitations like time and monies always make that impossible. First, fix the problems which affect safety of flight. Then, those items which prevent mission completion must be corrected. Lastly, those noncritical failures which affect availability and cost should be addressed.

Do not neglect ground operations. Toxic materials, high pressure systems, and ordnance are a few of the hazards which have caused lethal accidents in the past.

If a failure does not impact safety, i.e., malfunction of components not required for flight, it may still be mission critical. For every failure, the R&M engineer must determine if the failure would prevent accomplishment of any of the aircraft's designed missions. Experienced aircrew must be consulted in these determinations.

The least significant failure category is that class of defects which have no safety impact and do not prevent mission accomplishment, but still consume time and resources to correct.

In summary, failures should be considered in four general classes: safety-critical, mission-critical, noncritical-nondeferrable, and noncritical-deferrable. While safety-critical failure modes must be eliminated (and usually are), the less severe failure modes should be fixed if cost effective. Generally, not enough problems are fixed. That is, more front-end investment in reliability improvement would lower life cycle costs. History does not document a single instance of a military/aerospace product with excess reliability (measured in life cycle cost).

During program conduct each failure should be classified as to severity as discussed before. Also, each failure should be classified as to cause: i.e., inherent defect, induced defect, or no defect. The latter class includes those cases where no actual failure is ever found. The computerized maintenance data base should be capable of storing and recalling these classifications.

For data bases with those abilities, a most useful computer product is a listing of the most common failing items in each category. With such a listing, it is easy to see where the engineering emphasis must be placed to improve the vehicle. The test R&M engineer should review this high-usage listing to ensure that the most frequently failed items are being corrected.

As the test program progresses, the R&M engineer must search for the cause of failures and advocate any action needed to prevent recurrence of those failures. If flight test instrumentation is available to measure the environmental stresses (like temperature and vibration), a quick course of action may be to review existing data to ensure that the equipment is not being damaged by the environment. If the environment proves benign or instrumentation is not available, a detailed failure analysis (much like an autopsy) may provide the cause of failure. If the failure analysis points to an environmental overstress it may be necessary to add instrumentation to measure the operating environment. This is a lengthy process, but needed if the problem is severe enough. If the failure cause is overstress, the needed fixes are also difficult. Either the failed part must be made more environmentally durable or the operating environment must be improved.

When development resources are consumed, there will be many unfixed or partially fixed problems. These problems and the data resulting from investigations should not be discarded. If the problem could not be economically fixed in the first product versions, perhaps it will be possible to implement fixes in subsequent versions. And if no production versions of the aircraft have fixes, all aircraft are modified at some point in their service life and a fix may be more economically feasible at that time. A data base of problems and fixes, implemented or not, should be established and maintained throughout the life of the vehicle.

22.4 CONCLUDING REMARKS

The preceding paragraphs present an overview of flight test reliability and maintainability evaluations. Test objectives, planning efforts, data, and data reduction requirements were reviewed.

22.5 REFERENCES

- [22-1] Howell, J., "Reliability and Maintainability Flight Test Techniques", AGARDograph 300, "AGARD Flight Test Techniques Series", (To be published in 1995).
- [22-2] Various Authors and Titles, AGARDograph 160, "AGARD Flight Test Instrumentation Series", Volumes 1 - 9.

22.6 BIBLIOGRAPHY

MIL-HDBK-189, "Reliability Growth Management", Department of Defense, Washington, D.C., US, 1988.

MIL-STD-785B, "Reliability Program for Systems and Equipment", Department of Defense, Washington, D.C., US, 1980.

MIL-STD-470, "Maintainability Program Requirements for Systems and Equipment", Department of Defense, Washington, D.C., US, 1980.

MIL-STD-1629A, "Procedures for Performing Failure Modes, Effects and Criticality Analysis", Department of Defense, Washington, D.C., US, 1980.

AFR 800-18, "Reliability and Maintainability Program for Systems, Munitions and Equipment", US Air Force, Washington, D.C., 1986.

DEF-STAN 00-40 (Part1)/(NATO ARMP-1), "Requirements for Reliability and Maintainability", UK Ministry of Defense, Glasgow, UK, 1984.

Bazovsky, Igor, "Reliability Theory and Practice", Prentice-Hall Inc., Englewood Cliffs, New Jersey, 1961.



Chapter 23 – LOGISTICS TEST AND EVALUATION

Frank W. Baxley

Naval Air Warfare Center Aircraft Division
Patuxent River, Maryland 20670-5304
USA

23.0 INTRODUCTION

The Test and Evaluation (T&E) of logistics is a measurement of the support system's ability to meet predetermined performance requirements. Each element of logistics is equally important and must be given consideration for logistics T&E. Not all elements are applicable to every program acquisition due to the nature of the equipment being procured and subsequently tested. Care must be exercised to ensure that the impacted elements are included in the Logistics T&E process.

In addition to the above elements the logistics T&E process must also integrate the Reliability and Maintainability (R&M) process and the Human Factors (HF) evaluation. Note that the equipment's R&M design features have a great influence over the efficiency of the support system. For example, if the support system is developed concurrent with equipment design and an R or M design feature fails to meet the predicted level of performance, the equipment must be redesigned or modifications must be made to the effected logistics element to compensate for the failed design feature. Therefore, the developer of the support system performance requirements must be thoroughly knowledgeable of the R&M design requirements, the predicted performance, and achieved capabilities.

Closely associated with maintainability, and equally important in some cases to the equipment operator or maintainer, is the impact resulting from HF design. A lack of attention to HF primarily affects the quantity and type of people needed to operate and maintain the equipment. For example, if the physical size of an item is so large that it requires a four-man lift, or if the controls to operate a system are spread out beyond arm's length from a sitting position, additional manning may be required. (Also see Section 20).

When consideration is being given for logistics T&E, the logistics component of the flight test T&E team must ensure that the following items are well defined in the procurement contract in order to be able to properly evaluate the logistics elements:

- Parameters to be measured
- Methods for measurement
- Time frames for measurement
- Penalties and incentives associated with the achieved demonstrated performance.

Although a Flight Test Engineer (FTE) does not normally get directly involved in the Logistics T&E process, it is vital that he understand how and why Logistics T&E must be integrated into the test program. Systems must be available for ground maintenance evaluation tasks and HF evaluations, and this non-flying time must be considered when planning the overall test program.

23.1 PERSONNEL, TRAINING, AND TRAINING EQUIPMENT

The most important logistics elements are those which establish and maintain training for the personnel who will operate and maintain the equipment. Without trained personnel, even the most basic equipment

with highly efficient support systems will cease to provide the desired operational effectiveness. In some cases, systems or equipment could even be damaged if operated or maintained by untrained personnel.

23.1.1 Personnel Quality/Quantity

Prior to establishing the personnel requirements in the contract, it is essential that the basic design of the system being procured be fully known by the person establishing personnel requirements. This is necessary because the complexities of the design will determine the required skills and number of personnel needed to operate and maintain it.

New system designs that are on the leading edge of technology may demand the development of new skills or increase the number of personnel required to maintain the system. Either of these situations must be thoroughly researched to assess the impact to the operating activities. The impact of either situation can be contained to acceptable limits by specifying personnel constraints in the equipment manufacturer's contract. The assurance that performance is compliant with contract requirements can only be obtained through T&E.

During contract development, it can be specified that the quantity of personnel shall not exceed the present manning levels, which are expressed in terms of crew size per system and annual maintenance man-hours. This requirement is easier to establish for operators than for maintainers in that crew positions are usually obvious. Measurement of the maintainer requirements can begin early in system development and continue through maintenance task analysis. Each task requirement must be reviewed for applicability and effectiveness. Each task must also be reviewed to determine the number and skills of personnel required to accomplish it. This is a detailed process which involves an analysis of all of the subtasks necessary to accomplish a task. For example, if the task "what to do" is removal of a hydraulic actuating cylinder, the task "how to do" will include the individual subtasks to accomplish the removal of the actuator. The time required to accomplish each subtask must be determined for each person involved. When the analysis of each subtask is complete, the times are summed for each task and subsequently "rolled up" to the next higher equipment indenture level. The "roll-up" continues until the total system maintenance time has been calculated. See Equation 23-1.

$$AT_1 + AT_2 + \dots + AT_n = \Sigma AT_i$$

Where AT_i = Time in man-minutes to perform a Skill Level for task i.

Therefore, for Skill Levels A ... C the total time (TT) in hours is defined as follows:

$$\frac{\Sigma AT_i}{60} + \frac{\Sigma BT_i}{60} + \frac{\Sigma CT_i}{60} = TT$$

Equation 23-1

Task times must include the time required for isolating the fault; gaining access to the failed part; removing, repairing, and installing or replacing the part; adjustments; and repair verification. The maintainability design features are therefore of major importance. Another major element in determining total system maintenance time is task frequency. This element is a function of equipment reliability and, when coupled with task time, assists in determining the annual maintenance man-hours for the system.

23.1.2 Training Materials/Equipment/Facilities

Once operator and maintainer skill requirements have been determined, a comprehensive training program must be developed. Developing the training program includes, but is not limited to, the following elements: identifying training requirements, such as course prerequisites, course length, class size, and milestone schedule; establishing training methods; developing instructional material such as training aids, training equipment, and facilities; presenting and validating the initial courses; and providing instructor training for sustaining the program. Inadequacies in any of these areas could adversely affect system availability. Because each separate element of training must be integrated with the others, it will be difficult to impose contractual constraints on one element without impacting all elements of training. The constraint normally imposed on training is the availability of money.

Training T&E during the engineering and manufacturing development phase of equipment acquisition, and during the early production and deployment phase, is equally difficult because of the lack of contractual constraints or measurable performance criteria.

It is recommended that a comparison of actual task completion times to predicted repair times be made and a training adequacy review be accomplished to determine the effectiveness of the training program. Initial assessment should be accomplished soon after the first operating activity has received its full complement of systems. Follow-up assessments should be accomplished on a routine basis.

Trainers and training equipment development, and subsequent T&E, is a detailed activity that closely parallels the activity associated with a major system acquisition. That is, design engineering, system integration, support system identification, and development, manufacturing, and production are all applicable to trainers and training equipment. Occasionally, however, there are milestone schedules that may require delivery of the trainers and training equipment before or at the same time as the major system. Trainers and training equipment must be identical representations of the system they support; therefore their development must follow system development. This demands the expeditious completion of all engineering and logistics tasks in order to meet the delivery schedules.

23.2 TECHNICAL DATA

Technical data consists of the recorded information regardless of form or character. The Technical Manuals (TMs) and the engineering drawings are the most expensive and possibly the most important data acquisitions made in support of a system. Engineering data such as drawings are crucial to life cycle costs in that they could permit competitive re-procurement of spares, repair parts, and modifications of systems. The TMs are the documentation provided by the manufacturer for the operation and maintenance of the equipment. The requirements for TM development and for TM T&E must be expressed in the contract. The development of TMs must be integrated with training program development in that these are the instructions that will ultimately guide the operator and maintainer. TMs must be totally accurate documents.

23.2.1 Operational and Maintenance Requirements

In the case of some military organizations, a separate contractual document entitled "Technical Manual Contract Requirements" is provided to the manufacturer as an attachment to the logistics statement of work or detail specification. This document identifies the manufacturer's requirements for developing TMs or TM source data by establishing the manuals to be developed, the format to which they are to be developed, their content, the quantity of manuals to be delivered, and the time and place where they are to be delivered. TM source data are usually the functionally validated operating and maintenance tasks which are delivered to a separate organization for publishing to the final format.

TMs or TM source data are usually very expensive but necessary items in every hardware or software procurement. The costs are a function of the quantity of tasks, the complexity of the tasks, the number of illustrations required to support the text, and the format used to produce the manuals. With regard to the quantity of tasks, one method to ensure that the costs are kept to the minimum is to require the equipment manufacturer to accomplish a task analysis and to substantiate the task requirements on known or anticipated failures. This, of course, requires the TM developer to be knowledgeable of the reliability features of the equipment design.

23.2.2 Source Data Technical Evaluation

Because the technical accuracy is so vital to the proper operation and maintenance of the equipment, testing of this accuracy is equally important. A "table top" verification of accuracy is normally followed for TM source data which only provide a system description. This entails nothing more than a grade level check of the test to ensure readability and a verification of the technical accuracy. A "hands on" verification is normally specified for 100 percent of those procedures which detail the operation and maintenance of the system. This verification must be accomplished on a system that is representative of production equipment and completed during the initial T&E phase.

Measurements of accuracy can be based on a percentage of the total number of tasks developed. Time to complete the tasks can also be measured against the predicted times. Additionally, measurements can be made of the errors discovered in the form and format requirements that are expressed in the contract requirements.

23.3 SUPPORT EQUIPMENT

Support equipment (SE) generally falls into one of two categories - items used to repair systems or equipment, and items used to test systems or equipment. The development of SE, as discussed for trainers and training equipment, is also a detailed activity that closely parallels the activity associated with a major system acquisition. All of the design engineering, system integration, support system identification and development, manufacturing, and production tasks are normally applicable when the requirement for a new item of SE has been determined. It must be noted that considerable cost can be controlled or avoided by specifying that a new system be designed to be compatible with existing SE. For example, it could be specified that a new system must be capable of utilizing an existing tow bar, a hydraulic "mule", or an auxiliary power unit. A significant portion of the resources necessary to support a new system may already be available in the existing supply system and the logistician must research this capability and also determine if it is appropriate to require a new system to be compatible with existing capabilities.

T&E of SE is conducted in the same manner as it is for major systems in that requirements are established, plans are written, tests are accomplished, and data are collected and analyzed. Measurable R&M design and system performance requirements are always established in the SE development contract. Human factors such as man-machine interface are also applicable and must be well defined, as are requirements for system interoperability.

23.3.1 System Requirements

When the equipment manufacturer accomplishes a system task analysis and identifies the tasks needed for operation and maintenance of the system, he can also begin to identify the tools and test equipment necessary to support those tasks. The complexity of the task, the extent of system diagnostic aides (Built-In-Test), equipment accessibility, and the physical size of the equipment all have direct influence on the SE requirements. A thorough knowledge of the maintainability design features and the opportunities to change the design can have a significant impact on the tools and test equipment requirements.

23.3.2 Handling Requirements

Handling equipment include such items as slings, skids, dollies, tow bars, and tugs. Human factors are a major consideration in the design of handling equipment. Keeping them simple and limiting their quantity can help contain the costs associated with their procurement and limit the impact to the equipment operator or maintainer. Depending on the maturity of the equipment designs, the logistician can control the costs by specifying that new equipment be designed to be compatible with existing handling equipment. When this is not possible, the procuring activity must closely monitor the requirements for new handling equipment and maintain approval authority for all new items.

23.3.3 Servicing/Testing/Calibration

The requirements for servicing, testing, and calibration equipment also can be determined through a comprehensive task analysis. For equipment used in servicing and testing tasks, alternative support concepts and a cost benefit analysis could assist in determining the need for new equipment. For example, if the new equipment can reduce system down time (out of service hours) and system readiness is essential, then justification for procurement of the new equipment could be substantiated. When these analyses are being conducted, careful consideration must also be given to the logistics support system requirements for the new SE. These requirements are discussed in paragraph 23.3.5. The requirements for new SE which have unique calibration requirements can also drive the requirement for a new or modified support system and/or an increased quantity of assets. The increase in assets would be generated by the need to have operable SE available for use while the prime asset is undergoing periodic calibration.

23.3.4 Repair

The SE needed for the shop repair or overhaul of failed equipment can be very complex and extensive. Therefore, controlling these SE needs is essential. Considering that these SE items can generate the need for additional special skills, training, and facilities, the costs of their acquisition could outweigh the benefits of repair. In these cases, discarding the failed item could be the most economical decision.

23.3.5 Logistics Support for SE

All too often, the logistics support system for the SE is an area overlooked during equipment acquisition and for T&E after procurement. This area is as important as the major system logistics support system and must be an equal candidate for T&E. The conditions that apply for measuring the performance of the major system logistics support system are applicable for SE. If applicable, the following logistic elements must be given consideration: Personnel, Training, and Training Equipment; TM's, SE for SE, Spares and Repair Parts; Facilities; and Packaging, Handling, Storage, and Transportation (PHS&T). The computer resources such as automatic test equipment, Engine Diagnostic and Recording Systems, etc., must not be overlooked when considering logistics support for SE.

23.4 SPARES AND REPAIR PARTS

Spares and repair parts are those repairable and non-repairable items that are stocked at strategic locations and are used to return a system or repairable part to an operational or serviceable condition. Spares are commonly repairable items such as generators, hydraulic actuators, receivers, brake assemblies, power supplies, etc. When a like item has failed on the in-service system, a spare part is ordered from a stocking point and then used by the maintenance technician to return the system to an operable status. Repair parts are normally non-repairable, consumable items such as gaskets, packings, capacitors, resistors, etc. They are usually stocked at the repair site and treated as pre-expended parts. In other words, they are ordered in bulk quantities that are determined by annual usage. Resupply is based upon established high and low limits.

23.4.1 Estimated Requirements

One of the most difficult problems encountered with this element of logistics is accurately determining spare and repair parts requirements. This problem is more pronounced for systems or equipment that are undergoing development and are to become operational for the first time. These systems are still in the prototype stage and the spares needed to support their repair during early test activity will be unique to the system's prototype configuration. The range and depth of spare and repair parts must be sufficient to ensure test requirements are met, but cannot be overstocked because of the high costs of procurement and their potential limited application. Usually, the burden of responsibility for sparing the initial testing of newly developed systems is placed upon the equipment manufacturer. The procuring activity must still pay for these spares so provisions are usually made to have the spares upgraded to the configuration that is eventually delivered to the using activities.

Estimating the spare and repair parts to support the early introduction of these systems is usually accomplished with the aid of a spares model. Several computer models are available for this purpose and all rely upon factors such as equipment failure rates, annual operating hours, and repair turn around times.

23.4.2 Lead Time

Lead time refers to the delay encountered for receipt of a newly manufactured part following initial ordering. This delay is attributable to manufacturing and assembling of the part and often includes the time needed for the equipment manufacturer to subcontract with parts vendors. In the cases where major structural items are being procured and requests for metal forgings are involved, the lead time can exceed 18 months. To avoid the possibility of not having the required spare and repair parts available to effect equipment or system repair, lead time must always be considered when the lay-in or resupply of existing stocks is being accomplished.

23.4.3 Prepositioning

It is not uncommon for the stocking point of spares to be at a location different than the system operating location. Stocking points are partially determined by the equipment failure rates, costs, number and location of using activities, transportability, and required stock quantities.

23.4.4 Interim Support

One method frequently used to ensure the availability of spare and repair parts during the time prior to the full provisioning is to require the equipment manufacturer to establish Interim Support. Included in this method of support is the manufacturer's responsibility to provide the spare and repair parts, stock these items at the point of need, issue the items to the using activity, receive the failed item, ship the failed item to a prearranged point of repair, and receive new and repaired items. This method of support is normally for a short duration, one to two years, because of the high cost of maintaining it.

23.4.5 Spare and Repair Parts T&E

Items to be considered for T&E of spares and repair parts would include the following items: system not operationally ready time due to lack of parts; stocking point resupply time; and spares and repair parts availability, (i.e., the percentage of time the ordered or needed item was available within 24 hours after ordering).

23.5 FACILITIES

Facilities can generally be classified into two categories - permanent and mobile. Their uses can cover a diverse range, including maintenance, storage, classroom, berthing, administrative, etc. It is impractical to establish T&E on a permanent facility constructed for its original intended purpose. If the design of the facility does not satisfy its purpose, reconstruction must be accomplished or logistics support will be negatively impacted. This reconstruction will demand additional expense and delay the intended use of the facility. Therefore, extreme care is always taken to positively identify the construction requirements. Constructing a new military facility normally requires a long period of time. For example, having to construct or modify a facility under the Military Construction Program requires a lead-time of approximately three to five years. A last-minute decision to build the approved facility in a different locale may require extraordinary military department or, in the United States, Congressional action. Unlike permanent facilities, mobile facilities do align with T&E activity. Facility movement from site to site, setup or erection at the new site, and pack-up times can all be specified and later measured. Consideration could also be given for facility expandability and adaptability to new purposes or environments. All are measurable attributes.

23.5.1 Requirements

Facility requirements are determined after a thorough study on the system or equipment being procured has been accomplished and the needs associated with repair, training, administrative, storage, etc., have been established.

23.5.2 Site Survey

After the study identifies the requirements, existing facilities are surveyed to determine their capability to satisfy the new system's needs. The physical size of existing facilities is often verified for acceptability through the use of a model which can generate a floor plan representative of the facility. The foot print of the new equipment is then added to the floor plan to determine the used and available space. These models are relatively inexpensive and should be considered for facility T&E.

23.6 PACKAGING, HANDLING, STORAGE, AND TRANSPORTATION

PHS&T is the combination of resources, processes, procedures, and methods necessary to ensure that all system, equipment, and support items are preserved, packaged, handled, and transported properly. This is an area often overlooked as a candidate for T&E and for the role it plays in overall system supportability. The user of provisioned spares and repair parts, however unknowingly, depends very heavily on the serviceability of those items. He expects them to be in a ready-for-use condition upon receipt.

To ensure equipment serviceability, PHS&T planning must begin early in the equipment design process. The packaging and storage requirements for an item must align with available or planned transportation methods and storage facilities.

An inexpensive approach for T&E of PHS&T can also be accomplished through modeling in a manner similar to that used for facilities. Consideration should be given for requirements that identify space, weight, adaptability for use with standard size reusable containers, availability of construction materials for special packaging, and special requirements for handling equipment such as forklifts, cranes, dollies, slings, etc. Contract requirements established at the beginning of the equipment design effort can ensure packaging or modularizing of the equipment to meet the using activities needs.

23.7 DATA COLLECTION/REDUCTION

Data collection during logistics T&E, as during any other major system T&E activity, depends heavily on data accuracy. A data collection system must be established and be in place prior to initiation of test activity, data points to be collected must be known by the data collectors, and knowledgeable personnel must be available to assess the data.

Although all major test activities and equipment manufacturers generally have their own systems for data collection, occasional review of those systems should be accomplished. This is especially true if two independent activities are expected to compare test results. Whatever system is considered acceptable, it should be capable of providing output which will permit the assessment of the impact that the new equipment may have on the existing support system. The system should also permit readiness impact assessments based upon the non-availability of individual support resources.

23.8 SPECIAL CONSIDERATIONS

With the advent of Computer-aided Acquisition and Logistics Support (CALs), the development and delivery of engineering and logistics products changes from the traditional paper form to a digital form. This requirement demands the availability of compatible computer resources and software, in that the delivery format specified can be direct electronic transfer through telecommunications, 9-track tape, 3.5-inch or 5.25-inch floppy disk, or CD ROM.

The impact to the ultimate users of these products, the operator and maintainer, must be thoroughly researched in order to reduce the shock of introduction. The logistic element where the greatest impact can be made, and the greatest shock can be felt, is in TMs. Eliminating the manuals that provided the operating and maintenance instructions that have been relied upon in the past and replacing them with on-screen representations generated by a personal computer could be traumatic for the user. Preparing the operator and maintainer to readily accept these products can best be accomplished by extensive user training and incremental phasing-in of the digital data. This method of introduction produces a greater acceptance by establishing user confidence in the accuracy and availability of the information. The importance of product accuracy and reliability of the computer resources cannot be over stressed. Any errors in the procedures or failures in the equipment will quickly erode user confidence. A thorough T&E of these products is essential prior to introduction.

23.9 CONCLUDING REMARKS

Some form of T&E is applicable to every logistic element. T&E will ensure that the logistics support system performance requirements are obtainable. The engineering design, especially R&M, exerts a great influence over the efficiency of the support system. A thorough knowledge of the equipment's intended design by the logistician is essential prior to establishing the support system performance requirements. This design knowledge will also enable an assessment of design impact on the logistics support system. Effective logistics T&E can only be accomplished if the requirements are positively established in the equipment manufacturer's development contract.

23.10 BIBLIOGRAPHY

Andrews, R.A., Systems 225 class, "The Basics of Integrated Logistics Support", School of Systems and Logistics, Air Force Institute of Technology, Wright-Patterson Air Force Base (AFB), Ohio, (Undated).

"Logistics Test Handbook", Air Force Flight Test Center, Edwards AFB, California, (To be published).

DoD Manual 5000.2, "Defense Acquisition Management Documentation and Reports".



Chapter 24 – PROPULSION

Lawrence A. Thomas
Strike Aircraft Test Directorate
Naval Air Warfare Center Aircraft Division
Patuxent River, Maryland 20670
USA

24.0 INTRODUCTION

This chapter provides a basic guide to the flight testing of propulsion system operability and compatibility (O&C). For the purposes of establishing a frame of reference, O&C refers to the ability of the aircrew to establish and maintain the desired level of propulsion system net propulsive force throughout the operating envelope of the aircraft. For the purposes of definition, net propulsive force is used to refer to the vector resultant of all throttle dependant forces acting upon the aircraft. By limiting the discussion in this Section to flight testing of the O&C of the propulsion system, it should not be interpreted to mean that these are the only factors that need to be considered when conducting flight test to evaluate an aircraft propulsion system. Propulsion system structural interfaces, pneumatic interfaces, mechanical interfaces, hydraulic interfaces, thermodynamic interfaces and electrical interfaces must all be evaluated prior to or concurrently with the O&C test program in order to ensure a safe and effective flight test program of the aircraft and propulsion system.

24.0.1 Operability and Compatibility

Propulsion system O&C flight testing should be considered as a process rather than an event. Propulsion system O&C testing may be required at any stage of the research, development, test and evaluation and service support process. Propulsion system flight testing could be conducted as a prototype/technology demonstration effort, a full scale development effort, or as part of a post production support effort.

24.0.2 Pretest Planning and Coordination

When planning to conduct a flight test program of propulsion system O&C, it is important to ensure that the approach focuses on the integrated propulsion system and not just the more visible components of the system. While the engines, rotors, etc., may represent the more visible components of the propulsion system, it is the integrated system, with all the aircraft interfaces which will ultimately define the O&C of the aircraft propulsion system. Figure 24-1 illustrates some of the factors which might be considered when planning to conduct a flight test program to evaluate propulsion system compatibility.

PROPULSION

- DESIGN CONSTRAINTS

- Inlet Maximum/Minimum Airflow (Choke/Buzz)
- Rotor/Fan/Compressor Choke Flutter, Stall Flutter, Rotating Stall
- Rotor/Fan/Compressor Mechanical Speed Limits
- Shaft Torque Limits
- Casing Structural Limits
- Combustor/Afterburner Rich and Lean Stability Limits
- Turbine/Nozzle Temperature Limits
- Aft Fuselage Thermal/Acoustic Loads

- ADDITIONAL FACTORS WHICH INFLUENCE PROPULSION SYSTEM O&C

- Mass Moments of Inertia
- Mechanical Hysteresis and Delays
- Sensor Response/Resolution, Accuracy
- Control System Operating Modes
- Control System Dynamic Response
- Shaft Torsional Stiffness
- Chemical (Combustion) Delay
- Transient Temperature Limits
- Component to Component Performance Variations
- Cycle Sensitivity to Component Variations
- Deterioration
- Cycle Sensitivity to Deterioration
- Cycle Sensitivity to Reynolds Number
- Cycle Sensitivity to Thermal State
- Cycle Sensitivity to Distortion
- Cycle Sensitivity to Bleed Extraction
- Cycle Sensitivity to Horsepower Extraction
- Transient (Dynamic) Cycle
- Cycle Sensitivity to Fuel Characteristics
- Internal Heat Transfer Characteristics
- Internal Mass Storage Characteristics

- PRIMARY FLIGHT TEST FACTORS/VARIABLES

- Inlet Recovery
- Distortion
- Transients
- Thermal State
- Fuel Properties
- Bleed/horsepower Extraction

Figure 24-1. Factors Which Affect Propulsion System O&C.

With such a broad range of potential variables, any flight test program to assess O&C must be developed with a broad perspective. With such a large potential list of variables it would be very easy to establish such a large test matrix that it would be totally impractical to execute the O&C test requirements during a flight test program. By establishing proper coordination with the technical specialists in related disciplines and by making effective use of the available pre-test data base, it will be possible to apply a much more systematic and efficient approach to the planning, execution and analysis of propulsion system O&C flight testing.

The most common sources of information for the data base are inlet recovery and distortion estimates from aerodynamic/propulsion wind tunnel tests or previous flight test of an aircraft with the same forebody/inlet design, propulsion system component performance and sensitivity estimates from engine sea level and altitude test facility results, and aircraft/propulsion system interface condition estimates developed from subsystem designs and rig test results. These preliminary estimates are integrated to generate installed propulsion system performance models, propulsion system compatibility/stability estimates and propulsion system dynamic response estimates and models.

For highly integrated propulsion systems the propulsion data base should also be integrated with other system/subsystem data bases (e.g., aerodynamic, flight control, fuel, structure, thermal management, etc.) in order to develop estimates and models for the overall aircraft.

Once the data base has been established it should be possible to establish preliminary estimates for the O&C of the propulsion system. These preliminary estimates should be used to predict the more critical points and maneuvers for the determination of O&C. The preliminary estimates also allow the flight test team to assess the relative influences of the most important variables which affect engine O&C (e.g., the effects of angle of attack on inlet distortion may be dominant during some maneuvers whereas corrected airflow may be the dominant factor for other conditions).

Developing an appreciation for these relative sensitivities will aid the flight test team in developing the test approach and developing a logical buildup to the more critical flight test conditions. Wherever possible, propulsion system O&C testing should be integrated and coordinated with all the other related flight test disciplines. Establishing a coordinated approach between the propulsion test requirements and the other elements of the flight test program will not only improve the efficiency of the test program, but, more importantly, interdisciplinary coordination is also essential to the process of hazard identification and risk management which is critical to the safe conduct of any flight test program.

24.1 TEST OBJECTIVES

Obviously, test objectives must be established which are consistent with the design objectives of the aircraft propulsion system. A propulsion system designed to support a carrier-based, supersonic, air superiority fighter aircraft will have more challenging O&C design objectives than a land-based subsonic transport aircraft. Both of these aircraft will have O&C design objectives but the large disparity in mission requirements and operating envelope of the two aircraft will dictate vastly different flight test objectives. Similarly, the test objectives will be much narrower for the flight test of O&C for the modification of a previously developed and tested system if the modification only affects propulsion system operation over a limited portion of the flight envelope.

24.1.1 Types of Test Objectives

Test objectives can be contractual, operational and/or technical. With the possible exception of exploratory development flight test programs, where the overriding objectives may be technical, most flight test programs will probably entail all three objectives. Contractual objectives will usually be geared toward demonstrating very specific O&C capability under very specific test conditions. Operational test objectives are less maneuver specific and are more oriented toward assessing O&C during specific mission tasks. Technical objectives are established to support both contractual and operational objectives. Technical objectives should also support the verification and or refinement of the propulsion system O&C data base. Once the data base has been refined and validated, this data base can be used to predict the effects of conditions/variables which may be beyond the scope of the flight test program (e.g., effects of engine-to-engine variations or operating characteristics at extreme climatic conditions).

24.1.2 Operability and Compatibility Objectives

An in-depth discussion of all the factors which affect O&C, and therefore which must be integrated into the O&C flight test objectives, is beyond the scope of this volume. However, in order to plan and execute a safe and effective flight test program the flight test team must have an appreciation of the primary variables and how they will affect test results. In the broadest possible terms, O&C relates to the ability to manage the net propulsive forces on the aircraft throughout the flight envelope to perform the aircraft mission. O&C flight test objectives must address not only the more obvious manifestations (e.g., compressor surge, flame out, inadequate propulsion system power response, etc.) but also the more subtle manifestations (high cycle fatigue stresses caused by localized blade/vane flow separation, hot end distress caused by distorted combustor pattern factor, higher than predicted performance losses associated with the effects of lower than predicted inlet recovery or distortion influences on gas generator performance, afterburner (A/B) rumble, A/B screech, etc.).

The individual components of the propulsion system (rotors, gearboxes, inlet, fuel systems, gas generators, power turbines, nozzles, control systems, etc.) will have been evaluated prior to the integration into the aircraft. (See Section 9). The objective of the flight test program is to evaluate the fully integrated propulsion system O&C. Figure 24-1 summarizes some of the factors which influence integrated propulsion system O&C.

Figure 24-1 divides the factors into three categories; (a) Design constraints, (b) additional design factors which influence O&C, and (c) factors which have the most relevance to flight test O&C objectives. If the designers and integrator have done their jobs properly, the integrated propulsion system should never approach the design constraints except in response to a failure. The second category lists factors which affect O&C but which are normally outside of the control of the flight test team. The third summarizes the factors which affect propulsion system O&C which the flight test team can influence during the flight test program and which should be the primary focus of the flight test team. The test techniques presented in this chapter are oriented toward addressing this category.

Figure 24-2 presents a summary of the causes and influences of propulsion system flight test variables. It should be emphasized, however, that effective flight test hazard analysis and risk management dictates that the factors in the first two categories be given full consideration in the planning, execution, and analysis of the flight test program.

FACTOR	CAUSES	INFLUENCES
Inlet Distortion	Far Field Wake Turbulence Rocket Gas Ingestion Catapult Steam Ingestion Near Field Rotor/Propeller Wash Forebody Separation Boundary Layer Ingestion Shock/Boundary Layer Induced Separation Inlets Lip Separation Throat Separation Shock Instability (Buzz) Secondary Inlet Separation Diffuser Separation	Reduced Fan/Compressor Stability Margin Potential High Cycle Fatigue Reduced Gas Generator Performance Control Input Biases
Reynolds No./ Reynolds No. Index	Boundary Layer Characteristic Changes	Increased Inlet Distortion Reduced Inlet Recovery Reduced Fan/Compressor Combustion Stability Decreased Gas Generator Performance
Thermal State	Variations in Tip/Vane/Seal Clearances due to Differential Expansion Rates of Case, Blades, and Rotor Discs Fluid Viscosity Effects	Variations in Performance Variations in Fan/Compressor Stability Margin Variations in Parasitics losses and Dynamic Response
Bleed/Horsepower Extraction	Aircraft Services Demand Changes	Variations in Performance Variations in Fan/Compressor Stability Variations in Transient Response
Transients	Pilot Demand Changes Abrupt State Input Changes Automated Inputs Systems	Compressor Operating Line Combustion Stability Margin

Figure 24-2. Causes and Influences of Propulsion System Flight Test Variables.

24.2 INSTRUMENTATION

Instrumentation requirements should be a natural evolution based upon the test objectives. Instrumentation requirements must be consistent with the practical limitations inherent in the flight test of an aircraft. Instrumentation decisions should, wherever possible consider correlation with the data base (e.g., inlet rakes at the same location as they were in the aero/propulsion wind tunnel model, engine instrumentation package identical to that used in the altitude test cell program, etc). Figure 24-3 provides a generic list of instrumentation which is typical for a major propulsion system operability and compatibility test program. The list is grouped into three general categories: (a) flight conditions parameters; (b) gas generator parameters, and (c) propulsion system parameters. The flight conditions parameters are the standard measurements that are applicable to any flight test program. The gas generator parameter will be specific to the type of gas generator under evaluation. The propulsion system parameter listing will also be type specific and installation specific.

FLIGHT CONDITIONS	PROPULSION SYSTEM	GAS GENERATOR
Ambient Temperature	Average Inlet Total Pressure	Rotor Speed
Ambient Pressure	Average Total Temperature	Rotor Torque
Mach Freestream	Average Static Pressure	Fan Speed
Angle of Attack	Distortion Indices Static	Fan Vg Position
Angle of Sideslip	Distortion Indices Dynamic	Fan Discharge Pressure
Configuration	Inlet Ramp Positions	Fan Discharge Temperature
	Inlet Bleed Positions	Compressor Speed
	Pilot Power Demand	Compressor Vg Position
	Nozzle Exit Static Pressures	Internal Stability Bleed
	Rake Individual Pressures	Compressor Discharge Pressure
	Rake Individual Temperatures	Compressor Discharge Temperature
	Aircraft Service Bleed	Nozzle Throat Area
	Aircraft Service Horsepower	Nozzle Exit Area
		Fuel Flow
		Fuel Temperature
		Fuel Specific Gravity
		Fuel Lower Heating Value
		Turbine Inlet Temperature
		Turbine Outlet Temperature
		Turbine Outlet Pressure
		Power Turbine Outlet Temperature
		Power Turbine Outlet Pressure
		Power Turbine Horsepower
		Extraction
		Exhaust Gas Temperature
		Afterburner Fuel Flow
		Afterburner Fuel Temperature
		Afterburner Fuel Specific Gravity
		Afterburner Ignition
		Afterburner Light

Figure 24-3. Potential Propulsion System Instrumentation Parameter.

Instrumentation parameter ranges should be selected based upon the predicted propulsion system operating ranges based upon the engine specification and installed performance model with suitable margins applied. Frequency response requirements for the instrumentation must be based upon the requirement to define the O&C of the propulsion system. If a rake is installed in the inlet, or intercompressor rakes are installed, and dynamic pressure distortion data are required, then frequency response requirements for gas generator pressures are also high in order to detect rotating stall. In addition, high response is needed to evaluate stability and correlate to inlet distortion effects. Digital parameters from the aircraft multiplex (MUX) bus or output of a digital control system will be self defining in terms of frequency response.

24.3 TYPICAL TEST TECHNIQUES

Based upon the large extent of potential test objectives and the wide variation in propulsion system and control system designs, it is not practical to try to cover in detail all of the potential O&C test techniques.

The test techniques selected for presentation here are those which are considered to have the broadest applicability to a propulsion system flight test program. Test techniques are as type aircraft/type propulsion system non-specific as possible (e.g., power can be interpreted to refer to rotorcraft/propeller torque output or to turbojet thrust output).

24.3.1 Steady-state Tests

Steady-state test conditions are established to define the performance and operating baseline of the propulsion system. The steady state test matrix should systematically vary the primary propulsion system compatibility parameters (i.e., power setting, Mach, altitude, and/or angle of attack/sideslip) to provide a baseline from which to verify the effect of these parameters on overall propulsion system operation. Due to the relatively slow thermal response rates of compressor rotor discs, stabilization times for steady state propulsion system performance determination should be fairly long. Three to four minutes stabilization is adequate in most cases, however, much longer times can be required for large changes in thermal state (e.g., going from a cold engine state to maximum power). Good practice for conducting steady state propulsion system testing is to vary power setting in an up and down staircase sequence. If the increments in power are kept reasonably small (e.g., 10 steps from idle to maximum (max) power), thermal state changes and thermal transient effects will be minimized. By stepping up to max power and then down to idle, any residual thermal effects can be identified and any hysteresis effects of the control system can be detected.

24.3.2 Transient Conditions

Propulsion system transients should be considered in terms of first order and second order response. The first order response is the initial response to an abrupt input or interface change. For the purposes of this section, we will use the term "transient" to refer to this first order change. Second order response (thermal stabilization, slow or moderate changes in inlet conditions during a climb) will be characterized as quasi-steady state conditions. While these definitions may be somewhat arbitrary, they do provide a frame of reference for defining transient test techniques.

24.3.2.1 First Order Transients. The most common form of propulsion system first order transient is the response of the propulsion system to a change in demand by the aircrew. The demand change can be at any rate and entail both magnitude and direction of the net propulsion force. Dynamic propulsion system test condition can also be generated without direct propulsion system aircrew input by automated propulsion system controls (e.g., inlet ramp schedules, Mach speed lockup functions, auto throttle systems, etc.). Propulsion system transients may also be induced by rapid changes in any of the primary propulsion system interfaces (e.g., sudden change in aircraft bleed demands or horsepower extraction). Finally, propulsion system transient conditions can be induced by external influences such as carrier catapult steam ingestion or rocket gas ingestion. In order to evaluate the propulsion system O&C during transients, test techniques need to be developed which characterize the propulsion system response.

24.3.2.2 Acceleration and Deceleration Transients. Slow acceleration and deceleration transients (nominally two minutes to transit the power range from idle to max) are used to establish the near steady state propulsion system operating characteristics, establish the linearity between power demand and output and identify any regions where high structural dynamic conditions or propulsion system control instability might be encountered. Slow transients also provide a means of verifying that all the propulsion system variable geometry systems are operating within nominal design tolerances.

24.3.2.3 Step Transients. Step accelerations and decelerations are conducted to define the engine response to demand changes throughout the operating range. Both the magnitude of the steps and the starting and finishing point should be varied to establish the propulsion system response throughout the operating ranges. The selection of the steps to be evaluated should also consider changes in control

system modes (e.g., at low power the control system mode might be open loop on fuel flow and at high power conditions might be closed loop on rotor speed) and the regions of the flight envelope where the pilot will be faced with high gain, closed loop tasks that will require rapid and precise power management (e.g., hover, landing, approach, close formation tasks, or in-flight refueling).

24.3.2.4 Interface Transients. Propulsion interface transients are conducted to establish the propulsion systems dynamic response to "external" variables. The most common interface transients are horsepower extraction and bleed air extraction for aircraft services. Selecting bleeds on and off and changing horsepower extraction (generator on and off) at selected power settings will allow the test team to evaluate the effects of these dynamics. As with the other test maneuvers, some consideration of operating modes and sensitivities should be factored into selection of the test conditions. Bleed change will have a more significant effect on propulsion system characteristics when the engine is operating on a temperature limit. Horsepower extraction changes will have a much larger impact on system response at high altitude, low power settings where horsepower extraction becomes a much larger percentage of the total power available in the engine.

24.3.2.5 Level Accelerations and Decelerations. Fixed throttle level aircraft accelerations and decelerations are conducted to establish the effects of airspeed/Mach and angle-of-attack variations on inlet recovery and distortion, verify inlet and engine control system schedules, determine quasi-state performance and verify propulsion system stability. The test altitudes for these maneuvers and the power settings used are selected to provide a test matrix which encompasses the aircraft level flight envelope and the relevant engine power ratings and control system limiting regimes. If isolation of the effects of Mach from propulsion thermal transient effects is desired the engines are pre-stabilized at the test power rating prior to commencing the acceleration/deceleration run.

24.3.2.6 Climbs and Dives. Fixed throttle climbs, zoom climbs, descents, and dives are conducted to verify the effects of altitude/Reynolds' number index (ReI) on inlet recovery and distortion, verify inlet and engine control system schedules, determine quasi-steady state propulsion system performance and verify propulsion system stability. Test airspeed/Mach and power setting used are selected in order to provide a test matrix which encompasses the aircraft envelope and the relevant power ratings of the propulsion system and control system limiting regimes. If isolation of the effects of altitude from thermal effects is desired, the engines should be pre-stabilized at the desired power setting prior to commencing the climb/decent.

24.3.2.7 Maneuvering Flight. Fixed throttle angle-of-attack (α) and angle-of-sideslip (β) sweeps (windup turns, pullups, pushovers, and intentional sideslips) are conducted to verify the effect of α and β on inlet recovery and distortion (both leeward and windward), verify the effects of normal and lateral acceleration, verify compressor stability, and verify the function of stability enhancement systems (if applicable). Altitude, airspeed/Mach, thermal state, and power setting used are selected in order to provide a test matrix which encompasses the maneuvering flight envelope of the aircraft and the relevant propulsion system power settings and control system operating regimes.

24.3.2.8 Power Transients. Power transients at or near steady flight conditions are conducted to determine propulsion system response characteristics, verify the effects of airflow changes on inlet recovery and distortion, verify combustion stability, verify transient effects on compressor operating lines and verify compressor stability. Test conditions and power transients conducted are selected to provide a test matrix which encompasses the aircraft level flight and maneuvering flight envelope. Transient test conditions should be sequenced to build up from the predicted less critical to the predicted more critical (e.g., from low to high inlet distortion based on the effects of Mach, angle-of-attack, configuration, ReI, etc.). Non-pilot induced transients (control system reversions to degraded modes, gas ingestion, etc.) are also assessed using a test sequence which builds up to the predicted most critical test conditions.

24.3.2.9 Relight and Airstart. Relight and airstart tests are conducted to define the useable restart envelope for the engines. Restart testing should encompass immediate (spooldown) starting characteristics as well as cold restart characteristics. Both assisted (crossbleed and/or starter assisted) modes should be assessed if applicable. Both primary and secondary control modes as well as alternate fuel characteristics should be defined. Automatic relight features (if applicable) should also be assessed. Restart testing should be conducted commencing from the center of the predicted satisfactory envelope and working outward until the restart envelopes are defined.

24.3.2.10 Environmental Factors. The effects of environmental factors (e.g., ambient temperature, and humidity) on propulsion system performance, O&C are assessed by systematically varying the environmental conditions and verifying that the changes in performance, O&C are consistent with the predicted behavior of the propulsion system. Environmental factors can be varied by judicious choice of the scheduling for specific tests (e.g., time-of-day and/or seasonal) or deployment to specific test sites which provide the required test conditions and/or use of special test facilities (e.g., Eglin AFB Climatic Test Facility, icing spray rigs for helicopters, water/icing spray tanker aircraft, etc.). [24-1]

24.3.2.11 Stability Margins. Compressor stability margin and combustion stability margin checks are conducted at conditions and during maneuvers which are predicted (or known based upon previous test results) to have minimal stability margin. These maneuvers will target conditions where several of the primary factors (i.e., distortion, transients, thermal state, ReI, etc.) tend to provide the most adverse conditions. The conditions and maneuvers will vary greatly with the propulsion system design. Some of the commonly used test techniques are provided for information ("slam" and "chop" are defined as movement of the throttle through its full operating range in 0.5 seconds or less).

- Cold slam - shortly after start or after a prolonged period at ground/flight idle, conduct a slam to maximum power and hold maximum power until the gas generator has stabilized.
- Cold chop - shortly after start or after a prolonged period at ground/flight idle, conduct a slam to max power. As soon as the engine reaches max power, chop the throttle to idle.
- Hot slam - heat up the engine at maximum power, decelerate to idle. As soon as the engine reaches flight idle, slam to max.
- Hot reslam/bodie - heat up the engine at max power, chop the throttle to idle. As the engine is decelerating, reslam the engine throttle to max power. Vary the throttle dwell at idle to achieve reslam as the engine decelerates through desired power ranges.

24.3.2.12 Power Changes. Sinusoidal power demand changes are input over targeted power ranges. The input demand is systematically increased from low frequency to high frequency. The power regime, range of input, and frequency range tested is selected based upon conditions where the aircrew will be faced with high gain closed loop propulsion system power management tasks (e.g., hover, approach, formation flying, in-flight refueling, etc.).

24.4 APPLICATION OF TEST TECHNIQUES

The applicability of test techniques presented in paragraph 24.3 will obviously vary with the aircraft aerodynamic and propulsion system design and the mission of the aircraft. This paragraph will provide some suggestions to guide the reader in the application of test techniques.

24.4.1 Ground Tests

24.4.1.1 Static Tests. Ground tests with the aircraft secured should be the first phase of any flight test program to evaluate propulsion system performance O&C. Ground test provides the opportunity to

perform a functional check of most of the propulsion system and interface components to be evaluated during the test program, checkout all the instrumentation system and evaluate propulsion system performance, compatibility and operability under static conditions, which can potentially be critical conditions due to high static inlet distortion levels. Establishing the baseline steady state performance, quasi-steady state performance, transient characteristics and compatibility for the static condition also provides an installed baseline which can be used to compare to predicted characteristics in order to verify installation losses and identify any interactions which will adversely affect the aircraft and/or the test program. Ground tests should also be used to preview the effects of any failure modes or emergency operations (engine out, degraded control modes, etc.) prior to commencing flight test. Ground tests should also be used to verify the impact of alternate fuels on operating characteristics, compatibility and performance. (See Section 9).

24.4.1.2 Engine Starts. Ground starting tests should verify engine starting characteristics in primary and secondary control modes (if provided). All start modes (gas turbine starter, external air, cross bleed) should be verified. Relative wind direction should be assessed to determine the potential for reingestion and the potential impact on starting characteristics. Warm engine (short shutdown elapsed time since previous operation) starting characteristics should also be evaluated.

24.4.1.3 Taxi Tests. Engine response and power management during taxi should be assessed to insure that power modulations in the taxi range are manageable, to assess idle thrust characteristics affects on brake usage, and to verify that passing through the exhaust wake of another aircraft does not result in a compressor stall or overtemperature.

24.4.1.4 Response and Performance. Engine response and performance during pre-takeoff runup should be assessed for symmetry of engine response, torque/thrust symmetry, and/or quasi-steady state performance (thrust droop).

24.4.1.5 Transient Response. Propulsion system transient response should be evaluated during simulated takeoff refusal/aborted takeoff to verify transient response of the engines and thrust reversal system (if applicable).

24.4.2 In-flight Tests

24.4.2.1 Take-offs. Propulsion system compatibility and transient response should be evaluated under crosswind takeoff conditions and during catapult launch steam ingestion conditions (if applicable).

24.4.2.2 Steady State. Propulsion system steady state performance, stability, and symmetry should be evaluated during cruise, loiter and dash maneuvers.

24.4.2.3 Quasi-steady State and Maneuvering. Propulsion system operability, compatibility, and quasi-steady state performance should be assessed during air-combat-maneuvering flight, weapons delivery maneuvers, intercept maneuvers, and other mission tasks.

24.4.2.4 Ordnance Delivery. Propulsion system compatibility and transient response should be assessed during forward firing of ordnance (rockets, missiles, guns, etc.).

24.4.2.5 High-gain Closed-loop Conditions. Propulsion system transient response should be assessed during high gain closed loop power management tasks (formation, landing approach, hover, and/or in-flight refueling).

24.4.2.6 Transient Conditions. Propulsion system transient response, performance, and compatibility should be assessed during missed approaches, waveoffs, carrier bolter, and touch-and-go maneuvers.

24.4.2.7 Other Than Transient Conditions. Propulsion system performance O&C should be assessed during probable failure modes (one engine out, degraded control modes).

24.5 DATA ANALYSIS

In order to be effective the data analysis procedures should (a) support the flight test program, (b) support the technical development process, and (c) support the primary customer, the potential user of the aircraft. The first objective is the support of the flight test program because it has the most immediacy. Real-time monitoring and first order analysis of the data should be conducted using telemetry data link to detect critical component or subsystem failures or to identify adverse trends which could hazard the test aircraft. Post-flight analysis should also be used to identify adverse trends and identify areas where test results are not following predictions and which might warrant redefining subsequent flight test for further investigation or providing a more conservative buildup to critical test conditions. The second objective, supporting the technical development process, requires the coordinated efforts of the integrated test team: the flight test team and the specialists in the various subsystems. This analysis should be concurrent with the flight test program and utilize and refine computer models of the individual subsystem and fully integrated models of the aircraft. The third objective, support for the primary customer, entails integrating the detailed technical analysis with the more qualitative data from the aircrew to define the capability of the aircraft to perform its intended mission and to define any system operating limits in practical terms for the operators.

24.5.1 Propulsion System

Propulsion system performance analysis should be distinct from aircraft aerodynamic performance analysis but the two must be integrated in order to develop the overall air vehicle performance. Aerodynamic performance focuses on the performance of the aircraft at a given net propulsion force. Propulsion system performance should focus on the factors which determine net propulsive force. The propulsion system performance analysis should not focus on the performance of individual components (rotor, compressor, turbine, etc.) but on verifying the integrated performance of the propulsion system.

24.5.1.1 Inlet Performance. Inlet performance is characterized in terms of inlet recovery and inlet distortion. Inlet recovery is normally presented as the ratio of engine face total pressure to free stream total pressure. Inlet distortion is characterized in terms of distortion indices which are engine manufacturer specific. Distortion indices used for steady state propulsion system performance analysis are usually the steady state distortion levels as opposed to dynamic distortion indices. Distortion indices may include circumferential total pressure distortion, radial total pressure distortion, static pressure distortion, inlet swirl, and total temperature distortion. Inlet recovery and inlet distortion are calculated from the flight test data and compared to the predicted inlet performance. Data are organized to illustrate the effects of primary flight test variables on inlet recovery and performance. Data are referenced to corrected airflow, inlet configuration, and flight conditions.

24.5.1.2 Gas Generator. Gas generator performance is analyzed with respect to the differences from the predicted gas generator performance characteristics. The flight test interface conditions (inlet conditions, aircraft services bleed and horsepower, main burner fuel flow, power turbine horsepower extraction, afterburner fuel flow, nozzle exit static pressures, etc.) are input into a model of the engine and the output of the model is compared to the measured gas generator performance parameters to determine if the engine is responding to installation influences as predicted. For simpler propulsion systems operating in fixed geometry modes the traditional correction factors (engine inlet total temperature divided by standard day sea-level static temperature (θ) and engine inlet total pressure divided by standard day sea-level static pressure (δ)) may be used to correct engine gas generator performance to standard day conditions. For more complex propulsion systems an installed propulsion system cycle computer model will be required.

24.5.1.3 Quasi-Steady State. Propulsion system quasi-steady state performance is analyzed with respect to the increments in gas generator performance and power output compared to the steady state performance levels. Differences between the quasi-steady state and steady state performance are normally presented as time histories of the primary propulsion system performance parameters over the period of engine stabilization and as ratios of cold to stable performance (e.g., percentage thrust decrement for a cold engine at takeoff power rating (thrust droop)).

24.5.2 Compatibility

Aircraft engine compatibility data are analyzed with respect to the primary flight test variables. Both compression system stability and combustion system stability are analyzed. For compatibility analysis, dynamic distortion indices are used for correlation. For high Mach test results, mass flow ratio may be used in preference to engine mass flow to characterize the influences of power setting on compatibility. Transient effects may be characterized by the migration in compression operating lines, rotor rematch, and/or overfueling/underfueling. Main and A/B combustion stability are characterized in terms of parameters which are related to fuel-to-air ratio, air temperature, and pressure in the combustion region. For operational use, compatibility data are analyzed and presented in formats which are more practical for use by the aircrew. Data are provided which characterize propulsion system compatibility in terms of operating envelopes which are related to parameters readily available to the aircrew (e.g., altitude, Mach, and angle-of-attack).

24.5.3 Transient Response

Propulsion system transient response characteristics are analyzed to establish basic system response and verify the effects of the variables which significantly affect system response (e.g., thermal state and fuel characteristics). Both open-loop pilot tasks and closed-loop pilot tasks are analyzed. For the flight test program the analysis is focused upon the net propulsive force response (torque, thrust, and thrust vectoring angle, if applicable) to a demand change. Defined characteristics (effective time delay, time constants, damping characteristics, and bandwidth) are correlated with pilot handling qualities ratings to establish the suitability of propulsion system response characteristics for specific mission tasks. Once the propulsion system transient performance characteristics are defined, the net forces and moments are input into the aerodynamic performance and stability and control databases to update the aircraft dynamic performance database.

24.6 PRODUCT OF TESTING

The product of the flight test program to evaluate propulsion system O&C is a natural outgrowth of the test objectives established in paragraph 24.1. The products (reports, data, model revisions, recommendations, etc.) should address all of the objectives established in paragraph 24.1. Test results should identify any system deficiencies, provide the necessary technical basis of identifying redesign requirements, establish whether contractual and/or specification requirements have been met or not, provide recommendation for certification, and provide recommendations for operating procedures and flight limitations.

24.7 SPECIAL CONSIDERATIONS

24.7.1 Safety and Risk Management

Any flight test program entails risk. Flight test of the propulsion system has inherent risks - not only those directly related to the propulsion system but also those related to inter-system hazards. The propulsion system operating envelope and the aircraft flight envelope are likely to be similar. Flight tests of the

propulsion system compatibility at high angle-of-attack and/or high sideslip is likely to encroach on the aerodynamic limits of the aircraft and high angle-of-attack aerodynamic flight tests are likely to approach engine compatibility limits. Preflight test hazard identification and risk management procedures should integrate propulsion system hazards, aerodynamic hazards, structural hazards, etc., into a failure modes and effects analysis to identify planned test conditions where inter-system influences could aggravate the risk and identify procedures to manage the risk. Propulsion system O&C flight test planning and execution for single engine aircraft must acknowledge the consequences of engine out operation. Whether intentional (shutdown for restart testing) or unintentional (flameout or hung stall/locked surge), operation of the aircraft with the engine out must be considered in the planning and execution of flight test program. Planning and execution should address the impact of engine out operation on all aspects of the aircraft; performance, controllability, cabin conditioning/aircrew environment, essential electrical services, etc. The functioning of all of the systems essential to aircraft recovery with the engine out, whether basic aircraft systems (e.g., windmilling hydraulics, ram air turbines, auxiliary power units, emergency oxygen, etc.) or specially installed backup systems (e.g., battery or emergency power systems) should be checked out prior to commencing envelope expansion or restart testing. Propulsion system compatibility and operability flight testing of multi-engine aircraft offers the potential for hazard reduction and improved risk management; however, realization of this potential still requires that the test team apply proper planning, coordination and execution to ensure that the loss of an engine does not hazard the recovery of the aircraft and to ensure that the buildup and test maneuvers are structured to minimize the risk of precipitating unintentional multiple engine stalls/flameouts. Planning, buildup, and maneuver execution for compatibility and airstart testing should consider static and dynamic minimum control speeds for the most critical engine out conditions. Buildup and maneuver selection for compatibility testing should be structured to minimize the risk of generating non-recoverable stalls on multiple engines.

24.7.2 Technical Considerations

While the broad technical objectives of the propulsion flight test program may be similar for aircraft of similar design and mission requirements, specific design features of the aircraft and propulsion system may present unique technical challenges to the flight test team. Detailed discussion of the effects of specific design features on the flight test program is beyond the scope of this volume; however, the following observations and suggestions are provided as a guide to some of the factors which should be considered and some possible approaches to the planning, execution and analysis of specific propulsion system features.

- Engine O&C are not necessarily symmetrical even on installations which appear to be geometrically symmetrical. Inlet flow fields which are influenced by propeller or rotor wash may induce asymmetry; residual exhaust gas swirl may produce asymmetric throttle dependent lift, drag, and moments; and/or inlet and engine designs may generate swirl which produces asymmetric propulsion system performance and compatibility. Flight testing of aircraft with these features should address the impact of asymmetry on O&C and verify the satisfactory operation of the predicted critical engine for each maneuver.
- Propulsion systems with multi-variant control systems, highly integrated propulsion systems, and/or propulsion controls with performance seeking or stall margin management modes not only present unique challenges to the designer, but also, greatly complicate the task for the flight test team. The definition of the pre-test data base, the definition of test objectives, selection of the proper test techniques, hazard identification and risk management, and the analysis and interpretation of results all become more difficult with highly integrated, complex, multi-variant aircraft propulsion system designs. While adoption of a systems engineering approach to propulsion system flight testing is highly desirable for all programs, it is essential to the safe and effective flight test of highly integrated designs.

24.8 CONCLUDING REMARKS

Propulsion system flight testing must be planned, executed and analyzed considering the propulsion system as an integral part of the aircraft and not as an isolated system or discipline. Propulsion system flight test objectives, and the test techniques and maneuvers they engender, vary significantly according to the phase of development, and the design objectives of the propulsion system. Evaluation of test results must be a continuing process, commencing with the first ground run of the aircraft. The analysis team should include the relevant technical specialists as well as the flight test team. Test results must address the intra-systems influences of the propulsion system as well as the propulsion system specific results. Hazard identification and risk management for the flight test program should identify inter-systems/inter-disciplinary influences and the procedures to manage those risks.

24.9 ACKNOWLEDGEMENTS

The following people contributed substantially to this Section.

- Paolo Cinquetti, I.A.M.-R. Piaggio SPA, Viale R. Piaggio, 17024 Finale Ligure (SV), Italy
- Georgio Vismara, AGUSTA SPA, Flight Test Department, 21017 Samarate (Varese), Italy
- Jan P. K. Vleghert, Parkietstraat 36, 1171 HV Badhoevedorp, The Netherlands
- Allan Webb, US Air Force Flight Test Center, Edwards AFB, CA, US

24.10 REFERENCES

[24-1] Hendrickson, C.L., "Flight Testing Under Environmental Extremes", AGARDograph 300 Flight Test Techniques Series, Volume 8, June 1988.

24.11 BIBLIOGRAPHY

Various, "Engine Response to Distorted In Flow Conditions", AGARD-CP-400, Mar 1987.

Various, AGARD Flight Test Techniques Series, AGARDograph 300.

Pool, A. and Bosnan, D., "Basic Principles of Flight Test Instrumentation", AGARDograph 160, Vol 1, AGARD Flight Test Instrumentation Series, original publication 1974. Issue 2 of Vol 1 published Mar 1994.

AGARD-LS-72, "Distortion Induced Engine Instability", Nov 1974.

AGARD-LS-148, "Engine Airframe Integration for RotorCraft", June 1986.

AGARD-LS-183, "Steady and Transient Performance Prediction of Gas Turbine Engines".

AGARDograph 237, "Guide to In-Flight Thrust Measurement of Turbojets and Fan Engines", MIDAP Study Group (UK), 1979.

Society of Automotive Engineers, Aerospace Information Report, "Inlet Total Pressure Distortion Considerations for Gas Turbine Engines", SAE AIR 1419, May 1983.

PROPULSION

Society of Automotive Engineers, Aerospace Recommended Practice, "Gas Turbine Engine Inlet Flow Distortion Guidelines", SAE ARP 1420, Mar 1978.

SAE SP 674, "In-flight Thrust Determination and Uncertainty".

Chapter 25 – ARMAMENT TESTING AND STORES SEPARATION

Major Raymond E. Mosher, USAF

46th Test Wing/EAF
Eglin AFB, FL 32542-1031
USA

25.0 INTRODUCTION

To ensure that specified weapons and stores (bombs, missiles, pods, guns, and fuel tanks) will safely and successfully operate from a particular aircraft platform, compatibility flight testing is usually required. The objective of this testing is to demonstrate that the aircraft can fire its gun and carry its intended stores safely and satisfactorily and achieve the required levels of maneuverability and performance for each stores configuration. In addition, the store must be capable of withstanding the captive flight environment, separate cleanly, and follow a predictable trajectory to its target. Note that aircraft limits and the flight envelope may be significantly reduced when carrying stores.

Before beginning any tests or analyses, checks must be accomplished to assure that the store configuration selected is physically compatible with the aircraft. This initial fit test, using scale drawings, is often referred to as a "paper fit check". If the configuration passes the paper fit test, an "all-up fit check" using the actual hardware should be conducted as early as possible using the standardized fit test procedures specified in MIL-STD-1289. [25-1]

A functional analysis must also be conducted as early as possible for stores that require an electrical interface with the aircraft. These tests are to ensure that the store power and signal requirements are compatible with aircraft power output characteristics. This analysis should be closely followed by an actual functional test on the aircraft using aircraft cockpit switchology. These tests should be conducted in conjunction with the fit checks and should include ground static ejection tests, as appropriate, to define compatibility between the store and pylon/rack, acceptability of the ejection force (especially for multiple-bomb racks), defining optimum lanyard lengths for "retarded" stores such as the MK-82 Snakeye, etc.

Store separation prediction techniques such as theoretical computational methods, empirical and semi-empirical methods utilizing wind tunnels, and analogy (comparison to similar stores) methods, all described in detail in references 25-2 and 25-3, must also be conducted and data analyzed prior to first flight tests.

Additional detailed information on store separation flight testing and weapons delivery analysis and ballistic flight testing can be found in references 25-2 and 25-3.

25.1 AIRCRAFT ARMAMENT CONTROL SYSTEM

If the carrier aircraft is intended to employ free fall bombs, it is usually necessary to verify that the aircraft weapon release computer correctly calculates the point of store release so that the bomb hits the target. To accomplish this, live or dummy bombs are dropped under controlled conditions, intending to duplicate those maneuvers expected in an operational environment (dive, loft, toss, etc.). Computer bomb release signals are recorded as are aircraft attitude, position, and velocity. Impact points are recorded and bomb trajectory is determined using Time Space Positioning Information. From there, error sources are determined, whether they are the inputs to the calculations, computer algorithm, or separation effects coefficients. Separation effects are due to the store passing through the aircraft flow field before entering the freestream air. Ballistic coefficients, the stores' drag, lift, and side-force coefficients while under the

influence of the aircraft's flow fields and the stores' freestream drag coefficient (K_D) are determined and entered into the weapons computer. Ballistic coefficients and K_D are determined in an iterative process to determine converged values, usually requiring three iterations (as described in Appendix C of reference 25-3). This process is generally required for each class of store employed from each aircraft type.

25.2 FLUTTER

Using computer models, aircraft are analyzed to determine their flutter sensitivity when carrying stores. Flutter flight testing is used to validate or update the computer analysis and determine safe carriage speeds. Flutter considerations can be a prime determinant of the flight envelope.

The aircraft is specially instrumented to record accelerations and strains at critical locations on the aircraft structure and stores. A safe envelope is determined by flight testing at increasing dynamic pressures and Mach numbers. After stabilizing at a test condition, the aircraft is forced to respond at the primary structural frequencies. This force may be imparted by a control surface impulse or an on-board exciter system. Frequency and damping values are then determined for the primary modes. These values are tracked throughout the envelope in real-time. By identifying lightly damped or rapidly decaying modes, testing can be terminated before the aircraft flutters. Real-time and post mission data reduction consists of fast Fourier transforms to measure the aircraft structural response and damping levels. More information on flutter testing can be found in Section 14 and in reference 25-4.

25.3 AIRCRAFT AND STORE LOADS

Aircraft and store load testing is necessary to verify structural integrity and to determine if the aircraft and store suspension system can safely carry the store with the store induced loads. The aircraft (with stores loaded) is flown at 80- and 100-percent design limit loadings throughout the flight envelope. This standard Captive Flight Profile is defined in MIL-STD-1763A and includes a speed soak, throttle chops, wind up turns, etc. [25-5] When analysis of specific aircraft/store combinations indicates that design limits will be exceeded for certain flight conditions, real-time loads flight testing is required to determine safe carriage limits. The aircraft and store are instrumented to record rates and accelerations, shear, bending moment, torsion, stress, and pressure at specific aircraft locations. Analysis consists of determining the loads encountered at the known conditions, comparing these to those predicted and ensuring that no damage occurred to the aircraft.

25.4 STABILITY AND CONTROL

Large masses alter aircraft center of gravity and altered airflow can impact stability and control. Thus the aircraft handling tests described in Section 15 must be conducted to determine if the aircraft's stability and control characteristics remain satisfactory when carrying all required external stores configurations. The test configurations are selected, depending on the aspect under investigation, to give the worst cases in terms of mass, drag, pitch or roll inertia, etc. To keep the tests within economic bounds, analogies may be drawn between similar stores, and extensive use made of appropriate computer models/simulations. The aircraft is loaded with the desired stores and the pilot maneuvers the test aircraft inducing steady-state sideslip, pitch doublets, rolls, wind-up turns, high and low speed runs, accelerations, and refueling. The outputs of the testing consist of the aircraft response to perturbation inputs (number of overshoots), stick force per 'g' encountered and a qualitative pilot evaluation. Analysis consists of a comparison to stability without the stores present and to specification criteria.

25.5 FLYING QUALITIES

Similar investigation occurs to determine if flying qualities degradation due to stores is acceptable. Following checks of such aspects as vibration, buffet and stall onset, spin resistance, and departure characteristics, the aircraft is exercised throughout the operational flight profiles, especially in the "high gain" tasks such as air combat maneuvers, ground attack profiles, and air-to-air refuelling. In a primarily qualitative evaluation, aircraft handling characteristics are then compared to qualities without stores. Flying qualities testing should also investigate the effects of asymmetric conditions that could result from "hung" stores.

25.6 PERFORMANCE

Performance testing is conducted in the manner described in Section 13 in order to determine the effects of each stores configuration on the aircraft's takeoff, cruise, climb, maneuver, and dash performance. Again, the tests are normally limited to a few configurations chosen to provide coverage of the full range of stores' mass and drag. The results are used to derive the increment in aircraft drag attributable to each store/station which can then be used to construct the Flight Manual.

25.7 VIBRATION

The flight environment causes store vibration as does gun fire (see paragraph 25.11). Vibration flight testing is designed to determine if store vibration levels exceed those to which the store was designed and qualification tested. To investigate vibration, the aircraft with an instrumented store or store simulator is flown throughout the flight envelope, particularly the transonic and stall regions, using the full range of power settings including throttle slams and chops to idle. Store vibration frequencies and levels are measured and acceleration spectral density versus frequency plots are calculated. These are then compared to design specifications.

25.8 AEROACOUSTIC

Aeroacoustic testing attempts to determine if the store can withstand real-world operational environments. Airborne maneuvers consist of accelerations, decelerations, wind-up turns, pull-ups, pitch-overs, and gunfire. During each maneuver, dynamic pressure and Sound Pressure Level (SPL) are recorded to develop SPL versus time and frequency plots. Time histories of transient events are analyzed to see if the actual environment encountered is comparable to that anticipated.

25.9 THERMAL

The thermal environment also presents a challenge to aircraft armament systems. Thermal testing determines if the store can withstand the actual thermal environment it will experience during high speeds in flight. Maneuvers are accomplished while recording store internal, external, and wall temperature. (Consideration must be given to the effects of high ambient temperatures that may be encountered prior to flight). From the raw data, temperature contours and rates of change are derived. Analysis of this data is undertaken, looking for values in excess of specifications and/or design limits. The test article is also inspected for damage.

25.10 SAFE SEPARATION

The purpose of separation flight testing is to determine if the aerodynamic flow field permits safe separation from the carrier aircraft. Stores are released under operationally representative conditions such as types of releases (i.e., singles, pairs, ripple, jettison, etc.) and various weapons delivery maneuvers (laydown, toss, loft, turning flight, etc.). The minimum safe time interval between weapon releases is also investigated to prevent store-to-store collisions. These are usually from level flight and in dives and from zero to four 'g's. Special consideration has to be given to the separation of low density stores such as empty or partially empty fuel tanks and to the firing of missiles and/or rockets which could result in engine problems due to rocket plume ingestion. The release is photographed by high speed on-board and chase cameras. Chase pilot and on-board pilot comments are also recorded. The film is analyzed to determine the store attitude and distance from the store to the aircraft versus time during release. Paint scratches are marked before the mission to facilitate identifying any new ones that might occur during release. The aircraft is inspected for impact damage upon landing. Analysis consists of motion modeling, film review, and comparisons with any previous wind tunnel data and analytical predictions.

25.11 GUNFIRE

To evaluate performance, safety, and reliability of the gun system, in-flight testing is required. This also allows a determination of the gun system's affect on the aircraft and crew. To test the gun and its effects, it is operated throughout the gunfire envelope. On-board and chase photography plus acceleration and strain data are measured during testing to provide insight on gun gas accumulation and engine ingestion, vibro-acoustic profiles in the aircraft cockpit and individual components, blast over-pressures, recoil and counter-recoil, blast loads, aircrew visibility degradation due to flash and smoke, gun control, accuracy, clearing times, power requirements, and impact on aircraft stability and engine performance. Analysis consists of qualitative and quantitative evaluations and comparisons to specifications.

25.12 SPECIAL CONSIDERATIONS

Few aircraft-store combinations would require testing in all these areas. Many combinations are similar to others already certified for carriage and employment. In these cases, no or limited flight testing is required. Flight testing is expensive, time consuming and often entails an element of risk - all reasons to avoid flight testing if possible. Consequently, flight testing is conducted to validate extensive analysis and simulation, and as early as reasonable.

In some cases there is little similarity to other combinations, limited technical data or little time to conduct extensive data derivation. In such cases, a more "brute force" approach is warranted. [25-1] Risk is reduced by ground testing and a build-up flight test approach is used. This method may be used as an interim one to provide a quick, emergency capability. More extensive analysis would be conducted later for more routine employment.

25.13 CONCLUDING REMARKS

Compatibility between aircraft and stores should be considered early and designed into the systems. Flight testing should be conducted as early as possible in the design stage so that problems can be discovered when corrections are easier. However, production representative items are required to provide a realistic test.

25.14 REFERENCES

- [25-1] MIL-STD-1289A, Military Standard "Ground Fit and Compatibility Tests of Airborne Stores", 1 November 1976.
- [25-2] Arnold, R.J. and Epstein, C.S., "Store Separation Flight Testing", AGARDograph 300 AGARD Flight Test Techniques Series, Volume 5, April 1986.
- [25-3] Arnold, R.J. and Knight, J.B., "Weapons Delivery and Ballistic Flight Testing", AGARDograph 300 AGARD Flight Test Techniques Series, Volume 10, July 1992.
- [25-4] van Nunen, J.W.G. and Piazzoli, G., "Aeroelastic Flight Test Techniques and Instrumentation", AGARDograph 160 AGARD Flight Test Instrumentation Series, Volume 9, 1979.
- [25-5] MIL-STD-1763A, "Aircraft/Stores Certification Procedures".

25.15 BIBLIOGRAPHY

US Navy Flight Test and Engineering Group Instruction (FTEGINST) 8020.1, "Ordnance Systems SOP", 27 July 1993.

Proceedings of the Symposium "Store Carriage, Integration and Release", Royal Aeronautical Society, London, 4-6 April 1990, ISBN 0 9034409 63 1.

Proceedings of the 7th Aircraft/Stores Compatibility Symposium, Joint Ordnance Commanders Group (JOCG), Wright-Patterson AFB, Ohio, 8-10 April 1986.

Proceedings of the 8th JOCG Aircraft/Stores Compatibility Symposium, JOCG, Fort Walton Beach, Florida, 23-25 October 1990.

Proceedings of the 57th Symposium "Store/Airframe Aerodynamics", Athens, Greece, 7-10 October 1985.



Chapter 26 – SOFTWARE TEST AND EVALUATION

Dr. K. Rodger

Engineering Systems Division
Aeroplane and Armament Evaluation Establishment
Boscombe Down, Salisbury, Wilts, SP4 OJF
UK

26.0 INTRODUCTION

The concept of developing a system to give a desired control function (i.e., relationship between input and output) is far from new, and was (and still is) applied to mechanical linkages, electric, pneumatic and hydraulic circuits and analogue electronics. In general, the number of inputs that can be handled by such means is usually modest, and the control algorithms are rather simple.

Nowadays, many of the systems incorporated into modern aircraft (and, for that matter, in other vehicles and branches of engineering which involve control strategies of similar sophistication) rely extensively on digital electronic control, wherein the required control algorithms are achieved by means of "software". That is, the desired response (or output) of a system to a given set of conditions (or inputs) is achieved via an electronic device ("computer") controlled by a "set of instructions" (program), rather than by direct mechanical or electrical means. The principle reason for adopting such software-controlled digital electronic systems is that they can readily be designed to accept and process data in quantities, at rates, and with a degree of complexity that cannot be matched by other types of control systems. They also tend to be physically compact, light, with low power and cooling requirements. Individual systems can be integrated relatively easily and, as system design requirements become individually and collectively more complex, the use and significance of software will increase. It will remain the technology of choice for many control functions for the foreseeable future.

Software does not exist in a physical sense (although it is a component of, and pervades, the electronic system it controls) and is therefore not directly amenable to test by empirical means although, with important reservations, its behaviour can be assessed by monitoring the performance of the systems it controls. Because it is employed extensively in the majority of recent aircraft designs, and is likely to become even more dominant in future designs, it is essential that the flight test engineer should appreciate the nature of software, and the problems posed by its design, development and testing (which relies mainly on non-physical test techniques).

This Section offers an introduction to the test and evaluation (but not production) of software, based on experience at the UK Test and Evaluation Directorate. It indicates the contribution that the Flight Test Engineer (FTE) can make to the overall assessment of aircraft containing a significant element of software-controlled digital electronic systems. (To assist readers unfamiliar with the terms used in software engineering, extracts from the glossary used by the Institute of Electrical and Electronic Engineers (IEEE) are given as Appendix 26-1).

26.1 THE NATURE OF SOFTWARE

Software (which resides in the electronic system it controls) has no physical manifestation, but is represented by documentation which aims to describe and define the purpose of the control laws involved, and their development from the initial concepts through more detailed specifications to the executable code, or machine (readable) language, used by the computer. The "working part" of the software documentation, called source code, may be written in:

- A machine language, to be executed directly by the computer
- An assembler language, which requires transformation or translation (called assembling) via an assembler and (usually) a linker into machine code, or
- A High Level Language (HLL), such as Fortran, Basic, and Ada, which is nearer to plain text (and therefore, easier to understand) but which needs more complex transformation via a compiler to produce code in an assembler language which, in turn, requires assembling and (possibly) linking to produce executable code.

The transformation to convert source code written in assembler language to machine code may be done "by hand" or by using appropriate computer programs, but each transformation can produce additional problems. With some computers, transformation of code written in an assembler language is relatively simple in that mapping of the source code into the machine code is reversible (or, at worst, any deviations are easily understood). Codes written in HLL are less specific to a given computer (and therefore more widely applicable) than those written in machine code or assembler, but they also need the most complex transformation and that transformation between the compiler's source code and the resultant machine code will not be reversible.

Software is precise, versatile, adaptable and easily modified. Its quality will not change during manufacture, it cannot wear out through use and it is immune to random failure, such that its reliability in these respects is identically 100 percent. Thus, it can only cause problems if it contains errors that were generated by faulty design (e.g., by wrong development, or errors in coding or processing the code or a faulty implementation of a good design), or if the documentation itself is erroneous. Because the initial concepts are usually simple, errors are more likely to be generated during development of the specifications rather than during the initial enunciation of the requirement. In the past errors in the specifications have been more common than those generated by encoding. However, the earlier any errors are introduced during development, the greater will be their impact and the cost of their correction.

If there is a fault in the design of the software, the same undesired response will be provoked every time the appropriate conditions occur. The probability that the undesired response will be encountered thus depends solely on the frequency with which the appropriate conditions occur. Hence, if reliability is to be predicted from statistical modelling, it has to be proved that the occurrence of the appropriate conditions is a random phenomenon (and the author is unaware of any evidence which suggests that this has ever been done). Consequently, the rate at which a design's faults will be found cannot be predicted at present (and may prove to be impossible in principle).

Currently, then, the dependability of software cannot be quantified unless it is possible to prove that the error density is exactly zero. Achievement of zero error is possible in principle (and in this respect software is unique in that, with any other form of engineering system, there must be some discrepancy, however small, between the nominal design and the achieved implementation), but proof of its achievement requires the use of mathematical techniques whose application requires human intervention and skill, which themselves are prone to error.

Finally, it should be noted that software's desirable attributes of adaptability and ease of modification constitute a two-edged sword as any modification (including correction) may introduce error. Hence, any modifications must be subject to the same levels of rigour in design, development and testing as those applied to their forebears (as described below), and very strict discipline is needed to achieve this.

26.2 THE DESIGN AND DEVELOPMENT OF SOFTWARE

As implied in the previous paragraph, the design and development of software is a progressive process in which the desired control characteristics are expressed initially in rather general terms, and then refined as the architecture of the system is developed. This process may be documented and controlled, to provide traceability, using software tools. A typical program is constructed from many modules, for each of which the appropriate software specification and corresponding source code must be produced, tested and documented. With the current state of the art, this is a labour-intensive and slow process. Thus, to reduce the costs of production, software is often classified according to whether or not the presence of an error is likely to constitute a hazard to the aircraft: if it is, the software is termed "safety-critical". The Safety Critical Software (SCS) to be used in the aircraft's systems is then developed, written and maintained using a regime of greater rigour than that accorded to the non-safety-critical software. (It should be noted that software must be produced early in the development of a system: if it is inadvertently produced to a "lower" standard than is appropriate to its criticality, the cost of remedial action is very high indeed.)

For SCS there must be acceptable "proof" that:

- The software specifications are developed correctly
- The code is congruent with the software specifications
- There is no coding error
- Software development is recorded correctly
- The SCS is free from influence by all other non-SCS.

If the SCS is coded in HLL, it is also necessary to ensure that no error is introduced by the necessary processes of compilation, assembly, and linking. It is to be noted that there must be an evaluation and certification of compilers, assemblers, and linkers prior to their use. Further, software upgrades must also be thoroughly evaluated before installation. However, it should be noted that the cost of proving that the SCS is to a satisfactory standard arises solely from its complexity, and if a hardware system of comparable complexity were to be built, similar difficulties would arise in trying to prove satisfactory behaviour under all possible combinations of conditions and inputs.

For non-SCS there must be acceptable "proof" that it has no safety implications.

Two common approaches to the design of SCS are:

- Get it Right, and
- Try to Get it Right, but make sure that the result is Checked Internally.

In the first approach, every effort is used to eliminate error in the finished product by taking particular care in writing the code in order to reduce (ideally, avoid) the generation of error, and then testing it to identify any residual error. In the second, based on the common practice of increasing the reliability of hardware by multiplexing, the system design incorporates two or more channels controlled by totally dissimilar software so that no common fault can exist and an "error" in the output of any channel will be detected via a comparator.

Because of the cost of SCS (due to the need to exercise, and prove, high standards of engineering), attempts are often made to reduce the amount of SCS involved by designing the system to be resilient to software faults. This process, which is sometimes known as mitigation, introduces its own problems, namely:

- In achieving and maintaining integrity in the rest of the system (e.g., by partitioning)
- A need for software segregation to ensure that a fault in the non-SCS does not disrupt the SCS
- Production of software modules to differing design standards.

26.3 SOFTWARE TEST TECHNIQUES

26.3.1 Physical Testing

Because software has no physical manifestation, it cannot be tested directly by physical means although, in principle, the functions of a system controlled by that software certainly can. Unfortunately, for all but the very simplest of systems, the time required to test the full set of functions with all possible combinations of inputs would be utterly impracticable, even if the testing were to be conducted using the fastest available computers to simulate the various inputs. It might be argued that where the code is both simple and non-safety-critical, empirical testing is adequate. This approach has been widely accepted (even when the code was far from simple), but it may well come to be considered indefensible. Software executed by a digital computer is discontinuous by its very nature, and thus interpolation between test points is not valid unless the response of the system has been proved to be quasi-continuous: however, the number of input conditions is usually so great that this cannot be proved by empirical means. Thus, software is better tested using the non-physical techniques discussed below.

26.3.2 Testing by Static Code Analysis

As noted in paragraph 26.2, retrospective modification at a late stage of software development can be very expensive, and is likely to result in unacceptable delays in commissioning. Thus, each software sub-module and module is tested as soon as it has been developed in the hope that any errors in the source code can be detected and rectified at the earliest possible stage. The principal means of testing are various forms of scrutiny of the software documentation, usually with the assistance of appropriate computer programs, as discussed in this paragraph.

One means of assessing the correctness of code is Static Code Analysis (SCA) which, as its name implies, does not require the code to be run. At its simplest level, SCA consists of no more than checking the software by reading it. At its most advanced, it constitutes a form of rigorous mathematical analysis of all the software's documentation using an application of set theory (See definitions in Appendix 26-1) which, if complete, identifies every anomaly and every case of static indeterminacy. Even for quite small programs this analysis is far beyond human capabilities and, for many years past, SCA has been conducted using automated computer tools. However, ensuring and proving that the development of software code is error free remains largely a qualitative process, reliant on the exercise of engineering discipline. Tools to automate and control formal methods of writing and developing software specifications are under development, and if these could be extended to the generation of software code, SCA would become unnecessary.

The vast majority of source code is written in HLL because such code is easier to read and write and so is less prone to error. Frequently, additional requirements and constraints are added to the language to define a language subset. This is done to avoid features of the language that are either undefined or, experience suggests, prone to error. Standard language subsets (sometimes called safe subsets) exist for some HLLs, but simply using a subset does not automatically guarantee that the software will be safe, or even that the code will be error-free. The software development process still requires disciplined coding standards. Indeed, by the application of a disciplined coding standard it is possible to write perfectly safe code in any language. However, imposing the discipline, proving that the coding standard has been met, and proving the resulting program may be difficult for some languages.

Another consideration in the use of HLLs is the transformation (or compilation) process needed to convert the source code into executable code. Although validated compilers are available, the confidence in them is insufficient to justify their application, unchecked, to SCS. Therefore, in safety critical applications the executable code should be verified against the source code.

Thus, the use of HLLs in safety critical applications requires caution, and the following recommendations are made:

- Minimise the use and complexity of SCS
- Use a subset of the HLL and a disciplined coding standard
- Use computer tools to verify adherence to the language subset and coding standard, and the resulting program.

At about the time the UK first used software in flight safety critical applications, the first computer tools were being developed to assist in performing SCA. These tools detect errors of coding and provide an automated way of assisting the analysis of control flow, data use, information flow, semantics and compliance, the first three being used to detect errors in the structure of the code, and the last two to prove that the code and specification are congruent. Using the tools available for the analysis of practically any source, compiled or executable code, a skilled analyst can "prove" (analysts are human and can make mistakes) absence of error in the coding, and congruency between the specifications and the code. However, current SCA tools are not good at detecting dynamic (timing) errors.

26.3.3 Dynamic Testing

Dynamic testing is conducted by running the software on a computer. Tests should be devised in advance with reference to the requirements and the specifications (not the code), and tools can be used to develop the test cases. Testing can be done at module level on a host computer or as a total system on the target computer (i.e., the "real one"), together with emulators, rigs, or even the aircraft. In the former case, test coverage tools can be used to determine the extent of test coverage, maximise that coverage and provide statistics to demonstrate the effectiveness of the tests. These tools will, to some extent determine the nature of the testing. However, although each pathway may be tested, because both the number of modules and pathways is large, testing all combinations of pathways is impractical.

System level testing is done to gain some confidence that the software can do what is wanted, at least some of the time. Because the target computer is used, it also tests the hardware and the software-hardware integration; it is the only form of testing for the executable code in its final form in its working environment. Analysis of these results often provides the only evidence that the translation of source code to executable code does not introduce further errors, or that the code's performance is adequate in real time. Dynamic test tools also provide data relating to various metrics which are supposed to measure the quality of the software, but use of these metrics is controversial.

The various tools available improve the value of dynamic testing by imposing a structure and discipline on the selection of test data and identifying all the pathways that have been exercised. However, limited time means that although every pathway may be tested not every combination of pathways can be tested. Some of these tools insert changes (such as instrumentation) to the source code, which can effect the compiled code. If these insertions are not in the production version, the tested and released codes differ: if they are retained, the released code will contain redundant elements, which is potentially very dangerous and should not be permitted with SCS. The results produced by the analysis of dynamic testing are still referenced to the source code so the need to prove congruency between specification and code remains. Finally, while human skill is still needed in both the selection of test data and interpretation of the results, dynamic testing is of great use during development and in testing to prove that the software can do what is required.

26.3.4 Errors in Tools

It is, of course, possible that any tool (including those used to support SCA) might itself contain errors. False indications of (code) error are a nuisance and slow down the process of certification but can be dealt with easily. Missed (code) errors are more serious and more difficult to detect, although the error must be of a very subtle type to cause a genuine problem (an error in the tool must coincide with an error in the code under analysis in such a way that the error in the code is overlooked).

Error in the tools may be one of two types. Firstly, the mathematics upon which the process of static code analysis is based may be incomplete or flawed (and formal proof of completeness and correctness is very difficult, if not impossible). Secondly, errors may exist in the encoding of the tools (although the use of mature, non-project-specific, verification tools may help to minimise this). However, while the possibility of deficiencies in the tools must be recognised, it must also be acknowledged that complete testing of software by empirical means is impractical, and SCA is the only known means of showing that the computer will be correctly instructed to follow all of the specification, and nothing else.

More seriously, the possibility of error in the tools used to develop the software must not be overlooked. These include tools used to assist in performing the hazard analysis (which determines the software's criticality), the compiler, and some forms of elementary code generation tools. Error in the first could result in software being developed and tested to inadequate standards, and its criticality never being realised. Error in the second could result in the generation of incorrect executable code from good source code, and error in the third could result in erroneous source code. In addition, human error, which is ever-present and is not amenable to mathematical verification, can only be guarded against by the use of checks and discipline.

26.4 HARDWARE/SOFTWARE INTEGRATION

Software must, of course, be integrated with its target hardware. Even with "perfect" software many problems can arise, as described briefly in this paragraph.

26.4.1 Interrupts

Real-time computers are required to respond to changes in the external environment. The fastest response is achieved if the computer interrupts its current activity the instant that a change is detected (called asynchronous interrupts, because their occurrence is not synchronous with the computer's own timing). Unfortunately, many problems can be caused by interrupts, including:

- Timings may become unpredictable
- Dynamic test results may become unrepeatable
- In terms of dynamic path coverage, asynchronous interrupts result in an infinite number of paths through the code
- The use of interrupts effectively introduces concurrency, which is difficult to analyse statically.

For SCS, synchronous interrupts should be forbidden unless they are essential to achieve an essential function.

Because computer cycle times are usually very short (typically a few milliseconds) asynchronous interruption is rarely required, an exception being weapon release. Unless the required response time is less than the computer's cycle time, the cue to interrupt should be held in a memory buffer until the program has reached a state where it changes operations in a well-ordered manner. The interrupt is then synchronous and can be analysed statically, and its worst-case timing determined unambiguously. All

synchronous interrupts must be identified and analysed separately to ensure that behaviour is orderly at all times, and that the time taken is within the budget. Lastly, under some conditions the computer may be unsure whether or not the flag (signal indicating an interrupt) has been raised. This is a known problem which may be circumvented at the design stage by appropriate hardware and software measures.

26.4.2 Overload

Overload can occur when the amount of data for processing exceeds that which can be dealt with, either because the bus or the memory buffers is/are overloaded. Spare capacity may have to be proved empirically, but SCA can reduce the amount of testing required.

26.4.3 Corrupt Data

Software should be written to cope with the possibility of data being wrong due to noise, or failure of a sensor. Examples of "defensive programming" strategies are:

- Ensuring that data are within an expected range
- Providing tests for "reasonableness", e.g., comparing data with earlier values, taking into account the expected behaviour.

26.5 FUTURE DEVELOPMENTS

The applications of software and the methods and tools for its assessment are all in a state of rapid development, and as yet there is no single clearly defined recipe for certification. This is usual with any developing technology and continuing development is to be expected, although guidance can be obtained from references 26-1 through 26-5. While SCA and dynamic testing offer some insight into software performance, neither is perfect: tools can only help, rather than replace, the analyst and reduce, but do not eliminate, the opportunity for human error.

Past experience suggests that the density of software errors generated in developing the specifications exceeds that generated in writing the code. Although it is the only representation of this development, documentation in the past has been very poor; often obscure and incomplete, it also lacked configuration control. Modern development is better controlled and documented but modern code is larger, more complex and (often) more critical. Ensuring correct development of the concepts still requires human scrutiny, although assistance from tools is increasing. Formal methods for both writing and developing the specifications exist and suitable tools to automate and control the processes are under development. If formality can be extended to generation of code, the need for SCA could be eliminated (a distant goal!).

The use of a safe language is of greatest value when used in conjunction with analysis tools; this way software can be developed that is demonstrably safe. Increasingly, tools are being used which ensure that the safe sub-set of a language is used and that the necessary disciplines are maintained. There is also work in hand to define both HLL and the tools in formal notation, and to develop SCA tools that will detect timing errors.

26.6 THE ROLE OF THE FLIGHT TEST ENGINEER

From the foregoing it will be appreciated that the validation of software is **not** part of a FTE's work, but will be conducted by specialists as an integral part of system development. However, to be able to assess the overall performance (and thus suitability for Service use) of systems which incorporate software, the FTE must be able to understand the specialist's reports which purport to show, among other things, that the code and software specification are congruent and free from coding error.

In addition, the FTE will require evidence that the concept has been developed correctly such that the specification unambiguously demands what is required, and only what is required. At present this evidence can only be generated by imposing a structured approach to the development, which requires human scrutiny and understanding. While the procedures employed should limit the opportunities for the software to fall victim to Murphy's Law ("Things will go wrong if they can"), the FTE must consider aspects arising from human error which follow McMurphy's Law ("Things will go wrong even if they cannot"). Thus, the FTE's skill in taking an overall system view should be applied to ensure that adequate consideration is given to the effect defects in the software might have on the system, and vice versa.

The problems of verifying software have implications for the FTE's assessment task beyond that of confirming that the SCS is satisfactory. As a specific example, consider its significance for the interpretation of flight test data. Flight testing cannot cover the entire envelope and the untested part is inferred by interpolation between the test points. Interpolation of data in respect of flying qualities is usually based on the (reasonable) assumption that the relationship between the pilot's control inputs and the aircraft response varies in a continuous and "smooth" manner. In an aircraft using a Flight Control Computer (FCC), the control laws are actually defined only in the FCC software and, if there is a software fault, the output from the FCC can change abruptly. Unless it has been shown that the response of the software is quasi-continuous, interpolation of the aircraft's behaviour between test points may not be valid.

Thus, it is essential that FTEs become sufficiently involved in the assessment of software to be "comfortable" with software and its characteristics, especially the methods (and the limitations of those methods) used in its validation. In the end, it is the FTE who must interpret the "proofs" offered by software specialists to judge whether or not, in the context of all other relevant factors, the aircraft is suitable for its intended Service role(s).

26.7 CONCLUDING REMARKS

The advantages of software-controlled digital electronics over other forms of control (greatly enhanced capability and versatility, permitting the implementation of much more complex functions) make them the preferred technology for many control functions for the foreseeable future.

Software is an engineered item that can, and should, be subjected to appropriate engineering discipline. It has a property unique to an engineering system in that, in principle, it is capable of being "perfect". In practice, its development and production require controlled vigilance to avoid errors of engineering and/or design which would result in an undesired response every time the appropriate conditions were encountered. (NB: Similar care would also be required for the production of hardware of comparable reliability and complexity, were that possible.) However, software engineering, as opposed to programming, is still new and the need to impose discipline is not always recognised. Furthermore, since software is more complex than the design of most hardware components to date, the need for discipline is greater.

Testing of software can show that errors exist and/or that, for the test conducted, and so far as the acceptance criteria could tell, the software does what is wanted. However, the procedures are subject to continuing rapid development and are of variable rigour. Software testing cannot yet (and may never) prove the absence of error. There is no known way to predict the dependability of software in quantitative terms and dependability can only be assessed on the basis of critically reviewed evidence. Neither flight testing nor any other empirical testing is the way to "prove" software.

While not being responsible for the testing of software itself, the FTE must consider its implications when judging the acceptability for Service use of an aircraft employing software-controlled digital electronic systems. Thus, the FTE must be sufficiently familiar with the characteristics of software, and the

principles of its development and testing, to be able to interpret reports prepared by software specialists in the context of the overall features and intended role(s) of the host aircraft.

26.8 REFERENCES

- [26-1] RTCA Do 178A, "Software Considerations in Airborne Systems and Equipment Certification", March 1985.
- [26-2] RTCA Do 178B, "Software Considerations in Airborne Systems and Equipment Certification", December 1992.
- [26-3] MIL-STD-882B, "System Safety Program Requirements", March 1984.
- [26-4] Interim Def Stan 00-55 Issue 1, "The procurement of safety-critical software in defence equipment", April 1991.
- [26-5] Interim Def Stan 00-56 Issue 1, "Hazard analysis and safety classification of the computer and programmable electronic system elements of defence equipment", April 1991.
- [26-6] "IEEE Standard Glossary of Software Engineering Terminology", IEEE STD 610.12-1990, Institute of Electrical and Electronics Engineers, 10 December 1990.
- [26-7] TAC/1019/N7, "The user guide for MALPAS Release 6.0", TA Consultancy Services Ltd, The Barbican, East St, Farnham, Surrey GU9 7TB, UK.
- [26-8] Carre, B.A., Clutterbuck, D.L., and Debney, C.W., "Spade Semantic Analysis Manual Version 4.0", Program Validation Ltd., 22 Queen's St, Southampton, UK, November 1985, revised June 1986.

APPENDIX 26-1

GLOSSARY

(Note: "(IEEE)" indicates definition is that given in reference 26-6).

Anomaly (IEEE) Anything observed in the documentation or operation of software that deviates from the expectations based on previously verified software products or reference documents.

Code (IEEE)

- 1) In software engineering, computer instructions and data definitions expressed in a programming language or in a form output by an assembler, compiler or other translator.
- 2) To express a computer program in a programming language.
- 3) A character or bit pattern that is assigned a particular meaning, e.g., a status code.

Computer Program (IEEE) A combination of computer instructions and data definitions that enable computer hardware to perform computational or control functions.

Deterministic Used here to describe constructs in code whose behaviour will control the computer in a way that can be predicted from knowledge of the program and input data, i.e., without the need to run the program for each change of conditions. (More formally, "statically determinate" since it can be argued that dynamic testing/analysis can remove some indeterminacies.)

Documentation Written representations of the software at any stage of development, from enunciation of requirements to executable code (inclusive).

Executable Code Code that is executable by a microprocessor, i.e., binary digits in machine language.

Formal Method A software engineering method characterised by using a formal language to specify the requirements mathematically, a deduction calculus to prove theorems in the language and a method giving guidance on the sound use of the logic.

High Level Language (IEEE) A programming language that requires little knowledge of the computer on which the program will run, can be translated into several different machine languages, allows symbolic naming of operations and addresses, provides features designed to facilitate expression of data structures and program logic, and usually results in several machine instructions for each program statement. Examples include Ada, COBOL, FORTRAN, ALGOL, PASCAL.

Language (IEEE)

- 1) A systematic means of communicating ideas by the use of conventional signs, sounds, gestures or marks, and rules for the formation of admissible expressions.
- 2) A means of communication, with syntax and semantics, consisting of a set of representations, conventions and associated rules, used to convey information.

Level of Language (also called Order of Language) The term derives from the history of software development. Originally, computer programs were written as executable code which worked "deep" within the computer, i.e. at "low" level. As computer technology developed, it became possible to write programs in languages nearer to plain text, i.e. at "high" level, which are transformed in the computer into executable code. The greater the amount of processing required within the computer before instructions can be implemented, the higher the level of the language.

Program (IEEE) See **Computer Program**

Safe Sub-set A sub-set of a High Level Language needed to support well-structured programming. (A "safe subset" of a high level language has no universally accepted definition, but is generally taken to mean a restricted selection of all instructions available in that language, together with defined operating rules, that encourages "good programming", i.e., results in a programme that is easily understood and maintained.)

Segregation The isolation of a part of the software such that it cannot be interfered with by another part. It can be done in several ways, including by physical separation. However, there is no known way to segregate software on the same microprocessor.

Set A number of items which "belong together" by reason of the similarity, or complementary nature, of one or more of their characteristics.

Set Theory A branch of mathematics dealing with the properties of collections or aggregates. Set theory is applied in many ways during static code analysis (SCA). For example, the software is analysed to list all items that are written to before being read (set V), and all inputs (set I, which should **not** be written to before being read). Checks are then made to establish that the intersection or conjoint set that contains both V and I is empty or, in other words, that parameters with this conflicting characteristic are not both contained in the same set. (Details of the application of set theory to SCA are given in references 26-7 and 26-8.)

Software (IEEE) Computer programs, procedures, and possibly associated documentation and data pertaining to the operation of a computer system. (Note: In this paper, the term software is used to cover all of these items.)

Software Tool (IEEE) A computer program used in the development, testing, analysis or maintenance of a program or its documentation. Examples include comparator, cross-reference generator, decompiler, driver, editor, flowcharter, monitor, test case generator and timing analyser.

Source Code (IEEE) Computer instructions and data definitions expressed in a form suitable for input to an assembler, compiler or other translator.

SPARK A language sub-set of Ada designed for use in Safety-Critical applications. (The acronym SPARK is derived from SPADE Ada **K**ERNEL.)

Specification (IEEE) A document that specifies, in a complete, precise, verifiable manner the requirements, design, behaviour or other characteristics of a system or component and, often, the procedures for determining whether these provisions have been satisfied.



Chapter 26A – SOFTWARE TEST AND EVALUATION: A VIEW FROM THE US

Luke O. Campbell

Naval Air Warfare Center Aircraft Division
Patuxent River, MD 20670-5304
USA

26A.0 INTRODUCTION

This addendum to Section 26 Software Test and Evaluation (T&E) will provide a brief overview of a software test and evaluation philosophy as being applied in the United States and the role that the Flight Test Engineer (FTE) must play in this scenario. The role of the FTE in the software T&E process has been changing rapidly and will continue to evolve as new software development and T&E techniques are developed. Currently, only few projects utilize the new techniques described in this paper, however, the techniques are becoming widely known through many different forums of information exchange and the techniques have been well received. Moreover, new instructions such as the replacement for DOD-STD-2167A (i.e., MIL-STD-498) espouse these processes and techniques. It is important that the FTEs understand how testability is achieved. Because of the evolving nature of this process, the new FTE is well advised to carefully review and become intimately familiar with the procedures and techniques that are available and utilized at his home base.

One of the highest paybacks to any development is assuring that a repeatable process is in place which is well managed. In the recent past the software T&E "process" was far less structured than it is, and will be, under evolving directives and standards. The software T&E process described in this section follows the Total Quality Leadership (TQL) paradigm of inspect, measure, and improve. By evolving the process, we will have considerably better testability than previously available.

Software T&E, in the US, has historically been applied much as one would apply checks of quality to hardware, i.e., waiting until the product begins to appear, and then begin to make measurements on overall performance. This approach had some merit and could have positive results while software programs were only a few tens of thousands of Source Lines Of Code (SLOC) in length, and subsystems were black box oriented. However, with today's highly integrated architectures, the virtual disappearance of black boxes in new systems, and software sizes greater than 2 million SLOC in platforms, this approach is woefully inadequate. The current software T&E process, which consists of tests derived from black-box and white-box techniques based on requirements analysis as determined by the human mind are simply not sufficiently comprehensive to test the software to any depth. A complete restructuring of our thinking for software T&E is required to have any hope of actually determining if the software will meet any particular specification or set of requirements. This restructuring will require **software tools and techniques**; in particular, techniques for formal requirements elicitation, in addition to modeling and simulation tools which supply engineering rigor to the entire development process. From this standpoint, the test engineer in today's developments and updates is learning to become a **stakeholder** from the very beginning of the development process. (In this context, a "stakeholder" is one who has become involved in the software generation process and retains responsibility for his inputs as the process evolves). As a stakeholder, he is an integral part of the development team for the life cycle of the product. Albeit at the beginning of the process, his inputs and presence are small - but critical - to the entire development.

Due to the "invisible" nature of software, the role of the FTE in the software development process is quite different from his dealings with aircraft hardware. Software provides the functionality within the aircraft, but this functionality manifests itself in many hidden ways such as flight control solutions and target

tracking displays on aircraft screens. The FTE must be aware of and involved with the development to assure the final product meets the originally intended functionality from the users perspective.

26A.1 SOFTWARE DEVELOPMENT, TEST, AND EVALUATION PHASES

Each phase of product development must utilize techniques, tools, and procedures to advance our ability to develop and test software. For discussion and application purposes, the description here breaks the entire program development into three areas: inception, development, and Post Deployment Software Support (PDSS). These three parts mark major phases in the evolution of a program where new "players" become involved, and, not coincidentally, match the newer DoD 5000.2 Guidelines on Acquisition. [26A-1]

26A.1.1 Inception

Documented studies have shown that the best opportunity to change program development (to assure schedules and costs remain within budget and the system operates according to need) arises during the time of requirements definition and elicitation for each program phase as defined in DoD 5000.2. [26A-2, 26A-1] This opportunity will occur prior to the beginning of each 5000.2 phase. It is first performed within the government using automated software tools, new techniques and methods for requirements elicitation, and precedes any work performed by contractors for actual development. It should then be continued and enhanced by the contractors, with continuous electronic feedback to the government for ongoing analysis and continuous understanding.

Requirements definition historically begins with the generation of ideas and concepts from the gray matter of project personnel who write the original specifications, together with "external" program requirements such as general government-wide specifications; e.g., logistics, maintainability, and documentation. T&E has never really been a dominant factor in this process. Worse, the requirements definition process itself has been ill defined and generally involved a set of reviews of a paper specification by an ad hoc set of players. Each of these persons adds, modifies, or deletes some set of requirements. The end result is a specification which may be inconsistent, incomplete, and inadequate to describe the required program development. While initial specifications developed within the government suffered this condition, the contractors have the same problem with detailed designs.

Proper inception of the specification should still begin with the generation of the ideas and concepts from the project personnel, but with the use of automated software tools and techniques such as "storyboarding" (a technique to facilitate the gathering of requirements by developing tiered requirements relationships during meetings) and "rapid prototyping" (a technique for developing visual representations of requirements). [26A-3] Capture, organization, and prioritizing of requirements - in short, elicitation of requirements - is the fundamental concept in this phase. [26A-4]

Management and complete understanding of requirements can be accomplished with new tools such as lexical analyzers (tools which consistently interpret and categorize the English language and verbiage used) and Requirements Management Requirements Engineering (RMRE) tracking and tracing tools (for requirements management: tools which provide the capability to link all requirements throughout the design of the program and thereby show their connectivity; and for requirements engineering: tools which develop models based upon mathematical relationships to each identified instance of a requirement), and techniques such as the use of recorders to capture ideas and storyboarding. [26A-5] Each participating person becomes identified and is held accountable for his requirements - and is thus identified as a stakeholder. These requirements must withstand not only the scrutiny of the remainder of the stakeholders, but also the mathematical rigor imposed by the engineering modeling tools, and the connectivity and traceability of the management tools. In this manner, rigor and engineering disciplines are added to an otherwise historically ad hoc process.

During this phase of definition and elicitation, stakeholders representing **all** phases of ultimate development are present: the Program Manager (PM) organization, field activity technical experts in all disciplines, T&E personnel (which will include the FTE), and operations and support disciplines. The entire operation may be choreographed to first breakdown the major components of the design (such as airframe, propulsion, and avionics), and then recombine these elements into not just a comprehensive paper specification **but also** electronic media containing simulated performances (for areas such as displays and controls) and models which portray the design, together with outputs from RMRE tools. This specification package is then available to bidders. [26-2]

Note that in this description, no specific discipline has priority over another; they are melded through a several-month process to develop a set of documentation and electronic media to completely describe the requirements. For software T&E, identifying testable components, capability, and methodology for test all become integral parts of the design specification package.

26A.1.2 Development

This "phase" (including Concept Exploration (CE), Demonstration Validation (DEMVAL), and Engineering and Manufacturing Development (E&MD)) marks the involvement of platform development contractors in the design. Initially during CE, there may be many bidders, while downselect to one or two might occur during DEMVAL and E&MD (DEMVAL and E&MD are also phases described in DoD 5000.2).

During development, and to specifically emphasize T&E, automated software tools are available to show testability of the design; and these tools are in addition to more common techniques of simulation, test code and test case development, and modeling which are performed almost simultaneously and independently during development. In the initial stages before code is written, the automated tools model the design in a rigorous mathematical fashion to assure correct implementation. During coding, other tools which are and have been available Commercial-Off-The-Shelf (COTS) for at least 5 years as of this writing show testability and coverage, and test cases are developed to allow virtual 100-percent T&E.

For areas deemed as higher risk and/or on the leading edge, it is also possible to utilize simulation combined with rapid prototyping to analyze peculiar facets of the ultimate design.

In any event, the key concept to realize is that T&E of total platform software capability could easily involve the testing of millions of software paths, which then translate into functions from an operational standpoint. Flight tests can only uncover, at most, a very small fraction of the capability. To assure that each function is (1) identified, and (2) performs properly, the bottom line is that T&E capability must be an integral part of the design. Only automated tools allow us to track and correlate such a massive list of capabilities. This does not mean that the currently available tools are forced to actually test millions of paths, rather, they show that as each path is designed, there is positive, correct, and unambiguous connection with other designed paths, thus eliminating/minimizing the possibility of information taking a "wrong turn" in the software.

It is important to realize that the use of tools in itself does not assure success. To assure high quality software is developed, the underlying process of the developer's shop must be maximized. An increase in the level of the developer's process can be achieved through use of the Software Engineering Institute (SEI) Capability Maturity Model (CMM). [26A-6] Perhaps the most significant concept of understanding the process is that the result of the process - in this case, the aircraft software - actually becomes a by-product. In a strict sense, one is not concerned with coding, but with the methodology, structure, and procedures of that coding. This concept is similar to an oil refinery; while fuel is the product, the process must be strictly maintained and is the key to achieving that product.

When the process is refined (which includes metrics to analytically describe gains or losses) the reliability, quality, schedule, and cost of the end product become statistical events which can be quantified with exact mathematical relationships. Perhaps more importantly, the reasons for increases or decreases in these attributes can be tracked and traced to the source - and then continuous refinement can be implemented to improve the results.

Throughout DEMVAL and E&MD, the FTE will want to assure that each requirement which is identified in the design is shown to have a test case. The FTE will analyze the test cases to begin the implementation of a test plan. The FTE must assure that the test plan contains sufficient resources (i.e., time for test and access to test features) such that all the test cases can be carried out.

26A.1.3 Post Deployment Software Support (PDSS)

The PDSS phase (which is specifically the software maintenance portion of the Operation and Support (O&S) as defined in DoD 5000.2) is generally defined as beginning when a product handoff is made from the developer to the user and the corresponding support organizations. PDSS can also include upgrades and Pre-Planned Product Improvement (PPPI) to existing equipments. None of these changes must escape the rigor which was described in the inception and development "phases".

Historically, by the time PDSS arrives - generally at Initial Operational Capability (IOC) - the requirements describing the original intent have already been lost. The concept to realize here is that adherence to the strict engineering disciplines described during inception and development will allow a flowdown of requirements when PDSS is achieved. From this standpoint, PDSS is then a combination of inception and development phases: It involves modifications and/or additions to the platform (a "mini" inception phase), and then actual insertion of this capability (a "mini" development phase).

During PDSS, the FTE will perform similar activities which were performed at the end of E&MD, but generally only to test those changes which have been made by the PDSS update. If the program **has** used automated tools in an RMRE environment, the FTE can be assured that testing only changes will be sufficient - because this is mathematically provable. If, however, the program has **not** utilized automated tools properly in an RMRE environment, the FTE will also need a regression set of tests available to assure that unchanged requirements did in fact not change. These tests will be selected via statistical analysis based on the total functionality of the weapon system. This statistical analysis is simply an inspection of the size of each function and apportioning regression tests in a manner which represents the percentage size of each function when compared to the whole.

Because PDSS involves both inception and development (albeit on a smaller scale in general), the organizations involved in PDSS must be well versed in all the tools and techniques of the first two phases. Because of this, it is highly recommended that PDSS personnel become an integral part of the design team. This too, has not been done historically. The concept here is that prior to the completion of DEMVAL, the PDSS concept must be completely defined. Only in this manner can the appropriate resources be brought to bear to ensure the lowest life cycle cost of the platform.

26A.2 THE ROLE OF "TOOLS" IN THE SOFTWARE DEVELOPMENT PROCESS

A well defined process in which automated tools are available and utilized, is the key to obtaining testability.

With regards to process and testability: [26A-6]

- A well defined software development process is the foundation for good design. A poor foundation means the design will not progress quickly nor rise to completion as desired.
- The software development process includes steps which create the first order of rigor and discipline to define the architecture of the application
- The software development process is composed of training, automation, techniques, and tools which are put together in a defined series of steps which are consistently applied. Measures are used to provide data which is analyzed to refine the process.
- Testability and the goodness and comprehensiveness of the tests are byproducts of process control. Therefore, the better the process, the better the testability.

With regards to tools and testability: [26A-7]

- Automated software tools provide force multipliers and automate process steps. Tools provide relief to beleaguered human abilities and allow us to track the myriad of details which arise in a design
- Requirements modeling tools are used to form mathematical models of the application, which is described in textual form
- The mathematical model (which appears in pictorial form on a workstation) forms a set of vectors and equations which can define the connectivity of requirements
- The connectivity identifies the paths of data and information flow of the application. Each path identifies a test case. Since paths are catalogued, testability for each path are also known and become well defined.
- Full testability results from subsequent refinement and breakdown of model "blocks" to atomic levels of the design to continue the path and test case definition.

A key concept for the FTE to remember is the magnitude of the number of software paths and decisions which become a part of the design. In typical avionics software, there are literally hundreds of millions of paths which the software can take. Therefore, for T&E purposes, it is critical to have an overall structure for the software development with Computer Software Configuration Items (CSCIs), Computer Software Components (CSCs), and Computer Software Units (CSUs) which have clear, concise, and definable entry and exit criteria. [26A-8] In addition, requirements at all levels must show complete connectivity. Only in this manner, will all software paths be identifiable, and the capability to fully test will be possible.

The FTE must therefore be involved not just from the inception of the development, but from the inception of the requirements definition for the development, to assure that testability of software is maintained, and that the test organization is prepared with the resources (equipment, personnel, and tools) for overall test.

Several new techniques are available today which are coupled to computer workstations and COTS software engineering tools which allow the number of incorrectly stated and/or ambiguous requirements to be greatly reduced. At the same time, these techniques force more consideration of ownership and allow us to capture the rationale behind the requirement, i.e., each requirement should have an **owner**; someone who can articulate, justify, and defend the exact need for the requirement. After this has been done, the requirement and its associated rationale are promulgated through the development for future generations to peruse and easily understand. From this standpoint, we have the ability to utilize lessons learned in a more rigorous fashion, as well as preserving the reasons for initial design which will be invaluable for future platform upgrades and improvements.

Two new techniques which are very important and bear mentioning are:

- Lexical analysis is a technique which utilizes automated software tools to analyze the English sentences in the specification. [26A-9]
- Storyboarding is a technique which considerably enhances the elicitation process. It not only allows more detailed specifications to be developed, but it does so in a shorter time period. [26A-5] Here too, COTS tools are used to enhance the process, and they are generally coupled with at least one facilitator (an individual with no specific knowledge of the development, but who ensures that all stakeholders exercise their knowledge and understanding in the proceedings and keep the requirements engineering process in forward motion towards closure) and recorders to capture information. In this manner, the stakeholders can concentrate on what they are there for, the development of proper requirements, without being encumbered by secretarial functions.

The FTE must know that the process for software development is sound, and this knowledge comes from review of the software developer's procedures. The SEI developed CMM assures the developing and maintaining organizations have and improve a valid software development process. It cannot be overemphasized how critical a good development process is to the ultimate functionality and testability of the software.

Due to the massive number of software paths which could be tested, it is also necessary for the FTE to assure that CSU, CSC, and CSCI testing is completed in stepwise fashion during development with sufficient stimuli to each component to exercise all software paths. The automated software tools will show the exact number of paths exercised by each test case, and they will also outline deficiencies in test cases which the FTE must assure are corrected. CSUs are tested primarily in isolation while interfaces among CSUs must also be tested during CSC tests. Only by managing the growth of CSC, CSU, and CSCI combinations will the number of test cases be manageable.

Finally, once the product is in service use, the test engineer's job is not complete. The probability of follow-on changes and updates for the platform is close to one, and the processes, tools, and techniques must not be abandoned simply because PDSS has been achieved. They must be reapplied and continuous refinement must be the order of business.

26A.3 TEST OBJECTIVES

Software T&E is conducted to validate the end product against an initial set of requirements, and to understand how the end product withstands the rigors of threats in a real-world environment. It would not be atypical for an Operations Requirements Document (ORD) to contain 200 requirements, the Request For Proposal (RFP) to contain 2500 requirements, and detailed design to contain 50,000 requirements. Software T&E should prove that each requirement can be traced to its peers, parents, or progeny, and that the functions which are produced by the detailed design correspond to the total list of detailed requirements.

In any case, the primary objective of the FTE's effort is to assure that the end product meets the user needs via the requirements set from which the product is developed. To accomplish this task, we must assure that the FTE and the T&E community, which generally has good communications with the end users, also has clear paths, plus a chain of command, control, and communications with the design agent(s) and developers: A total integrated team effort is the only solution to today's complex systems.

26A.4 TYPICAL MEASURANDS AND DATA RATES

Software T&E measurements would include analysis of functionality such as end-to-end response time for occurrence of system functions (e.g., from release of a pickle button to release of a weapon, or press of a display button to actual display of requested data). A detailed understanding of the architectural data paths, their transfer rates and delay times is essential and required, as well as an understanding of other system "features" such as computational execution times, is required to assure that robust test cases are generated. Response times and functionality to scenarios which are presented to the system must be extracted from tests, and this clearly indicates that the test engineer must understand what scenarios will in fact stress the system architecture and software. Automated software engineering analysis tools such as Statemate and SES Workbench provide mathematical models of the design which in turn provide traces of each action of each requirement. The FTE should be associated with testing during design.

During development, typical measurands which would indicate software failures would be determinism (a condition where the tool shows requirements cannot or are not connected) which is less than 100 percent, and/or connectivity paths which the tools show statistically fall outside the required limits. During flight test, the hardware should have Real Time Non-intrusive Instrumentation (RTNI) capability which allows instrumentation of detailed bus, memory, and computer operations. With general purpose computers running at 100s of millions of instructions per second (MIPS), signal processors running at billions of operations per second (BOPS), and an aircraft such as the F-18 containing over 40 computers, data rates can clearly become phenomenal. If properly designed, RTNI provides the capability to constantly capture information, but only stores perhaps several thousand instances at any time. However, once a prescribed anomaly occurs, the previously captured data can be viewed historically to determine the states of machinery prior to the malfunction. The FTE must assure that RTNI techniques are available such that anomalous situations can be tagged.

26A.5 TYPICAL TEST TECHNIQUES

Software test techniques will rely on an iterated approach throughout development; i.e., it will not be sufficient to wait until product development is complete to apply a set of test cases; there must be continuous flow of test cases throughout the design.

Techniques such as RTNI and Real Time Always-intrusive Instrumentation (RTAI) should be basic tenants of the design. [26A-10] RTNI and RTAI are built-in hardware and software, respectively, which provide detailed information about the system in a real-time mode which will not interfere with the functionality of the system. RTNI features can return information on bus structures and cache memories, and this can be combined with RTAI software to capture system states during operational scenarios for later analysis. The combination of RTNI and RTAI provides not only the tester, but also the developer, with invaluable information to monitor the health of the system during operational scenarios, and a method to capture real time information which would be otherwise impossible to obtain without these techniques. RTNI and RTAI can be used during flight test, as the additional hardware and software is built-in to the basic design. For example, every significant maneuver is compared with the simulation not only to verify performance of the software but to evaluate and investigate aircraft peculiar characteristics such as aerodynamic asymmetries. In addition, the data is vital for validating simulation predictions for bandwidths, frequency response, and stability margins. RTNI may require additional hardware modules to capture the data from the computers.

Because of the sheer number of possible software paths, it is simply not possible to produce a sufficient number of test cases, after the software has been developed, to test each variable which may enter each of these paths. But even though each variable entering each path cannot be tested, this does not mean that we cannot ensure the limits of each path are not tested. Therefore, test techniques should rely heavily on

automated tools during the development process. That is, by use of automated software tools for requirements management, requirements engineering, requirements modeling, and architectural modeling, the developing agency can ensure that testability is a byproduct of design, and that a dictionary of testability features are a product of the design. The FTE organization must have a well defined role in the development for this reason.

Once the design has been completed, test techniques must center primarily on simulation and automation of test scenarios. Only with simulation will it be possible to stimulate the developed software with a sufficient number of inputs to complete the testing process in a timely fashion, and with a minimum of resources.

26A.6 DATA ANALYSIS CONSIDERATIONS

With literally millions of software paths tested during development and T&E, a statistical approach to data analysis may be necessary, at least initially. This approach will allow the T&E organization to focus on trouble spot areas and work the more difficult issues up-front. Metrics which consider Software Problem Reports (SPRs) and their age, the amount of software which is designed, coded, and tested over periods of time, and the size, composition, and effort expended per unit time of the workforce should all be monitored during development, because they contribute to overall testability and quality of the software.

The FTE would not necessarily be concerned with metrics during design, except for relatively gross concepts such as the Quality Assurance (QA) personnel composition of the workforce: It should never really fall below 5 percent of the assigned personnel, and more acceptable levels are 8-12 percent of the workforce. Additionally, measures of software complexity (such as McCabe's Cyclomatic complexity) could and should be used to indicate where tests might be most effective. [26A-11] The FTE should focus more of his efforts on complex software areas - examples of complex areas here would include the operating system, and coding of detailed mathematical algorithms. Regarding the maturity and experience of the developing personnel, a wide variation of product quality can be found based on personnel qualifications. Statistics should also be kept by the FTE on the errors which are found by the compiler during development to determine how much re-work is being performed prior to test. Considerable re-work shows a basic lack of understanding of the problem domain, or simply inexperienced personnel. If this is the case, it is highly likely that the product, while capable of compilation, will have functional errors and thus fail test. Unfortunately, while the FTE can currently highlight this condition, the cure can only be affected by better training of the software developers and implementation of better process.

Once flight testing commences, the FTE's capabilities become more pronounced, and attentions can now center on non-functional requirements and anomalous reports from RTNI. The FTE's test cases will be based on the modeling and simulation work done during design. RTNI and RTAI information will provide data for analysis during flight test. The FTE must take the anomalies from flight test back to the engineering models for simulation, such that anomalies can be simulated, and changes can be incorporated into the design. (Anomalies can be of any type but could consist of, for example, incorrect target identification during engagement, inability of the sensors to detect at required range, or human factors non-compliance of console switches). These changes must be reflected in the actual requirements which make up the design (if the requirements are in error), or changes in subsequent software code (if the software has been coded improperly). A critical concept to understand is that only by changing the requirements and models will data and requirements tracking be available for future updates to the aircraft system.

26A.7 TYPICAL PRODUCTS OF TESTING

In the final analysis, the T&E group, including the FTE, must be able to show that an initial set of requirements for specific platform functionality have been decomposed through detailed design and show connectivity and completeness. Proof of test cases being developed for each step of the decomposition should be available. Results from compiler outputs during development showing the number of errors during development must be organized and shown to be controlled. Test reports from unit test, subsystem, and system integration should not only be available, but should statistically show a small number of errors which decrease in number through program development. The T&E group should be able to show an understanding of the software complexity through analysis, and that test cases and simulation have been used to stimulate the software in accordance with the complexity of the design. All this output should be the result of automated tools used during development. To a large degree, the output of the T&E group should be shared during the entire development process with the developers, and the T&E group must have the capability to alter trends which cause an increasing number of errors and or software complexity.

It should be noted that the previously mentioned efforts of the T&E group and the FTE must be extended into PDSS.

26A.8 SPECIAL CONSIDERATIONS

During a typical development, it should be expected that the Software Engineering Environment (SEE), which includes all the tools required for the development effort, could change many times (due to updates and revisions). This is especially true with the Ada language, and it should be understood that the language itself produces many complexities in design. Each time a new compiler is introduced, for example, the tester must be aware of the features and assure that there is backwards compatibility from previously developed software. Optimizing compilers are especially "dangerous" to the test environment, since they can drastically alter the software paths from one compiler release to another. Moreover, special software inserted for test must be carefully monitored and controlled to assure that this test software does not somehow interfere with the operational aspects of the end product.

The T&E community - and in particular, the FTE - may find it necessary to assure that certain compiler features are not used during development, such that testable software is produced. An example here again is the optimizing compiler, which takes it upon itself to produce more efficient code. This non-use of an optimizing compiler may be impractical in, for example, a flight control software suite where safety of flight is critical.

Software designed with Artificial Intelligence (AI) is currently perhaps the most difficult software to test. By its nature, AI (which for purposes of this discussion would include neural nets and fuzzy logic systems) may respond differently for each occurrence of identical stimulus. This situation requires that the test engineer have even larger control over the requirements set, and the range of expected outputs from given inputs.

26A.9 CONCLUDING REMARKS

Software testing must be significantly bettered, especially considering its pervasive nature in our systems. Up-front involvement of T&E personnel (including the FTE) can be a large factor in decreasing program development time, and actually decrease the amount of T&E resources in the long run. Additionally, a well defined process with tools can give us the needed boost in testability.

In all, the key to bettering T&E is to assure that a team effort with the developers, combining talent, tools, techniques, and process to the time prior to specification delivery to the contractors, and coupling this with

constant attention to requirements management and the testability of those requirements through design. This does not mean that the elapsed time for specification must increase (it can and should actually decrease!), nor does it mean that we must work harder, rather, we must work smarter using the desktop and engineering computer resources which are now commonplace and combine them with new techniques and methodologies to better the **process**.

Historically then, the FTE's role has been set apart from development, and the FTE enters the life cycle at the point of testing the product. Because of the complexity of the weapon systems and the pervasiveness of software within modern weapon systems, this situation is no longer possible nor desired. The FTE is becoming an integrated part of the development team, to assure that original requirements are properly placed and stated such that they can be properly tested. Further, the FTE must be a conduit to assure that problems found during flight test ripple back through the design such that requirements of the entire design remain consistent, and data and rationale is available for future updates and future Flight Test Engineers.

26A.10 REFERENCES

- [26A-1] DoD INST 5000.2, "Defense Acquisition Management Policies and Procedures", USD(A), 23 February 1991.
- [26A-2] Requirements Management Requirements Engineering (RMRE) Presentation, AIR-546N, 23 September 1993.
- [26A-3] Andriole, Dr. S. J., "Software Systems Engineering: The Case for a New Discipline", December 1992, Director, Center for Multidisciplinary Information Systems Engineering, College of Information Studies, Drexel University, Philadelphia, PA.
- [26A-4] "Requirements Engineering and Analysis Workshop", Software Engineering Institute, 12 March 1991.
- [26A-5] "AVDIV Handbook: Requirements Management Requirements Engineering", Naval Air Systems Command, Washington, D.C., June 1993.
- [26A-6] "Capability Maturity Model for Software, Version 1.1", Software Engineering Institute, CMU/SEI-93-TR-24, February 1993.
- [26A-7] IEEE P1209 "Recommended Practice for the Evaluation and Selection of CASE Tools", 3 December 1992.
- [26A-8] DoD-STD-2167A, "Defense System Software Development", 29 February 1988.
- [26A-9] Palmer, Dr. J. D. and Evans, R., "Advanced Integrated Requirements Engineering System (ARIES); Processing of Natural Language Requirements Statements", The Center for Software Systems Engineering, School of Information Technology and Engineering, George Mason University, July 1993.
- [26A-10] "Embedded Computer System Real Time Nonintrusive (RTNI) Monitoring Functional Requirements", SSA Engineering Working Group; RTNI Subtask Working Group, 3 March 1990.
- [26A-11] McCabe, T.J., "A Complexity Measure", IEEE Transactions of Software Engineering SE-2, pp 308-320, 4 December 1976.

26A.11 BIBLIOGRAPHY

Humphrey, W.S., "Software Measurement Concepts for Acquisition Program Managers", Technical Report CMU/SEI-92-TR-11 ESD-TR-92-11, Software Engineering Institute, June 1992.

Humphrey, W.S., "Managing the Software Process", Addison-Wesley, 1989.

"A Method for Assessing the Software Engineering Capability of Contractors", Technical Report CMU/SEI-87-TR-23, Software Engineering Institute.

Davis, A.M., "Software Requirements Analysis & Specification", Prentice Hall, 1990.

Bacon, VADM R.M., "Enhancements to Test & Evaluation Process", USN, Oct/Nov 1992.

Adolph, C.E., "Test and Evaluation Challenges In The Nineties", Director, T&E, Office of the Secretary of Defense, December 1992.

Whitman, Dr. E.C., "Open Systems: An Awkward Necessity", Crosstalk, October 1992, Deputy Assistant Secretary of the Navy.

AVIONINST 5235.1, "Avionics Software Metrics", AIR-546, Naval Air Systems Command, Washington, D.C., 18 June 1993.

Dobbins, J.H., "Software Acquisition and Management: In a Nut Shell", "Program Manager: Journal of the Defense Systems Management College", Jan-Feb 1994.

IEEE Guide to Software Requirements Specifications, ANSI/IEEE Std 830-1984.

APPENDIX 26A-1**LIST OF ACRONYMS**

AI	Artificial Intelligence
CE	Concept Exploration (phase of DoD 5000.2)
CMM	Capability Maturity Model
COTS	Commercial Off-The-Shelf
CSC	Computer Software Components
CSCI	Computer Software Configuration Items
CSU	Computer Software Unit
DEMVAl	DEMonstration VALidation (phase of DoD 5000.2)
E&MD	Engineering & Manufacturing Development (phase of DoD 5000.2)
FTE	Flight Test Engineer
IOC	Initial Operational Capability
O&S	Operation and Support
ORD	Operational Requirements Document
PDSS	Post Deployment Software Support
PM	Program Manager
PPPI	PrePlanned Product Improvement
QA	Quality Assurance
RFP	Request For Proposal
RMRE	Requirements Management Requirements Engineering
RTAI	Real Time Always-intrusive Instrumentation (software)
RTNI	Real Time Non-intrusive Instrumentation (hardware)
SEE	Software Engineering Environment
SEI	Software Engineering Institute (Pittsburgh, PA)
SLOC	Source Lines Of Code
SPR	Software Problem Report
SSA	Software Support Activity
T&E	Test & Evaluation
TQL	Total Quality Leadership

Chapter 27 – ELECTROMAGNETIC INTERFERENCE/ ELECTROMAGNETIC COMPATIBILITY

Robert W. Borek
Principal Engineer
SPARTA, Inc.
Lancaster, CA 93535
USA

27.0 INTRODUCTION

Ideally, Electromagnetic Interference/Electromagnetic Compatibility (EMI/EMC) testing should have been completed before an aircraft makes its initial flight. However, it is almost inevitable that problems will occur during the ensuing flight test program. Moreover, the Flight Test Engineer (FTE) will be involved in the ground testing of the aircraft. This Section provides some background information on EMI/EMC for the novice FTE involved in these disciplines. Furthermore, it identifies some of the standards and specifications used for developing test objectives and procedures for EMI testing. The discussions are based primarily on existing military requirements. This was done with the supposition that industrial and commercial specifications may vary from country to country, whereas the referenced military documents are uniformly related and generally obtainable. However, the one exception is a set of civil standards that are used all over the world. These standards are continually updated and thoroughly address the EMI conditions to which civil aircraft are subjected. [27-1]

Further, this Section describes the major sources of EMI and the broad range of system-subsystem EMI/EMC testing, typical test equipment, and the facilities generally used. In addition, some basic EMI precautions to be taken in designing aircraft and instrumentation systems are discussed.

27.1 THE PHILOSOPHY OF STANDARDS AND SPECIFICATIONS

Standards and specifications have been written to establish the EMC performance characteristics that individual system installations must meet. Standards and specifications differ in that a standard is a general guideline from which specifications may be derived. A specification is a document usually containing numerical details to which adherence is a contractual requirement.

The philosophy of writing general specifications rather than specific "tailored" specifications is that if the design of each "black box" adheres to the specification, EMC will be achieved. Although specifications should not be unquestionably relied upon, they do provide a baseline useful in system design. As a result they are widely used and often quoted.

One concept of widespread importance in the use of standards and specifications is that of the EMI safety margin (EMISM) which is defined as the ratio between the susceptibility threshold and the interference present on a critical test point or signal line. The EMISM concept applies to both conducted and radiated interference. Conducted interference paths are quite well defined, whereas the radiated signal received by a susceptor depends upon its distance as well as its physical orientation relative to the source. A greater safety margin, therefore, may be required for radiation coupling than for conduction. [27-2]

27.2 THE ROLE OF THE FLIGHT TEST ENGINEER

The complexity of the problems created by electromagnetic interference has increased greatly in recent years. Although consideration of the EMI problem has not been neglected throughout the development of individual electrical and electronic systems, the overall problem has increased and will continue to do so unless preventive measures are taken by designers and system users. It is in the area of the system user that the FTE can contribute to EMI control and the overall safety of the flight test program.

In general there are three areas of significance: ordnance, personnel hazards and system interaction.

- Hazards to ordnance items are complicated because of the large number of electro-explosive devices (EEDs) and the geometries and sensitivities of these devices. Each type of EED represents a particular receiving-end impedance; thus, appearing as an antenna with a different impedance match for each frequency. Where ordnance items are concerned the FTE should pay special attention to new installations of radiation type equipment and wiring.
- Hazards to personnel will usually take the form of excessive radio frequency (RF) power density levels. Human tolerance levels to RF radiation have been established by various investigators and although a universally accepted standard has not been reached, a limit of 10 mW/cm² for continuous exposure has been established in the Western world. [27-3] The FTE should warn personnel working near the aircraft of the potential hazards of RF radiation and enforce adherence to the applicable safety regulations.
- Unwanted interactions can occur between component and module, between systems and the system environment. As the process of flight testing develops it is of prime importance that the FTE carefully and critically monitors modifications and the installation of additional electrical/electronic systems in the aircraft always keeping in mind the criteria used for the selection of the applicable standards and specifications referenced. [27-4]

27.3 TYPICAL EMI/EMC TEST OBJECTIVES

The successful operation of most aircraft depends upon the interchange of electronic (conducted) or electromagnetic (radiated) information. It is therefore unacceptable if this operation is degraded because of the susceptibility of certain aircraft systems to conducted or radiated interference from other systems or from sources external to the aircraft. The ultimate goal of EMI/EMC testing is to ensure the compatibility of both present and future on-board systems by providing the necessary data for predicting interference situations during the design, development, and installed stages. Data to be obtained from such measurements should, as a minimum, be comprised of the following:

- The performance of equipment and systems in an operational electromagnetic environment
- The effect of a particular equipment or system on the electromagnetic environment of other equipments or systems.

This information can be used for establishing the characteristics required of new equipment for compatible operation in present and future electromagnetic environment.

In order to provide an ordered procedure, EMI and EMC testing will be divided into three levels of measurements:

- Level one - Individual equipment and subsystem testing
- Level two - System and vehicle testing
- Level three - Operational and environmental tests.

27.3.1 Level One - Individual Equipment and Subsystem Testing

Level one performs evaluation of components, individual equipment and subsystems. Typically, these test procedures are described according to MIL-STD-462, MIL STD-461, MIL-STD-449, MIL-STD-704, and unique testing of some equipment according to NACSEM 5100 requirements. [27-5, 27-6, 27-7, 27-8, 27-9]

For example, the objectives of MIL-STD-462 (test procedure) and MIL-STD-461 (specification limits) ensure that the radiation levels from one equipment to another, including cabling, will not cause EMI problems. The intent is to provide some degree of assurance that the second level of testing will have only a few, if any, EMI problems.

27.3.2 Level Two - System and Vehicle-level Testing

Level two confirms that the EMC requirements have been achieved at the system and aircraft level. A typical procedural test is MIL-E-6051. [27-10] These tests involve operating the systems in routine modes of operation and recording any malfunctions or system degradation due to EMI.

At this level of testing the entire aircraft installation must operate in a compatible manner. There is no doubt that some problems will exist since the number of operational variables is excessive. However, the EMI encountered should be of a minimum magnitude.

The intent of testing at levels one and two is to formally demonstrate compliance with specification limits. In most cases these are contractual requirements and testing will include applicable parts of the appropriate U.S. Military Standards (MIL-STDs).

27.3.3 Level Three - Operational and Environmental Tests

Level three immerses the entire aircraft in a typical electromagnetic environment. Specifically, does the environment cause a malfunction or degradation to the performance of the aircraft and if so, what systems are affected?

It would seem reasonable that satisfactory completion of levels one and two would result in only minor problems at level three. However, one of the objectives at this level is to determine the effects of external sources on the aircraft.

27.4 SOURCES OF EMI

27.4.1 Lightning

One of the most severe environments that the aircraft will be subjected to is that produced by lightning strikes. The early wooden-structured aircraft with metal control cables and strut wires were not capable of conducting lightning strike current. As a result, parts of the aircraft often caught fire or exploded. Even if the aircraft was not severely damaged, the pilots were frequently shocked or burned. In some cases the fuel tanks caught fire and exploded. These effects, aided by severe air turbulence and wet weather, quickly taught the pilots to stay clear of any areas that even hinted of thunderstorms. [27-11]

With the development of metal-skinned aircraft and later-on all metal aircraft, the hazardous results of lightning strikes were greatly minimized. However, thunderstorm areas even today are treated with a great deal of respect. In recent years, the trend of thinking is concerned with secondary or indirect effects. Even though the aircraft's metallic structure provides a high degree of shielding, some of the fields penetrate through windows, composites, and non-conducting materials, and induce transient voltage surges in the aircraft's electrical wiring causing systems to fail.

The dominant, naturally-occurring EMI noise source below 30 MHz is atmospheric noise produced by electrical discharges, i.e., lightning, occurring during thunderstorms. Electrical-discharge noise has a moderately broad emission spectrum with the largest amplitude components occurring between 2 kHz and 30 MHz.

There are some fundamental differences between the electromagnetic environment created by lightning and that generated by on-board EMI sources necessitating that this external interference source be given specific consideration.

Briefly:

- The electromotive forces (EMF) generated by lightning currents are of high amplitude, as compared with those generated by on-board avionics and electrical systems
- Lightning currents flowing along major sections of the aircraft cause EMF to interact with all wiring and components inside as well as outside the airframe. This differs from the localized sources of EMI such as single antennas and "black boxes".
- Lightning is a flow of high amplitude current through major sections of the aircraft from a low impedance source, as contrasted to the relatively high impedance sources of on-board generated EMI
- Lightning creates one or more discrete electromagnetic field pulses as contrasted with an oscillating repetitive field radiated from a corresponding signal in a particular circuit or antenna
- The lightning magnetic field is accompanied by electrostatic fields caused by the differences of potential along the structure as well as external to it.

The most significant interference is coupled into interconnecting electrical wiring in the form of transient over-voltages. The first step in lightning EMC analysis is to determine the amplitude and pulse wave shape of such voltages, because these define the voltages to which the connected components will be subjected. [27-11]

Prior to actual attachment to the aircraft, an oncoming lightning flash will induce corona and streamers from surfaces or appendages on the aircraft where the electric field gradient is great enough. When the field strength around protruding objects reaches 5,000 volts/cm a breakdown will commence usually to the point on the aircraft where the gradient is greatest. If this happens it is apparent that some portion of the resulting current could flow along to some compartment area. This current will have a wave shape similar to that of the lightning stroke itself and will be limited by the impedance of the conducting circuit. Even a small percentage of a 100,000 ampere lightning stroke current could surpass the current handling capability of the circuit and damage various components. Exploding wires, insulation fires and circuit breaker trip-outs are a result of this. [27-11]

Coincident with this conducted current is a conducted voltage pulse. This voltage will initially be limited by the breakdown voltage level at the strike point, and later by the stroke current arc voltage drop as an arc forms. A large percentage of this voltage will develop at the compartment end with accompanying current to cause damage.

The following information must be obtained before an appropriate protector can be specified.

- Physical characteristics of the susceptible component
- Breakdown voltage of the susceptible component
- Current carrying capability of the associated aircraft electrical circuitry
- Maximum surge voltage and current levels of other equipment to which the circuit is connected.

Another mechanism by which lightning can affect aircraft electrical and avionics systems is in the generation of magnetically-induced and resistive voltage rises within aircraft electrical circuitry. Even if the aircraft has an electrically continuous metallic skin, its non-cylindrical geometry will enable some magnetic flux to be present within the wing and fuselage, even if all of the lightning current were to flow through the skin only. The magnetic flux will link electrical circuits within these enclosures, causing induced voltages. Similarly, the finite resistivity of the metallic skin (and structure) will permit resistive voltage rises within the skin along the path of lightning current flow. If the aircraft electrical circuit uses the structure as a return path, then this resistive voltage enters this circuit in series with the magnetically-induced voltage in the same circuit and any other (normal circuit voltage) voltages present. Capacitively coupled voltages may also be produced in these circuits, however, the essentially uniform conducting metallic skin keeps potential differences low thus limiting the voltages which can be electrostatically coupled to interior electrical circuits. Experimental measurements have shown magnetic and resistive components to be the most predominant.

Aircraft stroke zones are usually defined as consisting of three regions on the external surface: [27-11]

Zone 1. The surface area for which there is a high probability of direct stroke attachment.

- Radomes. Methods available for protecting radomes from lightning damage include metal foil strips, thick metal strips, and segmented/resistance strips.
- The main rotor blades represent the most likely strike point on a helicopter.

Zone 2. Surfaces for which there is a probability of strokes being swept rearward from a Zone 1 point of direct stroke attachment.

- Plastic sections such as radomes over antennas and fairings over structures. The dielectric strength of the plastic must be strong enough to preclude possible voltage puncture. If practical, metal foil or segmented strips may be used.

Zone 3. All other areas but especially plastic surfaces which electrically isolate the empennage or extremities from the overall aircraft structure.

- Lightning protection is usually provided by lightning arresters, spark-gap devices, or conductive paths to transfer the currents from the entry point to the exit point.

27.4.2 Precipitation Static

Another factor to be considered near thunderstorm activity (and the most common) is precipitation static. If an aircraft is flying through dry precipitation in the form of sleet, hail, or snow, the impact of these particles on the aircraft will cause a phenomenon known as triboelectric charging, commonly called precipitation static or P-static. This process generates interference (noise) or "static" in the aircraft communications and low frequency navigational aids. The results of P-static discharges from the vicinity of sharp extremities on the aircraft produce a visible glow or corona called St. Elmo's fire.

Precipitation static as generally defined includes all atmospheric electrical effects, other than lightning, which can produce external corona or streamer discharges on an aircraft or its antennas. Precipitation static is a problem for which there are very few specifications, general guidelines, and no overall, generally available data. The necessity of a complete precipitation-static-interference control program, rather than just the use of dischargers, cannot be overemphasized.

It is important to emphasize a balanced approach taking into consideration the many aspects of precipitation-static interference effects on an aircraft.

Consideration must be given to:

- Electrification sources such as friction charging of metal surfaces and plastic surfaces, engine charging, and thunderstorm electrical crossfields
- Basic noise-generation mechanisms including corona discharges from the antennas, discharges across non-metallic sections of the aircraft, generation of direct ultra high frequency (UHF) interference in the engine exhaust, and most important, the charging of electrically external metal sections of the aircraft
- Precipitation-static control techniques include use of static dischargers, antenna location and shape, judicious use of resistive coatings on external nonmetallic sections, and careful control of aircraft external bonding.

There are three techniques available for the control of major problem areas.

- The use of an adequate number of dischargers suitably located on the aircraft. Properly identifying a precipitation-static source among the many possible sources is exceedingly difficult, and the difficulty is often compounded by the interference being attributed to internal EMI problems.
- The use of resistive coatings on frontal surfaces. Use of amply grounded conducting paints on plastic frontal surfaces should be considered a definite necessity for aircraft with high frequency (HF) systems. Streamer interference has been found to exist up into the gigahertz region.
- An adequate bonding-control program to assure that no external, floating metal sections exist to produce severe HF and often very high frequency (VHF) and UHF interference of which they are capable.

The importance of careful control throughout the entire aircraft design-development-operational cycle can hardly be overemphasized. This fact is evidenced by the experience of the commercial airlines and the military programs under which careful monitoring of the performance has been made. [27-12]

Using these three principal measures the precipitation-static performance of an aircraft may be brought under reasonable control. For optimum performance greater efforts are required. These include analysis of antenna types, shapes and location, and most important, actual precipitation-static-electrification measurements on the aircraft.

27.4.3 Extra-Terrestrial EMI Sources

Extra-terrestrial EMI sources include those such as sky-background noise, solar noise, and secondary cosmic noise sources. Sky-background noise and solar noise are well known phenomena.

Until recently secondary cosmic noise has not been a problem with aircraft. However, a new and interesting phenomenon called "single event upsets" (SEUs), initially observed on spacecraft, deserves more than just a little attention since recent experience has shown its effects on semiconductor devices.

As hardware geometry and operating voltages shrink in size and levels, semiconductors become progressively more vulnerable to high-energy particle strikes. According to recent experience, explicit recognition of this phenomenon has been observed at altitudes of 29,000 ft (E-3/Airborne Warning And Control System aircraft) and 65,000 ft (National Aeronautics and Space Administration ER-2 aircraft). The SEU rate increased by a factor of about 2.2 going from mid to high altitude suggesting that energetic atmospheric neutrons, created by cosmic rays, are the main cause of the upsets. This problem will no doubt become progressively more serious as each new generation of integrated circuits utilize smaller active volumes, since this allows lower and lower mass cosmic rays to produce upsets. [27-13]

The effects of SEU on micro-electronics range from correctable soft logic errors (the SEU), to permanent circuit damage resulting from single event gate rupture, single event latch-up, single event snap-back, and single event burnout.

Present research has focused exclusively on static random access memory modules. Additional research in other devices such as logic chips and microprocessors is required. It has been suggested that as guidelines are established for controlling SEUs, they be included in government handbooks such as MIL-HDBK-217. [27-14]

27.4.4 Man-Made External Sources of EMI

Man-made external sources of EMI originate from devices, equipments, and machines created by humans. Their emissions may come from either terrestrial or extra-terrestrial (earth satellites, space ships) locations.

In general the man-made sources can be divided into two groups: Communications-emitters and industrial/consumer electrical noise sources. The examples used here will focus on communications-emitters because of their specific applications and universal documentation. [27-15]

The communications-emitter group will be divided into five segments:

(1) Commercial Broadcast, (2) Communications, (3) Relay Communications, (4) Navigation, and (5) Radars.

Commercial broadcast bands cover:

- HF Amplitude Modulation (535 - 1605 kHz)
- VHF Frequency Modulation (88 - 108 MHz)
- VHF Television Lower Bands (54 - 88 MHz)
- VHF Television Upper Bands (174 - 216 MHz)
- UHF Television (470 - 890 MHz)
- International AM broadcasting

The significance of being aware of these commercial frequency assignments can best be illustrated by use of an example: Television channels 14 - 83 are limited to fundamental emissions of 5 MW (+ 97 dBm). The US Federal Communications Commission requires that the spurious radiation need only be 60 dB down from the fundamental. Thus, 97 dBm - 60 dB = 37 dBm or 5 watts. Since this is not defined as a power spectral intensity (dBm/kHz), the level could exist everywhere as a broad-band jammer. It is interesting to note that TV Channel 26 at 542 - 548 MHz has a second harmonic at 1090 MHz, a TACAN channel.

Communications equipment are the greatest in number and most varied of all emitter types. They occupy portions of the spectrum interlaced with other activities from 20 kHz to 1 GHz. Above 1 GHz, point-to-point communications is generally of the relay type.

Relay communications emitters usually consist of one or more of the following:

- Common Carrier, Microwave Relay (2.1 - 11.7 GHz interspersed)
- Satellite Relay (2.4 - 16 GHz interspersed)
- Ionospheric Scatter (400 - 500 MHz)
- Tropospheric Scatter (1.8 - 5.6 GHz interspersed).

It is not uncommon for the microwave relay frequencies to interfere with the assigned S-Band telemetry used for aircraft/space research programs.

Navigation emitter types are (radar is a separate class. See below):

- VOR (VHF Omni Range): 108 - 118 MHz
- TACAN (Tactical Air Navigation)
- Marker Beacons: 74.6 - 75.4 MHz
- ILS (Instrument Landing Systems)
- ILS Localizer: 108 - 118 MHz
- Glide path: 328.6 - 355.4 MHz
- Altimeter: 4.2 - 4.4 GHz
- Direction Finding: 200 - 1750 kHz
- Loran C: 90 - 110 kHz
- Loran A: 1.8 - 2.0 MHz
- Maritime: 285 - 325 kHz; 2.9 - 3.1 GHz; 5.47 - 5.65 GHz
- Land: 1638 - 1708 kHz

Radars are perhaps the greatest offender of EMI emitters because of their large peak pulse powers and attendant spectrum spread due to short pulses occupying broad basebands. They are also offensive because of their relatively high harmonic radiations. They are omnipresent: air traffic control, air and surface search, harbor surveillance, mapping, weather, and satellites, most generally in the frequency spectrum of 225 MHz to 35 GHz.

Particular concern must be given to the operational environment of an on-board radar system and the possible influence that it may have on other nearby systems on or in an aircraft. Environmental considerations involve the possible damaging effects of unwanted signals on other equipment. Sideband energy and/or more direct high energy effects may cause interference in non-radar systems. Routine testing indicates that the high level RF energy can be coupled into unprotected cabling and chassis wiring and then envelope-detected in the first nonlinear element encountered.

Recent changes to RTCA/DO-160B (resulting in DO-160C) have made provisions for lab testing to meet high intensity radiated field levels. Historically, these levels of 150 - 200 volts/meter were established to evaluate systems externally mounted to the aircraft. In general, these levels were expensive and difficult to generate in the lab and system evaluation was done using actual potential interfering radars as sources. With the advent of digital fly-by-wire flight systems and non-conducting aircraft "skin", these high level field tests have been reconsidered. [27-1] (It is interesting to note that initial ground tests of the X-29 were done using multiple high power tracking radars located at the NASA Dryden Flight Research Center, Edwards AFB, CA. The point to be made here is quite important: More than one high powered tracking radar may be directed at a given target . . . in this case the X-29).

The degree of coupling is relatively independent of transmitter frequency except when resonances are found in the detecting circuitry. These resonances are difficult to predict since the circuitry involved is often designed to meet video or audio requirements which are highly vulnerable to this effect.

27.4.5 Sources of Internal EMI

The concern here is with the internal (inside the aircraft) sources of EMI which involve components that may conduct and/or radiate electromagnetic energy. Component emitters are sources of EMI which emanate from a single element rather than from a system. Examples of component noise sources include wires and cables, connectors, motors, relays, and transistors. Although these components are not actual sources, their improper operation can produce EMI.

- **Wires and Cables.** Wires and cables provide an induction or radiation medium to couple undesired energy into or out of other wires, circuits, or equipments. While not a direct source of electrical noise, connectors may develop EMI indirectly due to poor contacts. In effect this acts like a variable-impedance switch which may be environmentally sensitive, such as to shock and vibration. The result is to impedance modulate a current or voltage source which can then emit EMI. Voltage standing wave ratio, inadequate circumferential shielding, and/or contact potential are other attributes of connectors contributing to interference.
- **Motors and Generators.** Motors and generators which use brushes and commutators are inherent sources of broadband transient EMI noise. Transients develop as a result of an arc discharge upon separation of the rotating brush-commutator interface. The coupling mode of EMI may be either conducted or radiated and significant transients may exist up to 100 MHz or higher. Interference due to magnetic induction may be significant below 100 kHz.
- **Relays.** Electromagnetic relays and solenoids are also capable of producing EMI in sensitive equipment up to 300 MHz or higher. Upon de-energizing a relay, the stored magnetic energy develops a reverse voltage typically 10 - 20 times the supply voltage. Thus, arcing will develop at the switch contacts which may conduct and/or radiate broadband transient EMI. However, solid-state relays are widely used whenever possible since they have no moving parts thus preventing arcing.
- **Solid State components.** Diodes may produce transients as a result of reverse recovery periods which develop transient spikes from AC supplied sources.

27.5 TESTING FOR EMI

The guidelines so far have assumed that the aircraft under-going test is one-of-a-kind. That is to say, it is a production model for which there is only one configuration. In reality, this very rarely occurs, since continuing evolution of the airframe and on-board electronics, external stores and purpose of mission are continually changing. For these conditions it is not unusual for a "live" mock-up to be assembled and used as a simulator. Typical use for this type of simulator is sub-system installation and integration. Mock-up boards cannot provide the same environment as the actual aircraft. Cable harness build-up, power distribution and integrated sub-system operation will reflect environmental conditions and aid in EMI/EMC problem solving.

The highly integrated tactical fighters being developed today, which are using the latest in high level technology, are an example of the complexity of modern aircraft. The task of transitioning a prototype aircraft to production can take as long as 10 years. The cockpit will have complex multi-function, flat-panel color liquid crystal displays that offer pictorial representations of targets and threats, system status, and friendly support forces. The aircraft will include a high powered radar with an active, electronically scanned array antenna that can direct the radar beam to anywhere within the radar field of regard in almost

realtime. Multiple hybrid transmit and receive modules will operate over a wide range of frequencies. Integrated navigation and identification avionics will utilize multi-function antennas and shared assets, while the integrated electronic combat avionics will use multi-function apertures and shared assets to perform multiple functions of radar track warning, missile launch detection, and threat identification.

It is important to note that these systems will be designed, engineered, and built by separate subcontractors and integrated at another location. The task of testing is lengthy and thorough since the systems are linked by programmable, very high-speed integrated circuit technology all of which are software driven. (See Sections 26 and 26A.)

It should also be pointed out that in addition to the above there are the basic vehicle management systems (VMS), many of which are traditional noise generators. A typical VMS will consist of: flight control computer, engine control computer, fuel management, inertial navigation, air data transducers, the heavy duty power systems such as the landing gear and surface hydraulic systems, primary and auxiliary power, life support, and fire protection; and finally, the cockpit controls and indicator systems. These all represent a formidable testing task even with the use of high percentages of digital "noise immune" electronics.

Instruments, test methods and procedures are the requirements for meaningful EMI measurements. Data collection is the result of a man-machine interface and it is therefore most difficult (if not impossible) to become proficient in EMI measurement without mastering both instruments and test techniques. (It is also very helpful to be able to successfully interpret MIL-STDs.) Proficiency in all the above requires experience and tenacity.

Typical EMI test areas for levels of testing include shielded enclosures, RF anechoic chambers, and open areas (fields). EMI sensors include such items as antennas, susceptibility test chambers, current and voltage probes, and line impedance stabilization networks. Typical test equipment includes EMI receivers and spectrum analyzers, impulse and spike generators, power oscillators, and amplifiers.

The objective is to establish EMI test areas and enclosures that provide an isolation barrier between (1) the test environment with its associated test object and equipment and (2) the surrounding electromagnetic environment. The purpose for this is to permit EMI test measurements to be performed so that the surrounding electromagnetic environments will not disturb, confuse or invalidate test measurements. Conversely, susceptibility measurements can be performed on the test object without introducing EMI to the surrounding environment. Accordingly, the testing environment becomes a problem of concern unto itself with regard to facilities, instruments, and techniques.

27.5.1 Open Area Test Sites

An open area implies a remote site ideal for radiation emission and susceptibility testing. This site should be in the open, have a flat terrain, and be a considerable distance from buildings, power lines, fencing, underground cabling, and pipelines. The site should have a sufficiently low level of ambient electromagnetic radiation to allow testing to applicable radiated-interference specification limits.

Some types of EMI tests can only be performed in an open area, such as measurement of RF spectrum characteristics. Tests such as emission spectrum include the combined effects of transmitters, their antennas, and usually the surrounding terrain. For antennas not intended to clear the first Fresnel zone, the terrain is a very important part of the emission spectrum. The test intercept site may have to be as far away as one kilometer to satisfy far-field requirements. Thus, to assure valid data, meaningful EMI measurements can only be performed in an open area. However, security requirements may dictate that testing be conducted in a shielded enclosure and again, special care is required to ensure that meaningful data is obtained.

Radio Frequency test ranges are rather common and usually consist of a full scale aircraft, mock-up, airframe section, or scale model mounted on a pylon in such a manner that the test object on the pylon can be elevated and/or rotated around its attach point.

From a practical point of view, open-area testing is not performed on small samples such as components, equipment chassis, and sub-systems for a number of reasons:

- Lost time and cost associated with locating personnel and equipment at the open area test site
- Varying weather conditions that can delay or postpone testing
- Weather may create idle time during which the sample could be used for other testing
- Because these tests involve the use of the RF spectrum, RF spectrum scheduling is required so that testing is done on a non-interference basis.

As a result nearly all EMI testing on small objects are performed inside shielded enclosures.

27.5.2 Shielded Enclosures and RF Anechoic Chambers

The shielded enclosure or screen room has been in use for many years for performing electronic measurements where a low electromagnetic environment is required. The main advantage of the shielded enclosure used for making EMI measurements is that it provides RF isolation from and to the surrounding environment. Its use allows meaningful conducted and radiated emission measurements to be made where in normal locations such testing would not generally be possible. The exception is magnetic fields at Extra Low Frequencies and lower. For example, the enclosure walls offer little attenuation to 60 Hz fields and input power lines allow easy emission entry.

A satisfactory RF anechoic chamber must provide a quiet zone or volume of sufficient size to encompass the antenna or object under test. The level of reflected energy should be from 30 to 60 dB below that of the direct-ray energy level from the transmitting antenna. This quiet zone must be at a distance from the transmitting antenna which satisfies far-field criteria for both the amplitude and phase distribution of the illuminating field.

The design of anechoic chambers is far from an exact science and is preferably based on past experience with a wide range of sizes, configurations, and absorbing materials. The potential user of a chamber is advised to specify reflectivity levels that are meaningful to his proposed project. Insistence upon 60 dB performance when 40 dB is adequate occurs all too often. The result often eliminates chamber testing due to excessive chamber size and resultant costs.

27.5.3 EMI/EMC Test and Measurement Instruments

Test antennas are used to make radiated emission and/or radiated susceptibility measurements for EMI. They are designed and used for open area testing as well as for measurements inside of shielded enclosures, provided certain precautions are taken, especially with active antennas. The RF spectrum of concern typically spans from 30 Hz to 20 GHz and it should come as no surprise that there are literally dozens of antenna designs to choose from. Typical design concepts are the: capacitive probe, loop antennas and magnetic probes, active and passive rod antennas, dipoles, bi-conical, log-spiral, and ridged-guide antennas. Fortunately, most test procedure documents specify the type/types of antennas to be used for testing in a specific frequency range. Following those suggestions is most appropriate.

A different class of EMI testing involves conducted emission and/or conducted susceptibility tests in order to measure either a voltage or current or to inject a voltage or current into a line. The category of devices used to accomplish this are called conducted sensors and injectors. Typical conducted emission sensors

are the current probe, the line impedance stabilization network, and the voltage probe. Conducted injectors typically consist of special transformers and impedance-matching devices for injecting a specified voltage across or current into lines for susceptibility testing. An assortment of isolation pads, rejection networks, and low pass filters is also required. [27-15, Vol. II]

Electromagnetic Interference receivers are tunable frequency-selective audio and RF voltmeters which measure the unknown voltage appearing at the terminals from a suitable conducted or radiated sensor mentioned earlier. The EMI receiver is a superheterodyne receiver with emphasis placed upon attempting to accurately measure signal or noise amplitude. [27-15, Vol II]

Unlike the EMI receivers, spectrum analyzers are generally characterized by untuned front-ends, relatively high noise figures, and a built-in video display unit variable screen persistence. The principal advantage of the spectrum analyzer over EMI receivers is their flexibility and functional displays for a smaller investment per octave coverage. A typical set of three or four spectrum analyzers will have a combined frequency span from about 1 KHz to Ghz, nearly eight decades (25 octaves). They are used primarily for intercepting, displaying, and examining signal and electrical noise activity.

Impulse generators are used to amplitude calibrate EMI receivers in broadband units of dB V/MHz from about 200 Hz to approximately 10 Ghz. The impulse generator is basically a device which charges a pulse-forming line to a maximum amplitude of about 200 volts and then rapidly discharges it into a 50 ohm load at its output which is connected to the receiver. The result is a transient spike of one-half the amplitude of the DC source and an equivalent pulse width of twice the line length or typically a few tenths of a nanosecond.

The EMI transient generator, better known as a spike generator, is used as a source for performing transient conducted-susceptibility testing in accordance with MIL-STD-462/461 and other requirements developed in the commercial aircraft industry.

The EMI susceptibility testing requirements cover an enormous frequency span of 26 octaves. Although this entire range may not have to be tested, some test units having susceptibility requirements will have to be tested over at least 20 octaves. Antenna efficiencies are such that power sources well in excess of standard 0 dBm laboratory signal generators are required. For example, to achieve a field intensity of 10 volts/meter, this will apply over much of the spectrum, even when susceptibility chambers are used. Thus, it follows that RF power sources greater than 0 dBm and capable of being scanned or swept over many octaves are a requirement. This is the job of the sweep oscillator.

Power oscillators and power amplifiers are used to perform susceptibility measurements. They are used to drive signal injectors for conducted excitation of power lines, signal and control leads, and to drive antennas or special chamber configurations. Where power oscillators are used, they are driven by either signal or sweep generators to boost the RF output power.

27.5.4 Level-Two and -Three Testing

In many test organizations the FTE will be involved in the Level-Two and -Three testing.

Level-Two testing performs EMI/EMC tests at the system and aircraft level. It involves solving the problems that arise from bringing systems together, at first in a simulator or mock-up and later in the actual aircraft. The systems should be operated in routine modes and any malfunction or system degradation due to EMI should be remedied. In the end the entire aircraft installation must operate in a compatible manner. There is no doubt that some problems will still exist, unnoticed, since the number of operational variables is excessive.

Level-Three testing involves full scale operational and environmental tests. During these tests the entire aircraft is immersed in a typical electromagnetic environment. One of the objectives at this level is to determine the effects of external sources on the aircraft. What is to be specifically investigated is whether the environment causes a malfunction or degradation to the performance of the aircraft and if so, what systems are affected. Typical sources to be investigated at level three testing are lightning, precipitation static, and high energy RF emitters, such as tracking radars.

Testing at Level-Three generally implies that some form of mission profile be evaluated. A true mission profile should be followed because just turning on and turning off equipment one at a time and recording the results is not a true representation of the actual operational conditions. Nor should all equipment and subsystems be turned on and off simultaneously since this situation may probably never occur either. A more meaningful system evaluation results when one or more mission profiles are written and followed by programming the on-off modes of equipment within the system. For example, very specific programming can be written for engine start, house keeping systems on, taxi, transceiver radio check, canopy close, instrumentation systems on, and so forth. These steps represent realistic sequencing and power loading.

27.6 MEASUREMENT ERROR ANALYSIS CONSIDERATIONS

The error problem exists because EMI and EMC are usually not deterministic situations. Rather, they are probabilistic - the probability that EMI will not exist and EMC will. It is a function of many variables, some of which at best are poorly defined or not defined at all but rather estimated. Typical sources of measurement errors are: instrument errors, calibration errors, test setup and procedure errors, and data recording errors.

The subject of error analysis is pointed out since most U.S. MIL-STD procedures include statements of "accuracy of measurement" requirements. An error data base must be maintained and it is very helpful to the test engineer to maintain an "overall probable error" of each type of test. If a data base is not established then a "best estimate" should be recorded at the time of the test.

27.7 SOME GUIDELINES FOR DESIGN

Until the development of solid-state circuitry and its application to aircraft electronics the indirect effects from lightning did not warrant much attention. However, lightning strike reports (civil and military) are showing increasing incidents of avionics damage without evidence of any direct attachment of the lightning flash to the electrical systems. While outages occur in only a small percentage of all incidents, the systems affected indicate potential problems that are slowly developing due to the following:

- Increased use of non-metallic aircraft skin
- Increased use of solid-state electronics
- An increasing dependence on electronics to perform flight critical functions.

(Although the design of aircraft or instrumentation sub-systems is not the responsibility of the FTE, some design guidelines are of direct relevance during the lifetime of an aircraft when systems are modified and new one installed. In most cases the FTE is a part of the design/instrumentation engineering team as suggested in paragraphs 27.2 and 27.3.)

27.7.1 Installation Design Goals [27-16]

The following installation guidelines should be kept in mind:

- Install the wiring and hardware in such a manner as to prevent the indirect effects of lightning from damaging the aircraft system
- Review the installation to be certain that hardware accessibility, and aircraft and crew safety has not been reduced due to the installation
- Select or design electronic equipment that can tolerate input/output transients on power and information circuits, whenever possible
- Review the trade-offs that must be made between the cost of providing tolerant equipment (see above) and cost of shielding equipment and wiring
- Take advantage of inherent aircraft shielding. Avoid areas where equipment and wiring are exposed to the lightning generated EMF
- Locate the most EMF sensitive equipment in areas where the EMF produced by lightning effects are presumed to be the lowest
- Maintain adequate electrical conductivity between access doors/plates and their interface
- Maintain all wiring close to a metallic ground plane or use metal conduit if uncertain.

27.7.2 Use of Shielding

Shielding wires and cables against magnetic fields that have been created by lightning requires the shields to be grounded at both ends so that the shield can carry a circulating current. It is this circulating current that cancels the magnetic fields that produce common-mode voltages. The term common-mode voltage as used here refers to the magnetically-induced voltage appearing between a single conductor and the airframe or conductive skin.

The requirement that a shield intended for protection against lightning effects be grounded at both ends raises the discussion of single versus multi-point grounding of circuits. In general, low-level circuits need to be shielded against low frequency interference and shields intended for this purpose are grounded at only one end. Often overlooked is that the physical length of such shields must be short as compared to the wavelength of the interfering signals. Lightning produced interference, however, is usually broad band and includes frequencies much higher than those typically considered for low frequency shields. As a result the needs for both cannot easily be met by the use of a one shield system.

Both requirements are usually met by having one shield system to protect against low-frequency interference and a second overall shield system to protect against lightning-generated interference. Within the overall shield the necessary aircraft circuits are independently routed with their own shields and grounding philosophy. [27-16, 27-1]

27.7.3 Bonding and Grounding

Even with experienced aircraft manufacturers, electrical bonding and grounding never ceases to be a problem during the entire aircraft life cycle. The importance of effective bonding and grounding of the aircraft to take advantage of the excellent shielding of the electro-magnetic Faraday shield of the outer conducting skin (where and if it exists) can not be over emphasized.

The use of new composites with resistivities, such as graphite epoxy, has introduced new problems in obtaining adequate grounding. Composite structures illustrate the need of new concepts of bonding and

grounding fiber conductors that are subject to vibration, temperature stress, and other environmental considerations.

27.8 CONCLUDING REMARKS

The magnitudes of EMI/EMC complexity and the broad range of system-subsystem testing has been briefly presented. The sources of EMI have been described. Fundamental concepts of the testing objectives, basic considerations, typical test equipment used, and associated guideline standards have been discussed.

27.9 REFERENCES

- [27-1] RTCA/DO-160C, "Environmental Conditions and Test Procedures For Airborne Equipment", Radio Technical Commission for Aeronautics, Suite 500; 1425 K Street, N.W., Washington, D.C. 20005, 4 December 1989.
- [27-2] Keiser, B., D.Sc.E.E., "Principles of Electromagnetic Compatibility", Published in the USA by ARTECH HOUSE, Inc., 610 Washington Street, Dedham, Massachusetts, copyright 1979.
- [27-3] ANSI C95.1-1982, "American National Standard Safety Levels With Respect to Human Exposure to Radio Frequency Electromagnetic Fields, 300 KiloHertz to 100 GigaHertz".
- [27-4] Newton, P.M., "Aircraft Testing in the Electromagnetic Environment", Paper 28, AGARD Conference Proceedings No. 470, Flight in Adverse Environmental Conditions.
- [27-5] MIL-STD-462, "Electromagnetic Interference Characteristics, Measurement of", U.S. Department of Defense.
- [27-6] MIL-STD-461C, "Electromagnetic Emission and Susceptibility Interference Requirements for the Control of Electromagnetic Interferences", U.S. Department of Defense, 4 August 1986.
- [27-7] MIL-STD-449, "Radio Frequency Spectrum Characteristics, Measurement of", U.S. Department of Defense.
- [27-8] MIL-STD-704, "Electric Power Aircraft, Characteristics and Utilization of", U.S. Department of Defense.
- [27-9] NACSEM 5100, "Radiation Standard for Communication and Other Information Processing Equipment", U.S. Department of Defense.
- [27-10] MIL-E-6051, "Electromagnetic Compatibility Requirements, Systems", U.S. Department of Defense.
- [27-11] Fisher, F.A., and Plumer, J.A., "Lightning Protection of Aircraft". Published in USA. NASA Reference Publication 1008, October 1977.
- [27-12] AIR 1406, "Lightning Protection and Static Electrification", Society of Automotive Engineers, February 1976.
- [27-13] "The SEU Concept", Military & Aerospace Electronics", PennWell Publishing Co., August 1992.

- [27-14] MIL-HDBK-217, "Reliability Prediction of Electronic Equipment", U.S. Department of Defense, 1991.
- [27-15] White, D.R.J., "A Handbook Series on Electromagnetic Interference and Compatibility", First Edition, published in USA by Don White Consultants, Inc., Germantown, Maryland. 1973-1975, Volumes I through IV.
- [27-16] Borek, Robert W., "Practical Aspects of Instrumentation System Installation", AGARDograph No. 160 Vol. 13, Flight Test Instrumentation Series.

27.10 BIBLIOGRAPHY

- MIL-HDBK-35 (USAF), "Management and Design Guidance Electromagnetic Radiation Hardness for Air Launched Ordnance Systems", U.S. Department of Defense, 15 January 1981.
- MIL-STD-463, "Definitions and Systems of Units, Electromagnetic Interference Technology", U.S. Department of Defense.
- MIL-STD-220, "Methods of Insertion Loss Measurements, Filters", U.S. Department of Defense.
- MIL-STD-285, "Measurements for Enclosures, Electromagnetic Shielding, for Electronic Test Purposes, Methods of", U.S. Department of Defense.
- MIL-STD-1757A, "Lightning Qualification Test Techniques for Aerospace Vehicles and Hardware", U.S. Department of Defense.
- DoD-HDBK-263, "Electrostatic Discharge Control Handbook for Protection of Electrical and Electronic Parts, Assemblies, and Equipment (Excluding Electrically Initiated Explosives)", May 1980.
- FCC Rules Part 15, "Low-Level RF Devices", and Part 18, "Industrial, Scientific, and Medical Equipment.
- AFSC DH 1-4, "Air Force EMC Design Handbook", 10 January 1972.
- FAA-AC-020-0136, "Protection of Aircraft Electrical/Electronic Systems Against the Indirect Effects of Lightning", Advisory Circular, Federal Aviation Agency, U.S. Department of Transportation, 5 March 1990.
- Redman, M.B., "Electromagnetic Compatibility and the Flight Test Engineer", Proceedings of the 18th Annual Symposium of the Society of Flight Test Engineers, Amsterdam, 28 September - 2 October 1987.

Chapter 28 – POST FLIGHT OPERATIONS

Y. Zundel

Centre D'Essais en Vol, SDT/SE
91228 Bretigny-Sur-Orge Cedex
FRANCE

28.0 INTRODUCTION

After each test flight there are a number of actions that must be taken to assure that the objectives of the flight were met, no unexpected results were encountered (or if they were encountered to ensure that they are accounted for prior to the next flight), and to determine when the next flight can be conducted. The immediate results of test flying are seldom simple to express because of the multitude of specific data collected during each flight, and the great number of specialists interested in those data. However, the cost of test flying requires that tests progress as fast as possible and this in turn dictates that test data be verified and issued in the most timely and efficient manner. The comments of the test crew are part of the test data base and are invaluable even if they relate only to the specific test condition of one flight. Their comments can often serve to identify conditions that are not obvious in the recorded data but deserve further evaluation. The final step, assuming that there are no serious reasons for not continuing, is to launch the preparations for the next test flight.

Therefore, it is necessary to set up an organization which can efficiently ensure after each flight:

- Collection and dissemination of all information necessary to lead the program day after day
- Collection and dissemination of all information to prepare and process the data of flight data recorders
- Collection, comparison, collation, summarization, and formatting all data from all flights concerning a specific test objective into an understandable and usable form to better define any anomalies and/or ensure that data gathered is consistent with that previously gathered
- Identification and correction of the test vehicle malfunctions and malfunctions of any supporting equipment such as an instrumentation parameter, ground-based equipment including telemetry room, space positioning equipment, etc.
- That the next flight can be safely and efficiently conducted.

As noted in Sections 3 and/or 8, it is vital that the test methods, procedures, and conventions are common to all the units and/or personnel involved in the acquisition, analysis, and interpretation of the flight test data. Since the prime purpose of this section is to describe the overall post-test plan of action, this point is not covered in detail here. It is important that the rules and procedures of the parent organization always take precedence over the procedures noted here.

This section will cover the actions, such as post-flight de-briefing, data analysis, data evaluation, reporting, and briefly, the planning that must be completed before the next test flight.

28.1 POST FLIGHT DEBRIEF (PFD)

The PFD is a short debrief - lasting 1 hour maximum - to ensure direct communication between specialists involved. The purposes of the briefing are to point out the important points of the flight, make the required decisions immediately, and inform the different parties directly involved in the tests of necessary actions in near real time.

28.1.1 Participating Personnel

The following people should be present at the PFD:

- Those having a direct participation in the flight program: crew, test engineers, instrumentation engineers, and main telemetry room specialists - to present and discuss test conduct and observations
- Flight-line mechanics team - to identify the work to be performed before the next flight
- Instrumentation engineers and technicians - to identify malfunctions and deficiencies that require correction
- Flight data recorder analysis team - to identify data processing and analysis required before the next flight and launch the priority work
- Team specialized in the tested equipment - to assist in evaluating the success of the test flight and/or assist in evaluating any anomalies encountered
- Representatives of the hierarchy above the people listed earlier, when deemed necessary, to ensure that non-technical points like delays and priorities are taken into account in the short term work schedule.

It is generally the crew, preferably the pilot, who leads the debrief while other specialists step in to give some comments or to ask questions to clarify a point.

28.1.2 Contents

PFD should cover at least the following points.

- Review of malfunctions and failures experienced during the flight including general malfunctions without direct link with the trial, in order to use all disciplines represented to cover all the aspects, without exception. Decisions should be made to correct deficiencies or effect repairs before the next flight (with mechanics' opinion on time delays), delay correction of known malfunctions until next aircraft overhaul, to initiate a technical investigation, etc.
- Comments on flight events and phenomena experienced, preferably in a chronological order, using the test order and the telemetry room flight data sheet as a guide to ensure completeness. Video records or graphs may be useful to illustrate a point. (However, data processing should not start until after the PFD, unless there is an urgent need for data to explain an anomaly.) Differences between test order and actual test conduct should be explained at this point. (There should not be an extensive discussion of differences at this time. It should be generally understood that real-time flight management constraints make it difficult to make the optimum decision).
- Pilot comments on flight test points with emphasis on points which resulted in a specific problem or in an unexpected event
- Review of the short term actions with the concerned people: works to carry out before the next flight, priorities in data processing, delay deadlines, etc.
- Flight test instrumentation report specifically noting any anomalies.

28.1.3 Data Sources

Data sources to support the PFD are:

- Flight briefs/test cards to sum up all demands for test points and the associated test conditions. The test order is the best guide to list the flight phases.
- Pilot and flight telemetry room data sheets, which should contain all necessary information to review the flight, as well as other data sheets that contain significant remarks or parameters. Specific demands on precision or comments are often based on those sheets, which also helps on data processing preparation.

28.2 REPORTS

There are a number of executive overview or summary reports which must be prepared and sent to various activities. Typically these reports incorporate at least the:

- Test objectives
- Test activity involved
- Major facts and observed results, with the usual reservations about possible misinterpretation.

The list of addressees established in accordance with the officials in charge of the program will generally be:

- Concerned Government officials
- Users (client)
- Contractors involved in the program.

The level of the addressee will depend upon the importance of the program and the use to be made of the report. It is obvious that for a major program, such a report will concern high levels of the government as well as in the contractor's hierarchy. The procuring authorities will also be addressed to enable them to eventually deal with the contractual implication.

Some specific test flights are considered as key milestones for the program, for example the first flight, a prototype acceptance flight, a missile firing at the final step of a weapon system development phase, etc. To avoid the release of partial or erroneous information, often under high media coverage, it will also be necessary to establish an immediate report procedure that is in complete compliance with the rules and procedures of the parent test organization and the affected test site.

28.2.1 Routine Reports

Typical reports prepared on a flight-by-flight basis include:

- A pilot report on every flight to document the pilot's observations. This report should be based on his observations or on the interpretation of recordings of test point data history representing the build-up of the test point parameters. The pilot report should take into account that readers may not be familiar with the test world. It should include items such as crew composition, aircraft flown, software versions and test area weather, if pertinent, type of tests conducted, any anomalies, and pertinent recommendations about proceeding to the next series of tests. All interpretations of a deficiency should be clearly identified, if reasonable.
- Other crew member report, depending on the trial

POST FLIGHT OPERATIONS

- Flight telemetry room report specifying "goodness" of data and/or any anomalies noted
- A pilot report to identify and describe any unusual events or any incident involving flight safety
- Maintenance crew or line mechanics report in case of incident
- A Flight Test Engineer's (FTE's) flight summary report for management that contains flight duration, data points flown, incidents, etc.

The progress report is normally used to forward preliminary data to the official responsible test agency as well as the other official services involved in the trial. In order to protect the government and companies' secrets, the list of addressees should be very carefully controlled. It should be noted that the test activity must be very careful in the selection of data to be included in these preliminary reports so that the test sponsoring activities do not reach incorrect conclusions based on preliminary data that is not representative of the final data. No data should be forwarded if there is any question as to its validity.

28.2.2 Special Reports

Unexpected events could require that a special report be written. The starting point of a technical investigation or corrective actions will be the report of the specialist in charge of the equipment or the concerned function. It should emphasize the circumstances of the event, the observations on the equipment, and possible repairs on it.

Depending on the nature and severity of the event and the service or people concerned, the reports could be:

- The aircraft log
- Incident report (short or extensive). This document is to report when the actual functions of the equipment do not comply with their specifications or the ground test results.

An activity report may be required to report a specific set of test and test results to just one agency.

28.3 DATA REDUCTION

The first phase of data processing is pre-processing - the conversion of raw measurement values into tables or time histories in engineering units. The second phase is the processing of test data to standard conditions which were previously agreed to by the data users. Often, both phases are carried out by the test team even though the technical design office may carry out the subsequent detailed data processing and analysis. In any event, the flight test team must be able to conduct enough post-flight analysis in sufficient depth to be able to:

- Confirm that all parameters appear to be recorded satisfactorily
- Confirm the quality of calibrations and the manner in which they are applied
- Confirm that the data appears to be consistent with previous results
- Construct a data base, updated from flight to flight, in order to refine the definition of, and prepare for, the test points from successive flights.

The test team should use the mathematical tools - or a practical guide - issued by the technical design office in order to be able to predict the consequences of a configuration change or even of a test system version change based on experimental data gathered under similar conditions.

Should the test team not be able to use the software itself, the test team must be part of the quality control in charge of the measurements validation, and be in a position to get all necessary information to prepare for the next activity.

28.4 DATA ANALYSIS

For this Section, data analysis is concerned only with that to be accomplished to permit conduct of the next flight or flights and will support the initiation of the full analysis of the data, including the coordination necessary for accomplishment of the data analyses. This necessary analysis covers both routine analysis and that required to support a specific requirement. It is to be noted that the division of data analysis tasks between the test activity, responsible management organization, and the design office will vary greatly between organizations involved in the design, testing, and procurement of the aircraft.

28.4.1 Routine Evaluation of Test Results

A routine preliminary evaluation of test results should be conducted before a decision is made to proceed with the next flight. This evaluation should include:

- Validation of the requested recordings or the analysis of the flight of concern ("goodness" of the data recorded, identification of possible failures in the measurement process, possible periods of time where the data were not available such as loss of telemetry, loss of trajectory information, etc.)
- Gathering and analysis of a first set of gross results derived from the collected data (quick look data)
- A check on the status of the systems or equipment under test. Safety related parameters should be monitored in real time. Other parameters could be checked after the flight.

This analysis will concern, first, the data requested in real-time for safety purposes and for the control of the test flight and, second, the systematic data reduction necessary for the fulfillment of the above three items.

It must be emphasized that this analysis will be "routine" only if prior to the flight test campaign, or specific flight, the requirements for analysis of the required data have been complete enough so that it has been possible to prepare not only the configuration of the test installation but also specify the required tasks for the processing and the analysis of the data (calculation software and configuration of the displays in the flight telemetry room in particular).

This preparation will normally be well handled for the real-time concerns (configuration of the telemetry rooms), but may be somewhat overlooked for the subsequent analysis to the detriment of the data analysis schedule and the quality of the work to be done.

28.4.2 Analysis and Discussion

At the flight testing level, the analysis and discussion must be oriented towards a number of immediate objectives:

- Update of the test tools (dedicated test equipment, instrumentation, supporting ranges, facilities, etc.) to constantly improve the quality of the comparison with the computed or simulated values. Was the measurement equipment adequate for its purpose (type of parameters recorded, accuracy, rate, acquisition range, synchronization, etc.) taking into account the observed phenomena and the test goal? Were the mathematical tools satisfactory (non-linearity, calibration, etc.)? Were the

POST FLIGHT OPERATIONS

data transmission, data description, and data validation equipment adequate for the data processing (delay, error rate, documentation, etc.)?

- Utilization of the overall knowledge of the measurement equipment and of the experience gained in previous flight testing to assist the people in charge of the data processing in the following areas:
 - Instrumentation system specifications and performance
 - Flight test techniques, possibilities and limits
 - Instrumentation system performance with the pilot in the loop, if relevant
- The update of the model used in simulation. The test engineer must understand the necessity to proceed cautiously and extensively before initiating any change and the difficulty of drawing conclusions after a single flight.
- The identification of the test point for which the mathematical model does not match - or poorly matches - with the observed phenomenon.
- Immediate modifications/corrections on the tested equipment, or eventually on some details of the test method as a result of comparison of test results and predicted values.

It must then be determined if the test performed will allow for a sufficient characterization of the test results or if complementary testing will be required.

The ultimate goal will be of course to match prediction and test results or, at least, to precisely determine the area of matching and, consequently, the area where the math model must be changed to match the reality of the test data. However, the FTE is cautioned that updating of the math model should be approached with great caution. "Fine tuning" of a model can sometimes be expected based on results of a given flight but major changes should not be undertaken based on a single flight.

28.4.3 Specific Analysis

When an unexpected event occurs (including measurement system failures), the following actions should be taken to provide data for the incident reports noted in paragraph 28.2.2, above:

- Identification and description of the event
- Identification of the available data that will be useful for the analysis
- Assessment of the availability of the involved specialists
- As soon as reasonable, list the specific tasks to undertake with their degree of priority.

28.4.4 Coordination

Coordination will be the key to maintain the coherence between the short term (that will drain all the energies to prepare the next flight) and the mid-term goals (that will allow comprehensive analysis of data, up-dating of any models, preparation of data presentations such as graphs, tables, cross-plots, etc.).

It is essential that each person in the data acquisition, processing, and analysis team be provided with the detailed information required for them to properly perform their tasks. For example, the data acquisition and processing members must know the specific parameters that are required for each flight, the calibration date for each transducer, the range and sampling rates required for each parameter, etc., so that the aircraft data acquisition system and the data processing system have the identical configuration. This entire set-up must be systematically organized through:

- Meetings between the specialists involved in the routine analysis who must be prepared to respond quickly in order to provide necessary data in the short intervals between test flights
- Coordination with the other activities to guarantee transmission of the necessary data for a thorough analysis of the flights and to take the data processing and analysis into account for the next flights.

28.4.5 Identification of the Safety Margins and Waivers to be Accepted for the Next Flights

The routine analysis and the complementary actions that may have followed will give some additional information to the data collected during the flight debriefing to identify the conditions in which the next flight could be launched:

- Operation of the equipment:
 - Are the anomalies or failures observed confirmed, and the consequences assessed?
 - Can the needed adjustments or repairs be done immediately?
 - If not, can the equipment/system be flown again, for what type of flight test, and with what kind of adaptation in the procedures?
- Behavior of the equipment/system subject to test:
 - What are the differences between the measurement performed and the expected computed characteristics?
 - Do these differences result from a poor adjustment or from a poor integration? Is it mandatory to immediately start an adjustment or fine tuning, or is it advisable to first collect other complementary data?
 - Are the above differences significant from the safety point of view? What are the immediate conclusions to be drawn with respect to flight envelope, configuration, procedures for operation, or monitoring?

NOTE: In order to be able to readily monitor potentially critical parameters such as stress, vibration level, natural oscillatory modes, temperatures, etc., appropriate estimates of the limits judged safe for flight test purposes should be obtained from the manufacturer or other responsible agency. These limits can be derived from previous calculations or tests such as wind tunnels, rig tests, computational fluid dynamics, mathematical models, etc. These critical parameters and limits include a safety margin which is adjusted as the test program progresses and more precise and detailed knowledge is obtained.

28.5 PLANNING THE NEXT FLIGHT

The FTE must understand that the planning for a test sequence cannot wait until a given flight is completed. Test cards and test sequences can and should be defined soon after the test plan is approved. There normally is not sufficient time to wait for the completion of one flight before starting to prepare test cards and test sequences, especially if the aircraft is conducting several varieties of tests such as structural definition and aeroelastic tests or performance and handling qualities. After a given flight, the debriefing and data analysis will usually dictate how the next flight will be structured.

Once it has been determined that it is safe to proceed to the next flight the responsible test engineers must take a number of actions.

POST FLIGHT OPERATIONS

- They must select the next series of test points that will either provide additional information on anomalies already determined and/or test points to continue with the flight test investigation
- They must contact the maintenance organization and determine when the aircraft will be ready for the next test flight and any limitations on the aircraft due to maintenance requirements that have been delayed for any reason
- All test support activities have to notified of the flight date and time, approximate duration of the flight, the purpose of the flight to include such items as required instrumentation including ranges and sampling rates, items to be displayed in real time, the need for telemetry support, requirement for space positioning support and type such as trajectory following or time-space-position information
- Selecting and/or modifying pilot's test cards and procedures
- Etc.

Much of this detail can be preplanned so that test support activities will know and understand their role when they are told, for example, that the next test flight will include level accelerations, wind-up turns, and flight control "doublets" to investigate dynamic stability. This preplanning must be accomplished in great detail such that every required support item is defined for each type of test and will pay good dividends by minimizing the information that must be passed between flights. Even with this preplanning, however, the test engineer would be well advised to contact key supporting personnel to ensure that all information and requirements were received and understood.

28.6 SPECIAL CONSIDERATIONS

A flight test program could encounter an unexpected event that could result in damage to or loss of the test aircraft. The responsible test team should always be aware that this can happen and include procedures in their planning to take appropriate action if an accident/incident should occur. Each FTE must be aware of the rules, regulations and procedures that exist not only in their country but at their test base and understand what their role is in the event of an accident/incident. In no event should information regarding an accident or incident be issued without the knowledge and consent of the proper authorities at a given test site.

There is no way to generalize the multitude of procedures, rules, regulations, etc., that exist at each test site. The test team must review these documents and understand what their role is! It is only common sense to be aware of any unique characteristics of the test vehicle/equipment such as hazardous materials that are a normal part of the aircraft and be prepared to communicate this information to the responsible recovery teams.

28.7 CONCLUDING REMARKS

The end result of a test flight is very little if the data gathered are not processed adequately and if the test results are not documented properly. To meet this objective, it is necessary that a structure for the data collection, transmission, and processing be organized and permanently adapted to the development and test needs in order to maintain the best compromise among the answers to be given to the following questions:

- What information should be collected?
- Who needs this information?
- What is the level of the analysis required?
- How quickly are these data or analysis required?

This Section has offered some guidelines and suggestions that will expedite the flow of information yet require the test program be conducted safely.

28.8 ACKNOWLEDGEMENTS

The Centre D'Essais en Vol (CEV) RAFALE Test Team provided support in the preparation of this Section.

28.9 BIBLIOGRAPHY

Ecole du Personnel Navigant D'Essais et de Reception

- Pratique des Essais en Vol Helicopteres (2 Vol), ref EPNER 25.
- Pratique des Essais en Vol Avions (3 Vol), ref EPNER 24.
- Pratique de la Reception (1 Vol), ref EPNER 27.

US Navy Test Pilot School (USNTPS) INST 5213.3B, "Report Writing Instruction", 1 December 1987.

U.S. Government Printing Office, "Style Manual", March 1984.

AF Flight Test Center, AFFTC-TIH-88-002 "The Author's Guide to Writing AFFTC Technical Reports", Rev 3, January 1993.

American National Standard for Information Sciences, ANSIZ39.18-1987 "Scientific and Technical Reports - Organization, Preparation, and Production".



Chapter 29 – POST-TEST OPERATIONS

Ronald J. Oblen

Naval Air Warfare Center Aircraft Division
Patuxent River, MD 20670-5304
USA

29.0 INTRODUCTION

Once a flight test program is completed there is normally a series of briefings and reporting requirements that must be met. This section will describe, in general terms, the briefings one should be prepared to perform, the types of reports that may be required including preparation of the final technical report, and data that can be provided for handbooks, simulators, and operator's manuals. Be sure to refer to and use your present organization's guides/requirements for reporting.

29.1 POST-TEST BRIEFINGS

Throughout a flight test the project engineer and the test team should be periodically briefing the supervisors and managers in his/her parent organization. Additionally, so as to avoid surprises, the test team should be continuously communicating with the sponsor (customer) throughout execution of the project. Once the last test flight is flown and all the data points have been achieved, there will be a series of formal or informal briefings. The project engineer would normally brief his/her supervisor and the management before any briefing to the customer. An early briefing is often required because the customer may be in a tight schedule usually driven by budget considerations or by contractual requirements. The customer needs to know the results of the flight tests and wants answers to the following questions: Were the tests successful? Does the aircraft/system perform as required by the specification/standard? Can the aircraft/system be operated by the pilot or flight crew? Is the aircraft/system an improvement on what is currently in operation? There are many other questions that one can hypothesize for a particular flight test that the customer might need answered. The project engineer/test team should understand early in execution of the project what questions need to be answered. These questions/requirements are pre-negotiated at the project commencement and should form the basis for the test objectives/test events and data requirements.

29.2 PREPARATION FOR REPORTING

Test reporting should be well thought out and the test team should generate the test plan with the reporting requirements in mind. (See Section 8). Report generation may start prior to commencement of testing. The introduction section of the report generally reads like a past tense version of the test plan with updated, accurate information. Result and discussion paragraphs may be formed with a fill-in-the blank format including blank tables and figures. The blanks would be filled in once data are collected and analyzed.

29.2.1 Data Collection and Analysis

The test team should construct a data base system to monitor the data collection and analysis effort before any tests are conducted. The data base system can be hard-copy or computer-based. An example of one system is shown below in Table 29-I. Each test point is given a number. Each numbered test point has a description that includes the name of the test, definition of the test configuration (flap position, landing gear position, thrust, gross weight, center of gravity position, autopilot or stability augmentation system

POST-TEST OPERATIONS

status, etc.), and definition of the test condition (airspeed, altitudes, etc.). The first four columns can be completed before the tests begin, using information from the test plan. Each test point should have milestones associated with it to indicate the status of the data. The milestone columns can be filled in with an X or a check as the data collection and analysis effort progresses. Finally, a column that references the applicable civil or military certification, authority, specification, or standard should be contained in the data base.

Table 29-I. Data Collection and Monitoring

Test Point Number	Test Point Description			Data Milestones				Applicable Specification or Standard
	Test Name	Test Configuration	Test Condition	Raw Data Collected	Raw Data Reviewed and Acceptable for Analysis	Raw Data Reviewed and Retest Required	Data Analysis Complete	

Data should be reviewed between flights to determine if it is acceptable for data analysis. More importantly, data review between flights should be a standard routine to satisfy safety-of-flight requirements because the review enhances the test team's ability to detect adverse trends. Whenever possible, data analysis should also be conducted between flights. The test team should not delay review and analysis of data until after the tests are complete because there will likely be pressure to deinstrument the aircraft and turn it over to the contractor, use for other tests, or deliver to the user as soon as tests are completed.

29.2.2 Instrumentation Signal Calibration

Flight test engineers should ensure that instrumentation signals are calibrated prior to flight tests. For long duration projects, longer than 2-3 months, periodic recalibration of instrumentation signals may be required. Upon completion of the flight test, calibration of instrumentation signals, regardless of the duration of the flight tests, is strongly recommended. Guidance for instrumentation signal calibration and recalibration can be found in certain military specifications or industry standards. Further guidance can be found in the AGARDograph 160 series. [29-1] Guidance and advice may also be obtained from the instrumentation engineers or instrumentation department (if your organization has one) and possibly from other senior engineers in your organization. If a telemetry system is used for the flight tests, the test team should verify that correct calibration data are used by the telemetry station for real-time tests and data processing support. This is especially important if data processing has to be repeated or if data is not processed in the order obtained. (See Section 6).

29.2.3 Data Comparison to Test Standards

Once the flight test is completed and all data has been collected and has been corrected for any calibration errors, the flight test engineer/flight test team compares the data with standards or specifications. The standards/specifications may be called out in a contract or other legally binding document. A comparison of collected data with the standards/specifications will determine whether the aircraft/system met its requirements. If the data did not meet the standards/specifications or contract requirements, then contract

penalties may be levied against the contractor, the sponsor may decide not to purchase the aircraft/system/modification, or the sponsor may be willing to accept the aircraft/system/modification as it is because it may be a significant improvement over existing operating systems even though it doesn't meet specifications.

29.2.4 Identification of Enhancing or Deficient Characteristics

Determination of contract compliance through satisfaction of military or civil certification authority specifications or standards is only part of the task assigned to the test team. The test team should also attempt to identify enhancing characteristics. Identification and reporting of enhancing and/or deficient characteristics enables the program sponsor's agency to incorporate the enhancing design features in future acquisition programs and may bode well for the success of the acquisition of the system under test. Identification of deficient characteristics early in a test program may lead to corrective action of a significant problem when correction may be less expensive. In addition, the test team should identify mission relatable deficiencies. A simple case of specification noncompliance that does not negatively impact performance of the mission is not necessarily a deficiency; however, it should still be brought to the attention of the test sponsor. A deficiency must negatively impact performance of the aircraft's intended mission. Each test activity will have established guidelines for categorizing deficiencies and recommending correction of deficiencies. Identification and reporting of mission relatable deficiencies enables the program sponsor's agency to seek contract penalties if the deficiency can be related to specification noncompliance. The test team should also recommend fixes to deficiencies if they are known. Test aircrew should be required to document enhancing characteristics and deficiencies in their individual daily flight reports since the enhancing characteristics and deficiencies are generally obvious to the aircrew.

29.3 REPORTING

29.3.1 Requirements

Reports are usually documentary response to a sponsor (customer) and thus, should meet the sponsor's requirements. Additionally, the team should write daily reports for their own use to track test program progress. The tester should meet with the sponsor during the test planning phase to determine report requirements so tests and reports can be tailored to meet those requirements. The reporting process should address report types, timing, frequency, content, and priority. Reports should be clear, concise, logically organized, and include information of value to the end user. Reports should provide a balanced and complete assessment.

29.3.2 Daily Report

Informal daily reports, which document day-to-day test program activity, should be written with as much technical detail as possible to facilitate smooth transition to a formal report. The daily report, which may include a flight report, should include qualitative and editorial comments to allow more accurate recall when formalizing the final technical report.

29.3.3 Flight Report

Test aircrew should document the results of each flight in a flight report. The content of the flight report should be detailed enough to allow the flight test engineers to write the final report without direct assistance by the aircrew. The report should focus on aircrew comments that can be used to mission relate the data (explain how the test results will impact performance of the mission), aircrew comments about the adequacy of flight manual operating procedures or recommended changes to the procedures, and

documentation of deficiencies and enhancing characteristics. The flight report should be provided to the flight test engineers and read by them prior to the next flight.

29.3.4 Quick Reaction Report

A quick reaction report is a concise report which is designed to provide a rapid response to the sponsor. The report should be short and usually does not contain detailed technical information but provides important results with specific conclusions and recommendations. The sponsor often uses quick reaction reports as a decision making tool. Be careful to send verifiable facts and follow-up with corrected information, if necessary.

29.3.5 Oral Report

Oral reports are an effective way to present test results. The test team may need to communicate test results quickly to allow the sponsor to make timely decisions. Oral reports may be used as regular progress reports or executive level briefs. The test team needs to know the target audience (sponsor, technical cadre, executives, government, industry, etc.) when preparing the report. Oral reports should use visual aids (e.g., overhead slides) to guide the audience through the report, and a hard copy of presentation material should be provided when possible.

The most important part of an oral report is preparation which includes formulating a preliminary plan (i.e., objectives, main ideas, and supporting information), preparing an outline (logical organization, easy to follow format, presentation of the data report, then summarize the report), preparing prompter cards and practicing the presentation. Ensure familiarity with the subject and talk to the audience using the outline (do not read). Slides should be simple, uncluttered, and highlight the most important items. Again, be careful to report only verifiable information and provide corrected information, if necessary.

29.3.6 Technical Report

A technical report encompasses the evaluated relevant facts drawn from the assigned technical investigation and stands as a permanent official record in a formal document. The primary purpose of the technical report is to disseminate the results of a technical investigation in an orderly manner and to form an authoritative basis upon which program decisions may be made. The technical report contains detailed technical information and may have lasting value as a historical document. The technical report background, purpose, description of aircraft/equipment, scope and method of test information should come directly from the test plan. However, the information should be updated for the report, if necessary, to accurately reflect the test specifics. The remainder of the report will include results and discussion, conclusions, and recommendations.

29.3.6.1 Executive Summary. An Executive summary should be included to provide a "thumb-nail" sketch of the report contents.

29.3.6.2 Background. The background should address how and why the test program came into being. Provide a historical development of sequences leading up to the evaluation. Reference previous relevant reports and documents. Cite the authorization to conduct the evaluation (e.g., sponsor tasking).

29.3.6.3 Purpose/Objectives. The purpose should be a clear and concise statement, defining what was expected to be learned from the tests.

29.3.6.4 Description of Aircraft/Equipment. Tailor the description to describe what was tested. If the article under test is expected to be representative of a production version, describe the aircraft, system, subsystem, or equipment which it represents as well as the test article itself. Include significant differences between the test article and production version. If the test article was an airborne system, describe the aircraft on which it was tested as well as for the aircraft for which it was designed (if different). Photographs, drawings, schematics, etc., may be used if feasible. Reference other documents, manuals, or reports for detailed descriptions.

29.3.6.5 Scope of Tests. Scope of tests summarizes what tests were conducted. A table is an effective way to present scope of tests and may include the following:

- Specific tests and test limitations
- Class of aircraft
- Number of wind tunnel, laboratory, ground, and flight hours
- Test configurations (aircraft, hardware, software, etc.)
- Test loadings (external to the aircraft)
- Test envelope and restrictions
- Specific test altitudes, airspeeds, gross weights, CG position, etc.
- Weather conditions (if test results are affected)
- Test standards and specifications
- Other conditions which may effect test results

29.3.6.6 Method of Test. Method of tests details how the tests were conducted. Describe actual test procedures for new or unique test methods and data analysis techniques. Also, describe special test facilities, equipment, instrumentation, and support used. Methods may be included by reference to other documents. Reference the Cooper-Harper scale for flying qualities.

29.3.6.7 Chronology. A chronology, which may be used for extensive test programs, describes when tests were conducted. It includes major milestones such as test article delivery date, start and finish of ground, laboratory, wind tunnel, and flight tests, interim reports, and completion of data analysis.

29.3.6.8 Results and Discussion. Results and discussion present the detailed technical test results (what happened?). They should be organized logically to allow easy reader comprehension. Present subsections in a logical order with the most important items discussed first in each subsection. The discussion should present adequate support of the eventual conclusions and recommendations. Discussion may include establishing test conditions; presenting and analyzing data, relating results to the mission, concluding, recommending, and citing standard comparison. Provide a balanced and complete assessment and indicate a confidence level of specific results.

29.3.6.9 Conclusions. Conclusions provide meaning to the results (so what?). A general conclusion is a concise statement that responds directly to the test purpose. Ensuing (specific) conclusions may provide amplification and limitations on the general conclusion; however, this section should only present information that was discussed previously in the report. Specific conclusions may address enhancing, satisfactory, and deficient characteristics. Statements regarding specification conformance/non-conformance should complete this section.

29.3.6.10 Recommendations. Recommendations should be based on the conclusions and should be a fallout of the tests. A general recommendation is a concise statement regarding further actions required.

POST-TEST OPERATIONS

Ensuing (specific) recommendations may provide amplification on the general recommendation; however, this section should only present information that was discussed previously in the report. Recommendations should be included to cover such items as Flight Manual restrictions. Provide information to resolve problems and explain implications of results.

29.3.6.11 Propose Corrections. The test team understands the aircraft/system under test and the operating conditions under which it will be used; therefore, they may be the best group to propose correction to deficient characteristics. However, the test team should work closely with the aircraft/system design engineers to explore technical options and ensure practical corrections.

29.3.7 Retest

A recommendation may be to retest the aircraft/system once corrections are implemented. The test team needs to inform the sponsor of what will comprise the retest. This information may include an estimated scope of test, timing when testing should commence, and any change to initial agreements with the sponsor.

29.3.8 Archive Data

Reports and data may be archived for future reference. These archives provide reference for future similar test efforts. Reports may include formal and informal, technical, quick reaction, daily, etc. Data may include raw and smooth, magnetic, hard copy, project notebook, etc. A frustrating and challenging part of archiving reports is providing an effective and useful cataloging system. Previous reports and data may assist the test team prepare for a test evolution, but the test team may not be aware that such reports and data exist, let alone know where to find the reports and data.

29.3.9 Distribution of Data/Reports

Distribution of data and reports may be dictated by the sponsor. However, test results, conclusions, and more importantly lessons learned may be shared, at the discretion of the sponsor or test authority, with other test programs, test organizations, and, if important, to industry in general, to preclude pitfall duplication.

29.3.10 Technical Memoranda

Technical memoranda may be used to publish results of scientific, engineering, technical investigations, and test by-products. Examples are the publication of unique data, instrumentation concepts or procedures, new test methods and data analysis techniques, new evaluation techniques, lessons learned, professional papers, etc.

29.4 SPECIAL CONSIDERATIONS

A close working relationship is required between different test disciplines so a coherent report may be compiled by the team leader. This relationship needs to begin as soon as the test team is identified. The team leader needs to ensure all team members are aware of their testing and reporting responsibilities so the risk of inadvertently overlooking a technical issue is minimized.

A comprehensive project notebook is required to organize test program information and allow easy compilation of report inputs.

Ensure the entire test team is aware of the "big picture" not only their test discipline. This will reduce the risk of having an issue fall through the cracks and will also reinforce the fact that all team members are critical to the success of an entire test program.

Informally keep the sponsor aware of test program developments. The sponsor should not be surprised by anything in a written report.

29.5 CONCLUDING REMARKS

The key to a successful test program is communication of test progress and results along with credible conclusions and recommendations. The sponsor needs to make programmatic decisions based on this communication. So, know exactly what the sponsor's reporting requirements/criteria are and structure the test plan, testing, and reporting around those requirements.

29.6 ACKNOWLEDGEMENT

Mr. Robert A. Russell, Technical Director, US Naval Test Pilot School, was a major contributor to all portions of this Section.

29.7 REFERENCES

[29-1] AGARDograph 160 "AGARD Flight Test Instrumentation Series".

29.8 BIBLIOGRAPHY

NAVAIRTESTCEN INST 3960.9C, "Instructions for Submission of BIS Yellow Sheet Reports", 20 December 1988.

NAVAIRTESTCEN INST 5213.3F, "Naval Air Test Center Technical Reports; Preparation of", 16 August 1984.

Naval Air Warfare Center (NAWC) Flight Test Engineering Group (FTEG) Instruction (INST) 5214.1, "Report Policy", 20 May 1992.

NAWC Force Warfare (FW) INST 3960.2A, "Force Warfare Aircraft Test Directorate Project Engineer's Guide".

NAWC FW NOTICE 5213, "Report Policy", 25 November 1991.

NAWC FW CHIEF PROJECTS NOTE #93-15, "FW RTR/QRR Checklist", 17 May 1993.

US Naval Test Pilot School (USNTPS) INST 5213.3B, "Report Writing Instruction", 1 December 1987.

U.S. Government Printing Office, "Style Manual", March 1984.

AF Flight Test Center, AFFTC-TIH-88-002 "The Author's Guide to Writing AFFTC Technical Reports", Rev 3, January 1993.

American National Standard for Information Sciences, ANSIZ39.18-1987, "Scientific and Technical Reports - Organization, Preparation, and Production".



Chapter 30 – FUTURE TRENDS

R.R. Hildebrand

US Air Force Flight Test Center
Edwards AFB, CA 93524-1031
USA

30.0 INTRODUCTION

The world of the Flight Test Engineer (FTE) has always been one of change. Looking back, the Wright Brothers' first flight in 1903 did not have a test range (although they did measure the distance flown - probably with a surveyor's chain - and took documentary pictures) nor did they have any special flight test instrumentation. Up until the first supersonic flight in 1947, there was little call for aircraft range support or for special instrumentation - the instrumentation system was notes on a pilot's or engineer's knee-board, or photographs of the pilot's panel or a duplicate set of the pilot's instruments. However, with the rapidly growing capability and complexity of the test aircraft, it was now necessary to provide an "automated" means of acquiring the data that was changing too fast for the pilot to record it and consequently, photo-observer panels and/or oscillographic recorders became common. The advent of missiles required the development of telemetry and accurate real-time Time-Space-Position Information (TSPI). With the advent of the "X" type aircraft and their high risk missions, the use of telemetry to provide pilot advisory information, assist in flight safety, and to assure that data were obtained became commonplace. The introduction of tape systems, computers, and miniaturized components also drove the need for more sophistication in the range - acquiring telemetry data in ever increasing quantities, rates, and accuracy, using space positioning instrumentation to provide TSPI rather than just providing pointing or air traffic control, etc. The advent of large missiles and space flight required another large step in the complexity and quantity of instrumentation and expanded range capability.

There was a major change in flight testing and the FTEs job resulting from the marriage of digital data recording and computer processing. Reading film and analog traces, manipulating data using slide-rules and mechanical calculators, and then hand-plotting the results quickly became a thing of the past. Instead the FTEs "got anything they wanted/plotted any way they wanted it". This massive increase in data, almost immediate availability in engineering units or reduced to standard day conditions, and plotted in a desired format changed the face of flight testing in that post-flight data processing and reporting was no longer seen as the critical path. The FTE is under increasing pressure to adopt a "pre-programmed" approach and minimize the number of sorties flown to achieve a given objective. "Simple" go/no-go criteria are preferred to extended team discussions of interim results before proceeding to the next sortie.

This section will discuss the trends that are occurring in the test community today that will impact the processes whereby the FTE accomplishes his work.

30.1 NEAR-FUTURE ENVIRONMENT

30.1.1 Nature of Systems to be Tested

The majority of the near-term workload for most FTEs will be testing upgrades to the systems/subsystems that are currently in operational use or are about to become operational. However, for both the near- and far-term future, there will be heavy emphasis on highly integrated, adaptive, software intensive avionics and electronic warfare systems that will generate data bus rates from 5 to 60 million bits per second. The advent of these highly integrated, software intensive systems complicates the flight testing task because of the almost infinite matrix of modes, capabilities, failure states, etc., and the relative ease with which they

can be changed. Proper software validation is critical, driven not only by safety conditions but also by the simple economics of bounding the flight test program.

A different type of workload will result with the advent of hypersonic aircraft such as the National Aerospace Plane (NASP) and the horizontal take-off and landing Single Stage to Orbit (SSTO) vehicle, particularly from the standpoint of the ground support required. While existing "range" capabilities will continue to be used, the required areas of coverage and the rates at which data are acquired will be greatly expanded. Interneting of numerous ranges will become commonplace. Data compatibility will be a major issue for the FTE. The far-term trend will probably be to move directly from computational fluid dynamics to flight tests with no intermediate capability to evaluate reactions of the vehicle, i.e., there will be no wind tunnel capability to evaluate the vehicle over much of its flight regime before the actual flight test is performed. The test engineer will have to be very concerned with model validation, testing build-up sequences, and establishing test profiles to ensure acquisition of data.

30.1.2 Nature of the Testing Tools

Flight test support capabilities have been experiencing many exciting and challenging growth requirements in the recent past. Some requirements such as vastly increased telemetry rates, improved TSPI accuracy and area of coverage, laser testing capability, expanded weapon footprint, etc., fall into the "traditional" range capability category. These will need to be accommodated and will drive evolutionary improvements and expansions.

Aircraft modification programs will probably not "stress" the capabilities of the test engineers nor their existing supporting test capabilities that have supported the major weapon systems development programs. However, many of these tests may provide little advance notice of support requirements. The FTEs and their managers need to devise ways to make their test capabilities more responsive. For example, it would appear prudent to continue to refine "strap down" airborne instrumentation systems with the capability to readily interface with the standard data busses. The use of "stick on" telemetry capabilities and non-intrusive data sensors may offer a "quick reaction" capability.

Many of the US ranges are expected to be netted, by the late 1990s, using satellite and fiber-optic transmission of data in order to provide the most efficient utilization of range capabilities. It will be possible to link other facilities (contractor, other test activities, and project offices) into the real-time test environment. With the advent of netting of test capabilities and the increased capability of personal work stations, much analysis will be done in real time at remote locations. Many of the specialists who have in recent years been located in the test control rooms will be located at diverse sites. This will emphasize the need for ensuring that test data is carefully and completely catalogued to ensure that all data users understand what data they are working with and what the limitations of the data are.

Networking between the ranges will require that a common scheduling system, data formats, data base standards, etc., be developed to assure that data can be quickly and effectively transmitted to all users in a readily usable format. In addition, all of this data must be handled in a secure fashion to avert compromise. The scheduling of this netted range will be a large challenge that is not capable of being handled in a timely fashion using current techniques. However, developments in the Artificial Intelligence (AI) technology and its application to an AI-based automated scheduling approach may provide a usable capability.

To enable satellites to be used for flight test, there is a need to develop a small, light, upward looking-antenna which can track a satellite and handle huge amounts of data. However, this antenna must not affect the characteristics of the test vehicle (especially those associated with "low-observable" technology).

It is virtually impossible (and it would be prohibitively expensive) to provide the many threats and cooperative forces needed to test under representative operational conditions the total offensive, defensive, and communications capabilities of the current (and likely future) highly integrated military systems. Therefore, the ability to fully exercise the total capabilities of the new highly integrated systems is virtually impossible to provide on open air ranges, especially from a cost standpoint. Therefore, it has become necessary to provide secure simulation/stimulation facilities for evaluating software intensive systems and highly integrated avionics in conjunction with flight tests.

Fully integrated simulation/stimulation facilities are needed where the full scale aircraft can be immersed in an environment that is as close to the "worst-case real world" full spectrum electromagnetic environment as is economically feasible. The facilities will need to provide, in addition to the electromagnetic environment, the capability to make all aircraft systems react as if they were in an aircraft in flight (with the exception of aerodynamic and acceleration forces). All aircrew members must be able to interact with the aircraft systems either in the actual aircraft or through geometrically correct cockpits in inter-netted simulators.

Although these latter capabilities are not "traditional" range systems they will be as necessary for the safe and efficient conduct of flight tests as are the more traditional capabilities such as TSPI and real-time data.

Technology is also aiding the engineer needing quick, inexpensive (relatively speaking) test results. Cassette recorders, recording data from on-board data busses and production instrumentation are already available. Sensors are getting smaller, cheaper, and more accurate. "Canned" flight test analysis routines are becoming available commercially. These trends are expected to continue.

30.2 IMPACTS ON THE FLIGHT TEST ENGINEERS' TASKS

All of these changes in systems and support capabilities have a direct impact on how the FTE gets his tasks accomplished. In many ways the FTE's job is becoming much more complex.

- He must deal with aircraft that are much more complex and with greater capabilities.
- The test engineer must work closely with his customer and the supporting engineers to clearly identify his test support needs and participate in developing usable, practical solutions.
- He is working with a complex data acquisition and processing system with distributed data processing. He must understand the impacts on the supporting activities when he makes data requests and specifies data sampling rates, data accuracies, data turn-around, etc. He must understand what is happening to his data throughout all of these processes so that he can verify that the answers he receives truly are the result of the test conducted and are not improperly influenced by data processing techniques. He must control cost by ensuring that he asks for only the data that is needed - data processing is expensive and often time consuming. And above all, he must ensure that other users of the test data understand what data they are actually working with and what the limitations of the data are.
- He will be working with more complex ranges and range scheduling systems. He must work with the range personnel to combat the continuing encroachments on the "traditional" test areas. He will also have to face and help resolve the increasing environmental impacts issues, i.e., noise, sonic booms, hazardous waste management/disposal, electromagnetic emissions, etc., raised by surrounding communities.
- The data from simulation/stimulation facilities has to be incorporated into the test data base. These same data must be used to extrapolate into untested flight regimes and also utilized to define the operational characteristics and capabilities of the aircraft.

FUTURE TRENDS

- The risk analyses for aircraft such as the NASP will have to consider many more variables such as ensuring that there is always a suitable landing facility available in the event of a power loss during any portion of the test profile which may cover most of the earth.
- The FTE must be prepared for and help facilitate the greater emphasis on operationally representative testing as the "final examination" of the system.
- Testing must progress through many steps or stages. The first steps include modeling and simulation (i.e., computational fluid dynamics and wind tunnel), and there is an ever increasing emphasis on both. These steps are followed by tests of components in integration laboratories, subsystem testing in hardware-in-the-loop facilities, and full system testing in installed system test facilities. The final step is the open air range testing. The results from each stage feed back to improve the fidelity and validity of previous steps. They also feed forward in predicting what will happen in subsequent tests. The FTE must understand and facilitate this entire process.

30.3 CONCLUDING REMARKS

The role of the Flight Test Engineer (FTE) has been constantly changing. Technology continues to provide capabilities undreamed of four decades ago. Every advance in aeronautics, electronics, instrumentation, range capability, simulation, data processing, etc., has required the FTE to modify his procedures and change the fashion in which he interfaced with the pilot and the various people who have supported the aircraft tests. In addition, because of the rapid diversification and specialization of these disciplines, the FTE will have to interface with the various specialists during test activities as well as during pre- and post-flight phases. This rate of change in the various disciplines and in the number of people with whom the FTE has to interface has been accelerating and will continue to accelerate in the future. It has always been so and always will.

EPILOGUE

The intent of this volume is to provide the novice Flight Test Engineers (FTEs), or those who have a need to be conversant with flight test techniques, a perspective or framework with which to assess the needs of their particular program and put together an executable plan to achieve those goals. The format for preparing this volume was presented in the Foreword.

Flight test, by definition, is exploring the unknown and the skilled test pilot is an indispensable part of the team which includes the pilot, systems operator, FTE, and personnel from supporting disciplines. Quite often, it is the pilot who first identifies anomalies. The entire test team must then seek answers/solutions. The FTEs must always expect the unexpected and, when it occurs, be prepared to exploit the event to better define capabilities or limitations.

There is a continuing need to keep the ever impressive capabilities of modern data acquisition and processing facilities firmly in their place as the servants, and not the masters, of the FTEs. Remember, computers are capable of implementing both correct and incorrect decisions at incredible rates of speed and precision!

It is the hope of this editor, the authors of the various sections, and the AGARD Flight Test Editorial Committee that this volume will prove useful to our audience no matter how the technology and the environment change. Our greater hope is that this volume will assist the new FTE in meeting the challenges of the future.



Annex – AGARD and RTO Flight Test Instrumentation and Flight Test Techniques Series

1. Volumes in the AGARD and RTO Flight Test Instrumentation Series, AGARDograph 160

Volume Number	Title	Publication Date
1.	Basic Principles of Flight Test Instrumentation Engineering (Issue 2) Issue 1: Edited by A. Pool and D. Bosman Issue 2: Edited by R. Borek and A. Pool	1974 1994
2.	In-Flight Temperature Measurements by F. Trenkle and M. Reinhardt	1973
3.	The Measurements of Fuel Flow by J.T. France	1972
4.	The Measurements of Engine Rotation Speed by M. Vedrunes	1973
5.	Magnetic Recording of Flight Test Data by G.E. Bennett	1974
6.	Open and Closed Loop Accelerometers by I. McLaren	1974
7.	Strain Gauge Measurements on Aircraft by E. Kottkamp, H. Wilhelm and D. Kohl	1976
8.	Linear and Angular Position Measurement of Aircraft Components by J.C. van der Linden and H.A. Mensink	1977
9.	Aeroelastic Flight Test Techniques and Instrumentation by J.W.G. van Nunen and G. Piazzoli	1979
10.	Helicopter Flight Test Instrumentation by K.R. Ferrell	1980
11.	Pressure and Flow Measurement by W. Wuest	1980
12.	Aircraft Flight Test Data Processing – A Review of the State of the Art by L.J. Smith and N.O. Matthews	1980
13.	Practical Aspects of Instrumentation System Installation by R.W. Borek	1981
14.	The Analysis of Random Data by D.A. Williams	1981
15.	Gyroscopic Instruments and Their Application to Flight Testing by B. Stieler and H. Winter	1982
16.	Trajectory Measurements for Take-off and Landing Test and Other Short-Range Applications by P. de Benque D'Agut, H. Riebeek and A. Pool	1985
17.	Analogue Signal Conditioning for Flight Test Instrumentation by D.W. Veatch and R.K. Bogue	1986
18.	Microprocessor Applications in Airborne Flight Test Instrumentation by M.J. Prickett	1987
19.	Digital Signal Conditioning for Flight Test by G.A. Bever	1991
20.	Optical Air Flow Measurements in Flight by R.K. Bogue and H.W. Jentink	2003

2. Volumes in the AGARD and RTO Flight Test Techniques Series, AGARDograph 300

Volume Number	Title	Publication Date
AG237	Guide to In-Flight Thrust Measurement of Turbojets and Fan Engines by the MIDAP Study Group (UK)	1979

The remaining volumes are published as a sequence of Volume Numbers of AGARDograph 300.

1.	Calibration of Air-Data Systems and Flow Direction Sensors by J.A. Lawford and K.R. Nippres	1988
2.	Identification of Dynamic Systems by R.E. Maine and K.W. Iliff	1988
3.	Identification of Dynamic Systems – Applications to Aircraft Part 1: The Output Error Approach by R.E. Maine and K.W. Iliff	1986
	Part 2: Nonlinear Analysis and Manoeuvre Design by J.A. Mulder, J.K. Sridhar and J.H. Breeman	1994
4.	Determination of Antenna Patterns and Radar Reflection Characteristics of Aircraft by H. Bothe and D. McDonald	1986
5.	Store Separation Flight Testing by R.J. Arnold and C.S. Epstein	1986
6.	Developmental Airdrop Testing Techniques and Devices by H.J. Hunter	1987
7.	Air-to-Air Radar Flight Testing by R.E. Scott	1992
8.	Flight Testing under Extreme Environmental Conditions by C.L. Henrickson	1988
9.	Aircraft Exterior Noise Measurement and Analysis Techniques by H. Heller	1991
10.	Weapon Delivery Analysis and Ballistic Flight Testing by R.J. Arnold and J.B. Knight	1992
11.	The Testing of Fixed Wing Tanker & Receiver Aircraft to Establish Their Air-to-Air Refuelling Capabilities by J. Bradley and K. Emerson	1992
12.	The Principles of Flight Test Assessment of Flight-Safety-Critical Systems in Helicopters by J.D.L. Gregory	1994
13.	Reliability and Maintainability Flight Test Techniques by J.M. Howell	1994
14.	Introduction to Flight Test Engineering Edited by F. Stoliker	1995
15.	Introduction to Avionics Flight Test by J.M. Clifton	1996
16.	Introduction to Airborne Early Warning Radar Flight Test by J.M. Clifton and F.W. Lee	1999
17.	Electronic Warfare Test and Evaluation by H. Banks and R. McQuillan	2000
18.	Flight Testing of Radio Navigation Systems by H. Bothe and H.J. Hotop	2000
19.	Simulation in Support of Flight Testing by D. Hines	2000

- | | | |
|-----|--|------|
| 20. | Logistics Test and Evaluation in Flight Testing
by M. Bourcier | 2001 |
| 21. | Flying Qualities Flight Testing of Digital Flight Control Systems
by F. Webster and T.D. Smith | 2001 |
| 22. | Helicopter/Ship Qualification Testing
by D. Carico, R. Fang, R.S. Finch, W.P. Geyer Jr., Cdr. (Ret.) H.W. Krijns and
K. Long | 2002 |
| 23. | Flight Test Measurement Techniques for Laminar Flow
by D. Fisher, K.H. Horstmann and H. Riedel | 2003 |



REPORT DOCUMENTATION PAGE			
1. Recipient's Reference	2. Originator's References	3. Further Reference	4. Security Classification of Document
	RTO-AG-300 AC/323(SCI-FT3)TP/74 Volume 14	ISBN 92-837-1126-2	UNCLASSIFIED/ UNLIMITED
5. Originator			
Research and Technology Organisation North Atlantic Treaty Organisation BP 25, F-92201 Neuilly-sur-Seine Cedex, France			
6. Title			
Introduction to Flight Test Engineering			
7. Presented at/Sponsored by			
The Flight Test Technical Team (FT3) of the Systems Concepts and Integration Panel (SCI) of the RTO.			
8. Author(s)/Editor(s)			9. Date
Mr. Fred Stoliker			July 2005
10. Author's/Editor's Address			11. Pages
808 Skeel Dr. Camarillo, CA 93010, USA			456
12. Distribution Statement			
There are no restrictions on the distribution of this document. Information about the availability of this and other RTO unclassified publications is given on the back cover.			
13. Keywords/Descriptors			
Aerodynamic stability	Certification	Hydraulic equipment	Specifications
Aeroelasticity	Data acquisition	Methodology	Strain measurement
AGARD	Experimental data	Operational effectiveness	Systems analysis
Airborne equipment	External stores	Project management	Test equipment
Aircraft	Flight control	Project planning	Test facilities
Aviation safety	Flight maneuvers	Reporting	
Avionics	Flight tests	Safety engineering	
14. Abstract			
<p>This is the Introductory Volume to the Flight Test Techniques Series. It is a general introduction to the various activities and aspects of Flight Test Engineering that must be considered when planning, conducting, and reporting a flight test program. Its main intent is to provide a broad overview to the novice engineer or to other people who have a need to interface with specialists within the flight test community.</p> <p>The first two Sections provide some insight into the question of why flight test and give a short history of flight test engineering. Sections 3 through 10 deal with the preparation for flight testing. They provide guidance on the preliminary factors that must be considered; the composition of the test team; the logistic support requirements; the instrumentation and data processing requirements; the flight test plan; the associated preliminary ground tests; and last, but by no means least, discuss safety aspects.</p> <p>Sections 11 through 27 describe the various types of flight tests that are usually conducted during the development and certification of a new or modified aircraft type. Each Section offers a brief introduction to the topic under consideration, and the nature and the objectives of the tests to be conducted. It lists the test instrumentation (and, where appropriate, other test equipment and facilities) required, describes the test maneuvers to be executed, and indicates the way in which the test data is selected, analyzed, and presented.</p> <p>The various activities that should take place between test flights are presented next. Items that are covered are: who to debrief; what type of reports to send where; types of data analysis required for next flight; review of test data to make a comparison to predicted data and some courses of action if there is not good agreement; and comments on selecting the next test flight.</p> <p>The activities that must take place upon completion of the test program are presented. The types of reports and briefings that should take place and a discussion of some of the uses of the flight test data are covered.</p> <p>A brief forecast is presented of where present trends may be leading.</p> <p>This AGARDograph was sponsored by the Flight Vehicle Integration Panel of AGARD and the Systems Concepts and Integration Panel (SCI) of the RTO.</p>			





BP 25
F-92201 NEUILLY-SUR-SEINE CEDEX • FRANCE
Télécopie 0(1)55.61.22.99 • E-mail mailbox@rta.nato.int



DIFFUSION DES PUBLICATIONS
RTO NON CLASSIFIEES

Les publications de l'AGARD et de la RTO peuvent parfois être obtenues auprès des centres nationaux de distribution indiqués ci-dessous. Si vous souhaitez recevoir toutes les publications de la RTO, ou simplement celles qui concernent certains Panels, vous pouvez demander d'être inclus soit à titre personnel, soit au nom de votre organisation, sur la liste d'envoi.

Les publications de la RTO et de l'AGARD sont également en vente auprès des agences de vente indiquées ci-dessous.

Les demandes de documents RTO ou AGARD doivent comporter la dénomination « RTO » ou « AGARD » selon le cas, suivi du numéro de série. Des informations analogues, telles que le titre est la date de publication sont souhaitables.

Si vous souhaitez recevoir une notification électronique de la disponibilité des rapports de la RTO au fur et à mesure de leur publication, vous pouvez consulter notre site Web (www.rta.nato.int) et vous abonner à ce service.

CENTRES DE DIFFUSION NATIONAUX

ALLEMAGNE

Streitkräfteamt / Abteilung III
Fachinformationszentrum der
Bundeswehr (FIZBw)
Friedrich-Ebert-Allee 34, D-53113 Bonn

BELGIQUE

Etat-Major de la Défense
Département d'Etat-Major Stratégie
ACOS-STRAT – Coord. RTO
Quartier Reine Elisabeth
Rue d'Evère, B-1140 Bruxelles

CANADA

DSIGRD2
Bibliothécaire des ressources du savoir
R et D pour la défense Canada
Ministère de la Défense nationale
305, rue Rideau, 9^e étage
Ottawa, Ontario K1A 0K2

DANEMARK

Danish Defence Research Establishment
Ryvangs Allé 1, P.O. Box 2715
DK-2100 Copenhagen Ø

ESPAGNE

SDG TECEN / DGAM
C/ Arturo Soria 289
Madrid 28033

ETATS-UNIS

NASA Center for AeroSpace
Information (CASI)
Parkway Center, 7121 Standard Drive
Hanover, MD 21076-1320

FRANCE

O.N.E.R.A. (ISP)
29, Avenue de la Division Leclerc
BP 72, 92322 Châtillon Cedex

GRECE (Correspondant)

Defence Industry & Research
General Directorate, Research Directorate
Fakinos Base Camp, S.T.G. 1020
Holargos, Athens

HONGRIE

Department for Scientific Analysis
Institute of Military Technology
Ministry of Defence
H-1525 Budapest P O Box 26

ISLANDE

Director of Aviation
c/o Flugrad
Reykjavik

ITALIE

Centro di Documentazione
Tecnico-Scientifica della Difesa
Via XX Settembre 123
00187 Roma

LUXEMBOURG

Voir Belgique

NORVEGE

Norwegian Defence Research Establishment
Attn: Biblioteket
P.O. Box 25, NO-2007 Kjeller

PAYS-BAS

Royal Netherlands Military
Academy Library
P.O. Box 90.002
4800 PA Breda

POLOGNE

Armament Policy Department
218 Niepodleglosci Av.
00-911 Warsaw

PORTUGAL

Estado Maior da Força Aérea
SDFA – Centro de Documentação
Alfragide
P-2720 Amadora

REPUBLIQUE TCHEQUE

LOM PRAHA s. p.
o. z. VTÚLaPVO
Mladoboleslavská 944
PO Box 18
197 21 Praha 9

ROYAUME-UNI

Dstl Knowledge Services
Information Centre, Building 247
Dstl Porton Down
Salisbury
Wiltshire SP4 0JQ

TURQUIE

Milli Savunma Bakanlığı (MSB)
ARGE ve Teknoloji Dairesi Başkanlığı
06650 Bakanlıklar – Ankara

AGENCES DE VENTE

NASA Center for AeroSpace Information (CASI)

Parkway Center, 7121 Standard Drive
Hanover, MD 21076-1320
ETATS-UNIS

The British Library Document Supply Centre

Boston Spa, Wetherby
West Yorkshire LS23 7BQ
ROYAUME-UNI

Canada Institute for Scientific and Technical Information (CISTI)

National Research Council
Acquisitions, Montreal Road, Building M-55
Ottawa K1A 0S2, CANADA

Les demandes de documents RTO ou AGARD doivent comporter la dénomination « RTO » ou « AGARD » selon le cas, suivie du numéro de série (par exemple AGARD-AG-315). Des informations analogues, telles que le titre et la date de publication sont souhaitables. Des références bibliographiques complètes ainsi que des résumés des publications RTO et AGARD figurent dans les journaux suivants :

Scientific and Technical Aerospace Reports (STAR)

STAR peut être consulté en ligne au localisateur de ressources uniformes (URL) suivant:

<http://www.sti.nasa.gov/Pubs/star/Star.html>

STAR est édité par CASI dans le cadre du programme NASA d'information scientifique et technique (STI)
STI Program Office, MS 157A
NASA Langley Research Center
Hampton, Virginia 23681-0001
ETATS-UNIS

Government Reports Announcements & Index (GRA&I)

publié par le National Technical Information Service
Springfield

Virginia 2216

ETATS-UNIS

(accessible également en mode interactif dans la base de données bibliographiques en ligne du NTIS, et sur CD-ROM)



BP 25
F-92201 NEUILLY-SUR-SEINE CEDEX • FRANCE
Télécopie 0(1)55.61.22.99 • E-mail mailbox@rta.nato.int



DISTRIBUTION OF UNCLASSIFIED RTO PUBLICATIONS

AGARD & RTO publications are sometimes available from the National Distribution Centres listed below. If you wish to receive all RTO reports, or just those relating to one or more specific RTO Panels, they may be willing to include you (or your Organisation) in their distribution.

RTO and AGARD reports may also be purchased from the Sales Agencies listed below.

Requests for RTO or AGARD documents should include the word 'RTO' or 'AGARD', as appropriate, followed by the serial number. Collateral information such as title and publication date is desirable.

If you wish to receive electronic notification of RTO reports as they are published, please visit our website (www.rta.nato.int) from where you can register for this service.

NATIONAL DISTRIBUTION CENTRES

BELGIUM

Etat-Major de la Défense
Département d'Etat-Major Stratégie
ACOS-STRAT – Coord. RTO
Quartier Reine Elisabeth
Rue d'Evère
B-1140 Bruxelles

CANADA

DRDKIM2
Knowledge Resources Librarian
Defence R&D Canada
Department of National Defence
305 Rideau Street
9th Floor
Ottawa, Ontario K1A 0K2

CZECH REPUBLIC

LOM PRAHA s. p.
o. z. VTÚLaPVO
Mladoboleslavská 944
PO Box 18
197 21 Praha 9

DENMARK

Danish Defence Research
Establishment
Ryvangs Allé 1
P.O. Box 2715
DK-2100 Copenhagen Ø

FRANCE

O.N.E.R.A. (ISP)
29, Avenue de la Division Leclerc
BP 72
92322 Châtillon Cedex

GERMANY

Streitkräfteamt / Abteilung III
Fachinformationszentrum der
Bundeswehr (FIZBW)
Friedrich-Ebert-Allee 34
D-53113 Bonn

GREECE (Point of Contact)

Defence Industry & Research
General Directorate, Research Directorate
Fakinos Base Camp, S.T.G. 1020
Holargos, Athens

HUNGARY

Department for Scientific Analysis
Institute of Military Technology
Ministry of Defence
H-1525 Budapest P O Box 26

ICELAND

Director of Aviation
c/o Flugrad, Reykjavik

ITALY

Centro di Documentazione
Tecnico-Scientifica della Difesa
Via XX Settembre 123
00187 Roma

LUXEMBOURG

See Belgium

NETHERLANDS

Royal Netherlands Military
Academy Library
P.O. Box 90.002
4800 PA Breda

NORWAY

Norwegian Defence Research
Establishment
Attn: Biblioteket
P.O. Box 25, NO-2007 Kjeller

POLAND

Armament Policy Department
218 Niepodleglosci Av.
00-911 Warsaw

PORTUGAL

Estado Maior da Força Aérea
SDFA – Centro de Documentação
Alfragide, P-2720 Amadora

SPAIN

SDG TECEN / DGAM
C/ Arturo Soria 289
Madrid 28033

TURKEY

Milli Savunma Bakanlığı (MSB)
ARGE ve Teknoloji Dairesi Başkanlığı
06650 Bakanliklar – Ankara

UNITED KINGDOM

Dstl Knowledge Services
Information Centre, Building 247
Dstl Porton Down
Salisbury, Wiltshire SP4 0JQ

UNITED STATES

NASA Center for AeroSpace
Information (CASI)
Parkway Center, 7121 Standard Drive
Hanover, MD 21076-1320

SALES AGENCIES

NASA Center for AeroSpace Information (CASI)

Parkway Center
7121 Standard Drive
Hanover, MD 21076-1320
UNITED STATES

The British Library Document Supply Centre

Boston Spa, Wetherby
West Yorkshire LS23 7BQ
UNITED KINGDOM

Canada Institute for Scientific and Technical Information (CISTI)

National Research Council
Acquisitions
Montreal Road, Building M-55
Ottawa K1A 0S2, CANADA

Requests for RTO or AGARD documents should include the word 'RTO' or 'AGARD', as appropriate, followed by the serial number (for example AGARD-AG-315). Collateral information such as title and publication date is desirable. Full bibliographical references and abstracts of RTO and AGARD publications are given in the following journals:

Scientific and Technical Aerospace Reports (STAR)

STAR is available on-line at the following uniform resource locator:

<http://www.sti.nasa.gov/Pubs/star/Star.html>

STAR is published by CASI for the NASA Scientific and Technical Information (STI) Program
STI Program Office, MS 157A
NASA Langley Research Center
Hampton, Virginia 23681-0001
UNITED STATES

Government Reports Announcements & Index (GRA&I)

published by the National Technical Information Service
Springfield
Virginia 2216
UNITED STATES
(also available online in the NTIS Bibliographic Database or on CD-ROM)