

Ford "120"

**4-CYLINDER
INDUSTRIAL ENGINE
MANUAL**



1585
12134
4758

15
12
175
12
812247 3



Water - 9099
4V3
V7/C

POWER RIGHT WITH FORD POWER!



FOR INDUSTRIAL POWER you're *right* 3 important ways when you use Ford Industrial Engines. 1st—the *right* power for your job, with a choice of five great engines. 2nd—the *right* features . . . all the latest advancements of Ford's famed progressive engineering. 3rd—the *right* service . . . convenient, economical, from Ford Dealers everywhere.

For years Ford Industrial Engines have worked farms . . . speeded construction . . . handled materials . . . generated power . . . pumped liquids and cut wood and drilled wells. Power your job *right* with Ford Industrial Engines—right 3 ways!



Ford 120 Four Cylinder Industrial Engine (120 cu. in. displacement)

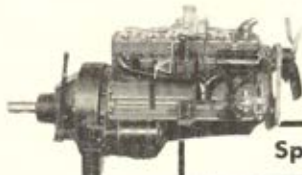

Ford 226 Six Cylinder Industrial Engine (226 cu. in. displacement)

Ford 239 V-8 Industrial Engine (239 cu. in. displacement)

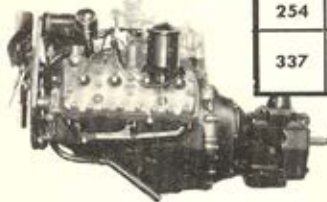

Ford 254 Six Cylinder Industrial Engine (254 cu. in. displacement)



Ford 337 V-8 Industrial Engine (337 cu. in. displacement)

Specifications of Ford Industrial Engines

| Model | Cylinders | Bore and Stroke | Displ. cu. in. | Dyn. B.H.P. | Max. Torque | Auxiliary Equipment Available |
|-------|-----------|----------------------------------|----------------|-------------|--------------|---|
| 120 | 4 | 3 $\frac{3}{8}$ x3 $\frac{3}{4}$ | 120 | 38 @ 2400 | 92#' @ 1600 | Clutch; 3 and 4 speed transmissions; SAE #5 housing and power take-off. Also complete power unit. |
| 226 | 6 | 3.3x4.4 | 226 | 80 @ 2400 | 182#' @ 1200 | Clutch; 3, 4 and 5 speed transmissions; SAE #3 and #4 housings; power take-off. |
| 239 | V-8 | 3 $\frac{3}{8}$ x3 $\frac{3}{4}$ | 239 | 85 @ 2400 | 187#' @ 1600 | |
| 254 | 6 | 3.5x4.4 | 254 | 95 @ 2400 | 212#' @ 1200 | Clutch; 5 speed transmission; direct drive power take-off. |
| 337 | V-8 | 3 $\frac{1}{2}$ x4 $\frac{3}{8}$ | 337 | 117 @ 2400 | 257#' @ 1600 | |

**YOUR JOB IS
WELL-POWERED
WHEN IT'S
FORD-POWERED**



FORD MOTOR COMPANY

INDUSTRIAL AND MARINE ENGINE SALES DEPARTMENT • DEARBORN, MICHIGAN

REPAIR DATA AND SERVICE INFORMATION



INDUSTRIAL ENGINES

8 NNN—FORD "120" 4 CYLINDER

- ★ 7HNN—FORD "226" 6 CYLINDER
- ★ 8MNN—FORD "254" 6 CYLINDER
- ★ 8RNN—FORD "239" V-8 CYLINDER
- ★ 8ENN—FORD "337" V-8 CYLINDER

★ COVERED IN SEPARATE MANUALS

FORD MOTOR COMPANY

Industrial Engine Sales Department
3000 Schaefer Road, Dearborn, Michigan

FOREWORD

This manual contains information and instructions for the overhaul or repair of the Ford 4-cylinder Industrial Engines built since 1947. Due to the differences in the various models using these engines, no attempt has been made in this manual to cover the procedures necessary to remove the engine from the vehicle. The procedures start with the engine already removed.

Each chapter in this manual is divided into sections as shown in the table of contents.

Chapter IV gives fits, tolerances, and wear limits in tabulated form. Maximum clearances are included since it is possible for two parts, either of which is satisfactory for further use when considered alone, to have excessive clearance when used together.

Throughout this book, on the first page of each chapter, a list of the major subjects in the chapter is given, each with an assigned section number.

In the inspection and repair chapter, each section contains complete inspection instructions, with wear limits which clearly point out when a part should be reworked or replaced.

Numbers appearing in the various illustrations in bold type are basic part numbers. When ordering parts from your Ford Dealer by these numbers, specify the type and serial numbers of the Ford Industrial Engine as shown on the name plate.

FORD MOTOR COMPANY
Service Department

CONTENTS

| | Page |
|--|-------|
| FOREWORD..... | II |
| ENGINE IDENTIFICATION and WARRANTY..... | 2 |
| TYPICAL USES OF FORD INDUSTRIAL ENGINES..... | 3 |
| CHAPTER I DESCRIPTION AND DISASSEMBLY..... | 4-9 |
| Section 111 Data..... | 4 |
| 112 Accessory Removal..... | 5 |
| 113 Engine Disassembly..... | 6-9 |
| CHAPTER II INSPECTION AND REPAIR..... | 10-35 |
| Section 121 Crankshaft and Flywheel..... | 10-12 |
| 122 Cylinder Block..... | 12-16 |
| 123 Pistons and Connecting Rods..... | 17-22 |
| 124 Camshaft and Valve Mechanism..... | 22-26 |
| 125 Cylinder Head and Front Cover..... | 26 |
| 126 Oil Pump..... | 26-28 |
| 127 Water Pump..... | 28-30 |
| 128 Governor..... | 30-34 |
| 129 Oil Pan, Intake and Exhaust Manifolds..... | 34-35 |
| CHAPTER III ASSEMBLY OF ENGINE..... | 36-43 |
| Section 131 Assembly..... | 36-42 |
| 132 Installation of Accessories..... | 42-43 |
| CHAPTER IV FITS AND TOLERANCES..... | 44-47 |
| Section 141 Definition of Fits..... | 44-45 |
| 142 Fits and Tolerances..... | 46-47 |
| 143 Torque Wrench Readings..... | 47 |
| 144 Ignition Settings..... | 47 |
| POWER CURVE and SPECIFICATIONS..... | 48 |
| "120" POWER UNIT..... | 49 |
| PREPARATION FOR STORAGE..... | 50 |

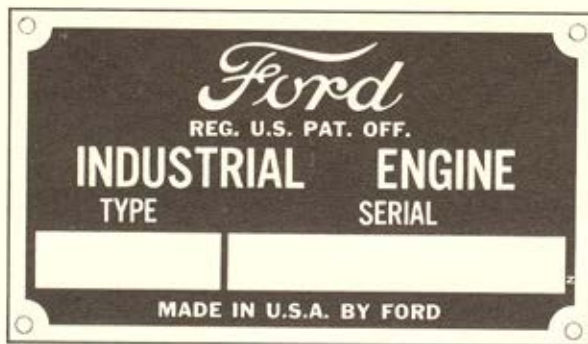

ENGINE IDENTIFICATION. A plate is attached to the Ford Industrial Engine showing type and serial number. When ordering parts for your Ford Industrial Engine, or when carrying on correspondence, be sure to mention the type and serial information stamped on this plate.

WARRANTY

Ford Motor Company, for a period of 6 months from the date of shipment from Ford Motor Company factory of each new Ford industrial engine or power unit, or until 90 days of service by first retail purchaser, whichever shall first occur, warrants each such engine or power unit to be free under normal use and service from defects in material and workmanship. The obligation hereunder is limited to replacement at the factory of manufacture of such parts which shall, within such period, be returned to Ford Motor Company with transportation charges prepaid and which its examination shall disclose to its satisfaction to have been defective. This warranty shall not apply to any such engine or power unit which shall have been repaired or altered outside of the factory of Ford Motor Company in any way so as in its judgment to affect the stability or reliability of such engine or power unit, nor to any such engine or power unit which shall have been subject to misuse, negligence or accident. If the purchaser shall use or permit to be used in such engine or power unit parts not made or supplied by the Ford Motor Company, then this warranty shall become void. This warranty is in lieu of any other warranty expressed or implied and any other obligation or liability on the part of Ford Motor Company and no person is authorized to make any representations beyond those herein expressed.

Ford Motor Company reserves the right to make changes in design and changes or improvements in its products without thus incurring any obligation to install any of such changes or improvements upon its products theretofore manufactured.

FORD MOTOR COMPANY

TYPICAL USES FOR FORD INDUSTRIAL ENGINES

An idea of the serviceability and utility of Ford Industrial Engines is given by the following list of typical uses. These uses include equipment made by many well-known manufacturers who appreciate the precision workmanship which results in exceptional flexibility with reliability that is characteristic of Ford Industrial Engines.

| | |
|--------------------------|-----------------------------|
| Air Compressors | Industrial Pumps |
| Amusement Park Devices | Irrigation Systems |
| Asphalt Distributors | Leaf Collectors |
| Booster Pumps | Light Plants |
| Combines | Logging Yarders and Loaders |
| Cranes | Portable Grain Mills |
| Dehydrators | Portable Saw Mills |
| Dredges | Portable Well Drillers |
| Drilling Rigs | Power Shovels |
| Feed Grinders | Refrigerating Units |
| Fire Pumps | Road Rollers |
| Forage Harvesters | Snow Loaders |
| Fuel Oil Pumps | Soil Pulverizers |
| Gang Mowers | Street Flushers |
| Gas Compressors | Street Sweepers |
| Gasoline Railway Coaches | Truck Tractors |
| Generator Sets | Welders |
| Industrial Lift Trucks | Winches |

To adapt Ford Industrial Engines to these uses they are available with S.A.E. No. 3, No. 4 and No. 5 flywheel housings, power take-off clutches, reduction gear units or heavy duty multi-speed transmissions.

Chapter

I

DESCRIPTION AND DISASSEMBLY

Section

| | |
|-------------------------|-----|
| Data..... | 111 |
| Accessory Removal..... | 112 |
| Engine Disassembly..... | 113 |

The Ford 4-cylinder engine (figs. 1 and 2) is of the L-head type, having all cylinders and the upper half of the crankcase cast in one piece. Steel cylinder sleeves are used, which are easily replaced when rebuilding the engine. The distributor is driven directly from the front end of the camshaft.

III. DATA

| | |
|------------------------------------|-----------------|
| Type..... | L-head |
| Number of cylinders..... | 4 |
| Bore..... | 3.187 in. |
| Piston displacement..... | 119.5 cu. in. |
| Firing order..... | 1-2-4-3 |
| Magneto breaker point setting..... | .016-.018 |
| Magneto timing (cranking)..... | Top dead center |

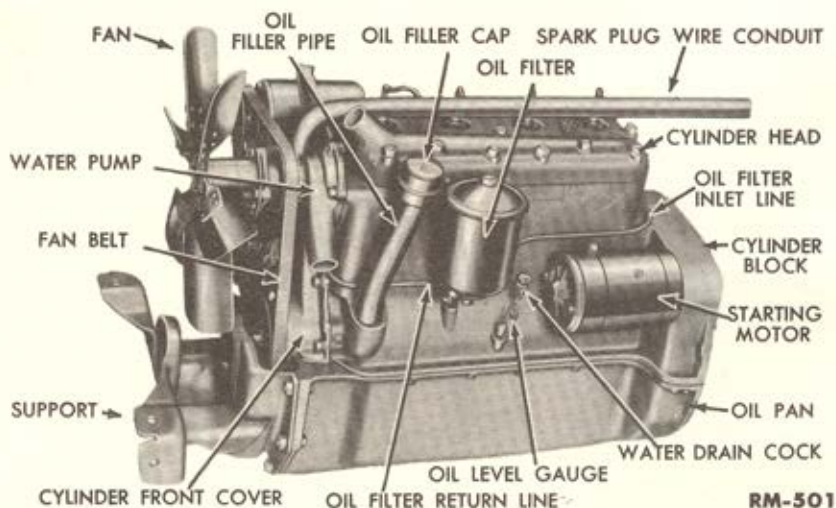

Fig. 1—Left $\frac{3}{4}$ Front View of Engine

§ III.

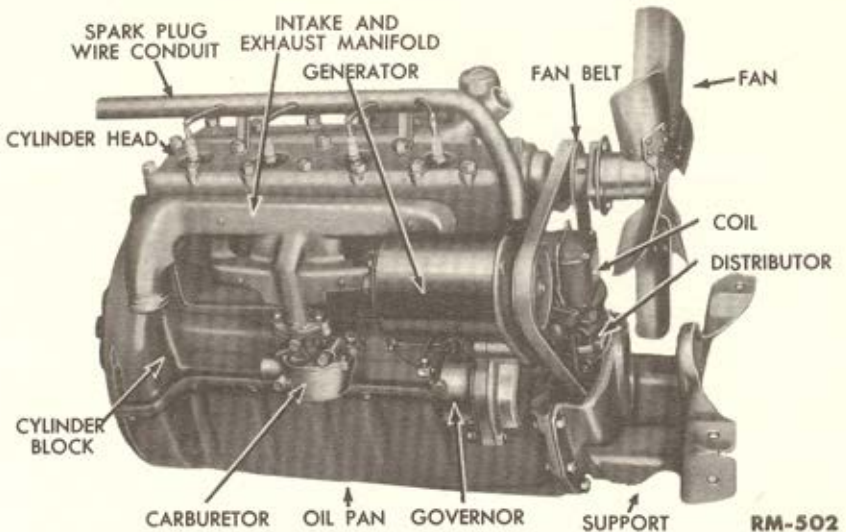

Fig. 2—Right $\frac{3}{4}$ Front View of Engine

Valve stem clearance to push rods:

| | |
|--------------------|--------------------|
| Intake..... | 0.010 to 0.012 in. |
| Exhaust..... | 0.014 to 0.016 in. |
| Valve lifters..... | Non-adjustable |

112. ACCESSORY REMOVAL.

In the disassembly procedures throughout this manual, disassembly is carried out only to the extent necessary for complete inspection of the parts subject to wear. The replacement or repair of the individual parts thus inspected is referred to as repair.

a. Remove Generator. Remove the nuts that secure the generator adjustment bracket to the timing gear side cover and generator. Disconnect the generator wiring. Remove the bolt and washer that secure the generator to the cylinder front cover, and remove the generator (fig. 2).

b. Remove Oil Filter. Disconnect the oil inlet line at the cylinder block. Disconnect the oil return line from the governor. Remove the two cap screws that secure the oil filter bracket to the cylinder head. Remove the oil filter and lines (fig. 1).

c. Remove Distributor and Spark Plug Wires. Remove the two nuts that secure the spark plug wire conduit to the cylinder head. Remove the two cap screws and lock washers that secure the

§ 112. c.

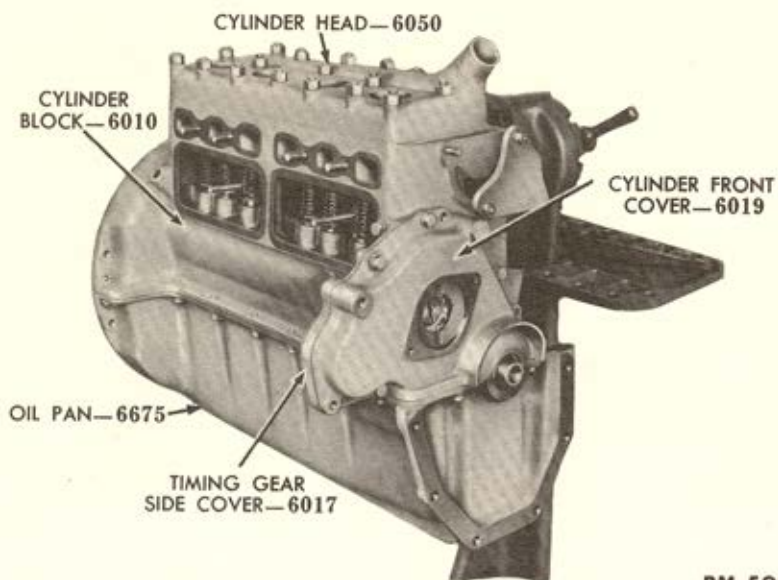

RM-503

Fig. 3—Stripped Engine

distributor to the cylinder front cover. Remove the distributor and wires.

d. Remove Carburetor. Remove the two nuts and lock washers that secure the carburetor to the intake manifold. Remove the carburetor (fig. 2).

e. Remove Starting Motor. Loosen the two starting motor cap screws until the starting motor is free of the clutch housing. Lift the starting motor from the engine (fig. 1).

113. ENGINE DISASSEMBLY.

This section contains instructions for the complete disassembly of the stripped engine.

a. Remove Intake and Exhaust Manifolds. Remove the nuts and washers that secure the intake and exhaust manifolds to the cylinder block. Lift the manifolds off the cylinder block as an assembly (fig. 2).

b. Remove Water Pump. Remove the cap screw and nuts which secure the water pump to the cylinder block. Lift the water pump from the cylinder block.

§ 113. b.

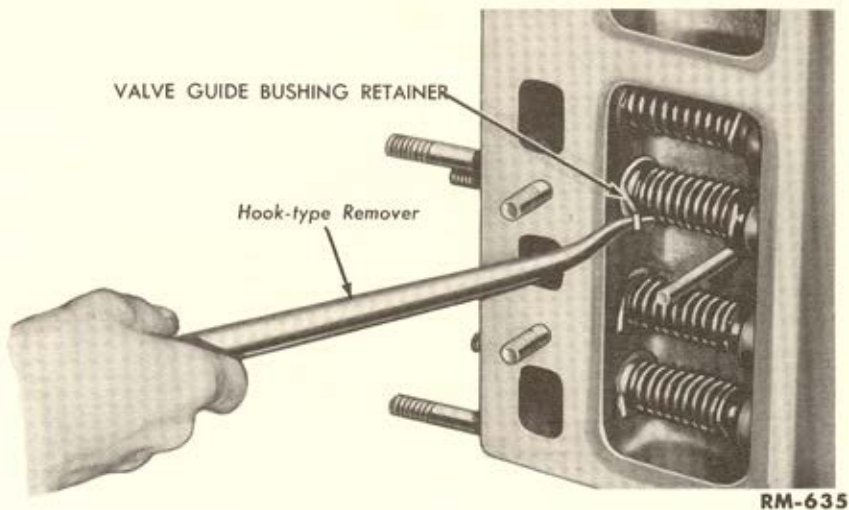

Fig. 4—Removing Valve Guide Bushing Retainer

c. **Remove Clutch Disk.** Press in on the clutch release levers, and install three wood wedges between the clutch release levers and pressure plate cover (fig. 48). Remove the six pressure plate cap screws, pressure plate, and clutch disk.

d. **Remove Flywheel.** Remove the lock wire from the four flywheel cap screws. Remove the four flywheel cap screws and dowel retainer. Tap the flywheel off the dowel pins with a rawhide hammer. Lift the flywheel out of the clutch housing.

e. **Remove Cylinder Head.** Remove all the nuts that hold the head to the cylinder block. Remove the cylinder head and gasket (fig. 3).

f. **Remove Valve Assemblies and Camshaft.** Remove the cylinder front cover (fig. 3) from the cylinder block. Remove the nut and flat washer from each valve chamber cover. Remove the valve guide bushing retainer with a hook-type remover (fig. 4) from all valves that are in the closed position. Turn the crankshaft until those valves which were in an open position are closed. Repeat the above procedure, and remove the remaining valve guide bushing retainers. Remove the valve assemblies from the cylinder block with

§ 113. f.

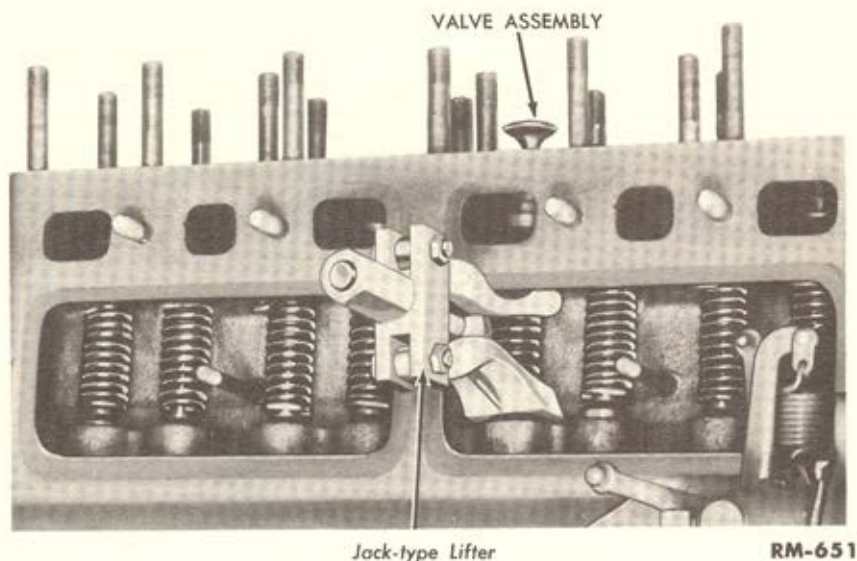

Fig. 5—Removing Valve Assembly

a jack-type lifter (fig. 5). As the valves are removed, tag or otherwise identify them as to the cylinders from which they were removed. Lift the push rods from the cylinder block. Slide the camshaft out of the cylinder block, being careful not to injure the camshaft bearing surface with the sharp corners of the cams.

g. Remove Oil Pump and Oil Pump Screen Cover Assembly. Remove the cap screws that secure the oil pan to the cylinder block, and remove the oil pan. Remove the lock wires and cap screws that secure the oil pump screen cover assembly to the oil pump (fig. 6). Remove the oil pump screen cover assembly from the engine.

h. Remove Connecting Rod and Piston Assemblies. Remove the two nuts from No. 1 connecting rod. Lift the connecting rod bearing cap from the connecting rod. Tap the connecting rod and piston out of the cylinder block with the handle end of a hammer (fig. 7). Install the connecting rod bearing cap on the connecting rod to prevent the bearing inserts from becoming mixed. Repeat the above procedure to remove the remaining connecting rod and piston assemblies.

§ 113. h.

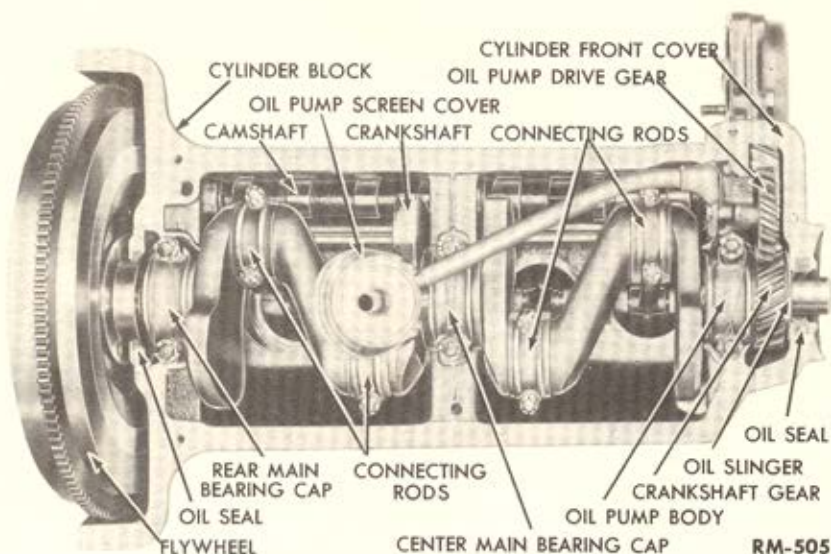

Fig. 6—Underside of Engine with Oil Pan Removed

i. **Remove Crankshaft.** Remove the lock wire and castellated nuts or self-locking nuts from the main bearing caps (fig. 7), and remove the bearing caps. Lift the crankshaft from the cylinder block.

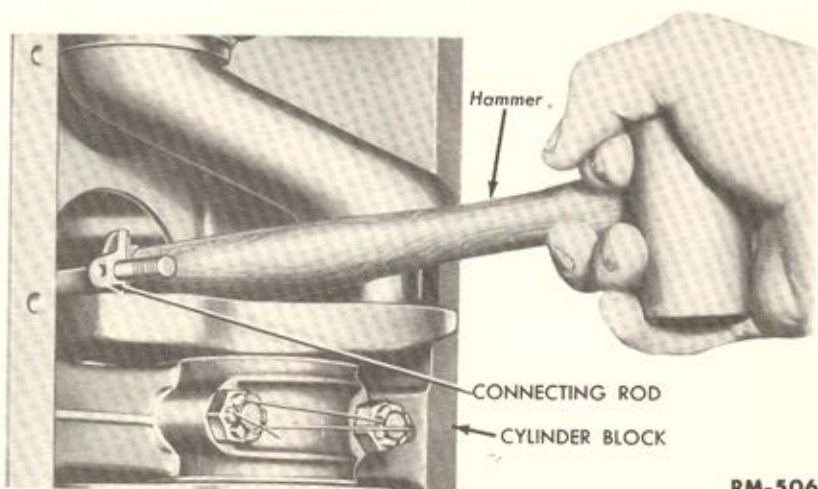

Fig. 7—Removing Connecting Rod and Piston Assembly

§ 113. i.

Chapter II INSPECTION AND REPAIR

| | Section |
|--|---------|
| Crankshaft and Flywheel..... | 121 |
| Cylinder Block..... | 122 |
| Piston and Connecting Rods..... | 123 |
| Camshaft and Valve Mechanism..... | 124 |
| Cylinder Head and Front Cover..... | 125 |
| Oil Pump..... | 126 |
| Water Pump..... | 127 |
| Governor..... | 128 |
| Oil Pan, Intake and Exhaust Manifolds..... | 129 |

121. CRANKSHAFT AND FLYWHEEL.

The disassembled crankshaft and flywheel assemblies are shown in figs. 10 and 11.

a. **Crankshaft.** Clean out the drilled oil passages in the crankshaft journals with a piece of wire. Clean the crankshaft thoroughly with cleaning solvent. Replace the crankshaft flange dowels if they are damaged. Replace a crankshaft gear that has chipped, broken, or worn teeth (subpar. (2) below). If the main journals or the crankpin journals are grooved or scored, the crankshaft must be remachined or replaced (subpar. (1) below). Light scores or scratches can be honed, then polished with No. 320 grit polishing paper. Measure

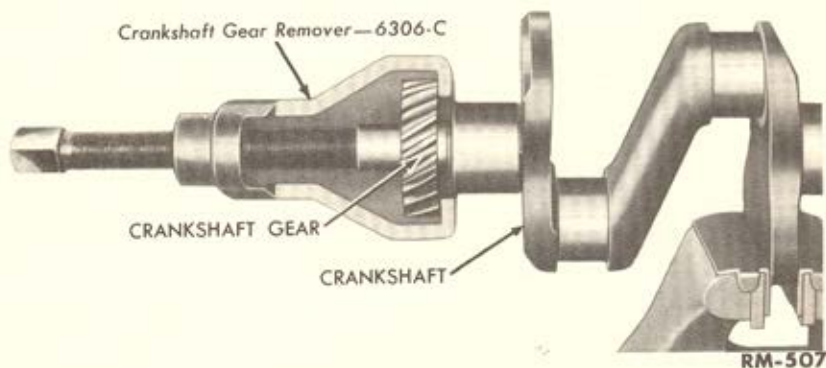
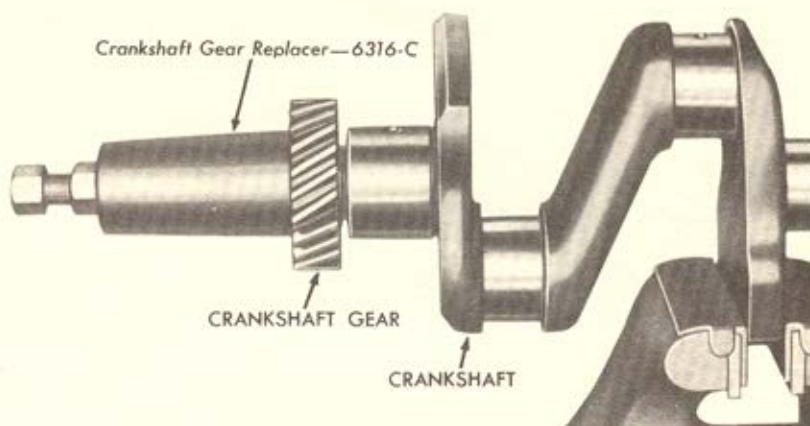

Fig. 8—Removing Crankshaft Gear

§ 121. a.



RM-508

Fig. 9—Installing Crankshaft Gear

each journal diameter at a minimum of four places to determine size, out-of-round, and taper. Remachine any journals that are out-of-round more than 0.0015 inch. Remachine journals that taper more than 0.001 inch (subpar. (1) below). Journals that are worn evenly with less than 0.001-inch taper, or less than 0.0015-inch out-of-round, need not be reground if the available bearings will provide not more than 0.003 inch clearance for the main bearings, or not more than 0.005 inch for the crankpin bearings.

(1) **REMACHINING CRANKSHAFTS.** Subtract the amount of undersize of the bearings to be used from the original size, and remachine the crankshaft by grinding it to this new size, then polish with No. 320 grit polishing paper, removing not more than 0.0009 inch from the diameter.

(2) **CRANKSHAFT GEAR REPLACEMENT.** Remove the crankshaft gear with a puller that pulls the gear evenly (fig. 8). Remove the woodruff key. To install the crankshaft gear, tap the woodruff key into the crankshaft, and install the gear on the crankshaft with a replacer as shown in fig. 9.

b. **Flywheel.** Clean the flywheel (fig. 11) thoroughly. Replace or reface a flywheel that has an excessively worn or scored friction face. Replace a flywheel ring gear (subpar. (1) below) that is cracked, chipped, or has excessively worn teeth.

§ 121. b.

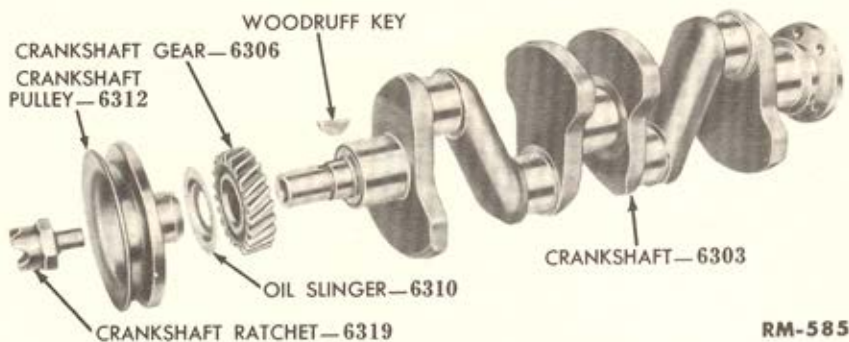

Fig. 10—Crankshaft Assembly, Disassembled

(1) **FLYWHEEL RING GEAR REPLACEMENT.** Drill a $\frac{17}{32}$ -inch hole nearly through the flywheel ring gear on the engine side of the gear. Split the ring gear at the drilled hole with a chisel, and lift the ring gear off the flywheel. Clean the ring gear recess on the flywheel. Heat the ring gear evenly to 360° F., and place it on the cold flywheel, making sure it is seated in the recess of the flywheel.

(2) **REFACE FLYWHEEL.** Remove just enough material from the clutch friction surface to obtain a smooth, flat surface parallel with the flywheel mounting flange. The same amount of material must also be removed from that portion of the flywheel to which the clutch pressure plate is attached. If the thickness of the flywheel, measured between the friction surface and the flywheel mounting flange, is reduced to less than 0.855 inch in order to obtain a smooth, flat, surface, the flywheel must be discarded.

(3) **CLUTCH PILOT BEARING REPLACEMENT.** Drive the pilot bearing out of the flywheel. Install the pilot bearing into the flywheel with a fiber block or a rawhide hammer (fig. 11).

122. CYLINDER BLOCK.

Strip off the old gaskets from all the surfaces of the cylinder block. Remove the oil passage plugs from the front and rear of the cylinder block, and clean all oil passages in the cylinder block with steam or compressed air. Scrape all of the carbon from the cylinder block.

a. **Inspection and Repair.** If the valve springs in the cylinder block are corroded or rusted or if there is an excessive amount of sludge in the valve chamber, it is an indication that the cylinder

§ 122. a.

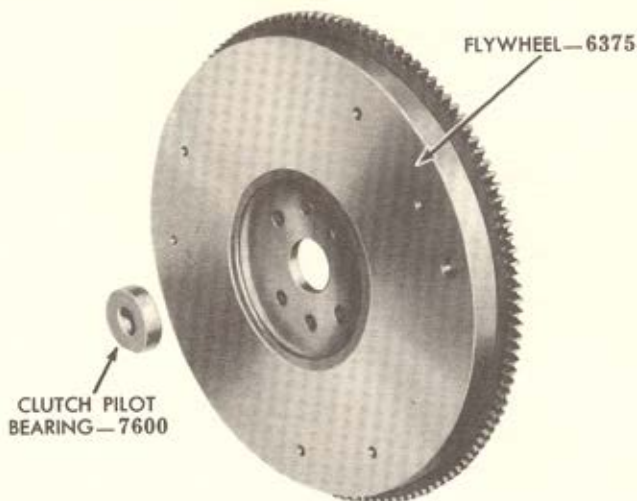

RM-589

Fig. 11—Flywheel and Clutch Pilot Bearing

block might be cracked and should be checked thoroughly. Replace the cylinder block if it is cracked. Replace any expansion plugs (fig. 1) that are loose.

(1) *STUDS*. Replace damaged or broken studs (par. d below).

(2) *VALVE SEATS*. Replace any valve seat insert that is cracked or that is loose in the cylinder block (par. f below). Reface valve seats where there is any indication that the valve has not been seating, if new guides are to be installed, or if the width of the seat (fig. 16) measures more than 0.125 inch (par. e below).

NOTE: *If the engine has been completely disassembled, reface all valve seats.*

(3) *CYLINDER SLEEVES*. Replace the cylinder sleeves (par. b. below) if a ridge is present at the top, or if the sleeves are collapsed or scored.

(4) *OIL RELIEF VALVE*. Replace the oil relief valve spring (fig. 12) located in the cylinder front cover if its tension is less than 44 ounces or more than 46 ounces when the length of the spring is compressed to 1.40 inches. Install the valve, spring, and valve nut in the cylinder front cover.

§ 122. a. (4)

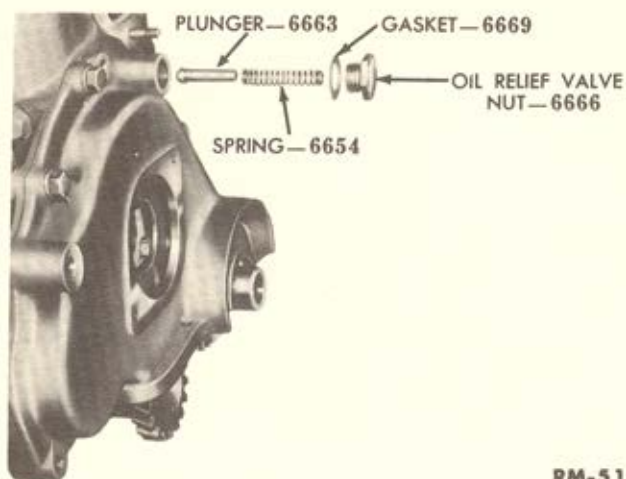

RM-511

Fig. 12—Oil Relief Valve, Disassembled

b. Steel Sleeve Replacement. Remove the sleeves from the cylinder block, using a crushing tool (fig. 14). Drive the tool all the way to the bottom of the cylinder, then pull the crushed sleeve out of the cylinder. Install new sleeves, using the replacer as shown in fig. 15. After the sleeves are installed, use a piston (without rings) or a plug gauge in the cylinder to determine if the sleeve was properly installed. If the piston or plug gauge has a tendency to stick, the sleeve was buckled during installation. Remove the damaged sleeve, install a new sleeve, and recheck it (fig. 15).

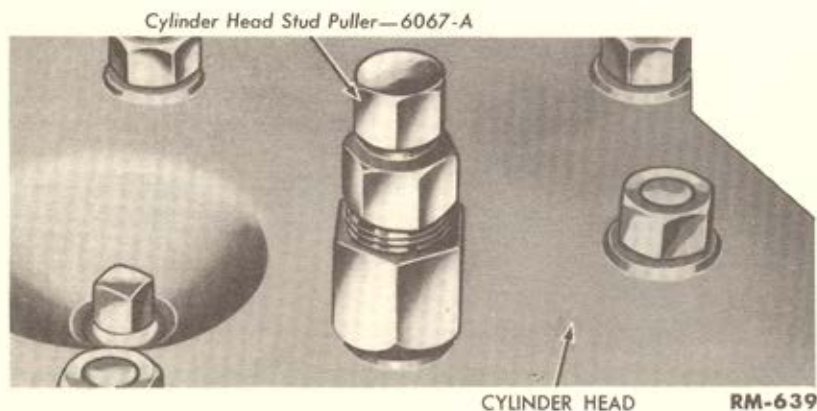

RM-639

Fig. 13—Removing Cylinder Head Stud

§ 122. b.

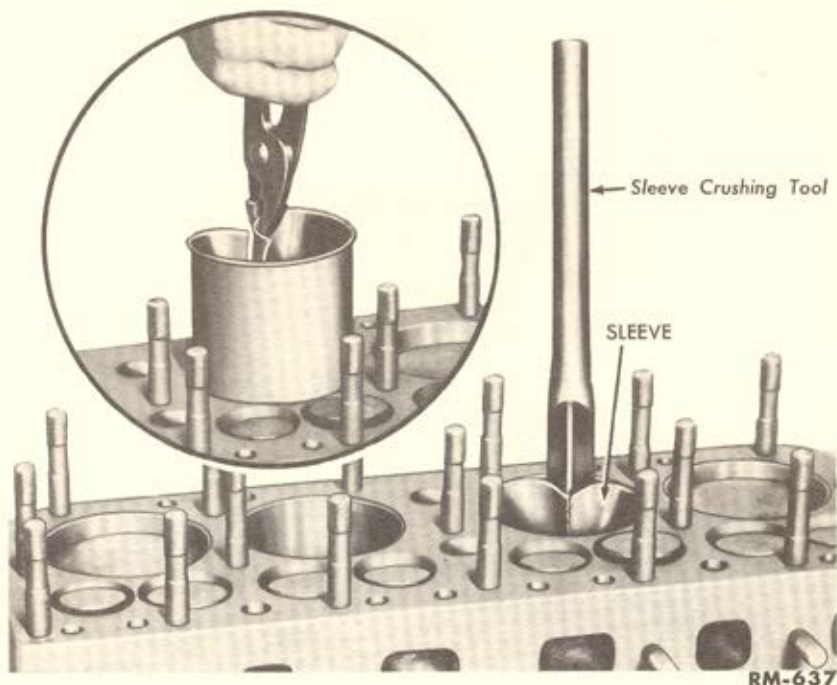

Fig. 14—Removing Cylinder Sleeve

c. **Stud Replacement.** Remove all damaged studs with a standard stud puller (fig. 13). To remove a broken stud, indent the end of the broken stud exactly in the center with a center punch. With a small drill, drill into the broken stud to a depth of approximately two-thirds of the length of the remaining portion of the stud, then follow up with a larger drill. The larger drill selected must leave a wall thicker than the depth of the threads. Select an extractor (EZ-out) of the proper size and insert it into the drilled hole, and screw out the remaining part of the broken stud. Install a new stud with a stud driver. Drive all studs until no threads show at the bottom of the stud.

d. **Valve Seat Insert Replacement.** Remove the valve seat inserts, being careful not to damage the cylinder block. If the counterbore is worn, remachine it to obtain a 0.0015 inch to 0.003 inch press fit on the replacement insert. Make sure that the counterbore is clean. Pack the new insert in dry ice for at least 15 minutes, and drive the insert in place in the counterbore, using a driver that assures the insert going into place evenly. Reface the valve seat insert (par. e below).

§ 122. d.

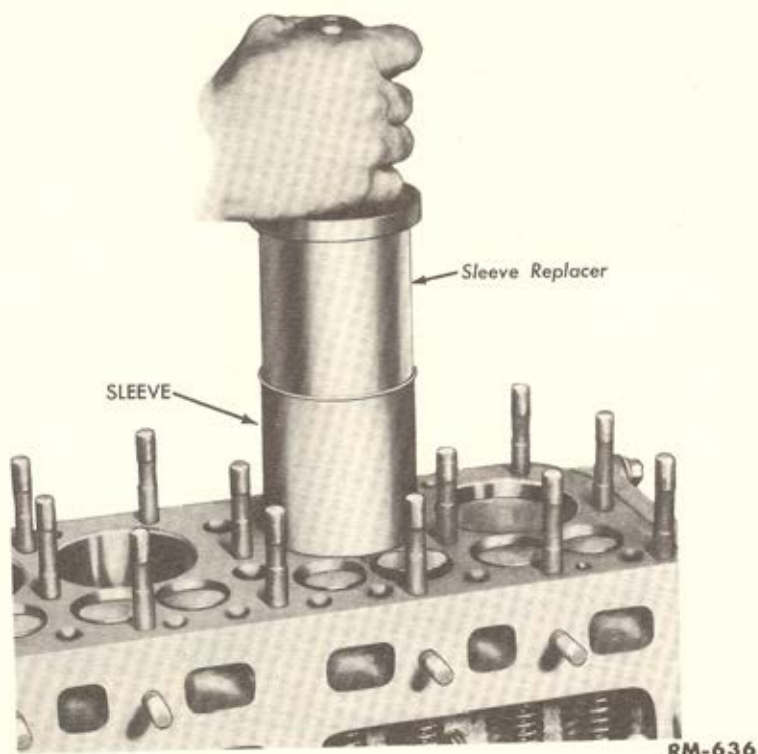

Fig. 15—Installing Cylinder Sleeve

e. **Valve Seat Refacing.** Reface each valve seat with a 90 degree (included angle) valve seat grinding wheel or valve seat cutter until the face of the seat is "cleaned up" and free from pits or nicks. If a valve seat cutter is used, it will be necessary to lap the valves into the seat. The time ordinarily required to lap the valves is saved by using an eccentric type valve seat grinder with which the grinding wheel contacts only one portion of the seat at any given time. If the grinder, including the pilot, is in good condition and the grinding wheel is kept sharp and properly dressed, it ordinarily is not necessary to lap the valves into the seats. After refacing, the width of the valve seat should not be more than 0.125 inch, measured across the face of the seat (fig. 16). If the seat is too wide, remove just enough stock from the top and/or bottom of the seat to reduce the width to 0.062 inch. Use a 120 degree (included angle) valve seat cutter for removing stock from the top of the seat and a 60 degree (included angle) cutter for removing stock from the bottom of the seat.

§ 122. e.

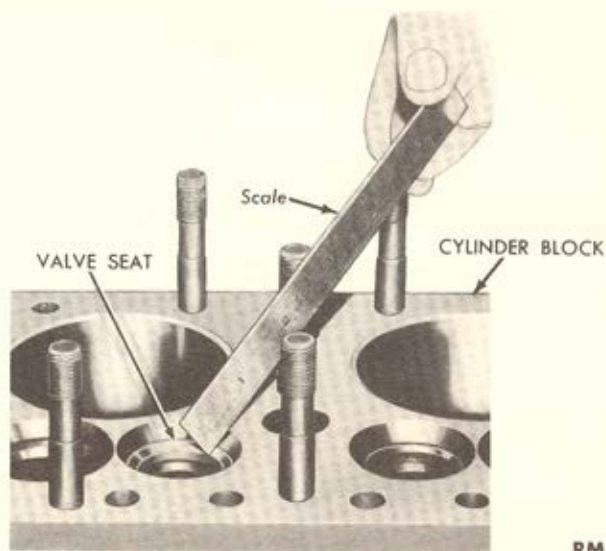

Fig. 16—Measuring Width of Valve Seat

123. PISTONS AND CONNECTING RODS.

To disassemble the piston and connecting rod, remove the piston rings with a piston ring expander. Remove the two piston pin retainers (fig. 17), and push the piston pin out of the piston. Scrape the carbon from the piston ring grooves and also from the top of the pistons. Clean all carbon and sludge from the oil holes in the oil ring groove. Make sure all of the oil holes in the connecting rod are open. Clean all parts thoroughly.



Fig. 17—Connecting Rod and Piston Assembly, Disassembled

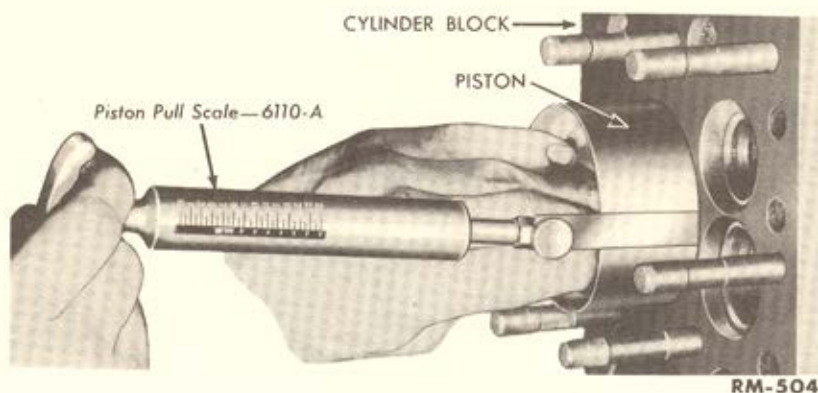

Fig. 18—Fitting Piston to Cylinder Bore

a. Inspection.

NOTE: Usually, the type of wear, or the condition of one of the reciprocating parts, can indicate a fault in other reciprocating parts, i.e. a bent connecting rod could result in unusual wear, on either, or both, the piston or the connecting rod bearing.

(1) **PISTONS.** Discard pistons which are cracked, scored, damaged or have burned spots.

(a) **FITTING PISTONS.** To check the clearance of a piston in a cylinder bore, use a thickness gauge $\frac{1}{2}$ -inch wide and long enough to cover the entire length of a piston, and attach it to a tension scale. Place the gauge on the side of the piston bore, and push the piston in the cylinder so that the side of the piston, which is 90 degrees (right angle) from the piston pin hole, is against the thickness gauge. Withdraw the gauge and observe the reading on the tension gauge (fig. 18). The thickness of the gauge to be used and the pounds pull for the various combinations of pistons and cylinder bores are as follows:

| Cylinder Bore and Piston Combinations | Steel Piston | |
|--|--------------------|----------------|
| | Gauge Thickness | Pull Pounds |
| New steel sleeve—new piston..... | 0.003 | 5-8 |
| Worn steel sleeve—new piston..... | 0.004 | 5-8 |
| Worn steel sleeve—worn piston..... | 0.005 | 5-8 |

§ 123. a. (1) (a)

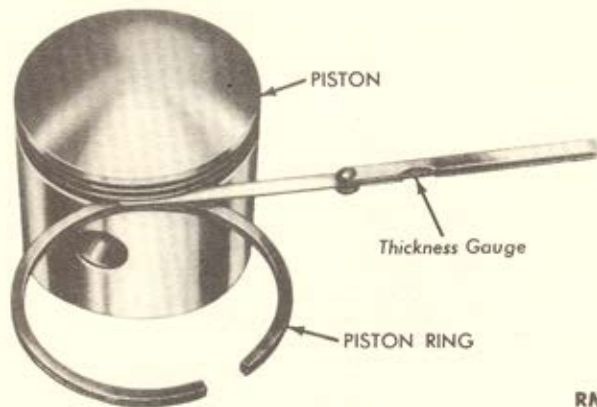

RM-514

Fig. 19—Checking Ring Groove Width

(b) **PISTON PIN BORES.** Use a new piston pin as a gauge, and insert it in the piston pin bore. If the pin falls through by its own weight, the pin bore is excessively worn and must be reamed and burnished or honed to accommodate an oversize piston pin (par. b below).

(c) **PISTON RING GROOVES.** Check the width of the ring grooves with a new piston ring and a thickness gauge (fig. 19). Discard a piston if the clearance between the ring and the piston exceeds 0.004 inch.

(2) **PISTON PINS.** Replace piston pins that have become worn and measure to less than 0.749 inch.

(3) **CONNECTING RODS.** Replace connecting rods which have damaged studs. To check the piston pin bushing for wear, use a new piston pin as a gauge. If any looseness is felt, rebush the connecting rod (par. c below), or fit an oversize piston pin in both the connecting rod and the piston (par. b below). Check the connecting rods for being twisted. Bent or twisted connecting rods must be aligned (figs. 20 and 21). Where possible, use the original connecting rod for each cylinder. If any of the old rods are used in a different cylinder, file off the old number. Number each rod and cap as follows: Use $\frac{3}{32}$ -inch steel stamps for numbering the connecting rods and caps, placing the new number in the same position as the old one.

§ 123. a. (3)

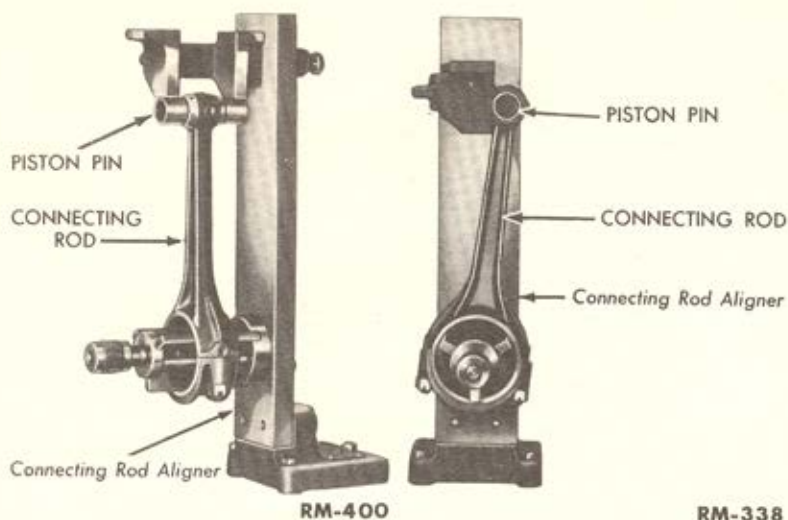

Fig. 20—Checking Connecting Rod for Bend

Fig. 21—Checking Connecting Rod for Twist

(4) **CONNECTING ROD BEARINGS.** Replace connecting rod bearings that are worn, pitted, scored, or discolored (due to overheating). Bearings otherwise satisfactory but with small pits need not be replaced. Bearings must be replaced where pits extend to the side of the bearing and permit oil to escape. Place a plug gauge (a round piece of accurately ground or rolled bar stock) on the inside surface of the bearing, and measure the thickness of the two pieces (fig. 22). Deduct the thickness of the bar stock from the reading obtained to determine the thickness of the connecting rod insert bearing. Replace each connecting rod bearing that measures 0.005 inch or more under its original size.

b. Fitting Oversize Piston Pins.

NOTE: *This procedure applies only when piston pins are to be fitted to old pistons. When new pistons are used, the connecting rod bushings must be replaced if the old bushing does not provide the correct fit for a standard piston pin (par. d below).*

If a connecting rod bushing or a piston pin hole is worn and its inside diameter does not measure more than 0.7535 inch, it can be reamed and burnished or honed to fit a 0.001 inch or a 0.002 inch oversize piston pin. The correct fit for a piston pin in the connecting rod bushing exists when the pin to be used will pass slowly through the bushing by its own weight when the piston and pin are dry. The

§ 123. b.

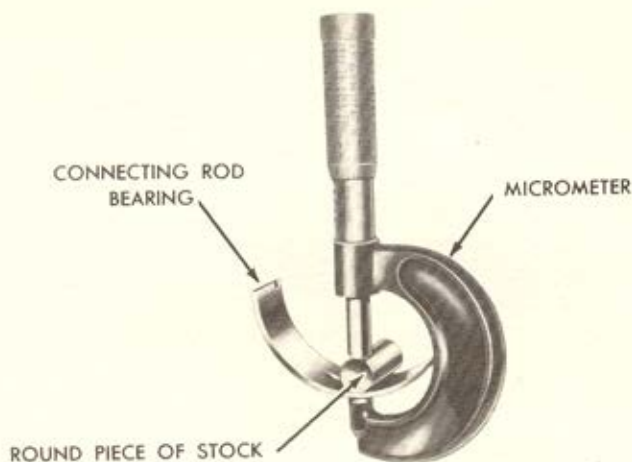

RM-412

Fig. 22—Measuring Connecting Rod Bearing for Wear

correct fit for a piston pin in the piston exists when it can be inserted in the piston by a light push by hand with the piston and pin temperature at approximately 70 degrees.

c. Connecting Rod Bushing Replacement. Drive the bushing from the connecting rod with a suitable driver. Press a new bushing into the connecting rod. Drill the four oil holes in the bushing to the same size as the holes in the connecting rod. Ream and burnish or hone the bushing to 0.7505 inch. Check the alignment of the connecting rod, correcting any misalignment (figs. 20 and 21).

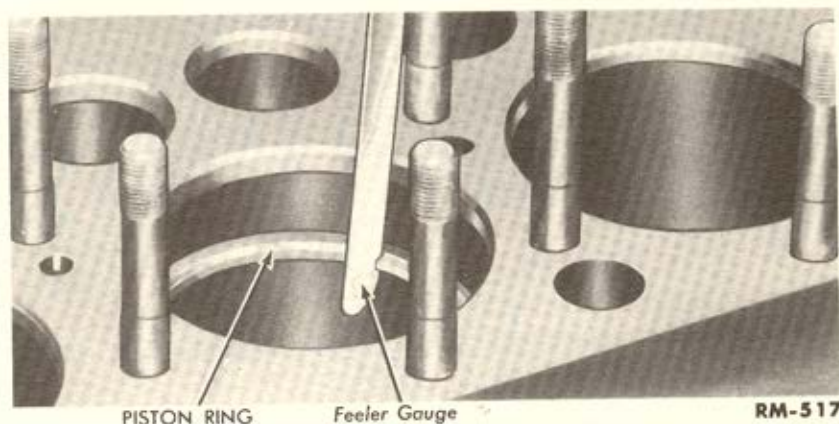

RM-517

Fig. 23—Measuring Piston Ring End Gap

§ 123. c.

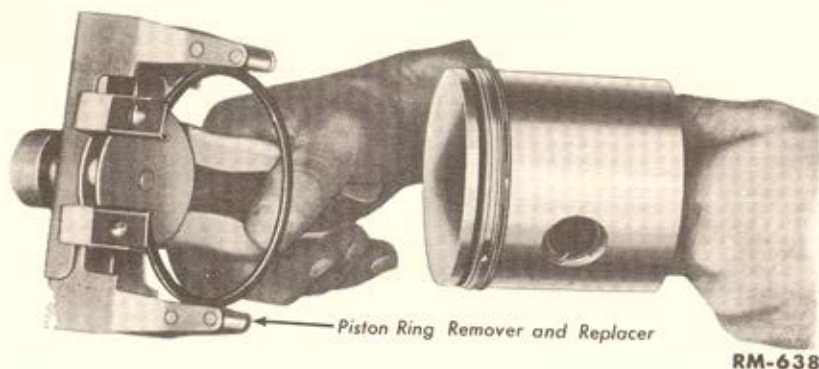

Fig. 24—Installing Piston Ring on Piston

d. **Assemble Piston, Piston Pin, and Connecting Rod.** Install the piston which was previously fitted (par. a (1) (a) above) for the particular cylinder to the connecting rod previously selected and having the number of that cylinder. Hold the piston in place on the connecting rod. Install a piston pin in the piston and connecting rod, and install a piston pin retainer in each piston pin bore groove.

e. **Fitting and Installing Piston Rings.** Place a new piston ring in the cylinder, and press it about half-way down into the cylinder bore with the bottom of a piston so the ring will be square with the cylinder wall. Measure the ring end gap with a thickness gauge (fig. 23). If the gap is less than 0.012 inch, remove the ring. Place the ring in a jig, and file it with a fine cut file until the correct gap (0.012 to 0.017 inch) is established. If the gap exceeds 0.035 inch, an oversize ring must be used. Roll the new piston ring around its groove in the piston. The top ring should roll freely and not have a clearance of less than 0.0015 inch or more than 0.0035 inch. The lower rings should roll freely and not have a clearance of less than 0.001 inch or more than 0.004 inch. Install the piston ring on the pistons with a piston ring expander (fig. 24). Repeat the entire above procedure for each piston ring.

124. CAMSHAFT AND VALVE MECHANISM.

The disassembled camshaft and valve assemblies are shown in figs. 25 and 26.

a. **Camshaft.** Thoroughly clean the camshaft and camshaft gear. Replace a camshaft that has excessively scored or damaged

§ 124. a.

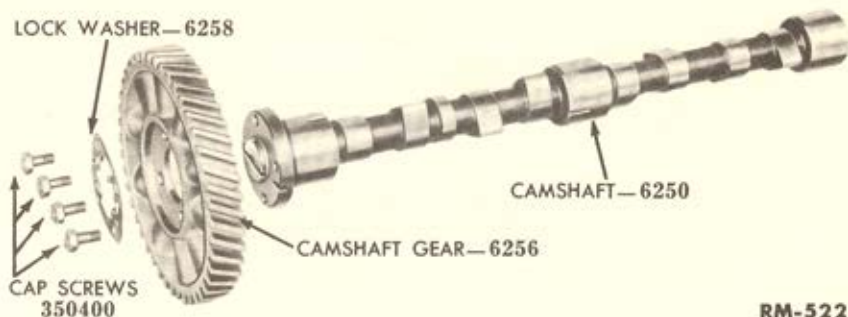

RM-522

Fig. 25—Camshaft, Disassembled

cams, or worn, corroded, scored, or discolored journals. Replace a camshaft if any of the journals measure less than 1.795 inches. Replace a camshaft gear that is visibly worn, broken, or has chipped teeth.

To remove the camshaft gear, straighten the four tabs on the camshaft gear locking ring. Remove the four cap screws and locking ring. Lift the camshaft gear from the camshaft (fig. 25). To install the camshaft gear, place it on the camshaft, and install the locking ring and the four cap screws. Bend the tabs on the locking ring down onto the cap screws.

b. Valve Push Rods. Clean the push rods thoroughly. Replace push rods if the diameter is worn to less than 0.998 inch, or if they

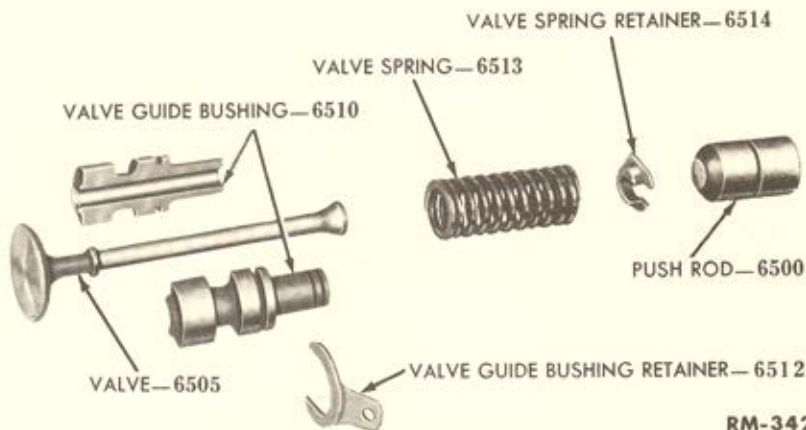

RM-342

Fig. 26—Valve Assembly, Disassembled

§ 124. b.

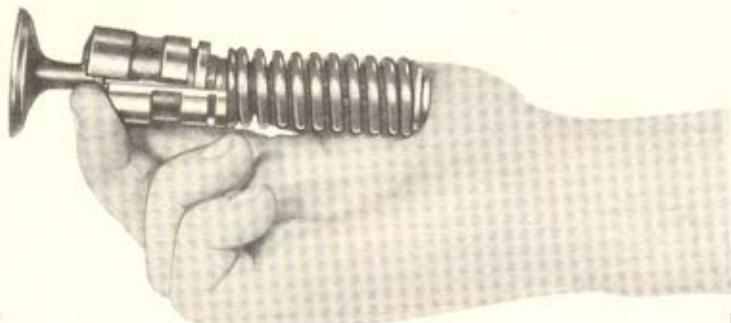

RM-71

Fig. 27—Disassembling Valve Assembly

are scored or cracked. Pressed-steel type push rods may be resurfaced at the bottom end only. Replace any push rods that are less than 1.710 inches long after resurfacing.

c. **Valves, Guides, and Springs.** Hold the valve assembly in the hand, and compress the valve spring as shown in fig. 27. Lift one-half of the valve guide bushing from the assembly. Remove the other half of the valve guide bushing, spring, and spring retainer (fig. 26).

NOTE: *Keep the two halves of each valve guide together in pairs.*

(1) **CLEANING, INSPECTION, AND REPAIR.** Scrape the carbon off the valve heads and stems. Clean the valves, springs, and valve guide bushings.

WARNING: *Do not use caustic or any material that will injure the protective coating of paint on the valve springs. This paint is necessary to protect the spring from crankcase moisture.*

Replace valves that have bent or scored stems. Replace any valves the stems of which are worn to less than 0.3065 inch. Reface pitted, corroded, or burned valves. Replace valves that are pitted, burned, or warped that will not clean up with a light cut of the grinding wheel. If a cutter was used to reface the valve seats in the cylinder block, lap each valve into its seat.

(a) **VALVE SPRINGS.** Replace a valve spring if it has lost its protective coating of paint, or if the tension is less than 30 pounds or is more than 34 pounds when compressed to 2.13 inches (fig. 28).

§ 124. c. (1) (a)

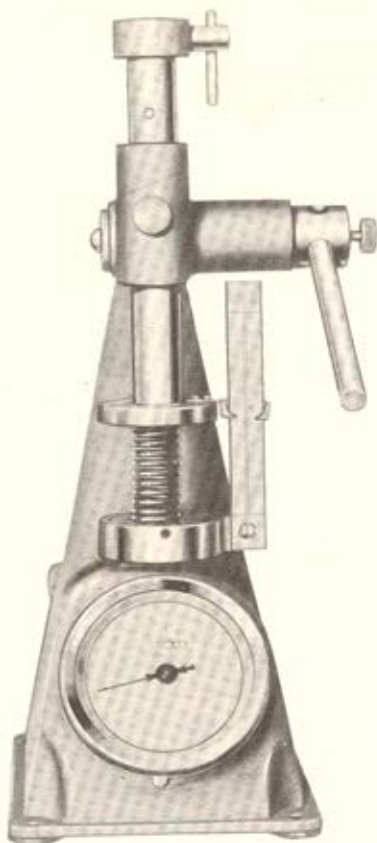

RM-69

Fig. 28—Checking Valve Spring Tension

(b) VALVE GUIDES.

NOTE: Any new valve guides that are to be used should be used as intake valve guides in order to keep the intake valve guide clearance to a minimum.

Using a valve with a stem diameter of 0.311 inch as a gauge, place the valve in each half of the valve guide bushing, and measure each side with a micrometer, as shown in fig. 29. Replace both halves of any valve guide bushing if the measurement is less than 0.6665 inch. Select guides for each valve, measuring each half with the valve with which it is to be used. Any new guides being used and the old guides having the least wear should be used with the intake valves. Any guide and valve combination measuring more than 0.666 inch is satisfactory for exhaust valves.

§ 124. c. (1) (b)



RMX-416

Fig. 29—Checking Valve Guide Bushing for Wear

(2) **ASSEMBLING VALVE ASSEMBLY.** Place the valve spring retainer and spring on the valve, and slide both halves of the valve guide bushing in place.

125. CYLINDER HEAD AND FRONT COVER.

Scrape all of the carbon from the cylinder head. Replace a cracked cylinder head or a head where the gasket surface is warped $\frac{1}{32}$ inch or more over the full length of the head. Replace the head if either the threads in the spark plug holes or the water temperature gauge hole is stripped. Repair any threads that are not stripped but are otherwise damaged. If the threads are damaged in either the spark plug holes or the water temperature gauge hole, clean up the threads with the correct size tap.

Replace the cylinder front cover and timing gear side cover if cracked or damaged in any way.

Check the gasket surface of the covers for nicks or damage, and make repairs as required.

126. OIL PUMP.

Clean all parts thoroughly, and blow out all oil passages with compressed air. Lift the driven gear from the pump (fig. 31). Press the drive gear from the driven gear and body (fig. 30).

a. **Inspection and Repair.** Replace an oil pump body if cracked or damaged. If the inside diameter of the drive gear bushing exceeds 0.566 inch, or the outside diameter of the driven gear shaft is less than 0.560 inch, replace the bushing or shaft (subpars. (1) and (2) below). Replace the fibre drive gear if it is worn, or if it has broken

§ 126. a.

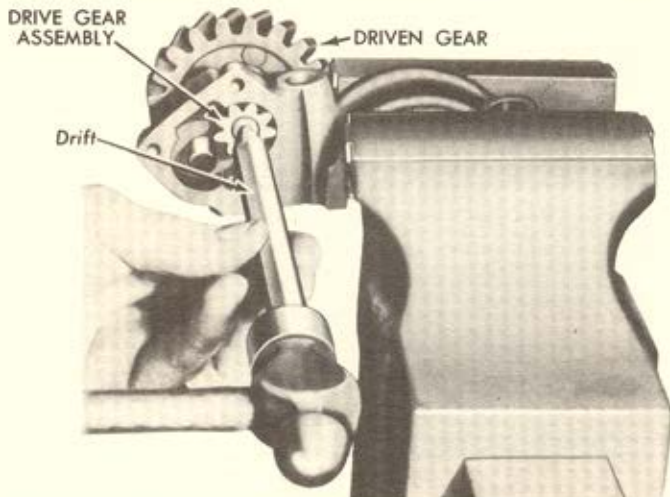

RM-528

Fig. 30—Removing Oil Pump Drive Gear From Driven Gear and Body

or chipped teeth. Replace the driven gear if it is less than 0.560 inch long, or if the teeth are worn, chipped, or broken. Replace a broken or damaged oil pump screen cover assembly.

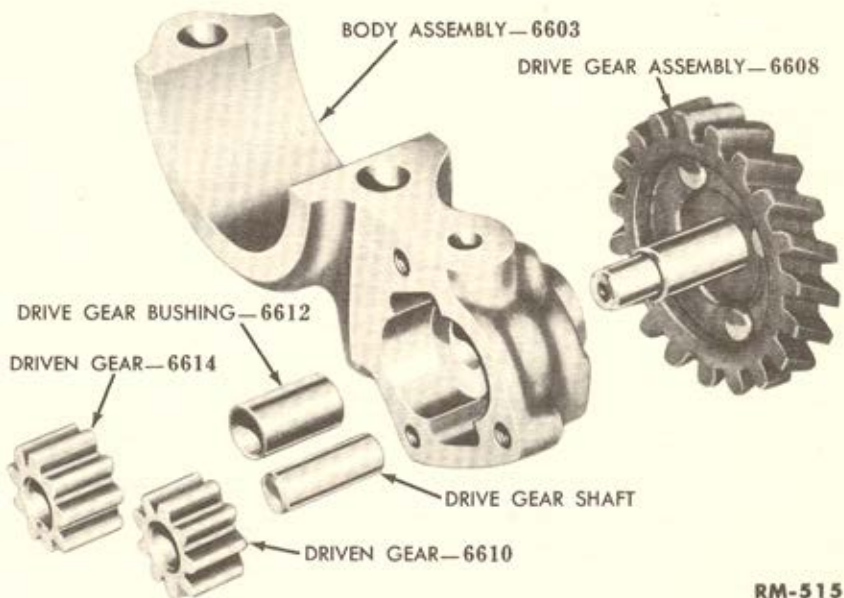

RM-515

Fig. 31—Oil Pump, Disassembled

§ 126. a.

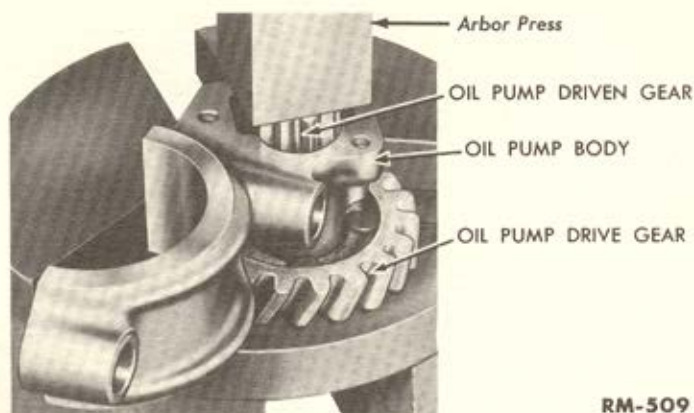

RM-509

Fig. 32—Pressing Oil Pump Driven Gear Onto Oil Pump Drive Gear and Shaft

(1) **DRIVEN GEAR SHAFT REPLACEMENT.** Drive the driven gear shaft from the oil pump body (fig. 31). To install the driven gear shaft, press it into the oil pump body until the end of the shaft is flush with the outside of the oil pump body.

(2) **DRIVE GEAR BUSHING REPLACEMENT.** Drive the bushing from the oil pump body with a driver. To install the bushing, press it into the oil pump body until the inner edge of the bushing is flush with the oil pump body. Ream the bushing from 0.5625 to 0.5630 inch diameter.

b. Assembly. Place the drive gear in the oil pump body. Press the driven gear on the drive gear shaft, making sure the flat in the gear is in line with the flat side of the shaft. Install the driven gear in the oil pump body.

127. WATER PUMP.

The disassembled water pump is shown in fig. 34.

a. Disassembly. Place the water pump in a vise. Drive the shaft out of the pulley with a driver as shown in fig. 33. Remove the snap ring (fig. 34) from the water pump body. Press the shaft and bearing assembly out of the water pump body (fig. 34).

Remove the water pump seal snap ring, washer, seal and spring from the impeller (fig. 34).

§ 127. a. .

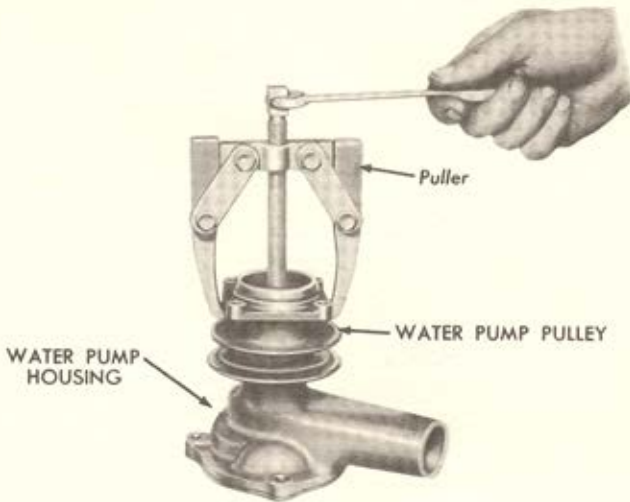

RM-595

Fig. 33—Removing Water Pump Pulley

b. **Cleaning.** Clean all of the metal parts thoroughly with cleaning fluid.

c. **Inspection.** Replace a cracked or damaged water pump body (fig. 34). Replace the water pump seal if it is worn. Replace an impeller if it is cracked, excessively pitted, or if it has broken or damaged fins. Replace a pulley hub that is cracked or has stripped threads. Rotate the water pump bearing. If the bearing binds or has a tendency to stick, replace the bearing assembly. Replace the bearing assembly if there is end play or side play in the shaft.

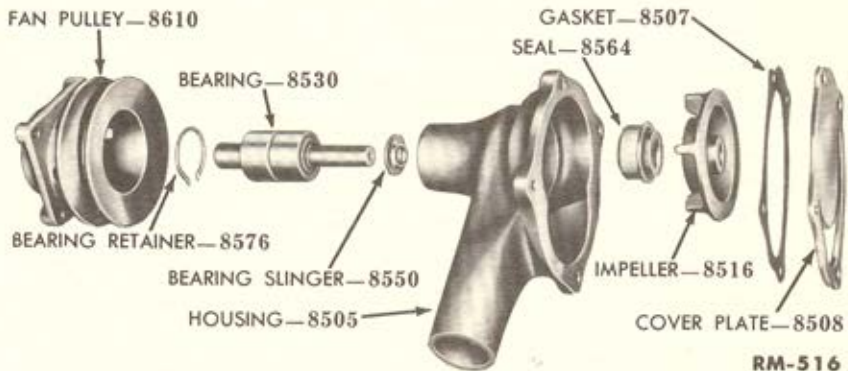

RM-516

Fig. 34—Water Pump, Disassembled

§ 127. c.

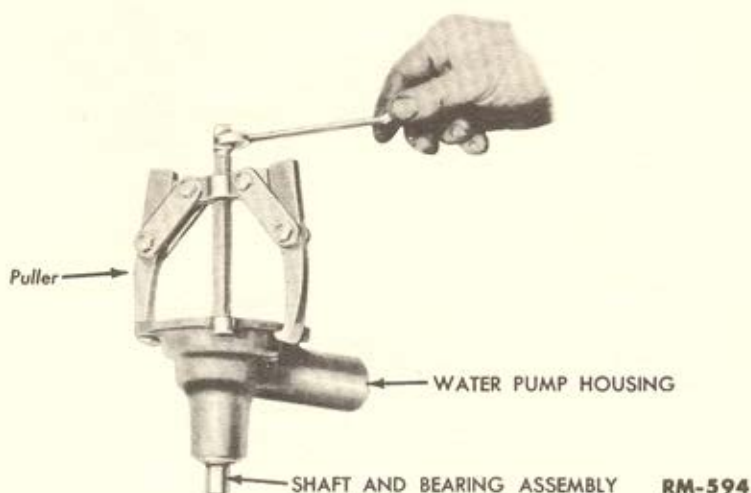

Fig. 35—Pressing Bearing and Shaft from Pulley Hub

d. **Assembly.** Press a new bushing in the body if the old one was removed. Dip a new seal and seal washer (fig. 31) in hydraulic brake fluid. Install the spring and seal assembly, seal washer, and snap ring in the impeller. Press the bearing and shaft assembly into the body (fig. 31). Press the impeller onto the shaft until it is flush with the end of the shaft. Install the water pump body snap ring in the body. Press the pulley onto the shaft until the pulley is flush with the shaft

128. GOVERNOR.

Remove the screw (fig. 36) that secures the driver unit to the body. Lift the driver unit from the body. Remove the hairpin clip, then remove the flat washer, shims, fork base, thrust bearing, upper race and balls (fig. 37) from the shaft. Remove the oil tube elbow connection from the body. Drive the grooved pin out of the fork and lever as shown in fig. 38. Pull the levers out of the body. Remove the dust seal and needle bearing from the body.

a. **Inspection.** Inspection of the governor should follow the nine procedures as given below

(1) **DRIVE GEAR.** Replace the drive gear (fig. 39) (par. b below) if it is chipped or worn.

(2) **BALL BEARING BASE.** Replace the ball bearing base (fig. 37) (par. b below) if it is cracked or damaged in any way.

§ 128. a. (2)

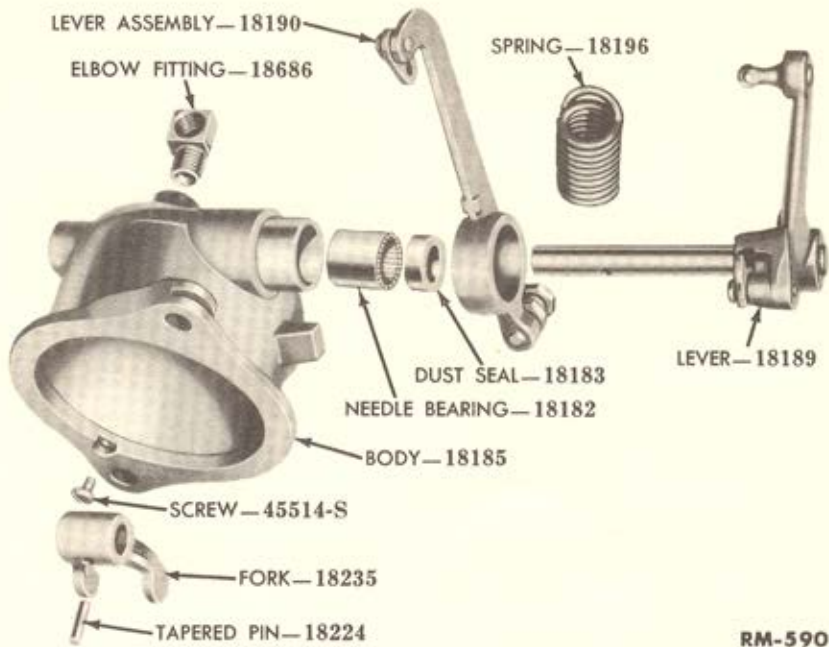

RM-590

Fig. 36—Governor, Disassembled

(3) **LOWER RACE ASSEMBLY.** Replace the lower race assembly (fig. 37) if the plate is pitted, grooved or if the bearing is worn or damaged.

(4) **DRIVE SHAFT.** Replace the drive shaft (fig. 37) (par. c below) if the plate is loose on the shaft or if the slots in the plate are worn.

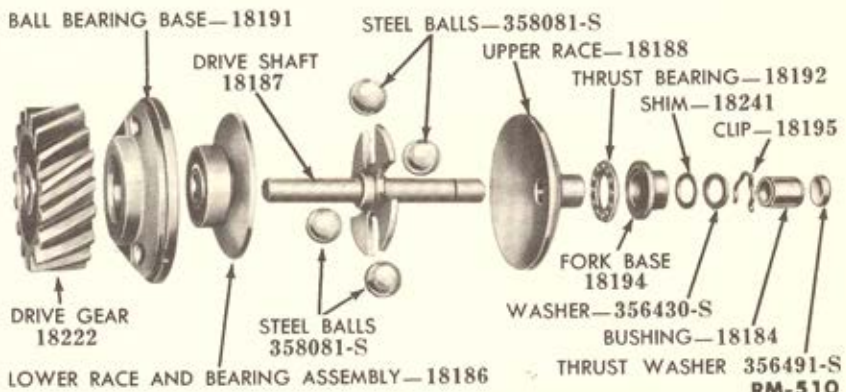

RM-510

Fig. 37—Governor Drive Shaft, Disassembled

§ 128. a. (4)

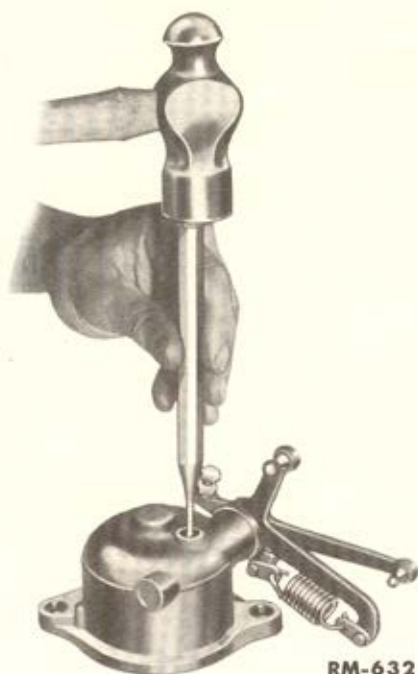

RM-632

Fig. 38—Driving Grooved Pin
from Fork and Lever



RM-583

Fig. 39—Removing Governor
Drive Gear

(5) **BALLS.** Replace a ball that has flat spots, pits, or that is damaged in any way. A discolored ball is due to a chemical reaction and does not effect the serviceability of a ball.

(6) **UPPER RACE.** Replace the upper race (fig. 37) if it is grooved or pitted.

(7) **THRUST WASHER.** Replace the thrust washer (fig. 37) if any of the balls are missing, or if any of the balls have flat spots.

(8) **FORK BASE.** Replace the fork base (fig. 36) if it is worn or damaged.

(9) **BODY.** Replace the body (fig. 36) if it is cracked or if the trunnion for the manual lever measures less than 0.916 inch. Replace the bushing (par. c below) (fig. 37) if there is more than 0.005 inch clearance between the shaft and bushing. Replace the needle bearing if any of the needles are flat, or if any are missing. Always replace the grease seal if the shaft has been removed. Replace the fork if the bearing surface is worn flat.

§ 128. a. (9)

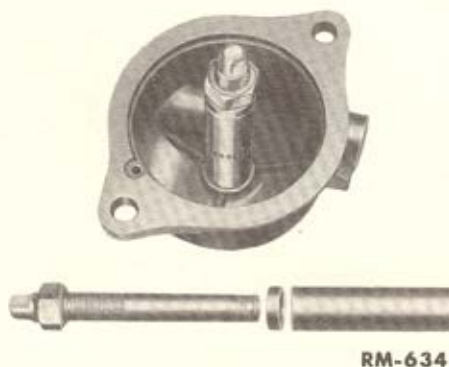

Fig. 40—Removing Governor Bushing

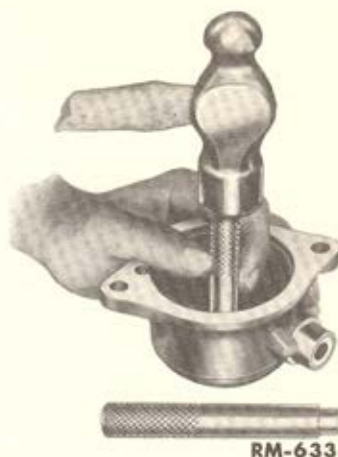

Fig. 41—Installing Governor Bushing

b. Repair. To replace the drive gear or ball bearing base, remove the drive gear from the shaft with a puller. Remove the ball bearing base and lower race from the shaft as an assembly. Press the lower race out of the ball bearing base. To assemble the shaft, press the lower race assembly in the ball bearing base. Install the ball bearing base assembly on the short end of the shaft (fig. 37). Press the gear on the shaft until the shaft is flush with the face of the gear.

To replace the bushing, remove the elbow connection from the body. Working through the elbow opening, drive the pin out of the fork and shaft with a small punch. Remove the levers from the body. Remove the bushing with an EZ-out type puller (fig. 40). To install the bushing, place the thrust washer in the body (fig. 37), and drive the bushing into the housing with a driver equipped with a pilot (fig. 41). Install the levers and fork in the body (fig. 36). Drive a new grooved pin in the fork and shaft. Install the elbow connection in the body.

c. Assembly and Adjustments. To assemble the shaft assembly, place the four balls in position on the shaft, and install the upper race (fig. 37) over the balls. Install the thrust bearings and fork base on the shaft (fig. 37). Install the flat washer, shims, and hairpin clip (fig. 36) on the shaft.

To adjust the shaft, clamp it and the driver assembly in the governor setting gauge as shown in fig. 42. The clearance between the washer and fork base should be 0.220 inch to 0.230 inch. Add

§ 128. c.



Fig. 42—Measuring Clearance
Between Washer and
Fork Base

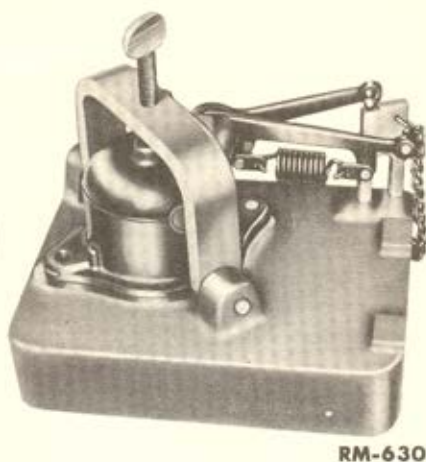

Fig. 43—"Go" and "No Go" Gauge
Inserted Behind Governor
Lever

or remove the 0.010 inch spacers as required until the correct clearance is established.

To install the drive shaft assembly in the body, install the lever and fork in the body, securing it with a grooved pin. Position the drive shaft assembly in the body, and install the governor body screw in the body.

To check the governor arm adjustment, install the governor on the governor setting gauge, and tighten the wing nut on the gauge finger tight. Hold the governor lever in the wide open position, and insert the "GO" and "NO GO" gauge as shown in fig. 43. If the gauge cannot be inserted, the clearance is insufficient and must be adjusted. If only the first step can be inserted, the clearance is satisfactory. If the second step can be inserted, the clearance is excessive and must be adjusted.

If the clearance is either insufficient or excessive, lay the governor arm across the bosses on the gauge (figs. 44 and 45). Strike the center of the governor arm with a light hammer. Recheck the arm adjustment.

129. OIL PAN, INTAKE AND EXHAUST MANIFOLDS.

Clean the oil pan thoroughly. Replace an oil pan that has stripped threads in the drain plug hole, or one that is badly dented, distorted, or cracked. Replace the oil pan drain plug and oil pump screen if damaged.

§ 129.



RM-631

*Fig. 44—Correcting Insufficient
Clearance on Governor
Arm*

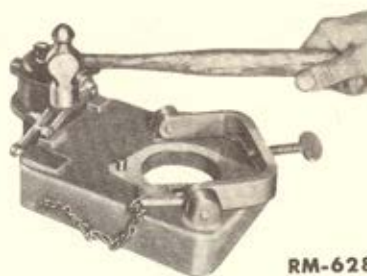

RM-628

*Fig. 45—Correcting Excessive
Clearance on Governor
Arm*

To clean the intake and exhaust manifolds, scrape off all the carbon and all parts of the old gaskets. Clean the manifolds thoroughly.

Replace a manifold that is cracked or broken. Replace broken or damaged manifold studs (sec. 122).

Chapter III ASSEMBLY OF ENGINE

| | Section |
|----------------------------------|---------|
| Assembly..... | 131 |
| Installation of Accessories..... | 132 |

131. ASSEMBLY.

Before assembling the component parts of the engine, make sure that each part is in a satisfactory condition for use (Chapter II).

a. **Install Crankshaft.** Install the three upper halves of the main bearing inserts in the cylinder block. Install the three lower halves of the main bearing inserts in the two main bearing caps and oil pump body. Coat the main bearing inserts with a light film of oil. Install the crankshaft rear bearing oil seal retainer and seal in the rear of the cylinder block. Place the crankshaft in the cylinder block, and install the main bearing caps and oil pump body on the cylinder block. Install the main bearing cap nuts or self-locking nuts and tighten them from 80 to 90 pounds-feet if using self-locking nuts. Tighten from 75 to 80 pounds-feet if using castellated nuts. Pry the crankshaft forward and insert a feeler gauge as shown in Fig. 46.

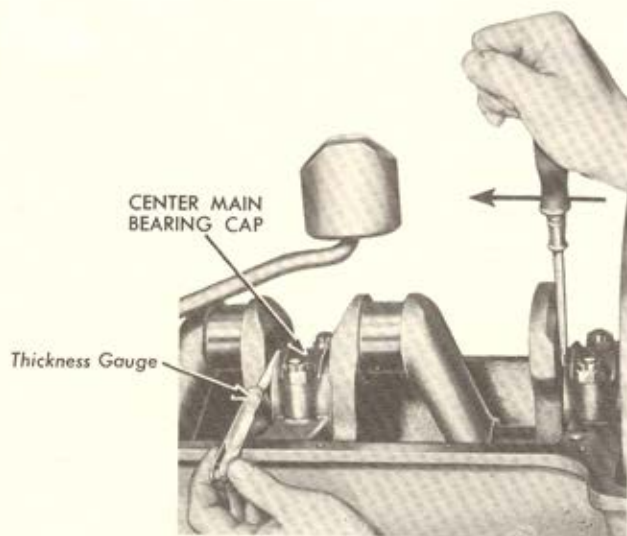
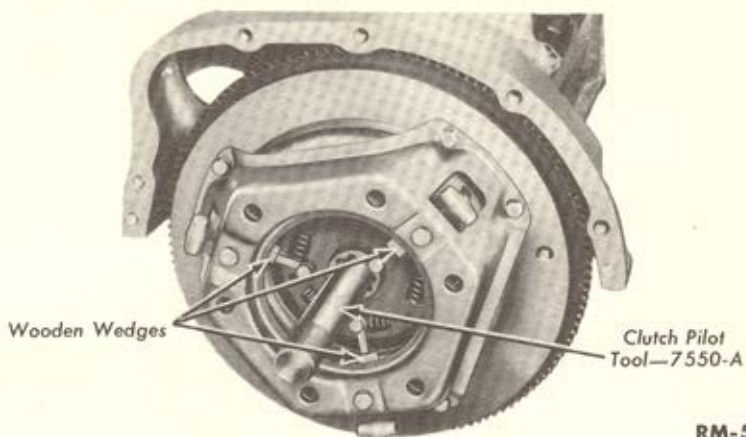

Fig. 46—Measuring Crankshaft End Play

RM-586

§ 131. a.



RM-587

Fig. 47—Installing Clutch Disk and Pressure Plate

If the clearance exceeds 0.006 inch or is less than 0.002 inch, install a different center main bearing insert with a thicker flange to reduce the end play, or one with a thinner flange to increase the end play. Install lock wire in all of the main bearing caps.

b. Install Flywheel. Place the flywheel in place on the crankshaft. Make certain that there is no foreign matter or burrs between the flywheel and crankshaft. Install the dowel retainer and cap screws. Tighten the cap screws from 65 to 70 pounds-feet. If self locking cap screws are used, tighten from 75 to 80 pounds-feet. Check the flywheel runout with an indicator. If the flywheel has a runout of more than 0.005 inch, take the flywheel off and turn it one-half turn on the crankshaft, and install the dowel retainer and cap screws. If the runout is still more than 0.005 inch, replace or reface the flywheel. Install lock wire in the four cap screws.

c. Install Clutch Disk and Pressure Plate. Block the three clutch release levers down with wooden blocks (fig. 47). Position the clutch disk on the flywheel, and install a clutch pilot tool into the pilot bearing and disk. Position the pressure plate on the flywheel. Install and tighten the six lock washers and cap screws. Remove the clutch pilot tool and the wooden blocks from the pressure plate.

d. Install Camshaft Assembly. Install the camshaft in the cylinder block, being careful not to damage the camshaft bearing

§ 131. d.

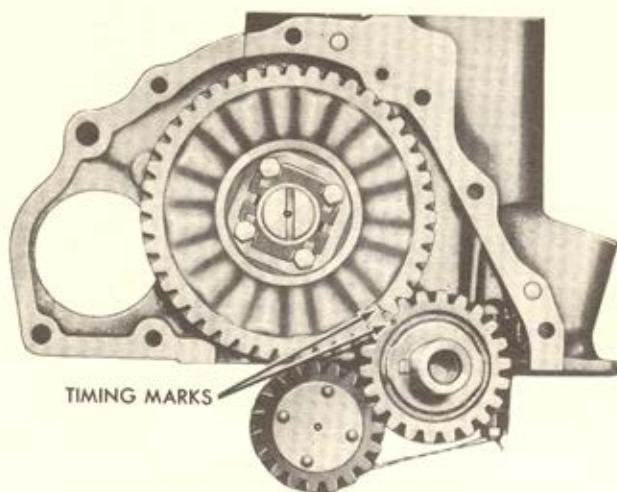

RM-518

Fig. 48—Timing Marks

surface with the sharp corners of the cams. Make sure the timing mark on the camshaft gear is in line with the timing mark on the crankshaft gear (fig. 48).

e. **Install Push Rod and Valve Assemblies.** Place a push rod in each push rod bore. If any of the push rods stick in the bore, they are too tight and must be replaced. Place each valve assembly in its respective port, and install the valve guide bushing retainers (fig. 49). Turn the camshaft until No. 1 push rod is resting on the heel of the cam (fig. 50). With a thickness gauge, check the clearance between the push rod and the end of the valve stem (fig. 51). If the

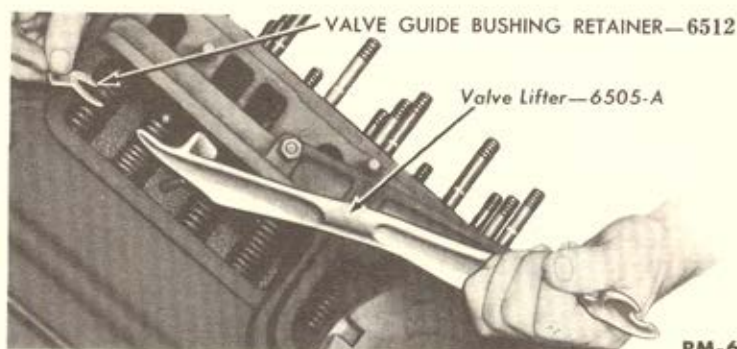

RM-656

Fig. 49—Installing Valve Guide Bushing Retainer

§ 131. e.

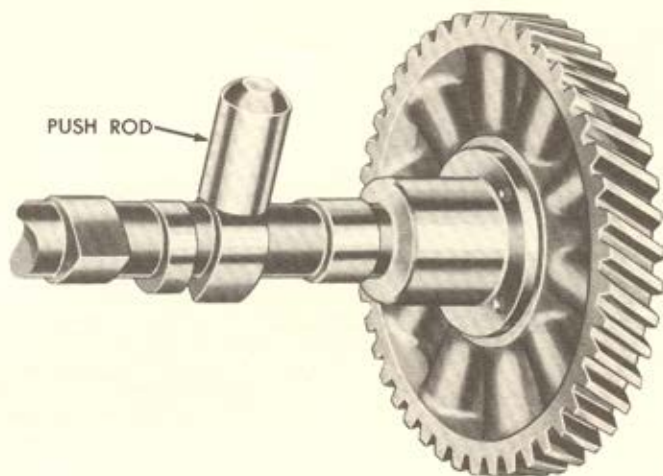

RM-519

Fig. 50—Push Rod on Heel of Cam

clearance exceeds 0.012 inch intake and 0.016 inch exhaust, select a longer valve, or reface the valve or valve seat to decrease the clearance. If the clearance is less than 0.010 inch intake or 0.014 inch exhaust, select a shorter valve or remove the valve assembly, and grind the lower end of the valve stem until 0.010 to 0.012 inch (intake) and 0.014 to 0.016 inch (exhaust) is established.

f. **Install Connecting Rod and Piston Assemblies.** Select the piston assemblies for each cylinder as outlined in section 123. Oil

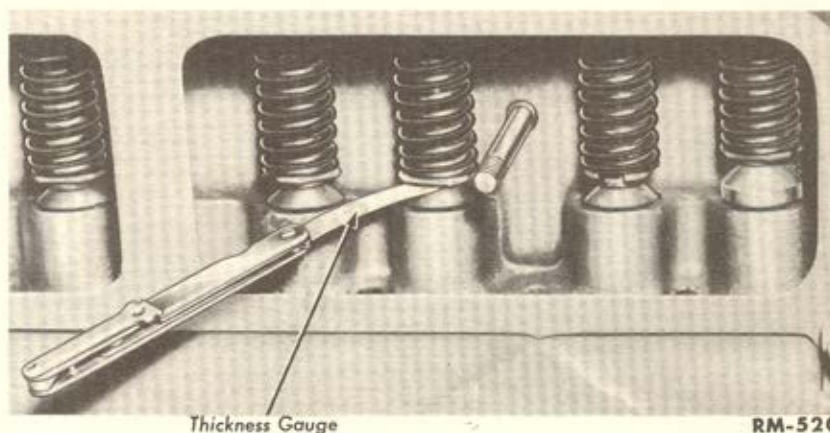

RM-520

Fig. 51—Checking Clearance Between Valve Stem and Push Rod

§ 131. f.

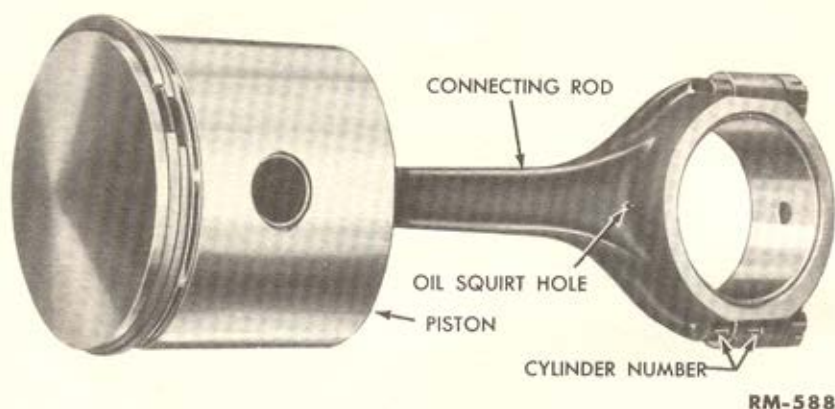

Fig. 52—Assembled Connecting Rod and Piston, Showing Oil Squirt Hole

the piston rings. Place No. 1 connecting rod and piston assembly in the No. 1 cylinder with the oil squirt hole in the connecting rod facing toward the front of the engine (fig. 52). Install a piston ring compressor on the piston rings, and tap the piston down into the cylinder with the handle end of a hammer (fig. 53). Place one-half of the connecting rod insert bearing in the connecting rod and the other half in the connecting rod bearing cap. Coat the connecting rod insert bearings with a light film of oil. Carefully position the connecting rod on the crankpin, and install the bearing cap on the connecting rod, making sure the number on the bearing cap is toward the camshaft side of the engine. Make sure that the insert bearings are not jarred out of place. Install, but do not tighten, the nuts. Repeat the above procedure when installing the other connecting rod and piston assemblies. Tighten all the connecting rod nuts from 35 to 40 pounds-feet, and install a cotter pin in each rod

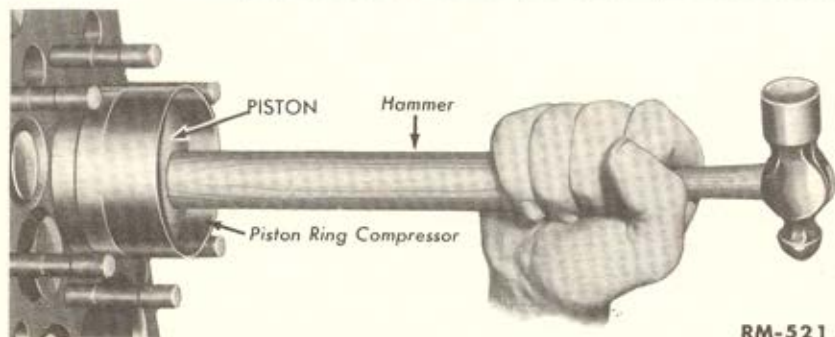

Fig. 53—Installing Connecting Rod and Piston Assembly

§ 131. f.

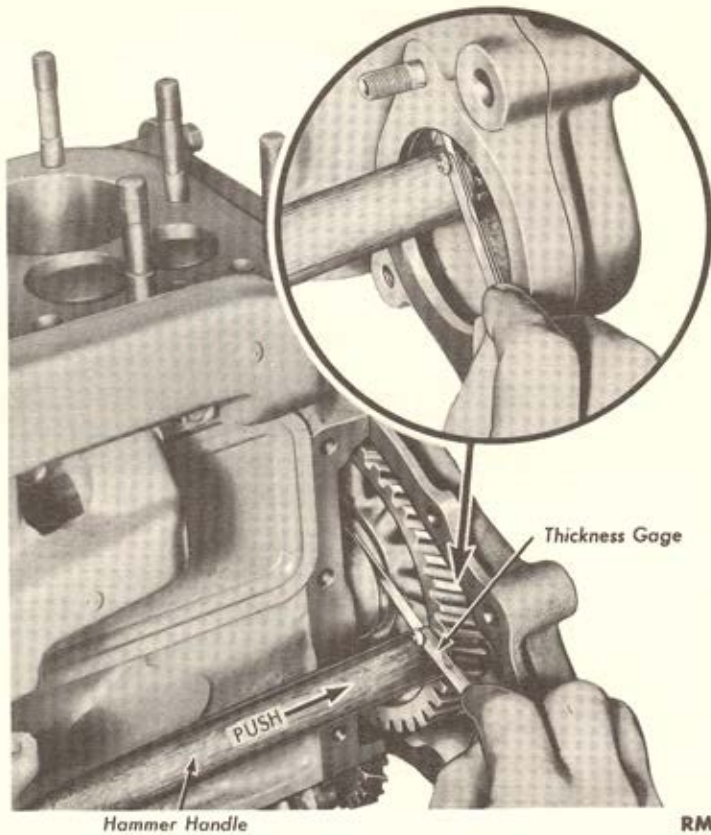

Fig. 54—Measuring Clearance Between Camshaft Gear and Cylinder Block

nut. If Marsden nuts (lock nuts) are used, tighten them from 40 to 45 pounds-feet.

g. Install Oil Pump Cover Assembly. Place the oil pump driven gear (fig. 31) on the shaft in the oil pump. Install the oil pump screen cover assembly and gasket onto the oil pump. Secure the screen cover assembly to the oil pump body with the three cap screws and lock wire.

h. Install Cylinder Front Cover and Camshaft Gear Side Cover. Hold the camshaft gear side cover and gasket in place on the cylinder block, and install the two lock washers and cap screws. Install the oil slinger on the crankshaft.

NOTE: Soak the crankshaft packing in oil for two hours before installation.

§ 131. h.

Install the crankshaft packing in the recess provided in the cylinder front cover. Insert a new gasket and cylinder front cover on the engine. Insert a thickness gauge between the camshaft gear and cylinder block while forcing the camshaft ahead with a hammer handle (fig. 54). If a clearance of more than 0.004 inch exists, replace the cylinder front cover.

i. Install Oil Pan.

NOTE: *Soak the crankshaft packing in oil for two hours before installation.*

Install the packing in the recess at each end of the oil pan. Coat the bottom machined surface of the crankcase with grease to hold the oil pan gasket in place. Install the oil pan gasket on the cylinder block. Position the oil pan on the cylinder block, and install the cap screws.

j. Install Crankshaft Pulley. Place the crankshaft pulley on the crankshaft. Turn the pulley by hand until the slot in the pulley is lined up with the woodruff key in the crankshaft. Drive the pulley on the crankshaft with a fiber block. Install the crankshaft ratchet.

k. Install Cylinder Head. Place a new head gasket on the cylinder block. Make sure there is no foreign matter either in the cylinders or on the surface of the cylinder head or block. Place the cylinder head on the cylinder block. Install and tighten the cylinder head nuts from 50 to 60 pounds-feet. When tightening nuts, start from a centrally located nut, and tighten alternately each way.

l. Install Water Pump. Position the water pump and gasket on the cylinder block, and install the nuts and cap screw.

m. Install Intake and Exhaust Manifolds. Place the intake and exhaust manifold gaskets on the cylinder block studs. Secure the manifold to the cylinder block with the four nuts.

132. INSTALLATION OF ACCESSORIES.

The following instructions are based on the assumption that the various accessories are in good working order. Overhaul or repair accessories before installation if required.

a. Install Starting Motor. Position the starting motor (fig. 1) on the cylinder block, and tighten the two starting motor cap screws.

§ 132. a.

b. Install Carburetor. Place the carburetor in place on the intake manifold (fig. 2). Install and tighten the two carburetor nuts and lock washers.

c. Install Distributor and Spark Plug Wires. Place the gasket in position on the distributor. Place the distributor in position on the cylinder front cover, making sure that the tang on the distributor shaft is entered in the slot in the camshaft. Secure the distributor to the cylinder front cover with two cap screws and lock washers. Secure the spark plug wire conduit to the cylinder head with the two cap screws.

d. Install Oil Filter. Secure the oil filter to the cylinder head (fig. 1) with the two cap screws. Connect the oil filter return line to the governor and oil filter. Connect the oil filter inlet line to the connection located at the right-hand side of the cylinder block and to the oil filter.

e. Install Generator. Hold the generator in place on the cylinder front cover (fig. 2). Install the cap screw and washer, but do not tighten until the fan belt is adjusted after the engine is installed.

Chapter

IV

FITS AND TOLERANCES

| | Section |
|----------------------------------|---------|
| Definition of Fits | 141 |
| Fits and Tolerances | 142 |
| Torque Wrench Readings | 143 |

141. DEFINITION OF FITS.

The Table of Fits and Tolerances (Sec. 142) gives the original clearance established between various parts at the time of manufacture, as well as wear and limit clearances that indicate to what point the clearance may increase before the parts must be replaced. These clearances are based on the parts involved, all being at 70° F. The following definitions of the various types of fits are given to assist in arriving at the correct amount of clearance between parts not included in section 142, as well as to give a better appreciation of why the various tolerances must be adhered to. Generally speaking, all bores are made to a standard size (so that standard reamers, plug gauges, etc., may be used) with a plus tolerance. The maximum size of the male parts is usually a standard size less the minimum clearance required for the type of fit desired. The minimum size for male parts is the maximum size minus the tolerance.

a. **Wring Fit.** A wring fit is the type of fit required between a bore and a plug gauge, when using the plug gauge, to determine the inside diameter of the bore. With a wring fit, it is necessary to turn or wring the plug gauge or part to force it through the bore. This type of fit does not provide space for a film of oil.

b. **Slip Fit.** A slip fit exists when the male part is slightly smaller than the female part and involves less clearance than a running fit (par. c below). An example of the minimum allowable clearance for a slip fit would be a piston pin that, from its own weight, would pass slowly through the connecting rod bushing (bushing and pin both in a vertical position). In most cases (except where only a limited move-

§ 141. b.

ment of the parts is involved) slip fits are specified when, due to anticipated expansion (par. f below) of the female part, enough additional clearance will result to change this type of fit to a running fit (par. c below) and provide adequate clearance for a film of oil.

c. Running Fit. A running fit is a fit providing enough clearance for a continuous film of oil between the two parts. A running fit usually requires 0.001 inch for oil film plus a minimum of 0.001 inch for each 1 inch of diameter (par. f below).

d. Press Fit. A press fit is one that requires force to enter the male part into the bore. Accepted practice for press fits is to have the male part larger by 0.001 inch for each inch of diameter than the bore into which it is to be pressed.

e. Shrink Fit. Generally speaking, a shrink fit is tighter than a press fit. The amount of the shrink ranging from 0.001 inch to 0.002 inch for each 1 inch of diameter, and in some cases even more. The parts having a press fit may be assembled either by force or by the shrink method. There are two methods of shrinking two parts together, either one of which may be used (both may be used in some instances). One method involves expansion of the female member by heating. The other method involves contracting the male member by chilling with dry ice or liquid air.

f. Effect of Expansion on Fits. Allowances are made in establishing fits on parts that are exposed to higher temperatures in order to provide for the anticipated expansion of the part during operation and still provide adequate clearance for the type of fit required. Allowances must also be made for unequal expansion of dissimilar materials. Absolute minimum allowance for expansion of parts exposed to flame or exhaust gases (pistons, piston rings, and valves) is 0.001 inch for each 1 inch of diameter or length. In anticipating the expansion of a piston to make allowances for the additional clearance required in the cylinder, 0.001 inch for each 1 inch of diameter is added. In anticipating the expansion of a piston ring, to make allowances for the additional gap required between the ends of the piston ring, 0.001 inch for each linear inch of the part is added.

§ 141. f.

142. FITS AND TOLERANCES

CYLINDER BLOCK

| <u>FIT LOCATION NAME</u> | <u>ORIGINAL FIT TOLERANCES</u> | <u>FIT WEAR LIMIT</u> | <u>TYPE OF FIT</u> |
|--|--------------------------------|-----------------------|--------------------|
| Cylinder bore out-of-round | — | 0.003 in. | — |
| Cylinder bore taper or maximum wear | — | 0.006 in. | — |
| Clearance between camshaft and bearing | 0.001 in. to 0.002 in. | 0.004 in. | Running |
| Clearance between push rod and push rod bore | 0.0005 in. to 0.0015 in. | 0.003 in. | — |

CONNECTING ROD AND PISTON ASSEMBLY

| <u>FIT LOCATION NAME</u> | <u>ORIGINAL FIT TOLERANCES</u> | <u>FIT WEAR LIMIT</u> | <u>TYPE OF FIT</u> |
|---|--|--|--------------------|
| Connecting rod side clearance | 0.004 in. to 0.008 in. | 0.011 in. | — |
| Piston pin clearance in connecting rod | 0.0002 in. to 0.0005 in. | 0.0015 in. | Slip |
| Piston pin clearance in piston | 0.000 in. to 0.0005 in. | 0.0015 in. | (Light Push) |
| Piston and cylinder | 6 pounds to 10 pounds pull with a thickness gauge 0.003 in. and 1/2 in. wide | 6 pounds to 10 pounds pull with a thickness gauge 0.005 in. and 1/2 in. wide | — |
| Top piston ring to groove side clearance | 0.0015 in. to 0.0030 in. | 0.004 in. | — |
| Balance of piston ring to groove side clearance | 0.0010 in. to 0.0025 in. | 0.004 in. | — |
| Piston ring end gap | 0.012 in. to 0.017 in. | 0.035 in. | — |

§ 142.

VALVES

| <u>FIT LOCATION NAME</u> | <u>ORIGINAL FIT TOLERANCES</u> | <u>FIT WEAR LIMIT</u> | <u>TYPE OF FIT</u> |
|---|------------------------------------|---------------------------|------------------------|
| Stem to guide clearance (exhaust) | 0.0025 in. to 0.0045 in. | 0.006 in. | Running |
| Stem to guide clearance (intake) | 0.0015 in. to 0.0035 in. | 0.005 in. | Running |
| Valve seat angle | 45 degrees | — | — |
| Spring tension at 2.125 inches | 31 to 34 lbs. | 30 lbs. | — |
| Clearance between valve stem and push rod (exhaust) | 0.14 to 0.16 in. | 0.015 in. | — |
| Clearance between valve stem and push rod (intake) | 0.010 to 0.012 in. | 0.013 in. | — |

OIL PUMP

| | | | |
|--|----------------------------|-----------|---------|
| Clearance between driven gear and shaft | 0.002 in. to 0.0035 in. | 0.005 in. | Running |
|--|----------------------------|-----------|---------|

CRANKSHAFT

| <u>FIT LOCATION NAME</u> | <u>ORIGINAL FIT TOLERANCES</u> | <u>FIT WEAR LIMIT</u> | <u>TYPE OF FIT</u> |
|---|------------------------------------|---------------------------|----------------------------|
| Crankshaft end play | 0.002 in. to 0.006 in. | 0.008 in. | |
| Main bearing clearance | 0.000 in. to 0.003 in. | 0.005 in. | Running |
| Crankpin to connecting rod clearance | 0.0013 in. to 0.0035 in. | 0.005 in. | Running and Floating |

143. TORQUE WRENCH READINGS.

| | |
|---------------------------------------|-------------------|
| Main bearing nuts..... | 75 to 80 lbs.-ft. |
| Self-locking main bearing bolts..... | 100 lbs.-ft. |
| Connecting rod castellated nuts..... | 35 to 40 lbs.-ft. |
| Connecting rod self-locking nuts..... | 40 to 45 lbs.-ft. |
| Cylinder head nuts..... | 50 to 55 lbs.-ft. |
| Flywheel cap screws..... | 65 to 75 lbs.-ft. |
| Flywheel self-locking cap screws..... | 75 to 85 lbs.-ft. |
| Spark plugs..... | 24 to 30 lbs.-ft. |

144. IGNITION SETTINGS

| | |
|--|-----------------|
| Distributor breaker point setting..... | 0.014-.016 |
| Distributor timing (cranking)..... | Top dead center |
| Magneto breaker point setting..... | 0.016-.018 |
| Magneto timing (cranking)..... | Top dead center |
| Spark plug gap..... | 0.025-.028 |

Ford "120"

POWER CURVE AND SPECIFICATIONS

FORD INDUSTRIAL ENGINE
FOUR CYL.-120
BORE 3.187 — STROKE 3.750

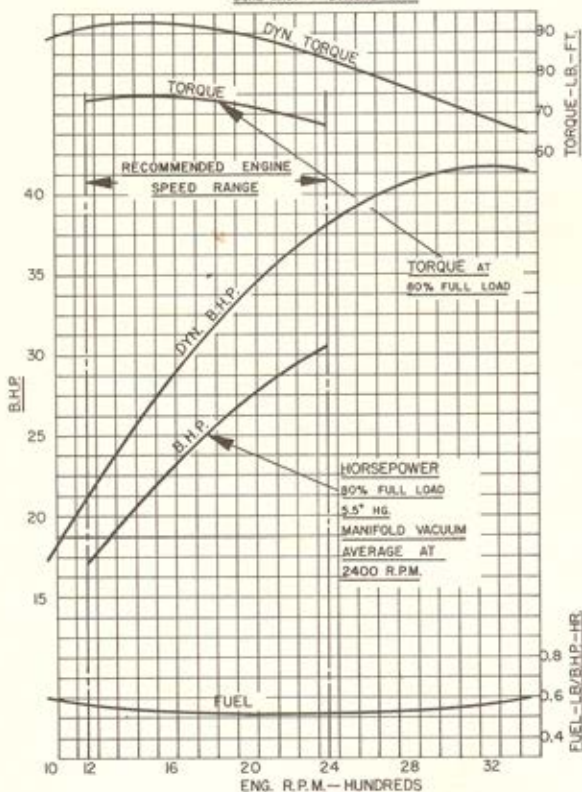

The dynamometer H.P. and torque curves are ratings for complete engine assemblies, including water pump and generator, but less fan. This is the power and torque that will be obtained when operating at sea level (at barometric pressure of 29.92 inches of mercury and at an air temperature of 60°F). The 80% H.P. and torque curves show the ratings for continuous speed and load operation under normal conditions.

| | |
|-------------------------|--|
| Model | 120 Four Cylinder |
| Type Fuel | Gasoline |
| Bore and Stroke | 3 $\frac{1}{8}$ x 3 $\frac{3}{4}$ |
| Displacement | 120 Cubic Inches |
| Compression Ratio | 6.5 to 1 |
| A.M.A. H.P. | 16.25 |
| Cylinders and Crankcase | Cast Integral |
| Cylinder Sleeves | Removable Dry Liners |
| Pistons | Lightweight Cast Alloy Steel |
| Crankshaft | Ford Alloy Steel—Static and Dynamic Balanced |
| Main Bearings | Replaceable Steel Backed Thin Wall Type |

| | |
|--------------------|--|
| Connecting Rod | |
| Bearings | Replaceable Steel Backed Thin Wall Type |
| Camshaft | Ford Alloy Iron |
| Valves | High Chrome Nickel Alloy |
| Valve Seat Inserts | Moly-chrome Alloy Steel |
| Type Lubrication | Full Pressure Feed to Rods and Bearings |
| Type Ignition | Battery or Magneto |
| Firing Order | 1-2-4-3 |
| Governor | Gear Driven, Variable Speed, Mechanical |
| Weight | 342 Lbs. with Accessories, Less Transmission |

FORD "120" POWER UNIT

This popular version of the Ford "120" Power Unit includes an industrial power take-off clutch at the rear of the engine which adapts the Power Unit for belt, chain or direct drive. This is an over center clutch which allows the operator to disengage the engine from the load for periods of time without remaining near the engine. It contains extra large bearings to combat any side thrust that may be imposed.

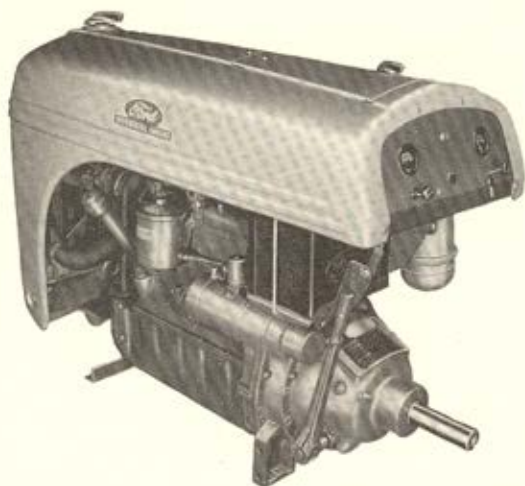

The Ford "120" Power Unit with the industrial power take-off clutch attached makes a self contained unit for most stationary and portable uses. This Power Unit is also available with three or four-speed transmission, or with bare flywheel for particular applications. Various flexible couplings are also available which attach directly to the flywheel when a clutch is not needed.

MAGNETO IGNITION

Magneto ignition is available as standard equipment on some models and as an accessory for the other models. For further details contact your nearest Authorized Ford Dealer.

CHASSIS PARTS

Late model chassis parts are available to manufacturers of reasonable volume for resale in a finished unit. These parts include wheels, hubs, bearings, brakes, front and rear axles, steering gears, driveshafts, springs, etc.

Many recognized manufacturers use Ford chassis parts in products varying from farm wagons to power shovels, and adapt gears and other parts to uses which would be extremely expensive if done in any other manner.

PREPARATION FOR STORAGE

FOR PERIOD NOT TO EXCEED ONE MONTH.

1. While engine is running treat upper cylinders by spraying M 4834 A Engine Preservative Oil (SAE 10) or equivalent into carburetor air intake for about two minutes. Open throttle for short burst of speed, shut off ignition and allow engine to come to a stop while continuing to spray M 4834 A into air intake.
2. Leave spark plugs in holes or seal spark plug holes with suitable threaded metal plugs and cover all openings into engine with dust-proof caps or shields.
3. Drain oil, water, and gasoline.
4. If engines are less transmission, spray flywheel and ring gear with mixture of one part M 4850, Bodied Anti-Rust Oil and one part M 4670, Stoddard Solvent or equivalents.

FOR INDEFINITE PERIOD.

1. Drain crankcase completely and refill with M 4834 A Engine Preservative Oil (SAE 10) or equivalent.
2. Run engine until completely out of gasoline, then restart and run on M 534 H or equivalent unleaded, undyed gasoline for at least 10 minutes.
3. While engine is still running, and at completion of above run, treat upper cylinders by spraying M 4834 A into carburetor air intake for about two minutes. Open throttle for short burst of speed, shut off ignition and allow engine to come to a stop while continuing to spray M 4834 A into air intake.
4. Drain oil, water and gasoline.
5. Remove grease and oil from exterior surface of engine.
6. Leave spark plugs in holes or seal spark plug holes with suitable threaded metal plugs.
7. Seal all openings in engine and accessories with M 6471, Non-Hygroscopic Adhesive Tape or equivalent. Mask off all areas to be used for electrical contact.
8. Make sure all surfaces are dry, then spray all taped openings, all engine accessories including ignition wiring, and all exterior surfaces of engine with M 4858 B, Insulation Compound, Ignition, or equivalent.
9. If engines are equipped with fiber-disc automotive type clutch, block clutch in slightly disengaged position so that lining and pressure plate are not in contact.

CAUTION: Do not completely depress clutch lever.

FORD INDUSTRIAL ENGINES GIVE VERSATILE "POWER-PERFORMANCE" IN WIDE RANGE OF INDUSTRIES



Leaf and Litter Collector, for park and street maintenance, powered by the Ford "120" Four-Cylinder Industrial Power Unit.



Ford Industrial Engines make an ideal power source for generator sets and similar equipment. One of many advantages is easy servicing.



Material handling is easy with Ford Industrial Power. This unit uses the "120" Four-Cylinder Engine.



Experienced operators use the Ford "120" Four-Cylinder Industrial Engine for park maintenance.



Under the hood, a Ford "120" Four-Cylinder Industrial Engine—one of many applications of this unit in the field of park maintenance operations.



The Ford "120" Four-Cylinder Industrial Engine gives day-in-day-out performance and low cost for users of equipment where reliability counts.



INDUSTRIAL ENGINES

*Installation drawings
showing Ford Industrial
Engines equipped with clutch,
transmission, S. A. E. hous-
ings, power take-offs, etc.,
available upon request.*

Industrial Engine Sales Department

FORD MOTOR COMPANY

DEARBORN, MICHIGAN