

Industrial Instrumentation

An Introduction

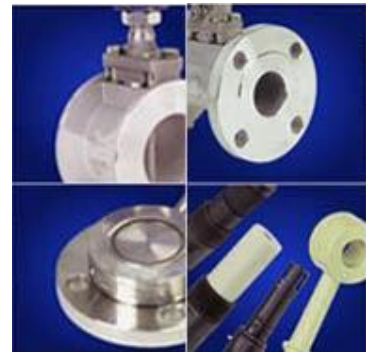

AN OVERVIEW OF INDUSTRIAL MEASUREMENT AND CONTROL SYSTEMS

Level 1

Bryon Lewis

INDUSTRIAL MEASUREMENT AND CONTROL SYSTEMS



Level 1

Introduction

This course will introduce the methods to apply instrumentation and control for use in industrial processes. It will show the proper way to install and calibrate basic instruments, as well as the use of controllers, control modes, and control loops.

Industrial instrumentation employees the use of applied physics to monitor and regulate processes. Instrumentation can be found in any number of the following industries, gas and petrochemical, food processing, pharmaceutical, paper and pulp, waste water and water treatment plants are just a few examples.

Objectives

The objectives of this course will be as follows...

1. Read P&IDs (process and instrumentation diagrams).
2. Read instrument loop diagrams.
3. To be able to install and calibrate basic instruments.
4. Apply basic instrumentation to control an industrial process.
5. Apply simple design of control loops used in processes.
6. Understand feedback, feedforward, cascade and ratio control.



INDUSTRIAL MEASUREMENT AND CONTROL SYSTEMS

Part 1 Course Objectives – Basic Instruments

1. Instrumentation Symbols and Terminology
 - a. Symbols, nomenclature and usage
 - b. P&IDs, Mechanical Flow Diagrams
 - c. Loop Diagrams
2. Basic Measurements
 - a. Basic Concepts
 - i. Standard signals used in instrumentation
 - ii. Instrument ranging and limitation
 - iii. Span, Upper range value and Lower range value
 - iv. Constant current and constant voltage
 - v. Static equilibrium in instrument measurements
 - vi. Open systems
 - vii. Closed systems
 - b. Pressure measurements
 - i. Static pressure and Head measurements
 - ii. Differential pressure and Head measurements
 - iii. Vacuum measurements
 - iv. Calibration
 - c. Level measurements
 - i. Wet Legs
 - ii. Suppressing the Zero
 - iii. Elevating the Zero
 - d. Temperature measurements
 - i. Thermocouples
 1. J type, K type, E type, T type (most commonly used)
 - ii. RTD (resistance temperature detectors)
 1. 100 ohm platinum (most commonly used)
 2. Bridge measurement application
 3. Constant current measurement application
 - iii. Capillary tubes and thermometers
 - e. Flow and Mass Flow measurements
 - i. Differential pressure and Head to measure flow
 - ii. Meter Types
 1. Magnetic
 2. Orifice
 3. Venturi
 4. Vortex
 5. Turbine
 - iii. Mass Flow measurement
 1. Electrical and Mechanical
 2. Pressure + Delta Pressure + Temperature
 3. Mass flow is proportional to Force measured
3. Open discussions of applications and experiences

INDUSTRIAL MEASUREMENT AND CONTROL SYSTEMS

Part 2 Course Objectives – Process Control

1. Control loops
 - a. Principles of operation and terminology
 - b. Open loop control
 - c. Closed loop control
 - d. Single loop controls
 - e. Cascade controls (outer and inter loop)
 - f. Wiring of instruments and controllers
2. Control Modes
 - g. PID control modes
 - i. Proportional control mode
 - ii. Integral control mode
 - iii. Derivative control mode
 - iv. Application of the three types of control modes
 - h. Differential Gap Control
 - i. Split Range Control
 - j. Time Proportioning Control
3. Final Correction Devices
 - k. Valves
 - i. Type of valves
 - ii. Valve terminology, trim, and characterization
 - iii. Applications of equal percentage, linear and quick opening vales
 - l. Pumps
 - i. Types
 - ii. Applications
 - iii. Control and interlocking to process controller
 1. Alarms
 2. Starting and stopping
 3. Shutdown systems
4. Applications of measurement, process control and P&IDs
5. Open discussions of applications and experiences

End of Course



Section 1 – Basic Instruments

Loop Diagram Symbols and P&IDs

P&IDs AND LOOP DIAGRAMS

P&IDs and loop diagrams are construction and documentation drawings that depict the flow of the process and illustrate the instrumentation control and measurement interactions, wiring and connections to the process. The process is illustrated in sections or subsystems of the process called loops. A loop diagram will detail the connections of pneumatics and wiring from the field device through any junction boxes or marshalling cabinet to the controller or computer interface which controls the process a single loop or a cascade loop of the process.

This section will focus on the standard symbols, identification tags and terminology used in the industry.

In the areas of engineering, design, drafting, installation and maintenance of an industrial instrumentation and control system, a solid understanding of the symbols and terminology used to depict the process system is required.

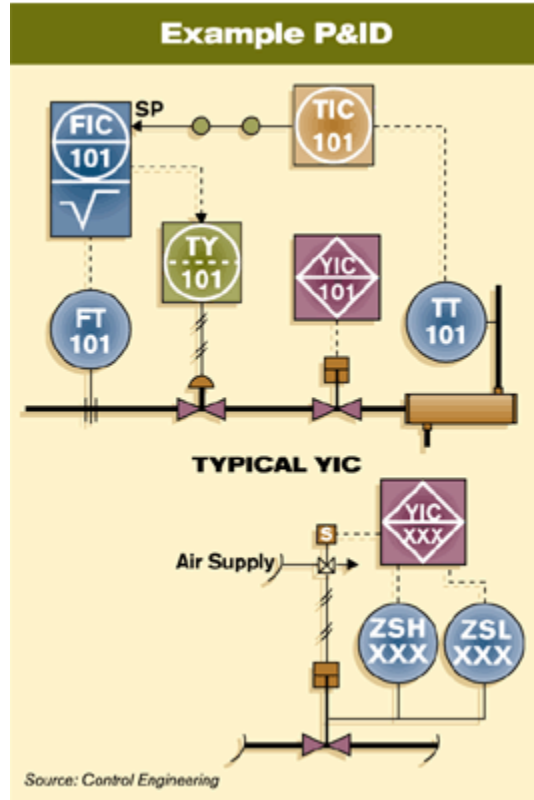

This course will use the ISA/ANSI standards shown in this section for all process illustrations. ISA (International Society of Automation) / ANSI (American National Standards Institute).

Instrument line symbols

ALL INSTRUMENT LINES ARE TO BE DRAWN FINE IN RELATION TO THE PROCESS PIPING LINES.

Common connecting lines	
Connection to process, or instrument supply:	
Pneumatic signal:	
Electric signal:	
Capillary tubing (filled system):	
Hydraulic signal:	
Electromagnetic or sonic signal (guided):	
Internal system link (software or data link):	
Source: Data from ISA S5.1 standard	













Section 1 – Basic Instruments Loop Diagram Symbols and P&IDs

Tagging nomenclature

The following table illustrates standard tagging to use for instrument identification.

P&ID TAG DESIGNATIONS		
TYPICAL TAG NUMBER		
<i>TIC</i>	103	- Instrument Identification or Tag Number
<i>T</i>	103	- Loop Identification
	103	- Loop number
<i>TIC</i>		- Function Identification
<i>T</i>		- First Letter (measured variable – see table 2)
		- Succeeding Letters (modifier, readout or function)
<i>IC</i>		
EXPANDED TAG NUMBER		
<i>10-PHA-5A</i>		- Tag Number
<i>10</i>		- Option Prefix
	A	- Option Suffix
<i>Note: Hyphens are optional as separators</i>		

The top of the tag will identify the instrument type and the bottom will identify the loop number. Refer to tagging nomenclature tables above. Remember the loop number is just a section or sub system of the process.

General instrument or function symbols			
	Primary location accessible to operator	Field mounted	Auxiliary location accessible to operator
Discrete instruments	1 	2 	3 
Shared display, shared control	4 	5 	6 
Computer function	7 	8 	9 
Programmable logic control	10 	11 	12 
<ol style="list-style-type: none"> 1. Symbol size may vary according to the user's needs and the type of document. 2. Abbreviations of the user's choice may be used when necessary to specify location. 3. Inaccessible (behind the panel) devices may be depicted using the same symbol but with a dashed horizontal bar. 			
Source: Data from ISA S5.1 standard			

Section 1 – Basic Instruments Loop Diagram Symbols and P&IDs

The table below shows the recommended tag identification letters for instruments and control element designations used in P&IDs and Loop Diagrams.

Identification letters					
	First letter		Succeeding letters		
	Measured or initiating variable	Modifier	Readout or passive function	Output function	Modifier
A	Analysis		Alarm		
B	Burner, combustion		User's choice	User's choice	User's choice
C	User's choice			Control	
D	User's choice	Differential			
E	Voltage		Sensor (primary element)		
F	Flow rate	Ration (fraction)			
G	User's choice		Glass, viewing device		
H	Hand				High
I	Current (electrical)		Indication		
J	Power	Scan			
K	Time, time schedule	Time rate of change		Control station	
L	Level		Light		Low
M	User's choice	Momentary			Middle, intermediate
N	User's choice		User's choice	User's choice	User's choice
O	User's choice		Orifice, restriction		
P	Pressure, vacuum		Point (test connection)		
Q	Quantity	Integrate, totalizer			
R	Radiation		Record		
S	Speed, frequency	Safety		Switch	
T	Temperature			Transmit	
U	Multivariable		Multifunction	Multifunction	Multifunction
V	Vibration, mechanical analysis			Valve, damper, louver	
W	Weight, force		Well		
X	Unclassified	X axis	Unclassified	Unclassified	Unclassified
Y	Event, state, or presence	Y axis		Relay, compute, convert	
Z	Position, dimension	Z axis		Driver, actuator	

Source: Data from ISA S5.1 standard

Section 1 – Basic Instruments Loop Diagram Symbols and P&IDs

First Letter	Process Variable	Controllers	Readout Devices	Switches and Alarm Devices	Transmitters	Elements and Final Correction Devices
	Initiating or Measured Variable	Recording Indicating Blind Self-Actuated Control Valves	Recording Indicating	High Low Comb	Recording Indicating Blind	Solenoids Relays, Computing Devices, Primary Element, Well or Probe, Viewing Device, Safety Glass, Final Element
A	Analysis	ARC AIC AC	AR AI	ASH ASL ASHL	ART AIT AT	AY AE AP AW
B	Burner/combustion	BRC BIC BC	BR BI	BSH BSL BSHL	BRT BIT BT	BY BE BW BG
C	User' Choice					
D	User' Choice					
E	Voltage	ERC EIC EC	ER EI	ESH ESL ESHL	ERT EIT ET	EY EE EZ
F	Flow Rate	FRC FIC FC FCV FICV	FR FI	FSH FSL FSHL	FRT FIT FT	FY FE FP FG FV
FQ	Flow Quantity	FQRC FQIC	FQR FQI	FQSH FQSL	FQRT FQIT	FQY FQE FQV
FF	Flow Ratio	FFRC FFC	FFR FFI	FFSH FFSL		
G	User' Choice					
H	Hand			HS		
I	Current	IRC IIC	IR II	ISH ISL ISHL	IRT IIT IT	IY IE HV IZ
J	Power	JRC JIC	JR JI	JSH JSL JSHL	JRT JIT JT	JY JE JZ
K	Time	KRC KIC KC KCV	KR KI	KSH KSL KSHL	KRT KIT KT	KY KE KV
L	Level	LRC LIC LC LCV	LR LI	LSH LSL LSHL	LRT LIT LT	LY LE LV LG
M	User' Choice					
N	User' Choice					
O	User' Choice					
P	Pressure/Vacuum	PRC PIC PC PCV	PR PI	PSH PSL PSHL	PRT PIT PT	PY PE PV PSV PSE PDV
PD	Pressure Differential	PDRC PDIC PDC PDCV	PDR PDI	PDSH PDSL PDSHL	PDRT PDIT PDT	
Q	Quantity	QRC QIC	QR QI	QSH QSL QSHL	QRT QIT QT	QY QE QZ
R	Radiation	RRC RIC RC	RR RI	RSH RSL RSHL	RRT RIT RT	RY RE RW RZ
S	Speed/Frequency	SRC SIC SC SCV	SR SI	SSH SSL SHHL	SRT SIT ST	SY SE SV
T	Temperature	TRC TIC TC TCV	TR TI	TSH TSL TSHL	TRT TIT TT	TY TE TP TW TV TSE TDV
TD	Temperature Differential	TDRC TDIC TDC TDCV	TDR TDI	TDSH TDSL TDSHL	TDRT TDIT TDT	
U	Multivariable		UR UI			UY UV
V	Vibration/Machinery		VR VI	VSH VSL VSHL	VRT VIT VT	VY VE VZ
W	Weight/Force	WRC WIC WC WCV	WR WI	WSH WSL WSHL	WRT WIT WT	WY WE WZ
WD	Weight/Force Differential	WDRC WDIC WDC WDCV	WDR WDI	WDSH WDSL WDSHL	WDRT WDIR WDT	WDY WE WDWZ
X	Unclassified					
Y	Event/State/Presence	ZRC ZIC ZC ZCV	ZR ZI	ZSH ZSL ZSHL	ZRT ZIT ZT	ZY YE YZ
Z	Position/Dimension					ZV
ZD	Gauging Deviation	ZDRC ZDIC ZDC ZDCV	ZDR ZDI	ZDSH ZDSL	ZDRT ZDIT ZDT	ZDY ZDE ZDV

Section 1 – Basic Instruments Loop Diagram Symbols and P&IDs

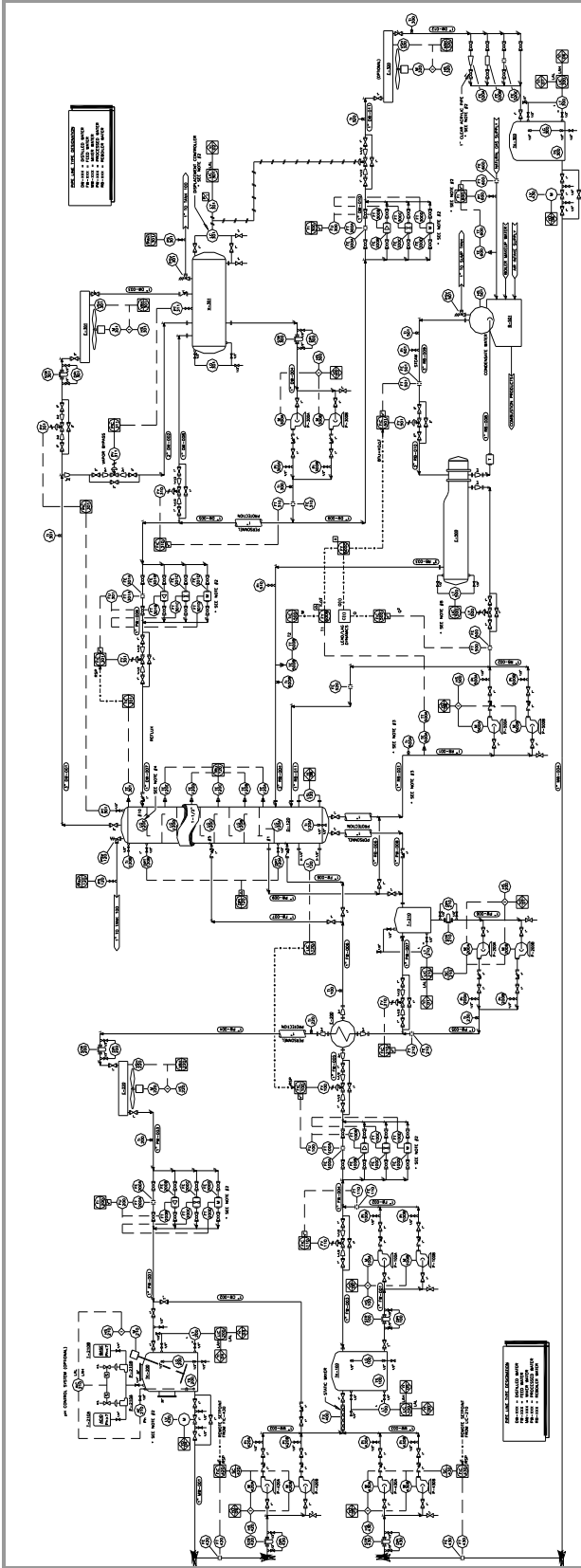

P&ID (process and instrumentation diagram)

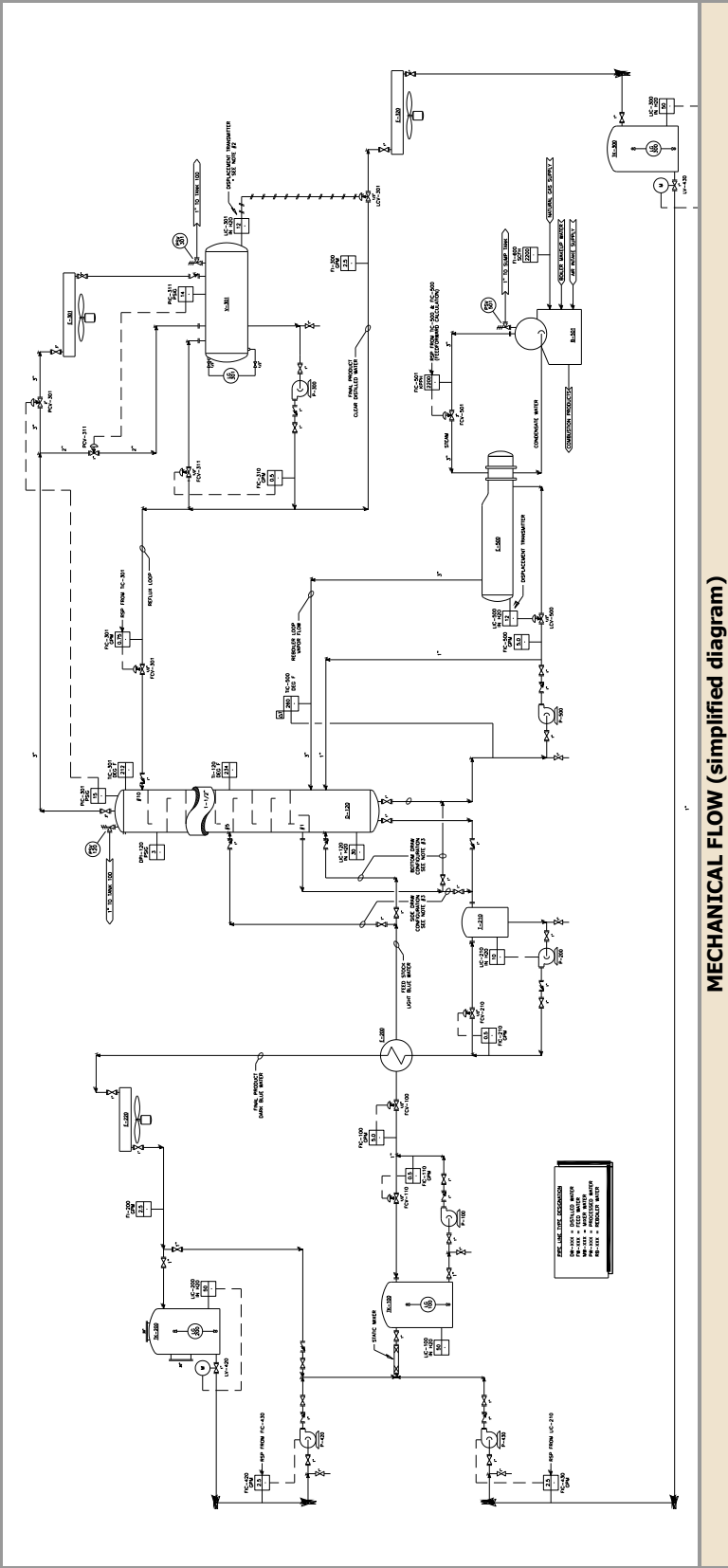

MECHANICAL FLOW (simplified diagram)

Section 1 – Basic Instruments Loop Diagram Symbols and P&IDs

This P&ID diagram illustrates the use of software data links between controllers. These controllers communicate over a communications bus and pass variables back and forth between the IOP (input output processor) sections of the DCS. The communications processor will then put the information in memory for the control blocks of the program to use. Some controllers can use Ethernet or Field Bus to communicate and pass the process variables back and forth. If the controllers are in the software of the same DCS (distributed control system) IOP or in the same SCADA (supervisory control and data acquisition) system RTU (remote terminal unit) or in a stand alone PLC (programmable logic controller) the control variables would be passed in memory.

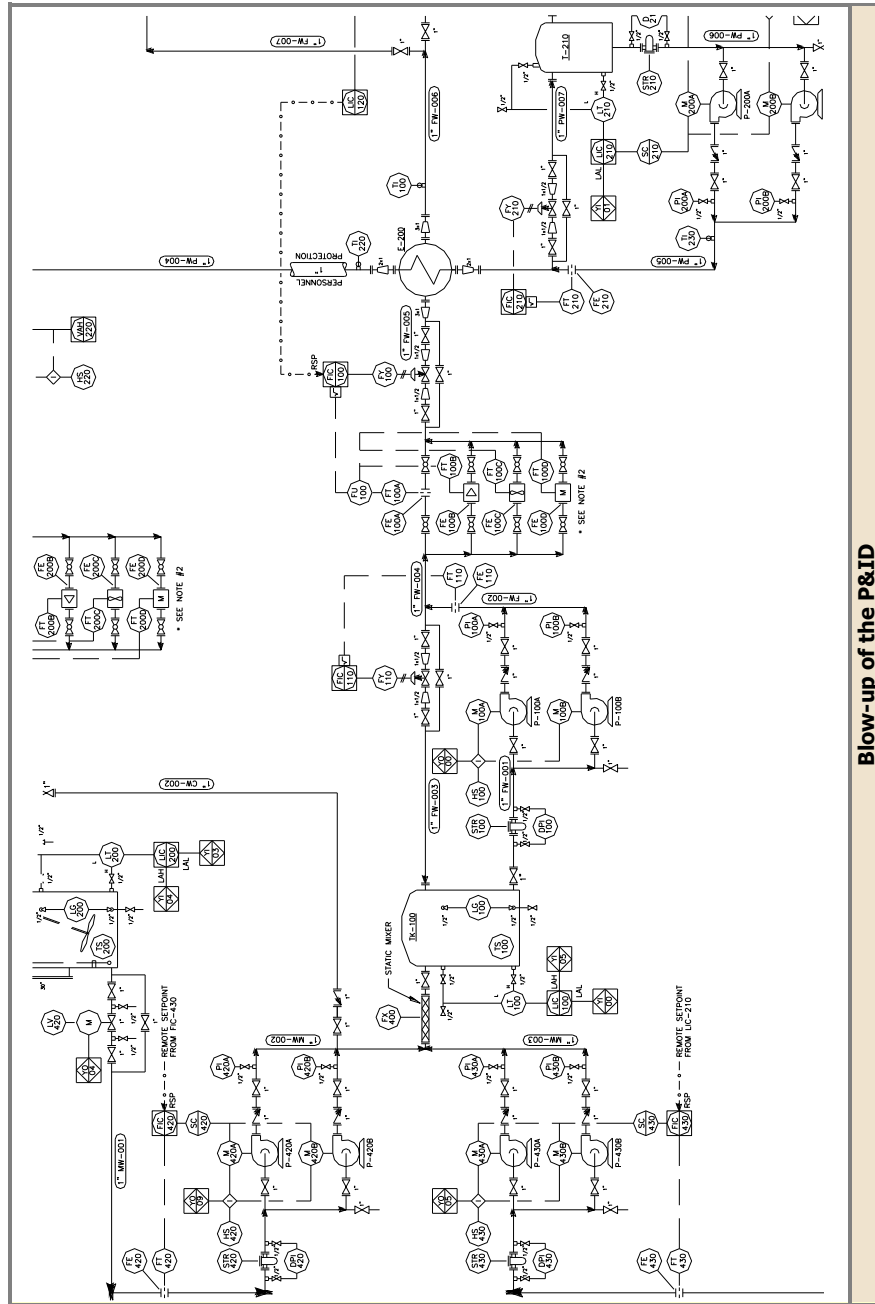

Blow-up of the P&ID

Section 1 – Basic Instruments Loop Diagram Symbols and P&IDs

This Loop diagram illustrates flow loop FT-100 from field to PLC controller and the display.

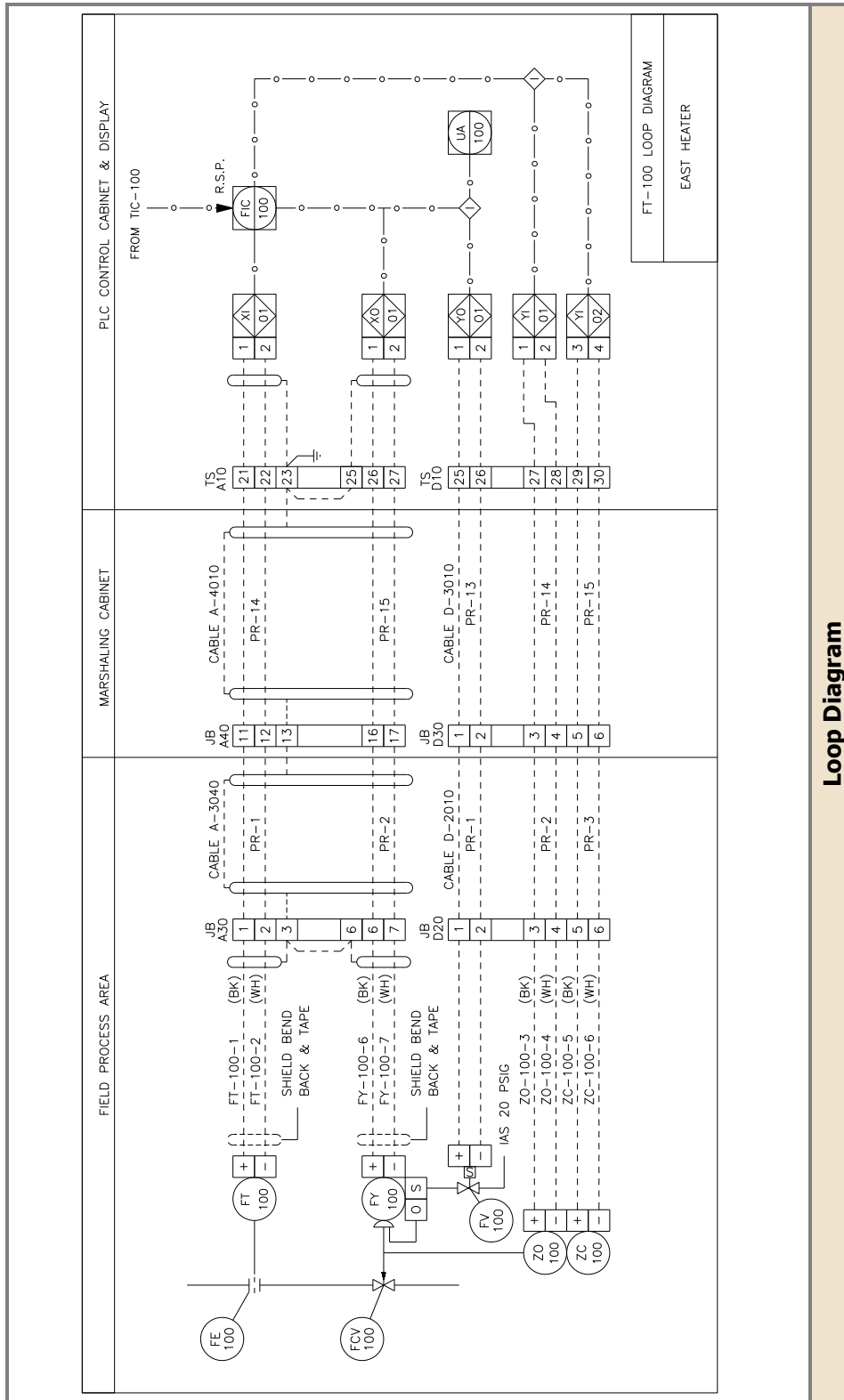

Loop Diagram

Section 2 – Basic Instruments Measurements and Calibration Procedures

Standard process signals

Industrial processes use standards for the measurement and control signals used throughout all industries. The signals used in industrial instrumentation are unique. Processes are referred to or measured as 0% to 100% of the process range. These signals also typically employ a live zero for 0% of process measurement.

A live zero gives insight as to if the process loop is functioning within given parameters or if the control loop is open or malfunctioning. If the loop is functioning in a proper manor, the signal will indicate a measurement greater than zero for 0% percent of process. There is also a measurement greater than zero for 100% percent of the process. For example if the process was using a signal of 3 PSI to 15 PSI, the range of the process is 3 to 15 PSI.

In the representation of the process, 3 PSI represents 0% of the process and 15 PSI represents 100% of the process. The span of the process is 12 PSI. The span is where the process takes place in a range of measurement.

Upper Range Value (URV) – Lower Range Value (LRV) = Span

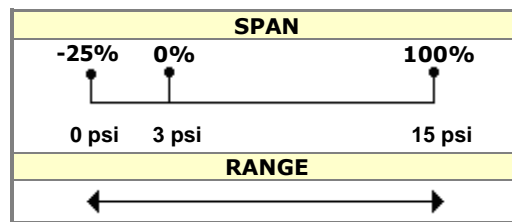

It can be seen from the chart above that if the process signal equaled 0 PSI or -25%, the loop is open or malfunctioning. This is a great advantage in industrial measurement for the troubleshooting of the process loop and identification and elimination of elements that are not associated with the source of the problem.

The chart below shows some of the various standard signals used for industrial instrumentation.

Measurement	Sensor	PV / MV	PV / MV
mV (millivolts)	0 -100	0-100	
V (volts)	0-10	1-5	0-10
mA (milliamperes)	20	4-20	10-50
in H2O	0-100		
PSI		3-15	6-30
kPa		20-100	

Section 2 – Basic Instruments

Constant voltage and constant current signals

Industrial electrical control signals are typically constant current or constant voltage. These signals obey ohm's law but are not the same as a resistor connected in series or parallel with the voltage supply.
Ohm's Law $E = I \times R$

With a **constant current control device** one or more resistive loads may be connected in series with the control device. The current flowing through the circuit will remain at a constant value of current even if the resistance of one or more of the resistive loads is varied at any period of time or frequency. Ohm's law still applies to this type of circuit. The voltage supply of the circuit must be equal to or greater than the sum of all maximum resistances in the circuit in ohms multiplied by the maximum current of the circuit in amperes.

$$[20\text{mA} \times (R_{\text{wire}} + R_{\text{device1}} + R_{\text{device2}} + R_{\text{n...}})] \leq V_s \text{ (power supply voltage)}$$

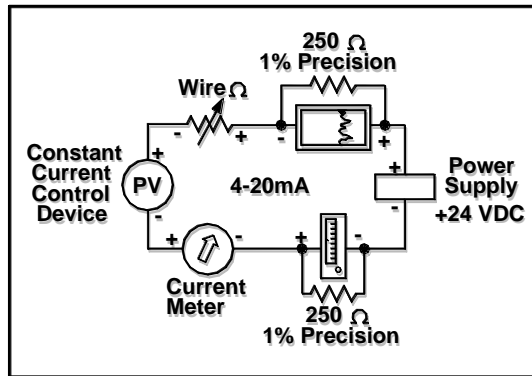

Notice the 1% precision resistors. The resistor will produce a 1-5 volt signal for the recorder and controller to read as input. $(4\text{mA} \times 250\Omega = 1\text{v}, 20\text{mA} \times 250\Omega = 5\text{v})$

With a **constant voltage control device** one or more resistive loads may be connected in parallel with the control device. The applied voltage across the resistances throughout the circuit will remain at a constant value of voltage even if the resistance of one or more of the resistive loads is varied at any period of time or frequency. Ohm's law still applies to this type of circuit. The voltage supply of the circuit must be equal to or greater than the sum of all maximum resistances in the circuit in ohms multiplied by the maximum current of the circuit in amperes.

$$[20\text{mA} \times \{1/(1/R_{\text{wire}} + 1/R_{\text{device1}} + 1/R_{\text{device2}} + 1/R_{\text{n...}})\}] \leq V_s \text{ (power supply voltage)}$$

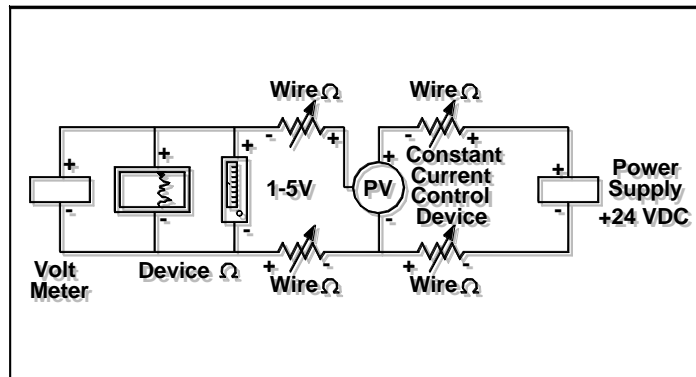

Notice the devices and the voltmeter are in parallel. The transmitter is sending a low power output constant voltage signal typically 1-5 volt. Notice the wire resistance. The devices must be kept close as possible not to produce significant error due to voltage drop.

Section 2 – Basic Instruments

Static equilibrium in instrument measurements

Most industrial instrument measuring devices use static equilibrium to measure the error in the process. The error is the difference between the setpoint (SP), the desired value of the process, and the process variable (PV), the actual value of the process.

The sum of forces must equal zero to be in static equilibrium ($\Sigma F = 0$). Most mechanical instruments can be thought of as a balance beam.

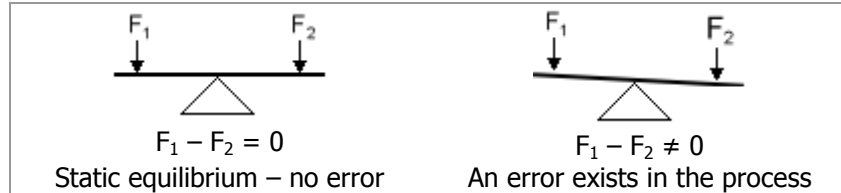

F_1 represents the setpoint (SP) and F_2 represents the process variable (PV). When the sum of the setpoint and the process variables equal zero ($SP - PV = 0$), the measuring instrument is in static equilibrium. This applies to the controller as well. When the error is zero $SP - PV = E_{(error)}$, the process is said to be at steady state. It is exactly where it should be, but in the real world this is extremely hard to achieve. There are constantly disturbances on the system and this is why constant monitoring of the process needed. With constant monitoring and correction of the process, the process can be regulated with extremely little or negligible error. The desired process value will be exactly what it should be within the tolerances of the system and it's components.

Open and closed systems

Industrial processes use tanks, device and instruments that are referred to as open and closed systems. These are not to be confused with open and closed control loops.

The following examples illustrate the application of open and closed systems. Take a look at the open systems first, then the closed system. Both level transmitters are in static equilibrium when the tanks are empty. The same applies to flow transmitters. We can measure the unbalanced pressure when a fluid is flowing in the pipes or a level exists in the tanks. This method reveals the energy in the system, stored or kinetic.

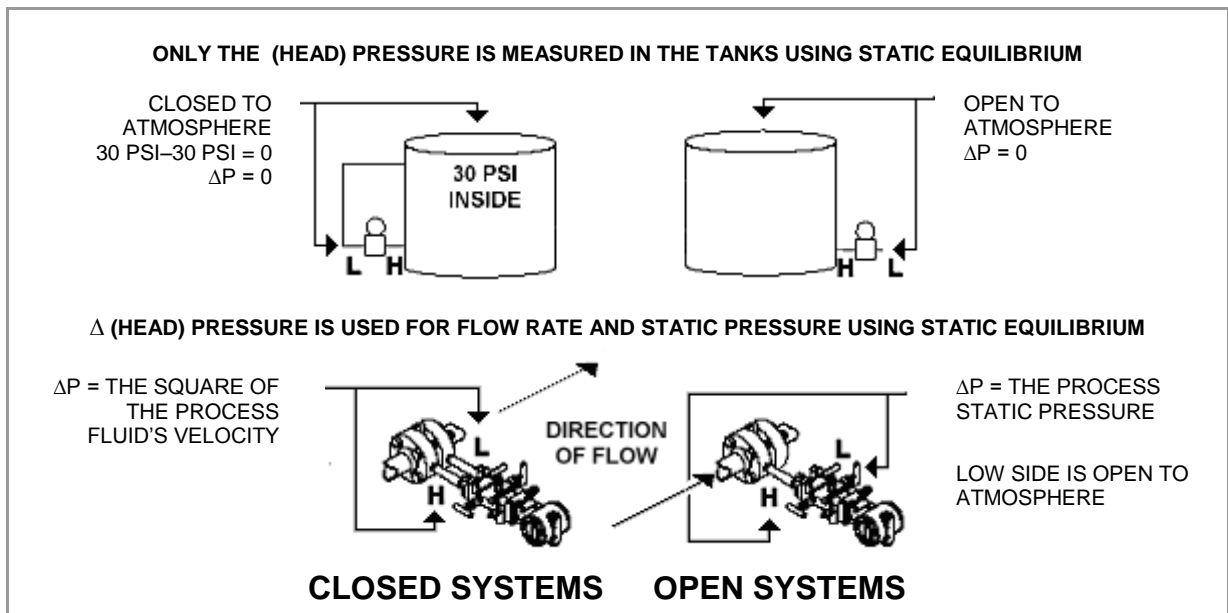

Section 2 – Basic Instruments

Pressure measurements

The most common measurement used in most industrial processes is pressure. The pressure measurement can be used to measure flow, level, mass, weight, and work. This type of measurement is an inferred measurement. An inferred measurement is proportional to the potential and kinetic energy in the system.

By first learning methods to measure pressure, then temperature and then differential pressure, it possible to control about any type of industrial process.

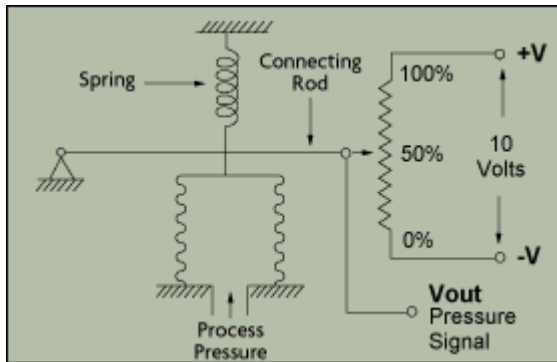

The illustration to left is a simple pressure meter. It uses a voltage divider to output a voltage that is proportional to the process pressure. At the 50% position it is in static equilibrium and the voltage out is equal to 0 volts. At the 0% position the voltage is equal to -5 volts. At the 100% position the voltage is equal to +5 volts. This design will indicate if the pressure is positive or negative. Pressure is typically referred to as a positive measurement but not always.

Potentiometric Pressure Transducer

The following illustration is of the bourdon tube design. This design is a very popular design for use in pressure gauges.

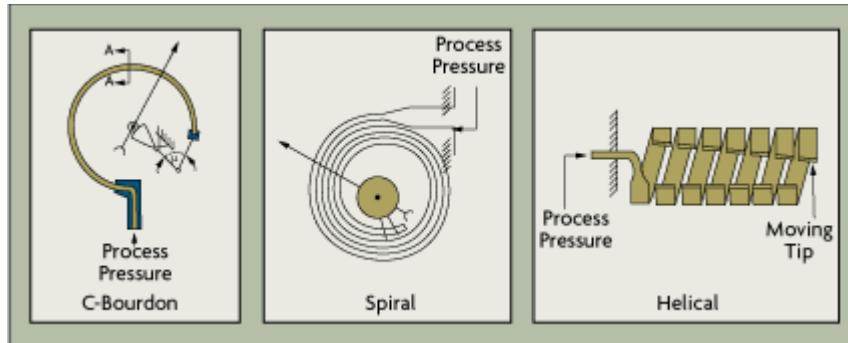

Bourdon Tube Designs

The following illustration is of sealed diaphragms. This method is very popular in the design of pressure transducers for process measurement.

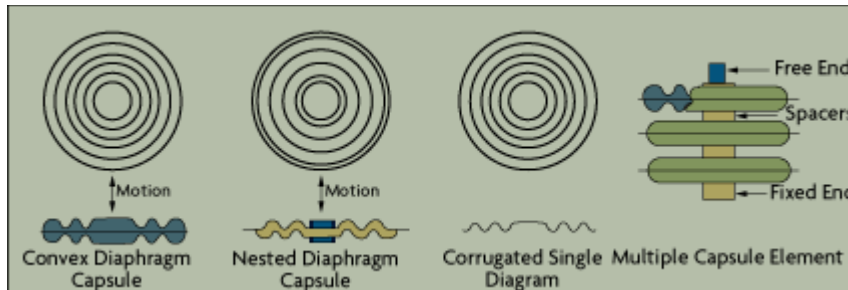

Pressure Sensor Diaphragm Designs

Section 2 – Basic Instruments

Pressure measurements

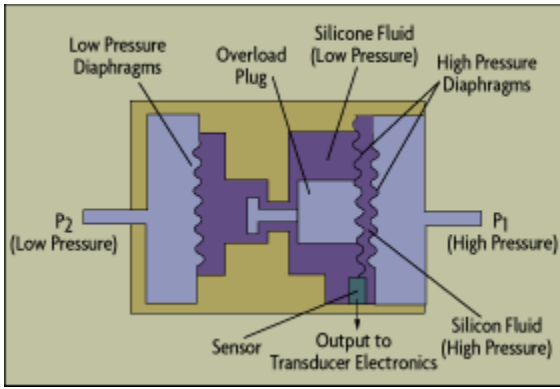

Strain-Gage Based Pressure Cell

The following example is of a strain gauge type measurement. Incorporating the diaphragm shown previously and sandwiching a strain gauge in between the two diaphragms it produces a sensor capable of measuring differential pressure. Notice the high and low sides of the transducer. The high side is designed to withstand a much higher pressure than the low side of the transducer to protect the sensor.

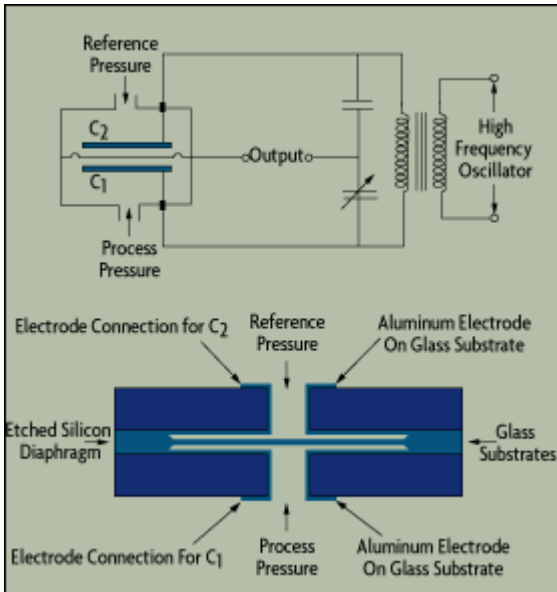

Capacitance-Based Pressure Cell

This design is the technology behind the Rosemount Omega cell differential pressure transducer. When the transducer is mounted in a housing complete with signal transmitting and conditioning electronics it is called a transmitter.

The pressure transmitter typically conditions the pressure signal and converts the signal to a 1-5 volt or the very popular and most widely used 4-20 milliamp signal. As discussed earlier in this book, the 4-20 mA signal does not vary with change in resistance of wire or resistance of series components. Later on this book we will continue this discussion of signals and ohm's law applied to signal limitations.

The following table illustrates typical pressure ranges for various pressure transducers. Consult the manufacture's technical data for actual ranging capabilities and limitation of the instrument for the application of the process.

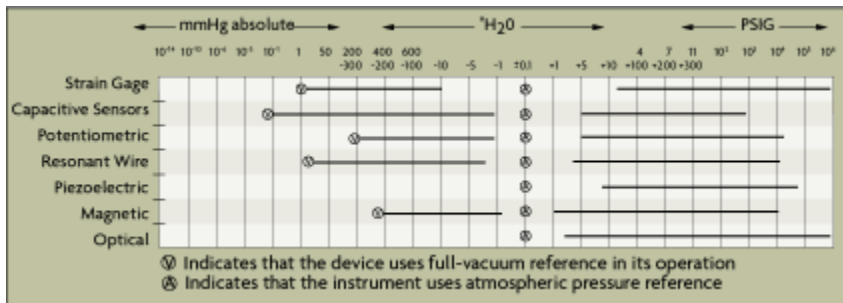

Electronic Pressure Sensor Ranges

This range table is only offered as a guideline. Consult manufacturer.

Section 2 – Basic Instruments

Introduction to Δ Pressure measurements with Flow and Level applications

The most common measurement used in most industrial processes is pressure. The pressure measurement can be used to measure flow, level, mass, weight, and work. This type of measurement is an inferred measurement. An inferred measurement is proportional to the potential and kinetic energy in the system.

By first learning the methods to measure pressure, differential pressure, and temperature it is possible to control about any type of industrial process.

Example of a Static Pressure Transducer

Measuring the flow of liquids is a critical need in many industrial plants. In some operations, the ability to conduct accurate flow measurements is so important that it can make the difference between making a profit or taking a loss.

With most liquid flow measurement instruments, the flow rate is determined inferentially by measuring the liquid's velocity or the change in kinetic energy. Bernoulli determined that an increase in the velocity of a flowing fluid increases its kinetic energy while decreasing its static energy. It is for this reason that a flow restriction causes an increase in the flowing velocity and also causes a drop in the static pressure of the flowing fluid.

Velocity depends on the pressure differential that is forcing the liquid through a pipe or conduit. Because the pipe's cross-sectional area is known and remains constant, the average velocity is an indication of the flow rate. The basic relationship for determining the liquid's flow rate in such cases is: $Q = V \times A$

Laminar and turbulent flow are two types normally encountered in liquid flow Measurement operations. Most applications involve turbulent flow with R values above 3000. Viscous liquids usually exhibit laminar flow with R values below 2000. The transition zone between the two levels may be either laminar or turbulent.

The flow rate and the specific gravity are the inertia forces, and the pipe diameter and viscosity are the drag forces. The pipe diameter and the specific gravity remain constant for most liquid applications.

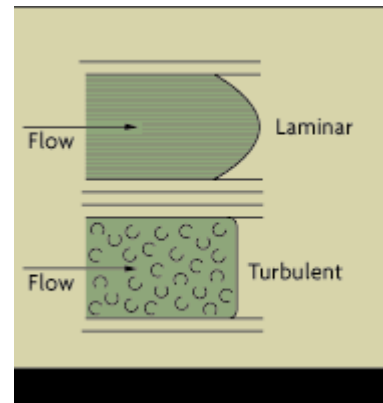

Section 2 – Basic Instruments

Flow measurements

Measuring the flow of liquids is a critical need in many industrial plants. In some operations, the ability to conduct accurate flow measurements is so important that it can make the difference between making a profit or taking a loss.

With most liquid flow measurement instruments, the flow rate is determined inferentially by measuring the liquid's velocity or the change in kinetic energy. Bernoulli determined that an increase in the velocity of a flowing fluid increases its kinetic energy while decreasing its static energy. It is for this reason that a flow restriction causes an increase in the flowing velocity and also causes a drop in the static pressure of the flowing fluid.

Velocity depends on the pressure differential that is forcing the liquid through a pipe or conduit. Because the pipe's cross-sectional area is known and remains constant, the average velocity is an indication of the flow rate. The basic relationship for determining the liquid's flow rate in such cases is: $Q = V \times A$

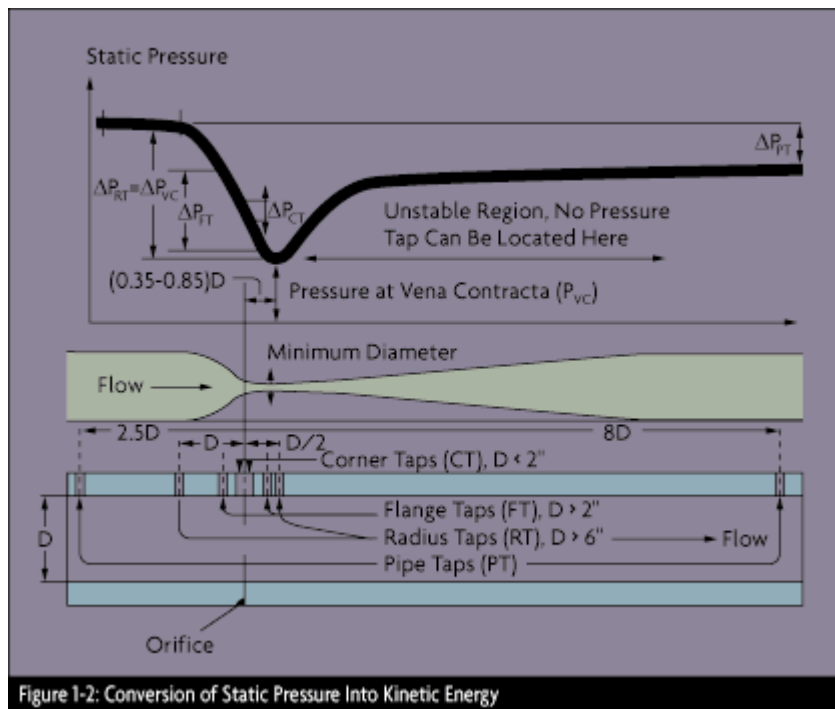

Q = liquid flow through the pipe
 V = average velocity of the flow
 A = cross-sectional pipe area
 β = beta ratio
 (pipediameter/orifice diameter)

K_e = kinetic energy = $V^2/2g$

$V^2 = \Delta P/SG$

Figure 1-2

The permanent pressure loss through a flowmeter is expressed either as a percentage of the total pressure drop or in units of velocity heads, calculated as $V^2/2g$, where V is the flowing velocity and g is the gravitational acceleration (32.2 feet/second² or 9.8 meters/second² at 60° latitude). For example, if the velocity of a flowing fluid is 10 ft/s, the velocity head is $100/64.4 = 1.55$ ft. If the fluid is water, the velocity head corresponds to 1.55 ft of water (or 0.67 psi). If the fluid is air, then the velocity head corresponds to the weight of a 1.55-ft column of air.

The permanent pressure loss through various flow elements can be expressed as a percentage of the total pressure drop (Figure 1-1), or it can be expressed in terms of velocity heads. The permanent pressure loss through an orifice is four velocity heads; through a vortex shedding sensor, it is two; through positive displacement and turbine meters, about one; and, through flow venturiers, less than 0.5 heads. Therefore, if an orifice plate (Figure 1-2) with a beta ratio of 0.3 (diameter of the orifice to that of the pipe) has an unrecovered pressure loss of 100 in H₂O, a venturi flow tube could reduce that pressure loss to about 12 in H₂O for the same measurement.

Section 2 – Basic Instruments

Flow measurements

Differential Pressure measurements

Measuring the flow of liquids is a critical need in many industrial plants. In some operations, the ability to conduct accurate flow measurements is so important that it can make the difference between making a profit or taking a loss.

The calculation of fluid flow rate by reading the pressure loss across a pipe restriction is perhaps the most commonly used flow measurement technique in industrial applications. The pressure drops generated by a wide variety of geometrical restrictions or "head" flow elements come in a wide variety of configurations, each with specific application strengths and weaknesses. Variations on the theme of differential pressure (d/p) flow measurement include the use of pitot tubes and variable-area meters (rotameters).

The pressure differential (**h**) developed by the flow element is measured, and the velocity (**V**), the volumetric flow (**Q**) and the mass flow (**W**) can all be calculated using the following generalized formulas:

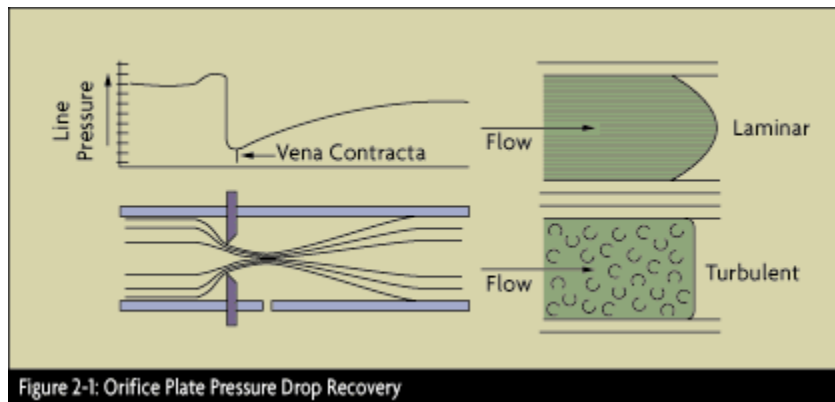

$$V = k (h/D)^{0.5}$$

$$\text{or } Q = kA(h/D)^{0.5}$$

$$\text{or } W = kA(hD)^{0.5}$$

k is the discharge coefficient of the element (which also reflects the units of measurement), **A** is the cross-sectional area of the pipe's opening, and **D** is the density of the flowing fluid. The discharge coefficient **k** is influenced by the Reynolds number (see Figure 1-5) and by the "beta ratio," the ratio between the bore diameter of the flow restriction and the inside diameter of the pipe.

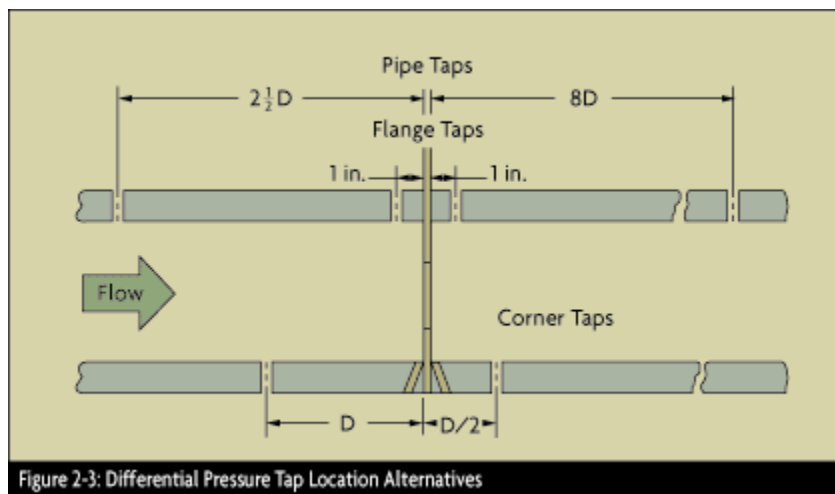

The d/p transmitter should be located as close to the primary element as possible. Lead lines should be as short as possible and of the same diameter. In clean liquid service, the minimum diameter is 1/8", in condensable vapor service, the minimum diameter is 1/4". In steam service, the horizontal lead lines should be kept as

possible and be tilted so that condensate can drain back into the pipe. In clean liquid or gas service, the lead lines can be purged through the d/p cell vent or drain connections, and they should be flushed for several minutes to remove all air from the lines. Entrapped air can offset the zero calibration.

Section 2 – Basic Instruments

Flow measurements

Orifice plates

The orifice plate is commonly used in clean liquid, gas, and steam service. It is available for all pipe sizes, and if the pressure drop it requires is free, it is very cost-effective for measuring flows in larger pipes (over 6" diameter). The orifice plate is also approved by many standards organizations for the custody transfer of liquids and gases.

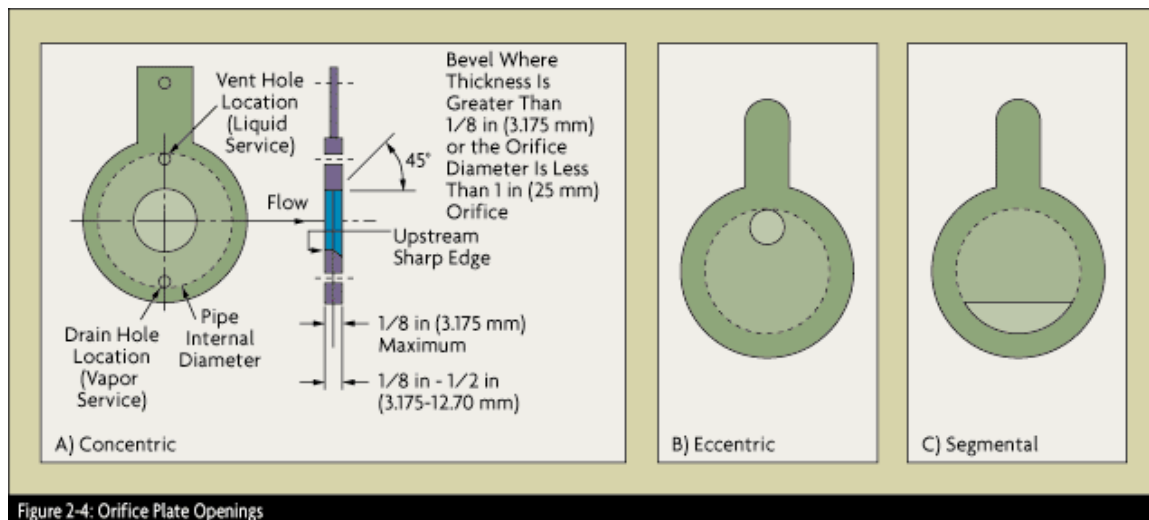

Figure 2-4: Orifice Plate Openings

The traditional orifice is a thin circular plate (with a tab for handling and for data), inserted into the pipeline between the two flanges of an orifice union. This method of installation is cost-effective, but it calls for a process shutdown whenever the plate is removed for maintenance or inspection.

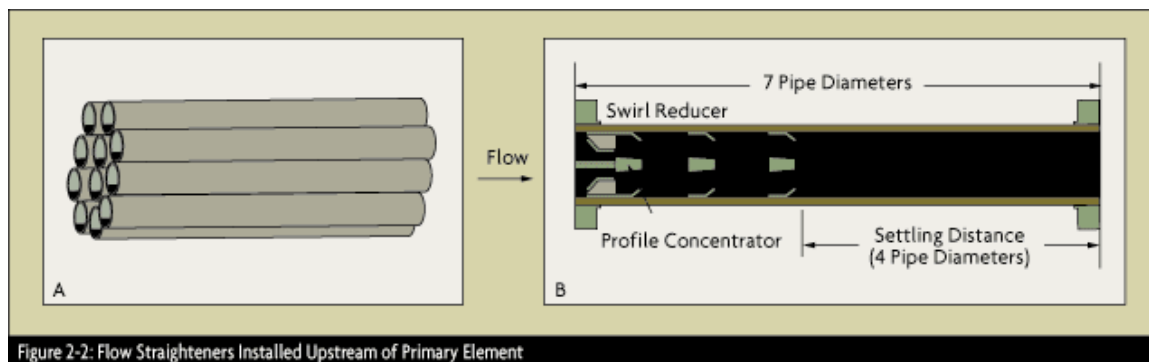

Figure 2-2: Flow Straighteners Installed Upstream of Primary Element

In order for the velocity profile to fully develop (and the pressure drop to be predictable), straight pipe runs are required both up- and downstream of the d/p element. The amount of straight run required depends on both the beta ratio of the installation and on the nature of the upstream components in the pipeline.

For example, when a single 90° elbow precedes an orifice plate, the straight-pipe requirement ranges from 6 to 20 pipe diameters as the diameter ratio is increased from 0.2 to 0.8. In order to reduce the straight run requirement, flow straighteners (Figure 2-2) such as tube bundles, perforated plates, or internal tabs can be installed upstream of the primary element.

Metering errors due to incorrect installation of the primary element can be substantial (up to 10%). Causes of such errors can be the condition of the mating pipe sections, insufficient straight pipe runs, and pressure tap and lead line design errors.

To minimize error (and the need for density correction) when dealing with compressible fluids, the ratio of differential pressure (h) divided by upstream pressure (P) should not exceed 0.25 (measured in the same engineering units).

Section 2 – Basic Instruments

Flow measurements

Differential pressure meters

Venturi tubes are available in sizes up to 72", and can pass 25 to 50% more flow than an orifice with the same pressure drop. The short form venturi (Figure 2-7A). The universal venturi (Figure 2-7B). The flow nozzle (Figure 2-7C) is often been used to measure high flowrates of superheated steam.

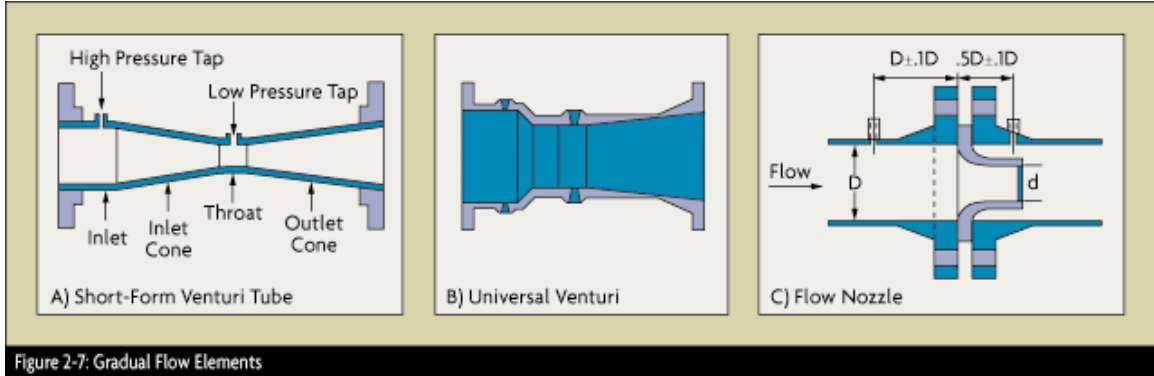

Figure 2-7: Gradual Flow Elements

Pitot Tubes are used to measure air flow in pipes, ducts, and stacks, and liquid flow in pipes, weirs, and open channels for industrial applications (Figure 2-9).

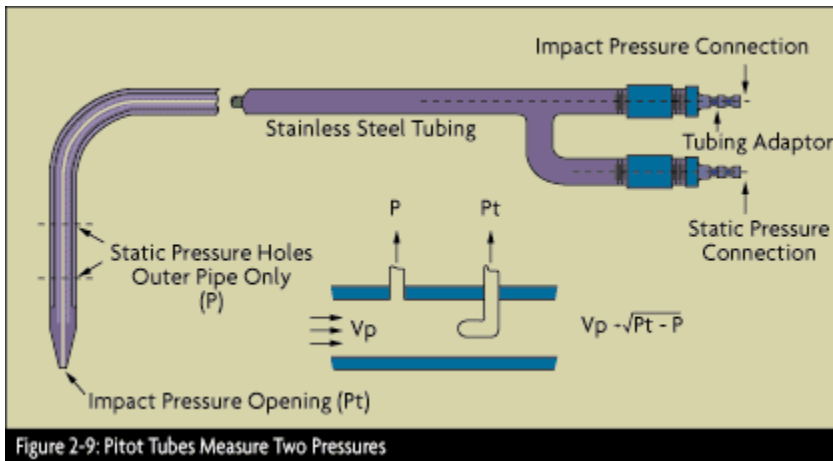

Figure 2-9: Pitot Tubes Measure Two Pressures

Rotameter it's main application is to control small gas or liquid purge streams.

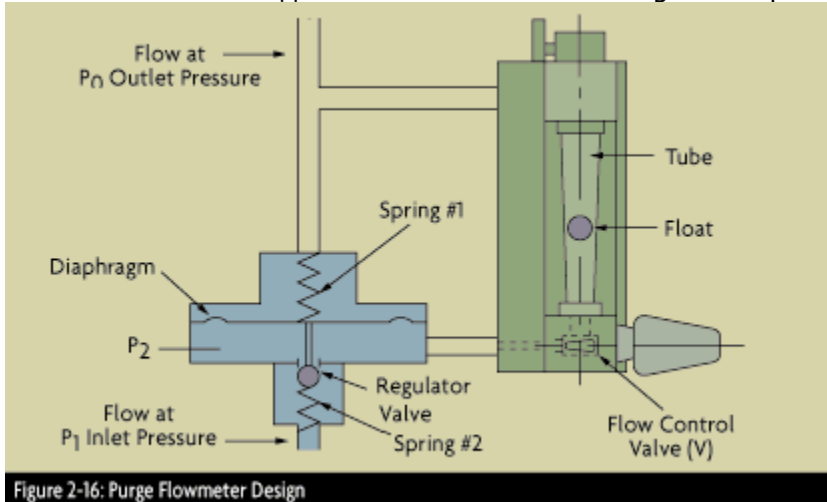

Figure 2-16: Purge Flowmeter Design

Section 2 – Basic Instruments

Flow measurements

Mechanical flowmeters

Positive displacement meters provide high accuracy ($\pm 0.1\%$ of actual flow rate in some cases) and good repeatability (as high as 0.05% of reading). Accuracy is not affected by pulsating flow unless it entrains air or gas in the fluid. PD meters do not require a power supply for their operation and do not require straight upstream and downstream pipe runs for their installation. The process fluid must be clean. Particles greater than 100 microns in size must be removed by filtering. PD meters operate with small clearances between their precision-machined parts; wear rapidly destroys their accuracy.

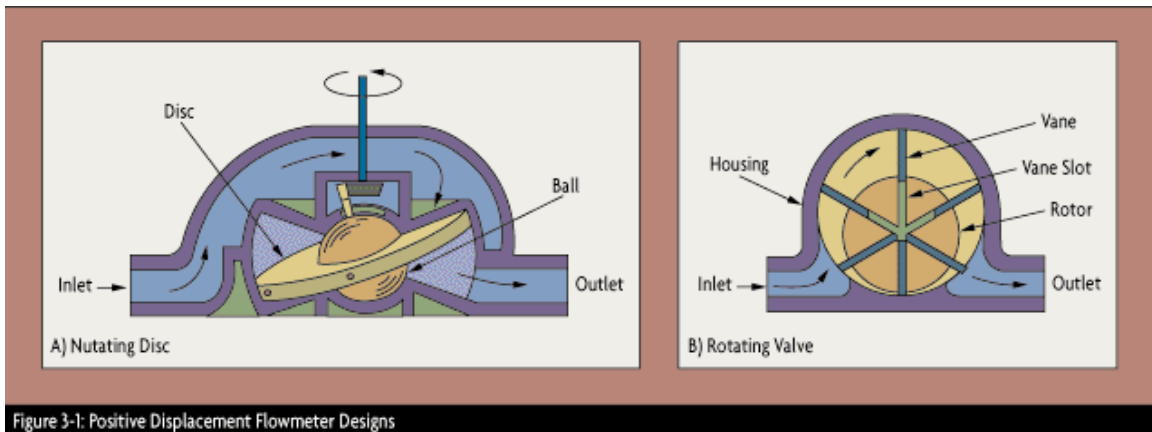

Turbine meters consists of a multi-bladed rotor mounted at right angles to the flow and suspended in the fluid stream on a free-running bearing. The diameter of the rotor is very slightly less than the inside diameter of the metering chamber, and its speed of rotation is proportional to the volumetric flow rate. Turbine rotation can be detected by solid state devices (reluctance, inductance, capacitive and Hall-effect pick-ups) or by mechanical sensors (gear or magnetic drives).

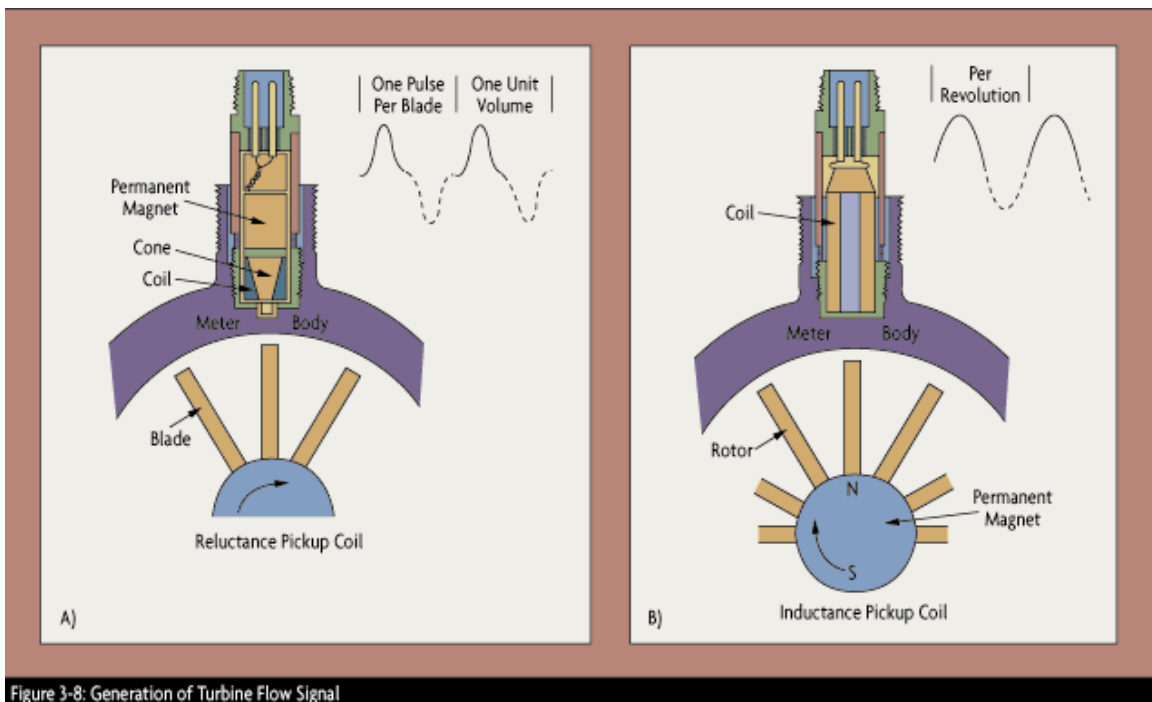

Section 2 – Basic Instruments

Flow measurements

Electronic flowmeters

Magneters can detect the flow of conductive fluids only. The magnetic flowmeter consists of a non-magnetic pipe lined with an insulating material. A pair of magnetic coils is situated as shown in Figure 4-1, and a pair of electrodes penetrates the pipe and its lining.

If a conductive fluid flows through a pipe of diameter (**D**) through a magnetic field density (**B**) generated by the coils, the amount of voltage (**E**) developed across the electrodes--as predicted by Faraday's law--will be proportional to the velocity (**V**) of the liquid (**E=kV**). The voltage that develops at the electrodes is a millivolt signal. This signal is typically converted into a standard current (4-20 mA) or frequency output (0-10,000 Hz) at or near the flowtube.

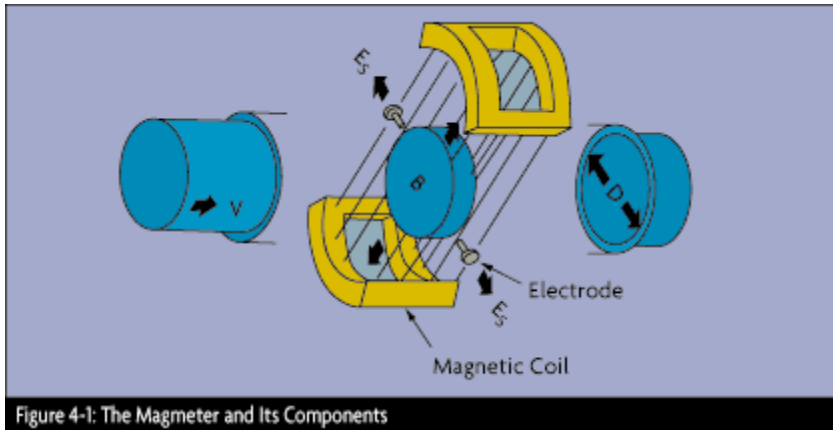

Figure 4-1: The Magmeter and Its Components

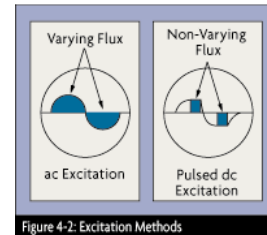

Figure 4-2: Excitation Methods

Vortex meters use piezoelectric or capacitance-type sensors to detect the pressure oscillation around the bluff body and respond to the pressure oscillation with a low voltage output signal which has the same frequency as the oscillation.

Vortex shedding frequency is directly proportional to the velocity of the fluid in the pipe, and therefore to volumetric flow rate. The shedding frequency is independent of fluid properties such as density, viscosity, conductivity, etc., except that the flow must be turbulent for vortex shedding to occur. The relationship between vortex frequency and fluid velocity is $S_t = f(d/V)$ Where S_t is the Strouhal number, f is the vortex shedding frequency, d is the width of the bluff body, B is the blockage factor and V is the average fluid velocity. $Q = AV = (A f d B)/S_t$

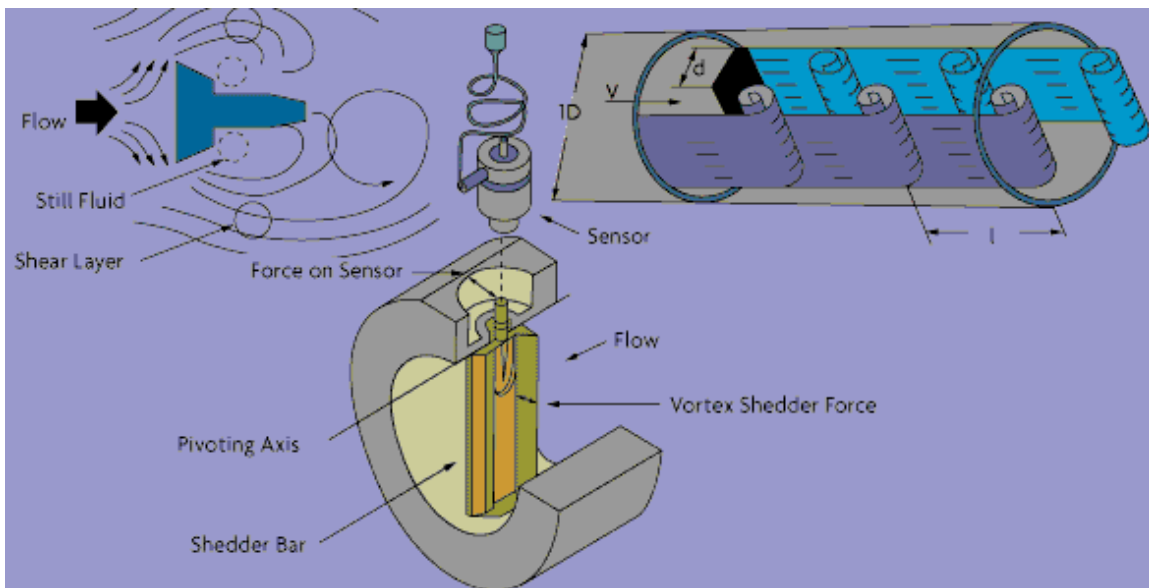

Figure 4-5: Vortex Detecting Sensor

Section 2 – Basic Instruments

Flow measurements

Ultra Sonic Meters

The speed at which sound propagates in a fluid is dependent on the fluid's density. If the density is constant, however, one can use the time of ultrasonic passage (or reflection) to determine the velocity of a flowing fluid.

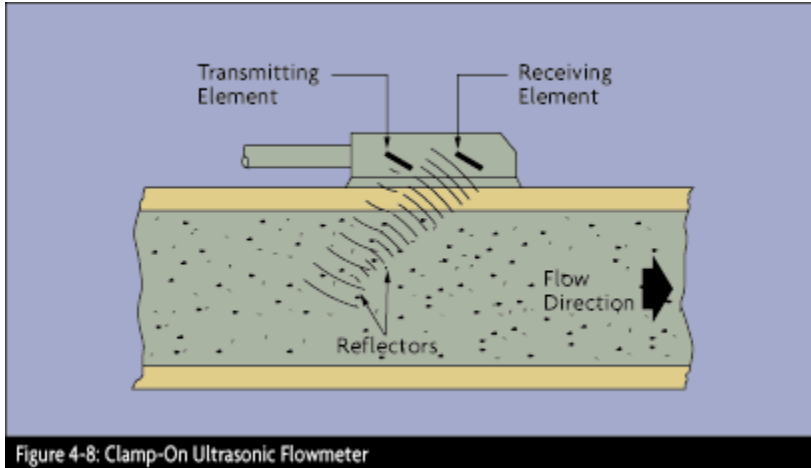

Figure 4-8: Clamp-On Ultrasonic Flowmeter

Some transducer systems that operate in the shear-mode, sending a single pulse and receiving a single pulse in return. Narrow-beam systems are commonly subject to walk-away (the signal completely missing the downstream transducer). The wide-beam systems overcome the beam refraction and work better in changing liquid density and temperature.

Doppler Shift flowmeter transducers operate at 0.640 MHz (in clamp-on designs) and at 1.2 MHz in wetted sensor designs. The transducer sends an ultrasonic pulse or beam into the flowing stream. The sound waves are reflected back by such acoustical discontinuities as particles, entrained gas bubbles, or even by turbulence vortices (Figure 4-7A). For clamp-on designs, measurement inaccuracy ranges from $\pm 1\%$ to $\pm 5\%$ full scale (FS).

The meter detects the velocity of the discontinuities, rather than the velocity of the fluid, in calculating the flow rate. The flow velocity (V) can be determined by: $V = (f_0 - f_1)C_t / 2f_0 \cos(a)$. Where C_t is the velocity of sound inside the transducer, f_0 is the transmission frequency, f_1 is the reflected frequency, and a is the angle of the transmitter and receiver crystals with respect to the pipe axis. Because $C_t / 2f_0 \cos(a)$ is a constant (K), the relationship can be simplified to: $V = (f_0 - f_1)K$

Thus, flow velocity V (ft/sec) is directly proportional to the change in frequency. The flow (Q in gpm) in a pipe having a certain inside diameter (ID in inches) can be obtained by:

$$Q = 2.45V(ID)^2 = 2.45[(f_0 - f_1)K](ID)^2$$

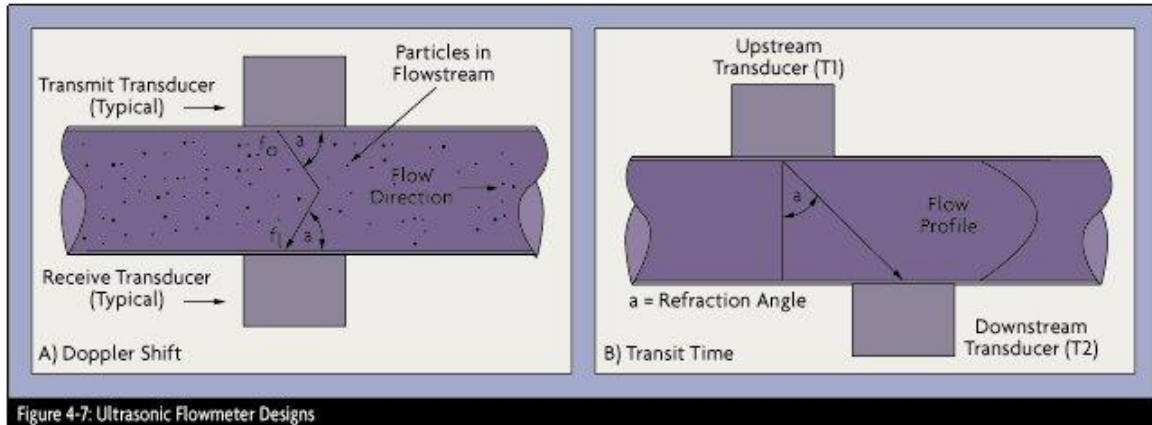

Figure 4-7: Ultrasonic Flowmeter Designs

Transit Time Measurement, the time of flight of the ultrasonic signal is measured between two transducers--one upstream and one downstream (Figure 4-7B). The difference in elapsed time going with or against the flow determines the fluid velocity. When the flow is zero, the time for the signal T_1 to get to T_2 is the same as that required to get from T_2 to T_1 . When there is flow, the effect is to boost the speed of the signal in the downstream direction, while decreasing it in the upstream direction. The flowing velocity (V_f) can be determined by the following equation: $V_f = Kdt/T_L$. where K is a calibration factor for the volume and time units used, dt is the time differential between upstream and downstream transit times, and T_L is the zero-flow transit time.

Section 2 – Basic Instruments

Flow measurements

Mass flowmeters

Mass flow measurement is the basis of most recipe formulations, material balance determinations, and billing and custody transfer operations throughout industry. With these being the most critical flow measurements in a processing plant, the reliability and accuracy of mass flow detection is very important.

In the past, mass flow was often calculated from the outputs of a volumetric flowmeter and a densitometer. Density was either directly measured (Figure 5-1A), or was calculated using the outputs of process temperature and pressure transmitters. These measurements were not very accurate, because the relationship between process pressure or temperature and density are not always precisely known--each sensor adds its own separate error to the overall measurement error, and the speed of response of

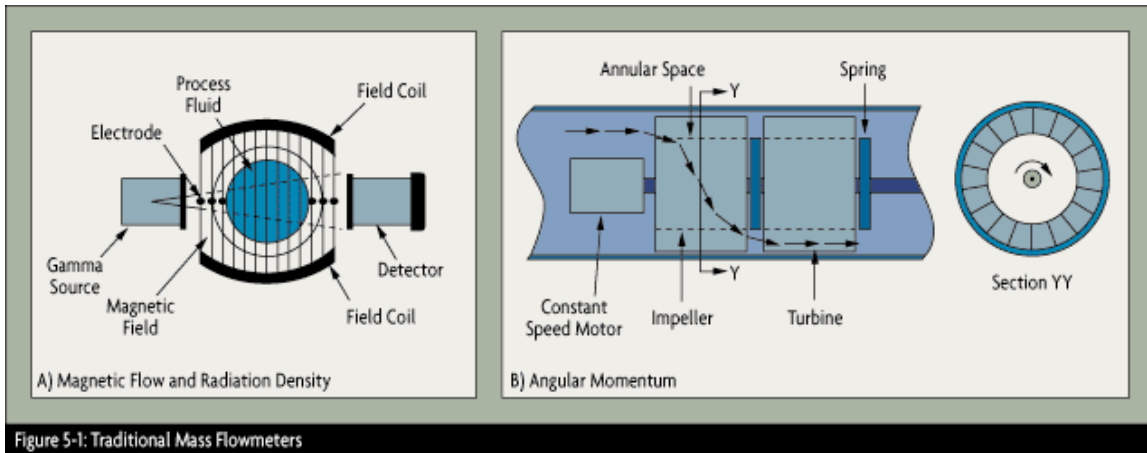

Figure 5.1

such calculations is usually not sufficient to detect step changes in flow.

One of the early designs of self-contained mass flowmeters operated using angular momentum (Figure 5-1B). It had a motor-driven impeller that imparted angular momentum (rotary motion) by accelerating the fluid to a constant angular velocity. The higher the density, the more angular momentum was required to obtain this angular velocity. Downstream of the driven impeller, a spring-held stationary turbine was exposed to this angular momentum. The resulting torque (spring torsion) was an indication of mass flow.

These meters all had moving parts and complex mechanical designs. First developed for the measurement of aircraft fuel, some are still in use. However, because of their complex nature and high maintenance costs, they are gradually being replaced by more robust and less maintenance-demanding designs.

Mass flow also can be measured by batch weighing or by combining an accurate level sensor with a densitometer. Another method is to mount two d/p transmitters on the lower part of an atmospheric tank at different elevations. In this case, the output of the top d/p cell will vary with the level in the tank, while the lower one will measure the hydrostatic head over a fixed elevational distance. This pressure differential yields the density of the material in the tank. Such systems have been used to measure the total mass flow of slurries.

Section 2 – Basic Instruments

Flow measurements

Mass flowmeters

Coriolis Mass Flowmeters artificially introduce a Coriolis acceleration into the flowing stream and measure mass flow by detecting the resulting angular momentum.

When a fluid is flowing in a pipe and it is subjected to Coriolis acceleration through the mechanical introduction of apparent rotation into the pipe, the amount of deflecting force generated by the Coriolis inertial effect will be a function of the mass flow rate of the fluid. If a pipe is rotated around a point while liquid is flowing through it (toward or away from the center of rotation), that fluid will generate an inertial force (acting on the pipe) that will be at right angles to the direction of the flow.

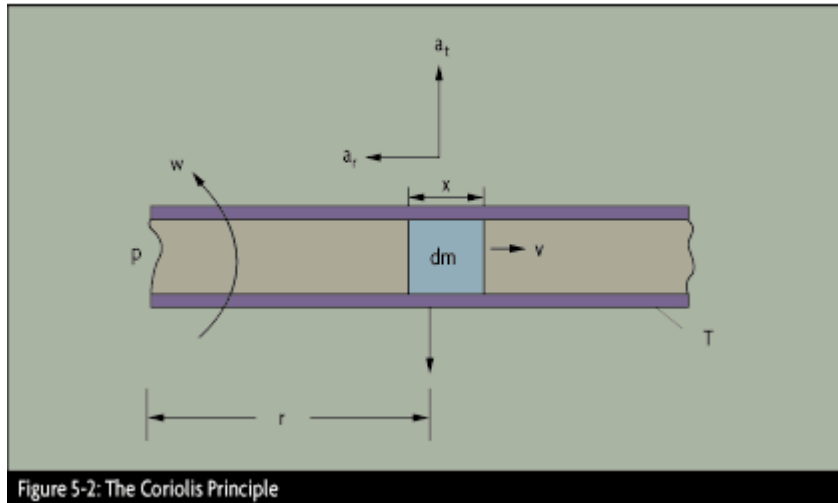

Figure 5-2

With reference to Figure 5-2, a particle (**dm**) travels at a velocity (**v**) inside a tube (**T**). The tube is rotating about a fixed point (**P**), and the particle is at a distance of one radius (**R**) from the fixed point. The particle moves with angular velocity (**ω**) under two components of acceleration, a centripetal acceleration directed toward **P** and a Coriolis acceleration acting at right angles to **a_r**:

$$\mathbf{a_r (centripetal) = \omega^2 r}$$

$$\mathbf{a_t (Coriolis) = 2\omega v}$$

In order to impart the Coriolis acceleration (**a_t**) to the fluid particle, a force of **a_t(dm)** has to be generated by the tube. The fluid particle reacts to this force with an equal and opposite Coriolis force:

$$\mathbf{F_c = a_t(dm) = 2\omega v(dm)}$$

Then, if the process fluid has density **D** and is flowing at constant speed inside a rotating tube of cross-sectional area **A**, a segment of the tube of length **x** will experience a Coriolis force of magnitude:

$$\mathbf{F_c = 2\omega v D A x}$$

Because the mass flowrate is **dm = DvA**, the Coriolis force **F_c = 2ω(dm)x** and, finally:

$$\mathbf{Mass\ Flow = F_c / (2\omega x)}$$

This is how measurement of the Coriolis force exerted by the flowing fluid on the rotating tube can provide an indication of mass flowrate. Naturally, rotating a tube is not practical when building a commercial flowmeter, but oscillating or vibrating the tube can achieve the same effect. Coriolis flowmeters can measure flow through the tube in either the forward or reverse directions.

In most designs, the tube is anchored at two points and vibrated between these anchors.

This configuration can be envisioned as vibrating a spring and mass assembly. Once placed in motion, a spring and mass assembly will vibrate at its resonant frequency, which is a function of the mass of that assembly. This resonant frequency is selected because the smallest driving force is needed to keep the filled tube in constant vibration.

Section 2 – Basic Instruments

Flow measurements

Tube Designs can be of a curved or straight form, and some designs can also be self-draining when mounted vertically (Figure 5-3). When the design consists of two parallel tubes, flow is divided into two streams by a splitter near the meter's inlet and is recombined at the exit. In the single continuous tube design (or in two tubes joined in series), the flow is not split inside the meter.

In either case, drivers vibrate the tubes. These drivers consist of a coil connected to one tube and a magnet connected to the other. The transmitter applies an alternating current to the coil, which causes the magnet to be attracted and repelled by turns, thereby forcing the tubes towards and away from one another. The sensor can detect the position, velocity, or acceleration of the tubes. If electromagnetic sensors are used, the magnet and coil in the sensor change their relative positions as the tubes vibrate, causing a change in the magnetic field of the coil. Therefore, the sinusoidal voltage output from the coil represents the motion of the tubes.

When there is no flow in a two-tube design (Figure 5-3A), the vibration caused by the coil and magnet drive results in identical displacements at the two sensing points (B1 and B2). When flow is present, Coriolis forces act to produce a secondary twisting vibration, resulting in

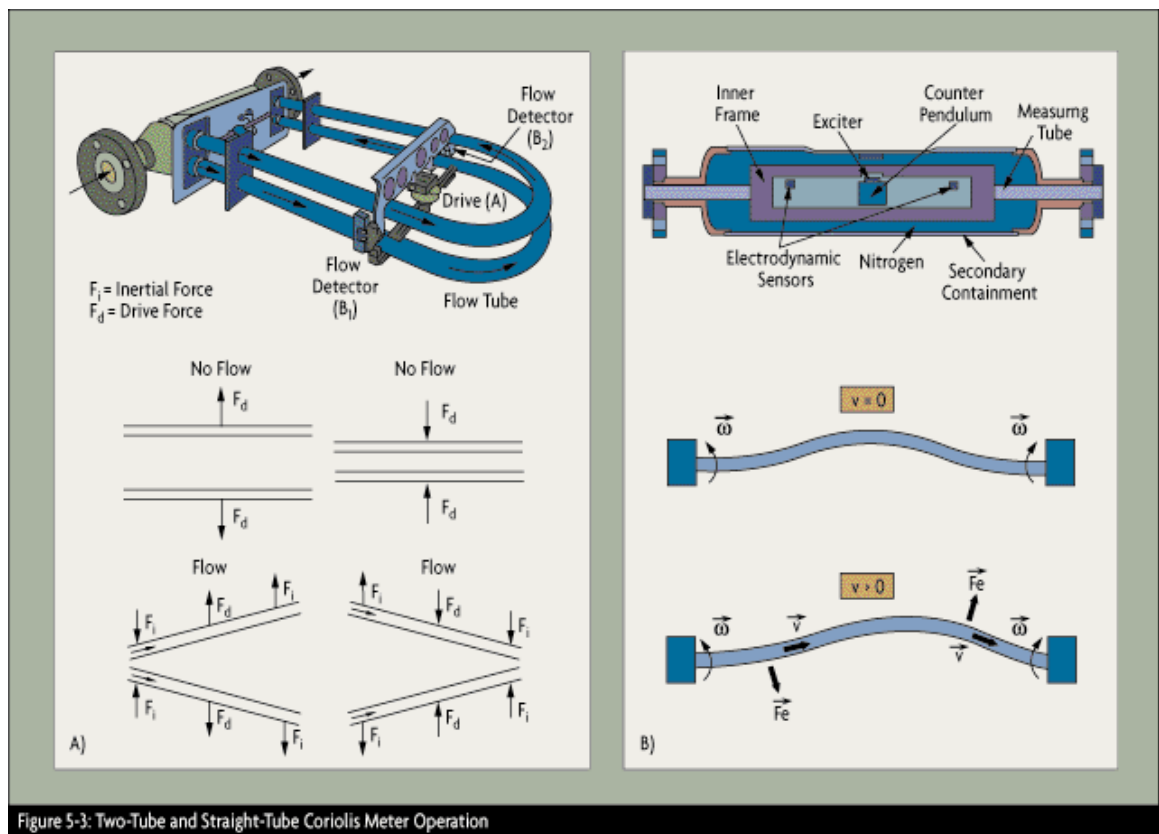

Figure 5-3

a small phase difference in the relative motions. This is detected at the sensing points. The deflection of the tubes caused by the Coriolis force only exists when both axial fluid flow and tube vibration are present. Vibration at zero flow, or flow without vibration, does not produce an output from the meter.

The natural resonance frequency of the tube structure is a function of its geometry, materials of construction, and the mass of the tube assembly (mass of the tube plus the mass of the fluid inside the tube). The mass of the tube is fixed. Since mass of the fluid is its density (D) multiplied by its volume (which is also fixed), the frequency of vibration can be related to the density of the process fluid (D). Therefore, the density of the fluid can be determined by measuring the resonant frequency of oscillation of the tubes. (Note that density can be measured at zero flow, as long as the tubes are filled with fluid and vibrating.) can detect the flow of conductive fluids only. The magnetic flowmeter consists of a non-magnetic pipe lined with an insulating material. A pair of magnetic coils is situated as shown in Figure 4-1, and a pair of electrodes penetrates the pipe and its lining.

Section 2 – Basic Instruments

Flow measurements

Strain Gauges for weight measurement

The most common way to measure weight is with a strain gauge transducer. The “S” hook shaped load cell or the cantilever load cell are the most popular used in industrial measurement.

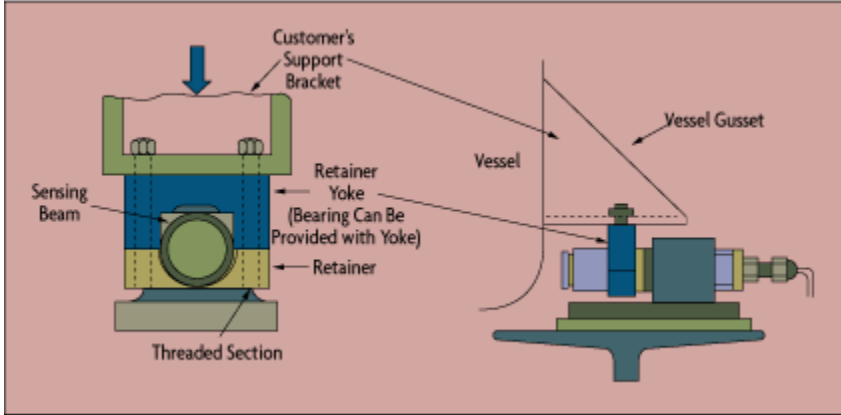

NOTE:

Always replace the load cell with a dummy load cell or attach a #6 awg wire from beam to beam where the load cell is to be mounted between these beams, when any welding is to be done.

This will prevent the load cell from being damaged due to high current running through the metal of the load cell and burning out the strain gauges.

Cantilever Load Cells Reduce Staying Requirements

The following illustration on the left shows a typical weighting platform such as one used to measure the weight of a container or vehicle. The illustration on the right shows the cantilever load cell used to measure the weight of mixing materials either for a continuous or batching process.

The “S” type strain gauge could be used for a batching process similar to that on the right. The hopper would be suspended from the above structure and the strain gauge would be connected in between the above structure and the hopper. The weight of the hopper would be measured by the strain on the metal making up the “S” shaped strain gauge.

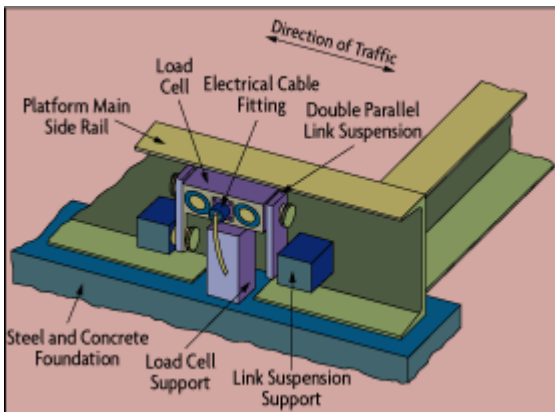

End-Loaded Shear-Beam Installation

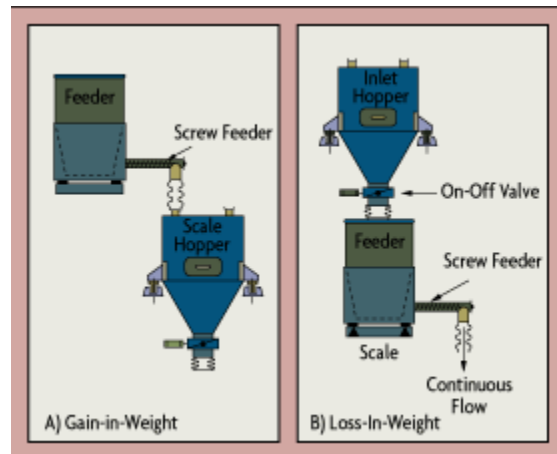

Load Cell Configurations for Solids Batching

Important note: Each load cell measuring the tank weight must be of equal resistance when the tank is in place. This is why a summing box with trimming resistors is used. The trimming resistor is put in series with the load cell’s strain gauge. After calibrating the trimming resistor each load cell will have the exact same resistance. The voltage drop across each load cell will be the same for an equally distributed load on the tank. These voltages will be summed to produce the total force on the tank. The tank’s tare weight will equal 0% when the transmitter is calibrated. ISO (international standards origination) weights will be placed on the tank and the span for 100% will be calibrated.

Section 2 – Basic Instruments

Level Measurements

The relationship between level and tank volume is a function of the cross-sectional shape of the tank. With vertical tanks, this relationship is linear, while with horizontal or spherical vessels, it is a non-linear relationship (Figure 6-1).

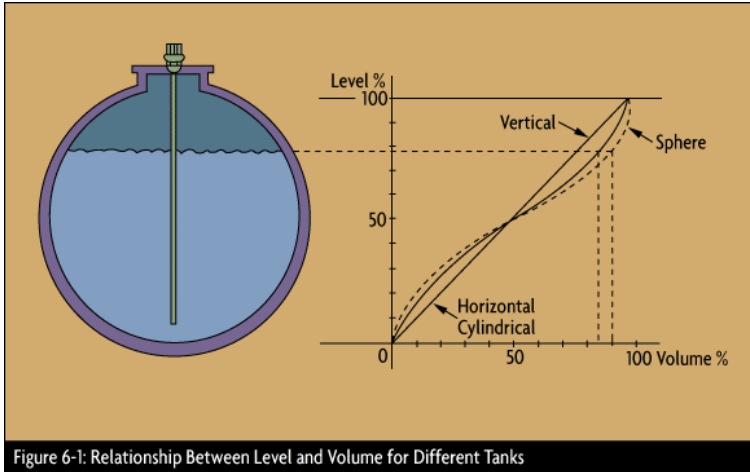

Figure 6-1: Relationship Between Level and Volume for Different Tanks

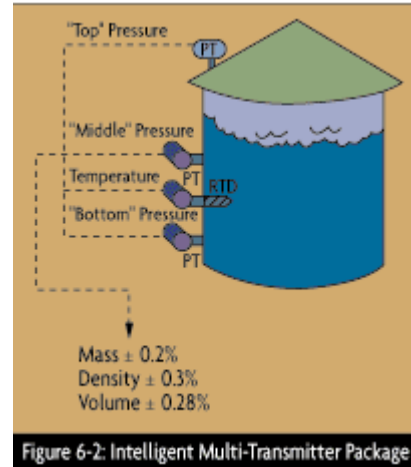

Figure 6-2: Intelligent Multi-Transmitter Package

If the level in a tank is to be inferred using hydrostatic pressure measurement, it is necessary to use multi-transmitter systems when it is desirable to:

- Detect the true level, while either the process temperature or density varies;*
- Measure both level and density; and*
- Measure the volume and the mass (weight) in the tank.*

By measuring one temperature and three pressures, the system shown in Figure 6-2 is capable of simultaneously measuring volume (level), mass (weight), and density, all with an accuracy of 0.3% of full span.

Sludge, Foam, & Molten Metals

When the process fluid is a sludge, slurry, or a highly viscous polymer, and the goal is to detect the level at one point, the design shown in Figure 6-5A is commonly considered. The ultrasonic or optical signal source and receiver typically are separated by more than six inches so that the process fluid drains freely from the intervening space. After a high-level episode, an automatic washing spray is activated.

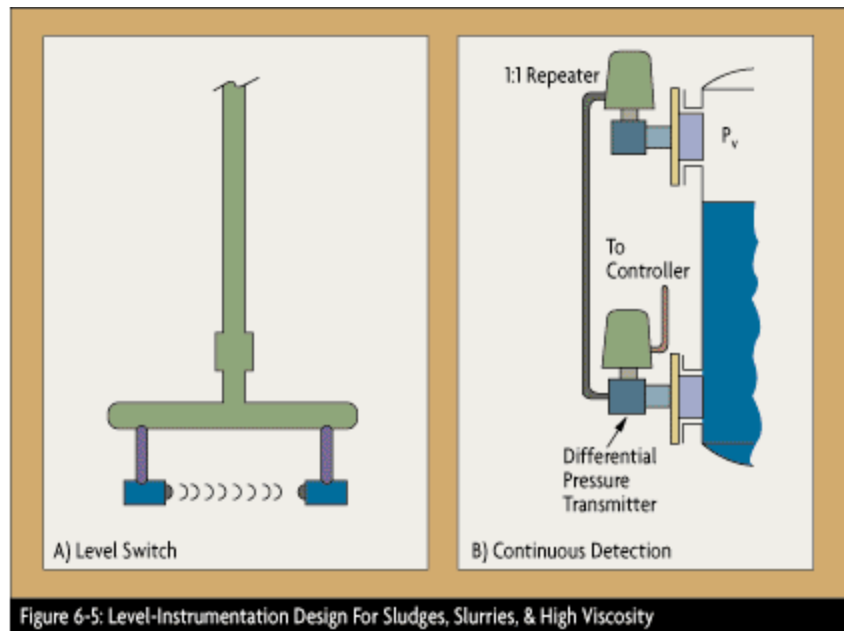

Figure 6-5: Level-Instrumentation Design For Sludges, Slurries, & High Viscosity

Section 2 – Basic Instruments

Level Measurements

Pressure/Density Level Instrumentation

One of the primary principles underlying industrial level measurement is that different materials and different phases of the same material have different densities. This basic law of nature can be utilized to measure level via differential pressure (that at the bottom of the tank relative to that in the vapor space or to atmospheric pressure) or via a float or displacer that depends on the density differences between phases.

Level measurement based on pressure measurement is also referred to as hydrostatic tank gaging (HTG). It works on the principle that the difference between the two pressures (d/p) is equal to the height of the liquid (h , in inches) multiplied by the specific gravity (SG) of the fluid (see Figure 7-1):

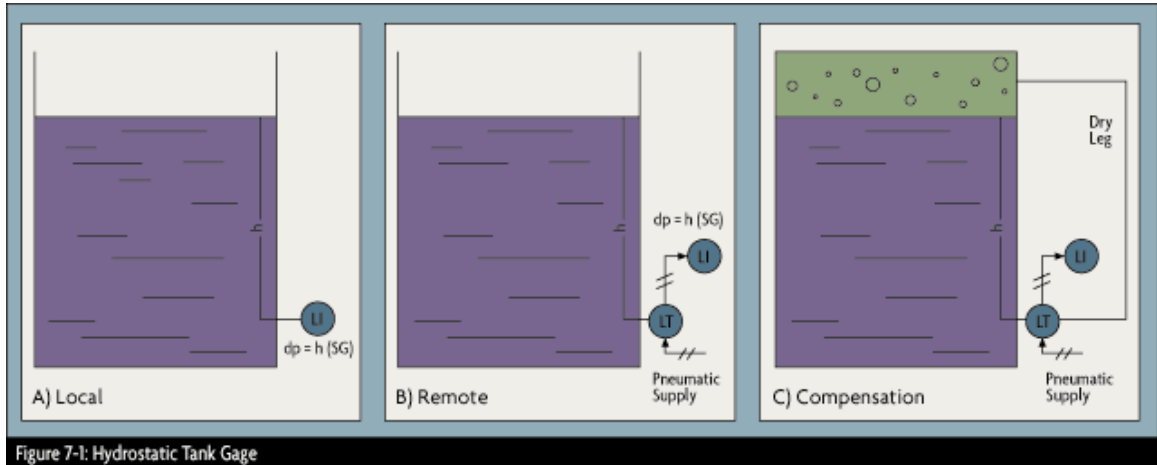

By definition, specific gravity is the liquid's density divided by the density of pure water at 68° F at atmospheric pressure. A pressure gage or d/p cell can provide an indication of level (accurate to better than 1%) over wide ranges, as long as the density of the liquid is constant. When a d/p cell is used, it will cancel out the effects of barometric pressure variations because both the liquid in the tank and the low pressure side of the d/p cell are exposed to the pressure of the atmosphere (Figure 7-1B). Therefore, the d/p cell reading will represent the tank level.

Dry & Wet Leg Designs

When measuring the level in pressurized tanks, the same d/p cell designs (motion balance, force balance, or electronic) are used as on open tanks. It is assumed that the weight of the vapor column above the liquid is negligible. On the other hand, the pressure in the vapor space cannot be neglected, but must be relayed to the low pressure side of the d/p cell. Such a connection to the vapor space is called a dry leg, used when process vapors are non-corrosive, non-plugging, and when their condensation rates, at normal operating temperatures, are very low (Figure 7-1C). A dry leg enables the d/p cell to compensate for the pressure pushing down on the liquid's surface, in the same way as the effect of barometric pressure is canceled out in open tanks.

It is important to keep this reference leg dry because accumulation of condensate or other liquids would cause error in the level measurement. When the process vapors condense at normal ambient temperatures or are corrosive, this reference leg can be filled to form a wet leg. If the process condensate is corrosive, unstable, or undesirable to use to fill the wet leg, this reference leg can be filled with an inert liquid.

In this case, two factors must be considered. First, the specific gravity of the inert fluid (SG_{wl}) and the height (h_{wl}) of the reference column must be accurately determined, and the d/p cell must be depressed by the equivalent of the hydrostatic head of that column [$(SG_{wl})(h_{wl})$]. Second, it is desirable to provide a sight flow indicator at the top of the wet leg so that the height of that reference leg can be visually checked.

Section 2 – Basic Instruments Level Measurements

Pressure D/P cells

The motion balance cell is well suited for remote locations where instrument air or electric power are not available. If a bellows is used as the sensing element in a motion balance d/p cell, an increase in the pressure on either side causes the corresponding bellows to contract (Figure 7-3A). The bellows is connected to a linkage assembly that converts the linear motion of the bellows into a rotary indicator motion, which can be calibrated to indicate the tank level.

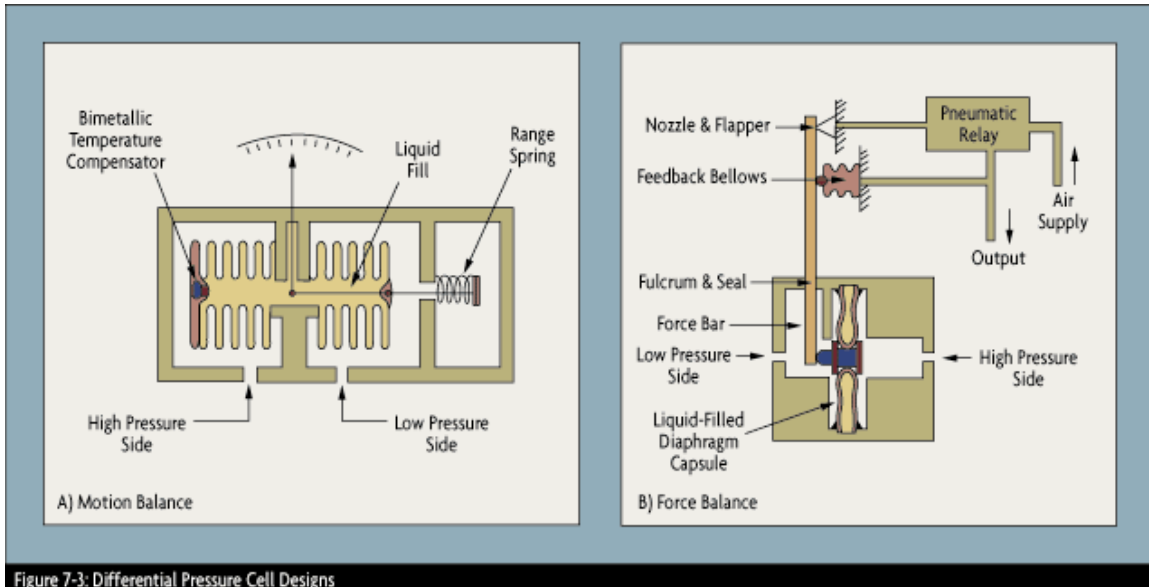

Figure 7-3: Differential Pressure Cell Designs

In a force-balance type of d/p cell, the sensing element (often a diaphragm) does not move. A force bar is provided to maintain the forces acting on the diaphragm in equilibrium (Figure 7-3B). In pneumatic d/p cells, this is often achieved by the use of a nozzle and flapper arrangement that guarantees that the pneumatic output signal will always be proportional to the differential pressure across the cell. The output of pneumatic d/p cells is linear and is usually ranged from 3 to 15 psig. The levels represented by such transmitted signals (pneumatic, electronic, fiberoptic or digital) can be displayed on local indicators or remote instruments. Pneumatic transmitters require a compressed air (or nitrogen) supply.

Electronic d/p cells provide $\pm 0.5\%$ of span or better precision typically conveyed via a 4-20 mA signal. The range of these simple and robust cells can be as narrow as a draft range of 0- 1/2 inH₂O or as wide as 0-1,000 psid. Some electronic d/p cells can operate at line pressures up to 4,500 psig at 250°F. The drift and inaccuracy of some of these units have been tested for periods of up to 30 months, and the errors did not exceed the $\pm 0.5\%$ of span limit.

Pressure Repeater If it is desired to keep the process vapors in the tank, a pressure repeater can be used. These devices repeat the vapor pressure (or vacuum) and send out an air signal identical to that of the vapor space. The measurement side of the repeater is connected to the vapor space and its output signal to the low pressure side of the d/p cell. If the tank connection is subject to material build-up or plugging, extended diaphragm Type 1:1 repeaters can be considered for the service (Figure 7-2).

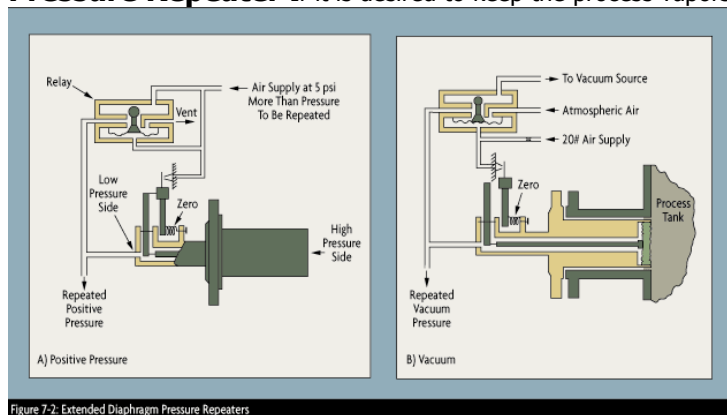
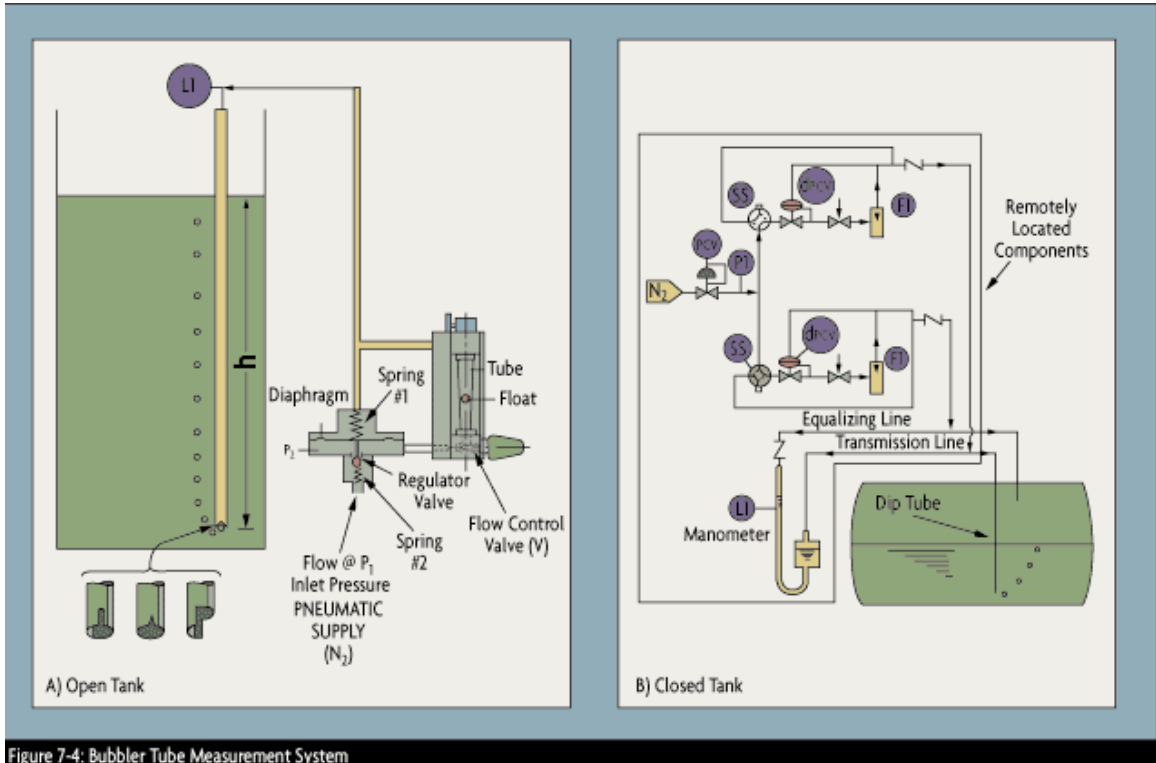

Figure 7-2: Extended Diaphragm Pressure Repeaters

Section 2 – Basic Instruments Level Measurements

Bubbler Tubes

Bubbler Tubes provide a simple and inexpensive but less accurate ($\pm 1-2\%$) level measurement system for corrosive or slurry-type applications. Bubblers use compressed air or an inert gas (usually nitrogen) introduced through a dip pipe (Figure 7-4A). Gas flow is regulated at a constant rate (usually at about 500 cc/min). A differential pressure regulator across a rotameter maintains constant flow, while the tank level determines the back-pressure. As the level drops, the back-pressure is proportionally



reduced and is read on a pressure gage calibrated in percent level or on a manometer or transmitter. The dip pipe should have a relatively large diameter (about 2 in.) so that the pressure drop is negligible. The bottom end of the dip pipe should be located far enough above the tank bottom so that sediment or sludge will not plug it. Also, its tip should be notched with a slot or "V" to ensure the formation of a uniform and continuous flow of small bubbles. An alternative to locating the dip pipe in the tank is to place it in an external chamber connected to the tank.

In pressurized tanks, two sets of dip pipes are needed to measure the level (Figure 7-4B). The two back-pressures on the two dip pipes can be connected to the two sides of a u-tube manometer, a differential pressure gage or a d/p cell/transmitter. The pneumatic piping or tubing in a bubbler system should be sloped toward the tank so that condensed process vapors will drain back into the tank if purge pressure is lost. The purge gas supply should be clean, dry, and available at a pressure at least 10 psi greater than the expected maximum total pressure required (when the tank is full and the vapor pressure is at its maximum).

An alternative to a continuous bubbler is to use a hand pump (similar to a bicycle tire pump) providing purge air only when the level is being read.

Bubblers do consume inert gases, which can later accumulate and blanket processing equipment. They also require maintenance to ensure that the purge supply is always available and that the system is properly adjusted and calibrated. When all factors are considered, d/p cells typically are preferred to bubblers in the majority of applications.

Section 2 – Basic Instruments Level Measurements

Floats and Displacers

Floats are motion balance devices that move up and down with liquid level. Displacers are force balance devices (restrained floats), whose apparent weight varies in accordance with Archimedes' principle: the buoyant force acting on an object equals the weight of the fluid displaced. As the level changes around the stationary (and constant diameter) displacer float, the buoyant force varies in proportion and can be detected as an indication of level. Regular and displacer floats are available as both continuous level transmitters and point-sensing level switches.

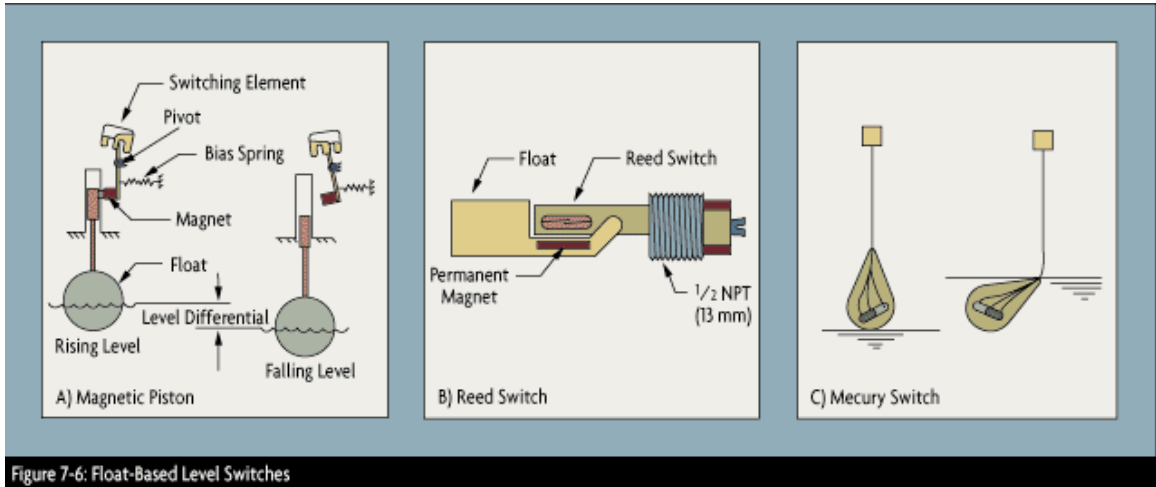

In industrial applications, displacer floats are often favored because they do not require motion. Furthermore, force can often be detected more accurately than position. However, regular floats are also used, mostly for utilities and in other secondary applications.

Float switches

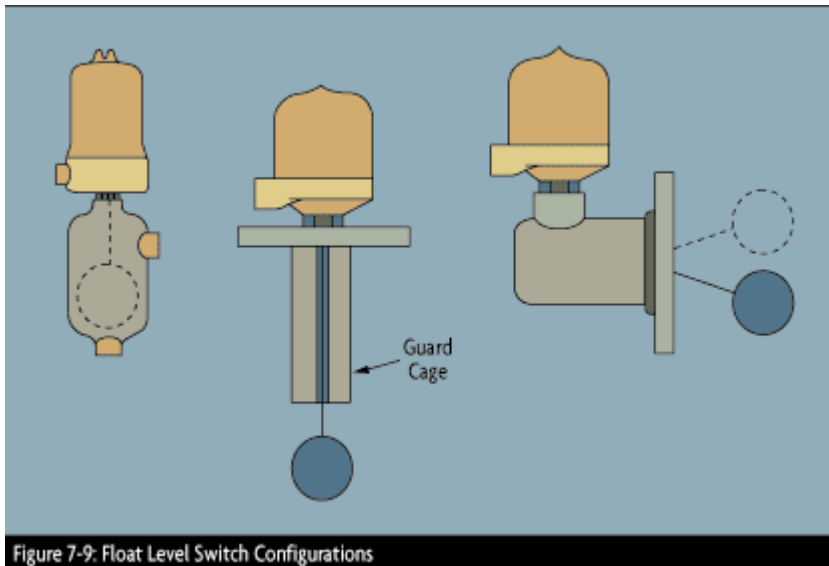

The buoyant force available to operate a float level switch (that is, its net buoyancy) is the difference between the weight of the displaced fluid (gross buoyancy) and the weight of the float. Floats are available in spherical (Figure 7-6A), cylindrical (Figure 7-6B), and a variety of other shapes (Figure 7-6C). They can be made out of stainless steel, Teflon®, Hastelloy, Monel, and various plastic materials.

Typical temperature and pressure ratings are -40 to 80°C (-40 to 180°F) and up to 150 psig for rubber or plastic floats, and -40 to 260°C (-40 to 500°F) and up to 750 psig for stainless steel floats. Standard float sizes are available from 1 to 5 inches in diameter. Custom float sizes, shapes, and materials can be ordered from most manufacturers. The float of a side-mounted switch is horizontal; a permanent magnet actuates the reed switch in it (Figure 7-6B).

Section 2 – Basic Instruments Level Measurements

Floats switches continued

Floats should always be lighter than the minimum expected specific gravity (SG) of the process fluid. For clean liquids a 0.1 SG difference might suffice, while for viscous or dirty applications, a difference of at least 0.3 SG is recommended. This provides additional force to overcome the resistance due to friction and material build-up. In dirty applications, floats should also be accessible for cleaning.

Floats can be attached to mechanical arms or levers and can actuate electrical, pneumatic, or mechanical mechanisms. The switch itself can be mercury (Figures 7-6A and 7-6C), dry contact (snap-action or reed type, shown in Figure 7-6B), hermetically sealed, or pneumatic. The switch can be used

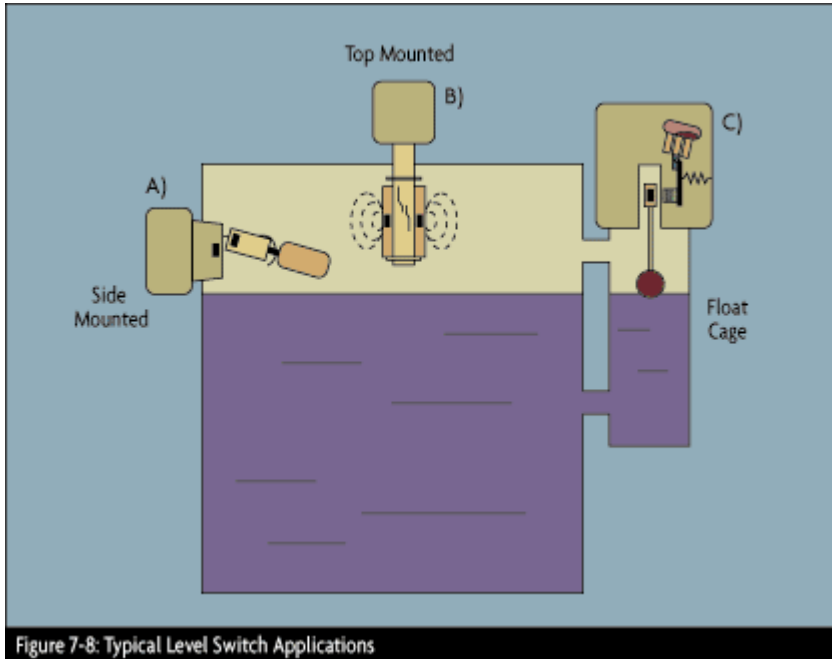

to actuate a visual display, annunciator, pump, or valve. The electric contacts can be rated light-duty (10-100 volt amps, VA) or heavy-duty (up to 15 A @ 120 Vac). If the switch is to operate a circuit with a greater load than the rating of the switch contacts, an interposing relay needs to be inserted. If the switch is to be inserted in a 4-20 mA dc circuit, gold-plated dry contacts should be specified

In top (or bottom) mounted magnetic float switches (Figure 7-8B), the magnet is in the cylindrical float that travels up or down on a short vertical guide tube containing a reed switch. The float's motion is restrained by clips and can be only 1/2 in or less. These float and guide tubes are available with multiple floats that can detect several levels. The switch assembly itself can be either inserted directly into the tank or side-mounted in a separate chamber.

A magnetic piston operated switch also can be mounted in an external chamber (Figure 7-8C). As the magnet slides up and down inside a non-magnetic tube, it operates the mercury switch outside the tube. These switches are completely sealed and well suited for heavy duty industrial applications up to 900 psig and 400°C (750°F), meeting ASME code requirements.

These switches can be side, top, or cage mounted (Figure 7-9) and can serve both alarm and control functions on steam drums, feedwater heaters, condensate pots, gas/oil separators, receivers, and accumulators. Light-duty caged float switches are also available for service ratings up to 250 psig at 200°C (400°F) and 400 psig at 40°C (100°F)--suitable for many boilers, condensate receivers, flash tanks, day tanks, holding tanks, and dump valve controls. The cages can be provided with level gages. Multiple switches are available for multiple-switching applications such as boiler level alarms and controls.

Section 2 – Basic Instruments Level Measurements

Displacer level transmitters and switches

Whereas a float usually follows the liquid level, a displacer remains partially or completely submerged. As shown in Figure 7-10A, the apparent weight of the displacer is reduced as it becomes covered by more liquid. When the weight drops below the spring tension, the switch is actuated. Displacer switches are more reliable than regular floats on turbulent, surging, frothy, or foamy applications. Changing their settings is easy because displacers can be moved anywhere along the suspension cable (up to 50 ft). These switches are interchangeable between tanks because changing the tension of the support spring can accommodate differences in process density, and a force of only one ounce is needed.

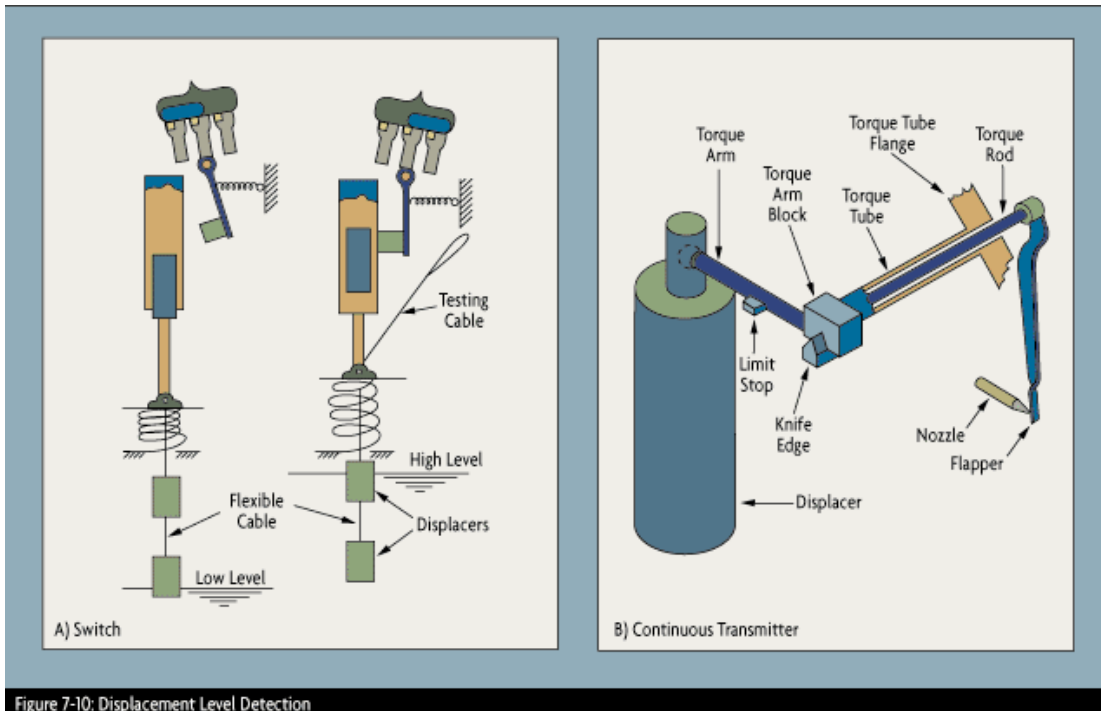

Testing the proper functioning of a regular float switch may require filling the tank to the actuation level, while a displacer switch can be tested simply by lifting a suspension (Figure 7-10A). Displacer switches are available with heavy-duty cages and flanges for applications up to 5000 psig at 150°C (300°F), suitable for use on hydraulic accumulators, natural gas receivers, high pressure scrubbers, and hydrocarbon flash tanks.

Displacers are popular as level transmitters and as local level controllers, particularly in the oil and petrochemical industries. However, they are not suited for slurry or sludge service because coating of the displacer changes its volume and therefore its buoyant force. They are most accurate and reliable for services involving clean liquids of constant density. They should be temperature-compensated, particularly if variations in process temperature cause significant changes in the density of the process fluid.

When used as a level transmitter, the displacer, which is always heavier than the process fluid, is suspended from the torque arm. Its apparent weight causes an angular displacement of the torque tube (a torsion spring, a frictionless pressure seal). This angular displacement is linearly proportional to the displacer's weight (Figure 7-10B).

Standard displacer volume is 100 cubic inches and the most commonly used lengths are 14, 32, 48, and 60 in. (Lengths up to 60 ft are available in special designs.). Displacer units are available with both pneumatic and electronic outputs and can also be configured as local, self-contained controllers. When used in water service, a 100 cubic inch displacer will generate a buoyant force of 3.6 pounds. Therefore, standard torque tubes are calibrated for a force range of 0-3.6 lb_f and thin-walled torque tubes for a 0-1.8 lb_f range.

Section 2 – Basic Instruments Level Measurements

Capacitive level transmitters and switches

Capacitance level detectors are also referred to as radio frequency (RF) or admittance level sensors. They operate in the low MHz radio frequency range, measuring admittance of an alternating current (ac) circuit that varies with level. In this chapter, the term capacitance level sensor will be used instead of RF or admittance.

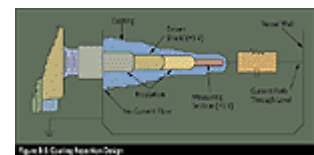
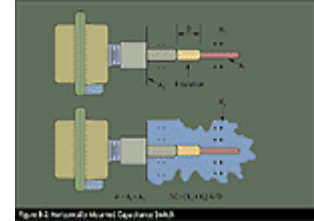
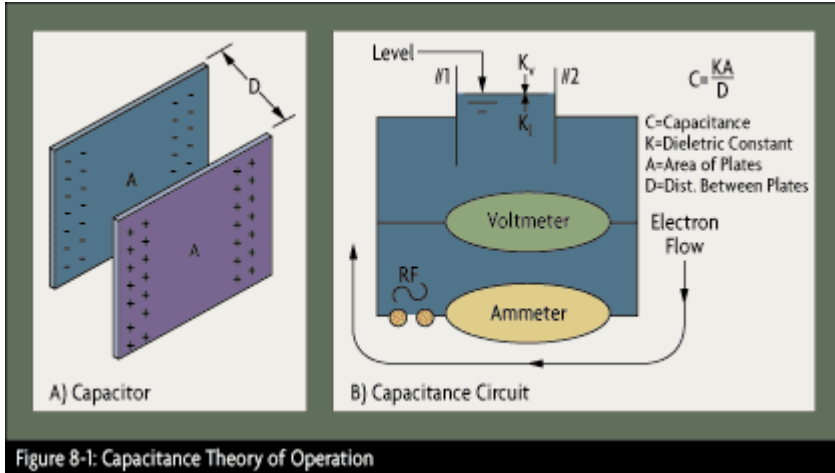

A capacitor consists of two conductors (plates) that are electrically isolated from one another by a nonconductor (dielectric). When the two conductors are at different potentials (voltages), the system is capable of storing an electric charge. The storage capability of a capacitor is measured in farads. As shown in Figure 8-1, the capacitor plates have an area (**A**) and are separated by a gap (**D**) filled with a nonconducting material (dielectric) of dielectric constant (**K**).

The dielectric constant of a substance is proportional to its conductivity. The lower the dielectric constant, the lower the conductivity of the material (that is, the less conductive it is). Capacitance (**C**) is calculated as: **C = KA/D**

If the area (**A**) of and the distance (**D**) between the plates of a capacitor remain constant, capacitance will vary only as a function of the dielectric constant of the substance filling the gap between the plates. If a change in level causes a change in the total dielectric of the capacitance system, because (as illustrated in Figure 8-1B) the lower part of area (**A**) is exposed to a liquid (dielectric **K₁**) while the upper part is in contact with a vapor (dielectric **K_v**, which is close to 1.0), the capacitance measurement will be proportional to level.

Applying an RF signal between the conductive probe and the vessel wall results in a minute current flow through the dielectric process material in the tank from the probe to the vessel wall. When the level in the tank drops and the probe is exposed to the even less conductive vapors, the dielectric constant drops.

This change is detected by the level switch's internal circuitry and translated into a change in the relay state of the level switch. In the case of continuous level detectors (vertical probes), the output is not a relay state, but a scaled analog signal.

The total area is the combined area of the level sensor probe and the area of the conductive vessel wall (**A = A₁ + A₂**), and the distance (**D**) is the shortest distance between the sensor probe and the vessel wall. Both of these values are fixed. The conductivity of vapors = (**K₁**), the process material = (**K₂**):

Change in C = (K₂-K₁)(A/D)

The sensitivity of a capacitance sensor is expressed in pico-farads (pF). In most level-sensing applications, the reference material is air (**K₁ = 1.0**). Table 7 gives the **K₂** values of a variety of process materials. As the dielectric constant of the process material gets close to that of air (**K₂**) the measurement becomes more difficult.

Section 2 – Basic Instruments Level Measurements

Radiation-Based Level Gages

An entire class of level instrumentation devices is based on a material's tendency to reflect or absorb radiation. For continuous level gages, the most common types of radiation used are radar/microwave, ultrasonic, and nuclear.

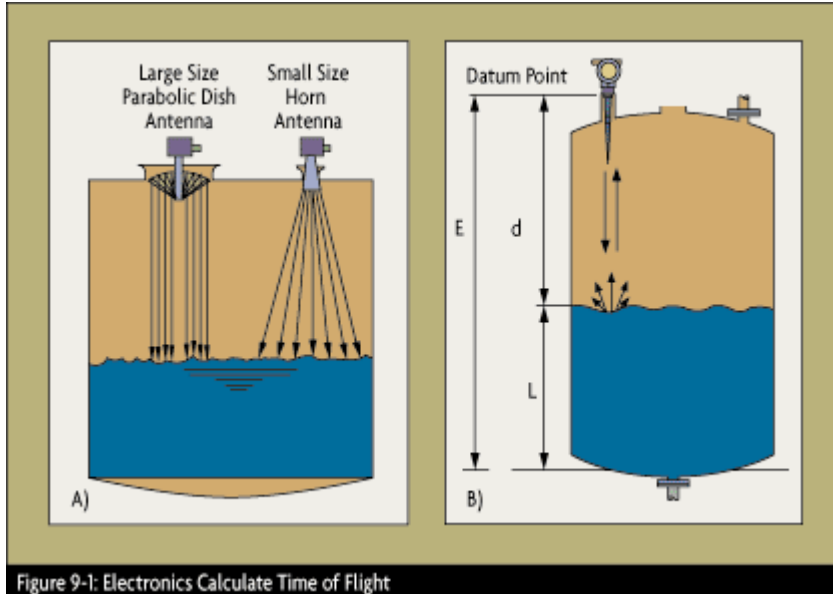

Both radar signals and microwaves travel at the speed of light, but are distinguished by their frequencies (FM radio broadcast frequency is from 88 to 108 MHz, while microwaves range from 1-300 GHz) and by their power levels (radar is around 0.01 mW/cm², while microwaves range from 0.1-5 mW/cm²). Because microwaves operate at a higher energy level, they can withstand more coating than can radar-type sensors.

Radar sensors consist of a transmitter, an antenna, a receiver with signal processor, and an operator interface. The transmitter is mounted on top of the vessel. Its solid-state oscillator sends out an electromagnetic wave (using a selected carrier frequency and waveform) aimed downward at the surface of the process fluid in the tank. The frequency used is typically 10 GHz.

The signal is radiated by a parabolic dish or horn-type antenna (Figure 9-1A) toward the surface of the process liquid (Figure 1B). A portion is reflected back to the antenna, where it is collected and routed to the receiver. Here, a microprocessor calculates the time of flight and calculates the level. Time of flight is the period between the transmission of the radar pulse and the reception of the return echo. It is determined by the radar detector, which is simultaneously exposed to both the sent and the reflected signal. The detector output is based on the difference.

The frequency-modulated (FM) signal varies from 0 to 200 Hz as the distance to the process fluid surface varies between 0 and 200 ft. Because this measurement takes place in the frequency domain, it is reasonably free of noise interference.

The depth of the vapor space (the distance between the datum point and the level in the tank, identified as "d" in Figure 9-1B) is calculated from the time of flight (**t**) and the speed of light (**c** = 186,000 miles/sec): $d = t/2c$

The level (L in Figure 9-1B) is calculated by figuring the difference between the total tank height (**E**) and the vapor space depth (**d**): $L = E - d$

Knowing the signal velocity (**c**) and the dielectric constant (**dc**) of the vapor (that is, the relative ability of the vapor to oppose and reflect electromagnetic waves), the velocity of the radar wave transmission (**V**) can be calculated: $V = c/(dc)^{0.5}$

Section 2 – Basic Instruments Level Measurements

Nuclear Level Gages

The penetrating power of nuclear radiation is identified by its photon energy, expressed in electron volts (eV) and related to wavelength (Figure 9-7). The most common isotope used for level measurement is Cesium 137, which has a photon energy level of 0.56 MeV. As any isotope decays, it loses strength--the time it takes to lose half of its strength is called its half-life. In about 5 years, the source must be replaced. This means not only the expense of purchasing a new source, but also the cost of disposing of the old one.

Gamma rays exhibited mysterious properties--they could pass through a seemingly solid, impenetrable mass of matter. In the passage, however, the gamma rays lost some of their intensity. The rays were predictably affected by the specific gravity and total thickness of the object, and by the distance between the gamma ray source and the detector.

For example, if radiation from Cesium 137 is passing through an 3-in thick steel object, 92% of the radiation energy will be absorbed and only 8% will be transmitted. Therefore, if the observer can hold all variables *except* thickness constant, the amount of gamma transmission can be used to measure the thickness of the object. Assuming that the distance between the source and detector does not change, an accurate measurement of either thickness (level), or, if thickness dose not change, then of the density of a process material.

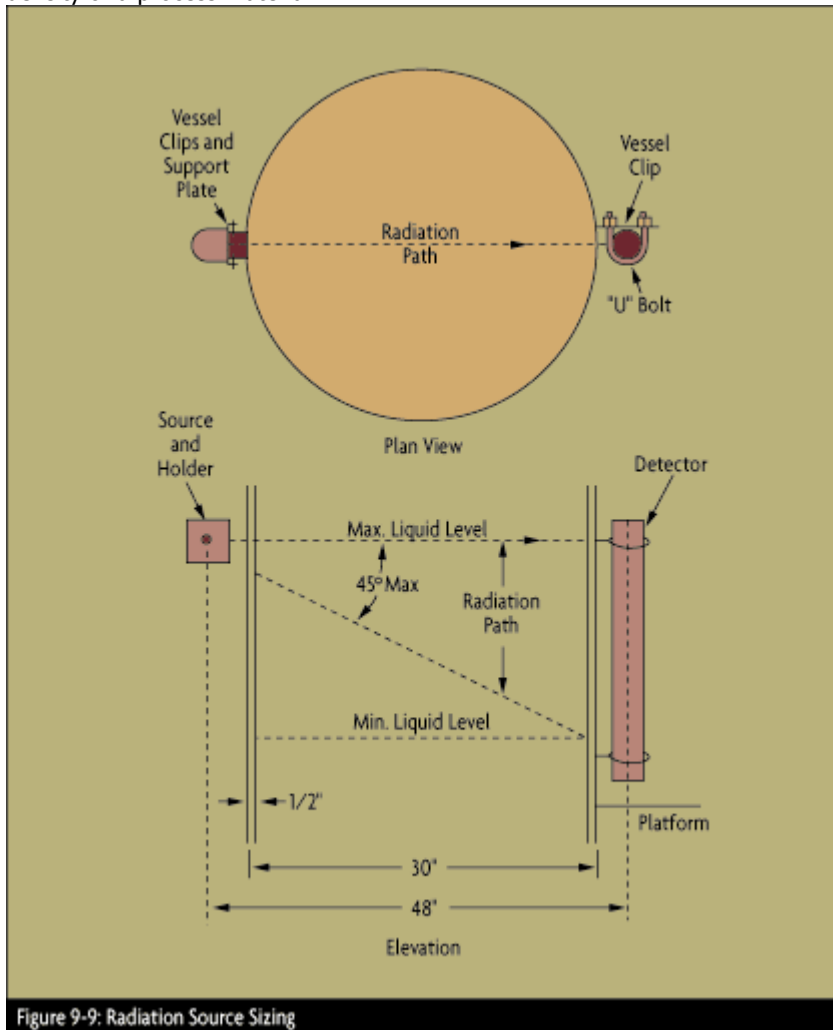

NOTE:

Calibration and the opening of nuclear sensors require a Nuclear Regulatory Commission (NRC) license.

Radiation level gages typically are considered when nothing else will work, or when process penetrations required by a traditional level sensor present a risk to human life, to the environment, or could do major damage to property. The liquids and bulk solids measured by nuclear gages are among the most dangerous, highly pressurized, toxic, corrosive, explosive, and carcinogenic materials around.

Section 2 – Basic Instruments

Temperature measurements

Temperature can be measured by a number of sensors types. All of them infer temperature by sensing some change in a physical characteristic. Six types with which the engineer is likely to come into contact are: *thermocouples*, *resistive temperature devices (RTDs and thermistors)*, *bimetallic devices*, and *liquid expansion devices*.

Thermocouples

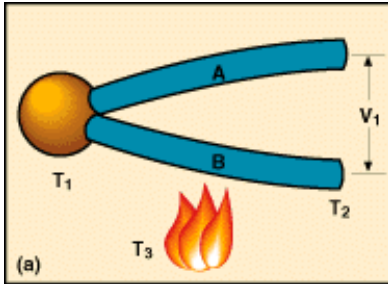

Thermocouples consist essentially of two strips or wires made of different metals and joined at one end. Changes in the temperature at that juncture induce a change in electromotive force (emf) between the other ends. As temperature goes up, this output emf of the thermocouple rises, though not necessarily linearly. This voltage is measured and interpreted by a thermocouple thermometer.

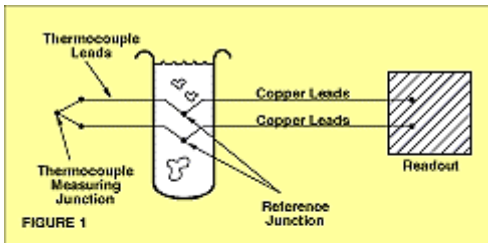

Thermocouples need what is referred to as a cold junction reference. The cold junction is typically an ice bath or an electronic circuit that will produce a reference voltage the same as if the thermocouple were in an ice bath.

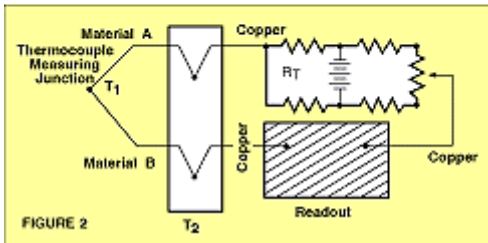

This electronic ice bath or reference junction circuit typically incorporates a 500-ohm precision resistor to measure the ambient air temperature.

Sheathed thermocouple probes are available with one of three junction types: grounded, ungrounded or exposed. At the tip of a grounded junction probe, the thermocouple wires are physically attached to the inside of the probe wall.



Grounded



Ungrounded









Exposed

Common sheathing materials for thermocouples and RTDs

Material	Maximum Temperature	Application Atmosphere			
		Oxidizing	Hydrogen	Vacuum	Inert
304 SS	900°C (1650°F)	Very Good	Good	Very Good	Very Good
Inconel 600	1148°C (2100°F)	Very Good	Good	Very Good	Very Good

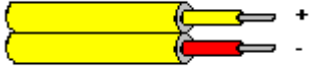
Section 2 – Basic Instruments

Temperature measurements

TC TYPE	THERMOCOUPLE MATERIAL	RANGE FOR CALIB. DEG F	USEFUL RANGE DEG F	TC COLORS
E	Chromel (+) Constantan (-)	-300 to 1830	200 to 1650	
J	Iron (+) Constantan (-)	-320 to 1400	200 to 1400 (300 TO 800)	
K	Chromel (+) Alumel (-)	-310 to 2500	200 to 2300	
R	Platinum 13% Rhodium (+) Platinum (-)	0 to 3100	1600 to 2640	
S	Platinum 10% Rhodium (+) Platinum (-)	0 to 3200	1800 to 2640	
T	Copper (+) Constantan (-)	-310 to 750	-310-660	

RTD (resistance temperature detector) & Thermistors

RTDs are typically a DIN 100 ohm resistor that comes in a sheathing as previously discussed with thermocouples. At a glance they look the same but are much different. As the name indicates, RTDs rely on resistance change in a metal, with the resistance rising more or less linearly with temperature. Thermistors are based on resistance change in a ceramic semiconductor; the resistance drops nonlinearly with temperature rise.

RTDs are more stable than thermocouples. On the other hand, as a class, their temperature range is not as broad: RTDs operate from about -250 to 850°C whereas thermocouples range from about -270 to 2,300°C. Thermistors have a more restrictive span, being commonly used between -40 and 150°C, but offer high accuracy in that range.

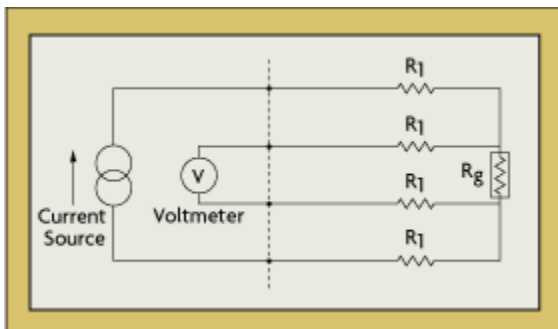

Because RTDs are passive resistive devices, you must pass a current through the RTD to produce a voltage that can be measured. RTDs have relatively low resistance (100 ohms at °C) that changes only slightly with temperature (less than 0.4 ohms/°C), so you might need to use special configurations that minimize errors from lead wire resistance.

Section 2 – Basic Instruments

Temperature Measurements

For example, consider the measurement of a 2-wire RTD. With this RTD, labeled R_T , the voltage drops caused by the excitation current, I_{EXC} , passing through the lead resistance, R_L , add to the measured voltage, V_O .

For longer lead length, the 4-wire RTD in Figure 4 is a better choice. With a 4-wire RTD, one pair of wires carries the excitation current through the RTD; the other pair senses the voltage across the RTD. Because only negligible current flows through the sensing wires, the lead resistance error is very small.

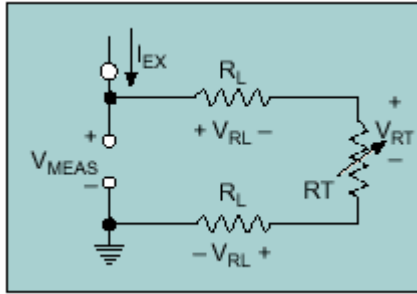

2-Wire RTD Measurement

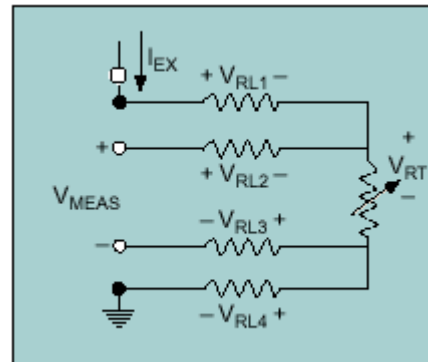

4-Wire RTD Measurement

Industrial Thermometers



A thermometer are used for temperature measurement in many industrial applications. The liquid-in-glass design is typically used due to low cost and ease of use.

Thermometers come in the four classes as follows...

Class I, Liquid-filled systems

These systems are filled with a liquid other than mercury. The filling liquid is usually an inert hydrocarbon such as xylene. The liquid will typically expand six times that of mercury resulting in smaller bulbs.

Class II, Vapor-filled systems

These systems are filled with a medium in both liquid and gaseous form.

Class IIA - the bulb will be mostly filled with gas, capillary liquid.

Class IIB - the bulb will be mostly filled with liquid, capillary gas.

Class IIC - measures both side of ambient but use larger bulb.

Class IID – uses non-volatile fluid as a hydraulic transmitter.

Class III, Gas-filled systems

Nitrogen is the favorite fill because it is inert and inexpensive.

Class IV, Mercury-filled systems

Mercury offers rapid response, accuracy and plenty of power for operating control elements. The incompressible nature of mercury makes temperature compensation less of a problem.

Section 2 – Basic Instruments Temperature Measurements

Thermowells

Thermowells are used to insert the thermocouple or RTD into the process fluid or stream. This way the process is isolated from the outside environment and the temperature sensor can be removed or replaced without interrupting the process operation.

Screw Type Thermowells

TAPERED STEM WELL

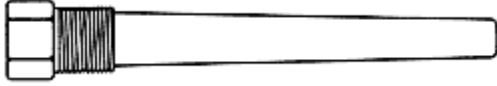

STRAIGHT STEM WELL

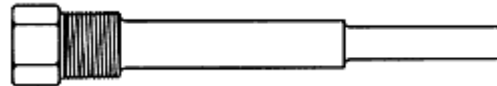

STEPPED STEM WELL

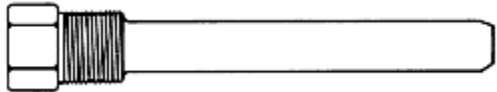

LIMITED SPACE STEPPED STEM WELL

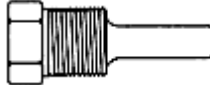

Flange Type Thermowells

STRAIGHT STEM FLANGED THERMOWELL

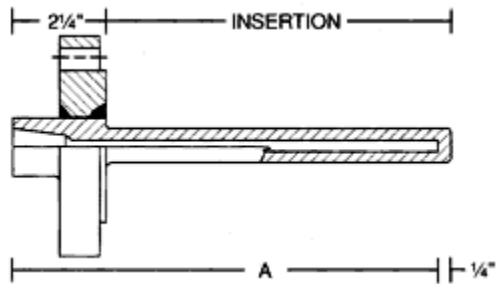

TAPERED STEM SANITARY WELD THERMOWELL

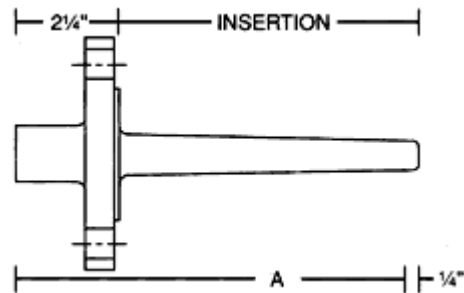

TAPERED STEM FLANGED THERMOWELL

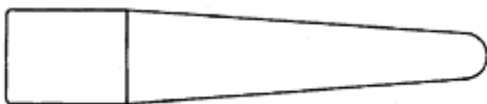

STEPPED STEM FLANGED THERMOWELL

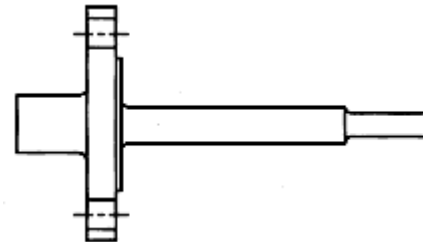

STEPPED STEM SOCKET WELD THERMOWELL

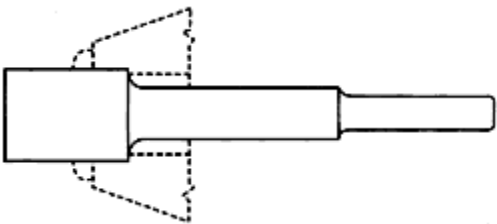

STRAIGHT STEM VAN STONE THERMOWELL

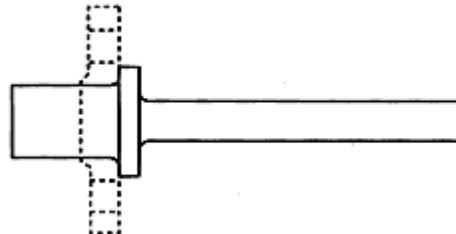

Section 2 – Basic Instruments Calibration Procedures

Calibration connection on transmitters

The following illustrates the basic pneumatic connection for calibration a transmitter standard or smart.

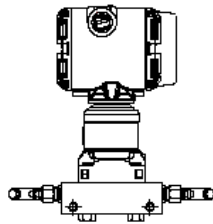
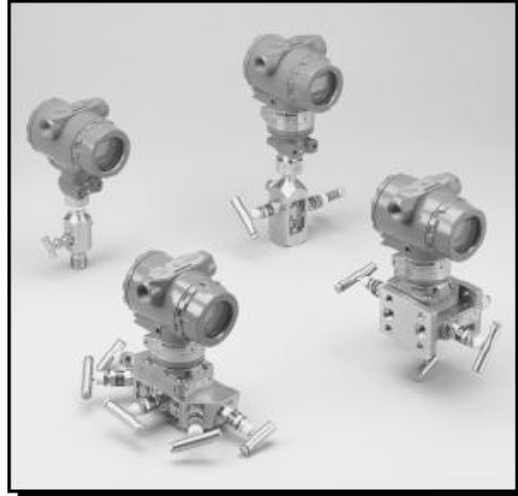
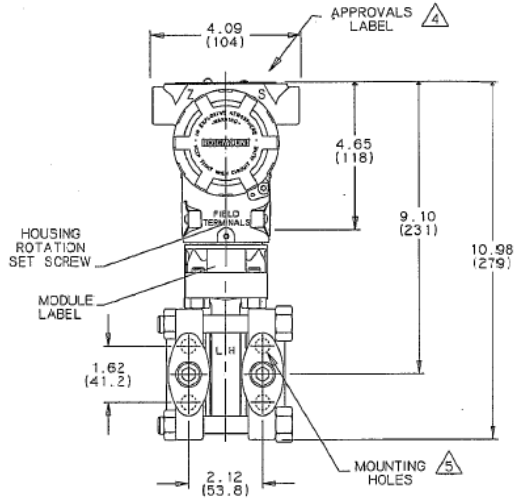

COPLANAR DESIGN

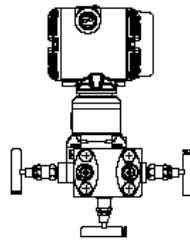

TRADITIONAL DESIGN

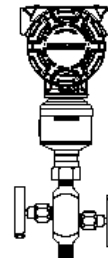

IN-LINE DESIGN

Figure 2-3. Installation Examples

GAS OR LIQUID SERVICE

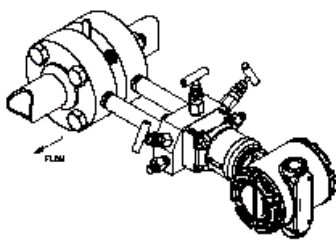

GAS SERVICE

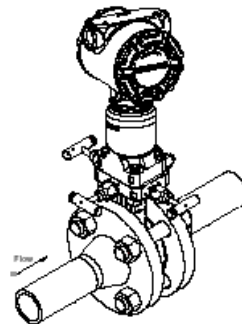

STEAM SERVICE

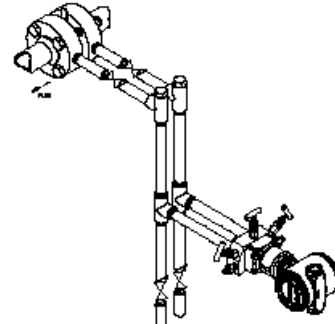

Section 2 – Basic Instruments Calibration Procedures

Power Supply and Line Resistance

The following illustrates the basic electrical connection for calibration a transmitter standard or smart.

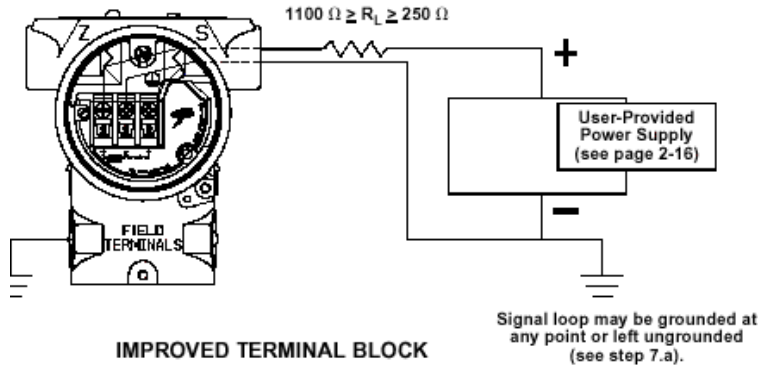

Maximum field loop Resistance = $43.5 * (\text{Power Supply Voltage} - 10.5)$

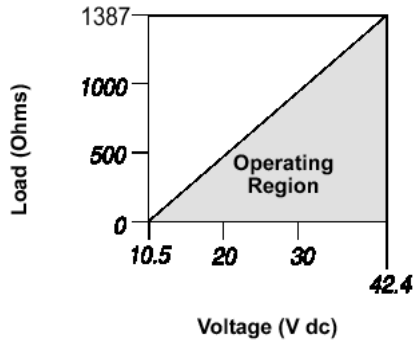

Communication requires a minimum loop resistance of 250 ohms.

Figure 2-6. Power Supply Load
Limitations, 4–20 mA
Transmitters

Loop resistance is determined by the voltage level of the external power supply, as described by:

$$\text{Max. Loop Resistance} = \frac{\text{Power Supply Voltage} - 11.0}{0.022}$$

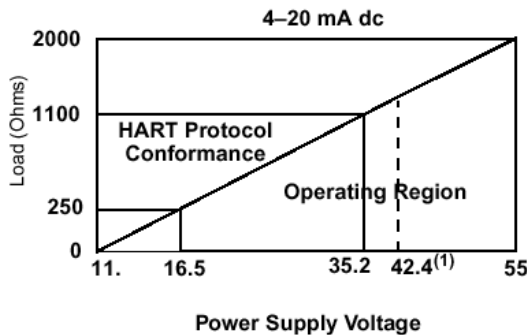

HART protocol communication requires a loop resistance value between 250–1100 ohms, inclusive.

(1) For CSA approval, power supply must not exceed 42.4 V dc.

NOTE:

Ohm's law still holds true here. It is important to note the listed maximum voltage of the instrument as well. The supply voltage of the power supply cannot exceed the working or rated voltage of the instrument or damage will occur.

The typical supply voltage for instrumentation is 24 volts DC and 42 volts DC.

Section 2 – Basic Instruments Calibration Procedures

Typical ranges for industrial instrumentation

The following illustrates the basic connection for calibration a transmitter (standard or smart).

TYPICAL RANGES	TYPE OF RANGE	RANGE	LOWER RANGE-VALUE	UPPER RANGE-VALUE	SPAN
(1) THERMOCOUPLE 0 _____ 2000°F [_____] TYPE K T/C	MEASURED VARIABLE	0 to 2000°F	0°F	2000°F	2000°F
-0.68 _____ +44.91 mV [_____]	MEASURED SIGNAL	-0.68 to +44.91 mV	-0.68 mV	+44.91 mV	45.59 mV
0 _____ 20 [_____] x100=°F	SCALE AND/OR CHART	0 to 2000°F	0°F	2000°F	2000°F
(2) FLOWMETER 0 _____ 10 000 lb/h [_____]	MEASURED VARIABLE	0 to 10 000 lb/h	0 lb/h	10 000 lb/h	10 000 lb/h
0 _____ 100 in H ₂ O [_____]	MEASURED SIGNAL	0 to 100 in H ₂ O	0 in H ₂ O	100 in H ₂ O	100 in H ₂ O
0 _____ 10 [_____] x1000=lb/h	SCALE AND/OR CHART	0 to 10 000 lb/h	0 lb/h	10 000 lb/h	10 000 lb/h
(3) TACHOMETER 0 _____ 500 rpm [_____]	MEASURED VARIABLE	0 to 500 rpm	0 rpm	500 rpm	500 rpm
0 _____ 5V [_____]	MEASURED SIGNAL	0 to 5V	0V	5V	5V
0 _____ 80 ft/s [_____]	SCALE AND/OR CHART	0 to 80 ft/s	0 ft/s	80 ft/s	80 ft/s

Section 2 – Basic Instruments Calibration Procedures

The following illustrates the electrical connections to transmitters for general calibration with smart calibrator.

Constant Current 4-20 mA

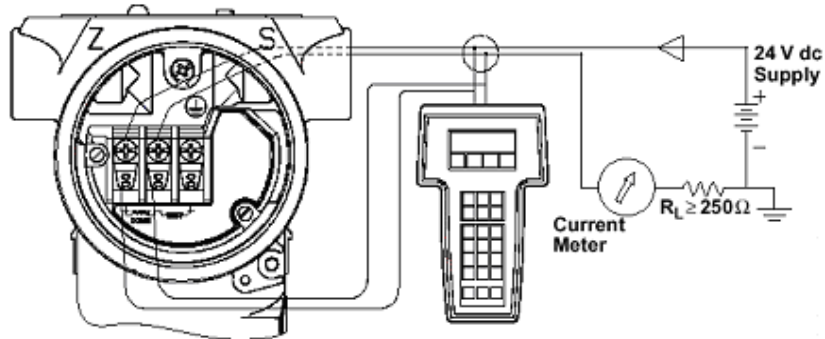

Constant Voltage 1-5 volts

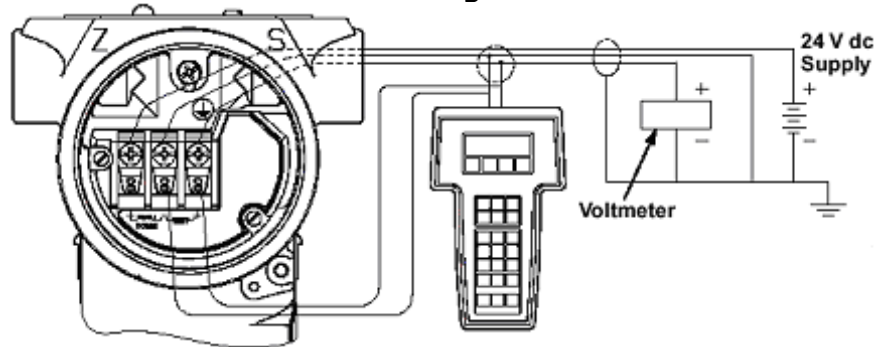

Bus Configuration

FIGURE 2-15. Typical Multidrop Network.

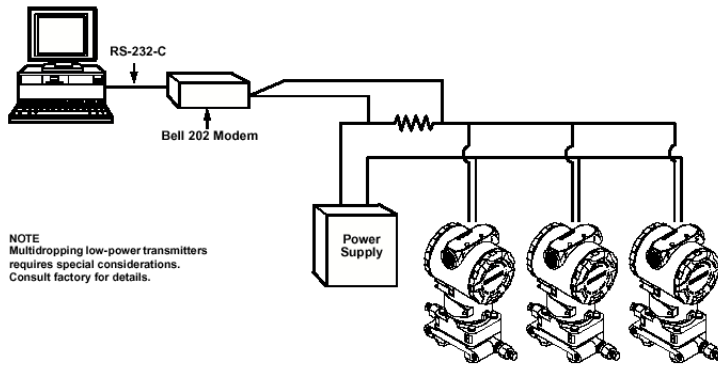

NOTE
Multidropping low-power transmitters requires special considerations. Consult factory for details.

NOTE
The Model 3051 is set to address 0 at the factory, allowing it to operate in the standard point-to-point manner with a 4–20 mA output signal. To activate multidrop communication, the transmitter address must be changed to a number from 1 to 15. This change deactivates the 4–20 mA analog output, sending it to 4 mA. It also disables the failure mode alarm signal, which is controlled by the upscale/downscale jumper position. Failure signals in multidropped transmitters are communicated through HART messages.

NOTE

Default low power output is 1–5 V dc. After changing output between 1–5 V and 0.8–3.2 V, perform a low power output trim.

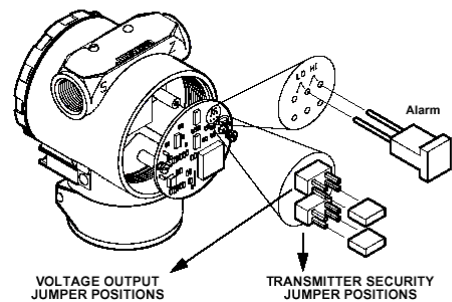

VOLTAGE OUTPUT JUMPER POSITIONS

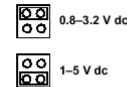

TRANSMITTER SECURITY JUMPER POSITIONS



NOTE

Security jumper not installed = Not Write Protected.
Alarm jumper not installed = High Alarm.
Voltage output jumper not installed = 1–5 V

Section 2 – Basic Instruments Calibration Procedures

Calibration calculations

Pressure measurements are zero or non-zero based. The illustration on the right is a zero based measurement. That is the transmitter is level with the bottom of the fluid to be measured or at zero elevation. The transmitter to the left is non-zero based. The transmitter is below the zero or bottom elevation of the fluid to be measured.

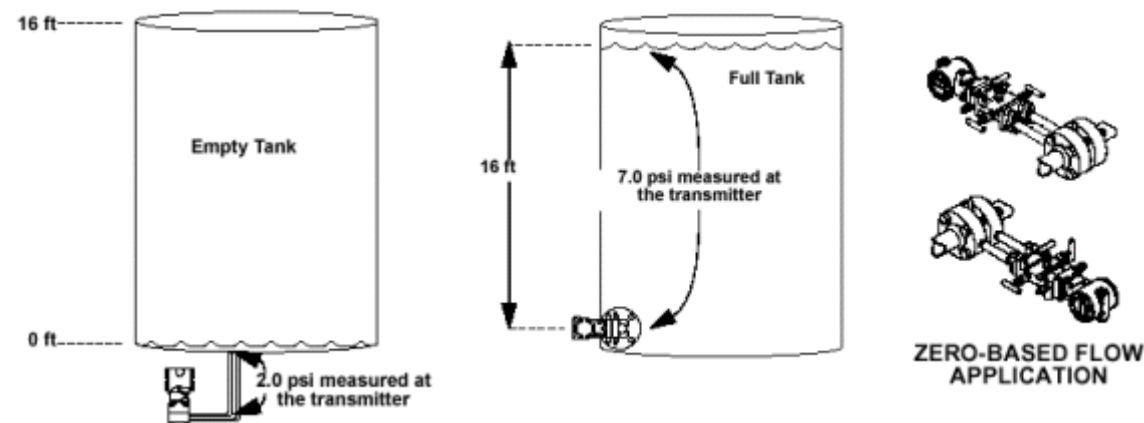

The illustration on the left will have to be calibrated with what is referred to as an elevated zero. The measurement will start at 2.0 PSI equal to 0% or 4 mA. The illustration on the right will start with 0.0 PSI equal to 0% or 4 mA and the span is 7.0 PSI for 100% level in the tank.

The left tank will read the same span of 7.0 PSI at 100% for the same contents in the tank because the 2.0 PSI below the tank has already been subtracted from the measurement.

HEAD Pressure

Head pressure is independent of the tanks height or area. The transmitter measures head pressure. Head pressure is the measure of potential energy in the system. It will measure from how high the fluid is falling. The distance the fluid will falls will dictate the force generated ($F=ma$). This is why the density of the fluid must be known to calibrate a pressure transmitter for a process.

To illustrate these facts we will start with one gallon of water. The gallon of water equals exactly 231 cubic inches and weights approximately 8.342 pounds. Pressure is measured in PSI (POUNDS PER INCH SQUARED). The only area that needs to be measured is 1 square inch to calculate the height of the water and the force it will exert.

Stack the 231 cubic inches of water on top of each other to form a tall column of water with a base of 1 square inch. The column of water will be 231 inches tall. Divide the height of the column of water, 321 inches, by the weight of the water, 8.342 pounds. The result will be 27.691 inches of water per pound. In plain words a column of water 27.691 inches tall will produce a force of 1 pound per inch squared or 1 PSI.

By knowing the height of the fluid multiplied by its density at time of calibration, the pressure can be calculated. Therefore the height of the fluid or level can be calculated from its head pressure regardless if the tank is 5 ft in diameter or 20 ft in diameter. This pressure is typically measured in inches of water for low-pressure measurements and psi for large pressure measurements.

In instrumentation it is common to measure in inches rather than feet of water for calibration purposes.

Calibration Procedures

Calibration calculations

The Wet Leg

Another non-zero based application is the tank on the right. This measurement uses what is referred to as a wet leg. As remember the wet leg is used to equalize the pressure across the transmitter in a pressurized tank. Because of condensation the wet leg eventually will fill up and the transmitter will no longer be in static equilibrium and a constant varying error will exist over time. The solution is to fill the wet leg up with the product to be used in the tank or an antifreeze product. This is where the name "WET LEG" comes from.

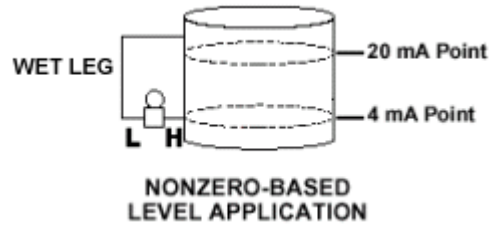

Sample Calculations

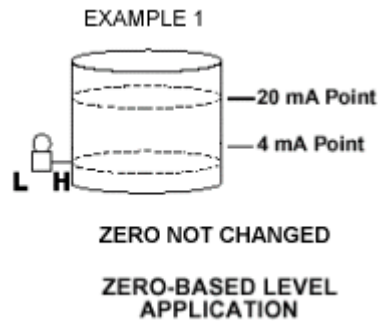

Tank Level = 0 to 100 inches
S.G. = 1.1
(switch jumper to normal zero)

$0'' \times 1.1 = 0'' = 4 \text{ mA}$
 $100'' \times 1.1 = 110'' = 20 \text{ mA}$
 Calibrated span from 0'' to 110'' H2O

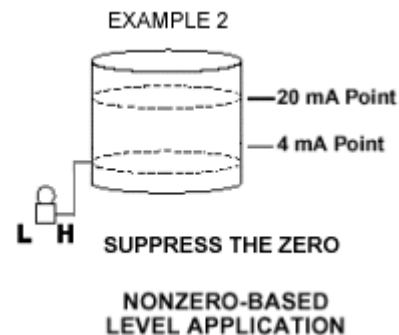

Tank Level = 0 to 100 inches
S.G. = 0.9
(switch jumper to suppress zero)

$20'' \times 0.9 = 18'' = 4 \text{ mA}$
 $100'' \times 0.9 = 90'' = 20 \text{ mA}$
 Calibrated span from 18'' to 90'' H2O

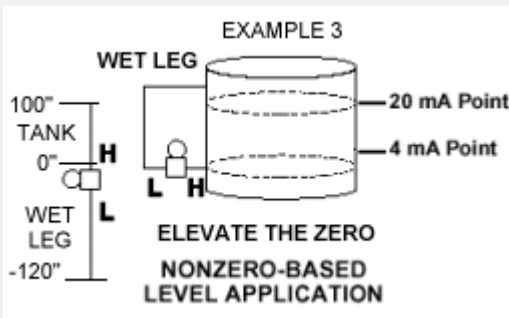

Tank Level = 0 to 100 inches
S.G. = 1.0 Wet Leg Fill Height = 120"
(switch jumper to elevate zero)

(Apply 120'' to low side of instrument for 0%)
 $(-120'' + 0'') \times 1.0 = -120'' = 4 \text{ mA}$

(Apply 100'' to high side with low side connected for 100%)
 $100'' \times 1.0 = 100'' = 20 \text{ mA}$
 Calibrate span from 0'' to 100'' H2O

OR

(Apply 20'' to low side with high side disconnected for 100%)
 $-120'' + 100'' = -20'' = 20 \text{ mA}$
 Calibrated span from 0'' to 100'' H2O

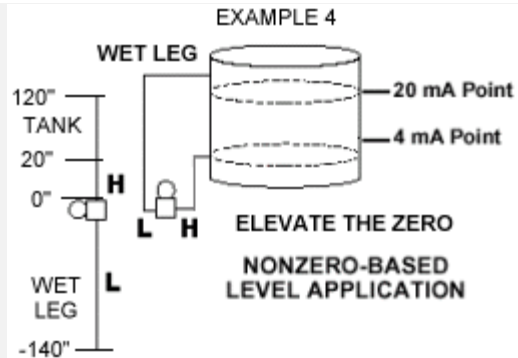

Tank Level = 0 to 100 inches
S.G. = 0.8 Wet Leg Fill Height = 140"
(switch jumper to elevate zero)

(Apply 96'' to low side of instrument for 0%)
 $(-140'' + 20'') \times 0.8 = -96'' = 4 \text{ mA}$

(Apply 80'' to high side with low side connected for 100%)
 $100'' \times 0.8 = 80'' = 20 \text{ mA}$
 Calibrated span from 0'' to 80'' H2O

OR

(Apply 20'' to low side with high side disconnected for 100%)
 $(-140'' + 120'') \times 0.8 = -16'' = 20 \text{ mA}$
 Calibrated span from 0'' to 80'' H2O

Section 2 – Basic Instruments Calibration Procedures

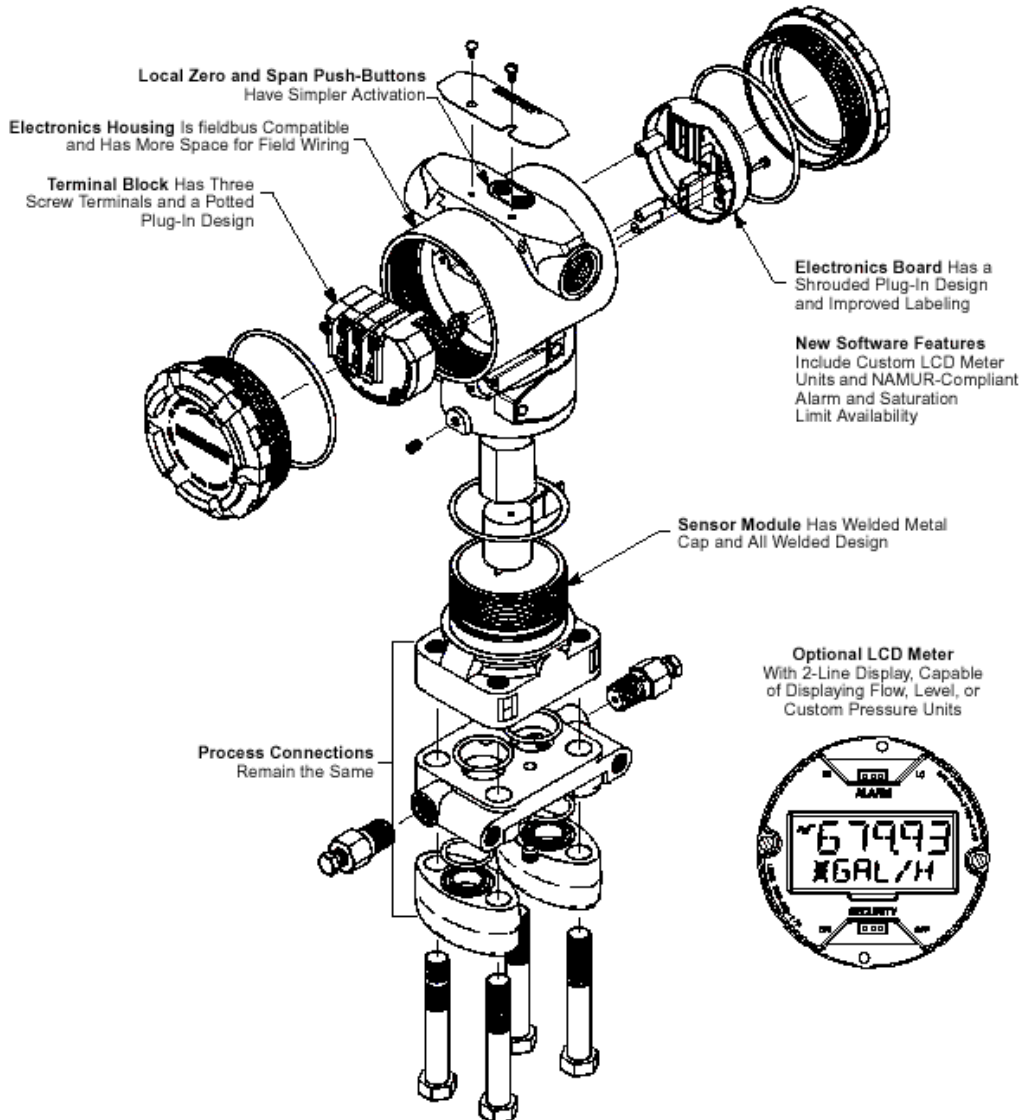
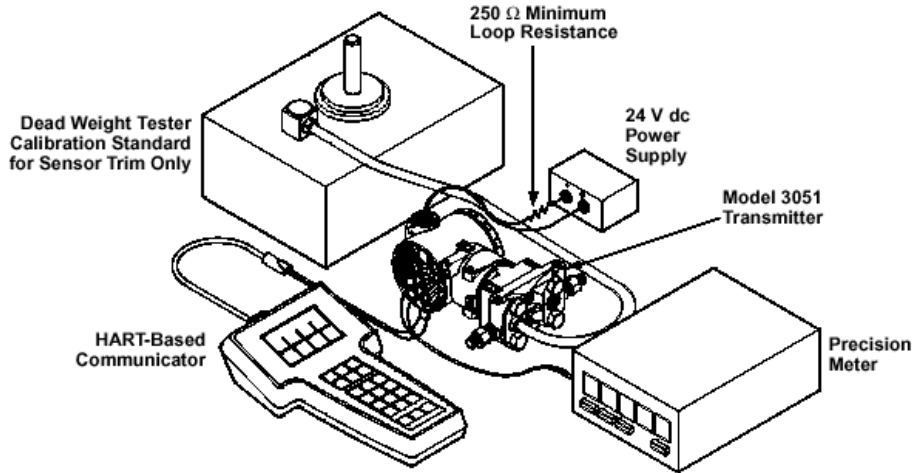

Section 1 – Process Control Control Loops

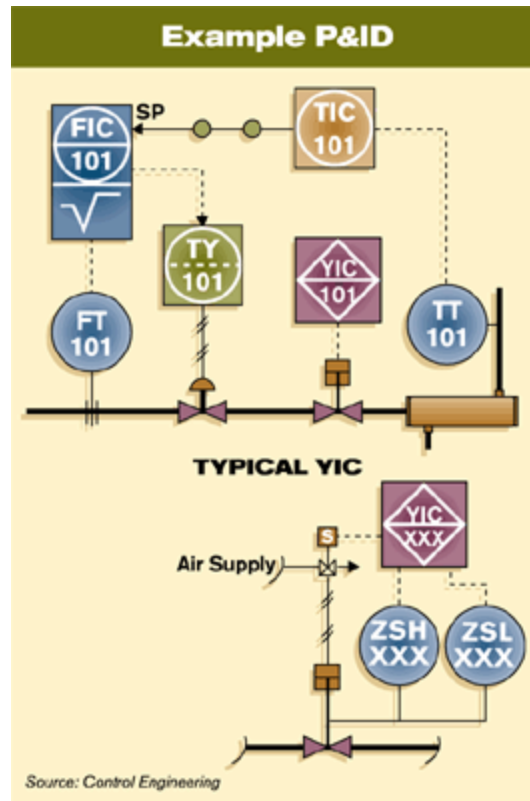

Open Loop

Open loop means there is no feedback in the process to maintain the desired setpoint of the process due to disturbances. A setpoint is set in the controller and not changed. The process operates at that setpoint. The setpoint can be as an example: temperature, speed or a flow rate. A change will occur in the process due to disturbances.

As in the previous examples: for temperature, the water may become colder going into the process and therefore the process cannot heat the water to the desired temperature. For speed, a conveyor belt may be carrying gravel. Excess gravel is loaded on the belt, making it load heavier. The belt will then be slowed down from the desired speed. For flow rate, a liquid traveling through a pipe may have its pressure decreased or an increase the pressure drop due extra valves and pipe will cause the flow rate to decrease.

Closed Loop

Closed loop means there is a feedback device in the process somewhere and the feedback device is connected to the controller. Now when there is a disturbance to the process, the feedback controller senses the disturbance and corrects for it automatically. For the temperature, the heater element will increase its output until the setpoint or desired temperature is reached. For the gravel conveyor, the motor will increase in speed until the desired speed is met. For the flow rate, the pump will speed up until the desired flow rate is met.

In the picture above, the top picture is a closed loop, while the bottom is an open loop.

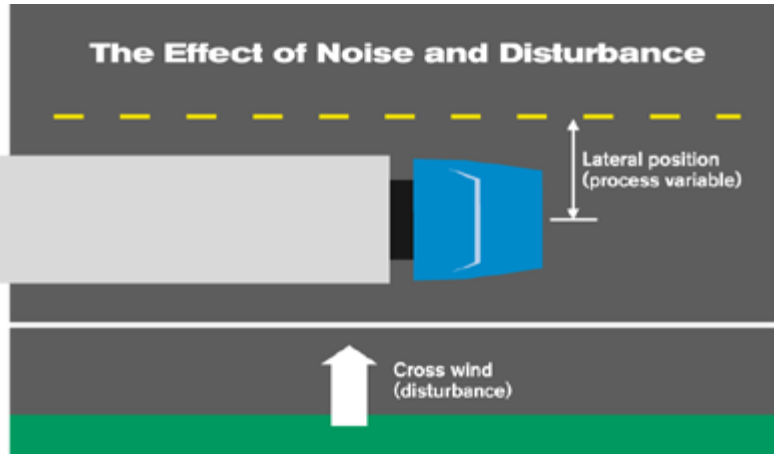

Section 2 – Process Control Control Modes

Typical process control falls into four main categories: Feedback, feedforward, cascade and differential Gap.

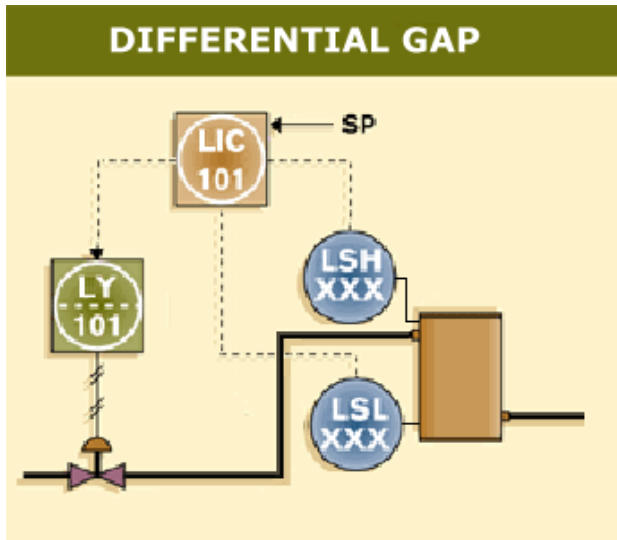

Differential Gap

Differential Gap is also known as bang-bang control. It uses two points for discrete control.

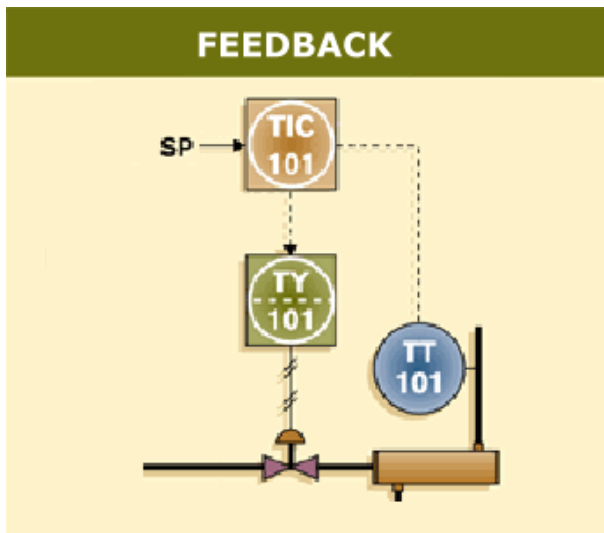

Feedback

Open loop means there is no feedback in the process to maintain the desired setpoint of the process due to disturbances. A setpoint is set in the controller and not changed. The process operates at that setpoint. The setpoint can be as an example: temperature, speed or a flow rate. A change will occur in the process due to disturbances.

As in the previous examples: for temperature, the water may become colder going into the process and therefore the process cannot heat the water to the desired temperature. For speed, a conveyor belt may be carrying gravel. Excess gravel is loaded on the belt, making it load heavier. The belt will then be slowed down from the desired speed. For flow rate, a liquid traveling through a pipe may have its pressure decreased or an increase the pressure drop due extra valves and pipe will cause the flow rate to decrease.

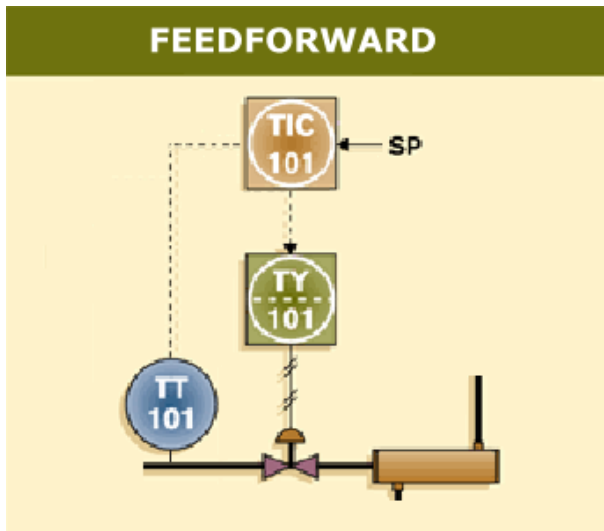

Feedforward

Closed loop means there is a feedback device in the process somewhere and the feedback device is connected to the controller. Now when there is a disturbance to the process, the feedback controller senses the disturbance and corrects for it automatically. For the temperature, the heater element will increase its output until the setpoint or desired temperature is reached. For the gravel conveyor, the motor will increase in speed until the desired speed is met. For the flow rate, the pump will speed up until the desired flow rate is met.

In the picture above, the top picture is a closed loop, while the bottom is an open loop.

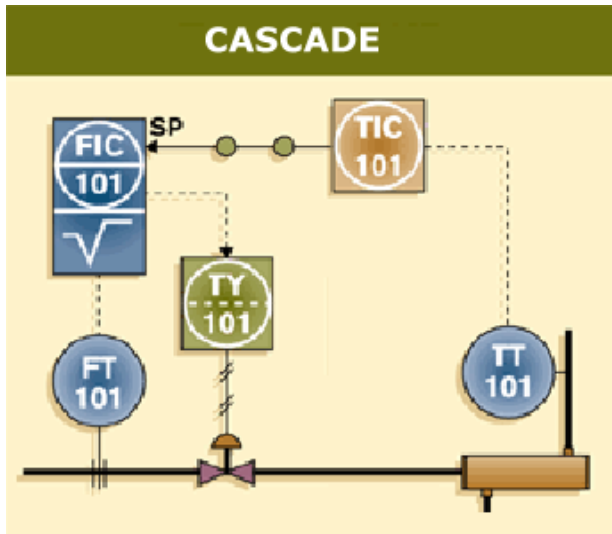

Cascade

Open loop means there is no feedback in the process to maintain the desired setpoint of the process due to disturbances. A setpoint is set in the controller and not changed. The process operates at that setpoint. The setpoint can be as an example: temperature, speed or a flow rate. A change will occur in the process due to disturbances.

As in the previous examples: for temperature, the water may become colder going into the process and therefore the process cannot heat the water to the desired temperature. For speed, a conveyor belt may be carrying gravel. Excess gravel is loaded on the belt, making it load heavier. The belt will then be slowed down from the desired speed. For flow rate, a liquid traveling through a pipe may have its pressure decreased or an increase the pressure drop due extra valves and pipe will cause the flow rate to decrease.

Differential Gap

Closed loop means there is a feedback device in the process somewhere and the feedback device is connected to the controller. Now when there is a disturbance to the process, the feedback controller senses the disturbance and corrects for it automatically. For the temperature, the heater element will increase its output until the setpoint or desired temperature is reached. For the gravel conveyor, the motor will increase in speed until the desired speed is met. For the flow rate, the pump will speed up until the desired flow rate is met.

In the picture above, the top picture is a closed loop, while the bottom is an open loop.

Section 3 – Process Control Final Correction Devices

Valves

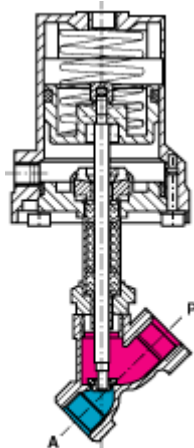
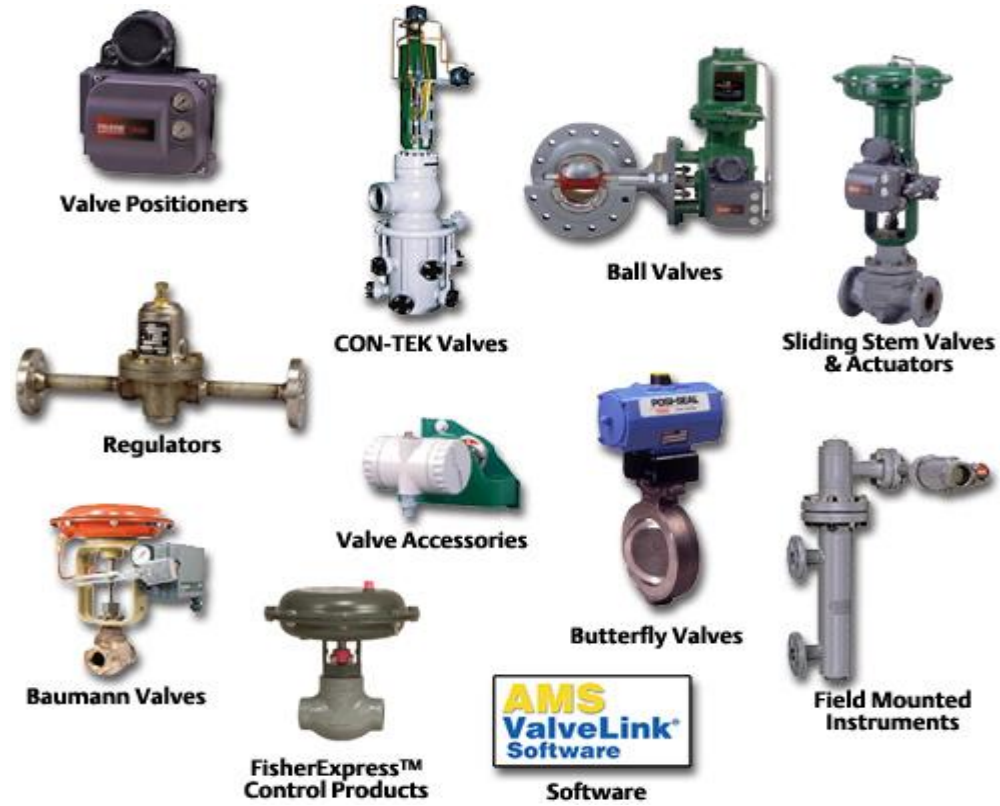

figure 7

Control Valve Flow Characteristics

Trim design will affect how the valve capacity changes as the valve moves through its complete travel. Because of the variation in trim design, many valves are not linear in nature. THE RELATIONSHIP BETWEEN VALVE CAPACITY AND VALVE TRAVEL IS KNOWN AS THE FLOW CHARACTERISTIC OF THE VALVE. Valve trims are specially designed, or characterized, in order to meet the large variety of control application needs. This is necessary because most control loops have some inherent nonlinearities, which you can compensate for when selecting control valve trim.

Charts similar to Figure 1 (see below) are used to illustrate various control valve flow characteristics. The percent of full flow through the valve is plotted against valve stem position. The curves shown are typical of those available from valve manufacturers. These curves are based on CONSTANT PRESSURE DROP across the valve and are called INHERENT FLOW CHARACTERISTICS.

The quick-opening characteristic provides large changes in flow for very small changes in lift. It usually has too high a valve gain for use in modulating control. So it is limited to on-off service, such as sequential operation in either batch or semi-continuous processes.

The majority of control applications are valves with linear, equal-percentage, or modified-flow characteristics.

- **Linear** - flow capacity increases linearly with valve travel.
- **Equal percentage** - flow capacity increases exponentially with valve trim travel; equal increments of valve travel produce equal percentage changes in the existing C_v .
- **A modified parabolic characteristic** is approximately midway between linear and equal-percentage characteristics. It provides fine throttling at low flow capacity and approximately linear characteristics at higher flow capacity.

When valves are installed with a pump, pipes, fittings, and other process equipment, the pressure drop across the valve will vary as the plug moves through its travel. When the actual flow in a system is plotted against valve opening, the curve is called the INSTALLED FLOW CHARACTERISTIC.

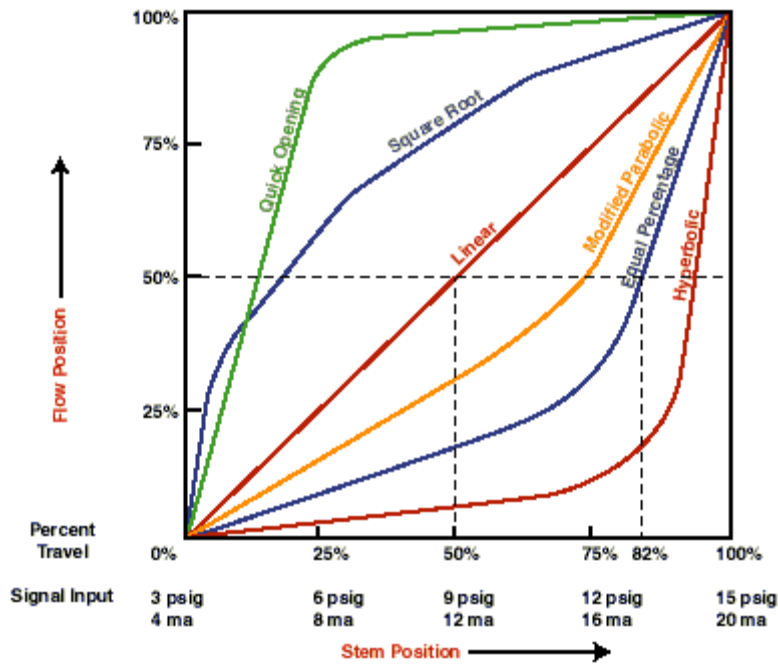

Linear Valve Features

- TORTUOUS FLOW PATH
- LOW RECOVERY
- CAN THROTTLE SMALL FLOW RATES
- OFFERS VARIETY OF SPECIAL TRIM DESIGNS
- SUITED TO HIGH-PRESSURE APPLICATIONS
- USUALLY FLANGED OR THREADED
- SEPARABLE BONNET

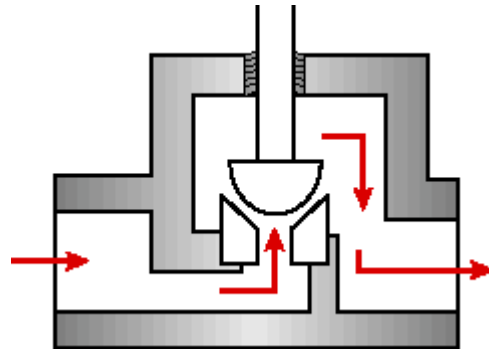

Rotary Valve Features

- STREAMLINED FLOW PATH
- HIGH RECOVERY
- MORE CAPACITY
- LESS PACKING WEAR
- CAN HANDLE SLURRY AND ABRASIVES
- FLANGELESS
- INTEGRAL BONNET
- HIGH RANGEABILITY

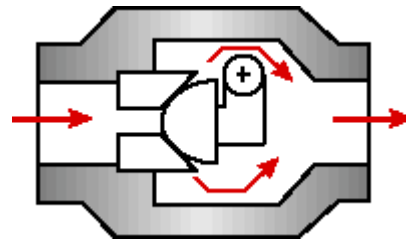

Control Valve Classification

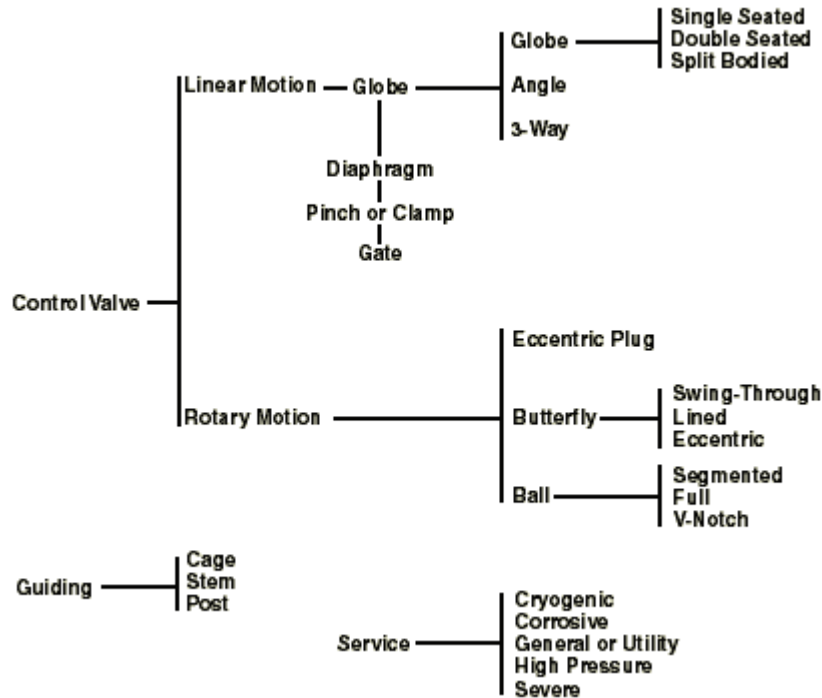

Direct-Acting and Reverse-Acting Positioners

The terms "direct" and "reverse" are frequently used when discussing control valves, positioners, and controllers. While the definitions of direct and reverse seem pretty straightforward, they cause quite a bit of confusion - especially when split-ranging is done.

The key to working with control valves and controllers is to remember that *there must always be a balance maintained in the system*. "Direct" and "reverse" are kind of like "positive" and "negative" in that where you find one you will usually find the other.

While control valve bodies and control valve actuators can be described as being direct acting or reverse acting, thinking about such things when working through a system problem only adds to the confusion. Therefore, *it is always best to consider the FAIL SAFE mode of the valve* and simply let the control valve be what it may be.

Positioners, 99% of the time, will usually mimic the input signal from the controller. That is, they will be DIRECT ACTING.

Direct-Acting Positioners

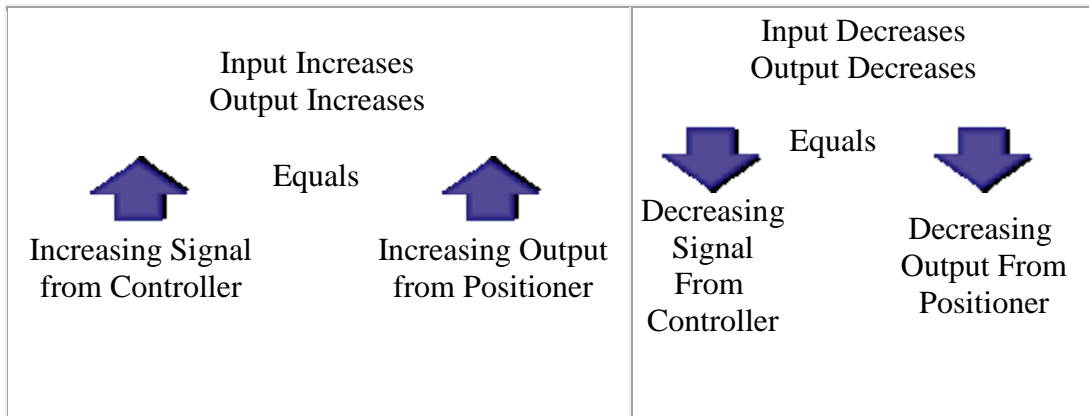

Another reason the direct-acting pneumatic positioner is so popular is that it can be by-passed and the control valve will respond to the input signal from the controller as though the positioner were in the control loop. If a positioner malfunction occurs or if the positioner causes the control valve to become unstable, it can be easily by-passed. Many control valves in the field are operating with a by-passed positioner.

Reverse-acting positioners are sometimes used on control valves, but their appearance is rare. Occasionally one will be found in a split-ranging sequence.

Reverse-Acting Positioner

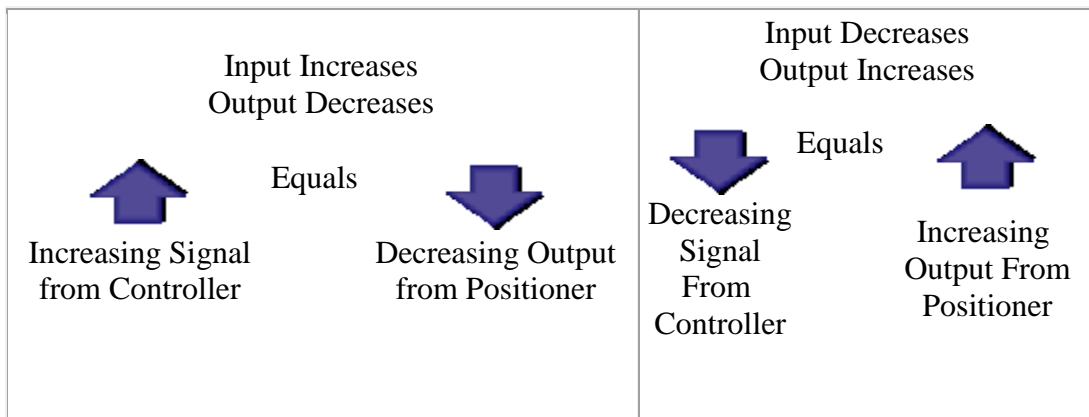

Direct-Acting and Reverse-Acting Controllers

Controllers can be set up in either direct or reverse modes. It was stated that 99% of the positioners are direct acting, and it follows that if a balance is to be maintained in the control loop that **99% of the controllers will be reverse acting**. If the control valve and its controller are not in balance, the control valve will either go to the wide-open position and stay there, or it will stay closed and act as though it is not responding. This situation can normally be corrected by reversing the action of the controller.

Direct-Acting Controller

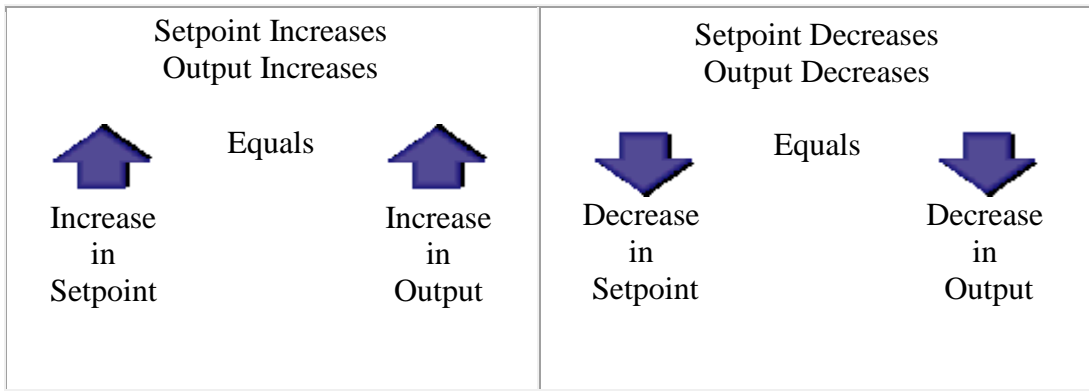

Reverse-Acting Controller

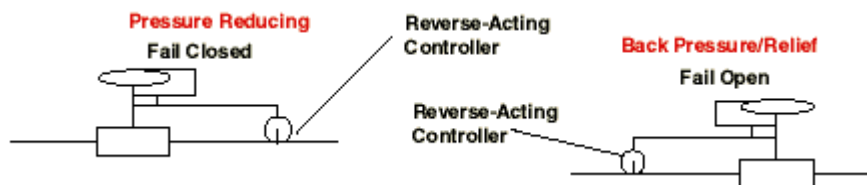
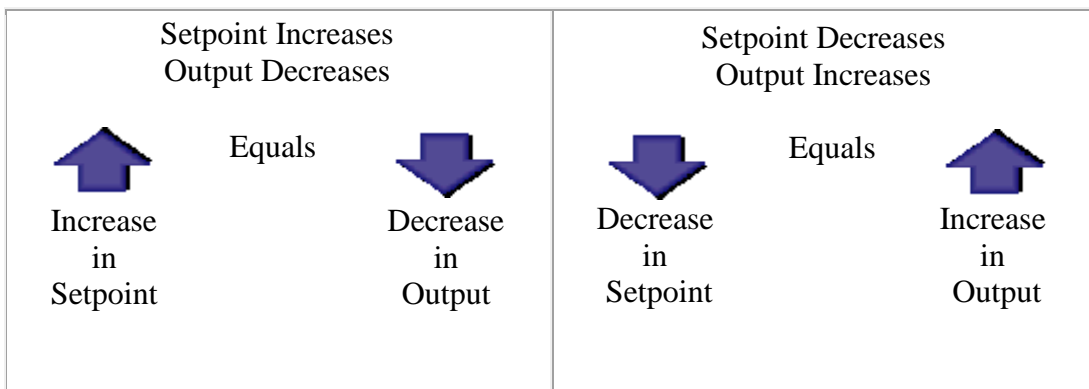

Two of the more common control valve uses are for pressure control. In both instances, the controllers are reverse acting. Most pressure-reducing valves will be fail-closed and most back-pressure control valves will be fail-open. If the pressure-reducing valve were fail-open or the back-pressure valve fail-closed, then the controllers would have been direct acting.

Control Valve "Fail-Safe" Positions

Cause of Fail-Safe Condition: Loss of Air Pressure

A. LINEAR SPRING/DIAPHRAGM ACTUATORS. Used with sliding stem control valves: i.e. globe-style valves. Can be accomplished two ways:

1. Fixed seat ring/plug orientation. Springs are interchanged to either above or below actuator diaphragm.

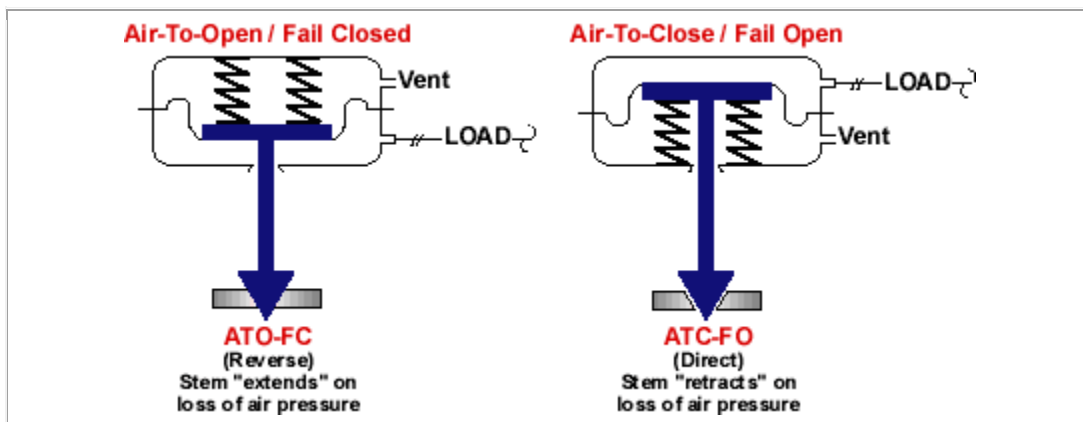

2. Fixed spring orientation. Plug and seat ring positions are reversed relative to each other. In the Fail Open design, plug travel is above the valve seat. In the Fail Closed design, plug travel is below the seat.

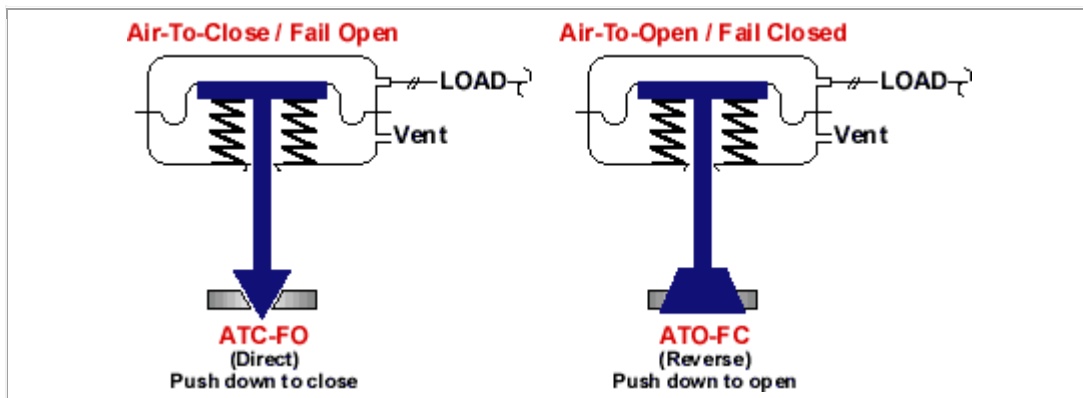

Rotary Spring/Diaphragm Actuators

Used with rotary control valves; i.e. butterfly, eccentric plug. Reversing the fail mode for this type of valve is normally accomplished by reversing the location of lever arm and plug. In order to maintain consistency, ATO-FC action will be considered as "Reverse" action for rotary or sliding-stem control valves.

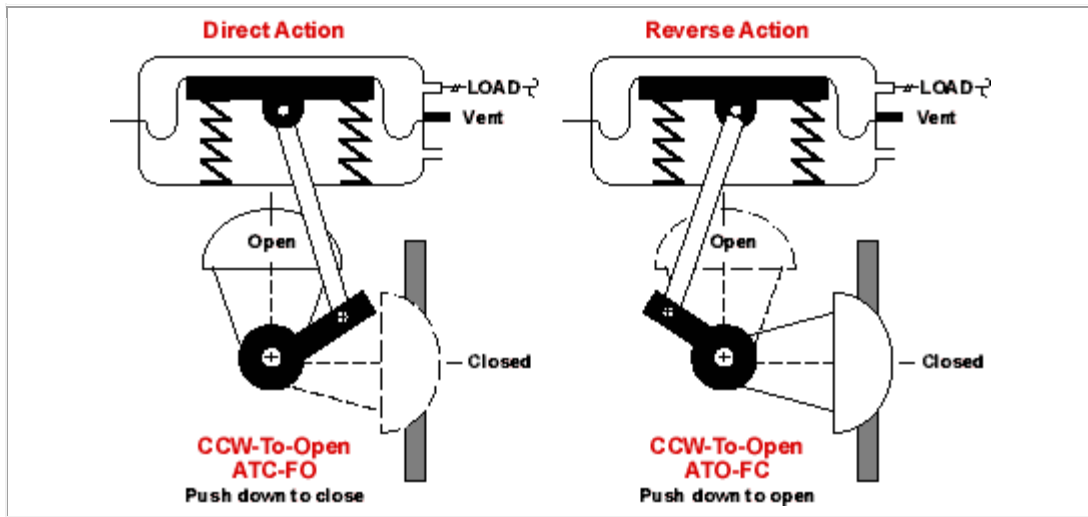

Actuators

Feature Comparison

Spring and Diaphragm

Advantages

- Lowest Cost
- Can Throttle Without a Positioner
- Simplicity
- Inherent Fail-Safe Action
- Low Supply Pressure Required
- Adjustability
- Easily Maintained

Disadvantages

- Limited Output Capability
- Large Size and Weight

Pneumatic Piston

Advantages

- High Torque Capability
- Compact
- Lightweight
- Adaptable to High Ambient Temperature
- Fast Stroking Speed
- Relatively High Actuator Stiffness

Disadvantages

- Fail-Safe Requires Accessories or Addition of Spring
- Positioner Required for Throttling
- Higher Cost
- High Supply Pressure Required

Electric Motor

Advantages

Compactness
Very High Stiffness
High Output Capability

Disadvantages

High Cost
Lack of Fail-Safe Action
Limited Duty Cycle
Slow Stroking Speed

Electrohydraulic

Advantages

High Output Capability
High Actuator Stiffness
Excellent Throttling Ability
Fast Stroking Speed

Disadvantages

High Cost
Complexity and Maintenance Difficulty
Large Size and Weight
Fail-Safe Action Only With Accessories

F₁ - (Flow Recovery Coefficient)

F₁ = The valve pressure recovery factor, a dimension less quantity. (Measured when valve is not choked.)

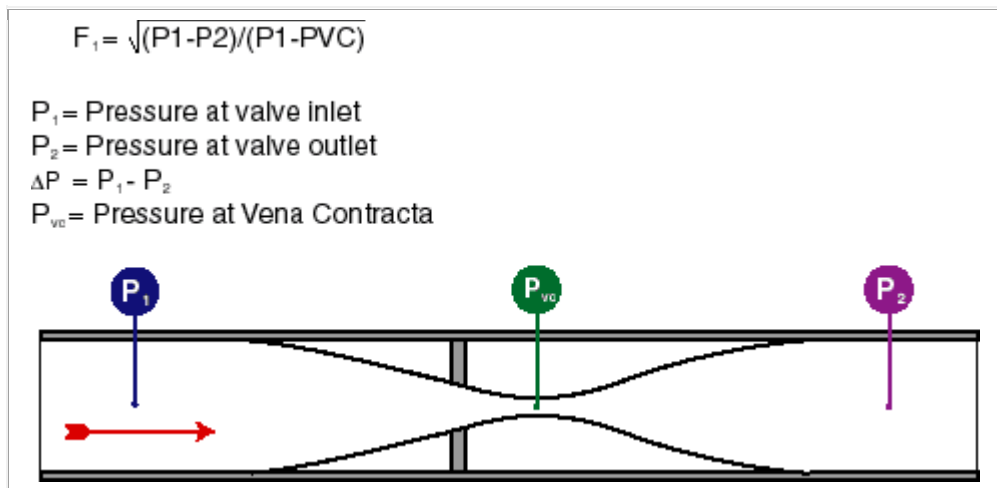

The Vena Contracta is the place along the axis of flow, just beyond the orifice, where the jet stream contracts to its minimum cross-sectional area. **Note:** It is at this point that the velocity is at its highest, and the fluid pressure is at its lowest.

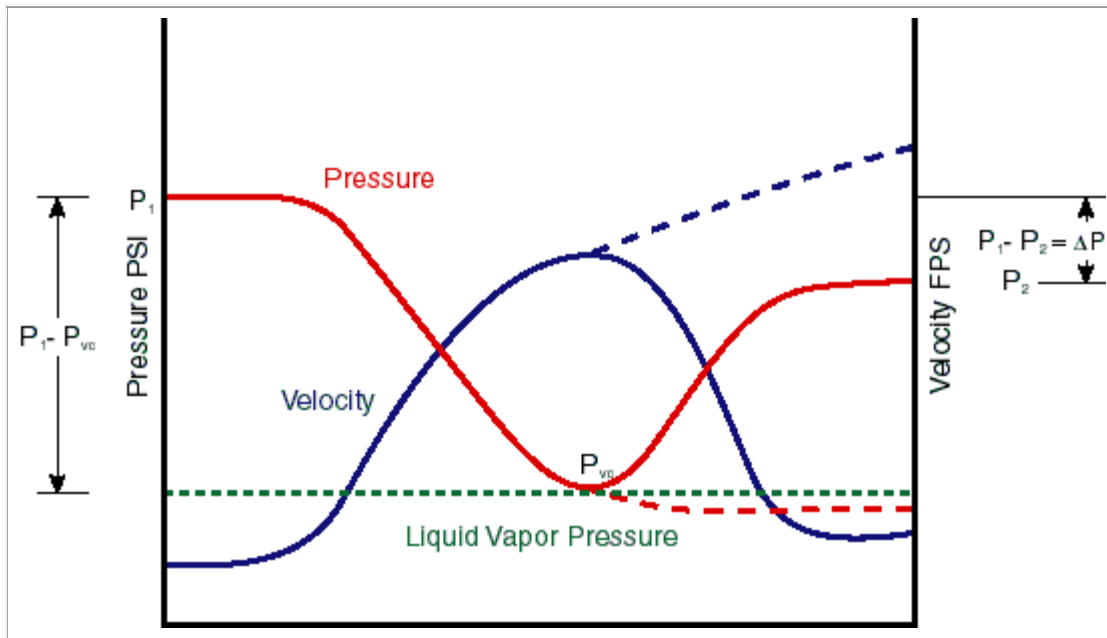

F_1 - Pressure Recovery Factor

LOW-RECOVERY RATE: A valve design that dissipates a considerable amount of flow-stream energy due to turbulence created by the contours of the flow path. Consequently, pressure downstream of the valve vena contracta recovers to a lesser percentage of its inlet value than a valve with a more streamlined flow path. **The F_1 factor does not vary with travel to any significant degree.**

HIGH-RECOVERY RATE: A valve design that dissipates relatively little flow-stream energy due to streamlined internal contours and minimal flow turbulence. Therefore, pressure down stream of the valve vena contracta recovers to a high percentage of its inlet value. **The F_1 factor of a high recovery valve will vary with its plug travel.**

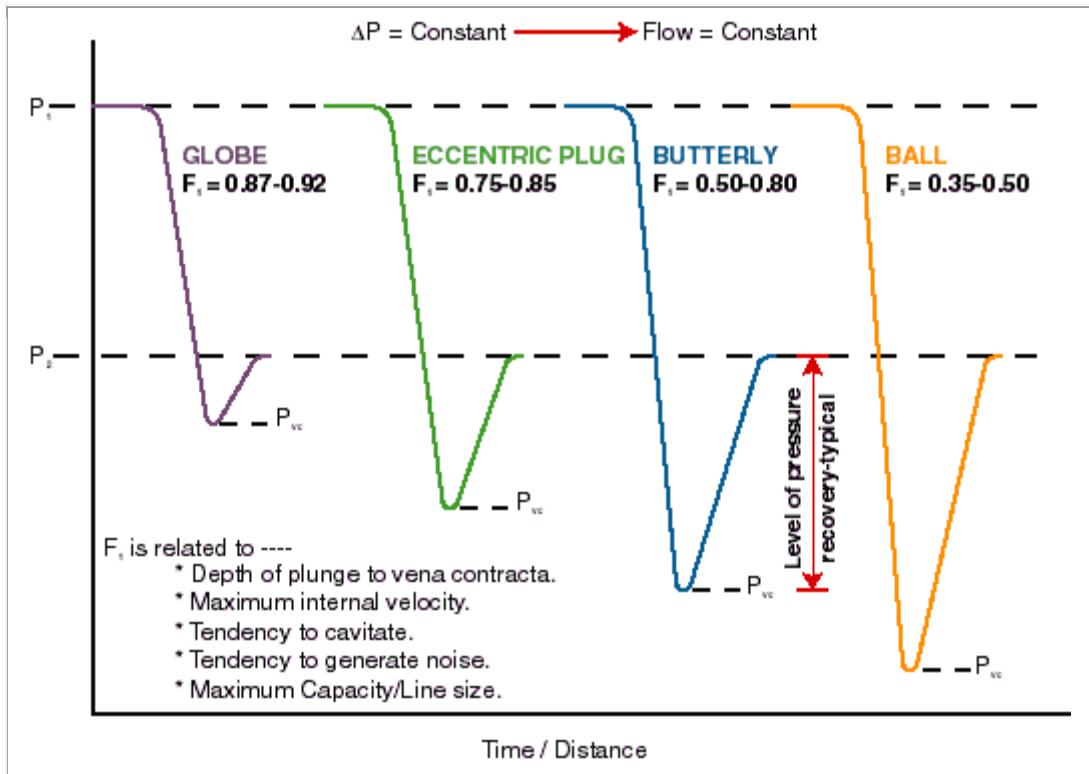

Pressure vs. Temperature for Selected Metals

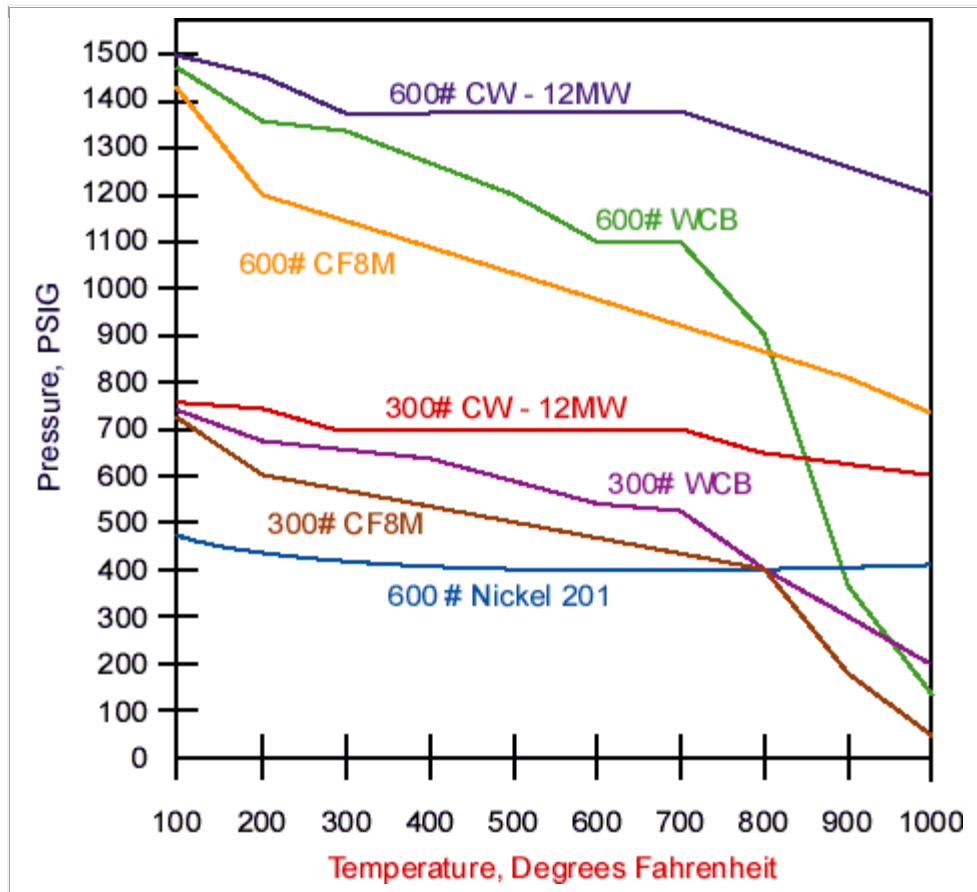

Pressure Products



Model 3051S Series of Instrumentation
The World's First Truly Scalable Measurement Architecture



Model 3051 w/ Foundation Fieldbus
Model 3051 Smart Pressure Transmitter
The World's Most Preferred Transmitter - One Million Units Sold Worldwide!



Model 3095FB Multivariable Transmitter w/Modbus™ Protocol
The Best Solution for Gas Metering!



Model 1151 Pressure Transmitter
Model 1151 Smart Pressure Transmitter
The industry standard for 30 Years



Model 2088 Gage or Absolute Transmitter
Model 2090P Flush Mount Pulp and Paper Transmitter
Model 2090F Tri-Clamp Food and Pharmaceutical Transmitter
Need a Low Cost Pressure Measurement?

Temperature Products



NEW! Model 3144P Smart Temperature Transmitters
The Ultimate Temperature Transmitter for Control and Safety Applications.



Model 3244MV Multivariable Temperature Transmitter with FOUNDATION fieldbus
Among the world's first devices to be registered with the Fieldbus Foundation.



Model 644H and 644R Smart Temperature Transmitters
High Accuracy and Reliability for Control and Safety Applications.



Model 244EH and 244ER Programmable Temperature Transmitters
Low cost transmitter with RTD and Thermocouple inputs for Temperature Monitoring Applications.



Model 144H PC-Programmable Temperature Transmitter
Low cost transmitter with RTD inputs for Temperature Monitoring Applications.



Model 444 Analog Temperature Transmitter
Field Mount Transmitter available with Low-Power and Fast Turn-on Options.

Flow Products

Vortex Flowmeters
Magnetic Flowmeters

Mass Flow Transmitters
Volumetric Insertion
Flowmeter



Model 8800C Smart Vortex Flowmeter
Designed for your toughest applications



Model 8800C Vortex Flowmeter
Now available with FOUNDATION™ fieldbus



Model 3095MV™ Multivariable Mass Flow Transmitter
The Best Solution for Gas and Steam!



Probar Flowmeter
Cost-effective volumetric flow measurements for gas and liquid streams



Proplate and Mass ProPlate Flowmeters
In-line flowmeter systems for ½ to 1½" service applications

Flow Products

Vortex Flowmeters
Magnetic Flowmeters

Mass Flow Transmitters
Volumetric Insertion
Flowmeter



Model 405P Compact Orifice

When a low-cost, reliable solution is required, the Model 405P is the ideal measurement device.



Model 8705 Magnetic Flowtube

Perfect for harsh, corrosive or other difficult to measure substances



Model 8712C/U/H Magnetic Flow Transmitter

Remote mount flow transmitter



Model 8732 Magnetic Flowmeter Transmitter

Obstructionless flow measurement ideal for any conductive fluid.



Coriolis Mass Flowmeters from Micro Motion

High accuracy mass flowmeters