

TI-36X Pro Calculator

Important information	2
Examples	3
Switching the calculator on and off	3
Display contrast	3
Home screen	3
2nd functions	5
Modes	5
Multi-tap keys	8
Menus	8
Scrolling expressions and history	9
Answer toggle	10
Last answer	10
Order of operations	11
Clearing and correcting	13
Fractions	13
Percentages	15
EE key	16
Powers, roots and inverses	17
Pi	18
Math	19
Number functions	20
Angles	21
Rectangular to polar	23
Trigonometry	24
Hyperbolics	26
Logarithm and exponential functions	27
Numeric derivative	27
Numeric integral	29
Stored operations	30
Memory and stored variables	31
Data editor and list formulas	34

Statistics, regressions, and distributions.....	36
Probability.....	48
Function table.....	49
Matrices.....	52
Vectors.....	54
Solvers.....	56
Number bases.....	61
Expression evaluation.....	63
Constants.....	64
Conversions.....	66
Complex numbers.....	69
Errors.....	71
Battery information.....	76
In case of difficulty.....	77
Texas Instruments Support and Service.....	78

Important information

Texas Instruments makes no warranty, either express or implied, including but not limited to any implied warranties of merchantability and fitness for a particular purpose, regarding any programs or book materials and makes such materials available solely on an "as-is" basis. In no event shall Texas Instruments be liable to anyone for special, collateral, incidental, or consequential damages in connection with or arising out of the purchase or use of these materials, and the sole and exclusive liability of Texas Instruments, regardless of the form of action, shall not exceed the purchase price of this product. Moreover, Texas Instruments shall not be liable for any claim of any kind whatsoever against the use of these materials by any other party.

MathPrint, APD, Automatic Power Down and EOS are trademarks of Texas Instruments Incorporated.

Copyright © 2010 Texas Instruments Incorporated

Examples

Each section is followed by instructions for keystroke examples that demonstrate the TI-36X Pro functions.

Examples assume all default settings, as shown in the Modes section.

Some screen elements may differ from those shown in this document.

Switching the calculator on and off

on turns on the calculator. **2nd** **[off]** turns it off. The display is cleared, but the history, settings, and memory are retained.

The APD™ (Automatic Power Down™) feature turns off the calculator automatically if no key is pressed for about 5 minutes. Press **on** after APD. The display, pending operations, settings, and memory are retained.

Display contrast

The brightness and contrast of the display can depend on room lighting, battery freshness, and viewing angle.

To adjust the contrast:

1. Press and release the **2nd** key.
2. Press **+** (to darken the screen) or **-** (to lighten the screen).











Home screen

On the Home screen, you can enter mathematical expressions and functions, along with other instructions. The answers are displayed on the Home screen. The TI-36X Pro screen can display a maximum of four lines with a maximum of 16 characters per line. For entries and expressions of more than 16 characters, you can scroll left and right (**◀** and **▶**) to view the entire entry or expression.

In the MathPrint™ mode, you can enter up to four levels of consecutive nested functions and expressions, which include fractions, square roots, exponents with $^$, $\sqrt[y]{x}$, e^x , and 10^x .

When you calculate an entry on the Home screen, depending upon space, the answer is displayed either directly to the right of the entry or on the right side of the next line.

Special indicators and cursors may display on the screen to provide additional information concerning functions or results.

Indicator	Definition
2ND	2nd function.
FIX	Fixed-decimal setting. (See Mode section.)
SCI, ENG	Scientific or engineering notation. (See Mode section.)
DEG, RAD, GRAD	Angle mode (degrees, radians, or gradians). (See Mode section.)
L1, L2, L3	Displays above the lists in data editor.
H, B, O	Indicates HEX, BIN, or OCT number-base mode. No indicator displayed for default DEC mode.
	The calculator is performing an operation.
	An entry is stored in memory before and/or after the active screen. Press  and  to scroll.
	An entry or menu displays beyond 16 digits. Press  or  to scroll.
	Normal cursor. Shows where the next item you type will appear.
	Entry-limit cursor. No additional characters can be entered.
	Placeholder box for empty MathPrint™ element. Use arrow keys to move into the box.

Indicator	Definition
	MathPrint™ cursor. Continue entering the current MathPrint™ element, or press an arrow key to exit the element.

2nd functions

2nd

Most keys can perform more than one function. The primary function is indicated on the key and the secondary function is displayed above it. Press **2nd** to activate the secondary function of a given key. Notice that **2ND** appears as an indicator on the screen. To cancel it before entering data, press **2nd** again. For example, **2nd** $\sqrt{}$ 25 **enter** calculates the square root of 25 and returns the result, 5.

Modes

mode

Use **mode** to choose modes. Press \downarrow \uparrow \leftarrow \rightarrow to choose a mode, and **enter** to select it. Press **clear** or **2nd** **[quit]** to return to the Home screen and perform your work using the chosen mode settings.

Default settings are highlighted in these sample screens.

```

DEG RAD GRAD
NORM SCI ENG
FLOA 0 123456789
REAL a+bi r∠θ

```

```

DEG HEX BIN OCT
CLASSIC 123456789

```

DEG RAD GRAD Sets the angle mode to degrees, radians, or gradians.

NORM SCI ENG Sets the numeric notation mode. Numeric notation modes affect only the display of results, and not the accuracy of the values stored in the unit, which remain maximal.

NORM displays results with digits to the left and right of the decimal, as in 123456.78.

SCI expresses numbers with one digit to the left of the decimal and the appropriate power of 10, as in 1.2345678E5 (which is the same as 1.2345678×10^5).

ENG displays results as a number from 1 to 999 times 10 to an integer power. The integer power is always a multiple of 3.

Note: \boxed{EE} is a shortcut key to enter a number in scientific notation format. The result displays in the numeric notation format selected in the mode menu.

FLOAT 0 1 2 3 4 5 6 7 8 9 Sets the decimal notation mode.

FLOAT (floating decimal point) displays up to 10 digits, plus the sign and decimal.

0 1 2 3 4 5 6 7 8 9 (fixed decimal point) specifies the number of digits (0 through 9) to display to the right of the decimal.

REAL a+bi r \angle θ Sets the format of complex number results.

REAL real results

a+bi rectangular results

r \angle θ polar results

DEC HEX BIN OCT Sets the number base used for calculations.

DEC decimal

HEX hexadecimal (To enter hex digits A through F, use $\boxed{2nd}$ [A], $\boxed{2nd}$ [B], and so on.)

BIN binary

OCT octal

CLASSIC MATHPRINT

CLASSIC mode displays inputs and outputs in a single line.

MATHPRINT mode displays most inputs and outputs in textbook format.

Examples of Classic and MathPrint™ modes

Classic mode	MathPrint™ mode
<p>Sci</p> <div style="border: 1px solid black; padding: 5px; display: flex; justify-content: space-around;"> 12345 <small>Sci</small> 1.2345E4 <small>Sci</small> </div>	<p>Sci</p> <div style="border: 1px solid black; padding: 5px; display: flex; justify-content: space-around;"> 12345 <small>Sci</small> 1.2345E4 <small>Sci</small> </div>
<p>Float mode and answer toggle key.</p> <div style="border: 1px solid black; padding: 5px; display: flex; justify-content: space-around;"> $\frac{1}{8}$ <small>Ans</small> 0.125 <small>Ans</small> </div>	<p>Float mode and answer toggle key.</p> <div style="border: 1px solid black; padding: 5px; display: flex; justify-content: space-around;"> $\frac{1}{8}$ <small>Ans</small> 0.125 <small>Ans</small> </div>
<p>Fix 2</p> <div style="border: 1px solid black; padding: 5px; display: flex; justify-content: space-around;"> 2π <small>Fix</small> 6.28 <small>Fix</small> </div>	<p>Fix 2 and answer toggle key.</p> <div style="border: 1px solid black; padding: 5px; display: flex; justify-content: space-around;"> 2π <small>Fix</small> 6.28 <small>Fix</small> </div>
<p>U n/d</p> <div style="border: 1px solid black; padding: 5px; display: flex; justify-content: space-around;"> $4\frac{5}{9}$ <small>U n/d</small> $4\frac{5}{9}$ <small>U n/d</small> </div>	<p>U n/d</p> <div style="border: 1px solid black; padding: 5px; display: flex; justify-content: space-around;"> $4\frac{5}{9}$ <small>U n/d</small> $4\frac{5}{9}$ <small>U n/d</small> </div>
<p>Exponent example</p> <div style="border: 1px solid black; padding: 5px; display: flex; justify-content: space-around;"> 2^5 <small>Exp</small> 32 <small>Exp</small> </div>	<p>Exponent example</p> <div style="border: 1px solid black; padding: 5px; display: flex; justify-content: space-around;"> 2^5 <small>Exp</small> 32 <small>Exp</small> </div>
<p>Square root example</p> <div style="border: 1px solid black; padding: 5px; display: flex; justify-content: space-around;"> $\sqrt{2}$ <small>Sqrt</small> 1.414213562 <small>Sqrt</small> </div>	<p>Square root example</p> <div style="border: 1px solid black; padding: 5px; display: flex; justify-content: space-around;"> $\sqrt{2}$ <small>Sqrt</small> 1.414213562 <small>Sqrt</small> </div>
<p>Cube root example</p> <div style="border: 1px solid black; padding: 5px; display: flex; justify-content: space-around;"> $\sqrt[3]{64}$ <small>Cbrt</small> 4 <small>Cbrt</small> </div>	<p>Cube root example</p> <div style="border: 1px solid black; padding: 5px; display: flex; justify-content: space-around;"> $\sqrt[3]{64}$ <small>Cbrt</small> 4 <small>Cbrt</small> </div>

Multi-tap keys

A multi-tap key is one that cycles through multiple functions when you press it.

For example, the $\left[\begin{smallmatrix} \sin \\ \sin^{-1} \end{smallmatrix} \right]$ key contains the trigonometry functions **sin** and **sin⁻¹** as well as the hyperbolic functions **sinh** and **sinh⁻¹**. Press the key repeatedly to display the function that you want to enter.

Multi-tap keys include $\left[\begin{smallmatrix} x^y \\ a b c d \end{smallmatrix} \right]$, $\left[\begin{smallmatrix} \sin \\ \sin^{-1} \end{smallmatrix} \right]$, $\left[\begin{smallmatrix} \cos \\ \cos^{-1} \end{smallmatrix} \right]$, $\left[\begin{smallmatrix} \tan \\ \tan^{-1} \end{smallmatrix} \right]$, $\left[e^{\square} 10^{\square} \right]$, $\left[\ln \log \right]$, $\left[\begin{smallmatrix} nCr \\ nPr \end{smallmatrix} \right]$, and $\left[\begin{smallmatrix} \pi \\ e \\ i \end{smallmatrix} \right]$. Applicable sections of this guidebook describe how to use the keys.

Menus

Menus give you access to a large number of calculator functions. Some menu keys, such as $\left[2^{nd} \right]$ [recall], display a single menu. Others, such as $\left[\text{math} \right]$, display multiple menus.

Press \blacktriangleright and \blacktriangleleft to scroll and select a menu item, or press the corresponding number next to the item. To return to the previous screen without selecting the item, press $\left[\text{clear} \right]$. To exit a menu and return to the Home screen, press $\left[2^{nd} \right]$ [quit].

$\left[2^{nd} \right]$ [recall] (key with a single menu):

RECALL VAR (with values set to default of 0)

1: x = 0

2: y = 0

3: z = 0

4: t = 0

5: a = 0

6: b = 0

7: c = 0

8: d = 0

math (key with multiple menus):

MATH	NUM	DMS	R \leftrightarrow P
1: $\blacktriangleright^n/d \leftrightarrow U^n/d$	1: abs(1: $^\circ$	1: P \blacktriangleright Rx(
2: lcm(2: round(2: ' (prime)	2: P \blacktriangleright Ry(
3: gcd(3: iPart(3: " (degrees)	3: R \blacktriangleright Pr(
4: \blacktriangleright Pfactor	4: fPart(4: r (radians)	4: R \blacktriangleright P θ (
5: sum(5: int(5: g (gravity)	
6: prod(6: min(6: \blacktriangleright DMS	
	7: max(
	8: mod(

Scrolling expressions and history

\leftarrow \rightarrow \uparrow \downarrow

Press \leftarrow or \rightarrow to move the cursor within an expression that you are entering or editing. Press **2nd** \leftarrow or **2nd** \rightarrow to move the cursor directly to the beginning or end of the expression.

After you evaluate an expression, the expression and its result are added automatically to the history. Use \uparrow and \downarrow to scroll through the history. You can reuse a previous entry by pressing **enter** to paste it on the bottom line, where you can edit it and evaluate a new expression.

Example

Scroll	7 x^2 - 4 (3) (1) enter	$7^2-4(3)(1)$ \approx 37
	2nd $\sqrt{}$ \uparrow \uparrow enter enter	$7^2-4(3)(1)$ \approx 37 $\sqrt{7^2-4(3)(1)}$ $\sqrt{37}$
	$\leftarrow \approx$	$7^2-4(3)(1)$ \approx 37 $\sqrt{7^2-4(3)(1)}$ $\sqrt{37}$ $\sqrt{37}$ \approx 6.08276253





Answer toggle



Press the  key to toggle the display result (when possible) between fraction and decimal answers, exact square root and decimal, and exact pi and decimal.

Pressing  displays the last result in the full precision of its stored value, which may not match the rounded value.

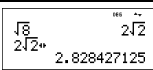

Example

Answer toggle	  8 	
		





Last answer



The last entry performed on the home screen is stored to the variable **ans**. This variable is retained in memory, even after the calculator is turned off. To recall the value of **ans**:

- Press  (**ans** displays on the screen), or
- Press any operations key (, , and so forth) as the first part of an entry. **ans** and the operator are both displayed.

Examples

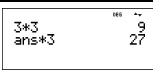
ans	3  3 	
	 3 	

7th	Permutations (nPr) and combinations (nCr).
8th	Multiplication, implied multiplication, division.
9th	Addition and subtraction.
10th	Conversions (n/d ↔ Un/d , F ↔ D , DMS).
11th	enter completes all operations and closes all open parentheses.

Examples

+ × ÷ -	6 0 + 5 × (-) 1 2 enter	$60+5*-12$ ≈ 0
(-)	1 + (-) 8 + 1 2 enter	$1+-8+12$ ≈ 5
	2nd [$\sqrt{}$] 9 + 1 6 enter	$\sqrt{9+16}$ ≈ 5
()	4 × (2 + 3) enter	$4*(2+3)$ ≈ 20
	4 (2 + 3) enter	$4(2+3)$ ≈ 20
^ and $\sqrt{}$	2nd [$\sqrt{}$] 3 x^{\square} 2 \blacktriangleright + 4 x^{\square} 2 enter	$\sqrt{3^2+4^2}$ ≈ 5

Clearing and correcting

$\boxed{2\text{nd}} \boxed{\text{quit}}$	Returns to the Home screen.
$\boxed{\text{clear}}$	Clears an error message. Clears characters on entry line. Moves the cursor to last entry in history once display is clear.
$\boxed{\text{delete}}$	Deletes the character at the cursor.
$\boxed{2\text{nd}} \boxed{\text{insert}}$	Inserts a character at the cursor.
$\boxed{2\text{nd}} \boxed{\text{clear var}}$	Clears variables x , y , z , t , a , b , c , and d to their default value of 0.
$\boxed{2\text{nd}} \boxed{\text{reset}} \mathbf{2}$	Resets the calculator. Returns unit to default settings; clears memory variables, pending operations, all entries in history, and statistical data; clears any stored operation, and ans .

Fractions

$\boxed{\frac{\square}{\square}}$ $\boxed{2\text{nd}} \boxed{\square \frac{\square}{\square}}$ $\boxed{\text{math}} \mathbf{1}$ $\boxed{2\text{nd}} \boxed{\text{f}\leftrightarrow\text{d}}$

In the MathPrint™ mode, fractions with $\boxed{\frac{\square}{\square}}$ can include real and complex numbers, operation keys ($\boxed{+}$, $\boxed{\times}$, etc.), and most function keys ($\boxed{x^2}$, $\boxed{2\text{nd}} \boxed{\%}$, etc.).

In Classic mode, fractions with $\boxed{\frac{\square}{\square}}$ do not allow operation keys, functions, or complex fractions in the numerator or denominator.

Note: In Classic mode, only number entries are supported when using $\boxed{\frac{\square}{\square}}$. Fractions in Classic mode are shown with a double-thick fraction bar (for example, $\frac{8}{9}$). The numerator must be an integer, and the denominator must be a positive integer. To compute more complex expressions (functions, variables, complex numbers, etc.), use $\boxed{\div}$ along with $\boxed{(}$ and $\boxed{)}$.

The calculator defaults output to improper fractions. Results are automatically simplified.

- $\left[\frac{\square}{\square}\right]$ enters a simple fraction. Pressing $\left[\frac{\square}{\square}\right]$ before or after a number can result in different behavior. Entering a number before pressing $\left[\frac{\square}{\square}\right]$ makes that number the numerator. To enter fractions with operators or radicals, press $\left[\frac{\square}{\square}\right]$ before you enter a number (in MathPrint™ mode only).
- In MathPrint™ mode, press \odot between the entry of the numerator and the denominator.
- In Classic mode, press $\left[\frac{\square}{\square}\right]$ between the entry of the numerator and the denominator. The fraction bar will appear thicker than the division bar.
- Pressing $\left[2^{nd}\right] \left[\uparrow\right]$ from any MathPrint™ level, including the denominator or a lower limit, places the cursor in the history. Pressing enter will then paste the expression back to that MathPrint™ level.
 - To paste a previous entry in the denominator, place the cursor in the denominator, press $\left[2^{nd}\right] \left[\uparrow\right]$ to scroll to the desired entry, and then press $\left[enter\right]$ to paste the entry to the denominator.
 - To paste a previous entry in the numerator or unit, place the cursor in the numerator or unit, press $\left[\uparrow\right]$ or $\left[2^{nd}\right] \left[\uparrow\right]$ to scroll to the desired entry, and then press $\left[enter\right]$ to paste the entry to the numerator or unit.
- $\left[2^{nd}\right] \left[\square\frac{\square}{\square}\right]$ enters a mixed number. Press the arrow keys to cycle through the unit, numerator, and denominator.
- $\left[math\right] 1$ converts between simple fractions and mixed-number form ($\blacktriangleright^n/d \leftrightarrow U^n/d$).
- $\left[2^{nd}\right] \left[f \leftrightarrow d\right]$ converts results between fractions and decimals.

Examples Classic mode

$n/d, U^n/d$	$3 \left[\frac{\square}{\square}\right] 4 \left[+\right] 1 \left[2^{nd}\right] \left[\square\frac{\square}{\square}\right] 7$ $\left[\frac{\square}{\square}\right] 12 \left[enter\right]$	$3/4+1\frac{7}{12}$ $\frac{166}{12}$ $\frac{7}{3}$
$n/d \leftrightarrow U^n/d$	$9 \left[\frac{\square}{\square}\right] 2 \left[math\right] 1 \left[enter\right]$	$9/2 \leftrightarrow 4\frac{1}{2}$ $\frac{166}{2}$

F \leftrightarrow D	4 $\frac{\square}{\square}$ 1 $\frac{\square}{\square}$ 2 2nd [f \leftrightarrow d] enter	$4\frac{1}{2}$ f \leftrightarrow d 4.5
-----------------------	--	--

Examples MathPrint™ mode

n/d, U n/d	$\frac{\square}{\square}$ 3 \downarrow 4 \rightarrow + 1 2nd $\frac{\square}{\square}$ 7 \downarrow 12 enter	$\frac{3}{4} + 1\frac{7}{12}$ $\frac{23}{12}$
$\frac{n}{d} \leftrightarrow U\frac{n}{d}$	9 $\frac{\square}{\square}$ 2 \rightarrow math 1 enter	$9\frac{2}{10} \leftrightarrow U\%$ $4\frac{1}{2}$
F \leftrightarrow D	4 $\frac{\square}{\square}$ 1 \downarrow 2 \rightarrow 2nd [f \leftrightarrow d] enter	$4\frac{1}{2}$ f \leftrightarrow d 4.5
Examples (MathPrint™ mode only)	$\frac{\square}{\square}$ 1.2 + 1.3 \downarrow 4 enter	$\frac{1.2+1.3}{4}$ 0.625
(MathPrint™ mode only)	$\frac{\square}{\square}$ (-) 5 + 2nd [$\sqrt{\square}$] 5 x ² - 4 (1) (6) \downarrow 2 (1) enter	$\frac{-5 + \sqrt{5^2 - 4(1)(6)}}{2(1)}$ -2

Percentages

2nd [%]

To perform a calculation involving a percentage, press 2nd [%] after entering the value of the percentage.

Example

2 2nd [%] \times 150 enter	2%*150 3
------------------------------	----------

Problem

A mining company extracts 5000 tons of ore with a concentration of metal of 3% and 7300 tons with a concentration of 2.3%. On the basis of these two extraction figures, what is the total quantity of metal obtained?

If one ton of metal is worth 280 dollars, what is the total value of the metal extracted?

3 [2nd] [%] [×] 5000 [enter]	$3\% \times 5000$ 150
+ 2.3 [2nd] [%] [×] 7300 [enter]	$3\% \times 5000$ 150 $\text{Ans} + 2.3\% \times 7300$ 317.9
[×] 280 [enter]	$3\% \times 5000$ 150 $\text{Ans} + 2.3\% \times 7300$ 317.9 $\text{Ans} \times 280$ 89012

The two extractions represent a total of 317.9 tons of metal for a total value of 89012 dollars.

EE key

[EE]

[EE] is a shortcut key to enter a number in scientific notation format.

Example

2 [EE] 5 [enter]	2×10^5 200000
[mode] [↓] [→] [enter]	MODE RAD GRAD NORMAL SCI ENG 0 1 2 3 4 5 6 7 8 9 REAL a+bi r∠θ ↓
[clear] [enter]	2×10^5 200000 2×10^5 2E5

Powers, roots and inverses

x^2	Calculates the square of a value. The TI-36X Pro calculator evaluates expressions entered with x^2 and $\left[\frac{1}{\square}\right]$ from left to right in both Classic and MathPrint™ modes.
x^\square	Raises a value to the power indicated. Use \blacktriangleright to move the cursor out of the power.
2^{nd} $\left[\sqrt{}$	Calculates the square root of a non-negative value.
2^{nd} $\left[\sqrt[n]{}\right]$	Calculates the n th root of any non-negative value and any odd integer root of a negative value.
$\left[\frac{1}{\square}\right]$	Gives the inverse of a value: $1/x$. The calculator evaluates expressions entered with x^2 and $\left[\frac{1}{\square}\right]$ from left to right in both Classic and MathPrint™ modes.

Examples

mode \blacktriangledown enter clear 5 x^2 $+$ 4 x^\square 2 $+$ 1 \blacktriangleright enter	5^2+4^2+1 Ans \rightarrow 89
10 x^\square $(-)$ 2 enter	10^{-2} Ans \rightarrow $\frac{1}{100}$
2^{nd} $\left[\sqrt{}\right]$ 49 enter	$\sqrt{49}$ Ans \rightarrow 7
2^{nd} $\left[\sqrt[n]{}\right]$ 3 x^2 $+$ 2 x^\square 4 enter	$\sqrt{3^2+2^4}$ Ans \rightarrow 5
6 2^{nd} $\left[\sqrt[n]{}\right]$ 64 enter	$6\sqrt{64}$ Ans \rightarrow 2

2 $\frac{1}{\square}$ $\frac{1}{\square}$ enter	$\frac{1}{2}$ $\frac{1}{2}$
---	-----------------------------

π

π (multi-tap key)

$\pi = 3.141592653590$ for calculations.

$\pi = 3.141592654$ for display.

Example

π	2 \times π enter	$2 * \pi$ 2π
	$\leftarrow \rightarrow \approx$	$2 * \pi$ $2\pi \approx 6.283185307$

Problem

What is the area of a circle if the radius is 12 cm?

Reminder: $A = \pi r^2$

π \times 12 x^2 enter $\leftarrow \rightarrow \approx$	$\pi * 12^2$ 144π 452.3893421
---	-------------------------------------

The area of the circle is 144π square cm. The area of the circle is approximately 452.4 square cm when rounded to one decimal place.

Math

math MATH

math displays the **MATH** menu:

- 1: $\rightarrow^n/d \leftrightarrow U^n/d$ Converts between simple fractions and mixed-number form.
- 2: lcm(Least common multiple
- 3: gcd(Greatest common divisor
- 4: \rightarrow Pfactor Prime factors
- 5: sum(Summation
- 6: prod(Product

Examples

$\rightarrow^n/d \leftrightarrow U^n/d$	9 $\frac{\square}{\square}$ 2 \rightarrow math 1 enter	$\frac{9}{2} \rightarrow \% + U\%$ $4 \frac{1}{2}$
lcm(math 2 6 2nd [,] 9 \square enter	lcm(6,9) 18
gcd(math 3 18 2nd [,] 33 \square enter	gcd(18,33) 3
\rightarrow Pfactor	253 math 4 enter	253 \rightarrow Pfactor $11 * 23$
sum(math 5 1 \rightarrow 4 \rightarrow $x^y z^t$ \times 2 enter	$\sum_{x=1}^4 (x*2)$ 20
prod(math 6 1 \rightarrow 5 \rightarrow 1 $\frac{\square}{\square}$ $x^y z^t$ \rightarrow \rightarrow enter	$\prod_{x=1}^5 \left(\frac{1}{x}\right)$ $\frac{1}{120}$

Number functions

math **NUM**

math **▶** displays the **NUM** menu:

- 1: abs(Absolute value
- 2: round(Rounded value
- 3: iPart(Integer part of a number
- 4: fPart(Fractional part of a number
- 5: int(Greatest integer that is \leq the number
- 6: min(Minimum of two numbers
- 7: max(Maximum of two numbers
- 8: mod(Modulo (remainder of first number \div second number)

Examples

abs(math ▶ 1 (-) 2nd [√] 5 enter	$ \sqrt{5} $ $\sqrt{5}$
round(math ▶ 2 1.245 2nd [,] 1) enter ↶ ↷ enter ↶ ↶ ↶ ↶ ↶ 5 enter	round(1.245,1) 1.2 round(1.255,1) 1.3
iPart(fPart(4.9 sto→ x^{yzt} $abcd$ enter math ▶ 3 x^{yzt} $abcd$) enter math ▶ 4 x^{yzt} $abcd$) × 3 enter	4.9 \rightarrow x 4.9 iPart(x) 4 fPart(x)*3 2.7
int(math ▶ 5 (-) 5.6) enter	int(-5.6) -6
min(max(math ▶ 6 4 2nd [,] (-) 5) enter math ▶ 7 .6 2nd [,] .7) enter	min(4, -5) -5 max(.6, .7) 0.7

mod($\boxed{\text{math}}$ \rightarrow 8 17 $\boxed{\text{2nd}}$ $\boxed{[,]}$ 12 $\boxed{)}$ $\boxed{\text{enter}}$ \leftarrow \leftarrow $\boxed{\text{enter}}$ \leftarrow \leftarrow 6 $\boxed{\text{enter}}$	$\overset{\text{DEC}}{\text{mod}}(17, 12)$ 5 $\overset{\text{DEC}}{\text{mod}}(17, 16)$ 1
------	---	--

Angles

$\boxed{\text{math}}$ **DMS**

$\boxed{\text{math}}$ \rightarrow \rightarrow displays the **DMS** menu:

- 1: $^{\circ}$ Specifies the angle unit modifier as degrees ($^{\circ}$).
- 2: $'$ Specifies the angle unit modifier as minutes ($'$).
- 3: $''$ Specifies the angle unit modifier as seconds ($''$).
- 4: r Specifies a radian angle.
- 5: g Specifies a gradian angle.
- 6: \rightarrow DMS Converts angle from decimal degrees to degrees, minutes, and seconds.

You can also convert between rectangular coordinate form (R) and polar coordinate form (P). (See Rectangular to polar for more information.)

Choose an angle mode from the mode screen. You can choose from DEG (default), RAD, or GRAD. Entries are interpreted and results displayed according to the angle mode setting without needing to enter an angle unit modifier.

Examples

RAD	$\boxed{\text{mode}}$ \rightarrow $\boxed{\text{enter}}$	$\overset{\text{DEC}}{\text{DEG}}$ \leftarrow $\overset{\text{DEC}}{\text{GRAD}}$ $\overset{\text{DEC}}{\text{MODE}}$ \leftarrow $\overset{\text{DEC}}{\text{SCI}}$ \leftarrow $\overset{\text{DEC}}{\text{ENG}}$ $\overset{\text{DEC}}{\text{FLOOR}}$ 0 1 2 3 4 5 6 7 8 9 $\overset{\text{DEC}}{\text{REAL}}$ a+bi r \angle θ
	$\boxed{\text{clear}}$ $\boxed{\sin^{-1}}$ 30 $\boxed{\text{math}}$ \rightarrow \rightarrow	$\overset{\text{DEC}}{\text{MATH}}$ \leftarrow $\overset{\text{DEC}}{\text{NUM}}$ \leftarrow $\overset{\text{DEC}}{\text{DMS}}$ \leftarrow $\overset{\text{DEC}}{\text{R+P}}$ $\overset{\text{DEC}}{\text{1}}$ \leftarrow $\overset{\text{DEC}}{\text{2}}$ \leftarrow $\overset{\text{DEC}}{\text{3}}$ \leftarrow $\overset{\text{DEC}}{\text{4}}$
	1 $\boxed{)}$ $\boxed{\text{enter}}$	$\overset{\text{DEC}}{\text{sin}}(30^{\circ})$ $\frac{1}{2}$

DEG	mode enter	<pre> DEG RAD GRAD NORM SCI ENG FLOAT 0 1 2 3 4 5 6 7 8 9 REAL a+b i r^2θ </pre>
	clear 2 π e i math ▶▶ 4 enter	<pre> sin(30°) 2πr 360 </pre>
▶DMS	1.5 math ▶▶ 6 enter	<pre> sin(30°) 2πr 360 1.5▶DMS 1°30'0" </pre>

Problem

Two adjacent angles measure $12^\circ 31' 45''$ and $26^\circ 54' 38''$ respectively. Add the two angles and display the result in DMS format. Round the results to two decimal places.

clear mode ▼▼▶▶▶▶ enter	<pre> DEG RAD GRAD NORM SCI ENG FLOAT 0 1 2 3 4 5 6 7 8 9 REAL a+b i r^2θ </pre>
clear 12 math ▶▶	<pre> MATH NUM 0000 R+P 12° 2: 3↓ </pre>
1 31 math ▶▶ 2 45 math ▶▶ 3 + 26 math ▶▶ 1 54 math ▶▶ 2 38 math ▶▶ 3 enter	<pre> 12°31'45"+26°54▶ 39.44 </pre>
math ▶▶ 6 enter	<pre> 12°31'45"+26°54▶ ans▶DMS 39.44 39°26'23" </pre>

The result is 39 degrees, 26 minutes and 23 seconds.

Problem

It is known that $30^\circ = \pi / 6$ radians. In the default mode, degrees, find the sine of 30° . Then set the calculator to radian mode and calculate the sine of $\pi / 6$ radians.

Note: Press **clear** to clear the screen between problems.

clear \sin^{-1} 30) enter	$\sin(30)$
mode ▶ enter clear \sin^{-1} π $\frac{\pi}{i}$ $\frac{\square}{\square}$ 6 ▶) enter	$\sin(30)$ $\frac{1}{2}$ $\sin(\frac{\pi}{6})$ $\frac{1}{2}$

Retain radian mode on the calculator and calculate the sine of 30° . Change the calculator to degree mode and find the sine of $\pi / 6$ radians.

\sin^{-1} 30 math ▶ ▶ enter) enter mode enter clear \sin^{-1} π $\frac{\pi}{i}$ $\frac{\square}{\square}$ 6 ▶ math ▶ ▶ 4) enter	$\sin(30^\circ)$ $\frac{1}{2}$ $\sin(\frac{\pi}{6})$ $\frac{1}{2}$
---	---

Rectangular to polar

math **R↔P**

math **Ⓢ** displays the **R↔P** menu, which has functions for converting coordinates between rectangular (x,y) and polar (r,θ) format. Set Angle mode, as necessary, before starting calculations.

- 1: P ▶ Rx(Converts polar to rectangular and displays x.
- 2: P ▶ Ry(Converts polar to rectangular and displays y.
- 3: R ▶ Pr(Converts rectangular to polar and displays r.
- 4: R ▶ Pθ(Converts rectangular to polar and displays θ.

Example

Convert polar coordinates (r, θ)=(5, 30) into rectangular coordinates. Then convert rectangular coordinates (x, y) = (3, 4) into polar coordinates. Round the results to one decimal place.

R↔P	clear mode ◀ ◀ ▶ ▶ enter	$\frac{\square}{\square}$ DEG RAD GRAD $\frac{\square}{\square}$ NOR SCI ENG FLOAT 0 23456789 REAL a+bi r∠θ
------------	--	--

<p>clear math \downarrow 1 5 [2nd] [,] 30) enter math \downarrow 2 5 [2nd] [,] 30) enter</p>	
<p>math \downarrow 3 3 [2nd] [,] 4) enter math \downarrow 4 3 [2nd] [,] 4) enter</p>	

Converting $(r, \theta) = (5, 30)$ gives $(x, y) = (4.3, 2.5)$ and $(x, y) = (3, 4)$ gives $(r, \theta) = (5.0, 53.1)$.

Trigonometry

\sin^{-1} \cos^{-1} \tan^{-1} (multi-tap keys)

Enter trigonometric functions (\sin , \cos , \tan , \sin^{-1} , \cos^{-1} , \tan^{-1}), just as you would write them. Set the desired Angle mode before starting trigonometric calculations.

Example Degree Mode

tan	<p>mode \downarrow \downarrow enter clear \tan^{-1} 45) enter</p>	
\tan^{-1}	<p>clear \tan^{-1} \tan^{-1} 1) enter</p>	
cos	<p>clear 5 [x] \cos^{-1} 60) enter</p>	

Example Radian Mode

tan	<p>mode \rightarrow enter clear \tan^{-1} π \div 4 \rightarrow) enter</p>	
-----	---	--

\tan^{-1}	clear tan tan^{-1} 1 $)$ enter	$\tan^{-1}(1)$ 0.785398163
	$\leftarrow \approx$	0.785398163 0.7853981633975+ $\frac{\pi}{4}$
COS	clear 5 \times cos cos^{-1} π \div 4 \rightarrow $)$ enter	$5 \cdot \cos\left(\frac{\pi}{4}\right)$ $\frac{5\sqrt{2}}{2}$
	$\leftarrow \approx$	$\frac{5\sqrt{2}}{2}$ 3.535533906

Problem

Find angle A of the right triangle below. Then calculate angle B and the length of the hypotenuse c. Lengths are in meters. Round results to one decimal place.

Reminder:

$$\tan A = \frac{7}{3} \text{ therefore } m\angle A = \tan^{-1}\left(\frac{7}{3}\right)$$

$$m\angle A + m\angle B + 90^\circ = 180^\circ$$

$$\text{therefore } m\angle B = 90^\circ - m\angle A$$

$$c = \sqrt{3^2 + 7^2}$$

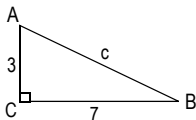

mode enter \downarrow \downarrow \rightarrow \rightarrow enter	MODE RAD GRAD NORMAL SCI ENG FLOAT 0 23456789 REG a+bi rZ8 ↓
clear tan tan^{-1} 7 \div 3 \rightarrow $)$ enter	$\tan^{-1}\left(\frac{7}{3}\right)$ 66.8

90 \ominus 2nd [answer] enter	$\tan^{-1}\left(\frac{7}{3}\right)$ 66.8 90-ans 23.2
2nd $\sqrt{}$ 3 x^2 + 7 x^2 enter	90-ans 23.2 $\sqrt{3^2+7^2}$ $\sqrt{58}$
$\leftrightarrow \approx$	90-ans 23.2 $\sqrt{3^2+7^2}$ $\sqrt{58}$ $\sqrt{58}^{\circ}$ 7.6

To one decimal place, the measure of angle A is 66.8° , the measure of angle B is 23.2° , and the length of the hypotenuse is 7.6 meters.

Hyperbolics

\sin \cos \tan (multi-tap keys)

Pressing one of these multi-tap keys repeatedly lets you access the corresponding hyperbolic or inverse hyperbolic function. Angle modes do not affect hyperbolic calculations.

Example

Set floating decimal	mode \downarrow \downarrow enter	
HYP	clear \sin \sin^{-1} \sin \sin^{-1} \sin \sin^{-1} 5) + 2 enter	$\sinh(5)+2$ 76.20321058
	\uparrow \uparrow enter 2nd \downarrow \sin \sin^{-1} \sin \sin^{-1} \sin \sin^{-1} enter	$\sinh(5)+2$ 76.20321058 $\sinh^{-1}(5)+2$ 4.312438341

Logarithm and exponential functions

\ln \log e^{\square} 10^{\square} (multi-tap keys)

\ln \log yields the logarithm of a number to the base e ($e \approx 2.718281828459$).

\ln \log \ln \log yields the common logarithm of a number.

e^{\square} 10^{\square} raises e to the power you specify.

e^{\square} 10^{\square} e^{\square} 10^{\square} raises 10 to the power you specify.

Examples

LOG	\ln \log \ln \log 1 \rightarrow enter	$\log(1)$ 000 $^{\sim}$ 0
LN	\ln \log 5 \rightarrow \times 2 enter	$\log(1)$ 000 $^{\sim}$ 0 $\ln(5)*2$ 3.218875825
10^{\square}	clear e^{\square} 10^{\square} e^{\square} 10^{\square} \ln \log \ln \log 2 \rightarrow enter \ln \log \ln \log e^{\square} 10^{\square} e^{\square} 10^{\square} 5 \rightarrow \rightarrow enter	$10^{\log(2)}$ 000 $^{\sim}$ 2 $\log(10^5)$ 000 $^{\sim}$ 5
e^{\square}	clear e^{\square} 10^{\square} .5 enter	$e^{.5}$ 000 $^{\sim}$ 1.648721271

Numeric derivative

2^{nd} $[d/dx]$

2^{nd} $[d/dx]$ calculates an approximate derivative of *expression* with respect to *variable*, given the *value* at which to calculate the derivative and ϵ (if not specified, the default is $1\text{E-}3$). This function is valid only for real numbers.

Example in MathPrint™ mode

$\boxed{2\text{nd}} \boxed{[d/dx\]}$ $\boxed{x^{yzt}} \boxed{abcd} \boxed{x^2} \boxed{+} \boxed{5} \boxed{x^{yzt}} \boxed{abcd} \boxed{\rightarrow} \boxed{\rightarrow}$ $\boxed{(-)} \boxed{1} \boxed{\text{enter}}$	$\frac{d}{dx}(x^2+5x) \Big _{x=-1} \approx 3$
--	---

Example in Classic mode

Classic: **nDeriv**(*expression, variable, value*[, ϵ])

$\boxed{2\text{nd}} \boxed{[d/dx\]}$ $\boxed{x^{yzt}} \boxed{abcd} \boxed{x^2} \boxed{+} \boxed{5} \boxed{x^{yzt}} \boxed{abcd}$ $\boxed{2\text{nd}} \boxed{[,]} \boxed{x^{yzt}} \boxed{abcd}$ $\boxed{2\text{nd}} \boxed{[,]} \boxed{(-)} \boxed{1} \boxed{) }$ $\boxed{\text{enter}}$	$\text{nDeriv}(x^2+5x, x, -1)$
---	--------------------------------

nDeriv(uses the symmetric difference quotient method, which approximates the numerical derivative value as the slope of the secant line through these points.

$$f'(x) = \frac{f(x + \epsilon) - f(x - \epsilon)}{2\epsilon}$$

As ϵ becomes smaller, the approximation usually becomes more accurate. In MathPrint™ mode, the default ϵ is $1\text{E-}3$. You can switch to Classic mode to change ϵ for investigations.

You can use **nDeriv**(once in *expression*. Because of the method used to calculate **nDeriv**(, the calculator can return a false derivative value at a nondifferentiable point.

Problem

Find the slope of the tangent line to the curve $f(x) = x^3 - 4x$ at

$$x = \frac{2}{\sqrt{3}}$$

What do you notice? (Fix 3 decimal places.)

mode	∇	∇	\rightarrow	\rightarrow	\rightarrow	\rightarrow	enter	$\frac{d}{dx}(x^3-4x) \Big _{x=\frac{2}{\sqrt{3}}}$ 0.000	
2nd	[d/dx]								
x^{yzt} abcd	x^{\square}	3	\rightarrow	-	4	x^{yzt} abcd	\rightarrow		\rightarrow
2	[\square]	2nd	[$\sqrt{\square}$]	3					
enter									

The slope of the tangent line at $x = \frac{2}{\sqrt{3}}$ is zero. A maximum or minimum of the function must be at this point!

Numeric integral

2nd [∫ \square dx]

2nd [∫ \square dx] calculates the numeric function integral of an expression with respect to a variable x , given a lower limit and an upper limit.

Example in RAD angle mode

2nd [∫ \square dx]	mode	\rightarrow	enter	clear	$\int_0^{\pi} (x \sin(x)) dx$ π	
2nd [∫ \square dx]						
0	\rightarrow	π	\rightarrow	\rightarrow		
x^{yzt} abcd	sin	\sin^{-1}	x^{yzt} abcd	\rightarrow		enter

Problem

Find the area under the curve $f(x) = -x^2+4$ from -2 to 0 and then from 0 to 2. What do you notice? What could you say about the graph?

2nd [∫ \square dx]	(-)	2	\rightarrow	0	\rightarrow	$\int_{-2}^0 (-x^2+4) dx$
(-)	x^{yzt} abcd	x^2	+	4	\rightarrow	

enter						$\int_{-2}^0 (-x^2+4) dx$ $\frac{16}{3}$
-------	--	--	--	--	--	--

\leftarrow	\leftarrow	enter					$\int_0^2 (-x^2+4) dx$ $\frac{16}{3}$
2nd	\leftarrow	\rightarrow	0	delete			
\rightarrow	2						

enter	$\int_0^4 (-x^2+4)dx = \frac{16}{3}$
-------	--------------------------------------

Notice that both areas are equal. Since this is a parabola with the vertex at (4,0) and zeros at (-2, 0) and (2, 0) you see that the symmetric areas are equal.

Stored operations

2nd [op] **2nd** [set op]

2nd [set op] lets you store a sequence of operations.

2nd [op] plays back the operation.

To set an operation and then recall it:

1. Press **2nd** [set op].
2. Enter any combination of numbers, operators, and/or values, up to 44 characters.
3. Press **enter** to store the operation.
4. Press **2nd** [op] to recall the stored operation and apply it to the last answer or the current entry.

If you apply **2nd** [op] directly to a **2nd** [op] result, the **n=1** iteration counter is incremented.

Examples

Clear op	2nd [set op] If a stored op is present, click clear to clear it.	$OP=$
Set op	× 2 + 3 enter	$OP=*2+3$
Recall op	2nd [quit] 4 2nd [op]	$4*2+3 \quad n=1 \quad 11$

	2nd [op]	$\begin{array}{r} 4*2+3 \\ 11*2+3 \end{array}$ $\begin{array}{r} n=1 \quad 11 \\ n=2 \quad 25 \end{array}$
	6 2nd [op]	$\begin{array}{r} 4*2+3 \\ 11*2+3 \\ 6*2+3 \end{array}$ $\begin{array}{r} n=1 \quad 11 \\ n=2 \quad 25 \\ n=1 \quad 15 \end{array}$
Redefine op	2nd [set op] clear x² enter	OP= ²
Recall op	5 2nd [op] 20 2nd [op]	$\begin{array}{r} 5^2 \\ 20^2 \end{array}$ $\begin{array}{r} n=1 \quad 25 \\ n=1 \quad 400 \end{array}$

Problem

Given the linear function $y = 5x - 2$, calculate y for the following values of x : -5 ; -1 .

2nd [set op] clear x 5 - 2 enter	OP=*5-2
(-) 5 2nd [op] (-) 1 2nd [op]	$\begin{array}{r} -5*5-2 \\ -1*5-2 \end{array}$ $\begin{array}{r} n=1 \quad -27 \\ n=1 \quad -7 \end{array}$

Memory and stored variables

x^{yzt}_{abcd} **sto**→ **2nd**[recall] **2nd**[clear var]

The TI-36X Pro calculator has 8 memory variables—**x**, **y**, **z**, **t**, **a**, **b**, **c**, and **d**. You can store a real or complex number or an expression result to a memory variable.

Features of the calculator that use variables (such as the solvers) will use the values that you store.

sto→ lets you store values to variables. Press **sto**→ to store a variable, and press **x^{yzt}_{abcd}** to select the variable to store. Press **enter** to store the value in the selected variable. If this variable already has a value, that value is replaced by the new one.

x_{abcd}^{yzt} is a multi-tap key that cycles through the variable names **x**, **y**, **z**, **t**, **a**, **b**, **c**, and **d**. You can also use x_{abcd}^{yzt} to recall the stored values for these variables. The name of the variable is inserted into the current entry, but the value assigned to the variable is used to evaluate the expression. To enter two or more variables in succession, press \blacktriangleright after each.

2^{nd} [recall] recalls the values of variables. Press 2^{nd} [recall] to display a menu of variables and their stored values. Select the variable you want to recall and press enter . The value assigned to the variable is inserted into the current entry and used to evaluate the expression.

2^{nd} [clear var] clears variable values. Press 2^{nd} [clear var] and select **1: Yes** to clear all variable values.

Examples

Start with clear screen	2^{nd} [quit] [clear]	
Clear Var	2^{nd} [clear var]	
Store	1 (Selects Yes) 15 $\text{sto}\rightarrow$ x_{abcd}^{yzt}	
	enter	
Recall	2^{nd} [recall]	
	enter x^2 enter	

sto → x_{abcd}^{yzt} x_{abcd}^{yzt}	$15 \rightarrow x$ 15 15^2 225 $\text{ans} \rightarrow y$
enter	$15 \rightarrow x$ 15 15^2 225 $\text{ans} \rightarrow y$ 225
x_{abcd}^{yzt} x_{abcd}^{yzt}	$15 \rightarrow x$ 15 15^2 225 $\text{ans} \rightarrow y$ 225 y
enter \div 4 enter	15^4 225 $\text{ans} \rightarrow y$ 225 y 225 $\text{ans}/4$ 56.25

Problem

In a gravel quarry, two new excavations have been opened. The first one measures 350 meters by 560 meters, the second one measures 340 meters by 610 meters. What volume of gravel does the company need to extract from each excavation to reach a depth of 150 meters? To reach 210 meters? Display the results in engineering notation.

mode \downarrow \rightarrow \rightarrow enter clear 350 \times 560 sto → x_{abcd}^{yzt} enter	$350 \times 560 \rightarrow x$ $196 \text{E}3$
340 \times 610 sto → x_{abcd}^{yzt} x_{abcd}^{yzt} enter	$350 \times 560 \rightarrow x$ $196 \text{E}3$ $340 \times 610 \rightarrow y$ $207.4 \text{E}3$
150 \times 2nd [recall]	RECALL VAR $1: x = 196 \text{E}3$ $2: y = 207.4 \text{E}3$ $3: z = 0 \text{E}0$
enter enter	150×196000 $29.4 \text{E}6$

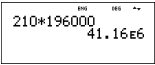
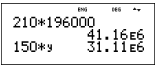
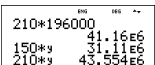
210 \times 2nd [recall] enter enter	
150 \times x^{yzt}_{abcd} x^{yzt}_{abcd} enter	
210 \times x^{yzt}_{abcd} x^{yzt}_{abcd} enter	

For the first excavation: The company needs to extract 29.4 million cubic meters to reach a depth of 150 meters, and to extract 41.16 million cubic meters to reach a depth of 210 meters.

For the second excavation: The company needs to extract 31.11 million cubic meters to reach a depth of 150 meters, and to extract 43.554 million cubic meters to reach a depth of 210 meters.

Data editor and list formulas



data

data lets you enter data in up to 3 lists. Each list can contain up to 42 items. Press **2nd** \uparrow to go to the top of a list, and **2nd** \downarrow to go to the bottom of a list.

List formulas accept all calculator functions and real numbers.

Numeric notation, decimal notation, and angle modes affect the display of an element (except fractional elements).

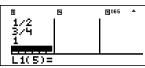
Example

L1	data 1 \square 4 \downarrow 2 \square 4 \downarrow 3 \square 4 \downarrow 4 \square 4 enter	
Formula	\rightarrow data \rightarrow	

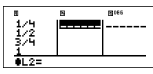
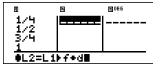
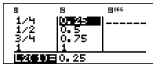
	enter	
	data enter 2nd [f↔d]	
	enter	

Notice L2 is calculated using the formula you entered, and L2(1)= in the author line is highlighted to indicate the list is the result of a formula.

Problem



On a November day, a weather report on the Internet listed the following temperatures.

Paris, France	8°C
Moscow, Russia	-1°C
Montreal, Canada	4°C

Convert these temperatures from degrees Celsius to degrees Fahrenheit. (See also the section on Conversions.)

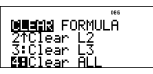
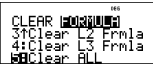
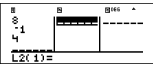
Reminder: $F = \frac{9}{5} C + 32$

data data 4 data → 5	 
8 ↓ (-) 1 ↓ 4 ↓ →	

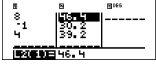
<code>data</code> \blacktriangleright 1	
<code>9</code> \div <code>5</code> \times <code>data</code> 1 $+$ <code>32</code>	
<code>enter</code>	

If Sydney, Australia is 21°C , find the temperature in degrees Fahrenheit.

\blacktriangleleft \blacktriangledown \blacktriangledown \blacktriangledown 21 <code>enter</code>	
---	---

Statistics, regressions, and distributions

`data` `2nd` [stat-reg/distr]

`data` lets you enter and edit the data lists.

`2nd` [stat-reg/distr] displays the **STAT-REG** menu, which has the following options.

Note: Regressions store the regression information, along with the 2-Var statistics for the data, in StatVars (menu item 1).

- | | |
|----------------|---|
| 1: StatVars | Displays a secondary menu of statistical result variables. Use \blacktriangledown and \blacktriangleup to locate the desired variable, and press <code>enter</code> to select it. If you select this option before calculating 1-Var stats, 2-Var stats, or any of the regressions, a reminder appears. |
| 2: 1-Var Stats | Analyzes statistical data from 1 data set with 1 measured variable, x . Frequency data may be included. |

- 3: 2-Var Stats Analyzes paired data from 2 data sets with 2 measured variables— x , the independent variable, and y , the dependent variable. Frequency data may be included. **Note:** 2-Var Stats also computes a linear regression and populates the linear regression results.
- 4: LinReg $ax+b$ Fits the model equation $y=ax+b$ to the data using a least-squares fit. It displays values for **a** (slope) and **b** (y-intercept); it also displays values for r^2 and r .
- 5: QuadraticReg Fits the second-degree polynomial $y=ax^2+bx+c$ to the data. It displays values for **a**, **b**, and **c**; it also displays a value for R^2 . For three data points, the equation is a polynomial fit; for four or more, it is a polynomial regression. At least three data points are required.
- 6: CubicReg Fits the third-degree polynomial $y=ax^3+bx^2+cx+d$ to the data. It displays values for **a**, **b**, **c**, and **d**; it also displays a value for R^2 . For four points, the equation is a polynomial fit; for five or more, it is a polynomial regression. At least four points are required.
- 7: LnReg $a+b\ln x$ Fits the model equation $y=a+b \ln(x)$ to the data using a least squares fit and transformed values $\ln(x)$ and y . It displays values for **a** and **b**; it also displays values for r^2 and r .
- 8: PwrReg ax^b Fits the model equation $y=ax^b$ to the data using a least-squares fit and transformed values $\ln(x)$ and $\ln(y)$. It displays values for **a** and **b**; it also displays values for r^2 and r .
- 9: ExpReg ab^x Fits the model equation $y=ab^x$ to the data using a least-squares fit and transformed values x and $\ln(y)$. It displays values for **a** and **b**; it also displays values for r^2 and r .

2nd [stat-reg/distr] \odot displays the **DISTR** menu, which has the following distribution functions:

1: Normalpdf Computes the probability density function (**pdf**) for the normal distribution at a specified x value. The defaults are mean $\mu=0$ and standard deviation $\sigma=1$. The probability density function (pdf) is:

$$f(x) = \frac{1}{\sqrt{2\pi}\sigma} e^{-\frac{(x-\mu)^2}{2\sigma^2}}, \sigma > 0$$

2: Normalcdf Computes the normal distribution probability between LOWERbnd and UPPERbnd for the specified mean μ and standard deviation σ . The defaults are $\mu=0$; $\sigma=1$; with LOWERbnd = -1E99 and UPPERbnd = 1E99. Note: -1E99 to 1E99 represents -infinity to infinity.

3: invNorm Computes the inverse cumulative normal distribution function for a given area under the normal distribution curve specified by mean μ and standard deviation σ . It calculates the x value associated with an area to the left of the x value. $0 \leq \text{area} \leq 1$ must be true. The defaults are $\text{area}=1$, $\mu=0$ and $\sigma=1$.

4: Binompdf Computes a probability at x for the discrete binomial distribution with the specified numtrials and probability of success (p) on each trial. x is a non-negative integer and can be entered with options of SINGLE entry, LIST of entries or ALL (list of probabilities from 0 to numtrials is returned). $0 \leq p \leq 1$ must be true. The probability density function (**pdf**) is:

$$f(x) = \binom{n}{x} p^x (1-p)^{n-x}, x = 0, 1, \dots, n$$

- 5: Binomcdf Computes a cumulative probability at x for the discrete binomial distribution with the specified *numtrials* and probability of success (p) on each trial. x can be non-negative integer and can be entered with options of SINGLE, LIST or ALL (a list of cumulative probabilities is returned.)
 $0 \leq p \leq 1$ must be true.
- 6: Poissonpdf Computes a probability at x for the discrete Poisson distribution with the specified mean μ (μ), which must be a real number > 0 . x can be a non-negative integer (SINGLE) or a list of integers (LIST). The probability density function (**pdf**) is:

$$f(x) = e^{-\mu} \mu^x / x!, x = 0, 1, 2, \dots$$
- 7: Poissoncdf Computes a cumulative probability at x for the discrete Poisson distribution with the specified mean μ , which must be a real number > 0 . x can be a non-negative integer (SINGLE) or a list of integers (LIST).

Note: The default value for μ (μ) is 0. For **Poissonpdf** and **Poissoncdf**, you must change it to a value > 0 .

1-Var Stats and 2-Var Stats results

Important note about results: Many of the regression equations share the same variables **a**, **b**, **c**, and **d**. If you perform any regression calculation, the regression calculation and the 2-Var statistics for that data are stored in the **StatVars** menu until the next statistics or regression calculation. The results must be interpreted based on which type of statistics or regression calculation was last performed. To help you interpret correctly, the title bar reminds you of which calculation was last performed.

Variables	Definition
n	Number of x or (x,y) data points.
\bar{x} or \bar{y}	Mean of all x or y values.
Sx or Sy	Sample standard deviation of x or y .

σ_x or σ_y	Population standard deviation of x or y .
Σx or Σy	Sum of all x or y values.
Σx^2 or Σy^2	Sum of all x^2 or y^2 values.
Σxy	Sum of $(x \dots y)$ for all xy pairs.
a (2-Var)	Linear regression slope.
b (2-Var)	Linear regression y -intercept.
r (2-Var)	Correlation coefficient.
x' (2-Var)	Uses a and b to calculate predicted x value when you input a y value.
y' (2-Var)	Uses a and b to calculate predicted y value when you input an x value.
MinX	Minimum of x values.
Q1 (1-Var)	Median of the elements between MinX and Med (1st quartile).
Med	Median of all data points (1-Var stats only).
Q3 (1-Var)	Median of the elements between Med and MaxX (3rd quartile).
MaxX	Maximum of x values.

To define statistical data points:

1. Enter data in L1, L2, or L3. (See Data editor.)
Note: Non-integer frequency elements are valid. This is useful when entering frequencies expressed as percentages or parts that add up to 1. However, the sample standard deviation, S_x , is undefined for non-integer frequencies, and $S_x = \text{Error}$ is displayed for that value. All other statistics are displayed.
2. Press **[2nd]** **[stat-reg/distr]**. Select **1-Var** or **2-Var** and press **[enter]**.
3. Select L1, L2, or L3, and the frequency.
4. Press **[enter]** to display the menu of variables.
5. To clear data, press **[data]** **[data]**, select a list to clear, and press **[enter]**.

1-Var Example

Find the mean of {45, 55, 55, 55}

Clear all data	<code>data</code> <code>data</code> \downarrow \downarrow \downarrow	
Data	<code>enter</code> 45 \downarrow 55 \downarrow 55 \downarrow 55 <code>enter</code>	
Stat	<code>2nd</code> <code>[quit]</code> <code>2nd</code> <code>[stat-reg/distr]</code>	
	2 (Selects 1-Var Stats) \downarrow \downarrow	
	<code>enter</code>	
Stat Var	2 <code>enter</code>	
	<code>x</code> 2 <code>enter</code>	

2-Var Example

Data: (45,30); (55,25). Find: $x'(45)$

Clear all data	<code>data</code> <code>data</code> \downarrow \downarrow \downarrow	
Data	<code>enter</code> 45 \downarrow 55 \downarrow \rightarrow 30 \downarrow 25 \downarrow	

Stat	2nd [stat-reg/distr]	
	3 (Selects 2-Var Stats) ⏴ ⏴ ⏴	
	enter 2nd [quit] 2nd [stat-reg/distr] 1 ⏴ ⏴ ⏴ ⏴ ⏴ ⏴	
	enter 45) enter	

Problem

For his last four tests, Anthony obtained the following scores. Tests 2 and 4 were given a weight of 0.5, and tests 1 and 3 were given a weight of 1.

Test No.	1	2	3	4
Score	12	13	10	11
Coefficient	1	0.5	1	0.5





- Find Anthony's average grade (weighted average).
- What does the value of n given by the calculator represent? What does the value of Σx given by the calculator represent?

Reminder: The weighed average is

$$\frac{\Sigma x}{n} = \frac{(12)(1) + (13)(0.5) + (10)(1) + (11)(0.5)}{1 + 0.5 + 1 + 0.5}$$

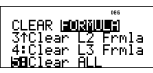
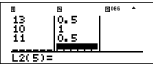
- The teacher gave Anthony 4 more points on test 4 due to a grading error. Find Anthony's new average grade.

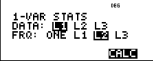
data data ⏴ ⏴ ⏴	
-------------------------------	--



<p>enter</p> <p>data \blacktriangleright \blacktriangledown \blacktriangledown \blacktriangledown \blacktriangledown</p>	
<p>enter</p> <p>12 \blacktriangledown 13 \blacktriangledown 10 \blacktriangledown 11 \blacktriangledown</p> <p>\blacktriangleright 1 \blacktriangledown .5 \blacktriangledown 1 \blacktriangledown .5 enter</p>	
<p>2nd [stat-reg/distr]</p>	
<p>2 (Selects 1-Var Stats)</p> <p>\blacktriangledown \blacktriangleright \blacktriangleright enter</p>	
<p>enter</p>	

Anthony has an average (\bar{x}) of 11.33 (to the nearest hundredth).

On the calculator, n represents the total sum of the weights.
 $n = 1 + 0.5 + 1 + 0.5$.

Σx represents the weighted sum of his scores.
 $(12)(1) + (13)(0.5) + (10)(1) + (11)(0.5) = 34$.

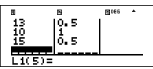
Change Anthony's last score from 11 to 15.

<p>data \blacktriangledown \blacktriangledown \blacktriangledown 15 enter</p>	
<p>2nd [stat-reg/distr] 2</p> <p>\blacktriangledown \blacktriangleright \blacktriangleright enter enter</p>	

If the teacher adds 4 points to Test 4, Anthony's average grade is 12.

Problem

The table below gives the results of a braking test.

Test No.	1	2	3	4
Speed (kph)	33	49	65	79
Braking distance (m)	5.30	14.45	20.21	38.45

Use the relationship between speed and braking distance to estimate the braking distance required for a vehicle traveling at 55 kph.

A hand-drawn scatter plot of these data points suggest a linear relationship. The calculator uses the least squares method to find the line of best fit, $y = ax + b$, for data entered in lists.

data data \odot \odot \odot	
enter 33 \odot 49 \odot 65 \odot 79 \odot \odot 5.3 \odot 14.45 \odot 20.21 \odot 38.45 enter	
2nd [quit] 2nd [stat-reg/distr]	
3 (Selects 2-Var Stats) \odot \odot \odot	
enter	
Press \odot as necessary to view a and b .	

This line of best fit, $y' = 0.67732519x' - 18.66637321$ models the linear trend of the data.

Press \odot until y' is highlighted.	
enter 55) enter	

The linear model gives an estimated braking distance of 18.59 meters for a vehicle traveling at 55 kph.

Regression example 1

Calculate an $ax+b$ linear regression for the following data: $\{1,2,3,4,5\}$; $\{5,8,11,14,17\}$.

Clear all data	data data \odot \odot \odot	
Data	enter 1 \odot 2 \odot 3 \odot 4 \odot 5 \odot \rightarrow 5 \odot 8 \odot 11 \odot 14 \odot 17 enter	
Regression	2nd quit 2nd stat-reg/distr \odot \odot \odot	
	enter	
	\odot \odot \odot \odot enter Press \odot to examine all the result variables.	

Regression example 2

Calculate the exponential regression for the following data:

L1 = {0, 1, 2, 3, 4}; L2 = {10, 14, 23, 35, 48}

Find the average value of the data in L2.

Compare the exponential regression values to L2.

Clear all data	[data] [data] 4	
Data	0 [down] 1 [down] 2 [down] 3 [down] 4 [down] [right] 10 [down] 14 [down] 23 [down] 35 [down] 48 [enter]	
Regression	[2nd] [stat-reg/distr] [up]	
Save the regression equation to $f(x)$ in the [table] menu.	[enter] [down] [down] [down] [right] [enter]	
Regression Equation	[enter]	
Find the average value (\bar{y}) of the data in L2 using StatVars.	[2nd] [stat-reg/distr] 1 (Selects StatVars) [down] [down] [down] [down] [down] [down] [down] [down] [down]	 Notice that the title bar reminds you of your last statistical or regression calculation.
Examine the table of values of the regression equation.	[table] 2	

	<code>enter</code> <code>0 enter</code> <code>1 enter</code>	<pre> *** MODE=STAT start=0 step=1 MODE X = ? CALC </pre>
	<code>enter enter</code>	<pre> *** X f(X) 0 9.875259892 1 14.81121828 2 22.21452036 Y=0 </pre>

Warning: If you now calculate 2-Var Stats on your data, the variables **a** and **b** (along with **r** and **r²**) will be calculated as a linear regression. Do not recalculate 2-Var Stats after any other regression calculation if you want to preserve your regression coefficients (a, b, c, d) and r values for your particular problem in the **StatVars** menu.

Distribution example

Compute the binomial pdf distribution at x values {3,6,9} with 20 trials and a success probability of 0.6. Enter the x values in list L1, and store the results in L2.

Clear all data	<code>data data</code> <code>⏏</code> <code>⏏</code> <code>⏏</code>	<pre> *** MODE FORMULA 2↑Clear L2 3:Clear L3 MODEClear ALL </pre>
Data	<code>enter</code> <code>3</code> <code>⏏</code> <code>6</code> <code>⏏</code> <code>9</code> <code>enter</code>	<pre> *** L1(4)= </pre>
DISTR	<code>2nd</code> <code>[stat-reg/distr]</code> <code>⏏</code> <code>⏏</code> <code>⏏</code> <code>⏏</code>	<pre> *** STAT-REG DISTR 2↑Normalcdf 3:invNorm MODEBinomcdf </pre>
	<code>enter</code> <code>⏏</code>	<pre> *** BinomialPcf X: SINGLE ALL </pre>
	<code>enter</code> <code>20</code> <code>⏏</code> <code>0.6</code>	<pre> *** BinomialPcf TRIALS=n=20 P(SUCCESS)=0.6 </pre>
	<code>enter</code> <code>⏏</code> <code>⏏</code>	<pre> *** BinomialPcf YLIST: L1 L2 L3 SAVE TO: L1 L3 CALC </pre>

	enter	
--	-------	--

Probability

$\frac{nCr}{nPr}$ 2nd [random]

$\frac{nCr}{nPr}$ is a multi-tap key that cycles through the following options:

!	A factorial is the product of the positive integers from 1 to n . n must be a positive whole number ≤ 69 .
nCr	Calculates the number of possible combinations of n items taken r at a time, given n and r . The order of objects is not important, as in a hand of cards.
nPr	Calculates the number of possible permutations of n items taken r at a time, given n and r . The order of objects is important, as in a race.

2nd [random] displays a menu with the following options:

rand Generates a random real number between 0 and 1. To control a sequence of random numbers, store an integer (seed value) ≥ 0 to **rand**. The seed value changes randomly every time a random number is generated.

randint(Generates a random integer between 2 integers, A and B , where $A \leq \text{randint} \leq B$. Separate the 2 integers with a comma.

Examples

!	4 $\frac{nCr}{nPr}$ enter	
nCr	52 $\frac{nCr}{nPr}$ $\frac{nCr}{nPr}$ 5 enter	

nPr	8 $\frac{nCr}{nPr}$ $\frac{nCr}{nPr}$ $\frac{nCr}{nPr}$ 3 enter	$\begin{array}{r} 4! \\ 52 \text{ nCr } 5 \\ 8 \text{ nPr } 3 \end{array} \begin{array}{r} 24 \\ 2598960 \\ 336 \end{array}$
STO ▶ rand	5 [sto→] [2nd] [random]	$\begin{array}{l} \text{PRB } \frac{nCr}{nPr} \\ \text{1:rand} \\ \text{2:randint(} \end{array}$
	1 (Selects rand) enter	$\begin{array}{r} 52 \text{ nCr } 5 \\ 8 \text{ nPr } 3 \\ 5 \rightarrow \text{rand} \end{array} \begin{array}{r} 2598960 \\ 336 \\ 5 \end{array}$
Rand	[2nd] [random] 1 enter	$\begin{array}{r} 8 \text{ nPr } 3 \\ 5 \rightarrow \text{rand} \\ \text{rand} \end{array} \begin{array}{r} 336 \\ 5 \\ 0.000093165 \end{array}$
Randint([2nd] [random] 2 3 [2nd] [,] 5) enter	$\begin{array}{r} 5 \rightarrow \text{rand} \\ \text{rand} \\ \text{randint}(3,5) \end{array} \begin{array}{r} 5 \\ 5 \\ 0.000093165 \\ 5 \end{array}$

Problem

An ice cream store advertises that it makes 25 flavors of home made ice cream. You like to order three different flavors in a dish. How many combinations of ice cream can you test over a very hot summer?

clear 25 $\frac{nCr}{nPr}$ $\frac{nCr}{nPr}$ 3 enter	$25 \text{ nCr } 3 \quad 2300$
---	--------------------------------

You can choose from 2300 dishes with different combinations of flavors! If a long hot summer is about 90 days long, you will need to eat about 25 ice cream dishes each day!

Function table

table displays a menu with the following options:

- 1: f(Pastes the existing $f(x)$ to an input area such as the Home screen to evaluate the function at a point (for example, $f(2)$).

2: Edit function Lets you define the function $f(x)$ and generates a table of values.

The function table allows you to display a defined function in a tabular form. To set up a function table:

1. Press **table** and select **Edit function**.
2. Enter a function and press **enter**.
3. Select the table start, table step, auto, or ask-x options and press **enter**.

The table is displayed using the specified values.

Start	Specifies the starting value for the independent variable, x .
Step	Specifies the incremental value for the independent variable, x . The step can be positive or negative.
Auto	The calculator automatically generates a series of values based on table start and table step.
Ask-x	Lets you build a table manually by entering specific values for the independent variable, x .

Problem

Find the vertex of the parabola, $y = x(36 - x)$ using a table of values.

Reminder: The vertex of the parabola is the point on the parabola that is also on the line of symmetry.

table 2 clear x^{yzt} (36 - x^{yzt})	$f(x) = x(36 - x)$
enter	TABLE SETUP ↑ Start=0 Step=1 AUTO $x = ?$ CALC
15 ↓ 3 ↓ ↓	TABLE SETUP ↑ Start=15 Step=3 AUTO $x = ?$ CALC

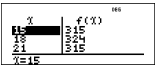
enter	
-------	--

After searching close to $x = 18$, the point $(18, 324)$ appears to be the vertex of the parabola since it appears to be the turning point of the set of points of this function. To search closer to $x = 18$, change the Step value to smaller and smaller values to see points closer to $(18, 324)$.

 **Problem**

A charity collected \$3,600 to help support a local food kitchen. \$450 will be given to the food kitchen every month until the funds run out. How many months will the charity support the kitchen?

Reminder: If $x =$ months and $y =$ money left, then
 $y = 3600 - 450x$.

<table border="0"> <tr><td>table</td><td>2</td></tr> <tr><td>clear</td><td></td></tr> <tr><td>3600</td><td>-</td><td>450</td><td>x^{yzt}</td></tr> </table>	table	2	clear		3600	-	450	x^{yzt}	
table	2								
clear									
3600	-	450	x^{yzt}						

enter 0 \downarrow 1 \downarrow \rightarrow enter \downarrow enter	
--	---

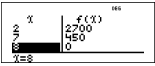
Input each guess and press enter.	
-----------------------------------	---

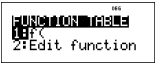
Calculate the value of $f(8)$ on the Home screen. 2nd [quit] table	
---	---

1 Selects $f($ 8 $)$ enter	
-------------------------------	---

The support of \$450 per month will last for 8 months since $y(8) = 3600 - 450(8) = 0$ as shown in the table of values.

Matrices

In addition to those in the Matrix **MATH** menu, the following matrix operations are allowed. Dimensions must be correct:

- $matrix + matrix$
- $matrix - matrix$
- $matrix \times matrix$
- Scalar multiplication (for example, $2 \times matrix$)
- $matrix \times vector$ ($vector$ will be interpreted as a column vector)

2nd [matrix] **NAMES**

2nd [matrix] displays the matrix **NAMES** menu, which shows the dimensions of the matrices and lets you use them in calculations.

- 1: [A] Definable matrix A
- 2: [B] Definable matrix B
- 3: [C] Definable matrix C
- 4: [Ans] Last matrix result (displayed as **[Ans]= $m \times n$**) or last vector result (displayed as **[Ans] dim= n**). Not editable.
- 5: [I2] 2×2 identity matrix (not editable)
- 6: [I3] 3×3 identity matrix (not editable)

2nd [matrix] **MATH**

2nd [matrix] \blacktriangleright displays the matrix **MATH** menu, which lets you perform the following operations:

- 1: Determinant Syntax: **det**($matrix$)
- 2: **T** Transpose Syntax: $matrix^T$
- 3: Inverse Syntax: $squarematrix^{-1}$
- 4: ref reduced Row echelon form, syntax: **ref**($matrix$)
- 5: rref reduced Reduced row echelon form, syntax: **rref**($matrix$)

2nd [matrix] **EDIT**

2nd [matrix] \blacktriangleleft displays the matrix **EDIT** menu, which lets you define or edit matrix [A], [B], or [C].

Matrix example

Define matrix [A] as $\begin{bmatrix} 1 & 2 \\ 3 & 4 \end{bmatrix}$

Calculate the determinant, transpose, inverse, and rref of [A].

Define [A]	2nd [matrix] \leftarrow	
	enter	
Set dimensions	\rightarrow enter \rightarrow enter enter	
Enter values	enter 1 \downarrow 2 \downarrow 3 \downarrow 4 \downarrow	
det([A])	clear 2nd [matrix] \rightarrow	
	enter 2nd [matrix] enter) enter	
Transpose	2nd [matrix] enter 2nd [matrix] \rightarrow \downarrow enter	
	enter	
Inverse	clear 2nd [matrix] enter 2nd [matrix] \rightarrow \downarrow \downarrow enter	

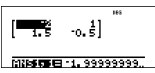
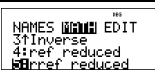
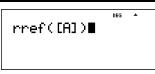
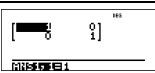
	enter	
rref	clear 2nd [matrix] \blacktriangleright \blacktriangleup	
	enter 2nd [matrix] enter)	
	enter Notice that [A] has an inverse and that [A] is equivalent to the identity matrix.	

Vectors

In addition to those in the Vector **MATH** menu, the following vector operations are allowed. Dimensions must be correct:

- $vector + vector$
- $vector - vector$
- Scalar multiplication (for example, $2 \times vector$)
- $matrix \times vector$ ($vector$ will be interpreted as a column vector)

2nd [vector] **NAMES**

2nd [vector] displays the vector **NAMES** menu, which shows the dimensions of the vectors and lets you use them in calculations.

- 1: [u] Definable vector u
- 2: [v] Definable vector v
- 3: [w] Definable vector w
- 4: [Ans] Last matrix result (displayed as **[Ans]=m×n**) or last vector result (displayed as **[Ans] dim=n**). Not editable.

2nd [vector] **MATH**

2nd [vector] \blacktriangleright displays the vector **MATH** menu, which lets you perform the following vector calculations:

1: DotProduct Syntax: **DotP**(*vector1*, *vector2*)
Both vectors must be the same dimension.

2: CrossProduct Syntax: **CrossP**(*vector1*, *vector2*)
Both vectors must be the same dimension.

3: norm magnitude Syntax: **norm**(*vector*)

2nd [vector] **EDIT**

2nd [vector] \blacktriangleleft displays the vector **EDIT** menu, which lets you define or edit vector [u], [v], or [w].

Vector example

Define vector [u] = [0.5 8]. Define vector [v] = [2 3].
Calculate [u] + [v], **DotP**([u],[v]), and **norm**([v]).

Define [u]	2nd [vector] \blacktriangleleft	
	enter	
	\blacktriangleright enter enter .5 enter 8 enter	
Define [v]	2nd [vector] \blacktriangleleft \blacktriangledown enter	
	\blacktriangleright enter enter 2 enter 3 enter	

Add vectors	<code>clear</code> <code>2nd</code> [vector] <code>enter</code> <code>+</code> <code>2nd</code> [vector] <code>↵</code> <code>enter</code>	$[u] + [v]$
	<code>enter</code>	$[2.5 \quad 11]$ $\text{norm}(2.5)$
DotP	<code>clear</code> <code>2nd</code> [vector] <code>→</code> <code>enter</code>	$\text{DotP}(\mathbf{\cdot})$
	<code>2nd</code> [vector] <code>enter</code> <code>2nd</code> [,] <code>2nd</code> [vector] <code>↵</code> <code>enter</code>	$\text{DotP}([u], [v])$
	<code>)</code> <code>enter</code> $.5 \times 2 + 8 \times 3$ <code>enter</code> Note: DotP is calculated here in two ways.	$\text{DotP}([u], [v])$ $.5*2+8*3$
norm	<code>clear</code> <code>2nd</code> [vector] <code>→</code> <code>↵</code> <code>↵</code> <code>enter</code> <code>2nd</code> [vector] <code>↵</code> <code>enter</code> <code>)</code> <code>↔≈</code> <code>enter</code>	$\text{norm}([v])$ 3.605551275
	<code>2nd</code> $\sqrt{}$ <code>2</code> x^2 <code>+</code> <code>3</code> x^2 <code>→</code> <code>↔≈</code> <code>enter</code> Note: norm is calculated here in two ways.	$\text{norm}(\sqrt{2^2+3^2})$ 3.605551275 $\sqrt{2^2+3^2}$ 3.605551275

Solvers

Numeric equation solver

`2nd` [num-solv]

`2nd` [num-solv] prompts you for the equation and the values of the variables. You then select which variable to solve for. The equation is limited to a maximum of 40 characters.

Example

Reminder: If you have already defined variables, the solver will assume those values.

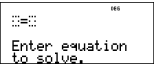
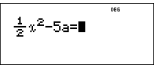
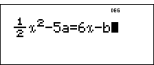
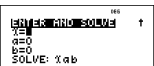
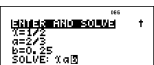
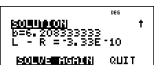
Num-solv	2nd [num-solv]	
Left side	1 $\frac{\square}{\square}$ 2 \rightarrow x_{abcd}^{yzt} x^2 - 5 x_{abcd}^{yzt} x_{abcd}^{yzt} x_{abcd}^{yzt} x_{abcd}^{yzt} x_{abcd}^{yzt} \rightarrow \rightarrow	
Right side	6 x_{abcd}^{yzt} $-$ x_{abcd}^{yzt} x_{abcd}^{yzt} x_{abcd}^{yzt} x_{abcd}^{yzt} x_{abcd}^{yzt} x_{abcd}^{yzt}	
	enter	
Variable values	1 $\frac{\square}{\square}$ 2 \downarrow 2 $\frac{\square}{\square}$ 3 \downarrow 0.25 \downarrow \rightarrow \rightarrow	
Solve for b	enter Note: Left-Right is the difference between the left- and right-hand sides of the equation evaluated at the solution. This difference gives how close the solution is to the exact answer.	





Polynomial solver

2nd [poly-solv]

2nd [poly-solv] prompts you to select either the quadratic or the cubic equation solver. You then enter the coefficients of the variables and solve.

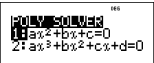
Example of quadratic equation

Reminder: If you have already defined variables, the solver will assume those values.

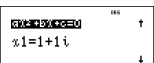
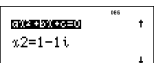
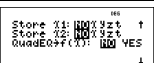
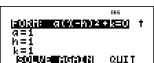
Poly-solv	2nd [poly-solv]	
Enter coefficients	enter 1	
	▼ [(-)] 2	
	▼ 2 enter	
Solutions	enter	
	▼	
	▼ Note: If you choose to store the polynomial to $f(x)$, you can use table to study the table of values.	
	▼▼▶ enter Vertex form (quadratic solver only)	

On the solution screens of the polynomial solver, you can press **◀▶≈** to toggle the number format of the solutions x_1 , x_2 , and x_3 .

System of linear equations solver

2nd [sys-solv]

2nd [sys-solv] solves systems of linear equations. You choose from 2×2 or 3×3 systems.

Notes:

- x , y , and z results are automatically stored in the x , y , and z variables.
- Use $\leftarrow \rightarrow \approx$ to toggle the results (x , y and z) as needed.
- The 2×2 equation solver solves for a unique solution or displays a message indicating an infinite number of solutions or no solution.
- The 3×3 system solver solves for a unique solution or infinite solutions in closed form, or it indicates no solution.

Example 2×2 system

Solve: $1x + 1y = 1$
 $1x - 2y = 3$

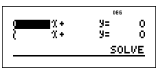
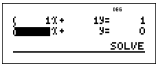
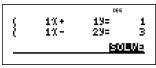
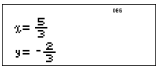
Sys-solv	2nd [sys-solv]	
2×2 system	enter	
Enter equations	1 enter + 1 enter 1 enter	
	1 enter - 2 enter 3 enter	
Solve	enter	

Toggle result type	$\leftarrow \rightarrow \approx$	$x=1.6666666667$ $y=-0.6666666667$
--------------------	----------------------------------	---------------------------------------

Example 3x3 system

$$\begin{aligned} \text{Solve: } 5x - 2y + 3z &= -9 \\ 4x + 3y + 5z &= 4 \\ 2x + 4y - 2z &= 14 \end{aligned}$$

System solve	2nd [sys-solv] \downarrow	SYSTEM SOLVER 1: 2x2 LIN EQU. 2: 3x3 LIN SYSTEM
3x3 system	enter	$\left[\begin{array}{ccc c} 5 & -2 & 3 & -9 \\ 4 & 3 & 5 & 4 \\ 2 & 4 & -2 & 14 \end{array} \right]$ SOLVE [1:1]=0
First equation	5 enter (-) 2 enter 3 enter (-) 9 enter	$\left[\begin{array}{ccc c} 5 & -2 & 3 & -9 \\ 4 & 3 & 5 & 4 \\ 2 & 4 & -2 & 14 \end{array} \right]$ SOLVE [2:1]=0
Second equation	4 enter 3 enter 5 enter 4 enter	$\left[\begin{array}{ccc c} 5 & -2 & 3 & -9 \\ 4 & 3 & 5 & 4 \\ 2 & 4 & -2 & 14 \end{array} \right]$ SOLVE [3:1]=0
Third equation	2 enter 4 enter (-) 2 enter 14 enter	$\left[\begin{array}{ccc c} 5 & -2 & 3 & -9 \\ 4 & 3 & 5 & 4 \\ 2 & 4 & -2 & 14 \end{array} \right]$ SOLVE
Solutions	enter \downarrow \downarrow	SYS=SOLUTION \uparrow $x=0$ \downarrow SYS=SOLUTION \uparrow $y=3$ \downarrow SYS=SOLUTION \uparrow $z=-1$ SOLVE=RETURN QUIT

Example 3×3 system with infinite solutions

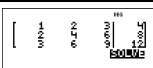
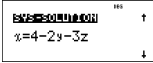
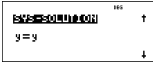
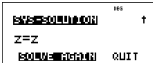
Enter the system	2^{nd} [sys-solv] 2 1 [enter] 2 [enter] 3 [enter] 4 [enter] 2 [enter] 4 [enter] 6 [enter] 8 [enter] 3 [enter] 6 [enter] 9 [enter] 12 [enter]	
	[enter]	
	[enter]	
	[enter]	

Number bases

2^{nd} [base n]

Base conversion

2^{nd} [base n] displays the **CONVR** menu, which converts a real number to the equivalent in a specified base.

- 1: ▶ Hex Converts to hexadecimal (base 16).
- 2: ▶ Bin Converts to binary (base 2).
- 3: ▶ Dec Converts to decimal (base 10).
- 4: ▶ Oct Converts to octal (base 8).

Base type

2^{nd} [base n] \odot displays the **TYPE** menu, which lets you designate the base of a number regardless of the calculator's current number-base mode.

- 1: h Designates a hexadecimal integer.
- 2: b Specifies a binary integer.

- 3: d Specifies a decimal number.
 4: o Specifies an octal integer.

Examples in DEC mode

Note: Mode can be set to DEC, BIN, OCT, or HEX. See the Mode section.

d ▶ Hex	<code>clear</code> 127 <code>[2nd]</code> <code>[base n]</code> 1 <code>enter</code>	<code>127▶Hex</code> <code>7Fh</code>
h ▶ Bin	<code>clear</code> <code>[2nd]</code> <code>[F]</code> <code>[2nd]</code> <code>[F]</code> <code>[2nd]</code> <code>[base n]</code> <code>↓</code> 1 <code>[2nd]</code> <code>[base n]</code> 2 <code>enter</code>	<code>FFh▶Bin</code> <code>11111111b</code>
b ▶ Oct	<code>clear</code> 10000000 <code>[2nd]</code> <code>[base n]</code> <code>↓</code> 2 <code>[2nd]</code> <code>[base n]</code> 4 <code>enter</code>	<code>10000000b▶Oct</code> <code>200o</code>
o ▶ Dec	<code>↶</code> <code>enter</code>	<code>10000000b▶Oct</code> <code>200o</code> <code>200o</code> <code>128</code>

Boolean logic

`[2nd]` `[base n]` `↓` displays the **LOGIC** menu, which lets you perform boolean logic.

- 1: and Bitwise AND of two integers
 2: or Bitwise OR of two integers
 3: xor Bitwise XOR of two integers
 4: xnor Bitwise XNOR of two integers
 5: not(Logical NOT of a number
 6: 2's(2's complement of a number
 7: nand Bitwise NAND of two integers

Examples

BIN mode: and, or	<code>mode</code> \downarrow \downarrow \downarrow \downarrow \rightarrow \rightarrow <code>enter</code> 1111 <code>2nd</code> <code>[base n]</code> \downarrow 1 1010 <code>enter</code> 1111 <code>2nd</code> <code>[base n]</code> \downarrow 2 1010 <code>enter</code>	<pre> R 000 ^ 1111 and 1010 1010b 1111 or 1010 1111b </pre>
BIN mode: xor, xnor	11111 <code>2nd</code> <code>[base n]</code> \downarrow 3 10101 <code>enter</code> 11111 <code>2nd</code> <code>[base n]</code> \downarrow 4 10101 <code>enter</code>	<pre> 000 ^ 11111 xor 10101 1010b 11111 xnor 10101 111110101b </pre>
HEX mode: not, 2's	<code>mode</code> \downarrow \downarrow \downarrow \downarrow \rightarrow <code>enter</code> <code>2nd</code> <code>[base n]</code> \downarrow 6 <code>2nd</code> <code>[F]</code> <code>2nd</code> <code>[F]</code> <code>)</code> <code>enter</code> <code>2nd</code> <code>[base n]</code> \downarrow 5 <code>2nd</code> <code>[answer]</code> <code>enter</code>	<pre> R 000 ^ 2's(FF) FFFFFFFF01h not(ans) FEh </pre>
DEC mode: nand	<code>mode</code> \downarrow \downarrow \downarrow \downarrow <code>enter</code> 192 <code>2nd</code> <code>[base n]</code> \downarrow 7 48 <code>enter</code>	<pre> 000 ^ 192 nand 48 -1 </pre>

Expression evaluation

`2nd` `[expr-eval]`

Press `2nd` `[expr-eval]` to input and calculate an expression using numbers, functions, and variables/parameters.

Pressing `2nd` `[expr-eval]` from a populated home screen expression pastes the content to `Expr=`. If the user is in an input or output history line when `2nd` `[expr-eval]` is pressed, the home screen expression pastes to `Expr=`.

Example

<code>2nd</code> <code>[expr-eval]</code>	<pre> Expr= </pre>
---	------------------------------

2 x_{abcd}^{yzt} + x_{abcd}^{yzt} x_{abcd}^{yzt} x_{abcd}^{yzt}	Expr=2x+z
enter 2	x=2
enter 5	z=5
enter	2x+z 9
2nd [expr-eval]	Expr=2x+z
enter 4 enter 6 enter	2x+z 14

Constants

Constants lets you access scientific constants to paste in various areas of the TI-36X Pro calculator. Press **2nd** [constants] to access, and **⏪** or **⏩** to select either the NAMES or UNITS menus of the same 20 physical constants. Use **⏴** and **⏵** to scroll through the list of constants in the two menus. The NAMES menu displays an abbreviated name next to the character of the constant. The UNITS menu has the same constants as NAMES but the units of the constant show in the menu.

NAMES	UNITS
1: c	Speed Light
2: g	GravityAccel
3: h	Planck Const

NAMES	UNITS
1: c	M/s
2: g	M/s ²
3: h	J s

Note: Displayed constant values are rounded. The values used for calculations are given in the following table.

Constant	Value used for calculations
c speed of light	299792458 meters per second
g gravitational acceleration	9.80665 meters per second ²
h Planck's constant	$6.62606896 \times 10^{-34}$ Joule seconds
NA Avogadro's number	$6.02214179 \times 10^{23}$ molecules per mole
R ideal gas constant	8.314472 Joules per mole per Kelvin
me electron mass	$9.109381215 \times 10^{-31}$ kilograms
mp proton mass	$1.672621637 \times 10^{-27}$ kilograms
mn neutron mass	$1.674927211 \times 10^{-27}$ kilograms
mμ muon mass	$1.88353130 \times 10^{-28}$ kilograms
G universal gravitation	6.67428×10^{-11} meters ³ per kilogram per seconds ²
F Faraday constant	96485.3399 Coulombs per mole
a0 Bohr radius	$5.2917720859 \times 10^{-11}$ meters
re classical electron radius	$2.8179402894 \times 10^{-15}$ meters
k Boltzmann constant	$1.3806504 \times 10^{-23}$ Joules per Kelvin
e electron charge	$1.602176487 \times 10^{-19}$ Coulombs
u atomic mass unit	$1.660538782 \times 10^{-27}$ kilograms
atm standard atmosphere	101325 Pascals
ϵ_0 permittivity of vacuum	$8.854187817620 \times 10^{-12}$ Farads per meter
μ_0 permeability of vacuum	$1.256637061436 \times 10^{-6}$ Newtons per ampere ²
Cc Coulomb's constant	$8.987551787368 \times 10^9$ meters per Farad

Conversions

The CONVERSIONS menu permits you to perform a total of 20 conversions (or 40 if converting both ways).

To access the CONVERSIONS menu, press **[2nd]** **[convert]**. Press one of the numbers (1-5) to select, or press **[↑]** and **[↓]** to scroll through and select one of the CONVERSIONS submenus. The submenus include the categories English-Metric, Temperature, Speed and Length, Pressure, and Power and Energy.

```
CONVERSIONS
1: English-Metric
2: Temperature
3: Speed, Length
```

```
CONVERSIONS
3: Speed, Length
4: Pressure
5: Power, Energy
```

English↔Metric conversion

Conversion

in ▶ cm	inches to centimeters
cm ▶ in	centimeters to inches
ft ▶ m	feet to meters
m ▶ ft	meters to feet
yd ▶ m	yards to meters
m ▶ yd	meters to yards
mile ▶ km	miles to kilometers
km ▶ mile	kilometers to miles
acre ▶ m ²	acres to square meters
m ² ▶ acre	square meters to acres
gal US ▶ L	US gallons to liters
L ▶ gal US	liters to US gallons
gal UK ▶ ltr	UK gallons to liters
ltr ▶ gal UK	liters to UK gallons
oz ▶ gm	ounces to grams
gm ▶ oz	grams to ounces

lb ▶ kg	pounds to kilograms
kg ▶ lb	kilograms to pounds

Temperature conversion

Conversion

°F ▶ °C	Fahrenheit to Celsius
°C ▶ °F	Celsius to Fahrenheit
°C ▶ °K	Celsius to Kelvin
°K ▶ °C	Kelvin to Celsius

Speed and length conversion

Conversion

km/hr ▶ m/s	kilometers/hour to meters/second
m/s ▶ km/hr	meters/second to kilometers/hour
LtYr ▶ m	light years per meter
m ▶ LtYr	meters to light years
pc ▶ m	parsecs to meters
m ▶ pc	meters to parsecs
Ang ▶ m	Angstrom to meters
m ▶ Ang	meters to Angstrom

Power and energy conversion

Conversion



J ▶ kWh	joules to kilowatt hours
kWh ▶ J	kilowatt hours to Joules
J ▶ cal	calories to Joules
cal ▶ J	Joules to calories
hp ▶ kWh	horsepower to kilowatt hours
kWh ▶ hp	kilowatt hours to horsepower

Pressure conversion

Conversion

atm ▶ Pa	atmospheres to Pascals
Pa ▶ atm	Pascals to atmospheres
mmHg ▶ Pa	millimeters of mercury to Pascals
Pa ▶ mmHg	Pascals to millimeters of mercury

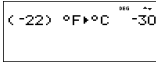
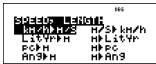
Examples

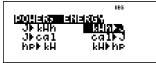
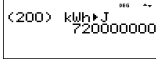
<p>Temperature</p> <p>() (-) 22) 2nd [convert] 2 enter enter</p> <p>(Enclose negative numbers/expressions in parentheses.)</p>	 <p>TEMPERATURE °C ↔ °F °C ↔ °F °C ↔ °C °F ↔ °F</p>  <p>(-22) °F ▶ °C -30</p>
<p>Speed, Length</p> <p>clear () 60) 2nd [convert] ▼ ▼ enter</p> <p>enter enter</p>	 <p>SPEED LENGTH km/h ▶ m/s m/s ▶ km/h Lit/yr ▶ H Lit/yr H ▶ Lit/yr Pct ▶ H H ▶ Pct An3 ▶ H H ▶ An3</p>  <p>(60) km/h ▶ m/s 16.66666667</p>
<p>Power, Energy</p> <p>clear () 200) 2nd [convert] ▼ ▼ ▼ ▼ enter ▸</p> <p>enter enter</p>	 <p>POWER ENERGY J ▶ kWh kWh ▶ J J ▶ cal cal ▶ J hp ▶ kW kW ▶ hp</p>  <p>(200) kWh ▶ J 720000000</p>

Complex numbers

2nd [complex]

The calculator performs the following complex number calculations:

- Addition, subtraction, multiplication, and division
- Argument and absolute value calculations
- Reciprocal, square, and cube calculations
- Complex Conjugate number calculations

Setting the complex format:

Set the calculator to DEC mode when computing with complex numbers.

mode \blacktriangledown \blacktriangledown \blacktriangledown Selects the **REAL** menu. Use \blacktriangleleft and \blacktriangleright to scroll with in the **REAL** menu to highlight the desired complex results format **a+bi**, or **r \angle θ** , and press **enter**.

REAL a+bi, or **r \angle θ** set the format of complex number results.

a+bi rectangular complex results

r \angle θ polar complex results

Notes:

- Complex results are not displayed unless complex numbers are entered.
- To access i on the keypad, use the multi-tap key $\left[\frac{\pi}{i}\right]$.
- Variables x , y , z , t , a , b , c , and d are real or complex.
- Complex numbers can be stored.
- Complex numbers are not allowed in data, matrix, vector, and some other input areas.
- For $\text{conj}()$, $\text{real}()$, and $\text{imag}()$, the argument can be in either rectangular or polar form. The output for $\text{conj}()$ is determined by the mode setting.
- The output for $\text{real}()$ and $\text{imag}()$ are real numbers.
- Set mode to DEG or RAD depending on the angle measure needed.

Complex menu	Description
1: \angle	\angle (polar angle character) Lets you paste the polar representation of a complex number (such as $5\angle\pi$).
2 :polar angle	angle(Returns the polar angle of a complex number.
3: magnitude	abs((or $ \square $ in MathPrint™ mode) Returns the magnitude (modulus) of a complex number.
4: $\blacktriangleright r\angle\pi$	Displays a complex result in polar form. Valid only at the end of an expression. Not valid if the result is real.
5: $\blacktriangleright a+bi$	Displays a complex result in rectangular form. Valid only at the end of an expression. Not valid if the result is real.
6: conjugate	conj(Returns the conjugate of a complex number.
7: real	real(Returns the real part of a complex number.
8: imaginary	imag(Returns the imaginary (nonreal) part of a complex number.

Examples (set mode to RAD)

Polar angle character: \angle	clear 5 2nd [complex] enter π_i $\frac{\square}{\square}$ 2 enter	$5\angle\frac{\pi}{2}$ $5i$
Polar angle: angle(clear 2nd [complex] \downarrow enter 3 + 4 π_i π_i π_i) enter	angle(3+4i) 0.927295218
Magnitude: abs(clear 2nd [complex] 3 (3 + 4 π_i π_i π_i) enter	$ 3+4i $ 5

► $r \angle \theta$	[clear] 3 [+] 4 [π^e_i] [π^e_i] [π^e_i] [2nd] [complex] 4 [enter]	$3+4i \rightarrow r \angle \theta$ $5 \angle 20.927295218$
► $a+bi$	[clear] 5 [2nd] [complex] [enter] 3 [π^e_i] [$\frac{\square}{\square}$] 2 [\blacktriangleright] [2nd] [complex] 5 [enter]	$5 \angle \frac{3\pi}{2} \rightarrow a+bi$ $-5i$
Conjugate: conj([clear] [2nd] [complex] 6 5 [-] 6 [π^e_i] [π^e_i] [π^e_i] [)] [enter]	$\text{conj}(5-6i)$ $5+6i$
Real: real([clear] [2nd] [complex] 7 5 [-] 6 [π^e_i] [π^e_i] [π^e_i] [)] [enter]	$\text{real}(5-6i)$ 5

Errors

When the calculator detects an error, it returns an error message with the type of error. The following list includes some of the errors that you may encounter.

To correct the error, note the error type and determine the cause of the error. If you cannot recognize the error, refer to the following list.

Press [clear] to clear the error message. The previous screen is displayed with the cursor at or near the error location. Correct the expression.

The following list includes some of the errors that you may encounter.

0<area<1 — This error is returned when you input an invalid value for area *invNormal*.

ARGUMENT — This error is returned if:

- a function does not have the correct number of arguments.
- the lower limit is greater than the upper limit.
- either index value is complex.

BREAK — You pressed the **[on]** key to stop evaluation of an expression.

CHANGE MODE to DEC — Base n mode: This error is displayed if the mode is not DEC and you press **[num-solv]**, **[poly-solv]**, **[sys-solv]**, **[expr-eval]**, **[table]**, **[matrix]**, **[vector]**, or **[convert]**.

COMPLEX — If you use a complex number incorrectly in an operation or in memory you will get the COMPLEX error.

DATA TYPE — You entered a value or variable that is the wrong data type.

- For a function (including implied multiplication) or an instruction, you entered an argument that is an invalid data type, such as a complex number where a real number is required.
- You attempted to store an incorrect data type, such as a matrix, to a list.
- Input to the complex conversions is real.
- You attempted to execute a complex number in an area that is not allowed.

DIM MISMATCH — You get this error if

- you attempt to store a data type with a dimension not allowed in the storing data type.
- you attempt a matrix or vector of incorrect dimension for the operation.

DIVIDE BY 0 — This error is returned when:

- you attempt to divide by 0.
- in statistics, $n = 1$.

DOMAIN — You specified an argument to a function outside the valid range. For example:

- For $x\sqrt{y}$: $x = 0$ or $y < 0$ and x is not an odd integer.
- For y^x : y and $x = 0$; $y < 0$ and x is not an integer.
- For \sqrt{x} : $x < 0$.
- For **LOG** or **LN**: $x \leq 0$.

- For **TAN**: $x = 90^\circ, -90^\circ, 270^\circ, -270^\circ, 450^\circ$, etc., and equivalent for radian mode.
- For **SIN⁻¹** or **COS⁻¹**: $|x| > 1$.
- For **nCr** or **nPr**: n or r are not integers ≥ 0 .
- For $x!$: x is not an integer between 0 and 69.

EQUATION LENGTH ERROR — An entry exceeds the digit limits (80 for stat entries or 47 for constant entries); for example, combining an entry with a constant that exceeds the limit.

Exponent must be Integer — This error is returned if the exponent is not an integer.

FORMULA — The formula does not contain a list name (L1, L2, or L3), or the formula for a list contains its own list name. For example, a formula for L1 contains L1.

FRQ DOMAIN — FRQ value (in **1-Var** and **2-Var** stats) < 0 .

Highest Degree coefficient cannot be zero — This error is displayed if a in a Polynomial solver calculation is pre-populated with zero, or if the you set a to zero and you move the cursor to the next input line.

Infinite Solutions — The equation entered in the System of linear equations solver has an infinite number of solutions.

Input must be Real — This error is displayed if a variable pre-populates with a non-real number where a real number is required and you move the cursor just past that line. The cursor is returned to the incorrect line and you must change the input.

Input must be non-negative integer — This error is displayed when an invalid value is input for x and n in the *DISTR* menus.

INVALID EQUATION — This error is returned when:

- The calculation contains too many pending operations (more than 23). If using the Stored operation feature (op), you attempted to enter more than four levels of nested functions using fractions, square roots, exponents with $^$, $\sqrt[x]{y}$, e^x , and 10^x .

- You press **enter** on a blank equation or an equation with only numbers.

Invalid Data Type — In an editor, you entered a type that is not allowed, such as a complex number, matrix, or vector, as an element in the stat list editor, matrix editor and vector editor.

Invalid domain — The Numeric equation solver did not detect a sign change.

INVALID FUNCTION — An invalid function is entered in the function definition in Function table.

Max Iterations Change guess — The Numeric equation solver has exceeded the maximum number of permitted iterations. Change the initial guess or check the equation.

Mean $\mu > 0$ — An invalid value is input for the mean (mean = μ) in *poissonpdf* or *poissoncdf*.

No sign change Change guess — The Numeric equation solver did not detect a sign change.

No Solution Found — The equation entered in System of linear equations solver has no solution.

Number of trials $0 < n < 41$ — Number of trials is limited to $0 < n < 41$ for *binomialpdf* and *binomialcdf*.

OP NOT DEFINED — The Operation [op] is not defined.

OVERFLOW — You attempted to enter, or you calculated a number that is beyond the range of the calculator.

Probability $0 < p < 1$ — You input an invalid value for a probability in DISTR.

$\sigma > 0$ sigma Real — This error is returned when an invalid value is input for **sigma** in the DISTR menus.

SINGULAR MAT — This error is displayed when:

- A singular matrix (determinant = 0) is not valid as the argument for **-1**.
- The **SinReg** instruction or a polynomial regression generated a singular matrix (determinant = 0) because it could not find a solution, or a solution does not exist.

STAT — You attempted to calculate 1-var or 2-var stats with no defined data points, or attempted to calculate 2-var stats when the data lists are not of equal length.

SYNTAX — The command contains a syntax error: entering more than 23 pending operations or 8 pending values; or having misplaced functions, arguments, parentheses, or commas. If using $\frac{\square}{\square}$, try using $\frac{\square}{\square}$ and the appropriate parentheses.

TOL NOT MET — You requested a tolerance to which the algorithm cannot return an accurate result.

TOO COMPLEX — If you use too many levels of MathPrint™ complexity in a calculation, the TOO COMPLEX error is displayed (this error is not referring to complex numbers).

LOW BATTERY — Replace the battery.

Note: This message displays briefly and then disappears. Pressing \square does not clear this message.

Battery information

Battery precautions

- Do not leave batteries within the reach of children.
- Do not mix new and used batteries. Do not mix brands (or types within brands) of batteries.
- Do not mix rechargeable and non-rechargeable batteries.
- Install batteries according to polarity (+ and -) diagrams.
- Do not place non-rechargeable batteries in a battery recharger.
- Properly dispose of used batteries immediately.
- Do not incinerate or dismantle batteries.
- Seek Medical Advice immediately if a cell or battery has been swallowed. (In the USA, contact the National Capital Poison Center at 1-800-222-1222.)

Battery disposal

Do not mutilate, puncture, or dispose of batteries in fire. The batteries can burst or explode, releasing hazardous chemicals. Discard used batteries according to local regulations.

How to remove or replace the battery

The TI-36X Pro calculator uses one 3 volt CR2032 lithium battery.

Remove the protective cover and turn the calculator face downwards.

- With a small screwdriver, remove the screws from the back of the case.
- From the bottom, carefully separate the front from the back. **Be careful** not to damage any of the internal parts.
- With a small screwdriver (if required), remove the battery.
- To replace the battery, check the polarity (+ and -) and slide in a new battery. Press firmly to snap the new battery into place.

Important: When replacing the battery, avoid any contact with the other components of the calculator.

Dispose of the dead battery immediately and in accordance with local regulations.

Per CA Regulation 22 CCR 67384.4, the following applies to the button cell battery in this unit:

Perchlorate Material - Special handling may apply.

See www.dtsc.ca.gov/hazardouswaste/perchlorate

In case of difficulty

Review instructions to be certain calculations were performed properly.

Check the battery to ensure that it is fresh and properly installed.

Change the battery when:

- **on** does not turn the unit on, or
- The screen goes blank, or
- You get unexpected results.

Texas Instruments Support and Service

For general information

Home Page:	education.ti.com
KnowledgeBase and e-mail inquiries:	education.ti.com/support
Phone:	(800) TI-CARES / (800) 842-2737 For U.S., Canada, Mexico, Puerto Rico, and Virgin Islands only
International information:	education.ti.com/international

For technical support

KnowledgeBase and support by e-mail:	education.ti.com/support
Phone (not toll-free):	(972) 917-8324

For product (hardware) service

Customers in the U.S., Canada, Mexico, Puerto Rico and Virgin Islands: Always contact Texas Instruments Customer Support before returning a product for service.

All other customers: Refer to the leaflet enclosed with this product (hardware) or contact your local Texas Instruments retailer/distributor.