

## DOCUMENT RESUME

ED 231 783

SP 022 615

AUTHOR Dougherty, Neil J., IV, Ed.  
 TITLE Physical Education and Sport for the Secondary School Student.  
 INSTITUTION American Alliance for Health, Physical Education, Recreation and Dance, Reston, VA. National Association for Sport and Physical Education.  
 REPORT NO ISBN-0-88314-249-X  
 PUB DATE 83  
 NOTE 413p.  
 AVAILABLE FROM American Alliance for Health, Physical Education, Recreation and Dance, P. O. Box 704, Waldorf, MD 20601 (\$11.95).  
 PUB TYPE Reports - Descriptive (141)

EDRS PRICE MF01 Plus Postage. PC Not Available from EDRS.  
 DESCRIPTORS \*Athletics; Dance Education; Exercise; Leisure Time; \*Lifetime Sports; Motor Development; \*Outdoor Activities; Physical Education; \*Physical Fitness; \*Recreational Activities; Recreational Facilities; Secondary Education

## ABSTRACT

This book provides an overview of sports and information on skills and technique acquisition, safety, scoring, rules and etiquette, strategy, equipment, and related terminology. The emphasis is on individual and dual sports for which facilities are widely available and body contact is limited or unnecessary. Chapters are included on: (1) Health Fitness (Russell R. Pate); (2) Motor Skill Development and Evaluation (Jerry R. Thomas and Jack K. Nelson); (3) Archery (Ruth E. Rowe and Julia Heagey Bowers); (4) Badminton (Arne L. Olson); (5) Basketball (Gene Doane); (6) Bowling (Norman E. Showers); (7) Dance in Education (Dennis Fallon); (8) Field Hockey (Barbara J. Belt and Barbara J. Reimann); (9) Cced Flag Football (Maryann Domitrovitz); (10) Golf (DeDe Owens); (11) Tumbling (Diane Bonanno and Kathleen Feigley); (12) Jogging (Russell R. Pate); (13) Orienteering (Arthur Hugglestone and Joe Howard); (14) Self-defense (Kenneth G. Tillman); (15) Racquetball/Handball (John P. Smyth); (16) Soccer (John F. Fellenbaum, Jr.); (17) Softball (Becky L. Sisley); (18) Swimming (Anne Ross Fairbanks); (19) Team Handball (Mike Cavanaugh); (20) Tennis (Jim Brown); (21) Track and Field (LeRoy T. Walker and Suzi D'Annolfo); (22) Volleyball (Barbara L. Viera); (23) Weight-training (Bob Ward); (24) Wrestling (Irwin Hess); and (25) A Career in Physical Education and Sport (Robert D. and Joyce A. Clayton). (JD)

\*\*\*\*\*  
 \* Reproductions supplied by EDRS are the best that can be made \*  
 \* from the original document. \*  
 \*\*\*\*\*

# Physical Education and Sport

for the  
Secondary  
School  
Student

ED231783

Neil J. Dougherty IV, Editor  
Rutgers College

Sponsored by



The National Association for  
Sport and Physical Education

an association of



The American Alliance for  
Health, Physical Education,  
Recreation and Dance

"PERMISSION TO REPRODUCE THIS  
MATERIAL IN MICROFICHE ONLY  
HAS BEEN GRANTED BY

G. Anderson

TO THE EDUCATIONAL RESOURCES  
INFORMATION CENTER (ERIC)."

U.S. DEPARTMENT OF EDUCATION  
NATIONAL INSTITUTE OF EDUCATION  
EDUCATIONAL RESOURCES INFORMATION  
CENTER (ERIC)

This document has been reproduced as  
received from the person or organization  
originating it.

Minor changes have been made to improve  
reproduction quality.

• Points of view or opinions stated in this docu-  
ment do not necessarily represent official NIE  
position or policy.

Copyright © 1983

The American Alliance for  
Health, Physical Education,  
Recreation and Dance  
1900 Association Drive  
Reston, Virginia 22091

ISBN 0-88314-249-X

# Purposes of the American Alliance For Health, Physical Education, Recreation and Dance

The American Alliance is an educational organization, structured for the purposes of supporting, encouraging, and providing assistance to member groups and their personnel throughout the nation as they seek to initiate, develop, and conduct programs in health, leisure, and movement-related activities for the enrichment of human life.

Alliance objectives include:

1. Professional growth and development—to support, encourage, and provide guidance in the development and conduct of programs in health, leisure, and movement-related activities which are based on the needs, interests, and inherent capacities of the individual in today's society.

2. Communication—to facilitate public and professional understanding and appreciation of the importance and value of health, leisure, and movement-related activities as they contribute toward human well-being.

3. Research—to encourage and facilitate research which will enrich the depth and scope of health, leisure, and movement-related activities; and to disseminate the findings to the profession and other interested and concerned publics.

4. Standards and guidelines—to further the continuous development and evaluation of standards within the profession for personnel and programs in health, leisure, and movement-related activities.

5. Public affairs—to coordinate and administer a planned program of professional, public, and governmental relations that will improve education in areas of health, leisure, and movement-related activities.

6. To conduct such other activities as shall be approved by the Board of Governors and the Alliance Assembly, provided that the Alliance shall not engage in any activity which would be inconsistent with the status of an educational and charitable organization as defined in Section 501(c) (3) of the Internal Revenue Code of 1954 or any successor provision thereto, and none of the said purposes shall at any time be deemed or construed to be purposes other than the public benefit purposes and objectives consistent with such educational and charitable status.

*Bylaws, Article III*

# Table of Contents

Foreword .....	vii
Acknowledgments .....	viii
<b>CHAPTER 1</b>	
Health Fitness .....	<i>Russell R. Pate</i> 1
<b>CHAPTER 2</b>	
Motor Skill Development and Evaluation .....	<i>Jerry R. Thomas and Jack K. Nelson</i> 21
<b>CHAPTER 3</b>	
Archery .....	<i>Ruth E. Rowe and Julia Heagey Powers</i> 35
<b>CHAPTER 4</b>	
Badminton .....	<i>Arne L. Olson</i> 47
<b>CHAPTER 5</b>	
Basketball .....	<i>Gene Doane</i> 63
<b>CHAPTER 6</b>	
Bowling .....	<i>Norman E. Showers</i> 77
<b>CHAPTER 7</b>	
Dance in Education .....	<i>Dennis Fallon</i> 93
<b>CHAPTER 8</b>	
Field Hockey .....	<i>Barbara J. Belt and Barbara J. Reirann</i> 103
<b>CHAPTER 9</b>	
Coed Flag Football .....	<i>Maryann D. Mitrovitz</i> 115
<b>CHAPTER 10</b>	
Golf .....	<i>DeDe Owens</i> 129
<b>CHAPTER 11</b>	
Tumbling .....	<i>Diane Bonanno and Kathleen Feigley</i> 151
<b>CHAPTER 12</b>	
Jogging .....	<i>Russell R. Pate</i> 179
<b>CHAPTER 13</b>	
Orienteering .....	<i>Arthur Hugglestone and Joe Howard</i> 191
<b>CHAPTER 14</b>	
Self-defense .....	<i>Kenneth G. Tillman</i> 201
<b>CHAPTER 15</b>	
Racquetball/Handball .....	<i>John P. Smyth</i> 223
<b>CHAPTER 16</b>	
Soccer .....	<i>John F. Fellenbaum, Jr.</i> 235

<b>CHAPTER 17</b>		
Softball .....	<i>Becky L. Sisley</i>	251
<b>CHAPTER 18</b>		
Swimming .....	<i>Anne Ross Fairbanks</i>	267
<b>CHAPTER 19</b>		
Team Handball .....	<i>Mike Cavanaugh</i>	289
<b>CHAPTER 20</b>		
Tennis .....	<i>Jim Brown</i>	305
<b>CHAPTER 21</b>		
Track and Field .....	<i>LeRoy T. Walker and Suzi D'Annolfo</i>	321
<b>CHAPTER 22</b>		
Volleyball .....	<i>Barbara L. Viera</i>	345
<b>CHAPTER 23</b>		
Weight-training .....	<i>Bob Ward</i>	365
<b>CHAPTER 24</b>		
Wrestling .....	<i>Irwin Hess</i>	383
<b>CHAPTER 25</b>		
A Career in Physical Education and Sport .....	<i>Robert D. and Joyce A. Clayton</i>	399

# Foreword

Physical education and sports, like other educational programs, have been undergoing continual revision. In response to developments in the field, the Secondary School Physical Education Council, a structure of the National Association for Sport and Physical Education, has updated and completely revised the popular textbook, *Physical Education for High School Students*.

The earlier editions and now this rewritten third edition have been the culmination of efforts of many concerned professionals who saw a need to provide the secondary school student with a comprehensive and authoritative textbook on contemporary physical education and sports concepts. This third edition carries a new title, *Physical Education and Sport for the Secondary School Student*. The book is designed to provide the student with an overview of sports, information on skill and technique acquisition, safety, scoring, rules and etiquette, strategy, equipment, and related terminology. In addition, several new chapters have been included to keep pace with the trends in present-day programming.

It is the intention of the National Association for Sport and Physical Education that this book will assist the student, physical education teacher, and parent in selecting and developing a well-balanced program of activities which today's youth can value throughout their lifetime.

Roswell D. Merrick, *Executive Director*  
The National Association for  
Sport and Physical Education

*NASPE is an association of the American Alliance for Health, Physical Education, Recreation and Dance.*

# Acknowledgments

## Planning Committee

Tim Brown, *Chair*  
Skidmore College  
Saratoga Springs, NY

Patricia Barry  
Montgomery County Public Schools  
Rockville, MD

Charles Bucher  
University of Las Vegas  
Las Vegas, NV

Neil Dougherty  
Rutgers University  
New Brunswick, NJ

Charles Hungerford  
School District of Lancaster  
Lancaster, PA

Roswell Merrick  
NASPE Executive Director  
Reston, VA

## Editorial Committee

Neil Dougherty, *Editor*  
Rutgers University  
New Brunswick, NJ

Patricia Barry  
Montgomery County Public Schools  
Rockville, MD

Diane Bonanno  
Rutgers University  
New Brunswick, NJ

Tim Brown  
Skidmore College  
Saratoga Springs, NY

*Special thanks to Isabelle Brown, Skidmore College; Jane Misurelli, Skidmore College; Sonia Regalado, East Brunswick High School, NJ; James Moryan, Linwood Jr. High School, NJ; and Richard Twitchell, Rutgers University, for their editorial assistance. We also extend our appreciation to Mrs. Janice Houtman for her assistance in the preparation of the manuscript, to Principal George Felton and the students at South Lakes High School, Reston, Virginia, for their time and cooperation, and to Annalisa Kraft and Jay Paul of The Loudon Times-Mirror, Leesburg, Virginia and Jim Kirby of The Reston Times, Reston, Virginia, for donation of cover photographs.*



## **Authors**

### *A Career in Physical Education and Sport*

Robert D. and Joyce A. Clayton,  
*Independent Consultants*  
Fort Collins, CO

### *Archery*

Ruth E. Rowe, *Consultant*  
National Archery Association  
Colorado Springs, CO

Julia Heagey Bowers  
Millersville State College  
Millersville, PA

### *Badminton*

Arne L. Olson  
East Stroudsburg State College  
East Stroudsburg, PA

### *Basketball*

Gene Doane  
Seneca Valley High School  
Gaithersburg, MD

### *Bowling*

Norman E. Showers  
Southern Illinois University  
Edwardsville, IL

### *Coed Flag Football*

Maryann Domitrovitz  
Pennsylvania State University  
University Park, PA

### *Dance in Education*

Dennis Fallon  
University of Missouri  
St. Louis, MO

### *Field Hockey*

Barbara J. Belt  
John F. Kennedy High School  
Silver Spring, MD

Barbara J. Reimann  
The American University  
Washington, DC

### *Golf*

DeDe Owens, *Consultant*  
National Golf Foundation  
West Palm Beach, FL

### *Health Fitness*

Russell R. Pate  
University of South Carolina  
Columbia, SC

### *Jogging*

Russell R. Pate  
University of South Carolina  
Columbia, SC

### *Motor Skill Development and Evaluation*

Jerry R. Thomas and  
Jack K. Nelson  
Louisiana State University  
Baton Rouge, LA

### *Orienteering*

Arthur Hugglestone and  
Joe Howard  
Smith Environmental Education Center  
Rockville, MD

### *Racquetball/Handball*

John P. Smyth  
The Citadel  
Charleston, SC

### *Self-defense*

Kenneth G. Fillman  
Trenton State College  
Trenton, NJ

### *Soccer*

John F. Fellenbaum, Jr.  
Lincoln Junior High School and  
Franklin and Marshall College  
Lancaster, PA

### *Softball*

Becky L. Sisley  
University of Oregon  
Eugene, OR

### *Swimming*

Anne Ross Fairbanks  
Skidmore College  
Saratoga Springs, NY

### *Team Handball*

Mike Cavanaugh  
United States Team Handball Federation  
Short Hills, NJ

*Tennis*

Jim Brown  
McNeese State University  
Lake Charles, LA

*Track and Field*

LeRoy T. Walker  
North Carolina Central University  
Durham, NC

Suzi D'Annolfo  
West Hartford Public Schools  
West Hartford, CT

*Tumbling*

Diane Boranno  
Rutgers University  
New Brunswick, NJ

Kathleen Feigley  
Feigley's School of Gymnastics  
South Plainfield, NJ

*Volleyball*

Barbara L. Viera  
University of Delaware  
Newark, DE

*Weight-training*

Bob Ward  
Dallas Cowboys Football Club  
Dallas, TX

*Wrestling*

Irwin Hess  
Kutztown State College  
Kutztown, PA

aerobic energy production (p. 7)  
atherosclerosis (p. 4)  
body composition (p. 9)  
cardiorespiratory endurance (p. 6)  
chronic diseases (p. 1)  
cool-down (p. 8)  
coronary heart disease (p. 4)  
coronary heart disease risk factors (p. 4)  
flexibility (p. 12)  
health (p. 2)  
health-related physical fitness (p. 4)  
hypokinetic diseases (p. 2)  
infectious diseases (p. 1)  
lordosis (p. 5)  
low back pain (p. 5)  
muscular endurance (p. 11)  
muscular strength (p. 11)  
obesity (p. 5)  
overload (p. 12)  
percent body fat (% fat) (p. 9)  
physical fitness (p. 3)  
physical working capacity (p. 6)  
static stretching (p. 12)  
warm-up (p. 8)  
wellness (p. 3)

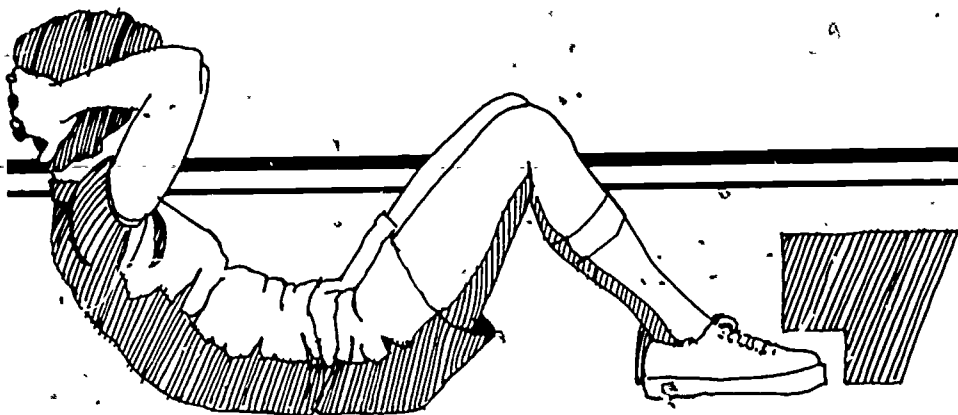

# Health Fitness

RUSSELL R. PATE,  
University of South Carolina,  
Columbia, SC

## INTRODUCTION

A basic characteristic of all animal life is the capacity for independent movement. Though styles of movement vary greatly within the animal kingdom, the motivations for movement are essentially the same in animals ranging from the one-celled protozoa to the higher order mammals. All animals, regardless of size and structural complexity, must move through their environment to find food, seek shelter, and to escape or defend against enemies. It is no exaggeration to say that, for animals, movement is the basis of life.

The human being, *Homo Sapiens*, is a perfect example of an animal species whose survival has depended on the ability to move effectively. Through most of his two million years on earth man has lived as a hunter and gatherer. His food supply, consisting mainly of wild animals, and naturally grown vegetables, was secured through the use of physical abilities such as endurance, strength, and speed. For early man, a new physical fitness test was presented daily and the prize was a valuable one—survival!

Today, machines do much of the physical labor which man used to do by hand. Indeed, the typical American of today is employed in a job which presents little or no physical challenge. Most Americans use automobiles for transportation, employ numerous "labor-saving devices" in their occupations, and even use machines to reduce the physical effort of leisure time activities. Thus, modern man, if he chooses, can lead a life almost totally void of vigorous physical activity. Some authorities have suggested, partly in jest, that man's species name should be changed to *Homo Sedentarius!*

The many technological advances of the past century have resulted in an enhanced standard of living for most Americans.

However, oddly enough, the life span of the typical American has increased only marginally since 1900. As indicated in Table 1, in 1900 the typical adult at age 20 could expect to live for another 42.8 years, while in 1976 the average 20-year-old male was expected to live 54.6 more years. It cannot be denied that numerous medical breakthroughs have occurred since 1900. However, most of these advances have contributed to treatment and prevention of infectious diseases such as smallpox, pneumonia, and tuberculosis. To date, medical science has not been successful in preventing chronic diseases such as coronary heart disease, stroke, and cancer. Today most Americans die, not from the infectious diseases which killed their grandparents and great-grandparents, but from chronic diseases and accidents (see Table 2). It is perhaps ironic that modern

Table 1. Life expectancy of Americans:  
1900-1976.

Year	Remaining Life Expectancy in Years		
	At Birth	At 20 Years	At 65 Years
1900	47.3	42.8	11.9
1950	68.2	51.3	13.9
1960	69.7	52.4	14.3
1970	70.9	53.1	15.2
1976	72.8	54.6	16.0

Table 2. Leading causes of death in 1900 and 1970 (deaths per 100,000 population).

1900	1970
1. Pneumonia and influenza (202)	Diseases of the heart (362)
2. Tuberculosis (194)	Cancer (163)
3. Intestinal diseases (143)	Stroke (102)
4. Diseases of the heart (137)	Accidents (56)
5. Intracranial lesions (107)	Pneumonia and influenza (31)
6. Kidney diseases (89)	Certain causes of infant death (21)
7. Accidents (72)	Diabetes (19)
8. Cancer (64)	Arteriosclerosis (16)
9. Senility (50)	Cirrhosis of liver (16)
10. Diphtheria (40)	Bronchitis, emphysema, asthma (15)

technology, which has contributed so much to our standard of living, has apparently brought with it a series of health risks for which science has yet to provide solutions.

Mounting evidence suggests that an inactive lifestyle, made possible by modern technology, is a direct contributor to many chronic diseases. Indeed, health professionals have coined a new term, hypokinesia, to describe a style of living characterized by lack of physical exercise. The so-called hypokinetic diseases are those which occur more frequently in sedentary persons than in persons who maintain high levels of physical activity. Often listed among the hypokinetic diseases are coronary heart disease, obesity, diabetes, high blood pressure, and low back pain. Clearly, industrialization and modern technology have left man vulnerable to a deadly set of health risks. The health challenge of the latter half of the 20th century is to conquer these diseases of affluence. Thus, the purposes of this chapter are: to discuss the relationship between exercise habits and health; to describe the specific components of physical fitness which, if maintained at a high level, can help prevent hypokinetic diseases and enhance the quality of life.

## CONCEPTS OF HEALTH AND FITNESS

### DEFINITIONS OF HEALTH

Twentieth century Americans are fortunate to live in a society which provides them with a considerable degree of security. The great affluence of today's society has liberated them from the day-to-day struggle for survival and has permitted them to strive for higher levels of human existence. Today it is common to ponder over the "quality of life."

Certainly, good health maintenance is an essential component of a high quality of life. In the absence of good health, it is impossible to enjoy the other benefits of an economically and culturally wealthy society. Since health is such a key aspect of the

quality of life, it is not surprising that modern America has made a massive investment in health care and health promotion. America's health consciousness is evident at every turn.

In 1979, for instance, Americans spent \$212.2 billion on health care. This figure represented 9% of the nation's Gross National Product (total output of goods and services). Clearly, Americans believe that health is important and are willing to pay a hefty price to secure it.

### Diseases—Treatment and Prevention

While 20th century Americans may be paying more for health services than any previous society, their basic approach to health care is neither unique nor new. Most organized health activities have been and continue to be disease-oriented. Persons have considered themselves healthy if they have not suffered from the symptoms of some ailment or illness. Indeed, health has often been defined as a state of being free from disease or pain.

Traditionally, most of man's professional health care has been designed to provide treatment for existing disease conditions. The earliest physicians spent most of their time attempting to cure or reduce the symptoms of illnesses, the causes of which were virtually unknown. Today, a much greater understanding of the causes of disease is had and treatment procedures have become highly sophisticated. Still, most health care professionals are primarily trained to help sick people become well again.

Nobody can argue with the need to provide health care for the sick and disabled. However, the inadequacies of a health care system which deals narrowly with treatment of disease while overlooking the benefits of disease prevention are being rapidly recognized. Among the weaknesses of a treatment-oriented health system are: no adequate treatments exist for many diseases (for example, no emergency care facilities can help a person who experiences a sudden lethal heart attack), many diseases, even if treated, leave permanent disabilities; most diseases involve painful or irritating symptoms which

reduce the afflicted person's functional capacity; cost of medical treatment can be massive.

Today, health planners are beginning to place greater emphasis on prevention of disease. A prevention-oriented approach to health maintenance has the potential to minimize the above-mentioned problems. Since 1900 notable successes with the infectious diseases have been recognized, many of which now can be prevented through inoculations. However, there is yet to be success in preventing the chronic diseases which are now the most common causes of death. Since the chronic diseases are often caused by societal and personal lifestyle characteristics, e.g., cigarette smoking, sedentary living, industrial pollution, prevention of these diseases will depend on changing human behavior. Some of those changes, undoubtedly, will be difficult to achieve. However, such changes are possible, and they are necessary if further significant improvement in the health of the population is to be gained.

#### Wellness

Relatively new to the field of public health is the concept of wellness. Wellness might be defined as a state of physical and mental health consistent with optimal human function. The wellness philosophy is based on the assumption that improvement of health variables, above the level needed to avoid disease, enhances quality of life. The wellness trend is an important one in contemporary America and suggests that the traditional definition of health, i.e., absence of disease, is no longer adequate. Thus, a more current and comprehensive definition of health might be a state of body and mind characterized by absence of illness and by a level of vigor which permits fulfillment of human potential.

#### DEFINITIONS OF PHYSICAL FITNESS

The term physical fitness is familiar to almost everyone. Surveys indicate that the typical American appreciates physical fitness, considers exercise to be a good health habit, and understands that one's physical fitness is related to his/her exercise habits. *Nonetheless, many Americans fail to exercise*

*regularly enough to maintain adequate physical fitness and many others use exercise improperly and consequently fail to achieve the potential benefits of good physical fitness.* These deficiencies suggest that many persons do not have a clear understanding of what physical fitness is and how it can be attained. To correct this problem it is important to develop a clear definition of physical fitness.

Over the years, many definitions of physical fitness have been proposed. One widely accepted definition suggests that physical fitness is the ability to perform daily tasks with vigor and alertness, without undue fatigue, and with ample energy to enjoy leisure-time pursuits and to meet unforeseen emergencies. It is important to note that this definition indicates that fitness is something which pertains to everyday lives. Physical fitness is not to be equated simply with performance on certain physical fitness tests. Rather, the ultimate test of physical fitness is the ability to meet, efficiently and effectively, the physical demands of daily life. Also, this definition of physical fitness implies that fitness is a matter of concern for everyone. Since everybody encounters physical demands, everybody needs to maintain an adequate level of physical fitness.

In studying man's physical abilities, researchers have identified several components of physical fitness. These components, which are listed and defined in Table 3, combine to determine an individual's overall physical performance capacity. As depicted in Diagram 1, all of the physical fitness components can be important in the

Table 3. Definitions of physical fitness components.

- Agility—Speed in changing direction or in changing body positions.
- Balance—Maintenance of a stable body position.
- Body Composition—Fatness, ratio of fat weight to total body weight.
- Cardiorespiratory Endurance—Ability to sustain moderate intensity whole body activity for extended time periods.
- Flexibility—Range of motion in a joint or series of joints.
- Muscular Endurance—Ability to perform repeated, high intensity muscle contractions.
- Muscular Strength—Maximum force applied with a single muscle contraction.
- Power—Maximum rate of force generation and work performance.

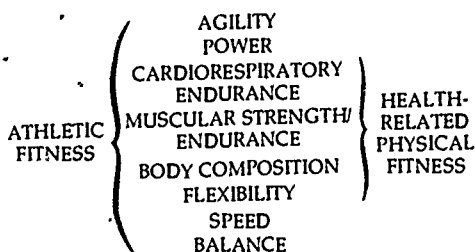

Diagram 1. Components of athletic fitness and health-related physical fitness.

realm of athletics; however, only a few of the fitness components are known to be related to health. These latter components contribute to health-related physical fitness which is a state characterized by: ability to perform daily tasks with vigor and without undue fatigue; demonstration of physical traits associated with minimal risk of developing hypokinetic disease. The following sections of this chapter provide a complete discussion of the health-related fitness components which should be of concern to everyone.

### RELATIONSHIPS BETWEEN PHYSICAL FITNESS AND HEALTH

Throughout much of recorded history, man has recognized physical fitness as a key component of a healthy lifestyle. The ancient Greeks were perhaps the first to actively promote exercise as a contributor to good health. Their philosophy, embodied in the Latin phrase *mens sano in corpore sano* (a sound mind in a sound body), has survived through the ages and today provides a philosophical basis for many health fitness programs. Today it is clear that regular exercise can contribute to good health by reducing the risk of developing certain diseases and by improving the body's ability to function, which in turn contributes to wellness and the quality of life. Developing a clear understanding of the values of physical fitness requires consideration of how health can be affected by regular exercise.

### EXERCISE AND DISEASE PREVENTION

Evidence indicates that individuals who exercise properly are less likely than inactive persons to develop three specific health

problems: coronary heart disease; obesity; low back pain. All of these diseases are widespread in modern America and have become more prominent as our population has become more inactive.

### Coronary Heart Disease

Diseases of the cardiovascular system, i.e., the heart and blood vessels, are responsible for roughly one-half of all deaths in the United States each year. Most of these cardiovascular disease deaths are due to a disease process called atherosclerosis. Atherosclerosis involves the buildup of fatty deposits, called plaque, on the inner wall of the arteries. Arteries are blood vessels which carry oxygenated blood to all the body's tissues. If these vessels become clogged with plaque, blood flow and oxygen delivery to vital tissues can be impaired or completely shut off. If the arteries affected by atherosclerosis are those which carry blood to the heart muscle the result can be coronary heart disease and, eventually, a heart attack.

The causes of coronary heart disease are not fully understood. However, several coronary heart disease risk factors have been identified. These risk factors are characteristics which, if present, tend to increase a person's chances of developing the disease. The primary and secondary coronary heart disease risk factors are listed in Table 4. It is important to note that physical inactivity is now considered to be a risk factor for coronary heart disease.

The conclusion that physically active persons are less likely than sedentary persons to develop coronary heart disease is based on several lines of research evidence. For one, several studies have shown that persons who have very physically active occupations are less likely than sedentary

Table 4. Coronary heart disease risk factors.

<i>Primary Risk Factors</i>	
Elevated Serum Cholesterol	
High Blood Pressure	
Cigarette Smoking	
<i>Secondary Risk Factors</i>	
Obesity	
Physical Inactivity	
Psychological Stress	
Diabetes	

workers to develop coronary heart disease. Also, as shown in Table 5, physically fit persons tend to have fewer of the risk factors associated with coronary heart disease than unfit individuals. In addition, studies of sedentary persons who enter exercise training programs have shown that many of the physical results of exercise training are beneficial in terms of cardiovascular health (see Table 6). While it should not be concluded that regular exercise can absolutely prevent coronary heart disease, it is likely that maintenance of good fitness can reduce the chance of developing this disease.

**Table 5.** Coronary heart disease risk factors in high and low fit adult men.\*

Risk Factor	Low Fit	High Fit
Cholesterol (mg%)	237	217
Diastolic Blood Pressure (mm Hg)	86	80
Serum Glucose (mg%)	112	102
Triglycerides (mg%)	179	87
% Body Fat	29	18

\*Cooper, K. H., Pollock, M. L., Martin, R. P., et al. "Physical Fitness Levels vs Selected Coronary Risk Factors. *JAMA* 236:166-9."

**Table 6.** Effects of exercise training which may reduce coronary heart disease risk.

*Increased*

- Oxygen transport ability
- Efficiency of heart function
- Tolerance to stress
- Glucose tolerance

*Decreased*

- Blood fat levels
- Obesity
- Arterial blood pressure

### Obesity

Excessive body fatness, or obesity, is extremely common in the American population and is a major cause of ill health. Obese persons are much more likely than persons of normal body fatness to develop diseases such as diabetes and high blood pressure. Also, obesity itself has been established as a risk factor for coronary heart disease.

Obesity is the result of excessive storage of fat in the body's tissues. This storage of fat occurs whenever an individual consumes more calories in food than are expended during daily activities. Obesity can result from overeating and other poor die-

tary practices. In addition, however, obesity is often caused by physical inactivity.

Obesity is rarely observed in individuals who are very physically active. Persons who continue to exercise regularly throughout adulthood tend to stay in caloric balance and to avoid the gradual addition of body fat which can lead to obesity. An increase in physical activity almost always causes a reduction in body fatness in persons who are moderately or severely obese.

### Low Back Pain

One of the most common ailments observed in adult Americans is low back pain. Chronic pain in the low back region can be caused by numerous factors including traumatic injury and genetic malformation of the spine. However, very frequently low back pain results from a condition called lordosis which develops gradually over several years. Lordosis, sometimes referred to as "sway back," is an exaggerated curvature in the lower spine (see Figure 1), frequently developing from lack of proper exercise.

Lordosis and the low back pain it causes are related to two fitness deficiencies: weakness in the abdominal muscles; tightness (shortening) of the low back and hamstring muscles (see Figure 1). Weakness of the abdominal muscles makes the organs of the abdominal cavity protrude and pull forward on the spine. Tightness in the muscles of the low back and hamstring areas tend to tip the hip bone forward, thereby exaggerating the curvature of the lower spine. Lordosis, if it becomes sufficiently extreme, can cause pressure on spinal nerves as they leave the spinal cord. This pressure causes pain which may become chronic and debilitating.

Low back pain is seldom observed in regular exercisers, since they tend to maintain good strength in the abdominal muscles and adequate flexibility in the low back region. Exercise routines are often prescribed by physicians for persons suffering from low back pain. Exercise cannot prevent or cure all cases of low back pain, but evidence suggests that the incidence of this problem would be lower if everybody exercised properly and regularly.



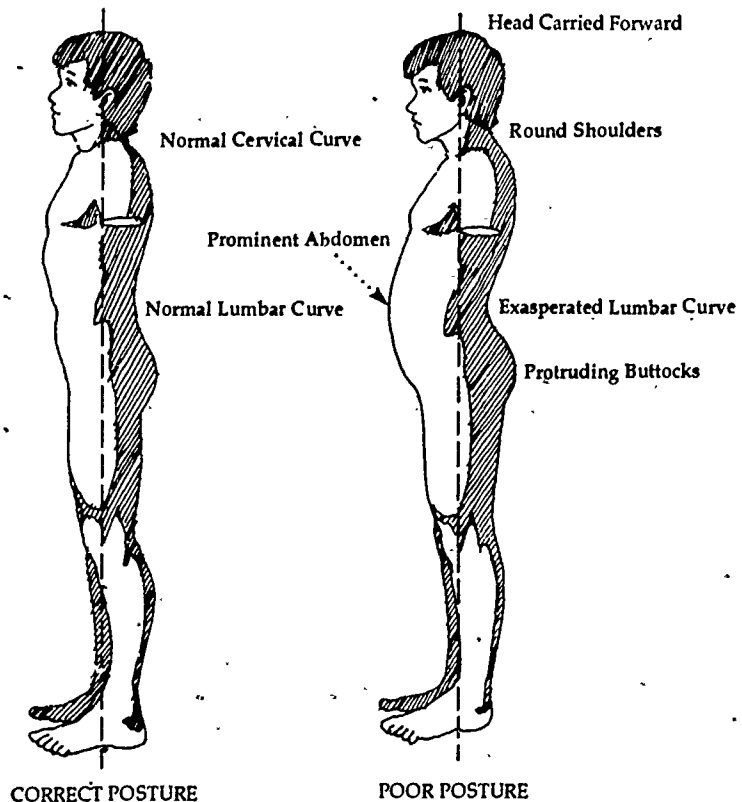

Figure 1. Lordosis, shown on the right, can contribute to low-back-pain.

### EXERCISE AND WELLNESS

The disease prevention benefits of regular exercise are highly significant. Most regular exercisers, however, report that the primary benefit of physical activity is simply "feeling better." Many exercisers agree that physical activity makes them feel more alert, relaxed, and vigorous. Persons who improve their physical fitness usually find that they are less fatigued by their daily tasks and are able to more comfortably participate in strenuous activities.

These beneficial effects of exercise are generally attributed to the increase in physical working capacity known to result from training. A person's physical working capacity is closely related to his/her ability to use oxygen for the production of energy in the muscle tissues. A person's ability to

consume oxygen is limited by the functional capacity of his/her body's cardiorespiratory system, i.e., strength of heart, elasticity of vessels. Endurance exercise training improves the fitness of the cardiorespiratory system and, thus, the body's ability to use oxygen. These effects make it easier for the physically fit person to perform those activities requiring sustained exertion.

Regular exercise may also carry significant psychological benefits. Many persons find that vigorous exercise helps them relax and to cope with the stresses of a busy life. Some psychologists even use exercise as a means for treating depression and other psychological disorders. The psychological effects of exercise are believed to combine with its physical effects to produce the feeling of well-being which most exercisers experience.

## COMPONENTS OF HEALTH-RELATED PHYSICAL FITNESS

The contributions physical fitness can make toward the prevention of disease and promotion of health are highly significant. Thus, it is crucial to know how to evaluate one's own fitness and how to maintain and/or develop a good level of health-related fitness. This section will present several simple tests of health-related fitness and will describe the types of exercise known to improve the health fitness components.

### CARDIORESPIRATORY ENDURANCE

Cardiorespiratory endurance is a person's ability to exercise for long periods of time. It is related to the fitness of the heart, lungs, and blood vessels, all of which work together to carry oxygen to the muscles. During exercise the active muscles require increased amounts of oxygen for use in energy production. Good cardiorespiratory endurance enables one to perform activities like jogging or swimming without tiring rapidly. Persons who have good cardiorespiratory fitness tend to be less fatigued by daily activities, and quickly recover after strenuous exertion.

Cardiorespiratory endurance can be easily measured with tests of distance running ability. The mile run for time is one of the tests of cardiorespiratory fitness designated

by the American Alliance for Health, Physical Education, Recreation and Dance (AAHPERD). To take the test, all that is needed is a track or other accurately measured area, and a clock. Before running the mile, the subject should do some distance running for practice and should learn the approximate pace of jogging or running he/she can sustain for the entire mile. An even pace is usually best; one should avoid starting the run at a pace which is too fast. Table 7 provides percentile scores against which the subject can compare his/her performance. If his/her score ranks above the 50th percentile, he/she currently has a good level of cardiorespiratory fitness. However, those scoring below the 50th percentile should strive to improve by starting a proper cardiorespiratory exercise program.

Cardiorespiratory endurance can best be improved by regular participation in aerobic exercise. Aerobic activities are those which increase the heart rate for long periods of time. Table 8 lists several of the most popular aerobic activities. In designing an exercise program one should select an activity or set of activities which he/she enjoys and participates in regularly. Many people combine the aerobic activities of Table 8 into an overall program which is practical and enjoyable, such as playing racquetball once per week and jogging twice per week.

Table 7. Norm scores for mile run (minutes and seconds).

GIRLS								
AGE	10	11	12	13	14	15	16	17
PERCENTILES								
95	7:59	7:46	7:26	7:10	7:18	7:39	7:07	7:26
75	9:30	9:12	8:36	8:18	8:13	8:42	9:00	9:03
50	11:06	10:27	9:47	9:27	9:35	10:05	10:45	9:47
25	12:54	12:10	11:35	10:56	11:43	12:21	13:00	11:28
5	17:00	16:56	14:46	14:55	16:59	16:22	15:30	15:24
BOYS								
AGE	10	11	12	13	14	15	16	17
PERCENTILES								
95	6:56	6:50	6:27	6:11	5:51	6:01	5:48	6:01
75	8:10	8:00	7:24	6:52	6:36	6:35	6:28	6:36
50	9:19	9:06	8:20	7:27	7:10	7:14	7:11	7:25
25	11:05	11:31	10:00	8:35	8:02	8:04	8:07	8:26
5	14:28	15:25	13:41	10:23	10:32	10:37	10:40	10:56

## 8 PHYSICAL EDUCATION AND SPORT FOR THE SECONDARY SCHOOL STUDENT

**Table 8. Aerobic activities.**

Walking	Aerobic Dancing
Jogging	Racquetball
Swimming	Handball
Cycling	Ice Skating
Rope Jumping	Cross-country Skiing

Having selected an aerobic activity, it is important that the activity be used properly. Following are some guidelines which will help to design a successful cardiorespiratory endurance training program:

- 1. Frequency of exercise.** Aerobic exercise should be engaged in three or more times per week. When first beginning an exercise program, it is usually best to exercise every other day. As fitness improves, frequency of training may be increased to five or six sessions per week.
- 2. Duration of exercise.** Aerobic exercise should be sustained continuously for at least 30 minutes per session. In starting a program it is often wise to limit the duration of exercise to 15-20 minutes. However, within a few weeks most persons are able to sustain 30 minutes of continuous, aerobic exercise.
- 3. Intensity of exercise.** To produce improvement of cardiorespiratory endurance, aerobic exercise must be used with sufficient intensity. However, it is important to note that only a moderate intensity of exercise is required. This intensity will cause the heart rate and breathing rate to increase, and will often bring about sweating. An easy way to establish a proper exercise intensity is to check the heart rate. This can be done by feeling the pulse in the wrist or neck. The procedure outlined in Table 9 should be used to determine the training heart rate.

When beginning a training program it is necessary to experiment to determine the intensity of exercise which will elicit the selected training heart rate. As shown in Diagram 2, heart rate tends to increase as exercise intensity increases. By checking his/her heart rate at several exercise intensities, the subject will find the intensity corresponding to the desired training heart rate (see Figure 2).

Having identified the appropriate intensity, the goal should be to sustain

**Table 9. Method for determining a training heart rate.**

- Step 1. Measure Resting Heart Rate (RHR).**  
Rest quietly for 5-10 minutes.  
Count heart beats for 60 seconds.
- Step 2. Estimate Maximum Heart Rate (MHR).**  
Maximal heart rate decreases with age.  
Estimate MHR with the following equation.  
 $MHR = 220 - \text{age in years.}$
- Step 3. Compute Training Heart Rate (THR).**  
An appropriate training heart rate can be computed with the following equation:  
 $THR = RHR + .6 (MHR - RHR)$

*Example*

If, RHR = 60 beats per minute  
and  
MHR = 205 beats per minute  
Then,  $THR = 60 + .6 (205 - 60)$   
 $= 60 + 87$   
 $= 147$  beats per minute

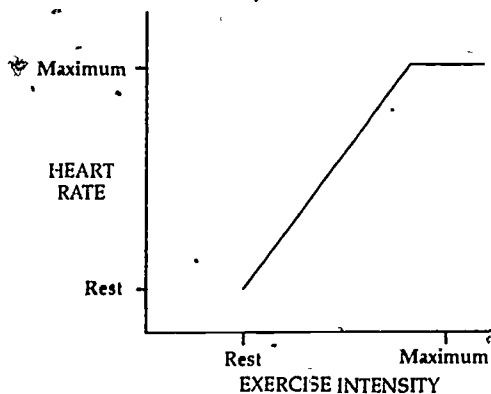

**Diagram 2. Relationship between heart rate and exercise intensity.**

that intensity for 30 minutes. However, few beginners are able to accomplish this, and should instead use intermittent exercise in which recovery periods alternate with exercise periods. For example, a beginning jogger might alternate 3 minutes of jogging with 2 minutes of walking for a total of 20 minutes.

- 4. Warm-up and cool-down.** Each training session should begin with light calisthenic exercises and/or some other form of low intensity exercise. This allows the body to gradually adjust to the demands of aerobic exercise. Likewise, each session should finish with a gradual cool-down. Usually five minutes of walking or light calisthenics is sufficient. Such activity allows the body to gradually return to the resting state.

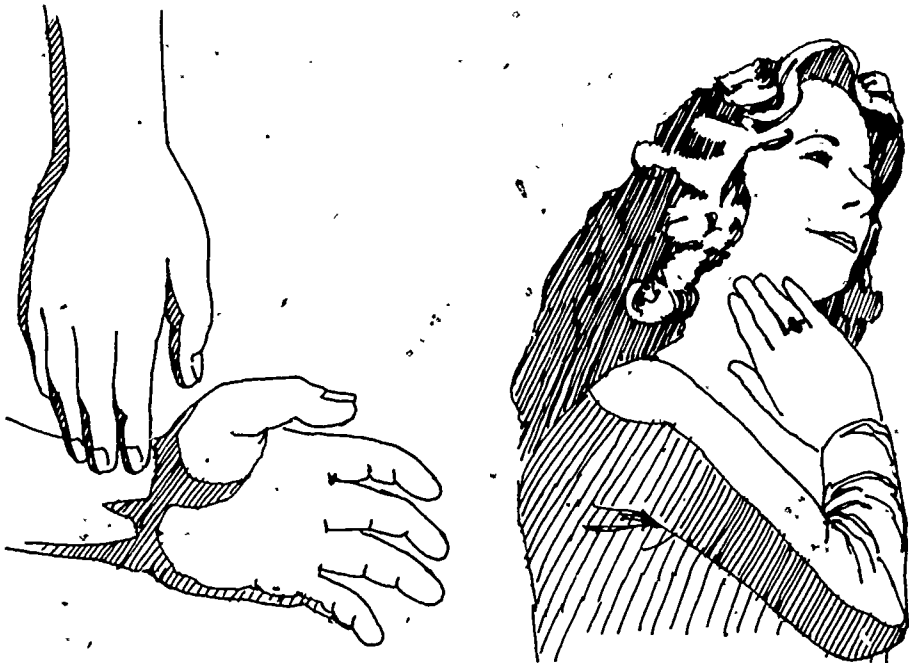

Figure 2. Methods for determining heart rate by palpating the pulse.

### BODY COMPOSITION

The term body composition refers to the relative proportions of lean tissue and fat tissue in the body. Lean tissues, which constitute most of the body weight, include the bone, muscle, skin, and connective tissues. Fat (or adipose) tissue consists of tiny fat cells distributed throughout the body. In particular, fat cells tend to accumulate under the skin and around the internal organs. Fat tissue usually represents between 10 and 30 percent of the total body weight. A person's body composition is expressed as percent body fat (% fat).

An estimate of an individual's % fat can easily be obtained by measuring the thickness of skinfolds at one or more locations on the body surface. A commonly utilized skinfold site is over the triceps muscle located on the back of the upper arm (see Figure 3). The thickness of the triceps skinfold can be measured using a device called a skinfold caliper (see Figure 4). The jaws of the caliper should be placed over a double thickness of skin and subcutaneous fat.

The thickness of the triceps skinfold is related to the total amount of fat in the



Figure 3. Triceps skinfold.

body: the thicker the skinfold, the greater the % of fat. Table 10 provides a normative scale against which the subject can compare his/her triceps skinfold. Those ranking above the 50th percentile have good body composition. A ranking between the 25th and 75th percentile indicates a greater percentage of fat than is proper. A loss of fat would be beneficial. Those ranking below the 25th percentile should initiate a program to reduce % fat.

Changes in % fat occur with changes in the balance between calories taken in through the diet and calories used up through daily exercise and activity. If more calories are ingested in food than are expended with daily activities, fat will be stored in the body. On the other hand, fat is lost when caloric expenditure exceeds caloric intake. Thus, there are three basic methods by which the % body fat can be reduced: diet modification to reduce caloric intake; increased exercise to increase caloric expenditure; a combination of the first two methods.

For many persons the safest and most effective approach to fat loss is to increase caloric expenditure through exercise. Increased exercise can be combined with a moderate reduction of caloric intake to accelerate this rate of fat loss. Some persons can successfully lose fat through dieting alone; however, severe "crash" diets should be avoided. They are often nu-

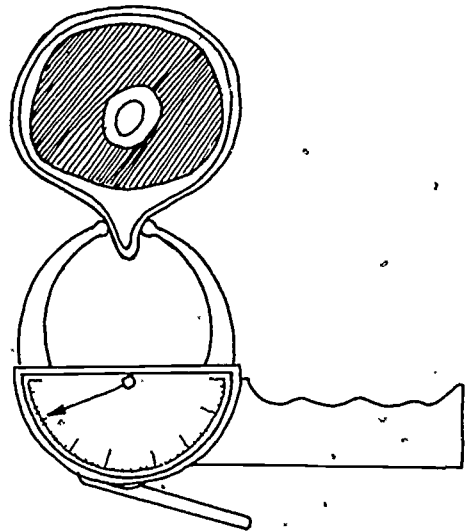

Figure 4. Measurement of skinfold thickness using calipers.

tritionally unsound, and cannot in any event be maintained on a permanent basis.

When initiating an exercise program to lose body fat, the primary goal should be to burn more calories. This can be accomplished most effectively by participating in activities involving whole-body, moderate-to-high intensity exercise. Activities such as walking, jogging, swimming, and cycling are best. These, of course, are the same aerobic activities recommended for improvement of cardiorespiratory endurance.

Table 10. Triceps skinfold norms.

GIRLS								
AGE	10	11	12	13	14	15	16	17
PERCENTILE								
95	6	6	6	6	7	7	8	8
75	9	9	9	9	11	12	12	12
50	12	12	12	12	14	15	16	16
25	15	15	16	17	18	20	21	20
5	23	23	25	26	27	29	30	29

BOYS								
AGE	10	11	12	13	14	15	16	17
PERCENTILE								
95	5	5	5	4	4	4	4	4
75	7	7	7	7	6	6	6	6
50	9	10	9	9	8	8	8	8
25	12	14	13	13	12	11	11	11
5	20	22	23	23	21	21	20	20

ance. In general, the guidelines used to design a program for improvement for cardiorespiratory endurance should be used to help reduce the % body fat.

### MUSCULAR STRENGTH AND MUSCULAR ENDURANCE

*Muscular strength* is defined as the greatest force which a muscle can exert in a single, maximal contraction. Strength is highly related to muscle size. The larger the muscle, the greater its ability to generate force. *Muscular endurance* reflects a muscle's ability to perform repeated contractions against a significant resistance. Muscular endurance is related to muscular strength, since when a muscle becomes stronger, its ability to perform repeated contractions usually improves as well. Muscular endurance should not be confused with cardiorespiratory endurance, which is dependent on cardiovascular function, not muscular strength.

Of particular concern in health-related physical fitness is the strength and endurance of the abdominal muscles. The abdominal muscles run between the lower border of the rib cage and the front of the pelvic bone. These muscles serve to flex the spine, as when performing a sit-up. The abdominal muscles also help to hold the organs of the abdominal cavity in place. If the abdominal muscles become weak, the abdominal

contents can fall forward and contribute to lordosis, previously mentioned. Maintenance of good strength in the abdominal region is, therefore, an important preventive to low back pain.

An accepted method for measuring abdominal strength involves performance of sit-ups. The specific test recommended by the American Alliance for Health, Physical Education, Recreation and Dance is a timed sit-up test in which the participant performs as many sit-ups as possible in one minute. For test purposes, the sit-up should be done with knees bent and arms folded across the chest. A partner should hold the participant's feet and count the number of sit-ups completed. Table 11 provides test norms for the sit-up test. Those subjects scoring below the 50th percentile should begin a program to improve abdominal muscular strength and endurance.

It is also important that adequate strength be maintained in the muscles of the arms and the upper trunk. Often, in daily activities, heavy objects need to be carried. If the arm and trunk muscles are weak, ability to lift and carry household objects can be impaired. Such impairment contributes to accidents and injuries, particularly among the elderly in whom muscular strength tends to be low.

Muscular strength and muscular endurance are best improved by exercises which

Table 11. Norm scores for sit-up test\*.

GIRLS								
AGE	10	11	12	13	14	15	16	17
PERCENTILE								
95	47	50	52	51	51	56	54	54
75	39	40	41	41	42	43	42	44
50	32	34	36	35	35	37	33	37
25	25	28	30	29	30	30	29	31
5	15	19	19	18	20	20	20	19
BOYS								
AGE	10	11	12	13	14	15	16	17
PERCENTILE								
95	50	51	56	58	59	59	61	62
75	40	42	46	48	49	49	51	52
50	34	37	39	41	42	44	45	46
25	27	30	31	35	36	38	38	38
5	15	17	19	25	27	28	28	25

\*One minute bent knee sit-up with arms placed across chest.

significantly overload the active muscle groups. Overload occurs when a muscle is forced to work against a greater resistance than normal. Strength improvement is specific to the muscles which are actively overloaded; to improve strength in several muscle groups, several specific resistance exercises are needed.

An effective way to develop good muscular strength and muscular endurance is to practice calisthenic exercises which overload the abdominal and upper body muscles. Figure 5 presents a series of exercises to improve abdominal muscle strength. Figure 6 shows strengthening exercises for the arms and upper body. As a general guideline, 15-20 repetitions of a particular exercise will ensure maintenance of adequate muscular strength and endurance in the exercised muscle groups. Strengthening exercises should be performed at least two to three times per week.

When beginning a strength-building exercise program, the subject should start with exercises that can be properly performed at least five to six times before encountering fatigue. As strength improves and the subject performs 15-20 repetitions with more or less ease, he/she should progress to a more difficult exercise. An example would be starting with 5-6 repetitions of the curl-up and, over a number of weeks, progressing to 15-20 repetitions of the full sit-up.

Another approach to strength improvement is weight-training, the use of barbells, i.e., free weights, or supported weights, e.g., Universal Gym, Nautilus, to overload selected muscle groups. Weight-training has become a popular activity and is certainly an effective way to maintain good muscular strength and endurance. Expensive weight-training systems are not necessary for maintenance of good health-related physical fitness. A more detailed discussion of weight-training is presented in Chapter 23 of this publication.

### FLEXIBILITY

Flexibility has been defined as the maximum range of motion possible in a joint or series of joints. Joint flexibility can

determine a person's ability to perform bodily movements with ease and efficiency. Poor flexibility, which is common in our society, may make one liable to muscle-joint injuries, or may make certain movements impossible.

Joint flexibility is determined by the elasticity of the muscles and connective tissues which cross the joints. Each joint is held together by ligaments, tendons, and joint capsules, all of which are composed of elastic connective tissues. Also, the muscles include many layers of connective tissues. If these various connective tissues in the muscles and joint tissues are maintained in a stretchable state, good joint flexibility will be maintained. However, if the muscle and joint connective tissues lose their elasticity, the result will be poor joint flexibility. Flexibility is highly specific to each joint; the same person might be very flexible in the shoulder joints, yet quite inflexible in the hip region.

Flexibility is considered a health-related fitness component because lack of flexibility can contribute to low back pain. Poor flexibility in the lower back and in the hamstring muscles can be a cause of lordosis and the pain it causes. Thus, maintenance of good low back/hamstring flexibility is an important goal of lifetime fitness programs. Low back/hamstring flexibility can be evaluated easily using the sit-and-reach test (see Figure 7). This test involves reaching as far forward as possible while seated in the straight leg position. Using the apparatus depicted in Figure 7, distance reach can be scored to the nearest centimeter. AAHPERD scoring tables for the sit-and-reach test are adjusted so that a score of 23 centimeters corresponds to toe level. Table 12 provides norm scores to determine one's relative rating for low back/hamstring flexibility.

Flexibility in the low back/hamstring region can best be improved by using static stretching exercises, involving prolonged maintenance of a stretched position. As a general guideline, a static stretch should be of sufficient intensity to cause moderate discomfort (but no more) in the stretched muscle. *Excessive, painful stretching may damage muscle or joint tissues and should be*

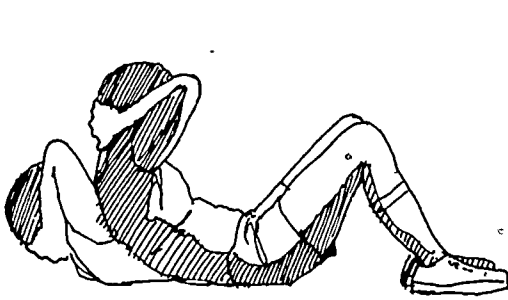

a. Curl-up.



b. Sit-up.

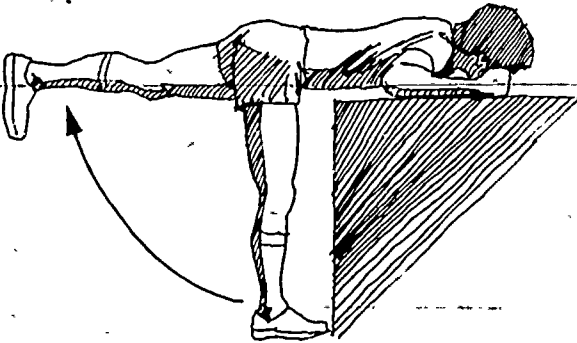

c. Leg raise prone.

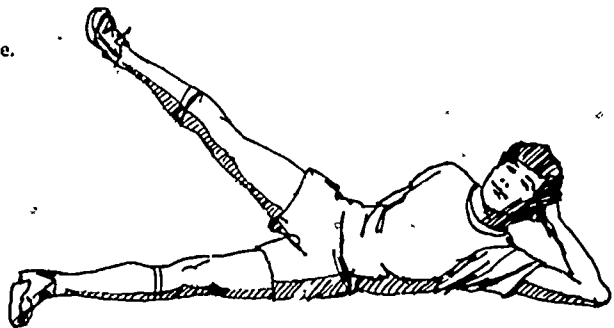

d. Side leg raise.

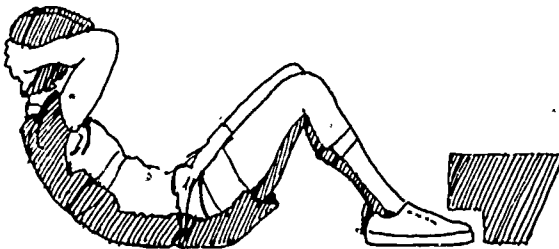

e. Isometric sit-up.

Figure 5. Exercises to strengthen the abdominal and lower trunk region.



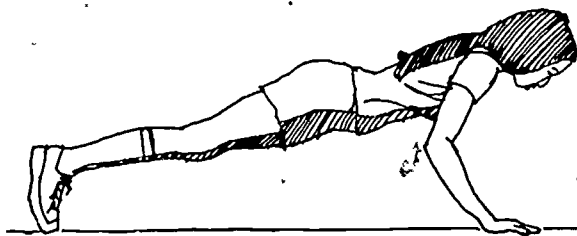

a. Push-up.

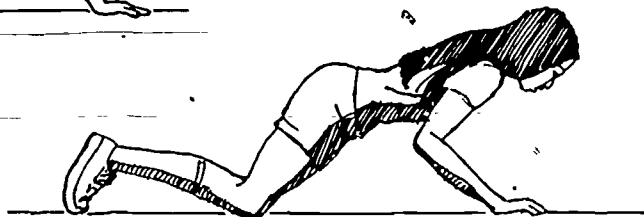

b. Modified push-up.



c. Pull-up.

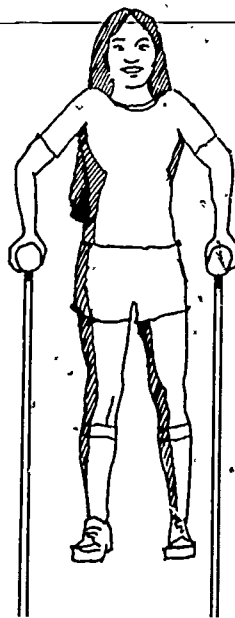

d. Parallel bar dip.

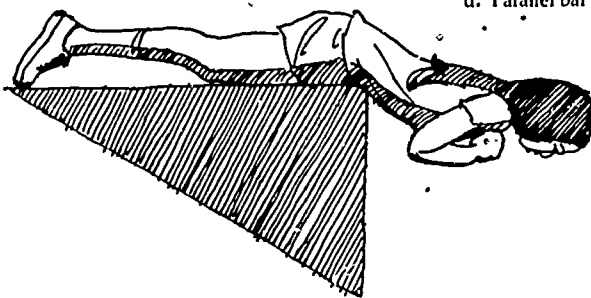

e. Back extension.

Figure 6. Exercises to strengthen the upper body.

Table 12. Norm scores for sit-and-reach test (centimeters).\*

		GIRLS							
AGE		10	11	12	13	14	15	16	17
PERCENTILE									
95		35	37	40	43	44	46	46	44
75		31	32	34	36	38	41	39	40
50		28	29	30	31	33	36	34	35
25		24	24	25	24	28	31	30	31
5		16	16	15	17	18	19	14	22

		BOYS							
AGE		10	11	12	13	14	15	16	17
PERCENTILE									
95		33	34	35	36	39	41	42	45
75		28	29	29	30	33	34	36	40
50		25	25	26	26	28	30	30	34
25		20	21	21	20	23	24	25	28
5		12	12	13	12	15	13	11	15

\*Scale set so that 23 cm is placed at the soles of the feet.



Trunk Flexion

Figure 7. Sit-and-reach test.

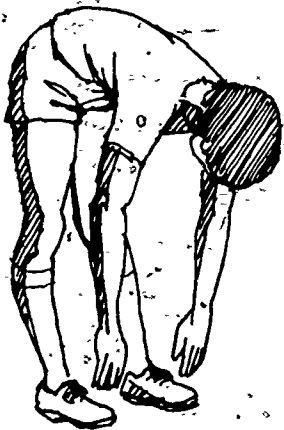

a. Bend and reach.

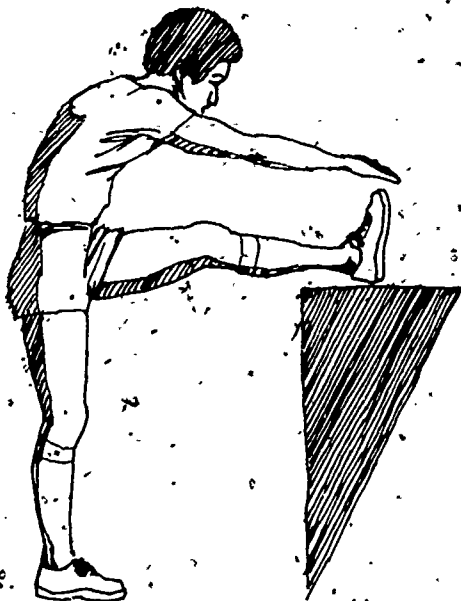

b. Hamstring stretch.



c. Hip flexor stretch.

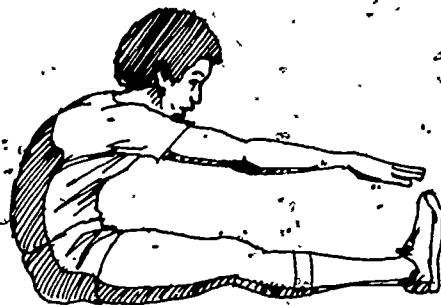

d. Sit-and-reach.



e. Upper back stretch.

Figure 8. Static stretching exercises.

avoided. A static stretch should be sustained for 10-30 seconds. Several examples of static stretching exercises are depicted in Figure 8. These exercises, employed three or more times per week, will develop and maintain a good level of low back/hamstring flexibility in most persons.

## FITNESS AND THE HEALTHY LIFESTYLE

This chapter has discussed the contribution regular exercise can make to overall health. Major emphasis has been placed on the four components of health-related physical fitness, why they are important, and how each can be improved.

In concluding this chapter it is important to emphasize that one's health status is determined largely by his or her personal habits and decisions. Recent studies have demonstrated clearly that several of the time-honored "good health habits" do in fact make a difference to long-term health. A recent study of 4,000 Californians found that future health status could be predicted on the basis of the five health habits listed in Table 13. Persons who had all these habits were significantly healthier than those persons having few or none of them. Two of these, regular exercise and maintenance of proper body weight, are directly related to habits of regular physical activity.

Table 13. Habits associated with maintenance of good health.

- Abstention from smoking.
- Moderate alcohol consumption.
- Regular exercise.
- Sleep for 7-8 hours per day.
- Maintenance of normal body weight.

In conclusion, the healthy lifestyle is there for the taking. By selecting proper health habits, including regular exercise, much can be done to reduce disease risks and to enhance the quality of life. It is often said that "knowledge is power," but knowledge is powerful only if it forms the

basis for action. The knowledge gained by reading this chapter will be useful only if it is applied. Now is the time to go to work. Reading about exercise will not improve the reader's health—exercising will!

## TERMINOLOGY

- Aerobic Energy Production.** A chemical process by which oxygen, transported from the atmosphere, is used by the cells of the body to produce energy needed for biological work, e.g., muscle contraction.
- Atherosclerosis.** A disease process by which fatty plaque is deposited on the inner walls of the arteries; may lead to coronary heart disease.
- Body Composition.** The percentage of the body weight which is fat (% fat).
- Cardiorespiratory Endurance.** Ability to sustain moderate intensity, whole-body activity for extended time periods.
- Chronic Disease.** A disease which develops over long periods of time; often caused by lifestyle and health habits.
- Cool-down.** A period of low intensity exercise performed at the conclusion of a training session.
- Coronary Heart Disease.** Impairment of blood flow and oxygen delivery to the heart muscle, caused by atherosclerosis in coronary arteries.
- Coronary Heart Disease Risk Factor.** A personal characteristic or habit associated with increased risk of developing coronary heart disease.
- Flexibility.** Maximum range of motion possible in a joint or series of joints.
- Hypokinetic Disease.** A disease associated with sedentary living, i.e., lack of regular exercise.
- Infectious Disease.** A disease caused by a germ, bacteria, or other disease-producing agent; can often be communicated between individuals.
- Lordosis.** An excessive curvative of the lumbar region of the spine.
- Muscular Endurance.** Ability to perform repeated high intensity muscle contractions.
- Muscular Strength.** Maximum force which can be applied with a single muscle contraction.
- Obesity.** Excessive body fatness.
- Overload.** A level of exercise intensity or resistance which exceeds that to which a person is already adapted.
- Physical Working Capacity.** Maximum rate at which a person can perform physical exercise; heavily dependent upon the individual's capacity for aerobic energy expenditure.
- Static Stretching.** Method for improvement of flexibility which involves maintenance of a stretched position for 10-30 seconds.

**Warm-up.** Period of light-to-moderate intensity exercise which precedes a training session.

### REFERENCES

- AAHPERD *Health Related Physical Fitness Test Manual*. Reston, VA. The American Alliance for Health, Physical Education, Recreation and Dance, 1980.
- Cooper, K. H. *Aerobics*. New York: Bantam Books, 1968.
- Cundiff, D. E., and Brynteson, P. *Health Fitness, Guide to a Life-Style*. Dubuque, IA: Kendall/Hunt Publishing, 1979.
- Getchell, B. *Physical Fitness: a Way of Life*. 2d ed. New York: John Wiley & Sons, 1979.
- Farquhar, J. W. *The American Way of Life Need Not Be Hazardous to Your Health*. New York: W. W. Norton & Co., 1978.

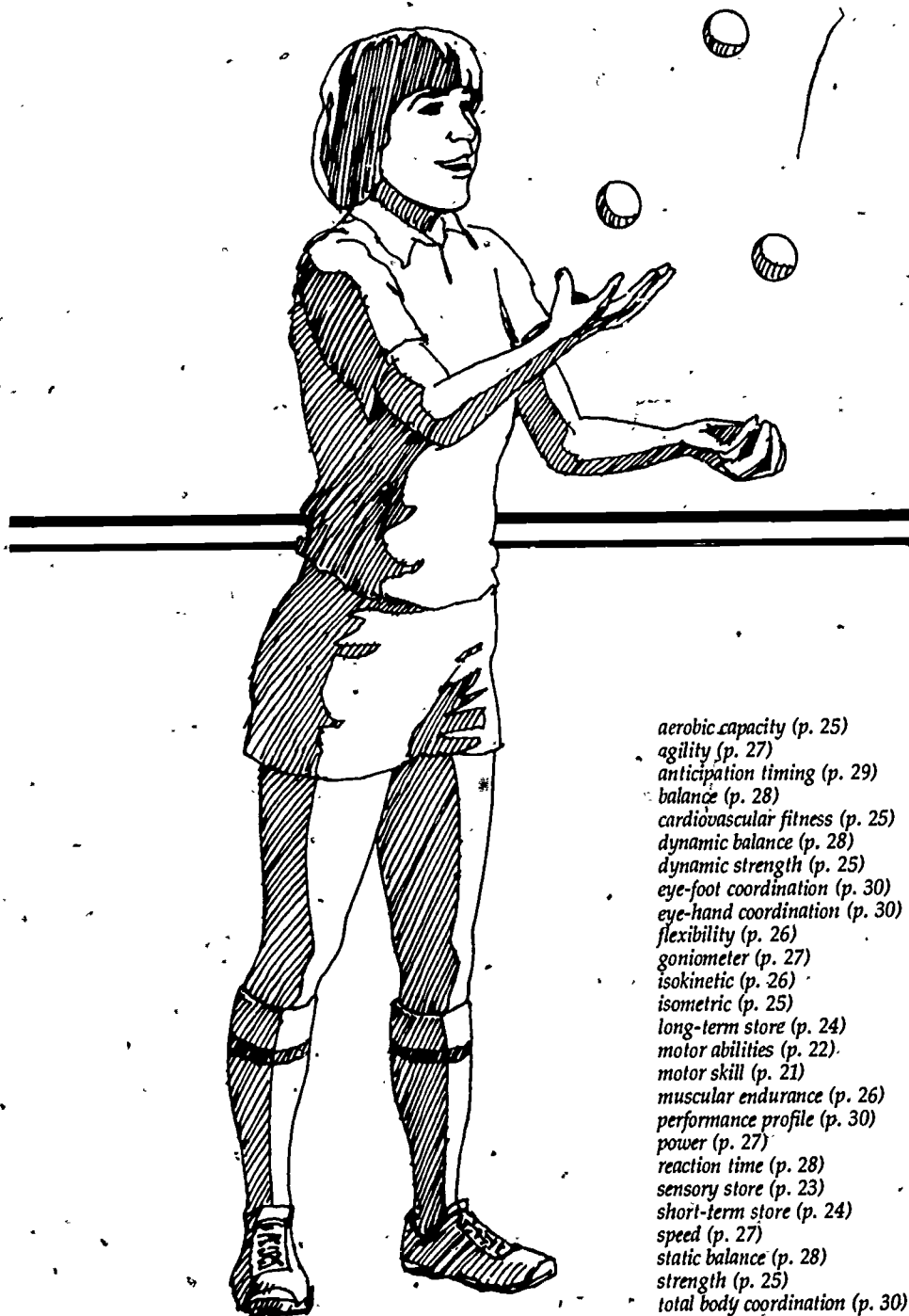

aerobic capacity (p. 25)  
agility (p. 27)  
anticipation timing (p. 29)  
balance (p. 28)  
cardiovascular fitness (p. 25)  
dynamic balance (p. 28)  
dynamic strength (p. 25)  
eye-foot coordination (p. 30)  
eye-hand coordination (p. 30)  
flexibility (p. 26)  
goniometer (p. 27)  
isokinetic (p. 26)  
isometric (p. 25)  
long-term store (p. 24)  
motor abilities (p. 22)  
motor skill (p. 21)  
muscular endurance (p. 26)  
performance profile (p. 30)  
power (p. 27)  
reaction time (p. 28)  
sensory store (p. 23)  
short-term store (p. 24)  
speed (p. 27)  
static balance (p. 28)  
strength (p. 25)  
total body coordination (p. 30)

# Motor Skill Development and Evaluation

JERRY R. THOMAS, *Professor and Chairman*  
and  
JACK K. NELSON, *Professor,*  
*Louisiana State University,*  
*Baton Rouge, LA*

## INTRODUCTION

As individuals mature from childhood through adolescence to adults, their ability to perform the motor skills associated with various sports and physical activities improves. This increase in performance is due to a number of factors. First, as people grow they become bigger and stronger. Thus, they can run faster, throw and kick farther, jump higher. Secondly, regular participation increases the efficiency of one's heart and circulatory, respiratory, and muscular systems, enabling better performance in many sports skills. Finally as children get older, they have performed more sports skills (due to past experiences). These experiences with a variety of skills increase their ability to learn new skills in new situations. All of these factors taken together are responsible for motor skill development and result in increased levels of motor performance with increased age.

By high school most students can perform a variety of everyday motor skills and many specific sports skills. Each of us can probably catch and throw a softball, do the standing broad jump, dribble and shoot a basketball, as well as many other sports skills. Individual interest in sports revolves around one or more of the following questions:

- what type of sport would I enjoy participating in on a lifetime basis?
- how do I choose sports which best provide the health benefits of regular exercise?

- since my skill level is very good in several areas, how do I select a varsity sport in which I may excel?
- can I learn certain sports that I can participate in with my family and/or friends?

In this chapter we hope to demonstrate how sports skills develop, how people learn these skills, and how to evaluate and select sports that will best suit individual needs. We will also discuss the basic motor abilities that are essential in sports performance and ways in which these abilities can be measured. A few simple tests of some of these abilities will be described so that you can test yourself and develop a performance profile. Then on the basis of your own abilities and interests you may be better able to select a sport or sports in which you should like to participate either recreationally or as an athlete with some information as to your chances for success and enjoyment. We believe regular participation in sports and physical activity provides many benefits on a lifetime basis such as:

- increased cardiovascular and respiratory efficiency;
- higher levels of muscular endurance;
- skillful movements in sports;
- positive mental health;
- fun and enjoyment;
- opportunities to socialize with family and friends.

## MOTOR SKILL DEVELOPMENT

A *motor skill* is the muscular activity necessary to accomplish a task. The task may

involve big muscles and lots of movement such as running, jumping, and turning handsprings, or it may involve the small muscles of the body and relatively little movement such as in typing, sewing, and talking. Many activities involve both large and small muscle tasks. *Motor abilities*, on the other hand, are more general in nature and help us develop motor skills. They include such things as strength, muscular endurance, cardiovascular endurance, power, speed, balance, flexibility, agility, and reaction time. The relationship between motor skills and motor abilities can be seen in the long jump. Motor abilities such as power and speed, play an important role in the development of the long jump motor skill.

Let us turn our attention to several factors that directly affect our ability to learn and perform motor skills.

**Age changes in motor performance.** The performance of fundamental skills (running, jumping, throwing, catching, striking, and kicking) increases in a rather consistent fashion for both boys and girls during the elementary school years. Diagram 1 illustrates that performance for these skills increases at each age level for boys and girls

up to 11 years. While the average performance of the boys is slightly better than the girls, there is much overlap between the sexes with girls' performance frequently exceeding that of the boys. Most people believe that the motor performance differences between boys and girls before age 11 is due to different cultural expectations for males and females. Girls may not be expected to learn and perform the skills as well. It is hoped, however, that recent federal laws (Title IX) which do not allow discrimination on the basis of sex will have positive effects on girls' participation in sports.

Beginning at about 11 or 12 years of age, the boys' performance goes up rapidly while the performance of girls begins to stabilize. This is due to both physical and cultural (home and community influence) factors. When a boy reaches puberty, large quantities of the hormone testosterone are present in his body. Testosterone promotes muscular development and the strengthening of bones as well as the secondary sex characteristics of whiskers, a deeper voice, and genital development. While small amounts of testosterone are present in girls, it does not lead to excessive muscular

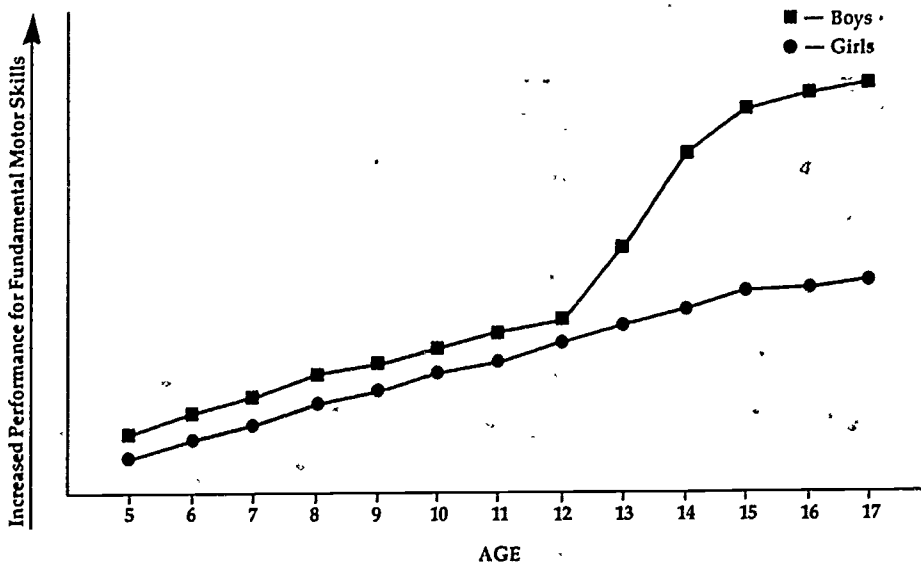

Diagram 1. Age and gender differences in performance of fundamental motor skills, (estimated curve).



development. The muscular development in boys improves motor performance where the rapid application of strength (called power) is important. Thus, skills like running, jumping, throwing, etc., show rapid gains during this time of development.

Girls' performance begins to level off at about 11 or 12 years of age. As girls reach puberty and start to look more like their mothers, their bodies begin to have a higher percentage of fat. This in combination with the lack of hormone-related muscle development tends to keep girls' performance on power tasks substantially below that of boys after puberty. Nevertheless, cultural factors are basically responsible for the leveling of performance. Many girls no longer participate and practice motor skills or specific sports skills. As more and more girls participate in sport and exercise on a regular basis after puberty, performance should increase.

**Factors that influence skill development.** A number of items influence the normal development and learning of motor skills. Physical fitness tends to vary only slightly among younger children but can play a substantial role beginning at about the fourth grade. If you cannot run for very long or if you are weak, there may be many skills you will unsuccessfully perform. If you are tired after 2-3 minutes of running, for instance, no matter how skillful you are in soccer, you won't be a very successful player. In this instance your cardiovascular endurance keeps you from effectively demonstrating the skills. Look carefully at the sports that interest you. Is your physical fitness level restricting your success? After completing this chapter you will be in a much better position to answer this question and take action based upon your response.

**Motor abilities are also important in learning sports skills.** Most people believe motor abilities such as hand-eye coordination and balance are inherited. Some people have more ability than others. Your success in whatever sport(s) undertaken is directly related to your motor abilities. While you may improve your coordination in specific sports skills (hitting the baseball

for example) by continued practice, you would probably do better to pick a sport in which hand-eye coordination is not so important (swimming, for example), if your eye-hand coordination is not good.

We've talked a good bit about developing *fundamental motor skills* like throwing, running, jumping, etc. Once the skills are developed during elementary school, you should apply them to specific sports. Even though you may have a good overhand throwing motion, it takes practice to apply this motion to efficiently throw a baseball or football. Spend much of your practice time in the correct performance of the specific skills for the sport(s) you choose. This continued practice, called *over-learning*, allows you to perform the skill in an automatic way without having to think about the parts of the movement. This overlearning of the correct movement in a variety of situations is what we strive for in sport and what practice is all about.

**How people learn skills.** When learning a new motor skill or practicing one already known, both the nervous and muscular systems are involved. Suppose you are learning to hit a tennis ball with a forehand stroke. Think about all the things involved. First the tennis racket is like a 2 1/2 foot extension of your arm. You must learn to grip it properly, swing it through a correct arc, turn the racket face at the correct angle, apply the proper amount of force to the swing, watch the tennis ball coming to you, decide where to hit the ball on the other side of the net, and then execute all of these individual acts with correct timing. How could anyone think all sport skills are physical? *The brain and nervous systems are the key factors in controlling movements.*

We frequently refer to the brain's function as an information processing system with three major components. The first is called a *sensory store* where incoming information is held very briefly; in the case of the tennis forehand the eyes send signals to the brain about the oncoming ball. In addition, the muscles and joints send signals to the brain about the position of various body parts, arms, legs, trunk, etc. Much of this information is taken from sensory store and used by the second component called

*short-term store (STS)*. STS is where everything happens. We integrate all of these incoming signals to make sense of them.

The third component is called *long-term store (LTS)* and is where information is kept for long periods of time. For instance, you have a plan in LTS to control your arms, feet, and trunk for performing the forehand stroke in tennis. This plan has been built up from all the times the stroke was done before. People who have learned this stroke correctly and practiced it numerous times have a very good plan that they can use without thinking about it. However if just learning this stroke, the plan is being developed and probably has many errors. When hitting a tennis ball, the plan must be adjusted for all of the signals received from the senses, i.e., how fast the tennis ball is coming, the player's position on the court, and where the ball is to be hit. This all happens in STS.

Once the plan is taken from LTS and adjusted in STS for all the current signals from the senses, then the plan is set into operation, and the stroke is performed. You are then able to see the results of this stroke and make corrections in the plan if need be, so that performance will be better next time.

Information processing systems work like this to control all motor skills. Two things are important to remember:

1. For slow movements or movements that take a long time, your plan can be corrected for errors along the way. However, if the movement is very rapid, the plan is quickly completed and corrections can only be made for the next time you attempt the skill. For example, when you are going to catch a fly ball in softball, you make adjustments as the ball is coming toward you. You can continue to make these adjustments until just before the ball arrives at your glove. But when you are hitting a ball thrown very fast, you don't have time to make any more adjustments in your plan once the bat swing is begun. That's why a curve will fool you when you are expecting a straight ball.
2. The basic objective of learning nearly all motor skills is to make them as automa-

tic as possible. This means you don't have to think about the parts of the skill itself but can concentrate on other aspects of the situation. In the case of the forehand stroke in tennis, the stroke itself should be automatic so that you can think about your position on the court and where you want to hit the tennis ball. You must practice a skill many times in all the specific situations it will be used to obtain the automatic control of the movement.

To summarize, the most important factor in learning and performing a movement is to develop a good plan. A good movement plan comes from correct instruction, effective information about the outcome of each try at the skill, and sufficient practice to make the plan automatically occur when you need it.

One of the most important considerations when learning a new skill is being able to determine when mistakes are made in the movement. Results of mistakes can be frequently seen, e.g., you hit the volleyball into the net or out-of-bounds. But what if the plan for the movement was incorrect? Your physical education teacher will help you analyze errors in your movement. However, you should also learn to do this yourself. Sometimes you will be practicing or playing at times other than in physical education class and there will be no one to give you error information. Try to be aware of where your body parts are as the skill is performed so that you can feel if something is wrong. Remember how it felt to do the skill correctly and try to make the next movement in the correct way. This ability to *self-analyze* and *self-correct* is very important and will speed up your learning of the skill. But remember, everyone's style is a little different, so what works for someone else may not work for you. Differences in style do not mean poor form, just that your body type as well as other considerations may suggest slightly different techniques. The main thing is don't get discouraged, just continue to seek *good instruction* and *practice*; skills will improve so you can have fun when you play and receive the positive health benefits, both physical and mental, of regular exercise.

## EVALUATING YOUR SKILLS

The remainder of this chapter is designed to aid you in evaluating your skills to determine the sport(s) in which you are likely to be most successful. Of course none of the techniques we are suggesting are fool-proof. But we believe if you will use them and judge yourself fairly, you can find a sport or physical activity in which you can be successful, have fun, and get regular exercise on a lifetime basis.

**Physical fitness components.** *Cardiovascular fitness* involves the proper functioning of the heart, lungs, and blood vessels. It is the ability to adjust to and recover from the stress of exercise. Examples of individuals having very high degrees of cardiovascular fitness are marathon runners, long-distance track runners and swimmers, and cross-country skiers.

The term *aerobic capacity* is used in connection with cardiovascular fitness. It refers to the maximum amount of oxygen you can consume per minute. In other words, your ability to vigorously exercise for a prolonged period of time is determined by your body's ability to deliver oxygen to the active muscles and organs. Although cardiovascular fitness (and aerobic capacity) can be improved through exercise, the aerobic capacity is largely determined by heredity. This is why some people are just naturally better-suited for distance running than others. The saying that "great runners are born, not made" arises from this fact.

Cardiovascular fitness can be measured in several ways. The most accurate measurement is done in a laboratory in which an individual runs on a treadmill while the air that is breathed out is analyzed for oxygen and carbon dioxide content. The maximum amount of oxygen that can be taken in per minute is thus determined (aerobic capacity). Since this way of measuring cardiovascular fitness requires expensive equipment, other methods are more commonly used, such as step tests and distance runs. In the step tests, a person steps up and down on a bench at a specific rhythm for several minutes. The pulse rate is then counted either im-

mediately afterward and/or during recovery.

Distance runs are most frequently used in testing for cardiovascular fitness. A general recommendation is that a distance run should involve at least five minutes of running. Consequently the most common distance runs are the 1-mile, 1½-mile, 2-mile, the 9-minute run, and the 12-minute run. A person who has a higher degree of cardiovascular fitness will be able to run a certain distance, such as a mile, in a shorter time or cover more distance in a set time period, such as 12 minutes, than a less fit individual.

*Strength* is a very important aspect of physical fitness. Simply stated, it is the ability to exert force. Strength is a necessary component in most sports and is also an important element in carrying out one's daily activities effectively and efficiently. It can be demonstrated in various ways. Force exerted during movement, such as lifting a barbell, is *dynamic (isotonic)* strength. Isometric strength is force exerted against an immovable object, such as pushing or pulling against a bar that is bolted to the wall.

Dynamic, or isotonic, strength has been measured mostly by the use of barbells and weights. A 1 RM means one repetition maximum, which is the greatest amount of weight a person can lift one time. Strength-training with weights utilize multiple RMs. For example, a person utilizing an 8 RM set would select a weight that he or she could only lift 8 times. As the individual grows stronger the number of times the weight can be lifted (repetitions) increases. When the person can lift it 12 times, more weight is added so that the maximum number of repetitions drops to 8 again. This is the basis for progressive resistance weight-training. A major advantage of weight-lifting is that measurement, i.e., knowledge of results, is automatic.

Isometric strength-training is used to supplement dynamic training. For example, we are not equally strong through the entire range of a movement. In other words, a heavier weight can be held better at hip level than when it's held at shoulder level because of mechanical leverage. In lift-

ing weights, you can only lift as much as can be handled at the weakest point. Therefore if you concentrate at that "sticking point" by maximum isometric contraction, strength can be improved at that specific place, and thus more weight can be lifted throughout the entire range of the movement.

Isometric strength-training is also done in home exercise programs through pushing and pulling against doorways, walls, and other immovable objects.

In *isokinetic* strength-training, an individual applies maximum exertion throughout a full range of motion. An example would be if you pushed as hard as you could on a car as it was being raised on a hydraulic lift in a service station. No matter how hard you push, the steady movement of the car would not be affected. Some machines are now used in strength-training that automatically adjust so as to provide resistance equal to the force being applied throughout the range of motion. This type of training supposedly combines the advantages of both isotonic and isometric training.

*Muscular endurance* is repeating a movement which requires less than a maximum effort. One typically thinks of exercises such as sit-ups and push-ups as representing muscular endurance activities. There are many daily tasks that involve muscular endurance. Raking leaves, hammering nails, painting, shoveling, and scrubbing floors are but a few examples of such tasks.

Muscular endurance is related to cardiovascular endurance and also to strength, but they are not the same abilities. For example, a person may have high cardiovascular endurance and be able to run many miles but can do very few push-ups, or a person may be able to lift a very heavy weight but cannot do many sit-ups. Obviously there are a number of factors that influence the relationship between muscular endurance and strength and cardiovascular fitness.

Although muscular endurance seems to be a rather simple clear-cut concept, the measurement of it is not. For example, push-ups supposedly measure muscular endurance of the arms and shoulders. Yet if

a person isn't strong enough to push his body weight up more than one or two times, we can't really say that the person has no endurance. The same can be said about pull-ups, sit-ups, parallel bar dips, etc. Because of the involvement of strength, these test items are often referred to as measures of strength and endurance. Nevertheless, an exercise cannot be considered as endurance unless it is submaximal (requires less than your greatest effort). In other words, you have to do it repeatedly.

*Flexibility* is another part of physical fitness—the ability to move the body and its parts through a wide range of motion. It is important in one's mobility in athletics, in the avoidance of injuries, and in posture.

When a person gets "out of shape," one of the first things noticed is reduced flexibility. This is because our muscles shorten when we do not regularly move and stretch. A person with reduced flexibility is more likely to suffer a "pull" or strain when he moves suddenly or beyond the normal range of motion. For this reason, teachers/coaches usually include a number of stretching exercises as part of any training program.

Flexibility is quite specific to the individual parts of the body. For example, an individual who is very flexible in the trunk and hips as evidenced by being able to bend over with the knees straight and touch the hands to the floor with ease, may be very "tight" in the shoulders, or vice versa. Also, there is what is called *dynamic* flexibility, in which mobility is demonstrated rapidly, and *static* flexibility, which is a slow steady stretching movement. In most sports, dynamic flexibility is more important than static flexibility.

Flexibility has been measured in a number of ways. One of the most common tests is whether or not you can bend over and touch your toes, keeping the knees straight. This is "non-specific" in that it is pass or fail—you either can or you cannot. We can be a little more exacting if we put a ruler between the feet and measure how far from the floor you can reach, or by having the person stand on a bench we can mea-

sure how far beyond toe level one can reach.

The sit-and-reach test essentially measures the same aspect of flexibility as the standing bend and reach. Most testers prefer to use the sit-and-reach. There are several other simple measures of flexibility that require only a ruler or tape measure. For example, trunk (and neck) flexibility can be measured by having the person to be tested lie face down with the hands behind his head. Someone holds the hips down on the mat while the person arches back as far as possible and holds this position momentarily while the tester measures from the mat to the chin. A measurement for shoulder flexibility is done with the person lying face down, arms stretched out in front, holding a stick, such as a yardstick, in both hands. Then, with the chin touching the mat, the person raises his arms as high as possible off the mat. The distance from the mat to the stick is used as an indication of shoulder flexibility.

Flexibility of specific joints such as the ankle, knee, elbow, etc., is sometimes assessed by physiotherapists and athletic trainers using a protractor-type device called a *goniometer*. This is often done to measure the patient's progress in regaining range of motion in a joint following inactivity due to injury, such as having been in a cast. There are also more accurate and expensive instruments available for measuring flexibility in laboratory research.

## MOTOR FITNESS COMPONENTS

*Power* is unquestionably one of the most important elements in athletics. Power is the ability to exert maximum force in the shortest period of time. The explosive charge of the football player, the great thrust of the shot putter, the long drive off the tee in golf, the mighty swing of the baseball bat, and the knockout punch in boxing illustrate power in sports. In fact, most of the popular team and individual sports are predominantly "power-oriented."

Evidence of natural power, explosiveness, force, etc., is one of the first things a coach looks for in new players in many

sports. Pre-season workouts and in-season practice drills focus heavily on power development.

The measurement of power is not an easy task. Power is comprised of both strength and speed, but it is the coordinated combination of the two abilities that actually constitutes power performance. In other words a person may be tremendously strong and yet not be as powerful as a person of lesser strength. Furthermore, increased strength will generally improve power but certainly not in direct proportion.

The standing broad jump and the vertical jump have often been used as power measurements. Less frequently, tests of such skills as the medicine ball throw, shot put, stair climb, and rope pull have also been utilized as power tests. Nearly all of these tests are quite easy to give and are accurate measures. However, as with most tests, they are specific to the part of the body that is primarily involved. For example, the standing broad jump primarily measures the power of the legs, while the rope pull or seated machine ball throw tests the power of the arms and shoulders.

*Speed* is another important aspect of a number of sports. Speed of movement is largely innate, which means that it is hereditary. You are either fast or you're not. Speed of movement, such as running, can be improved to a small degree by the practice of proper starting techniques and perhaps the development of better mechanics of movement.\*

Generally, speed is measured by some short run such as the 50-yard dash, the 100-meter run, etc. In football, the 40-yard dash has gained widespread popularity as the measure of speed for that sport, although probably a much shorter distance such as 5 yards would be considerably more appropriate.

*Agility* is the ability to change direction rapidly with a high degree of accuracy. A runner in football who is able to dodge, start, and stop quickly, and skillfully

\*The start of a speed of movement task involves the reaction to some stimulus such as the starter's gun or the command "go," or the movement of some person or object, will be mentioned under the heading of Reaction Time.

change direction displays outstanding agility. In fact, some individuals without great straightaway running speed are still very effective because of their ability to shift their body weight and change direction quickly and accurately.

Agility does not have to involve running. It can also be shown by rapid changes in body position, such as in gymnastics, diving, and wrestling.

Running tests of agility, commonly given in practice drills in athletics, relate quite highly to power. This is understandable because of the explosiveness that is required in many agility drills that call for rapid starts and acceleration. Obviously there are many different kinds of agility, such as zigzag runs, shuttle runs, squat-thrusts, and back pedaling, that are part of the conditioning and practice drills in athletics. A good teacher or coach will use agility drills (and tests) that involve the types of movements necessary for that particular sport.

*Balance* is the ability to maintain one's equilibrium. It is an important element in carrying out our daily activities effectively and efficiently. Balance is an important part of the body movements required in many sports as well.

There are different kinds of balance. One kind is called *dynamic balance* which is the ability to maintain proper body position while moving. Most sports require this kind of balance, but in many different ways. Obviously ice skating, roller skating, skiing, and all forms of dance are excellent examples of activities which demand dynamic balance. Any sport which involves agility and running, such as football, soccer, basketball, baseball, etc. also involves dynamic balance.

*Static balance* is the type of balance in which a stationary position must be maintained for a certain period of time. All of the events in gymnastics require static balance. Often in sports, static balance immediately follows movement such as when the basketball player leaps high to grab a rebound or pass and must land and keep from traveling, when the gymnast who turns a flip and must land and maintain balance on the beam, and in bowling, shot putting, discus, and javelin throwing where the performer

must suddenly stop after release and maintain his balance to keep from going over the foul line.

Another form of balancing ability involves balancing an object either when moving, such as trying to avoid spilling coffee while carrying a cup across a room, or when stationary, such as balancing the cup on your knee while seated. This kind of balance is not too prevalent in sports, yet it points out again the great amount of specificity of performance.

Because of the extreme amount of specificity, tests of balance are rarely included as a part of fitness tests. One could, however, measure certain kinds of balance by such tasks as walking on a beam, by standing on the ball of one foot as long as possible, and by tumbling stunts such as headstands and handstands.

*Reaction time* is a critical part of athletic performance. Reaction time is the time it takes a person to react or move after a stimulus has been given. The stimulus could be any number of things such as the starting gun in a race, the snap count in football, the movement of an opponent, the crack of the bat in baseball, etc. Success in many sports depends on one's ability to *recognize* the correct stimulus and to react accordingly.

Although the definition is very simple, reaction time is quite complex. Many things influence reaction time. For example, the type of stimulus (whether a sound, a sight, or a touch) makes a difference in how quickly you will react. The intensity of the stimulus, i.e., whether a loud sound, bright light, or a slap, will affect reaction. The movement or series of movements one has to perform after reacting greatly influences the speed of reaction. A person can react much faster if all that is required is to step on the car brake when the signal light turns yellow. On the other hand, if an individual has to perform a complicated or delicate maneuver, the reaction time will usually be considerably slower. An important point here is that practice and skill attainment in the required movement, or task, will greatly improve the speed of reaction. This is the reason why student pilots practice emergency procedures over and over until

the procedures become virtually automatic, so that when an emergency occurs the pilot can react instantly without having to pause and think of the sequence of steps.

A very similar situation is present in sports. Through countless hours of practice, the athlete develops more and more skill in the various aspects of the sport, thus decreasing the need to think about what has to be done, which in turn enables a faster response.

The measurement of reaction time in the research laboratory is done with electrical timers, which permit measurement of response to different kinds and intensities of stimuli and simple and complex responses. A very simple measure of reaction time can be accomplished using a yardstick. In this method, one utilizes the law of constant acceleration of free falling bodies (gravity) and merely converts distance to time.

The tester holds the yardstick at the top and lets it hang between the person's thumb and index finger. The upper surface of the thumb should be aligned with the 4-inch mark. The person being tested looks at the 8-inch mark and is told to react by catching the stick when it starts to fall. The tester says "ready," and drops the stick, varying the time between "ready" and the release. The distance the stick falls before it can be caught is changed to time by the formula

$$\text{time (seconds)} = \sqrt{\frac{(\text{distances in inches})}{6(32)}}$$

For example, if the stick drops 6 inches, the time that elapsed before the subject could react and pinch the fingers would be .18 seconds.

$$\sqrt{\frac{6 \text{ inches}}{6(32)}} = 0.18 \text{ seconds}$$

*Anticipation timing* involves the prediction of when an object such as a ball, an opponent, a shuttlecock, etc., is going to arrive at a particular point. The outfielder in baseball must determine where the fly ball is going to land (and when) to move under it in time to make the catch. The tennis player constantly has to make decisions as

to where and when to move and the footwork required to enable him to be in position (not too close to the ball, not too far away) to return the opponent's shot.

This is quite complex. There is much that is unknown about this kind of decision-making. Teacher/coaches constantly stress "keeping your eye on the ball." Yet, in many instances, we are simply not able to keep our eye on the ball and make the necessary movement. For example, to watch a pitched baseball all the way to the plate is impossible. Consequently, we must decide whether we are going to swing, and if so, start the swing sometime before the ball arrives and hope that we have correctly judged where the ball is going to be and the exact instant when it will be over the plate. The faster our reaction time the more time we have before we have to begin the swing. Moreover, the speed with which we can whip the bat around can also be advantageous.

The more we practice and the more experience we have in a sport, the more "clues" we pick up that help us in anticipation timing. In tennis, for example, such things as where the opponent is looking, the placement of his feet, body movements, the swing of the racket (its trajectory and speed), and the sound of the ball as it is struck gives us information that will influence our prediction as to the flight of the ball. Naturally we are sometimes badly fooled by some of these clues. A good player often tries to take advantage of the use of clues by deliberately looking in another direction and trying to disguise the force and path of the swing.

The saying, "keep your eye on the ball," is good advice even if it isn't always possible. Undoubtedly as a result, the performer concentrates more on the moment of contact, maybe even creating an illusion of seeing the bat or racket strike the ball.

## OTHER MOTOR ABILITIES

Skillful performance as is seen in athletics, dance, crafts, and many daily activities requires coordination of different parts of the body during movement. Since there are different kinds of movement, it

follows that there are different kinds of coordination. Some tasks primarily involve the coordination of the hand and arm in conjunction with vision such as in shooting a basketball, pitching in baseball, passing a football, and in bowling. These skills require *eye-hand coordination*.

A number of sports involve skillful movements of the feet and legs in which *eye-foot coordination* is necessary. Place kicking and punting in football and dribbling with the feet in soccer are examples of the need for this type of coordination.

The term *general* or *total body coordination* is sometimes used to refer to the simultaneous movements required of the total body as in a gymnastics routine, catching a pass in football, dribbling and shooting a lay-up in basketball, throwing the javelin, pole vaulting, high jumping and hurdling in track, and on and on. One thing to bear in mind is the specificity of performance and consequently, the specificity of coordination. We are prone to generalize too much and assume that because someone demonstrates good coordination in a sport that he will also be good in another or all sports. While there may be some similarities in movement patterns and basic skills in several different sports, success in one sport does not guarantee success in another.

### HOW CAN YOU PREDICT IN WHICH SPORTS YOU MIGHT SUCCEED?

Obviously, it is impossible to predict success in sports with any degree of certainty. There are simply too many factors involved. Instead, one can try to narrow the range of probabilities in accordance with one's abilities and characteristics.

It might be easier to rule out sports for which one is obviously not suited. For instance, a person who is tall and/or heavy should not dream of becoming a jockey. By the same token, an individual who is small and slow will probably be unsuccessful in football. Hence, genetics (heredity) does place limitations with regard to the chances of success in a number of sports. We should hasten to add, however, that there is always the exception. High levels of drive, ambition, and perseverance have been

known to make up for limitations in size and natural abilities.

In the following section, some basic physical performance tests are described. All of them can be done with very little equipment, and the directions are simple. You may have performed these tests at one time or another in your physical education classes.

These tests represent measures of motor fitness which are basic to athletic performance. Naturally, they should not be taken too seriously. In other words, just because you are below average on a test does not necessarily mean that you are hopelessly weak in that area. These tests should be thought of as mere indicators of abilities in certain areas. Remember, the various abilities such as speed, power, agility, and endurance that are involved in a sport are quite specific in the way in which they are utilized. Nevertheless, a profile can be constructed on these different kinds of abilities which may aid in predicting whether you are better-suited for some sports than others.

### TESTING YOURSELF ON MOTOR PERFORMANCE

**One-mile run (cardiovascular endurance).** It is best if you have a 440-yard track for this test, but the mile run can be done practically anywhere that you can lay off the correct distance. The only equipment necessary is a stopwatch or any wristwatch that can indicate the elapsed time to the nearest second.

When ready, start the watch (note the exact time to the second) as you start to run. Stop the stopwatch as you cross the finish line (or note the time to the exact second on a wristwatch). *Note:* it is important that you practice distance running for a while to get into some kind of shape as well as establishing the best pace for yourself. To try to get a realistic measure of your ability to run a mile if you haven't been practicing is a waste of time.

**50-yard dash (running speed).** Measure off exactly 50 yards, preferably on a running track. A stopwatch is needed so that you can record the time to the nearest tenth of a second.



You can score yourself or have somebody time you. In either case, the watch should be started as soon as you start to move and stopped at the exact instant that you cross the finish line. Take at least two trials and use the best score.

**Standing broad jump (explosive power).** All that is needed for this test is a yardstick or tape measure and a flat surface to jump on. You can score yourself, but it probably is a little easier to have someone spot your exact heel placement in the event that you move after landing.

Stand with your feet comfortably apart, toes, just behind a starting line. Swing your arms back and bend your knees; then spring forward as far as you can swinging the arms forward.

The measurement is taken from the starting line to the heel nearest the starting line. In other words, if you land with one foot slightly ahead of the other, the heel of the trailing foot is used as the point of landing. Take three trials and use your longest jump measured in feet and inches as your score.

**Push-up (muscular strength and endurance).** No equipment is necessary for this test. Begin by lying down with your chest on the floor and your hands about shoulder width apart. Push up to a straight arm support and return keeping your body straight throughout. The total number of repetitions without rest is the score.

**Bent knee push-up (muscular strength and endurance).** The only difference in the bent knee push-up is that the weight is supported by the hands and knees rather than the hands and feet. The starting position is thus modified to the extent that the knees are bent while lying face down. As you push to a straight arm support, the body must be kept straight from shoulders to knees.

**Shuttle run (running agility).** You need a good smooth running surface such as a gymnasium floor with lines 30 feet apart. The starting position is on the hands and knees with the hands just behind the starting line.

A starter gives the commands, "get set, go!" On the command "go," scramble to your feet and sprint to the other line that is 30 feet away. Touch your hand to the floor

just beyond the line and turn around and race back to the other line, touch the floor again just over that line and then sprint back across the starting line. (Hence, you run between the lines 4 times and touch a hand to the floor 3 times.)

The timer starts the watch on the command "go" and stops the watch as your chest crosses the finish line. The score is to the nearest tenth of a second. Take three trials and use your fastest time as the score.

**Squat-thrust (body movement agility).** A timer with a stopwatch should help you take this test. Start in a standing position. When ready move to a squat position with hands on the floor, thrust the legs backward to a push-up position with weight resting on the hands and feet, return to the squat position, and rise to a standing position.

Each of the 4 parts of the squat-thrust counts one point. In other words, one complete squat-thrust is worth four points. The score is the number of points acquired within ten seconds. The timer starts the watch on the command "go" and stops the watch at the end of 10 seconds, at which point, he yells "stop!" Perform three trials and use the best score.

## DEVELOPING YOUR PERFORMANCE PROFILE

Below are some standards of performance in the six tests based on many scores from boys and girls approximately 15 years of age. You can plot your own profile according to how you scored in each of the tests.

**Sample Profile.** A 15-year-old boy who is 5'6" tall and weighs 130 pounds had the following scores. Mile (7.48), 50-yard dash (6.9), Standing Broad Jump (8'0"), Push-ups (55), Shuttle Run (10.1), and Squat-thrusts (32).

In this example, the boy demonstrated excellent explosive power, muscular strength and endurance, and body movement agility. His cardiovascular endurance, running speed, and running agility were fair to average. With the boy's size, he probably would not excel in a sport such as football or perhaps basketball or baseball.

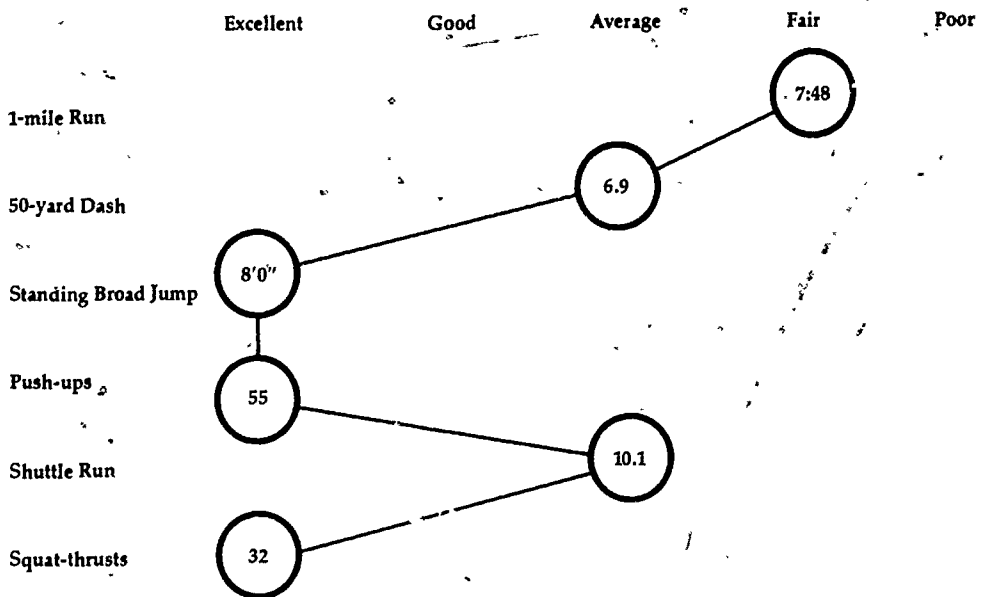

Diagram 2.

He also would probably be at a disadvantage in track and field. On the other hand, he may be admirably suited for sports such as gymnastics or wrestling in which his strength, muscular endurance, explosive power, and body movement agility would be helpful. This is merely a very limited example of how motor fitness abilities with respect to possible sports participation might be rated. There are, of course, many other sports in which the boy's abilities may or may not be well-suited. Remember also, that one's desire and determination can play a very important role in whether or not a person will be successful in any sport.

In this chapter we have tried to describe some of the processes that are involved in developing motor skills and some of the abilities that are necessary for success in sports, dance, and other activities. By testing yourself on some of these important physical abilities you should be better equipped to decide what sport(s) might be best suited for you.

Regardless of the chosen sport and for what purpose (recreation, fitness, or varsity competition) it is selected, it will take lots and lots of practice before you will be highly skilled. In addition, as you get more skilled you will get more enjoyment out of playing the sport. People usually will not play a sport for fun if they are very poor

performers unless they can see that they are improving. For example, tennis isn't much fun if the ball is constantly hit into the net or out-of-bounds. The ball has to be kept in play. But don't get discouraged right away. Improvement comes with practice, and with improvement comes enjoyment and satisfaction.

**Practice regularly.** Try to evaluate progress so that you can chart improvement. In tennis, for example, count the number of times the ball can be hit against the wall and the number of times the ball is served into each service court. If this is regularly done, improvement is obvious. The same kind of self-testing can be done in any sport.

Also, remember that by improving motor abilities such as strength, endurance, flexibility, etc., skill performance can be improved. For example, if you get tired very easily, reactions and speed of movement are slowed, and you can't get into the proper position quickly, which means you can't make a good play. By improving stamina you will find that you can play a higher skill level for a longer time.

So get in shape, listen to your instructor or coach and practice, practice, practice. You'll find that the joy of effort, the thrill of the challenge, and pride of accomplishment will carry over and enhance all aspects of your life.

Table 1.

**Standards for Fifteen Year-old Boys**

	<i>Excellent</i>	<i>Good</i>	<i>Average</i>	<i>Fair</i>	<i>Poor</i>
1. Cardiovascular Endurance (1-mile run)	6 min. & under	6:10-6:40	6:50-7:20	7:30-8:10	8:25 & over
2. Running Speed (50-yard Dash)	6.2 sec. & under	6.4-6.7	6.8-7.0	7.1-7.3	7.5 & over
3. Explosive Power (Standing Broad Jump)	7'9" & over	7'6"-7'1"	7'0"-6'6"	6'5"-6'1"	5'10" & under
4. Strength and Endurance (Push-ups)	48 & over	45-38	37-32	31-28	25 & under
5. Agility-Running (Shuttle Run)	9.4 sec. & under	9.5-9.9	10.0-10.3	10.4-10.8	11.0 & over
6. Agility-Body Movement (Squat-thrust)	32 & over	31-28	27-16	15-12	10 & over

**Standards for Fifteen Year-old Girls**

	<i>Excellent</i>	<i>Good</i>	<i>Average</i>	<i>Fair</i>	<i>Poor</i>
1. Cardiovascular Endurance (1-mile Run)	7:10 min. & under	8:20-9:15	9:20-10:30	10:45-12:15	12:30 & over
2. Running Speed (50-yard dash)	7.3 sec. & under	7.5-7.9	8.0-8.3	8.4-9.0	9.1 & over
3. Explosive Power (Standing Broad Jump)	6'3" & over	6'1"-5'7"	5'6"-5'1"	5'0"-4'7"	4'6" & under
4. Strength and Endurance (Bent Knee Push-ups)	31 & over	30-25	24-13	12-7	6 & under
5. Agility-Running (Shuttle Run)	10.3 sec. & under	10.5-11.0	11.1-11.6	11.7-12.4	12.5 & over
6. Agility-Body Movement (Squat-thrust)	30 & over	29-26	25-14	13-10	9 & under

**REFERENCES****For the Student**

- Benanno, D., and Dougherty, N. *Understanding and Assessing Human Movement*. Minneapolis, MN: Burgess, 1980.
- Corbin, C. B.; Dowell, L. J.; Lindsey, R.; and Tolson, H. *Concepts in Physical Education*. 2d ed. Dubuque, IA: Wm. C. Brown, 1974.
- Fitness for Life*. Glenview, IL: Scott, Foresman and Company.
- Thomas, J. R., ed. *Youth Sports Guide for Coaches and Parents*. Washington, DC: AAHPER, 1977.

**For the Teacher**

- Corbin, C. B. *A Textbook of Motor Development*. Dubuque, IA: Wm. C. Brown, 1980.

- Johnson, B. L., and Nelson, J. K. *Practical Measurements for Evaluation in Physical Education*. 3d ed. Minneapolis, MN: Burgess, 1979.
- Nelson, J. K., and Johnson, B. L. *Measurement of Physical Performance*. Minneapolis, MN: Burgess, 1979.
- Singer, R. N. *Motor Learning and Human Performance*. 3d ed. New York: MacMillan, 1980.
- Thomas, J. R. "Acquisition of Motor Skills: Information Processing Differences between Children and Adults." *Research Quarterly for Exercise and Sport* 51 (1): 158-73.
- Wickstrom, R. L. *Fundamental Motor Patterns*. Philadelphia, PA: Lea and Febiger, 1977.

aim (p. 38)  
anchor (p. 36)  
arrow size (p. 43)  
bow bite (p. 41)  
dominant eye (p. 41)  
draw (p. 36)  
draw weight (p. 42)  
kisser button (p. 42)  
nocking point (p. 42)

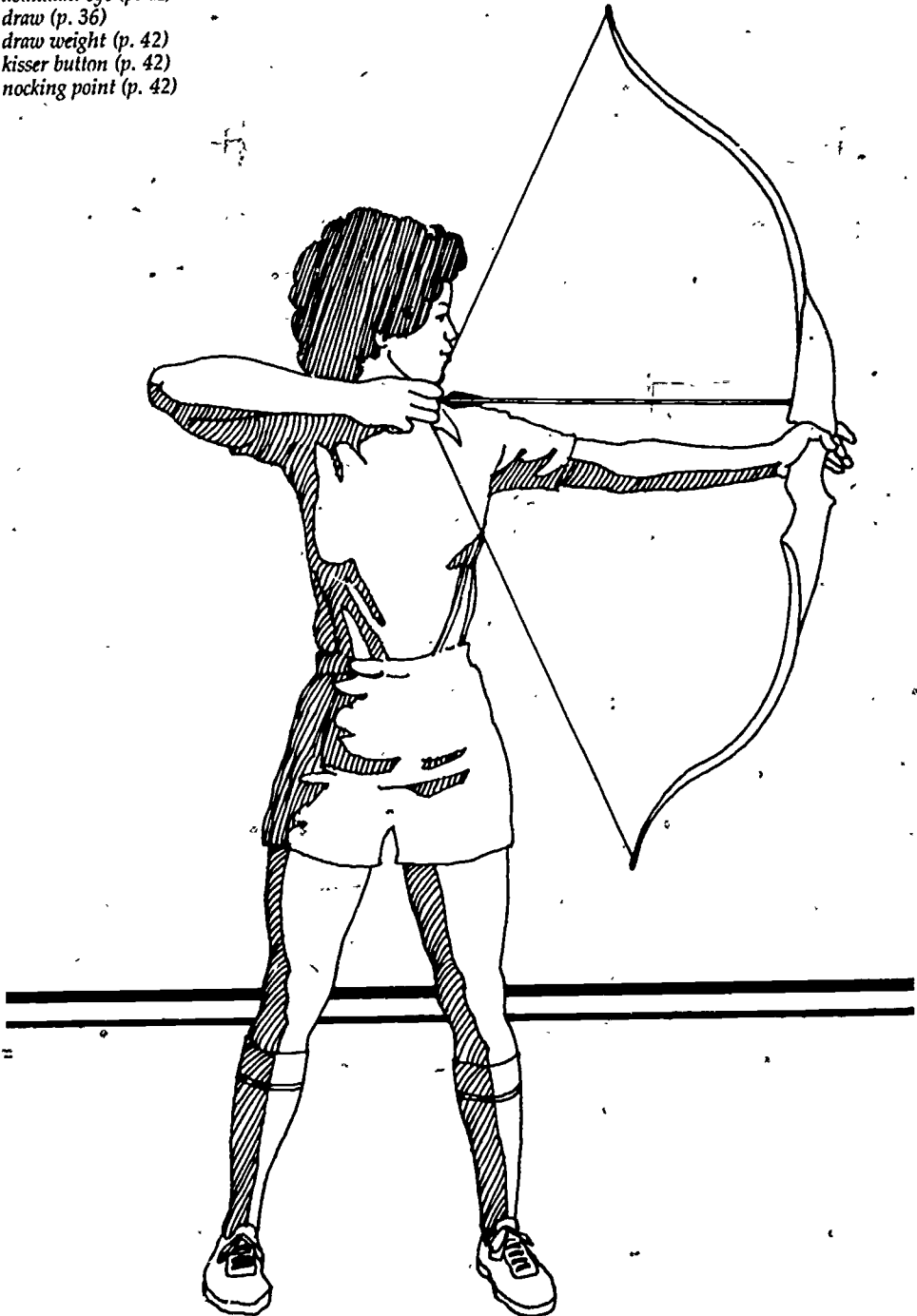

# Archery\*

RUTH E. ROWE,  
National Archery Association,  
Colorado Springs, CO

and  
JULIA HEAGEY BOWERS,  
Millersville State College,  
Millersville, PA

## INTRODUCTION

Archery belongs to a select group of activities that offer participation for all ages. Once the basic shooting skills of archery have been learned, many enjoyable activities open up to the archer. For young archers, there are junior programs in some local clubs, a national Junior Olympic Archery Development Program, and archery programs at some high schools and colleges. Regardless of age, bow hunting is an enjoyable pursuit. No matter what equipment is used, the basic shooting technique is the same.

For all archers, there are local, state, regional, and national championships in which one can participate regardless of proficiency in skill. If you work hard and truly become an expert, there are opportunities for international and Olympic competition. On any of these levels, there are many stimulating experiences as well as chances to meet people from many different areas.

The thought of expert shooting may seem far away, but remember, no matter what level of achievement is attained, it all starts at the same point—*learning the basics*.

## SKILLS AND TECHNIQUES

When beginning to shoot, practice at 10 yards until enough accuracy and confi-

\*The material in this chapter is from the *Guide for New Archers* available from the National Archery Association, 1750 E. Boulder Street, Colorado Springs, Colorado 80909.

dence is attained to move farther from the target. Remember that *any arrow shot is your responsibility, whether it hits the target or not*.

Stand so that an imaginary line that touches the toes of both feet will, if extended, go to the center of the target. This is a square stance. The feet should be shoulder width apart with the weight evenly distributed on both feet.

When confident enough to draw, anchor, aim, and let down with control, then nock an arrow by placing the arrow nock on the nocking point of the bowstring with the index fletching away from the bow. Place the fingers on the bowstring with the index finger above the nocking point and the second and third fingers below the nocking point. When shooting an arrow, the index finger is above the arrow and the other two are below. Place the string in the first joint of the fingers.

Once the fingers are placed on the string, extend the bow arm toward the target, keeping it at about shoulder level. The pressure of the bow upon the bow hand should be on the bottom part of an imaginary Y formed by the index finger and the thumb. The bow hand position is correct if the bow has no tendency to slide in any direction when the bow hand and fingers are relaxed. A relaxed bow hand means that the fingers can be moved when at full draw. The bow doesn't have to be gripped or squeezed; use the sling.

With the fingers on the string, the bow arm extended, and the bow hand position set, it is absolutely essential that the elbow

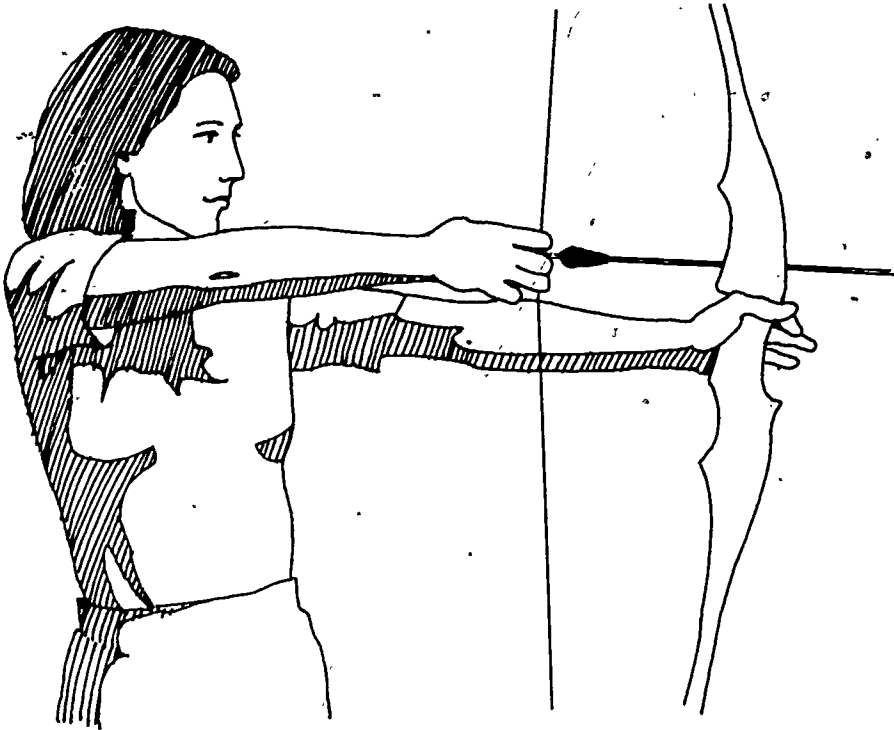

Figure 1.

joint of the bow arm be rotated downward, that is, the elbow joint is set so that the arm, if bent, will move in a plane parallel to the floor, not upward toward the head. This can be accomplished without changing either the shoulder or wrist position after some practice. Admittedly, it feels awkward at first, but keep at it. It will be a lot less painful than hitting the elbow with the bowstring. Do not rotate the bow hand outward on the bow so that the main pressure of the bow is on the thumb. This won't solve the problem, and it will create more problems later. Practice this arm position by placing the hand on a wall and rotating the elbow. Note that the elbow of the drawing arm is in line with the arrow at shoulder level, not pointed downward. Now draw the bowstring back, keeping the drawing hand relatively close to the bow arm. The elbow of the drawing arm moves parallel to the floor at shoulder level. When the full draw is attained, anchor so that the chin is touching the top of the index finger; the

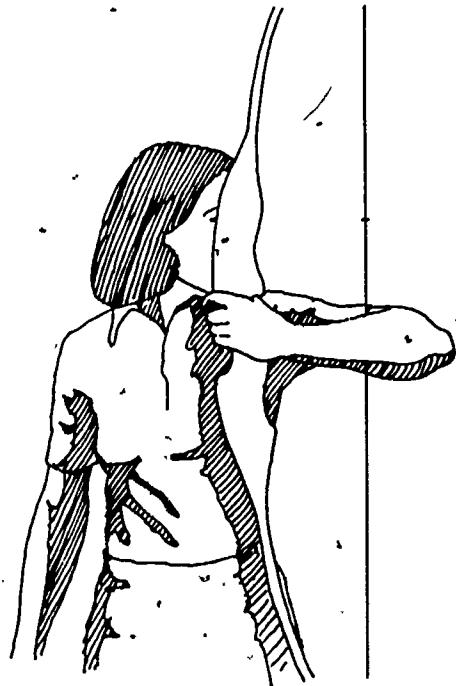

Figure 2.

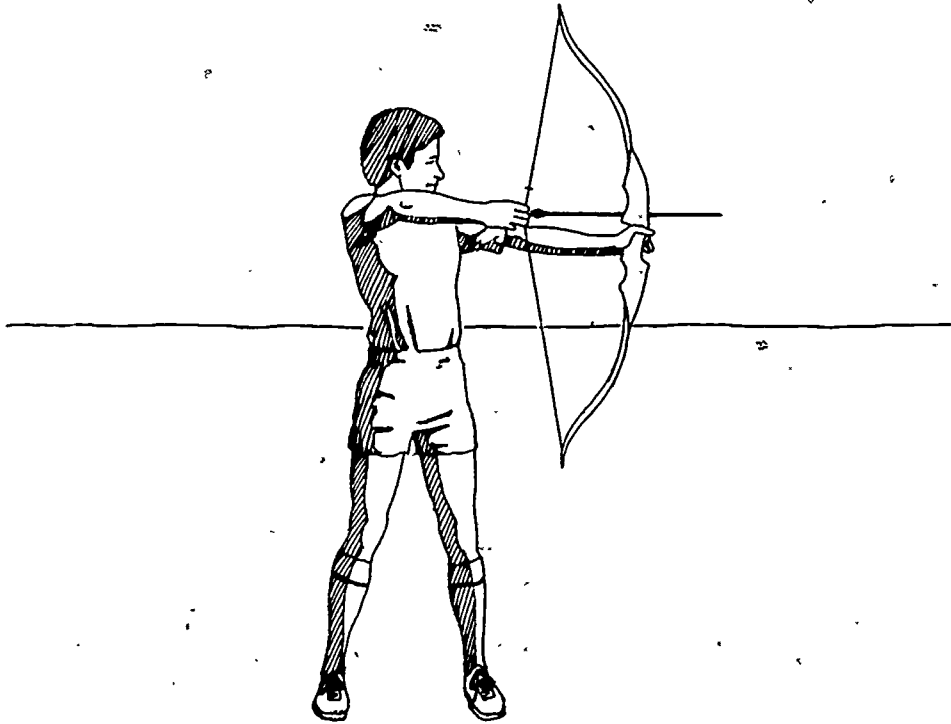

Figure 3.

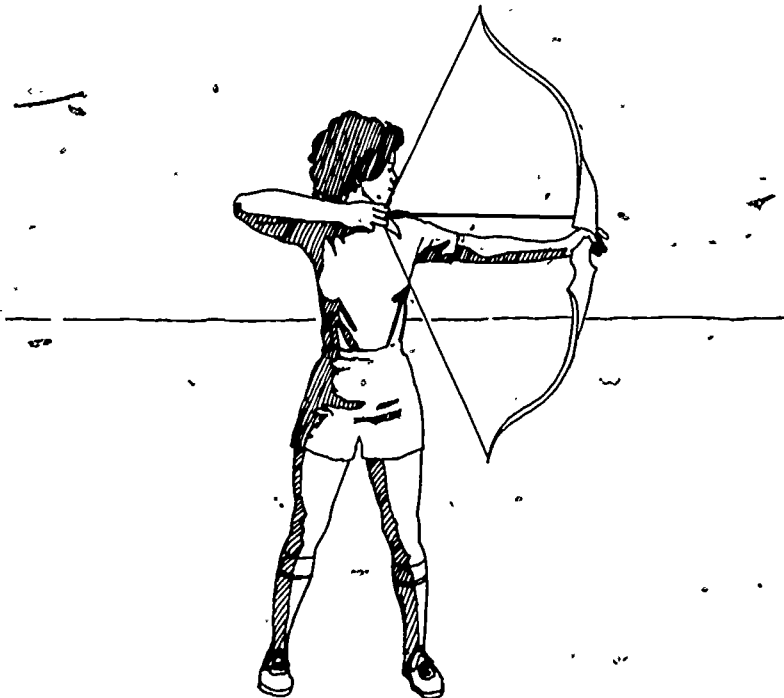

Figure 4.

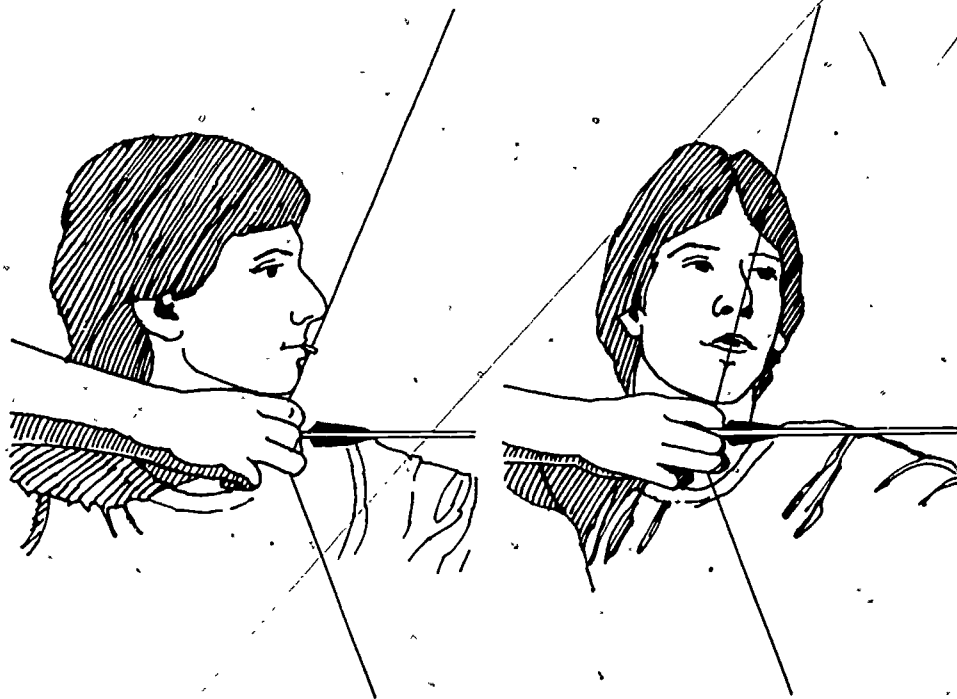

Figure 5.

bow string touches the center of the chin and the tip of the nose. If doing this is problematic, fasten a kisser button onto the string. Position it so that it touches the lips when the string hand is just touching under the chin.

Once a good anchor is attained, and you are in a full draw, tighten the muscles in the center of the back between the shoulder blades to hold the string and arrow at full draw. This does not necessarily increase the draw, but it does ensure that the arrow will not creep forward on the arrow rest.

While holding, aim by placing the sight on the center of the target. For shooting at ten yards, the sight should be about the same distance from the arrow as the eye is from the chin. If practicing without an arrow, let down after aiming.

Once you are aiming steadily, tighten the back muscles a little more while releasing the bowstring. The release is simply a relaxation of the fingers of the string hand—nothing more. Because the muscles across the back have been used and the

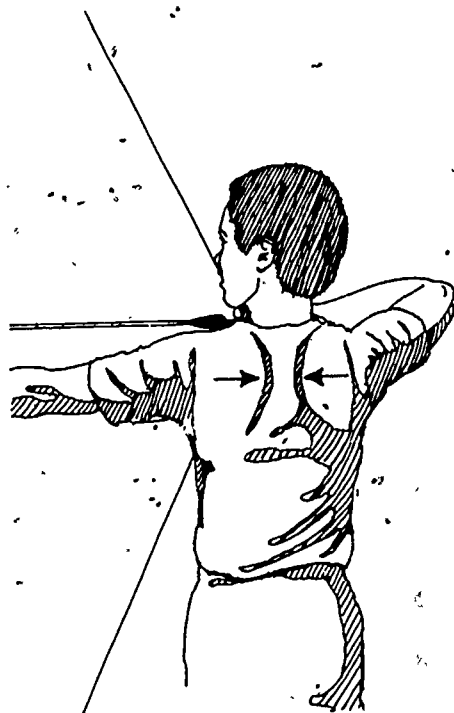

Figure 6.



weight has been released, the string arm will move away from the target and the hand along the neck in an involuntary motion. Allow it to do so, and once the hand has stopped moving, maintain this afterhold position until the arrow hits the target. Then relax and rest.

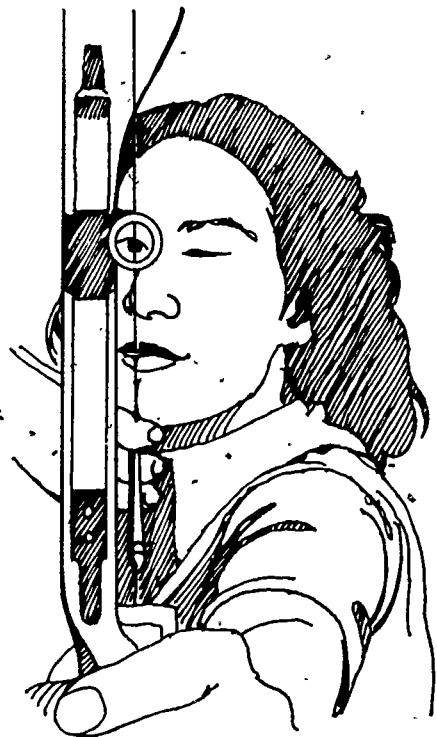

Figure 7.

When all arrows have been shot pull them from the target (or the ground, if the target was missed). Pull the arrows from the target by placing the back of one hand against the target, with a finger on either side of the arrow. With the other hand, grasp the arrow close to the point of entry into the target and pull straight backward, making sure no one is behind the body. Pulling directly backward is extremely important to keep from bending aluminum arrows. Hold any arrows pulled under the thumb of the hand that is against the target, or place them in a quiver.

If the arrow has buried in the target up past the fletching, go behind the target and pull it the rest of the way through. An arrow buried in the grass should be removed by finding the point and pulling it through the same direction it entered the ground. Do not pull upward any more than necessary as doing so will bend aluminum arrows, and may break wooden or fiberglass arrows.

After the arrows have been shot and are keeping on the target, it is likely that they will be in a group, but not exactly in the center. Move the group by adjusting sight—upward if the group is high, to the left if the group is left, etc. Always move the sight in the same direction as the group is from the center of the target.

#### Self-testing

1. Shoot two ends of six arrows from a distance of ten yards at a 36-inch target face.
2. Students in grades 7-9 should have ten hits on the 36-inch target face.
3. Students in grades 10-12 should have ten hits in the inner three circles of the 36-inch target face.

#### NEW SHOOTER'S PROBLEMS

It may not seem easy or significant, but concentration is extremely important to consistent performance. Quite often someone who is just beginning to shoot, will really concentrate on every detail of the shooting sequence and shoot a really good group. Then on the next end he/she will mentally relax, thinking that "Now I've finally got it," and scatter the arrows. After that he/she concentrates again and shoots well, only to relax later on and again shoot poorly. Concentrate on shooting each arrow well. More groups can then be shot successfully and consistently.

One of the first things many people attempt to do is draw the bow string with the string arm elbow pulling downward instead of in line with the arrow. It is impossible to shoot this way. The string arm must be in a line, that is parallel to the floor. Once at full draw, raise the elbow to help get full use of the back muscles that are necessary for proper shooting.

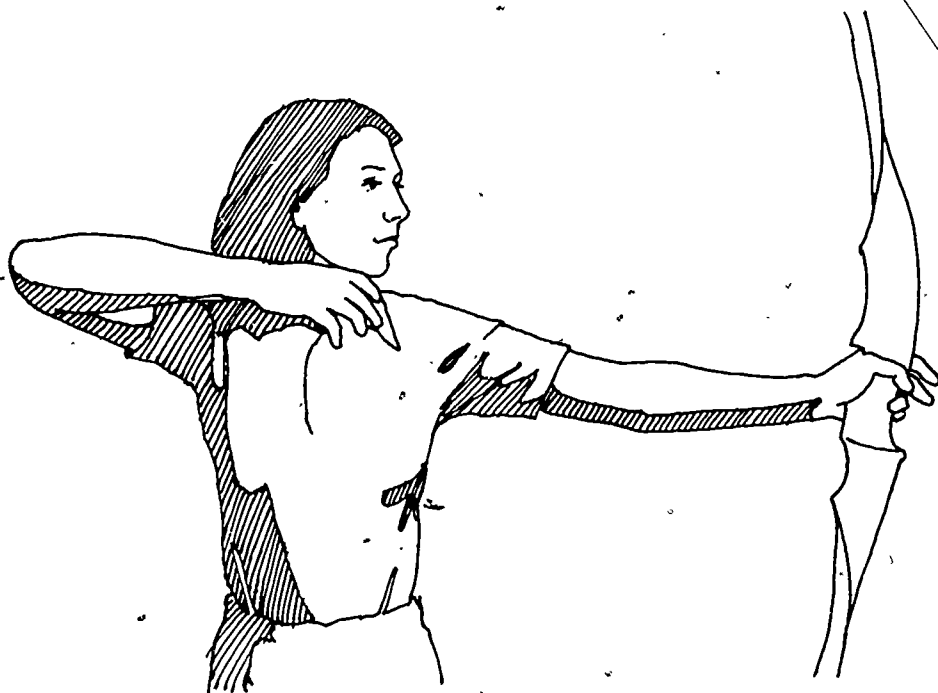

Figure 8.

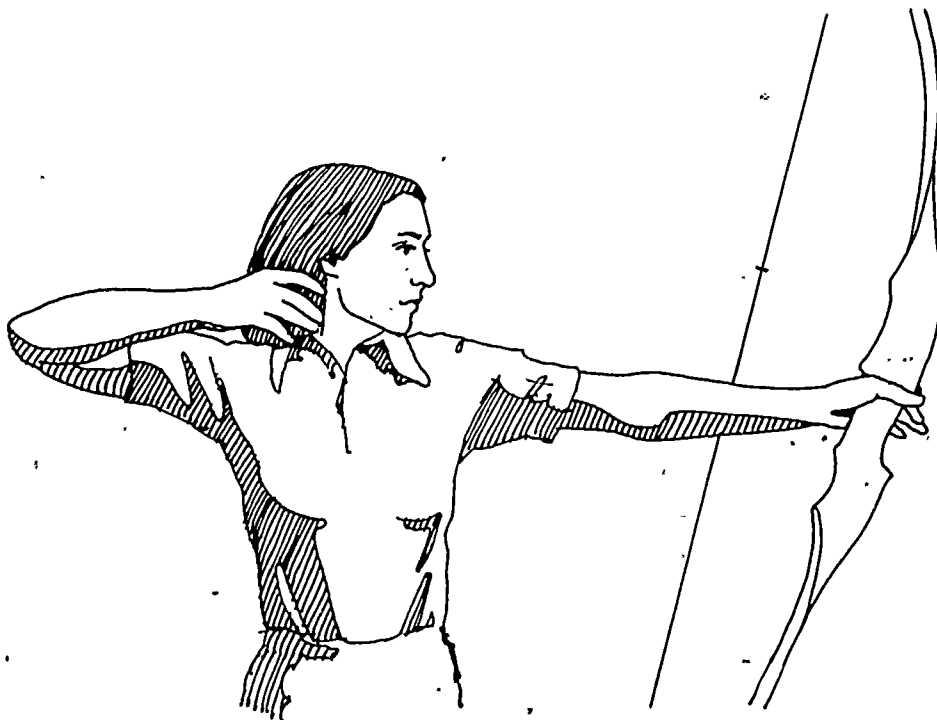

Figure 9.

If the arrow falls off the rest while drawing the string back, it is most likely due to one of five things: curling the fingers and/or bending your wrist, pinching the nock of the arrow between the fingers, gripping the bow and/or improper bow hand position, not keeping the bowstring close to the bow arm when drawing, not using the muscles of the back and shoulder while drawing.

In the beginning there may be difficulty getting to a full draw. The primary reason is usually that the draw weight of the bow is too heavy at this time. Be sure not to reach for the string with the head. When drawing the string back the only movement should be of the arm and the back muscles. Set the head and don't move it after that.

Almost invariably at some point the archer will receive a "bow bite"—a bruise on the elbow or arm caused by the string hitting the arm. To avoid this be sure the elbow is turned down. But be careful—don't allow either the shoulder or bow hand to change position. Yet, it is possible, and this will prevent hitting of the bow arm with the bow string at release. Until the arm can be kept in the proper position, wear the long armguard that covers the arm from the wrist to the bicep.

If missing the target consistently to one side, check to be sure that the proper eye is being used when aiming. Review the eye dominance test that is described at the beginning of the equipment section. If the dominant eye is not being used for aiming, it should be closed or covered with an eye patch.

For first attempts at shooting, it would be quite helpful to have a friend watch for a number of potential trouble spots. If errors can be eliminated now, shooting will be that much more pleasurable. (If working alone, try practicing the draw and anchor sequence *without an arrow* in front of a mirror. *Do not* release the string when doing this, as it may damage the bow.) Be aware of:

- Whether the bow is vertical. The arrows will group in the direction in which the top limb is tilted. This is called canting.
- Having your jaw closed on each shot. If the teeth are not together on each shot,

the shot will be erratically high and low on the target.

- Whether standing straight. Body position should be just as it is if standing at attention with the arms at the sides. Do not lean toward or away from the target, nor forward or backward on the feet.
- The need for string clearance. Be sure to use a square stance and keep the string close to the bow arm when coming to a full draw.
- Maintaining full draw. If the arrow is allowed to creep forward while at full draw a low shot will result (this cannot be observed if using a mirror, because there is no arrow).
- Peeking. If the head or bow arm is moved to watch the arrow in flight or watch it hit the target, it is almost guaranteed that movement will occur before the arrow has left the bow string or cleared the bow. Therefore the arrow will not hit the center of the target. Of course this will not happen unless actually shooting, so have someone observe the shooting.

## EQUIPMENT

If learning to shoot and not wishing to have equipment be a hindrance, some attention must be given to the type of equipment used. If buying equipment, choosing the proper pieces need only involve a modest investment. The equipment described here is the minimum quality needed while learning. More expensive pieces are certainly acceptable but not required at this point. If choices must be made in price and therefore quality, preferably choose a better arrow.

Before buying or borrowing a bow, determine the dominant eye since this will decide whether the shot should be made right or left-handed. Hold the hands out in front with the fingers crossing one another and the thumbs on top of each other. This will create a hole between the thumbs and the fingers. With both eyes open, look at some object through this hole and, with moderate speed, move the hands toward the face, keeping the chosen object in view through the hole. If the hole comes to the

right eye, you are right eye dominant and need to shoot a right-handed bow, and vice versa.

The bow should be constructed of wood and fiberglass laminations. The solid wood or solid fiberglass bows, while less expensive, will give an unpleasant recoil when the bow string is released. The handle of such bows is usually so poorly shaped that it is almost impossible to have a consistent bow hand position. For these reasons it is difficult to shoot well with these types of bows.

For target shooting, the taller the archer, the longer the bow that is needed, for shorter people the reverse is true. A good rule of thumb in selecting a bow length is to

have the upper tip of the bow come between the nose and chin when the bow is strung and held vertically with the lower tip set on the foot. If short, finding a bow of the proper length may be difficult, but try to come as close as possible.

The rule for the draw weight of the bow is to keep it as light as possible, particularly if borrowing or renting equipment. As the muscles become conditioned and the archer gets more proficient, increasing the draw weight may produce better performance, but if the draw weight has to be fought while learning to shoot, it is almost guaranteed that problems will develop that will only be a hindrance. As strange as it may seem, the muscles used for shooting properly are seldom used in this manner except for archery. So no matter how strong the archer is, it is very likely that those muscles are not in the condition required to shoot well. Learn to shoot properly and give the muscles a chance to become stronger. Find a lightweight bow—15-25 pounds for girls and 20-30 pounds for boys.

The bow string should be made of dacron with nylon servings. If the string is new, add a nocking point and a kisser button. These may already be on used or rented bows; if not, add them.\* Be careful with

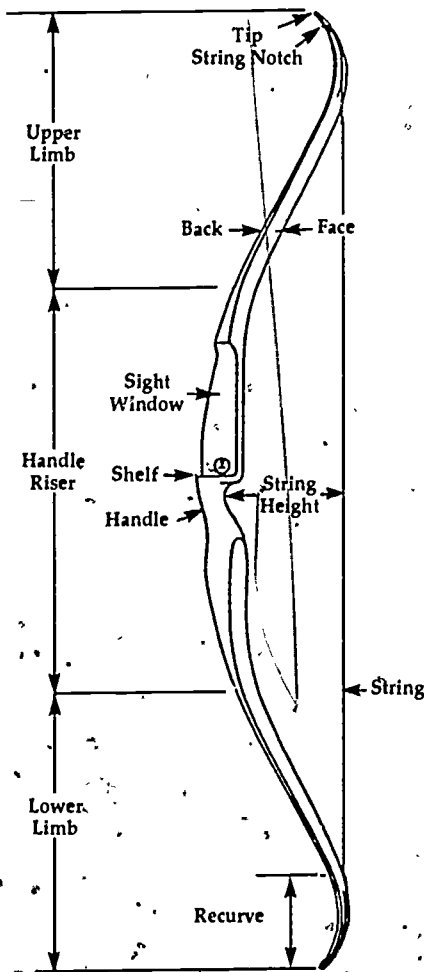

Diagram 1.

52

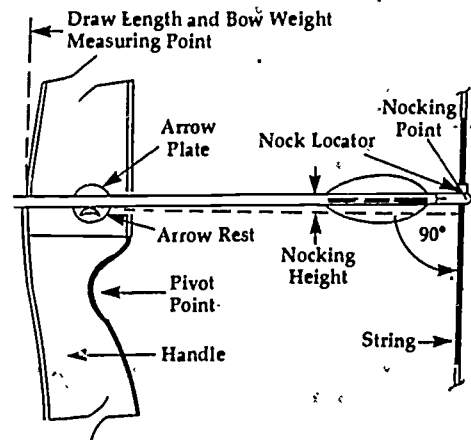

Diagram 2.

\*The nocking point should be set  $\frac{1}{8}$ " above perpendicular from the rest. Use a bow square or have an instructor put a nocking locator on the string. The kisser button is attached to the string at a distance above the nocking point that allows it to touch the lips or a tooth.

used strings they should neither be frayed nor worn on any part of the string.

The bow usually has an arrow rest already installed. If it is necessary to add one, an adhesive-backed plastic rest is easy to apply and quite durable for normal shooting. Also, some type of pressure point included with the rest is very important.

Some type of bow sight is necessary—the style and cost of a sight depends upon personal taste and budget. If the bow has stabilizers they can be used, they are not really necessary at this point and if they make the bow too heavy to hold throughout the practice session, do not use them until stronger.

The type of arrow chosen is a matter of preference but remember they are an investment and if possible an arrow that will be durable and that will perform well should be chosen.

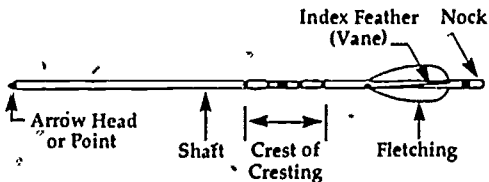

Diagram-3.

Wooden arrows will warp and break easily—they are not a good buy despite their price. Fiberglass arrows are too heavy for long-distance shooting but are a good choice because they are durable. Once proficient and desiring to shoot long distances, aluminum arrows will be needed.

If borrowing or buying used arrows, be sure they are in good condition—that they are not cracked or bent, that the points properly fit the end of the arrow shaft, and that the nock is neither chipped nor cracked. Shooting a damaged arrow is extremely dangerous to the archer and surrounding persons. Check the arrows after each end for damage.

The arrow size needed is dependent upon the draw length and the weight of the bow. For anyone just beginning to shoot, it is imperative that the arrow be an inch

longer than the draw length measured to the back of the bow. This is a safety margin which must be observed. If the draw length does not increase after shooting for several months, the arrows can be cut off if the extra length is bothersome.

Arrows fletched with feathers are highly desirable for people just learning to shoot.

In addition to the bow and some arrows, every archer needs an armguard, some sort of finger protection, preferably a finger tab, and a sling to keep the bow in the bow hand.

## SAFETY

Any bow can be dangerous, whether it is used for hunting or for shooting at indoor targets. It should be treated with respect. *Always shoot in such a way that there is absolutely no possibility that anyone could stray into the shooting area or get hit with a wild arrow.* In general, allow 50-100% more area as a safety buffer than necessary.

The three cardinal rules of shooting safety are:

1. Never run on an archery range or while carrying arrows.
2. Never indulge in any silliness or horseplay when handling equipment (or put the equipment away).
3. When an arrow is nocked, never draw the string back unless aiming at a target.

For personal safety and comfort, remember a few things before shooting. First, do what is necessary to keep anything from catching the bow string. Clothing should be relatively tight-fitting and preferably without pockets; at least any shirt pockets should be empty. Pin back any long hair that falls in the face or over the shoulders. Secondly, always use a stringer to string the bow. Finally, as mentioned in the equipment section, be sure that the arrows are at least one inch longer than the draw length. While learning, everything about shooting will change, including the arrow length. Accidentally overdrawing an arrow off the rest and then releasing it means it could go anywhere, including a strike of the hand or wrist.

## TERMINOLOGY

- Bow.** A device made of a piece of flexible material that is used to propel an arrow. A bowstring connects the two ends.
- Bow Sight.** A mechanical device placed on the bow with which the archer can aim directly at the target.
- Bow Square.** A device, usually shaped in a T used to measure string height and nocking height.
- Cent.** To tip or hold the bow to the right or left of vertical while at full draw. The reference to right or left is determined by the position of the upper limb.
- Creep.** To allow the arrow to slowly move forward before the release; to not maintain full draw before release.
- Draw Weight.** The weight, measured in pounds, used to bring the bow to full draw. The weight of the bow drawn to the standard draw length.
- End.** A set number of arrows that are shot before going to the target to score and retrieve them.
- Field Archery.** An archery round in which the archer shoots from a variety of distances in woods and fields.
- Fletching.** The feather, plastic vanes, or other devices that are attached to the arrow shaft to stabilize the flight of the arrow.
- Handle.** That part of the handle riser where the hand is in contact with the bow.
- Index Fletching.** The fletching that is set at a right angle to the slot in the nock.
- Kisser Button.** An indicator or protrusion, usually constructed from plastic, placed on the bow strings so that it touches the lips or teeth while the archer is at full draw.
- Laminated Bow.** A bow made of several layers (usually two layers of fiberglass and hardwood core) of different material glued together.
- Let Down.** Returning from full draw to the undrawn position with a control without releasing the string.
- Nock.** To place an arrow on the bow string. The attachment on the rear end of the arrow which is placed on the bow string and holds the arrow on the string.
- Nocking Point.** The area of the bow string covered by the nock.
- Peek.** To move the head or bow arm in order to watch either the arrow in flight or where it hits the target.
- Pressure Point.** The spot on the arrow plate or rest against which the arrow lies and presses when the bow string is released.
- Quiver.** A device used to hold arrows.
- Spine.** The stiffness or amount an arrow bends, determined by hanging a two-pound weight from the center of the arrow and measuring the amount of the bend.
- Square Stance.** The position of the feet in which an imaginary straight line would touch the toes of both feet and extend to the center of the target.
- Stabilizer.** A piece consisting of a weight which is extended at a distance by a relatively lighter rod, mounted on the handle riser. Any weight attached to the handle riser to minimize torque.
- Standard Draw Length.** When the bow string is drawn back to 26 $\frac{1}{4}$ " from the nocking point to the pivot point, and then adding 1 $\frac{3}{4}$ "; not to be confused with the manufacturer's true draw length (nocking point to pivot point) or the archer's draw length (arrow length required by each archer).
- Torque.** An undesirable twisting of the bow by the bow hand or of the bow string by the string hand.

*drive serve (p. 51)*  
*drop shot (p. 48)*  
*fault (p. 58)*  
*feints (p. 59)*  
*hairpin (p. 59)*  
*high clear serve (p. 48)*  
*high clear shot (p. 48)*  
*love (p. 57)*  
*love-all (p. 57)*  
*net flight (p. 60)*  
*offensive (p. 50)*  
*one hand down (p. 57)*  
*"poona" (p. 47)*  
*rally (p. 57)*  
*ready position (p. 59)*  
*receiver (p. 48)*  
*server (p. 48)*  
*service (p. 48)*  
*setting (p. 57)*  
*short serve (p. 48)*  
*shuttlecock (bird) (p. 47)*  
*side-out (p. 57)*  
*slung (p. 59)*  
*smash (p. 48)*  
*two hands down (p. 57)*

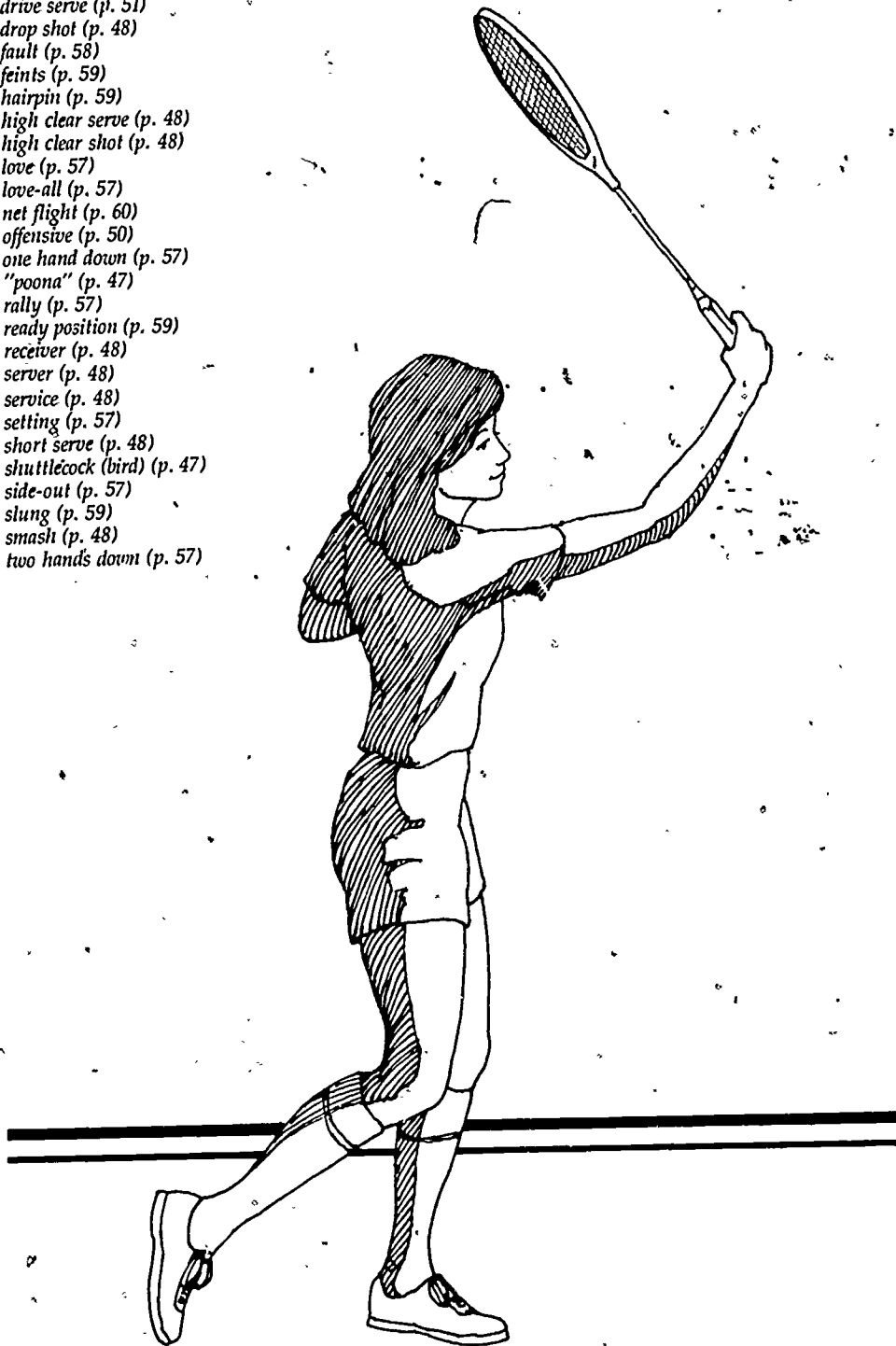

# Badminton

ARNE L. OLSON,  
*East Stroudsburg State College,  
 East Stroudsburg, PA*

## INTRODUCTION

Badminton is a court game that can be successfully played with enjoyment by most players after a brief practice period. Like most sports, it is played at many levels of skill, from the beginner to the advanced player who engages in world-wide competition.

Badminton can be played as a backyard relaxation change-of-pace game or it can be played as a highly competitive, fast-moving contest requiring great speed and agility as well as fine hand-eye coordination and quick judgment. Since the indoor shuttlecock (bird) is very light and slows down rapidly with certain stroke actions, the pace and the flight of the bird make the contest one of strategy as well as one of fine execution of fundamentals. (Many times, in fact, players find that court knowledge, placement of the shuttle, and position anticipation are as important in winning matches as powerful shots and physical prowess.)

All that is needed to begin play is to identify boundaries, and to possess a racket and an appropriate shuttlecock. The shuttlecock for outdoor play is much heavier and travels much farther with a less powerful hit. It therefore, is not affected by light winds. The playing court boundaries are 20 feet by 44 feet for doubles (4 players) and 17 feet by 44 feet for singles (2 players).

Badminton has been played for almost 100 years with equipment similar to that of today. Modern equipment has been refined and carefully manufactured, however, to allow the player to complete many shots more difficult with poor equipment. Apparently a game like badminton called "poona" was first played in India. A British

army officer brought the game to England where it gained popularity at a place like Badminton house where the net was in a rather narrow but high doorway and the court boundaries were in an hourglass, oval shape.

## SKILLS AND TECHNIQUES

### GRIP AND STROKING ACTION

The important consideration in gripping the racket is that it should permit the player to develop great racket head speed and yet make contact with the bird squarely so that it can be sent to the desired spot on the court. The stroking action is usually one of rotating the forearm in combination with wrist action so that the racket head moves quickly. The forehand stroke is used most frequently and a correct grip is demonstrated by placing the palm of the dominant hand flat against the strings of the racket. Then slide the hand down the racket, keeping the face of the racket and the palm in the same relative position, until the end of the handle is almost even with the edge of the hand. The handle should lie diagonally across the palm of the hand. Close the fingers and thumb around the handle in a natural but slanted manner. Spread each finger slightly and spread the index finger as far as possible while still having it wrapped around the handle. This should make a gap about finger width between the index and middle finger.

The backhand grip is taken by placing the thumb directly in back of the handle instead of at an angle. This position gives the player a stronger grip to react to the bird and also helps accelerate the racket head to hit the bird (see Figure 1).



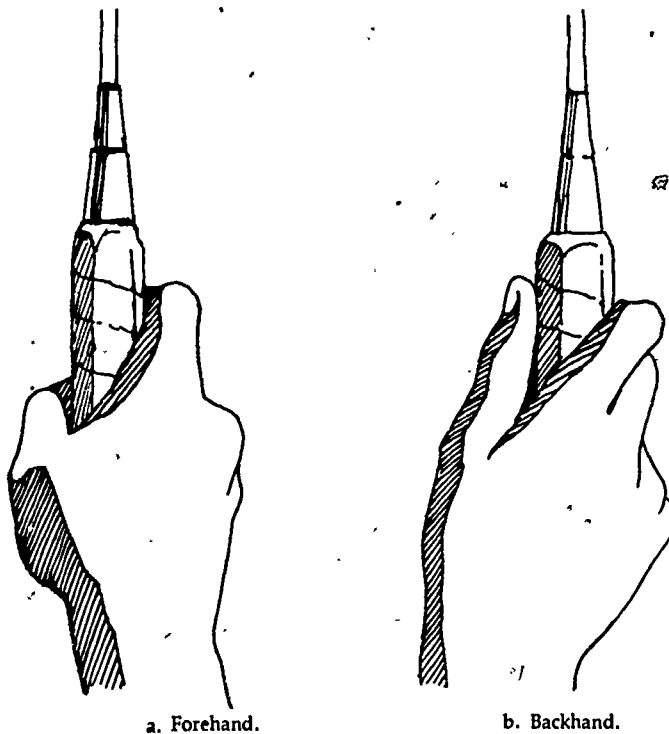

Figure 1. Note that the thumb closes around the grip in the forehand; in the backhand it is extended down the back of the handle.

### SERVICE

The contest and each point is started by having the player (or side in doubles) who has won the last rally serve the bird with an underhand motion. Technically the racket head must be lower than the server's serving hand and the bird must be contacted below the server's waistline. The server generally hits the bird high to the back of the opposite court, low, just over the net, to the front of the receiving court, or quickly straight at the player who is receiving the serve (the receiver). More long serves in singles and more short serves in doubles are typically used because of the size of the court and the requirements necessary to cover the court. The court is long and narrow in singles and short and broad in doubles.

The high shot is called the high clear serve because it is intended to be hit high enough so that it will be out of reach of the receiver and come down vertically on the back boundary line. The short shot is called

the short serve and it is intended to get down behind the net near the short serve line so that the receiver will have to hit the bird up in the air to return the serve. The server will then have the option of rapidly hitting the bird down (smash), of slowly hitting the bird down (drop shot), or of hitting a "high clear" shot.

### High Clear Serve

The high clear serve is hit with a powerful underhand action attempting to hit the bird "out" so that it gets deep into the court as well as high. Height is useful to give the player time to prepare for a return and also to give the bird a more straight up and down descent making it harder to hit. The server must remember that it is against the rules to "step into" the serve and, therefore, that the server cannot move his or her feet until the shuttlecock is struck. A weight shift from the back foot forward is helpful, however, to add power to the shot. Beginners may find it helpful to stand a little sideways and almost hit the

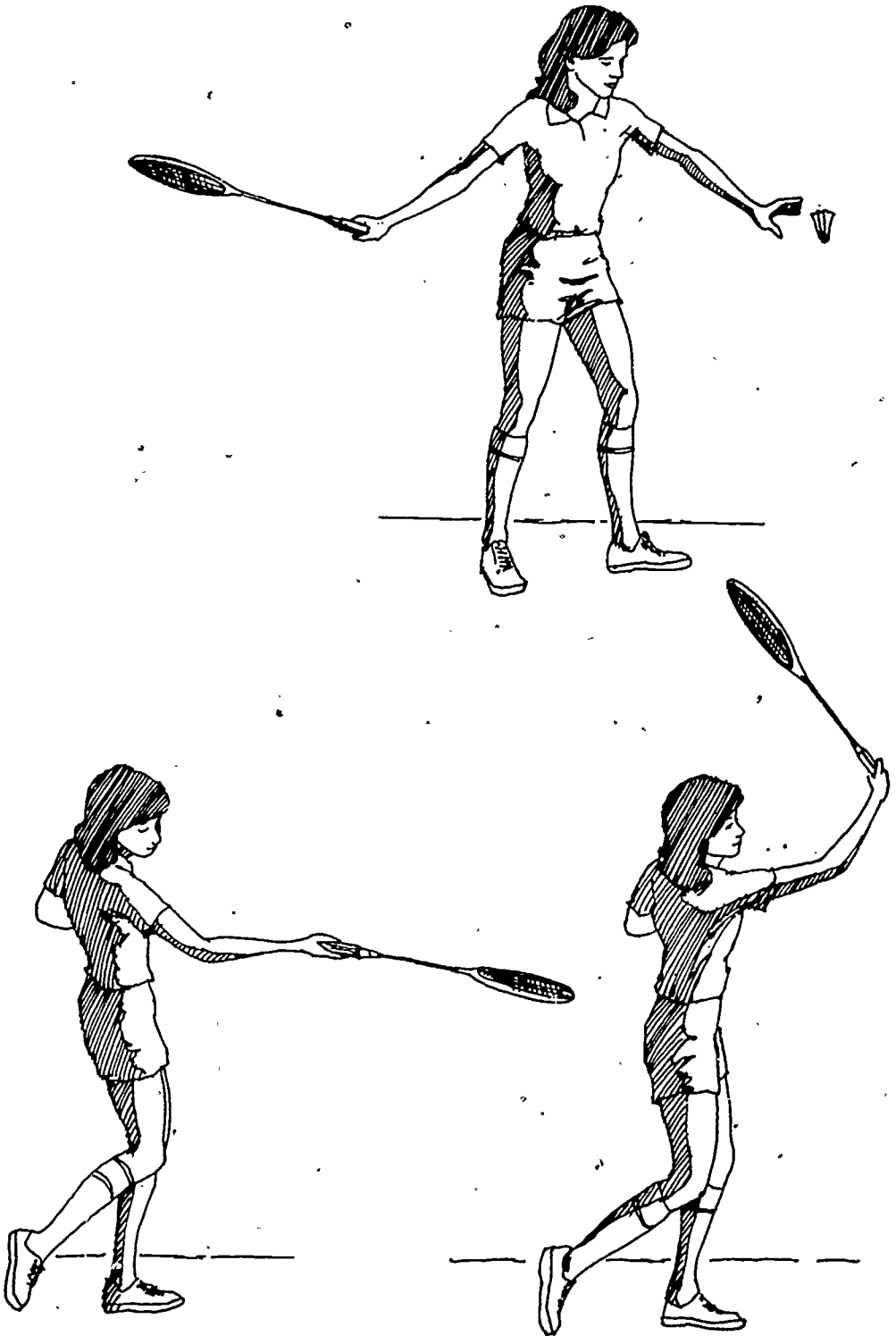

Figure 2. Sequence of the high clear serve.

shuttle out of their hands. More experienced players will probably face the opponent more directly and hit the bird after dropping it. Dropping the bird also allows the server to disguise the type of serve until the last moment. The server should place his/her non-dominant foot forward 12-15 inches and start with the racket arm extended backward with the weight primarily on the back foot. The racket should be about waist high as the bird is dropped and as the weight is shifted forward the wrist should uncock as the forearm is rotated inward rapidly. The follow-through should be high and extend over the opposite shoulder and actually pull the entire body into a square position (ready position) so that movement is easy in any direction. Height and depth are to be emphasized (see Figure 2 for the high clear serve sequence).

The Poole Long Serve Test can be used to evaluate your high clear serving ability. The court is marked with 1- or 2-inch lines as shown in Diagram 1. Four lines have to be drawn each 16 inches apart. The first is drawn parallel to the court lines and 2 inches in back of the back boundary lines as shown. The shots landing in the various zones are scored 5-4-3-2-1 if the serve is hit legally and goes over the extended arm and racket of a player who stands 11 feet from the net in the 15-inch marked square. Shots hitting the line are considered to be in the

highest point zone. The best 10 out of 12 serves are scored with 50, a perfect score. A rope or extra net across the court 11 feet away from the net and 9 feet high can be substituted for the player although the opponent standing in the court makes the test seem more gamelike. The test can be shortened to the best six out of eight trials with similar results for most students.

**Short Doubles Service**

Since the depth of the service court is less in doubles than in singles and the basic strategy in doubles is to hit the bird downward whenever it is possible, the basic serve in doubles is the short, low serve which usually forces the receiver to hit the bird up so that the serving team can take the offensive. The starting posture should be similar to that taken for the high clear serve except that some players shorten the preparation backswing so they can contact the bird quicker before the receiver can recognize it and, therefore, prepare for the short shot. (The receiver cannot move until the bird is struck either.) The shuttle is contacted higher and more or less "guided" over the net rather than being "struck." The stroke has a flat sweeping motion that is made without uncocking the wrist—almost pushing the bird over. The bird should be on a downward path as it crosses the net and usually is served at the front

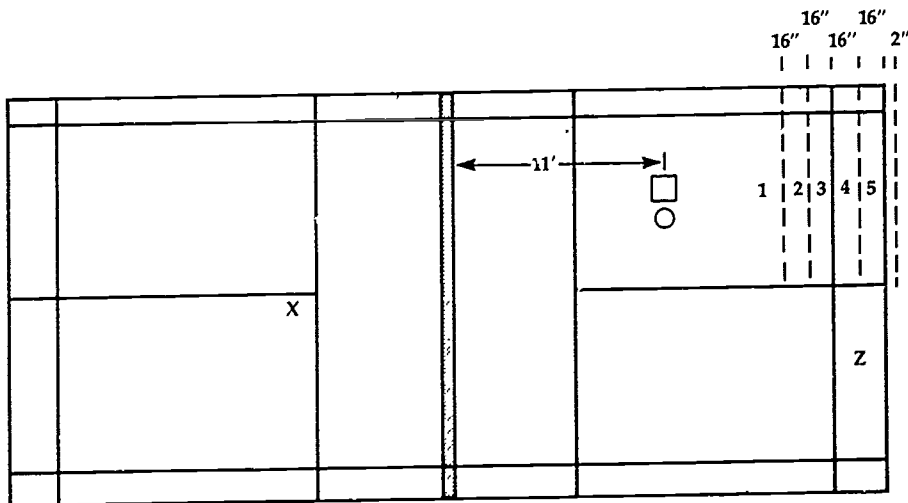

Diagram 1. Court markings for the Poole Long Serve Test.

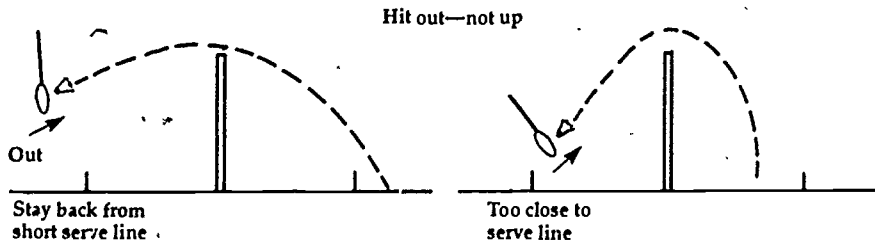

Diagram 2. Short serve paths (out and low to the net rather than up and down—short of service line).

center corner of the court. Only change-ups or surprise attempts are made to the side corners because the receivers have better angles on the return from the outside and can put the servers off-balance immediately.

A modified version of the French Short Serve Test is recommended to evaluate the short serve performance. The test is designed to evaluate the placement accuracy of a low short serve that would be difficult to smash. The shot should actually reach its highest point on the server's side of the net and be on a downward path as it crosses the net (see Diagram 2). A rope is stretched tight 14 inches above the net and fastened to the net standards. One- or two-inch wide markings are placed as shown in Diagram 3. The areas are 6 inches apart with the primary target 12 inches from the center corner. Straight lines of one-inch tape make preparation much easier and does not alter

the scores in most cases. A prepared cardboard "target" makes the test easy to administer and convenient to use in practice since it can simply be placed on the court and then removed when no longer in use. The point values are 5-4-3-2-1 and shots on the line are given the highest point value. The best 10 out of 12 trials are totaled for a test score and six out of eight can be used for most students. The server stands 2-3 feet from the short serve line in his/her proper service court.

**Drive Serve**

The drive serve is a quick "change-up" action usually sent directly at the receiver or possibly attempting to be hit past the receiver. The shot is disguised until the last instant and then performed with the racket head down in a "flick" type action. It should just miss the top of the net.

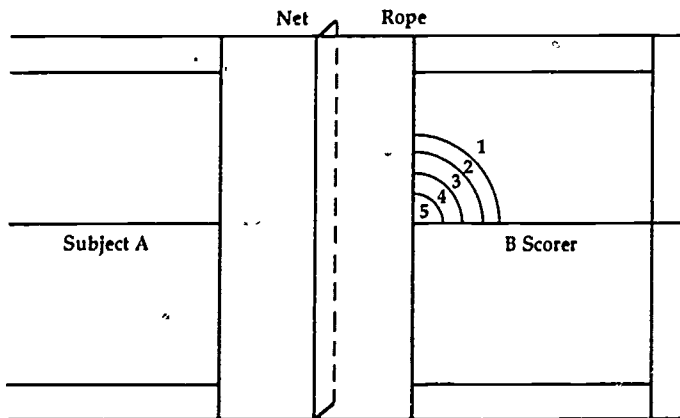

Diagram 3. Court markings for the French Short Serve Test.

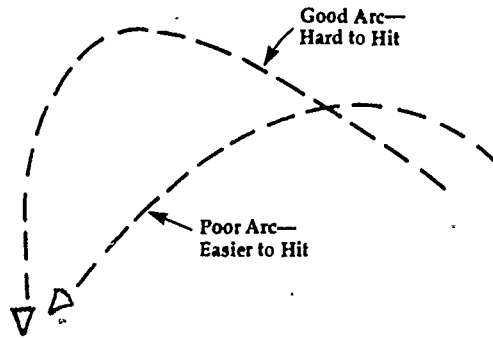

Diagram 4. Arc of clear or serve.

### OVERHEAD STROKES

The overhead strokes are divided into forehand and backhand motion with the desired bird flight being the deciding factor in the type of action. For the high clear return, the bird is usually contacted as high as possible and in front of the body. This makes it easier to hit the bird "out and up" and to get it to the back baseline where it should come down at a steep angle (see Diagram 4). At times a player will find it to their advantage to hit an offensive clear shot. This shot will not take as much time to get to the court since it is hit just out of the reach of the opponent trying to get the bird "down" behind the opponent (see Diagram 5). You should take an action stance that will place most of your weight on the foot on the racket side with the opposite foot well forward. The position and action is very much like throwing a ball a long distance. In preparation, you let the racket head drop low down your back and lead the

forward action with your elbow high. Just before contact is made with the bird, the elbow is straightened, the forearm is rotated, the wrist uncocked, and the whole arm fully extended to reach up at the bird. High racket head speed is important as weight is transferred from the back foot to the front and as the grip is tightened as contact is made. To hit the bird downward (an offensive smash) try to get the racket face a little on top of the bird and build speed in the same manner as the overhead clear (see Figure 3). For the drop shot, the action should appear the same to your opponent but the forearm rotation and wrist action are held back until after the bird is hit and only the arm moves rapidly to disguise the action. The bird is hit flat and at the top of the net, dropping quickly to the floor once it is over the net. Contacting the bird in front of your body is a key concept for all basic overhead shots.

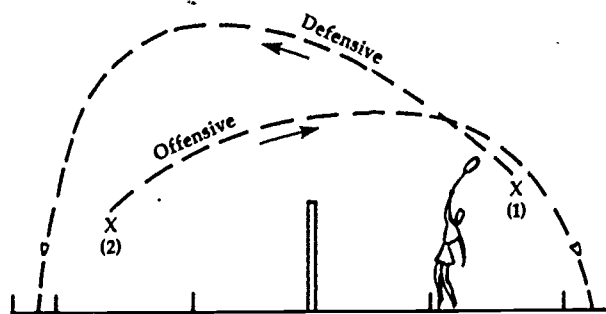

Diagram 5. Defensive clear (1) and offensive clear (2).

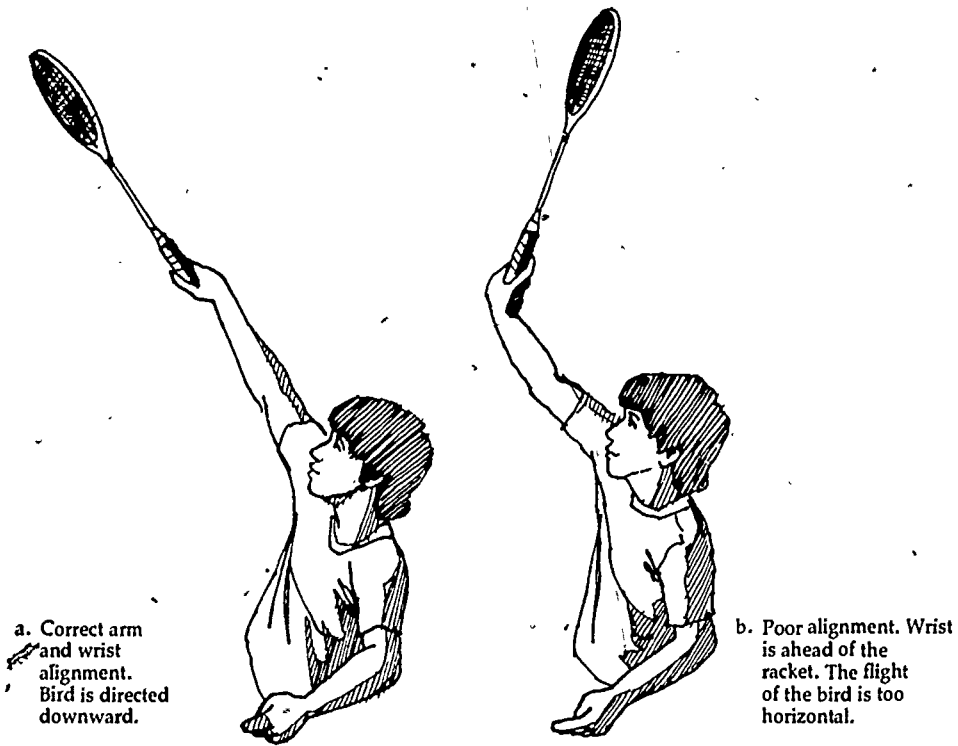

Figure 3. Arm and racket angles in smash.

The Poole Forehand and Backhand Clear Tests are recommended to evaluate the player's overhead clear performance. The court is marked as shown in Diagram 6. A 15- by 15-inch square is drawn 11 feet from

the net to show the "opponent" where to stand for the test and to establish if the clear is high enough so that it would not be an easy "kill" shot. Another 15- x 15-inch square is marked at the intersection of the

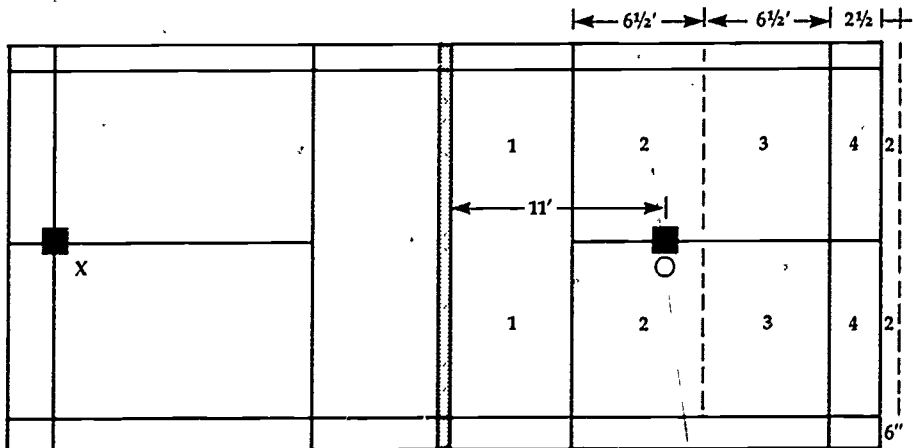

Diagram 6. Court markings for the Poole Forehand and Backhand Clear Tests.

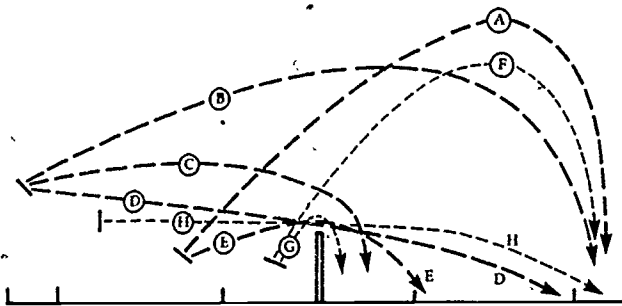

Diagram 7. Trajectory of the different strokes.

- A. Singles.
- B. Clear.
- C. Drop.
- D. Smash.
- E. Doubles (low) score.
- F. Net clear.
- G. Net (hairpin) drop.
- H. Drives.

doubles long serve line and the centerline on the other side of the net as shown. The person taking the test must keep one foot in this square until the bird is hit. The point values are 2-4-3-2-1 as shown with shots on the lines given the larger values. The player taking the test places a bird with feathers (or plastic) down on the forehand side of the racket, tosses the bird in the air, and then hits a high clear forehand or backhand shot depending upon the test. Tossing the bird in this manner takes some practice for beginners. The test consists of the points gained from the best 10 of 12 trials. To save time, six of eight shots usually give similar results.

**SIDEARM AND UNDERARM SHOTS**

Like the overhead shots, the racket head speed, direction of the action, and the angle of the racket face, as well as a clean contact in the center of the racket face are all important to a good execution of the sidearm and underarm shots. The bird flight desired is, once again, the determining factor in the manner in which the bird is hit. It is really just that the bird is down in front of you or to your side which makes the shot seem different. The type of action required is the same as for the overhead shots (see Diagram 7 for trajectory lines of the different strokes).

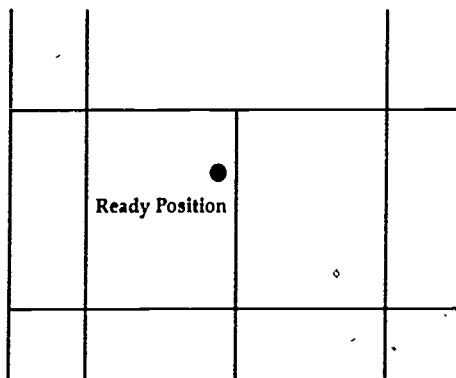

Diagram 8. Court location for ready position.

**FOOTWORK IN GENERAL**

The purpose of working on footwork is to enable you to get in position to hit the bird effectively. The ready position is an important part of footwork. If you are balanced with your knees bent and your weight on the balls of your feet, it is easier to start to move. The ready position is usually taken 2 to 3 feet behind the short service line a little to your "non-racket" side (see Diagram 8). This location helps protect the backhand and also helps the player move to the front corners of the court. A high clear shot is necessary for the opponent to get to the back corners and then, of course, the bird flight will give you more time to get to the back corners. The racket is normally held about waist high with its head up and square to the net just to the backhand side of your face (see Figure 4). A good drill for footwork practice is to rally with another player trying to hit the bird to the "four corners"—no "kill" shots. After each hit you should always try to return to the ready position.

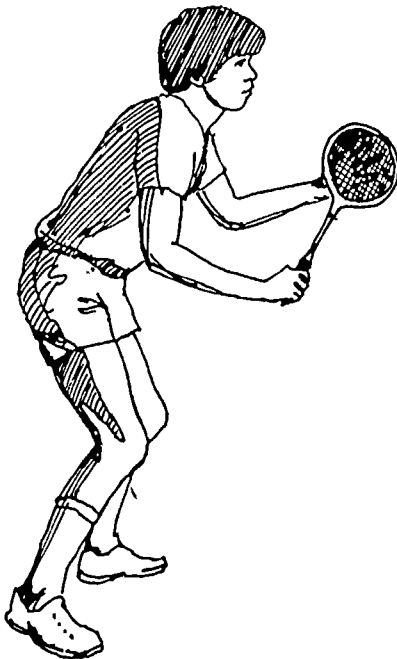

Figure 4. Ready position.

**Footwork to the left front court.** To move to the front left court in anticipation of a right-handed underhand clear or net shot, the following steps are taken:

1. Take a small "get ready" step backward with the left foot. This movement gets the player into a delicate balance position which helps him move his/her whole body quickly. The right shoulder moves forward and the left shoulder back as weight is shifted to the left foot.
2. The second step is a cross-over step with the right foot in the direction the player wants to move. The backswing is taken near the end of this step.
3. The next step with the left foot is adjusted depending upon the bird location.
4. The last step before the bird is hit is always with the foot on the racket side—the right in this case. Shift the weight to this foot, stretch, hit the bird, step up close to the right foot with the left, and start the return to the ready position by almost falling backward at the start and then taking small quick steps to get back.

**Footwork to the right front court.**

1. The first step is taken with the left foot again to put the player in delicate balance and to give direction to your movement.
2. Then step with the right foot toward the target as the backswing is taken.
3. Adjusting the left foot stride for the bird position, take the last right foot step with a body and leg stretching action and hit the bird with most of the weight on the racket side foot.
4. As you follow through from the shot, bring the left foot up near the right and again, in a nearly falling action with the body lowered, return to the ready position with small quick steps.

**Footwork to the left (backhand return of smash or drive).**

1. The left foot moves back in a small "jab" step to get you on delicate balance, the right shoulder is turned so the back is toward the net and the weight is shifted to the left.



2. The second step is a cross-over step with the right foot toward the bird location as you take the backswing and shift your weight to the right foot and stretch to the bird.
3. After the shot, move the left foot to a position next to the right and fall backward to the ready position by taking short quick steps.

**Footwork to the right (to smash a return or hit a drive or drop shot).**

1. Remember to start all movement from the ready position, racket up, weight on the balls of the feet, and the knees slightly bent.
2. Pivot to the right on the balls of the feet, shifting the weight to the right and turning the left shoulder toward the net.
3. Take a short step to the right with the right foot.
4. Take a short step with the left to get on balance and set up for the hit.
5. The last step is with the right foot (always the racket foot) adjusting the length to the bird position.
6. After hitting, push off the right foot and return to the ready position by taking small quick steps.

**Footwork to the back left (for deep backhand).**

1. Pivot to the left on the balls of the feet and shift weight to the left.
2. Take a small step forward and left with the right foot to give a small base lined up in the direction you desire to go and push off the right foot to start the movement back.
3. Rotate the body hard to the left and step backward with the left foot.
4. Step toward the anticipated bird position with a long right stride.
5. Take a medium step with the left foot and combine this motion with the backswing as you adjust to the bird position.
6. The last step is with the racket foot (the right if right-handed) in a stretch toward the bird.
7. Step toward the racket foot with a small step with the left, shift your weight toward the ready position and return to it with small quick steps.

**Footwork to the back right (for overhead forehand strokes).**

1. The left foot steps forward to set up the line of movement but the weight remains primarily on the right foot as you pivot on the ball of the right foot.
2. Push quickly with the left leg as you step down the line of movement with the right and rotate your body to face the sideline.
3. Step with the left foot to a spot close to the right toe with your weight heavy on the right.
4. The last step is made with the racket foot (the right) as you adjust to the bird location and prepare for the hit.
5. Lean toward the ready position on the follow-through and return to the base position with short quick steps.

In summary, all the footwork is designed to move the player quickly into position to make the desired shot and then return to the ready position. Wide stances are stable but time-consuming. Narrow positions are unstable but permit the player to move quickly if he/she can have his/her center of gravity headed in the right direction.

### SAFETY

Most injuries in badminton are due to lack of warm-up followed by fast quick movements and consequent pulled leg muscles or in tournaments where players overextend themselves. A hundred or more smash shots in a one-day doubles tournament, for example, may result in injury to the elbow or shoulder joint. Players should be aware that they should warm up completely before a match and then not play in extended tournaments without being in good physical shape. They should remember to pace themselves in this sport which requires fast, quick movements.

Occasionally in doubles, two players who are not regular partners will both go for the same shot and either hit the other player or his/her racket. Voice signals should be used when there is time to call "I've got it" when going after a slow, short, high shot. A typical example occurs when the player in the backcourt is coming up to hit the bird hanging over the partner who is in the front court.

## RULES

### STARTING THE GAME

A racket spin or a coin toss is used to determine who gets the choice of courts or to serve or receive at the beginning of a match. If the racket spin is used, some mark is identified which is only on one surface of the racket and the opponent is asked if they prefer that mark or the other side. (M or W on the end of a handle of a Wilson racket for example.) The player then places the head of the racket on the floor and spins it as it is turned loose to fall to the floor. The side that is up determines who gets the choice of court preference or to serve or receive. The other side gets the alternate choice.

The side winning the serve starts the contest with a serve from their right-hand court (as they face the net). The server must serve so that the bird would land in the right-hand receiver's court (as the receivers face the net). The rally continues until one player fails to return the bird to the playing area. If the side serving commits an error, the serve and scoring opportunity goes to the opposite team. No points. If the receiving team commits an error, a point is scored and the serving side serves again, this time from the left service to the left receiver's court. The server should announce the score just before the next serve is made (*Example.* saying the server's score first, 1-love, no hands down). Love means no score, hands down means the number of times the serving team has lost in this serving turn. The usual terms used are no hands down, one hand down, and side-out. With two hands down, the side is declared "side-out" and the other side serves first from the right-hand court and announces their score first, 0-?, no hands down (substitute the original team's score for the question mark).

In doubles, the side taking the first serve starts with "one hand down," as though they have made a mistake in that serving turn. When they lose the serve, they are "side-out." After the first person serves, however, each side gets two "hands down," before they are "side-out." When your side earns the serve in doubles, the player who has the right court serving or

receiving responsibility serves first. This player continues to serve, alternating service courts until the serving team makes a fault or an error. The service and receiving court locations for players in doubles are determined according to the players' responsibility at the beginning of the game. The player who was on the right on the first point should always be there when serving or when receiving when their team score is even (0, 2, 4, 6, etc.). When the team's score is odd, the players should be in the opposite court to the court they were in at the beginning of the game. On the serve, the player who is in the receiving court must return the bird. After the serve, either player may return the bird. After the first serve for each side in singles, the side winning the serve serves according to their score (from the right side if their score is even and from the left side if their score is odd).

### SCORING

Badminton scores are made when a player is serving and the opponent fails to return a serve or a following shot during a rally. If the server commits an error (faults) on the serve or is not able to return a shot after the serve, the side is out (loses the serve) or the side uses one of its allowed errors while the team is serving in doubles. The point total required to win a game is 15 in men's singles or any doubles match and 11 in women's singles. If the score is tied at 13, the side getting to 13 first has the option of "setting" the final total to 5 additional points (18) or playing to the regular total of 15. If the score was not set at 13 and the score is tied at 14, the side getting to 14 first has the option of setting the final score at 3 additional points or playing to the regular total of 15. After the game has been set, the score is called "love-all" and the side which first gets to the 5 or 3 points wins the game.

In women's singles, if the score is tied at 9, the player who reached 9 first has the option of "setting" the game to 3. If the game was not set at 9 and the score is tied at 10, the player who reached 10 first has the option of "setting" the game to 2 points. In handicap games, setting is not permitted. A match is usually two out of three games.

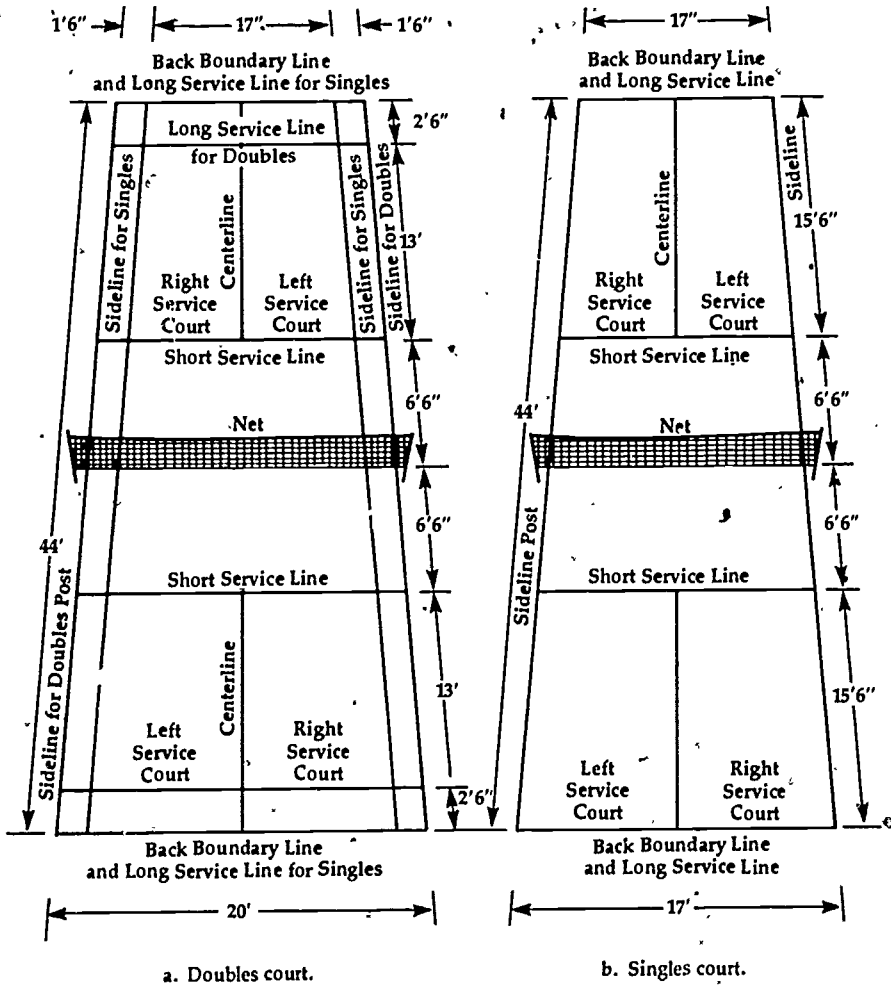

Diagram 9.

**THE COURT**

The court in badminton is 20 feet wide and 44 feet long. One and one-half inch lines divide the court into specific areas for the service conditions and playing conditions of the game (see Diagram 9).

The posts shall be 5'1" from the floor and placed on the side boundaries of the court. The net shall be 5'0" at the center with a 3-inch white tape at the top.

The outside lines mark the boundary area for doubles play. The line is always good. The singles court does not include the alley areas on either side of the court.

The service courts are bounded by the short serve line and centerline in singles

and doubles. The doubles service court is shortened by not including the back alley while the singles court is narrowed by not including the side alley (in summary, doubles short and fat, and singles long and thin). Serves are made on a diagonal path—right service court to right receiving court.

**FAULTS**

Faults are violations of the rules that result in points or loss of the serve.

1. Both the server and the receiver must stand within the proper service court when serving and neither can move his/her feet until the bird is struck.

2. On the serve, the bird must be contacted below the server's waist and the server's racket head must be lower than the server's hand.
3. No preliminary feints or movements can be made by the server or the receiver prior to the server striking the bird.
4. If the bird touches the top of the net and continues to the correct court, the bird is legally in play. (This is not a fault.)
5. The shuttlecock can be hit over the net only with the racket, and it can only be contacted once on each side of the net.
6. If a player touches the bird with his/her racket, it is a fault and it cannot be contacted again by that side.
7. If you do not return the shuttlecock to the proper area, it is a fault unless it is touched by an opponent or his/her racket before it touches the court.
8. A player or his/her racket may not touch the net, reach over the net, or cross under the net while the bird is in play.
9. The shuttlecock must be contacted cleanly. If it is hit twice, comes to rest on the racket briefly, or is "slung" off the racket, this is a fault. The bird may be hit with any part of the racket.

## STRATEGY

### BIRD FLIGHT STRATEGY

The badminton player tries to get the opponent to hit the bird up in the air so that he/she can hit it down toward the court. If the bird comes across the net fast, most shots are returned just over the net in a drop shot action so that the original player will have to hit the bird up in the air and, therefore, be on the defensive. Since neither player prefers to be on the defensive, a common return for a drop shot is to return a drop shot just over the net in a "hairpin"-like action. When a player overplays a position, an opponent frequently tries to get the bird down to the court behind the receiver to an open shot. This shot is designed to force the opposition to make a mistake and hit a weak return, thus setting up a kill shot (a smash).

### SINGLES STRATEGY

In singles, most players play a waiting game and move the bird around the court until their opponent makes a mistake. If the bird is smashed too early, like when you are in the back alley playing a high clear, an experienced opponent can frequently drop the bird back to your front court before you can finish your follow-through and, therefore, wins the rally on the smash. Varying shot velocity and placement while trying to unbalance the opponent and being patient to search for weaknesses is basic singles strategy. The most difficult shot to return for most players is deep to the backhand side, especially if the player is leaning forward to cover net shots. This, in effect, is trying to "get the bird down behind the opponent" as previously mentioned. The basic serve in singles is high and deep to the back alley near the center of the court so the opponent does not have sharp angles to use on your position and also so that you can respond in time to the bird when it is returned to your court.

### DOUBLES STRATEGY

The basic serve in doubles is short, low, and just over the net to the center corners. This serve gives the opponent only angles which must pass your "ready position" and also forces the opponent to hit the bird on an upward trajectory. Because most serves are short, the receiver crowds the line a little and if the bird is up a little, the receiver looks for a quick smash. To counter this "crowding" action, the server keeps the receiver honest by occasionally serving a low, fast, clear shot to get the bird down behind the receiver, serving a drive serve at the receiver to force an error or a weak return, or plays a serve to the outside alley corner to catch the receiver off-balance. These alternatives cannot be overused because they give the receiver good angles back to the server's court, especially if the shot is not perfect. Any imbalance of the receiver from your shot is nullified in doubles by the partner who can simply cover a little more court on the next shot. In doubles, all players look for the chance to hit the bird downward and go on the offensive. On the

serve, the basic court coverage is for the server and the receiver to play short and cover the short shots. If one player is not as strong as his/her partner on the overhead shots, the team may decide to have the weaker player always play up on the net and take all short shots after the serve. The simplest court position for a team to choose is a side-by-side position where each player, in effect, plays his/her half of the court. On shots down the middle, the player on the forehand side usually takes the shot unless they are out of position or definitely a weaker player. When a team has made a mistake and hits the bird weakly up in the air, the best defense for the expected smash return is also the side-by-side formation because the court is more easily covered. When a player hits short they should go to a short position near the net to cover a hairpin net flight return unless their partner is "playing up" and, therefore, is responsible for the net position. When a player hits a smash shot, the partner should move to the net to cover weak returns or attempts to drop the bird just over the net. The rules do not allow a player to hit the bird until it has crossed to your side. You cannot hit the net although it is permissible to follow through over the net if you do not touch the net or the opponent.

Most skilled doubles teams play varying formations depending upon the position of the bird at the time and the expected net shot. This is called the "combination systems" of play.

## EQUIPMENT

### RACKETS

The racket used can help shot-making ability. Some outdoor rackets are light and flimsy and make it difficult to control the bird or hit it with power. Prices for rackets may vary from about \$1.98 to \$40.00. Quality corresponds with price but rackets costing \$8.00 to \$15.00 will be wood, fiberglass, or steel or other light metals and have the durability and quality that is sufficient for beginners or even intermediate players.

Nylon strings can be strung tighter and usually last longer than gut strings. Wooden rackets are usually a little heavier than metal or fiberglass and although it may be difficult to move them rapidly, they have a larger mass which gives more "reactive force" to the bird. Wooden head rackets should be kept in a press if they are stored where the humidity is high or varies a lot.

### SHUTTLECOCKS

The shuttlecock or bird as it is commonly called, is usually nylon with a rubber tip. In tournaments, birds of goose feathers are used. The range of weights available is from 73 to 85 grains with the heavier bird flying further and used in heavier or colder air. The correct bird is determined by the players at the beginning of the game. Each player serves a few high clear serves and the bird should come down near the back baseline to be correct for the players and the conditions of play. If you are using feathered birds, they should be kept in a damp area to keep the feathers moist and to prevent breakage. The nylon shuttle can last 10-15 games while a goose-feathered shuttle lasts from a few hits up to two or three games.

## TERMINOLOGY

- Alley.** The 18-inch extension on each side of the singles court used only in doubles play.
- Back Alley.** The area between the back boundary line and long service line in doubles. This area is 30 inches in depth and is used in both singles and doubles.
- Baseline.** The back boundary line of the court on both ends. (The long service line is 30 inches short of this line for doubles service only.)
- Base Position.** The position approximately in the center of the court which a player tries to return to after making each shot.
- Bird.** Another word for shuttlecock. The common structure is nylon and for most tournament play, of goose feathers.
- Block.** Placing the racket in front of the bird is to make it drop to the opponent's court. Very little stroke movement is made in this shot.
- Carry.** Holding the bird on the racket during a stroke. This is an illegal stroke.

- Cross-court.** A stroke hit diagonally from one side of the court to the other.
- Double Hit.** Hitting the bird twice on the same shot. This is an illegal stroke.
- Drive.** A hard flat shot, which usually passes a player close to the net or is a shot right at a person.
- Drop Shot.** A bird which just cleared the net and immediately starts to fall in the opponent's court.
- Fault.** A violation of the rules.
- Foot Fault.** A violation of the rules in which the feet of the server or receiver are not in the position required by the rules. This could be an illegal position (outside the receiving court or serving court by the server or receiver) or a movement on the serve.
- Hairpin Net Shot.** A stroke made below the net to just over the net with the bird dropping close to the net on the other side.
- Inning.** The time during which a player or team is serving.
- Kill Shot.** A fast downward return which cannot be returned.
- Let.** On the serve or during a rally when play must be stopped due to interference from outside the court, when the players are not sure of the call, if the shuttle hits the net and falls in the proper court on the serve, it is a good serve.
- Love.** A term used to indicate no score.
- Match.** A match is usually 2 out of 3 games.
- Match Point.** The point which, if won by the server, wins the match.
- Obstruction.** This fault is called when a player hinders or interferes with an opponent when they are making a shot. It usually occurs when a player has made a weak high shot and then yells or waves his/her racket to distract the opponent.
- Overhead.** A stroke played from above the player's head.
- Rally.** The exchange of strokes when a shuttle is in play.
- Ready Position.** The basic position that a player takes just before the opponent serves. It is usually taken with slightly bent knees and the racket held about chest high.
- Receiver.** The player who is positioned in the proper court and scheduled to receive the service.
- Round-the-head Shot.** The forehand stroke made on the backhand side of the body. Usually it is hit overhead and can be either a clear, drop, or smash shot.
- Second Service.** The term used in doubles play to indicate that one person has lost the service and is down although the player's partner will still take his/her turn.
- Server.** The player who delivers the service or who is scheduled to do so.
- Service Court.** The area into which the service must be delivered.
- Short Service Line.** The line six and one-half feet from the net that serves must get to in order to be long enough to be legal.
- Shuttle Cock.** The official name for the shuttle or bird.
- Side-by-side Formation.** A doubles formation that is used where the players play primarily on one-half of the court and cover their own territory.
- Side-in.** This term refers to the side serving.
- Side-out.** This occurs when the side that is serving loses the serve and becomes the receiving team.
- Smash.** The hard overhead stroke hit downward with great force to the floor. It is a principle point maker in badminton.
- Underhand.** A stroke made when the shuttle is contacted below the level of the shoulders and the racket is below the hand. It is usually used to serve or to hit the bird upward to cross the net.
- Wood Shot.** The shot which results when the shuttle is struck with the frame of the racket. This is a legal shot.

## REFERENCES

- Burris, Barbara J., and Olson, Arne L. *Badminton*. Boston, MA. Allyn and Beacon, Inc., 1974.
- Devis, Pat. *The Badminton Coach. a Manual for Coaches, Teachers, and Players*. London: Kaye and Ward, 1976.
- Poole, James. *Badminton*. Pacific Palisades, CA: Goodyear Publishing Company, Inc., 1969.

*bounce pass (p. 64)*  
*center (p. 73)*  
*chest pass (p. 64)*  
*dribbling (p. 63)*  
*forwards (p. 73)*  
*free throw (p. 68)*  
*guards (p. 73)*  
*jump shot (p. 69)*  
*lay-up (p. 66)*  
*overhead pass (p. 64)*  
*rebounding (p. 70)*

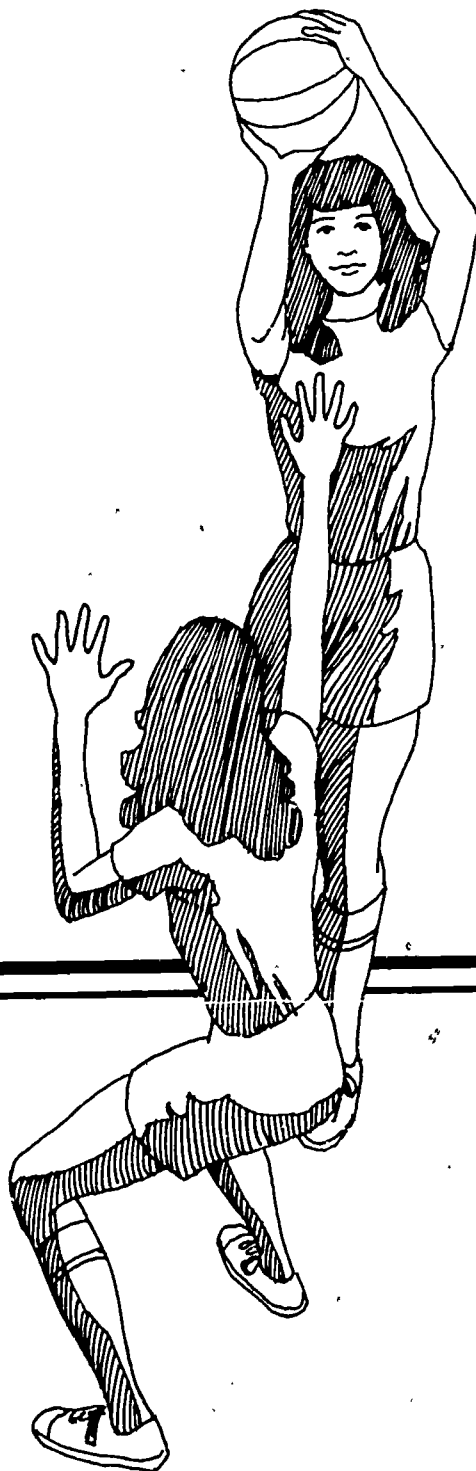

# Basketball

GENE DOANE,  
*Seneca Valley High School,  
Caithersburg, MD*

## INTRODUCTION

Basketball is unique in the annals of sports. It was developed to satisfy an aggressive group of football players with nothing to do until springtime in the New England winters. It was in this setting that Dr. James Naismith met this need. Basketball is now one of sport's most popular games. More people have witnessed basketball than baseball and football combined. The 1982 NCAA championship game played before over 60,000 people set an indoor stadium record.

Basketball is played by two teams of 5 players each. The goal of each team is to score a basket by throwing the ball into the team's own basket while preventing the opposing team from scoring. The thirteen original rules of basketball are still basically the same. Probably the most important characteristic is the placement of the goal area above the floor. This provided the challenge which has made the game what it is today. What is the player's first impulse when looking up at the goal? Most commonly, "Can I put it through the hoop?"

## SKILLS AND TECHNIQUES

### DRIBBLING

Dribbling is the only manner in which a player may independently move the ball down the court. To accomplish this, use a soft touch with the fingers and wrist with a slight forearm movement to push the ball downward. Never slap at the ball. Always keep the head up so that other players can be seen. The body should be in a flexed position for better ball control. For protec-

tion of the ball always keep the body between the ball and the opponent. When tightly guarded keep the free forearm up to ward off this pressure. There are two basic forms of dribbling: high dribble for speed; low dribble to protect the ball. Points to remember when dribbling the ball are:

- use both the right and left hand;
- pass off the dribble;
- keep the ball slightly out in front;
- dribble to a stop and pivot;
- dribble sharply to the right or left (change of direction);
- use a change of pace.

### Dribbling Exercises

1. Dribble in a restricted area while changing speeds and directions. Vary the size of the area.
2. Set up five obstacles, e.g., chairs, cones, etc., and dribble weave around them. Obstacles may be placed in a straight line or in a random pattern.
3. Go 1 on 1 with the defender being passive. Try to get from one point to another within a relatively narrow lane. Vary the lane width from approximately 10' to 5' as skills improve.
4. Go 1 on 1 with the defender being aggressive.

### Self-testing

1. Speed dribble the length of the court and back. How much time did it take and how many dribbles were used?
2. Low dribble around five chairs 6 feet apart and time how long it takes to weave around and back again.

### PASSING

Passing is the foundation for all scoring plays; its importance is second only to



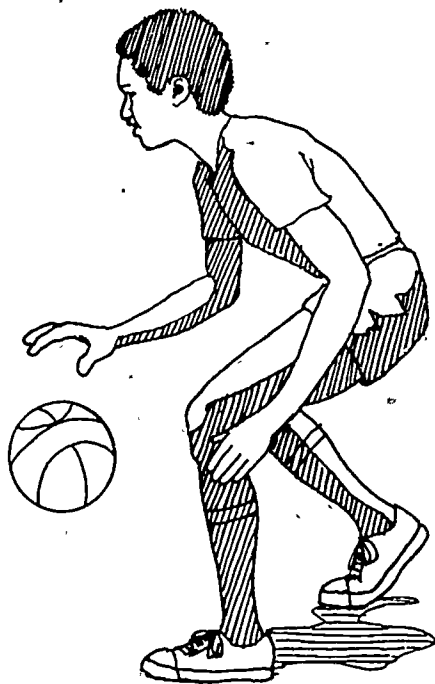

Figure 1. Proper dribbling position.

shooting. The fundamental requirements of every pass are that it be accurate, well-timed, quick, and the proper type for that situation. A passer must approach 100% effectiveness to be considered a good passer.

The primary passes are the chest pass, 2-handed bounce pass, and the 2-handed overhead pass. There are other passes like the hook pass, baseball, and behind-the-back that require more skill. For the *chest pass*, hold the ball directly in front of the body, chest high, with the fingers on the sides of the ball and the thumbs in back (parallel to each other). The elbows are close to, but not against, the body. Push the arms forward. Snap the fingers and wrist with the weight shifting to the extended foot as the pass is executed by stepping toward the receiver. An easy-to-handle back spin is imparted at release. The *bounce pass* is the same as the two-handed chest pass except for the release. The ball should strike the floor two-thirds of the way to the receiver and bounce to waist height. The *overhead pass* is one of the most effective passes that a player can master. The ball is

held on each side and toward the back with widespread fingers. The thumbs should be pointed toward each other. With the ball held over the head, the pass is begun by a quick, short step in the direction of the receiver. The ball is released by extending the arms and flicking the wrists and fingers downward. Aim for the receiver's shoulders. The follow-through causes the thumbs to turn downward. The following should be remembered when performing a pass:

- in the beginning, execute passes slowly;
- emphasize correct form;
- execute passes while in motion to a moving player while progressing;
- always try to hit a receiver in the chest area;
- do not telegraph passes, which is unknowingly telling the opponent where the pass will go in advance;
- control the ball with the fingers;
- put a back spin on the ball;
- follow through.

#### Passing Exercises

1. Pass the ball to a target area approximately chest high on the wall.
2. Two players pass the ball back and forth while stationary and then moving down court using the chest pass, bounce pass, or other types of passes.

#### Self-testing

1. Pass ten times to a chest high target at a distance of 8', 14', 18'.
2. Repeat the above test. Keep track of the time it takes to make those 10 passes and count the total number of times the target was hit.

#### CATCHING

There are certain fundamental techniques that equally apply to the catching of any pass. First, "see" the ball into the hands. Second, the eyes should track the ball in flight while the hands intercept and give with the ball. What this does is permit the hands, wrists, and arms to absorb the impact of the ball, preventing a fumble. Whenever possible a pass should be caught with both hands, while stepping to meet the ball. The following points should be remembered when attempting a catch:

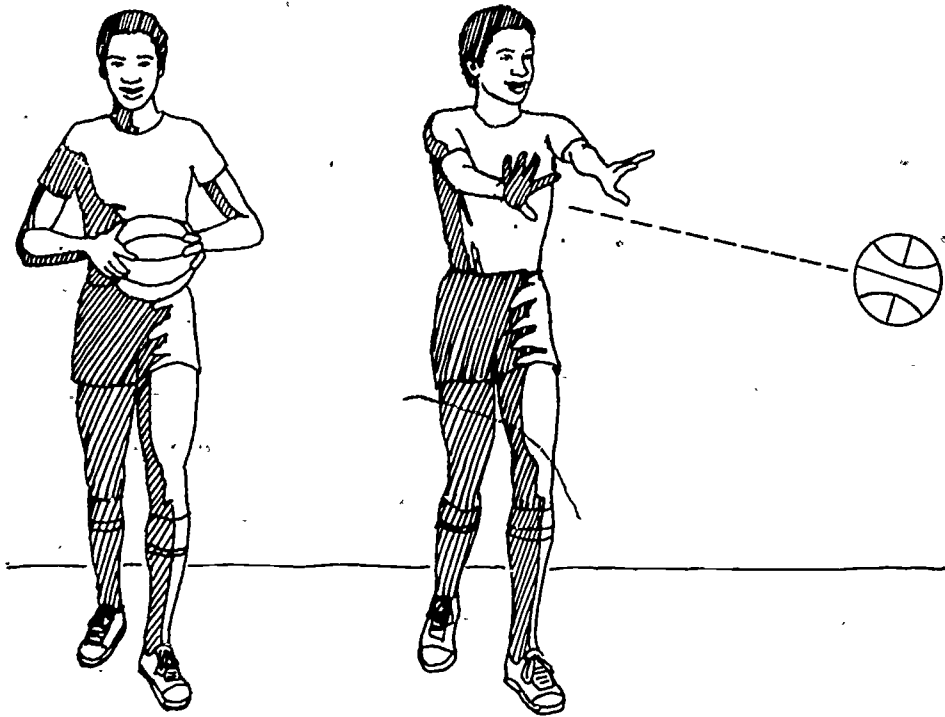

Figure 2. The chest pass.

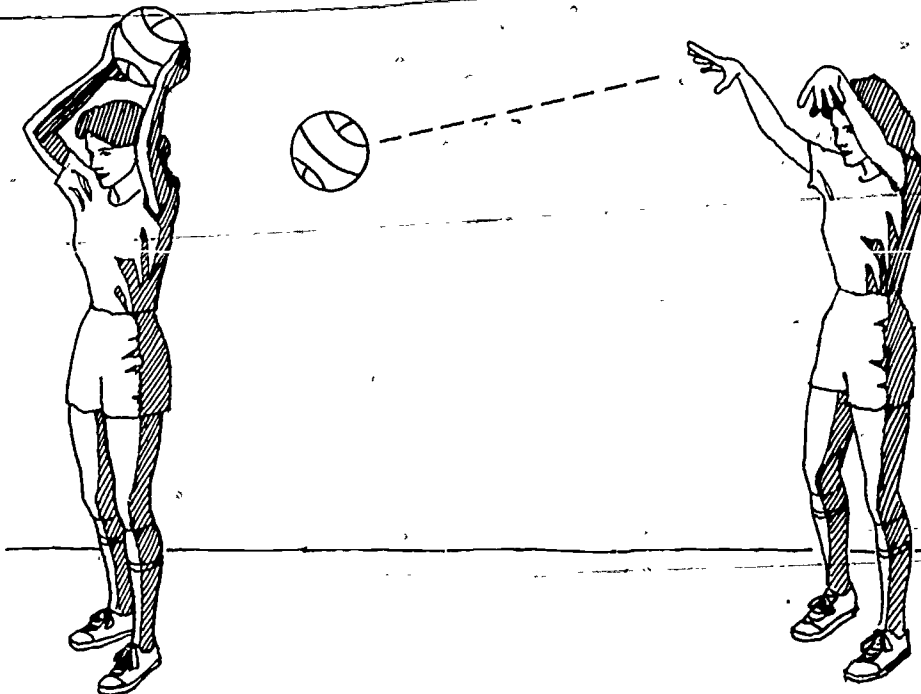

Figure 3. The overhead pass.

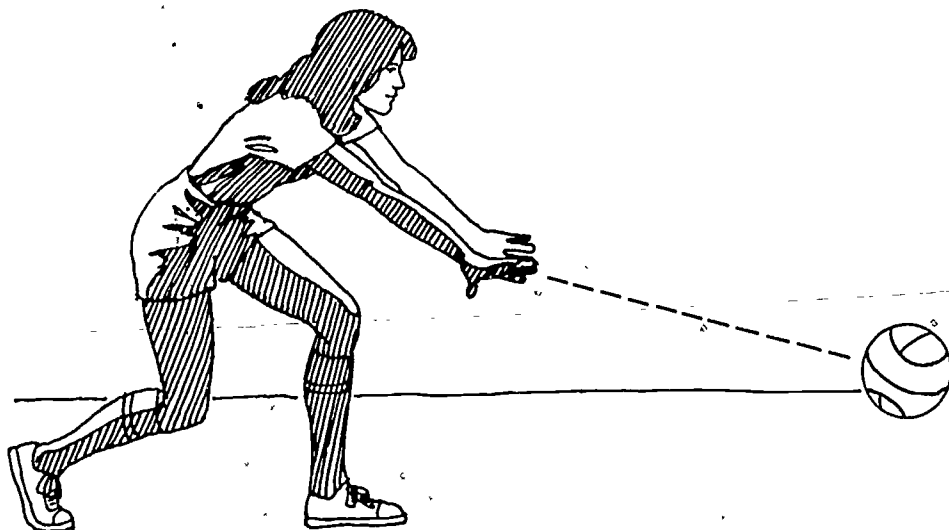

Figure 4. The bounce pass.

- whenever possible catch the pass with both hands;
- see the ball into the hands;
- step toward the passer with either foot;
- extend both hands chest high in front of the body;
- the palms should be facing each other with the fingers widespread;
- catch the ball with the fingertips;
- permit the arms to naturally give toward the chest.

#### Catching Exercises

1. Have a teammate throw various passes. Have the speed of the pass and the areas of the body to which the pass is thrown varied.
2. Turn your back to a teammate 15 feet away. Have him/her throw a pass then yell "ball." Upon hearing the sound, turn, locate the ball, and catch it before it hits the floor.

#### Self-testing

Stand 3 feet from the wall and bounce the ball off the wall for 30 seconds. See how many passes can be caught in this time.

#### SHOOTING

One skill everyone enjoys practicing is shooting. It is without a doubt the main offensive factor in the game. It is challenging to the individual to develop personal

abilities to the point where he/she can be considered a "great shooter."

#### The Lay-up

The lay-up shot is the first shot the basketball player learns. The ball is laid on a spot about a foot and a half above the rim to the right, left, or center of the board so that the ball will fall into the basket. The palm of the shooting hand should be facing the backboard as the ball is released. Take off (jump) on the foot opposite the shooting hand. Be a high jumper, not a long jumper. That means to jump as high as possible. Extend the shooting arm and release the ball at the height of the jump with a full arm extension. When performing a shooting exercise the following points should be remembered:

- keep the eyes on the spot on the backboard where the ball is going to be laid;
- place the ball softly upon the backboard;
- shoot left-handed on the left side and right-handed on the right side;
- whatever the speed used when approaching the basket the lay-up should always be released with the same soft touch.

#### Shooting Exercises

Two lines, one formed from the right and one from the left, alternately dribble and shoot.

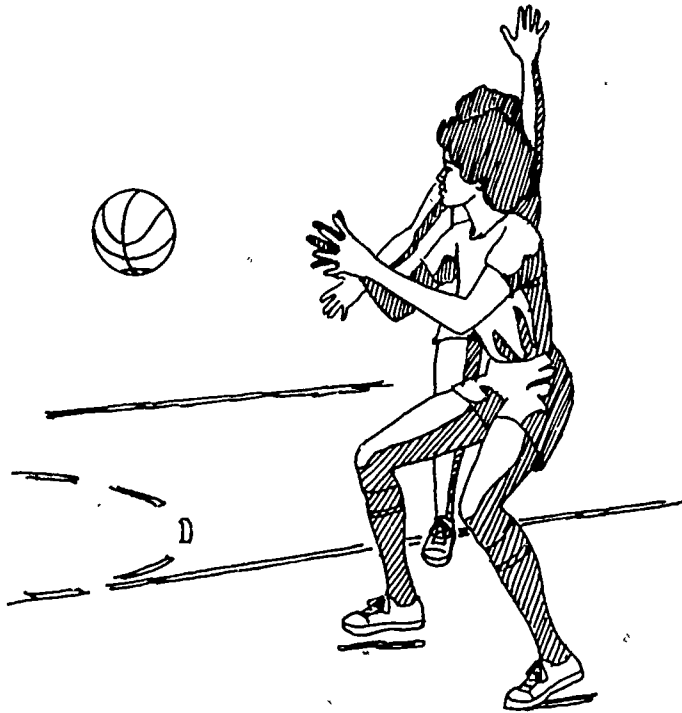
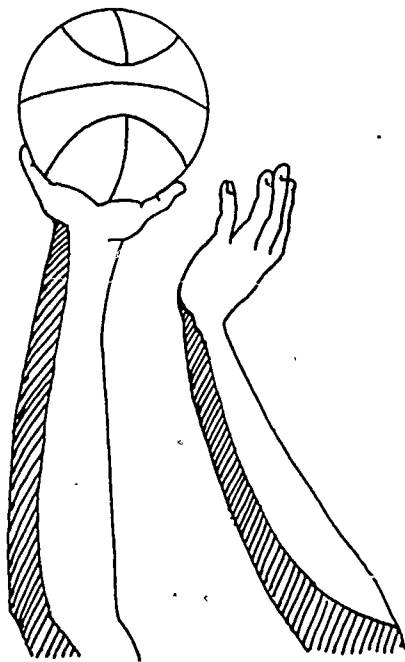
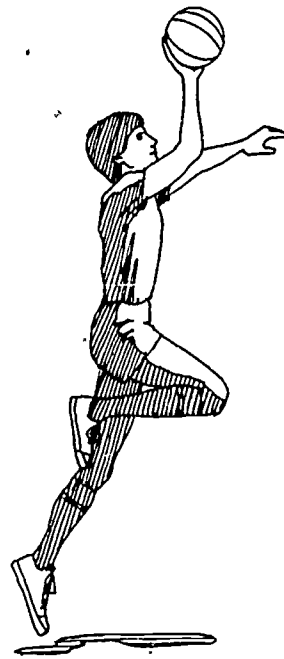

Figure 5. Catching a pass.



a. Lay up with a soft touch.



b. Take off on the foot opposite the shooting hand.

Figure 6. The lay-up.

**Self-testing**

Alternate shooting right- and left-handed lay-ups for 60 seconds. Count the number of shots attempted and the number made.

**The Free Throw**

The free throw shot should become as mechanical and reflexive as possible. Therefore, all preliminary actions and foot positions should be the same for every attempt. Select one style and stay with it. Move up to the line and set the feet in the exact position that is always used for free throws. Shoot to have the ball hit the middle of the target (rim). The ball should be balanced in both hands about chest high in the starting position. Take the ball up with the shooting hand with the elbow staying in and the arm continuing through with a full extension toward the basket. This is done in one motion. Have a high release with a good follow-through. When executing the free throw the following points should be remembered:

- relax, concentrate, and think of only this shot;
- control breathing by slowly inhaling and exhaling;
- spin the ball in the hands to acquire the proper feel before shooting;
- bounce the ball on the floor a few times before shooting to relax the arms and body;
- practice, practice, practice.

**Shooting Exercises**

Face a partner 9 feet away and practice form by shooting to each other for 5 minutes. Move out 2 feet at a time until 15 feet apart.

**Self-testing**

1. Shoot 100 free throws in a row daily. Keep a record while striving for a 70% average.
2. Shoot 25 one plus ones in which if the first is missed the second is not received. Total the number of first one plus ones made.

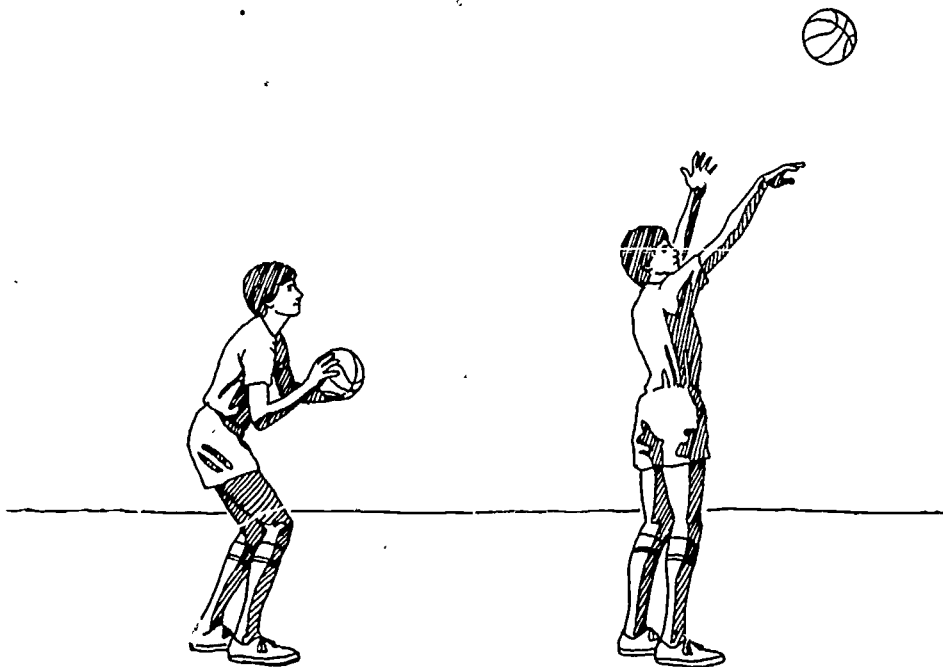

Figure 7. Free throw shooting.

### The Jump Shot

The jump shot is really an extension of the one-handed set shot. The ball is held in the fingers of the hand with the fleshy pads of the palm rather than the center of the palm touching lightly. This is where "touch" comes from. The shooting hand is behind the ball, with the non-shooting hand to the side of the ball to give better ball control. Face the basket with the hips and shoulders square with either a staggered stance or parallel feet. The feet should be shoulder width apart. Think in terms of shooting the ball over the front rim into the center of the hoop. The power for the shot comes from the legs. Bending the knees to a flexed position and good wrist action are very important. Sight over top of the ball with the elbow in toward the body.

One of the most important areas of shooting is *rotation*. This is achieved by bringing the fingers under the ball when the wrist is bent (flexed). Use good wrist action or snap in every shot. As in hitting a golf ball, baseball, or tennis ball, the *follow-through* is essential. A nice arm extension after the shot creates good rhythm, good motion, and makes for a smooth shot. Extend the hand and fingers on the follow-through. After release, the body should have a slight forward lean.

At this point transfer these mechanics to the jump shot. What is important in the jump shot is not to jump too high, but to be comfortable. The ball should be released a split second before a personal peak is reached, *not* at the peak of the jump. Know personal range and do not go beyond it as this will put a strain on motion. When executing the jump shot the following points should be remembered:

- lay the ball in the hand with the fingers comfortable and the thumb slightly up;
- make sure the wrist is relaxed (if it isn't the fingers and thumb are probably spread too wide);
- keep the elbow in toward the body;
- flex the knees and lean slightly toward the target;
- have good wrist and finger action on the follow-through for rotation;
- have a high release for a high arc;

- release the ball a split second before the peak of the jump is attained;
- make sure the jump is a comfortable one;
- concentrate.

### Shooting Exercises

1. Stand 2 feet in front of the rim and place the ball in a correct shooting position. Now shoot as many times as necessary to develop the proper release.
2. In the same position as above, jump. After each shot back up one step until out of range. Now work back one step at a time. Repeat.

### Self-testing

1. Shoot from 5 spots on the court working from the right baseline to the left baseline. Shoot 20 shots at each spot and record the percentage at each spot.
2. Have a teammate rebound after each shot. Shoot for 60 seconds at each spot and see how many shots are done and how many are made. This is a quickness drill.

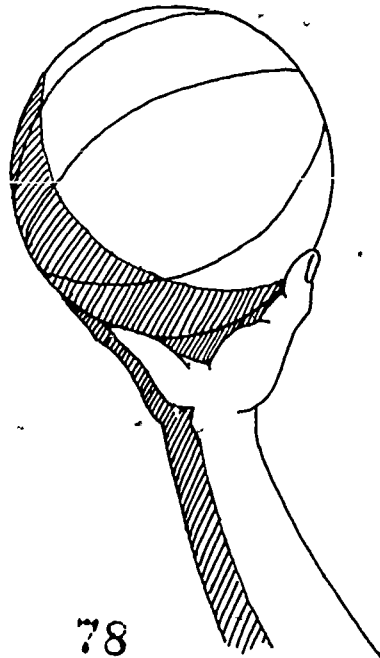

Figure 8. Hand position for the jump shot.



Figure 9. Knee flex for set shot.

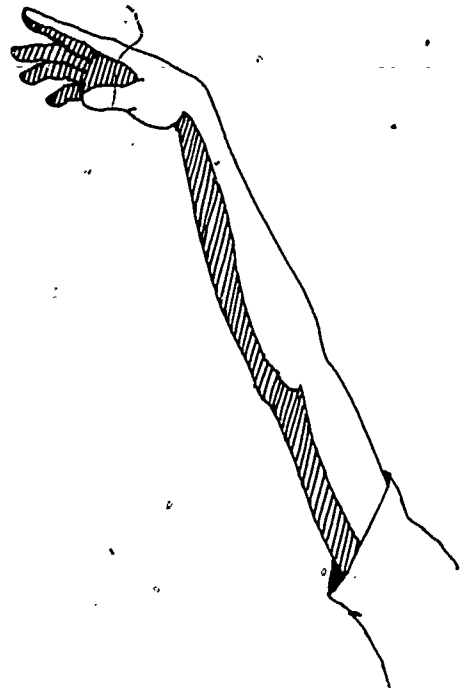

Figure 10. Follow-through for the jump shot.

## REBOUNDING

Two of the most important aspects of rebounding are timing and balance. To maintain balance a wide, strong base from which movement is made must be established. The knees should be slightly bent, the hips lowered, with the body braced to receive contact should it occur. The elbows should be held wide at shoulder level with the upper arms parallel to the floor. The forearms and hands are held high in a vertical position. The hands are facing the basket with the fingers spread. Have the body lean slightly forward with the weight on the balls of the feet.

The timing of the jump is very critical. It is even more important than the height of the jump. What must be known is the height and direction of the rebound. Considering this, the rebounder jumps into the ball. The ball should be caught at the highest point of the jump. The legs and elbows should be spread wide with the buttocks extended for maximum room. Catch the ball with one hand above and one below it. Land with the feet and elbows wide and the hips low with the buttocks pushed out.

Bring the ball into the chest for protection. Some points to consider for offensive rebounding are:

- great concentration is required as well as a desire to get the ball;
- try to determine the rebound area of the ball (shots from the right usually go to the left if missed and vice versa);
- maneuver around a player who tries to block his/her opponent out;
- if unable to attain possession of the ball, try to tip it until possession can be gained.

Important rebounding points to consider are:

- take a wide, arms out, feet apart stance facing the basket.
- don't follow the flight of the ball immediately but concentrate on the opponent and then pick up the ball;
- pivot in front of the opponent, blocking his/her path to the basket;
- after sighting the ball, time the jump so as to reach it at the peak of the jump;
- go for it, high, wide, and with authority.

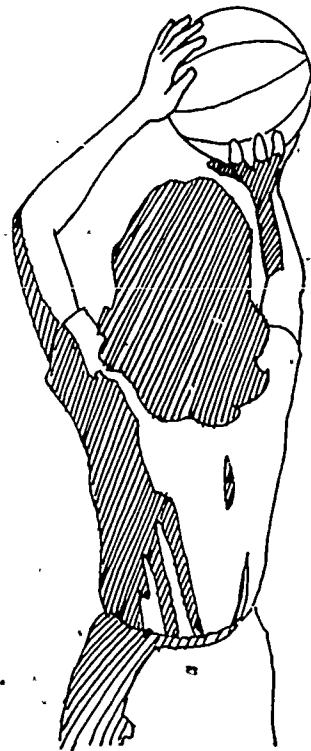
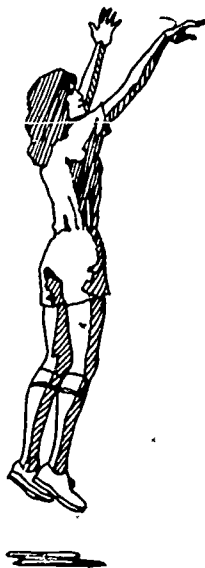
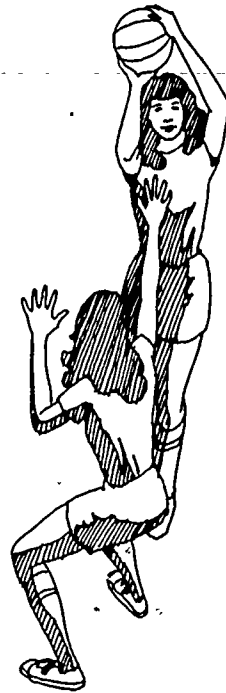
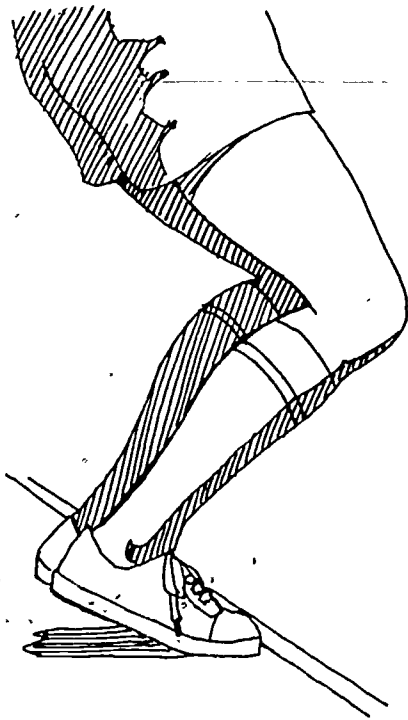

Figure 11: The jump shot.



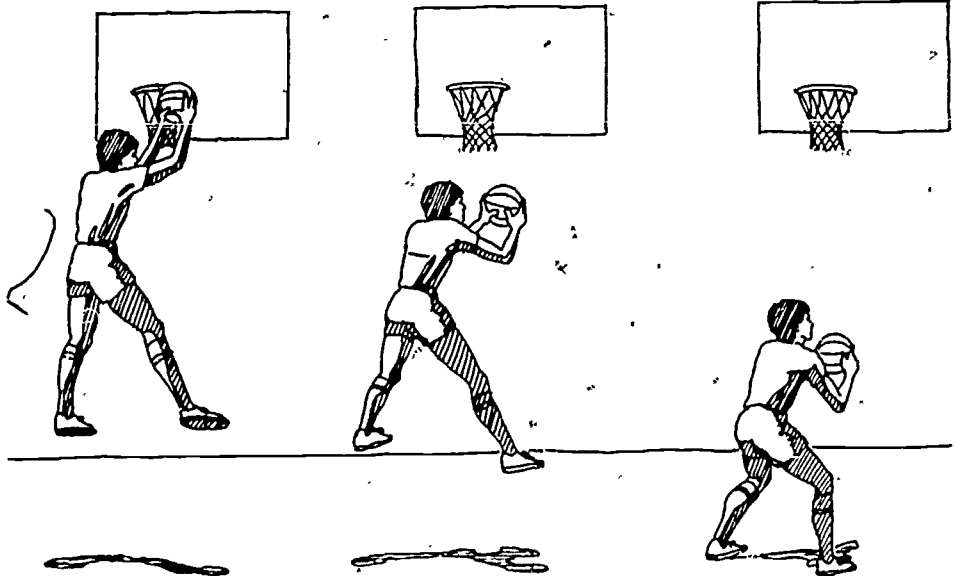
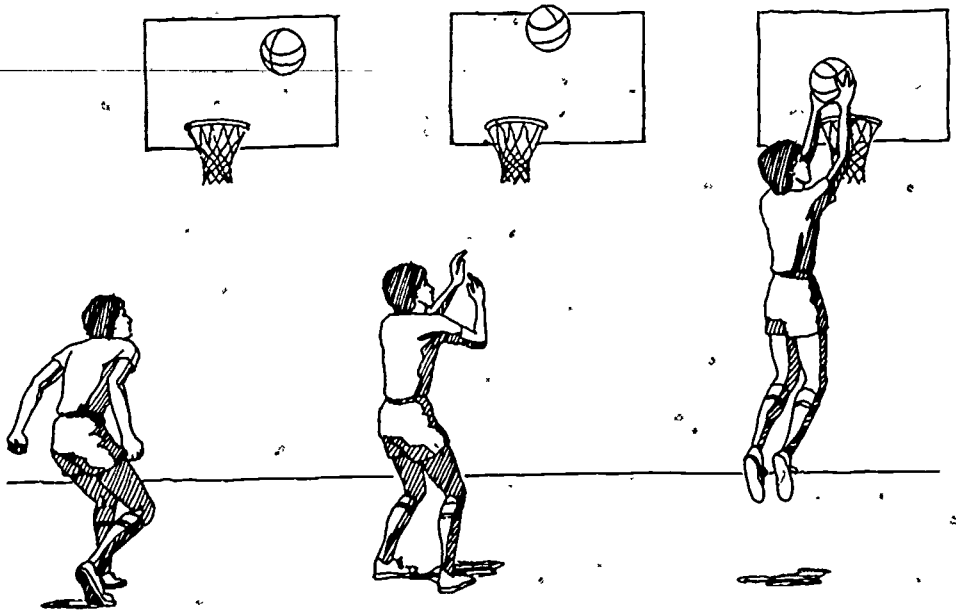

Figure 12. Rebounding form.

### Rebounding Exercises

1. Stand in front of the backboard and toss the ball off it, while timing the jump to reach the ball at a peak.
2. Work with another player, one defensive rebounding the other offensive. The offensive player tosses the ball against the backboard. Players can switch positions.

### Self-testing

1. Place the ball in a circle at the free throw area. Face the ball with another player behind the body. See if the other player can be blocked away from the ball for 60 seconds.
2. Stand on the dot line in the 3-second lane facing midcourt. Have a shooter move around and take shots aiming for the rim. Turn, locate the ball, and go for the rebound. See how many can be gotten before the ball hits the floor.
3. Jump and touch the rim or net repeatedly 6 times without shifting weight or floor position. Rest 10 seconds, then repeat. Do this ten times.

### SAFETY

In basketball, as in most sports, the best method of self-protection is physical fitness. Basketball is an all-out fast-paced game that requires the body to be gradually worked into shape. Since many injuries occur due to lack of warm-up, it is very important to properly warm up before practice and games. Flexibility exercises are vital to an athlete playing basketball due to the violent quick stops and starts as well as the effects of constant jumping and twisting. All the sliding to the right and left on defense causes severe strain in the groin area. Therefore stretching is very important both before and after practice.

The eyes can be protected with special goggles or by switching to contacts (if glasses are worn). Shoes are the most important part of a player's equipment. Make sure that shoes fit properly and wear two pairs of socks to cut down on friction. Socks should be white. In case of a blister, the dye from a colored sock can cause an infection. To avoid early season blisters and muscle

pulls, do not start practice with new shoes. Try to gradually break them in before practice. This will help prevent blisters and ankle sprains. Check the playing area for dangerous objects such as unpadded posts, backboards with no pads, or loose boards in the floor, etc. When outside, check for objects such as rocks and glass.

### RULES

The playing court is a rectangular surface with dimensions not greater than 94 feet by 50 feet. There should be two backboards (one at each end of the court) with rims and nets. The rim is to be 10 feet from the floor. The official ball is made of leather or a synthetic material. Its circumference is between 30" to 29½", with a weight of between 20-22 ounces.

A basketball team consists of five players, usually divided between the following positions:

- *center*—the player who is the tallest or best leaper usually plays this position; he or she will jump center at each quarter.
- *forwards*—there are two players in this position; they are generally good rebounders with one of them being a good shooter while the other one excels on defense;
- *guards*—there are two, with one being a shooting guard (called 2-guard) and the other being the point guard (the point guard sets up and runs the offense).

The game of basketball in the high school consists of four quarters of 8 minutes duration. The game is started with a jump ball at midcourt, which is taken by the centers. All other players must be outside the circle and be stationary. Each quarter is started this way. The team that gains the tap is on offense and will attack in the direction its center was facing at the toss of the ball.

Play continues uninterrupted until a rule infraction occurs, or the ball is passed out-of-bounds. When a basket is scored, play continues uninterrupted as the other team brings the ball immediately in-bounds and goes to the other end of the court in an attempt to score.

Two points are awarded for each successful field goal. On a field goal attempt where

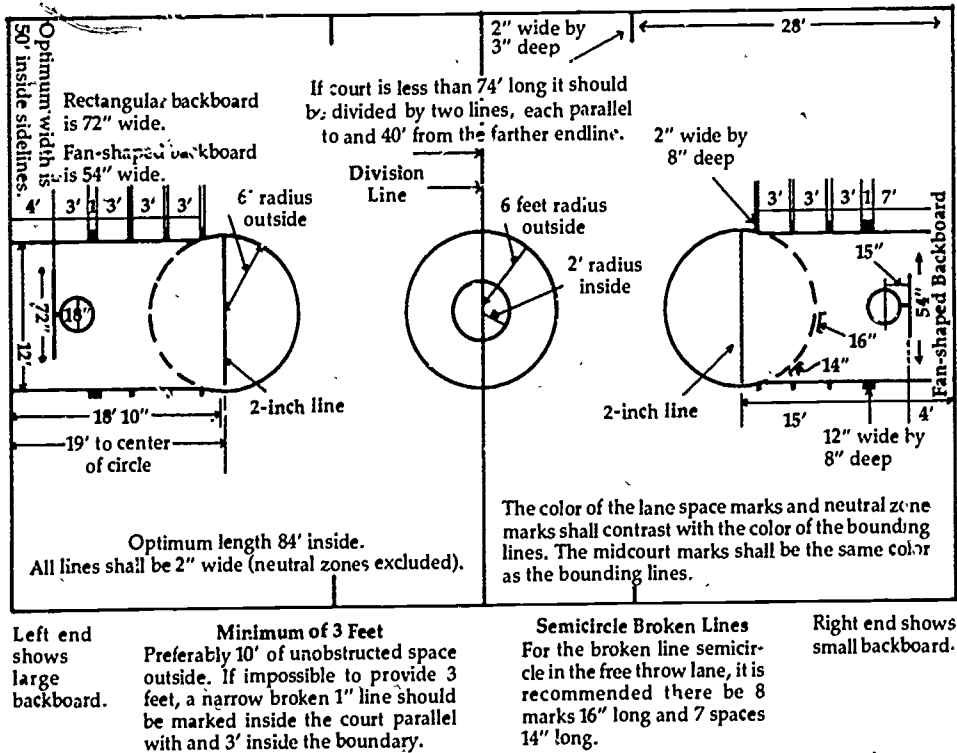

Diagram 1. Regulation basketball court.

one fouled in the act of shooting, a bonus free throw is awarded. If, however, an attempted field goal was unsuccessful two free throws would be awarded. Each team is put into a bonus one plus one, after the fifth team foul. When shooting the one plus one, two free throws are not awarded.

When it becomes necessary for an official to stop play due to a rule infraction, the clock is stopped. After the infraction has been dispensed, play resumes.

For further explanation of the rules of basketball, the reader is referred to the current rulebook of the National Federation of High School Associations.

## STRATEGY

The primary function of an offense is to obtain a high percentage shot. The primary attack is generally employed by two or three players, while the other two or three use tactics to distract their opponents attention away from the focal point of the attack.

Rebound responsibility, defense balance, and secondary shooting, etc., must also be carried out.

There are as many different approaches to offense as there are coaches to teach it. What is important is that they should be based on sound fundamentals and utilize the abilities of each player to best advantage.

Defensive strategy is based on individual defensive fundamentals and must be coordinated so that players function as a unit whether evenly matched with an opponent or not. Each team must be prepared to react to every offensive tactic. To accomplish this strategy they must have mental alertness, aggressiveness, hustle, and anticipation, among other things.

## EQUIPMENT

Basketball clothing consists primarily of shorts, a shirt, and shoes. The importance of comfortable, perfect-fitting shoes that

grip the floor firmly cannot be overstressed. There is no article of wearing apparel more important to a player. The shoe should have one-half inch at the end of the shoe. This is to permit room for the big toe to move when making those quick turns and sudden stops. A player must determine if the shoe is to be primarily worn indoors or outdoors. Should play occur indoors a softer rubber sole should be used, while in outdoor play a harder rubber sole should be used.

### TERMINOLOGY

**Bounce Pass.** A two-handed or one-handed throw to another player which rebounds off the floor about two-thirds of the distance away from the passer.

**Changing Directions.** To dart quickly from right to left or vice versa.

**Follow-through.** The continuation of body movement after the ball is shot or passed.

**Foul.** An infraction of the rules, which is charged and penalized.

**Free Throw.** An unguardé'd shot at the basket which is awarded to a player fouled in the act of shooting or when the fouling team is over the team limits on fouls.

**High Dribble.** For speed in an open court area.

**Jump Shot.** A shot executed while the shooter is in the air.

**Lay-up.** To gently place the ball above the rim onto the backboard.

**Low Dribble.** Dribble used for protection of the ball in congested areas.

**Overhead Pass.** A two-handed throw to another player which is initiated from above the head.

**Passing.** To throw the ball either two-handed or one-handed to another player.

**Pivot.** The act of turning by lifting one foot off the floor and turning on the ball of the other foot to face in a different direction.

**Rebounding.** To jump up and catch the ball after it missed its mark and bounced off the rim or backboard.

**Rotation.** The back spin that is imparted on the basketball as it is released.

**Shooting.** To throw the ball at the target, in this instance, the basket.

**Take-off Foot.** The foot opposite the shooting hand on a lay-up that is used for pushing off the floor.

**Touch.** The feel for the ball in the fingertips.

### REFERENCES

- N.F.B.R. *Basketball Rule Book*. Kansas City, MO: Brice B. Durbin Pub., 1981.
- Physical Education. *Instruction Guide Grades 7-12*. Rockville, MD: Montgomery County Public Schools, 1978.
- Universal World Reference Encyclopedia, Basketball*. Chicago, IL. Consolidated Book Publishers, 1959.

approach (p. 81)  
delivery (p. 83)  
5-step approach (p. 83)  
4-step approach (p. 81)  
fouling (p. 86)  
illegal pin fall (p. 86)  
miss (p. 87)  
pin bowling (p. 81)  
pushaway (p. 80)  
release and follow-through (p. 83)  
sandbagging (p. 86)  
spare (p. 87)  
spot bowling (p. 80)  
stance (p. 79)  
starting positions (p. 83)  
strike (p. 86)

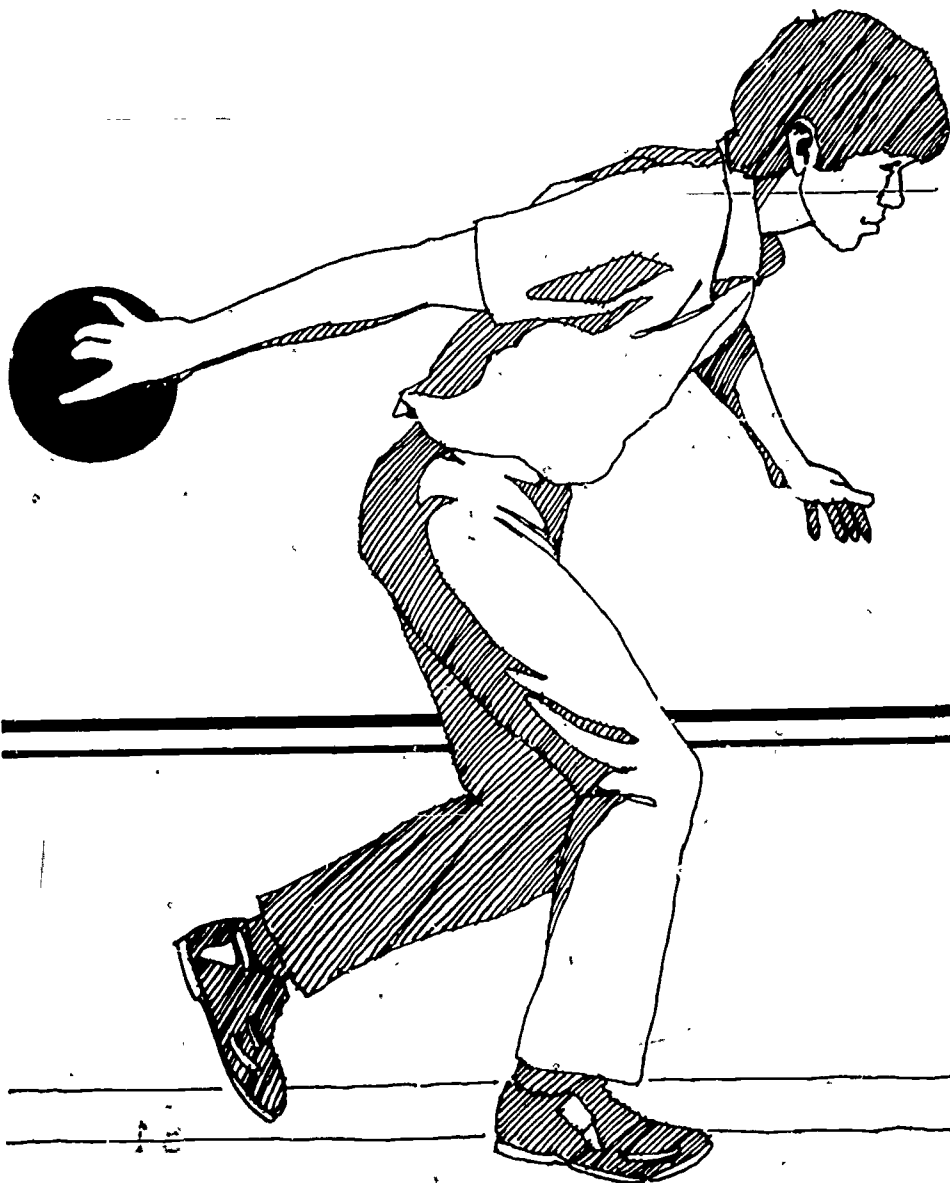

# Bowling

NORMAN E. SHOWERS,  
Southern Illinois University,  
Edwardsville, IL

## INTRODUCTION

### PURPOSE

Bowling may be enjoyed by all individuals regardless of age and size. In its simplest form, bowling is a game in which a player (bowler) attempts to knock down ten bowling pins by rolling a ball some 60 feet down a smooth, level lane. A game consists of ten frames with a maximum score of 300. Knocking all pins down with a legal first ball is called a strike (X), and knocking all the pins down with two balls is called a spare (/). If neither a strike nor spare is made, then it is either a miss, open, blow, or split.

### HISTORY

Bowling may be one of the oldest non-combative sports. Egyptian children used small round stones to knock over sticks or tall stones in a form of bowling about 7000 years ago. The Italian game of *Bocci*, bowling a ball at a target ball on the grass, dates back to 50 B.C. Early Polynesians in the Pacific had a game which resembled bowling as they used flat stones to knock over other stones or sticks, their alley was 60 feet long (the same as the distance from our foul line to the head pin in our present ten-pin game).

Around 1100 A.D. the King of England outlawed bowling-on-the-green since men were bowling-on-the-green too much and not practicing archery. During the 1500s Rev. Martin Luther standardized the rules for the popular game of nine-pins. Bowling was brought to this country by settlers from Holland in the early 1600s. Many cities had places for bowling-on-the-green. Bowling moved between buildings (alleys), then the lanes were covered and became so popular

later on that some New England legislatures outlawed the game of nine-pins because too many people were betting on the game. Shortly thereafter an enterprising man added a tenth pin, changed the pin positioning, increased the width of the lane, and devised the present ten-pin game.

Attempts to standardize the ten-pin game failed until a group of men met in New York City in 1895 and formed the American Bowling Congress (ABC) which governs all aspects of the game. The Women's International Bowling Congress (WIBC) organized in 1916 in St. Louis, Missouri governs women bowlers. The American Junior Bowling Congress (AJBC) started in 1941 in Chicago, Illinois to accommodate student-age bowlers. Other organizations such as the National Bowling Council (NBC), the Professional Bowlers Association (PBA), and the Women's Professional Bowlers Association (WPBA) were later established to promote bowling at various levels. The Bowling Hall of Fame and Museum, located in St. Louis, Missouri, includes lanes, equipment, pictures, etc. from the past. More than 60,000,000 bowlers make this sport the largest participant sport in the United States, of which more than 11,000,000 are regular league bowlers. Annual tournaments sponsored by the ABC (men) and the WIBC (women) involve more than 35,000 participants in each tournament making them the largest participant tournaments in the world.

### GOALS

The goal of bowlers is to bowl a perfect game (300) with 12 consecutive strikes in a row. An immediate goal within reach of most bowlers is a 200 game. Top flight bowlers usually compile a 200 average per game.

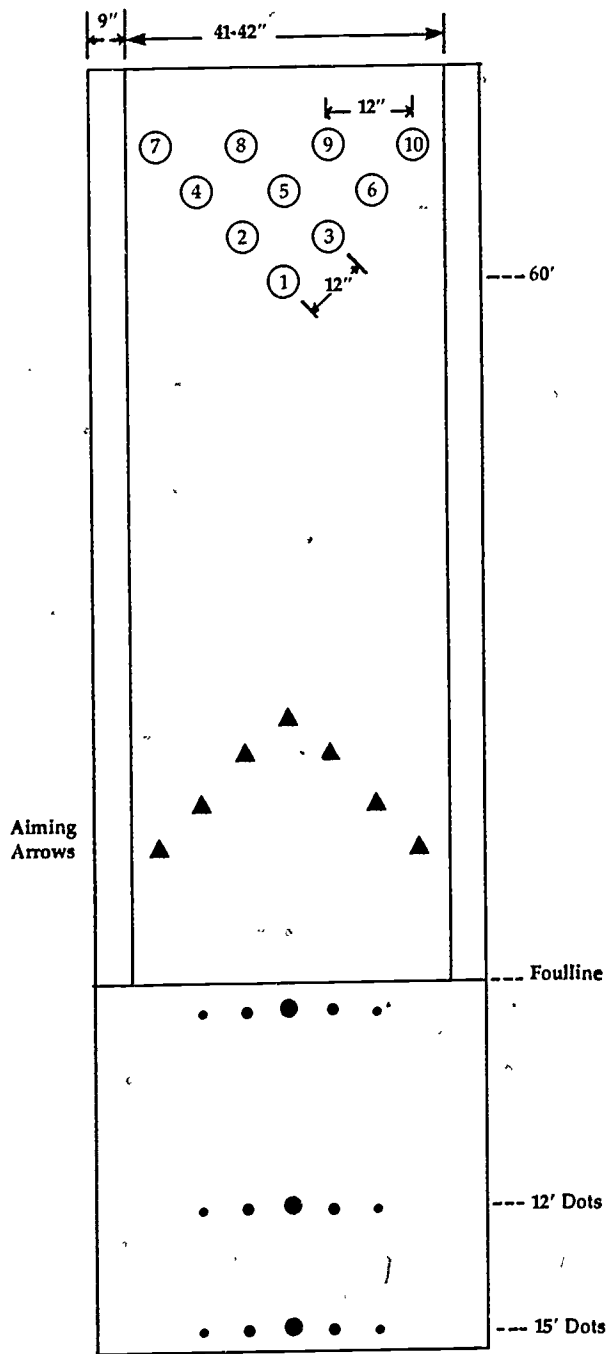

Diagram 1. Ten-pin bowling lane.

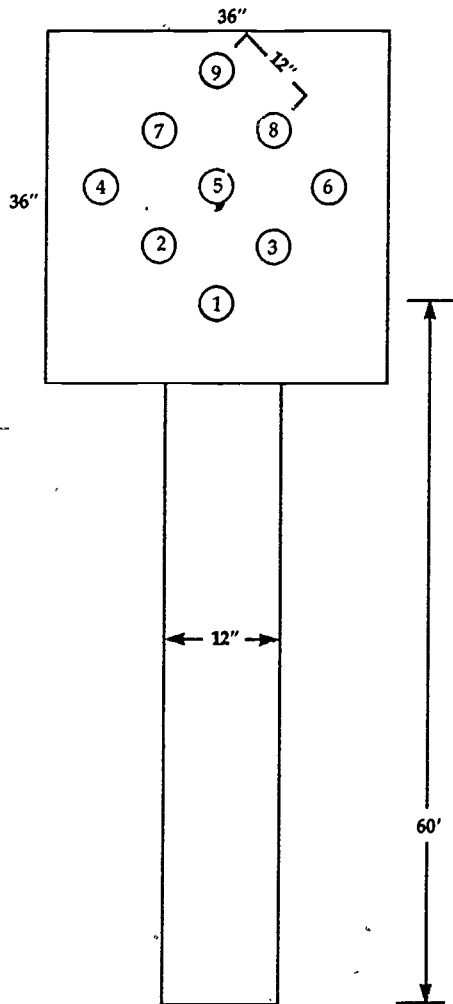

Diagram 2. Nine-pin bowling lane.

Scores depend upon consistency and accuracy. Studies done by N. Showers<sup>1</sup> and R. Showers<sup>2</sup> on league bowlers, demonstrated that men bowling a 200 average or a woman bowling a 190 average occurred about one time out of every 1000 bowlers. The average league-average for a man is about 154 and for a woman is 126.<sup>3</sup>

## SKILLS AND TECHNIQUES

There are many different ways to bowl. Each individual will have his/her own style; however, there are better ways to become more proficient.

### PROPER STANCE AND HOLDING THE BALL

With a properly fitted ball and shoes, a stance should be assumed that permits freedom of movement while maintaining body balance. First, stand so that the body weight is evenly distributed on both feet (see Figure 1). This is done by keeping both feet even. If one foot is placed forward, the

<sup>1</sup>Showers, Norman E. "A Statistical Analysis of Bowling Averages (Men)." *Illinois Journal of Health, Physical Education and Recreation*. Fall, 1975.

<sup>2</sup>Showers, Robert G. "A Study of Certain Factors Affecting Bowling Performance of Female Bowlers." *Illinois Journal of Health, Physical Education and Recreation*. Winter, 1970.

<sup>3</sup>Showers, Norman E. "Informal Study of 40,000 Men and Women League Bowling Averages." 1975.



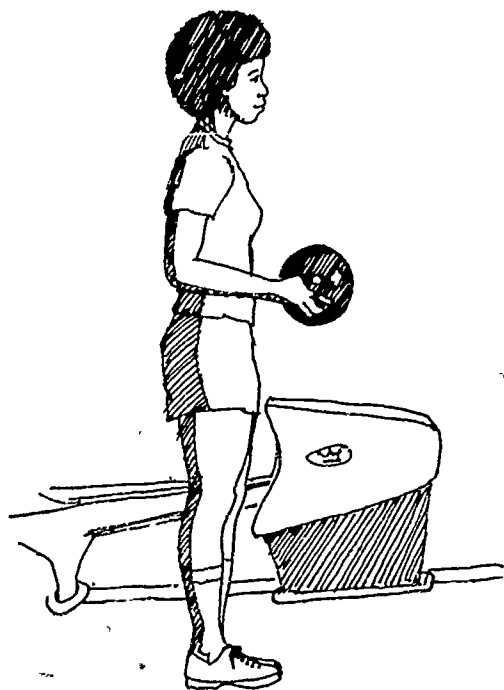

Figure 1. Starting stance, side view.

body will usually turn, which may cause a problem.

Second, hold the ball so that some of the ball weight is supported in the non-throwing hand. Put the thumb and fingers all the way into the ball. This will permit a more relaxed grip and better ball control during the pushaway.

Third, keep the wrist and forearm in a straight line. The wrist should be straight and firm, not rigid. Do not cup the ball or bend the wrist. Keeping the wrist straight and firm permits a better pushaway and allows the ball to swing close to the body.

Fourth, hold the ball near waist level and next to the body (see Figure 1). The ball may need to be held at about chest level. Holding the ball near the chin or higher is not desirable as the weight of the ball, dropping the extra 1-1½ feet, can create balance and delivery problems. Bending forward is the least effective way to hold the ball as this method, coupled with the weight of the ball, tends to cause severe body control problems. Holding the ball close to the body is most desirable.

Holding the ball away from the body may cause the body to lurch forward on the first step.

### PUSHAWAY

A properly executed pushaway is extremely important. The pushaway determines, in most cases, how well the bowler will walk to the foul line and how well the ball will be released. Hold the ball in close to the body, about waist high (no higher than chest high), with the thumb and fingers completely in the ball, wrist straight on the outside (see Figure 2a), elbows next to the side with the ball partially supported by the non-throwing hand. Now, without walking, push the ball forward and down so that the ball swings freely; keep the arm relaxed; let the weight of the ball work for you. As the ball comes down and back, the wrist should be straight (see Figures 2b and 2c).

What is done at the beginning of the pushaway will affect the rest of the approach, delivery, follow-through, and the final pin fall.

### WHICH TARGET? — SPOT OR PINS?

The selection of the aiming target is most important. There are two basic targets. (1) Spot (arrow) bowling is looking at and rolling the ball over one of the small triangular darts beyond the foul line. Keep an eye on the target arrow until the ball is released.

The most advantageous arrow for a right-handed player is the second arrow from the right side. For the left-handed bowler it is the second arrow from the left. Studies completed by N. Showers<sup>4</sup> and R. Showers<sup>5</sup> revealed that spot bowlers averaged at least 10 pins per game more than pin bowlers. The idea is that a target some 12-15 feet away is easier to hit than pins 60-63 feet away. The ball goes straight most of the way down the lane before curving so a player does not have to make allowance for

<sup>4</sup>Showers, Norman E. "A Study of Certain Factors Affecting Bowling Performance (Male)." *Illinois Journal of Health, Physical Education, and Recreation*, Winter, 1970.

<sup>5</sup>Showers, Robert G., 1970.

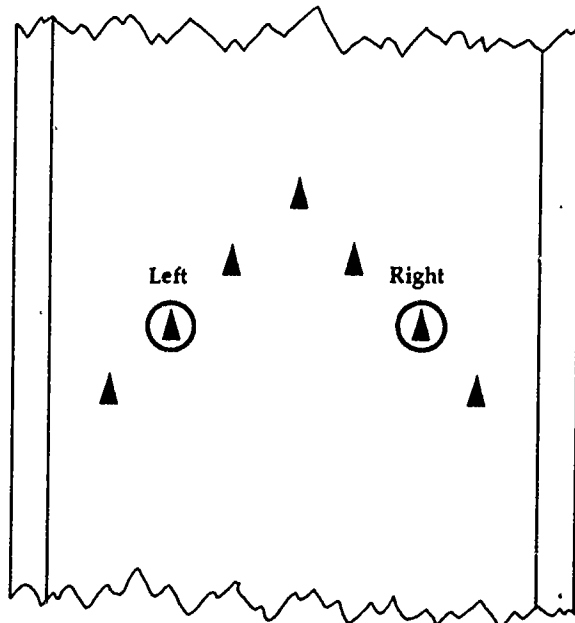

Diagram 3. Target arrows for the right-handed and the left-handed bowlers.

a curve in the same way as when pin bowling. (2) Pin bowling is looking at the pin or pins as the ball is released. When pin bowling, allow for the ball curve which usually means looking somewhere different than where the ball is to be hit.

#### APPROACH

When the bowler is in the correct stance, has the pushaway ready, and is looking at the proper target arrow, the next phase is to determine how many steps should be taken. The best bowlers use either 4 or 5 steps.

Prior to trying the 4- or 5-step approach, the player must determine how far away from the foul line to begin the steps. This is done by starting at the foul line and taking  $4\frac{1}{2}$  normal walking steps for a 4-step approach or  $5\frac{1}{2}$  steps for a 5-step approach away from the foul line. Most females will have their starting position at or near the 12-foot dots, and males will usually start about halfway between the 12-foot and 15-foot dots and males using 5 steps begin near the 15-foot dots. When pacing steps be sure to take normal walking steps. The extra half step is for the slide during the final step.

(Steps in bowling are not really steps, they should be more like a shuffle. If a bowler lifts his/her feet off the floor more than a fraction of an inch, the player tends to lose balance which causes problems.) Practice the walk at home without a ball.

#### 4-step Approach

The sequence of a 4-step approach is very rhythmical. Keep the eyes focused on the target arrow, the second arrow from the channel. Step 1. The ball is held near waist high, as mentioned before, then the ball and starting foot (right foot for right-handers, left foot for left-handers) move at the same time. The first step should be short, just enough to get the momentum started. Step 2. The second step continues with the ball still moving in a forward and downward movement and beginning backward. The second step is longer than the first step and a little faster. Step 3: This step has more momentum, the ball continues its backward arc and reaches its highest point (it should not be higher than shoulder level). Step 4: This is the final step and includes the slide. The ball is now moving forward in its downward arc and continues forward through the release. The sliding

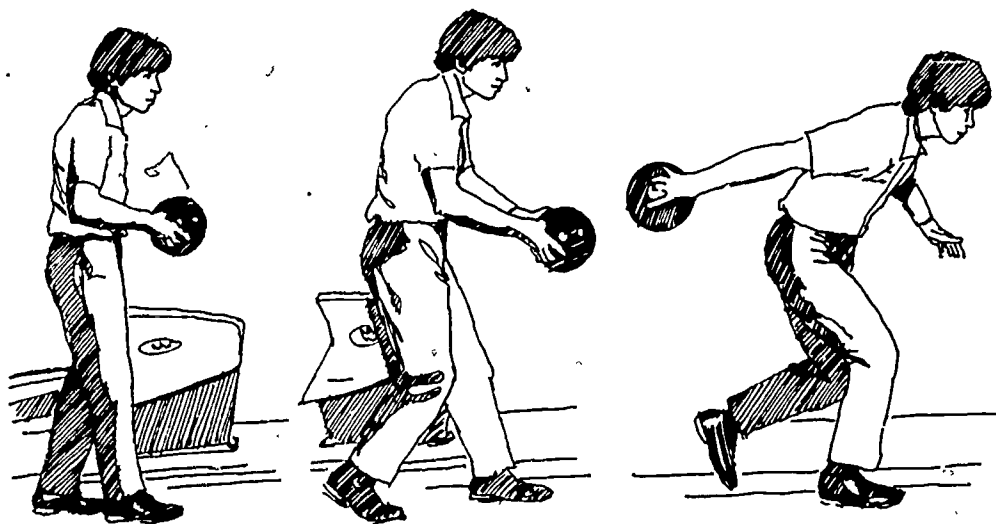

a.

b.

c.

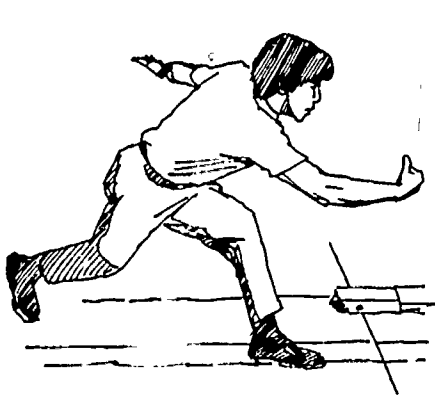

d.

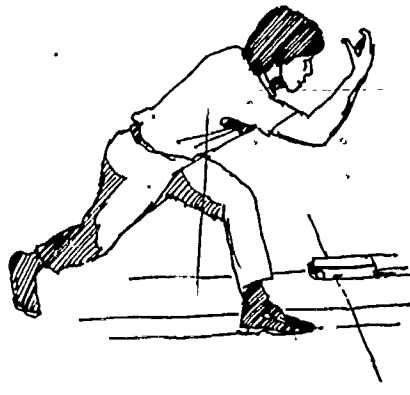

e.

Figure 2. The 4-step approach (side view).

foot should be straight and facing toward the target. The upper body should be leaning forward from the waist (not bent or hunched). The balance should be on the sliding foot with the knee bent, the trailing foot should be off the floor. The arm should continue the follow-through, with the middle fingers bent into the palm and the arm staying on the same side of the body (not across the body). It is very important that the eyes be focused on the target arrow all the time during the approach. Continue to watch the ball as it crosses over the target and stay at the foul line until the ball is seen to hit the pins (often a player is off-balance at the foul line; one of the causes is taking the eyes off the target as the ball is released).

#### The 5-step Approach

The 5-step approach approximates the 4-step with the exception that when starting, the first step is started and then the ball is started forward. The final step-slide movement is similar to picking up an object on the floor by stepping forward, bending the knee and swinging the arm down, and picking up the object while continuing the arm movement.

#### RELEASE AND FOLLOW-THROUGH

A very important part of bowling is the proper release of the ball and the arm follow-through. Even though the ball is released just after the bottom of the arm swing, the follow-through is a continuation of the total movement. The ball path, rotation on the ball, and accuracy are all affected by proper arm swing and follow-through. The arm from which the ball is released should continue in an arc (pendulum style) so that the arm does not cross the body. Proper arm swing and follow-through permits the ball to be properly released off the fingers; these in turn impart the proper rotation to the ball.

#### DELIVERY

The four main delivery styles are the curve, hook, backup (reverse curve), and straight ball releases. The hook ball or curve ball are the best deliveries. Bowlers who

use the hook or curve ball release average 10-15 pins higher than those players who use the backup delivery and about 20 pins better than those who use the straight ball. The main reason is the action of the ball when hitting the pins and this action is caused by proper hand, arm, and finger action at the release point. Until the player becomes proficient, he/she should concentrate on the ball release which approximates the handshake release; then continue the arm movement forward and up (see Figures 2c and 2d). The arm should be relaxed and the grip firm but not rigid.

#### STARTING POSITIONS

There are seven basic positions that permit nearly all of the spares to be made. Learn these starting positions. As the player becomes more proficient some final adjustments may be necessary. All references made are to the placement of the right foot for right-handed bowlers and for the left foot for left-handed bowlers. Use the best angle and lane width possible. The center of the foot should be placed on the same board as the starting dot.

The key to this system is to walk in the same straight line that is being faced as noted by the foot position and dotted line. When a right-hander is trying for the strike, 2-, 4-, 5-, or 7-pin leave, he/she faces square to the foul line and walks straight ahead. A left-hander walks straight ahead when attempting the strike, 3-, 5-, 6-, or 10-pin leave. When a right-hander attempts the right side spares (3, 6, 10) he/she should walk in the same direction that he/she is facing. Left-handers trying for the left side spares (2, 4, 7) need to face in the direction of their walk. Always roll the ball the same way; do not alter the delivery style.

There are times when a player needs to bowl at a pin that is not standing. Determine where the pins and ball will deflect. Some of the types of combinations of spares are as follows: *strike positions*—generally when the 5-pin is in the set-up such as 5, 5-8, 5-9, 1-5-9, 1-5-8; *2-pin*—2, 2-8, 1-2-10, 1-2-8, 4-5, 5-10, 2-4-5-8; *3-pin*—3, 3-9, 1-3-9, 3-5-6-9, 5-7, 5-6; *4-pin*—4, 2-7, 4-7, 4-7-8, 2-10; *5-pin*—same as strike; *6-pin*—6, 3-10, 6-9-10, 6-10, 3-7; *7-pin*—7,

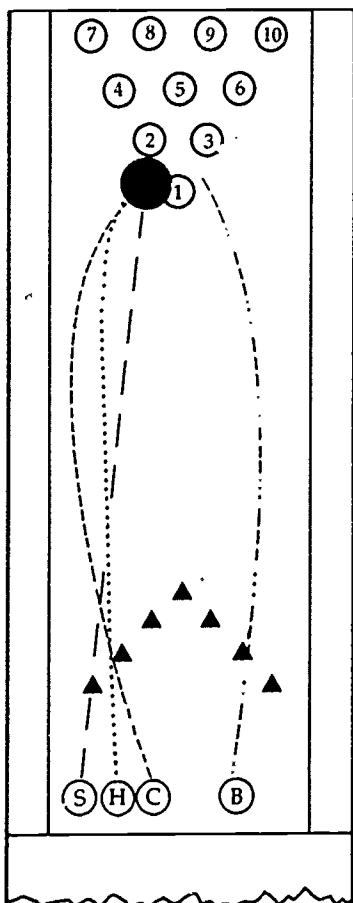

Diagram 4. Ball paths for the left-handed bowler (B-back-up, C-curve, H-hook, S-straight).

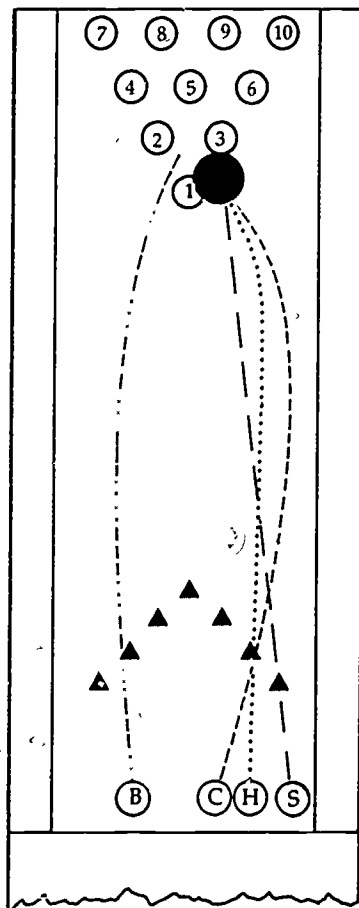

Diagram 5. Ball paths for the right-handed bowler (B-backup, C-curve, H-hook, S-straight).

4-10, 4-7-10; 8-pin—same as 2-pin; 9-pin—same as 3-pin, 10-pin—10, 6-10, 6-7, 6-7-10.

### STRIKES OR SPARES; WHICH IS MORE IMPORTANT?

Obviously strikes are what the game is all about, but most players do not get many strikes, so spares become a very important part of the game. As previously noted, until bowlers average 200, they will be trying for many more spares per game than they will strikes. There is a saying, "Get your spares, and strikes will take care of themselves." The more accurately spares are made, the more accurately will strikes eventually be made.

There are certain kinds of spare leaves that almost defy being made; the object is to knock over as many pins as possible. Pin combinations that fall into this category are: 8-10; 7-9; 7-10; 4-6; 4-6-7-10.

### PRACTICE

As noted in the bowling studies completed by the Showers brothers, the more one practices and/or the more leagues in which a player bowls, the better his/her average. For the average bowler this means two or three practice games and two to three leagues per week. When practicing, do not worry about scores but keep track of the completed frames. Attempt either the 10-pin or 7-pin, or 4-pin or 6-pin, or 2-pin

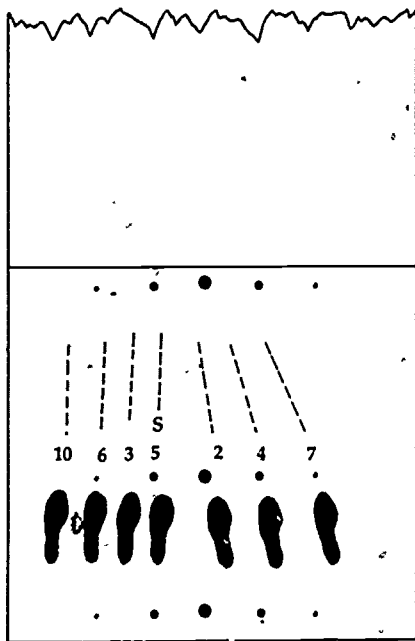

Diagram 6. Left-hander's placement of left foot for various pin leave positions.

Foulline

Basic Pin Leaves and Direction of Walk

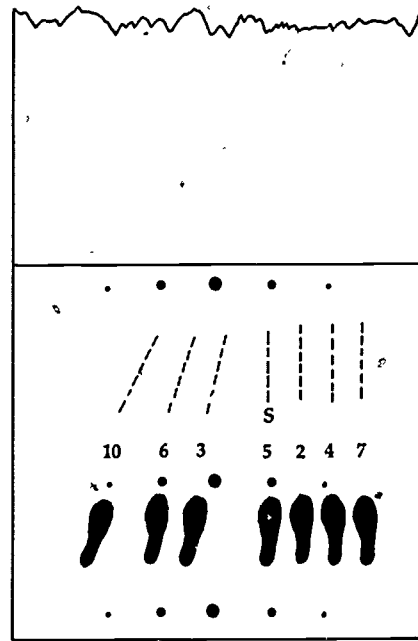

Diagram 7. Right-hander's placement of right foot for various pin leave positions.

or 3-pin with the first ball and then attempt a strike with the second ball since the head pin should be left and other pins should be remaining. When practicing, be sure that positive action is being done, do not perfect an imperfection by continuing to do something that is mechanically poor. Each bowling establishment has a person qualified to help.

### COMMON FAULTS

The most common faults for a bowler to look for are as follows: three steps, pin bowling, straight or backup ball delivery, walking too fast, walking too slow, turning the sliding foot, throwing the ball too hard, throwing the ball too slow, bending or slumping at the waist, leaning backward, leaning to either side, dropping the shoulder, holding the ball too high, holding the ball too low, no pushaway, no backswing, missing the spot, using the wrong angle for spares, standing up too straight at the foul-line, not bending the sliding foot knee at the foul-line, not keeping the body balanced, no follow-through, hopping or skipping when

walking, swinging the ball around the back; not using the proper weight ball; not having the ball fitted to the hand's size. These are the most important. All bowlers will have some of these faults but every player should attempt to minimize them. Have a qualified person to watch the player's bowling performance.

### PLAYING THE LANES

An experienced bowler will learn to determine how the lanes are to be played. First of all, keep in mind how the ball is bowled on the best lane in the regular bowling establishment. When attempting to bowl and after warming up, compare results with how the good lanes worked; then make any adjustments. If the lanes are slow, keep the same target arrow and adjust the starting foot position 2-3 boards to the right for left-handers and 2-3 boards to the left for right-handers. If the lanes are slick (fast) make adjustments 2-3 boards to the right for a right-hander or 2-3 boards to the left for a left-hander from the normal starting positions. Shadow balls are an ex-

cellent method to help determine whether the lanes are fast, slow, or just right.

Remember that lane conditions may change during a bowling session. As more players bowl, the lane dressing changes, which will usually cause a "breakdown" of the surface dressing which in turn causes the ball to have more curve.

### ANALYZE THE GAME

When bowling, keep a mental or physical record of what pins are continually left standing after the first ball. Light hits not hitting the pocket well mean that the player's starting position needs to be moved a couple of boards toward the outside of the normal starting position. If crossing over the head pin or hitting high on the head pin, move the starting position toward the center of the lane 2-3 boards. Some causes may be throwing the ball too hard (light hits) or too slow (high hits) or taking the eyes off the target.

### SAFETY

Safety considerations in bowling are rather minimal, as can be seen below.

1. Pick up the ball with both hands on the side of the ball. Picking up the ball with the hand exposed to an oncoming ball may result in a smashed hand.
2. Be careful of practice swings.
3. Wear loose-fitting clothes. Tight-fitting clothes restrict movements.
4. Don't step in liquids. Getting the sliding shoe wet may cause the player to stop too quickly.
5. Make sure the thumb and finger holes are not tight.
6. It is a good idea to test the sliding area on the approach prior to bowling.

### RULES

The game of bowling has many rules. Some of the more common ones are.

1. **Fouling.** Many players step over the foul line or touch a wall or support beyond the foul line. These are fouls even though the automatic foul light detector does not activate. Players and/or team

members should call a foul just as if the foul detector had been activated. *Deliberate fouls* may disqualify a player.

2. **Sandbagging.** Players who deliberately bowl a low score may be banned from league and/or tournament bowling.
3. **Illegal Pin Fall.** If the ball goes off the bowling lane surface for any reason and then comes back on to the lane surface and knocks over any pins, those pins must be respotted or not counted. Often a ball thrown into the channel (gutter) will bounce out and knock over the 7- or 10-pin. If a pinsetter knocks over any pins left standing or even if a pin is touched by the pinsetter while the pin is falling down, the pin or pins must be respotted or not counted. This often happens when a pin moves off spot after the first ball in a frame.

### ETIQUETTE

Bowling has some unwritten customs or etiquette. Those which are most common are listed below.

1. Be ready to bowl when it is your turn.
2. Do not talk to a player who is ready to bowl.
3. Wait your turn. Make sure the bowlers on the lanes next to you are not ready to bowl.
4. Use your own ball.
5. Stay on your approach.
6. Do not foul.
7. Make sure the pins are ready.
8. Do not put powder or other foreign substances on your shoes.
9. Make sure there are no liquids on the soles of your bowling shoes.
10. Do not loft the ball.
11. Always exhibit good sportsmanship.

### SCORING

Bowling has its own unique scoring system. Once the process is understood, scoring is not as difficult as it may seem. Examine the rules for scoring (see terminology for definitions).

1. A strike (X) counts as 10 plus a bonus of 2 balls (pins knocked down with the next

	1	2	3	4	5	6	7	8	9	10
You	7 /	5 3	9 /	F 6	5 -	X	2 X	8 /	X X	X X X
	15	23	33	39	44	72	92	112	142	172
	10 + 5	5 + 3	10 + 0	0 + 6	5 + 0	10 + 10 + 8	10 + 8 + 2	10 + 10	10 + 10 + 10	10 + 10 + 10
	15	+ 8	+ 10	+ 6	+ 5	+ 28	+ 20	+ 20	+ 30	+ 30

Diagram 8. How to score the game.

two balls). Exception occurs in the tenth frame when awarded two more balls for making a strike with the first ball. (Consecutive strikes are denoted with a small 2.)

2. A spare ( / ) counts as 10 plus a bonus of one ball (pins knocked down with the next ball). Exception occurs in the tenth frame; no bonus is permitted on a last ball spare.
3. Miss, open, blow, or split not converted into a spare—count only the total pins knocked down with both balls in the frame.
4. A foul counts as zero (0) for that ball.

Now examine the game score given in Diagram 8.

Frame 1—7 pins knocked down with first ball, 3 pins with second ball. This counts as a spare ( / ). Frame total is 15 (10 + 5 for first ball in second frame).

Frame 2—5 pins with first ball plus 3 pins with second ball. Total for frame is 5 + 3 = 8. Cumulative score is 15 + 8 = 23.

Frame 3—9 pins with first ball, 1 pin with second ball counts as a spare ( / ). Score in frame is 10 + 0 (foul on first ball in fourth frame). Total score is 23 + 10 = 33.

Frame 4—0 pins with first ball (foul) plus 6 pins with second ball. Total for frame is 0 + 6 = 6. Cumulative score is 33 + 6 = 39.

Frame 5—Total for frame is 5 (5 with first ball, 0 with second ball). Grand total is 39 + 5 = 44.

Frame 6—Strike with first ball. Score for frame is 28 [10 + next two balls which is 10 (strike in seventh frame) + 8 (first ball in eighth frame)]. Grand total is 44 + 28 = 72.

Frame 7—Strike with first ball. Score for frame is 20 [10 for strike + 10 for spare (8 + 2) in eighth frame]. Grand total for frame is 72 + 20 = 92. (Note: Score for a frame is automatically 20 when a strike is followed by a spare.)

Frame 8—8 pins with first ball and 2 pins with second ball for a spare. (The large 0 in the small box denotes a split which was picked up for a spare.) Score for frame is 20. (Note: Score for a frame is automatically 20 when spare is followed by a strike.) Grand total is 92 + 20 = 112.

Frame 9—Strike with first ball. Score in frame is 30 (10 + 10 + 10). (Three consecutive strikes count as an automatic 30 since the player receives 10 + next two balls which were also strikes.) Grand total is 112 + 30 = 142.

Frame 10—Three consecutive strikes. Score in frame is 30 (10 + 10 + 10). (Three consecutive strikes is an automatic 30.) Bonus balls are allowed only for first strike. Final game score is 142 + 30 = 172.

Try your scoring skill with the practice game. The answer is in the diagnostic quiz Good luck.

	1	2	3	4	5	6	7	8	9	10
You	7 /	X	5 4	X	6 /	3 5	7 ①	X	2 X	8 X

Diagram 9. What is the game score?



## STRATEGY

Bowling has strategy but is different from other sports. There is no defense in bowling; it is an offensive-based sport. A bowler can not be kept from taking his/her turn, so other considerations become paramount e.g., placing players in certain positions in the team lineup. Usually the best player is listed last (anchor) position; the next best usually bowls first and the lowest average player is in the middle with the other players either second or fourth. Another consideration occurs in the last frame as the bowlers take their turns; the player on the right bowls first and this may be important if the game is close.

Additional strategy occurs when certain types of splits are attempted. When in doubt, always try to get as many pins as possible. Examples are splits such as the 7-10, 4-6, 8-10, 7-9, and 4-6-7-10. These splits are next to impossible to convert into spares, so try for the count, that is, the sure pins. The only time to attempt these split-spares is if the game depends on making

the spare which usually occurs only if the player is the last person to bowl.

## EQUIPMENT

A big advantage in bowling is that all bowling centers have available equipment. Bowling balls are furnished at no cost and bowling shoes may be rented. However, after bowling for a more extensive period, it is advisable to purchase a ball and shoes. Studies completed by N. Showers<sup>6</sup> and R. Showers<sup>7</sup> revealed that players who owned shoes averaged about 5 pins more per game, and players who owned a ball averaged about 10 pins more per game than players who did not own bowling shoes or a ball.

A properly fitted ball and shoes are a must if one wishes to bowl well. Most bowling centers have a resident pro to help with equipment.

<sup>6</sup>Showers, Norman E., 1970.

<sup>7</sup>Showers, Robert G., 1970.

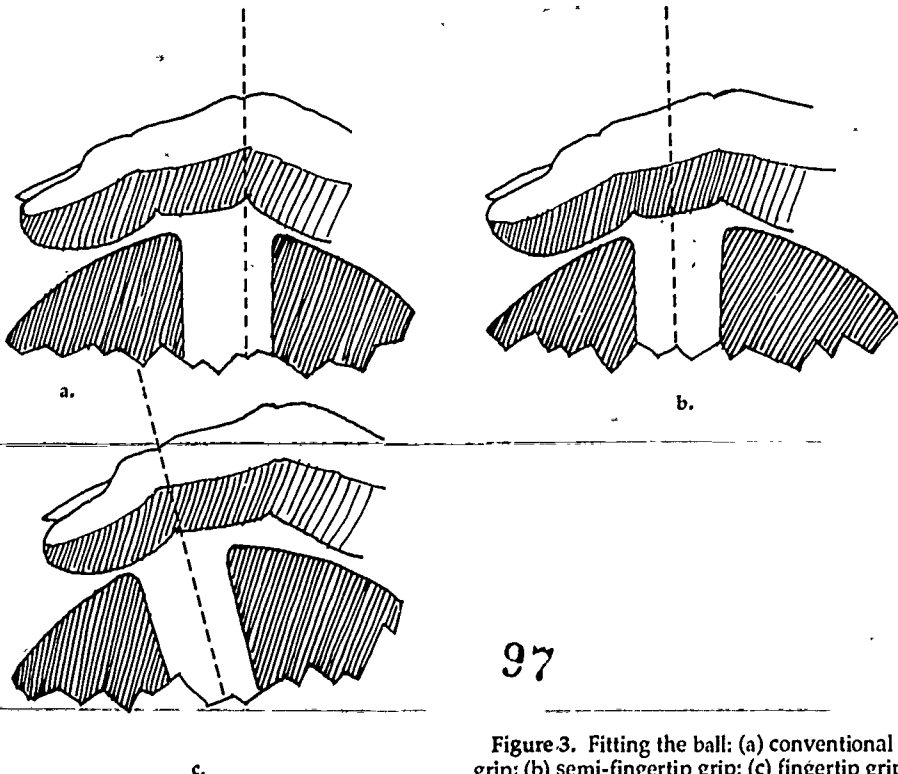

97

Figure 3. Fitting the ball: (a) conventional grip; (b) semi-fingertip grip; (c) fingertip grip.

## SHOES

Bowling shoes should be the same size as street shoes. Bowling shoes have rubber heels and a composition sole for sliding. Some shoes have a leather sole for sliding on one shoe and a rubber sole for traction on the other. Most rental shoes use composition soles.

## BALL

Bowling balls come in assorted weights, colors, and hardnesses. The conventional (3-finger) grip is recommended because bowlers usually do not have the necessary control to master the special grips such as the semi-fingertip or the fingertip until their league average is at least 180. When selecting a ball, two things should be considered: weight, size of thumb and finger holes. Ball weights will vary from the usual 10 pounds to 16 pounds (maximum). Some balls are even lighter in weight. As a ball is selected, find the heaviest weight ball that can personally be handled: high school girls, 10-12 pounds; high school boys, 12-16 pounds; junior high school girls, 9-12 pounds; junior high boys, 11-14 pounds. After selecting the proper weight, insert the thumb all the way in—the thumb should be able to move in and out with ease—do not bend the thumb—a thumb hole that is just larger than the thumb is needed, with the thumb all the way in the thumb hole, stretch the hand across the ball so that the middle two fingers extend over the finger holes. The first finger joints should extend about  $\frac{1}{4}$  inch beyond the near edge (nearest the thumb hole) of the finger holes, hold the ball alongside the body. The ball weight should not be too noticeable and the ball should hang on the hand. The bowler should not have to squeeze or bend the thumb or fingers; he/she should have no more space between the palm and the ball surface than the thickness of the little finger. Swing the ball along the side of the body, the ball should feel comfortable. A note of caution: a ball that fits correctly will not feel heavy; a lightweight ball that doesn't fit will usually feel heavy.

## THUMB PROBLEMS

Many times thumb problems occur when the thumb hole is too tight, too loose, or the span (distance between the thumb hole and finger holes) is too narrow or too wide. Sometimes thumb problems occur because of the way a ball is released, usually spinning the ball off the thumb.

## CLOTHING

Bowling may be done in almost any type of normal clothing; however, the player should use comfortable loose-fitting garments. Tight clothing is restrictive to swinging, walking, bending, and sliding.

## LEAGUES

Most players bowl in a league. Several players get together to form a team, and then join a league which normally bowls three games, one day per week, for about 35 weeks. (Summer leagues are much shorter.) Most leagues are handicapped so that all teams have a good chance to win. Most high average players select a scratch (no handicap) league.

## DIAGNOSTIC QUIZ

Following are some questions that can aid the player to bowl better from the beginning.

1. What are the differences between house balls and custom-fitted balls?
2. Are there differences in bowling shoes?
3. Which is better, a curve or straight ball delivery?
4. Which is better, the pin or spot method of sighting?
5. Why is it better to take 4 steps rather than 3 steps?
6. Why is a medium walking speed best?
7. Is a ball thrown fast better than a medium speed ball?
8. Where should the player stand to pick a 2-pin spare? a 10-pin spare? a 5-pin spare? a 4-7-pin spare?
9. Name the proper target pin in the following spare combinations: 3-10 pins; 2-7 pins; 1-2-8 pins; 1-3-9 pins; 5-10 pins; 5-7 pins; 1-2-4 pins; 1-3-6 pins.

10. Which grip is best for a beginner to use?
11. Is practice worthwhile? How should a player practice?
12. Did you get a score of 165 for the game shown in Diagram 9? Frame by frame totals are 20-39-48-68-81-89-97-125-145-165.

### TERMINOLOGY

- ABC.** American Bowling Congress. Men's governing body.
- AJBC.** American Junior Bowling Congress. Governing organization for school-age boys and girls.
- Anchor.** Last bowler on a team. Usually the team's best bowler.
- Arows (also spots).** A series of seven triangular darts, 12 to 15 feet beyond the foul line. Spot bowlers use these aiming targets.
- Automatics.** Term used to designate the pinsetting equipment.
- Average (also grand average, composite average).** Add all games bowled in a league and divide by the number of bowled games. (Drop all fractions.)
- Baby Split.** The 3-10 and 2-7 splits.
- Backup Ball.** Ball that curves to the right for a right-handed bowler, or to the left for a left-handed bowler.
- Blind.** A predetermined score used for a missing player.
- Blow (also miss, open, error).** Failing to get a strike or a spare in a frame.
- Bonus.** The number of additional pins scored after getting a strike or a spare.
- Brooklyn (also crossover).** Ball hitting to the left side of the head pin for a right-hander, or to the right side of the head pin for a left-hander.
- Bucket.** The 2-4-5-8 and 3-5-6-9 pin leaves.
- Channel Ball (also gutter ball).** Throwing the ball into the shallow 9-inch wide trough on either side of the bowling lane.
- Cherry (also chop).** Knocking down at least the front pin or pins during a spare attempt and leaving adjacent or rear pins, such as knocking down the 6-pin from the 6-10 set-up.

- Convert.** Ability to make a spare. (also picking a split).
- Count (Pin Count).** Failure to get at least 9 pins in a frame or 9 pins on the first ball following a spare or multiple strikes.
- Curve.** A ball that is rolled toward the outside of the lane which then curves back toward the center of the lane.
- Dead Ball.** A ball rolled on the wrong lane or out of turn; also, a delivered ball that causes little or no pin action.
- Dead Mark.** Last ball spare or strike in tenth frame; no bonus is allowed on a dead mark.
- Delivery.** Rolling the ball. Used to designate either the curve, hook, backup, or straight ball.
- Double (also called a chicken).** Two consecutive strikes in a game.
- Double Pinocchio.** Leaving the 4-7-6-10 split after the first ball.
- Doubles.** Team consisting of two players.
- Dutchman or Dutch 200.** Alternating strikes and spares in a game.
- Fast Lanes.** Term used when the ball doesn't curve very much due to a slick lane.
- Foul.** Touching or going over the foul line when delivering the ball. It is also a foul to touch anything beyond the foul line even if the foul light does not go on. A foul counts as a ball rolled but a zero is received for that ball.
- Frame.** A game consists of ten frames per player; either one ball (strike) or two balls are rolled per frame, except in the tenth frame, an extra ball is received if the player gets a spare, and two extra balls if the player gets a strike on the first ball.
- Handicap.** A score adjustment based on the difference between team or individual averages. Usually 75% of the difference is used.
- Hook.** A ball rolled so that the ball takes a straight path and then takes a sharp turn (hook) at the end.
- Kegler.** Another name for a bowler.
- Kingpin.** Name given to the number 5 pin.
- Lane (also alley).** Name given to the wooden surface that extends from the foul line to the end of the pin deck.
- League Bowling.** Bowling in a regularly scheduled league is a good way to bowl. Usually

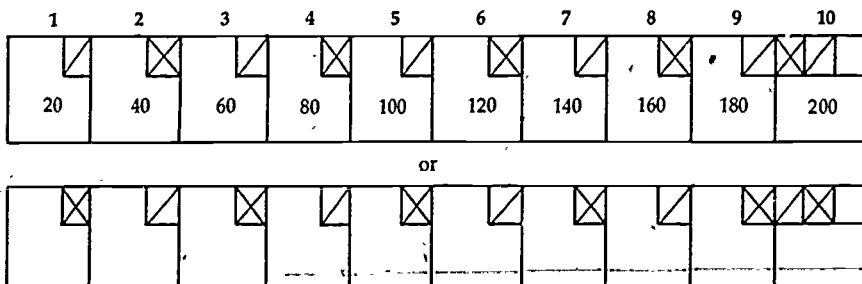

Diagram 10. Dutch 200 games.

teams are composed of five players. Most are handicap leagues. League sessions are usually for three games and players alternate lanes, that is, bowl first frame on one lane, second frame on the adjacent lane, third frame on same lane as first frame, etc.

**Mark.** A strike or a spare. A mark is tallied for each strike (two for each consecutive strike) and spare. Each mark represents approximately 10 pins on one's game. Keeping track of a team's marks will let the bowler know how the teams are doing against each other.

**NBC.** National Bowling Council.

**Nose Hit.** Ball that hits the number 1 pin squarely.

**Perfect Game.** A score of 300. Twelve consecutive strikes in a game.

**Pin.** The regulation pin is 15 inches tall and usually weighs between 3 pounds 2 ounces and 3 pounds 6 ounces.

**Pin Bowler.** Player who looks at the pins when releasing the ball.

**Pin Deck.** The area where the pins are spotted. The pin deck is 41-42" wide.

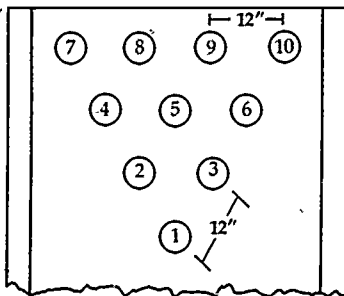

Diagram 11. Call pins by number.

**Pin Spots.** Spots on the pin deck. Pins are placed 12 inches apart, center-to-center, forming a 36-inch triangle.

**Pit.** Area at the end of the pin deck into which the pins fall.

**Pocket.** The 1-3 pins for right-handed bowlers and 1-2 pins for left-handers.

**PBA.** Professional Bowlers Association. Men's organization.

**Return.** A track on which the ball returns to the bowler.

**Sandbagger.** Player who deliberately bowls a low score.

**Scratch Bowling.** Player does not get any handicap.

**Series.** Usually three games, such as in a league session.

**Singles.** Bowler competing as an individual.

**Span.** Distance between the thumb hole and the finger holes on a bowling ball. There are three basic spans: conventional; semi-fingertip; and fingertip grips.

**Spare.** Knocking down all 10 pins with two balls in a frame. A spare counts 10 plus the number of pins knocked down with the next ball. There are 1023 different spare combinations.

**Split.** When an intermediate pin is missing in any series of pins, providing the head pin is not standing after delivering the first ball in a frame. Typical splits are: 5-10; 5-7; 3-10; 2-7; 7-10; 8-10, 4-5; 5-6; 4-6; 7-10; etc. There are 459 different splits.

**Spot Bowler.** A player who uses the target arrows or boards rather than looking at the pins when releasing the ball.

**Steps.** Refers to the number of walking steps a player takes when walking to the foul line. Most bowlers use the 4-step approach.

**Strike.** Knocking down all 10 pins with the first ball in a frame except in the tenth frame where the bowler may have three chances for strikes.

**Tournament Bowling.** Tournaments are usually based on handicaps. Players are handicapped from a predetermined score either as teams, doubles, or singles. Final standings are based on total score plus handicap.

**Turkey.** Three consecutive strikes in a game.

**WIBC.** Women's International Bowling Congress.

**WPBA.** Women's Professional Bowlers Association.

## REFERENCES

- American Bowling Congress. *Rules and Regulations*. Greendale, WI, current year.
- American Junior Bowling Congress. *Rules and Regulations*. Greendale, WI, current year.
- Showers, Norman E. *Bowling*. 3d ed. Glenview, IL: Scott, Foresman and Company, 1981.
- Showers, Norman E. "Suggestions for Teaching Bowling." *Bowling and Archery Guide*. Washington, DC: American Association for Health, Physical Education, and Recreation, 1975-76.
- Women's International Bowling Congress. *League Rule Book*. Greendale, WI, current year.

*ballerina (p. 93)*  
*ballet (p. 93)*  
*ballroom dance (p. 96)*  
*basic waltz step (p. 100)*  
*caller (p. 96)*  
*corps de ballet (p. 93)*  
*country western two-step (p. 100)*  
*danseur (p. 93)*  
*disco line dance (p. 99)*  
*figures (p. 96)*  
*folk dance (p. 96)*  
*head couples (p. 96)*  
*jazz dance (p. 94)*  
*modern dance (p. 93)*  
*popular dance (p. 98)*  
*side couples (p. 96)*  
*square (p. 96)*  
*square dance (p. 96)*  
*tap dance (p. 95)*

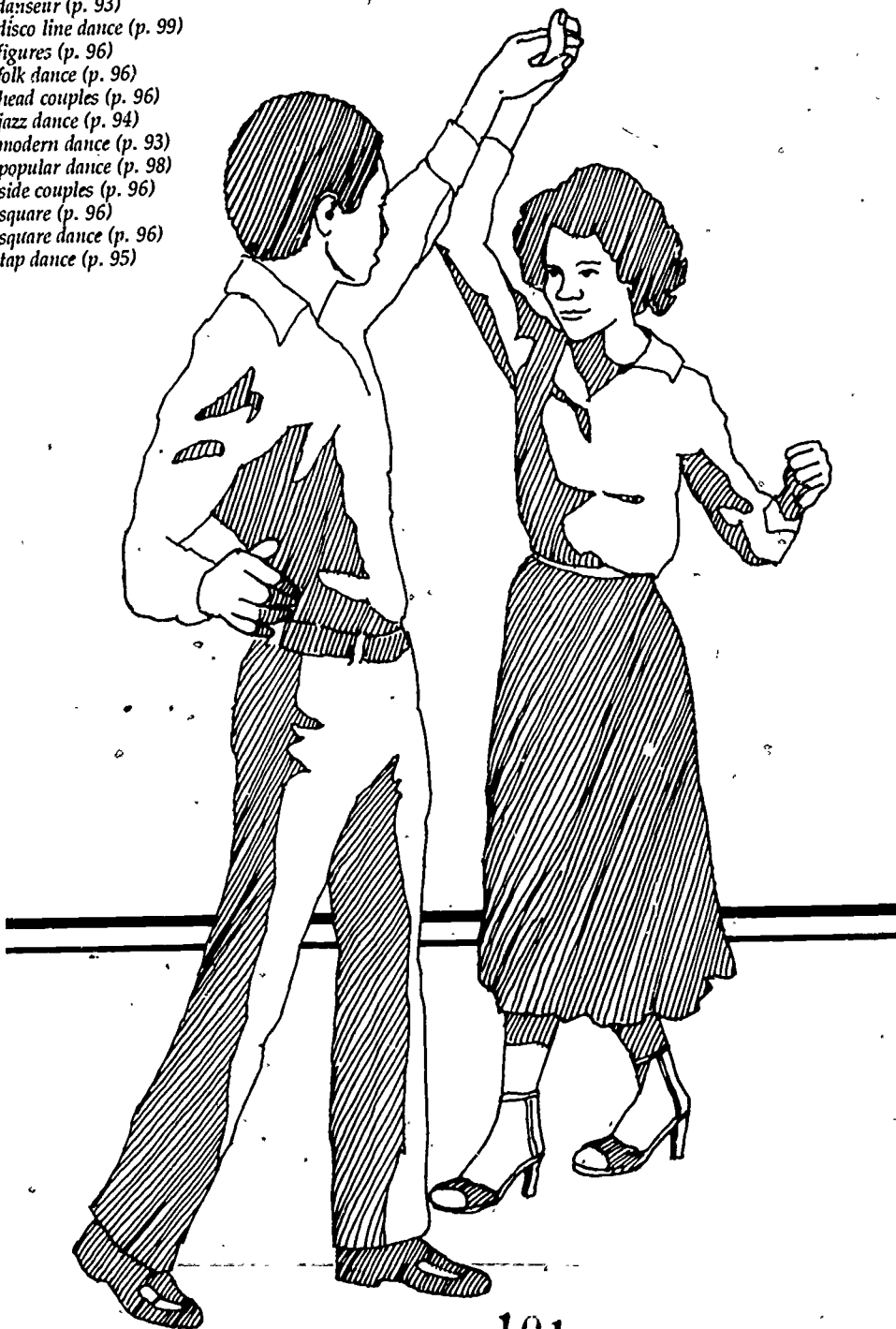

# Dance in Education

DENNIS FALLON,  
University of Missouri,  
St. Louis, MO

## INTRODUCTION

Throughout the ages dance has been an important aspect of all cultures. Among primitive cultures, dance was a major form of religious ritual and social expression. Men and women danced to gain the favor of the gods who provided food, shelter, health, and safety. They danced to express their joy in birth, their happiness in love, their courage in war, and their sadness in death. Their movements were inspired by nature—the movement of animals, the flight of birds, and the beauty of a rising and setting sun.

Dancing has become a part of American tradition. The Indians, the immigrant colonists, and the black slaves have contributed their dance forms to this tradition. Today Americans enjoy one of the richest cultural traditions in the dance world.

Dance forms appeal differently to each person. It may simply be an enjoyable social activity performed at the community center or at the school prom, it may be a demanding performing art, it may be a highly competitive as well as colorful, cultural expression of dance. Each person has a basic need to express himself/herself in movement. Dance provides many recreational and artistic opportunities for everyone.

Do you remember moving naturally and spontaneously to the sound of music as a child? Do you remember the fun you had in the square dance class? Do you recall your first dance at the high school prom or the wedding dance where you saw your parents dance for the first time? Several forms of dance are described in the following pages. Perhaps, these descriptions will inspire you to join the world of dance.

## SOME FORMS OF DANCE IN AMERICA

### BALLET

Ballet is the supreme classical form of dance in the western world. Born in Italy, ballet came to life in the courts of France during the 16th and 17th centuries. Ballet flourished throughout Europe and Russia in the 18th century ultimately reaching a new artistic height in the early 19th century. The year 1841 marks a zenith in the history of ballet with its full introduction of the pointed shoe and the era of the ballerina. Ballet in the 20th century is experiencing a renaissance period and major ballet companies can be seen throughout the world.

The movements of ballet include traditional positions of the feet, arms, and body. The movements are performed standing in place, springing or leaping into the air, or traveling through space. The classical nature of the form is recognizable with the strong vertical alignment of the body as well as the turned-out position of the legs.

Many students study ballet just for the love and beauty of the art. Others, a select few, join companies as members of the *corps de ballet*. If a girl is an outstanding performer, she may become a *ballerina*. If a boy is an outstanding performer, he can become a *danseur*.

### MODERN DANCE

Modern dance in America emerged as a new form of dance free from the traditions of ballet and responsive to the vitality of the American pioneer spirit. In the early 20th century, Isadora Duncan felt that dance



Figure 1. Ballet.

should reveal not only the natural and pure beauty of the human body but that it should be a truthful expression of human emotions and ideas as well. Other dancers like Martha Graham and Doris Humphrey developed techniques of theatrical dance that expanded the expressive and virtuosic range of the body in motion.

Beginning dancers are introduced to principles of movement relative to space, tempo, flow or continuity, and the force. As they apply these principles dancers discover and create new movement patterns.

Professional modern dancers spend many years developing their bodies for artistic expression. They learn to improvise with dancers, sets, costumes, props, and sound. Ultimately, they learn to organize their movements and materials into formal choreography. Although few will choose a professional career in modern dance, it can still be appreciated as a performing art.

#### JAZZ DANCE

Jazz dance is a splendid combination of European and African dance, characterized by syncopated and complex rhythms,



Figure 2. Modern dance.

European folk dance steps combined with African rhythms.

During the early 20th century, jazz dance gained acceptance in minstrel shows and a new theatrical form called Vaudeville. The increased visibility of black performers had a marked influence on the emergence of social dances, such as the Turkey Trot,

African rhythmic foot patterns all have contributed to our American tap dance.

The purpose of tap dance has usually been entertainment. Popularized in the minstrel shows of the 19th century and by such entertainers as Bill Robinson and Sammy Davis, Jr., in the 20th century, tap dance captures the energy and rhythm of



Figure 3. Jazz.

Charleston, Black Bottom, the Shimmy of the 1920s, and the Lindy Hop of the 1930s.

Today jazz dance combines its ethnic heritage with modern dance and is frequently referred to as modern jazz dance. Students who are interested in careers in the theatre usually study jazz dance and ballet.

#### **TAP DANCE**

Many of the early European and African dances were characterized by distinct heel and toe movements. The Irish Jig, the English Clog, the Spanish Flamenco, and the

this country. The early tap dancers invented their own steps and variations featuring fast footwork, vigorous body movements, humorous talk, and songs. During the days of Vaudeville the dancers developed a smoother and more polished style of dance. Some specialized in sand dancing, soft shoe, and various forms of clog dancing.

Tap dancing has always been an important part of theatrical entertainment in America. Today it appeals to many people because of its artistry and showmanship.



## SQUARE DANCE

Square dance originated from the French quadrilles and the country dances of the British Isles. Today it is very much a part of American culture.

Square dance is social dancing in its most vivacious form. Because it is relatively easy to learn, it is popular with both children and adults. With its rural or country flavor, square dance is extremely popular in metropolitan areas where men in cowboy boots and women in full skirts frequent their local clubs to square up and dance to country music.

The unique feature of square dance is the *caller*. The caller establishes the rhythm of the dance and cues or directs the dancers through known *figures* changing the dancers of a *square*. Each square consists of four couples. The couples are numbered one, two, three, and four in a counterclockwise direction around the square. Couples number one and three are also referred to as the *head* couples and two and four are referred to as the *side* couples.

Originally, square dancing used a few simple figures dancing as one couple visited another and then moved on to the other couples to repeat the figure. Today, many figures are used as the eight dancers move in intricate patterns. Because of the increased complexity of square dancing, The National Federation of Square Dance Callers was formed to establish standards and order in square dance. Most callers have their own clubs where they teach the fifty basic figures of square dance. The simple figures, such as, *swing*, *promenade*, *circle*, and *star* form the foundation for more difficult figures.

Today there are two kinds of square dance. One is danced to singing calls, the other to patter calls. Singing calls are composed to the lyrics of a popular song and consist of predetermined figures. Between the figures of a singing call the caller will sing some lyrics of the song. Patter calls consist of patterns of figures that the caller spontaneously arranges. Between figures the caller will insert rhyming phrases (patter) that provide a rhythmic quality to the call.

The square dance is a truly American folk dance. Unlike ballet and modern dance which emphasize theatrical performance, square dance invites everyone to dance.

## FOLK DANCE

Folk dance is an international experience that reveals the distinct tradition, dress, and character of a nationality through a common medium, dance. The highlights of every festive national holiday are the folk dances that remind people of their heritage and ancestry. Persons today are returning to the true ethnic nature of folk dance by using the original musical instruments, the national dress, the style, and the precision of the dances.

Folk dances range from simple to complex dances. Some dances consist of walking steps in simple patterns while others include steps, hops, and jumps in various rhythms and in intricate patterns. In either case enjoyment is derived from dancing in style and rhythm akin to the music.

A rather attractive aspect of folk dance is the varied formation and grouping used in dancing. Some dances use lines, circles, groups of three or more, couples, and individuals. Some dances are performed by men, some by women, and some by both men and women. In every dance the grouping tells the happy and sad stories from the past about religious and secular beliefs, birth and death, courtship and marriage, victory and defeat.

Every year over one million people immigrate to the United States. They bring with them their cultural heritage and their energy. Folk dance, indeed, is a cultural experience enjoyed by all persons.

## BALLROOM DANCE

Ballroom dance is an enjoyable form of social dance performed by men and women dancing as couples in recreational settings, clubs, and ballrooms. Ballroom dance has its roots in the peasant dance tradition of Europe. In the 16th and 17th centuries, the peasant dances were refined by the aristocracy into extravagant, elegant, and highly social dances. Some of the early court dances were the courante, the pavane, the



Figure 4. Square dance.



Figure 5. Folk dance.

allemande, the gavotte, the gigue, and the galliard. In the 18th and 19th centuries the contredanse, the quadrille, the cotillion, the mazurka, the polka, the schottische, and the waltz, gained popularity in Europe and America. Today the polka and the waltz are popular ballroom dances in this country.

The music and dance of millions of African slaves, strongly influenced popular music and dance in the 19th century. By 1890 Black culture manifested itself in the only original art form, jazz. Brass bands popularized jazz, ragtime, and slow mournful blues during the "Roaring Twenties." The foxtrot and the swing, two of today's more popular ballroom dances, became popular across the country.

Immigrants from Latin and South America during the early 20th century brought with them several ballroom dances that are popular today: the tango, the rumba; the cha cha. Ballroom dance in the United States, indeed, is a multi-cultured experience, one that can be enjoyed at a

recreational level or pursued at a competitive level in local, regional, national, and international contests. Included in the final section of this chapter are basic steps of selected ballroom dances.

### POPULAR DANCE

Popular dance refers to that form of social dance that is currently favored by most people. Heavily influenced by popular music the dances reflect the mood and interests of the time.

In the early part of this century people danced to the Turkey Trot, Grizzly Bear, and the Bunny Hop. Later they boogied to the Varsity Drag, Boogie, Shag, and Suzie Q. Possibly the most popular dance to sweep the country was the Twist which appeared during the 1960s. During the 1970s the Bump, Bus Stop, Rope, and Hustle were danced. These are forms of disco dance, a kind of dance popularized in clubs called discotheques.

Most popular dances have very simple foot patterns and obvious body movements



Figure 5. Ballroom dance.



Figure 7. Popular (disco) dance.

that allow for personal interpretation. Disco dance is performed both individually to felt rhythms and patterns and with a partner.

### SKILLS AND TECHNIQUES

The skills and techniques of dance like the skills and techniques of sport are founded on the basic laws of motion. Although the skills and techniques of ballet and modern dance differ from those of ballroom dancing and the skills and techniques of basketball differ from those of tennis, dancers and basketball players learn the basic skills of dance and sport rather easily. The basic reason for this is that dancers have learned to apply the basic laws of motion.

In dance, students continually search for beautiful movement while in sport they strive for productive movement like hits and runs. As dancers acquire skill and technique their movements become more

beautiful. They begin to apply the laws of gravity to their posture and movement and begin to control their energy in various movements. Dancers become more aware of lines and begin to distinguish tempo of movement as they begin to move into beautiful flowing patterns.

Dance is locomotor movement. Persons move by walking, running, skipping, hopping, galloping, leaping, and sliding. They point their feet forward, touch them to the side, dot them behind, and kick them high.

When the basic locomotor movements of dance can be performed, put them into a sequence. Try these:

#### Disco Line Dance

Beat	Foot	Direction
1	Right	Forward
2	Left	Forward
3	Right	Forward
4	Left	Kick
5	Left	Backward
6	Right	Backward
7	Left	Backward
8	Right	Kick

**Basic Waltz Step**

Beat	Foot	Direction
1	Left	Forward
2	Right	Forward
3	Left	Close
4	Right	Backward
5	Left	Backward
6	Right	Close

*Note:* The girl begins this pattern by stepping backward on the right foot.

**Country Western Two-step**

Beat	Foot	Direction
1 & 2	Left	Forward
3	Right	Forward
4	Left	Close
5 & 6	Right	Backward
7	Left	Backward
8	Right	Close

*Note:* The girl begins this pattern by stepping backward on the right foot.

The first pattern is easy because it is basically walking to the beat of the music without a partner. The second pattern is also a walking pattern but performed with a partner. The third pattern is similar to the second except that the first and fourth steps are slow and take two beats while the other steps are quick and take one beat each. If this pattern can be mastered, the polka, schottische, rumba, and samba, can be attempted.

**SAFETY**

Injuries occasionally occur to a dancer's feet. Blisters, callouses, sprains, and stress fractures are common injuries. Most injuries can be prevented if dancers pay attention to their bodies' warning signal, pain. There, of course, must be space for the dancers to move freely and the floor should be a finished, non-slippery hardwood upon which they can glide with bare feet, soft sandals, or lightweight dancing shoes.

Other injuries like pulled muscles can happen when students attempt movement without sufficient warm-up or beyond their capability. Students, therefore, should learn the basic movements of dance and acquire the necessary strength, flexibility, and timing for them before attempting more advanced movements. This advice should serve as a basic rule of safety.

**SCORING, RULES, AND ETIQUETTE**

In competitive solo, ballroom, and disco dance there are rules and scoring procedures similar to those used in competitive figure skating. The dancers must perform compulsory (required) as well as free dance movements, and they are generally scored on precision, showmanship, and use of dynamics.

Etiquette and form are significant aspects of dance. Through dance we acquire an appreciation for courtesy, graceful movement, and correct posture.

**EQUIPMENT**

Compared to most sports there is little personal expense for dance equipment. For ballroom and popular dance, dress attire is often appropriate. For folk and square dance, many dancers wear appropriate ethnic and western attire. Modern dancers, ballet dancers, and jazz dancers usually wear leotards for practice sessions and complimentary attire for performances. The clothing, of course, must fit well and permit free movement. For social dance, tap, and ballet dancing, shoes and slippers must be comfortable and of good quality.

**TERMINOLOGY**

**Allemande.** A square dance movement during which the designated man and woman grasp forearms and turn each other around once.

**Arabesque.** One of the basic poses in ballet.

**Cha Cha.** A social dance from Cuba performed in slow-slow-quick-quick-slow rhythm and  $4/4$  time.

**Chasse.** A side, close, side step pattern.

**Choreography.** The grouping or patterns of a dance composition.

**Close.** Bringing the feet together.

**Curtsey.** A dip performed either forward or backward.

**Danseur.** The male ballet dancer.

**Danseuse.** The female ballet dancer.

**Do-sa-do.** A square dance movement during which the man and woman pass right shoulders, move around each other back to back, and return to a facing position.

**Gallop.** A basic form of movement in a diagonal direction and a step, close, step, close pattern.

**Grapevine.** A sideward dance movement in a side, behind, side, front pattern.

**Hesitation.** A social dance step in a step, touch, step, touch pattern.

**Hop.** A form of movement where one jumps and lands on the same foot.

**Jitterbug.** An American social dance performed to fast jazz music. Also called the Lindy.

**Kick.** A quick, fast movement forward, backward, or sideward without a transfer of weight.

**Leap.** A form of movement where one jumps from one foot to another.

**Lindy.** See Jitterbug.

**Measure.** A grouping of musical beats made by the regular occurrence of a heavy beat.

**Meter.** Refers to time in music or grouping of beats to form the underlying rhythm in a measure.

**Pas de Deux.** A ballet dance for two.

**Pirouette.** A turn on the balls of the feet.

**Plié.** A bending of the knees.

**Point.** Pointing the toe of the free foot in a specified direction.

**Polka.** A Bohemian social dance performed in 2/4 time and a hop, step, close, step pattern.

**Promenade.** A square dance movement performed by couples moving counterclockwise around the square with the boy on the inside and the girl on the outside of the circle.

**Rumba.** A Latin American dance performed in 4/4 time and quick, quick, slow or slow, quick, quick rhythm.

**Samba.** A Latin American dance performed in 4/4 time and quick, quick, slow rhythm.

**Schottische.** A dance, done in 4/4 time and a step, close, step, hop pattern.

**Skip.** A form of movement where one steps and then hops on the same foot.

**Slide.** Form of movement where one moves sideward in a step, close, step, close pattern.

**Square.** The basic formation in square dance. A square consists of four couples facing the center of the square with the boys on the left side of their partners.

**Syncoption.** A musical term referring to the accenting of the second and fourth beats rather than the usual first and third beats of a measure.

**Tango.** A Latin American dance from Argentina performed in 2/4 or 4/4 time—slow, slow, quick, quick, slow rhythm.

**Touch.** A fast movement without a transfer of weight.

**Two-step.** A dance step performed in 2/4 time—a step, close, step pattern and quick, quick, slow rhythm.

**Waltz.** A social dance from Austria performed in 3/4 time and a three-step, even rhythm.

## REFERENCES

- The Basic Movements of Square Dancing.* Los Angeles, CA: American Square Dance Society, 1972.
- Cayou, Delores K. *Modern Jazz Dance.* Palo Alto, CA: National Press Books, 1971.
- Cheney, Gay, and Strader, Janet. *Modern Dance.* Boston, MA: Allyn and Bacon, 1969.
- Chujoy, Anatole. *The Dance Encyclopedia.* New York: Simon and Schuster, 1967.
- DeMille, Agnes. *American Dances.* New York: MacMillan Publishing Company, Inc., 1980.
- Fallon, Dennis. *The Art of Disco Dancing.* Washington, DC: AAHPERD, 1980.
- Fallon, Dennis, and Kuchenmeister, Sue Ann. *The Art of Ballroom Dance.* Minneapolis, MN: Burgess Publishing Company, 1977.
- Gilbert, Cecil. *International Folk Dance at a Glance.* Minneapolis, MN: Burgess Publishing Company, 1974.
- Grant, Gail. *Technical Manual and Dictionary of Classical Ballet.* New York: Dover Publications, Inc., 1967.
- Harris, Jane, et al. *Dance a While.* Minneapolis, MN: Burgess Publishing Company, 1978.
- Joukowsky, Anatol. *The Teaching of Ethnic Dance.* New York: J. Lowell Pratt and Company, 1965.
- Kirstein, Lincoln. *Dance: a Short History of Classic Theatrical Dancing.* New York: Dance Horizons, 1974.
- Kraus, Richard, and Chapman, Sarah. *History of the Dance in Art and Education.* Englewood Cliffs, NJ: Prentice-Hall, Inc., 1981.
- Lockart, Aileen, and Pease, Esther. *Modern Dance.* Dubuque, IA: Wm. C. Brown Company Publishers, 1977.
- Nash, Barbara. *Tap Dance.* Dubuque, IA: Wm. C. Brown Company Publishers, 1969.
- Sachs, Curt. *World History of the Dance.* New York: W. W. Norton and Company, 1965.
- Sorell, Walter. *The Dance through the Ages.* New York: Grosset and Dunlap, 1967.
- Steinberg, Cobbett. *The Dance Anthology.* New York: New American Library, 1980.

## DANCE ASSOCIATIONS

- American Dance Guild, P.O. Box 109, Princeton, NJ 08540
- National Dance Association, 1900 Association Drive, Reston, VA 22091

bully (p. 109)  
centers (p. 108)  
corner (p. 110)  
defense hit (p. 110)  
the dribble (p. 103)  
forwards (p. 108)  
fouls (p. 110)  
free hit (p. 110)  
fullbacks (p. 109)  
goalkeeper (p. 109)  
halfbacks (p. 108)  
the hit (p. 105)  
inners (p. 108)  
links (p. 108)  
penalty corner (p. 110)  
penalty stroke (p. 110)  
the push (p. 104)  
push-in (p. 110)  
receiving (p. 106)  
16-yard hit (p. 110)  
sweeper (p. 109)  
tackling (p. 108)  
wings (p. 108)

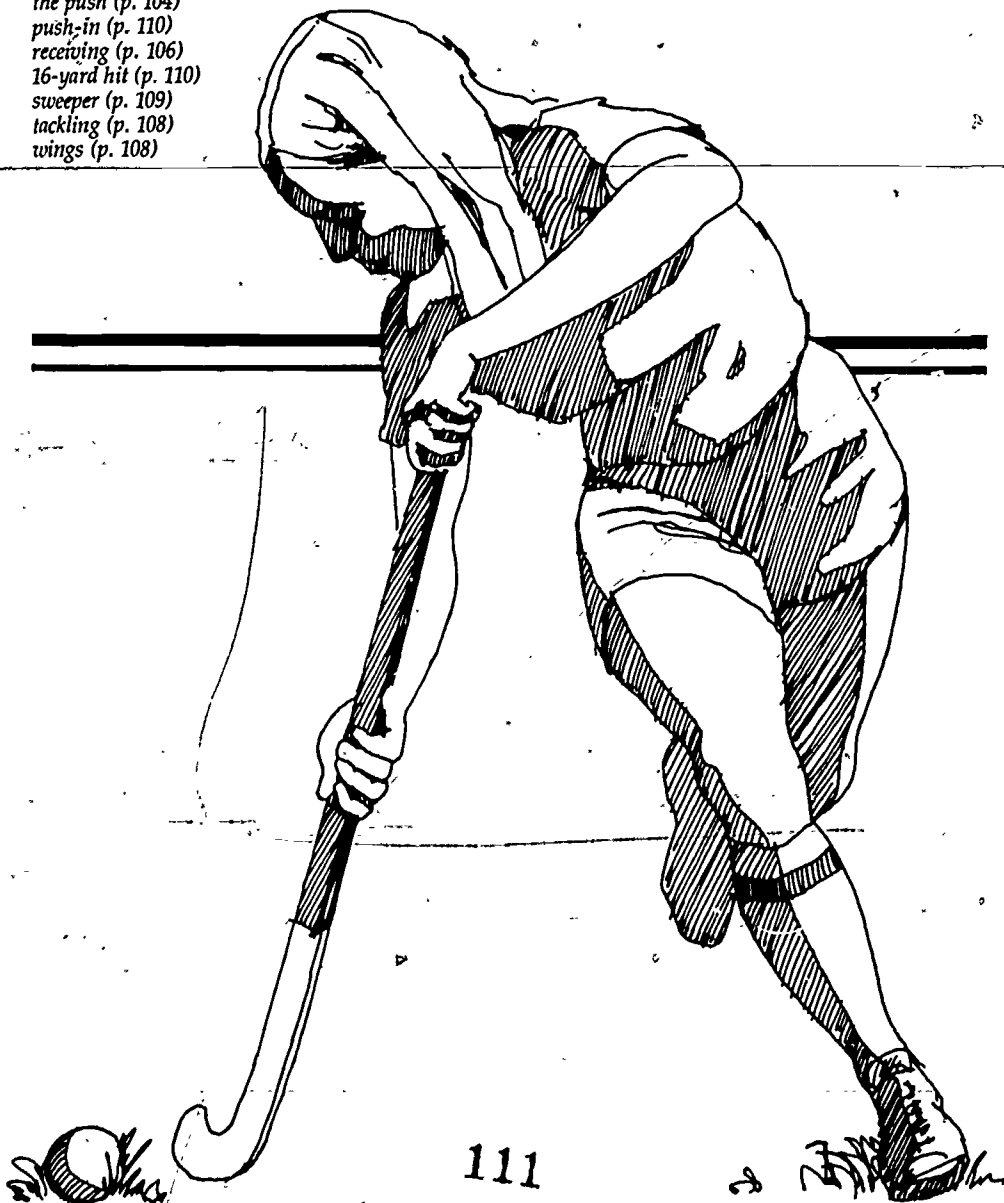

# Field Hockey

BARBARA J. BELT,  
*John F. Kennedy High School,  
Silver Spring, MD*  
and

BARBARA J. REIMANN,  
*The American University,  
Washington, DC*

## INTRODUCTION

Field hockey is a fast, exciting game played by men and women of all ages around the world. Using a curved, wooden stick and a small leather or plastic ball, two teams attempt to maneuver the hockey ball down the field while trying to score a goal. Basic skills include dribbling, passing, dodging, and tackling. The game is played on a grass or synthetic-surfaced field, and can be adapted for indoor play.

The sport was first introduced in the United States in 1901 by Constance Applebee of England. With extraordinary zest for the game, "The Apple" promoted hockey for its development of speed, endurance, coordination, and cooperative teamwork. Field hockey generates an enthusiasm that is shared by everyone regardless of skill level. Field hockey was one of the first organized team sports for women. Since the early 1900s, opportunities to participate in the sport have expanded to include programs in schools, colleges, clubs, and associations across the country. The United States Field Hockey Association (USFHA) governs play for women and the Field Hockey Association of America, Inc. governs play for men.

Involvement in field hockey can lead to exciting experiences in international competition as a player, coach, or an official. The sport is a recognized Olympic event for both men and women. Imagine how exciting it would be to represent a country at an international match before a

packed stadium of 65,000 cheering fans! Just such a crowd was on hand to watch the U.S. women's team play the English team to a 2-2 tie at London's Wembley Stadium in March, 1978.

## SKILLS AND TECHNIQUES

There are several basic skill techniques that must be developed by each player. These include the dribble, the push, and the hit (often called the drive). Learning and practicing these skills will enable each player to become more involved in the game. The more advanced skills, such as the flick and the scoop, are natural extensions of the basic skills.

A player must learn to receive a pass and to tackle and regain possession of the ball. Dodging is a more advanced ball-handling skill that enables a player to evade an opponent without losing the hockey ball as a result of a wayward dribble or pass.

The following section of this chapter explains the basic skills needed to play field hockey. Each explanation includes examples of specific practices that can be used to improve individual skill.

### THE DRIBBLE

The dribble is the technique used to advance the ball while running. The left hand is placed at the top of the stick with the back of the hand facing forward. The left wrist must remain straight and the left elbow must be held well away from the side. A straight line should be able to be



drawn from the stick through the wrist and up to the elbow. At no time should the elbow collapse into the side (see Figure 1).

The right hand is held approximately 6 inches below the left. The ball is contacted in front of the body and slightly to the right and is advanced forward with alternate short taps. This should be practiced until a real feel for the ball on the stick is obtained.

The feet should point forward and the body should lean slightly forward. The head can move slightly to permit the eyes to watch the ball and to look for the position of the opponents.

It is best to practice the dribble at various running speeds since individual speed will vary depending on the game situation.

#### Practice Drills: The Dribble

1. Practice dribbling 50-100 yards moving at different speeds and changing speeds.



Figure 1. The grip.

2. Dribble on a gym floor following the lines of the court. Establish a course on the court; dribble the course making certain that the ball stays on the line. Record the length of time required to complete the course. Add a half second for every time the ball goes off the line. Attempt to lower individual time and reduce the number of errors.
3. On a gym floor or a similar hard even surface, set up 10 traffic cones, 3 yards apart. Dribble around the cones; when the last cone is reached, dribble straight back to the starting point. Record the length of time. Repeat 5 times each practice time (see Diagram 1).

#### THE PUSH

The push is a technique used to pass the ball a short distance from one player to another. The left hand is held at the top of the stick with the back of the hand facing forward. The right hand is slightly below the left, similar to the dribble position. The body is sideways so that the left shoulder faces the line of the pass. The left wrist must be straight and the left elbow away from the body. The left foot is forward and the ball should be off of the heel of the left foot. The feet are astride with the feet pointing in the

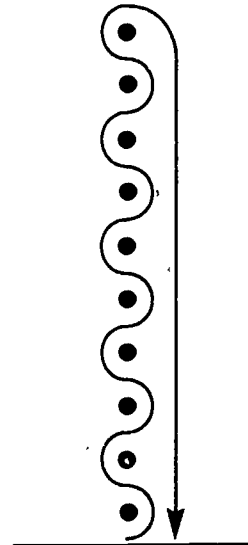

Diagram 1.

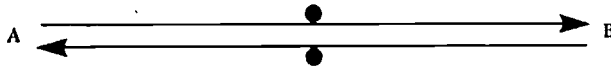

Diagram 2.

same direction as the pass. The stick is placed behind the ball, and pushes it. This is executed by a synchronization of a hard push through the ball with the right hand as the left hand simultaneously pulls back and the weight shifts from the right to the left foot. There is no back swing. The body must remain low. The stick should follow through in the direction of the pass (see Figure 2).

#### Practice Drills: The Push

1. Push the ball against a wall from a distance of 5-7 feet. Increase the distance and the force of the pass. Emphasize the follow-through in the direction of the pass. Concentrate on the stroke and the transfer of weight.
2. Push the ball back-and-forth with a partner from a stationary position about 3 yards apart. Increase the distance and change directions by passing to the left and the right side of each other.
3. Push for accuracy with a partner, using a target of two traffic cones. As accuracy improves, narrow the distance between the cones and increase the distance between partners (see Diagram 2).

#### THE HIT

The hit is a technique used to move the ball long distances or to move a shot on the goal. The left hand is held at the top of the stick with the right hand immediately below it.

The feet are about shoulder width apart and the ball is placed opposite the left foot. On the back swing move the stick back keeping the left arm straight and cocking the wrist. The head of the stick should be slightly above the wrist and the right arm should be away from the body. The weight is on the right foot. The weight shifts to the left foot at the start of the down swing. At the moment of impact with the ball the



Figure 2. The push stroke. Note the position of the hands and the follow through to obtain maximum

accuracy.

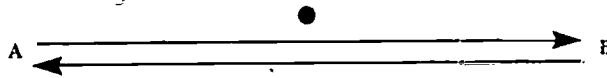

Diagram 3.

wrist should be firm and the stick should be tightly gripped.

All the muscles in the arms and shoulders are tensed as the ball is hit; the arms are straight. As with all of the techniques, the eyes must be kept on the ball. The follow-through with the stick should be in the direction of the hit. The stick must be controlled by the wrist and should not come above the waist.

- Hitting to the left is a relatively easy move. Simply move the ball in front of the left foot, swing through the ball so it moves to the left, and follow through (see Figure 3).
- Hitting to the right is more difficult. The ball is overrun, or pulled back so it is opposite the right foot. The trunk of the body is twisted so the right shoulder is pulled back and the left shoulder turns toward the target.

#### Practice Drills: The Hit

1. Practice in a stationary position hitting the ball against a wall or some other hard surface concentrating on the swing, transfer of weight, and contacting the ball squarely, and the follow-through.
2. Hit with a partner.
3. Set up a target of traffic cones between partners. Hit for accuracy between the cones. As accuracy improves, narrow the distance between the traffic cones and increase the distance between partners (see Diagram 3).
4. Dribble the ball and hit it while on the move; hit left, right, and straight ahead.

#### RECEIVING THE BALL

Due to the nature of the game it is necessary to receive the ball from all directions, i.e., left, right, and behind. To



Figure 3. Hitting on the move.

successfully receive the ball the eyes and mind must be kept on the ball. If either are taken off the ball, it may be missed. When receiving the ball straight ahead, the stick should be held at right angles to the ground with the right hand well down the stick. The left hand should be farther away from the body than the right hand to trap the ball. As the ball approaches the stick, give with it so as not to create a deflection. A deflection or rebound is likely to permit the opponent to steal the ball. A ball that is well-received will be controlled and will permit immediate play. The ball can be received while the player is stationary or on the move.

#### Receiving from the Left

If the ball approaches from the left side, allow it to cross over in front of the left leg and field it inside of the right foot. The grip on the stick is the same as the dribbling position.

#### Receiving from the Right

When the ball comes from the right it is slightly more difficult to field since the trunk must be twisted in that direction. The feet should continue to point in the direction of the opponent's goal as does the left shoulder. The left elbow is high and well away from the body and the left wrist is straight so as to form a straight line from where the left hand grasps the stick to the left elbow (see Figure 4).

Common mistakes to avoid when receiving the ball:

1. Pushing at the ball rather than giving as it hits the stick.
2. Bending the left wrist.
3. Putting the left elbow in the side.
4. Taking the eyes off the ball.

#### Practice Drills: Receiving

1. Have someone roll the ball to the player while the player is stationary. Practice stopping the ball with no deflection.



Figure 4. Receiving from the right.

2. Same as #1 but increase the speed of the ball.
3. Same as #1 but move forward to meet the ball and control it immediately on the stick.
4. Stand behind a line and have a partner hit or roll the ball to the player. See how many balls can be stopped directly on the line.
5. Hit the ball into a wall on the left. Play the rebound so that the ball is received from the left. Repeat, sending and receiving the ball from the right.

### TACKLING

Tackling requires a great deal of self-discipline. The timing of the skill is of the utmost importance. It requires concentration, timing, poise, and technique. Rushing on to an opponent who has control of the ball can be a serious mistake. Do not permit the player to be bluffed by the opponent. Face the opponent, if possible. The feet should be shoulder width apart, knees bent, head down, eyes on the ball, weight evenly distributed, and the back should be bent forward. The dribbler will attempt to deceive or fake the tackler into a mistake. The better the ball control, the more likely the dribbler will be able to deceive the tackler with footwork and body moves.

The tackler must retain balance and not be pulled to one side or the other by a fake move. The tackler can increase the reach by removing the right hand from the stick and holding the stick at the top with the left hand. The tackler must watch for an opportunity when the ball is not controlled on the dribbler's stick. At this point the ball can be taken from the dribbler's control. It is easy to foul when attempting a tackle. Be careful not to place the body between the dribbler and the ball so that there is an obstruction.

If the dribbler has passed a player then the player must run to catch up and overtake the person with the ball. It is preferable to do this on the goalside of the player to prevent them from moving toward the goal. When attempting to overtake the dribble, be careful not to obstruct or to interfere with the stick of the

dribbler. This violation will result in either a penalty corner or a penalty stroke to the offense.

### Practice Drills: Tackling

Tackling is a difficult skill to practice. The dribbler must work to keep the ball and not just give it up to the tackler. The skill practice requires concentration on the part of both players.

A 1-on-1 situation is one of the best practice drills that can be had. Set-off an area about 10' by 10'; one person is the offense (dribbler); the other person is the defense (tackler). This is the same situation as playing 1-on-1 in basketball.

After this has been practiced awhile, set up a scoring system to determine how successfully the ball is being captured from the offensive player.

### THE PLAYERS

The game of field hockey is played between two teams of eleven players each, including a goalkeeper for each team. The other players are a variety of forwards and defenders whose positions depend on the style of play that best suits the players' skills. Various lineups can be used to include forwards, halfbacks, links, fullbacks, a sweeper, and a goalie (see Diagram 4).

The forwards are the wings, inners, and centers of the team's attacking front line. These players must possess excellent stickwork for dribbling, passing, and receiving. They should also be able to move quickly with or without the ball and anticipate the next action on the field, so that they can create scoring opportunities. A skilled forward should keep the defense guessing by dodging and faking and constantly changing speed and position. Although forwards are concerned with scoring, they must be ready to play defense when needed to help regain possession of the ball.

The links and halfbacks are mid-field defenders. These are the play-makers, constantly sending passes to the forwards as the team moves into scoring position. The links are expected to move through onto the front line when needed on attack

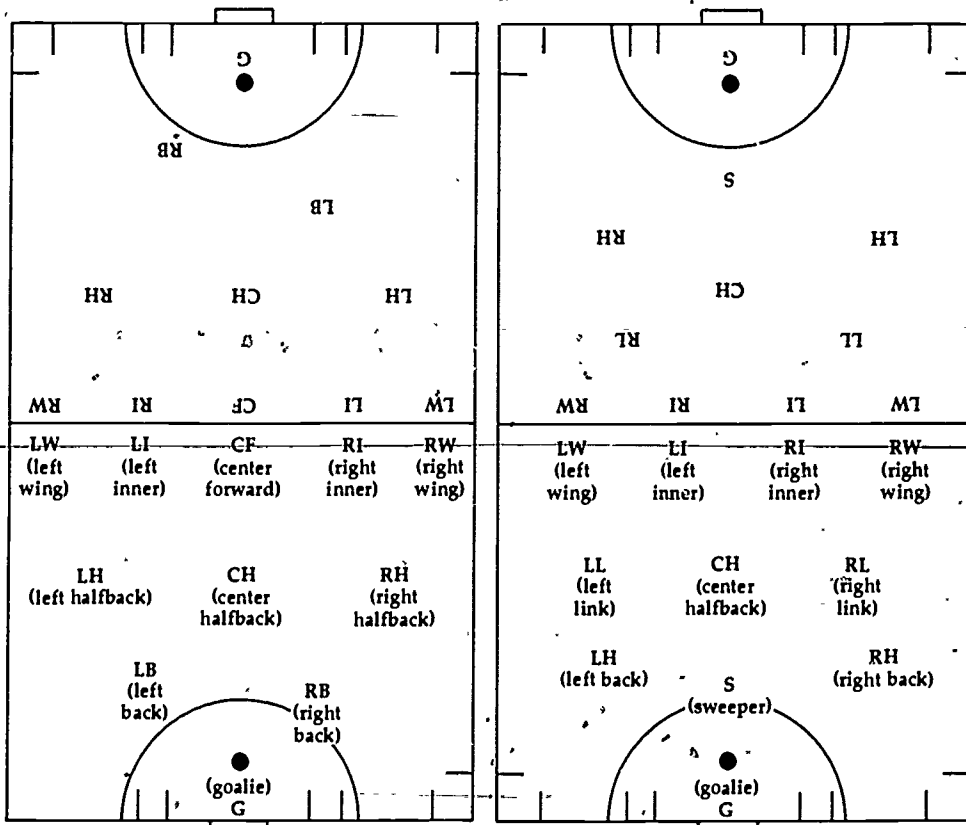

Diagram 4. Sample line-ups for hockey positions.

and they recover to take-up defensive assignments as well. The halfbacks are more defense-oriented. They cover an area or mark a player as the action gets closer to the goal. They should be strong tacklers and they must anticipate the passing angles for making interceptions.

The fullbacks, sweeper, and goalkeeper are responsible primarily for defending the goal. The sweeper and fullbacks intercept the long, through passes and they mark any free player who comes into the circle. They should possess good stickwork and a strong drive for use in clearing the ball.

A skilled goalkeeper is the last line of defense and the first line of attack for a team. A properly cleared shot on goal will determine where the team will be able to pick up the action and move down the field on attack.

All eleven players must work well as a team. They must cover and support each other. Good teamwork is based on strong

stickwork, excellent conditioning, and the ability to quickly analyze a situation. These are improved through training and daily work on skill techniques and strategies of game play.

## THE GAME

The game begins with all players on-sides or within their own defending half of the field. A bully is taken at the center of the field between two opposing forwards, each facing a sideline with his or her own goalline to his or her right. In the bully, the players tap their sticks first to the ground and then together over the ball. This sequence is repeated three times. On the third tap of sticks, the ball is in play and the action begins. All players must remain five yards away until the bully has been completed.

A goal is scored when the ball crosses completely over the goalline between the

goalposts and under the cross bar. The ball must be hit by an attack player within the scoring circle although the player taking the hit may be outside the circle. Each goal counts one point.

During the game or match, fouls occur that result in free hits for the opposing team. A free hit is an undefended opportunity to pass the ball to a teammate. All players must be five yards away until the hit is taken. The free hit must be made from the point where the foul occurred except for those fouls that occur inside the scoring circle. (These result in various set play situations.)

The following are considered common fouls: sticks; advancing, obstruction; offside, using the round side of the stick; swinging dangerously at an opponent; unnecessary roughness; interfering with an opponent's stick; picking up or throwing the hockey ball. Several of these fouls are defined in the terminology section at the end of this chapter.

There are various set play situations that occur during a match. The *push-in* is the method for putting the ball in play when it goes out-of-bounds over the sideline. The *penalty corner* is taken by the attacking team when the opposing defense commits a foul within the scoring circle. A *corner* is taken by the attack when the defense unintentionally sends the ball over the goalline and a goal is not scored. The *penalty stroke* is taken by one attack player when a deliberate foul is committed that prevents a goal from being scored.

When the attack commits a foul in the circle, a *defense hit* is taken on any spot within that circle or from any spot within 16 yards of the goalline on a line drawn through the place where the foul occurred and parallel to the sideline. If the attack fouls outside the circle but within 16 yards of the goalline, the defense takes a *16-yard hit*. This is from any point on a line running out 16 yards from the goalline through the point of the foul and parallel to the sideline. All players must remain five yards away while these various types of plays are taken by each team.

A match is played in two halves of 30-35 minutes each. There is a 5- to 10-minute

intermission. There are no time-outs except for an injury or a penalty stroke. Substitutions may be limited or unlimited depending on the rules followed by each school, club, or association.

Field hockey has been adapted for indoor play in a gymnasium. Specific rules have been established. The principle differences involve using only the dribble and push-pass to maneuver the ball on the court. By using teams of 5, 6, or 7 players (maximum), the activity is fast and furious and the enthusiasm for indoor hockey is on a rapid rise.

As with most other sports, field hockey undergoes "experimental" rule changes from time to time. These are initiated on the international level and then applied to the secondary school level with varying degrees of modification.

Recently, several new rules were tested during competition. The "bully" was replaced with a pass back to a teammate or a pass forward into the attack (similar to soccer). The stick can be raised above the shoulder only if it does not create a dangerous situation with other nearby players. If the ball goes out-of-bounds over the sideline, players may use a hit or a push-in to put the ball back into play. A player may move within 5 yards of a teammate taking a free hit as long as all players are more than 5 yards away from any circle. The long corner will be replaced with a free hit situation with *all* players from both teams permitted to move no closer than within 5 yards of the player taking the hit from the endline. If these and other rule changes prove to be assets to the game, they will become permanent.

### TACTICS AND STRATEGIES

A player's individual skills are used to develop game tactics and strategies with teammates. There are many smaller games happening constantly within the larger game on the field. By remaining aware of what is happening, all players become more efficient at moving with or without the ball to create a space, to meet the pass, and to be an active part of the hockey game.

Much of the play involves creating and maintaining triangles within the total team

concept. Defenders work to maintain a triangle by staying goal-side and ball-side of the opponent with the ball. Attack players attempt to maintain a triangle by spacing themselves to permit through, flat, and back passes. These are more difficult to intercept than the diagonal pass.

This section includes sample drills and suggestions for self-evaluation. These can be used while learning basic tactics for game play. Beginning and intermediate players should concentrate on small game situations prior to playing with an entire team.

- Drills: Pass  $\longrightarrow$  Run  $\dashrightarrow$  Dribble  $\rightsquigarrow$
1. Fill-the-corner: using an imaginary square, pass and move to the empty corner; reverse directions.

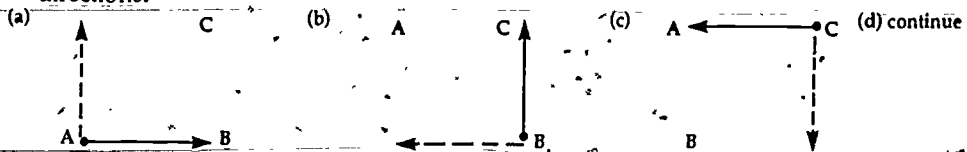

2. Pass-to-empty corner: player moves to meet the pass, passer moves to fill the spot left by the receiver.



3. Moving triangle: using the length of the field; switch roles each time down the field and use the flat pass to the right; maintain spaces while receiving on the move.

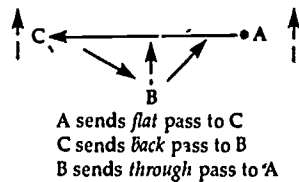

4. Through pass, maintaining spaces, moving to receive the pass, filling the open position.

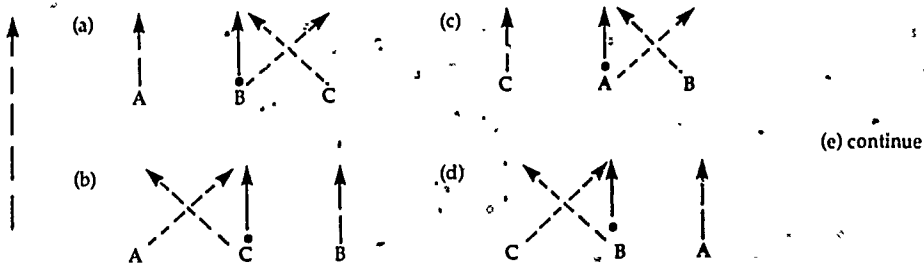

5. Weave: always follow the pass; receive on the move; use flat passes.

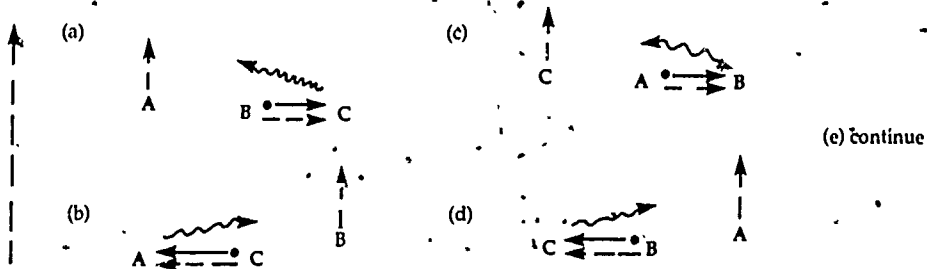



- Repeat #5 and add one defender—3 v 1; repeat #5 and add two defenders—3 v 2.

Beginning and intermediate players should play small games of 3 v 3, 4 v 4, 5 v 5, and 6 v 6. These are excellent ways to learn skillwork and concepts of team play. The 11-player game should be used by the more-advanced players.

Questions for small group and self-evaluation:

- Were your passes crisp and direct?
- Could you receive a pass onto your stick and maintain control?
- Did you maintain spaces by moving to receive the pass or supporting your teammate(s) from the side?
- Was it difficult to maintain spaces after adding a defender? If so, why? If not, why not?

### EQUIPMENT

Basic equipment for the game consists of a hockey ball and stick. The solid ball has a

white leather or plastic covering. It weighs not more than  $5\frac{3}{4}$  ounces nor less than  $5\frac{1}{2}$  ounces; its circumference is not more than  $9\frac{1}{4}$  inches nor less than  $8\frac{13}{16}$  inches. The wooden stick has a handle with a curved toe. The handle has a leather, towel, or rubber grip. The stick is flat on the left-hand side and rounded on the right-hand side. Hockey sticks measure 26-38 inches in length and 12-23 (women) or 28 (men) ounces in weight.

To determine the proper length for a stick, stand straight with the stick resting against the right side of the body and place the right hand on the stick. There should be just enough room remaining for the left hand to be placed on the stick between the right hand and the end of the handle (grip).

The hockey field measures 100 yards by 60 yards. It is flat and free of obstructions with a grass or synthetic surface. The goals are rectangular wooden or metal frames covered by a net. Each goal is 12 feet wide, 7 feet high, and 4 feet deep with a white wooden facing (see Diagram 5).

The goalkeeper is the only player who can legally kick the ball during play, and then only when inside the scoring circle.

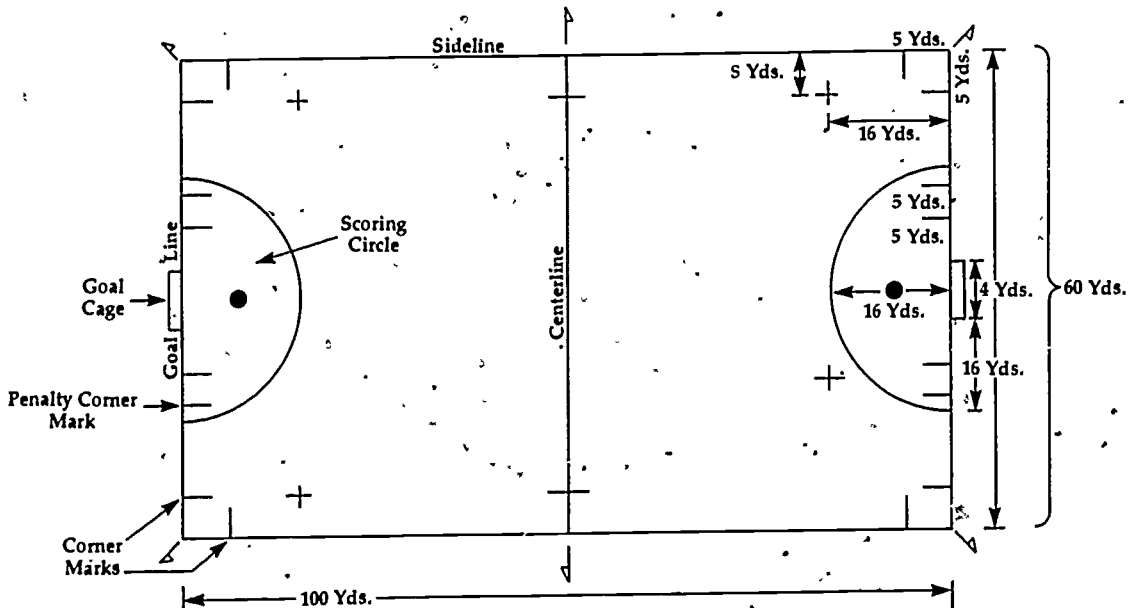

Diagram 5. Field markings and dimensions.

Goalies wear leg pads, kickers (over the shoes), gloves, and a face mask. The glove fits tightly with extra padding for the palm. The face mask is similar to that worn by ice hockey goalies. It must be made of plastic or another synthetic material.

The traditional team uniform worn by women includes a kilt, lightweight sport shirt, pullover sweater, knee socks, and rubber-cleated shoes. The uniform for men is similar except that shorts are worn instead of kilts. In addition, most players wear mouthguards and shinguards as extra protective equipment.

### TERMINOLOGY

**Attack (Offense).** Team that has possession of the ball.

**Advancing.** Foul called when using any part of the body to move the ball or any part of the body except the hand to stop the ball.

**Bully.** Method to begin play at the start of each half or after a goal is scored.

**Circle.** Scoring area around each goal.

**Corner.** Set play awarded to the attack when the defense unintentionally sends the ball over the goalline without a goal being scored.

**Cutting.** Moving to meet the pass or creating a space into which the ball can be hit by a teammate.

**Defense.** Team that does not have possession of the ball.

**Defense Hit.** Free hit taken after the attack commits a foul in the circle.

**Dodge.** Method for avoiding an opponent without losing possession of the hockey ball.

**Dribble.** Short taps taken to move the ball while maintaining control with the stick.

**Drive.** A hard, direct pass or shot on goal.

**Flick.** Type of stroke with the ball lifted to knee level (no backswing); a natural-extension of the push-pass.

**Free Hit.** Method for putting the ball into play following an opponent's foul outside the circle.

**Marking.** Defending against a player by staying close (stick-to-stick) and not permitting him to be free to make a play.

**Obstruction.** Player places any part of the body or stick between the ball and an opponent who is trying to play the ball.

**Offside.** Player is ahead of the ball in the opponent's half of the field and there are fewer than two opponents between him/her and the goalline at the time that the ball is hit.

**Penalty Corner.** Awarded to the attack when the defense commits a foul inside the circle.

**Penalty Stroke.** Awarded to the attack when the defense commits a deliberate foul that prevents a goal from being scored.

**Push-in.** Method for putting the ball in play at the point where it went out-of-bounds over the sideline.

**Push-pass.** Hockey ball is pushed along the ground directly off the stick (no backswing).

**Scoop.** Hockey ball is lifted into the air using a shoveling motion (no backswing).

**Square (Flat) Pass.** Type of pass that travels across the field (right or left) perpendicular to the sidelines.

**Sticks.** Foul called when any part of a player's stick comes above the shoulders at anytime during that player's possession of the ball.

**Tackle.** Method for taking possession of the hockey ball from an opponent.

**Through Pass.** Type of pass that travels straight down the field parallel to the sidelines.

### REFERENCES

- Barnes, Mildred. *Field Hockey. the Coach and the Player.* Boston, MA: Allyn and Bacon, Inc., 1979.
- Field Hockey Rule Book.* Kansas City, MO: The National Federation of State High School Associations.
- Gros, Vonnie. *Inside Field Hockey for Women.* Chicago, IL: Contemporary Books, Inc., 1979.
- Kentwell, Richard. *Field Hockey. Techniques and Tactics.* Brooklyn, MI. Sauk Valley Sports Supply, 1976.
- NAGWS Guide: Field Hockey.* Reston, VA: The American Alliance for Health, Physical Education, Recreation and Dance.
- Official Field Hockey Rules for School Girls.* North Chili, NY: USFHA, Inc., 1980.
- United States Field Hockey Association. *The Eagle.*

blocking (p. 123)  
carrying position (p. 120)  
cut (p. 119)  
dead ball (p. 123)  
direct exchange (p. 116)  
field goal (p. 123)  
handoff (p. 118)  
kickoff (p. 121)  
pitchout (p. 118)  
place kick (p. 121)  
punt (p. 120)  
screen (block) (p. 115)  
scrimmage play (p. 122)  
shotgun formation (p. 116)  
3-point stance (p. 115)  
tie game (p. 123)  
touchdown (p. 123)

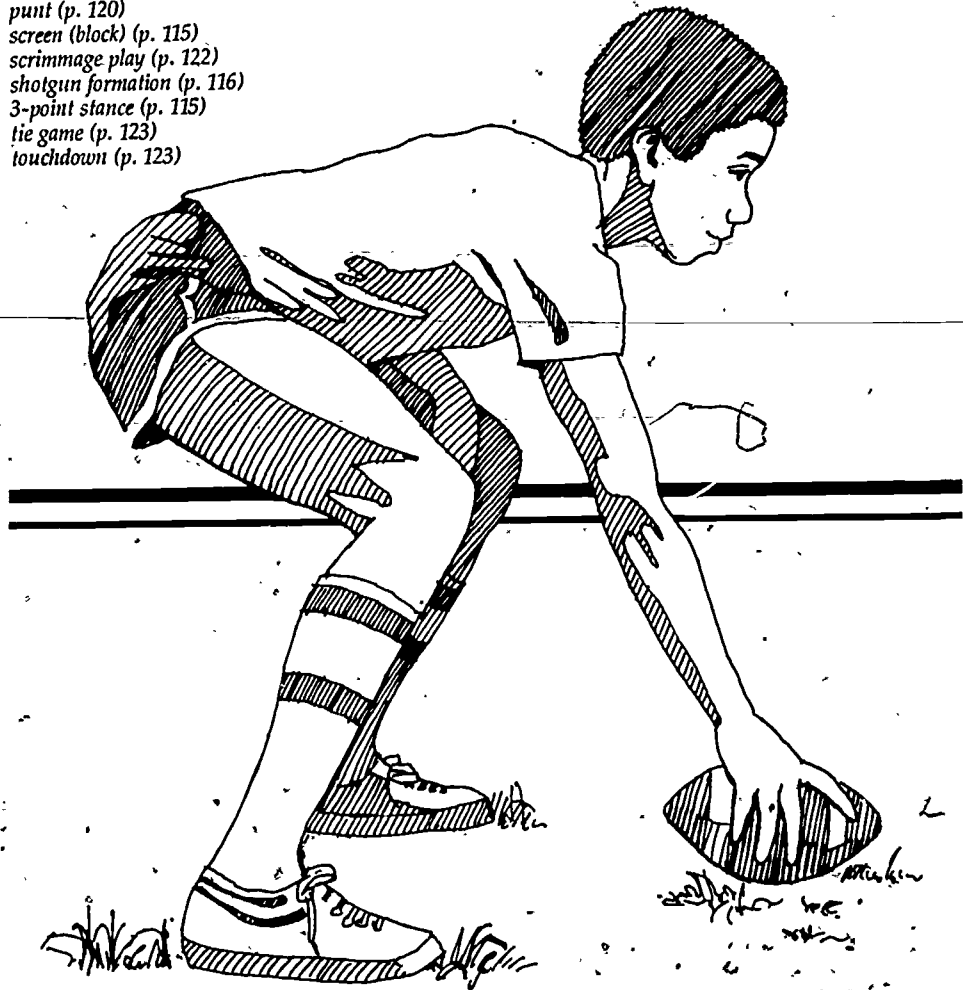

# Coed Flag Football

MARYANN DOMITROVITZ,  
*Pennsylvania State University,  
 University Park, PA*

## INTRODUCTION

The fascination that the public has for the game of football is evidenced by the many programs that exist from youth leagues to professional football conferences. Many individuals, who for various reasons cannot participate in highly competitive football programs, are not content in the spectator role. These are the men and women who are becoming actively involved in some form of recreational football. These recreational leagues range from flag or tag football teams for men and women to programs involving coed flag football competition. Various recreational programs in cities, high schools, and colleges have utilized the rules and strategies of regulation football, flag football, and tag football programs. These modifications make the game safe, enjoyable, and competitive for the participants.

A coed flag football team is composed of eight participants (four men and four women) although the game can be modified to accommodate from six to ten players. The playing field (40 x 100 yards) has four 20-yard zones and 10-yard end zones. Scoring takes place by a touchdown (6 points), conversion (run or kick-1 point), safety (2 points), or field goal (3 points). The ball is advanced as in regulation football by running or passing although some modifications are stipulated in the rules. Progress of the player in possession of the ball is stopped by pulling off one of the flags attached to a belt worn around the waist. All the skills and strategies of regulation football, with the exception of contact, are utilized, thus making coed flag football fun, challenging, and physically demanding.

## SKILLS AND TECHNIQUES

### OFFENSIVE AND DEFENSIVE STANCE

In the game of coed flag football, blocking (physical contact) is not permitted. The emphasis, therefore, is not on physical strength, but on quickness. On signal, the offensive lineman's responsibility is to move quickly and screen for a teammate whether it is for a run or pass play. (A screen is a player maintaining a position, without use of contact, between a defender and the ball carrier. The arms and elbows of the screener must remain in contact with the body.) Defenders must be just as quick and controlled, for they are expected to move around the screen and rush the quarterback or ball carrier. Because both the defensive and offensive players are expected to move quickly at the snap of the ball, the stance used by both is similar. If a 3-point stance is used, the feet are placed shoulder width apart, and the hand reaches forward and rests on the ground. The posterior is raised so that the back is nearly parallel to the ground and the free arm rests on the leg above the knee. To ensure balance, the weight should be equally distributed on the feet and the hand, with the head raised and the focus forward. A 3-point stance is not specified in the rules; therefore, it is acceptable for the lineman to be positioned on the line with the knees flexed and the hands resting on the legs just above the knee. The rule enforced is that the offensive lineman must be motionless prior to the snap. This rule, however, does not apply to the defensive lineman.

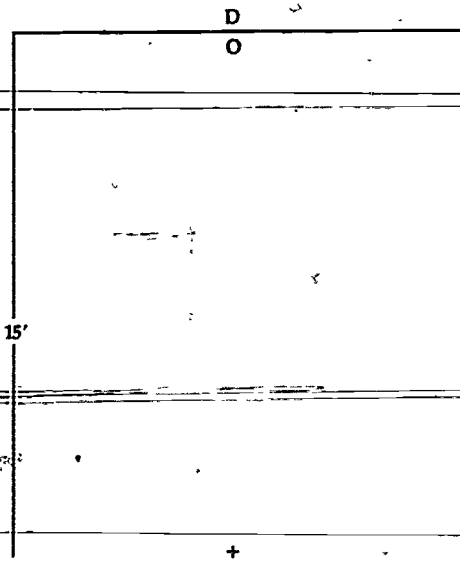

Diagram 1.



Figure 1. The 3-point stance.

*Offense versus Defense Drill*

D-Defense O-Offense +-Cone

How long can the defense be prevented from touching the cone?

How quickly can the offense be out-maneuvered and the cone tagged?

**Procedure**

1. Designate a spot 15 feet from the cone for the offense and defense.
2. Offense must assume a 3-point stance.
3. Defense may cross the line when offense moves from a 3-point stance.
4. Offense may not make contact with the defense when trying to obstruct the defender's movement to the cone.
5. Defense must move around the offense and tag the cone.

**CENTERING AND RECEIVING THE FOOTBALL**

Before offensive play can take place the ball must be exchanged between the center and the quarterback. This is done either by positioning the quarterback directly behind the center or in a shotgun formation ten to fifteen feet behind the center. Since flag football is primarily a passing game, most teams utilize the shotgun formation because it gets the ball deep into the backfield and more time is permitted for the decision to pass or run. If the direct exchange is used, the center assumes the 3-point stance, focuses forward, and grips the ball

in the same manner as for the throw. With a secure grip, the ball resting on the ground, and the nose of the ball pointing forward, the center sweeps the arm straight back and up between the legs. As the ball is being swept back, the center rotates the ball one-quarter turn so the ball can be placed securely into the hands of the quarterback. It is most important that the swing of the arm and the rotation of the football be simultaneously executed.

To receive the ball the quarterback should form a pocket by placing the heels of both hands together, spreading the fingers, and placing the throwing hand on top. Both hands are positioned under the center with the back of the top hand pressed against the buttocks of the center. The quarterback, with the knees bent, feet parallel, and shoulder width apart, calls the signal for the exchange. Movement away from the center should not occur until the ball has been exchanged.

If the shotgun is used, the center widens the stance, looks at the target and eliminating the one-quarter turn, spirals the ball back to the quarterback. This action is very similar to throwing a pass under the legs.



Figure 2. Centering the ball.

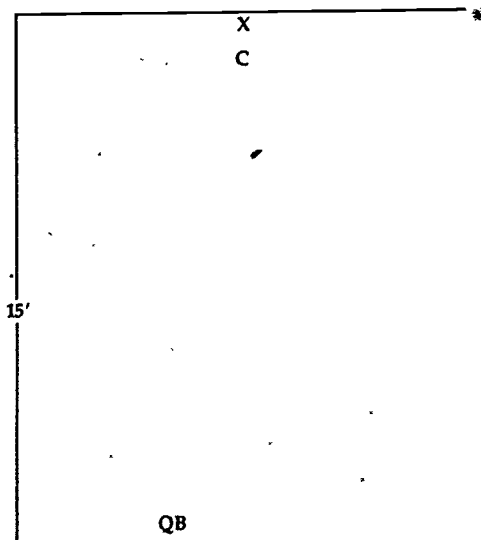

*Centering Drill*

C-Center QB-Quarterback X-Ball

How successfully is the football being centered to the quarterback?

**Procedure**

1. Center is positioned 15 feet from the quarterback.
2. Quarterback counts the number of successful snaps out of 10 attempts.
3. A successful attempt is any ball reaching the quarterback between the waist and the shoulders.

Diagram 2.

### Handoff and Pitchout

After receiving the snap, the exchange (handoff) between the quarterback and the backfield player occurs. The backfield player, preparing to receive the ball, raises the arm nearest the quarterback to chest level. The near arm must be parallel to the ground with the open hand facing down and the elbow bent at a right angle so the forearm is across the front of the body. The far arm, also parallel to the ground, is across the waist with the palm up. As the ball is placed in the stomach, the hands quickly close on the football. The ball is then placed in a secure carrying position prior to running down field.

If the play is designed as a pitchout, the quarterback places the hands under the football and tosses the football underhand to the backfield player. The football is tossed so that it is received at chest level. The backfield player must concentrate on

the football until it is caught in the hands and then tucked into the armpit.

### GRIP AND PASSING

The football must be securely gripped in the throwing hand with the thumb and index finger comfortably spread before the pass. The thumb and index finger should be on the circle of the football with the remaining fingers placed on the laces. The non-throwing hand should press the football into the throwing hand and both hands assist in raising the football to ear level. As the football continues to be brought back behind the shoulder, the shoulders and body rotate so that the non-throwing side of the body is facing the direction of the pass. When the non-throwing hand can no longer remain in contact with the football, it should be extended in the direction of the intended target. The rear foot (plant foot) bearing the majority of the weight, should initiate the throw by pressing into the ground to transfer weight onto the forward foot which is pointing in the intended direction of the pass. As the weight is being

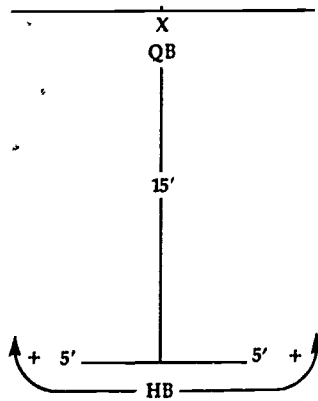

Diagram 3.

#### Pitchout Drill

X—Ball                                    +—Cone  
QB—Quarterback                    HB—Halfback

How successfully is the ball being pitched to the halfback?

How successfully are pitchouts being received?

#### Procedure

1. Halfback is positioned 15 feet behind the quarterback.
2. On signal from the quarterback, the halfback cuts left/right.
3. Quarterback pivots and pitches to the halfback.
4. A total of 10 pitchouts, 5 to each side, is attempted.
5. A successful attempt is one that reaches the halfback between the shoulders and the waist.
6. Quarterback counts the number of successful attempts.
7. Halfback counts the number of successful catches.

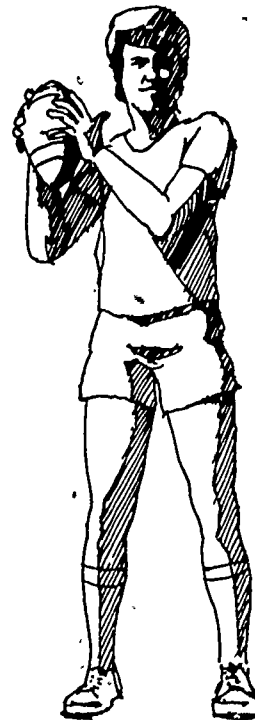

Figure 3. The grip.

transferred, the hips and shoulders should unwind resulting in the chest facing the intended target. The throwing arm, led by the elbow, is whipped forward over the shoulder. As the arm is extended, the wrist and fingers snap downward on the release, thus imparting a spiral to the ball. Follow-through occurs as the throwing arm is extended in the intended direction of the pass. After the ball is released, the arm is drawn downward to the non-throwing side. The throw is completed with the weight on the forward foot and the passer concentrating on the target of the throw.

### CUTTING, RECEIVING, AND CARRYING

Prior to receiving a pass, the offensive player must maneuver into an open area.

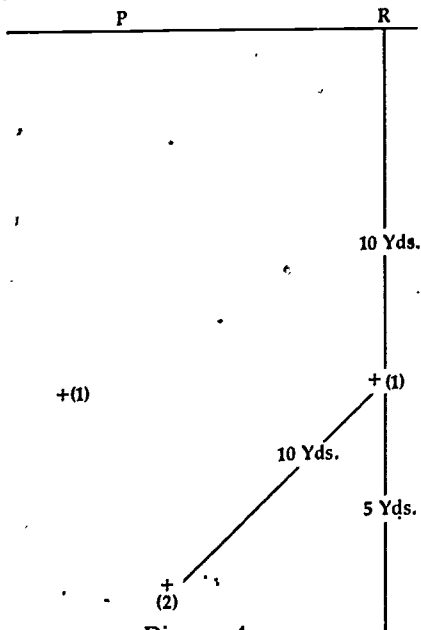

Diagram 4.

#### Passing and Catching Drill

+—Cone P—Passer R—Receiver

How many passes can be successfully thrown?  
How many passes can be successfully caught?

#### Procedure

1. On a signal from the passer, the receiver runs toward the first cone, cuts behind the cone, and heads toward the second cone.
2. Passer must throw the football after the receiver passes the first cone but before reaching the second cone.
3. Receiver must be ready to catch the pass after cutting behind the first cone.
4. 10 passes are attempted, 5 from each side.
5. A successful throw is one that reaches the receiver between the waist and top of the head.

This can be accomplished by running a pre-determined pass pattern. The quick change of direction (cut) needed to put the offensive player in an unguarded position is executed by pushing off of the inside of the foot that is on the opposite side of the intended cut. Therefore, if a player wants to cut to the right, the push is off the inside of the left foot. This cut can be facilitated by running at a controlled speed, taking short steps, and lowering the body by bending the knees. After the cut has been mastered, a fake which can be done with the head and/or shoulders should be incorporated into the movement. Once the cut is made into an open area, the offensive player should turn, face the quarterback, and concentrate on the flight of the football. This concentration must continue until the football rests in the receiver's hands.

As the pass approaches, both arms should be extended with the palms facing the football and the thumbs pointing inward. The fingers should be relaxed and spread. As contact occurs, both the arms



Figure 4. The carrying position.



and fingers give and pull the football into the body. If the pass is thrown below the waist the fingertips point downward and the little fingers face inward. Once in possession of the ball, the receiver should immediately put it into the carrying position by spreading and extending the fingers over its point. The football is then tucked high up and under the arm and held tightly against the body. Moving down field, the ball carrier must combine speed, quick cuts, and pivots to prevent removal of a flag. Since contact is not permitted in flag football, utilizing teammates for screening purposes is a strategy that must be incorporated into the offense.

**PUNTING**

When a team fails to advance the designated distance for a first down or score, one of the options available to the offense is punting the football. In coed flag football, rushing the kicker is not permitted; therefore, complete concentration should be placed on the punt execution. After receiving the football, the punter rotates it so the laces are on top. With hands on either side of the football, the punter simultaneously extends both arms forward while taking one short step onto the kicking foot followed by a normal step onto the support foot. As the kicking leg swings forward, the football is dropped, allowing contact to

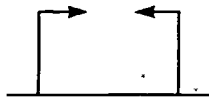

DOWN AND IN



DOWN AND OUT

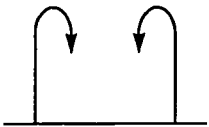

HOOK IN

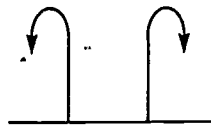

HOOK OUT

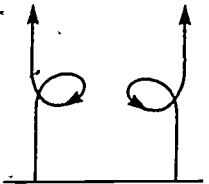

HOOK AND GO

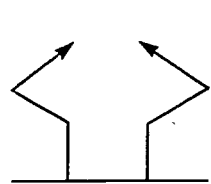

Z IN

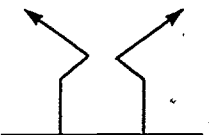

Z OUT



QUICK IN

Diagram 5. Pass patterns.

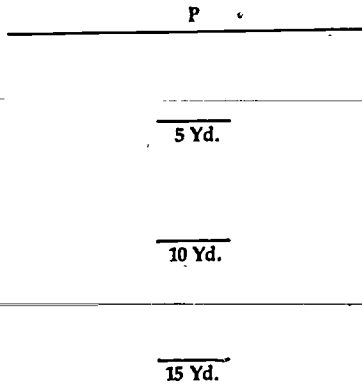

Diagram 6.

**Punting Drill**

**P-Punter**

How far can the football be punted?

**Procedure**

1. Punt the ball from behind the designated line.
2. Measure the best punt out of 5 attempts.
3. Measure the punt from the line to the spot where the ball hits the ground.

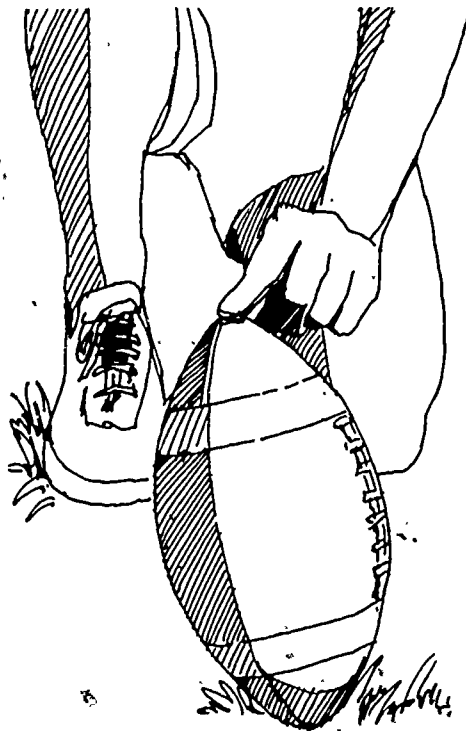

Figure 5. Holding the ball for the place kick.

occur on the upswing. Contact, with a firm ankle and the toe pointing down, is made on the instep of the foot at approximately eighteen to twenty-four inches off the ground. Maximum distance is achieved by a full extension of the kicking leg with the follow-through continuing to shoulder height. When the support foot leaves the ground, both arms are extended to the side to ensure balance and control.

**PLACE KICK**

In most instances, place kicking in coed flag football (kickoff, field goal) is done without a tee; therefore, the mechanics for the kickoff and field goal attempts are similar. After the holder receives the football the laces are turned forward and the football is placed on the ground with a slight backward tilt. The kicker, with the head down, approaches the football and focuses on a spot below the center where contact must occur. The support foot, pointing in the direction of the kick, is planted to the side and slightly to the rear of the football. As the kicking leg is brought forward, the knee is bent and the ankle is flexed and firm. The swing of the leg must be forceful

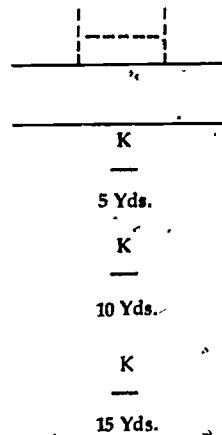

Diagram 7.

**Field Goal Drill**

**K-Kicker**

How many field goals can be successfully kicked?

**Procedure.**

1. Count the number of successful field goals out of 9 attempts.
2. Take 3 attempts—5 yards, 10 yards, and 15 yards from the goalline.

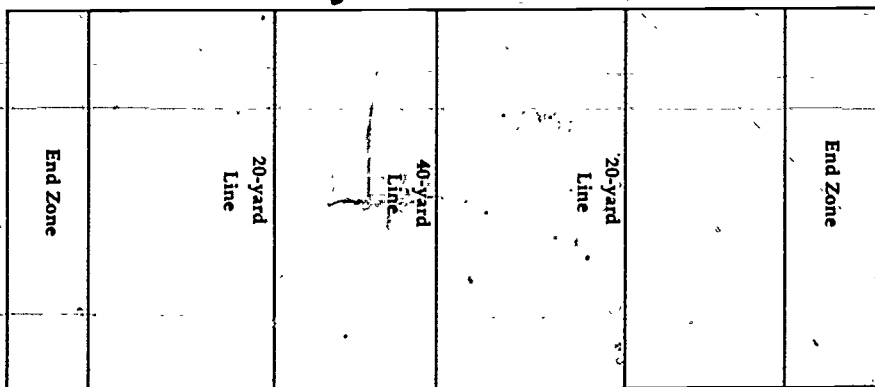

Diagram 8.

with full extension forward and upward using the arms to aid in maintaining balance.

### SAFETY

Due to the game's structure, the outdoor setting, and the variety of weather conditions under which the game is played, numerous types of injuries can occur in coed flag football. Many of the sprains and strains can be prevented by adequately warming up prior to the game. Improper running, throwing, catching, and kicking techniques also result in ankle, finger, elbow, and shoulder injuries. These can, however, be prevented by proper teaching and coaching.

Too often, more serious injuries occur as a result of collisions caused by one or more participants playing in an uncontrolled manner. A player unable to quickly stop, turn, or change direction can be a hazard to other participants. Therefore, the no-contact rule must be strictly enforced. The individual supervising or officiating the activity must not permit the participants to confuse coed flag football with regulation football where the participant has the advantage of protective equipment.

Acceptable playing conditions, adequate warm-up, proper technique, good coaching, and responsible officiating all contribute to safe and enjoyable participation in this activity.

### COED FLAG FOOTBALL RULES.

1. **Team.** Eight (8) players, four men and four women, shall constitute a team.

2. **Field.** The playing field shall be 100 yards long and 40 yards wide. There shall be a 10-yard end zone at each end of the field. Goalposts will be placed on the back line of the end zone. The field shall be marked by lines dividing the field into four 20-yard zones. The in-bounds line shall be 10 yards from the sidelines.
3. **Time.** The game shall be played in halves of 20 minutes each. Teams will switch ends of the field at halftime only. The rest period shall be five minutes at the half. Each captain may call one time-out (1 minute) each half.
4. **Start of Game.** The team captain winning the coin toss may elect one of the following: kick; receive; goal to defend during the first half. At the start of the second half, teams will reverse field positions, and the team who kicked off at the start of the game will receive.
5. **Kickoff.** The kickoff shall be made from the kicking team's 20-yard line. It must be a place kick and the ball cannot be teed up in any manner. The receiving team must position five players on the midfield line. The kick must travel 20 yards before becoming a free ball.
6. **Scrimmage Plays.** Prior to start of play, the offensive team must come to a "set" position for one second. One player only may be in motion, but cannot be moving toward the scrimmage line. Advancement via the run from behind the line of scrimmage is restricted to girls only. There are no advancement

restrictions for a male once he has obtained possession of the ball beyond the line of scrimmage.

7. **First Downs.** A team shall be allowed four downs to advance the ball across each zone line (20 yards apart). Each time a team advances the ball across a line it is awarded a first down and will be allowed four more downs to make the next zone line. Upon a change of team possession, the line to gain shall be that line immediately down field from the spot where the ball becomes dead.
8. **Detached Flag.** Ball becomes dead when ball carrier's flag becomes detached from the flag belt. The ball carrier cannot use hands or clothing to prevent opponents from pulling the flag.
9. **Blocking.** No blocking is permitted. Offensive players may screen for the ball carrier by keeping both arms in contact with the body and moving laterally into the path of an opponent. No contact is permitted.
10. **Passing.** All forward passes must be thrown from a point behind the line of scrimmage.  
Restrictions on use of the forward pass:
  - a. During a 4-down series, males are restricted to only one forward pass attempt. If the down in which the pass was attempted is repeated because of a penalty or if a new series begins, he may again attempt one pass in the series.
  - b. Male pass receivers must receive all forward passes beyond the line of scrimmage.
  - c. There are no restrictions on female passing or pass-receiving.
11. **Fumbles.** All fumbles are ruled a dead ball and may not be recovered by either team. The offensive team retains possession.
12. **Dead Ball.** The ball becomes dead when:
  - a. The ball carrier's flag becomes detached from the flag belt (pulled or falls off).
  - b. When any part of the ball carrier's

body other than the hands and feet touch ground.

- c. Following an incomplete forward pass.
  - d. Following a fumble.
  - e. When the ball goes out-of-bounds.
13. **Kicking.** When the offensive team elects to kick, it must call the play "kick." Defensive team must have 5 players on the line of scrimmage. No player on either team may cross the line of scrimmage until the ball has been kicked.  
A punt or kickoff may be made by either sex, but advancement of the ball from either of these two techniques is restricted by the following:  
The male punt or kickoff receiver cannot advance the ball forward from his point of contact with the ball, but may, however, move backward or perpendicular to that first point of contact. Advancement is only possible by a female ball carrier.
14. **Scoring.** Touchdown—6 points. Try after touchdown—1 point (kick or run). Field Goal—3 points. Team must announce intention to attempt field goal. Neither offensive or defensive players may cross the scrimmage line until the ball has been kicked. The kick must be made from a spot directly behind the point from which the ball is centered. The ball shall not be teed up in any manner for placement attempts. Safety—2 points. A safety results when the offensive team is responsible for grounding the ball behind its own goalline.
15. **Substitutions.** Unlimited substitution is permitted.
16. **Equipment.** Plastic or metal spiked and cleated shoes are prohibited. Gym shoes, street shoes, or shoes with molded rubber cleats are permitted. Players may not wear any device that might cause injury to other participants. Two flags, attached to the flat belt in a proper manner, shall be worn by all players.
17. **Tie Games.** If teams are tied in score, the team with the most first downs will be declared the winner. If teams are

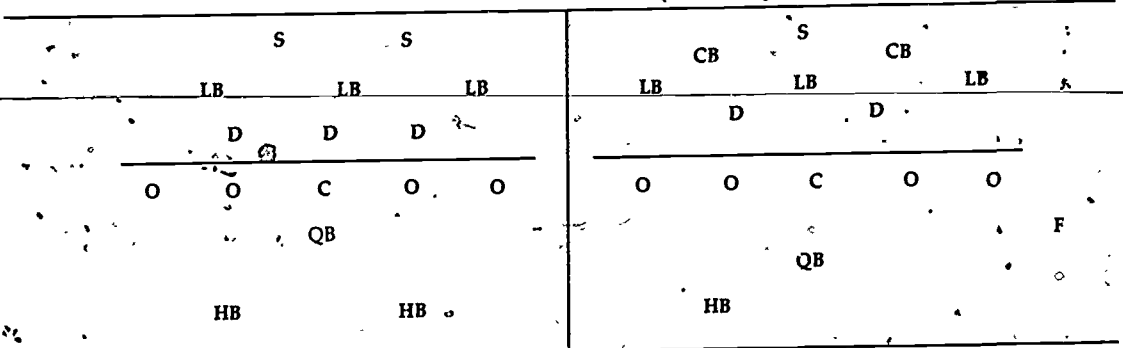

**Offense**  
 C—Center  
 O—Offensive Lineman  
 QB—Quarterback  
 HB—Halfback  
 F—Flanker

**Defense**  
 D—Defensive Lineman  
 LB—Linebacker  
 CB—Corner Back  
 S—Safety

Diagram 9. Offensive and defensive formations.

tied in score and first downs, an overtime series of plays will be run. The ball shall be placed on the midfield line, and one team will start a series of four downs (choice of first offensive series by toss of coin). Team "A" (offense) will attempt to advance the ball as far as possible into "B's" territory in four consecutive downs. Team "B" will then take over the ball at the point where "A's" series ended. The position of the ball at the conclusion of "B's" four downs will determine the winner. If the ball is in "A's" territory, then "B" is the winner.

An interception by opponents will terminate a team's series of downs. The recovering team will start play from the point where the interception run-back ends.

*No punting or field goal attempts are permitted in the overtime series.*

- 18. **Penalties.**  
 Offside—5 yards.  
 Illegal motion—5 yards.  
 Intentionally grounding ball—loss of down and 5 yards from spot of pass.  
 Illegal forward pass—loss of down and 5 yards from spot of pass.  
 Illegal advancement by male—5 yards from line of scrimmage and loss of down; 5 yards from spot of illegal advancement on punt or kickoff.

- Illegal wearing or protecting of flag—15 yards.
- Unnecessary roughness—15 yards and disqualification of player.
- Defensive pass interference—offensive team ball at point of foul; automatic recorded first down.
- Offensive pass interference—15 yards and loss of down.

**STRATEGY**

**OFFENSE**

Since the game of coed flag football is primarily a passing game, the offensive strategy should be composed of a variety of passing plays with available running options. Basically, the offensive skills that are most essential for successfully advancing the football are throwing, catching, and open field running. A variety of options should be incorporated into the strategy because everyone is eligible in coed flag football to run, throw, and receive the ball except as specified in the rules. The limitation on the number of forward passes that a male quarterback may throw, emphasizes the need for a skilled female quarterback. It is also important that the offensive linemen are agile and skilled in executing screens to prevent the rushing defensive players from getting to the quarterback.

## DEFENSE

The defensive strategy in the game of coed flag football is to pressure the quarterback and prevent the ball from being advanced via the run or pass. This pressure is the responsibility of the defensive linemen who must evade the opponent's screen, contain the quarterback, and remove one flag before a pass can be attempted. While the quarterback is being subjected to this pressure, the linebackers and corner backs must remain with their assigned opponent. Usually, man for man coverage is used in coed flag football. Each defender must constantly maintain a position between the opponent and the goalline. If an opponent does gain possession of the football, a flag must be quickly removed. This can be accomplished by the defender moving toward the opponent, focusing on the waist, and reaching out and quickly pulling a flag from the belt. As soon as the flag is removed, the defender immediately raises the flag above the head so that the official and players are aware that play has stopped.

## EQUIPMENT

### FOOTBALLS

The size of the football selected for play is dependent upon the age level of participants in the activity. What must be taken into consideration is the fact that coed flag football involves women throwing and catching the football; therefore, the size of the football is of prime consideration. A youth size football should be considered for the younger participants while an intermediate size is more appropriate on the high school and college level.

A rubber-covered football, ranging in cost from \$11.00 to \$15.00 depending on size, is more durable for teaching, intramural, and recreational situations, whereas, a leather-covered football costing from \$15.00 to \$25.00 may be more appropriate for competitive situations.

## FLAGS AND BELTS

Consideration must be carefully given to the selection of the type of flags and belts to purchase. Regardless of the type of closure, rings, or velcro, the belt should be easily adjusted as needed by the participants. The most functional attachment of flags to the belt seems to be with velcro on flags and belt. Although the most common material used in the construction of flags and belt is a flexible plastic, a heavy canvas fabric which seems to be the most durable is also available from some companies. Prices range from \$17.00 to \$23.00 for one dozen belts and twenty-four flags.

It should also be pointed out that strips of any durable fabric can be tucked into waistbands of gym shorts or warmup suits permitting the game of flag football to be introduced without an expensive investment in equipment.

## DOWN MARKER

Although official down markers are available and range in cost from \$85.00 to \$115.00, a plastic pylon, thirty-six inches in height, can also be used. In situations where first downs are determined by crossing into a designated zone, the pylon, with the downs painted around the side, is all that is needed.

## TERMINOLOGY

**Center.** The offensive lineman who snaps the football to the quarterback.

**Defense.** The team that does not have possession of the football.

**Fake.** A move made by a player for the purpose of deceiving an opponent.

**Field Goal.** A three-point score when the football is kicked from a place kick over the crossbar and between the uprights.

**First Down.** The first of four attempts to move the football forward into the next 20-yard zone or end zone.

**Forward Pass.** A pass thrown from behind the line of scrimmage toward the opponent's goalline.

**Handoff.** An exchange of the football from the quarterback to a teammate.

**Offense.** The team that has possession of the football.

**Offside.** Movement across the established line of scrimmage before the football is snapped.

**Safety.** An offensive player in possession of the football is downed in own end zone (2 points).

**Screen (Block).** An offensive player positioning the body between an opponent and the ball carrier.

**Scrimmage Line.** Imaginary line drawn from the forward tip of the football to the sideline.

**Touchdown.** An offensive player having possession of the football in the opponent's end zone.

### REFERENCES

Bluth, Robert G, ed., *Youth League Football*. Chicago, IL: The Athletic Institute, 1975.

Little, Mildred J.; Dowell, Linus J.; and Jeter, James M. *Recreational Football*. Dubuque, IA: William C. Brown Co., 1980.

National Association for Girls and Women in Sport. *Flag-Football—Speedball—Speed-a-way. Rules Guide 1980-1982*. Reston, VA: The American Alliance for Health, Physical Education, Recreation and Dance, 1980.

### UNPUBLISHED MATERIALS

*Intramural Coed Flat Football Rules—1980.* Maryann Domitrovitz: The Pennsylvania State University, University Park, PA.

*Soccer—Speedball—Flag Football Manual.* Maryann Domitrovitz: The Pennsylvania State University, University Park, PA.

birdie (p. 142)  
bogie (p. 142)  
casual water (p. 142)  
direct hazard (p. 143)  
double bogie (p. 142)  
eagle (p. 142)  
fore (p. 139)  
full swing (p. 129)  
greens (p. 141)  
ground under repair (p. 142)  
hazards (p. 141)  
honors (p. 139)  
lateral hazard (p. 143)  
lost ball (p. 142)  
out-of-bounds (p. 142)  
overlap grip (p. 130)  
par (p. 141)  
putting (p. 136)  
set-up (p. 130)  
short swing (p. 134)  
target hand (p. 129)  
trajectory (p. 146)  
triple bogie (p. 142)  
unplayable lie (p. 142)  
water hazard (p. 143)

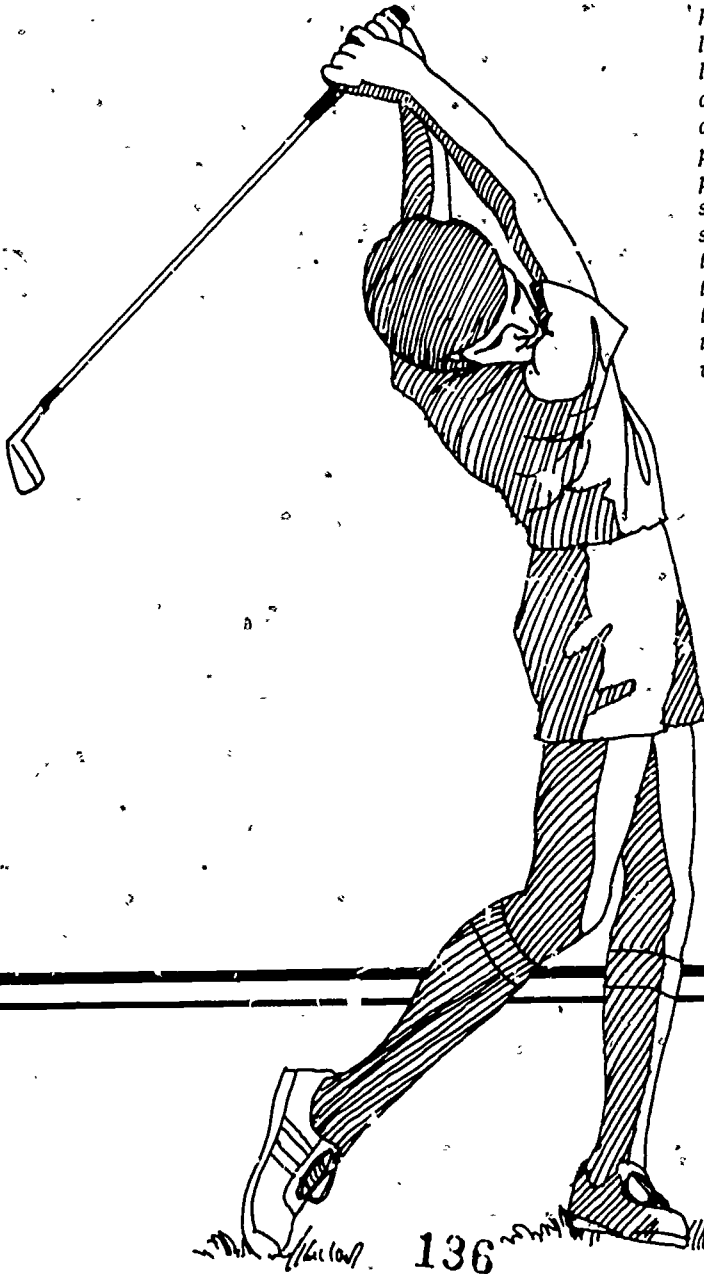



# Golf

DEDE OWENS,  
National Golf Foundation,\*  
West Palm Beach, FL

## INTRODUCTION

Golf is a game in which all individuals can play regardless of size, strength, age, or sex. It's a game in which an individual may play alone or with others. It may be played for fun or for competition.

The exact origin of golf is unknown. However, it is speculated that shepherds while tending their flocks played a game similar to golf in which they hit stones and pebbles with their crooks. Through the centuries a stroking game similar to that of the shepherds evolved. Golf as we play it today on a golf course with 9 or 18 holes had its origin in St. Andrews, Scotland.

The game of golf was introduced in the United States around 1880 by Robert Reid. Reid was a Scotsman who had immigrated to the United States and settled in Yonkers, New York. Since that time the interest in the game has grown. Today there are close to 16 million people playing at least 14 rounds of golf a year. Golf is a very exciting game. It provides an ongoing challenge for all those who participate in it.

## SKILLS AND TECHNIQUES

There are two basic skills which must be learned to play golf: the golf swing (full and short); putting. The golf swing is used to get the ball airborne. The design of the equipment enables the golfer to select a club for the various required trajectories and distances. Therefore, the same basic golf swing is utilized. Putting is a skill similar to croquet in that the ball is rolled along the ground. This skill is used primarily on

the green to get the ball into the hole. A putter is used and designed specifically for this purpose.

## GOLF SWING

### Full Swing

To picture the motion of the golf swing, visualize a child swinging in the park. The swinging motion is continuous from beginning to end. The motion is repeatable. There is a constant arc with the height of the swing on one side the same as on the other side. The motion is rhythmical and flowing (not jerky). There is a swing center around which the motion evolves.

The golf swing has the same characteristics as those describing the swing in the park. Try to visualize a picture of the golf swing as a flowing motion involving the body working as a whole.

### Grip

The grip is the first and most important concept. The hands are the only part of the body which come in contact with the golf club. It is important, therefore, to have the hands positioned on the club so that they are not only comfortable but efficient.

Two grip positions are recommended. Both positions should be attempted to find the one most comfortable for each individual. Both positions are efficient and whichever chosen, will become more comfortable with practice.

*Target Hand (Hand on Top Nearest the Intended Target)*

1. Stand with the shoulders in line with an imaginary target,
2. Hold the club (grip end) along the target side (side closest to the target) with the club head on the ground and the club facing pointed toward the target.

\*Art concepts courtesy of The National Golf Foundation.

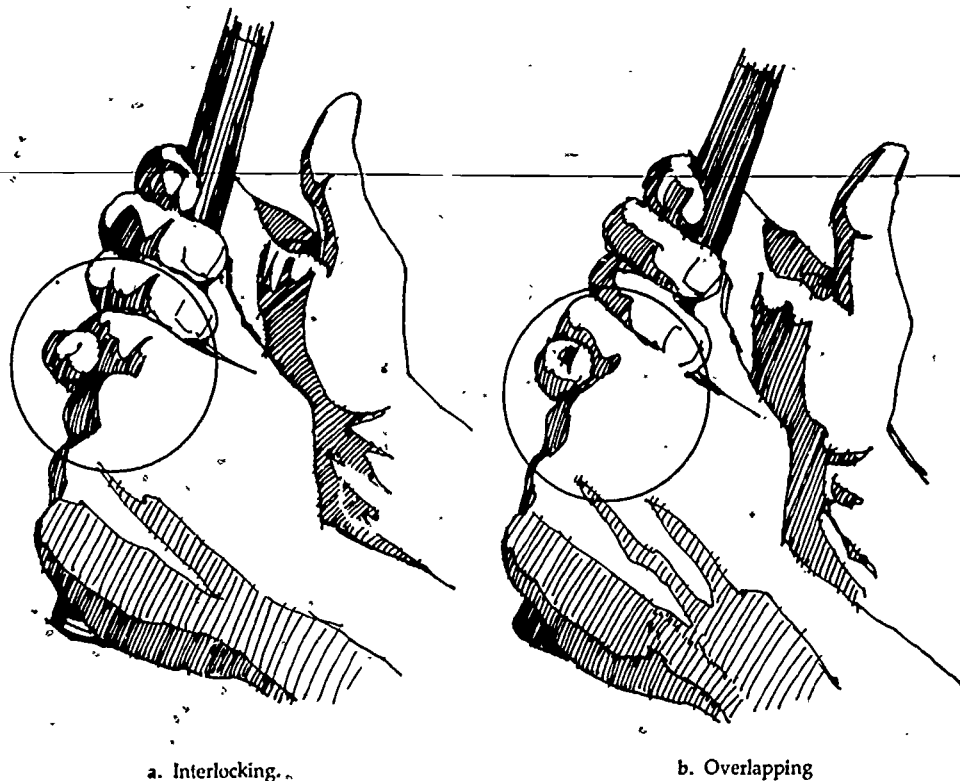

Figure 1. The grip.

3. With the target arm hanging in a relaxed position, place the target hand on the club as if to shake hands with the club.
4. Bring the club head off the ground in front of the body with the target arm extended.

#### *Rear Hand (Bottom Position)*

Extend the rear hand as if to shake hands with the club.

#### *Overlap Grip*

Place the little finger of the rear hand between the index and middle finger of the target hand.

#### *Interlocking Grip*

Interlock the index finger of the target hand and the little finger of the rear hand.

#### *Set-up*

The set-up position is the "ready position" of the body for swinging a golf club. It is important that the set-up permit easy freedom to move the entire body. The more consistent the set-up, the more consistent

will the swing become. The set-up is always taken as it relates to a target. The following steps are suggested for achieving an efficient set-up.

#### *Alignment*

Establish a target (anything will do). Take two clubs (sticks, lines on a gym floor) and place them on the ground like railroad tracks (see Diagram 1). The ball is on one track (target line) and the feet are on the other track (body line). The feet, hips, and shoulders are parallel to the direction of the intended ball flight. This is called a square stance. Repeat this without the parallel clubs.

#### *Stance*

The feet should be about shoulder width apart (measured from the inside of the heels).

#### *Weight*

The weight should be centered over the middle of both feet with the weight on the balls of the feet. (*Hint:* it should be easier to

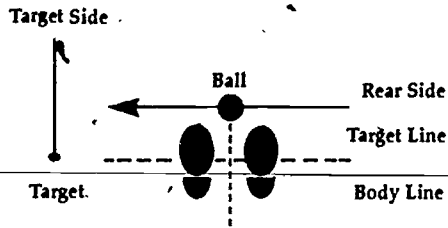

Diagram 1.

tap the heels (both feet) than to tap the toes.)

#### Posture

1. With the back straight, bend forward from the top of the thighs to about a 45° angle.
2. The arms and hands should be relaxed and hanging freely from the shoulders.
3. There should be a slight flex in the knees with just enough motion to mobilize them.

#### Ball Position

The ball should be positioned in the stance just to the target side of center.



Diagram 2.

#### Full Swing Motion

The golf swing is a continuous motion in which the body parts work sequentially. The parts are synchronized to produce the rhythmical and flowing motion. The various stages of the golf swing which follow are described with illustrations and cues.

#### Practice Drills

##### Without Club

1. Place two clubs parallel on the ground so that each is pointed toward a target.

2. Take the set-up position with the arms hanging freely from the shoulders over the parallel clubs.
3. Maintaining the posture position, swing around the swing center, begin swinging the arms back and through—short swings to begin with, and with the arms relaxed. (Imagine the arms as the swing chain.)
4. As the arms get higher gradually allow the lower body to take on the rhythm of the arms, feel the weight shift from one side to the other (target side to rear side, rear side to target side).
5. Try to establish a rhythm and tempo: slow back; then accelerate coming through to the target side.
6. As the arms are swinging, let the target knee touch the rear knee—rear knee to the target knee. This helps the weight to shift and the heels to come off the ground.
7. Feel the motion in the lower body.
8. At the top of the swing, feel the back to the target (coiled as a spring), swing through (uncoil), and check that the belt buckle is pointed toward the target.
9. Swing the arms and turn (backswing); turn and swing the arms (forward swing).

#### With the Club

1. Repeat the same sequence without a ball (remove parallel clubs).
2. Repeat the same sequence (without parallel clubs), hitting a tee instead of a golf ball.
3. Repeat the same sequence (without parallel clubs), hitting balls off a tee.
4. Repeat the same sequence and hit balls from the grass without a tee.

#### Checkpoints

1. Top of swing.
  - a. Back to target.
  - b. Target knee close to or touching rear knee.
  - c. More weight on rear foot.
  - d. Drive high.
2. Follow-through.
  - a. Arms and hands in high finish.
  - b. Belt buckle to target.
  - c. Weight on target foot.
  - d. Rear knee touching target knee.

**Steps of the Golf Swing**

1. During the takeaway, the triangle of the hands, arms and shoulders will move the club head along the ground on the extended target line. The head remains steady to ensure that the swing center, or "hub" (that point, once again, just above the sternum), will also remain steady.

2. As the swinging action expands, the upper body "coils" or "winds" as it turns away from the target. The right elbow will begin to hinge.

3. At the top of the backswing you will feel maximum turn of the shoulders and hips away from the target into a fully coiled position. To sustain the constant arc, the hub remains steady and the target arm is firmly extended, but not rigid.

4. As the forward swing begins, the first major move is in the lower body, with the legs leading, triggering a steady uncoiling of power to accelerate club head speed.

5. To help you realize the sequential moves taking place in the swing, note the position of the club, arms, and hands in relation to the hips.



- a.
- Feet shoulder width apart.
  - Ball forward of center in stance.
  - Body in "ready" position.



- b.
- Takeaway sequence: hands-arms-shoulders.
  - Hub steady and behind ball.



- c.
- Target arm extends; rear arm hinges.

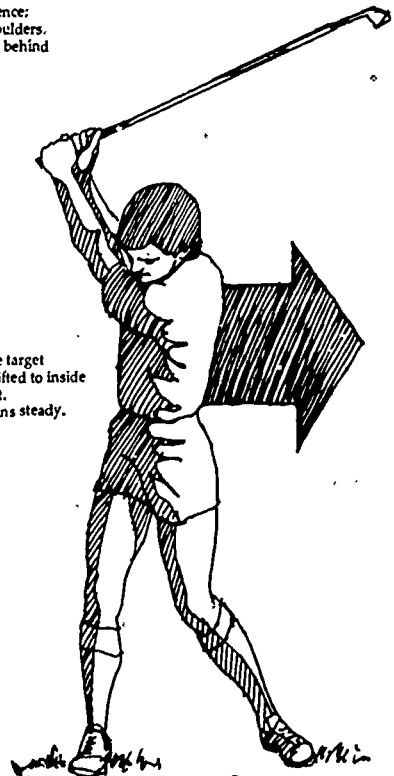

- d.
- Back to the target
  - Weight shifted to inside of rear foot.
  - Hub remains steady.

Figure 2. The full swing.

6. At the moment of impact you should feel all body movement and energy directed toward the target. The hips will have begun to turn, and by now are well out of the way, permitting the arms and hands to swing freely, fully extending the club head out toward the target. Think of swinging through the ball not to the ball.

7. In the follow-through strive to maintain full extension of both arms until the diminishing momentum of club head speed carries them to a natural resting position.

8. At the completion of the swing, the shoulders and hips will have completed their rotation, shifting the majority of the weight to the target foot and forcing a natural tilt of the rear heel from the ground. The arms and hands should finish high.

**Summary:**

Think of the foregoing stages as one continuous movement governed by balance and timing that will maneuver the club head into position to strike the ball squarely and at its greatest speed

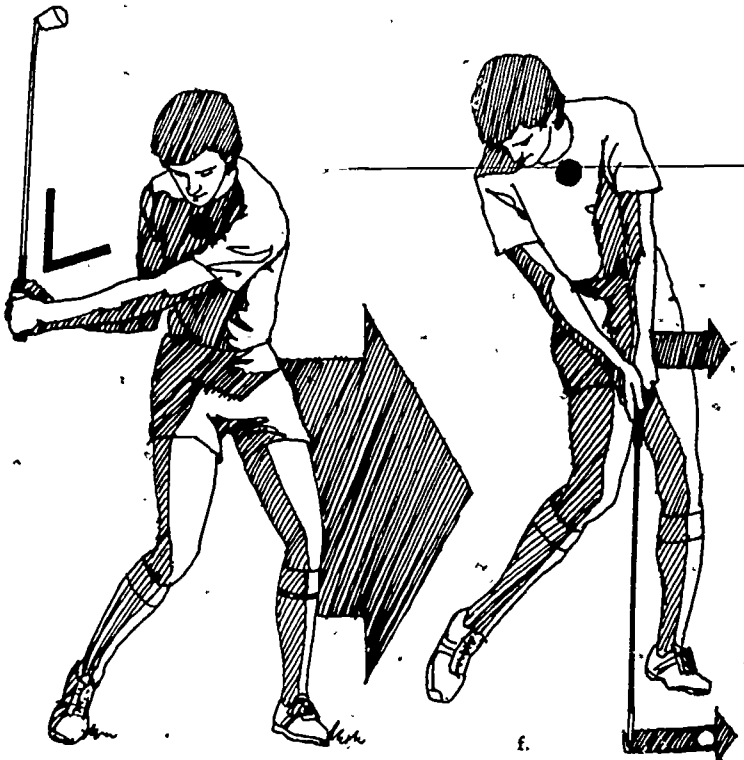

- e.
- Legs drive laterally toward target.
  - Arms follow.
  - Hands delay.

- f.
- Weight shifts to target side.
  - Hands and arms produce "square" clubface at impact.
  - Hub remains steady behind the ball.
  - Club head at maximum speed.



- g.
- Arms rotate after impact.
  - Hub continues to remain steady.

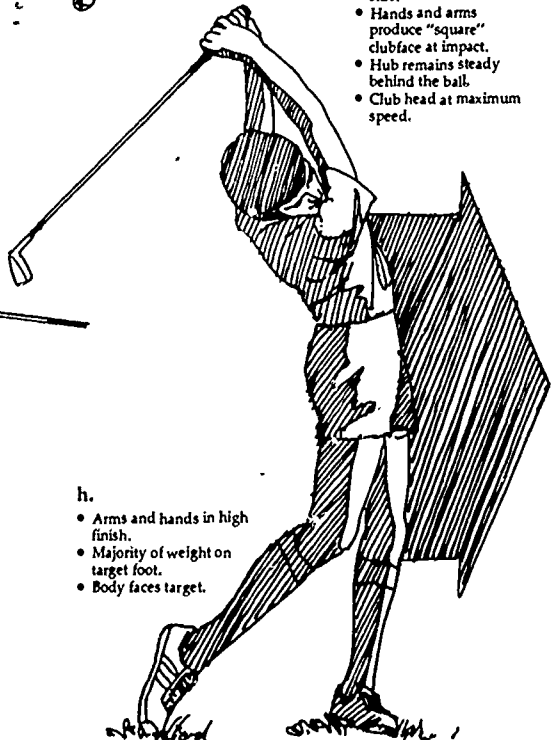

- h.
- Arms and hands in high finish.
  - Majority of weight on target foot.
  - Body faces target.

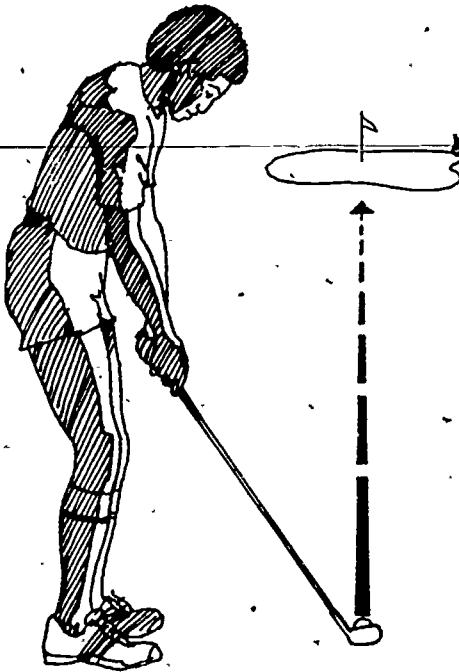

Figure 3. Practicing the approach shot (full swing).

• **Short Swing**

During a round of golf, the distances from the ball to the target continually vary. As a result, a full swing or distance swing is not always required. The short swing is primarily used when approaching the green when accuracy is the major objective.

The short swing has the same swing characteristics as the full swing. However, because accuracy and not distance is the major objective, there are differences in the set-up position, and the length of the backswing and follow-through.

To produce a shorter swing the changes in the set-up position help the body to create a different feel from the full swing.

**Set-up Position**

1. Feet closer together.
2. More weight on the target foot.
3. More bend from the top of the thighs.
4. Grip the club closer to the shaft (choke up on the grip).
5. Ball position is slightly farther back of center.

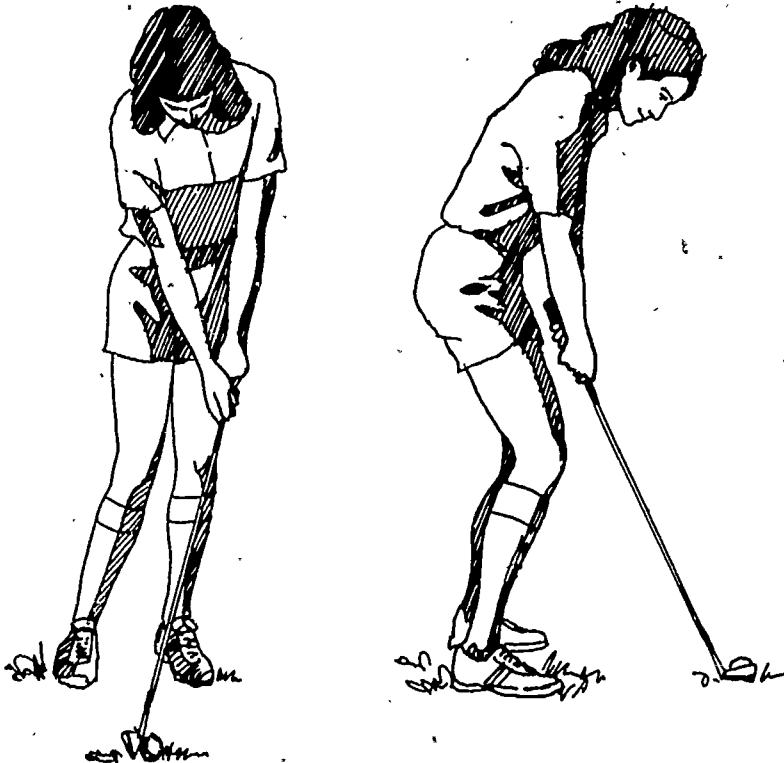

Figure 4. The short swing set-up position.

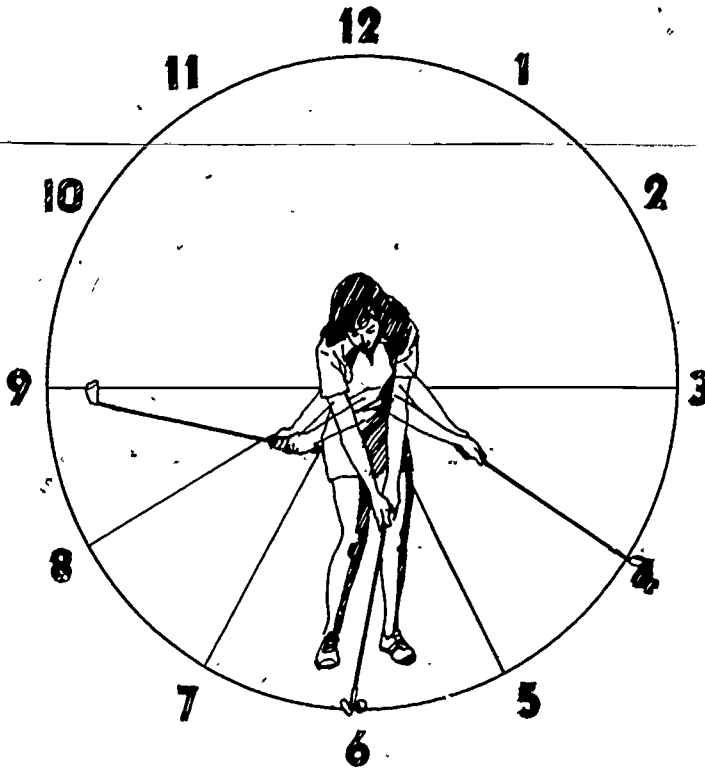

Figure 5. The short swing.

6. Hands, arms, and swing center slightly in front of the ball.

To establish a feel for the short swing, imagine a clock as the one illustrated. The length of the backswing and follow-through will help determine the distance that the ball will go. As skill level advances, varying the speed of the swing will also influence distance. Initially, concentrate on the techniques and vary the length of the swings with a constant speed: 7:00 to 5:00; 8:00 to 4:00.

The swing is initiated and continued by swinging the arms and hands as a unit, back and through. There is very little motion in the lower body. This is primarily an arm and shoulder swing. Permit the lower body to respond naturally. Avoid being still and rigid in the lower body.

The purpose of this shot is to land the ball on the green and get it rolling to the hole, hopefully ending with the ball close to the pin. The technique which has been pre-

sented may be used with any selected club. Initially the more lofted clubs should be used (9, 8, 7) to provide for the highest ball flight. As the skill progresses, variations in the short swing can be learned. However, the prime objective in the beginning and intermediate skill levels is to get the ball on the green and directed toward the target. With practice the short swing can be quickly learned.

#### Practice Drills

##### *Without a Club*

1. Place two clubs parallel on the ground directed toward a target.
2. Take the set-up position with the arms hanging over the clubs and hands extended.
3. Place the hands together with the palms facing.
4. Point the target hand toward the rear side.
5. Swing the arms and hands back and

forth as a unit between the clubs. Vary the swing lengths (7-5, 8-4) as illustrated by the clock.

### Checkpoints

1. Motion is straight back along the track and straight through.
2. The back of the target hand is facing the target throughout the motion.
3. No wrist break.
4. Motion is with the arms and shoulders.

### With the Club

1. Place two clubs parallel on the ground directed toward a target. The clubs should be a little wider than the length of the club head.
2. Take the set-up position with the club between the parallel clubs. The clubs will then form a guide for a straight swing.
3. Swing the club back and forth between the clubs.
4. Vary the length of the swing (7 to 5, 8 to 4, 9 to 3).
5. Swing back, through, and hold the follow-through for a few seconds.
6. Repeat: placing a tee in the ground and hitting the tee; hitting balls from the tee (place the tee close to the ground); hitting balls without the tee; removing parallel clubs.

### Checkpoints

1. The back of the target hand and clubface point toward the target throughout the motion.
2. Hold the follow-through, check position of the clubface. Is it toward the target?
3. The hands and arms should be slightly ahead of the clubface prior to and at the end of the swing.

## PUTTING

The putting stroke is used on the green. The ball should be *rolled* on the ground. There is no air time as with the full and short swings. A specifically designed club, the putter, is used. The blade or face of the club is vertical to permit a rolling motion, and the angle of the shaft with the ground is more upright.

The technique of the putting stroke is similar to the short swing. The stroke is



Figure 6. The putting grip.

very short and compact. The length of the backswing and forward swing are the same. The motion is smooth and continuous. The stroke is initiated with the arms and shoulders.

There are differences between the putting stroke and short swing (as well as the full swing) in the grip and set-up positions. These differences are due to the club design and the purpose of the stroke, which is to roll the ball. To more readily understand these differences, take one of the suggested grip positions with the putter and either the short or full swing set-up positions. Notice that the putter is shorter than the other clubs and that the putter does not rest flat on the ground. Therefore, a few adjustments in the grip and set-up are necessary for an efficient putting stroke:

### Grip

The full or short swing grip is modified by turning both hands away from the grip of the club. This new position places the palms of both hands facing more upward as opposed to facing each other in the regular



grip. The pressure remains in the last three fingers of both hands. This grip also permits the elbows to separate from the extended position of the full and short swings. The arms should bend with the elbows pointing away from the body.

### Set-up

As in the full and short swing, the set-up position for putting is important in developing consistency in the stroke. It should be noted that a set-up is basically the same as the full and short swing *except* the arms are closer to the body and the eyes are over the ball. The following steps are presented as a review for getting an efficient set-up with the differences italicized:

### Alignment

After taking the *putting grip*, place the clubface behind the ball square to the intended target. The feet, shoulders, and hips should be parallel to the target line of the ball.

### Stance

The feet should be about shoulder width apart (measured from the inside of the heels).

### Weight

The weight should be toward the middle of both feet.

### Posture

The back should be relatively straight and bending from the top of the thighs. The arms should be bent or flexed with the elbows pointing away from the body on a line parallel to the intended direction. There should be a slight flex in the knees.

### Eyes

The eyes should be positioned over or slightly behind the ball.

### Ball Position

The ball should be positioned in the stance just to the target side of center.

### Putting Stroke

The stroke is a pendulum motion. There is no motion in the lower body. The stroke is accomplished with the arms and shoulders working as a unit (one-piece) back and through the ball. The club is a part of the

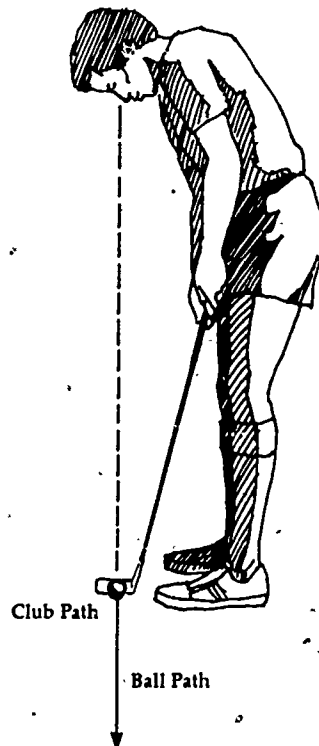

Figure 7: Eye position for putting.

unit. There is initially no hand or wrist action. As the skill level advances, greater feel will develop for the stroke and some hand and wrist play may be added. The stroke should be kept low to the ground, back and through. The length of the backswing and forward swing are the same.

### Putting Practice (Carpet or Carpet Stripes/ Green/Gym Floor)

The drills below are designed for practicing stroke techniques, and distance and direction judgment.

#### Without the Ball

1. Place two clubs parallel on the ground just a little wider than the width of the putter blade on line and 10 feet apart from a target on a wall or backstop.
2. Practice taking the grip and set-up position.
3. Practice the stroke technique back and through between the two clubs.
4. Stroke back through and hold the finish.

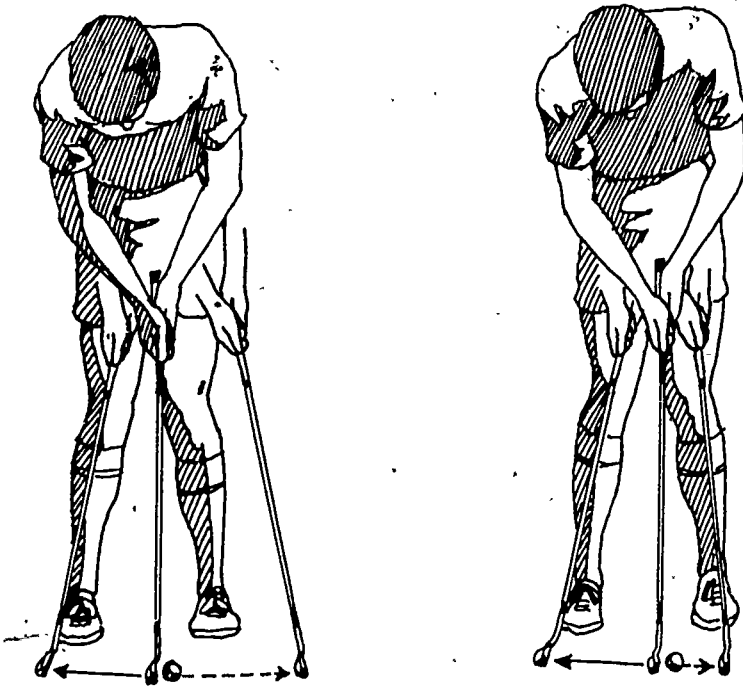
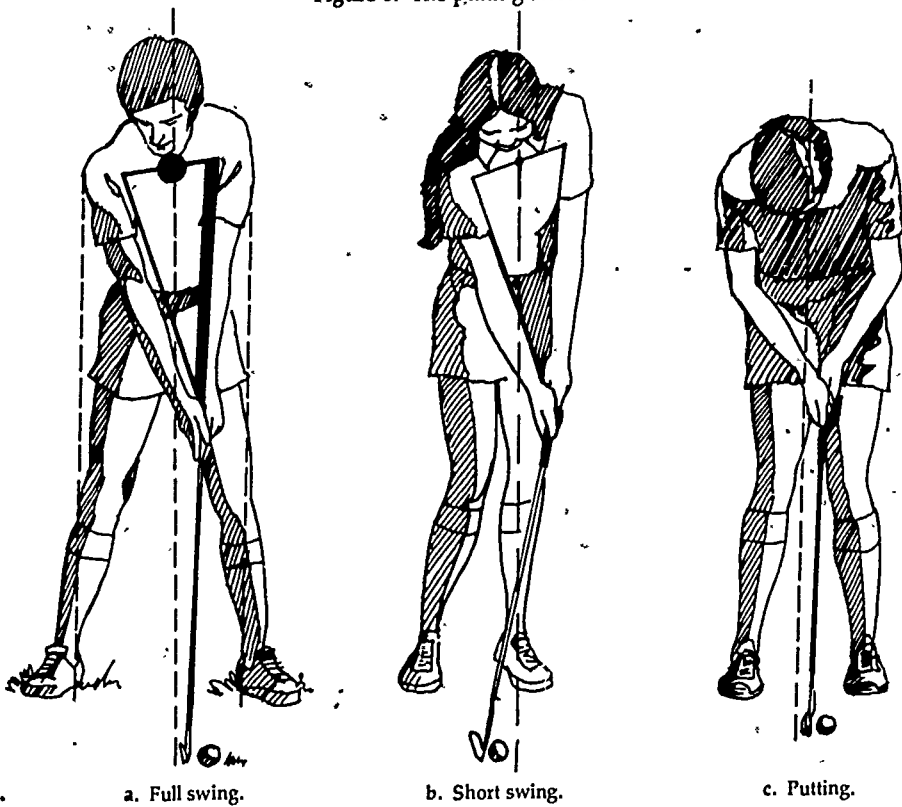

Figure 8. The putting stroke.



a. Full swing.

b. Short swing.

c. Putting.

Figure 9. Body alignment for different strokes.

Table 1. Summary of key points.

Key Points	Full Swing	Short Swing	Putting
1. Emphasis	Distance and Direction	Direction	Direction
2. Grip	Overlap or Interlock	Overlap or Interlock	Modification of Overlap Interlock
3. Set-up			
A. Alignment	Parallel to the Intended Direction	Same	Same
B. Posture			
C. Stance	Feet Shoulder Width Apart	Feet Narrower than Shoulders	Feet Shoulder Width Apart
D. Weight	A. Middle to Balls of the Feet B. Weight Evenly Distributed between Both Feet	A. Same B. More Weight on the Target Foot	A. Same B. Weight Evenly Distributed between Both Feet
E. Ball Position	Target Side of Center	Center to the Rear Side of Center	Target Side of Center
F. Swing Center	To the Rear Side of the Ball	To the Rear Side of the Ball	Even With the Rear Side of the Ball

### Checkpoints

- The blade should go back and through, low to the ground.
- From the set-up position, check eye alignment by dropping a ball from the bridge of the nose. The ball should fall between the clubs.
- Hold the finish and check in relation to target:
  - Blade alignment to the target (square is desired).
  - Blade in relation to ground (low is desired).
  - Length of forward swing (equal to desired backswing).
  - Arm and hand position (same unit posture as set-up).

After the first tee, the player with the lowest score on the previous hole hits first on the next tee.

- On the fairway, the player whose ball is farthest from the green hits first.
- When a player is hitting, other players should stand quietly. They should stand to one side of the person hitting, not in front.
- Players should be ready to hit their shots when their turns come.
- A player should not hit until the players in front of them are safely out of their hitting distance.
- The warning cry "fore" should be yelled if a ball is in the air and other players are in danger of being hit.
- The score on a hole (for example, hole 8) should be recorded on the next tee (for example, hole 9).
- A player should be sure no one is in front or behind when swinging a club or hitting a ball.
- A player should *never* throw clubs.
- A player or group of players who are playing slowly should let the player(s) behind them go through to avoid slow play.

### ETIQUETTE AND SAFETY

Golf, as other sports, has a code of behavior, or recommended actions for the participants, known as golf etiquette. Golf etiquette helps individuals to enjoy the game, to keep play moving on the course, to encourage safety, and to protect the course from unnecessary damages.

Examples of golf etiquette are:

- The player who hits first on the tee has *honors*. Honors is decided on the first tee by flipping a coin or drawing lots.

Most injuries in golf occur when a club is swung recklessly or carelessly or a golf ball is hit without attention to its direction and those around. Injuries may be avoided by

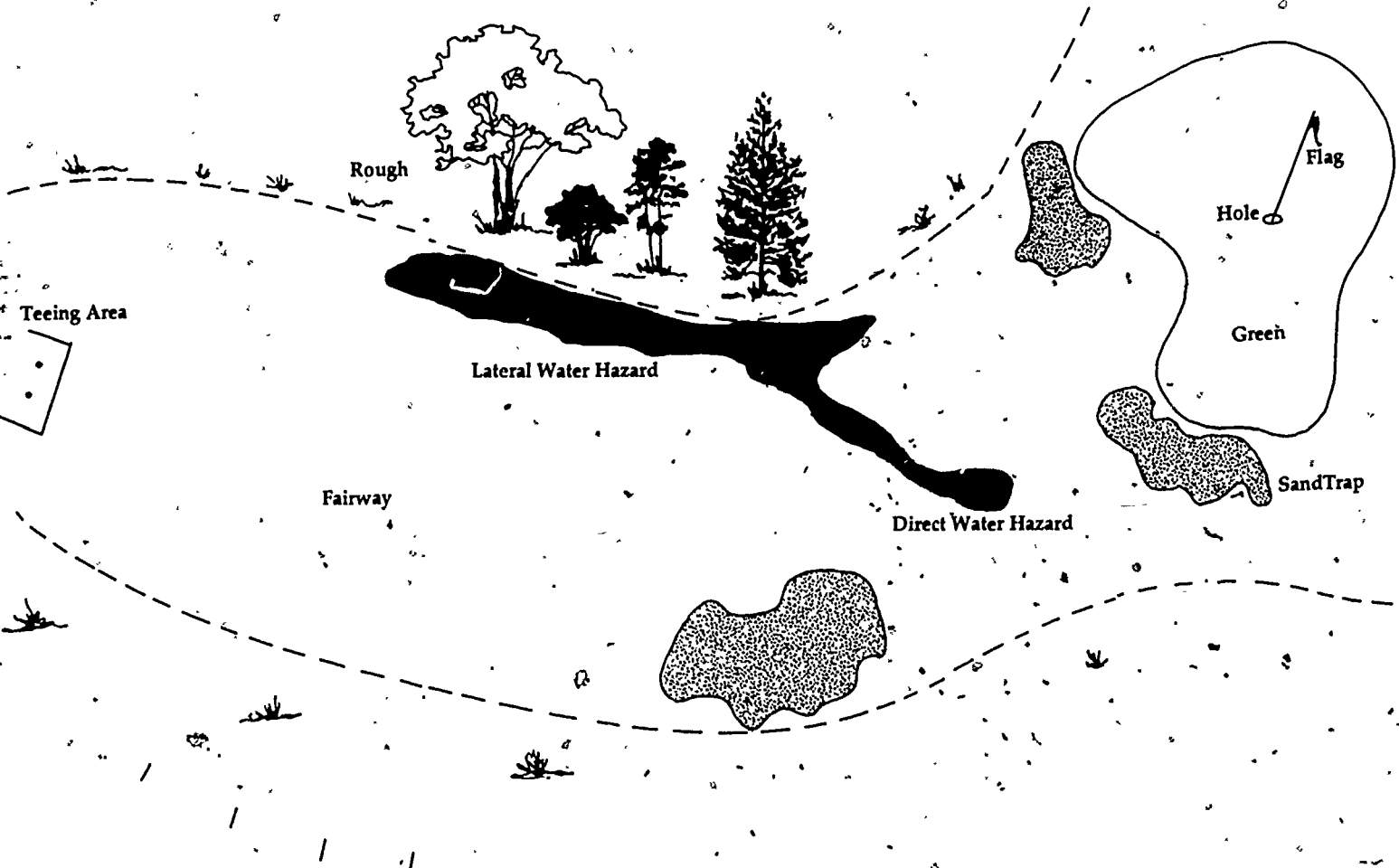

Diagram 3.

Out-of-bounds

being more aware of golf etiquette and its implications for safety.

## THE GAME OF GOLF

### COURSES

Golf courses are composed of 9 or 18 holes and each course is different in appearance, length, terrain, and difficulty. A course has unique characteristics which reflect the design of different golf course architects. Just as an artist paints different pictures, an architect designs each hole with its own personality. The holes vary in the type of hazards or obstacles (water and sand), the length of the holes (short, long, medium), and the contour of the greens (large or small, round and kidney-shaped). The courses may vary from very flat and boring layouts to extremely rolling and highly wooded terrain which presents exciting challenges.

Golf is played on courses which may have 9 or 18 holes. An 18-hole course is usually considered a regulation course. Courses with 18 holes vary in length (total yardage) from around 5,000 yards or less to as long as 8,000-yards.

### HOLES

Individual golf holes vary in length from about 85 yards to 600 yards. Holes are categorized by the length or total yardage from the teeing area (point for beginning each hole) to the cup or middle of the green. The holes are labeled. *short* (85 yards or less to 245 yards), *medium* (245 to 445 yards), *long* (445 yards to 600 or more yards).

Golf holes have a unique personality as reflected in the architectural designs. Given the uniqueness, there are basic components that the majority of golf holes and courses will have. These are labeled in Diagram 3. Sand and water on a golf course are considered hazards or obstacles which may or may not induce penalties. The use and placement of water hazards (direct and lateral) and sand traps in a golf hole will depend on course design. They may or may not appear on a hole or holes. Out-of-bound (OB) markers define the outer perimeters of a course. They are most often seen where a course is bordered by roads or housing developments.

### SCORING

The objective in golf is to progress from the teeing area to the green (see diagram) and into the hole in the fewest number of strokes. The total number of strokes taken on the hole is recorded as a score. At the end of the 9 or 18 holes, the scores on each hole are added for a total score for the golf round.

To make scoring easier a score card is provided at golf courses. A sample score card is illustrated in Diagram 4. Note the term *par* on the score card. Each hole has a designated par which is the established stroke standard for the given length of hole in yards (total yardage). The designated pars are 3 (short holes), 4 (medium holes), and 5 (long holes). Generally, an 18-hole course will have 4 par 3 holes, 10 par 4 holes, and 4 par 5 holes.

The score card is divided into two sets of 9 holes (holes 1-9, holes 10-18) with the holes numbered consecutively from 1 to 18.

Yardage	510	326	137	365	342	160	490	362	382	3074	325	380	485	130	365	290	500	151	351	2975	6049
Handicap	1	13	17	7	11	15	3	9	5		12	6	4	18	8	14	2	16	10		
Par	5	4	3	4	4	3	5	4	4	36	4	4	5	3	4	4	5	3	4	36	72
Hole	1	2	3	4	5	6	7	8	9	Front	10	11	12	13	14	15	16	17	18	Back	Total
Sue																					
John																					
Mary																					
George																					

Diagram 4. Sample score card.

Each 9 holes and the total 18 holes have a designated par. This is obtained by adding the individual pars on the first 9 holes (holes 1-9) which is called the *front side* and adding the individual pars on the second 9 holes (holes 10-18) which is called the *back side*. The total for the front side and back side is the designated par for the course. Referring to the score card, par on the front side (holes 1-9) is 36, and par on the back side (holes 10-18) is 36. The course par (holes 1-18) is the front side 36 plus the back side 36 for a total of 72.

When an individual goes to play golf, he/she is trying to obtain a score which is equal to, or lower than par. However, not everyone is a Nancy Lopez-Melton or Jack Nicklaus and capable of shooting a score equal to or lower than par. Par is, however, a standard of excellence against which individuals may evaluate their own skill.

### Terminology of Scoring

The following terms are associated with scoring. The terms are defined with reference to par and a numerical example. Par for this hypothetical hole is 4.

Par	= stroke standard on a hole	.....	= 4
Birdie	= 1 stroke less than par	.....	= 3
Eagle	= 2 strokes less than par	.....	= 2
Bogie	= 1 stroke more than par	.....	= 5
Double Bogie	= 2 strokes more than par	.....	= 6
Triple Bogie	= 3 strokes more than par	.....	= 7

### RULES

➤ To give order and direction to the game of golf, rules were established. As in other sports, situations arise during play which may or may not invoke penalties. The rules of golf are established by the United States Golf Association (USGA), the ruling body of golf in the United States. The rules govern situations on golf courses which are direct results of the actions of a player in attempting to hit the ball, end results of hitting the ball, or the conditions of the course over which the player has no control.

An understanding and knowledge of the rules help the players to make accurate de-

isions in situations which require an interpretation of the rules during the golf round. Rules governing particular situations may impose 0, 1, or 2 strokes on the player's score. The most stringent penalty is disqualification and may occur in certain situations when in competition. The most common rules encountered on the golf course will be presented by the number of strokes imposed. Some of the rules permit the players to decide how they want to put the ball back into play and are called options. Some options are not always possible.

### No Penalty Strokes

**Casual water.** Water which is not normally on the course and is the result of rain or faulty watering systems.

**Action:** The player may lift and drop the ball at the nearest point of relief for swing and stance not nearer the hole.

**Ground under repair.** Marked area on the course which is under construction. Usually indicated by a sign or coded in white paint.

**Action:** The player may lift and drop the ball at the nearest point of relief of swing and stance not nearer the hole.

**Hole made by a burrowing animal.** Holes made by moles, snakes, and other burrowing animals are often found on the course.

**Action:** Player may lift and drop the ball at the nearest point of relief of swing and stance not nearer the hole.

### One (1) Stroke Penalty

**Out-of-bounds (OB).** The outer perimeter of a golf course is usually marked by white stakes. A ball lying outside the inner edges of the stakes is considered OB and out of play.

**Action:** Player must drop (if on tee, may re-tee) a ball and hit from the spot where the last ball was hit OB.

**Lost ball.** A ball which was hit and cannot be found within five minutes of searching.

**Action:** Player must drop a ball (if on tee, may re-tee) and hit from the spot where the lost ball was hit.

**Unplayable lie.** A player may declare the position of any ball unplayable. Normally

an unplayable position is such that swinging a club or taking a stance is difficult or unsafe to equipment or the golfer.

**Action:** Three options. (a) Player may return to the original spot and drop a ball where the ball was originally hit. (b) Player may take two club lengths relief in a half-moon area from an unplayable ball position. (c) Player may go back on a line as far as he/she desires from the unplayable ball position keeping the spot between the player and hole.

**Water hazard.** Defined on the course by yellow or red stakes. All area within the stakes is considered part of the hazard. If there are no stakes, the water is considered the hazard boundary.

**Lateral hazard** (red stakes). Water hazard that is parallel to the fairway.

**Action:** Three options: (a) Player may play the ball from where it lies in the hazard (no penalty strokes). (b) Player may drop the ball within two club lengths of the point where it last crossed the margin of the hazard, on either side of the hazard. (c) Player may go back to the point and drop the ball where the last ball was played.

**Direct hazard** (yellow stakes). Water hazard that crosses the fairway.

**Action:** Three options: (a) Player may play the ball from where it lies in the hazard (no penalty stroke). (b) Player may drop the ball on a line anywhere back from the point where the ball last crossed the margin of the hazard keeping that spot between him/her and the hole. (c) Player may go back and drop the ball at the point where the last ball was played.

**Whiffing or missing the ball.** An attempted swing at the ball and missed contact.

**Action:** The ball is played where it lies.

**Ball moves.** A ball that is moved accidentally by the player while addressing the ball (except when teed) or removing debris from around it in preparation to hit.

**Action:** Ball is replaced to its original position prior to moving.

## Two (2) Stroke Penalty

**Playing the wrong ball.** A player hits a ball other than own.

**Action.** If the error is discovered before hitting the next tee the player may go back

and play his/her own ball with the 2 stroke penalty and not count any of the strokes played with the wrong ball.

**Grounding the club in a hazard.** A player may not sole the club in a hazard when addressing the ball. Doing so results in the designated penalty.

**Hitting an unattended flagstick.** A player when on the green must have the flagstick held by another player/caddie or removed from the hole and placed out of the line of the putt. Failure to do so and having the player's ball hit the flagstick (either in the hole or lying on the green) results in the designated penalty. The ball is played from the final resting spot.

**Hitting another player's ball on the green.** When putting, a ball in the line of putt should be marked by the owner. If there is failure to have it marked, and the ball putted hits another, the penalty is assessed and the hit ball is replaced.

There are, however, other rules which are less commonly encountered and are described in greater detail in the *USGA Rule Book* and four volumes entitled *Decisions of the USGA*.

The rules of golf are meant to make the game more fair and challenging. Learn the rules and abide by them.

## STRATEGY

Strategy may be phrased simply as a plan of action. A golfer's strategy has two steps: the selection of the route or target areas for each shot; selection of the club to reach the target areas.

### STEP 1: SELECTION OF ROUTE

The golfer standing on each tee must determine the route to the green. The route is the direction he/she would like to hit each shot. The route or Step 1 of the plan of action or strategy is pre-planned. The best route is one which avoids potential penalties or trouble as water, sand, out-of-bounds, or woods. It is important to remember, the best route is not always the shortest route.

Planning the route or selecting target areas is not difficult. Two things must be

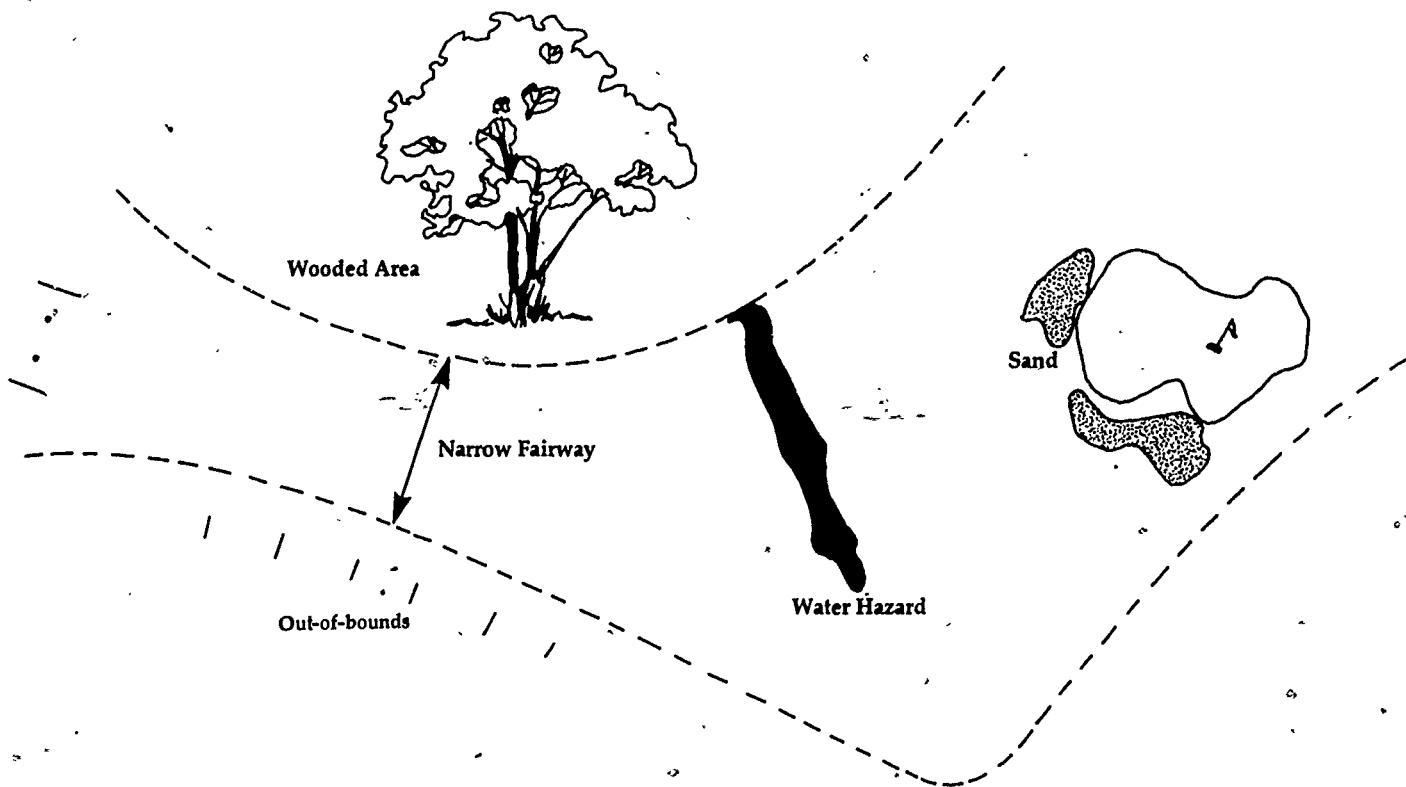
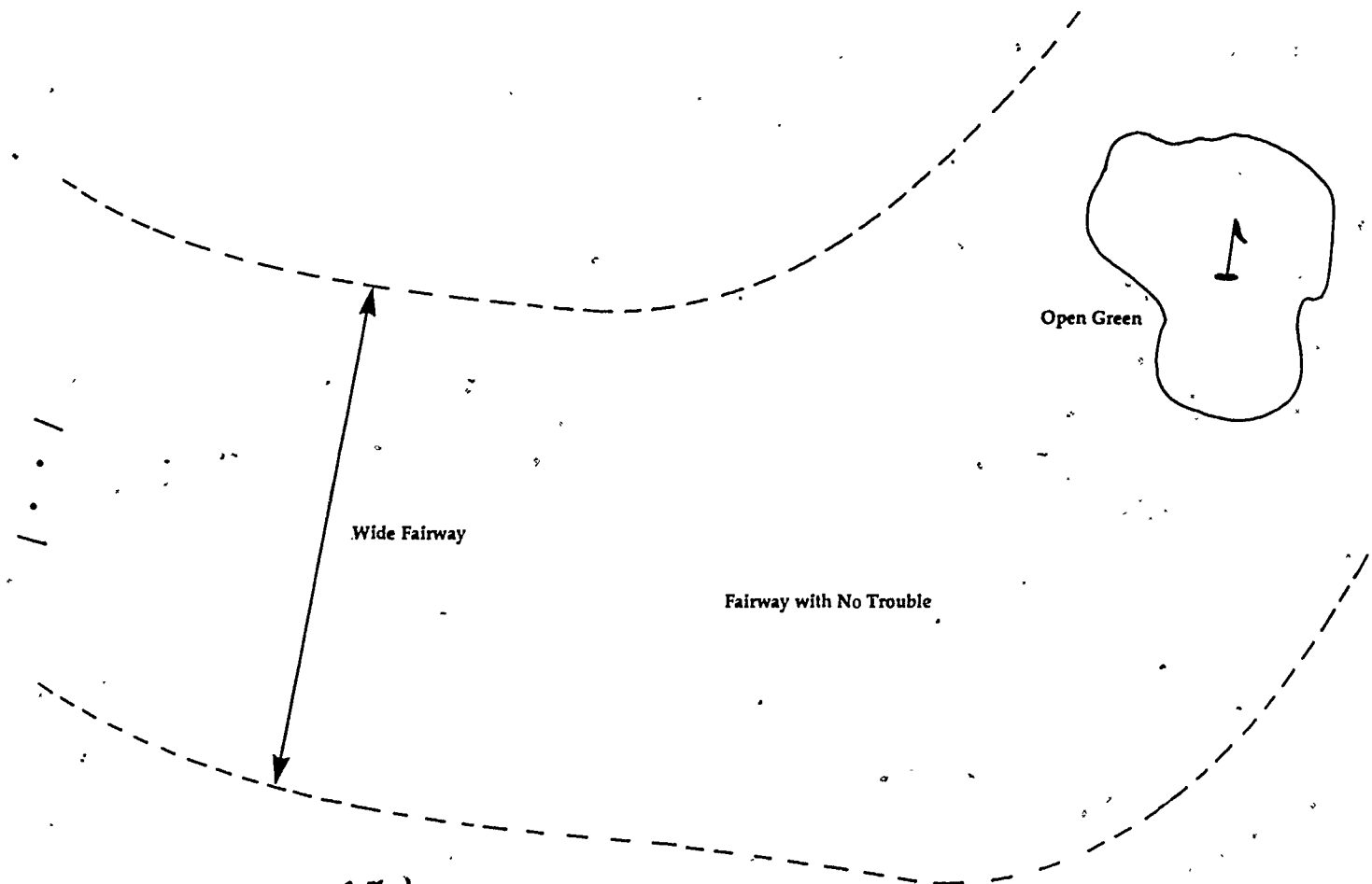

Diagram 5. Strengths of a golf hole.





153

Diagram 6. Weaknesses of a golf hole.

considered: the strengths and weaknesses of the golfer; the strengths and weaknesses of the golf hole. Through practice, both on the practice tee and the golf course, a golfer learns strengths and weaknesses. The golfer learns how far and short each club can be hit and in which direction the balls tend to go when they are hit right, left, straight, high, or low. Practice is *very important* in helping a golfer learn what his/her abilities are and the areas requiring improvement.

A golf hole has strengths and weaknesses, just as a golfer. These are observable by standing on the tee and looking down the fairway. The strengths of a golf hole are sand traps, water hazards, out-of-bounds, narrow fairways, wooded areas (trees), and/or small greens. They are strengths because they are potential trouble areas for the golfer which may or may not result in penalties (discussed in Rules).

The weaknesses of a hole are wide fairways, fairways or parts of fairways with no trouble as traps or water, open areas in front of the green with no hazards, and/or large greens. These are weaknesses because the areas are free of trouble and lack challenges.

A golf hole may have few or many strengths, few or many weaknesses, or a combination of strengths and weaknesses. Each golf hole must be viewed individually for strengths and weaknesses.

For review, Step 1 (selection of target areas) of strategy is pre-planned. The key to the selection of target areas is for the golfer to use strengths against the weaknesses of the golf hole. In other words, avoid potential trouble areas. Play toward the open areas in the fairway and in front of the green. Play away from the trouble.

## STEP 2: CLUB SELECTION

In selecting the club to reach the chosen target area (Step 1), three questions must be asked by the golfer. The questions can easily be remembered by the letters *LTD*:

- L 1. What is the *lie* of the ball?
- T 2. What ball *trajectory* (or height) is needed?
- D 3. What is the *distance* to the decided target area?

The *lie* of the ball refers to the ball's position in the fairway, rough, or hazards. These positions may be good (easy to hit from) or bad (more difficult to hit from). Generally, the more of the ball which can be seen, the easier the shot. Therefore, the better the lie, the greater the club selection or more choices of clubs to use.

The *trajectory* of the ball is the height and the angle of the ball after it is hit. Diagram 7 demonstrates various heights and angles of the ball when hit by different clubs. Notice the higher the trajectory the less roll or distance after the ball lands. Basically, as the clubs go progressively down in number (9, 8, 7 . . .) as illustrated, the trajectory decreases and the distance increases.

The *distance* to the target areas is assessed by "visual feel" or by actually stepping the distances off. Through practice a golfer visually learns to make estimations of the distance each club will go when hit. If a course is frequently played, actually stepping off the yardage from markings on the course becomes very helpful. More advanced players regularly do this.

### Considerations in Club Selection

The following general *rules* in club selection (*LTD*) should be learned.

1. The better the lie, the greater the number of options available in selecting a club.

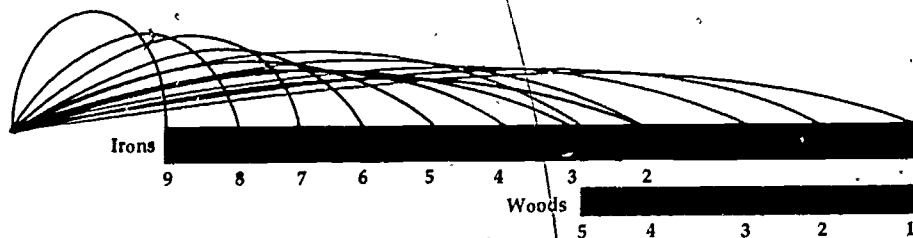

Diagram 7.

- As the lie gets worse, there are less clubs to choose. It is better to favor a more lofted club with bad lies. (L)
- 2. The higher the *trajectory* needed, the more lofted club should be selected (higher numbers). The less trajectory needed the less lofted clubs are selected (lower numbers). (T)
- 3. The greater the distance required, the less lofted and longer clubs are selected (smaller numbers). The less the distance required, the more lofted and shorter clubs are selected. (D)

### SUMMARY OF GOLF STRATEGY

Playing golf becomes more exciting and challenging when a golfer feels in control. Not every shot planned will end up in the decided target areas. Not every club selection will be the right one, but, the time taken to think about the shot and develop strategy will draw the golfer closer to a more consistent performance. Remember, strategy begins with practice to develop an understanding of abilities and strengths and weaknesses. Practice, time, and patience are needed to develop the desired consistency.

## SELECTING EQUIPMENT

### CLUBS

A set of golf clubs is composed of both woods and irons. The maximum number of clubs which may be carried by a player is 14 under USGA rules. However, this does not prevent a player from carrying fewer than 14 clubs.

The advanced or intermediate player may have a complete set of clubs. The set may include the following clubs. 1, 3, 5 woods, 2-9, pitching and sand irons, putter. Some players may substitute a 4 or 7 wood for the 2 iron.

The beginner may initially only want a starter set which may have a 5 or 7 wood, 3, 5, 7, 9 irons, and a putter. Once the player feels comfortable using these clubs, acquiring the other clubs would be suggested.

### Selection

Two considerations in selecting golf clubs are the fit and cost. The first and most important consideration is selecting a club which is appropriate for the player. Clubs may be purchased in different lengths and weights. The appropriate club for an individual depends on height, strength, and hand size. Using a club which is too heavy or light or too long or short is detrimental to developing good technique. Club fitting charts, available in most golf shops, help an individual select the appropriate length, weight, and grip size in golf clubs. Most golf professionals and teachers can lend assistance in fitting clubs and their assistance is advised.

The second consideration in selecting clubs is cost. New clubs may be a costly adventure, but the money invested in buying a good set is worth it. A set of clubs can feasibly last a lifetime. New clubs can range in price from \$10.00 or less to more than \$40.00 for an iron or wood. A complete set (14 clubs) range from \$150.00 to \$600.00. A starter's set (6 or 7 clubs) ranges from around \$50.00 to \$100.00. Used clubs may be purchased for much less and often are as equally good for an individual to use provided they fit appropriately. Used clubs may be obtained singularly or in sets. Sources for new and used-sets are golf shops located at golf courses, discount houses or golf shops, driving ranges, friends, or family.

### BALLS

Golf balls on the market today are either a wind or solid ball. A wind ball has a liquid (acid) center within a rubber casing followed by many layers of rubber winding. The cover (white) may be Surelyn which is tough and durable or Balatta which is softer and more easily damaged. The solid ball has a solid core with a durable cover. For the majority of players, the solid ball is better because it does not cut or damage as quickly. It retains its shape (roundness) longer.

The cost of new golf balls ranges from \$.85 to \$1.75 each. Used balls may be purchased for much less. Used balls are often

very good balls (often new balls) which have been found and are being resold. These balls are fine to play with; however, they should be round and free of deep cuts. Cuts reduce the effectiveness of the ball for distance and direction.

### TERMINOLOGY

**Addressing the Ball.** Preparation to swing the club by taking a stance and placing the club behind the ball.

**Apron.** Short grass around the green.

**Away.** The ball farthest from the hole.

**Birdie.** One stroke less than par.

**Bogie.** One stroke more than par.

**Divot.** Turf removed from the ground while hitting.

**Dogleg.** Curvature in the fairway.

**Double Bogie.** Two strokes more than par.

**Eagle.** Two strokes less than par.

**Fairway.** The short grass between the tee area and green.

**Fore.** A warning to individuals in the direction of play that the ball is coming.

**Green.** The putting service (closely mowed grass).

**Hazard.** Term used to indicate sand traps and water on the course.

a. *Lateral water*—water that runs parallel to the fairway.

b. *Direct water*—water that runs across the fairway.

**Honors.** Order of teeing off (lowest score on preceding hole).

**Hook.** Curvature of the ball to the left (right-handed player).

**Obstruction.** An artificial object (house, shed, ball washer, etc.) on the golf course.

**Out-of-bounds.** Area that is not part of the golf course.

**Par.** Standard score set for a hole.

**Path.** Direction in which the club is swung.

**Provisional Ball.** A second ball hit when the first ball is thought to be lost or out-of-bounds.

**Pull.** Starting direction of the ball to the left (right-handed player) of the desired target area.

**Push.** Starting direction of the ball to the right (right-handed player) of the desired target area.

**Rough.** The long grass parallel to the fairway.

**Slice.** Curvature of the ball to the right (right-handed player).

**Target Area.** Desired landing area for the ball.

**Tee.** A peg on which the ball may be placed on the teeing area.

**Tee Area.** The designated area for beginning each hole.

**Unplayable Lie.** A position of the ball from which it may be difficult to hit.

### REFERENCES

National Golf Foundation. *Golf Instructor's Guide*. North Palm Beach, FL: National Golf Foundation, 1980.

National Golf Foundation. *Twelve Golf Lessons*. North Palm Beach, FL: National Golf Foundation, 1980.

Owens, DeDe. "Analysis of Amputee Golf Swings." Unpublished Ph.D. diss., University of Virginia, 1980.

Toski, B., and Flick, J. *How to Become a Complete Golfer*. Westport, CT: Golf Digest Book Service, 1978.

*back bend (p. 161)*  
*back extension (p. 157)*  
*back handspring (flip-flop) (p. 170)*  
*back walkover (p. 166)*  
*backward roll (p. 154)*  
*bridge kick-over (p. 161)*  
*cartwheel (p. 158)*  
*forward limber-over (p. 162)*  
*forward tuck roll (p. 153)*  
*front handspring (p. 164)*  
*front walkover (p. 163)*  
*handstand (p. 155)*  
*headstand (p. 154)*  
*movement sequence (p. 151)*  
*round-off (p. 159)*  
*Tinsica (p. 169)*  
*valdez (p. 168)*

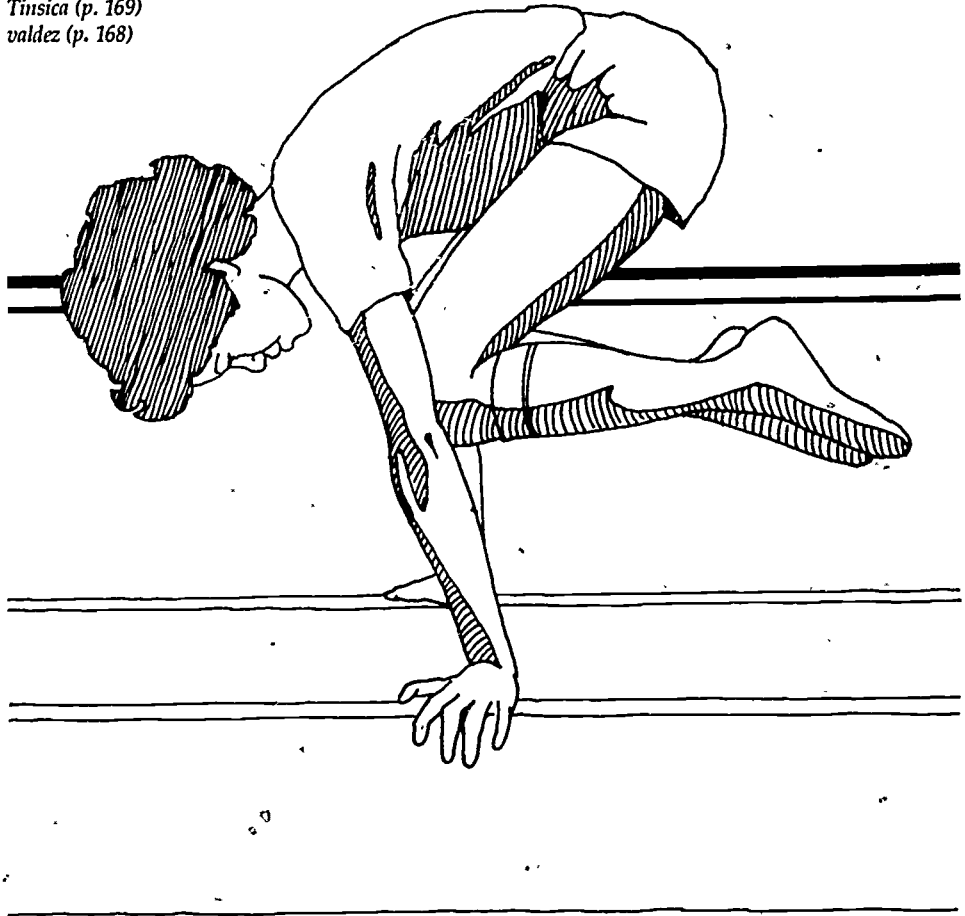

# Tumbling

DIANE BONANNO,  
Rutgers University,  
New Brunswick, NJ  
and

KATHLEEN FEIGLEY,  
Feigley's School of Gymnastics,  
South Plainfield, NJ

## INTRODUCTION

Tumbling is a series of self-testing activities which offer the discovery and expansion of movement capabilities in a challenging and exciting setting. Unlike many other sports, tumbling is not only a competitive activity but a self-improvement activity as well. The goal of tumbling is to develop overall performance by increasing an individual's strength, flexibility, power, endurance, balance, agility, and coordination. This occurs through the use of prescribed exercises or skills which range in difficulty from a basic balance like the front scale to a difficult twisting maneuver like a twisting back somersault.

Over the years a wide variety of skills and apparatus have been developed to assist the person in discovering and expanding movement capabilities. The basic forward roll, for instance, has at least twenty variations which can be used to add variety and challenge when learning a basic forward rotary movement. Tumbling offers something for everyone regardless of entry level. If patient and diligent when working through the progressions provided by the instructor, many things can be accomplished that at first seemed impossible.

Media coverage of gymnastics in the Olympics has given a glimpse of what the sport is like at advanced levels, but what is not unattainable. Gymnastics covers a wide range of activities and is, in fact, several sports rolled into one. There is tumbling, vaulting, the balance beam, rings, uneven bars, the horizontal bar, and the

sidehorse, each of which requires special abilities. Regardless of the one you choose recognize that a strong tumbling background is important.

## SKILLS AND TECHNIQUES

### MOVEMENT SEQUENCES

The sole purpose of any tumbling routine is to provide the performer with an organized means of demonstrating control of the body while moving through space at varying speeds and different levels. A truly good routine will be composed of small units of activity which emphasize varying degrees of difficulty in the areas of flexibility, agility, power, strength, endurance, and balance. In combination, these smaller units, which are known as movement sequences, represent the totality of an individual's movement capabilities.

Like the sentences in a paragraph these movement sequences are composed of many separate elements. If the elements in the sequence, like the words in a sentence, are carefully chosen and placed in the proper order, they will permit the creator or in this case the tumbler to effectively communicate to the audience.

To be effective, each movement sequence in a routine should include at least four of the elements listed below:

- locomotor movements which can be performed
  1. forward, backward, or sideward.
  2. at a high, medium, or low level.
  3. fast, medium, or slow.

4. on different parts of the body.
5. along different pathways (straight, zig-zagged, or curved).
- nonlocomotor movements (bending, stretching, twisting, curling, etc.) which can be performed
  1. rhythmically or arrhythmically.
  2. at a high, medium, or low level.
  3. by a varying number of body parts.
  4. symmetrically or asymmetrically.
  5. at a fast, medium, or slow pace.
- balances which can be performed
  1. at a high, medium, or low level.
  2. with any number of points of contact with the floor.
  3. in a symmetrical or asymmetrical position.
  4. in different body positions (inverted, sideways, etc.).
  5. in different styles (angular, straight, rounded).
- flexibility movements which can be performed
  1. while moving or stationary.
  2. in the air or in contact with the ground.
  3. using different joints.
- strength movements which can be performed to show strength of different body parts
  1. in a slow sustained manner or an explosive manner.
  2. by moving slowly through the range of motion or by holding a specific position.
- rotary movements which can be performed
  1. at a high, medium, or low level.
  2. in different directions.
  3. in contact with the floor or freely in the air.
  4. at different speeds.
- springing movements which can be performed
  1. at a high, medium, or low level.
  2. from many different body parts.
  3. in different directions.

Below are three movement sequences which are written in general terms. Think about each element that is listed. Next to each one write a skill that you can do in order to accomplish that element. Practice the sequence as you have written it. When

you can move from one element to the next in the first sequence so that your movements are fluid, work on sequence number two and then three until you can perform them with equal success. When you have completed each sequence write your own in the fourth space provided, then connect all the sequences together so that you can move from sequence number one to sequence number four without stopping. When you are finished you will have completed a tumbling routine.

- I. Movement Sequence Number One.
  - A. From a stand move slowly into a one-point balance.
  - B. Do a rotary movement into a balanced position.
  - C. Spring to a balanced position at a high level.
  - D. Do a forward locomotor movement for at least three beats.
  - E. Do a symmetrical jump.
  - F. Do a rotary movement backward.
  - G. Do a two-point balance at a medium level.
- II. Movement Sequence Number Two.
  - A. Do a movement which demonstrates flexibility of some joint.
  - B. Do an inverted balance position, hold for three beats, rock, or roll out.
  - C. Spring, and do a one-half turn in the air.
  - D. Do a rapid forward locomotor movement.
  - E. Move sideways in an inverted position.
  - F. Balance at a low level.
- III. Movement Sequence Number Three.
  - A. Spin out of a low level pose into a high level pose.
  - B. Do a rapid forward locomotor movement, changing types of movement at least twice.
  - C. Do a movement onto the hands, with the feet momentarily leaving the ground.
  - D. Do a half turn.
  - E. Do a backward movement onto the hands with the feet momentarily leaving the ground.
  - F. End in a movement which demonstrates flexibility of the legs.

**Performance Checklist**

Ask your partner to watch your routine and evaluate your performance according

to the guidelines provided below. Be sure they include comments for each category.

	<i>Good</i>	<i>Fair</i>	<i>Needs Improvement</i>
1. Were the movements creative?	_____	_____	_____
2. Were the movements performed with maximum amplitude (with greatest stretch or height possible)?	_____	_____	_____
3. Were the movements controlled (performed without a wobble)?	_____	_____	_____
4. Was the sequence performed fluidly?	_____	_____	_____
5. Were the movements compatible (was it easy to go from one to the next; was extra movement needed)?	_____	_____	_____

G. Move to a balance which demonstrates abdominal strength.

**IV. Movement Sequence Number Four.**

- A.
- B.
- C.
- D.
- E.
- F.

6. Keep the hands reaching forward as though you were going into another roll so that you can stand up.

**B. Spotting.**

A spotter can assist the beginner by placing a hand behind the performer's head to ensure that it is tucked.

**C. Self-analysis.**

**TUMBLING SKILLS**

**I. Forward Tuck Roll.**

**A. Description.**

1. From a stand, squat, and place the hands on the mat, shoulder width apart approximately one arm's length from the feet.
2. Place the chin on the chest and elevate the hips.
3. Push off by extending the legs while placing weight on the hands.
4. As the hips come forward overhead use the arms to gently lower the shoulders, keeping them rounded back, to the mat.
5. Remaining in a tight tuck, with the heels close to the buttocks, continue rolling onto the feet.

*Yes No*

1. Were the hands properly placed in front of the body? — —
2. Did the hips elevate before moving forward? — —
3. Was the head tucked? — —
4. Did the arms lower the body to the floor with the shoulders making the first contact? — —
5. Was the performer able to stand without having to touch the floor with the hands? — —

**D. Variations.**

1. Straddle to tuck.
2. Lunge to tuck (the straight leg should be dragged across the floor until it meets the oppo-



site leg which is now also extended.

3. Pike to tuck.
4. Straddle to straddle. (stay *tightly* compressed throughout the roll and use the hands in between the legs to return to the straddle stand).
5. Pike to pike.

## II. Backward Roll.

### A. Description.

1. From a stand, squat and place the hands slightly above the shoulders with the palms facing the ceiling.
2. Rest the chin on the chest, with the forehead toward the knees; keep the elbows close to the body.
3. Remaining in a tight tuck, rock backward onto a rounded back (be sure not to open).
4. As soon as the palms contact the floor push against the floor while extending the elbows (remember to keep the elbows close to the body).
5. While pushing with the arms, quickly place the feet on the floor directly overhead (avoid shooting the feet into the air).
6. As soon as the feet are firmly on the floor and your head is free, immediately rise to a stand.

### B. Spotting.

1. Kneel at the performer's side.
2. The spotter should place the hand closest to the performer's back on the performer's near hip. As the roll begins and the hips start off the floor the other hand reaches around the performer's back to grasp the other hip.
3. To prevent any strain on the neck, the spotter should perform a lifting action of the hips as the hips rise above the shoulders and the body passes over the neck.

### C. Self-analysis.

- |   | Yes | No |
|---|-----|----|
| 1. Was the body tightly tucked at the beginning of the skill? | —   | —  |
| 2. Did the body remain tightly tucked throughout the skill?   | —   | —  |
| 3. Did the elbows remain close to the body throughout?        | —   | —  |
| 4. Did the arms push evenly after contact with the floor?     | —   | —  |

### D. Variations.

1. Tuck to tuck.
2. Tuck to straddle.
3. Tuck to straight leg (pike).
4. Straddle to straddle.
5. Straddle to straight leg (pike).
6. Straight leg to straight leg (pike).
7. Tuck to knee scale.
8. Tuck to front scale.

## III. Headstand.

### A. Description.

1. Start in a lunge position (see Figure 1), and place the hands and front knee on the floor. The hands should be placed under the shoulders in line with the knee.
2. Place the hairline on the mat so that it forms the top of an equilateral triangle ▲ which is made by the hands and head. Be sure you can see your hands.
3. Slide the straight leg forward until the hips are above the head then slowly, with control, lift the leg to a vertical position as the bent front leg begins to straighten and slowly joins the other leg in the vertical position. As you do this you will feel your weight shift from the hairline to the top of the head. Keep the neck straight throughout this movement.

4. Use the fingers and heels of the hands to maintain balance.
5. In case of overbalancing or as an alternate means of coming down, pull the chin toward the chest, bend at the hips, and pike the legs toward the face and continue rolling to a stand.

#### B. Spotting.

1. Stand close to the performer facing his/her side.
2. Grasp the performer's leg as it hits the vertical position, thereby aiding in balancing.
3. If the performer chooses to roll out, the spotter should keep the legs in a vertical position until the performer can lower them in a controlled manner to a tight compression (verbally instruct them to maintain straight knee position to avoid injury).

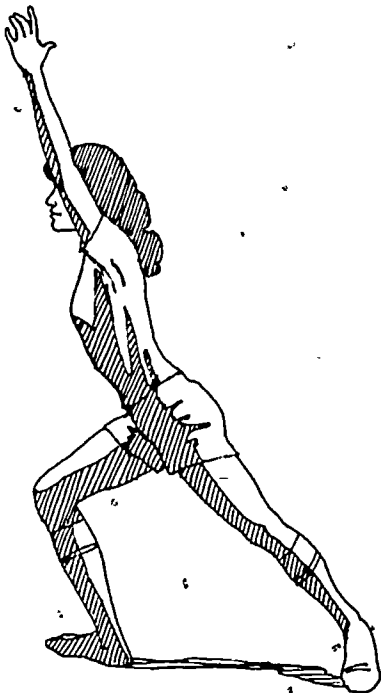

Figure 1. The lunge position.

#### C. Self-analysis.

- |  | Yes | No |
|--|-----|----|
| 1. Did the hands and head form an equilateral triangle?  | —   | —  |
| 2. Were the hips placed directly above the head?   | —   | —  |
| 3. Did the neck remain straight throughout (or did a relaxed neck cause a roll-out or arch to occur)?  | —   | —  |
| 4. Did the legs lift in a controlled manner?   | —   | —  |
| 5. Was the performer's body absolutely straight at the top of the headstand or was there a pike or arch that pulled the headstand off-balance? | —   | —  |
| 6. If the performer chose to roll out was it with control and straight legs?   | —   | —  |

#### D. Variations.

1. Tripod to headstand, forward roll.
2. Tip up to headstand, forward roll.
3. Kick up to headstand, forward roll.
4. Kick up to headstand, to stag (pose), forward roll.
5. Kick up to headstand, to double stag, forward roll.
6. Straddle to headstand, forward roll.
7. Drag-up headstand (start in a prone position and with the hands by the shoulders, drag the hips over your head; the legs should remain straight throughout), and without bending the legs bring them up over the hips.

#### IV. Handstand.

##### A. Description.

1. From a standing position step forward through a lunge position, (the arms should remain overhead).

2. Bend forward at the waist while lifting the back leg and placing the hands on the floor approximately two feet ahead of the forward leg and shoulder width apart.
3. Gently push off the forward leg, while continuing to lift the back leg until the legs meet in a vertical position. The arms must remain perfectly straight throughout.
4. The head should be in a neutral position, not lifted or tucked, with the eyes focused on the floor between the hands. The back should be perfectly flat with no pike or arch.
5. To return to a stand the performer can split the legs and step back down to a lunge position or, bend the arms, tuck the head, and slowly, with control, lower the body to a forward roll with the legs remaining straight.

#### B. Spotting.

1. The spotter should stand slightly back from where the performer will place the hands and slightly to the side. (It is better to be too far than too close to the performer as it is easier to move forward to compensate for the distance than back.)
2. As a performer kicks to a handstand the spotter reaches forward and grasps the performer's thigh with both hands to keep the performer from going over and to help support the performer's weight.
3. Under no circumstances should the performer's leg be pulled into a vertical position if he/she does not have enough leg lift.
4. If the performer chooses to step down, the spotter can shift the hand nearest the

belly side of the performer to under the performer's stomach to help lower him/her down. If the performer chooses to roll out, the spotter should remain in contact with the performer's thigh, lifting up to support as much of the performer's weight as possible as the roll-out occurs. (Remind the performer to roll slowly, tuck the head, and keep the knees straight.)

#### C. Self-analysis.

- |   | Yes | No |
|---|-----|----|
| 1. Did you begin in a perfect lunge?  | —   | —  |
| 2. Did you move your body toward the mat in a straight line position?   | —   | —  |
| 3. Did you lift your lead leg into place?   | —   | —  |
| 4. Did you maintain a straight body position while upside down?   | —   | —  |
| 5. Were you able to hold your balance for at least three seconds without breaking form or moving hand position? | —   | —  |

#### D. Variations.

1. Handstand to stag pose.
2. Handstand to double stag pose.
3. Handstand snap down.
4. Forward roll to a handstand forward roll.
5. Headstand, pop into a handstand (draw knees to chest before popping legs upward).
6. Backward roll to immediate handstand (back extension).
7. Side handstand (half a cartwheel).
8. Handstand chest roll.
9. Handstand to a split.
10. Handstand pirouette.
11. Press up handstand.

V. Back Extension.

A. Description:

1. From a standing position, bend the knees and squat to a tuck position. The arms should move from a stretched overhead position to a bent position slightly above the shoulders with the palms facing the ceiling.
2. As in the backward roll, the chin should be toward the chest, the elbows close to the body, and the back should remain rounded to make the rolling action easier.
3. Begin to roll backward while remaining in a tight tuck. As the hands contact the floor, extend the elbows so that they are totally straight. At the same time open the hip angle and shoot the legs straight toward the ceiling to end in a handstand, split the legs, and step down to a stand. (If the timing is correct you will extend your body slightly before the vertical position is attained because the backward momentum will carry you right to the vertical by the end of your extension. The total opening action should have an explosive quality.)
4. Key timing and execution problems to look for: if you are short of the handstand or falling back toward the direction from which you started, then your push is premature; if you are over or beyond the handstand your push was too late and/or too slow; lifting your head as you open will cause an undesirable arch instead of a straight body handstand.

B. Spotting.

1. Stand to the side of the performer near the spot where

his/her hands will make contact with the floor.

2. Watch for the hands to contact the floor and immediately grasp the performer's closest thigh with both hands.
3. Exert your force upward to help the performer reach a balanced handstand position. Support the performer's weight in case the arms do not straighten quickly or completely.
4. Be aware that:
  - a. An early push by the performer may cause him/her to be falling toward the back. By grasping the thigh early you can pull the performer to a handstand or quickly instruct him/her to tuck the head and roll out as you lower him/her to the floor.
  - b. A late push would cause the performer to land in a push-up position. You can prevent this by picking the thigh up early and also by giving a verbal cue, e.g., "now," so that the performer learns to push as the hands contact the floor. If the performer has already passed the vertical position, quickly shift your hand that is on the front of the thigh to the performer's waist to break the fall and allow them to step down.

C. Self-analysis.

- |  | Yes | No |
|--|-----|----|
| 1. Was the body tightly tucked at the beginning of the skill?          | —   | —  |
| 2. Were the elbows held close to the body throughout?                  | —   | —  |
| 3. Did the legs shoot upward as the hands made contact with the floor? | —   | —  |

4. Did the legs shoot up — — toward the ceiling  
     (not toward the front or back wall)?
5. Did the legs and body — — straighten explosively?
6. Did the arms push — — evenly?

#### D. Variations.

1. Tuck to extension and snap down.
2. Tuck to extension, and walk out (one leg comes down at a time).
3. Tuck to extension, and roll out forward.
4. Straddle to extension.
5. Pike to extension.
6. Tuck to extension to split.
7. Tuck to extension to double leg shoot-through.

### VI. Cartwheel.

#### A. Description.

1. This entire skill will be performed with the body traveling sideward along a straight line.
2. Perform a sideward lunge and place the closest hand on the floor arm's length from and in line with the bent front lunge leg. At the same time lift the straight rear leg overhead toward the ceiling.
3. As the bent front leg extends and pushes from the floor, the second hand should now make contact with the floor along the same straight line at a minimum of shoulder's width from the first hand; the body should now be in a straddled handstand.
4. Your momentum should continue to pass smoothly through the vertical position as the first leg over the head contacts the floor. The first hand down will now lift off the floor and straight over the head. Then the second hand

will lift off over the head, and finally the pushing leg will land on the floor along the same straight line.

5. This entire wheeling action should have a 1,2,3,4 rhythm (hand, hand, foot, foot).
6. The elbows must remain straight throughout, and the head should remain in a neutral position, neither lifting upward nor with the chin in a tucked position.
7. The path of your cartwheel should be on a very straight line and through a vertical position.

#### B. Spotting.

1. The front of the spotter's body should be facing the performer's back and the spotter should be positioned with the feet in a stride position at the approximate spot where the performer's hands will make contact with the mat.
2. As the wheeling action begins, the spotter should place the hand closest to the performer on the hip of the lunge leg. As the performer's hand contacts the floor the spotter should place the second or hand farthest away on the performer's other hip which will now be leading.
3. The spotter may have to actually grasp and lift the hips to help the performer attain the vertical position and to support the weight in case the performer bends the elbows.
4. Instruct the performer to remain tight and to keep the legs straight throughout the skill to prevent the spotter from being kicked by bent legs.
5. Guide the performer through the skill until he/she is standing.

Left-handed



Right-handed

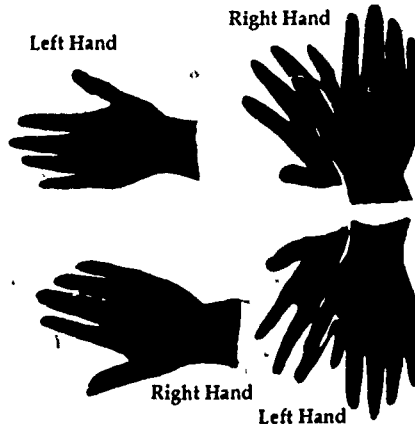

Diagram 1. Hand and foot placement for the round-off.

C. Self-analysis.

	Yes	No
1. Did you start in a perfect lunge?	—	—
2. Did you stretch forward as you went to place your hands down?	—	—
3. Did you maintain a wide straddle throughout?	—	—
4. Did you maintain an even tempo throughout, i.e., hand, hand, foot, foot?	—	—

D. Variations.

1. Cartwheel quarter turn at the end of the skill either in or out.\*
2. One-handed cartwheel with the near arm.
3. One-handed cartwheel with the far arm.
4. Cartwheel, close the legs in a handstand position at the top of the wheel.
5. Quarter turn at the start of the cartwheel.
6. Dive cartwheel.

1. A round-off begins in the same way a cartwheel does but builds much greater speed and the performer lands on two feet.
2. Start in a lunge position with the knee in front of the ankle so that your lower leg is at a 45° angle to the floor.
3. Hand placement is quite varied but in general the wider the hand placement the more power that can be exerted. The fingers of the first hand down should point toward your lunge leg, while the fingers of the second hand are facing the same direction as your back. Arms should remain next to the head throughout.
4. As the back leg drives over the head and the front leg pushes powerfully from the floor, the hands are placed on the mat along a straight line, while the head is kept in a neutral position throughout. Lifting the head creates an undesirable back arch.
5. The performer should push very hard off the lunge leg so it can meet with the other leg before the vertical position is

\*The easiest turning cartwheel to perform is one that begins with a one-quarter turn of the body in toward the direction you will go or ends with a one-quarter turn of the body back toward the direction from which you came.

attained. A pirouetting action or quarter-turn of the body occurs as the legs snap together. Quickly snapping the legs together will permit the trick to proceed at maximum speed.

6. As the feet contact the floor the arms should be continuing overhead and the body should now land facing the direction from which it came.
7. There are two very important methods of this last stage of the round-off called the snap-down.

- a. Block under—the feet are snapped down to the floor as close to the hands as possible so a backward momentum is continued so that a back hand-spring (this action should not be done unless a spotter is standing behind you to stop your momentum or unless you are continuing to another skill such as a back hand-spring).

- b. Block out—the feet are placed back away from hands so as to stop backward momentum and convert it to upward momentum. Blocking out would be used if the round-off were to be followed by a vertical jump or a somersault.

**B. Spotting.**

1. The spotter should stand on the same side as the performer's lead leg and in the approximate spot where the performer will place the hands.
2. Grasp the performer's second arm down with your near arm and place your far arm in the performer's hip area to assist in landing.

3. As the performer's feet contact the floor switch your far arm to the performer's back to prevent over-rotation.
4. An advanced spotting technique for a powerful blocked under round-off would be to stand to the side and behind where the performer's feet will contact the floor. As the legs pass by, you must quickly reach in and grasp the performer's waist to prevent over-rotation. Your nearest hand should go on the performer's closest hip. Your second hand should reach around back to the opposite hip. Be sure you are standing on the same side as the performer's lead leg and do not step in until the legs have passed you.

**C. Self-analysis.**

- |  | Yes | No |
|--|-----|----|
| 1. Did the skill begin in a good lunge position?   | —   | —  |
| 2. Were the hands placed wide apart?   | —   | —  |
| 3. Were the hands placed in the proper pattern?  | —   | —  |
| 4. Did the arms remain next to the head throughout?  | —   | —  |
| 5. Did the back leg kick quickly upward?   | —   | —  |
| 6. Did the front leg extend and push off forcefully?   | —   | —  |
| 7. Did the legs meet before they reached the vertical?   | —   | —  |
| 8. Did the pirouette begin as the legs snapped together?   | —   | —  |
| 9. Did the hands push off the floor and continue overhead as the feet made contact with the floor? | —   | —  |

## D. Variations.

1. Round-off, snap down.
2. Round-off, walk out.
3. Round-off, back extension.
4. One-handed round-off.
5. Round-off, flip-flop.

## VIII. Lead-ups for Limbers and Walkovers.

## A. Back Bend.

## 1. Description.

- a. Stand with the feet side by side and approximately shoulder width apart, with the arms stretched toward the ceiling, the stomach in, and the head facing forward.
- b. Stretch the fingertips up and back as you begin to arch the upper back. The head should move back with the arms as you begin to look for the floor.
- c. As you continue backward your lower back will arch. The knees and hips should not move forward but should remain directly over the base of support.
- d. The hands should contact the floor with control permitting the shoulders to move to a proper bridge position. The hands should be shoulder width apart.
- e. To return to a standing position rock the hips up and forward, taking care not to pike at the hips.
- f. Push from the hands as you rock forward, keeping the head back between the arms.
- g. Continue movement until you arrive back to the starting position described in "a."

## 2. Spotting.

- a. Stand to the side of the performer in a wide stable stance.

- b. Place your far arm behind the performer so that your arm stretches across the small of his or her back and your hand grasps the waist.

- c. The other arm should stretch across the front of the performer.

- d. As the performer reaches backward, gently lower him/her to the mat and provide support in the bridge.

- e. As the performer returns to a standing position, give gentle assistance as the back and hips move upward and forward.

## 3. Variations.

A back limber could be performed following step "d" of "Description" by pushing off both feet simultaneously as the hips move up and back. As the body reaches a flat body handstand, pike at the hips and bring both feet to a standing position on the floor. Lift the chest, head, and arms to end in position "a" of "Description."

## B. Bridge Kick-over.

## 1. Description.

- a. Start in a bridge position with the feet on a raised surface such as a folded mat.
- b. Lift one leg toward the ceiling.
- c. Begin to bridge the shoulders (move the shoulders beyond the fingers, away from the folded mat), and gently lift the support leg off the mat as the body moves toward a flat back handstand with the leg in a split position. The arms should remain very straight throughout.
- d. While in a vertical position with the shoulders di-



rectly over the hands, rotate the hips toward the floor and bring the lead leg down as close to the hands as possible without letting the shoulders move from the position directly above the hands. Now lift the chest, head, and arms as the back leg lowers to a lunge position. (Allowing the shoulders to move forward during this last phase could cause the gymnast to collapse forward.)

2. Spotting.

Spotter #1

- a. Stand to the side of the performer so that you are facing the direction to which he/she will be kicking (face their hands with your back to his/her feet).
- b. Reach under the performer's body with the arm that is closest to his or her hip and grasp the waist.
- c. Place the other hand on the hip that is closest to your body.

Spotter #2

- a. Stand to the side of the performer so that you are facing the direction to which he/she will be kicking (face their hands with your back to his/her feet).
- b. Reach under the performer's body with the arm that is closest to his or her hip and grasp the waist.
- c. Place the free hand under the performer's shoulder to stop the arms from collapsing during the skill.
- d. As the performer kicks over, lift the hips up and gently rotate forward.

IX. Forward Limber-over.

A. Description.

1. Begin as you did in the handstand. Upon reaching the vertical position, attempt to move your shoulders back toward the direction from which you came, so that your shoulders are now behind your wrists (this bridging action will permit a soft, controlled landing).
2. Continue your forward momentum as you arch your lower back and place the feet softly on the floor in a bridge position with the hands as close to the feet as possible without an extreme back arch. Ideally the feet will be placed side by side but as a beginner you may have to place the feet shoulder width apart. Your knees should be only slightly bent upon contact with the floor.
3. Your hips should continue to move upward and forward, with your head back. The arms remain next to the head as you rise to a stand (be sure to keep the head back until the hips are over your base of support).

B. Spotting.

1. The spotter stands to the side of the performer's path of action and, as in the spot for the handstand, grasps the performer's nearest thigh.
2. As the performer safely reaches the vertical position the spotter's hand on the back of the leg slides down the body to the middle back, while the hand on the front of the thigh moves to grasp the performer's nearest upper arm (during this phase it will be necessary for the spotter to bend the knees or widen the stance to stay in contact with the performer).
3. Use the hand under the performer's back to assist in lift-

ing the hips up and forward and the hand on the upper arm to assist with the forward lifting momentum and to keep the arms in line with the head. The hand on the upper arm can also be used to pull the performer's weight backward if over-rotation is occurring as the performer is returning to a standing position.

4. Another advanced method of spotting could be used after the performer is capable of attempting the skill with less physical lifting and is ready for more assistance with the correct technique. This method would have the spotter kneeling next to the performer and placing the farthest hand on the performer's shoulder, and the nearest hand on the performer's waist. The spotter would then assist the performer in feeling the correct shoulder action by *gently* pushing the performer's shoulders back toward the direction from which they came.

C. Self-analysis.

	Yes	No
1. Did you begin in a perfect lunge?	—	—
2. Did you stretch for the mat with a straight body?	—	—
3. Did you move into a handstand position without an arch?	—	—
4. Did you rely on an upper back arch rather than a lower back arch?	—	—
5. When your feet landed did you push with your hands?	—	—
6. Did you watch your hands throughout the exercise?	—	—

7. Was your head the last body part to come up?

X. Front Walkover.

A. Description.

1. From a standing position, step forward through a lunge position, with the arms over the head. (It is best to step forward onto the leg on which you do the best side split.)
2. Bend forward at the waist while lifting the back leg and place the hands on the floor shoulder width apart approximately two feet ahead of the forward leg.
3. Gently push off the forward leg, while continuing to lift the back leg.
4. As the body moves toward a vertical position, keep the legs in a wide split and begin the shoulder bridging action as described in the limber-over, where your shoulders move back toward the direction from which you came. Your shoulders are now behind your wrists. Your elbows should remain very straight throughout the entire skill.
5. Continue the bridging action as you arch your back and place your lead leg on the floor as close to your hands as possible without an extreme arch, and with your knee only slightly bent.
6. As you rise to a stand, your second leg should be held in a horizontal position or above, the hips should line up over the support leg with the stomach pulled in; the arms should remain by your ears, and your head should remain back until your weight is over your base of support. Then focus directly forward.

B. Spotting.

1. The spotter stands to the side

of the performer's path of action and as in the spot for the handstand, grasps the performer's nearest thigh.

2. As the performer safely reaches the vertical position the spotter's hand on the back of the leg slides down the body to the middle back, while the hand on the front of the thigh will move to grasp the performer's nearest upper arm (during this phase it will be necessary for the spotter to bend the knees or widen the stance to stay in contact with the performer).
3. Use the hand under the performer's back to assist in lifting the hips up and forward and the hand on the upper arm to assist with forward lifting momentum and to keep the arms in line with the head. The hand on the upper arm can also be used to pull the performer's weight backward if over-rotation is occurring as the performer is returning to a standing position.
4. Another advanced method of spotting could be used after the performer is capable of attempting the skill with less physical lifting and is ready for more assistance with the correct technique. This method would employ the spotter in a kneeling position next to the performer and placing the farthest hand on the performer's shoulder, and the nearest hand on the performer's waist. The spotter would then assist the performer in feeling the correct shoulder action by gently pushing the performer's shoulders back toward the direction from which they came.

#### C. Self-analysis.

- |   | Yes | No |
|---|-----|----|
| 1. Did the body begin in a good lunge position?                             | —   | —  |
| 2. Were the hands placed approximately two feet ahead of the forward leg?   | —   | —  |
| 3. Were the hands shoulder width apart?                                     | —   | —  |
| 4. Did the front leg push off as the hands made contact with the floor?     | —   | —  |
| 5. Did a bridging action take place?  | —   | —  |
| 6. Was there a <i>wide</i> split throughout?                                | —   | —  |
| 7. Did the elbows remain straight throughout?                               | —   | —  |
| 8. Did the lead leg land on the floor close to the hands?                   | —   | —  |
| 9. Was the trailing leg held in a horizontal position upon landing?         | —   | —  |
| 10. Did the head remain back until the weight was over the base of support? | —   | —  |

#### D. Variations.

1. Front scale, front walkover.
2. Front walkover, forward roll.
3. Front walkover, front walkover.
4. Front walkover, split.
5. Front walkover, handstand double stag, roll-out.

#### XI. Front Handspring.

##### A. Description.

1. From a standing position, step forward to a lunge with the knee ahead of the foot.
2. Bring the hands quickly to the floor without breaking the shoulder angle and with the back in a hollow position (shoulder blades spread, stomach in). The hands must contact the floor before the

- forward leg straightens; otherwise a diving action onto the hands will occur and this is not desirable in the front handspring.
3. As your hands are beginning to contact the floor you must already be anticipating pushing off the mat so you can push immediately upon contact. At the same time your back leg should be driving straight overhead and your forward leg should be extending and pushing powerfully from the floor.
  4. Your legs should join before attaining the vertical position if you are performing a two-foot landing. If you are doing a one-foot landing you should feel almost a stopping action of the first leg before the vertical position is attained. (To avoid pressure on the lower back it is recommended that the beginner learn this skill by landing on one foot, or landing on a soft mat with the assistance of a spotter.)
  5. The push-off should be before the vertical position is attained so that flight (a moment in the air without floor contact by the hands or feet) occurs after the push but before the feet land.
  6. The landing should be such that the foot or feet are directly underneath the hips. The arms should remain stretched beside the head at all times. The head should remain back until the very end when a shift is made to a forward focus. (Never tuck the chin as this breaks the body line and cuts off rotation causing a sitting action at the end of the skill.)
- B. Spotting.
1. The spotter stands to the side of the performer's path of action and, as in the spot for the handstand, grasps the performer's nearest thigh.
  2. As the performer safely reaches the vertical position the spotter's hand on the back of the leg slides down the body to the middle back, while the hand on the front of the thigh moves to grasp the performer's nearest upper arm (during this phase it will be necessary for the spotter to bend the knees or widen the stance to stay in contact with the performer).
  3. Use the hand under the performer's back to assist in lifting the hips up and forward and the hand on the upper arm to assist with forward lifting momentum and to keep the arms in line with the head. The hand on the upper arm can also be used to pull the performer's weight backward if over-rotation is occurring as the performer is returning to a standing position.
  4. Another advanced method of spotting could be used after the performer is capable of attempting the skill with less physical lifting and is ready for more assistance with the correct technique. This method would have the spotter kneeling next to the performer and placing the farthest hand on the performer's shoulder, and the nearest hand on the performer's waist. Assist the performer in feeling the correct shoulder action by gently pushing the performer's shoulders back toward the direction from which they came.
- C. Self-analysis.

Yes No

1. Did the body begin in

a good lunge position?

2. Did the hands come to the floor quickly
  - a. without breaking the shoulder angle? — —
  - b. with the back in a hollow position? — —
  - c. before the forward leg straightened completely? — —
3. Did the straight leg whip upward and forward forcefully? — —
4. Did the legs join together before either reached the vertical position? — —
5. Did the push-off occur before the vertical position was attained? — —
6. Did the arms remain stretched alongside of the head throughout? — —
7. Did the head remain back until the landing? — —
8. Upon landing did the head shift forward (but not downward)? — —
9. Was there an extended air moment (time when the hands and feet are off the floor simultaneously)? — —

D. Variation.

1. Handspring walk-out.

XII. Back Walkover.

A. Description.

1. Start from a standing position on one leg (the support leg) with your other leg lifted off the floor (the lifted leg should be the leg on which you do your best split). The arms should be stretched over the head, the support leg straight, and the stomach and

back muscles pulled tight without any arch or sag.

2. As you begin to arch backward you should feel as though you're going up and back as opposed to straight down and back. Start by lifting your free leg, slightly arching your back, lifting your arms up and back, as your head watches your fingertips stretch toward the floor. The support leg should remain straight throughout and the hips should remain over the support leg without moving forward.
  3. The hands should contact the floor softly, shoulder width apart, and as close to the support foot as possible without an excessive lower back arch.
  4. As the hands contact the floor, the shoulders should be in a good bridge position so that the support leg can just gently and with control lift off the floor.
  5. As you pass through the vertical position, your back should straighten as the shoulders are extended. The head should be in line with the straight arms, and the legs should be in a wide split (see Figure 2).
  6. Continue your movement through the vertical position as your hips tilt toward the floor and the lead leg keeps stretching toward a spot on the floor approximately 1-2 feet from the hands. Land on one leg with the free leg held up as the arms, chest, and head lift as one unit to the vertical position.
- B. Spotting.
1. Stand to the side of the performer facing the performer's shoulder.
  2. Reach across the small of the performer's back and grasp

the performer's waist with your far arm.

3. The spotter on the lead leg side should place the hand under the performer's thigh.



Figure 2. The back walkover.

4. As the performer reaches backward gently lower the hands to the mat.
5. Assist the lead leg as needed.

C. Self-analysis.

	Yes	No
1. Was the body stretched throughout the skill?	—	—
2. Was the lead leg straight throughout the skill?	—	—
3. Were the shoulders in a good bridge when the hands made contact with the floor?	—	—
4. Did the head stay even with the arms throughout?	—	—
5. Was a wide split maintained?	—	—
6. Did the hands land softly on the mat?	—	—
7. Was the skill performed smoothly?	—	—
8. Did the hands push off of the mat?	—	—

D. Variations.

1. Back walkover to front scale.

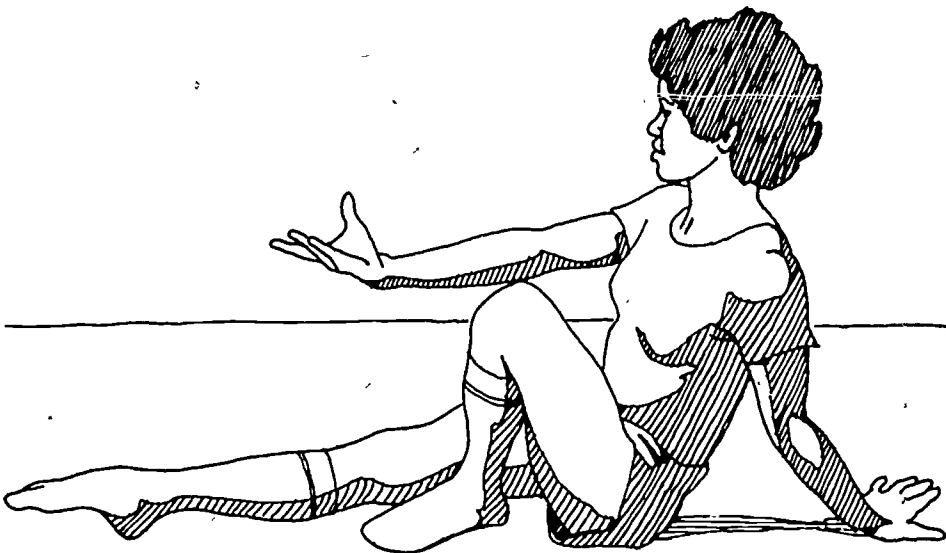

Figure 3. The valdez.

2. Back walkover to split.
3. Back walkover to chest roll (stop in handstand and chest roll-out).
4. Back walkover to kneeling pose.
5. Switch leg back walkover (lead leg stops when it is vertical to the floor; trailing leg bypasses lead leg and lands first).

### XIII. Valdez.

#### A. Description.

1. A valdez is a back walkover from a sitting position (see Figure 3). The leg you would normally lift first for a back walkover is the leg that should be extended while you are sitting. The other leg should be bent in a tuck position with your heel close to the body. The arm on the same side as the straight leg should be extended and held parallel to that leg. The other arm should be placed on the floor behind the back and held as close to the body as is comfortable with the fingers facing away from the body.
2. To begin the valdez, lift the straight leg up and back and while straightening the bent leg, lift the hips up toward the ceiling. Keep the head facing forward; do not look back immediately. Have the eyes follow the fingers of the forward arm.
3. The forward arm should lift straight up and back and then stretch toward the floor alongside the other hand. The main thing to remember with the back hand is to keep your elbow straight and gently let your wrist rotate so that your fingers slide to point forward when you pass through the vertical handstand position. The head should follow the

movement of the forward arm.

4. You will pass through a bridge position with one leg extended in the air; as you come to this point, you will bridge your shoulders allowing your support foot to gently lift off the floor. As the body moves to the vertical position, straighten the back, extend the shoulders, and continue as you would in a back walkover.
5. Place the foot on the floor by tilting the hips downward and stretching the lead leg toward the floor a few inches from the hands. Keep the shoulders over the hands and as the back leg comes down to lunge position lift the arms, head, and chest to a vertical position. (A lead-up for this skill would be to go from a sitting position to a bridge with the extended leg lifted and then return back to a sitting position. Concentrate on keeping the arms straight, going straight up and back as opposed to going around the side or pushing the hips forward. The spotter should be used for the first few attempts.)

#### B. Spotting.

1. Kneel next to the performer on the extended leg side.
2. Place the far hand on the performer's back at the top of the hips.
3. Place the near hand under the thigh of the extended leg.
4. As the performer lifts up and back, gently lift the hips and rotate backward.
5. Assist the leg when needed.

#### C. Self-analysis.

- |  | Yes | No |
|--|-----|----|
| 1. Did the head face forward as the hips moved upward? | —   | —  |

2. Did the straight arm stretch up and back before going toward the floor? — —
3. Did the back arm remain straight? — —
4. Did the lead leg remain straight throughout? — —
5. Did the bent leg extend vigorously? — —
6. Did the body move into a good "bridge" position, i.e., shoulders over the support hand? — —

#### XIV. Tinsica.

##### A. Description.

1. Begin as in the front walkover, from a standing position stepping forward through a lunge with the arms overhead.
2. The chest and arms lower to the floor as the rear leg lifts.
3. The hands are placed on the mat one at a time in a split position. The first hand contact is made by the same side as the forward lunge leg. The second hand should be placed along a line straight ahead of the first hand down and as far away from the first hand as possible. The fingers should be facing forward and the shoulders should be on a slight diagonal line.
4. As you reach the vertical position the back should be straight, the legs split, and the shoulders extended.
5. At the vertical position your shoulders will twist slightly back toward a normal handstand position. Then your shoulders will bridge as your first foot stretches toward the floor and the lower back arches slightly to pass through a bridge position. The first hand down lifts off

- the floor, followed by the second hand lifting off the floor.
6. You will rise to a stand as in the front walkover by aligning the hips directly over the landing foot, while keeping your head back, and the arms stretched alongside of the head. As you come to a stand your focus will move forward and the stomach muscles will be pulled inward to allow you to bring your second leg down with control.
  7. This skill has the rhythm of a cartwheel (hand, hand, foot, foot) and the appearance of a walkover.

##### B. Spotting.

1. The spotter stands to the side of the performer's path of action and, as in the spot for the handstand, grasps the performer's nearest thigh.
2. As the performer safely reaches the vertical position the spotter's hand on the back of the leg slides down the body to the middle back, while the hand on the front of the thigh moves to grasp the performer's nearest upper arm (during this phase it will be necessary for the spotter to bend the knees or widen the stance to stay in contact with the performer).
3. Use the hand under the performer's back to assist in lifting the hips up and forward and the hand on the upper arm to assist with forward lifting momentum and to keep the arms in line with the head. The hand on the upper arm can also be used to pull the performer's weight backward if over-rotation is occurring as the performer is returning to a standing position.
4. Another advanced method of spotting could be used after



the performer was capable of attempting the skill with less physical lifting and is ready for more assistance with the correct technique. This method would have the spotter kneeling next to the performer and placing the farthest hand on the performer's shoulder (upper back), and the nearest hand on the performer's waist. The spotter would then assist the performer in feeling the correct shoulder action by *gently* pushing the performer's shoulders back toward the direction from which they came.

C. Self-analysis.

- |   | Yes | No |
|---|-----|----|
| 1. Was the skill done in a four-count rhythm (hand, hand, foot, foot)?      | —   | —  |
| 2. Did the body begin in a good lunge position?                             | —   | —  |
| 3. Were the hands shoulder width apart?                                     | —   | —  |
| 4. Did the front leg push off as the hands made contact with the floor?     | —   | —  |
| 5. Did the bridging action take place?                                      | —   | —  |
| 6. Was there a <i>wide</i> split throughout?                                | —   | —  |
| 7. Did the elbows remain straight throughout?                               | —   | —  |
| 8. Did the lead leg land on the floor close to the hands?                   | —   | —  |
| 9. Was the trailing leg held in a horizontal position upon landing?         | —   | —  |
| 10. Did the head remain back until the weight was over the base of support? | —   | —  |

D. Variations.

1. This skill may also be done beginning in a complete sideward position as described in the cartwheel and at the vertical position shifting the hips and shoulders to finish as with a forward walk-over.
2. Tinsica right.
3. From a front scale.
4. To a front scale.

XV. Back Handspring (Flip-flop).

A. Description.

1. You can begin the flip with your arms in a variety of positions (overhead, forward at horizontal, or by the sides of the body). The important factor is that you do not let your chest come forward as you begin. For our purposes we will start with the arms at the sides since having the arms overhead sometimes gives the feeling of a lack of momentum

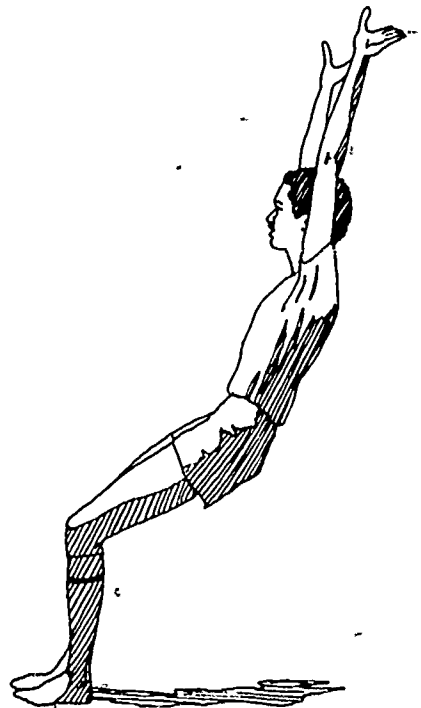

177 Figure 4. The fall for the back handspring.

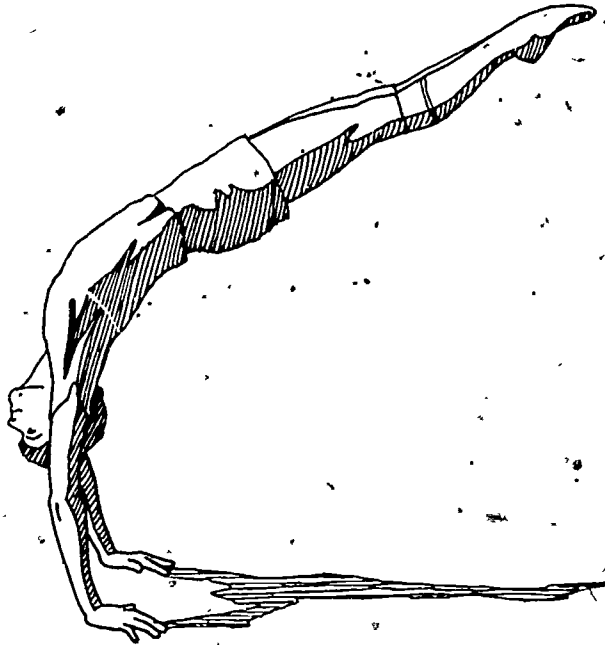

Figure 5. Contact with the floor in the back handspring.

and the arms in a horizontal position creates a down-up wind-up which usually causes the chest to move forward.

2. Standing with the arms at the sides begin to fall backward from your feet without letting your chest or knees come forward.
3. As you begin to fall bend your knees slightly to give power for the push-off (see Figure 4). Every body part should be behind your base of support.
4. Next you will very quickly and powerfully extend the knees and push from your feet as your arms are thrown overhead.
5. You should contact the floor with your shoulders over the hands, and the legs not quite vertical (see Figure 5).
6. The last and final phase is called the "snap-down." From a slight tight arch with the shoulder blades pinched,

move quickly to a hollow body position with the stomach in and the shoulder blades extended to a very broad position.

7. Where you snap your legs down to the mat will depend upon the trick that follows. As in the round-off if you wish to do a series of flip-flops you must "block under," i.e., bring the feet down very close to the hands to continue the backward momentum. If you plan to continue to a somersault or stop your momentum you must block out; put your feet far from the hands to convert your speed to an upward direction.
8. The verbal cues for the flip-flop are "Fall - Sit - Go!"
9. The verbal cues for the snap-down are "Arch-Hollow!"

#### B. Spotting.

1. Stand or kneel to the side and slightly behind the performer

so that you are facing his/her shoulder.

2. Place the far hand on the performer's back at the top of the hips.
3. Place the near hand under the performer's thigh.
4. As the performer begins the skill, gently lift and rotate the hips over.
5. Assist the thigh as necessary.
6. Be sure that the performer's hips are lifted high enough to allow him/her to place the hands down so that the shoulders are above them.

C. Self-analysis.

	Yes	No
1. Did the body fall backward from the feet rather than the waist?	—	—
2. Did the chest and knees stay behind the base of support (ankles) during the initial phase?	—	—
3. Did the body extend rapidly and powerfully?	—	—
4. When the hands made contact with the mat		
a. were the shoulders over the hands?	—	—
b. were the legs almost at a vertical position?	—	—
c. was the head facing the mat?	—	—
5. Did the head stay even with the arms throughout?	—	—
6. During the snap-down, did the body move to a "hollow" position?	—	—

D. Variations.

1. Back handspring, back handspring.
2. Back handspring, walk-out (one leg down at a time).
3. Round-off, back handspring.

**CONDITIONING**

To meet the physical demands of tumbling and to be successful in learning new skills it is essential that the performer achieve a certain degree of strength and flexibility. Since it will be necessary to constantly support your own weight while doing stunts like handstands and cartwheels, the minimum strength requirement would be the ability to support your own weight with your arms. Adequate strength not only permits you to perform your moves with control but ensures a greater degree of safety.

Flexibility, or range of motion of the joints, is another key component for safe and successful gymnastics. Flexibility not only protects your muscles from injury but is also essential for the performance of certain skills such as walkovers and splits.

In order to achieve the greatest degree of improvement, flexibility exercises should be performed daily and strength exercises performed a minimum of three times weekly. The exercises listed below are not warmup exercises but exercises that should be incorporated into a regular gymnastics conditioning program.

**ARM AND SHOULDER STRENGTH**

**Pull-ups**

From a straight hang on a bar with the hands in an overgrip, bend the arms and pull the body upward so that the chin is above the bar.

*Lead-ups*

1. Bent arm hang—have a partner lift you into a bent arm position and hold this position as long as possible not to exceed one minute.
2. Modified pull-ups—perform pull-ups on uneven bars with the feet resting on a low bar if you are not strong enough to lift the body weight from a straight hang.

**Push-ups**

In a prone position with the body totally straight, lower the body by bending the arms as close to the floor as possible; return to a straight elbow support.

*Lead-ups*

1. Assume the same prone position as

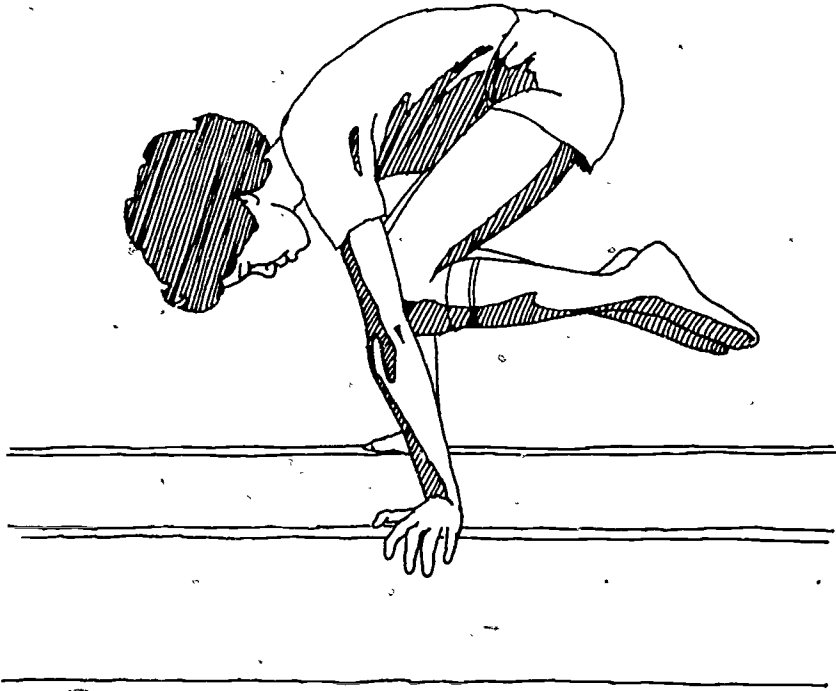

Figure 6. The planche dip.

- above and remain balanced in that position for 15-30 seconds.
- In the prone position as above, place the knees on the floor and lower and raise the body by bending the arms.

#### Variations

- With the feet on a raised surface so that the hips are over the shoulders, bend the arms to touch the head to the floor and return to support.
- While balanced in a headstand position, bend the legs slightly and push the arms straight to a handstand.

#### Dips

- Stand between parallel bars or between two beams placed approximately shoulder width apart and raised to at least elbow level.
- Jump to a straight arm support.
- Raise and lower the body by bending the elbows to a 90° angle.

#### Lead-ups

- Bend and straighten the arms only slightly until your strength is adequate enough to support a full range of movement.

- Jump up and down from the floor to a starting position (the performer can start with the bars low and eventually raise them to chest height).

#### Variation

- Planche Dip (see Figure 6)—dip with the legs in a tuck position in front of the body and with the hips raised so that the back is parallel to the ceiling. (A lead-up for a planche would be to just maintain the position without dipping.)

### ABDOMINAL STRENGTH

#### Sit-ups

The sit-up is one of the oldest yet most appropriate developers of abdominal strength.

- Lie on the floor, with the hands clasped behind the head, the knees bent, and the feet flat on the floor.
- Curl up starting with the head until the chest touches the thighs.
- Curl down starting with the lower back to a starting position.

#### Lead-ups

- Do sit-ups with a spotter holding your

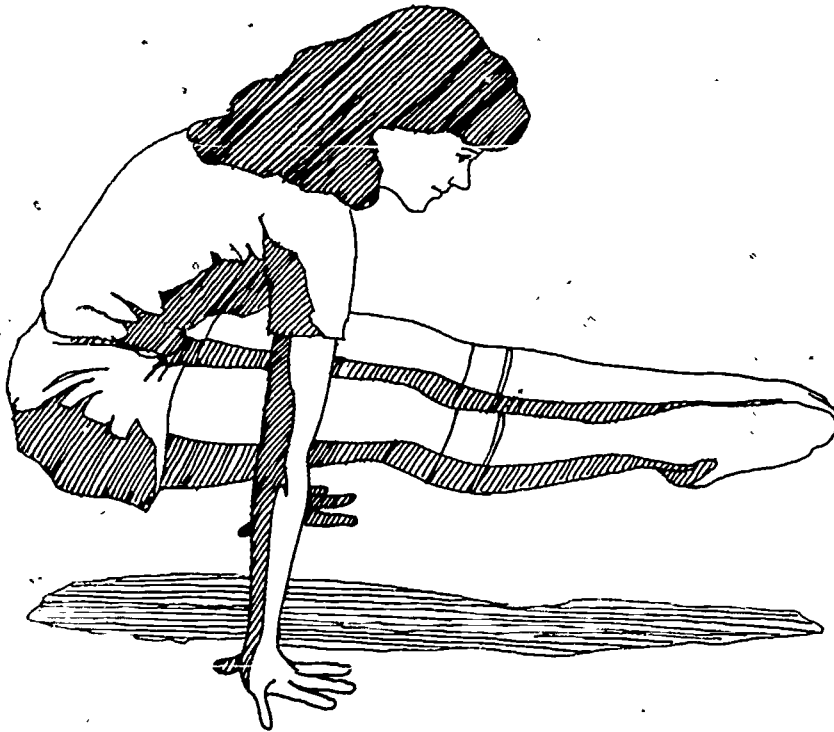

Figure 7. The L-hold.

hands and assisting in raising and lowering during the sit-up.

2. Do sit-ups with the hands overhead and use the momentum of the arms swinging forward to help lift the body.

*Variations*

1. Do sit-ups on a slant board with the head at a low portion of the incline board and the feet at a high portion.
2. V Sit-ups—with the hands behind the head and the legs straight, lift the head and chest at the same time as when lifting the legs to a V balance. (To increase difficulty of the V sit-up, raise to the V and lower to an open position where the shoulders and legs come within inches of the floor but do not touch.)

**L-Hold (See Figure 7)**

1. Sit on the floor in a pike position.
2. Place the hands next to the legs near the top of the thighs with the fingers pointing forward.
3. Lift the legs and rear from the floor so that the entire body weight is supported on the hands.
4. Hold the position as long as possible.

*Lead-up*

Perform the same exercise as above but with a spotter assisting with balance and support of weight by grasping the performer's toes and lightly lifting upward.

*Variations*

1. Straddle hold—same as the L-Hold except the legs are in a straddle position and the hands are placed between the legs instead of on the outside of the legs.
2. V-hold—after achieving the L position, shift the hips forward and the shoulders back to counterbalance and attempt to hold.

**Leg Lifts**

1. Start in a straight body hang with the hands on a sturdy bar raised high enough so that the feet cannot touch the floor.
2. Pike at the hips and lift the legs with the knees perfectly straight to touch the bar between your hands.
3. Slowly lower the legs back to a hanging position.
4. Attempt to use the abdominal muscles rather than to swing in this exercise.

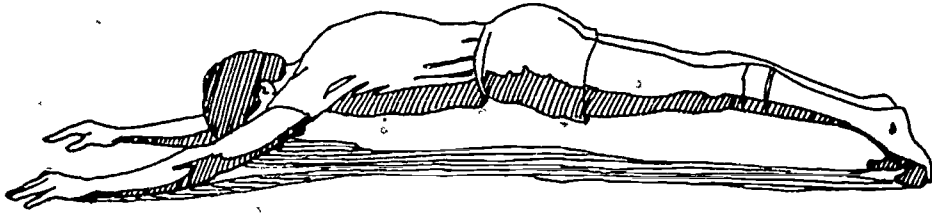

Figure 8. The push-out hold.

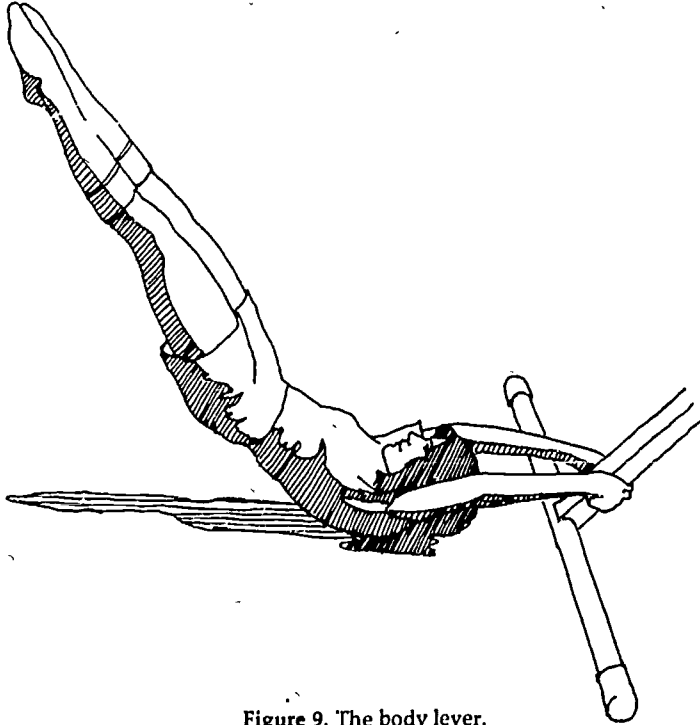

Figure 9. The body lever.

#### *Lead-up*

Perform the exercise as above but raise and lower the legs only to a horizontal position. Perform the leg lift with the spotter grasping under one thigh and helping to lift the legs and then, if possible, lower the legs alone.

#### *Variation*

Perform a leg lift in a straddle position so that when you lift the legs, your feet touch the bar on the outside of the hands.

### **GENERAL OVERALL BODY CONDITIONING**

#### **Push-out Holds (See Figure 8)**

1. Assume a push-up position.
2. Gradually extend the shoulder angle backward, so that the shoulders are

moving farther and farther beyond the hands (the feet will slide slightly backward).

3. Continue to push back until the shoulder angle is as straight as possible and your whole body as one straight tight unit is as close to the ground as possible without touching (see Figure 8).

#### **Chin-up Pullovers**

1. Start by hanging by the hands in an overgrip on a sturdy bar raised high enough so that the feet cannot touch the floor.
2. Bend the arms and pull the chin over the bar.
3. Immediately lift the legs straight up and over the bar you are holding onto, and end in a front support.

4. Bend the arms and slide down the bar with the chest toward the bar to return to the long hang position.

### Body Levers (See Figure 9)

1. From a supine position on the floor and with the legs straight, the arms straight overhead, the hands grasping the stable floor bar or a partner's ankles, lift tucked legs toward the ceiling so that a partner can grasp the ankles.
2. Attempt to slowly lower the body as a unit back to a starting position so that the feet, legs, and back touch the floor at the same time. (The only break in the body line should be at the shoulders. The arms should remain straight.)

## LEG STRENGTH AND POWER

### Straddle/Pike Jumps

1. Alternate jumping into the air with the legs straddled on the first jump and the arms stretched sideward to touch the toes.
2. On the second jump, lift the leg straight forward to a 90° angle pike position with the arms forward.

### Running

1. Running is still one of the best leg strength- and power-developing exercises. To increase leg strength and power it is best to do quick, short sprints, or alternate jogging with quick burst sprints.

## SAFETY

Tumbling is an activity which permits a person to experiment and discover the outer limits of his/her movement capabilities. As such, those who participate in the sport often find themselves moving through space or performing in a way that is unfamiliar to them. While experiencing something for the first time can be exciting, it can also be risky unless we take the proper precautions to protect ourselves.

Being cautious in tumbling means three things. First of all, it means being aware of the possible outcomes of an activity. Second it means being aware of the procedures that can be used to eliminate any negative outcomes associated with that activity and

third it means being alert and practicing safety.

For your safety and for the safety of those around you, become familiar with the safety checklist that follows and resolve to practice it regularly.

### BEFORE PERFORMANCE

#### Clothing Check

- Remove all jewelry, including rings and earrings when you perform.
- Be sure your hair is worn so that it does not block your vision or hamper your spotter's performance.
- Be sure to wear appropriate footwear. Heavy sneakers or shoes can be extremely dangerous to you and your spotter.
- Never have anything, i.e., gum, candy, in your mouth.
- Wear clothing that will allow you to perform freely.
- Wear clothing that is comfortable but not baggy. Baggy clothing makes it difficult to spot.
- Be sure your clothing is free of belts, buttons, rivets, or zippers.
- Eyeglasses should be secure.

#### Performance Area Check

- Be sure the area is sufficiently matted for the skill you are going to perform. As a general rule, the less familiar you are with the skill and/or the more difficult it is, the more matting you should have.
- Check the matting to be sure that it is not slippery and that it is free of faults such as rips or gashes.
- If using more than one mat be sure they are securely fastened together.
- Check the landing surface to ensure that it can absorb the weight of a landing or fall. After years of use, mats lose their resiliency and landing on them is like landing on the floor.
- Be sure tumbling strips or individual mats are placed in such a way as to permit ample space between each area for traffic or spotter movement.
- Be sure that mats are located a sufficient distance from walls or other pieces of apparatus.
- Check the area to be sure it is free of equipment that is not in use or is inap-

propriate, i.e., scooters, balls, equipment carriers.

- Be sure the pathway you have chosen for your tumbling run does not cross anyone else's pathway.
- When you are not performing be sure to first yield the right-of-way to performers using vaulting runways, tumbling areas, and landing mats.

#### Performer and Spotter Check

- Do not attempt a skill with a student spotter unless your instructor has given you permission to do so.
- Two spotters should be used at all times unless the use of two people interferes with the safe flow of movement.
- Be sure you have a thorough understanding of how to execute the skill.
- Determine whether you have the necessary prerequisites to safely perform the skill.
- Determine whether you are in the proper physical condition to safely execute the skill. Be sure your body is well-conditioned with regard to strength, flexibility, and muscular and cardiovascular endurance. Do not attempt a skill beyond your present physical ability.
- Be sure you understand the proper progression.
- Be sure your spotter knows what exercises you would like to try and that he/she knows how to spot the skill.
- Be sure your spotter is strong enough to spot a person of your size.
- Be sure you trust your spotter and that your spotter is confident in assisting you.

#### AT PERFORMANCE

##### Area Check

- Be sure the instructor is present in the gymnastics area.
- Be sure the instructor is aware of and has given you permission to attempt the skill you are about to perform.

##### Performer Check

- Warm up sufficiently.
- Stop and rest when you or your spotter become fatigued.
- Follow the progression step by step just as the instructor has outlined.
- Only attempt skills in which instruction has been given.

- Perform at your *own* level and not above, just because someone else is performing a skill.
- Always use a spotter.
- Follow a skill through to its completion; never change your mind in the middle of a movement, because you could seriously hurt yourself as well as your spotter.
- Be sure your spotter knows *exactly* when you are ready to begin.
- Use gymnastics chalk to keep your hands dry so that you won't slip.

### SCORING

The scoring system for gymnastics and tumbling has become quite elaborate, with competitors not only receiving credit for excellence of performance but also for originality and virtuosity. The highest possible score on each event is a 10.0. A woman can receive a maximum of 3.0 points for the difficulty of her routine, 0.5 for bonus points for original and risky moves, 2.50 for how well her routine is composed, and 4.0 for execution and virtuosity. A man receives 3.4 for difficulty, 1.6 for the value of his combinations, 4.4 for his manner of execution, and 0.6 bonus points for rare, original, or virtuous moves.

In a national level competition there are four judges who make deductions as the gymnast performs such errors as form breaks and falls, lack of amplitude (which includes stretch of the body and height of each move), insufficient difficulty, and lack of originality. The score of the high and low judge are dropped and the middle two scores are averaged to derive the gymnast's final score.

At the conclusion of the meet all the gymnasts' individual scores (4 for women and 6 for men) are added to determine what is called the gymnasts' all-around score. Next time you see a high level meet see if you can come up with a score by deducting .1 for every small error observed such as a flexed foot or a slightly bent knee, .2-.3 for a medium error such as a large arm bend or a very low leap and .5 for a major error such as a fall from the apparatus, then compare your score to the flashed score.



*cardiorespiratory fitness (p. 180)*  
*duration of training (p. 181)*  
*flexibility (p. 184)*  
*frequency of training (p. 180)*  
*frostbite (p. 187)*  
*heat exhaustion (p. 187)*  
*heat stroke (p. 187)*  
*individualization (p. 181)*  
*intensity of training (p. 181)*  
*muscular strength (p. 184)*  
*progression (p. 184)*



# Jogging

RUSSELL R. PATE,  
University of South Carolina,  
Columbia, SC

## INTRODUCTION

The jogger, once a rarity, has become a common sight on American streets. The decade of the 1970s witnessed a phenomenal growth in jogging participation, which has continued at a rapid pace. Approximately 30 million Americans jog regularly. Girls, boys, men, and women in all parts of the country have been attracted by the benefits of jogging, and can be seen loping on city streets, through suburban neighborhoods, and down country roads. Indeed, a visitor from a foreign country might well conclude that America has become a nation of joggers!

Jogging has become such a widespread fitness and recreational activity because of its great benefits for those who properly use it. However, like any activity, jogging can be misused or used without positive effects. The purpose of this chapter is to promote jogging and to provide the reader with the basic information necessary to design an effective jogging program. Following the guidelines outlined in this chapter will ensure the reader of jogging safely and in an enjoyable and beneficial manner.

## SKILLS AND TECHNIQUES

### FUNDAMENTALS OF JOGGING

Jogging is a familiar activity, and fortunately one which requires minimal skill. *Jogging is slow running.* It is similar to running in that, during each stride, both feet leave the ground for a brief period. In walking, one foot is always in contact with the ground (see Figure 1). Thus, unlike walking, both running and jogging have a "flight phase" (see Figure 2).

There are many different, individual styles of jogging. While there is no single

correct way to jog, there are certain basic principles which proper jogging styles have in common:

1. In jogging, as the foot comes forward to strike the ground, the heel should make contact first. Often this is difficult to see with the naked eye and it may appear that the foot is flat at contact. One should avoid "running on the toes" which involves contacting the ground with the ball of the foot. Such an approach can cause soreness and lower leg injury.
2. The jogger should maintain an erect posture, neither leaning backward nor excessively forward. The muscles of the

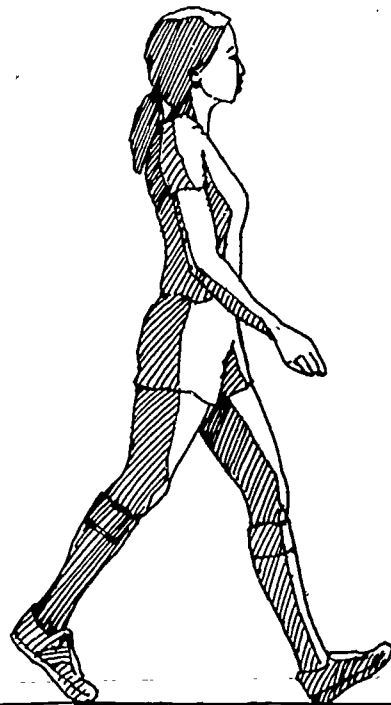

Figure 1. In walking one foot is always in contact with the ground.



**Figure 2.** In jogging and running, both feet leave the ground during a "flight phase."

trunk and neck should be as relaxed as possible.

3. The arms should be kept at a low carriage and should be permitted to move freely and to travel slightly across the front of the body. The arms, hands, and fingers should remain as relaxed as possible.
4. With jogging, only a moderate knee lift is required. The high knee lift used by sprint runners is too vigorous for long duration activities.
5. The jogger should breathe in a relaxed, natural manner. It is not necessary to consciously regulate breathing. One should breathe through both the nose and the mouth.

### BENEFITS OF JOGGING

There are many reasons why jogging has become one of the most popular fitness activities in America. One of the most important reasons is the increased recognition by the American public of the health benefits of regular aerobic exercise. Millions of people have initiated jogging programs because they feel that it can help reduce the risk of developing chronic diseases such as coronary heart disease, make them feel more lively and energetic, burn extra calories during a weight control program,

and improve their body composition and appearance.

The health benefits of aerobic exercise such as jogging are quite significant (see Chapter 1 for a more detailed discussion). Nonetheless, one might wonder why jogging, in particular, has become so popular? The answer may lie in the practicality of jogging:

1. *Jogging is an easy skill.* Nearly everyone can jog because running is one of the fundamental movement patterns that can be learned as a child.
2. *Jogging is inexpensive.* The only significant expense associated with jogging is the cost of proper running shoes. No expensive equipment or club memberships are needed.
3. *Jogging is an individual activity.* While it may be fun to jog with a partner or group, no partners are really needed. This means that one can jog whenever it is personally convenient without worrying about coordinating the activity with a friend. This is the major advantage jogging has over many other sport activities.
4. *Jogging requires no special facilities.* One can jog virtually anywhere: home; school; work. The only facilities needed are a place to change clothes and a facility in which to wash after jogging. With proper dress, jogging can be done outside year-round in most parts of the United States. Thus, no special tracks, gymnasias, machines, or courts are needed.

### DESIGNING A SUCCESSFUL JOGGING PROGRAM

A basic goal of any jogging program is to improve or maintain cardiorespiratory fitness. To achieve this goal a jogging program must be organized in accordance with certain basic principles of training. Important considerations are the frequency, duration, and intensity of exercise.

#### Frequency

Research evidence indicates that one must jog on an average of three or more times per week to be sure of developing and/or maintaining a good level of cardiorespiratory fitness. Two sessions per

week can help maintain a given fitness level for several weeks but will only improve fitness in persons who are originally very sedentary. A training frequency of less than two sessions per week is unlikely to cause much improvement or to maintain a good level of cardiorespiratory fitness.

Frequencies of training higher than three sessions per week are recommended for persons who are already accustomed to jogging. Many people enjoy a daily jogging session and find that such regular exercise helps them to feel more energetic and relaxed. Certainly, for most persons, participation in daily exercise such as jogging is a reasonable and worthy goal. Persons who attain this goal are almost certain to maintain an excellent level of cardiorespiratory fitness and a fine body composition (% body fat).

#### Duration

To optimally benefit from jogging, the duration of each jogging session should be at least 20-30 minutes. Ideally, the exercise should be continuous, i.e., without recovery breaks. However, studies show that little is lost by taking periodic rest breaks as long as the total jogging time is at least 20 minutes. Jogging longer than 30 minutes is fine for persons who already have good cardiorespiratory fitness and who enjoy longer runs. Many persons, however, find that a jogging session of approximately 30 minutes is ideal since it involves a relatively small time commitment and is sufficient to maintain a good level of fitness.

#### Intensity

To derive the health benefits of a jogging program, only a moderate intensity of exercise is required. The appropriate level of exertion will cause the heart rate, i.e., pulse rate, and breathing to increase somewhat and may cause sweating. It is important to note that *exhaustive exercise is not required to improve cardiorespiratory fitness*. With jogging the intensity of exercise is directly related to the speed of movement: the faster the jog, the higher the level of exertion. There are several ways to determine how fast one needs to jog to improve his/her fitness. All the methods involve individualization, that is, selection of a jogging

pace which is right for the individual. The key is to find one's own best pace, which may or may not be the same as someone else's. Successful jogging requires that participants do their own thing!

One of the most widely accepted techniques for selecting a proper jogging pace is to use heart rate as a guide. As was discussed in Chapter 1, a proper training heart rate can be computed, if the individual's resting and maximum heart rate are known or estimated. After determining the target heart rate for training, it is necessary to experiment to determine the pace of jogging which will bring one's heart rate to this desired level. This can be accomplished by checking the heart rate after 3-4 minutes of walking or jogging at various paces. It is best to begin with a slow pace and to increase the pace every three or four minutes until the proper heart rate is obtained. Note that, after the first 2-3 minutes of jogging at a particular pace, heart rate remains relatively constant for many minutes. Thus, once a proper pace has been identified, there is no need to check the heart rate more than once or twice per training session.

Another simpler method by which to monitor intensity of exercise is to use the "talk test." A proper jogging pace will cause the rate and depth of breathing to increase but should not cause such breathlessness as to prevent easy speech. Those jogging faster than necessary will fail the talk test, and should slow to a more comfortable pace.

#### Putting It All Together

Successful jogging programs involve proper combinations of training frequency, intensity, and duration. As summarized in Table 1, joggers should exercise at least three times per week, for at least 30 minutes per session, and at an appropriately individualized pace. Many combinations of

Table 1. Guidelines for designing a jogging program.

<i>Frequency of Training</i>	3 or more sessions per week
<i>Duration of Training</i>	20 or more minutes of sustained activity
<i>Intensity of Training</i>	jogging pace which elevates heart rate to 70-85% of maximum

frequency, intensity, and duration of jogging will successfully maintain a good level of cardiorespiratory fitness. The key is to find a jogging routine which generally adheres to the recommended guidelines and which is practical and enjoyable.

As the fitness level improves, it may be necessary to adjust the jogging program. In particular, the pace of jogging must be increased to achieve the selected training heart rate. This is expected because one of the effects of aerobic exercise training is a reduction of the heart rate at any particular level of exertion, i.e., jogging pace. Also, joggers may find they can comfortably increase the duration of the jogging session, and may wish to increase training frequency. Such adjustments are fine if they occur gradually and contribute to the enjoyment of the activity.

### BEGINNING JOGGING

The critical phase of any physical fitness program is the first few weeks, because the body must adjust to a significant new stressor. If that stressor, the exercise, is properly applied, most persons can rapidly adapt to it. If it is incorrectly used, negative effects such as injury, illness, lack of improvement, or failure to adhere to the program can result. Thus, in starting a jogging program it is crucial that certain basic guidelines be followed.

First, it is very important to begin a jogging program with appropriate and reasonable expectations in mind. Jogging can cause important health benefits such as weight loss and improved cardiorespiratory fitness. However, jogging is not a "miracle cure" that will produce overnight results. As with any proper form of exercise training, the beneficial effects of jogging occur gradually and require several weeks or months to mature. It must also be recognized that a proper jogging program involves work. The work should not be exhaustive, but, for the beginner, jogging does require discipline and perseverance. For the experienced exerciser, jogging may be "effortless" and "exhilarating." Such feelings, however, should not be expected in the early stages of a jogging program.

There is no effortless way to build fitness—so it is best to begin a jogging program knowing that the major benefits are a few weeks and miles "down the road."

### Golden Rules

For the beginning jogger there are two "golden rules": the program should start at a level which is appropriate for current fitness status; the training dose should progress very gradually during the first few weeks of the program. The guidelines provided earlier in this chapter should aid in designing a program which starts at an appropriate level. Many persons should begin a jogging program by not jogging at all, but, rather, by walking. Walking is less intense than jogging and is less stressful for the bones, joints, and muscles. Thus, particularly for older adults, it is often best to start with a few weeks of walking or alternate walk-jog exercise. A gradual build-up to continuous jogging is a good way to maximize enjoyment and to minimize the chances of injuries. Tables 2 and 3 present two suggested beginning jogging programs. The program outlined in Table 2 is

Table 2. Suggested jogging program for older and/or previously sedentary beginners.

Week*	Activity	Duration (min.)	Intensity (% Max HR)#
1	Walk	15	60-70
2	Walk	20	60-70
3	Walk	20	70-75
4	Walk/Jog	20	70-80
5	Walk/Jog	25	70-80
6	Walk/Jog	30	70-80
7	Walk/Jog	30	70-80
8	Jog	20-30	70-80
9	Jog	25-30	70-80
10	Jog	30	70-80
11	Jog	30	70-80
12	Jog	30	70-80

\* Three sessions per week on non-consecutive days.

# See Chapter 1 for estimation of maximum heart rate.

recommended for older, previously sedentary persons, begins at a lower level, and progresses more gradually than the program prescribed in Table 3, which is appropriate for younger and/or already moderately active persons.

**Table 3. Suggested jogging program for younger and/or previously moderately active beginners.**

Week*	Activity	Duration	Intensity
		(min.)	(% Max HR) #
1	Walk/Jog	20	70-75
2	Walk/Jog	25	70-75
3	Walk/Jog	30	70-75
4	Walk/Jog	30	70-80
5	Jog	20	70-80
6	Jog	25	70-80
7	Jog	30	70-80
8	Jog	30	70-80
9	Jog	30	70-80
10	Jog	30+	70-80
11	Jog	30+	75-85
12	Jog	30+	75-85

\* Three or more sessions per week.

# See Chapter 1 for estimation of maximum heart rate.

In beginning a jogging program it may be helpful to exercise with a partner or group. This helps the beginner to adhere to the program and can make the initial stages of a training regimen more enjoyable. Despite the partnership, however, it is crucial that each jogger run at a pace and for a duration appropriate for him/her as an individual; he/she should not strive to compete or keep up with a more highly trained person.

**Shoes for Joggers**

Another important tip for the beginning jogger is to obtain appropriate footwear. Good running shoes involve a significant expense; however, experience indicates that the investment is worthwhile. The key is to obtain a pair of shoes which properly fit and which have been designed specifically for running. Good running shoes (see Diagram 1) have several basic characteristics. Among these are:

1. A moderately elevated heel consisting of material with good shock-absorbing qualities (the jogger should be able to compress, with the fingers, the sole portion of the heel).
2. The heel should be well-padded and should fit so that little or no slippage of the foot occurs during running.
3. The toe portion of the shoe should be deep enough to avoid rubbing the toenails and should fit so that the toes do not contact the front of the shoe during running.
4. An arch support should be included and should be aligned comfortably with the arch of the foot.
5. The outer sole of the shoe should be made of a very sturdy rubber material which will withstand many miles of jogging. Most joggers find that the heel portion of the outer sole wears first and this area should be reinforced to give longer wear.
6. The front part of the shoe should be snug enough so that very little lateral foot movement occurs.

**Medical Clearance for Beginners**

Most persons can safely begin a jogging program without formal medical clearance. For persons in certain age and health status categories, however, a physician's examination is a wise way to begin a fitness program. In general, a doctor's clearance is recommended for previously sedentary persons over age thirty-five and for anyone, regardless of age, who has a personal history of coronary heart disease or other diseases of the cardiovascular system, e.g.,

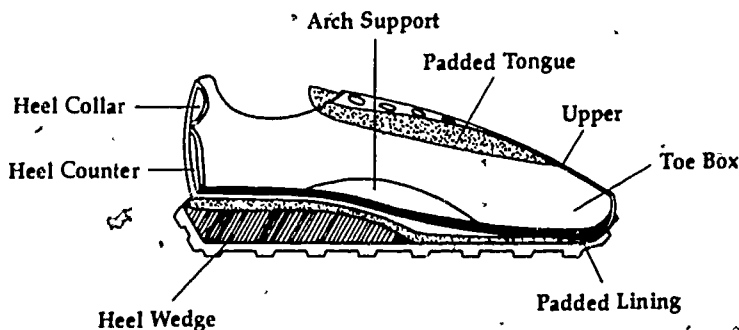

**Diagram 1. Characteristics of a good running shoe.**

high blood pressure, rheumatic fever, heart murmur. Table 4 presents guidelines for determining whether a person needs to see his/her doctor before beginning a jogging program.

**Table 4.** Recommendations regarding the need for a medical clearance before beginning jogging.

Category	Under Age 35	Over Age 35
Normal individual, physically active at least three days per week	Unnecessary	Optional
Normal individual, physically active once per week	Unnecessary	Suggested
Normal individual, sedentary	Suggested	Highly recommended
Individual with risk factors for coronary heart disease*	Highly recommended	Mandatory
Individual with known heart condition or symptoms of coronary heart disease	Mandatory	Mandatory

\*Major CHD risk factors are cigarette smoking, high blood pressure, and high levels of blood cholesterol

## PREVENTING AND TREATING RUNNING INJURIES

As mentioned previously, jogging can contribute significantly to health enhancement. However, it also must be recognized that jogging, if improperly employed, can cause or aggravate certain health problems. Of particular concern to joggers are injuries to the bones, joints, and soft tissues of the feet and legs. This section presents information which should help the jogger prevent such injuries, or to treat them properly if they do occur.

### PREVENTION OF RUNNING INJURIES

Certainly it is preferable to prevent injuries rather than to attempt to treat them after they have occurred. Experience indicates that adherence to the following guidelines will minimize the risks of developing orthopedic, i.e., bone and joint, injuries while jogging.

1. *Gradual progression in training.* A primary cause of many jogging injuries is too rapid a progression of the training dose. Jogging is a weight-bearing activity placing considerable stress on the bones, joints, and muscles of the leg. Given adequate time, these tissues can adapt to the stresses of jogging. But it is crucial that beginners progress very gradually and that experienced joggers avoid rapid increases in training intensity or duration.
2. *Proper footwear.* During jogging the foot is required to withstand the forces generated during each stride. In a sense, the foot is the body's "shock absorber." Because of this, many running/jogging injuries occur in or around the foot. Other injuries to the leg or back are caused by anatomical and mechanical problems in the foot. Proper running shoes, as described earlier in this chapter, provide the foot with the support needed to function properly during jogging. It is highly recommended that the jogger obtain running shoes. In certain instances, special shoe inserts or arch supports may be needed, however, these should be prescribed by a physician.
3. *Maintenance of muscular strength and flexibility.* Jogging develops cardiorespiratory fitness and maintains good body composition. It will not, however, develop muscular strength or flexibility. This is unfortunate, since certain injuries to joggers are associated with poor strength and/or flexibility in the muscle groups of the legs. Specifically, the jogger should be concerned with maintaining adequate strength in the muscles on the front of the abdomen and leg, and should work to maintain good flexibility in the muscles of the lower back and the rear portion of the legs. The principles of developing strength and flexibility have been discussed in Chapter 1. Figures 3 and 4 present some exercises which are highly recommended for joggers. Ideally, these exercises should be performed before and/or after each jogging session.
4. *Know your limits.* Perhaps the best advice for preventing injuries is to use

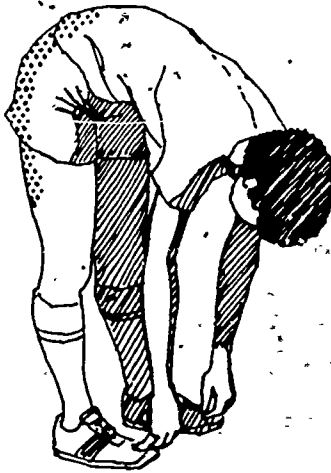

a. Low back stretch.

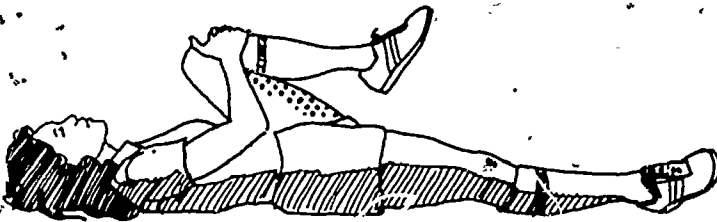

b. Hamstring stretch.

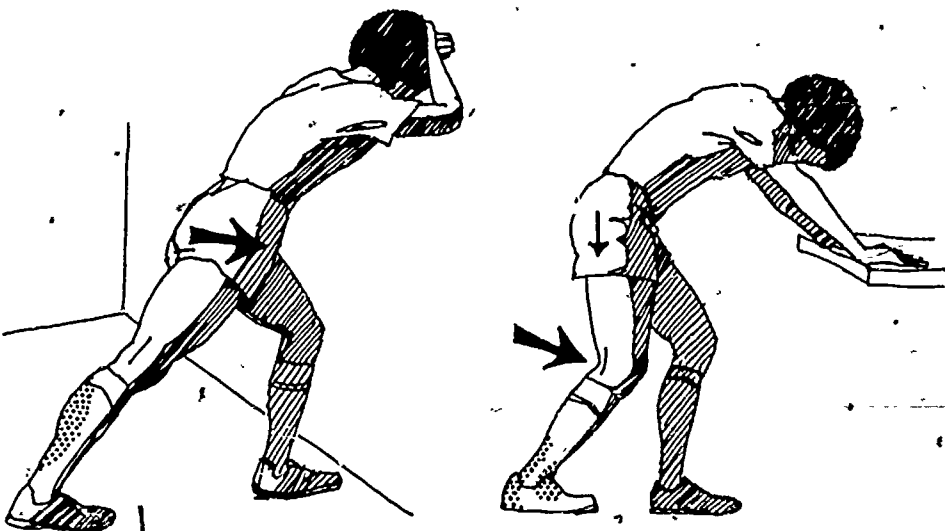

c. Calf and Achilles tendon stretch.

Figure 3. Static stretching exercises for joggers.



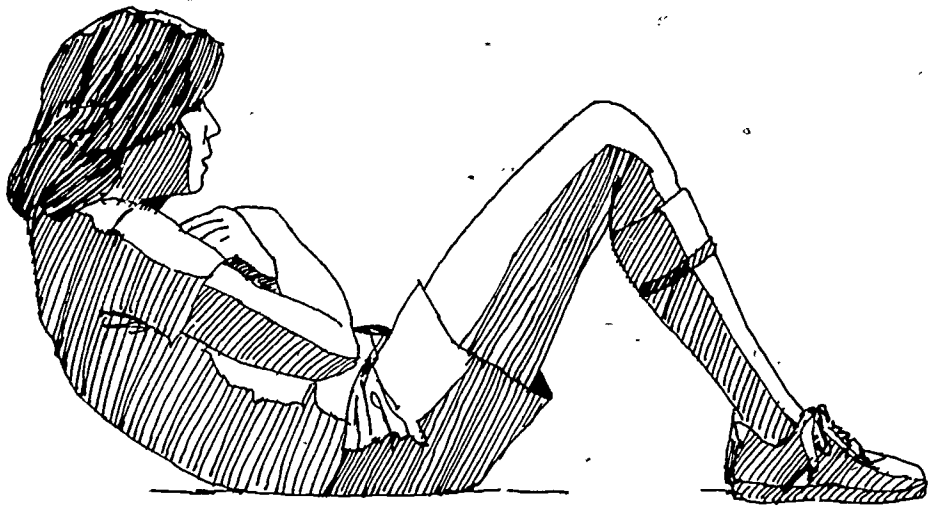

Figure 4. The sit-up (strengthening exercise for joggers).

common sense and "listen to your body." Each individual has a certain tolerance for exercise stress. If that limit is exceeded, fatigue, muscle soreness, minor aches, and/or injuries will occur. The jogger should be sensitive to these signals and should respond to them by reducing the training load and, possibly, seeking proper treatment.

### TREATING RUNNING INJURIES

Injuries can occur in some joggers even when all the proper precautions have been taken. When injuries occur, it is important that they be promptly and appropriately treated. With proper treatment most injuries will heal quickly, allowing the jogger to return to normal activity within a few days.

Most injuries to joggers involve pain in the foot or leg region. A complete description and discussion of the various injuries occurring to joggers is beyond the scope of this chapter, these general procedures are presented as appropriate responses to most jogging injuries:

1. *Recognize the injury.* If injuries are recognized and treated promptly, their negative effects can be minimized. The jogger should respond to any severe pain or to

a moderate pain which persists for more than a day.

2. *Rest.* Most injuries respond to reduced activity or complete rest. If the injury causes only moderate discomfort, the jogger can often continue with a reduced training program, e.g., shorter distances, fewer sessions per week, slower pace. If the pain is severe or if a moderate pain persists for more than a few days, complete rest is recommended.
3. *Program modification.* Jogging injuries are likely to recur unless the cause of the injury is addressed. Thus the injured jogger should be prepared to modify his/her training procedures to eliminate the cause of the injury. Often, recurrence of an injury can be prevented by reducing the training program, increasing strength or flexibility, or obtaining different footwear.
4. *Physician's care.* When injuries persist for more than a few days, the treatment of a physician should be sought. Usually the jogger is well-advised to seek out the services of an orthopedist or podiatrist specializing in sports medicine.
5. *Return to action.* Following recovery from an injury, joggers should return very gradually to a normal level of activity. A rapid return to normal activity can aggravate an injury.

## SAFETY

Proper jogging is a very safe activity. However, there are two major hazards the jogger should recognize and endeavor to avoid: automobile traffic; stressful environmental conditions, e.g., heat and cold.

### AUTOMOBILE TRAFFIC

Automobile traffic is potentially the most lethal hazard confronting the jogger. The safest recommendation is to simply avoid jogging in heavy traffic areas. If this is not possible, the jogger should take the following precautions to ensure personal safety.

1. Jog in traffic areas only when a sidewalk or wide shoulder is available.
2. Always jog facing traffic.
3. Always be prepared to give the right-of-way to the motorist.
4. Recognize that the motorist may have difficulty seeing the jogger and may be unable to quickly react to an unexpected jogger in the roadway.
5. When jogging at dusk or after dark, the jogger should wear light-colored clothing and reflective materials. Such materials are invaluable in alerting the motorist to the presence of a jogger.
6. Obey all traffic laws which apply to pedestrians.
7. Be particularly careful when crossing a street at an intersection since turning automobiles may approach rapidly from the "blind side."

### JOGGING IN HOT CONDITIONS

Hot and humid environmental conditions can represent a significant health hazard for the jogger. This is particularly true for persons who run at high intensities and/or for long periods of time. The major risks are heat exhaustion and heat stroke. In extreme cases, the latter can result in death.

During heavy exercise the body generates considerable heat. This heat must be transferred to the environment so that a normal body temperature can be maintained. In hot conditions heat transfer to

the environment is impaired. Heat transfer is further limited by high humidity, which restricts a necessary factor in the body's, primary cooling process, the evaporation of sweat.

Heat illnesses in joggers can be prevented if attention is paid to the following recommendations:

1. In hot and/or humid conditions the jogger should reduce the intensity and, perhaps, the duration of the training session.
2. Jogging should be done at the coolest times of the day.
3. Minimal clothing should be worn (no sweatsuits or rubber suits).
4. Care should be taken to adequately replace the fluid lost through sweating by drinking liberal amounts of water after exercise. These recommendations should be particularly followed by beginning joggers and obese persons since they are at greater risk of heat illness than are more experienced joggers.
5. Competitive running should be avoided when conditions are particularly hot and/or humid.

### JOGGING IN COLD CONDITIONS

Cold conditions are far less stressful and dangerous for the jogger than are hot conditions. Nonetheless, extreme cold can be a hazard for the jogger. In particular the jogger should be alert to the risks of frostbite.

Frostbite occurs when body tissues are exposed to subfreezing temperatures for long periods of time. Particularly vulnerable to frostbite are the fingers and ears, since blood flow to these tissues is reduced during cold exposure. Thus the winter jogger should wear gloves and a hat to protect the ears.

When jogging in the cold the jogger should wear sufficient clothing to maintain comfort *after the warm-up*. Normally, two or three layers of light clothing are adequate. In the coldest conditions more layers and a windbreaker may be needed. Clothing should be of a light material which "breathes," so as to avoid an accumulation of sweat on the body surface.

## ROAD RACING

Competitive long-distance running has become one of America's most visible and popular recreational sports. The development of competitive road racing has paralleled the rapid increase in participation in jogging for fitness enhancement. Indeed, many thousands of persons have "graduated" into the ranks of the competitive long-distance runners after first becoming involved in jogging strictly as a fitness activity.

Most competitive long-distance running events are conducted on roads and thus are referred to as "road runs" or "road races." The distance of these runs varies from a mile or two up to the full marathon distance (26.2 miles). Some road racing events include several races of differing distances.

Road racing has become popular partly because, unlike many athletic activities, long-distance racing provides individual challenge. In any given road race, only a small number of competitors entertain a realistic expectation of winning the race. However, every competitor can derive satisfaction in running his or her personal best time for the distance, or can be proud of simply completing the race. Also, most races are truly many races in one, since awards are usually given in many age and sex categories.

Joggers who have not previously participated in competitive road races are well advised to begin with shorter distances, and with a non-competitive attitude. One should acquire experience in road racing before striving for optimal performance. Needless to say, a good level of cardiorespiratory fitness should be developed before considering entry to any competitive road race. In addition, the beginning road runner should consider the following tips.

1. The runner should enter a road race only if confident of his/her ability to run the entire distance. Thus, it is preferable that the competitive distance has been previously covered in practice.
2. The race should be run at an approximately even pace. Particular care should be taken to avoid starting a race at a pace which is too fast.

3. In his/her first few races, the road runner should disregard the other competitors and focus on running at a proper pace. Racing should begin only after the runner has acquired a complete understanding of his/her own abilities.
4. In racing it is crucial that properly fitted shoes be worn. Runners should not wear new shoes in a race. Joggers desiring to learn more about road racing should contact their local running clubs or write to:

American Running & Fitness  
2420 K Street, NW  
Washington, DC 20037

or  
Road Runners' Club of America  
c/o Jeff Darman  
2737 Devonshire Place, NW  
Washington, DC 20008

## SUMMARY

This chapter has provided the information needed to design a safe and successful jogging program. Jogging is an enjoyable, practical activity used by millions of Americans to develop good cardiorespiratory fitness, to control body weight, and to maintain a high state of vigor. Successful jogging programs must begin at an individualized level and progress gradually. An optimal jogging program involves three or more jogging sessions per week, for 30 or more minutes per session at a moderate exercise intensity.

Some bone and joint injuries have been associated with jogging, however, most injuries can be prevented by following sound training procedures. The jogger's safety can be threatened by jogging in heavy automobile traffic or by extreme weather conditions. Proper preventive measures, however, can minimize these risks as well.

In summary, jogging can serve as the cornerstone of a successful lifetime physical fitness program. In addition, for properly trained persons, competitive jogging/running, e.g., road racing, can be a satisfying and enjoyable recreational sport.

## TERMINOLOGY

- Cardiorespiratory Fitness.** The ability to sustain moderate intensity, whole body activity for extended time periods.
- Frostbite.** Freezing or partial freezing of a body part.
- Heat Exhaustion.** Extreme fatigue caused by prolonged exercise in hot weather.
- Heat Stroke.** A failure of the body's temperature regulating system, associated with high body temperature, hot, dry skin, and disorientation or unconsciousness.
- Individualization.** Design of an exercise program in accordance with the characteristics of the particular exerciser.
- Progression.** The rate at which the frequency, intensity, and/or duration of a training program is increased.

## REFERENCES

- Bowerman, W. J., and Harris, W. E. *Jogging*. New York: Grosset & Dunlap, 1967.
- Bridge, R. *The Runner's Book*. New York: Charles Scribner's Sons, 1978.
- Cooper, K. H. *The New Aerobics*. New York: Bantam Books, 1970.
- Fixx, J. F. *The Complete Book of Running*. New York: Random House, 1977.
- Heindnen, J. *Running for Women*. New York: J. B. Lippincott Company, 1979.
- Sheehan, G. A. *Dr. Sheehan on Running*. Mountain View, CA: World Publications, 1975.

aiming off (p. 197)  
attack point (p. 195)  
contour interval (p. 193)  
contour line (p. 193)  
control card (p. 194)  
control point (p. 194)  
grid north (p. 193)  
magnetic needle (p. 197)  
magnetic north (p. 193)  
map symbols (p. 193)  
orienteeing arrow (p. 197)  
orienteeing compass (p. 195)  
quadrangles (p. 193)  
topographic maps (p. 191)

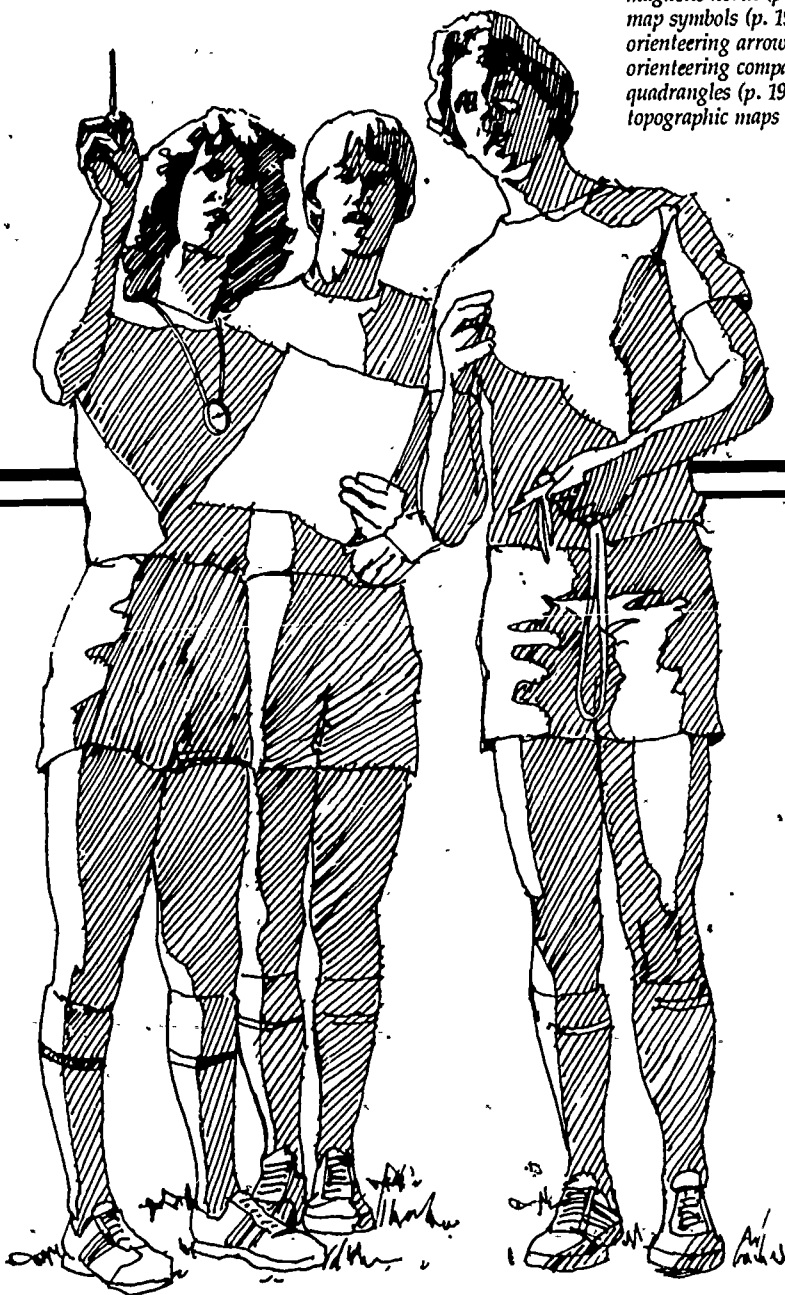

# Orienteering

ARTHUR HUGGLESTONE  
and  
JOE HOWARD,  
*Smith Environmental Education Center,  
Rockville, MD*

## INTRODUCTION

Orienteering offers the thrills and excitement of a track meet and a treasure hunt all rolled into one. Orienteering adds new purpose and interest to jogging. The jogger who takes up orienteering will find that he or she has substituted the highway fumes and noises for the forest sounds and smells and has replaced boredom with mental stimulation. You must be mentally prepared to read a map, use a compass, and be physically able to run the course.

Orienteering is often called the thinking person's sport. The fastest runner going in the wrong direction cannot be a winner. Successful participants must solve a series of problems and make a number of choices before they can decide on the course that they will take. Orienteering courses can be set up for novices, intermediate, and advanced competitors.

Orienteering probably began as a Swedish military exercise. A runner would be given a map with several destinations and a message to be delivered. Orienteering is considered a national sport in most Scandinavian countries and is a required sport for students. With the Scandinavian love of skiing, it is not surprising that orienteering began on skis almost as soon as it began on foot. Orienteering has increased in popularity and spread around the globe. Meets are now conducted on bicycles, in canoes, at night, on cross-country skis, and even underground. Orienteering may be a formal, sanctioned event, or it may be as informal as a family outing for the day with a map, compass, and picnic basket.

The first time that orienteering is experienced you will be content to complete the course with little regard for the time it takes. As you become more skilled in using the compass, interpreting the map, and observing the geological features, you will be more sure of the best route choice. With experience, speed and endurance will increase, and confidence will be had to tackle strange territory. The pleasure of going around a bend on an unfamiliar trail and discovering a landmark only seen on a map, or taking a cross-country shortcut and finding the trail just where expected is most satisfying and is all the more exhilarating when the expected landmark does not appear. Initially, an uncomfortable feeling may be experienced. There are no road signs, no buildings, no busses, none of the aids unconsciously depended upon to aid you around more familiar haunts. However, a quick check of the map and compass can get you anywhere you want to go.

## EQUIPMENT

The best way to learn is by doing, but before venturing afield, it would be wise to know how to use the equipment of orienteering. The best maps available are those specifically designed for orienteering. These maps cover a small area and are very detailed. Generally, they are topographic maps that have been enlarged and reworked by orienteering clubs. There are few of these maps at the present time, and most of them cover parklands that have special features of particular interest to the orienteerer. Maps like these are only available where orienteering is a very active

Match Column B with A.

A

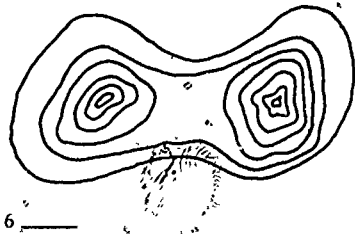
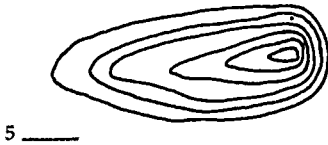
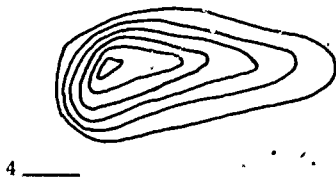
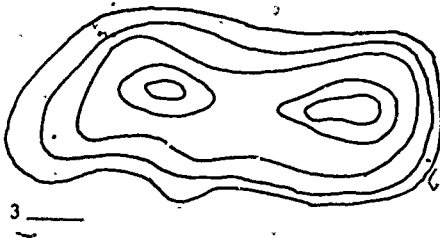
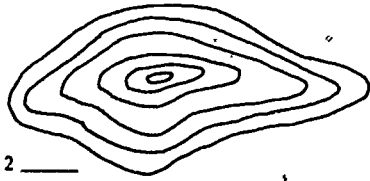

B

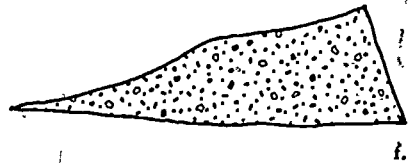
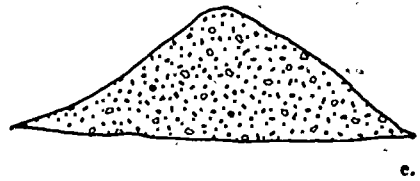
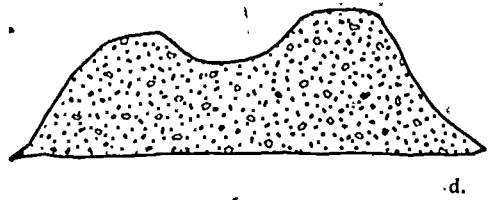
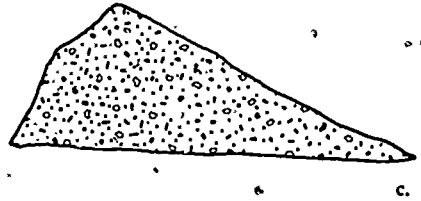
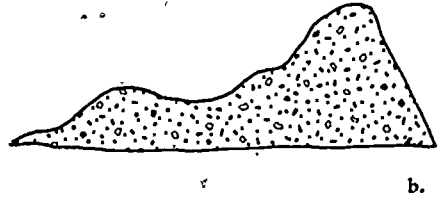
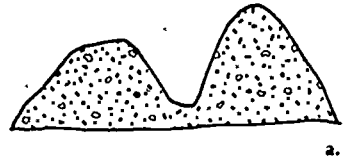

Solutions:  
 1 b.  
 2 e.  
 3 d.  
 4 c.  
 5 f.  
 6 a.

—Diagram 1. Contour line exercise.

sport. To contact local individuals who are active in the sport, write to: Orienteering Services USA, Box 1604, Binghamton, NY 13904. They'll forward free information and put you in contact with an orienteering group in your local area. The U.S. Orienteering Federation, P.O. Box 1039, Ballwin, MO 63011, can send information about membership and local affiliations. Most students, however, will have to be content with less detailed but otherwise excellent topographical maps produced by the U.S. Geological Survey. These maps, called quadrangles or "quads," come in two sizes, 15-minute maps and the more detailed 7½-minute maps. The 7½-minute quadrangle map covers an area bounded by 7½ minutes of longitude and 7½ minutes of latitude. The scale on this map is 1:24,000. This means that one inch on the map represents 24,000 inches or 2,000 feet on the ground. The 15-minute map has a scale of 1:62,500, which means that one inch on the map represents approximately one mile. Wilderness outfitters, sporting goods stores, or camping stores often sell these maps for local hiking areas. If a quad cannot be located for a specific area, request a free topographical map index circular for that area's state, a free folder describing topographical maps, and a free topographical map symbol sheet from: National Cartographic Information Center, 507 National Center, Reston, VA 22092. When ordering the particular quadrangles, request a woodland copy. Mature forests are shown in green on these maps.

### SYMBOLS

Once the quadrangle is received, study it and become familiar with the symbols. Buildings are shown in black, water is blue. If the map has been updated by aerial photography, all the recent changes are in a plum color. Contours of mountains and valleys are represented by brown lines. These lines indicate equal elevation which means that everything on that line is the same number of feet above sea level. The heavy brown lines have numbers written on them which makes it easier to determine the elevation for the other contour lines. The contour interval is the vertical distance be-

tween lines and may be anywhere from 10 to 80 feet depending upon the map being used. The closer the lines, the steeper the slope, the farther apart, the flatter the land. If these swirling brown lines are closely examined, a pattern can be seen. The lines connect to form an irregular shape with one inside of another and another until the smallest shape is reached, representing the top of a mountain or hill. The following exercise should help test ability to read contour symbols (see Diagram 1).

Study the map. Learn as much as possible about the area which is going to be traveled through. Have fun planning different routes over the varied terrain. Even in a very familiar area, things can be discovered which you didn't know existed.

### SKILLS AND TECHNIQUES

In orienteering, use only the magnetic North as indicated on the lower margin of the map. If it differs from true or grid North, it will be seen as an arrow identified as "MN" off to either side of the true or grid North line which is identified by a star.

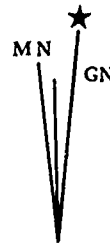

Diagram 2.

Find the magnetic arrow in the lower margin of the map and draw arrows that are parallel to the magnetic North arrow, approximately one inch apart and extending through the area of travel. If the school or local club furnishes a xeroxed section of a quadrangle, the parallel magnetic North arrows will probably extend the length of the map. If not, it is easy to put them there.

If a quadrangle is acquired that covers a nearby area, some informal orienteering may be attempted. Have a friend come along, tell a third person the starting point, destination, and the latest time expected to return. Be sure to check back with that person upon return.



Listed below is a list of equipment that you should have:

1. Map—most recent edition possible. There might be new buildings and roads and even ponds, but the mountains and valleys won't change.
2. Compass—use a cord to tie it around the wrist or neck. Don't lose it or use it near iron or steel objects.
3. Wristwatch—make sure this is on the opposite hand from the one that will hold the compass.
4. Plastic Whistle—use the whistle to signal for help in case there is an injury. Plastic is non-magnetic and will not affect a compass.
5. Appropriate Clothing—wear old clothes that will protect the orienteer from thorns, poison ivy, or whatever the terrain and time of year have to offer. Shoes should be comfortable, support the feet, and give adequate traction when needed.

When at the starting point, mark it on the map as the center of a six mm triangle or with the letter "S." The first leg of the route should lead to an easily identified physical feature. The end of each leg should be identified on the map by a six mm circle. Use a red pen to mark the circles and to draw a single line connecting them. Fold the map so that it is just large enough for the landscape to be seen surrounding the direction of travel.

The next step, orienting the map, is an important one and will have to be repeated often. Turn the map around until the features on the map are in the same relative position as those on the land. If there is a hill to the left, then the hill should be to the left of the position on the map. If there are several recognizable features in sight, this can be easily done, otherwise use the compass. To orient the map using a compass, simply turn the map around until the magnetic North arrows on the map are pointing in the same direction as the magnetic needle on the compass. Directions on the map and on the ground will now match.

If heading northward, read the printing on the map. However, if the direction of travel is southward, the printing will be upside down. This will not affect ability to

read the map, reading the map means interpreting the contour lines and symbols that represent natural and human-made structures, such as hills and valleys, churches and schools, and streams and lakes. Hold the map in front of you. Turn the map around so that the starting point is closest to you and the first destination is farthest away. Turn around until the map is oriented. The direction of travel is now being faced. Pick out features along the red line that mark the route from the starting position to the first destination. Look up and pick out a distant landmark that was seen on the map. As the already identified features are passed, put the thumb on the spot where standing, with the nail pointing toward the destination. Track of progress can always be kept with this procedure and exact location will be known. This technique works well as long as the orienteer is careful with the thumb and orientation of the map. When the thumb marks the point where the first circle was drawn, the first destination should have been attained.

## COMPETITION

If participating in an orienteering meet, a control point would be at the center of the circle. The control point refers to a specific place and is not indicated by a dot. On land, the control is indicated by a flag, a 3-dimensional triangle, or a plastic gallon milk jug and is almost always red and white. The control is easily visible and is marked with a number or letter that corresponds to the one on the map for that specific location. In an orienteering meet, you have to prove that you have found each control point. Each competitor has a control card (see Diagram 3) often carried in a plastic envelope or bag along with the map. The card will be the document that proves how long it took to run the course and that each of the control points were located. The proof may be that each block on the card is marked with a different colored pen or special stamp that was tied to the control, or different code words that were on the control may be written in the blocks.

Name		Course		No.					
School or Club									
(Fold and tear along line)									
Name		Course		No.					
School or Club									
Date		Compass							
		Hours	Min.	Sec.					
Finish									
Start									
Time									
Penalty									
Place									
1	A	2	B	3	C	4	D	5	E
6	F	7	G	8	H	9	I	10	J
11	K	12	L	13	M	14	N	15	O

Diagram 3. Control card.

You may also be furnished with a control description sheet. This is a list of clues or short descriptions that will help to recognize the control point. If the map that is used is xeroxed, the control description sheet is often put on the back. Table 1 is an example of a control description sheet (also see Diagram 4 for map).

When traveling from one control point to another, choose the fastest route. Often the most direct route will not be the fastest. If there is a hill between you and the next control point, the fastest route may be around unless you are a strong runner. A good trail may be twice as fast as a rock strewn meadow, three times as fast as an open forest, and five times as fast as thick brush.

If there isn't a landmark close to a control point, use an orienteering compass to navi-

gate from the nearest easily found landmark called an attack point. Draw a red line from the attack point to the control point. Put the compass on the map with the long side over the red line that extends from the

Table 1. Summit Lake orienteering course.

Control No.	Description
1	A road crosses the buried cable
2	A high ground, edge of a clearing
3	A boulder
4	The highest ground
5	Ruins
6	Fork in stream
7	A ravine
8	A spring (good water)
9	A building

*Note.* There will be a penalty for being late. If you become completely lost and wish to drop out of the meet, head south to Hampton Valley road. Road will be checked one hour after meet is over. Emergency phone number: (301) 271-9810.

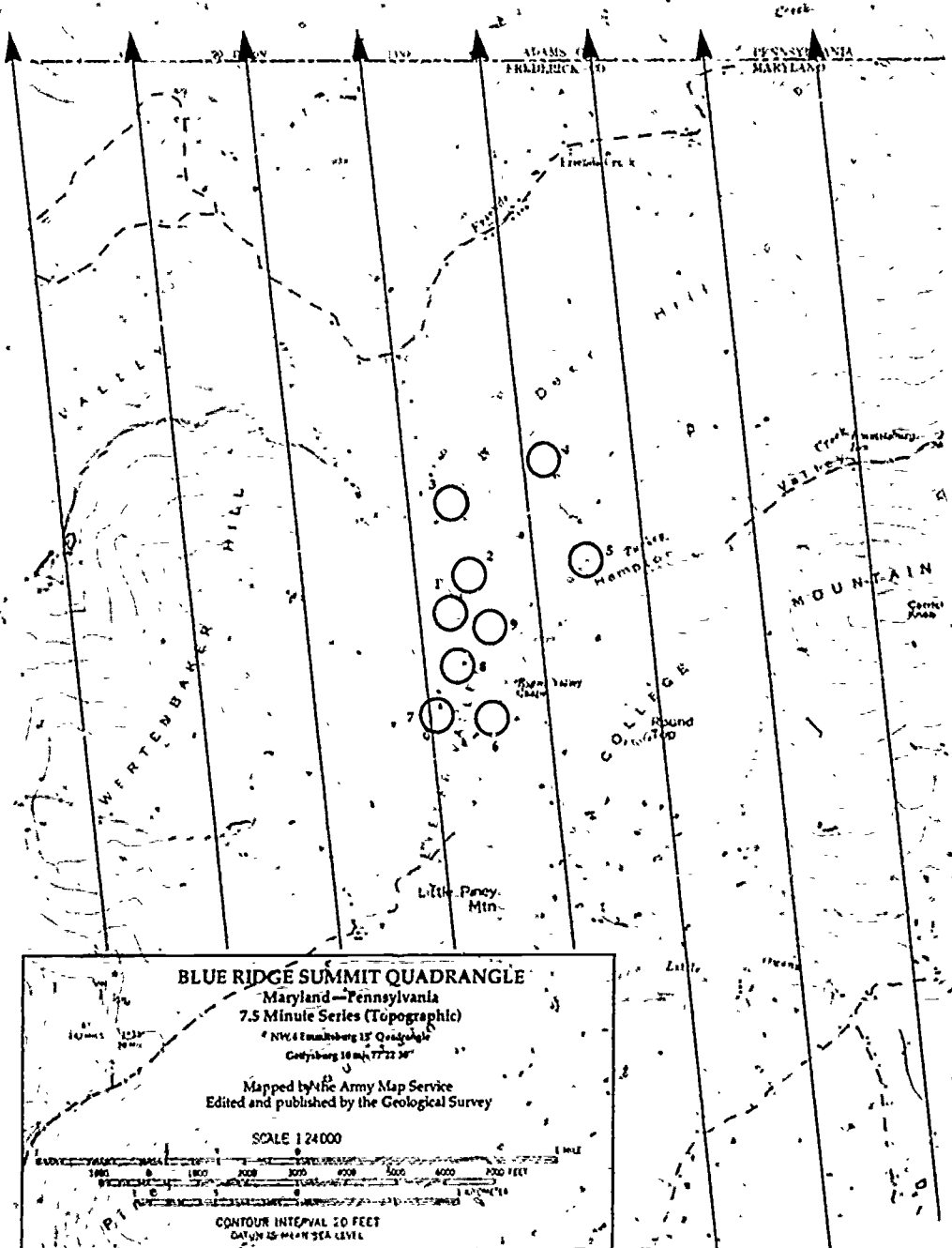

Diagram 4.

203

attack point, where you are, to the control point (see Diagram 5). Make sure that the direction of travel arrow is pointing in the direction parallel with the intended course. Hold the compass base firmly to the map so that it will not slip as the compass housing is turned. Turn the compass housing around until the orienteering arrow is parallel and points in the same direction as the North magnetic arrows on the map. Remove the compass from the map. Hold the compass level in front of you with the direction of travel arrow pointing straight ahead. Turn around until the red or pointing end of the magnetic needle and the orienteering arrow are pointing in the same direction. The direction of travel arrow is now pointing to the control point.\* Assuming that the control is not in sight, pick a distant object that is in line with the direction of travel and head out. If the student begins to lose sight of that object, use the compass again. Hold it level and in front of you with direction of travel arrow pointing straight ahead. Remember

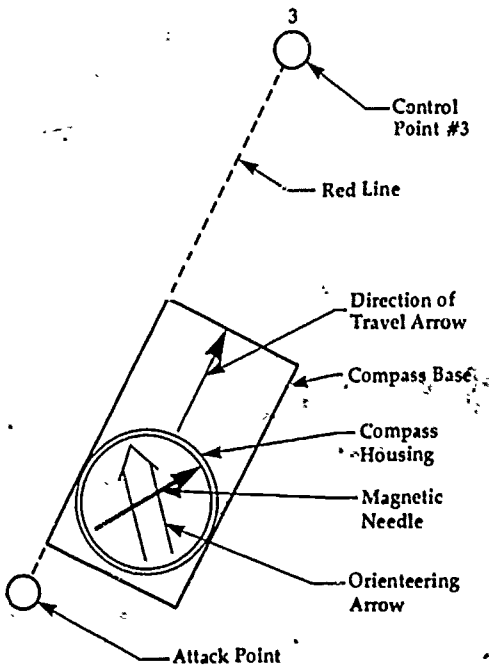

Diagram 5.

\*The most common mistake made by the beginner is to follow the magnetic needle. Don't follow this needle unless you want to go north.

to turn around until the magnetic needle and the orienteering arrow point in the same direction. Use the direction of travel arrow to pick out a precise spot in the distance and head out again. In a thick forest, this process will have to be repeated often.

As long as the object or spot can be seen, you will be on course. If you lose sight of the object and keep on going without checking the compass, you may lose accuracy and time. A few extra seconds spent being careful with the map and compass work can save minutes of running and perhaps be the difference between first and second place.

If you feel that you may have passed the control point, stay on course. Check the map to see if there are any features you would come across if you had passed the control point. If there are none, or if one is found that is not good enough to use as a new attack point, it is time to retrace the route. Use the compass to do this. Do not move the compass housing; simply hold the compass in front of you with the direction of travel arrow pointing straight ahead. Turn around until the red end of the magnetic needle and the orienteering arrow are pointing in opposite directions. The direction of travel arrow is now pointing to the return route.

If a control point is located along a road, a cliff, a stream, or a trail, and you are approaching from a position that is at right angles or broadside to that feature, try a technique called "aiming off." Instead of heading directly to the control point, aim enough to one side so that when the feature is reached, the other side should be turned, to find the control.

In Diagram 6, the participant at A decided to aim off to the left. When the stream is reached, he or she will know to turn to the right and continue until reaching the fork in the stream. If control point B is not in sight, the fork in the stream can be used as an attack point. If the orienteerer in Diagram 6 had not decided to aim off, a slight error in navigation could result in missing control point B. When the stream is reached, the orienteerer will not know

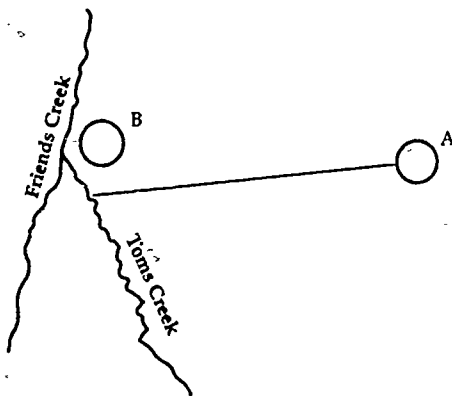

Diagram 6.

whether to turn back or follow the stream to the left or right. Aim off and be sure.

The following exercises should help improve skill with the compass.

- Find and face the following directions:
  - $35^\circ$
  - $90^\circ$
  - $165^\circ$
  - $180^\circ$
  - $270^\circ$
  - $345^\circ$
- Place a penny or other small object by the feet.
  - Take a bearing of  $60^\circ$ ; walk 10 steps.
  - Add  $120^\circ$ ; walk 10 steps.
  - Add  $120^\circ$ ; walk 10 steps.
  - Look down at the feet; you should be standing on top of the penny.
  - Repeat the exercise with 20 steps.
  - Repeat the exercise using the following three bearings at 20 paces:  $80^\circ$ ;  $200^\circ$ ;  $320^\circ$ .
  - Try f. at 30 paces.

There are many kinds of orienteering meets and lots of tips and tricks to learn. Read as much as possible but, most important, get out and do it.

## TERMINOLOGY

**Aiming off.** A technique that may be used when the target is located on a feature such as a river or ridge which is at right angles to the direction of travel. The orienteerer will aim off to one side of the target and be certain which way to turn when he/she reaches the feature.

**Attack Point.** An easy-to-find feature from which the orienteerer will carefully navigate.

**Bearing.** A direction of travel measured from North.

**Contour Line.** A line on a map representing an imaginary line on the ground that connects areas of equal elevation.

**Control.** An easily visible marker that can be seen from any angle and has a means of proving the visit.

**Control Point.** A specific location identified on the map by a 6 mm circle and a letter or a number; on the land it is identified by a control; on the control description sheet it is identified by a description of the feature.

**Elevation.** The height (vertical distance) above sea level.

**Feature.** A land form or structure that is identifiable on the map.

**Legend.** An illustrated description of symbols used on a map. It is most often located on the lower margin of the map.

**Minute.** A geographical unit of measure equal to  $1/60$ th of a degree.

**North Grid.** The vertical grid used as a zero reference.

**North Magnetic.** The particular direction indicated by the needle of the compass.

**North True.** The direction of the North geographical pole.

**Quadrangle.** A topographic map produced by the U.S. Geological Survey.

**Ravine.** A depression larger than a gully and smaller than a canyon.

**Topographic Map.** A map that shows physical features in minute detail.

## REFERENCES

- Andresen, Steve. *The Orienteering Book*. Mountain View, CA: Andresen World, 1980.
- Bengtsson, Hans, and Atkins, George. *Orienteering for Sport and Pleasure*. Battleboro, VT: The Stephen Green Press, 1977.
- Chapman, J. R. *Orienteering: an Aid to Training*. London, England: Cadet Supply Department, 1968.
- Disley, John. *Orienteering*. Harrisburg, PA: Stackpole Books, 1973.
- Disley, John. *Your Way with Map and Compass Orienteering*. Willowdale, Ontario, Canada: Canadian Orienteering Services, 1973.
- Geary, Don. *Step in the Right Direction: a Basic Map and Compass Book*. Harrisburg, PA: Stackpole Books, 1980.
- Kjellstrom, Bjorn. *Be Expert with Map and Compass*. New York: Charles Scribner's and Sons, 1976.
- Pirie, Gordon. *The Challenge of Orienteering*. Kent, England: Pelham Books, 1968.
- Riley, Michael. *Basic Orienteering*. Chicago, IL: Contemporary Books, Inc., 1979.
- Watson, J. D. *Orienteering: Know the Game*. Wakefield, Yorkshire, England: E. P. Publishing, Ltd., 1975.

back fall (p. 207)  
back trip throw (p. 219)  
bear hug (p. 213)  
falling (p. 205)  
flying mare (p. 218)  
front choke hold with two hands (p. 213)  
front fall (p. 207)  
front wrist breaker (p. 214)  
hand blows (p. 207)  
heel kick (p. 210)  
hip throw (p. 218)  
knee kick (p. 210)  
rear choke hold with two hands (p. 214)  
rear choke with two arms (p. 214)  
rear wrist breaker (p. 217)  
side fall (p. 207)  
side thrust kick (p. 210)  
snap kick (p. 210)  
stance (p. 203)  
tapping (p. 202)  
two-hand wrist release (p. 211)  
wrist release (p. 211)

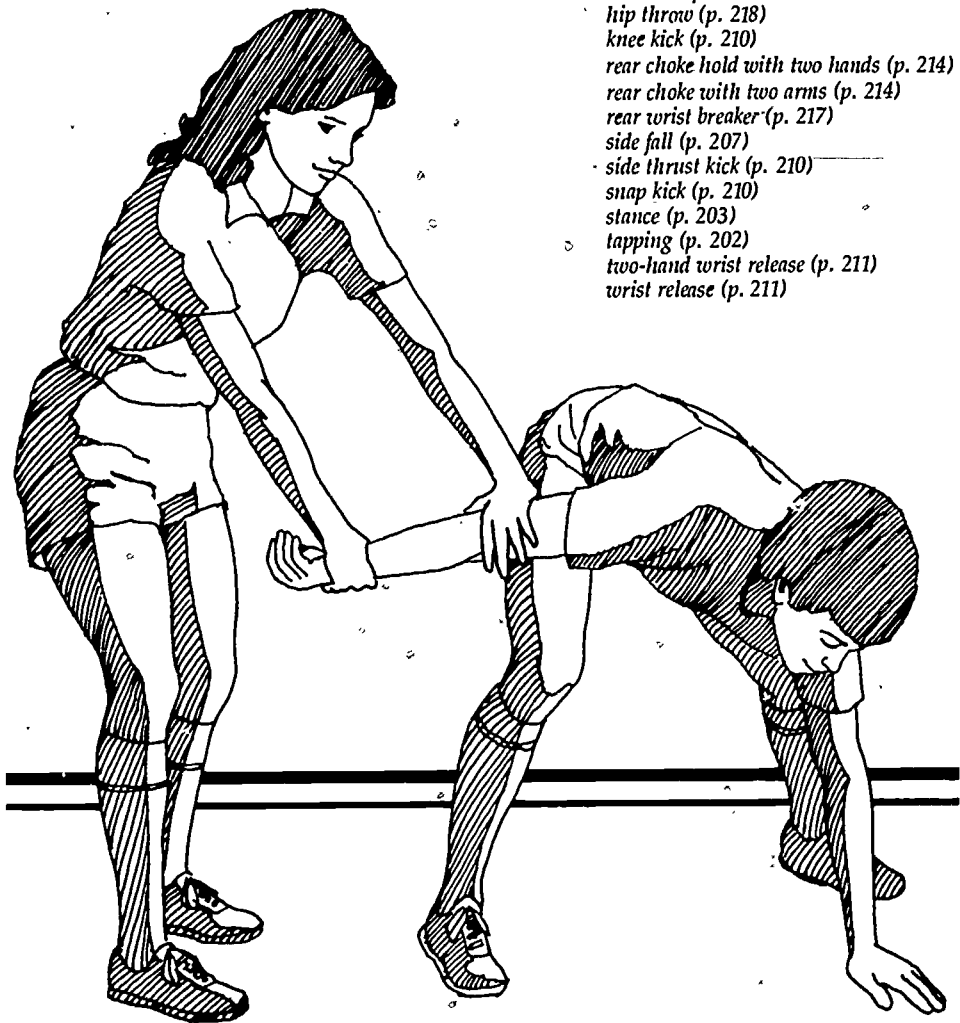

# Self-defense

KENNETH G. TILLMAN,  
*Trenton State College,  
Trenton, NJ*

## INTRODUCTION

Self-defense is, unfortunately, a much-needed course. The violence that exists in communities indicates the need for people of all ages to be capable of defending themselves. Appropriate physical skills must frequently be used in time of personal danger or danger to others. However, personal physical skills alone have limited value. Mental and psychological preparation is equally important. One must know when to use the many defensive techniques available and be able to select the best maneuver for the danger situation that is encountered. It is equally important to understand when physical force may or should be used.

There is a difference between skills learned in self-defense and the skills learned in most other physical education courses. It is hoped that you will never have to use the self-defense skills. In other courses, the goal is to develop skills that will be used on a consistent basis, while in school and throughout life. Self-defense must therefore be approached from an entirely different perspective. The skills learned are to be used only in emergency situations when personal safety or the safety of another is threatened.

Developing skills of self-defense is beneficial in many ways. Confidence will be gained in defending oneself and satisfaction achieved from knowing that dangerous situations can be handled. Physical skills such as agility, balance, and body control will improve as techniques of self-defense are practiced.

Techniques for defending oneself have been used as long as history has been recorded. Defensive techniques were neces-

sary for survival in ancient times and were learned by children at an early age. This need decreased as civilization progressed into modern times. However, there has always been a need to develop skills that can be used in times of danger. Practicing self-defense techniques develops physical skills and the mental alertness which is needed when threatened with violence by another individual or group of people.

Violence causes many problems in the United States and throughout the world. A person who is skilled in self-defense should have a deep sense of respect for others and work hard to decrease the amount of violence that is found in almost every community. It is very important for people skilled in self-defense to do everything within their power to avoid a situation in which violence will result. This is the first rule to follow. The second rule is to walk, or run, away from danger situations that are developing. This is the attitude toward violence that must form the foundation for learning self-defense.

Why learn self-defense skills when one could learn judo, karate, or some other martial art? There are basically two advantages. First of all, using a combination of techniques is better than being restricted to one style. The other reason is that an activity such as karate requires a much higher level of coordination, strength, and agility. It takes years of practice to become skilled in using karate self-defense techniques and the high level of skill that is needed for success requires continued practice. Remember that judo and karate are more than self-defense techniques. They are excellent sport activities that are fun to learn and provide enjoyable competition.

## CAUTIONS

People have a right to defend themselves. Everyone should be able to live a life free from the fear that accompanies intimidation and physical abuse imposed by others. It must be remembered that self-defense techniques should not be used to violate the rights of others or to injure another person unless personal welfare or someone else's well-being is threatened.

Laws governing the actions people may take in defending themselves vary from state to state. In general terms, a victim must believe that bodily injury is about to occur and there must be apparent danger to the victim, his or her property, or another person. In these situations, all force and means that are considered necessary to prevent injury may be used. The same principles apply when saving a third party from death or injury. Deadly force may be used only if life is in danger, not in defense of property. Retaliation can be used only up to the point necessary to stop the attack. The intended victim is not permitted to use excessive force for defense or for punishment. Verbal abuse is not a legal cause for physical retaliation unless an act is threatened which justifies a defensive action.

A person has the responsibility to avoid violence whenever possible. Legally, how-

ever, this does not mean that one has to retreat before protecting himself/herself. The following principles should be kept in mind:

- anticipate dangerous situations and use every possible measure to prevent them from occurring;
- walk away from dangerous locations even if it is ego-deflating;
- run from danger rather than get into a situation where self-defense tactics are required.

## SAFETY

There are a number of safety guidelines that must be considered when learning self-defense. These guidelines are to be followed at all times.

1. Work slowly when learning the techniques. The skill must be learned before movements can be controlled during practice. Speed can be increased as control is developed.
2. Tap for safety. Tapping is the universal signal to stop. It is not necessary to suffer extended periods of pain to become successful in executing self-defense techniques. Tap the mat, a partner, or oneself to stop the action. It is imperative that participants stop instantly when the tapping signal is given.

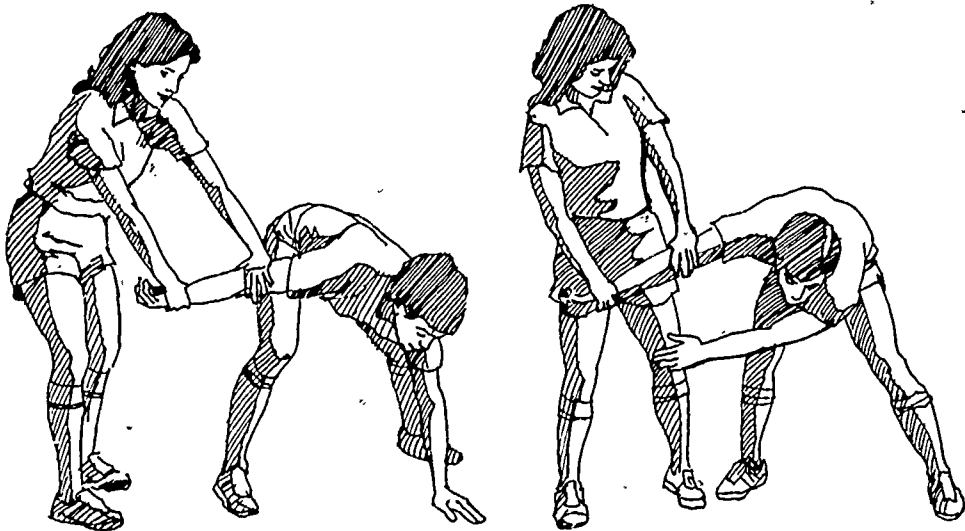

Figure 1. Tapping techniques.



3. Learn how to fall properly. Skill in falling is crucial for learning self-defense techniques safely.
4. React properly to pressure that is exerted. Go with the pressure when possible.
5. Never try to injure a partner in practice sessions. Full scale self-defense maneuvers should be used only when actually defending oneself or someone else from bodily harm.
6. Body blows and jabs can never be practiced at full force on a partner.
7. Do not wear jewelry or other accessories.
8. Wear comfortable physical education clothing that does not have buckles or other items that can cause injury to oneself or a partner when practicing self-defense techniques.

### LEARNING PROCEDURE

Work with a partner when learning self-defense skills. A partner should provide feedback to give an accurate evaluation of success in executing the skill being practiced. Start off with each partner practicing the self-defense move that is being learned. When both can complete the move properly, one will be the attacker and the other will use the self-defense technique. Then alternate roles. Start by going through the skills slowly and gradually increase speed until running through the maneuvers at full speed. *Remember that all dangerous skills are acted out; they are never carried out with full force against a partner.*

After learning several self-defense skills, develop a fight routine with a partner. Use the skills learned in class and practice routines as close to full speed as possible. Naturally, most of the skills in the routine cannot be completed because they would cause an injury. Develop the routine so that a different maneuver is moved to before there is the danger of an injury. The constant repetition of moving from one skill to another develops competency with the skills and increases ability to use self-defense tactics as effective fighting tools.

This chapter is arranged to cover the major categories of self-defense skills. After

learning the proper stance and gaining a basic knowledge of the vulnerable body parts, begin practicing the basic skills found in each section of this chapter. Hand blows, kicks, techniques for breaking holds, wrist breakers, and throws form the self-defense categories. Learn skills in each category. It is best to learn one or two techniques in each area rather than covering all the techniques in one category before moving to the next.

### STANCE

A well-balanced stance should be practiced. The feet should be about shoulder width apart with the knees slightly flexed. Keep the weight over the legs. This provides a firm base for executing the basic movements of self-defense. The arms should be in front of the body with the elbows flexed about 90° and the hands slightly cupped. The feet should be staggered with one foot slightly in front of the other. A comfortable stance should be assumed so that one can defend himself/herself and attack when necessary. The



Figure 2. Basic stance.

stance should permit rapid movement and give the best possible protection to parts of the body that can be easily injured.

**VULNERABLE BODY PARTS**

Be aware of the vulnerable parts of the body. This knowledge is important for defensive maneuvers as well as for offensive tactics. Applying blows to the eyes, instep, groin, kneecap, kidney area, windpipe, and the bridge of the nose can have a disabling effect. Other areas of the body also cause extensive pain.

Figure 3 illustrates the parts of the body that are most vulnerable. Memorize each of these vital areas and know how to best attack each one.

1. temples
2. eyes
3. bridge and tip of nose
4. side of neck
5. under nose

6. chin
7. Adam's apple
8. collarbone
9. armpit
10. heart
11. solar plexus
12. under last rib
13. stomach
14. groin
15. inside edge of thigh
16. kneecap
17. side of knee
18. shins
19. instep
20. ear
21. base of skull
22. back of neck
23. under shoulder blade
24. small of back
25. kidneys
26. elbows
27. tailbone
28. wrists

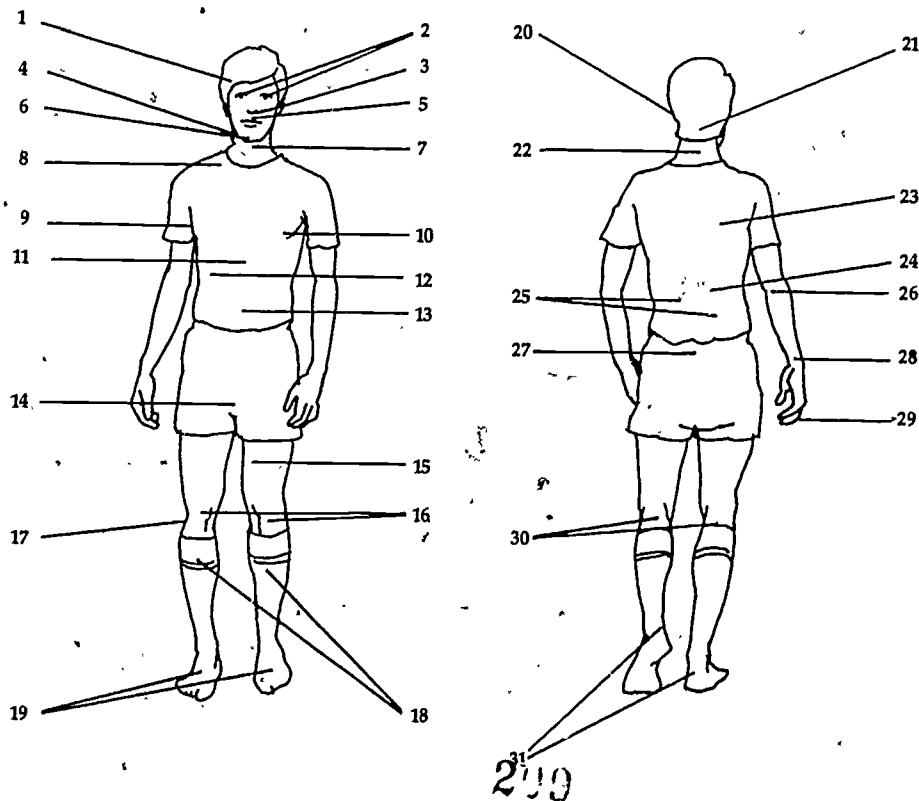

Figure 3. Vulnerable parts of the body.

- 29. fingers
- 30. behind knees
- 31. Achilles tendon

Blows with the fist, heels of the hand, and a knife-like slash with the side of the hand can all be effectively used on the vulnerable areas. Extended fingers to the eyes or throat will also stop an assailant. Sharp, forceful strikes with the knee or foot are equally effective on the lower extremities and when the attacker is on the ground. Force from a kick or blow to a joint can also immobilize an attacker. Pressure should be exerted against a joint whenever possible.

**FALLING**

Falling techniques are important to learn for self-defense. The ability to properly fall will prevent many injuries, will maintain body control, and will even at-

tain an offensive advantage after completing a controlled fall. Be able to properly execute the forward, backward, shoulder, and forward dive rolls before learning advanced falls. These rolls are covered in basic tumbling classes. If uncomfortable performing these rolls, practice them during the early part of the personal defense course.

Always practice falling on thick mats to protect from injury and to give confidence when learning falls. Develop proper form by practicing each fall slowly and then speed up as proper technique is learned. Remember that a fall should not be broken by reaching out with the hand. The objective should be to spread the impact of falling over a larger surface of the body and to develop the ability to relax the body rather than stiffening it.

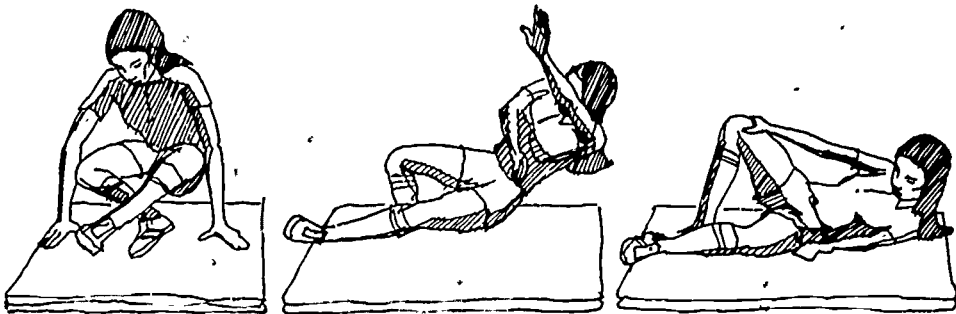

Figure 4. Side fall from squat.

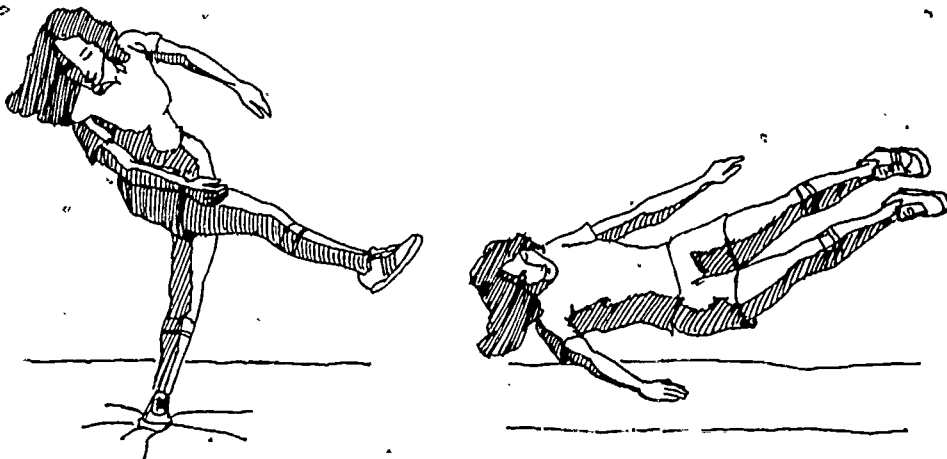

Figure 5. Side fall from stand.

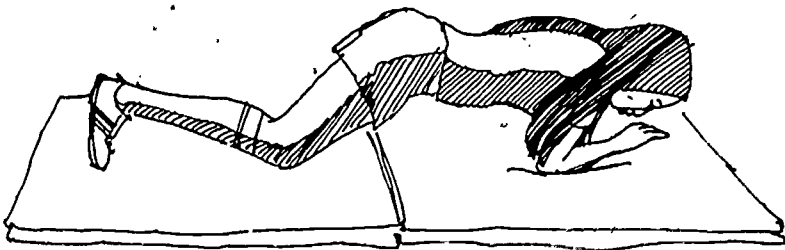
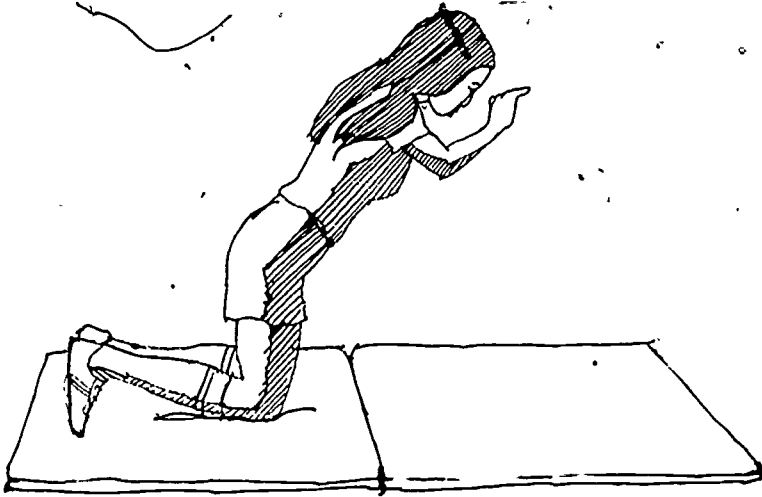
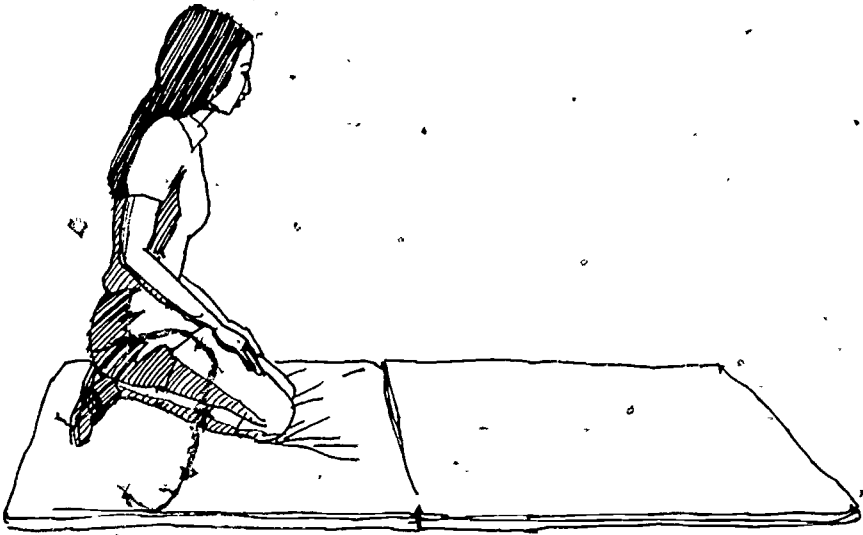

Figure 6. Front **211**

### Side Fall

The side fall is a frequently-used fall. It is an effective means of avoiding injury when thrown to the ground or floor.

A good way to learn this fall is to start in a squatting position with one leg crossed in front of the other. The forward leg is moved forward and the arm on the falling side brought up in the air as balance is lost. When landing, distribute the force of the fall from the foot to the shoulder and slap the mat with the palm of the hand to break the fall. The arm should be extended and the fingers slightly spread. Keep the head off the mat and slap the mat vigorously. After the side roll is mastered from a squat, gradually start farther from the mat until capable of falling from a standing position. Practice rolling to the stomach by bringing the bent leg over the straightened leg. Use this maneuver to move away from the opponent and come to the feet.

Figure 5 illustrates the side fall technique from the feet. Standing with the weight evenly distributed, kick the foot across the body (see Figure 5) and fall to the side. The right arm and leg are raised as the right buttock hits the mat; roll back to the shoulder and slap the mat with the right hand. The head stays off the mat at all times and the legs should be raised when the fall is completed.

### Front Fall

Learn the front fall by beginning in a kneeling position on the mat. As the body falls forward, slap the mat with both hands slightly cupped. The force of the fall is absorbed with the hands and forearms. Keep the hands and forearms straight.

When the front fall can be performed from the knees without jarring the body, move to a standing position. Fall forward smoothly from a relaxed position and make contact with the mat simultaneously with the hands and forearms. Keep the body straight when falling forward, only the hands, forearms, and toes should be in contact with the mat when the fall is finished. Do *not* hit the mat with bent wrists.

### Back Fall

Learn the back fall by beginning in a sitting position. Have the back slightly rounded and the head tilted forward. Round the back and roll back with an easy motion as the arms and legs are raised. Slap the extended forearms and hands to the mat as the upper back hits the mat. As with other falls, keep the head from hitting the mat.

The next step is to begin the back fall from a squatting position. Roll onto the back while tucking in the buttocks to avoid shock to the back. The movement after making contact with the mat with the buttocks is the same as when starting from a sitting position. Finish by slapping the hands and forearms against the mat. Keep the chin tucked to the chest. The legs should be raised in the air when finished.

### HAND BLOWS

There are several different hand positions that should be learned. One of the most effective positions for delivering a blow is to hold the hand straight, with the fingers together and extended. Then strike

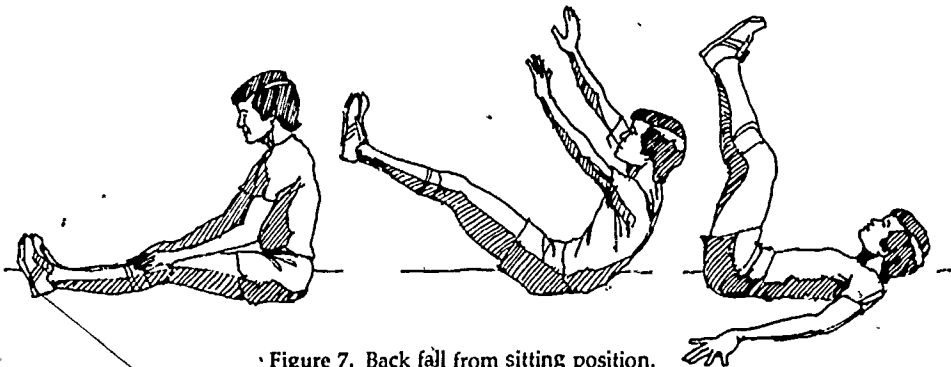

Figure 7. Back fall from sitting position.

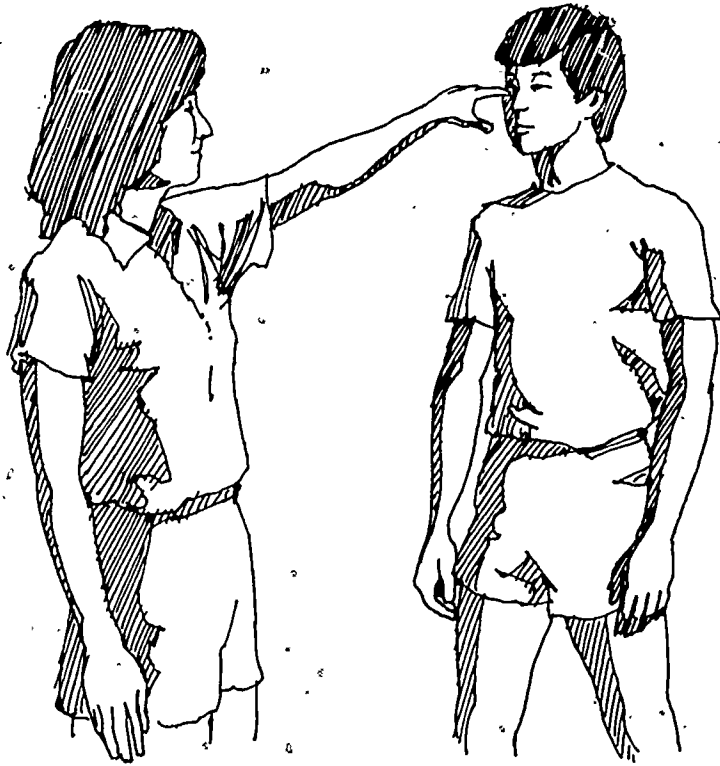

Figure 8. Eye jab.

a vulnerable area of the opponent's body with the fleshy outer edge of the hand. The bridge of the nose, the Adam's apple, the side or back of the neck and the stomach are good examples of body parts where this type of blow is very effective.

A closed fist can also be used to make contact with vital areas. When delivering a blow with the fist, make contact with the second knuckles of the first and second fingers. It is also possible to extend the knuckle of the middle finger and use this weapon against unprotected body parts. Remember that the fist is used primarily on soft body parts of the opponent. If bony areas are hit there is a risk of breaking a bone or bones in the hand. A backhand motion is another way the fist can be used. This is a particularly good way to strike the face of an attacker.

Extension of the fingers on the hand makes a good fingertip jab weapon. Spread

the fingers when poking the eyes and keep them together when jabbing other vulnerable body parts such as the groin or solar plexus. Deliver blows with the fingers by using short, rapid jabs. This will keep the attacker off-balance and cause a great deal of pain.

The heel of the hand is one of the best weapons when an attacker is getting close. Drive the heel of the hand sharply to the chin of the attacker. The secret is to strike the chin as sharply and as forcefully as possible. This blow can also be used if the attacker's arms are around the victim's body. Use the heel of the hand of a free arm to rip into the chin or nose of an attacker.

These hand blows should be practiced on a dummy, padded wall, or some other resilient material. Remember never to use full force against a hard surface or an injury may occur to the hand or fingers. Work on correct form at first. Never practice these blows on a partner.

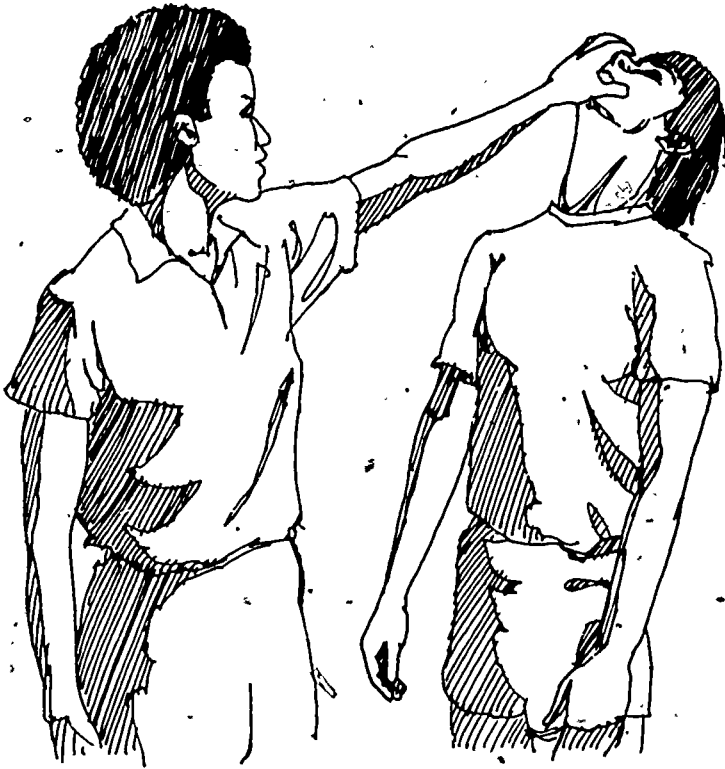

Figure 9. Heel of hand blow.

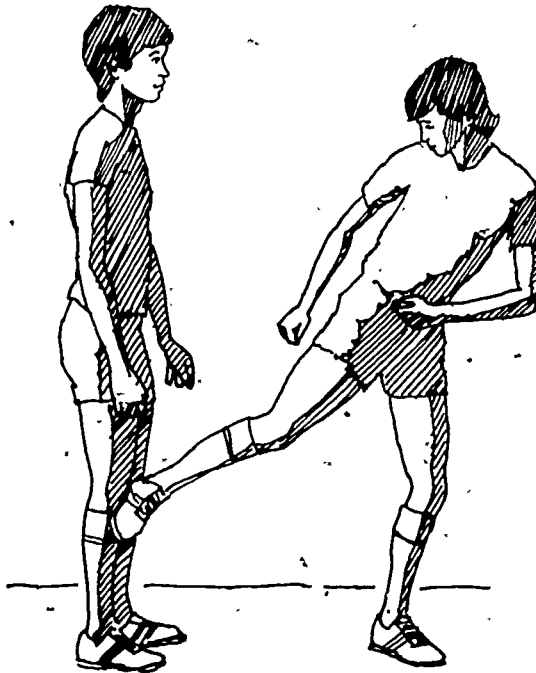

Figure 10. Snap kick using the bottom of the foot.

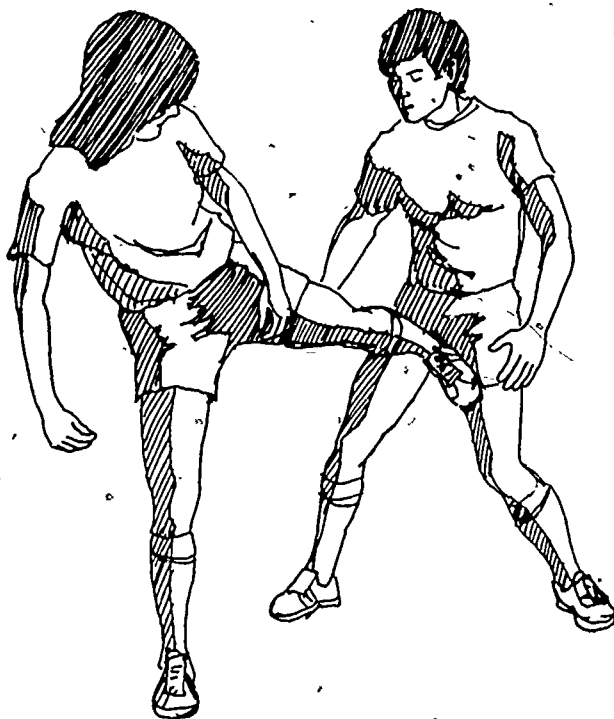

Figure 11. Heel-kick to the groin.

## KICKS

Self-defense situations call for different types of kicks. The toes, heel, ball, side, and bottom of the foot can all be used for kicking. The shoe will protect the foot and cause additional pain to the attacker. Do not kick with the toes if they aren't protected with a hard shoe. Use the ball of the foot instead. When the bottom of the foot (shoe) is used, turn a side to the attacker and make a short, powerful *snap kick* to the knee.

The *snap kick* can also be effectively used when facing the attacker. Again, aim the kick at the knee and use a fast action so that the attacker cannot grab the foot or step out of range. Do not kick higher than the knee unless highly skilled in using leg kicks because the attacker may grab the foot.

A *side thrust kick* is similar to the snap kick. The main difference is that the opponent is smashed with the side of the foot rather than the bottom. To properly use this kick pivot so that a side is facing the assailant, draw the knee of the kicking leg to the body, and then vigorously extend the

leg and make contact with the side of the foot.

The *heel kick* should be practiced to make contact with the shin of the person who approaches from behind. The heel should also be used to come down forcibly on the instep of an attacker who grabs from behind.

The heel kick can also be an effective weapon when vigorously propelled to the groin of an attacker who is behind the victim. It must be carefully timed to be used either when breaking away from an attacker or stopping an assailant's charge from behind. This must be a speedy kick so that the kicking foot will not be grabbed by the attacker.

The *knee kick* is another effective self-defense tool. It is used when facing and in close contact with an attacker (see Figure 12). A gap should be created between the victim and his/her attacker. Drive the knee sharply to the groin area. There will usually be room to use the knee kick because most attackers will be using their arms to try to



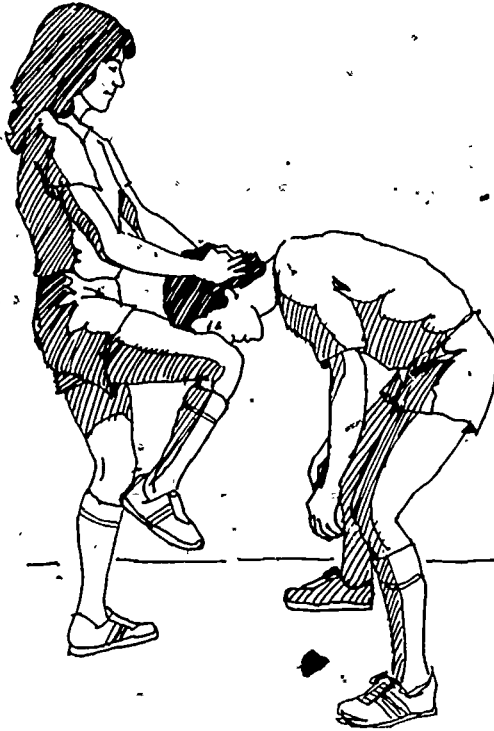

Figure 12. Knee kick to the face.

control the arms and upper body. It may be necessary to force the hips away to have enough room to use the knee.

If the assailant is bent down or the victim is able to deliver a blow to the back of the head to put the attacker's face within knee range, a vigorous *knee kick* to the face can abruptly stop the attack. Attempt to drive down on the head at the same time that the knee is being kicked upward. This will increase the power of the blow and will prevent the head from being pulled out of range of the knee.

As with hand blows, kicks should be practiced on dummies, padded walls, or some other padded surface. Work on speed of execution after developing correct body position and balance. Emphasis should be placed on contacting the shin, knee, and groin area.

## BREAKING HOLDS

### Wrist Release

The natural reaction when someone grabs the wrist is to pull back. This is exactly

what the attacker wants the victim to do. The appropriate action is to drop the elbow forcefully and use a twisting action to exert force against the attacker's thumb.

The same action is used when the assailant has a hand on each of the wrists. Twist each wrist toward the attacker's thumb. Immediately move to a good defensive stance or attack if the assailant is off-balance or in a position where the victim can use a kick or hand blow.

### Two-hand Wrist Release

If an attacker grabs one wrist with both hands, release can be gained by grasping the fist of the grasped arm with a free hand and pulling it sharply upward while lowering the elbow of the held arm. Lower the body weight to give additional leverage and maintain a balanced position when the arm is freed.

Another release technique, when one of the wrists is controlled, is to deliver a blow to the attacker's throat, mouth, nose, or eyes, with the free hand. Use the extended hand position and expend all force possible

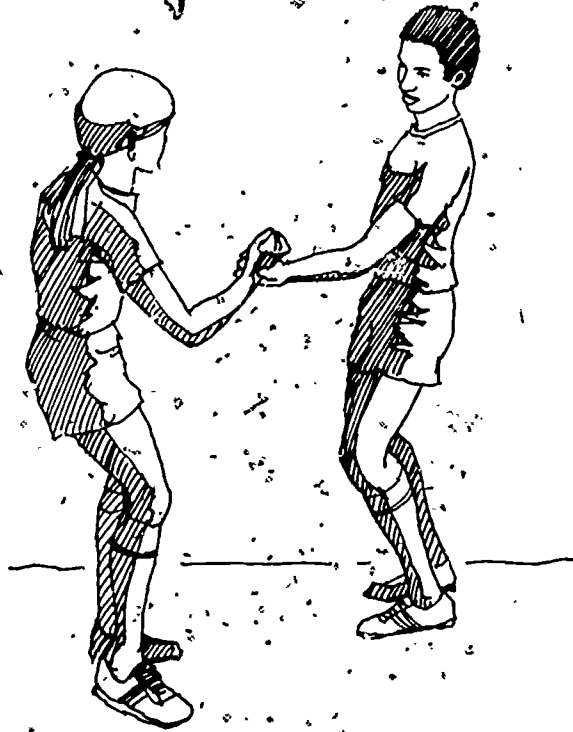

Figure 13. Single wrist release.

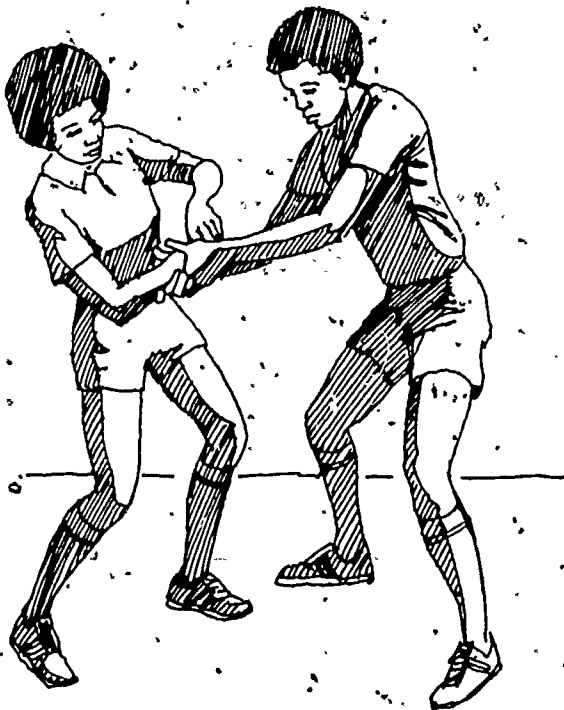

Figure 14. Two-hand wrist release.

to slash into the attacker with a chopping action. Repeat the blow rapidly if the attacker remains in a vulnerable position by maintaining hold of the wrist.

### Bear Hug

Several different ways should be learned to break free from a bear hug. The bear hug prevents the victim from moving away from the attacker and limits the blows that can be used to overcome the attacker. It is therefore important that one know how to break free from a bear hug.

Several techniques were covered in the section on kicks. The shin can be kicked with the toe or scraped with the side of the shoe. The groin can be kicked with the knee. One can also lean back and give a hand chop to the throat or a vigorous smash to the chin with the heel of the hand.

If the bear hug is from behind, kicks and blows are again effective. A kick to the shin, stamping on the instep, or stepping to the side and striking the groin with the hand

are all effective methods. Grasping a finger and pulling back with all possible force and biting a hand or arm across the face should also be considered.

Two other techniques that can be used against the bear hug are to butt forcefully into the opponent's face and pinch tightly on the inside of the thigh. Against a male attacker, grab the scrotum, squeeze, and jerk.

### Front Choke Hold with Two Hands

If the attacker grabs the neck with both hands and begins choking, react rapidly. The first action to release the grip is to clasp your hands and drive the arms up between the attacker's arms. This will release the grip. Immediately go on the offensive by smashing the hands over the bridge of the attacker's nose or use another striking or kicking movement to disable the attacker.

Another technique to use is to raise your arms above your head outside the attacker's arms and twist rapidly to apply pressure on

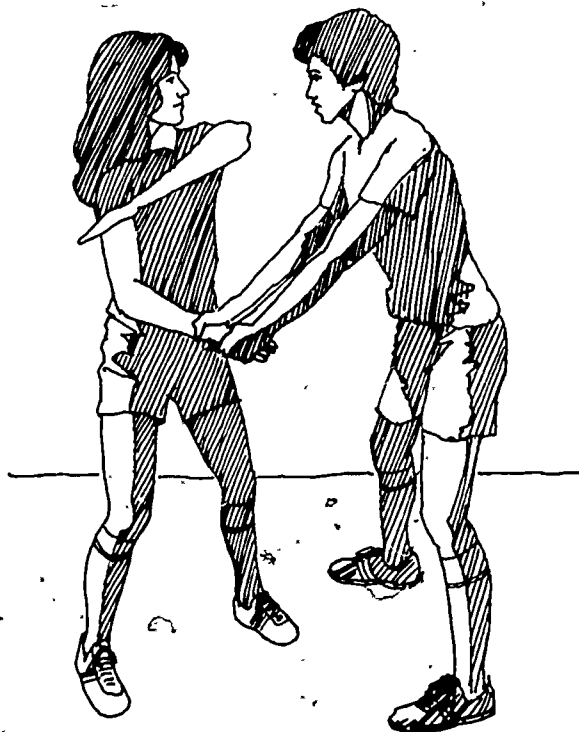

Figure 15. Chop release for two-hand wrist grasp.

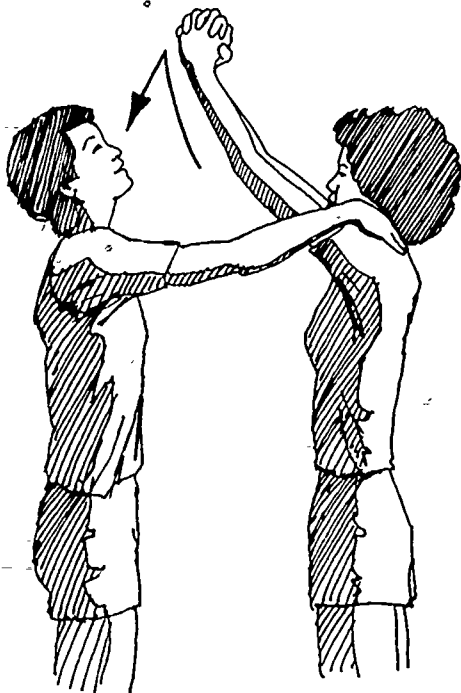

Figure 16. Arm shoot to release choke hold.

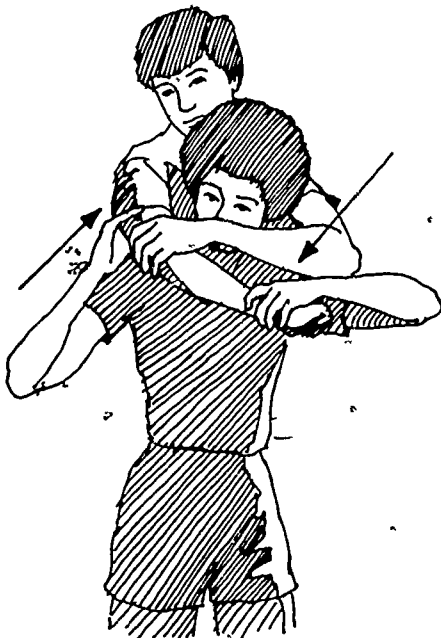

Figure 17. Rear choke lift and duck release.

the attacker's wrists. This will release the neck grasp and provide an opening for a counterattack.

#### Rear Choke Hold with Two Hands

The double arm twist also works effectively to counter a rear choke hold. As soon as you turn and free yourself look for an escape route or strike a vulnerable part of the attacker's body.

#### Rear Choke with Two Arms

When the throat is encircled from behind, act rapidly. Tuck the chin into the chest to take pressure off the throat. Grasp the assailant's right elbow with your right hand as shown in Figure 17. The left hand grasps the attacker's right wrist. Lift on the elbow, push down on the wrist, and duck under the arm. Keep control of the arm if possible and pull it behind the attacker's body where it can be twisted or jerked upward to control the assailant.

#### WRIST BREAKERS

##### Front Wrist Breaker

Grasp the assailant's right hand with your left (or the assailant's left hand with your right). Place your thumb on the center of the knuckles and grab the palm of the hand near the thumb with the fingers. Pull the attacker's hand to the inside so that the fingers point straight up. While turning the hand, place your right thumb on the knuckles next to the attacker's left thumb and grab the palm of the hand near the little finger with the fingers on your right hand.

Note that the fingers meet in the palm of the assailant's hand and that the little fingers are near the wrist. When the hands are in position, immediately drive the attacker's fingers straight up and push hard with your thumbs to cock the wrist as far as it will go.

Keep the wrist cocked and turn the palm of the attacker's hand to the outside. Keep pressure on the wrist as your body weight is shifted forward; pivot your hips toward the attacker's free arm and drop him/her to the ground with the pressure being placed on the wrist.

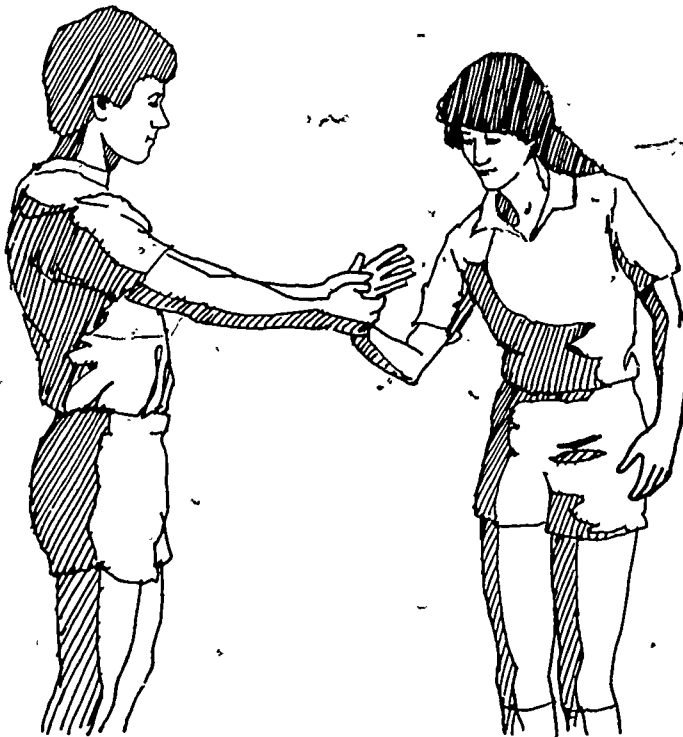
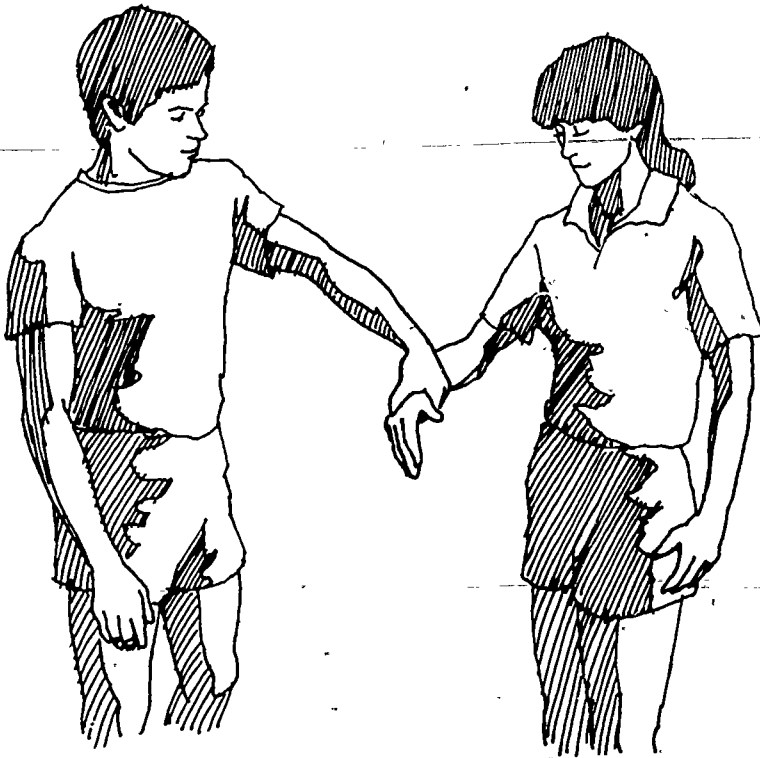

Figure 18. Hand position for front wrist breaker.

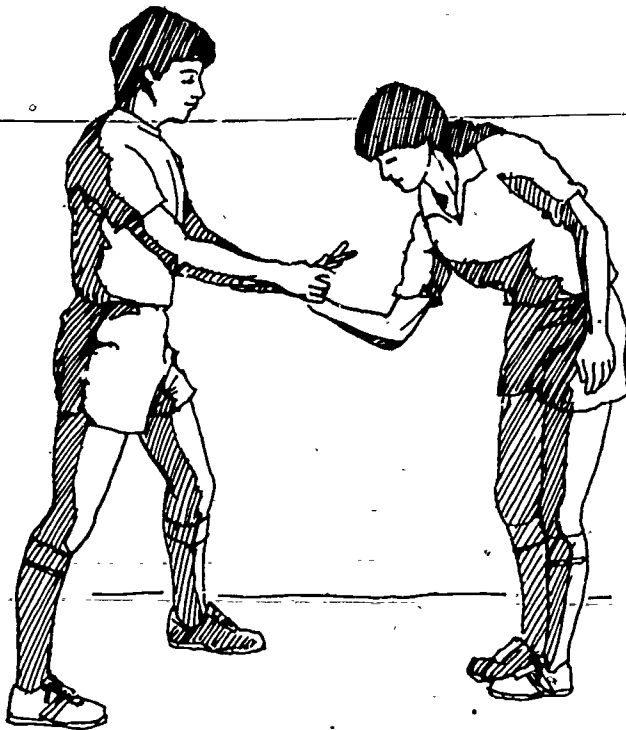

Figure 19. Wrist cocked.

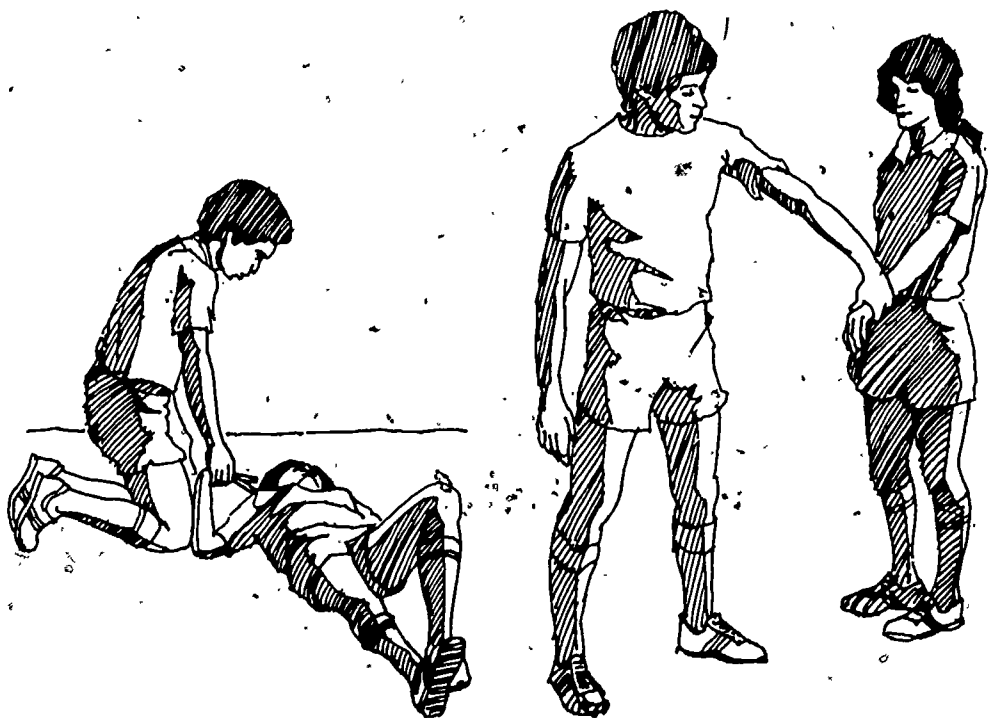

Figure 20. Finish of front wrist breaker.

Figure 21. Hand position for rear wrist breaker.

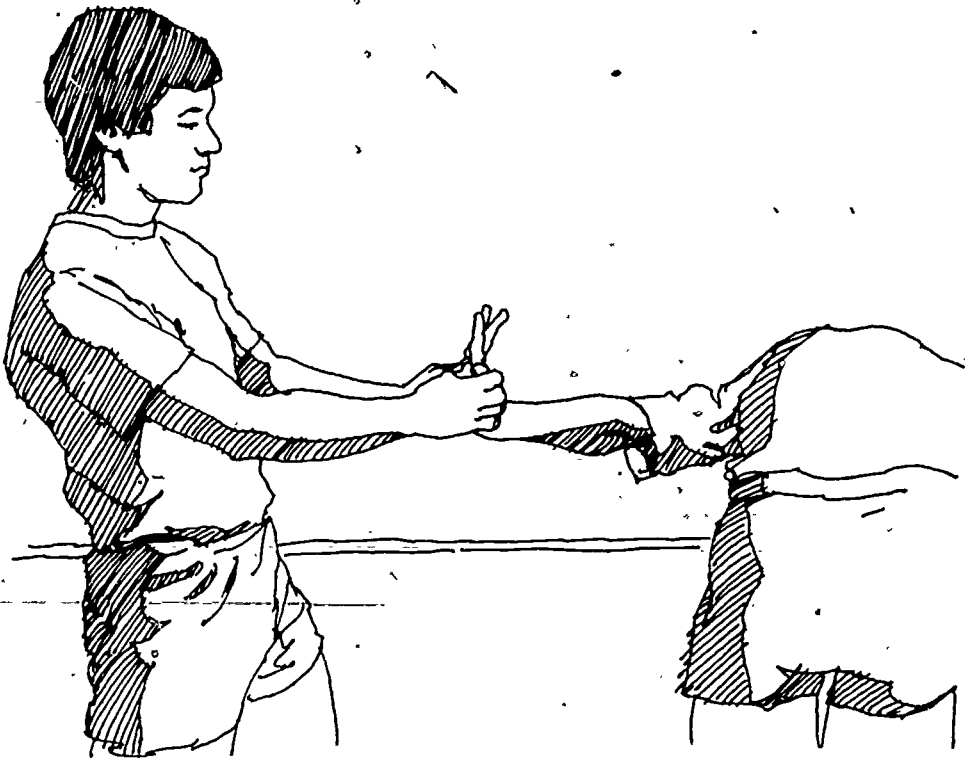

Figure 22. Rear wrist breaker.

### Rear Wrist Breaker

A technique similar to the front wrist breaker is called the rear wrist breaker. Reach across the attacker and grasp his/her right hand with your right hand or his/her left hand with your left hand. The thumb is again placed in the center of the knuckles and the little finger side of the hand is grasped with your fingers. The attacker's hand is then twisted to the outside and the wrist is cocked.

The other hand is then placed in a similar position with your thumb on the knuckles and your fingers clamped on the thumb side of the palm. Place the second hand in position as soon as possible. Turn the attacker's hand to the outside of his/her body; then move your body to a rear position (see Figure 22). Point the fingers of the attacker straight up by putting pressure with the thumbs and pulling in vigorously with the fingers. This is a very painful hold. The attacker can be driven to the ground; control can be maintained by extending your arms

and increasing the leverage being placed on the wrist. The correct leverage is being applied if the knuckles are being driven toward the elbow.

### THROWS

Throws should not be considered a first line of defense. To throw someone the victim must be close to that person. This leaves the victim vulnerable to blows, choke holds, and kicks. It is best to use a defensive tactic which will keep the victim out of range of the assailant. Throws require skill and an attacker can sometimes neutralize the skill with strength and brute force. Learn throws only after knowing how to fall properly.

It is important to learn some basic throws since there will be times when the victim finds himself/herself in a position where a throw is the best defensive technique.

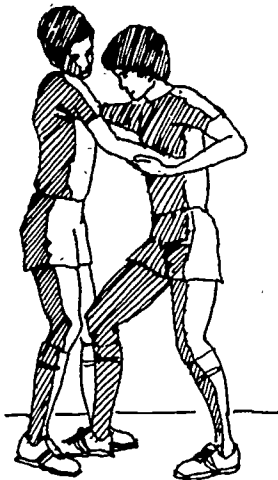

Throws are also good to practice since the victim learns to fall correctly and recover rapidly after being thrown. In many rough and tumble fights, throws to the ground will be used. The victim must know how to react.

#### Hip Throw

This throw is used when the victim is close to the attacker. Grasp the attacker's right arm with the left hand and slide the right arm around the waist. Simultaneously place the right foot next to the inside of the attacker's right foot. The victim then pivots on the right foot and steps back so that the attacker's body will be across the victim's hip. To initiate the throw, the victim bends the knees and then springs up. This will pull the attacker off the mat. The victim completes the throw by bringing the opponent forward over the victim's hip and follows to the mat.



#### Flying Mare

This is a technique to use when grabbed from the rear with a choke hold.



Figure 23. Hip throw.

Figure 24. Choke hold position.



Reach both hands up and hold as high as possible on the attacker's upper arm. Keep good balance with a low center of gravity. With the attacker's weight on the victim, an explosive forward and downward motion of the head should be used to bring the assailant over the victim's head and onto the mat. A vigorous downward motion should be used while the arm is pulled hard.

Using the flying mare will free the victim and provide an opportunity to escape or use one of the disabling techniques once the opponent is on the ground.

#### Back Trip Throw

If the attacker's arms are around the waist, drive forward to destroy his/her balance. It is important to maintain a position above the attacker if at all possible. Shift the hips quickly to the side, step the inside leg behind both legs of the attacker, push vigorously at the shoulders while simultaneously kicking the attacker's leg upward. This will drop the attacker to the ground

with sufficient force to provide the victim with an opening to attack with a kick or blow.

### ADVANCED SKILLS

There are many other more advanced skills that can be learned after developing the ability to use the skills in this chapter. Various types of advanced blocks, trips, throws, and holds will provide a continuing challenge.

Now that the basic self-defense techniques are known, consider different types of danger situations where each can best be utilized. Continue to practice the skills learned to be prepared for any danger situation that may be confronted.

Always remember that self-defense techniques are used only when absolutely necessary. Every measure is used to avoid physical encounters. Blows, kicks, and other types of force are used only when

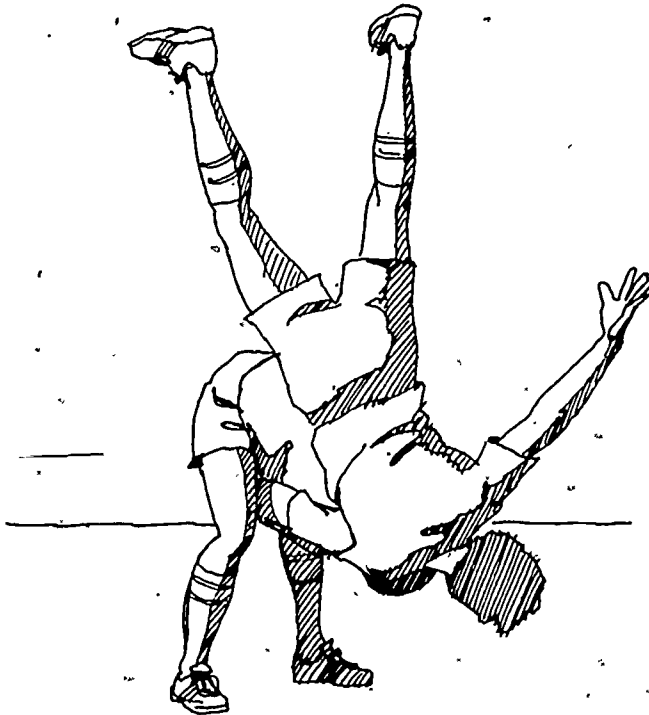

Figure 25. Flying mare being executed.



Figure 26. Back trip throw.

such action is clearly indicated because life is endangered or a hazardous situation exists.

## REFERENCES

- Burg, Kathleen Keefe. *The Womanly Art of Self-Defense*. New York: A & W Publishers, Inc., 1979.
- Conroy, Mary, and Ritvo, Edward R. *Common Sense Self-Defense—a Practical Manual for Students and Teachers*. St. Louis, MO: The C. V. Mosby Company, 1977.
- Farkas, Emil, and Leeds, Margaret. *Fight Back—a Woman's Guide to Self-Defense*. New York: Holt, Rinehart and Winston, 1978.
- Heyden, S. Margaret, and Tarpinning, Allan V. *Personal Defense for Women*. Belmont, CA: Wadsworth Publishing Company, Inc., 1970.
- Hudson, Kathleen. *Every Woman's Guide to Self-Defense*. New York: St. Martin's Press, 1977.
- Hyams, Joe. *Playboy's Book of Practical Self-Defense*. Chicago, IL: Playboy Press, 1981.
- Kaufman, Doris A.; Rudeen, Robert D.; and Morgan, Carol Anne. *Safe within Yourself*. Alexandria, VA: Visage Press Inc., 1980.
- Neff, Fred. *Everybody's Book of Self-Defense*. Minneapolis, MN: Lerner Publications, 1978.
- Pacala, Lynn. *Self-Defense*. Santa Monica, CA: Goodyear Publishing Company, Inc. 1980.
- Seidler, Armond. *Defend Yourself—Scientific Personal Defense*. Boston, MA: Houghton Mifflin Company, 1978.
- Tegner, Bruce. *Bruce Tegner Method of Self-Defense: 10 Lessons for Home Study*, 2d ed. Ventura, CA: Thor Publishing Company, 1971.
- Willard, Nancy; Cameron, Richard; and Chenell, Bruce. *Realistic Self-Defense—a Road to Escape*. Dubuque, IA: Kendall/Hunt Publishing Company, 1974.
- Wyness, G. B. "Jerry." *Practical Self-Defense*. Palo Alto, CA: Mayfield Publishing Company, 1975.

avoidable hinder (p. 231)  
back court (p. 231)  
back wall shot (p. 230)  
ceiling shot (p. 230)  
change-of-pace serve (p. 227)  
cross-court serve (p. 225)  
drive or power serve (p. 225)  
drop shot (p. 229)  
fist ball (p. 230)  
foot faults (p. 231)  
front court (p. 231)  
game (p. 231)  
handshake grip (p. 224)  
hinder (p. 231)  
kill shot (p. 228)  
lob serve (p. 226)  
long serve (p. 231)  
match (p. 231)  
order (p. 231)  
out (p. 231)

passing shot (p. 228)  
ready position (p. 223)  
the serve (p. 225)  
service box (p. 231)  
service line (p. 231)  
service zone (p. 231)  
short serve (p. 231)  
short service line (p. 231)  
striking position (p. 224)  
unavoidable hinder (p. 231)  
volley (p. 230)  
Z serve (p. 226)

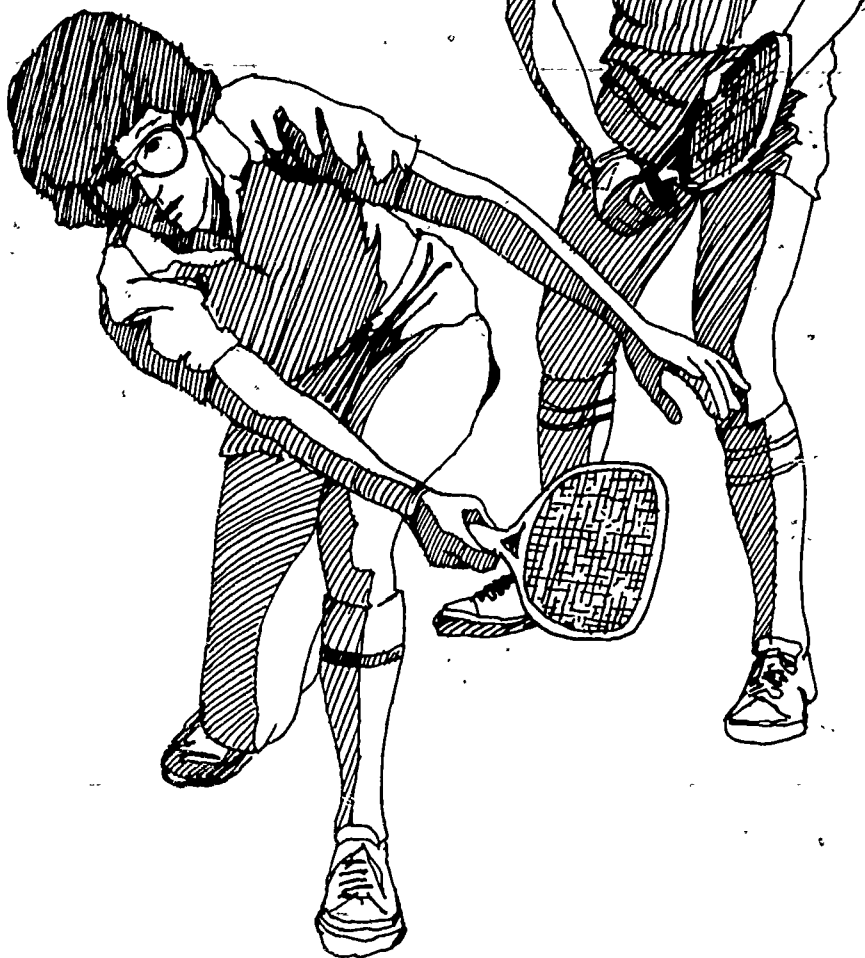

# Racquetball/Handball

JOHN P. SMYTH,  
*The Citadel,*  
 Charleston, SC

## INTRODUCTION

Racquetball and handball are court games that can be learned with relative ease. As with other sports, performance can be progressively improved and enjoyed with planned practice and play.

Early forms of handball have been historically traced to the *thermae* of ancient Rome. The present American game can be traced back to the mid-1800s. Handball can be played on courts of one, three, and four walls by two, three, or four players. It requires only the playing surface, ball, and protective gloves. Protective glasses are required in youth competition and are strongly recommended for the safety of players of all ages. The goal of the game is for the players to alternately strike the ball with the hand causing it to strike the front wall and then bounce twice on the floor before the opponent can successfully return it to the front wall. The game is played to twenty-one points, with only the serving side or player eligible to score. Handball play is governed by the unified rules adopted by the AAU, YMCA, USHA, and the Jewish Welfare Board.

Racquetball is played on the same court as handball with essentially the same rules. The use of a paddle to replace the hand can be traced to Earl Risky at the University of Michigan in the 1920s. Joe Sobek brought the strung racquet into the game nearly twenty years later. The International Racquetball Association and the United States Racquetball Association have promoted the sport and regulated competition since the early 1970s. Racquetball involves the same strategies and fitness requirements as handball, but the use of the backhand replaced the use of the non-dominant hand. The backhand,

the larger striking area, and the absence of direct contact between the ball and the hand are differences which might lead novice players to choose racquetball over handball.

The added weight and velocity of the racquet add a potential safety hazard to the game, and therefore great caution is required when playing a ball near a partner or opponent.

Handball and racquetball are good health fitness activities. The simple rules, short game duration, and enjoyable nature of the activities have made them perhaps the fastest growing American sports of the 1970s, with the promise of even greater popularity in the future.

Four-wall court facilities are rapidly expanding in number, but the building rate has not matched the growth in popularity. The use of one- and three-wall courts found in many parks and gyms has helped to provide modified opportunities to play handball and racquetball. The game can be fun for any age and any skill level. As with most games, the greatest enjoyment comes from participation with and against players of nearly equal ability.

## SKILLS AND TECHNIQUES

### BODY POSITION

The body position fundamentals of handball and racquetball follow the general rules for most racquet sports. The ready position is a balanced position with the feet spread shoulder width apart, the knees comfortably bent, the back straight, and the head held erect. When strokes are executed to the side of the body, the body should be turned perpendicular to the front wall, permitting leverage of the body to assist the primary movement of the striking arm and

hand. Underhand and overhand strokes can be executed while facing the front wall by using the basic throwing positions with the legs functioning in opposition to the striking action.

### HAND POSITION

The gloved hand is the striking implement in handball; therefore, it is important to cup the hand to contact the ball with the palm of the hand and permit it to roll off the closed fingers.

The grip in racquetball is the conventional handshake grip. The racquet is held with its face perpendicular to the floor with the grip extended toward the body. The dominant hand "shakes hands" with the grip. It is important to keep the palm of the hand parallel with the face of the racquet by keeping the "V" formed by the thumb and index finger slightly to the left of the middle position, as the player looks down at the grip. It is equally important to lay the racquet grip across the palm diagonally from the heel of the palm to the base of the index finger, permitting the racquet to become an extension of the arm, as opposed to a segment which joins the arm at a right angle. The index finger should act as a "trigger finger" on the grip. Beginning players have difficulty in adjusting the grip during play; therefore, a slightly weaker forehand grip, involving the counterclockwise rotation of the right hand should be used to assume a position which is more suitable for the backhand. This modified grip is called the continental grip. It is employed by players who cannot or prefer not to switch grips by rotating the hand over the top of the grip to put the wrist behind the backhand stroke.

### STRIKING POSITION

The ready position is the best position to assume in anticipating the shot of an opponent; it facilitates reactive movement in any direction with the least amount of wasted motion. The often overlooked ability of body position and anticipation is in use between the ready position and the striking position. The player must anticipate the speed, direction, and height of the ball to move to the most advantageous position. Much of playing

the bounce is learned through court experience; however, there are some fundamental considerations. Optimal court position is just behind the short service line, because of its potential for court coverage. A high bouncing or flying ball is difficult to strike on low trajectory without the return resulting in a high bounce. Also, forehand shots are generally easier for beginners to execute. Ideally, then, the beginning player should seek to play the ball near center court from a low position and when possible with the forehand. Since this position is not always possible the player must adjust court position while the opponent's shot is heading toward the front wall or as it rebounds. The feet should be slid or shuffled, rather than using a stride in which the legs are crossed. The last slide step should take the body into a position perpendicular to the front wall or the angle of the oncoming ball. The arm and hand must be taken back in the backswing position in anticipation of the stroke. The knees permit adjustments in height corresponding to the height of the bounce. The high backswing arm position is assumed before the ball bounces on the floor. The hand and wrist are relaxed but cocked in at high backswing position to permit the hand or racquet to hit through the ball as the body weight is transferred from the back foot to the front. The elbow should be bent and held slightly away from the body in the backswing. The forward swing should combine hip and shoulder rotation with the weight shift and arm swing. The ball should be contacted at approximately three-fourths of an arm's length and the point of contact should be at a point even with the lead foot. The follow-through should be level with the swing and in the direction of the intended line of flight.

### Basic Strokes

Most of the basic strokes can be hit from the forehand, overhead, underhand and, in racquetball, backhand positions. The game situation will dictate which shot is employed. The player's court position, the court position of the opponent, the speed of the ball, the court placement of the ball, the

height of the ball, and a working knowledge of the opponent's strengths and weaknesses help determine proper shot selection.

**THE SERVE**

The ball is put into play by a serve. The server stands within the serving zone, drops the ball, and strikes it on the first bounce so that it contacts the front wall first and rebounds past the short service line, either before or after touching one of the side walls. The serve may be played from any of the hitting positions, but because of the power and accuracy, the forehand in racquetball and the dominant hand in handball are frequently used most.

**The Drive or Power Serve**

The drive serve is the most powerful of all serves. The serve is struck from a low bounce and contacted well below the knees. The path of the serve forms a "V." The rebound from the front wall carries the ball toward the backhand corner at a speed great enough so it will get to the corner but not sufficient for it to rebound from the back wall. Another desirable target is the side wall on the backhand or non-dominant hand side just beyond the short service line, when this spot is hit near the floor line, the result is a short low bounce. The purpose of the shot is to take the receiver out of

offensive position and permit a minimum amount of time to react to the placement. Speed is important, but speed without placement is often counter-productive, as the ball will rebound off the back wall in good position for a high percentage offensive return by the receiver. The server should select a spot on the front wall as a target for optimal trajectory and angle. The height of the target should be three feet or less, depending on the speed of the serve. The target is lowered as the server learns to generate more speed. The serving spot should be a stationary point in the service zone, to add consistency to the required angle to the deep corner. The server can mark a target area on the floor with tape, for practice and self-evaluation. The size and shape of the target will vary with ability level; for beginners a rectangular target measuring three feet by ten feet should represent a suitable challenge. When the target area is hit at a seventy percent level of accuracy, the server can reduce the target area or increase the speed. The beginner should practice bouncing the ball to provide proper placement. If difficulty is encountered in making contact, the student should practice throwing the ball at a target, using an underhand motion. The throwing drill will emphasize proper weight shift from the back to front foot, and emphasize the need for hip and shoulder rotation. The follow-through is a good indication of the direction of force, and the length of follow-through indicates the extent of force at contact. The server should visualize a full follow-through extended toward the line of flight. Some players find that a step into the serving action aids in transfer of weight and increased momentum for the hand and arm.

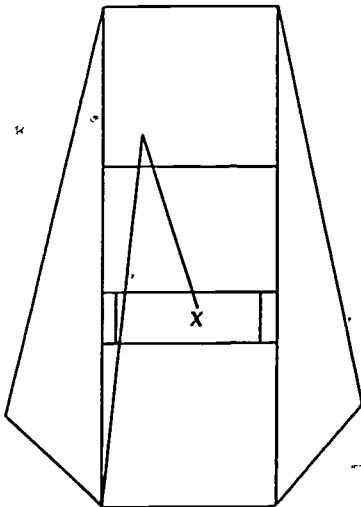

Diagram 1. Drive serve.

**The Cross-court Serve**

The server should stand two feet away from the center of the court, on the same side as the target corner. From this off-center position, the server can strike the ball against the front wall at a point three or four feet away from the far side wall, causing the ball to carom at a sharp angle against the side wall and bounce deep into the diagonally opposite corner. The ball

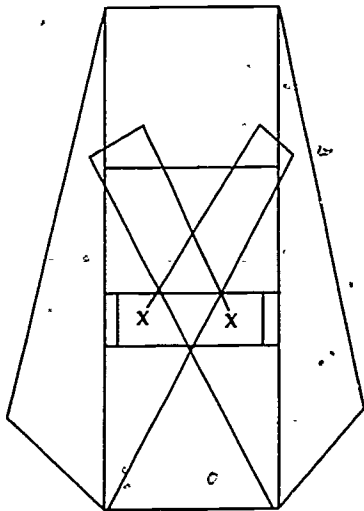

Diagram 2. Cross-court serve from right or left side.

should strike the front wall about three to five feet above the floor with sufficient force to carry it near the back corner after one bounce. It should be noted that each additional wall the ball touches affects the spin and reduces the speed of the ball. Accuracy is important in the cross-court serve to avoid a middle court set-up for the receiver. If the receiver errs by striking the side wall *first*, then the serve is lost. If the serve strikes three walls before striking the floor, the server has committed a fault and must make a second serve. A second fault causes the server to lose the serve which is called side-out. The beginner can mark the front wall with an "X" to practice accurately placing the ball in the back corner, permitting the receiver the lowest percentage shot. The same serve can be hit high off the front wall if it is struck with the proper amount of force to cause a high bounce in mid-court and then permitting it to die in the corner.

#### The "Z" Serve

The "Z" serve is a cross-court serve delivered at a sharper angle than usual, causing it to strike the floor and then the side wall deep in the corner. The impact on the third wall slows the speed of the ball and imparts a reverse spin, causing the ball to rebound nearly parallel with the back

wall. This unusual spin causes beginning players some difficulty, but when the "Z" serve is used against skilled opponents it is imperative to cause the ball to strike the third wall near the back wall to prevent an easy return. The serve will bounce parallel to the back wall if it is struck hard and if it strikes the front wall near the corner. This serve needs more than the usual amount of practice to perfect. The server should be cautioned not to move too near the side wall to achieve the "Z" path of flight, because of the amount of court space which cannot be covered to prepare for the return shot.

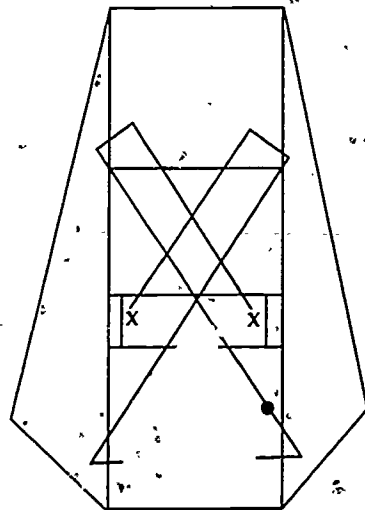

Diagram 3. Z serve from right or left side.

#### The Lob Serve

The lob serve may be struck underhand or overhand. The height of the bounce should accommodate the striking position, that is, a shoulder high bounce for the overhand and a bounce below the waist for the underhand stroke. Because of the high bounce and the greater difficulty in achieving the desirable arc with the overhand, the underhand is more appropriate for the beginning player. The underhand serve should be struck with moderate speed to a point approximately three-fourths of the way up the front wall. The ball should arc near the ceiling and bounce near the side wall with the arc of the

bounce ending near the back wall. If the ball brushes the side wall slightly the ball will tend to die in the back corner. The lob serve is easier to keep near the side wall if the server assumes a position near the wall and strikes the ball parallel to the side wall, but this approach leaves much of the court unprotected for the return shot. It is better if the serve can be struck from the off-center position, but the server must be careful not to select an angle so sharp as to cause the ball to strike the side wall early and rebound into center court for an easy return. The lob serve can be used to vary the game pace and make a skilled opponent play a high bouncing ball or a corner dig shot. The beginner should practice the lob with a three foot by six foot target box in both back corners. The serve is executed with the same mechanics as the underhand throw. The overhand serve is not used in racquetball.

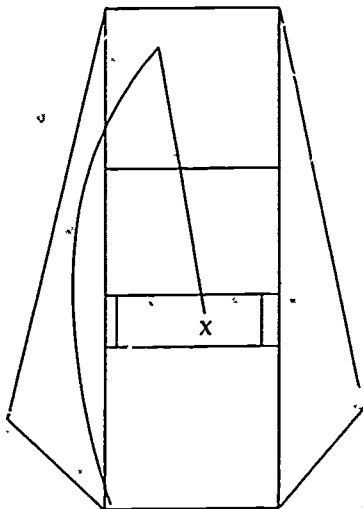

Diagram 4. Lob serve from off-center position.

**The Change-of-pace Serve**

The change-of-pace serve is executed with mechanics similar to the lob serve. The path of the serve should follow that of the drive serve. The speed of the serve determines how high on the front wall the serve should hit, but the speed and point of aim should always be coordinated to permit the trajectory of the bounce to end in the corner. When the change-of-pace serve is

executed properly the receiver does not know if it will carry to the back wall or fall just short of the wall. Experienced players refer to this strategic serve as a *half-speed* or *garbage* serve, but these terms should not be negatively interpreted. The strategy, timing, and placement of a change-of-pace serve cause it to be frequently used at all skill levels. The primary advantage of this serve for the beginning player is that it emphasizes accurate placement rather than speed. The de-emphasis of speed is particularly important, since beginning players tend to overhit shots rather than execute finesse shots.

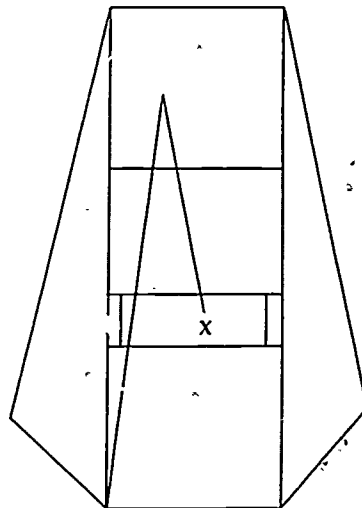

Diagram 5. Change-of-pace serve.

**Serving Fundamentals Review**

Speed is limited by the ability of the player to use it accurately. It is the frequent mistake of beginners to overhit all strokes, including the serve.

Placement is determined by the strengths and weaknesses of both players. Most players are weaker on the backhand or non-dominant hand side. The opportunity to hit the ball low and end the rally diminishes in proportion to the distance from the front wall and the increased height of the bounce. The prime target of the serve is in the backhand corner close to the side wall. It is generally undesirable to hit the ball so hard that it bounces against the back wall and rebounds into mid-court. It is also undesirable to permit a serve to contact the



side wall unless this contact is early and causes the ball to rebound toward the back diagonal corner, or is late enough to cause the ball to take only a very small bounce in the back court.

The serve must be struck on the first bounce. The stroke should be a total body activity much like throwing. If the serve strikes the floor, ceiling, or side wall first, it is a side-out. If a serve touches three walls in the air, carries to the back wall in the air, or fails to carry beyond the short service line, it is a fault. Two consecutive faults constitute a side-out.

### GAME SHOTS

Many of the strokes made during a rally are executed with the same mechanics and placement as the serve. The greater difficulty of executing the service-type stroke during play lies in anticipating the speed and direction of the return. Beginning players have difficulty in visualizing the rebound from the side walls, and often find themselves following the ball too near the back wall to be able to play it off the rebound. Also, the beginning player frequently tends to think of the sport as a "my turn, your turn" game wherein the ball is hit to the opponent on the rebound, and the player moves to the side of the court after each stroke. This misconception should be contrasted with the competitive strategy of hitting the ball away from the opponent or low enough that the opponent cannot play it, after which the player should immediately return to center court position. Scoring is greatly enhanced by a varied repertoire of strokes and the ability to execute them in sequences which cause the opponent to move the greatest distance between strokes and to hit while moving.

#### The Kill Shot

The kill shot is a shot of high velocity and low trajectory. The name "kill" is derived from the fact that the rally is ended by a shot which hits so low on the wall that the opponent has no chance to play it before it bounces twice. An effective kill shot will hit the wall less than a foot above the floor. As the skill level improves this height from the floor will have to diminish if the shot is to be

an effective kill shot. The probability of executing a kill shot with the necessary trajectory is related to the height of the shot preceding the kill. If a player attempts to kill a high bouncing ball at the height of its bounce, or to kill a shot from an overhand volley position, the probability of getting a low bounce from the rebound off the front wall is much less than it would be for playing a forehand rebound off the back wall at half-height.

The low shot is ideally suited for a kill return. Thus, it is crucial to hit an effective kill shot, or the low ball resulting will be subject to a kill shot by the opponent. The kill shot may be hit against the front wall to rebound along the side wall. An even lower bounce results from contacting two walls with the kill shot. When two walls are contacted the angle of the bounce is very different when the side wall is contacted first from when it is contacted second. The angle and speed determine if the ball will carry to the front wall after encountering the resistance of the side wall. Corner or "pinch" kill shots tend to rebound out to a center court position, and must carry a low trajectory to be effective. The kill shot should be struck below the knees with a stroke parallel to the floor. The height of the shot is more important than the speed. The beginner should practice hitting consecutive kill shots in a rebound drill from the front court, emphasizing the bend of the knees and the swing plane close to the floor. The goal can be adjusted by lowering the target line on the front wall or by raising the target number of consecutive hits.

#### The Passing Shot

The passing shot is a drive shot that is executed when the opponent is in the front court; the angle of the shot prevents the opponent from reaching the ball. The passing shot can be targeted down the side wall when the opponent is positioned near the side wall in the opposite half of the court. It is especially important to keep the side wall passing shot off the side wall to avoid an easy return for the opponent. The side wall passing shot should be struck hard enough to carry to the back wall, but not so hard that it rebounds back into play.

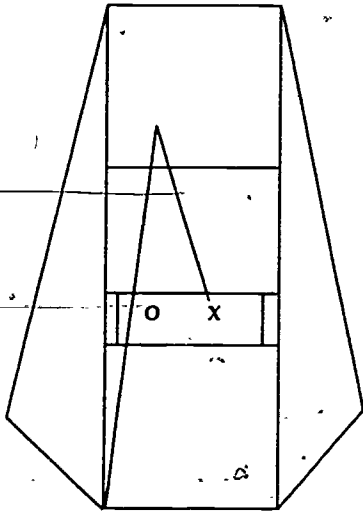

Diagram 6. Cross-court passing shot.

If the opponent is beside or in front of the player, then the ball can be angled off the front wall to strike the side wall adjacent to the opponent. The carom from the cross-court passing shot should travel to the opposite corner but not rebound from the back wall. If the opponent is near enough to the front wall, then the shot can be angled off the front wall with a carom directly to the back corner. It is important that this type of passing shot not hit the side wall and rebound out to the middle of the floor.

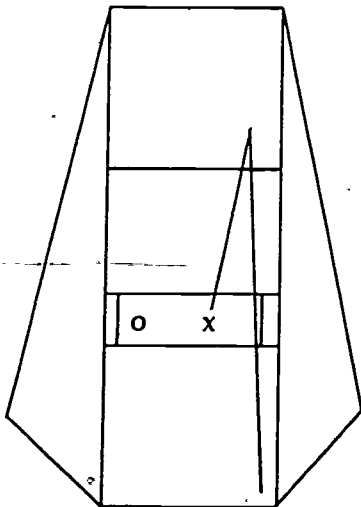

Diagram 7. Side wall passing shot.

Passing shots should be struck from below the waist to produce a bounce that will fall short of the back wall. The shot is most effective when the opponent is near the front wall or a side wall. This side wall should be avoided unless the shot is intended to strike the side-wall-adjacent-to the opponent while passing the opponent on the way to the diagonal back corner.

A good drill for practicing the side wall pass is to set up near the short service line, about three feet from the side wall, and hit consecutive drive shots between that position and the wall without rebounding the ball off the side or back walls. The drill should be practiced from both sides of the court. The cross-court passing shot is practiced with the drive serve drill. It is important for the player to remember that the opponent is generally more difficult to pass on the forehand or dominant side, so a greater angle may be required when passing on that side.

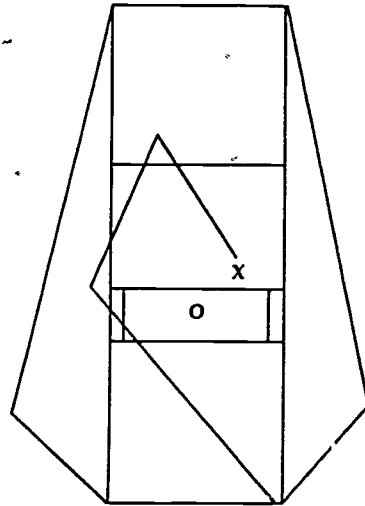

Diagram 8. Passing off of side wall.

### The Drop Shot

The drop shot is a change-of-pace shot requiring great touch and finesse. The shot should be executed by playing the ball at a reduced speed into the corner producing a low, short bounce. The shot is most effective when the player is in the front court and the opponent is in the back court. It can be played from either side, and is more accurate when played at waist level or

lower. The drop shot is best practiced in a consecutive volley drill from near the front court into the corner from ten to twelve feet away from the front and side wall. Practice at this shot is important as a poor drop shot is almost invariably subject to a kill or passing shot by the opponent.

### The Ceiling Shot

The ceiling shot is primarily a defensive shot. The shot should contact the ceiling about two or three feet from the front wall. In the front court variation, the front wall is hit first, then the ceiling is hit by the upward arc. The front court variation should not be used from the back court because of the difficulty of achieving the desirable depth of rebound. The ceiling shot can be struck overhand with more accuracy than can most of the other shots. The best target for the ceiling shot is along the side wall, deep into the back corner. Like most bad shots, the poor ceiling shot is subject to a high percentage return shot when it strikes the side wall. The ceiling shot can be practiced by using the overarm throwing drill to gain accuracy and confidence.

### Stroke Variations

Most shots can be struck from a variety of positions and under a wide variety of conditions. Three of the more common stroke variations are the volley, back wall shot, and the fistball.

The *volley* is a stroke contacting the ball before it bounces. Hitting the ball on the fly this way requires quicker reflexes and often produces a higher contact point than is desirable, but it allows the player to maintain a front court position instead of retreating to play a ball from the bounce. The volley should be executed with a short, firm stroke for accuracy. The beginning player tends to hit too many volleys, especially from the overhand position. The volley should be used to maintain court position, or to force the opponent to react more quickly to returns which will require considerable court movement.

The back wall shot has much variety. Any ball which rebounds from the back wall before it is struck is a back wall shot.

is often more desirable to play the ball from the back wall than to play it off the front wall. The advantages of the wall shot are the reduced height of the bounce, reduced momentum of the ball, greater time to achieve court and body position, and the movement of the racquet or hand in the same direction as the ball. Beginning players often fail to realize that the ball will return to them from the back wall and, therefore follow the ball too near the back wall to be able to take full swing. The beginner should remember not to get closer to the back or side wall more than one arm's length. Unlike a tennis ball, the ball will come back to center court, often with a more advantageous height of bounce.

In executing the handball strokes, the closed fist may be substituted for the open hand technique. The closed fist often results in a more powerful but less controlled shot. The novice player often prefers this stroke because of the reduced sensitivity of the fist to the impact of the ball.

### SAFETY

Safety precautions should begin before the game ever starts. Warmup exercises should be planned to stretch the legs, back, arms, and shoulders before stroking the ball. Handball players should wear padded gloves until the hands become accustomed to striking a hard rubber ball. If bone bruises occur, the player must permit sufficient time for recovery by resting. The feet should be protected by two pairs of socks to minimize friction caused by sliding in the shoe. Shoes should be light to accommodate the running, but the soles should be substantial to protect the feet from the constant pounding. The eyes should be protected by eyeguards. The guards are of great benefit in reducing accidental contact by the handball, racquetball, racquet, or other players. Players should not turn to face the shot behind them. The ability to see the ball with peripheral vision, paired with the skill of determining the opponent's position by the direction of the return should enable the player to face the front wall and reduce the danger of being hit in the eye by the ball.

One of the greatest dangers of both games is over-swinging at the ball. When the player over-swings there is less muscular control and a greater likelihood of striking a wall, another player, and even himself/herself. When there is the slightest chance of striking an opponent, a "hinder" should be called, and the point replayed.

### RACQUETBALL/HANDBALL RULES OF NECESSITY

The following rules are the primary ones necessary for the novice to effectively begin to enjoy the game of racquetball or handball.

1. **Points.** Points are scored only by the serving side, when it serves an ace or wins a volley.
2. **Game.** A game is won by the side first scoring 21 points.
3. **Match.** A match is won by the side first winning two games.

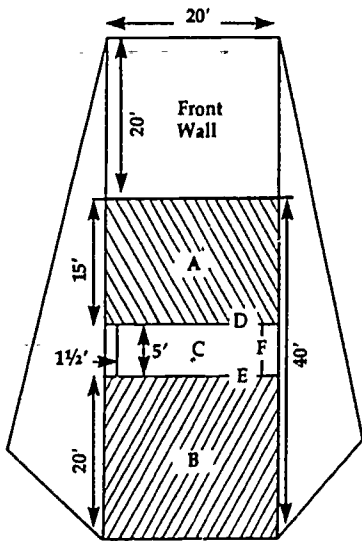

Diagram 9. The court.

- A = Front Court
- B = Back Court
- C = Service Zone
- D = Service Line
- E = Short Service Line
- F = Service Box

4. **Court.** See Diagram 9 for line designations.
5. **Order.** The player or side first winning the ball toss becomes the first server.
6. **Serving.** The server must serve from the service zone (see Diagram 9). The serve must strike the ball on a bounce so that it hits the front wall and on the rebound hits the floor in back of the short line, either with or without touching one of the side walls.
7. **Service Faults.** The following serves are faults, and two in succession results in a hand-out:
  - a. **Foot Faults**—A foot fault results:
    1. when the server leaves the service zone before the served ball passes the short line.
    2. when the server's partner leaves the service zone before the ball passes the short line.
  - b. **Short Serve**—a ball which rebounds before the short line.
  - c. **Long Serve**—a ball which hits the back wall without bouncing.
  - d. **Ceiling**—a serve which touches the ceiling.
  - e. **Out**—any ball going out of the court.
  - f. **Three-wall Serve**—any serve that hits two-side walls on the fly.

8. **Avoidable Hinder.** Avoidable interference, not necessarily intentional, by one player with another's clear shot. The penalty is loss of serve or point.
9. **Unavoidable Hinder.** Unavoidable interference by one player with another's clear shot. This "dead ball" (unavoidable) hinder causes the point to be replayed.
10. **Volleys.** Each legal return after the serve is called a volley. Play during volleys must be according to the following rules:
  - a. **One or Both Hands**—the ball must be hit with one or both hands. Switching hands to hit a ball is an out (racquetball only).
  - b. **One Touch**—in attempting returns, the ball may be touched only once by the player on the returning side.

A violation of either (a) or (b) results in a hand-out or point.

## STRATEGY

Court position is vitally important to developing and implementing a game strategy. The center court position, just behind the short service line, is considered best. It is important to hit shots which move the opponent away from the center court position. The opponent should be moved from front court to back court and back again, by hitting shots in combination.

The hitting position should be fundamentally the same for each shot. It is important to assume a stance facing the side wall, and to get the hand or racquet back in a striking position while bending the knees to bring body force into the low swinging action. Good strategy involves moving the opponent to prevent his/her having time to assume the correct hitting position, or forcing the opponent to hit while moving, the most difficult circumstance in which to execute an accurate placement.

The most effective shot selection strategy is to force the opponent to play his/her weakest stroke most often. Players can also affect tempo and shot control by playing high percentage shots from a good low bounce position. For instance, the time gained by permitting a high flying ball to pass by to the back wall will allow the player to be set up in good position to play the ball from a much lower position as it rebounds off the back wall. In the three-wall or one-wall game, the passing shot can be used more frequently without fear of bringing the ball back to center court, since there is no back wall rebound.

## EQUIPMENT

### CLOTHING

The handball or racquetball player should wear comfortable and cool clothing. A short-sleeved shirt or blouse, gym shorts, cotton socks, and thick-soled gym shoes are best. The uniform should provide for easy movement and the absorption of perspiration. The shoes should be light, but of sufficient thickness to prevent blisters on the bottom of the foot.

### Gloves

The racquetball player may select a glove for the racquet hand for the purposes of improved grip and protection. The racquetball glove should be thin and well-tailored for fit. If a wristband is used in conjunction with the glove, the player should find perspiration in the glove less of a problem.

The handball player must wear a glove on each hand. The handball glove is thicker than the racquetball glove for protection. Beginning players often choose a padded palm model to reduce bruising of the tissue of the palms.

### Protective Glasses

Protective eyeguards are required for junior players and *strongly* recommended for adult players. While racquetball has the greater danger of racquet injuries, both sports generate sufficient ball speed to cause serious eye damage from impact directly on the eye or even on the side of the face beside the eye. Several types of eyeguards are on the market. All of these at least slightly reduce the player's ability to see, but the resulting protection may permit the player life-long good vision that might otherwise be impaired by an errant shot.

### RACQUET

The racquetball racquet should be selected for grip size, grip material, overall length, head shape, overall weight, and construction material. The grip size relates to hand size, but generally a smaller grip is preferred to facilitate hand and wrist action in the stroke. The grip should provide for functional control even when heavy perspiration soaks the material. The overall length is generally from 17½ to 19 inches. Greater racquet length increases power, but reduces control. The weight of the racquet depends on the material used in the frame. Select a racquet that is heavy enough to generate power but light enough to be swung quickly. The plastic racquets are the lightest, followed closely by aluminum. Lightweight steel is of medium weight, the heaviest rackets are those of wood.

**BALL**

The ball manufacturing industries have greatly improved the quality of both handballs and racquetballs. A lighter-colored ball has largely replaced the traditional black ball in both games because of the black wall marks created by the black ball. Controversy has arisen concerning the two, hemisphere ball *v* the seamless ball, as to which has the liveliest bounce. Both models have had some difficulty with early breakage.

**TERMINOLOGY**

- Ace.** A legal serve not touched by the receiver.
- Back Court.** The portion of the court behind the short service line.
- Backhand.** Opposite of forehand side in racquetball.
- Backswing.** The preparatory movement to position the player for the down swing.
- Back Wall Shot.** Any shot made on a ball rebounding off the back wall.
- Ceiling Shot.** A shot which strikes the ceiling.
- Center Court.** The position directly behind the short line and between the side walls.
- Crotch Ball.** A ball which contacts the crack between two playing surfaces.
- Cut-throat.** A three-player game wherein the two receivers compete against the server.
- Doubles.** A four-player game wherein two-man teams compete.
- Drive.** A powerful stroke against the front wall between the knee and shoulder.
- Fault.** An infraction of the rules. Two service faults result in a *side-out*.
- Fist Ball.** Striking the ball with the fist in handball.
- Front Court.** The portion of the court in front of the short service line.
- Game.** The game is played to 21 points.
- Hand-out.** The loss of serve by one partner for his/her doubles team.

- Hinder.** An accidental or unavoidable interference with the opponent in the play.
- Kill Shot.** A low trajectory shot with no playable rebound.
- Lob Shot.** A high arching shot that bounces high to the back wall.
- Long Serve.** A serve that carries to the back wall on the fly.
- Overhead.** A shot struck at or above the shoulder level.
- Passing Shot.** A shot out of the reach of the opponent.
- Rally.** A series of shots by the players.
- Service Box.** The 5' x 1 1/2' area at the side of the service zone where the non-serving doubles partner stands during the serve.
- Service Line.** The front line of the service zone.
- Service Zone.** That portion of the court between the service line and the short service line.
- Short Ball.** A serve landing in front of the short service line.
- Short Service Line.** The back line of the service zone.
- Side-out.** The loss of service to the opponent(s).
- Singles.** A game of one player versus one other player.
- Straddle Ball.** A ball passing through a player's legs.
- Volley.** Striking the ball on the fly, before it bounces.

**REFERENCES**

Beldsoe, Davey. "The Basic Strokes." *Racquet World Review* 2(3): 14-9.

Bledsoe, Davey. "The Basic Strokes." *Racquet World Review* 2(4): 20-3.

Lawrence, A. Paul. *Fundamentals of Racquetball*. San Diego, CA: Ektelon, 1976.

Roberson, Richard, and Olsen, Herbert. *Beginning Handball*. Belmont, CA: Wadsworth Publishing Company, Inc., 1969.

Strandemo, Steve. "Game Analysis." *Racquetball* 6(2): 10-4.

Verner, Bill. *Racquetball*. Palo Alto, CA: Mayfield Publishing Company, 1977.

Wickstrom, Ralph. "Beginning Syndrome." *Racquetball* 9(9): 30-4.

defenders (p. 247)  
dribbling (p. 235)  
forwards (p. 247)  
goalie (p. 246)  
goalkeeping (p. 246)  
heading (p. 242)  
instep pass (p. 236)  
instep shot (p. 241)  
major infraction (p. 248)  
midfielders (p. 247)  
minor infraction (p. 248)  
offsides (p. 248)  
outside-of-foot pass (p. 236)  
passing (p. 236)  
tackling (p. 243)  
throw-ins (p. 243)  
trapping (p. 237)  
volley (p. 241)

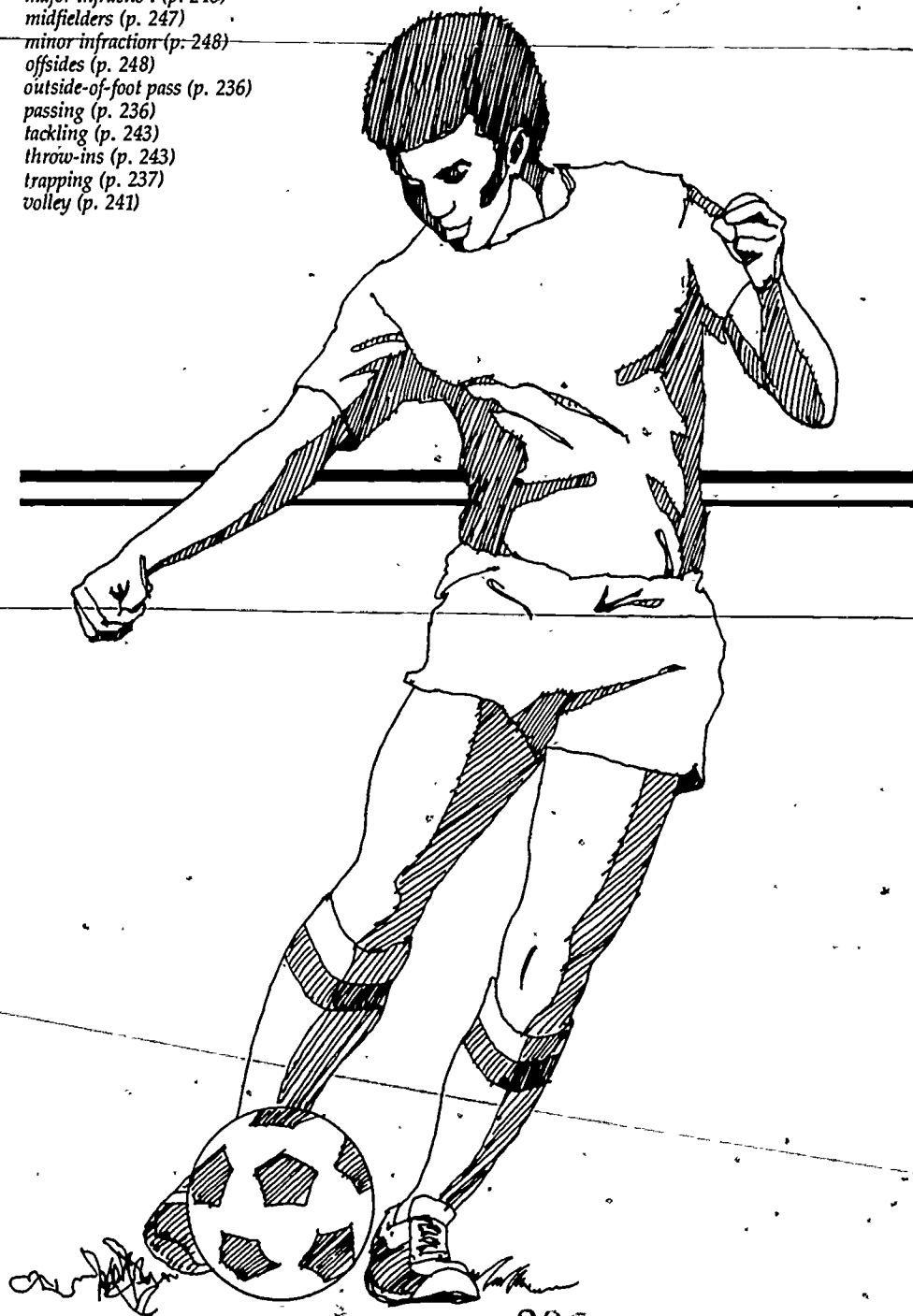

# Soccer

JOHN F. FELLEBAUM, JR.,  
*Lincoln Junior High School*  
 and  
*Franklin and Marshall College,*  
*Lancaster, PA*

## INTRODUCTION

Soccer is the world's most popular sport. It is a simple, inexpensive, and safe activity which can be enjoyed by both boys and girls regardless of size or age. This team sport can be played leisurely at a slow deliberate pace as recreational soccer or at a very fast pace as professional or World Cup competition. At all levels eye-foot coordination is a basic part of the game since the ball is kicked up and down the field. Fitness components such as strength and endurance must also be developed along with agility, quick judgment, tactics, and strategy.

In earlier times fitness may have been stressed in playing soccer, but due to the number of players on a team, other skills remained undeveloped. For example, in Japan a game called Kemari was played where a leather-filled ball would be kicked from one end of a village to the other with as many as a few hundred players on a team. However the modern version of soccer originated in England with the formation of Association Football, later shortened to "Assoc" which became the word "soccer." In 1863, the English Football Association was organized giving soccer unified rules for the first time. F.I.F.A. (Federal Internationale Football Association), established in 1904, has become the governing body of world soccer and under its leadership the U.S.S.F. (United States Soccer Federation), founded in 1913, oversees soccer organizations in our country.

One of these organizations is the U.S.Y.S.A. (United States Youth Soccer

Association) which, since its formation in 1974, already represents over two million youth soccer players. Soccer is the fastest growing team sport in the United States.

## SKILLS AND TECHNIQUES

### DRIBBLING

Dribbling is the use of soft touches of the feet to control the ball on the ground without the help of a teammate. Three different types of dribbling are inside of the foot, outside of the foot, and with the sole of the foot.

With the inside of the foot, the ball is gently touched at the base of the greater toe and pushed along the ground with control. Using the outside of the foot, the ball is caressed at the base of the small toe and using the sole of the foot, the ball can be rolled forward and backward and in a right and left direction. In soccer both feet should be used, the ball should be kept close to the feet, short strides should be taken, and the weight should be carried on the support foot.

### Dribbling Exercises

1. Dribble in a restricted area, changing directions and speed.
2. Dribble around cones or pylons.
3. Dribble against a passive defender.
4. Dribble against an active defender.

### Self-testing

Place six cones three yards apart and time how long it takes to weave around the cones and back again.





Figure 1. Dribbling with the inside of the foot.



Figure 2. Dribbling with the outside of the foot.

## PASSING

Passing is the art of playing the ball from one player to another. It is the fastest way to advance the ball on the field and, therefore, is one of the most important skills to be developed.

To have success, proper coordination between the server and receiver is necessary. Timing of the pass, proper pace on the ball, and correct contact with the ball are essential elements in good passing.

Passing with the inside of the foot is the most accurate type of short pass. This is made with the inside of the foot just below the ankle bone between the big toe and the heel. Points to remember using the inside-of-the-foot pass:

- when striking the ball, lock the ankle with the toes pointed upward;
- concentrate on the ball;
- follow straight through the target with the kicking foot;
- contact the ball from the center to the top with the support foot pointed toward the target.

The outside-of-the-foot pass is done by striking the ball with the outside part of the instep. The ball is contacted on the outside part of the shoelaces with the support foot placed away from the ball to give the kicking leg room to properly kick the ball. This type of kicking motion comes from the knee and is a flicking action of the leg.

A player saves time with this pass since the lead foot can be used and it is not necessary to set up as for the inside of the foot. In soccer, which is a game of time and space, it is important to be able to use this type of pass. Points to remember using the outside-of-the-foot pass:

- keep the ankle locked and the toes pointed downward on the kicking foot;
- concentrate on the ball and follow through with the kicking foot to the target;
- strike the center to the top half of the ball to keep it low.

The instep pass which is executed with the hardest part of the foot is used for power in passing or shooting. It is generally

utilized for long passes downfield or by defenders to get the ball out of danger in front of the goal. Points to remember with the instep pass are:

- concentrate on the ball;
- lock the ankle;
- follow through to the target;
- the support foot should be beside the ball 6–8" away and pointing toward the target.

#### Passing Exercises

1. Two players pass the ball back and forth down the field using the inside and outside of the foot.
2. Several players in a circle pass to each other and follow the pass.

#### Self-testing

Pass ten times with each foot through two cones three yards apart from a distance of ten to fifteen yards.

#### COLLECTING

Trapping or "collecting" is the ability to control the ball on the ground or in the air and stop it close to the body before it is put

into play. When a ball is not properly collected, possession can easily be lost and taken by the opponent.

One must be able to collect balls that are on the ground or in the air. With ground balls the sole of the foot, the inside of the foot, and the outside of the foot, can be used. Air balls can be collected with various surfaces such as the inside and outside of the foot, the thighs, and the chest.

#### Ground Balls

The sole of the collecting foot is raised about four inches off the ground with the knee slightly bent. The toes are higher than the heel so the rolling ball is wedged in the "V" formed between the sole of the foot and the ground. The inside of the foot trap can be performed the same way as the inside of the foot pass except the foot is drawn back on contact to cushion the ball. The ankle, instead of being locked, should be relaxed for ball control. The outside of the foot trap is similar to the outside of the foot pass except the foot is relaxed to cushion the ball.

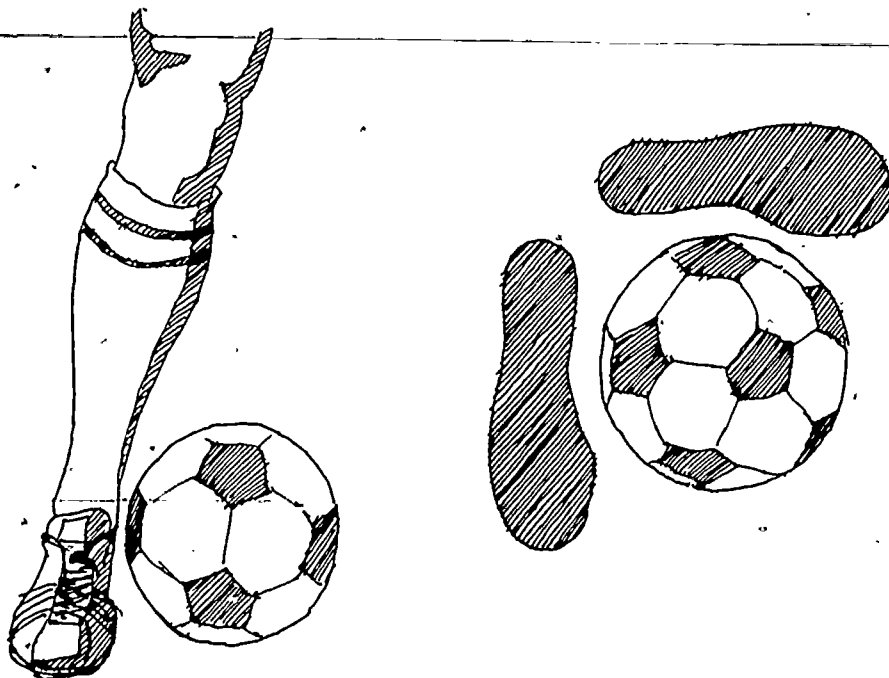

Figure 3. Inside-of-foot pass.



a. Put the balance foot ahead and away from the ball so that there is room to swing the kicking foot.

b. Point the toes of the kicking foot down and hold the ankle firm. Kick with the outside of the foot through the center of the ball.

c. Keep the eyes on the ball and follow through with the kicking foot.

Figure 4. Outside-of-foot pass.

### Air Balls

In the thigh trap collecting is done by getting in the path of the ball and moving toward it. Just before the ball arrives, raise the thigh and make contact with the inside of the thigh drawing it back and allowing the ball to drop to the ground.

With the chest trap, once again it is important to position the body in the path of the ball. Lean back with the chest and, on contact with the ball, relax the chest and straighten the body to bring the ball under control. Using the instep, get in the ball's path, relax the instep on contact, and draw the ball to the ground. Collecting air balls with the inside and outside of the foot is the same procedure as when collecting ground balls with the inside and outside of the foot

- Points to remember in collecting:
- body in path of the ball;
  - relax body surface on contact;
  - concentrate on ball;
  - deaden balls on ground as quickly as possible.

### Collecting Exercises

1. Two players pass the ball back and forth while practicing collecting.
2. In a circle, practice passing and collecting.
3. Two players stand 8 yards apart and throw the ball underhanded to practice collecting air balls.

### Self-testing

One player throws the ball to the other receiver who is awarded a point for each good trap.

### SHOOTING

In today's game of "total" soccer, the objective is for all players to play both offense and defense. Fullbacks have opportunities to score goals and every player, except the goalkeeper, must learn to shoot with power and accuracy. Unless shooting is learned, one cannot be a complete player.

The most powerful type of shot in soccer is the instep shot. Contact is made on the hardest part of the foot at the shoelaces.

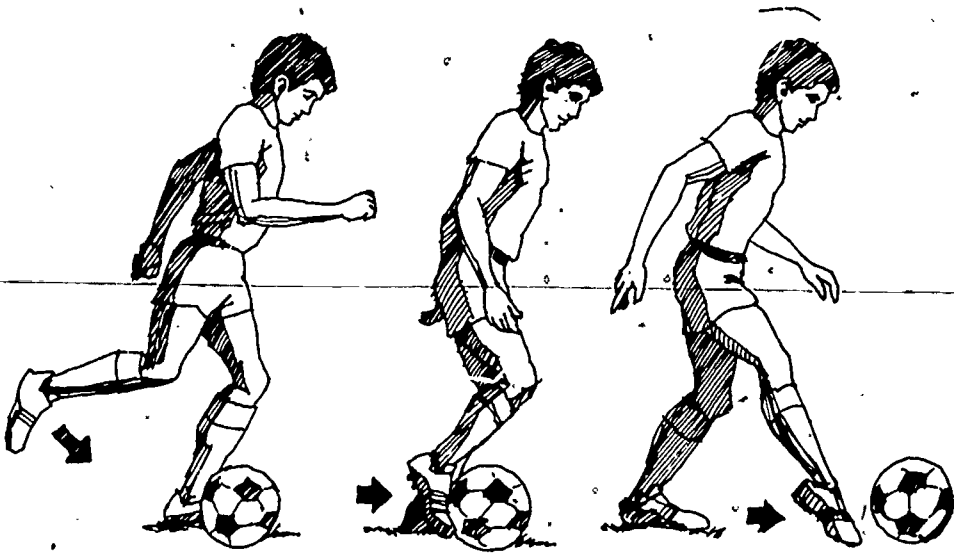

- a. Bring the kicking foot back and keep the eyes on the ball.
- b. Hold the ankle of the kicking foot firm and point the toes down so that the ball is hit by the top of the instep.
- c. Kick through the center of the ball and follow through with the toes pointed down.

Figure 5. Instep pass.

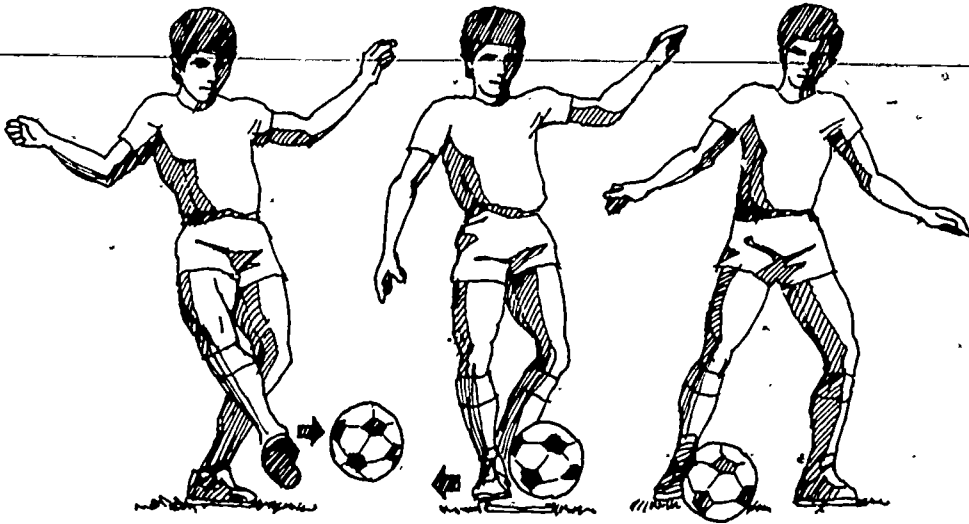

- d. Move the leg forward and meet the ball with the inside of the foot.
- e. Move the foot back as contact is made to slow the ball down.
- f. Bring the ball far back to control it and stop it dead.

Figure 6. Collecting low balls with the inside of the foot.



a. Meet the ball in midair with the thigh.

b. Let the ball land midway between the knee and the top of the thigh.

c. Withdraw the thigh on contact so that the ball drops to the ground.

Figure 7. Collecting high balls with the thigh.

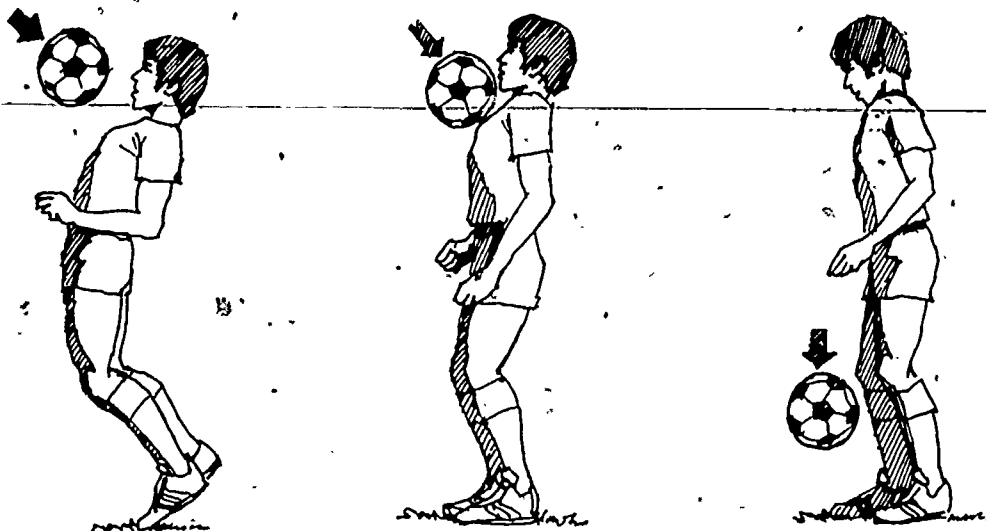

d. Prepare to meet the ball with the center of the chest. Arch the body backward to cushion the ball.

e. Bend the knees to aid in cushioning the ball.

f. When contact is made, straighten the chest immediately so that the ball drops directly down.

Figure 8. Collecting high balls with the chest.

The instep shot is done the same way as the instep pass, only the ball should be kicked on the top half to keep the shot low.

One of the most difficult shots to do properly is the volley because of the re-

quired timing. The ball has to be struck out of the air with the support foot pointed toward the target; the kicking foot is held rigid and must hit through the center of the ball straight toward the goal.

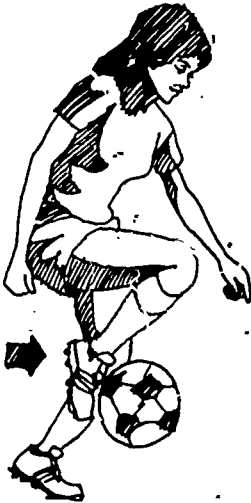

a. To prepare to kick the approaching ball face it and point the balance foot toward it.

b. Point the toes down and keep the ankle rigid, as in instep passing. Strike through the center of the ball. Put plenty of weight behind the shot by lifting the heel of the balance foot at the moment of impact.

Figure 9. Volley shot using the instep.



c. Prepare to kick the approaching ball by facing it and pointing the balance foot toward it

d. Keeping the toes down and the ankle rigid, strike through the center of the ball.

e. Pivot on the balance foot in the direction the shot is to go. Put weight behind the shot by lifting the heel of the balance foot at the moment of impact.

Figure 10. Sideways volley shot using the instep.

### Shooting Exercises

1. Two lines, one from the left and one from the right, alternately dribble and shoot at goal from 15 to 18 yards.
2. Two or three players passing the ball between them down the field and one player takes a shot at goal from 15 to 18 yards.

### Self-testing

Ten balls are placed on the ground in a semicircle about 15 yards from the goal and a shooter tries to score using first the right foot, then the left foot. Continue alternating feet until all balls have been kicked.

### HEADING

Heading is the ability to control, pass, or direct the ball with the head. A complete soccer player needs to perform heading skills to score a goal, collect the ball, pass to a teammate, or, as a defender, head the ball out of danger.

When heading from a stationary, or standing position, the feet should be placed shoulder width apart while bending at the knees and waist and arching the back. The chin should be touching the chest as the

body is whipped forward striking the ball with the head. On contact, the chin is released from the chest and the ball hit straight through to the goal.

In a jumping header, or jumping to head the ball, the skill is performed the same as in standing heading, only contact with the ball is made at the top of the jump. The take-off is usually on one foot and the head is snapped through the ball to the target.

### Heading Tips

1. Get in the path of the ball.
2. Concentrate on the ball, keeping the eyes open and the mouth closed.
3. Strike the top half of the ball to pass or shoot, and the bottom half to clear the ball out of danger.
4. Begin to move the head when the ball is about 12 inches away and contact the ball on the forehead.

### Heading Exercises

1. Practice heading to another player 8 yards away. Pass the ball back and forth across a circle of players.
2. Count the number of times the ball is headed without touching the ground.

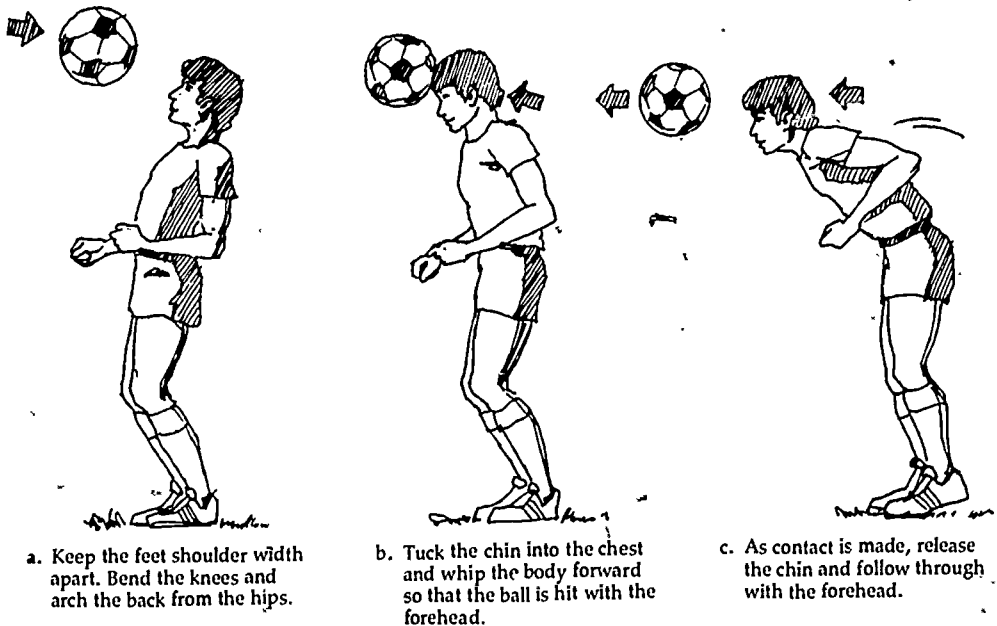

Figure 11. Stationary heading.

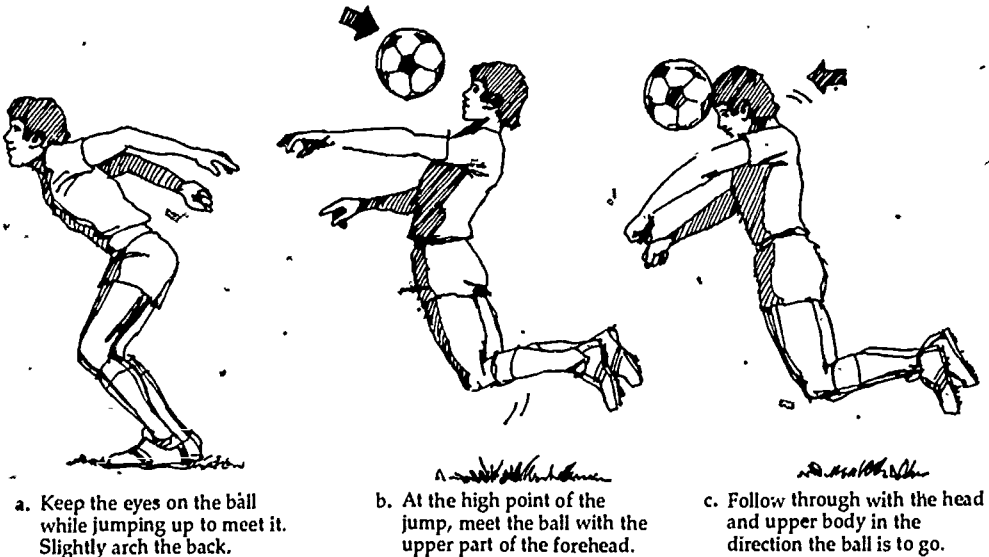

Figure 12. Jump heading.

### Self-testing

Count the number of times a thrown ball can be accurately headed to a teammate's feet.

### TACKLING

Tackling is the act of taking the ball away from the opponent. By making good tackles and winning the ball all over the field, a team is ensured of greater success. Points to remember on the front tackle:

- square up on the opponent;
- bend the knees and keep a low center of gravity;
- block the ball with the tackling foot;
- keep the weight on the support leg;
- push the ball through with the tackling foot.

### Tackling Exercises

1. Two players stand 15 yards apart. One player passes to a teammate who traps and dribbles the ball while the first player makes the tackle.
2. Two players start in a tackling stance at a stationary ball and, on a given signal, each player tries to gain possession of the ball.

### Self-testing

Play one against one in a small area (10 yards by 10 yards) for two minutes and whoever has possession of the ball for the longest time is the winner.

### THROW-INS

A throw-in is the method used to put the ball into play from the sideline or touchline. For the standing throw-in, the player faces the field with two hands equidistant on the ball. The ball is thrown from back over the head with a follow-through and both feet in contact with the ground. A running throw-in is done the same as a standing throw-in except the thrower runs to gain distance on the throw.

### Throw-in Exercises

1. Two players practice throws back and forth.
2. One player runs and the other player attempts to throw to the moving player's feet.

### Self-testing

1. Mark five targets at various places on the field. Attempt one standing throw-in and one running throw-in at each target. Score two points for each direct hit and





a. Block ball with tackling foot.



b. Weight on non-tackling leg.



c. Knees are bent.



d. Push ball through with tackling foot.

Figure 13. Tackling techniques.

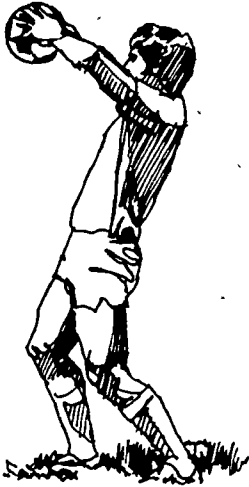

a. Use staggered stance with feet approximately 12 inches apart.



b. Lean trunk backward. Knees are bent.

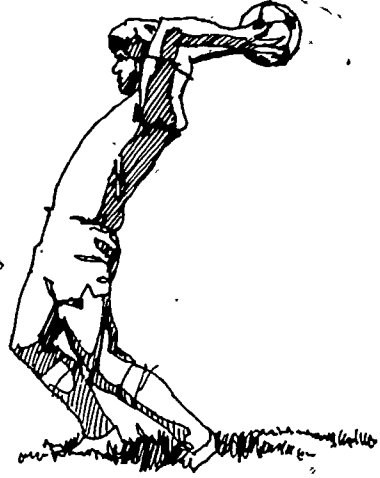

c. Bend elbows with ball behind head



d. Drive trunk forward and straighten arms.

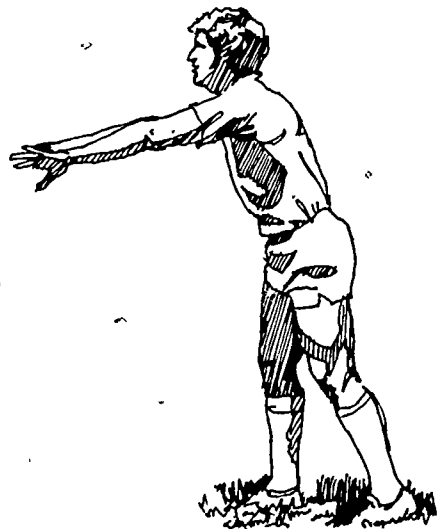

e. Follow through to target.

Figure 14. Throw-in techniques.

- one for each near miss (within three feet).
2. Repeat the same exercise using a moving player as a target. A two-point throw will land just in front of his/her feet. A one-point throw may be up to four feet in front of the player.

### GOALKEEPING

The goalkeeper is the only player on the field allowed to use the hands and, being the last line of defense, serves a very important function. Not only does the keeper try to prevent goal-scoring by the opponents, but is also in a position to begin the team's attack with a quick outlet pass to an unguarded teammate. Because of their important team function, "goalies" must learn to use both feet and hands.

#### Catching Ground Balls

When catching ground balls, face the ball with the body directly facing the line of

flight. Bend at the waist allowing the arms to drop with the palms facing the ball and the fingers spread. Hands and elbows should be held close together. On contact with the ball give with the hands and bring the ball up to the chest. The procedure for catching low air balls is the same as catching ground balls. With the high air balls, an attempt should be made to get the chest in back of the ball. Hands should be held close together with the fingers spread and the thumbs touching each other.

### SAFETY

Players can protect themselves from injury in soccer by keeping physically fit, by developing proper skills, and by using body protectors. Soccer is a vigorous game for which the body should be gradually conditioned. Warm up completely every day before practice or playing a game. Take care of early season blisters and muscle pulls. Alternate tennis shoes with soccer shoes the first week to help prevent blisters. Kicking too hard at the beginning of the season often results in serious strains in the legs and groin.

Injury can be prevented by using shin-guards and guards for glasses (the latter a "must" for the player who has to play with glasses). Shinguards are worn inside knee-length socks.

Shoes are the most important part of the player's equipment. Regulation shoes are cleated with rubber to protect the player against slipping.

It is recommended that the goalie wear a distinguishing color to enable forwards to recognize him/her easily as they attack. The privileges of a goalie may result in dangerous maneuvers if he/she is not known during an aggressive play.

Never kick a ball that is above the hips and never head a ball that is below the head.

The playing fields or areas should be checked for holes and cleaned of dangerous objects such as rocks and glass.

Shinguards can be worn as optional equipment to protect the legs from injuries.



Figure 15. Positioning and grip.

**RULES**

The soccer field is rectangular (110–120 yards in length and 55–75 yards in width). The official ball is made of leather or a synthetic material. It is 27–28" in circumference and weighs between 14 and 16 ounces. A soccer team consists of eleven players, divided among the following positions:

**Goalie**—the person who defends the goal against scoring attempts. The goalie is the only player who is allowed to touch the ball with his/her hands. This privilege is only allowed, however, when they are within the penalty area.

**Defenders**—field players whose task is to help defend the goal. They are frequently referred to as wings, the stopper, and the sweeper.

**Midfielders**—players who provide a link between the offense and the defense. They are frequently called on to assist both the defenders and the forwards and must be able to assume either role with equal skill. Midfielders are often referred to as halfbacks.

**Forwards**—the scorers on the team. Often referred to as strikers or wings, they align themselves in positions to gain the advantage over the defense and score on the goal.

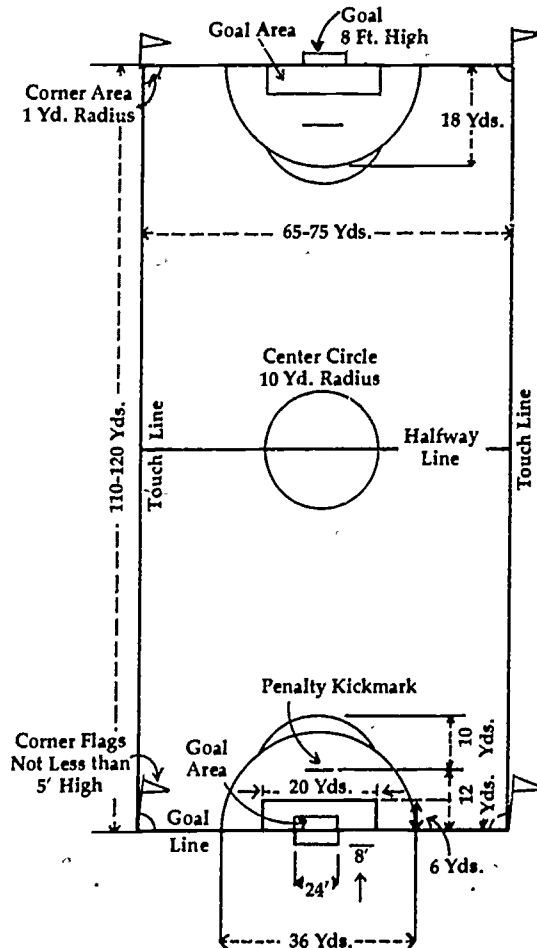

Diagram 1. Regulation soccer field.

The game of soccer consists of two 30-minute halves and is begun with a kickoff in the center of the field. Every player must be in his/her own half of the field and the initial kick must be forward and move at least one full revolution before being touched by another player. Kickoffs occur at the start of each half and after each goal. A goal may not be scored from the kickoff.

After the kickoff, play continues until the ball passes out-of-bounds, a penalty occurs, or a goal is scored. A goal is worth one point and is credited only when the entire ball passes over the goalline and into the goal. A ball which is on or only partially over the goalline will not be considered a score. A goal will not count if an offensive player is offside. Offside occurs when an offensive player is nearer the opponent's goalline than the ball unless the player is in his/her own half of the field; two defensive players are between the offensive player and the goalline; the ball was last played by the other team.

If, during the course of play, the ball passes out-of-bounds on the sidelines, it is awarded to the team opposite that which last touched it. The team awarded possession will then restart play with a throw-in. If the ball passes out-of-bounds at the end-lines, the game is restarted with either a goal kick or a corner kick depending on which team last touched the ball. If the offense last touched it, then a goal kick is awarded. If the defense last touched the ball, the game is restarted with a corner kick.

When, during the course of play, it becomes necessary for an official to stop play due to a rule infraction, either a minor or major infraction may be called. A minor rule infraction is penalized by awarding an indirect free kick to the team which was fouled. If the official views the infraction as a major penalty, a direct free kick may be awarded. A direct free kick, unlike an indirect free kick, may go directly into the goal without being touched by another player. If a major defensive infraction occurs within the penalty area, a penalty kick will be awarded. This is a free kick from the twelve-yard line with no defenders except

the goalie between the ball and the goal.

For a further explanation of the rules of soccer and the judgment involved in assessing penalties, the reader is referred to the various soccer rulebooks, particularly the National Federation edition.

## STRATEGY

Currently popular soccer alignments are the 4-2-4, 4-3-3, and 4-4-2 (see Diagrams 2-4, respectively).

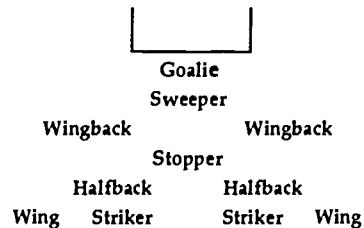

Diagram 2. The 4-2-4 alignment.



Diagram 3. The 4-3-3 alignment.

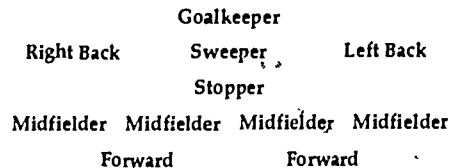

Diagram 4. The 4-4-2 alignment.

The 4-2-4 formation lends itself well to the modern concept of complete soccer where all players are able to play offense and defense. A lot of movement and interchange of offensive players is one way to confuse the defense and create scoring chances. If the offense can force the defense to spread

out then there is more space available for scoring opportunities. Defensively, a team wants to stay compact and support each other on the ball, rather than spreading out to the point that the players are unable to help each other.

## TERMINOLOGY

**Backs.** Halfbacks and fullbacks.  
**Center Circle.** A circle with a 10-yard radius at the center of the field.  
**Centerline.** A line connecting the two sidelines at midfield, dividing the field into two equal parts.  
**Clear.** A defensive play moving the ball away from scoring range.  
**Corner Kick.** A direct free kick taken by the offensive team from within a one-yard arc at the corner of the field.  
**Direct Free Kick.** An unobstructed place kick which may go directly into goal.  
**Dispossessing.** Taking the ball away from an opponent. Tackling.  
**Dribble.** The act of running with the ball under control using a series of pushes or taps of the feet.  
**Feed.** To pass the ball to a teammate in position for a shot on goal.  
**Goal Area.** A marked area immediately in front of the goal twenty-four yards wide and six yards deep.  
**Goal Kick.** An indirect free kick taken by the defense after the ball has passed over the endline.  
**Goalline (Endline).** The boundary line marking the end of the field.  
**Head.** To play the ball with the head.  
**Holding.** To restrict an opponent's movement with the arms or hands.

**Indirect Free Kick.** An unobstructed place kick which must be touched by another player before it can enter the goal.  
**Instep.** The inside portion of the foot from the toes to the ankle.  
**Interchanging.** Offensive players moving out of regular positions to confuse the defense.  
**Offside.** A player who is nearer the opponent's goalline than the ball at the moment the ball is played except as provided by the rules.  
**Pass.** To kick or head the ball to a teammate.  
**Penalty Area.** A marked area in front of the goal, 44 yards wide and 18 yards deep.  
**Penalty Kick.** A direct free kick taken by the offensive team in response to a foul occurring in the penalty area.  
**Save.** To prevent the ball from entering the goal.  
**Striking.** The act of kicking or contacting the ball.  
**Tackle.** A maneuver used to cause an opponent to lose possession of the ball.  
**Throw-in.** A method of restarting the game after the ball has gone out-of-bounds over the sideline.  
**Trap.** A method of bringing the ball under a player's control.

## REFERENCES

- Chyzowych, Walter. *The Official Soccer Book*. Chicago, IL: Rand, McNally and Company, 1979.  
 Kenney, Gene. *Soccer*. North Palm Beach, FL: The Athletic Institute, 1977.  
 Stanley, D. K., and Wagcow, D. F. *Physical Education Activities Handbook*. Boston, MA: Allyn & Bacon, Inc., 1962.  
 U.S.S.F. *Soccer Tips. How to Improve Your Skills*. New York: U.S.S.F., 1977.

*advance* (p. 256)  
*back-up* (p. 261)  
*base path* (p. 260)  
*batting eye* (p. 255)  
*batter's box* (p. 260)  
*bunt* (p. 256)  
*diamond* (p. 259)  
*error* (p. 260)  
*fast pitch* (p. 251)  
*foul* (p. 260)  
*hit and run* (p. 262)  
*infield fly* (p. 260)  
*inning* (p. 259)  
*lead-off* (p. 258)  
*pitcher's plate* (p. 254)  
*ready position* (p. 253)  
*run* (p. 259)  
*sacrifice* (p. 256)  
*signal* (p. 261)  
*slow pitch* (p. 251)  
*squeeze* (p. 262)  
*steal* (p. 262)  
*strike* (p. 260)  
*strike zone* (p. 261)

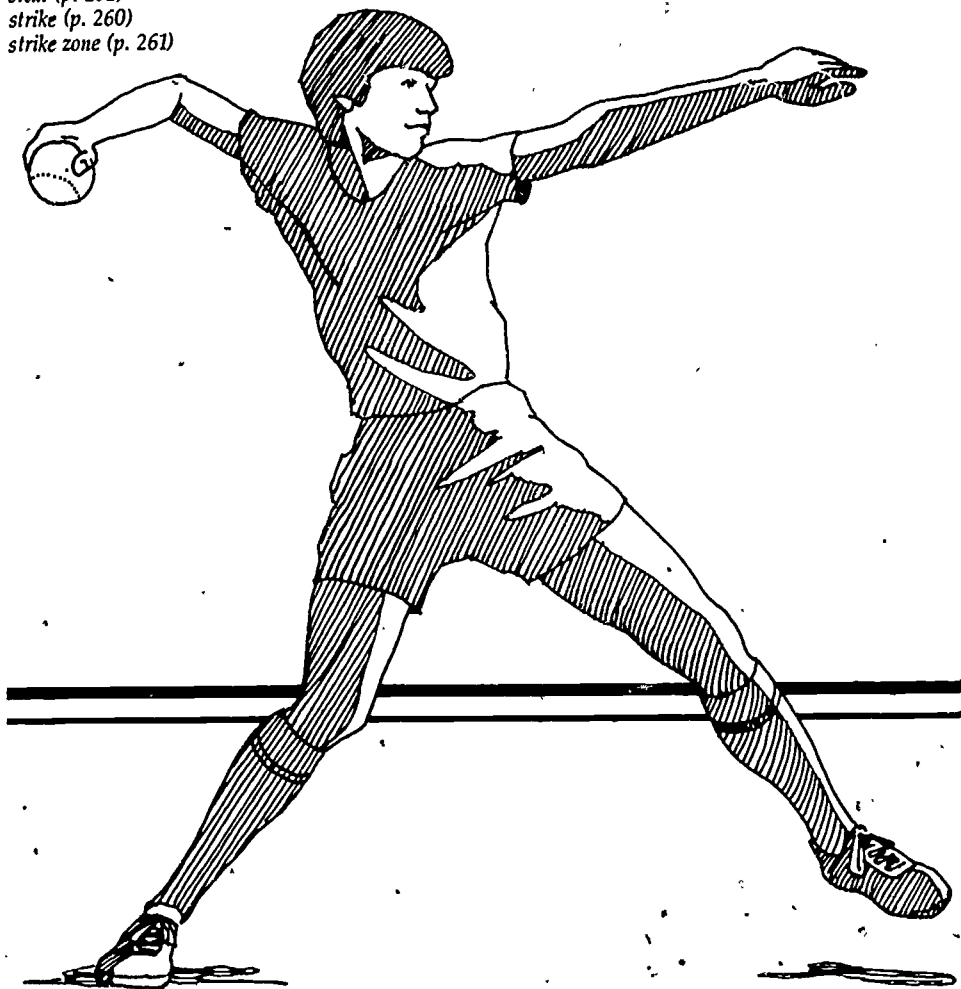

# Softball

BECKY L. SISLEY,  
University of Oregon,  
Eugene, OR

## INTRODUCTION

The game of softball is nearly one hundred years old. It has undergone numerous changes since its first appearance on Thanksgiving Day in 1887. George Hancock of Chicago, is credited with originating the game. Hancock made the first ball out of a boxing glove and wrote the first set of rules which were modified as the game spread throughout the United States and Canada. Some of softball's variations were known as Kitten Ball, Mush Ball, Fast Ball, Big Ball, and Diamond Ball.

It soon became apparent that there was a need to standardize the rules and equipment used for the game. The first set of unified softball rules was established in 1933. The Amateur Softball Association was created in 1934 and still remains the governing body for softball in the United States. This organization has done much to encourage expanded programs for participants of all ages and competitive interests. Leagues are sanctioned under the sponsorship of ASA as well as state, regional, and national tournaments.

The twelve-inch slow pitch game emerged in the mid-1950s. This game permits a team to be successful without possessing a pitcher who is a fast-ball, strike-out artist. Rules require that the ball be pitched with an arc of anywhere from three to twelve feet. Slow pitch was first played primarily by older players, but this emphasis has changed. The fact that there are many hits and runs indicates that the game is filled with plenty of action.

The ASA has developed a broad youth program for both fast and slow pitch. Most local communities sponsor summer softball leagues on different competitive levels and for various ages. Coed teams are popular for school intramurals as well as for city

league play. There are plenty of opportunities to enjoy the exciting and challenging game of softball.

## SKILLS AND TECHNIQUES

The following basic skills are essential in playing softball: throwing; catching; fielding; batting; running. The first three are considered defensive skills while batting and baserunning are offensive skills.

### THROWING

There are three basic ways of throwing: overhand, underhand, sidearm. Regardless of which type of throw is used, these fundamentals should be observed:

1. Stand in a stride position with the foot opposite the throwing hand in front.
2. Grip the ball with the first and second fingers on top of the ball and with the thumb under the ball (three fingers may be used with a small hand). The ball rests only on the finger pads and is away from the palm of the hand.
3. On the wind-up, rotate the body by turning the glove side toward the direction of the throw. Keep the eyes on the target as the body weight is rotated onto the rear foot.
4. The elbow should lead the forward arm motion with the hand following.
5. As the throwing arm moves forward, let the body rotate forward so that the weight is transferred from the rear foot to the front foot.
6. Release the ball with the fingers pointing toward the target.
7. Follow through with the arm in the direction of the target.

Each of the throws differ in regard to the position of the palm of the hand as the ball is released. In the overhand throw the palm faces down; in the underhand throw the



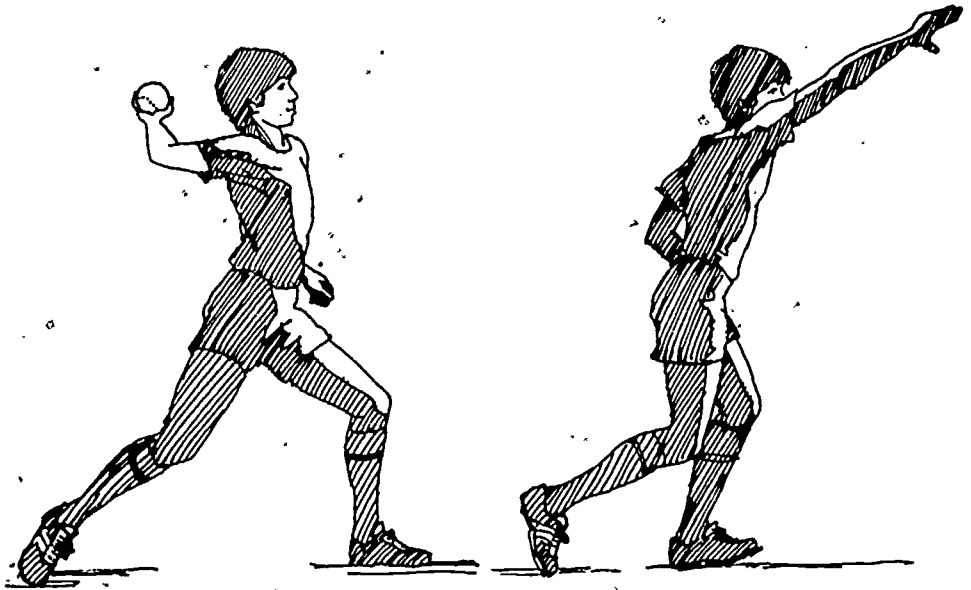
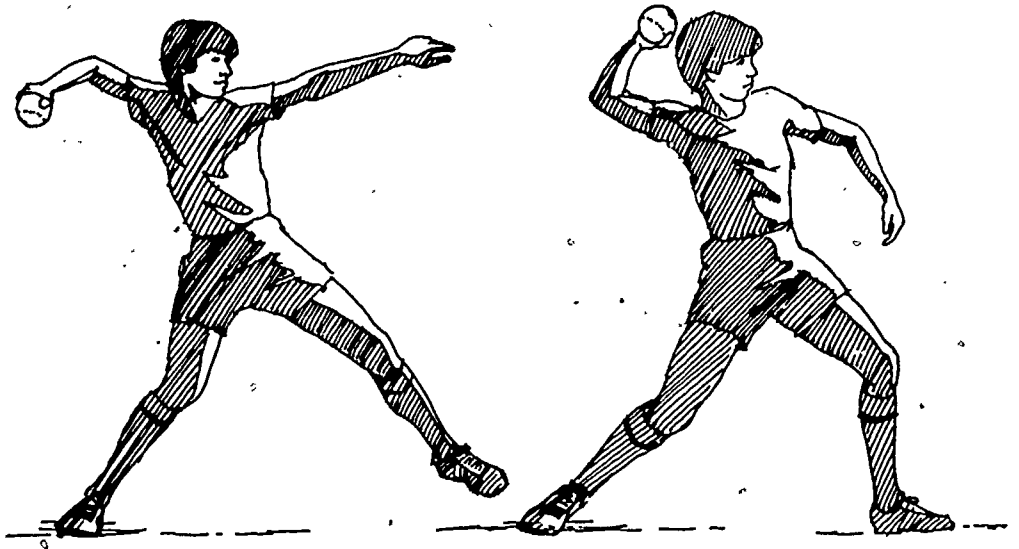

Figure 1. Overhead throwing pattern.

palm faces up; in the sidearm throw the palm faces the body.

Since the ball can be thrown farther with the overhand throw, it should be used by catchers and outfielders; however, all players can use this more easily controlled and accurate throw when they have sufficient time to make a play. The sidearm throw is generally used by infielders when they need to throw in a hurry. When tossing the ball a short distance to a teammate, use an underhand throw.

The overhand throw is one of the most used skills in softball. Figure 1 shows the body action of a skillful thrower. Notice that the rear leg is under the body, supporting the body weight, at the beginning of the movement pattern. The weight is transferred to the front foot as the body starts to rotate toward the target. It is important that the elbow of the throwing arm be held up and away from the body and that the arm is directed forward in a whip-like action. The wrist is snapped just as the ball is released. The greater the distance and the faster the movement of the arm, the greater the force that can be transferred to the ball.

The following activities can be used to evaluate ability in the overhand throw.

#### Throw to a Wall Target

Place a target consisting of three concentric circles on the wall. The center circle should measure two feet in diameter, the middle circle four feet, and the outer circle should be six feet in diameter. Stand behind a line 40 feet from the wall for girls and 65 feet for boys. Attempt to throw the ball to the center of the target. Score five points for hitting within the smallest circle, three points for hitting within the middle circle, and one point for hitting within the outer circle. Ten trials may be attempted. Score the total of all trials.

#### Velocity Throw

Stand in the shortstop position. Field a ground ball which is thrown by a teammate from home plate and throw to first base. The ball must be picked up after it has crossed a line between second and third base.

#### Throw for Distance

Measure the distance the ball can be thrown in the air. Make sure that the arm is properly warmed up before throwing as hard as possible.

#### CATCHING AND FIELDING

A large part of catching and fielding is being in a "ready" position, able to move quickly to react to a hit. In this position the body is crouched with the knees and hips flexed. The feet should be comfortably apart in a parallel position. The hands should rest on the knees, or the arms should hang loosely toward the ground as the pitcher begins the delivery. The eyes should focus on the pitcher. As the ball is pitched, the weight is evenly distributed on the balls of the feet, the body leans forward, and the arms are slightly raised, putting the body in a complete state of alertness. This is particularly true of outfielders. Infielders usually have their gloves close to the ground as they anticipate the hit.

#### Fielding Ground Balls

Learning how to properly field ground balls requires much practice. Figure 2 shows the position for fielding a ground ball. The following cues describe the mechanics of this skill.



Figure 2. Fielding a ground ball.

1. The eyes need to watch the batter's swing and remain in contact with the ball throughout the fielding action.
2. The body is moved to center behind the ball.
3. The feet should be in a stride position with the knees bent and the glove side foot forward.
4. The body should be bent at the waist with the hips low to the ground.
5. The arms should be outstretched, and the fingers pointed downward with the little fingers together. Contact should be made with the ball opposite the glove side foot.
6. The arms should "give" as the ball is caught.

The following drills can be done to develop ground ball fielding ability:

1. *Wall rebound fielding*—throw a rubber ball or tennis ball against a wall. React to the rebound off the wall to field the ball. The ball can be thrown slightly to the right or to the left so that the player will have to move to get behind the ball when fielding.
2. *Fielding thrown balls*—have a partner throw ground balls to the right and left. Have the balls thrown softly at first and then thrown harder as fielding ability improves.
3. *Fielding hit balls*—have a batter hit ground balls to be fielded. See if ten balls in a row can be successfully fielded and returned to a catcher.

### Fielding Fly Balls

When catching fly balls players should position themselves so that the ball is caught on the throwing side of the body in front of the throwing shoulder. These cues emphasize the mechanics of catching a fly ball:

1. Hustle to where the ball is to be caught.
2. Get the body behind the ball and move forward to catch.
3. Have the arms outstretched and make the catch with two hands at head height. Hands are held with thumbs together and fingers pointed upward.
4. The catching motion blends into the backswing for the throw as the body weight shifts onto the throwing side leg.

5. Grasp the ball securely before throwing and make sure the body weight is balanced.

Players must learn to get a quick start when fielding fly balls and also to call for the ball if more than one player is likely to try to make the catch. It is best to clearly and loudly yell "mine" or "I have it."

The following drills will help to improve skill in fielding fly balls.

1. *Catching thrown balls*—stand about twenty feet from a partner. Have the partner throw the ball so that it can be caught with a forward, backward, or sideward movement of the body.
2. *Turn and catch*—stand approximately ten feet from a partner with the back turned. Have the partner toss the ball high into the air and yell "turn" as they do so. When the partner yells, turn, locate the ball, move into position, and make the catch before the ball hits the ground.
3. *Catch thrown balls*—stand five feet from a partner who will be the thrower. Run toward the thrower, toss him or her a ball, then circle away. The thrower should toss the ball high into the air as if throwing a long forward pass. Run out and away, keeping an eye on the ball. Move into position and make the catch.

### PITCHING

Another major defensive skill in softball is pitching. As a pitcher, know how to grip the ball, release the ball, control the pitch, pitch the ball so that it hits the corners of the plate, and be ready to field a batted ball. The style of pitching will vary depending on whether fast or slow pitch ball is being played. The pitching rules describe what makes a pitch legal. The mechanics presented here will be for fast pitch. Rule differences which relate to slow pitch are discussed later in the chapter.

In making a legal pitch assume a starting position with the ball held in both hands in front of the body and with both feet touching the pitcher's plate. Take only one step toward the batter as the ball is released. A second step is necessary to follow through to regain balance and get the body in a good fielding position. The quicker the arm and

hand are moving at the time of release, the faster the ball can be thrown. The pitching motion can be divided into three distinct phases: the backswing; the forward swing and release; the follow-through.

### Backswing

Swing the pitching arm backward as far as possible. Try to get the hand up higher than the shoulder. Let the shoulders and hips rotate toward third base (left-handed pitchers toward first base) while cocking the wrist. Throughout this motion the weight should be placed on the back foot.

### Forward Swing and Release

The weight begins to shift forward as a step forward on the foot opposite the pitching arm is taken. The shoulders and hips rotate back to their original position so that they face the batter. As the pitching hand swings past the thigh the wrist snaps forward and the hand releases the ball.

### Follow-through

The pitching arm continues up and across the body while the rest of the body continues to face the batter in the ready position so that the ball can be fielded if necessary.

A good pitcher must practice many hours to develop speed and control. The following drills may be of help:

1. *Wall target pitching*—place a target the size of a normal strike zone on the wall. Boys take their pitching stance 46 feet from the wall while girls stand 40 feet from the wall. Practice pitching to the target using a legal pitching motion.
2. *Four corners*—for this drill pitching may be done to a catcher or a wall target. Practice throwing at the extreme corners of the normal strike zone for the purpose of developing control and accuracy. Since it is important to concentrate on the catcher's target, learn to wait off the mound until the catcher is ready. Once the catcher is in position step on the mound and begin the motion.
3. *Calling balls and strikes*—pitch a designated number of innings to a catcher who is calling balls and strikes. This drill permits different count situations and game-like pressure to be experienced.

## BATTING

Batting is a striking activity that involves hitting one moving object with another. The most important factor in hitting a ball is to provide force with the bat. A firm grip is necessary to transfer power and to control the bat. In batting, practices and drills are essential for developing timing, a level swing, and a "batting eye." It is seldom that two players will use identical batting techniques.

The following fundamentals lead to good batting skills:

1. Use a bat which feels comfortable to swing and is easy to control. Make sure that the weight and length of the bat and the size of the grip in relation to the size of the hands is right. Avoid the tendency to use a bat which is too heavy or too long.
2. While waiting for the pitcher to deliver the ball, hold the bat with a firm but relaxed grip. Hands are together at the neck of the bat. The arm closest to the pitcher should be extended parallel to the ground. Hold the bat back and off the right shoulder (see Figure 3).



Figure 3. Batting stance.

3. Stand in a comfortable position facing the home plate. Turn the head toward the pitcher so that the oncoming ball is being viewed directly. Remember to watch the ball as it is released by the pitcher and step into the swing with the left foot.
4. The bat should be swung forward in a smooth motion to make contact with the ball in front of home plate. (*Note:* There is a tendency for the inexperienced batter to jerk the bat forward then backward and then forward again.)
5. Finish the swing with a follow-through past the left hip.
6. The feet should provide a solid base of support with the back foot planted.

As progress is made in the ability to bat and as skill becomes more refined these cues for efficient performance should be emphasized: swing the bat level; have the arms straight and snap the wrists at the point of contact; keep the body level during the swing (no dipping); keep the step toward the pitcher short and consistent, keep the head position still.

There are a number of ways to work on batting skill. Some suggestions are below.

#### Mirror Swing

Stand in front of a mirror and take a normal swing. Concentrate on the mechanics of a good swing. The bat can also be swung while a partner evaluates form.

#### Toss Ball

Stand about ten feet from a net, fence, or other impact-absorbing surface. A partner kneels in a facing position so that he/she is opposite the rear foot and well out of swinging range. When in position, the partner tosses the ball to the strike zone (see Diagram 1). Execute a normal swing at the ball

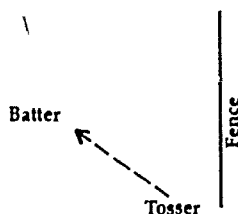

Diagram 1. The toss ball drill.

It will be helpful to concentrate on one element of the swing at a time.

#### Batting Tee Hitting

Hitting a stationary ball placed at a variety of heights can be practiced with the use of a batting tee. Practice hitting line drives in all directions as well as distance hitting to all fields. This is also a good opportunity for other players to practice fielding. It is best to have a catcher nearby to retrieve the balls thrown in from the field. It is also possible to work independently with a batting tee by hitting into a screen or backstop.

#### BUNTING

Fast pitch rules allow the batter to bunt the ball. A bunt is a legally hit ball, not swung at, but purposely met with the bat and tapped slowly within the infield. In most cases the bunt is used to advance a baserunner from one base to the next while the batter is put out. This is called a sacrifice bunt. Some batters can have such accurate placement on a bunt that they can beat the ball to first and thus get a base hit. In addition to the sacrifice bunt and the bunt for a hit there is the drag bunt and swinging bunt. Foot placement varies with the type of bunt being executed.

Bunting is an intermediate level skill that can add to the strategy used in the game. When performing a sacrifice bunt, the bat should be held parallel to the ground at shoulder level in front of the body with the arms slightly extended. The batter can pivot into this position with the feet square to the pitcher when the pitcher starts the arm action. Figure 4 illustrates the batting stance for the bunt. If the ball is low, bend the knees so that the bat is kept level. It is good advice to bunt only pitches which are within the strike zone. Diagram 2 shows the best area in which to place a bunt.

#### BASERUNNING

Running speed and the ability to use sound offensive judgment are essential qualities of a good baserunner. Quickly get-

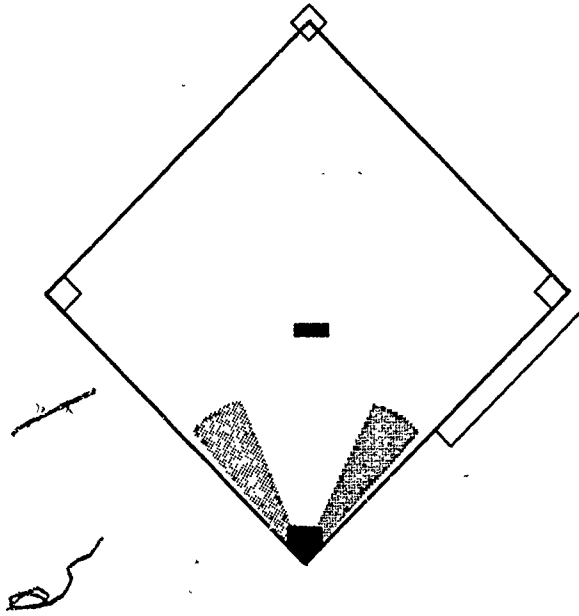

Diagram 2. Bunt placement.

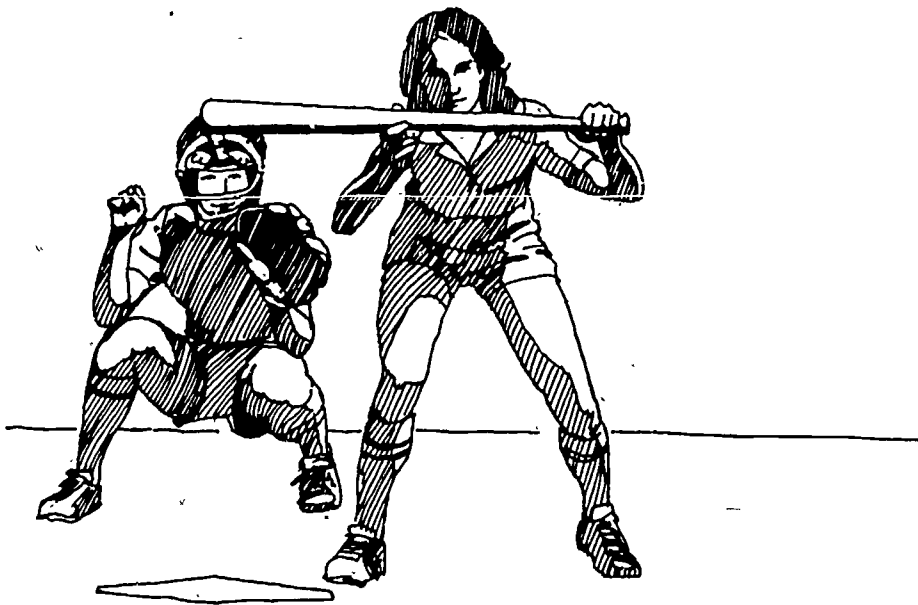

Figure 4. Bunting stance.

ting out of the batter's box is very important. A common fault made by batters upon hitting the ball is waiting to see where the ball goes before running. To correct this fault concentrate on finishing the swing and practicing the push-off start toward first base. The batter should run out every hit because a field error could occur and he/she may reach first base safely. The following suggestions will help improve baserunning:

1. Keep an eye on the ball and advance additional bases whenever possible, i.e., when four balls are called on the batter, on a wild throwback from catcher to pitcher, a wild pitch, and on any poorly thrown ball.
2. Avoid wide turns when rounding the bases.
3. Run on any hit ball when there are two outs.
4. Lead off after each pitch and advance if possible (differs in slow-pitch).
5. When running out an infield hit stay within the running lane in foul territory which is designated by a white line to the right side of the baseline about midway between home and first base.
6. Run along the foul territory side of the line from third base to home to avoid being hit by a fairly batted ball.
7. Know the number of outs, innings, score, and count on the batter.
8. Avoid interfering with a player or the ball while it is being fielded.
9. Listen to and watch the base coaches for assistance.

To work on baserunning skills the following drills can be practiced:

1. *Getting out of the box*—practice taking a swing at an imaginary pitch then dropping the bat, getting quickly out of the box, and running straight through first base.
2. *Around the bases*—run all the way around the bases making narrow turns and touching the inside corner of each base. Have someone time running speed with a stopwatch.
3. *Stealing a base*—practice leaving the base when the ball leaves the pitcher's hand and advancing to the next base before the catcher can make the play.

## SAFETY

There is much that can be done to ensure that the game is played under safe conditions and that precautions are taken to prevent injury. Proper equipment which complies with the rules is mandatory. The catcher's mask and chest protector should fit properly. The catcher must be wearing this equipment when a batter is involved in practice situations as well as in game play. Bats should have grips which help to prevent them from slipping out of the batter's hands. Check to be sure that all aluminum bats are of single unit construction. An aluminum bat with a handle that is separate from the barrel is dangerous because these elements can separate from one another on impact. There must always be a place to put equipment when it is not being used so that it is not a hazard during game play or practice.

The softball diamond should be located where there are no protruding hazards such as goalposts, telephone poles, or sprinkler heads. The surface must be smooth. Rules state there must be 25 feet of unobstructed area beyond each foul line and behind home plate, and that the pitcher's plate must be securely fastened down.

It is each player's responsibility to warm up properly in order to avoid potential injury to muscles, joints, and tendons. Warm-up drills which include stretching, easy throwing, and running are an essential part of any softball class or team practice. When drills are performed it is important to have groups working in the same direction and with adequate space. It is also important to be alert to the direction of the sun, which can be very blinding at certain times of the day.

Everyone must do his/her part to ensure their own safety and that of fellow players. Always keep an eye on the ball to be aware of what play is developing and so that the appropriate reaction can be given. Be alert for the actions of teammates and opponents to avoid unnecessary collisions and injuries. Remember, safe play means fun play for all.

## SCORING, RULES, AND ETIQUETTE

### THE GAME

A game of softball is played between two teams of nine players (fast pitch) or ten players (slow pitch) on a softball diamond. Diagram 3 shows the layout for a softball diamond and placement of the defensive team. The extra player in slow pitch usually plays in a short field position. The object of the game is to score more runs than the opponent in a regulation game which consists of seven innings. An inning is that part of a game within which the teams alternate on offense (up to bat) and defense (in the field) and in which there are three outs for each team. A run is scored each time a baserunner crosses home plate having legally touched all bases before the third out of an inning is made. The home team takes the field first. For class and intramural games the team first in the field can be determined by the toss of a coin.

#### Fast Pitch and Slow Pitch Rule Differences

There are several major rule differences between fast pitch and slow pitch. Most of

these differences relate to pitching regulations. Listed below are some of the most important rules which differ.

1. In slow pitch the ball shall be released at a moderate speed and must have an arc of at least three feet and go no higher than 12 feet from the ground.
2. The pitching distance for men's and women's slow pitch is 46 feet, while the fast pitch distance is 46 feet for men and 40 feet for women.
3. At the beginning of the pitch the slow pitch pitcher need only have one foot in contact with the pitcher's plate while in fast pitch both feet must touch the plate.
4. Slow pitch does not allow any base stealing and the baserunner may not leave the base until the ball crosses home plate or has been hit by the batter. In fast pitch the baserunner can take a lead-off when the ball leaves the pitcher's hand.
5. While bunting is a major part of fast pitch, the batter is out in slow pitch if he/she chops downward on the ball or attempts to bunt the pitch.
6. In slow pitch if a swing is made and a third strike missed, the batter is out

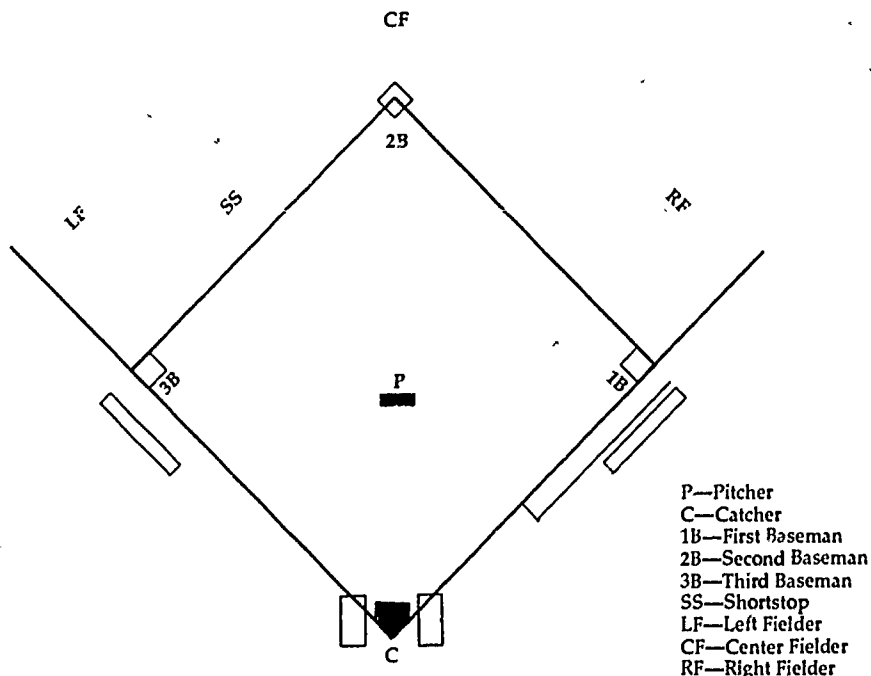

Diagram 3. Softball diamond and players.



whether the catcher catches the ball or not. In fast pitch, if the catcher drops the third strike the batter may run to first base with the liability to be put out if there are less than two outs and the base is unoccupied. If there are two outs, he/she may run whether or not the base is occupied.

7. If a batter hits a foul ball with a two strike count in slow pitch, the batter is out.

### Pitching Rules

A few of the major rules are listed below.

1. The pitcher must take a stance on the pitcher's plate and present the ball in front of the body before beginning the delivery.
2. The ball must be thrown with an underhand motion and the wrist can be no farther away from the body than the elbow when the wrist passes below the hip.
3. The pitcher's delivery motion may not involve more than one arm rotation, or include a change of forward motion or rocker motion where both hands return to the ball.
4. The pitch is completed when one step is taken toward the batter as the ball is released. In slow pitch a step is not required.

### Batting Rules

Listed below are some of the basic rules for batting.

1. If the batter swings at a pitched ball and misses, a strike is called.
2. If the batter gets three strikes, he/she is called out. The batter is awarded first base if he/she gets four balls.
3. A foul ball is called if a hit ball lands outside the lines defining the playing field.
4. The batter may reach first base by one of the following methods. by hitting the ball in fair territory and getting to first before the ball, by being hit with a pitched ball, by getting a walk when four "balls" have been thrown by the pitcher; by an error by a fielder, by the catcher or catcher's equipment interfering with him/her.
5. The batter is out under these conditions. when a fielder catches his/her fly ball;

when a third strike is caught by the catcher, or on a third strike when first base is occupied and there are less than two outs; when a bunt goes foul on a third strike; when the batted ball is thrown to first before he/she arrives; when an "infield fly" is hit, if first and second bases are occupied and there are less than two outs; when he/she interferes with players attempting to make a put-out; when batting out of order; when hitting the ball while standing out of the batter's box.

### Baserunning Rules

The batter becomes a baserunner as soon as he/she hits the ball in fair territory. Here are some important rules which govern baserunning:

1. A baserunner may leave the base as soon as the ball leaves the pitcher's hand (fast pitch).
2. A baserunner is out if he/she interferes with a player fielding a batted ball.
3. A baserunner must run the bases in order and may not leave the imaginary three-foot base path in order to avoid being tagged out.
4. A baserunner is out if touched with the ball while off a base.
5. A baserunner may attempt to advance a base after a legally caught fly ball (fair or foul) is first touched.
6. Two baserunners may not occupy the same base.

### ETIQUETTE

Good sportsmanship helps to make the game of softball fun to play. There are many things teammates can do to display good sportsmanship. It is important to respect the umpires and to graciously accept their decisions. Be sure to give positive encouragement to teammates and acknowledge the good plays of opponents. Pick up the catcher's mask at the beginning of the inning. Remove the bat from home plate area when up to bat. Make every attempt to avoid unnecessary collisions. As a baserunner or as a fielder learn how to execute skills in a safe manner which will help to prevent injuries. Congratulate the opposite team after the game. Play hard and be a good sport.

## STRATEGY

The game of softball becomes more challenging as basic skills improve and attention is turned to offensive and defensive tactics. Probably one of the most important elements of strategy is to place the players in the field in the positions which best match their defensive skills.

In intermediate and advanced level play, much strategy is used in determining the order in which the players will bat. The game situation takes into account the number of outs, location of baserunners, and the score of the game. The inning as well as the specific skills of fielders and batters determine the particular strategy to be employed.

Many of the elements of strategy used in baseball can be applied to softball. The following hints on strategy which relate to defensive play, batting, and baserunning will be helpful as softball playing ability is developed.

### DEFENSIVE PLAY

Defensive strategy results largely from anticipation, i.e., knowing what to do with the ball when it comes. Keep these hints in mind when concentrating on the defensive elements of the game.

1. Recognize that the primary task is to field the ball first and then to make an accurate throw. Get behind the ball and use two hands when fielding.
2. Before the ball is pitched, know the play to be made. Mental preparation is important.
3. Always play for one sure out.
4. Talk to teammates to build strong team unity. Remind them of the number of outs, where the batter hit the last time up to bat, and give positive encouragement to the pitcher.
5. Know teammates' defensive skills, especially those playing nearby. Be sure to know how to share responsibilities such as covering a base or backing up a play. (To back up a play means to be positioned behind a player who is fielding a hit or thrown ball so to be in position to get the ball if it is missed by the first fielder.)

6. As a baseman, do not stand on base unless involved in a play, because the positioning could block a baserunner.
7. Learn how to cover a base properly for a tag play or a force out.
8. As an outfielder, know the responsibilities for backing up hit balls and thrown balls. Effectively communicate with other fielders to avoid collisions. The basic rule is to throw the ball one base ahead of the runner on fly balls and two bases ahead on ground balls.
9. Hold up the throw if it will be too late to make a play. Having good judgment about when not to throw is just as important as knowing where to throw.
10. As a pitcher, concentrate on the target given by the catcher. It is best to work on getting the ball over the plate rather than trying to strike out opponents.
11. Fielders must be ready to anticipate the play and react to the action of the offense. Intermediate level strategy may involve bunting and stealing.
12. In more advanced play the pitcher will attempt to pitch to each batter's weakness and the fielders will adjust their positions depending on the batter's strengths and the game situation.

### BATTING STRATEGY

Some elements of batting can be practiced by performing drills, however, the real test of offensive power is how well a player can produce in a game. Here are some suggestions:

1. Once in the batter's box, be ready, but relaxed, and concentrate on the pitcher.
2. A batter's primary task is to hit the ball. Be ready to swing at every pitch. Hold up the swing if the ball is not in the strike zone. Know the strike zone.
3. It is best not to swing when there is a three-ball and no-strike count.
4. Be prepared to bunt the ball if there is a runner on first base with one or no outs.
5. If a skillful batter, survey the defensive positioning of opponents to see an open space where a bunt or hit may be placed.
6. If playing with base coaches, look for a signal from the coach prior to moving into the batter's box. In addition to calling for a bunt, other offensive plays sig-

naled by the coach in the more advanced game might be. hit and run (the batter must hit the pitch no matter where it is pitched and the baserunner "steals" when the ball leaves the pitcher's hand), steal (the batter does not want to hit the pitch because a teammate is stealing a base and the batter must protect the baserunner); bunt for a base hit (the batter executes a short bunt when the defense is playing back).

### **BASERUNNING STRATEGY**

Aggressive baserunning is an exciting part of softball. Although the baserunner may not leave the base prior to the ball leaving the pitcher's hand, which is legal in baseball, there are many offensive tactics which challenge each baserunner's ability. To be a good baserunner be aggressive and confident. Below are some suggestions for developing baserunning skills.

1. Be sure to touch each base in order. Remember that second or third base cannot be overrun.
2. Take a lead-off with each pitch and be ready to advance a base if the ball gets away from the catcher.
3. Always know the number of outs. If there are two outs, run with the hit. On a fly ball hit to the outfield if there is one or no outs, stay near the base, and return to the base after the ball is caught. Run to the next base after the ball is caught if time permits. A runner on third should stay on the base and run home after the catch. On ground balls with one or no outs, advance to the next base with the hit.
4. Avoid an unnecessary collision with defensive players covering a base.
5. If on first base in the early part of the game try to steal second base to determine the throwing ability and alertness of the catcher.
6. On a bunt play, be sure the ball is hit to the ground before advancing to the next base.
7. In more advanced level play, when coaches are used to guiding the offensive strategy, be ready to follow the signals of the coaches who might call for a

steal, hit-and-run, or squeeze play. At this level of play the coaches analyze the defensive strengths of their opponents and then call for certain offensive plays depending on the game situation.

8. It is the responsibility of the base coach to tell the baserunners to slide, stand up, stop at the base, or continue to the next base. Verbal and/or visual signals may be received to indicate what it is that needs to be done.

The offensive and defensive strategy employed in slow pitch is somewhat different from that described above because of rule variations. The pitching method contributes to more hits and more baserunners; however, some of the more advanced aspects of batting and baserunning tactics related to stealing and bunting cannot be used in slow pitch. Both games create a challenge to the players as the players attempt to apply strategy to beat their opponents within the spirit and requirements of the rules.

### **EQUIPMENT**

The quality of softball equipment used and its care can have a definite effect on skill performance. Experience has shown that it is best to buy equipment which is made by a well-known manufacturer and which meets the official standards specified by the rules. Equipment will last longer if it is of good quality.

### **BALLS**

There are numerous brands and kinds of softballs. Those which meet ASA approval are so marked and have "official softball" stamped on them. The cover of the ball is made of tanned horse or cowhide. Balls with a whiter cover are designed for both day and night use. These often have a slicker surface. Restricted flight balls have red seams. These balls are used for the slow pitch game. It is important that balls be kept dry. Once they become wet and dry out, they get heavier and could cause injury to the throwing arm. It is good to have a supply of rubber-covered balls for poor weather.

## BATS

Bats come in various shapes and sizes. In recent years there has been more use of aluminum bats because they last longer than wooden bats. Bats which meet rule specifications are marked "official softball" by the manufacturer. It is good to have a variety of bats.

## GLOVES

One key to success in playing softball is to have a top quality glove. Rules allow only the catcher and first baseman to use mitts. Purchase a glove which has a good pocket and one that can be easily manipulated in the hand. Glove oil may be used to loosen up the leather of a new glove. Saddle soap can be used to clean dirt from the leather. Let a wet glove dry naturally; then oil it and use saddle soap on it. It is helpful to store a ball in the glove with a band to hold it in place to create and retain the shape of the pocket. Treat a glove with care and it will last a long time.

## CATCHER'S EQUIPMENT

Acquiring the appropriate catcher's gear is a must. The mask needs to be adjustable so that it can snugly fit the head. There are both lightweight wire masks and heavier bar-style models. Chest protectors can be purchased in different models and sizes. Here again, it is necessary that the protector fit properly. For fast-pitch softball, it may be advisable for the catcher to wear shin-guards. These should be securely fastened and fit the length of the lower leg. When equipment is properly cared for and stored in the appropriate manner, it will last longer.

## UNIFORMS

Sharp-looking uniforms can add spice to any team. The better the quality of the uniform, the longer it will last. Long-sleeved undershirts are an essential part of the uniform in cooler weather. Sun visors or hats may be a necessity. Sliding pads can help to prevent abrasions, especially if players are wearing shorts. Cleated shoes help to ensure good footing for baserunning and

fielding. Both rubber and metal cleats are available. Take pride in a uniform and care for equipment.

## TERMINOLOGY

- Advance.** To run from one base to the next.
- Backing up.** A fielder moving behind another fielder to stop the ball if an error occurs.
- Bag.** A base.
- Ball.** A pitch which is not within the strike zone of a batter.
- Batter's Box.** The area on either side of home plate where the batter must stand when batting.
- Battery.** The pitcher and the catcher.
- Bunt.** A legally hit ball, not swung at, but purposely tapped with the bat and directed near the foul lines in the infield.
- Cleanup.** The fourth hitter in the batting order.
- Diamond.** The area formed by the four bases (the entire playing field is also considered the diamond).
- Double Play.** Defensive action which results in two outs.
- Error.** A defensive misplay.
- Fair Ball.** A batted ball which is touched or stops between the foul lines in the infield or which first lands between the foul line beyond the bases.
- Force Out.** A putout on a baserunner who was forced to advance due to the batter becoming a baserunner.
- Foul Ball.** A ball hit outside of fair territory.
- Full Count.** Three balls and two strikes on the batter.
- Infield Fly.** A fair hit ball within the infield area which can be easily caught by an infielder. With one or no outs and with runners on first and second or all three bases, the infield fly rule is in effect.
- Inning.** That portion of a game within which the teams alternate on offense and defense and in which there are three outs for each team.
- Lead-off.** A quick move off the base by a runner once the ball leaves the pitcher's hand (fast pitch).
- On Deck.** The next batter to come to bat.
- Pitcher's Plate.** The rubber form, two feet by six inches, from which the pitcher must pitch.
- Sacrifice.** A batted ball which intentionally advances the runner, but results in the batter being put out.
- Shut out.** A game in which one team does not score.
- Squeeze.** To advance a runner home from third base on a bunt.
- Steal.** To advance from one base to the next from the time the ball leaves the pitcher's hand until he/she is ready to pitch again.

**Strike Zone.** That area above home plate between the batter's knees and armpits (fast pitch) when the batter is in his/her normal batting stance. The batter's highest shoulder is the top of the area for slow pitch.

**Umpire.** The official who calls balls and strikes, makes judgments as to whether a runner is safe or out, and assures that play complies with the rules of the game.

**Wild Pitch.** A pitched ball which is so high, so low, or so wide that the catcher has no chance of controlling it.

Dobson, Margaret J., and Sisley, Becky L. *Softball for Girls*. New York: The Ronald Press Company, 1971.

Drysdale, Sharon, ed. *NAGWS Softball Guide January 1981-January 1983*. Washington, DC: The American Alliance for Health, Physical Education, Recreation and Dance, 1979.

Kneer, Marian E., and McCord, Charles L. *Softball Slow and Fast Pitch*. 2d ed. Dubuque, IA: Wm. C. Brown Company Publishers, 1976.

Walsh, Loren. *Inside Softball*. Chicago, IL: Contemporary Books, Inc., 1977.

Whiddon, N. Sue, and Hall, Linda T. *Teaching Softball*. Minneapolis, MN: Burgess Publishing Company, 1980.

### REFERENCES

Brown, Paul, et: al. *Coaching Youth Softball*. Chicago, IL: The Athletic Institute, 1978.

back stroke (back crawl) (p. 278)  
beginning freestyle (p. 269)  
bobbing (p. 268)  
breast stroke (p. 283)  
breathing (p. 267)  
buoyancy (p. 267)  
diving (p. 276)  
dog paddle (p. 269)  
elementary backstroke (p. 272)  
finning (p. 269)  
floating (p. 269)  
forward glide (p. 268)  
intermediate freestyle (p. 281)  
jumping (p. 276)  
kicking (p. 269)  
propulsion (p. 287)  
push (p. 267)  
recovery (p. 267)  
resistance (p. 287)  
sculling (p. 271)  
sidestroke (p. 283)  
surface dive (p. 278)  
treading water (p. 272)

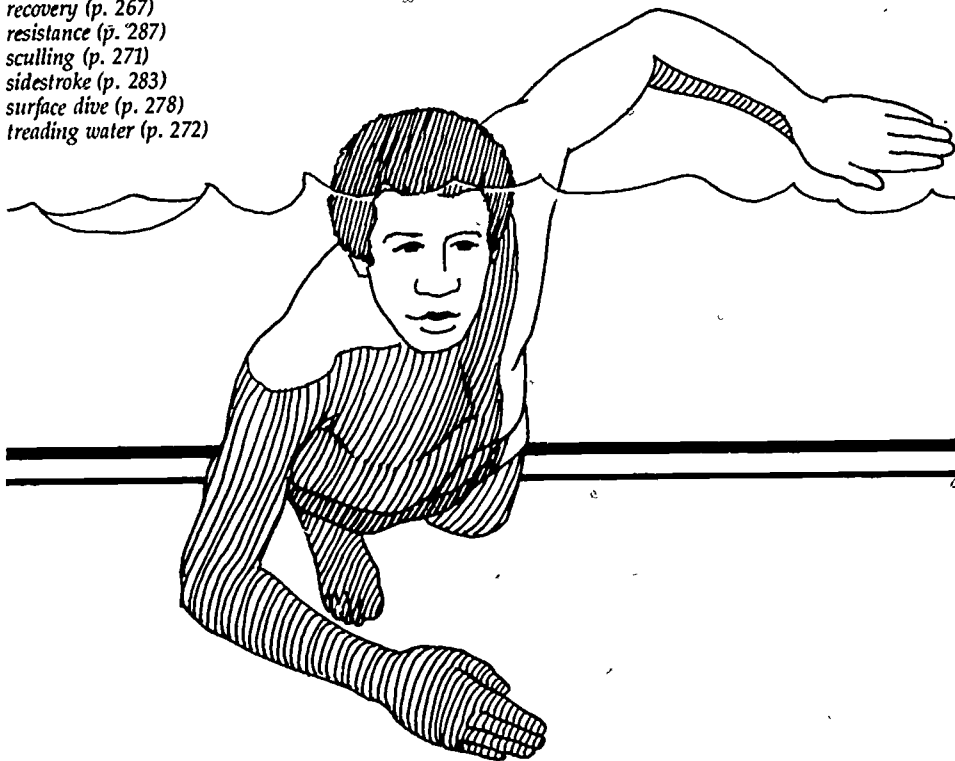

# Swimming

ANNE ROSS FAIRBANKS,  
*Skidmore College,  
 Saratoga Springs, NY*

## INTRODUCTION

Swimming is an important skill for everyone to learn. In order to become a *good* swimmer, one must work hard and practice often. It is, however, relatively easy to learn enough of the basics so that the water can be safely enjoyed.

As in most sports, your learning should proceed step by step, especially at the beginning. Breathing is a more important factor in swimming than in any other sport because one cannot breathe water. One must, therefore, learn when and how to breathe while in the water. Although this need to regulate breathing may seem strange and troublesome at first, it soon becomes natural and occurs without thinking.

To move through the water, one must push in a steady continuous motion. You push your hands toward your feet to move forward, or push down toward the bottom if you want to remain in one place. "Recovery" is important as well, since you can push only so far before the arm or leg must return to a satisfactory pushing position. Breathing must be regulated as naturally as possible within these propulsive movements. Additional and important skills include: getting into the water by jumping or diving, ability to hold a steady position by treading water or floating, ability to get underwater quickly and swim a short distance underwater. When these things can be done smoothly, comfortably, and effectively by combining movements into various strokes, you are a swimmer, and there are worlds of new experiences open in many aquatic areas.

## SKILLS AND TECHNIQUES

### BEGINNING TO SWIM

#### First Steps

The first part of learning to swim is getting acquainted with the feeling of being in water, finding out what happens while moving in the water. Walk into water up to the waist. Notice how difficult it is to move the feet quickly, how heavy it feels to walk. Push with the hands against the water in any direction and notice the pressure against the skin. Then go a little deeper, or bend the knees to bring the water chest deep, and let the arms float relaxed on the surface, feeling their lightness. This is the support the water gives, called buoyancy.

#### BREATHING

Take an easy breath through the mouth, hold it, and place the face in the water. Concentrate on just holding the breath, and let the head rest easily so that the water covers the face but the back of the head is still out. Hold for a few seconds, then lift the head again, blowing the air out through the mouth as the head is lifted. Practice this while holding onto the side of the pool or a friend's hands until able to stay under for about ten seconds at a time. A little more energy to blow out must be used than usual since the water is being blown against, creating bubbles. Try to time it so that blowing out occurs as the face breaks through the surface. This will blow away much of the water which otherwise runs down the face.

Try opening the eyes while underwater. Everything will be a little fuzzy, but

recognizable. To clear the eyes, blink a few times after back in the air; do not rub the eyes hard.

When fairly comfortable with the breath holding and submerging, try the same procedure while lying flat on the water. First, hold onto the pool edge or someone's hands. Bend the knees and place the head forward into the water. Keep leaning forward until the feet can leave the bottom and allow the legs to stretch out easily behind the body, then lift the head and stand up. It is important to get the feet under the body *before* lifting the head so that balance can be maintained.

When working on breath control, never stay underwater until air is desperately needed. This forces the body to rise too quickly which can throw it off-balance. A better plan is to move slowly to recover footing just as another breath is needed. If your breath can be held in the water only for a very short time, practice holding it while standing completely in the air. This can be done for quite a long time. The more rapid need felt for air when the head is underwater is really the fear of the new environment. The breath can soon be held underwater as long as it can be on land.

### FORWARD GLIDE

The next step is to practice the two things learned: taking a breath; putting the face in the water, followed by stretching out with the face submerged. Can this position be glided into? If near a wall, back away a foot or so and glide to the wall while leaning forward. With a friend, it's even better, because a friend can give a hand if ability is misjudged. Keep increasing the distance, and soon the face can be put in; glide forward, and stand up again without holding onto anything. Move slowly and deliberately, and enjoy the supportive feeling of the water.

### BOBBING

The breathing process can be further improved if "bobbing" is practiced. This means moving up and down while standing or holding onto the wall, blowing out underwater, and catching a breath again while in the air. Concentrate on breathing in and out continuously and maintaining a steady, relaxed pattern. If this can be comfortably done ten times in succession, a habit will be eventually established which will make breathing with strokes much easier to learn.

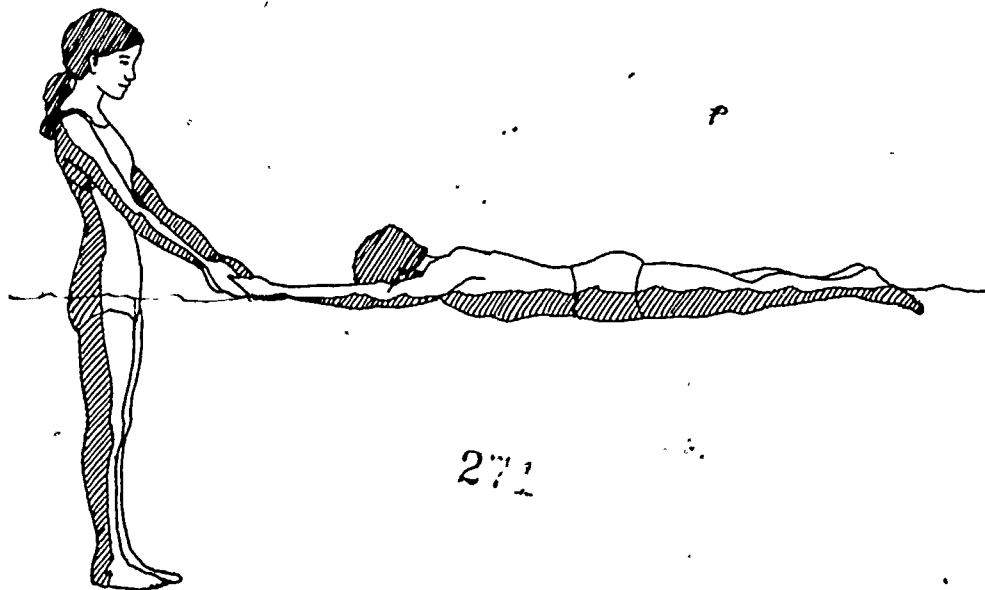

271  
Figure 1.



## KICKING

Even before learning to float, hang onto the wall and kick the feet up and down. As a friend pulls, with the face in, begin to move the legs up and down, one at a time, making a little but not too much splash. This is the start of a flutter kick. When able to glide forward alone (prone glide), try kicking a little too, letting the legs pass each other with relaxed knees.

## FLOATING

Floating means achieving balance in the water without movement. It does not always mean lying on the back with the toes out of the water. Floating can be done on the face, rolled up in a ball (tuck float), hanging forward (jellyfish), as well as in a semi-vertical position, forward or backward. One does not have to be able to float to be a good swimmer, but it helps, and it is nice to feel that one can rest without effort. Almost everyone can learn to float in some position although some people may need to move just a little to maintain this position.

The forward position can be experimented with, having the present knowledge of breath holding and position recovery. To try it on the back, stand low in the water (up to the chin), set the head back gently as on a pillow, and lean back flat until the feet can leave the bottom. Do not lift the feet up; let them find the place where they balance. This is likely to be somewhere between horizontal and vertical. Meanwhile keep the shoulders back, chest up, arms in a "Y" position in the water overhead. Holding the breath will help in floating at first. It is best to experiment with a friend standing by, or at the corner of a pool, for initial support.

Next see if a back glide can be done. Do everything as would be done in a back float, except keep the arms at the sides and push off from the bottom a little with the feet. When at a stop, sit down, letting the arms reach forward and moving the face forward in the water. When the feet are under the body, stand up.

## BEGINNING FREESTYLE

The front crawl or freestyle stroke can now be begun. In the forward glide position, take one arm at a time and push down and back under the middle of the body. When the arm can go no further, sneak it back close to the body until it is forward again. The arms move one after the other as the legs do when walking. One pushes back as the other sneaks forward. In the push, do what is natural; let the elbow bend as it wants to and just push against the palm of the hand. This is a "dog paddle" and is much like the underwater part of freestyle swimming.

Along with the arm movements of the dog paddle, kick the legs up and down easily. Try to use the whole leg from the hips, letting the knees relax a little and the feet flap. The feet should just break the surface behind the body, passing each other so that there is approximately a foot of distance between them at the most (up and down distance).

It is best to work on this while holding the breath with the head in the water all the time, stopping when air is needed. Eventually try breathing while swimming, as would occur in bobbing: blow out steadily underwater; lift the head just enough to take in a quick breath and put it right in again and blow out. Be sure to place it into the water only to the hairline, and not down so far that the bottom can be seen below.

Now try taking the arms out of the water at the end of each push-back. Bend the elbow first, and swing the arm forward easily to place it in front of the shoulder as shown in Figure 3. The head can be turned to the side to catch the breath each time the arm on that side is back. As that same arm swings forward, turn the head into the water and exhale. Keep the kick going easily behind the body. The basic combination of arms, legs, and breathing for the freestyle has been completed.

## KICKING AND FINNING

To move while on the back, add to the back glide an easy up and down movement.

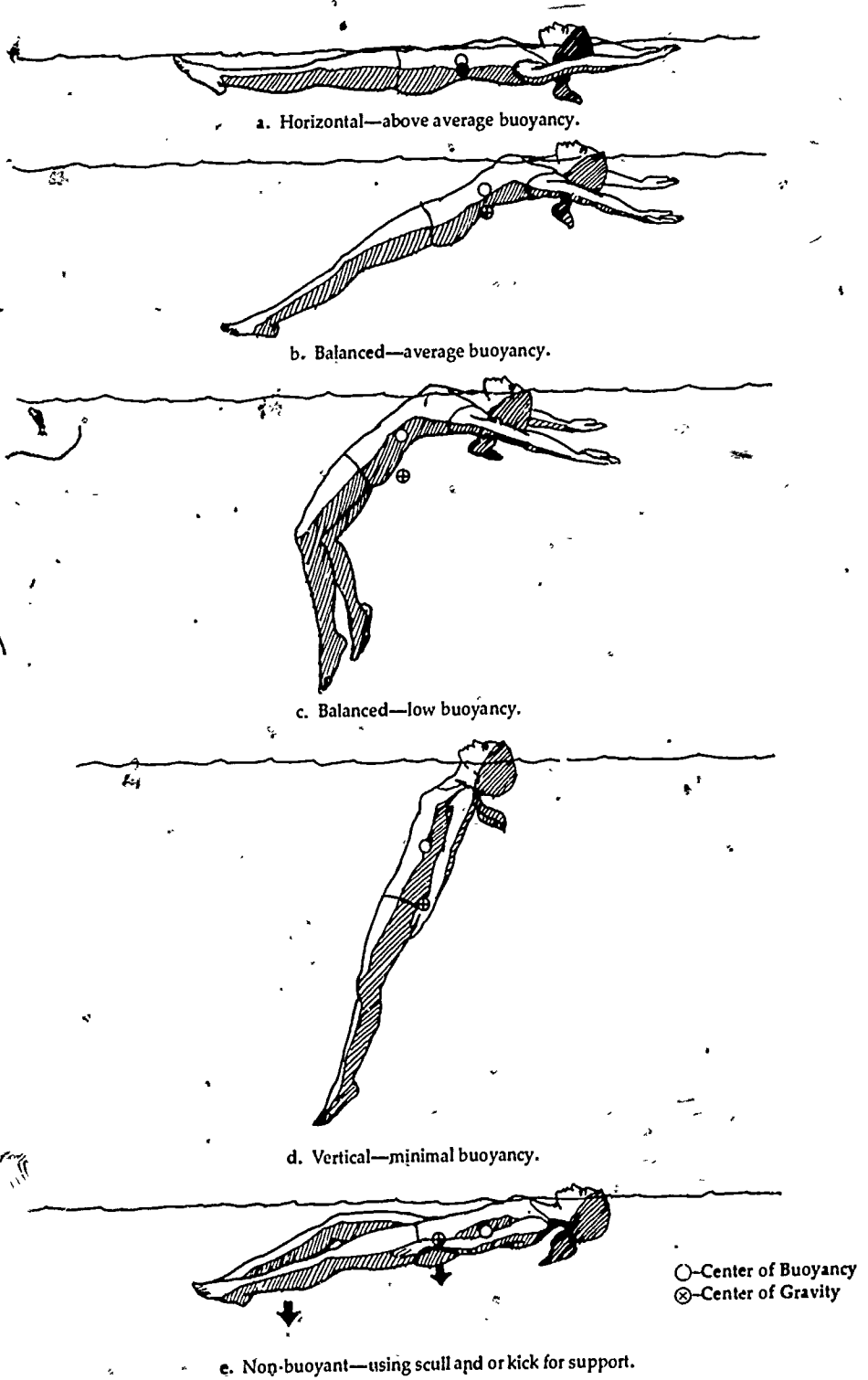

Figure 2. Buoyancy.

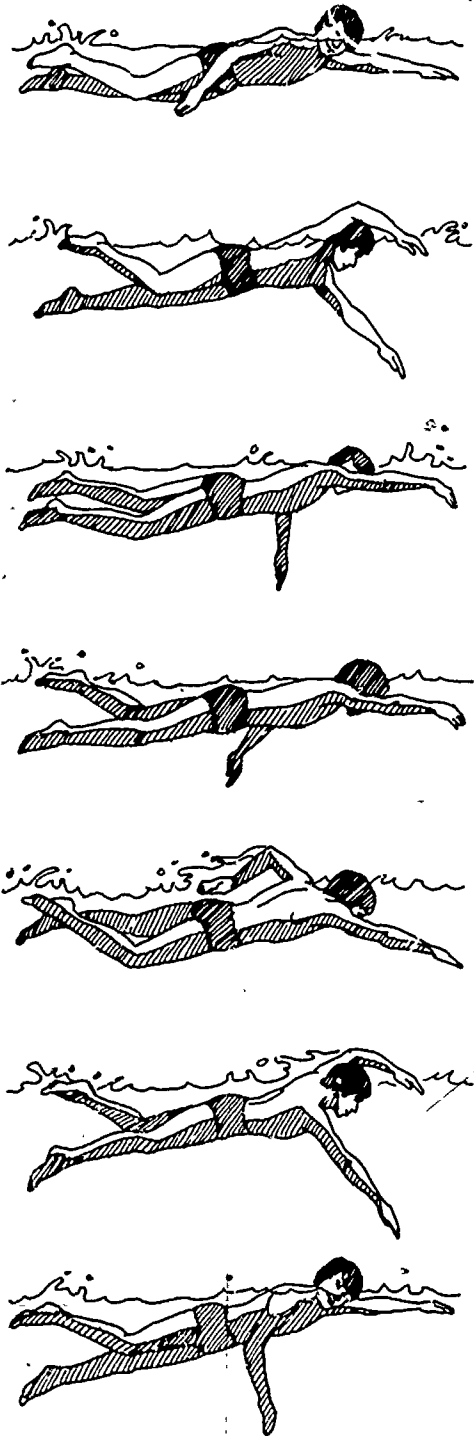

Figure 3. Beginning freestyle.

with the feet. Let the knees and ankles relax, and kick so that the surface of the water is broken. Always try to stay as flat as possible with the back of the head in the water. Resist the temptation to sit down. Hands and arms can help by pushing water toward the feet. Start with the arms at the sides; bend the elbows and slide the hands up close to the body for a short way, fingers pointing toward the feet. Point the fingers outward, reach out and push the arms straight back and down to the sides. This should be a small movement, with the kick going on all the time, arms pausing for a short rest at the sides. Make a difference between the slide up (recovery) and the press out and back down (propulsion). The arm movement being done is called finning (see Figure 4).

### SCULLING

A more advanced form of hand-arm propulsion is called sculling. Here, instead of sliding the hands up close to the body, leave the arms fairly straight along the sides. Turn the hands over so that the thumbs are toward the bottom; then push out slightly away from the body. Turn the hands over so that the thumbs face upward and pull back to the sides. During this the wrists are extended and firm, fingers together so that the hand is flat; the elbows are not stiff, but give easily with the movement. The movement should be almost continuous, a feeling of equal push in each direction without slowing down. Sculling is stronger than finning because there is really no recovery stage other than quickly turning the hands over.

With the beginning freestyle, and finning or sculling with kicking on the back, a lot of distance can be covered. However, be sure to stay in the water not over the head. Try combining these beginning strokes: start out swimming freestyle; after a few strokes, get a rest by turning onto the back and finning or sculling. See if this can be done back and forth without touching bottom in between.

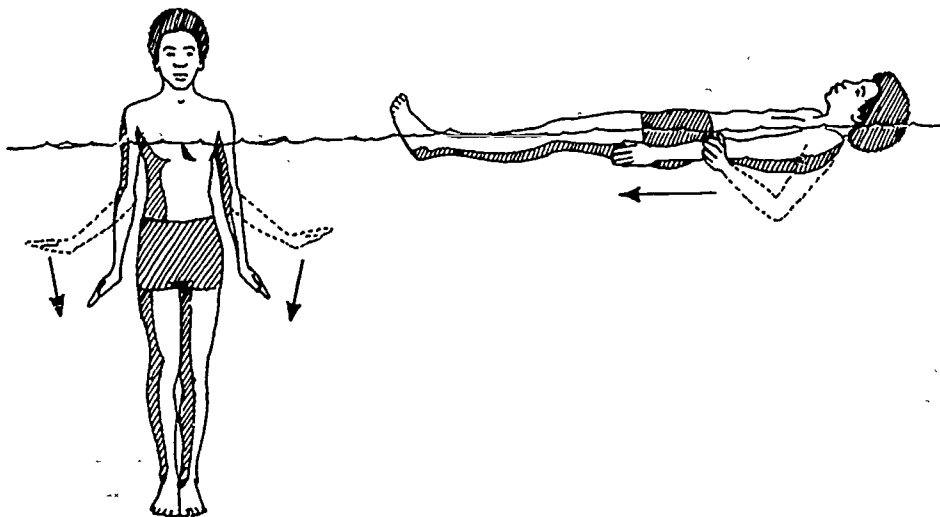

Figure 4. Finning.

### ELEMENTARY BACKSTROKE

The elementary backstroke is an excellent next step from finning and sculling. This is a stroke on the back with an extended glide. The arms and legs move at the same time, all under the water's surface. Strokes should be long and easy, and there is no special breathing to learn as the face is out of the water at all times.

#### Arms

The arms move as in finning except that the movement is much longer. Moving close to the body, both hands move up to the shoulders, then reach out with the fingertips and sweep just under the surface back to the sides. This may be done by pushing down with the forearms fairly close to the body, or by straightening the arms a little over the head and sweeping out and down. The first movement going up close to the body is slow and easy (recovery); the push or sweep toward the feet is stronger, and a glide is held in the finish stretch for a second or two.

#### Kick

The leg kick should be carefully learned since it sets the pattern for the breast stroke kick later. From the back lying position, bend the knees, dropping the feet below the knees. There should be no turning out

(pointing the knees to the sides) though the knees should be three or four inches apart and parallel to each other. Keep the hips up to avoid a sitting position; merely relax the knees. Then lift the toes, press the soles of the feet a little to the side in a circling motion with the knees spreading apart a little more. Continue pressing with the feet as the legs are straightened and pressed together. Timing is important: ONE—easy, slow knee bend; TWO—quicker, stronger press out with the feet through to finish extension. Hold glide at finish.

Together, arms and legs bend and move easily in their first actions; then both push in the direction of the feet, and end as in the beginning in the extended glide position. As the stroke is improved, start the arm recovery slightly before the leg recovery, then push at the same time with both arms and legs into the glide. Figure 5 illustrates the movement pattern and sequence of the elementary backstroke.

### TREADING WATER

This skill is needed to stay in one place in water which is over the head. Movement through water in a horizontal position has already been learned. When at a stop, floating can be on the back, or a vertical position may be preferred so that people can be seen

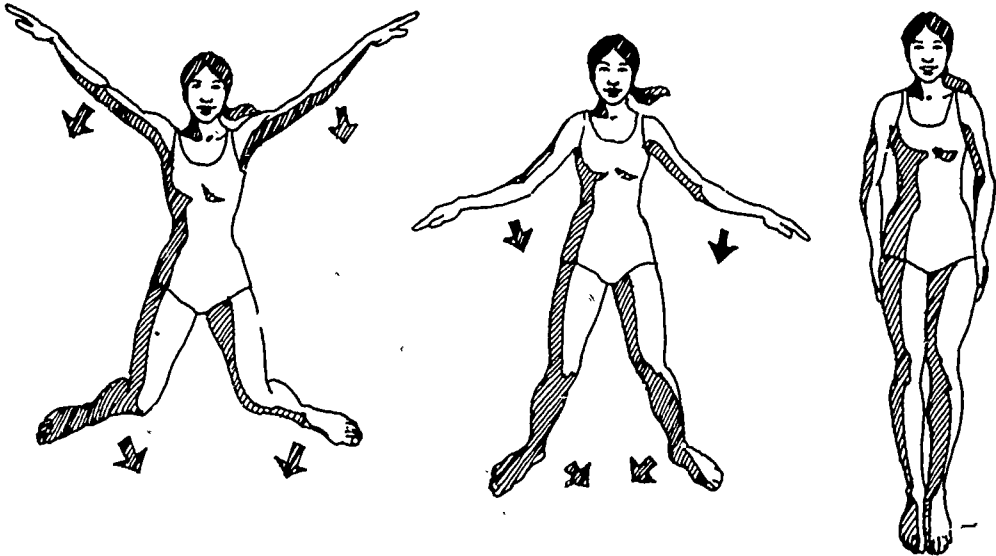
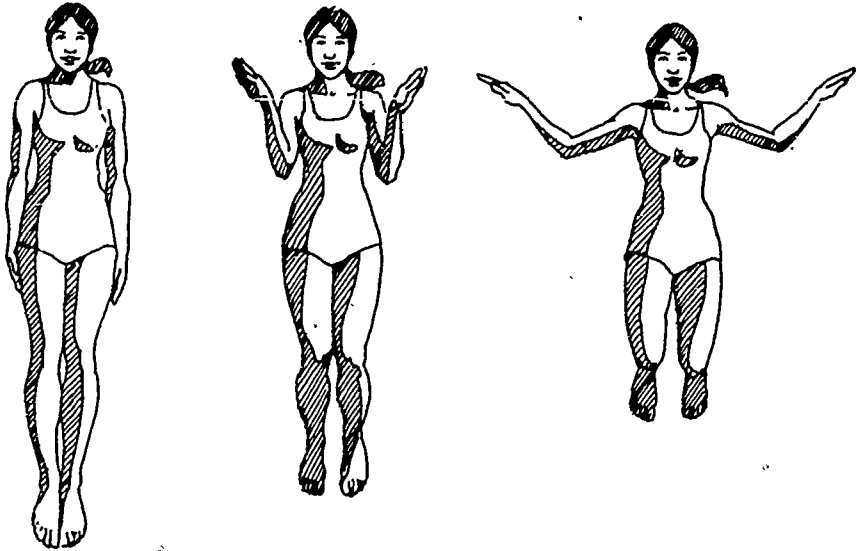

Figure 5. The elementary backstroke.

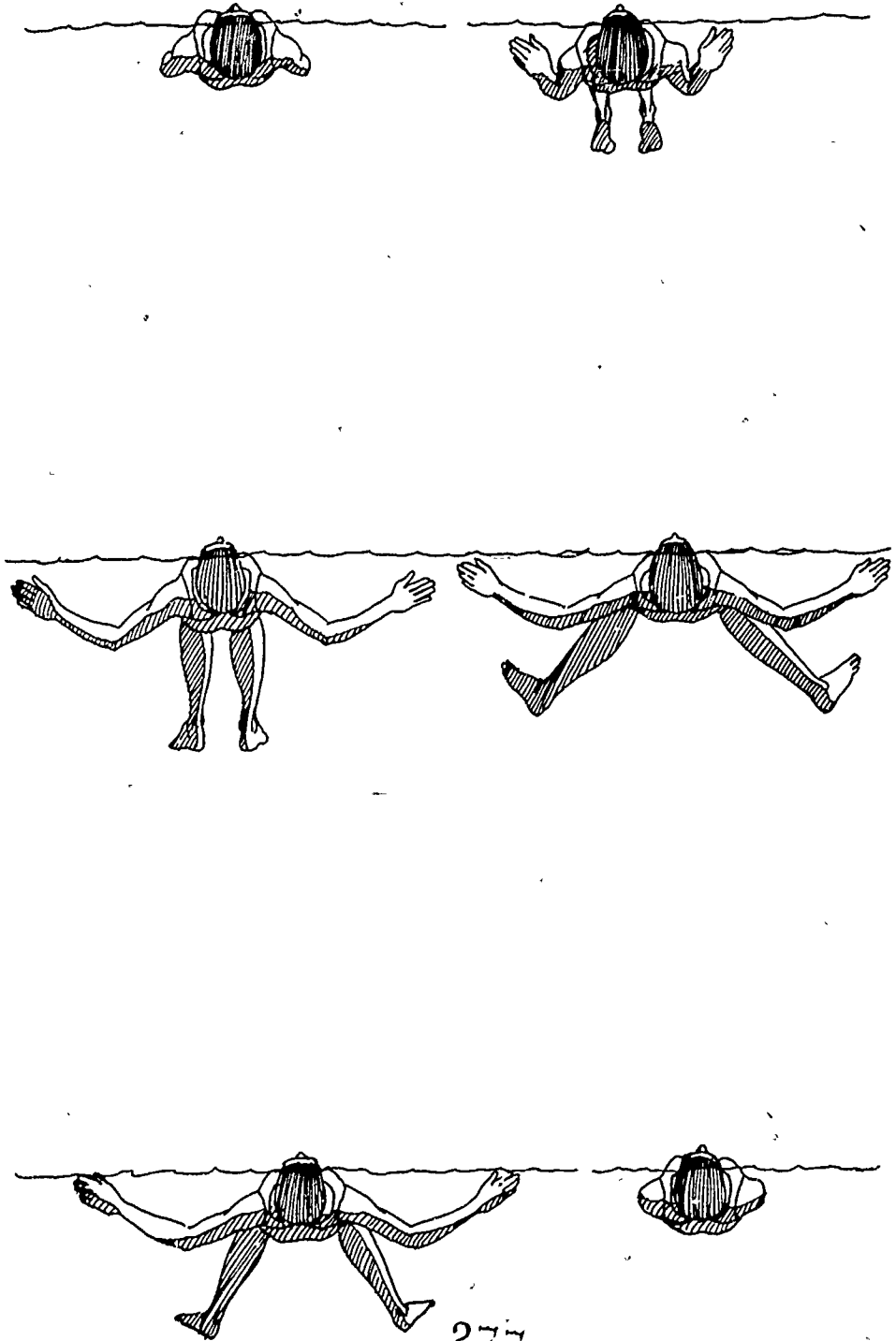

Figure 5. (Continued).

and conversation made. Slow arm and leg movements will support the body in this position.

### Arms

A flat scull is done with the arms, that is, with the hands flat and fingers together, move the hands back and forth to the front and to the side, turning the hands over at each change of direction so that the palms always push against the water. Keep the hands slanted so that a pushing down occurs slightly at the same time. It is like smoothing down two piles of sand, one with each hand. As in all sculling, the movements should be continuous, and constant pressure should be felt against the palms of the hands.

### Legs

The leg action in treading water starts with big slow movements as though riding a very large bicycle. The legs are under the body, standing, so that one knee is bent up and the bicycle riding is begun, making large circles and pressing forward-under-back each time. Keep the pushes even so that balance can be maintained. The flat scull with the hands a little under the water's surface and the slow bicycle with the legs should hold the position of the body. The idea is to stay there with as little effort as possible, enough to hold position and keep the chin just above water, no more.

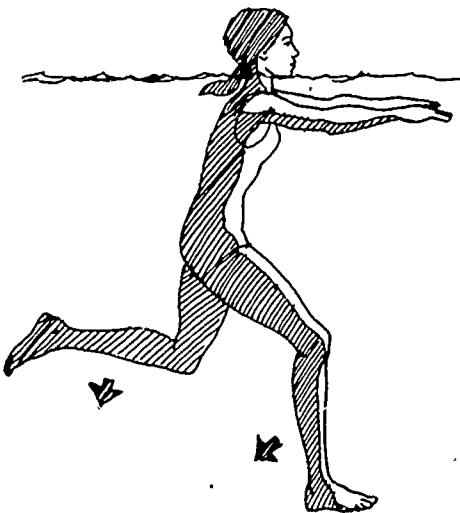

Figure 6. Treading water.

There are other ways to tread water, Later, when other types of kicks have been learned, a breast stroke kick or scissors kick combination may be used, rather than the bicycle kick.

In learning to tread, experiment with the hand scull in shallow water. See if the feet can be taken off the bottom one at a time, and support the body with the sculling alone. Go under the water and scull back up. Then try the same in water shoulder deep. Experiment with the legs by holding onto a pool wall in deep water, one hand at a time, close to the side in water that is just over the head.

If at any time it is felt that the side cannot quite be reached again, hold the breath, drop to the bottom and push to the side. The bottom will be only a few inches away. Let the knees bend after the feet touch, lean forward, and push to a front glide position. This is useful to do at any time when water is unintentionally over the head.

### SWIMMING IN DEEP WATER

Having learned to move short distances through the water on the face and back, keep practicing until two or three laps can be swum across the shallow end of a pool. If swimming at a beach, try to do approximately twenty strokes (counting arm pulls) with the freestyle or finning, without stopping to rest. Work on the treading in chin-deep water until easily done for ten seconds.

Learning the swimming skills in shallow water, the feet can now leave the bottom and move through the water well. When beginners first realize that they are "over their heads," they sometimes suddenly panic. Their muscles tense and their movements become fast and jerky because they are afraid. Always maintain control and move deliberately. Remember that if a certain distance can be swum over shallow water, the same can be done over any depth. Also remember sinking will not occur. Almost everyone balances at the surface, but sudden jerky movements will make one bob up and down in the water.

When trying to swim in deep water for the first time, swim freestyle from deep to

shallow water along the side of the pool, then from shallow to deep. If possible, try not to stop and rest along the way. If tired, try turning over to float, or change to finning and kicking to catch the breath. Sometimes people find that swimming on their backs is easier, others like it better on the face. You should do whichever is easier the first time an attempt to move in deep water is made. When relaxed and at ease with swimming one length of the pool, begin to slow down halfway, and try treading water for a short time before resuming the swim. This will give practice in controlling the body's position, will strengthen treading, and develop the skill of leveling off to swim again, all without touching the side.

If outdoors, at a lake or bay, find something nearby which can be swum to for a first deep water swimming. There may be life lines around the area, or someone who swims well or who knows safety skills can swim along side. When it is known that someone is right there, it gives confidence to try it for the first time even though help probably won't be necessary.

### GETTING INTO THE WATER

Learning to jump or dive into the water is a separate part of learning to swim. It is a quick, explosive way to get into water.

#### Jumping

Jumping in is the easiest way to start since the body does not turn over on the way to the water. If starting above water where the bottom can just be touched, step off the side, reaching out with one foot, and keep the head erect so the eyes can look straight ahead. Try to put the feet together quickly, keep the arms close to the sides, and hold the breath. While going through the water, be ready to have the feet touch the bottom. Relax the knees a little, just as if jumping down from a bench on land. This will make the head go underwater entirely; then straighten the knees and the body will be standing with the head above water. When accustomed to this, try leaning forward after the bottom has been touched, pushing forward with the arms ahead. This will permit a glide forward to the surface just as when beginning to swim. It is called

"leveling off," and means that in shoulder-deep water, it is easy to jump in and proceed to swim.

It is very important to jump into deep water. Jumping into waist-deep water or less means landing too hard or failing to bend the knees soon enough, the impact on the bottom may injure the ankles, knees, or back. Jumping into water over the head is safer. The bottom can still be reached and a push off to the top can still be attained in water which is slightly over the head. In water several feet over the head, kicking a little after a downward momentum has been lost or the use of arms to push toward the top may be desired. If the body easily floats it will easily float to the top.

#### Diving

Diving, or getting into the water head first, comes next. This skill is important for gaining more distance if swimming for speed later, for learning to go deeper into the water, or for spring board diving.

To dive, turn yourself over halfway when pushing from the side, so that the body goes into the water hands first. When completely under, lifting the head and arms will bring the body to the surface. To learn to turn over easily, start sitting on the side, or kneeling on one knee. Bend forward as far as possible without falling in, with the arms in front and together, the ears between the arms. The head should be down, the chin up enough to see the water below and to see the fingertips aiming a foot or two away from the side (see Figure 7). From this posi-

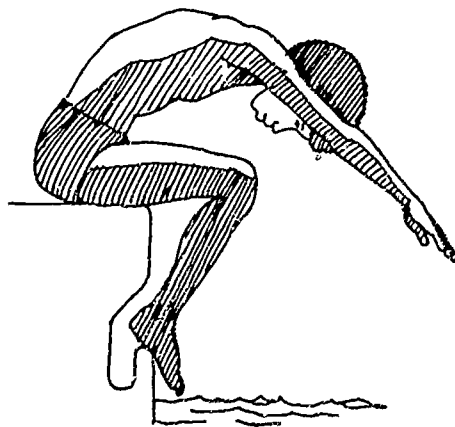
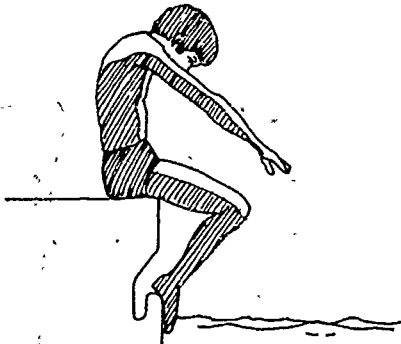
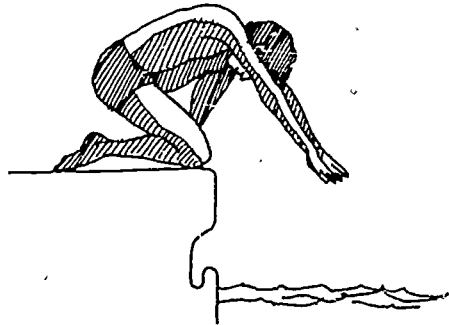

Figure 7. A beginning dive.





a. Step 1—sit.



b. Step 2—one knee.

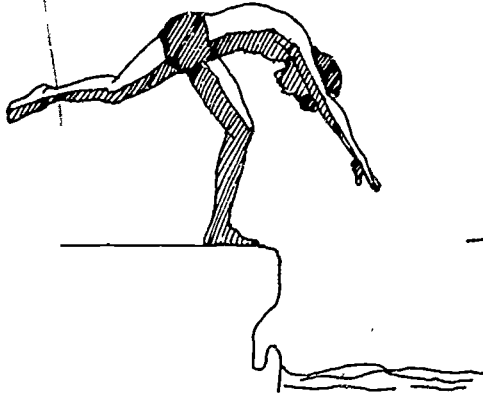

c. Step 3—tip-in.

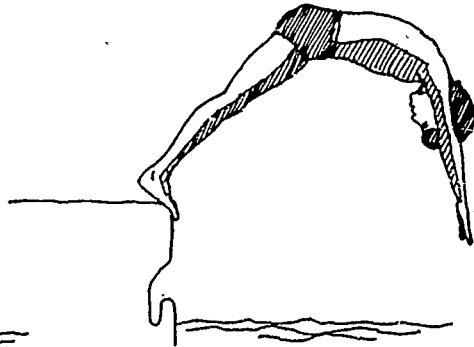

d. Step 4—fall-in.

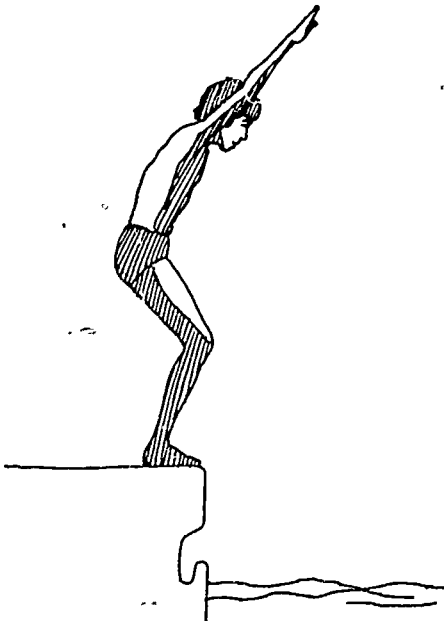

e. Step 5—small spring.

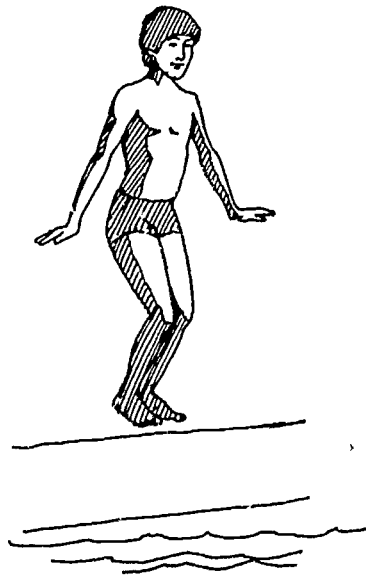

f. Step 6—spring, arm coordination.

Figure 8. Learning to dive.

tion, roll in, trying to keep the hands aimed just where they are, follow the line into the water, unrolling the body as it falls.

It will be discovered that it is natural to hold the breath while going in. If water is felt going "up the nose," try blowing out a little as the body rises toward the surface. Pressure may also be felt around the head as the body goes deeper, perhaps against the ears or nose. This is a normal occurrence as one goes below the surface of water. Blowing out when underwater relieves the pressure, but most people get used to the feeling and realize that it creates no harm. If actual pain is felt, check with the instructor for procedures which help alleviate the pain for pressure-sensitive people.

When the rolling-in dive is comfortable and successful, do the same thing from higher positions with one foot back, knees partially bent, knees straight, body bent over, and finally, standing up with a push from the feet into a forward arc (see Figure 8). Always follow the first instructions concerning keeping the head right between the arms, arms straight with hands together, and aiming for the entry. Experiment with how hard to make the push, where to look for the entry point, and the place at which to be straight and holding for a nice entry.

Some people find it very unsettling to be upside down, so here are some things to try beforehand. Learn to do a handstand on the grass, or in a gym. Possibly with a buddy, try this in shallow water, with the hands on the bottom. See if a little distance can be swum, then take a breath, duck the head, bend in the middle and try to touch bottom right below the body. This is the beginning of learning the "surface dive," which is the same as a dive from the side only it starts on the surface of the water. The surface dive is the way to get underwater quickly, for swimming underwater, or for finding something dropped on the bottom. Figure 9 illustrates the sequence of movements involved in a surface dive.

### INTERMEDIATE SWIMMING

As an intermediate swimmer five basic strokes should be performed reasonably

well. These are the elementary backstroke, freestyle, backstroke, breast stroke, and sidestroke. The swimmer should be completely at home in deep water, both above and below the surface of the water, and should be able to swim longer distances.

#### Backstroke (Back Crawl)

The simplest of the three new strokes is the backstroke, sometimes called back crawl. It is similar to the freestyle only it is done while lying on the back. The body is flat on the water and the legs move up and down in a flutter kick. Arms alternate in pushing the water from overhead to the sides of the body and recovering over the water to push again from overhead. Figure 10 shows the sequence of movements involved in the backstroke.

#### Kick

The legs move up and down past each other so that there is about 12 inches between the foot breaking the surface and the one below. In the movement of each leg the knees bend a little to finish the downward movement of the foot, then straighten on the way to the surface. The feet are relaxed on the down phase, extended on the upward phase. This extension of the feet is mostly a passive action—it just happens due to the pressure on the instep. The knees should not break the surface, the hips should stay as close to the surface as possible throughout. Kick timing is steady and continuous, with more force in the upward direction than the downward.

#### Arms

As in the freestyle, the arms move in opposition to each other. One pushes water from the overhead position to the side while the other recovers above the water to return to the overhead position. Taking the action of one arm alone, the arm is placed overhead on the water with the little finger contacting the water first (palm turned outward). This straight arm drops beneath the surface as the hand is pressed against to begin a push. Allow the arm to drop under a few inches, then direct the push toward the feet. The hand, as it passes the shoulder, should move strongly. Ideally the

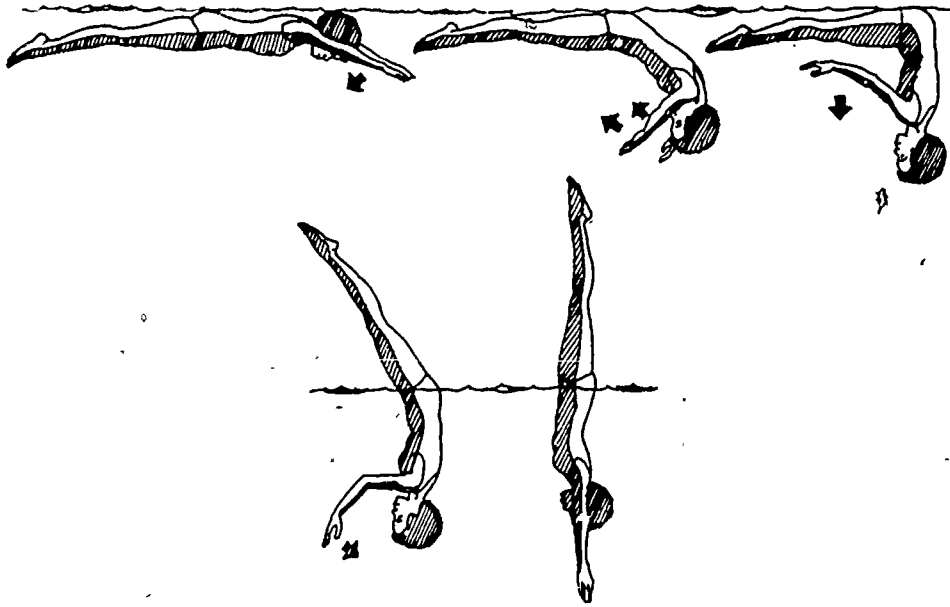

a. Pike position.

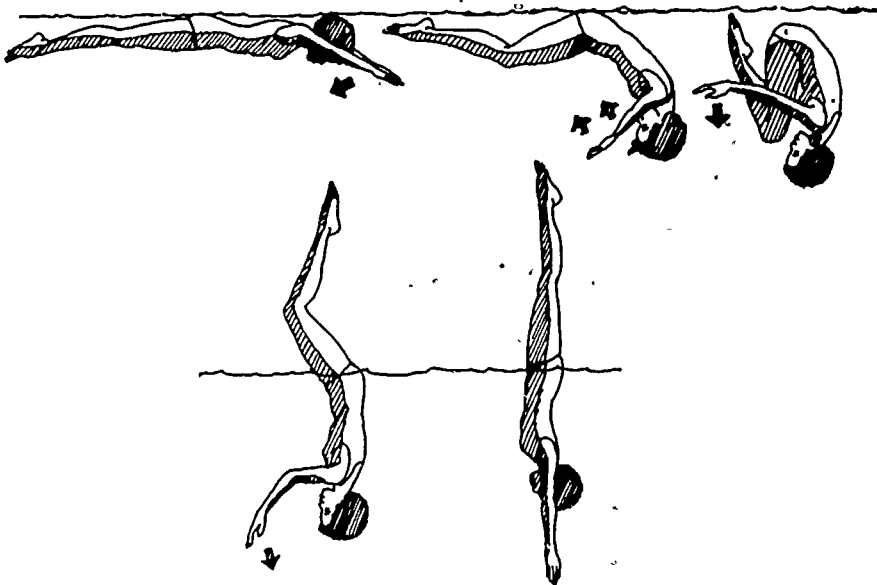

b. Tuck position.

Figure 9. Surface dives.

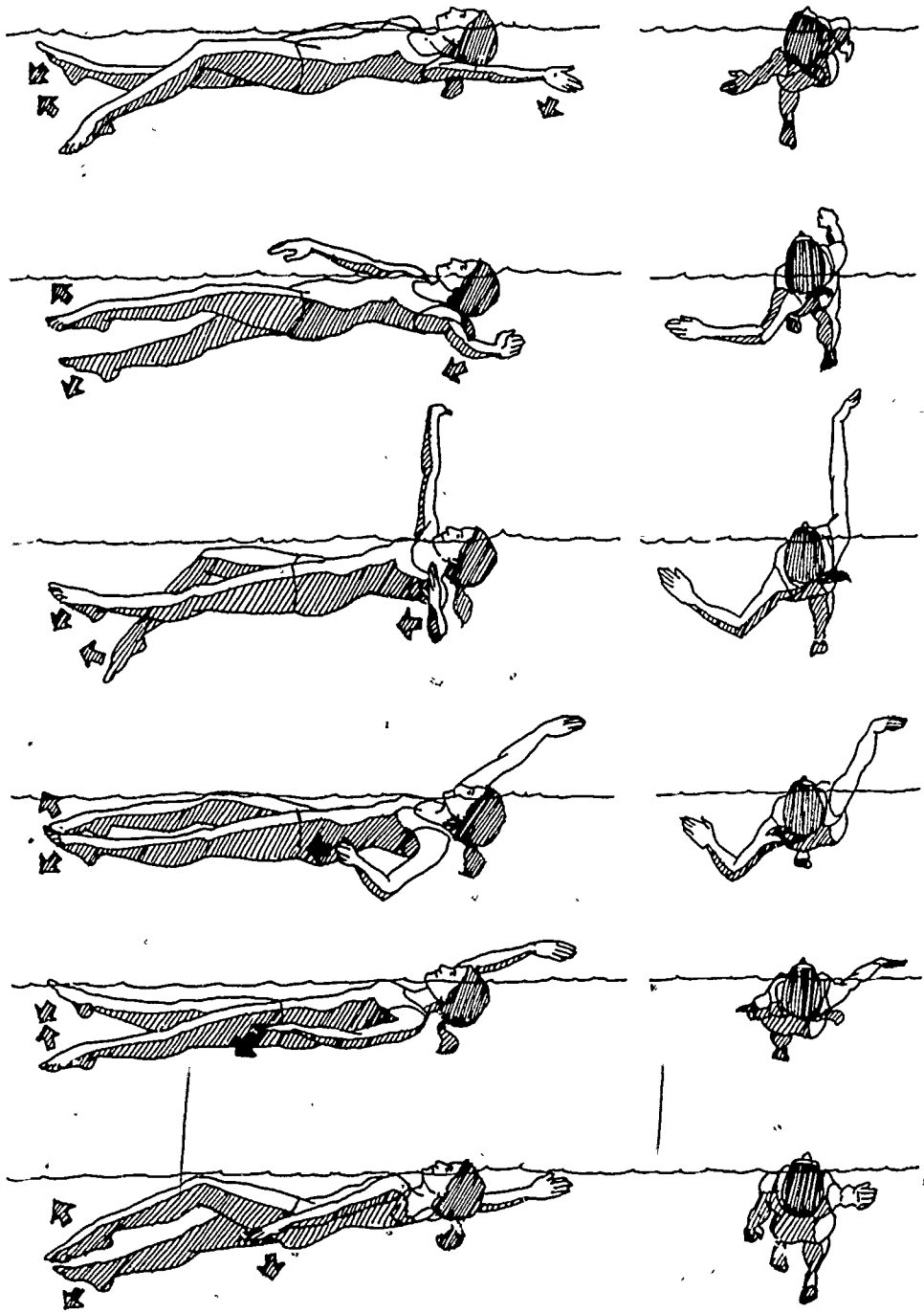

293

Figure 10. The back crawl stroke.

elbow bends as the hand pushes its strongest. This bend is not a collapse, but a firm position against which the forearm can move rapidly to the finish at the side with the arm straight again. Let the body roll slightly toward the side of the pushing arm. This will make the push stronger, and help the recovering arm clear the water on the other side. The recovery of the arm is an easy lift of the whole arm, straight but not tense, up and back to drop easily into the water again.

#### *Together*

Arm actions are continuous, one arm always exactly opposite the other. Attention to this oppositional timing, that is, never letting one arm begin to "catch up" with the other, makes a cross-balance of power from one arm to the other and makes a smooth backstroke. The rapidity of kicking depends upon the individual swimmer. Most swimmers do about three kicks per arm push.

### Intermediate Freestyle

As the freestyle learned as a beginner is worked on, begin to learn these more advanced details.

#### *Arms*

At the start of the stroke, let the arm drop underwater a little. Then by pressing with the palm and bending the elbow a little and holding the bend firmly, push the water down the center of the body toward the feet. As the hand passes under the body it will finish pushing at the thigh. At this point lift the shoulder and elbow, and swing the arm forward out of the water to drop forward for the next stroke. On this swing forward lift the elbow fairly high, relax the forearm and hand underneath. This arm recovery should be as easy as possible, not tense and tight. Hands are firm and flat on the push underwater (not "cupped"), and completely relaxed on the recovery.

One arm is pushing underwater while the other is recovering over the water. Timing is best if one arm is exactly opposite the other in a continuous motion, just as in the backstroke. One arm pushing helps the other to recover. An easy body roll toward

the underwater arm helps in the strength and balance of the stroke.

#### *Breathing and Arms*

For breathing the head rolls to one side with the chin up a little and the ear underwater. The intake is quick, through the mouth. The head is then turned back into the water and air is blown from the mouth. If possible, allow the head to return a little past the midpoint. Keep the chin up slightly so the water contacts the head at the hairline.

To synchronize the breathing with the arms, turn and breathe in on the "open side"; that is, when the arm on that side is back, ready to come forward, then the head will be moving back into the water as that same arm finishes moving forward. Practice putting the breathing together with the arms for every stroke. Find what seems to be a natural side for breathing and practice this until it is easy. Then try the other side, and ability to breathe alternately (every third arm pull) should eventually be developed.

#### *Tips and Cautions*

The head position is very important. If the chin is too low discomfort will result from water getting up the nose. To check this, be sure to keep a generous open space between the chin and the neck at all times. Do not look at the bottom when the face is in the water, but see the hands as they enter the water ahead of the body. A big breath is not necessary. A swimmer can become quite breathless by taking in too much air and then not having time to blow it all out. Take a small breath—the face will be above water again very soon—then blow out firmly just the amount taken in. If swimming is kept easy and fairly slow, the swimmer can "pay as he goes" and will not be out of breath as the strength to cover more distance is developed.

#### *Kick*

The kicking movement is a total leg action all the way from the hips in the up-and-down flutter kick. The knees bend downward slightly at the start and straighten on the upbeat. The ankles remain relaxed all the time; they will move

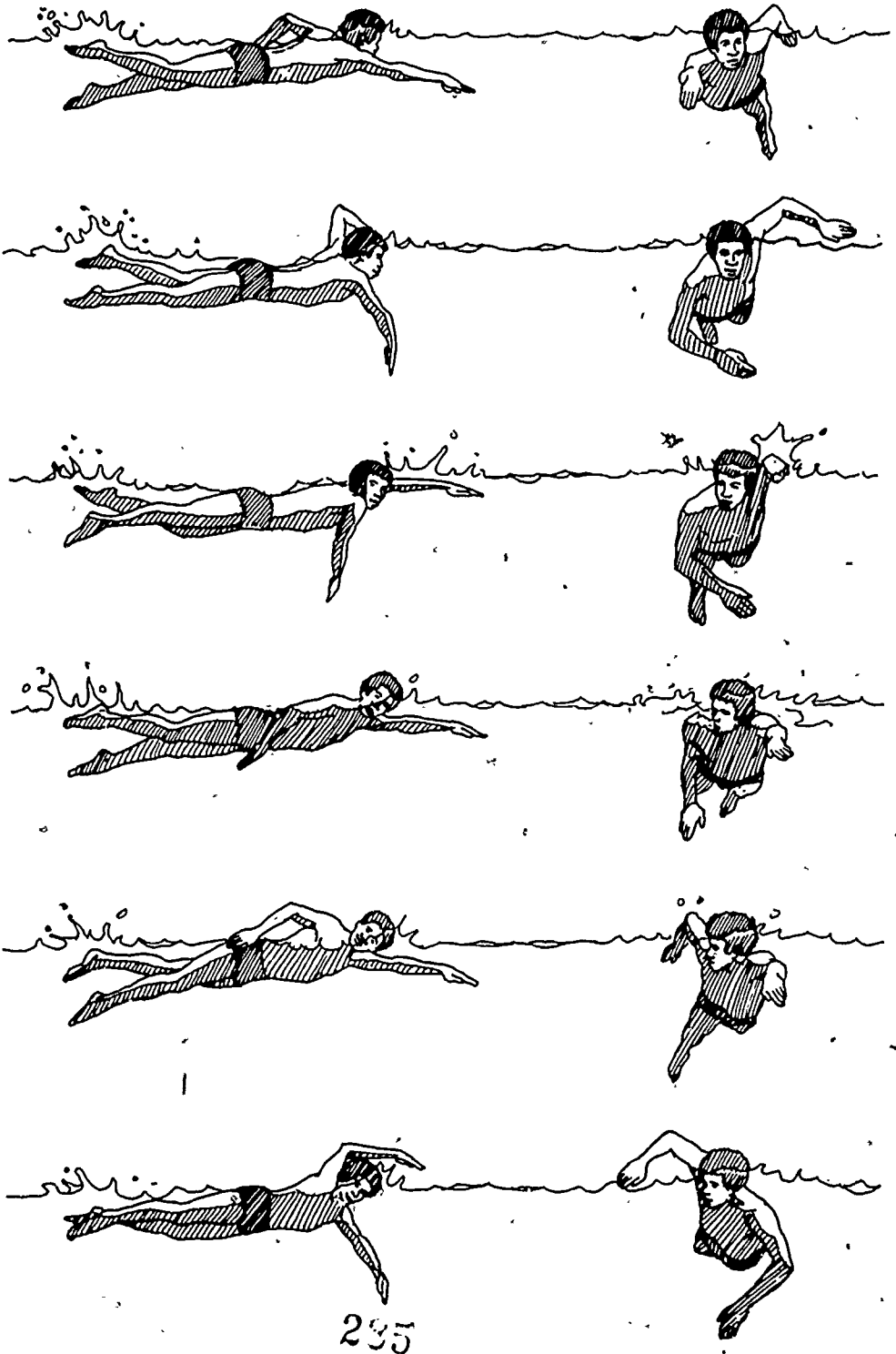

235

Figure 11. The front crawl.

because the water pushes against them and should just flap. The relaxed feet should just break the surface of the water. This steady alternating kick is best at about three kicks per arm push, but there is no rule. It is good to practice at about three per arm to develop a 'steady kick at about the right depth. Then what seems to provide the best balance in the stroke can be determined. See Figure 11 for the sequence of movements involved in the front crawl.

### Breast Stroke

In the breast stroke a swimmer moves in the prone position alternating arm pulls with leg kicks and holding a glide at the end of each whole stroke.

#### Arms

From a front lying position, with arms forward in the water and head in the water, press the arms in a sideward-downward direction in a small stroke. Before the arms reach halfway to the sides (still in a forward "Y" position), the head lifts and a breath is taken in; the elbows drop down, and the hands slide together under the chin. Then the head is returned to the water; the arms straighten ahead and together and are held forward for the glide. Breath is blown out during the glide and the first part of the pull.

#### Legs

The legs are straight and together at the beginning. The kick pattern is the same as for the elementary backstroke. First the knees bend easily with the legs slightly apart. Do not "turn out" the knees, but point them down to the bottom and bring the heels close the body. This is a slow easy action. The feet and ankles, relaxed to this point, make a quick movement to a flat-foot position (dorsal flexion), then immediately press slightly outward and backward in a small moving circle, straightening and stretching the knees together at the finish and pointing the toes. In the kick as a whole, the knee bending is a sneaking up; the dorsal flexion action of the feet is short and quick; the leg press into the stretched position is strong. The first part, then, is recovery; the second part is a power phase,

or propulsion. The timing of the kick is ONE—bending knees followed by picking up the feet; TWO—press around and back and together.

#### Together

Arms start by pressing; arms and legs recover at the same time, legs press as arms reach into the stretch position. Hold the glide a second before starting the next stroke (see Figure 12).

#### Tips

There are refinements made as the swimmer progresses in learning the breast stroke. The palms of the hands press back as soon as possible within the arm stroke, not sideward. The elbows are held in a slightly bent position on the press, and should be under the shoulders. The intake of air should be briefly done toward the end of the arm pull but before the forward reach. The timing of the kick in relation to the arms should give a feeling of kicking into the stretched position of the whole body.

In the kick, the action of the ankles is extremely important. The flat feet must be pushing into extension throughout the power phase of the kick, ending in the pointed toe position. If it is being done well, water will press on the palms and on the soles of the feet. Be sure that both feet are doing the same thing at the same time. The stroke will feel like ARMS . . . LEGS . . . GLIDE . . . (holding both steady).

The breast stroke is thus intermittent with a rest after each stroke. It can be seen that this can be a good stroke for resting, even though it can be accelerated for racing.

### Sidestroke

This, along with the breast stroke, is one of the oldest swimming strokes and although it may seem old-fashioned, it is extremely useful as a resting stroke, for strengthening the kick for water treading, for lifesaving carries, and for synchronized swimming.

The starting position is lying on the side with legs stretched and together. The arm on the lower side reaches straight overhead on the surface, and the other is straight along the side of the body. The head is lying on the water so that one ear is underwater.

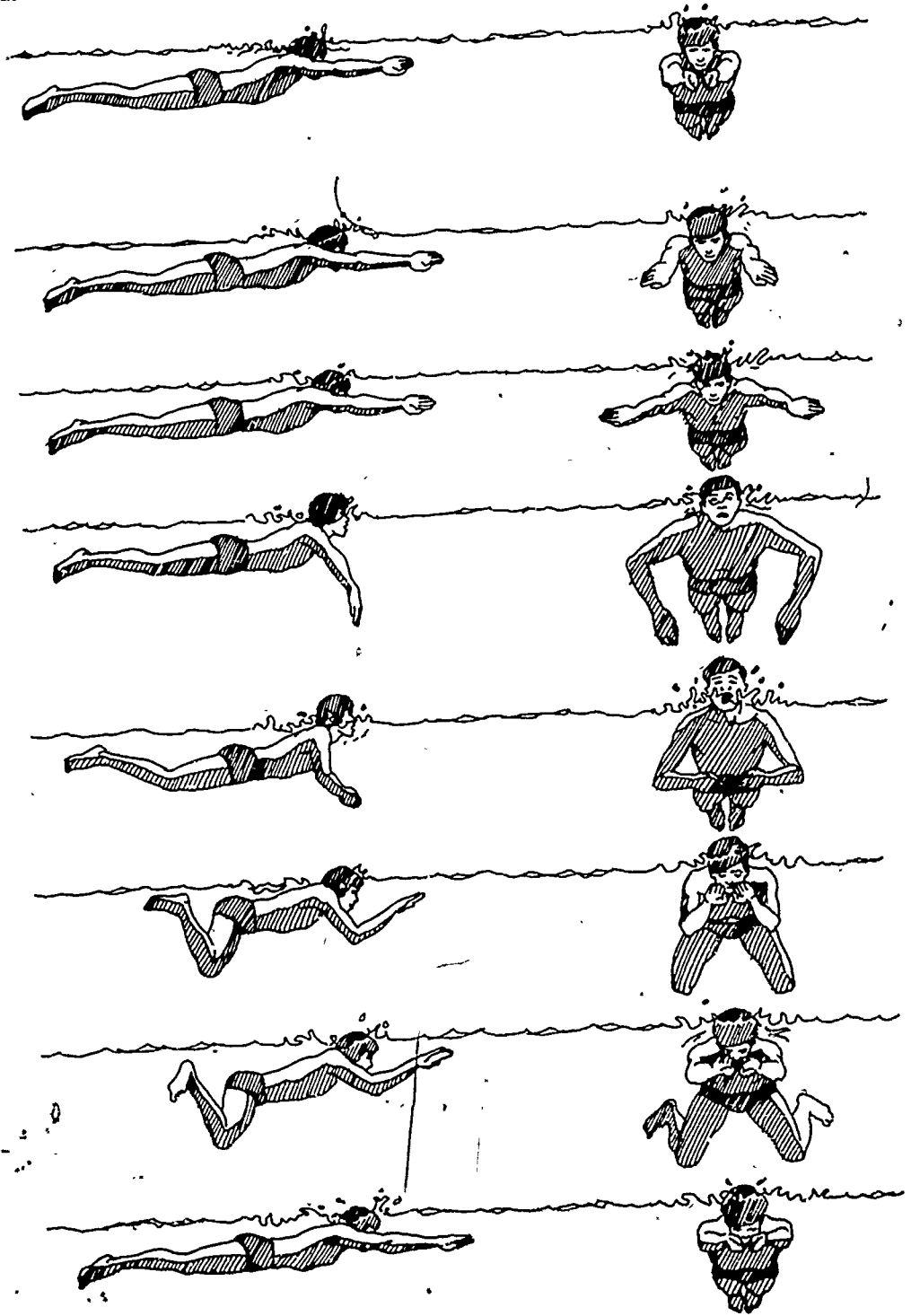

Figure 12. The breast stroke.



Turn the head slightly toward the back so that the face is clear. In the process of the stroke the body should remain on the side and in a straight line.

### Legs

The kick provides the power in this stroke, as it does in the breast stroke. The arms contribute, but more to balance than to power, and the timing of the two with each other is important.

From the extended position, bend the knees together, pulling them up into a half-tucked position. Then reach forward with one foot and backward with the other, keeping both just under the surface. This is done in a sweeping rounded action, keeping the backward foot pointed and the forward foot flat (dorsal flexion), at the start of the push, and both feet pointed at the end. The strong circular sweep is parallel to the surface in a scissor action (hence called a scissors kick), and finishes as the legs meet again in a stretched position. The leg moving forward should be the one nearest the surface of the water. The swimmer may feel as though he/she is reaching in a big step forward with one leg, and at the same time reaching back with the other one. The timing of the kick is: **ONE**—easy tucking up of legs together; **TWO**—reach up-out-around in one big motion to finish back in the stretched position; **THREE**—hold this stretch for a second (glide).

### Arms

The arm which is stretched overhead pushes diagonally down toward the body, pushing the water toward the feet. Then it bends and slips back to the overhead stretch. At the same time, the arm at the side sneaks up close to the body to a position in front of the face, then pushes out and down to return to the side. The timing of the arms with each other is like the dog paddle, one and then the other, each pushing in, turn toward the feet and then holding the stretch for a glide.

### Together (see Figure 13)

First push diagonally down with the overhead arm. Bend knees and sneak up with the arm at the side as the first arm begins its recovery. Reach out and push

with the kick as the second arm pushes back to the side.

This means that the arms and the legs finish in the glide position at the same time and then return to the starting position. The total stroke timing is really the same as in the breast stroke. The sidestroke can be thought of as an adaptation of the breast stroke, now turned onto the side.

## GOING ON . . .

Skill in swimming develops as it is done for longer periods of time over longer distances. Long-distance swimming means doing strokes over and over many times. A swimmer will tire easily if there are faults in the strokes. Try to analyze the stroke as it is performed. Have someone watch and examine the stroke as it is being performed.

The method of breathing is very important, especially in the freestyle and breast strokes. In all strokes, use little energy in the recovery parts of the strokes. Try to relax muscles on the recovering body parts, and add strength to those pushing against the water. Pushes must be smooth and steady, remembering the nature of water, directed always toward the feet with little force to the side or up and down. Keep the main part of the body flat in the water.

As longer distances are attempted, budget strength evenly over the distance. Don't swim too hard and fast the first part of the swim. Whatever the distance, finish breathing easily, not out of breath. This is learning "pace," the ability to distribute strength and energy steadily and evenly for the distance swum.

All information needed to continue into specialized aquatics has been previously discussed. There are many interesting choices, opening a world of interesting experiences.

*Safety Training and Certification:* training in personal safety, lifesaving, and rescue.

*Competitive Swimming:* adding butterfly stroke, racing starts and turns, work on stroke mechanics and strength for speed and endurance.

*Spring Board Diving:* learning control of a spring board in combination with turns in the air in various directions.

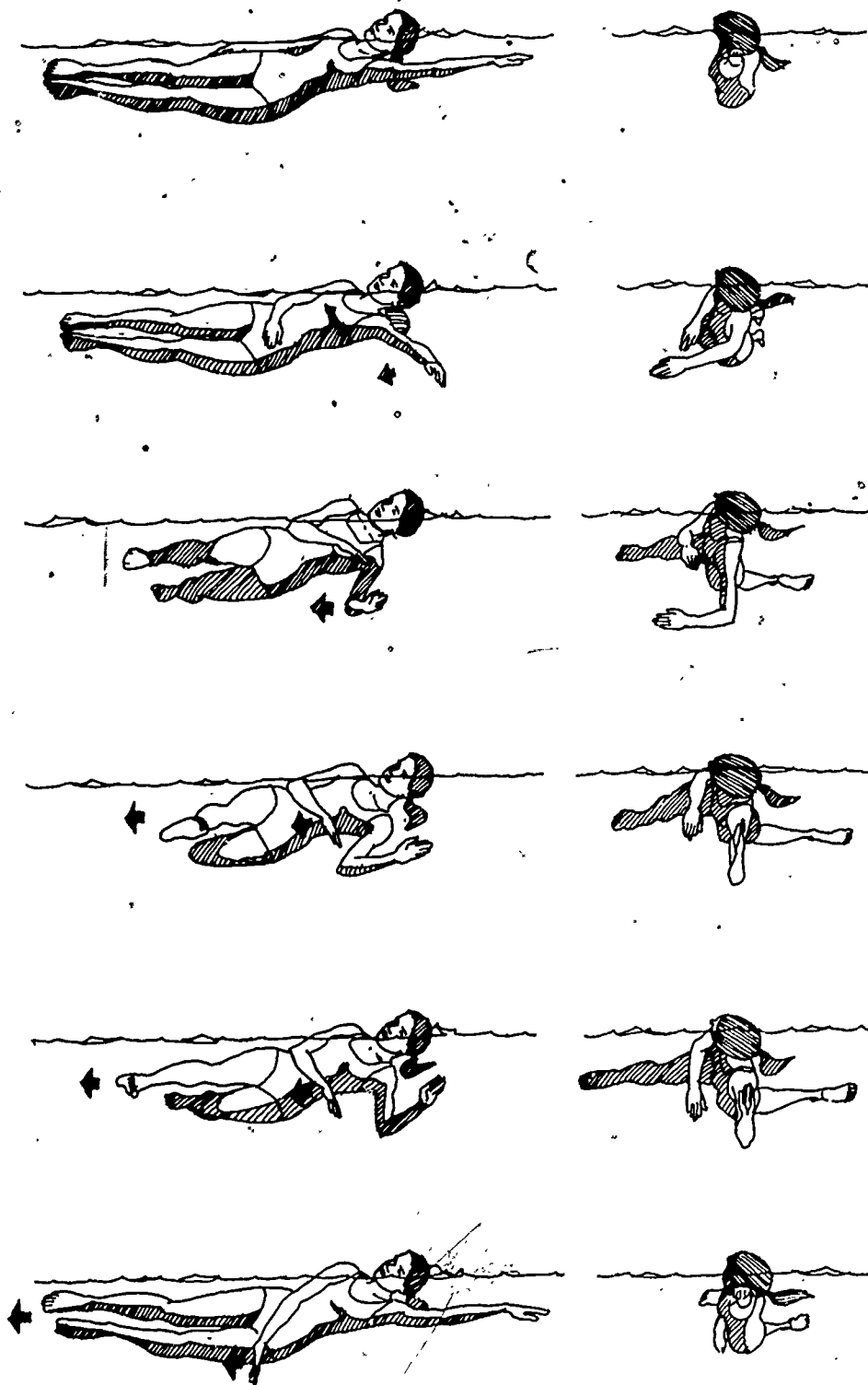

Figure 13. The sidestroke.

*Synchronized Swimming*: combining swimming skills with music including stunts and figures on and underwater.

*SCUBA*: learning to make use of underwater breathing apparatus for underwater sport, exploration, and salvage.

*Water Polo*: swimming skills put into a ball handling team sport.

There are also many related activities to choose from around water such as canoeing, sailing, rowing, water skiing, and motor boating.

### SAFETY

Swimming is not dangerous in itself, and following common sense rules keeps it safe. Disregarding safety rules, however, can cause accidents. One has to respect the power of wind, waves, and weather.

### COMMON SENSE

1. Always swim with someone else, never alone.
2. Swim in a safe place, ideally with lifeguards present.
3. Before entering the water, find out how deep the water is, what sort of bottom there is, and how much space can be used before the depth is over the head.
4. Be careful if it is quite cold. You can tire more easily in cold water.
5. Note if there are any special rules posted, and follow them.
6. For diving, be sure the water is over the head (or twice the height if diving from a low board).
7. Never dive without knowing the nature and depth of the bottom.
8. In open water (lakes, oceans, bays) swim parallel to shore for practice, not away from shore.

### TERMINOLOGY

**Buoyancy.** The amount of floating possibility each person has. Actually it is the amount of water volume that will hold the swimmer up: your "floatability."

**Propulsion.** In swimming strokes, the part of the movement of arms or legs which makes the body move through water; the push against the water.

**Recovery.** In swimming strokes, the part of the movement of arms or legs back to a good pushing position again. The recovery is the movement from the end of one push back to where push can begin again.

**Resistance.** The pressure of water against the body when moving. This is felt against arms or legs when pushing or kicking against water (propulsive phase of movement), and holds one back when feeling this pressure in the recovery parts of strokes. A streamlined body position creates the least resistance to movement as a whole. Well-directed stroke movements with as little resistance as possible in the recovery parts make for the most effortless swimming.

### REFERENCES

- Armbruster, David A., Allen, Robert H., and Billingsly, Robert S. *Swimming and Diving*, 6th ed. St. Louis, MO: C.V. Mosby Company, 1973.
- Counsilman, James. *The Science of Swimming*. Englewood Cliffs, NJ: Prentice-Hall Inc., 1968.
- Harris, Marjorie M. *Basic Swimming Analyzed*. Boston, MA: Allyn and Bacon, Inc., 1969.
- Midtlyng, Joanna. *Swimming*. Philadelphia, PA: W.B. Saunders Company, 1974.
- Sports Illustrated Book of Swimming*. New York: J. B. Lippincott Company, 1961.
- Swimming and Water Safety*, Washington, DC: American National Red Cross, 1968.

checking (p. 298)  
circle, dive, or fall shot (p. 292)  
corner throw (p. 295)  
fast break (p. 296)  
free throw (p. 295)  
free throw line (p. 293)  
goal area (p. 292)  
goalie (p. 301)  
goal throw (p. 295)  
jump shot (p. 290)  
penalty line (p. 293)  
penalty shot (p. 292)  
set shot (p. 292)  
2:4 offensive formation (p. 297)  
3:3 offensive formation (p. 297)  
throw-in (p. 295)  
wing shot (p. 292)

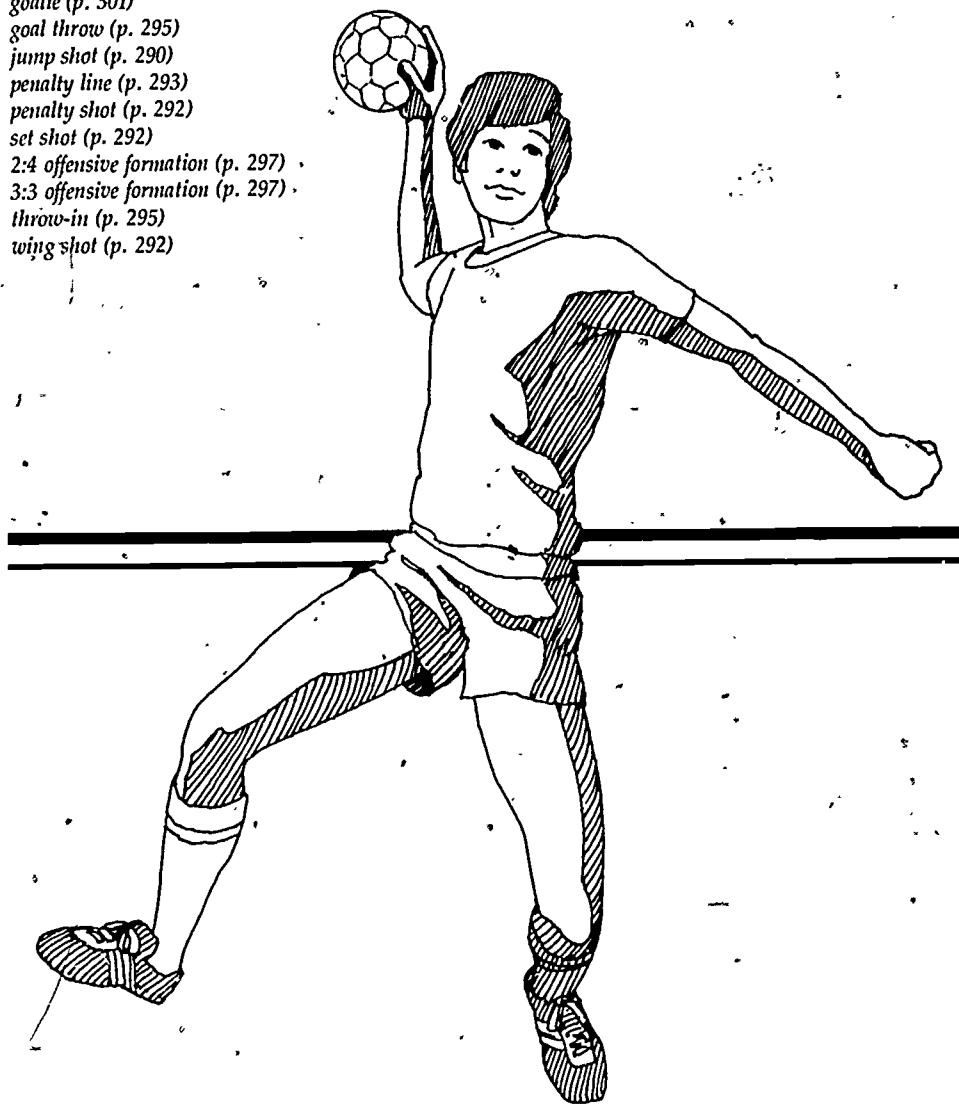

# Team Handball

MIKE CAVANAUGH,  
*United States Team Handball Federation,  
 Short Hills, NY*

## INTRODUCTION

Team handball is a new sport emerging on the American scene that involves continuous play, high scoring, body contact and graceful, skilled movements by the players. It is a permanent Olympic event for both men and women. The game has been described as ice hockey without the ice and sticks, and as water polo without the water. It also combines skills, rules, and strategy that are common to basketball and soccer. Yet, in spite of this seeming blend of many different sports, team handball retains a unique nature that makes it attractive to players and spectators of all ages.

In Europe, where team handball began, the game is referred to only as "handball." However, for most of America the name "handball" brings to mind a game using a little black ball played within a small enclosed, four-walled room. Thus, in America, we use the name team handball to distinguish a game involving 14 players, including two goalies, who, on a court larger than a basketball court, attempt to score by throwing a ball into a goal.

Germany, Czechoslovakia, and Denmark claim responsibility for the development of games that closely resemble team handball. The game originally was played during the early 1900s, on a large outdoor field, and involved as many as 22 players (11 per team) at one time. Gradually, team handball evolved into its present-day accepted form of 7 players per side, predominantly played on an indoor court, the size of which resembles a court somewhat larger than a basketball court. In 1946 the International Handball Federation (IHF) was formed and the rules of team handball were formalized. Today there are over 65 nations affiliated with the IHF. The United

States Team Handball Federation (USTHF) was formed in 1959 marking the beginning of modern team handball in the U.S.

In 1972, team handball for men was included in the Munich Olympic Games. Four years later in 1976, the Montreal Olympic Games saw the addition of women's team handball. The U.S. Men's National Team qualified and competed in both the 1972 and 1976 Olympic Games. Team handball is now a permanent Olympic event for both men and women. There are ongoing team handball programs at numerous high schools, junior high schools, and elementary schools throughout the United States. Our success in future Olympic competition will depend upon the success and exposure team handball will enjoy through these various grassroot programs.

While on offense the idea of team handball is to throw a ball past a defense and a goalie, into a goal. While on defense, the idea is to defend one's own goal from the attack of the opponent. There are markings on the court that restrict play in the goal area and therefore influence offensive and defensive movement. Offensively, the ball is moved primarily by passing, though a player is allowed to dribble freely, run three steps with the ball, and may hold the ball for three seconds. While defensive "checking" and the use of the body to obstruct an opponent are permitted, there are rules restricting contact and unnecessary rough play, making the game sensible and safe for players.

## SKILLS AND TECHNIQUES

### PASSING, CATCHING, DRIBBLING

Team handball is primarily a passing game. A variety of passes can be used effec-

tively depending on the game situation. The primary pass is the shoulder pass with either an overhand or sidearm delivery. Bounce passes, wrist passes, lob passes, and shovel passes are all effective team handball passes. Timing, accuracy, and deception are all elements of a good pass. To catch a team handball, two hands are used to both secure possession and cushion the arrival of the ball. To ensure proper handling of the ball it should be caught away from the body. Dribbling is a necessary skill but, again, should not be emphasized in play. Players should practice dribbling at full running speed to simulate fast break situations. Normal offensive movements require infrequent dribbling but during fast breaks the dribbling skill becomes very important.

### SHOOTING

The basic concept of the game is to throw or shoot the ball into the goal. The most effective shots are taken while moving toward the goal. To become an effective shooter one must develop a quick release, accuracy with corners of the goal, and the ability to know when to shoot. By knowing when to shoot, a player will know not to shoot with a defender directly in front of him/her when he/she is too far away, or at an extreme angle from the goal. Remember that the defensive opponent must first be beaten and then you must also beat the goalie. The true essence of the game is a shooter waiting until the last possible second, reading the goalie's position, before taking the shot; the goalie must then react to the shot that has been taken.

#### Types of Shots

##### Set Shot

Form for a set shot is similar to a baseball throw. It may be taken overhand or sidearm; it is bounced or shot directly at the goal.

##### Jump Shot

In this shot the player attempts to jump in the air and throw over the defensive players. The ball is thrown while in the air and usually involves the use of three full steps to execute. Jump shooters land on the same leg from which they initiated the jump.



Figure 1. The overhand set shot.



Figure 2. The sidearm set shot.

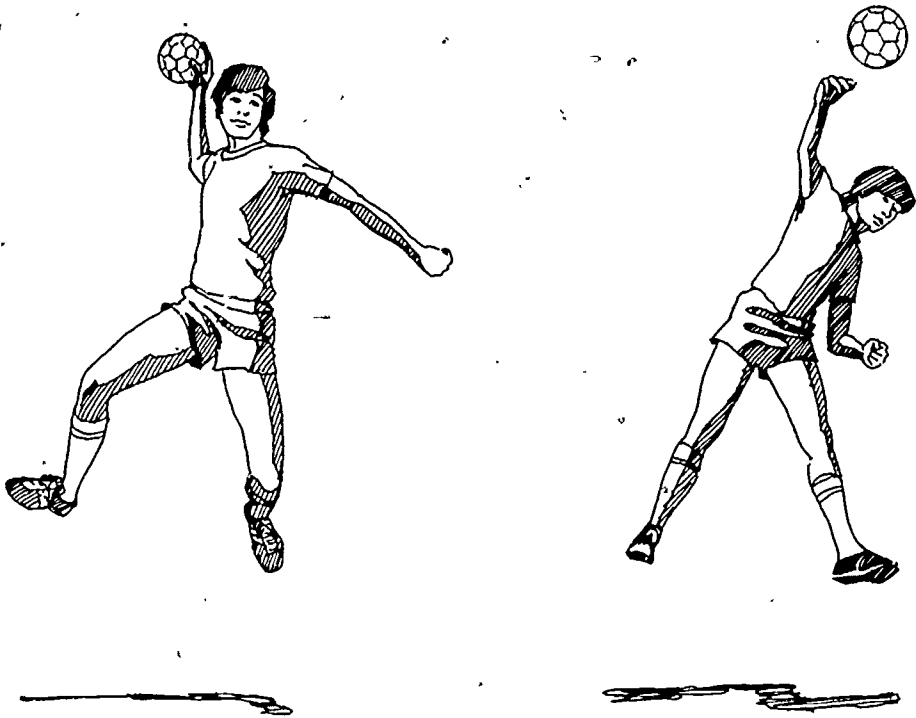

Figure 3. The jump shot.



Figure 4. The circle, dive, or fall shot.

*Circle, Dive or Fall Shot*

This is a specialty shot usually taken from the 6-meter line. Upon receiving the ball the player attempts to dive or fall into the circle (goal area) and shoots while in the air. Upon completing the shot, players normally break their fall with their hands and a chest slide or by a modified shoulder roll.

*Wing Shot*

Taken from the wing position this specialty shot is actually a combination jump shot and dive shot. Because of the extreme angle that the wing player is in relation to the goal, an attempt must be made to jump into the goal area and improve the shooting

angle. Recovery for the wing shooter is similar to the recovery for the dive shot.

*Penalty Shot*

Taken at the 7-meter mark, this specialty shot is actually a combination set shot and dive shot.

**BASIC RULES**

Diagrams 1 and 2 are examples of a team handball court. Diagram 1 supplies the measurements of the court, while Diagram 2 shows the names of the various lines on the court. It is important to note that in Diagram 2 the area enclosed by the 6-meter line, or goal area line, has been shaded.

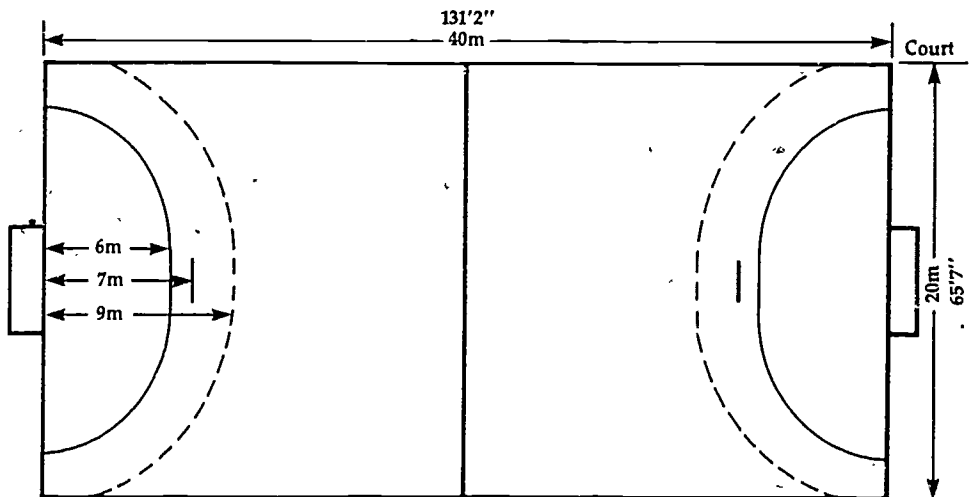

Diagram 1.

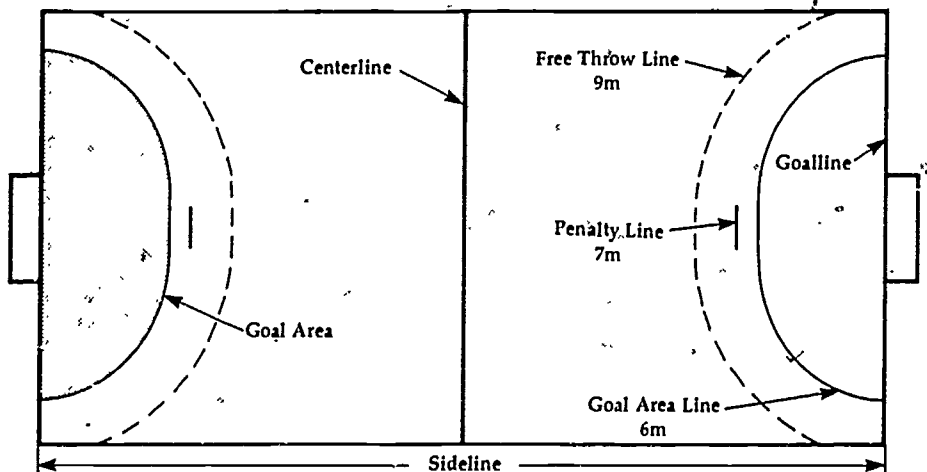

Diagram 2.



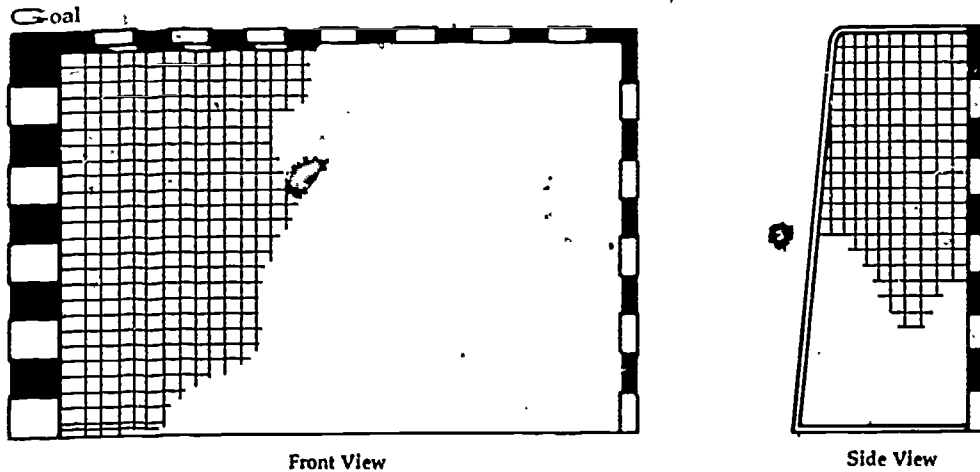

Diagram 3. Regulation goal.

Goalie is allowed to stand inside the goal area. However, both offensive and defensive players have "air space rights" inside the goal area. While trying to throw the ball into the goal, offensive players may jump into the goal area, as long as their take-off was from outside the goal area and they release the ball before landing in the goal area. Likewise, the defensive player may jump into the goal area in an attempt to block a shot on goal, but may not touch the ball while in contact with the goal area. Once play is completed in the goal area, players entering must exit by the shortest possible route. The goal area is usually referred to as the circle or circle area. The 9-meter line, or free throw line, is used when minor penalties are given in the game. The 7-meter line, or penalty line, is used when major penalties are given. It is important to note that a team handball court can be adapted to a smaller area other than the regulation 20 × 40 meters, but that the width of the court is more important than the length.

Diagram 3 is an example of a regulation goal. Goals are 2 × 3 meters in measurement, painted in contrasting colors, and provided with a net. They are usually made of wood or metal tubing.

### BALL

The ball used in team handball looks like a small soccer ball. Men use a ball that

weighs 15 to 17 ounces and measures nearly 24 inches in circumference. Women and youth use a smaller ball that is lighter (12 to 14 ounces) and smaller (nearly 22 inches in circumference). There is an even smaller ball used for elementary children in a game called mini-handball. While common playground balls are used to play team handball the size and dribbling nature of a rubber bladder, leather-covered regulation team handball is recommended for play

### DURATION OF THE GAME

There are no time-outs in team handball. Men play two 30-minute halves with a 10-minute intermission, while women and juniors play two 25-minute halves. For tournaments and for youth teams, playing time is often modified to meet the needs of participants.

### PLAYERS

Internationally, a team is allowed a total of twelve members. A playing team consists of seven players, six court players, and one goalie; there are five substitute players who may enter the game at any time from an area called the substitution area, located usually between the bench and the timekeeper. Diagram 4 illustrates a commonly-used offensive formation with the names of each position played.

It is helpful if both the right wing and right backcourt throw with the left hand,

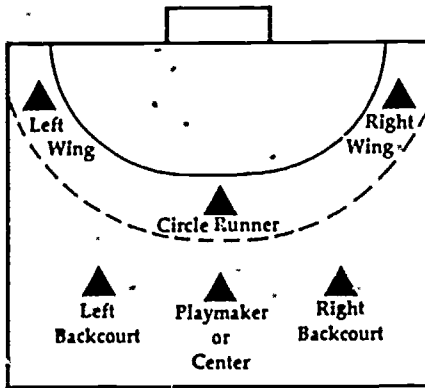

Diagram 4.

and if both left wing and left backcourt throw with the right hand, so that they may have the best possible throwing angle on the goal.

**STARTING THE GAME**

Diagram 5 shows the formation used to begin a game. A coin flip determines who will first have possession of the ball. The game starts with the official's whistle and throw-on. A throw-on consists of a simple pass to a teammate at the centerline. This procedure is repeated after each goal is scored. Diagram 5 shows a throw-on, A starts the game with a pass to B.

**GOAL AREA**

The area inside the 6-meter line is called the goal area. We have said that only the goalie is allowed to stand inside this area. If, while scoring a goal, the offensive player steps inside the goal area or steps on any part of the 6-meter line, the goal does not count and a line violation occurs. The player may, however, land within the goal area after a dive shot as long as the take-off occurred outside of the goal area. If the defense likewise steps in the goal area or on the 6-meter line and gains an advantage by doing so, a penalty throw is awarded. A ball or player is not considered to be in the goal area if it is in the air.

**PLAYING THE BALL**

We have mentioned that players may dribble the ball, and there is not a limit to the amount of dribbles to be taken. However, double dribbling or touching the ball with two hands while dribbling, is not allowed and the opponents are given a free throw. It should be noted that while dribbling is permitted it should be discouraged among new players. This is because team handball is a passing game and dribbling slows the tempo and should be used only when necessary. Players may not play the ball with their legs below the knee. Diving on the floor for a loose ball is not allowed.

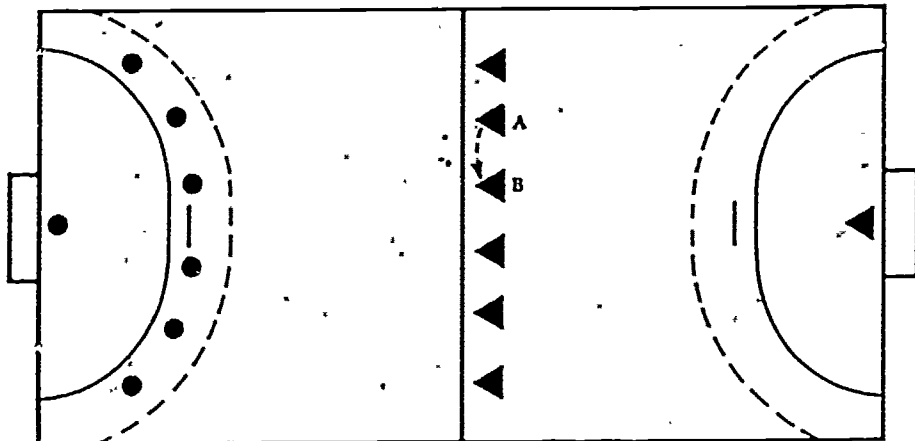

Diagram 5.

	MAY	MAY	MAY	MUST
Player receives the ball.	Take 3 steps.	Dribble (as many times as desired).	Take 3 more steps.	Pass or shoot within 3 secs.

Diagram 6.

Diagram 6 depicts the possible sequence of movement a player may take upon gaining control of a ball.

### CONTACT WITH THE OPPONENT

Players are allowed to use their bodies to obstruct an opponent with or without the ball. A player is not allowed to use the arms or legs to push, hold, trip, or hit an opponent in any manner. Proper checking techniques will be covered in elements of defense. It is important to note that offensive players are not allowed to charge into a defensive player who is in proper position. In instances of an offensive or defensive violation to these contact rules, a free throw is awarded.

### THROW-IN

If a ball goes out-of-bounds on the side-line a throw-in is taken. The defense must be 3 meters away from where the ball is passed in-bounds. The player taking the throw-in stands near the spot where the ball went out-of-bounds and throws the ball into play with one or two hands with one or both feet on the ground.

### CORNER THROW

A corner throw occurs when any defensive player (excluding the goalie) is the last one to touch the ball as it goes out-of-bounds over his/her own goalline. The ball is awarded to the offensive team, and the corner throw is executed in the manner shown in Diagram 7. Player A executes the corner throw by passing to any other team member, in this case player B.

### GOAL THROW

A goal throw occurs when a goalie deflects a ball over the goalline. The goalie

puts the ball back into play by throwing it from the goal area into the playing area.

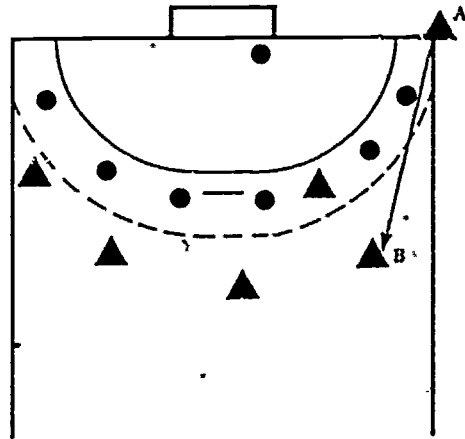

Diagram 7.

### PENALTIES

When a foul rule violation occurs, a free throw is awarded. The free throw is taken from the place where the violation occurred and without the intervention of the referee. The defense must remain three meters away from the player taking a free throw. The thrower may pass to any teammate within three seconds while maintaining one foot in contact with the court. The thrower may score directly from a free throw. The majority of minor fouls or common fouls occur in the area between the goal area line (6-meter line) and the free throw line (9-meter line). When this occurs the free throw is taken from the free throw line at a spot directly opposite from where the violation occurred, as in Diagram 8.

A penalty throw is awarded for more serious or major violations of the rules. Penalty throws are usually awarded when an offensive player is in a good shooting

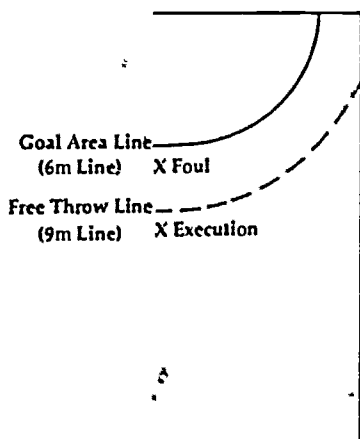

Diagram 8.

position and has an almost sure chance of scoring when fouled. To distinguish between whether the foul that occurred should be given a penalty throw or a free throw the referee must carefully consider the position of the offensive player, that is, whether a clear scoring position had been established and whether the foul took that scoring chance away. If, during a shooting drive by an offensive player, a minor foul occurs, which does not interfere with the advantage the shooter may be gaining, the referee will let play continue. To execute the penalty throw one foot must remain in contact with the court behind the 7 meter line until the ball is released. All other players must stand behind the 9 meter line when the penalty throw is taken. The penalty throw may be taken by any player on the team that is fouled. Internationally, penalty throws result in a goal nearly eighty percent of the time.

### SUSPENSION

If a player is involved in repeated personal fouls the referee will interrupt play and by displaying a yellow card to the responsible player will be issuing a warning to that player. If that player or any other player becomes involved with unsportsmanlike conduct, unnecessary rough play, or continued intentional fouls, the referee will issue a 2-minute suspension from the game. If a player receives a third 2-minute suspension or is involved in an

unusual rule violation he/she will be disqualified from the game. When a player receives a 2-minute penalty the team must play "short" (suspended player on the bench) until the penalty time has been served.

The preceding pages include information concerning the basic rules of team handball. To ensure a complete and thorough understanding of the rules of team handball you are urged to obtain an official copy of the rulebook issued to the USTHF by the IHF.

### REFEREES

Two referees are used in team handball. They control the game solely by whistle and hand signals. The referees rarely touch a ball, as players retrieve balls to be put back into play. The referee has a difficult task because of the fast pace of the game and the body contact that is allowed. While holding, pushing, and hitting are technical violations and result in free throws, individuals do not carry a limit to the number of these violations they can commit. However, repeated intentional violations or dangerous play can lead to a 2 minute suspension. A certain level of contact, holding, hand checking and, pushing occurs throughout the game and will not draw the referee's whistle depending on the level of the play and experience of the teams involved and the degree of the violations occurring. Referees are charged with the control of the game and safety of the players, and must enforce the rules to allow both players and the game to develop.

### PRINCIPLES OF OFFENSE

#### OFFENSIVE STRATEGY — FAST BREAK

Offensive attack is generated by a strong defense. This is because the defense is in a position to steal a pass, block a shot, or take advantage of an offensive mistake to initiate a fast break attack before a defense can develop. If the fast break is successful, the eventual shooter should face the goalie from close range uncontested by a defensive player. The goalie is a major factor in the fast break attack as not only must a shot

be blocked in order to gain possession of the ball, but then the ball must be quickly recovered before an accurate pass can be made to breaking players. Wing players are usually the faster players on the court and they are also usually the players who lead the fast break.

If the initial fast break does not result in a score, team strategy then shifts to the remaining players following the initial break. These trailing players constitute a secondary wave of attack and they attempt to attack the defense before they fully recover to their organized defensive positions.

### OFFENSIVE STRATEGY – ORGANIZED ATTACK

If the primary and secondary fast breaks do not yield a clear shot, the offensive team assumes their basic positions and begins a systematic attack. Movement and play can be organized around complex team plays, 2- and 3-player combination patterns, to an individual's free attack. A team handball organized attack resembles a basketball offense in that it incorporates a variety of screens or blocks and pick and roll, give, and go movements.

A good, organized offensive attack comes from coordinated movements between backcourt, circle, and wing players. Coupled with this coordinated movement, the team must have quick, accurate passing. Passing enables the offense to force the defense to shift into imbalance and thus create openings. The key elements in offensive attack are passing, movement (with and without the ball), and patience. It is interesting to note that effective wing and circle play serves to take defensive pressure off backcourt players and permits them, in turn, to become more effective in attack. Likewise, effective backcourt play serves to open up offensive play for the wings and circle player. A balanced scoring attack is the ideal situation in team handball.

### PRINCIPLES OF DEFENSE

It has been stated that the basis for a good offense begins with a good defense: the defense in transition becomes a fast breaking offense. Therefore, the first responsibility of a defensive team is to stop the fast break before becoming organized into their defensive formation. The defensive team

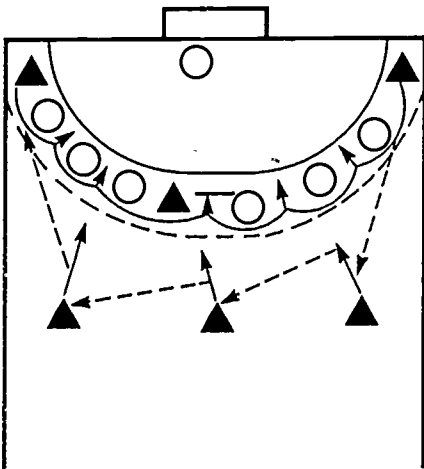

a. 3.3 Attack-wing switch. Wings exchange positions randomly looking for an opening in the defense for a pass and shot.

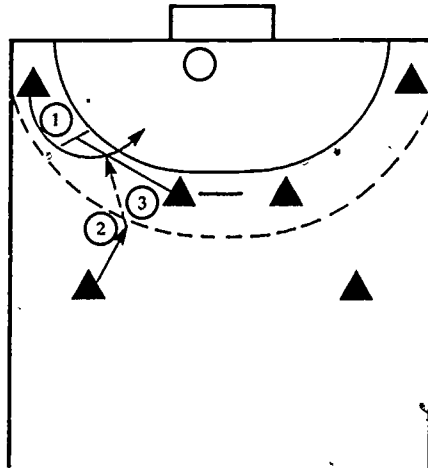

b. 2.4 Attack-circle runner pick for wing. Circle runner picks ①. Left backcourt attacks ② while left wing cuts off circle runner pick, and looks for pass from left backcourt for a shot.

must remember that they are basically defending the 6-meter or goal area line. Therefore, they should be careful not to let an offensive player get between them and the 6-meter line unnoticed. If they must leave the 6-meter to check against a jump or set shooter they need not venture beyond the 9-meter line, depending upon the shooting ability of the opponent. Once the check has been completed the defensive player must immediately return to the 6-meter line to once again fill the area left open by the checking movement.

Individual defense is played on the balls of the feet with the knees slightly bent. Hands and arms are held at the sides in such a manner as to block possible set or jump shots and block any passes to an offensive circle runner. Individuals shift laterally along the 6-meter line to balance any attack of the offensive players. Defensive players should always assume responsibility for one offensive player and be ready to help the players on their sides with their offensive opponent. It is easiest to think of team handball defense as being a zone defense until an offensive player with the ball threatens to shoot. Once a player is in a threatening shooting position, defense becomes one on one and contact should be made. Proper checking technique is vital to playing good defense and to the safety of all players. Remember, unnecessary rough play may and should always result in a 2-minute suspension. On the other hand, a too passive defense will allow offensive players to penetrate their line and score easily. It is important when checking another player that you impress the referee that you are using your body to obstruct an opponent and reaching for the ball with a free hand. Actually, with good body position, a defensive player can stop the offensive player's progress and reach to control the shooter's throwing arm or shoulder. While this is technically against the rules and results in a free throw, it is also considered good defense, because a priority is to not let the offensive player even attempt a shot.

Figure 5 depicts three defensive movements. In a. we have a demonstration of a defensive player blocking a jump shot

using both arms and a slight jump to counter the offensive player's jump. In b. we have a classic body check of an offensive player who may be in a set shooting position; note that both players remain on the floor. Checking a jump shooter is shown in c., note that both players have left the floor and while the offensive player has jumped higher, the defensive player can counter this advantage by controlling the shooting arm. To control the offensive circle runner the defense usually relies on hand checking (to know the circle runner's position, while watching the ball) and then by blocking any attempt to pass the ball to the circle runner by using their arms or body to deny position or the ball. While checking is a part of team handball for beginning players it is suggested that strict basketball defense be played. Gradually, as experience is gained, hand checking can be introduced and finally limited arm and body checking can be added.

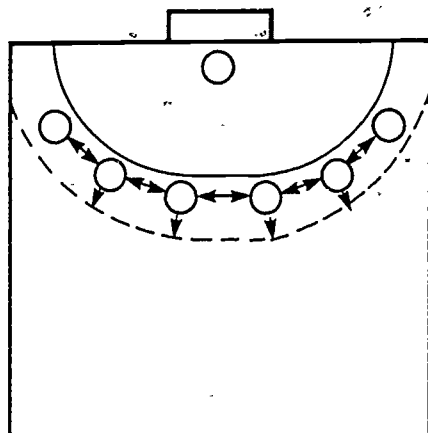

Diagram 10.

The 6-0 is the basic defensive formation. Diagram 10 illustrates the positions of the defensive players and the paths of their checking and shifting responsibilities. Remember, team handball defense is a basic combination zone that becomes player to player as the situation requires. Defensive players talk to one another repeatedly to assure that each player knows his/her responsibility and to keep close watch on the ever-changing position of the offensive cir-

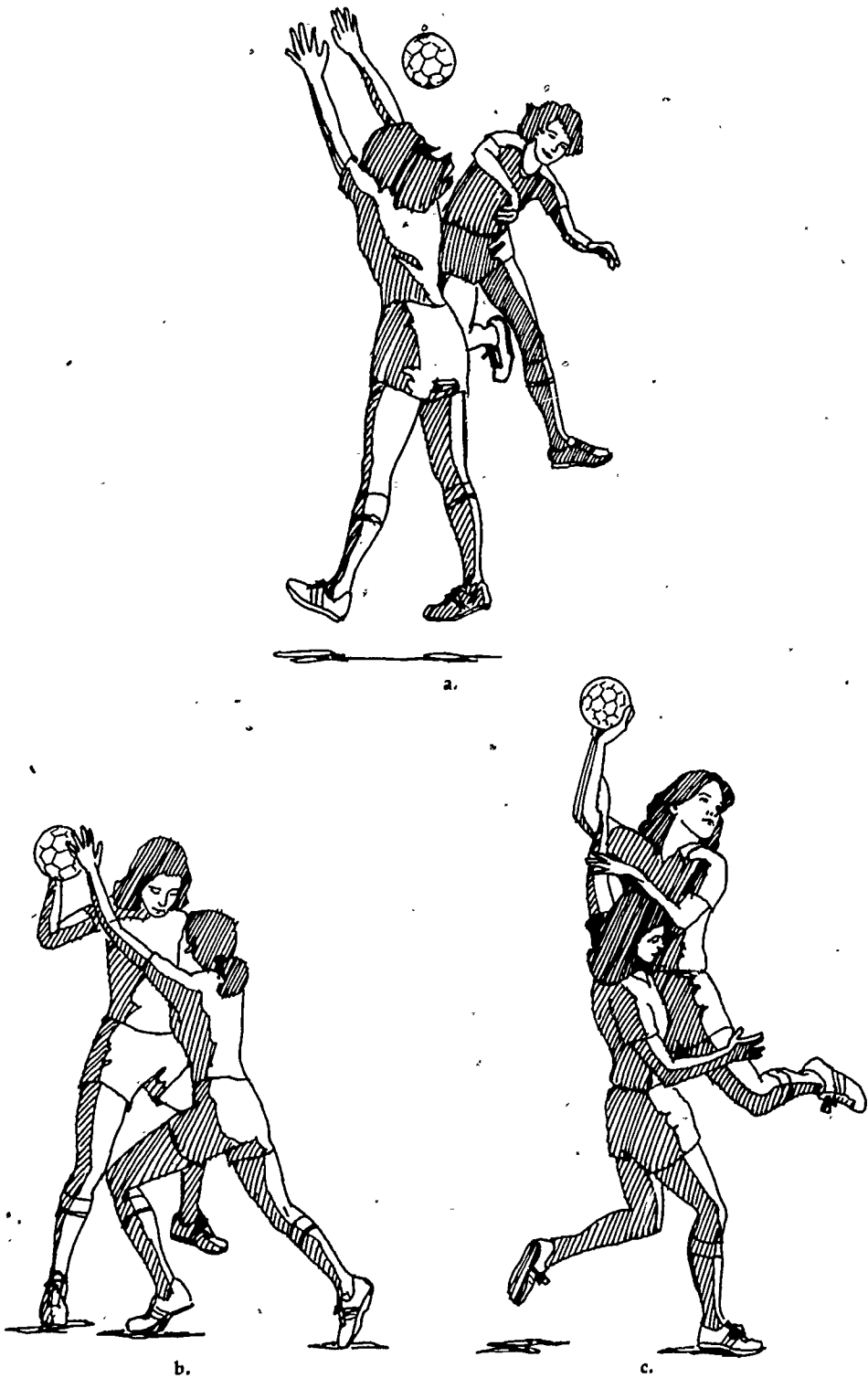
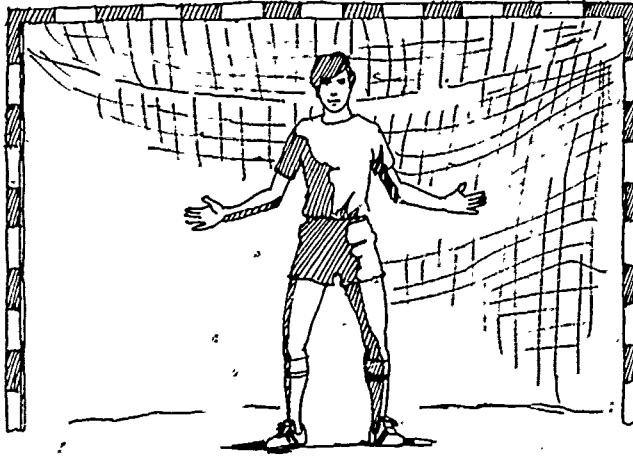
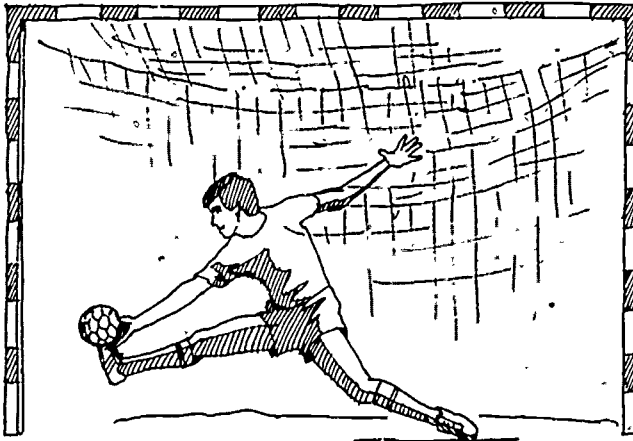

Figure 5. Three defensive movements.



a.



b.

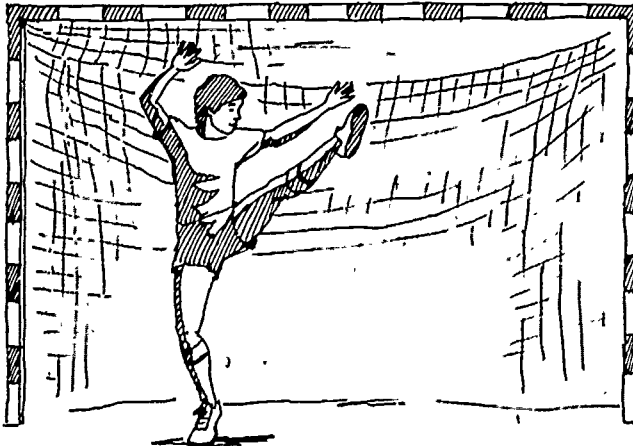

c.

Figure 6.



cle runner. Defensive players shift along the goal area line as the strength of the offensive team shifts. Again, each defensive player must actively assume and announce responsibility of an offensive player. Defensive players should not exchange positions in providing defensive coverage. As the offensive team shifts positions in their movement, the defensive players just shift player responsibility. Team defense is a series of shifting, helping out, and recovery of position for the next threat. Playing defense in team handball requires full effort by each individual. Once control of the ball is obtained and the defensive team goes on offense, the team can pace their attack and dictate the intensity of play and in doing so, recover from the effort expended on defense.

### GOALIE

The goalie has a major function on both offense and defense. On offense the goalie will initiate the fast break while on defense the goalie's prime function is to block shots. Quickness, both in thought and physical reaction, and courage are two major components needed to play the goal successfully. Figure 6 shows three common positions of a goalie. In a. we see the goalie in the ready position. In b. we see the goalie blocking a low shot to the corner, while in c. the goalie is blocking a shot to the high corner.

There are several rules that apply to the goalie only. The goalies may touch the ball with any part of their bodies and can move about the goal area without restriction. However, the goalie cannot leave the goal area with the ball under control. While a goalie can enter the playing area to obtain a ball he/she cannot reenter the goal area with the ball under control. While in the playing area with the ball in possession, goalies must observe step, dribbling, and 3-second rules as they apply to court players. A court player cannot throw a ball to his/her own goalie standing in the goal area; this violation results in a penalty throw. If a goalie deflects a ball over the goalline the goalie puts the ball back into play by a goal throw. To execute a goal throw the goalie throws

the ball from the goal area into the playing area. If a goalie deflects the ball out-of-bounds across the sideline, the opponents put the ball back into play by a throw-in. In Diagram 11 we see when a shot becomes a goal.

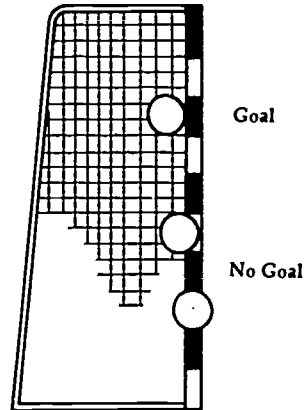

Diagram 11.

### TIPS FOR BEGINNING PLAYERS

1. Court may be modified to suit available area indoors or out, width is more important than length. Regulation goals, net, and balls are recommended, but can also be modified to include available equipment.
2. Do not allow body contact for beginning players.
3. As team handball is a passing game, discourage dribbling for beginning players. A leadup game of keep-away with no dribbling allowed is ideal for beginners.
4. Do not allow defensive players to pressure the offense. As offensive skills are acquired allow hand checking, limited contact, and finally arm and body checking.
5. Have every player touch the ball at least once before a shot is attempted each time on offense.
6. It is recommended to substitute only when on offense.

7. Referees should be verbal with beginning players, as well as giving the whistle and hand signals.
8. Beginning players have a tendency to shoot at the middle of the goal, right where the goalie stands! Put targets in the high and low corners of the goal for players to shoot at in practice and warmup situations.
9. Beginning players should be instructed to shout "corner," prior to shooting, as a supplementary reminder of where to shoot.
10. A gym mat draped over the front of a goal will leave only the high and low corners exposed for beginning players in practice situations.
11. Have everyone play the goal for an allotted time to gain an appreciation of the difficulty in playing the position.

### TERMINOLOGY

- Attack.** Team attacks when they are in possession of the ball.
- Centerline.** Divides the court in the center, game begins at the centerline.
- Charging.** An offensive player runs into or over a stationary defensive player who is in proper position.
- Checking.** Obstructing an opponent from taking a shot or establishing position on offense by using the arms and body.
- Circle.** Area described by the 6-meter line, referred to as the goal area.

**Corner Throw.** When a ball is last touched by defending players before passing over the goalline, it is put into play at the point of intersection between the sideline and goalline by a throw

**Free Throw.** Play continues after a minor rule violation, opponents maintain 3 meters from the player taking the free throw.

**Free Throw Line.** Dashed line at 9 meters used for taking free throws following minor fouls that occur between the 6- and 9-meter lines. Ball is put into play at a point on the free throw line directly opposite from the foul, while the defense must remain 3 meters from the ball.

**Goal Area Line.** 6-meter line or circle.

**Goal Throw.** Throw taken by goalie from goal area after the goalie deflects the ball over the goalline out-of-bounds.

**Penalty Line.** A line one meter in length, 7 meters from the center of the goal. Penalty throws are taken from this line.

**Referee's Throw.** When players from both teams infringe the rules at the same time or gain simultaneous possession of a loose ball, the referee will throw the ball to the floor at the spot where the incident occurred; no player can be closer than 3 meters to the referee.

**Substitution Area.** Substitutes must enter and leave the game from an area 4.5 meters on either side of the centerline. This designated area is located between the substitution bench and the timekeeper.

**Throw-in.** When a ball goes out-of-bounds across the sideline, it is put back into play from the spot where it went out-of-bounds.

**Throw-on.** The throw-on is taken after the referee's whistle and is a pass to a teammate at the centerline to start the game and after each scored goal.

*advantage (p. 313)*  
*approach shots (p. 315)*  
*backhand (p. 308)*  
*Continental grip (p. 310)*  
*drop shots (p. 315)*  
*Eastern forehand grip (p. 305)*  
*fault (p. 313)*  
*forehand (p. 305)*  
*groundstrokes (p. 315)*  
*half volley (p. 318)*  
*let (p. 313)*  
*lobs (p. 315)*  
*no-ad (p. 313)*  
*overhead smash (p. 312)*  
*percentage shot (p. 316)*  
*ready position (p. 305)*  
*serve (p. 309)*  
*tennis elbow (p. 312)*  
*tie breakers (p. 313)*  
*two-handed backhand (p. 308)*  
*umpire (p. 314)*  
*volley (p. 310)*

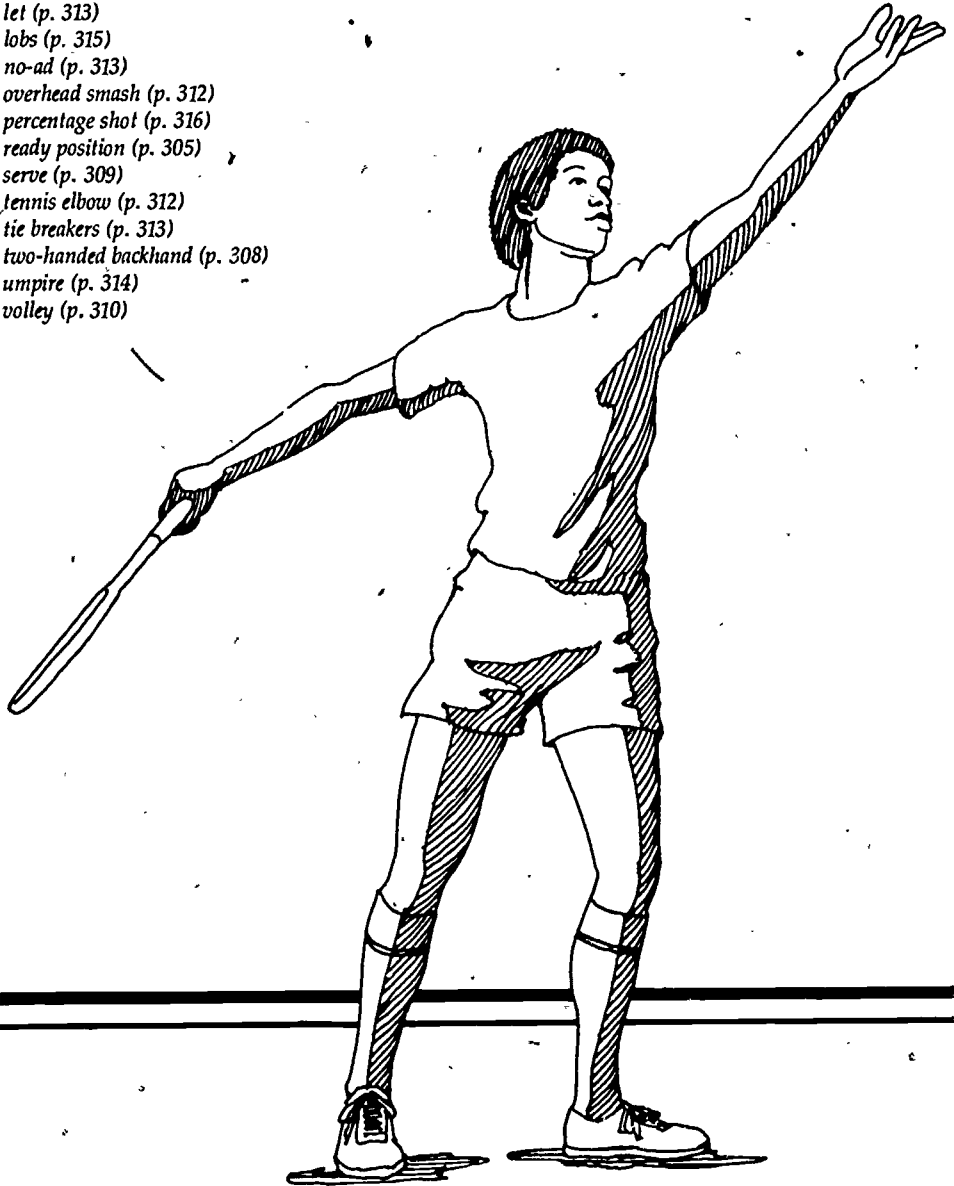

# Tennis\*

JIM BROWN;  
*McNeese State University,  
 Lake Charles, LA*

## INTRODUCTION

Before you decide that you are going to play tennis regularly, there are several things you should know. The benefits of playing tennis are obvious to most people, but the problems of learning to play are not as easily recognized.

Tennis can be fun to play, relatively inexpensive, good for your health, an individual or team sport, and one that can be played for a lifetime. It can be an activity for an afternoon of recreation with your family or friends, or a sport played competitively for hundreds of thousands of dollars.

Whatever your reasons for playing, be sure you know what you are getting into before you get serious about it. Tennis is a physically demanding game at most levels. It requires a wide range of physical skills and mental alertness, and can be difficult for some people to learn. The game looks easier to play than it is, so it will require your utmost attention. You do not have to be a great athlete to enjoy tennis, but physical skills and mastering techniques can add to your enjoyment. If you decide to play seriously, play often and decide that you are going to run, work hard, perspire, and enjoy doing it.

When Walter Wingfield received a British patent for lawn tennis in 1874, he could not have imagined what the game would be like today. During the past twenty years there have been some dramatic changes. These include a change from tennis primarily being played by a few men in private clubs to millions of men and women on public courts as well. The ages of players

have extended downward to six and seven year-olds and upward to the seventies and eighties. The United States Tennis Association estimates that about thirty million Americans regularly play tennis. Other recent changes in the game include more variety in the style of play, open competition between amateurs and professionals, an increase in televised tennis, and technological advances that have produced space age materials for rackets, balls, strings, courts, and other tennis-related products.

## SKILLS AND TECHNIQUES

### THE READY POSITION

The ready position is the stance to be assumed while waiting for return shots. Hold the racket out in front of the body with the racket pointing toward the opponent or slightly toward the backhand side (a right-hander's left side). Use the non-racket hand to support the racket at the throat or on the shaft (the parts between the head and the handle or grip). The racket should be far enough in front of you so that your weight is thrown slightly forward. This position will force you to put your weight on your toes instead of your heels, a position that should help you react faster to any shot (see Figure 1).

### FOREHAND

The Eastern forehand grip is used by most players for this shot. Shake hands with the base of the racket so that your palm is slightly behind the racket handle, the wrist is a little to the right of the top of the handle, and the "V" formed by the thumb and index finger is above, but slightly toward the back part of the grip (see Figure 2).

\*Portions of this chapter have been reprinted from Brown, Jim. *TENNIS: Strokes, Strategy, and Program*, © 1980, pp. Chapters 1,2,3. Reprinted by permission of Rentice-Hall, Inc., Englewood Cliffs, NJ.

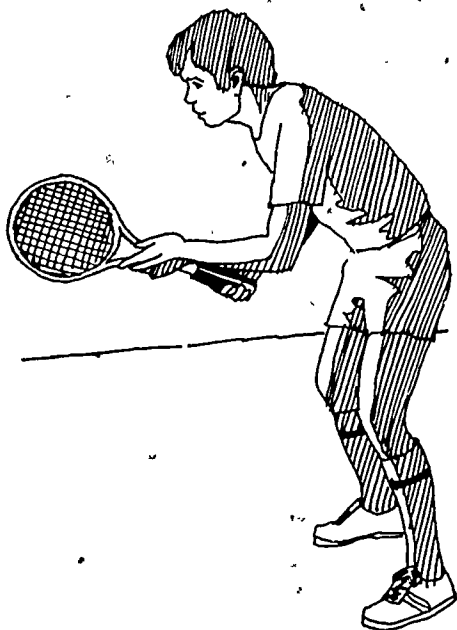

Figure 1. In the ready position, the weight is forward, the racket points to the opponent, and the knees are flexed.

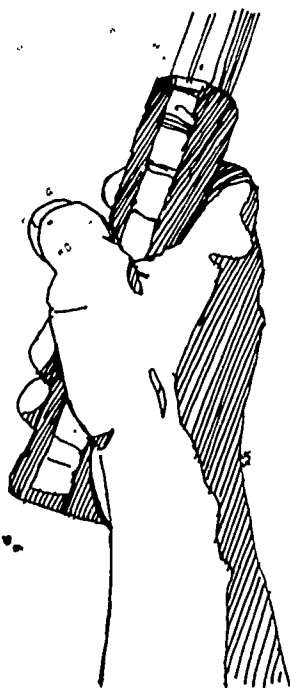

Figure 2. The Eastern forehand grip. As the player looks down on the racket, the wrist is slightly to the right of the top of the handle.

As soon as you know the ball is going to your forehand side, begin the backswing. The backswing is made by bringing the racket back either in a straight line parallel to the court or in a slight up, then down loop to a position where the racket is a bit lower than waist high and pointing to the wall or fence behind your baseline (see Figure 3).

As the ball comes to the forehand, move into a position so that the left shoulder points to the ball and the feet form a line approximately parallel to the sideline. Push off with the foot farther away from the net and transfer your weight forward as you begin to swing at the ball.

Swing in a slightly upward motion. This upward and forward action of the racket permits a hit with a little topspin, which is good for control and for making the ball bounce high on the other side. Make contact with the ball just before it reaches a point even with the midsection of your body. Keep your wrist firmly in place throughout the stroke (see Figure 4).

Follow through in the direction of the net, across the front of your body, and high

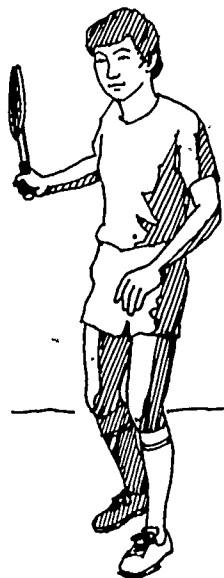

Figure 3. Turning your side to the net and taking the racket back to the fence for the forehand backswing.



Figure 4. Making contact with the ball for the forehand.



Figure 5. The forehand follow-through.

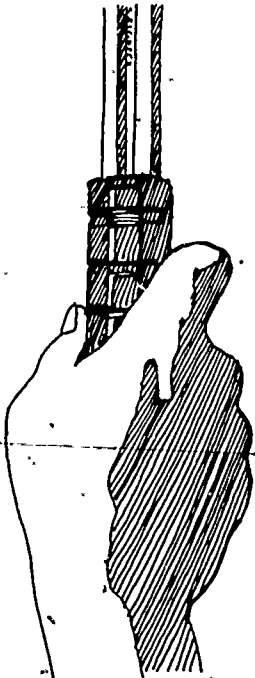

Figure 6. The Eastern backhand.



Figure 7. Taking the racket back so that it points to a wall or fence behind you for the backhand.

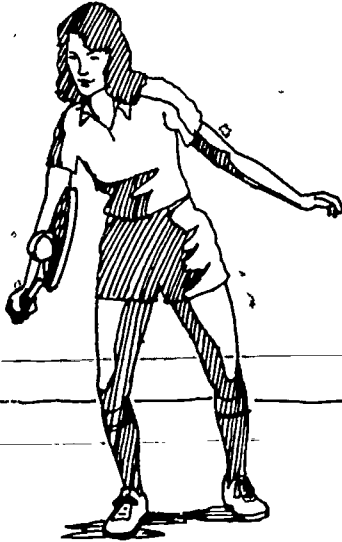

Figure 8. Making contact with the ball for the backhand.

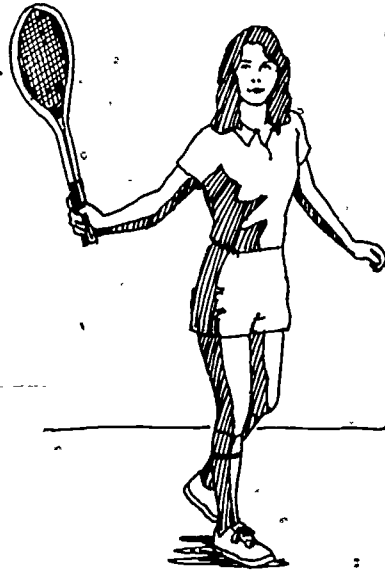

Figure 9. The backhand follow-through.

on the opposite side from which you started the swing (see Figure 5).

### BACKHAND

There are three acceptable ways to hold the racket for a backhand shot (one that a right-hander hits on the left side of the body). The most common grip is the Eastern backhand, in which the right-hander's wrist should be to the left of the top of the racket handle as you look down on the racket (see Figure 6). In this grip the inside part of the thumb is in contact with the back, flat part of the racket handle. The thumb may be extended or bent to provide support. Players with strong forearms might use the Continental grip. Here the wrist is directly on top of the racket handle. The thumb has to provide more support from the rear since the wrist is not positioned to provide as much. Some players use the Continental grip for the backhand and forehand so they do not have to change grips between shots. The two-handed backhand is used at all levels of the game. It provides more support, but it may be difficult to reach some shots, and the racket is hard to manipulate

on shots aimed directly at the body. There are players who use two forehand grips to attain a two-handed backhand, while others change to an Eastern backhand with the strong hand and add a forehand grip with the other.

However you decide to hold the racket, start taking it back as soon as you see the ball coming. Use the non-racket hand to cradle the racket along the shaft and to help turn the racket as you change to the backhand grip. Take the racket back to a position pointing to the fence at about waist height (see Figure 7).

Turn before you hit so that your shoulder is pointing in the direction you want the ball to go. Bend your knees slightly. Lean forward as you swing. You might even take a small step forward with the foot closest to the net.

Swing in a motion approximately parallel to the court. Keep your wrist firmly in place as you swing. Make contact with the ball before it gets even with the middle of your body (see Figure 8). Follow through out toward the net, across the front of your body, and up to the other side (see Figure 9).

### Groundstroke Tests

Most skill tests are based on the number of successful attempts in hitting balls into a target area. This type of test can be used with any stroke in tennis. Here are some examples:

1. *Drop and Hit.* Standing at the baseline near the center mark, drop and put into play as many balls as you can out of ten attempts. Shots that fall into the forecourt area count for one point; shots landing in the singles backcourt count for two points.
2. *Toss to Forehand.* Standing at the baseline near the center mark, return as many balls as you can out of ten balls thrown on one bounce to your forehand. Shots into the forecourt count one point; shots into the backcourt count two points.
3. *Toss to Backhand.* Same as the previous drill, except that balls are tossed on one bounce, waist high to the backhand.
4. *Wall Test.* Standing behind a line twenty-five feet from a rebound wall, drop the ball and put it into play. Continue hitting groundstrokes against the wall for thirty seconds. Every shot must be hit from behind the line, but shots do not have to be played on one bounce. If a shot does not come back behind the line, the player can retrieve the ball and return to the starting position before hitting the next shot. Each hit during the thirty seconds counts for one point.

### BEGINNER'S SERVE

The serve is used to begin a point and must be delivered from behind the baseline. Beginners should hold the racket with the Eastern forehand grip described earlier and start with the racket behind the back or head. Stand at about a 45° angle to the baseline with your weight on the foot away from the net (see Figure 10).

Toss the ball a little higher than you can reach and about a foot in front of you. Try to lift the ball without spin so that when you swing at it your arm will be fully extended. Remember to reach high to hit (see Figure 11). Follow through out toward the net, across the front of your body, and down on the other side (see Figure 12).



Figure 10. Starting the beginner's serve with the racket up and back, and the ball out in front.



Figure 11. Extending the arm upward to hit for the beginner's serve.



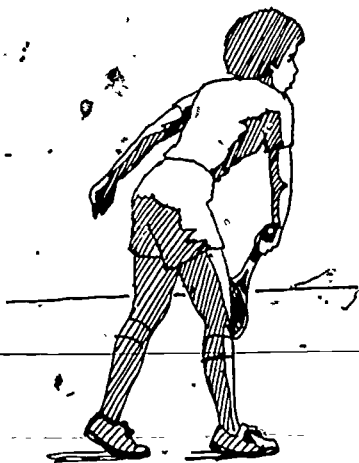

Figure 12. The follow-through for the beginner's serve.

Toss the ball a bit higher than you can reach. Reach high to hit and make contact in front of your body so that your weight will move forward with the swing. The foot that started out away from the net should move forward and touch down inside the baseline after you have hit the ball. This happens almost naturally to keep your balance after you have reached up and forward to hit. Follow through out, across, and down to the other side, in that order (see Figure 13).

#### Beginners' Serving Test

Standing at the baseline, start with the racket in the back scratch position and attempt to serve ten balls into the service court diagonally opposite from where you are positioned. Count one point for each ball that lands in the proper service court. Use the beginners' serving motion and try only for accuracy, not power.

#### INTERMEDIATE AND ADVANCED SERVE

Players with advanced serves usually hold the racket with a Continental grip. Some even move their wrists a bit toward the backhand side of the grip. These grips enable the server to hit with control, pace, and spin, while the Eastern forehand grip is mainly for control.

Stand at an angle to the baseline described for beginners, but begin motion

with the ball against the strings out in front of your body about chest high. Drop the racket in a pendulum motion by the side of your leg and at the same time drop the tossing hand prior to the toss. As the racket moves up behind you to a back scratching position, the other arm begins to move up to hit the ball for the toss. Move the hands down at the same time, then up together.

#### Intermediate/Advanced Serving Test

Draw a line across the service court four feet from and parallel to the service line. Standing behind the baseline and using the full swing motion, attempt to serve ten balls into the proper court. Shots that land in front of the line drawn count one point; shots hitting between the four-foot line and the service line count two points.

#### VOLLEY

A volley is a shot hit before the ball bounces. It is usually hit from a spot in the forecourt. Beginners will be more comfortable holding a forehand grip for forehand volleys and a backhand grip for backhand volleys. The advantage is comfort in hitting, the disadvantage is that there may not be enough time to change grips between shots. Intermediate and advanced players use the Continental grip. They sacrifice comfort in order not to have to change grips from the forehand to the backhand. The other fundamentals are the same.

Take a short backswing. There is not enough time for a big one. Block or punch the ball in front of and to the side of where you are on the court. Since you will not have time for a big backswing to provide power, it is important to make contact in front so that moving your body weight forward will help make up for the power loss. Step forward if you have time. If you are right-handed, step in the direction you want to hit with your left foot on forehand volleys. Step forward with the right foot on backhand volleys. If you do not have time to take a step, turn your shoulders before reaching forward to hit. Keep your eyes level with the ball. If it goes low, get down with it. Finally, try to hit the ball while it is rising. If you let it drop, you will have to volley up and hit a defensive shot.

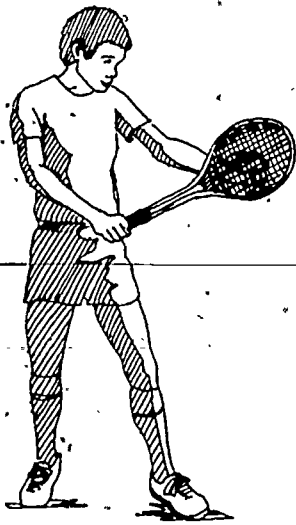

a.

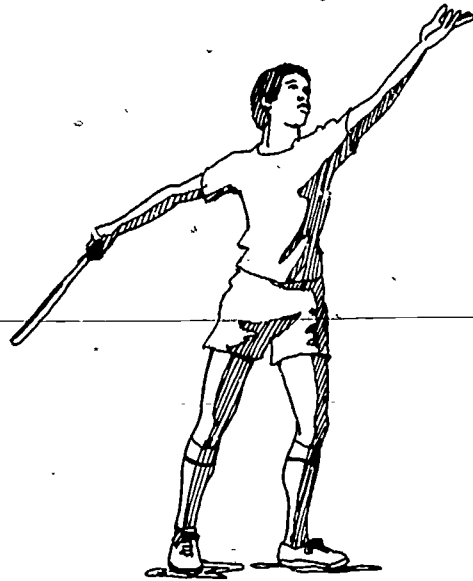

b.



c.

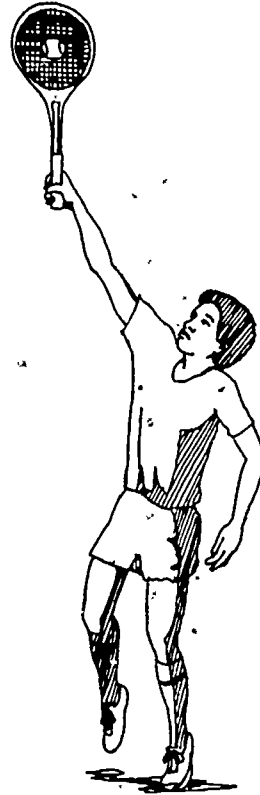

d.

Figure 13. Intermediates and advanced players begin the serve with both hands in front. They then go down together and up together. Extend your arm to a hit, and follow through, out, across, and down.



Figure 14. Shift your weight forward and reach high to hit the overhead smash.

### Volley Test

Standing approximately ten feet from the net, attempt to return as many balls as you can out of ten shots fed from the baseline. The feeder should mix forehand and backhand shots. Volleys that fall into the forecourt count one point, and shots that hit the backcourt area count two points.

### OVERHEAD SMASH

Beginners seldom hit overhead smashes, but when they do they usually hold an Eastern forehand grip. As with the serve, this grip allows for control but does not provide controlled power. Intermediates and advanced players hold a Continental grip for control and power. Take lots of steps to prepare for a smash. If you get set too soon, you may misjudge the ball and be in a poor position to hit. As you get ready to hit, your feet should be staggered so that

the right foot is back and the left foot forward. Again, this position allows you to shift your weight forward as you swing. Take an abbreviated backswing. Bring the racket straight up in front of your body to a position behind your head. A full wind-up does not give you as much control as this short one will. Keep the ball in front of you as you swing and reach high to hit. Your arm should be fully extended as you hit (see Figure 14).

### SAFETY

Since there is no body contact in tennis, there is less of a chance for injury than in some other sports. There are, however, ways to get hurt and ways to avoid injuries. In practice, stepping on balls scattered around the court and getting hit by stray tennis balls is always a problem. Clearing the court of extra balls and being alert can reduce the possibility of getting hurt that way. Many players are now using eyeguards to protect themselves against balls that glance off rackets and strike the eyes.

Blisters, sprains, strains, cramps, shin splints, and tennis elbow are the most common injuries. Gradually increasing the amount of playing time and using the correct grip size can cut down on blisters. Sprains are difficult to prevent, but playing within your capabilities and working to improve flexibility may help. Stretching and other warmup activities can prevent pulled muscles. Good conditioning and maintaining a proper balance of potassium, sodium, and water might help you avoid getting cramps. Shin splints can be caused by running on hard surfaces, poor conditioning, and poor running techniques, so correcting those problems might help solve the shin splint problem. Proper hitting technique, strong muscles, and using the right racket can reduce the possibility of getting tennis elbow.

### RULES

#### STARTING THE GAME

The players or teams spin a racket or flip a coin to decide who serves first. The winner of the spin or flip can choose to serve first,

receive first, to begin the match on either side, or to let the opponent make the choice.

The first serve is made from behind the right side of the baseline between the center service mark and the singles sideline. The serve for the second point is made from behind the left side of the baseline, and the server continues alternately serving from the right and left sides of the baseline until the first game is completed.

The serve is a "fault" if the server steps on or beyond the baseline before the ball is hit or if the ball does not go over the net and into the service court diagonally opposite the server. If the first serve is a fault, the server gets another chance. If the second serve is a fault, the server loses the point.

The serve is a "let" if the ball touches the top of the net and goes into the proper service court or if the receiver is not ready. If a serve is a let, that serve is repeated.

The players alternate serving complete games. After the first game, the server becomes the receiver and the receiver of the first game becomes the server. Change ends of the court (with a 90-second rest) when the total number of games in a set equals an odd number.

A player loses a point if:

- the ball bounces twice before it is hit;
- the server serves two faults in a row;
- a ball is returned so that it hits outside the boundary lines (balls that hit lines are good);
- a ball does not go over the net;
- the ball is hit more than once during a stroke or swing;
- a player touches the net while the ball is in play;
- the ball is hit by a player reaching over the net (unless the wind or spin has carried the ball back across the net);
- a player throws the racket and hits the ball.

In doubles, the players on each team take turns serving. The order of serving can be changed at the end of each set. The receivers take turns receiving the serve in each game. The order of receiving must be

decided at the beginning of each set and maintained until that set is completed.

## SCORING

The server's score is always given first. The first point won by a player is fifteen; the second is 30; the third is 40; the fourth is game unless the score is tied. Each player has zero points or "love" at the start of the game. If the score is tied at 40 - 40, the score is deuce and the game continues until one player gets ahead by two points. After the score is deuce, the player who wins the next point has the "advantage." The score can be called "ad in" if the server is winning and "ad out" if the receiver is ahead. "My ad" and "your ad" are also common expressions. If the player who has the advantage wins the next point, that game is over. If not, the score goes back to deuce.

No-ad scoring is simpler and used frequently at all levels of the game. Instead of calling the points love, 15, 30, 40, and game, the points are called 0, 1, 2, 3, and 4. The first player to win four points wins the game. When the score is tied at 3 - 3, the player who wins the next point wins that game. At 3 - 3, the receiver chooses the side from which he/she will return the serve.

In both regular scoring and no-ad scoring, play continues until a player wins at least six games and is ahead by at least two games (for example, 6 - 0, 6 - 2, 6 - 4). When that happens, a set has been completed. If the score is tied at 5 - 5, the players continue to play until one goes ahead by two games (for example, 7 - 5, 8 - 6, 9 - 7). A match usually consists of two out of three sets.

In most matches and tournaments, "tie-breakers" are used when the score is 6 - 6 in a set. There are two widely used tie breakers, one consisting of the best of nine points and the other the best of twelve points. Both systems are rather complicated, but details can be obtained by writing the United States Tennis Association Education and Research Center, 729 Alexander Road, Princeton, NJ 08540.

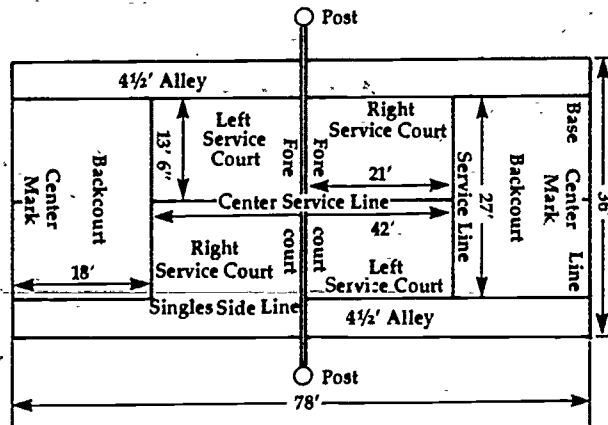

Diagram 1. Diagram and dimensions of a tennis court.

## THE COURT

A tennis court is seventy-eight feet long and twenty-seven feet wide for singles play. A doubles court is seventy-eight by thirty-six. The net is three feet at the center and three feet, six inches at the net posts. Lines should be two inches wide. A diagram of a singles and doubles court is shown in Diagram 1.

## ETIQUETTE

There are some unwritten rules which make the game more enjoyable. Here are some of them:

1. Each player calls shots on his/her side of the net.
2. When a ball is so close to the line that you cannot tell whether it is in or out, it should be played as good. Give the other player the benefit of the doubt.
3. Make verbal calls only when a shot is out. If a shot is close but in, play the ball without saying anything.
4. The server should call out the score following each point.
5. Do not walk behind a court when a point is in progress.
6. Do not return a ball to another court during play.
7. Wait until players are changing sides to ask about the score.

8. If there is an unusual delay between the first and second serves because of outside interference, allow the server to take two serves.
9. Do not distract serious players with loud talk or other noise from the side of the court. Tennis players react to sound, and sounds from the side of the court might be mistakenly interpreted as calls related to the match.
10. Do not umpire or coach during a match unless you are there to act in that capacity.

## SINGLES STRATEGY

### THE SERVE

1. Stand near the center of the baseline to serve.
2. Do not waste energy and time trying to serve aces (serves which the receiver cannot touch with the racquet).
3. Place serves to your opponents' weakest sides or to an open area in the service court.
4. Serve directly at players who take big backswings on their groundstrokes.
5. Do not follow your serve to the net unless your serve is very good and unless you can volley well.
6. Use more spin and less pace on second serves.
7. Use a variety of serves during a match.

**Returning Serves**

1. Stand so that you are in the middle of the two extreme sides to which the ball can be served (usually on or behind the baseline one to two steps from where the baseline and singles sideline meet).
2. Move in a step or two on second serves.
3. Learn to anticipate your opponent's second serves.
4. Return fast serves with a short backswing and a blocking motion. Do not try to return a hard serve with a hard return.
5. Return the ball deep to the corners when possible.

**GROUNDSTROKES**

1. Stand on or just behind the center of the baseline between groundstrokes. As soon as you hit one shot, move back to that position unless you are in the forecourt.
2. Hit most groundstrokes cross-court, deeply to the backcourt, and high over the net. That will make your opponent run to hit shots and to stay in his/her backcourt. It will also give you more distance with which to work.
3. Hit to open spots on the court when you can.
4. Do not try to put shots away from a position behind your baseline.
5. Keep the ball low and wide on passing shots.
6. Use your best stroke on all set-ups, even if you have to run around the ball to hit it.
7. Develop a pattern during a rally; then break it.

**APPROACH SHOTS**

1. Use approach shots on balls that bounce near or inside the service courts.
2. Take a shorter backswing on approach shots.
3. Use a backspin on most approach shots.
4. Hit most approaches down the line to which you are closest.
5. Do not try to win the point with an approach shot. Set your opponent up; then win with a volley.

**VOLLEYS**

1. Play volleys from a position about ten feet from the net near the center of the court.
2. Move closer to the net following a good volley.
3. Volley to the open part of the court.
4. When you volley a low shot, volley it deep and down the middle of the court.
5. When you volley a high shot, volley at an angle and go for a winner.
6. Cover the open court on your side after you hit a volley.
7. Get set to hit volleys. Do not hit on the run unless you have to.

**LOBS**

1. When you run wide to retrieve a deep shot, lob cross-court.
2. Make defensive lobs go deep and high into your opponent's court.
3. Use lobs more often when the other player has to look into the sun.
4. Follow offensive lobs to the net.

**SMASHES**

1. Change the direction of two smashes in a row.
2. Try to put smashes away when you are close to the net.
3. Do not attempt put-aways from the backcourt area.
4. Hit smashes flat (without spin) when you are near the net. Use some spin when hitting smashes farther from the net.

**DROP SHOTS**

1. Do not try drop shots from the baseline, when the wind is at your back, or against players who can run fast.
2. Use drop shots when your opponent expects you to hit a deep shot.

**DOUBLES STRATEGY**

1. Stand about halfway between the center mark and the doubles sideline to serve (see Diagram 2).
2. Serve to the backhand or to the open part of the service court.

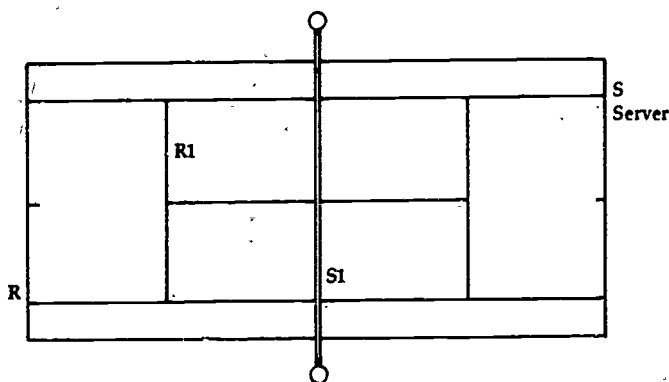

**Diagram 2.** Positions for starting a point in doubles. The receiver's partner (R1) may want to begin the point on the baseline instead of on the service line.

3. Let the strongest server begin serving each set.
4. Receive the serve at a point where the baseline meets the singles sideline (see Diagram 2).
5. If the server stays back after the serve, return the ball deep and cross-court.
6. If the server comes to the net following a serve, return the ball short and cross-court.
7. If the server's partner plays too close to the net, try lobbing.
8. Occasionally try to pass the server's partner at the net just so he/she will have something to think about.
9. When your partner is receiving the serve, stand either even with him or her on the baseline or move up to the middle of the service line on your side of the court (see Diagram 2).
10. When your partner is serving, stand about eight to ten feet from the net and two steps inside the singles sideline toward the center of the court (see Diagram 2).
11. If your partner has to move off to the side of the court to retrieve a shot, shift in that direction to cover the open court.
12. When your partner is serving, protect your side of the court, take weak shots down the middle, and smash any lobs hit to your side.
13. When you are playing at the net and a lob goes over your head, cross to the other side and fall back to cover the open court while your partner retrieves the lob.
14. When volleying, hit for the open part of the court or at the closest opponent if you are in an offensive position.
15. Volley to the opponent farther away from you if you are hitting a defensive volley.
16. When both opponents are at the net and you are on the baseline, hit most shots low and down the middle.
17. Hit most smashes down the middle of the court.
18. Play with a partner you like and can get along with on and off the court.
19. Talk to your partner during the match.
20. Let the player with the strongest backhand play the left side of the court when receiving serves.

### GENERAL STRATEGY

1. Change tactics if you are losing.
2. Hit toward a general target area instead of going for lines and corners.
3. Play the ball instead of your opponent, especially in pressure situations.
4. Do not try risky shots on points you cannot afford to lose.
5. Learn what percentage shots are and use them during a match.
6. Concentrate on winning the first point of every game and the first game of every set.

7. Try to be consistent rather than powerful. Most points are lost with poor shots, not won by great ones.
8. Do not fight power with power.
9. Start getting ready for the next shot as soon as you have hit the last one.
10. Find out what your opponent's weakest shot is and take advantage of that weakness.

## EQUIPMENT

### RACKETS

Tennis rackets range in price from a few dollars to hundreds of dollars. It is best not to spend a lot of money on your first racket, but to buy an inexpensive one until you have decided to regularly play the game. There are several ways to determine if you are getting a good racket. One way is to look on the side of the racket for markings indicating the racket's grip size and weight. Most good rackets will have those numbers, but there are other ways to look for quality. The general workmanship can tell you a lot about a racket, that is, the quality of the grip, the trim, the markings, and the welding or rivets on metal rackets. Getting opinions of other players can help you decide if a racket is of good quality.

Rackets are made of wood, steel, aluminum, carbon, graphite, fiberglass, and other products. Composite rackets are made of two or more products. There are many differences in these products, but generally, wooden rackets and rackets with oversized heads give you more control while rackets made from other products supply more power.

You will have to decide on the weight and grip size before buying a racket. Tennis rackets range in weight from twelve to fifteen ounces, and most players use light or medium weight rackets (indicated by an L or M on the side of the shaft). Grip sizes range from four to five inches. Players with small hands would probably use a racket with a grip size between four and four and one half inches, while those persons with larger hands might prefer a four and five-eighths grip. If the grip is too small or too large, the racket will slip when contact is

made with the ball. One way to decide which size is best for you is to hold a forehand grip. The end of your thumb should touch the first joint in the middle finger if the grip is the right size.

### Strings

Racket strings are either made from nylon or from beef or sheep muscle tissue. Almost all recreational players and many advanced players use nylon. Nylon strings are reasonably priced and durable. Beginners and intermediates should have their rackets strung between fifty-one and fifty-five pounds of pressure. Mid-sized and oversized rackets require more pressure, but get the advice of a stringer if you are not sure about what to do.

You can extend the life of your racket and strings by not storing rackets in extremely hot or cold places (like a car trunk or attic), by using racket covers between matches, by not spinning the racket on the court, by keeping the grip clean, and by not throwing or dropping your racket when you are angered.

### BALLS

It is important that even beginners play with good tennis balls. Brand names can be deceiving, but Penn, Wilson, Spalding, Dunlop, and Slazenger are some of the companies that make quality balls. Tennis balls cost from \$2.00 to \$5.00 for a can of three, but you can save money by watching for sales, shopping at discount stores, and buying a dozen or more balls at a time. Ask for heavy duty balls if you are going to play on hard surfaces like concrete. You cannot play with one can of balls forever. Three balls may last three or four outings for beginners and some intermediates, but after a while they will begin to lose pressure and bounce, or the fuzz will wear off. Advanced players use new balls almost every time they play. Keeping tennis balls stored in a can and out of the heat will make them last longer.

### TERMINOLOGY

**Acc.** A serve which the receiver cannot touch with the racket.



**Ad-in.** The score when the player serving has won the point after the score was deuce.

**Ad-out.** The score when the player receiving the serve has won the point after the score was deuce.

**Alley.** The lane or area on each side of the singles court. The alleys can be used for all shots after the serve in doubles.

**Approach Shot.** A shot which the hitter follows to the net. It is usually hit from the forecourt area.

**Backcourt.** The part of the court between the service line and the baseline.

**Baseline.** The boundary line at the back of the court that runs parallel to the net.

**Chip.** A groundstroke hit with a short backswing, with backspin on the ball, and one that usually falls into the opponent's forecourt.

**Choke up.** To hold the racket at a point away from the base of the grip.

**Chop.** A shot hit with backspin to any part of the court.

**Continental Grip.** A way to hold the racket so that the player does not have to change grips between the forehand and backhand. Holding the racket so that one edge points down; the wrist is directly over the top of the racket handle.

**Cross-court.** A shot hit diagonally from one corner of the court to the opposite corner.

**Deuce.** A tie score at 40 - 40 and each tie after that in the same game.

**Double Fault.** When the server does not hit either of his or her two attempts into the proper court.

**Drive.** A groundstroke hit with power deeply into the opponent's backcourt.

**Fault.** When the server does not serve the ball into the proper court.

**Flat.** A shot hit with little or no spin.

**Follow-through.** That part of the swinging motion after the ball has been hit.

**Groundstroke.** A shot which is hit after the ball has bounced.

**Half Volley.** A shot hit immediately after the ball has bounced on the court.

**Let.** A serve that hits the top of the net and bounces in the proper service court. Let also means that a point should be replayed for a number of reasons.

**Lob.** A high, arching shot.

**Love.** A word used meaning zero points.

**Match.** A contest between two players, two doubles teams, or two teams representing schools, clubs, or other groups.

**No-ad.** A scoring system in which the first player to win four points wins a game. The score is counted 1 - 2 - 3 - 4, instead of 15 - 30 - 40 - game.

**Passing Shot.** A groundstroke hit out of the reach of an opponent at the net.

**Percentage Shot.** The safest, most effective shot hit in a particular situation.

**Poach.** Movement of a player at the net in front of his or her partner to hit a volley.

**Pro Set.** A match which is completed when one player or team has won at least eight games and is ahead by at least two games.

**Rally.** An exchange of shots.

**Receiver.** The player who returns the serve.

**Service Line.** The line that is parallel to and twenty-one feet from the net.

**Set.** That part of a match when one player or team has won at least six games and is ahead by at least two games. The set may continue until one player is ahead by two games, or a tie breaker may be played when each player has won six times.

**Sideline.** The boundary line that runs from the net to the baseline. The singles sidelines are closer to the center of the court than the doubles sidelines.

**Tie Breaker.** A method of completing a set when both players or teams have won six games. Nine-point (best of nine) and twelve-point (best of twelve) tie breakers are the most commonly used.

**Topspin.** The spin put on a ball by a racket when the ball spins or rolls forward like a car wheel going forward.

**Umpire.** The official for a singles or doubles match.

**Volley.** A shot hit before the ball bounces on the court.

## REFERENCES

- Brown, Jim. *Tennis: Strokes, Strategy, and Programs*. Englewood Cliffs, NJ: Prentice-Hall, Inc., 1980.
- Brown, Jim. *Tennis without Lessons*. Englewood Cliffs, NJ: Prentice-Hall, Inc., 1978.
- Gould, Dick. *Tennis, Anyone?* Palo Alto, CA: National Press Books, 1980.
- United States Tennis Association Education and Research Center Publications. Princeton, NJ, 1980.

approach (p. 331)  
arm action (p. 329)  
baton (p. 324)  
body alignment (p. 329)  
border positions (p. 325)  
check marks (p. 333)  
conditioning (p. 341)  
delivery (p. 335)  
discus (p. 338)  
distance running (p. 329)  
foot placement (p. 329)  
foot plant (p. 331)  
Fosbury Flop (p. 330)  
glide (p. 337)  
grip (p. 335)  
hang (p. 334)  
high jump (p. 330)  
hitch-kick (p. 333)

horizontal jumps (p. 332)  
hurdles (p. 327)  
lead leg (p. 327)  
power position (p. 340)  
the reverse (p. 338)  
safety (p. 343)  
shot put (p. 335)  
spin (p. 340)

sprint relay (p. 324)  
sprints (p. 323)  
the start (p. 321)  
stride speed (p. 326)  
take-off (p. 331)  
trail leg (p. 327)  
triple jump (p. 335)  
zone awareness (p. 326)

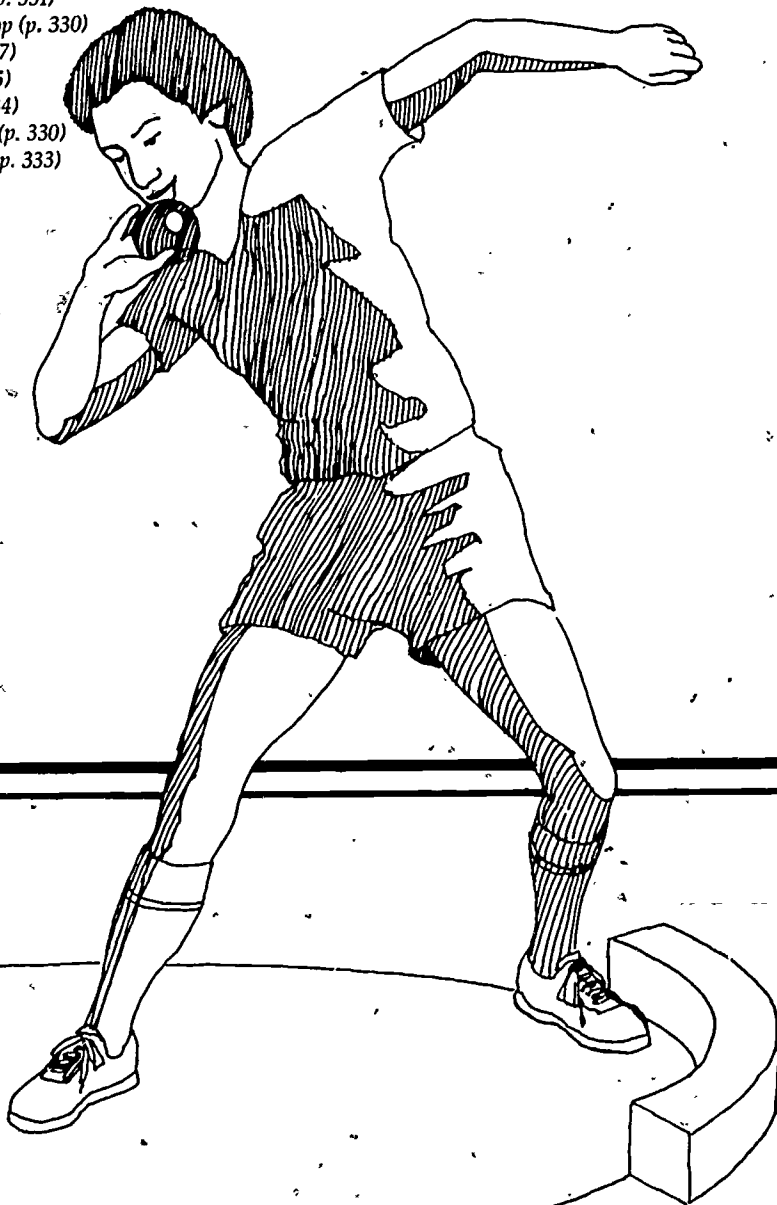

# Track and Field

LeROY T. WALKER,  
North Carolina Central University,  
Durham, NC  
and

SUZI D'ANNOLFO,  
West Hartford Public Schools,  
West Hartford, CT

## INTRODUCTION

*"Citius, Altius, Fortius"*  
*Swifter, Higher, Stronger*  
the Olympic Motto

The first Olympic Games took place in 776 B.C. in Ancient Greece. Male athletes participated in running events and throwing of the discus and javelin. Winners were awarded an olive wreath. Women participated in their own festival, the Heraea, which was held once every five years and featured a 100-foot race.

With the emergence of the Romans, the Olympic Games withered and eventually became a farce in 66 A.D. In 394 A.D., after 291 Olympic Games, Emperor Theodosius of Rome, a Christian opposed to pagan spectacles, formally abolished the Olympic Games.

The Modern Olympic Games were revived in 1896 by Baron de Coubertin, who authored the Olympic creed, "The important thing in the Olympic Games is not winning; but taking part. The essential thing in life is not conquering but fighting well." His plan was simple: Amateur athletes from all nations would gather every four years and compete in various sports. The champions of the First Olympiad received a gold medal and an olive branch.

Baron de Coubertin wished the Modern Games to be similar to the Ancient Games where the exclusion of women, as in the past, was a basic ingredient. Against the wishes of Baron de Coubertin, women's

track and field was initially included in the Olympic Games of 1928. The events included the 100 meters, high jump, discus, 400-meter relay, and 800-meter run. In 1932, the 80-meter hurdles and javelin were added, but the 800-meter run was deleted because it was "too strenuous" for women. The 800-meter run was not reinstated until 1960. While the 3,000, 5,000, and 10,000-meter races are collegiate events for women, the 1500-meter race was the longest event for women in the 1980 Olympic Games. The 1984 Olympic Games in Los Angeles will see the birth of the women's marathon.

## SKILLS AND TECHNIQUES

### THE START

Success in sprinting events depends upon natural speed as well as reaction time. An efficient start can make the difference in any sprint event. The fundamentals of the start involve three commands: (1) runners take your marks; (2) set; (3) go (the gun).

### Runners Take Your Marks (See Figure 1a)

The runner should stand in front of the blocks with the left foot about 12 to 18 inches behind the starting line and the right foot slightly behind the heel of the left foot. The right knee should be lowered to the ground next to the left foot; toes should be in contact with the ground. From this position, place the hands behind the starting line; the

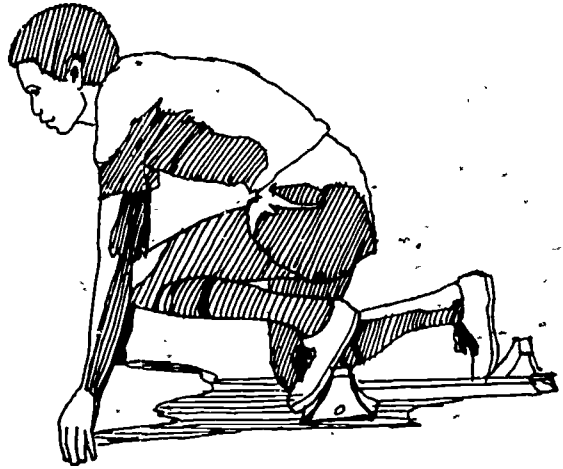

a. Take your mark.

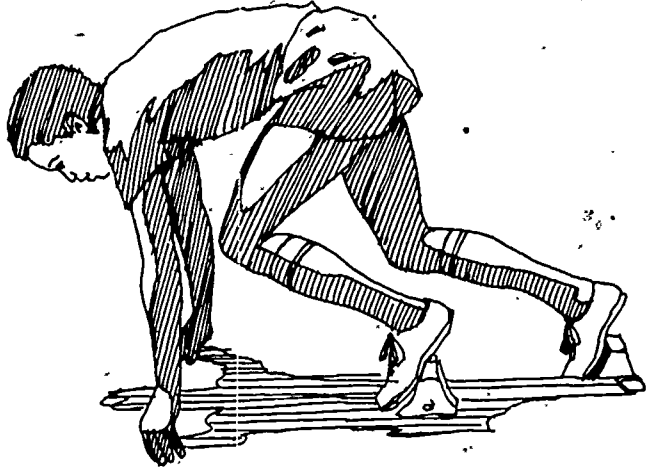

b. Set.

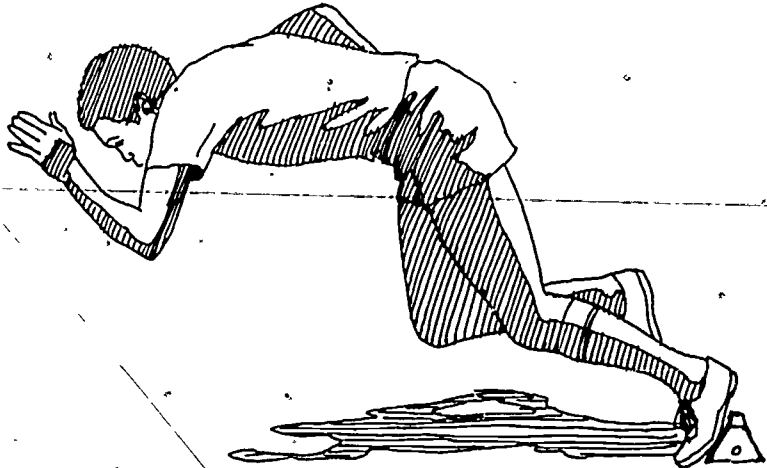

c. Go.

Figure 1. The start.

inside of the left elbow barely touches the left knee. The hands are spread shoulder width apart with the thumb and index finger placed behind the starting line and the remaining fingers bunched in back of the index finger. The fingers and thumb form a supporting arch. Body weight should be to the rear.

### Set (See Figure 1b)

The runner shifts his/her weight forward over the hands. The hips are raised to shoulder height as the back leg is parallel with the ground. The eyes are focused 8 to 10 yards ahead. Concentrate on the sound of the gun.

### Go (See Figure 1c)

React as quickly as possible to the sound of the gun. The rear leg and opposite arm explode forward as the other arm drives to the rear to hip height. The front leg drives off the block into full extension. The body angle is low and forward for about 10 to 15 yards. Emphasize force against the pedals of the block. Continue to drive the arms vigorously to aid in balance and power. Once a natural upright running position is achieved, elongate your strides.

### Drills

1. One on one, coach and athlete with the coach analyzing the start from the front, back, side, watches the position of the head, legs, shoulders, and arms.
2. To self-analyze foot placement and stride length, the starter uses chalk on the feet and works on the start, then by looking at his/her tracks, analyzes foot placement and stride length for efficiency.

## SPRINTS

Sprinting consists of two basic principles: stride length; stride frequency or rate of stride. Sprinting ranges from the short sprint (100 meters) to the long sprint (400 meters).

There are three basic parts of effective sprinting: the start, efficient running form, the finish. Each of these basic parts of the total sprint effort has essential demands which the sprinter must execute.

Sprinting form is a very individual matter because of different body builds; however fundamental running movements can be described in general terms of correct foot placement, arm action, shoulder and head angles, body alignment, and leg and knee action.

### Foot Placement

Emphasize the toes pointing straight ahead as opposed to in or out. To illustrate the importance of this, have the runner stand toeing out, and make a mark on the track; now have the runner rock back on the heels, rotate the toes straight ahead, and mark the track. The runner will see a difference of 1-4 inches between the marks. Efficient running saves steps.

### Arm Action

Arms are used for balance. As the right leg strides forward, the left arm comes forward, while the right arm moves back. The sequence is reversed when the left leg strides forward. Maintain a constant angle of the lower arm to the upper arm with thumbs up and the wrist and hand relaxed. The arm moves, driving the elbow forward and back, never passing higher than the armpit on the forward swing and never further back than 6 inches beyond the hips. Arms never cross the midline of the body.

### Shoulders

The shoulders should be relaxed. There should be little or no rotation.

### Head

The head should be straight ahead with the eyes focusing on the finish line. The face should be relaxed with the jaw hanging loose.

### Body Alignment

Have the runner raise up on the toes and lean forward just to where a loss of balance is not being maintained. This is the correct body lean. Forward lean is greatest when accelerating.

### Leg Action—Knee-Lift

Knees should come up close to parallel and straight ahead (don't permit the knees to rotate out or in). The sprinter should run on the ball of the foot, using a pushing action to get drive against the surface of the

track. Maintain stride length regardless of fatigue. Run relaxed. The faster the run, the longer the stride. When finishing the sprint race, run *through* and *lean* into the finish line.

#### Fundamental Drills

1. Arm pumping standing still, accelerating tempo—concentrate on angle and importance of arm action.
2. Foot placement—run on chalk lines or on a dirt track. Analyze foot placement for running efficiency.
3. Knee lifts—lean against the wall and do high knee lifts for improving leg reflex.
4. Do 40-yard sprints concentrating on high knee lift and drive from the track.
5. Quick knees—using the length of a football field, pump arms and knees as fast as possible for 5–10 yards; ease or slow to a stop and then repeat drill until length of football field is covered.

#### Sprinting Drills and Workouts

1. Practice relays working in groups of 5 at 100-meter intervals. Runners #1 and #5 are at the first station. Runner #1 runs a relay to Runner #2, Runner #2 to #3, Runner #3 to #4, Runner #4 to #5, Runner #5 to #1, and so on. Run relay continually over a given distance.
2. Roll-outs or Trains (see explanation in distance running training drills section).

3. Pole Progression or Ladders (see explanation in distance running training drills section).
4. Work from the blocks, accelerate 30 yards, and lean into the tape.
5. Run gradual downhill.
6. Run tall with proper body position.

Sprinting is a coordination of the start, proper running form and all its facets, as well as the finish. Each must be taught individually and built upon to develop proper running form to further efficiency of stride length and stride frequency.

#### Sprint Relay

The sprint relay is an event in itself. It involves four runners, each running approximately 100 meters. It is important for the four runners who make up a relay team to realize it is the relay *baton* which is getting timed around the track, not the sum of the four runners. The relay team members must possess a positive, aggressive attitude toward this race. All four runners need to understand baton handling, border positions, stride speed, zone awareness, and the finish.

#### Handling the Baton

So that the runner knows how the baton should feel in the hand, have the runner pick up the baton naturally from the ground, using the fatty part of the hand.

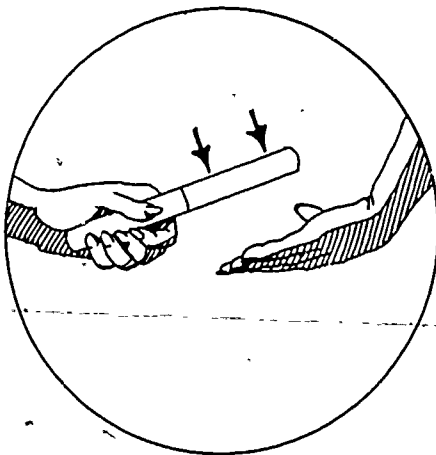

a. Palm up.

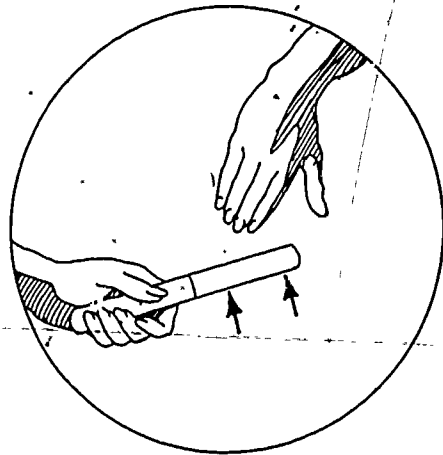

b. Palm down.

Figure 2. Exchanging the baton.

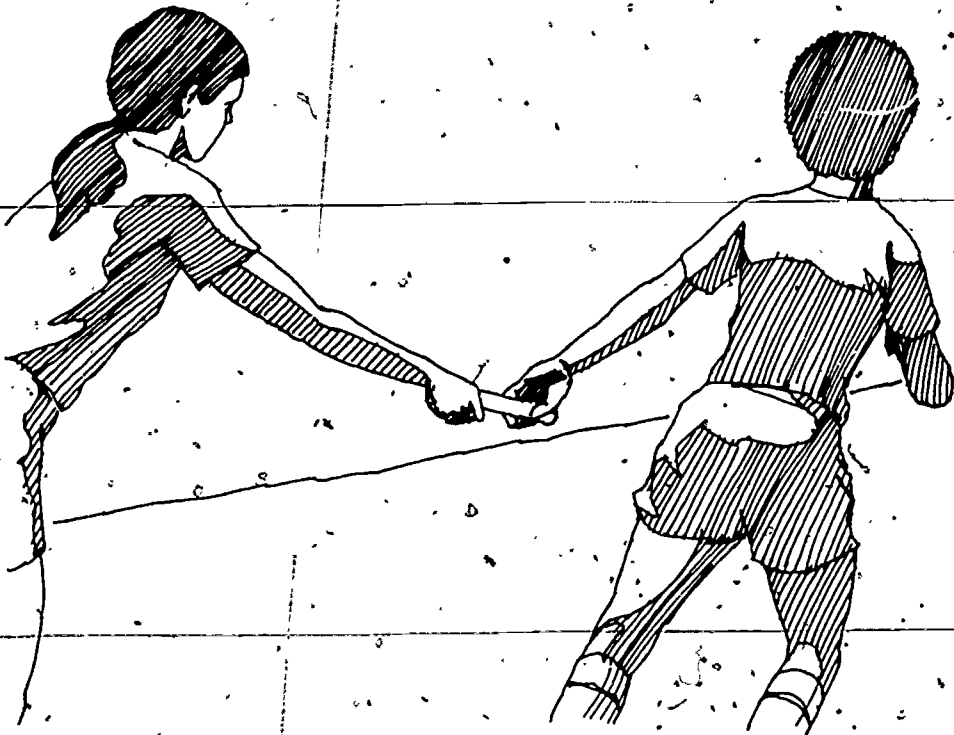

Figure 3.

The two basic methods of exchanging the baton are with the palm up or with the palm down (see Figure 2). Use the method that works best for the team.

In handling the baton, the following two facts should be remembered at all times: the baton is an extension of the arm (remember, the baton is being timed around the track, not the runners; by using the baton as an extension of the arm, many steps can be saved by the incoming and outgoing runners); the incoming runner should always "look" the baton into the next runner's hand (by keeping the eyes on the receiving hand of the next runner until the baton is placed firmly into the outgoing runner's hand—this will prevent any missed handoffs.)

#### Border Positions

The shortest distance around the track for the baton exchange in the sprint relay is right-left-right-left. Numbers 1 and 3 runners hold the baton in the right hands and numbers 2 and 4 runners hold the baton in

the left hands. There is not a change of hands by any individual runner; the hand used to receive the baton is the same one that a particular runner will use to hand off.

All four runners run borders of the lane (see Diagram 1). Numbers 1 and 3 runners run the curves, and thus, run the *inside* border of the lane, as this is the shortest distance around the track. Numbers 2 and 4 runners, who run the straightaways, run the *outside* border of the lane. Using border running, the baton is the only thing in the middle of the lane during the sprint relay.

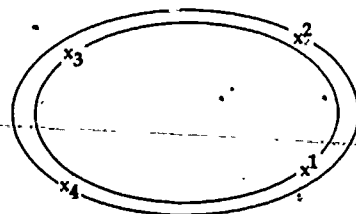

Diagram 1.

*Stride Speed (Acceleration and Transition)*

The incoming and outgoing runners must adjust their speeds so that a smooth baton exchange takes place. The incoming runner must keep up a consistent pace when approaching the outgoing runner. At the same time, the outgoing runner must develop the stride transition from a standstill to near maximum speed so that the baton exchange does not interrupt the running (stride) pattern of either the incoming or outgoing runner.

*Zone Awareness*

Each relay zone is 22 yards long. The baton exchange must be made within these 22 yards. However, the outgoing runner may begin a running pattern 11 yards before the official passing zone. This area is known as the international zone. The baton exchange should be made as close to the critical zone as possible (see Diagram 2).

*Selection of Personnel*

Selecting the four fastest runners won't always produce the fastest relay team; rather, it is how well the four runners work together. Some will have a natural feel for the baton exchange. The following general points should be kept in mind when selecting and placing relay personnel:

- #1 Runner—best starter—holds baton well in a good start—good curve runner—only involved in one handoff;
- #2 Runner—good straightaway runner—good competitor—handles baton twice;
- #3 Runner—good curve runner—handles baton twice;
- #4 Runner—reliable—can hold a lead or come from behind—knows the importance of running through the finish line.

Remember to incorporate the most workable combinations of runners and treat the sprint relay as a separate event.

*Drills*

1. Two students position themselves in border positions in a lane. #1 stands on the inside border; #2 stands on the outside border. |<sub>1</sub> |<sub>2</sub>| In a stationary position, practice handoffs with two people. The #1 runner uses a verbal command, i.e., "Red," to alert the #2 runner to position the hand for the baton exchange.
2. Repeat the above drill using four runners. |<sub>3</sub> |<sub>2</sub> |<sub>1</sub> |<sub>2</sub>| Runners 1, 2, and 3 use verbal commands to alert the next runner to position the hand for the baton exchange.
3. In a stationary position, all four runners synchronize arm pumping action; then begin the baton handoff from the #1 runner, using a verbal cue.
4. Repeat the above drill but jog around the track in close formation.
5. All four runners position themselves in their zones around the track. Jog through a complete relay concentrating on running borders, using the baton as an extension of the arm, and looking the baton into the next runner's hand.
6. Set up in relay zones and jog through a complete relay concentrating on the baton exchange being made within the passing zone. The incoming runner should give a verbal signal, "Go," for the outgoing runner to begin the stride and a second verbal signal, "Red," to prepare the runner for the baton exchange.
7. Repeat the above with increased speed until a smooth baton exchange is achieved within the passing zone.

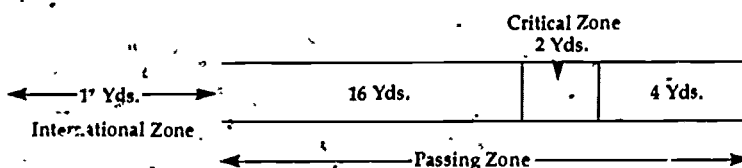

Diagram 2.



8. Practice in all lanes so that runners will be familiar with zones and runners' positions in relationship to their own.
9. Practice with people on either side of the lane to emphasize the importance of concentration and focus to the relay team.
10. Practice sprint drills with a baton.

#### Coaching Hints

The teacher/coach can minimize errors by observing the relay personnel from all angles. From the *front* and *back* angles observe:

1. border positions;
2. baton exposure (make sure the baton is the only thing in the middle of the lane);
3. body alignment (make sure the runner is running straight ahead, watch for body rotation);
4. position of incoming and outgoing runners;
5. hand position at exchange (the outgoing runner must keep a steady hand as the incoming runner plants the baton firmly in his/her hand);
6. *front* angle (the eyes of the incoming runner should be on the baton as it extends into the outgoing runner's hand. The teacher should not be able to see the whites of the incoming runner's eyes);

From the *side* angle observe:

1. the stride acceleration and deceleration of the runners;
2. extension of the arm on the baton exchange;
3. timing of the exchange;
4. body position.

#### HURDLES

Hurdling is a sprint event with seven or more obstacles. The hurdle race ranges from 80 to 400 meters. Regardless of a hurdler's build, the following three objectives apply to all hurdlers, to raise the center of mass as little as possible, to spend as little time in the air as possible, to return to the ground in a position to continue running as quickly as possible. Remember, it's speed along the ground that counts, not speed in the air!

#### Determine a Lead Leg

Using a low training hurdle, attempt to go over one hurdle to see which leg leads naturally. If there is no preference, use the left leg as it will serve as a definite advantage when running hurdles on the curve in the longer races.

#### Beginner's Drills

1. Walk over a hurdle; straddle it to see that the body fits over it.
2. Walk tall, on the toes with the knees high. This will permit the hurdler to improve posture and by doing so naturally raise the center of mass; when the hurdle needs to be cleared, the movement will be accomplished with greater ease.
3. Wall drills—(place tape on the wall, hurdle height). The following drills work on specific segments of the complete hurdling skill:

*Lead Leg*—the hurdler thrusts the lead leg toward the wall with the heel of the lead leg placed above the line. Emphasis should be on speed and aggressiveness (see Figure 4a).

*Arm Action*—add arm action to the above drill. The arms are kept fairly close to the body and involve a quick movement. The drive or lead arm is opposite the lead leg. The lead arm is brought slightly across the body as the lead leg is thrust forward. As the hurdler clears the hurdle (tape on wall), the lead arm exerts a quick movement as if opening a door. Keep the shoulders square as not to cause rotation of the body.

*Trail Leg*—place your hands on the wall for support. Draw the trail leg up with the knee driving up toward the chest, ahead of the thigh. The toes should be up to avoid hitting the hurdle on the follow-through (see Figures 4b and c).

#### Trail Leg Drills (work on side of hurdle)

Step in *front* of the hurdle with the lead leg (see Figures 4f and g). Then drive the trail leg up toward the chest and snap it down. Progression of this series of trail leg drills is:

1. walk tall with the knees high—exaggerate a marching motion over the side of the three hurdles;

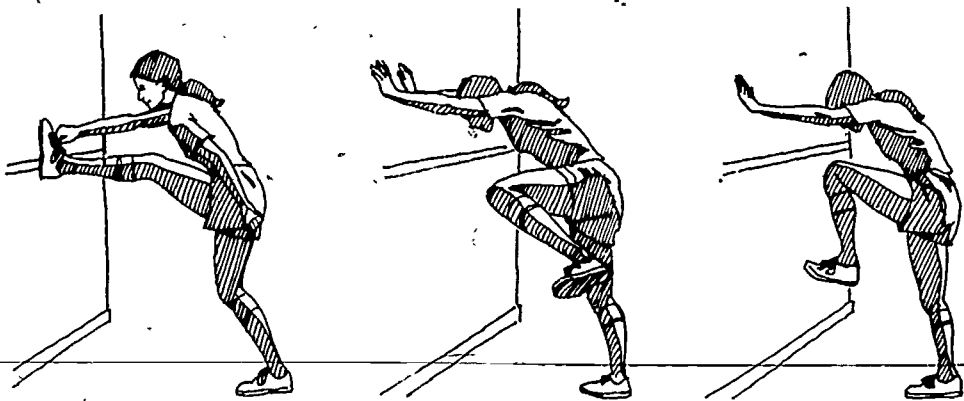

a.

b.

c.

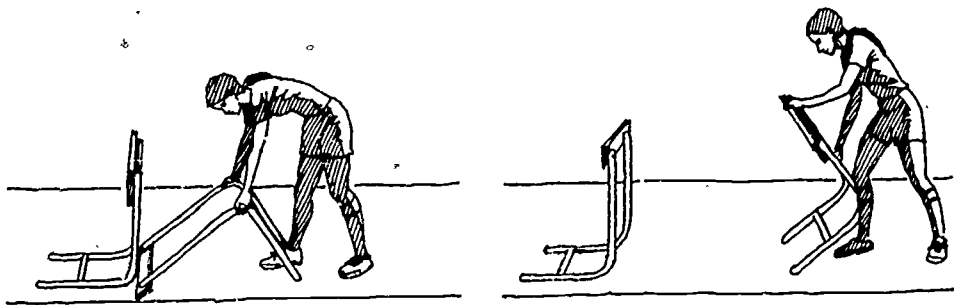

d.

e.

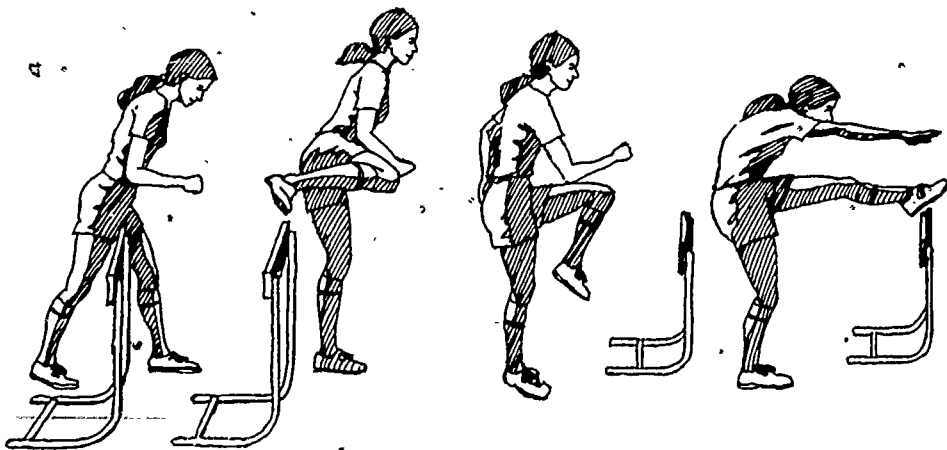

f.

g.

h.

i.

Figure 4.

2. add arm action over the side of the three hurdles;
3. jog over the side of the three hurdles;
4. run over the side of the three hurdles;
5. gradually add more hurdles as the hurdler progresses.

#### Lead Leg Drills (work on side of the hurdle)

1. With the lead leg, kick out and step past the side of the hurdle. Emphasize aggressiveness and speed (see Figures 4h and i).
2. Add the arm action.
3. Add more hurdles as the hurdler progresses.

#### Body Lean

When running over low hurdles, there is little or no body lean. Adjustments are made according to the length of the hurdler's legs.

#### Complete Hurdle Action

After working on the breakdown segments of the hurdling event, the student is now ready to attempt the complete hurdle action. Set up three hurdles at the correct racing distance on the track. Emphasize three steps between hurdles. The body *midline* should be in the middle of the hurdle so that the lead leg is to the right or left of the middle of the hurdle. This keeps the hurdler well within his/her own lane and avoids possible contact with the hurdler on either side. Emphasize acceleration and aggressiveness in the hurdle action. Add additional hurdles as the hurdler progresses.

#### Coaching Hints

1. Work on the start and getting to the first hurdle in control.
2. Snap the lead leg down and emphasize a quick step down with the trail leg to avoid floating or gliding over the hurdle.
3. Keep the shoulders square to avoid upper body rotation.
4. Throughout the hurdle race, focus attention on the top of the next hurdle.
5. Do flexibility exercises to increase the efficiency of the trail leg.
6. Remember that hurdling is a sprint event.

#### DISTANCE RUNNING

Distance running ranges from 800 meters to the marathon. In track and field classes, the 800-meter run (twice around the track) and the 1500-meter run ( $3\frac{3}{4}$  times around the track) are generally included.

All distance running programs are based on adapting to graduated stress on the body. Runners should start by building a broad base through slow intervals with short recovery periods and great quantities of running at much slower than racing pace. Distance runners should run relaxed, concentrating on a steady, even-paced rhythm.

The basic essentials of efficient running involve:

1. *Foot Placement*—the feet should be pointing straight ahead, not in or out. The sequence of the foot striking action is "Ball (outer edge), Heel, Ball."
2. *Arm Action*—the arms play a balancing role in running. The arms should be kept at about a 90° angle with the thumbs up. As the arms move forward and back in opposition, they should never pass higher than the chest on the forward move and never further back than the hip. The arms should never cross the midline of the body.
3. *Body Alignment*—once running speed is achieved, the body angle tends toward the perpendicular. The body is held almost erect with the shoulders and face relaxed. There should be little or no rotation in the upper body.
4. *Stride Length*—the slower the speed of the run, the shorter the stride. Conversely, the faster the run, the longer the stride. Longer strides require more energy. In distance running where economy of energy is important, runners should take *natural* strides.
5. *Breathing*—the runner should keep the jaw relaxed and breathe through the nose and mouth simultaneously.

#### Training Drills

1. *Train work*—runners form a line with the leader being responsible for the pace. At stipulated intervals, the last person in line sprints to the front and settles into a pace as the leader. The train

continues until everyone has been a leader a specific number of times or until a specific distance is covered.

2. Variation of trains—see how many times each person can be the leader within a certain distance.
3. Ladders or Poie progressions—(a) select a partner of equal ability and alternate running the following distances—100, 200, 300, 400, 500, 600, 700, 800, 900 meters and reverse beginning with 800 meters and working down to 100 meters (on reverse ladder, change directions). (b) same as "a" but select three other runners of equal ability and run in pairs. The pairs alternate distances with one pair doing a 100; as soon as they finish, the other pair runs it, etc. The rest time for alternating pairs is the distance just completed. (c) group all runners by ability (usually three groups) and run ladder distances one group at a time as fast as possible. This permits a greater recovery period.
4. Long sprints—group all runners by ability (3 groups). Run 400 meters, one group at a time. Repeat 5 times.

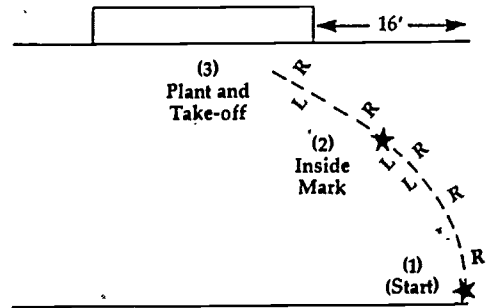

Diagram 3.

### Coaching Hints

1. Although aware of other runners around, concentrate on maintaining individual rhythm.
2. Pumping the arms will take considerable stress off the legs and make running more efficient.
3. Run relaxed, maintaining stride length and stride frequency.

### HIGH JUMP

The Fosbury Flop has quickly become the most popular form of high jumping and

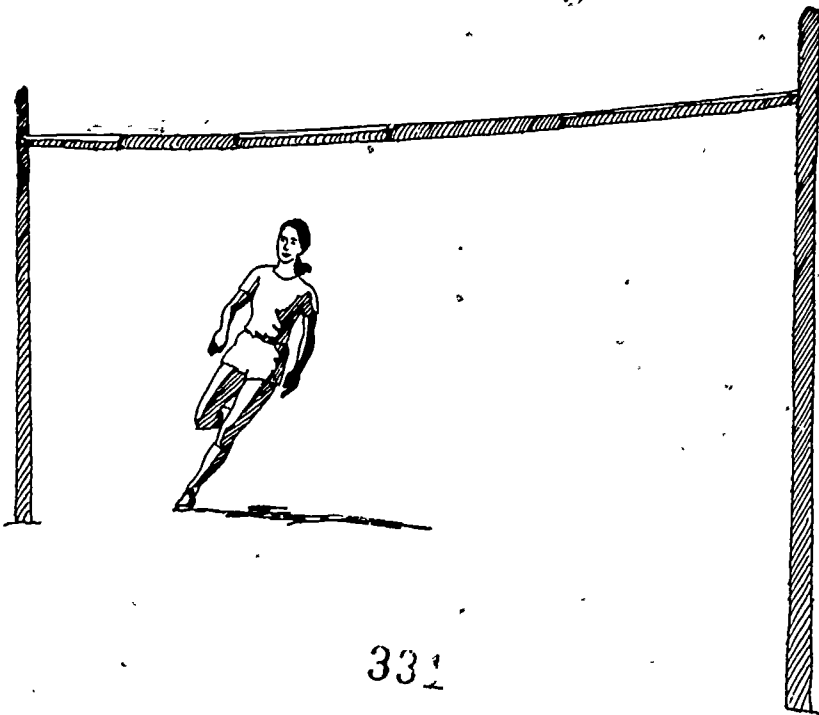

Figure 5. The high jump approach.

involves four major areas: approach; foot plant; take-off; bar clearance.

The high jump basically involves transferring horizontal velocity to vertical velocity. The essential movement is upward rather than forward. Speed and rhythm must be maintained throughout the entire technique.

### Approach

The approach to the high jump follows a "J"-shaped curve involving 7-11 steps from the take-off (see Diagram 3). Three marks should be established by the high jumper: start; inside mark; foot plant; take-off.

Approximately five steps from the start, the jumper should lean left as curving in begins, thus bringing the body almost parallel to the cross bar (see Figure 5). The jumper should initiate the curve of the approach with the right foot so that cross-over steps on the curve do not have to be used. The next to the last step should be long to lower the center of gravity, and the arms should be gathering for the double arm lift.

### Foot Plant

Only one foot may be used for the flop take-off. Most right-handed people push off with the left foot. The left foot should be planted heel first between the near pole and the middle of the bar; the foot should be pointed toward the far pole.



Diagram 4.

### Take-off

The take-off involves converting forward momentum to upward momentum. At the time of the take-off, the arms drive up to shoulder height and the bent lead knee (right) drives upward until it is parallel to the ground. This raises the center of mass and rotates the body so that the back is to the bar (see Figure 6).

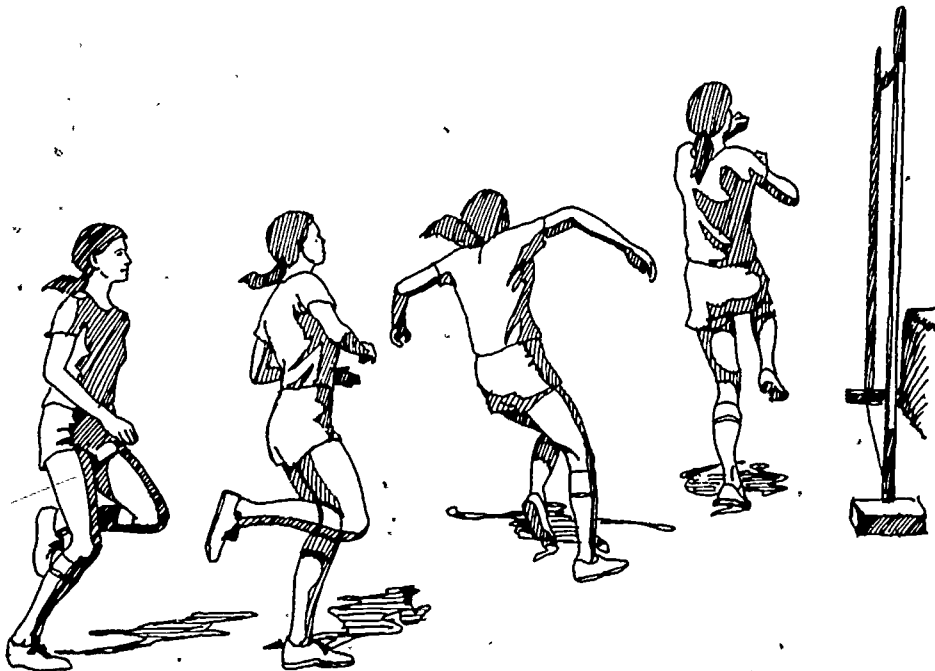

Figure 6. The high jump take-off.

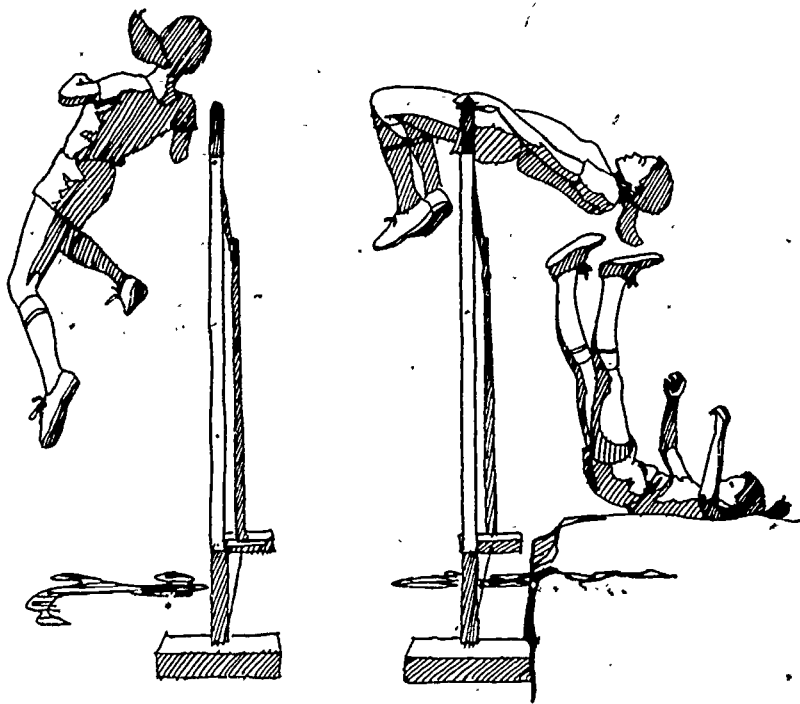

Figure 7. Clearing the bar in the high jump.

### Bar Clearance

The jumper arches the back to clear the bar, going over head first. The jumper should not reach out over the bar with the hands. As the torso clears, the knees and feet should be whipped up. When the hips are clear, it is often helpful to raise the arms, which in turn help to raise the feet. Again, maintain speed and rhythm throughout the entire technique (see Figure 7).

### Coaching Hints and Drills

1. Raising the center of mass as high as possible over the bar is the most important factor in the flop. Thus, the techniques of the approach, plant, and take-off should be practiced much more than the technique of bar clearance. (Work on leg and arm lift and bounding drills on the grass.)
2. If the jumper is hitting the bar on the way up (caused by reaching maximum height too soon, he/she is taking off too close to the bar).

3. Conversely, if the bar is being hit on the way down, the jumper is taking off too far from the bar.
4. To eliminate leaning into the bar, the jumper should press the inside shoulder up.

### THE HORIZONTAL JUMPS: The Long and Triple Jumps

The long and triple jumps are quite similar to one another, yet the two are in some aspects quite different. Both have four phases: the approach run; the take-off; in-flight; the landing. However, the triple jump has three take-off phases, one each in the hop, step, and jump phases and also three in-flight phases.

#### The Approach

In both horizontal jumps, the approach run is most critical. A successful, well-executed jump cannot be done without a smooth, relaxed, and controlled approach run.

The approach run length varies from 100 to 140 feet (with an average of about 120 feet). The length of the approach run is influenced by the basic speed and quickness of the jumper. The speed of the approach run is usually about 75-80% of the full speed of the jumper with a gradual acceleration from the starting check mark. It is necessary to retain the speed until the take-off.

Most jumpers in their speedy, relaxed, controlled approach run tend to shorten the last three strides before take-off to avoid a stretching action for the board. The stretch action at the board will place the body weight too far behind the take-off foot. This will tend to act as a breaking force to the good forward speed and will also limit the lift from the take-off board.

Determining the check mark to guarantee successful striking of the take-off board requires special attention to detail. One check mark at the beginning of the approach is preferred so that the jumper can concentrate on the relaxed sprint effort. To achieve the end of using only one mark, six steps should be followed in determining the start of the approach run.

1. Measure on the track the number of feet from a take-off point which according to the speed of the jumper would be required for effective jumping. Mark that point on the track.
2. Beginning at the designated point, sprint with gradual acceleration toward the line which represents the take-off board. Do this approach a dozen or more times, with occasional rest periods to permit time for recovery. Check each approach run for relaxation and gradual acceleration at nearly full effort.
3. Mark the strike point near the edge of the runway nearest to the take-off line.
4. Draw a line where the cluster of marks are made. If the cluster is not in line with the board, measure the distance from the line to the imaginary board.
5. Move the tentative starting check mark forward or backward the same distance measured from the cluster of marks to the take-off board.
6. Measure the exact distance from the newly established check mark to the

take-off point. This is now the distance which should be established on the runway.

#### The Take-off

The jumper must attempt to get sufficient height at take-off to allow time in the in-flight phase to execute leg extension. However, height alone is not enough. The action at take-off is a forward-upward lift.

Four essential points must be emphasized in executing the take-off:

1. The shorter last stride permits a slight bend of the take-off leg. A powerful extension of the bent leg provides a forward-upward lift from the take-off board.
2. The foot should strike the board firmly in a "flat foot" position. In this action, the heel lands first, but there is no attempt to execute a heel-ball-toe rock-up action.
3. The body weight should be directly over the board as the take-off foot strikes it, but it should be very slightly in advance of the take-off foot as the jumper leaves the board.
4. The final thrust into the air results from running off the board.

The jumper should stride off the board in a sprint action. The body weight must be moved slightly forward with the head high and with the eyes focused on some imaginary spot high and beyond the pit. The chest should be elevated. The knee opposite the take-off leg is thrust forward and high as the arms move vigorously in a counterbalancing action.

#### Flight

The two styles most frequently used by jumpers are the hitch-kick (running-in-the-air) and the hang.

#### Hitch-kick (Running-in-the-air)(See Figure 8)

Running in the air is a reaction fight against the downward pull of gravity. There is no gain in the momentum, but the style does reduce the difficulty of holding the legs up and helps to bring the body to the correct position at the right time.

The running-in-the-air technique or hitch-kick requires:



Figure 8. The hitch-kick.

1. Driving the knee of the free leg high as the take-off leg stretches down.
2. Stretching the free leg straight forward, down, and then bending it as it passes back under the body.
3. Snapping the take-off leg quickly forward in the same manner as the free leg was moved in the take-off action.
4. Bringing the heel of the leg which began the running action (free leg at take-off) adjacent to the heel of the take-off leg, holding the head up with the eyes focused straight forward.

The arms must be kept high and moving as they do in sprinting action. The chest must be elevated. The upper body must be kept erect and the head high.

#### The Hang (See Figure 9)

The hang style is used mainly by jumpers with great lift. The hang style requires excellent timing.

The flight action in the hang is as follows:

1. The free leg is stretched straight forward and then dropped beneath the body.
2. The take-off leg is thrust forward from the board to a position next to the free leg.
3. The arms drop back to the side.
4. The trunk is held erect, the head high, and the chest is lifted.
5. The legs whip forward and upward in a vigorous stretching action.
6. The arms press forward and downward in the landing position.

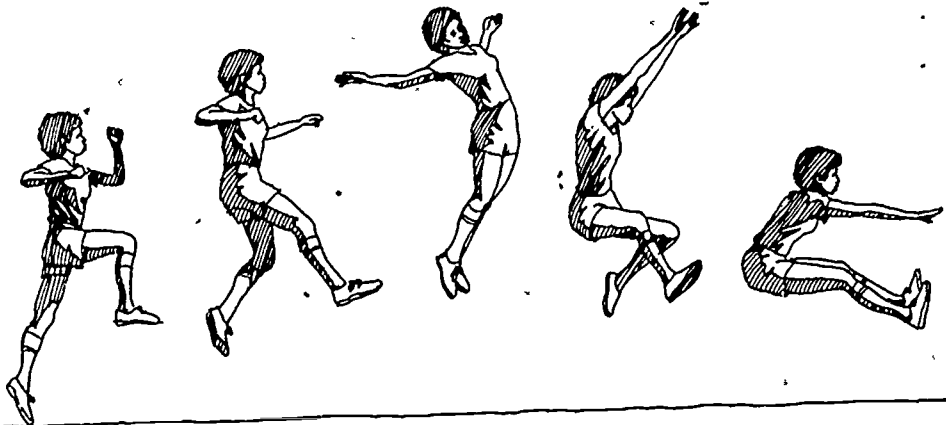

Figure 9. The hang.



**Landing**

It is important that the jumper not bend the trunk toward the thigh until the last moment before the legs are extended for landing. When the jumper hits the pit, the chest should be thrust forward as the knees are flexed.

At the moment of contact with the landing surface, the feet must be extended as far as possible in front of the body. The arms should be pressed forward and downward.

**THE TRIPLE JUMP**

There are some major differences between the long jump and the triple jump (see Figure 10). In secondary schools, the long jumper will usually be expected to double in the triple jump. Therefore, the jumper must understand the basic differences in the performance of the long and triple jump. These differences must be carefully practiced after the approach, take-off, flight, and landing phases of the long jump have been thoroughly learned.

The developing jumper should carefully consider seven basic differences in the technique of the long and triple jumps.

1. The body lean at take-off is more pronounced in the triple jump.
2. The take-off (for the hop) is executed low with minimum elevation. The head up, and eyes focused forward, are common to both.
3. The body position and elevation changes in each flight of the triple jump in contrast to the single flight of the long jump. The changes in the triple jump are from a very slight forward lean at take-off in the hop to a nearly erect position in the jump. With each increase in height, careful attention must be given to sustaining the forward momentum.
4. The triple jumper must master a coordinated, synchronized bending and unbending of the knees in the three flights as compared to the single action of the long jump.
5. The distance factor in the triple jump is influenced by the execution of three distinct flights instead of one. The step flight is the one that most often requires

lengthening. The complete pattern must be considered when adjusting any flight distance.

6. The stronger (best) jumping leg should be used in the third phase of the jump. Arrange the three phases to place the jumper in position for a strong final jump.
7. The triple jumper must establish a pattern of distance for each phase of the jump. The established ratio for the phases will provide a measuring rod to determine which phase is inadequate.

**SHOT PUT**

A good shot put performance demands an appropriate blend of speed and quickness, a high degree of explosive power, great strength, good height, and motivation. Effective shot putting involves a simple and natural movement coupled with a coordinated drive of the legs and thrust of the back with arm delivery.

The logical order of progression in practice of the shot put should be: developing the proper grip; developing the correct stance and making the delivery; practicing the glide across the circle; integrating the putting technique.

**The Grip**

The shot is held in the hand so that it presses against the base of the fingers reducing tension and permitting the full range of the fingers in the snap release. The fingers may be placed together or slightly spread. The shot may be gripped by placing the first three fingers together and using the small finger and thumb to hold it in position. The wide finger spread is recommended for putters with small hands. The spread should not be exaggerated to the point that the fingers cannot be used to give impetus to the shot. Beginners should carry the shot lower down in the palm of the hand until greater strength is developed.

**The Delivery**

Early practice of the delivery should be done in a correct stance at the front of the circle. The delivery is a sequence of coordinated movements from the foot to the tip of the fingers.

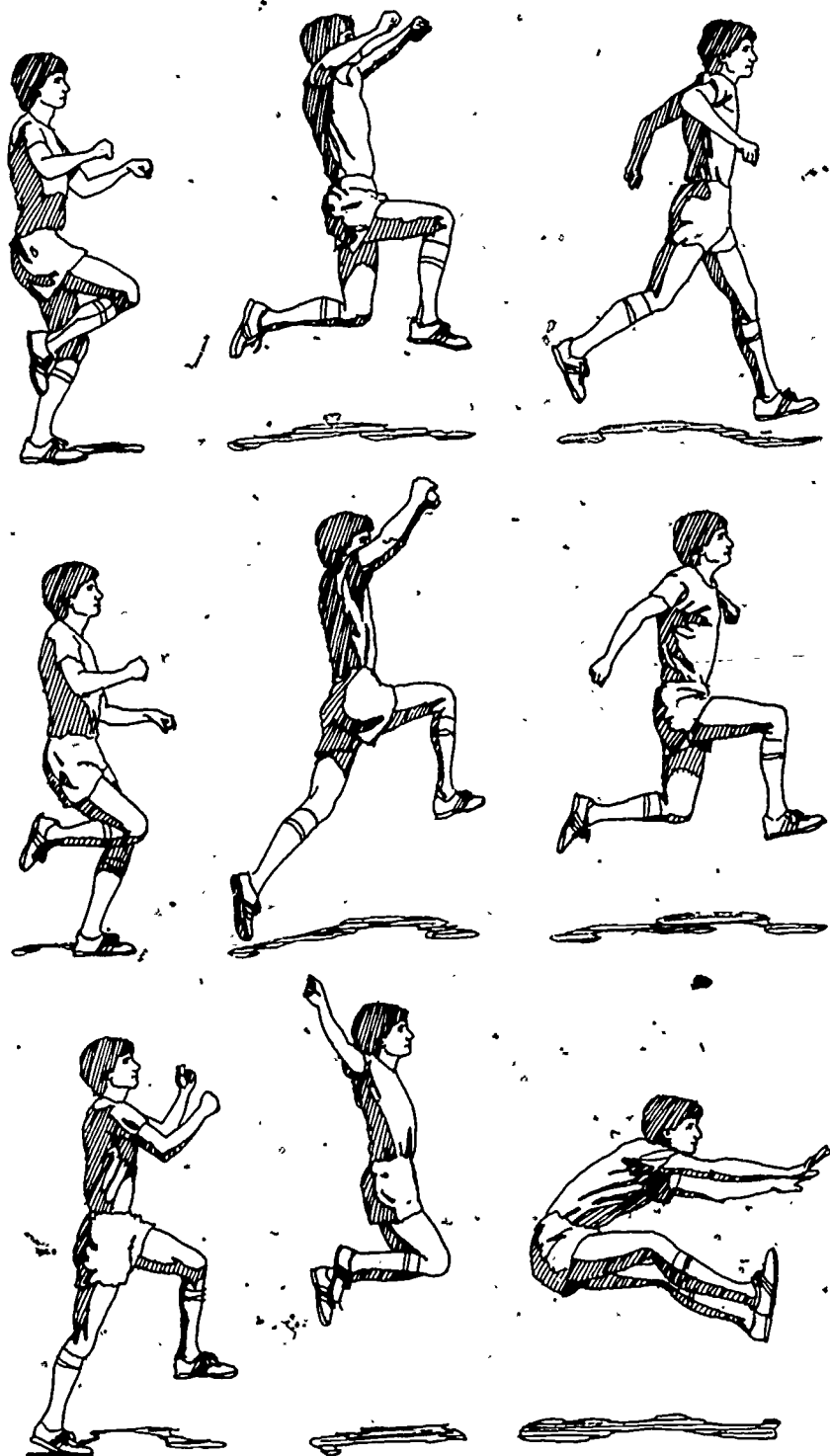

Figure 10. The triple jump.

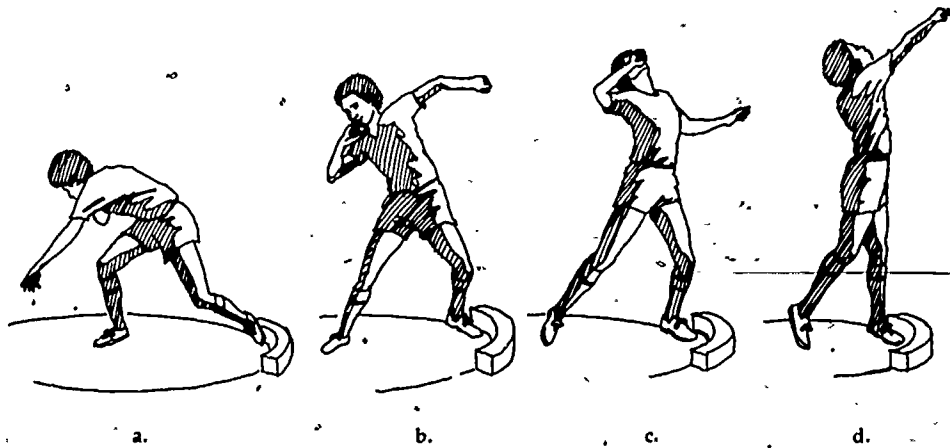

Figure 11.—The shot put delivery.

The right foot is placed in the middle of the circle at approximately a 45° angle to the flight of the shot. The knee is slightly flexed with the body weight over the right leg, which is well under the body. The center of gravity is far enough over the right leg for maximum drive (see Figure 11a). The right leg is vigorously extended to begin the force which moves up the leg, to the hips, to the trunk, and to the arm for the final delivery with a snap of the wrist (see Figures 11b-d).

The left leg serves as a brace against which the force is exerted. The foot of the left leg is against the toe board. The right foot remains on the surface and continues to deliver power in the delivery.

#### The Glide

The glide is used to travel from the rear of the circle to the correct position for delivery. The glide begins by standing at the rear of the circle with the back to the direction of the put. The glide must begin with the athlete in good balance.

From the erect, relaxed, balanced position at the rear of the circle (see Figure 12), the athlete lowers the head and shoulders by flexing the hips to a position in which the back is nearly horizontal. The eyes are focused on a spot directly behind the circle; the right knee is bent to a point which will give the greatest lifting power, and rocks forward until the weight is over the ball of the right foot (see Figure 13a).

Momentum is generated by moving the weight of the body toward the toe board. Additional momentum is gained by driving off the right leg and ball of the foot as the

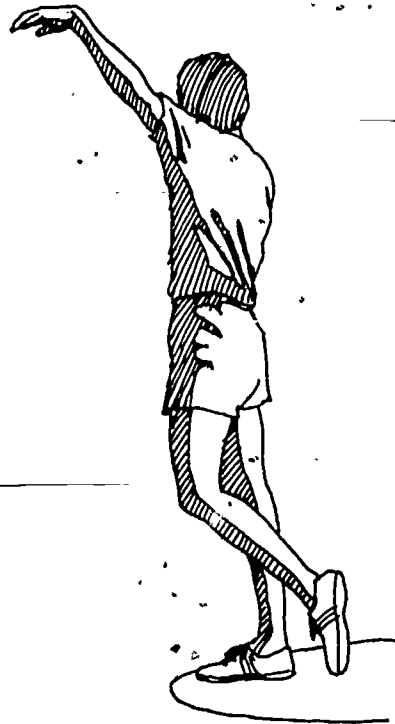

Figure 12.

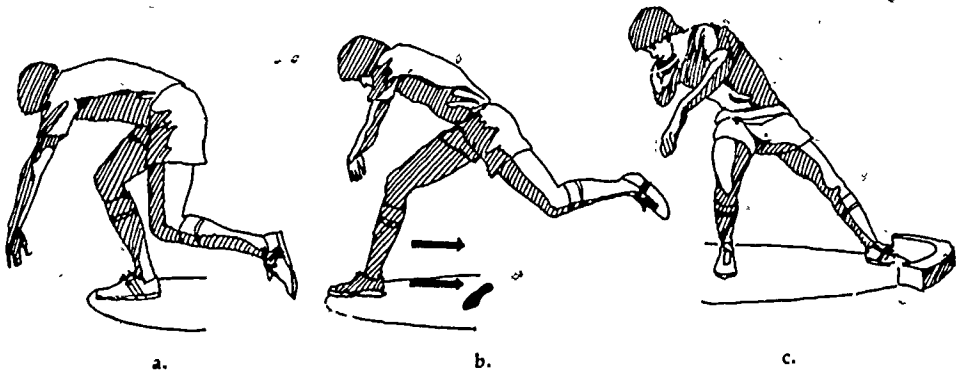

Figure 13.

left leg engages in a piston-like motion. The piston-like motion is achieved by first bringing the knee forward, then vigorously extending it straight back and down toward the toe board (see Figure 13b). The hips should remain low. The entire action should be made with the legs rather than with the upper body. The left leg, as indicated, lands against the toe board to the left

center of the circle (see Figure 13c). At the end of the glide and turn in position for delivery, the stance should be the same as the one assumed at the front of the circle during earlier practice sessions without the glide (see Figures 11b-d).

#### The Reverse (See Figure 14)

The purpose of the reverse is to prevent a foul after completion of a powerful delivery. The reverse is completed by switching the feet. The rear foot replaces the front foot by placing the outer edge of the rear foot at the inner edge of the toe board. The body weight is shifted back after the landing, but not until all power is delivered.

#### DISCUS

The logical order of progression in learning how to throw the discus is: developing the proper grip; developing the correct stance and release; practicing the spin across the circle; integrating the throwing technique. Throwing the discus is a combination of balance, power, speed, control, and timing.

#### The Grip

Have the athlete place the discus in the non-throwing hand. Place the palm of the throwing hand on top of and in the middle of the discus. Only the first joints of each finger should come over the edge of the discus. The thumb is placed at the edge of the discus but does not come over the discus rim. The thumb in this position is

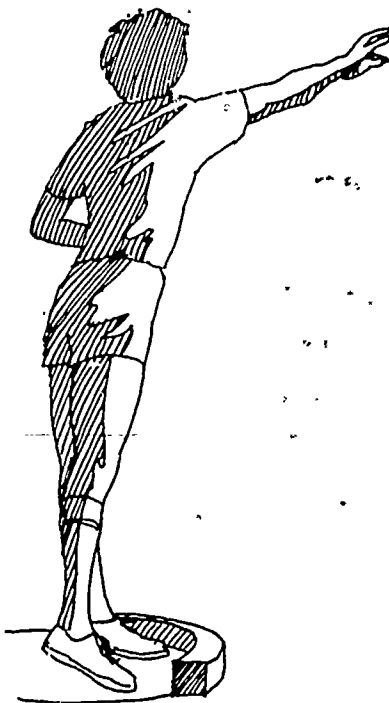

Figure 14. The shot put reverse.

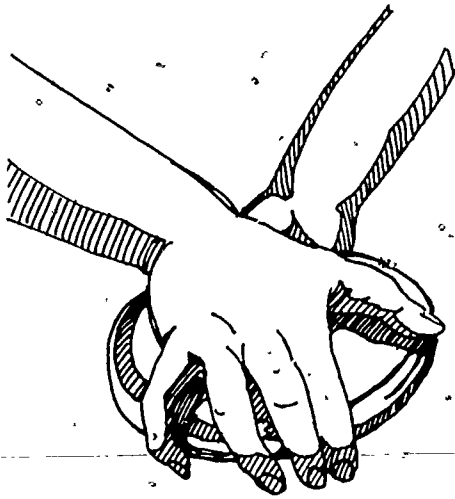

Figure 15. The discus grip.

pressed against the discus. Basically there are two ways that the fingers can be positioned on the discus. The fingers and thumbs are spread out, the index finger and middle finger are placed next to each other

with the other two fingers and thumb spread out on the discus (see Figure 15).

#### Release from the Hand

Primarily the discus is released off of the index finger and the discus rotates in a clockwise manner.

*Drill.* Rolling the discus (using the lines on a football field or any lines on the gym floor). To do this the athlete takes 4-5 steps carrying the discus extended down at the side, swings, and releases the discus down the line. (The action is similar to a bowling movement.) The discus should travel in a straight line. This movement is essentially the same as a release from the throwing position in that it comes off the index finger last.

#### Back of Ring (See Diagram 5 and Figure 16)

Both feet are at the back of the circle. The left foot is placed on the center line instead of having to straddle the line. Starting off in this position allows the athlete to use more of the circle and more of a circular motion, creating a greater velocity of the discus.

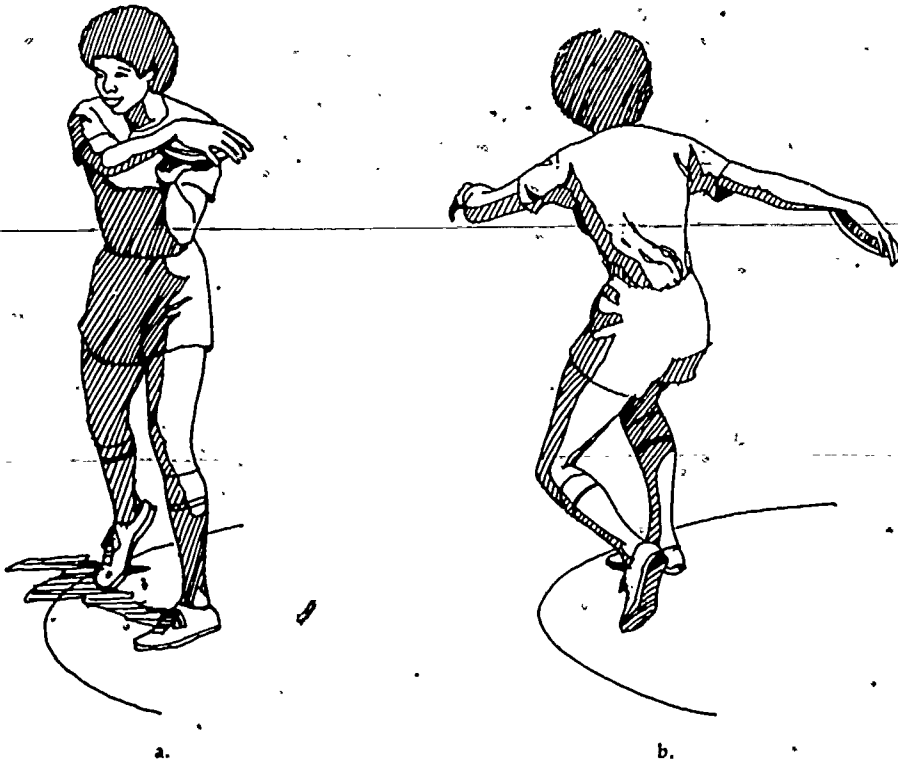

Figure 16.

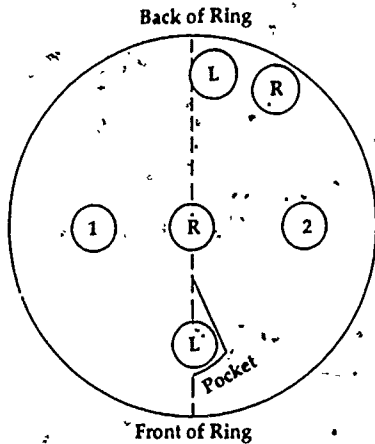

Diagram 5.

Coaches should note that 70-80% of all mistakes in the circle occur in the back of the circle.

#### Power Position

Place the right foot on the middle of the circle. Rotate the foot so that the toe is

pointing at about 10 o'clock. Weight is balanced on the flexed right leg. The left foot should land in the pocket. The toe of the left foot should be just about even with the right heel if not back a little, with the leg slightly flexed and relaxed. The feet are a little more than shoulder width apart (see Figure 17a). This is done so that when the athlete rotates the hips, he/she will be open to the throwing area. The hips constitute the direction of the discus (see Figure 17b).

#### Moving through the Circle

As the athlete moves through the circle, thought should be "slow, then fast with increasing speed," or just "quick." Be careful not to decelerate.

#### Spin

Always stay on the toes and rotate. The athlete must be active with the lower body and passive with the upper body.

1. Swing the right leg and foot around, keeping the leg ahead of the shoulders.
2. Relax muscles to get the right leg around, keeping the spread between the

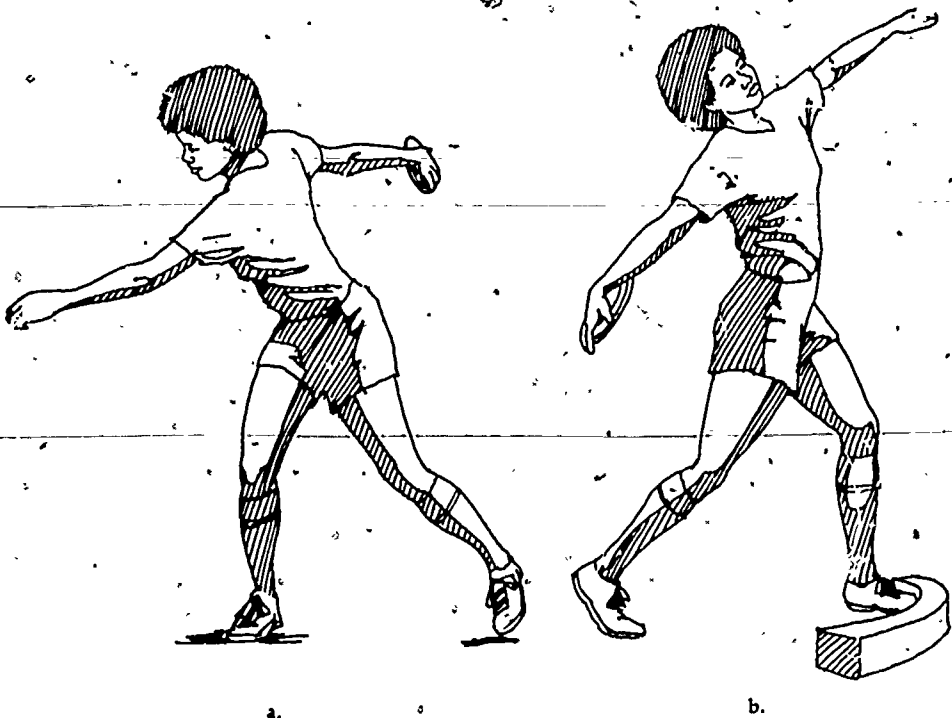

Figure 17. The power position for throwing the discus.

right leg and left leg on the first turn (pretend there is a bar between the two legs like a sprinter's running form—see Figures 18a and b). (a) legs and hips lead the movement to the key torqued position (see Figure 17a), (b) from the balance position, the body is accelerated across the ring by driving across the ring with the left leg.

3. The right foot is put down on the center of the circle. The right foot is turned upward prior to landing to ensure an early pivot and to keep the hips ahead of upper body for torque. (Stay on the toes and rotate.)
4. The hips must remain ahead of the shoulders and the discus, creating torque. (Torque: the difference between the hips and the shoulders which build up or make up an "X.") (See Figure 17a.)
5. Go into the power position. The upper body and discus are turned toward the right with the discus over the left heel (a torqued position).
6. Then release (see Figures 18c-e).

#### Finish (See Figure 18f)

1. Finish in a 360° rotation, facing the front of the ring with the knees flexed and feet apart.
2. Replacing the left foot with the right foot and lowering the center of gravity completes the release.

## CONDITIONING

Effective physical and mental conditioning provides a solid foundation for success in track and field performance. Three general areas make up physical conditioning: flexibility; strength; endurance.

### FLEXIBILITY

Flexibility or stretching exercises should be done before and after daily activity. Flexibility exercises increase the blood supply to the muscles making them more pliable and resistant to injury. Begin with the head and work down to the feet, rotating each joint and *gradually* stretching each large muscle group.

All flexibility exercises should be gradual movements to the point of resistance (slight tightness) and then held at that point for a minimum of 10 seconds. This is known as *static stretching*. Avoid jerky, rapid movements during warming up and cooling down. Stretching exercises are based on principles of progression, from gentle to strenuous exercises, large muscle areas to smaller areas, back area before legs. Each exercise should not be rushed; go through the full range of motion. Focus on "feeling" the stretch of each muscle group. The importance of stretching during the cooling down period at the end of activity is to reduce the lactic acid level in the body and to avoid stiffness the following day.

### STRENGTH

One of the major contributing factors in any sports performance is strength. Gains in strength are the result of three factors: the amount of stress or work that is applied to the muscle; the amount of time the muscle is under stress; the frequency (number of times) that stress is applied to the muscle. The muscle attempts to build up an immunity to stress or work by becoming stronger.

Weight-training is one of the most popular forms of strength-training. Three results can be achieved through weight-training: *increase in muscular strength* by performing a low number of repetitions with a high weight; *increase in muscular endurance* by using a lighter weight and increasing the number of repetitions; *improvement in power*—using a high weight and low repetition, the lifting movement is *explosive*. This result is a combination of force and speed and training for it is especially helpful when jumping or throwing.

Each activity in track and field involves different levels of strength. Some require more upper body strength (throwing) and some more lower body strength (jumping). However, overall strength-training will contribute to general sports performance.

### ENDURANCE

Endurance can be increased by overloading the cardiovascular system (heart) by

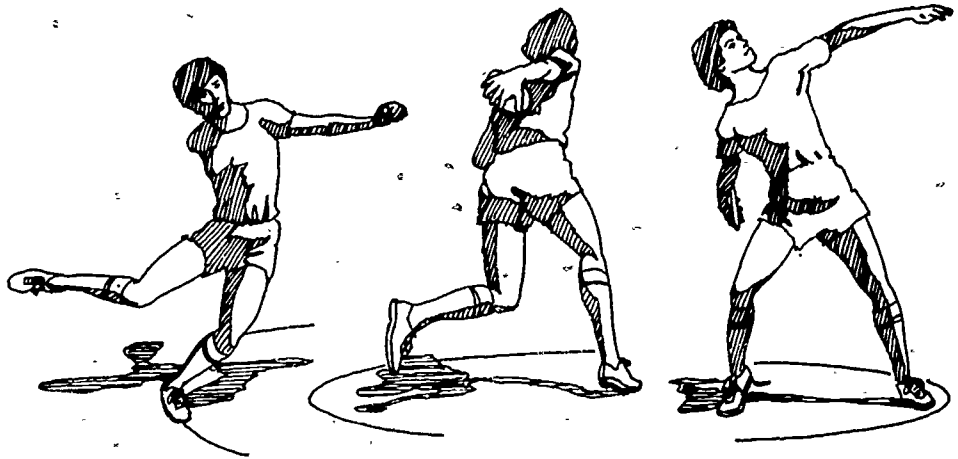

a.

b.

c.

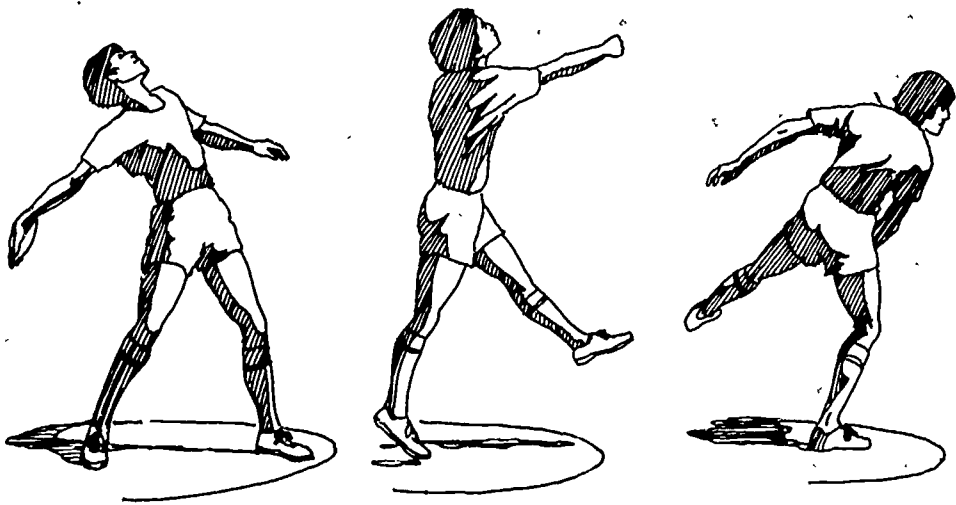

d.

e.

f.

Figure 18. The discus spin



doing an activity longer than usual and raising the pulse level. Examples of endurance work would include distance running.

Each activity in track and field involves different levels of flexibility, strength, and endurance. Overall conditioning should be done by all students with specific additional conditioning for particular events.

### MENTAL CONDITIONING

The track and field participant should practice blocking out what is occurring in the environment and learn to focus on the particular task or event at hand. He/she should learn to "listen" to the body and should practice visualizing each complete event prior to attempting it. At all times, "think positively and try to do your best."

### SAFETY

The key to safety in track and field is to *look* before you move.

1. Before walking onto the track, *look* to see that you are not walking into the path of a runner or hurdler.
2. Before walking into the throwing area, *look* to see that someone isn't in the shot or discus circle.
3. Before going into the jumping area, *look* to see that you are not walking into the path of a jumper.
4. If preparing to throw an implement, *look* first to see that the area is clear. After throwing the discus or putting the shot, do not stay out in the field and throw the implements back to the next participant.
5. If walking during a recovery phase of a workout, move either to the outside lane or completely off the track.
6. If sprinting or being timed in the inside lanes and approaching someone either walking or jogging in the same lane, yell, "track," to signal that person to move to a middle or outside lane.
7. *Look* before walking between hurdles to be sure that the hurdler's run is not being interrupted.
8. Do not leave implements (shot, discus, hurdles, tape measures, or other obstacles) on the track or field where someone could trip on them.

- attack lines (p. 361)*
- back set (p. 350)*
- base defense (p. 359)*
- block (p. 357)*
- cross-court spike (p. 354)*
- dig (p. 348)*
- dink (p. 355)*
- down-the line spike (p. 354)*
- float serve (p. 350)*
- 4-2 (p. 358)*
- free ball (p. 358)*
- heel plant (p. 354)*
- mintonette (p. 345)*
- off-hand spike (p. 355)*
- on-hand spike (p. 355)*
- opening up (p. 356)*
- overhand floater serve (p. 350)*
- overhand pass (p. 348)*
- power alley (p. 360)*
- serve (p. 350)*
- serve reception (p. 355)*
- set (p. 348)*
- spike (p. 352)*
- spike coverage (p. 357)*
- two-foot take-off (p. 354)*
- 2-1-3 (p. 360)*
- underhand pass (p. 345)*
- underhand serve (p. 350)*
- W-formation (p. 355)*
- wrist snap (p. 354)*

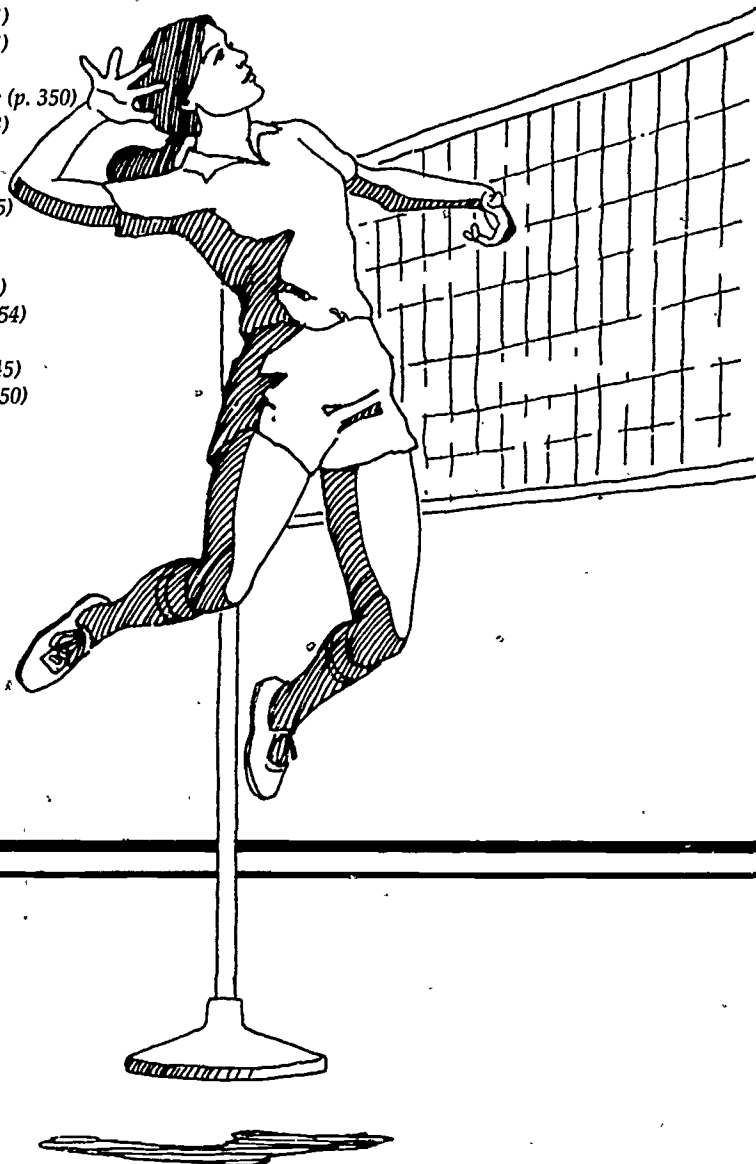

# Volleyball

BARBARA L. VIERA,  
*University of Delaware,*  
*Newark, DE*

## INTRODUCTION

The sport of volleyball was invented in the United States in 1895 by William G. Morgan while working in a YMCA in Holyoke, Massachusetts. Morgan needed a less strenuous game to meet the needs of some businessmen who would not play basketball. After experimenting with various balls including the bladder of a basketball, Morgan decided no ball then available satisfied the needs of the new game, which he called mintonette. The Spalding Company eventually provided the first official ball which was made of soft calfskin. In 1896 during a demonstration mintonette game in an old gymnasium at the School of Christian Workers (now Springfield College) a faculty member, Alfred T. Halstead, suggested that because the volleying action was such a characteristic of game play, the name of the activity should be changed to volleyball. Morgan accepted this change and the game of volleyball evolved to its present form.

Volleyball can be enjoyed by players of all ages. It is one of the few sports in the United States that has competitions in various age groups from elementary to the masters' level. It is also adaptable to many settings—from the informal to the highly competitive. Volleyball is the only team sport which has been professionally played on a coed basis. Although Morgan designed the game to be less arduous than basketball it has developed into a highly strenuous sport. When played by two teams closely matched in ability a five-game match can last for as long as 2½–3 hours. During this time players are constantly moving, changing direction, jumping, hitting the floor for defensive saves.

The addition of volleyball to the Olympics by the Japanese in 1964 helped increase its popularity. Volleyball is high on the list of participation sports in countries throughout the world. Over 25 countries currently list volleyball as their number one sport.

## SKILLS AND TECHNIQUES

To be a successful volleyball competitor one must be able to perform the five basic skills of the game at an efficient level of control. These five basic skills are the underhand pass, the overhand pass or set, the serve, the spike or attack, and the block. The block is only essential when playing against a team with strong spiking. Other advanced skills including the dive and roll are only essential at higher levels of competition. The soft attack or dink is an excellent change of pace and can also be mastered at beginning levels of play.

### UNDERHAND PASS

The underhand pass is used to receive the serve, to play any ball arriving low and with force, to receive spikes, and to play any ball below chest level. It is an extremely important skill because it is usually the first contact made by the team receiving the serve from the opponent. The skill is quite different from any that exist in other sports because the ball is contacted on the fleshy part of the forearms. The hands are gripped together and can be joined in a number of acceptable ways. The two best positions are placing one hand across the palm of the other, then cupping both hands so that the thumbs are together and facing up toward

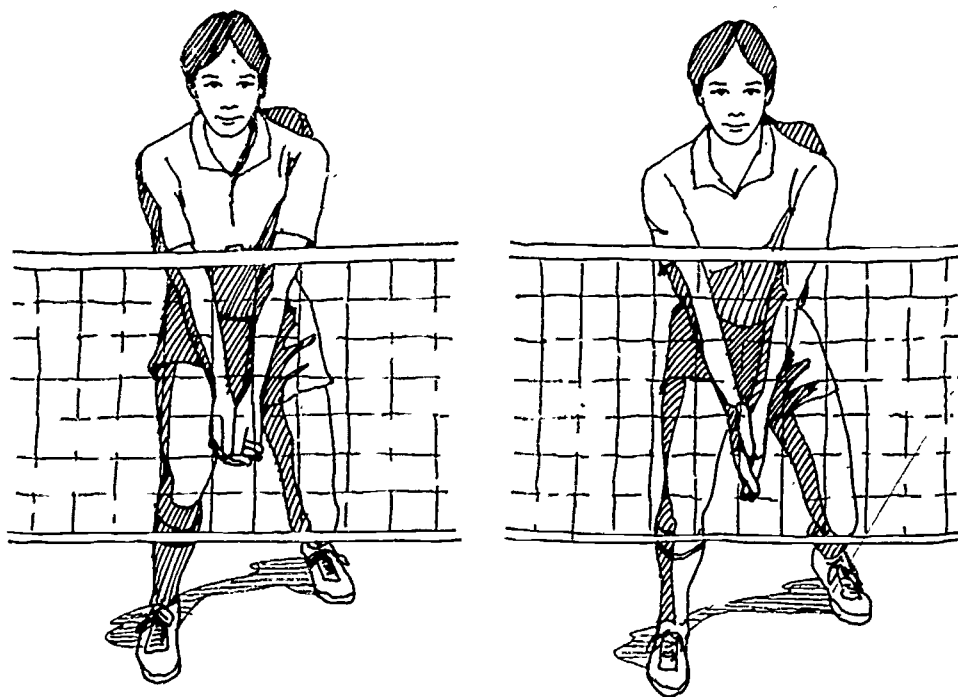

a. Cupped hand grip with thumbs on top.

b. Interlocking hand grip with thumbs on top.

Figure 1. The volleyball grip.

the ceiling (see Figure 1a), for more advanced players, joining both hands by lightly interlocking the fingers with the thumbs side by side and on top (see Figure 1).

It is important that the thumbs do not overlap, as this creates an uneven surface, causing an uncontrolled hit if the ball is accidentally received on the hands. The elbows are rotated in, so that the widest portion of the forearm faces upward. The elbows may be bent or locked as the ball approaches but must be locked at contact. The ball is contacted between the wrists and the elbows. The arms should be held away from the body and parallel to the thighs. The back should be erect and leaning slightly forward. The knees are bent at approximately a  $90^\circ$  angle, the feet are shoulder width apart and in a stride position with the foot which is farther from the target forward. The shoulders should face the intended direction of the pass. This position of the body in relation to the target is

essential if the player is to successfully direct the pass. The player should always establish a set body position before contacting the ball, rather than passing the ball while still moving. As the ball approaches, the player gets behind it, so that the ball is played between the legs and the player is in a low position. The player's eyes should be kept on the ball until it contacts the arms. The ball should be contacted low between the waist and the knees. As contact is made the knees are extended and the arms are raised slightly making a punching motion at the ball. The arms should not rise above shoulder level on the follow-through. At the same time the weight is transferred forward in the direction of the pass. The three most common faults by beginners are too much arm swing, bending at the waist instead of the knees, and a transfer of weight away from the intended direction of the pass. Figure 2 shows the underhand pass in a series of pictures. Check the following points of emphasis:



Figure 2. The underhand pass.

- the position of the body at contact,
- the point at which the ball contacts the arms;
- the locked elbows on contact;
- the transfer of weight from the back to the forward foot;
- the extension of the legs and arms,
- the height of the arms on the follow-through.

Players may not always be able to position themselves squarely behind an oncoming ball. In this situation the ball should be played outside the body and/or with one arm or hand. If the ball is played with one arm the hand should be held perpendicular to the arm, so that contact is made with the flat surface of the arm at the wrist. If the ball is contacted on the hand the player should break the wrist to help direct the ball. If the ball is played to the left or right of the body with two arms the shoulder closest to the ball should be dropped or dipped, so that the ball will rebound back in the same direction from whence it came. If this is not done the direction of the ball will not change and it will continue past the player and out-of-bounds.

When any hard-driven ball is received it is referred to as a dig. A one-armed reception is also called a dig. The underhand pass is often referred to as a forearm bounce pass, a bump, or just a forearm pass. These terms can be used interchangeably.

A player should have enough control over his/her passing to perform the following tasks:

- self pass the ball 15 consecutive times;
- pass the ball against the wall, to a height greater than 8 feet, 15 consecutive times;
- pass the ball with a partner 10 consecutive times;
- receive 5 out of 10 serves that come directly to the player by passing them to the target area with enough height so that they can easily be handled by the setter. The target area is the center one-third of the court and close to the net.

### OVERHAND PASS OR SET

The overhand pass is the most accurate method of playing the ball. It is used to receive any ball chest high or higher and

traveling very slowly. It is also used as the second contact by a team as it sets up its offense. When used in this manner, to deliver the ball to a spiker, the overhand pass is also referred to as a set.

In executing the overhand pass a player must first move into the correct position. As in the underhand pass it is extremely important that the player establish a set body position before playing the ball. When executing an overhead pass the player's shoulders must be square to the desired direction of the pass. Once in position the player should watch the ball closely until contact. The hands are raised to a position just in front of the forehead, and the player continues to look at the ball through the window formed by the hands. The ball is contacted 6 to 8 inches above the forehead. The hands are cupped around the ball, on the sides of the ball more than directly behind it. The thumbs should be closer to each other than the first fingers. The contact points on the fingers are the upper two joints. The greatest force comes from the thumbs and the first two fingers of each hand but all fingers do contact the ball. The action of the set is a very quick catch-and-throw motion. The angle of the elbows should not decrease as the ball is contacted and the fingers should be firmly held throughout. The wrists are hyperextended and the hands and wrists are both relaxed.

The body should be in an upright position and leaning slightly forward, knees bent, and back straight. The feet should be in an easy stride position with the foot closest to the net always forward. This prevents the ball from going over the net into the opponents' court.

On contact the wrists flick the ball forward as the elbows and knees extend and the weight is transferred toward the direction of the pass. The arms are fully extended on the follow-through and the hands point in the direction of the pass. The ball should be directed with good height. Figure 3 shows the overhand pass in a series of pictures.

Check for the following points of emphasis:

- the position of the hands and arms before contact;

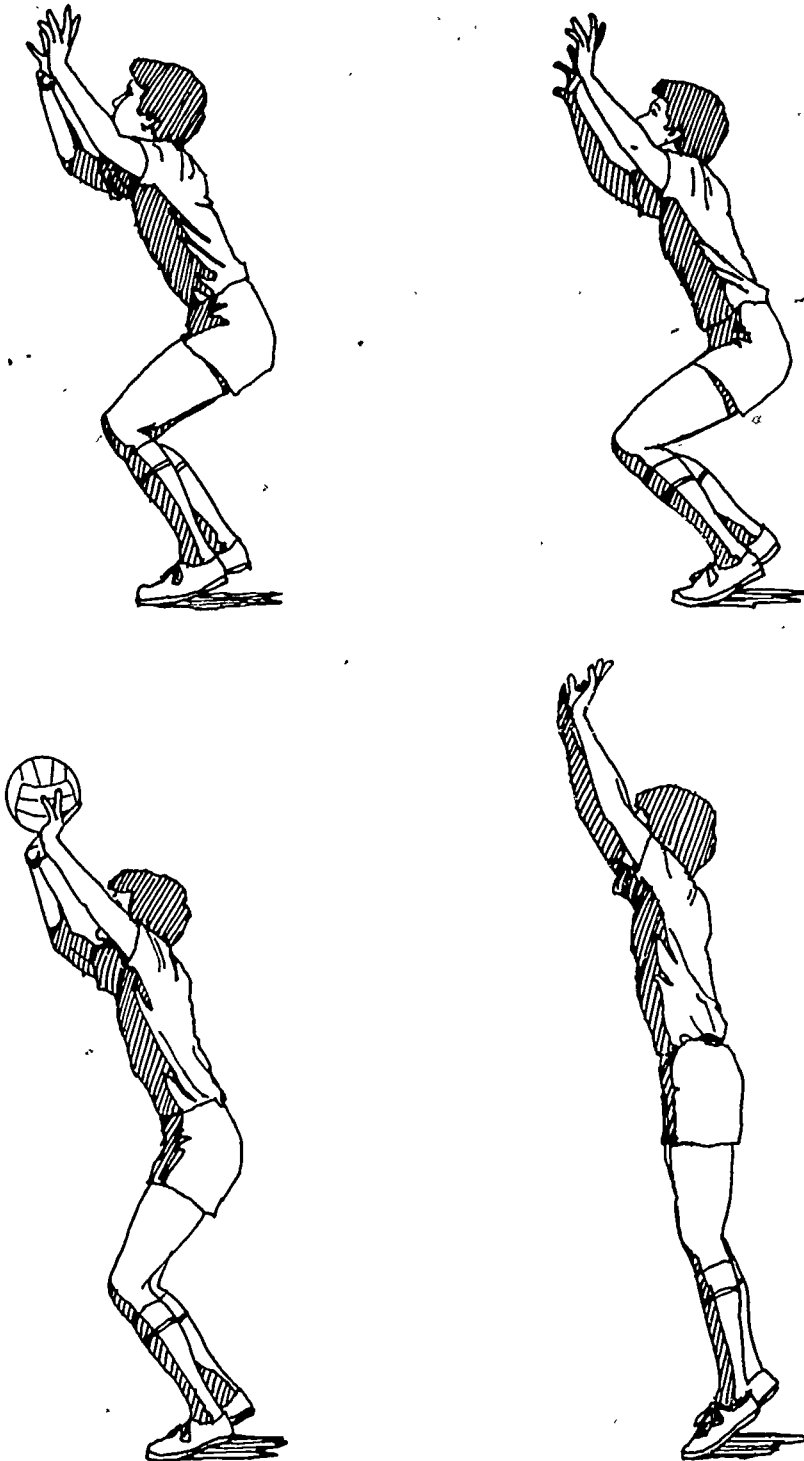

Figure 3. The overhead pass.

- the bent position of the knees and elbows before contact;
- the position of the hands and arms before contact;
- the bent position of the knees and elbows before contact;
- the fully extended arms on the follow-through.

The player can increase the complexity of sets by varying the height and speed with which they are delivered to the spiker. At beginning levels of play a high set is recommended almost exclusively.

The set can also be sent backward over the player's own head to a teammate behind the setter. This is called a back set. Everything is the same as with the front set until the point of contact. The player arches his/her back and pushes the ball straight up toward the ceiling, extending his/her arms and knees. The weight transfer will be back in the direction of the pass. The back set is very effective, as it often catches the opponents off-guard.

All players should be more accurate when using the overhand pass than when using any other volleyball skill. The setter is the player who will set the spikers the greatest percentage of the time, and should be excellent in performing this skill. All other players must be able to set effectively when the setter cannot make the second contact. Players should be able to complete each of the following tasks:

- overhand pass the ball successfully to themselves 20 times;
- overhand pass the ball to a height of 11 feet against a wall consecutively 20 times;
- complete 20 overhand passes while receiving a tossed ball from a partner with 10 tosses made to the passer's right and 10 made to the passer's left on an alternating basis.

### THE SERVE

The serve can be one of the most important skills of the game. If a team is lucky enough to win the first serve and is a good serving team it could get a good lead or even win the game before the opponents are able to serve. There are many varieties of serves which can be mastered and a

server who has mastered more than one serve can be extremely effective. Beginners should concentrate on performing one serve until they have 90 percent accuracy. That is, they are capable of making nine good serves in every ten attempts. The easiest serve to master is the underhand serve. Many players feel that the underhand serve is not effective. This is not necessarily true. If it is the only serve a player can perform with 90 percent accuracy then the player should use this serve entirely until he/she masters other styles. The underhand serve is hit with less force and on a higher trajectory than the overhand or roundhouse serves, but if hit as a floater it can have a lot of "action" on it and be highly effective. The floater action is similar to that of a knuckleball pitch in baseball. Hit without spin, the ball reacts unpredictably to the air currents, either curving, dipping, or rising.

The underhand serve is hit with an open hand, the major point of contact being on the heel of the hand. The ball should be hit with a locked wrist. The body should be facing the net with the feet in a stride position and about shoulder width apart. The forward foot should be placed so that the toe is pointing to the direction of the serve. The foot on the opposite side of the serving hand should be the forward foot. The ball is held at waist level or lower in the non-hitting hand. The holding hand must release the ball before it is contacted or the serve is illegal. The hitting arm swings back as the weight is transferred onto the back foot. As the arm swings forward to contact the ball the weight is transferred onto the forward foot. The ball should be contacted in a low position and as the hand follows through the player moves forward onto the court into a position of readiness to receive the return.

For beginners, it is not necessary to disguise the direction of the serve. The opponent who knows that there will be a serve to his/her position feels more pressure than one who does not expect the ball. This often causes a reception error.

The overhand floater serve is similar to the underhand serve as the player assumes the same initial position—body facing the





Figure 4. The serve.

net, feet in a shoulder width stride position, non-serving hand holding the ball, and eyes on the intended target. The holding hand begins with the ball at chest level or higher, and tosses the ball in the air slightly in front of the shoulder of the hitting hand, and 2 to 3 feet higher than head height. The ball is contacted with an open hand, the heel of the hand again being the major area of contact. The wrist is locked. There should be little to no follow-through. The hitting action is somewhat like a punching motion, and the ball is contacted on the center back. The server looks at the ball as soon as the serving motion begins, and should keep the eyes on the ball until contact. As the ball is tossed the weight is transferred onto the back foot. The striking arm is cocked back into a throwing position. As the arm swings forward toward contact it is extended, reaching full extension at contact. The entire action is similar to throwing a baseball. Once the ball is contacted the server moves onto the court and into his/her playing position. Figure 4 shows the serve in a series of pictures. Note the following points of emphasis:

- the position of the tossed ball with respect to the body;
- the cocked position of the arm before contact;
- the height of the ball above the shoulder at contact;
- the full extension of the arm at contact,
- the server's concentration on the ball,
- the limited amount of follow-through of the arm.

Servers should have three priorities in serving. First, they must be consistent. They must be able to get the ball legally into the opponents' court on nearly every serve. Secondly, the server should be able to serve to any spot which might be advantageous to his/her team. Thirdly, the server should try to "put something on" the ball, such as a spin or greater force. Servers should not try for the second priority until the first is met.

The most effective serves are directed to the deep corners of the opponents' court, to the seams (the area between two opponents), or to a weak receiver. Once players have mastered the first two priorities above, with one serve they can begin working on

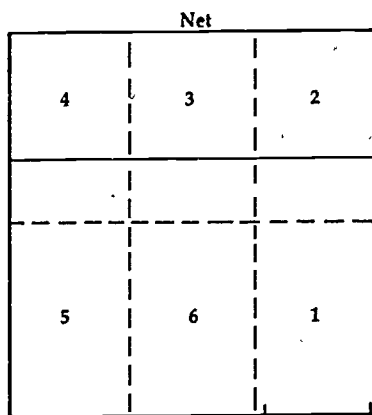

Diagram 1. The volleyball court divided into the six court areas.

another type of serve. Each player should be able to master each of the following tasks:

- serve 20 consecutive legal serves without a miss;
- serve to each of the six court positions in order for two full rotations;
- serve to any court positions called out by the teacher on twelve consecutive serves.

The court positions in volleyball are illustrated in Diagram 1.

### THE ATTACK OR SPIKE

The spike is the most exciting skill of the game and at the same time one of the most difficult skills to perform. In making a spike the player must jump into the air and hit a moving object (the ball) over an obstacle (the net) into a bounded area (the court). This task is not easy. Timing is the most important element of the spike. Spiking can be done on a variety of sets. For discussion here only the high set will be considered. This set is 7-10 feet above the top of the net.

The approach for the spike begins at the attack line, 10 feet from the net. Moving toward the net can be accomplished with any number of steps but better volleyball players limit themselves to two or three. The spiker must wait until the ball is set by the setter before beginning the approach, in order to go to the spot where the ball will arrive. Once the spiker has reached the cor-

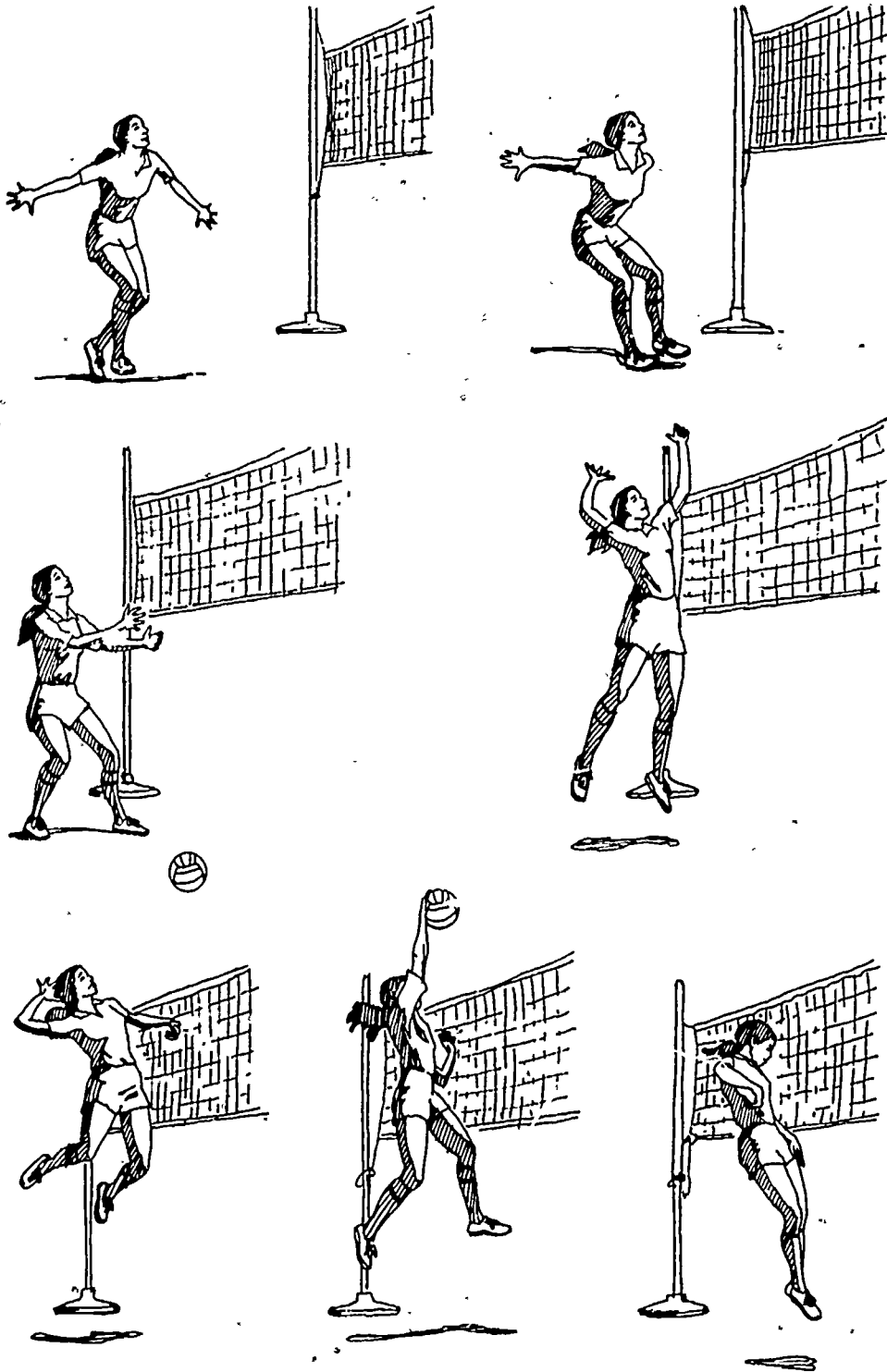

Figure 5. The spiking sequence.

rect spot he she brings both feet together by planting one heel first and closing with the other. All spiking is done with a two-foot take-off. Planting the heels changes forward momentum into upward momentum. As the heels are planted the arms swing down and back to about shoulder height; the knees are bent as deeply as they can go and get maximum thrust and control on the jump. As the spiker extends the knees to jump, the arms are swung forcibly forward and up. The swing of the arms is very important to increase height on the jump. The spiker concentrates on the ball as the jump is made. The hitting arm and hand are taken back behind the head into a throwing position. At the highest point in the jump the spiker swings the arm forward to hit the ball. The arm action is the same as that used to throw a baseball. The ball is contacted with force, with an open hand. As soon as contact is made there is a snap of the wrist. The wrist snap is very important because it puts topspin on the ball, causing it to dip severely in flight. The hand should be open wide and fairly relaxed at contact. As with the serve, the heel of the hand is the most important hitting surface. The ball should be contacted two to six inches in front of the hitter's shoulder on the hitting side of the body. As the arm swing is made the non-hitting arm is dropped forcibly to the player's side. This gives the player greater reach. The ball should be contacted at the spiker's greatest reach. As contact is made with the heel of the hand, the hand is snapped forward over the top of the ball to impart a forward spin on the ball, thus directing it downward. It is extremely important that the jump is straight up and down. The planting of the heels effectively stops forward momentum so that no net foul is committed.

During the follow-through the player's hitting hand drops back to the player's side, and the spiker returning to the floor should land simultaneously on both feet. It is important that immediately after landing the spiker prepare for the next play. Figure 5 demonstrates a spiking sequence. Look for the following points of emphasis:

- the plant of the heels and the two-foot take-off;

- the high backswing of the player's arms;
- the forward swing of both arms on the jump;
- the full extension of the arm on contact;
- the position of the ball in relation to the spiker's body (it is in front of the hitting arm's shoulder at contact);
- the snap of the wrist on contact;
- the landing of the spiker simultaneously on both feet.

Once the player has mastered the basic elements of the spike, the angle and direction of the spike should be practiced. The two main directions of the spike are cross-court and down-the-line. A cross-court spike is hit from the spiker to the opposite corner of the opponent's court (see Diagram 2). The down-the-line spike is hit

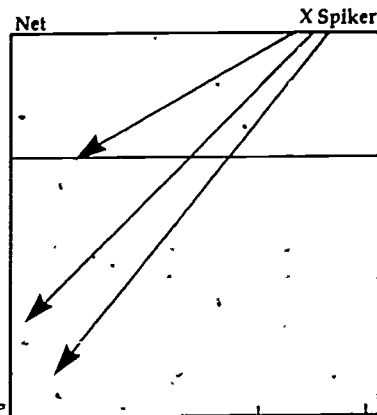

Diagram 2. Three different angles for cross-court spiking.

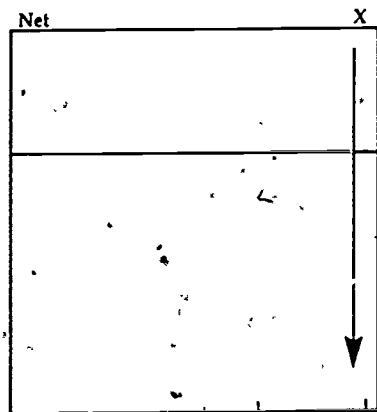

Diagram 3. Path traveled by a down-the-line spike.

along the sideline from the spiker to the corner of the opponent's court on the same side (see Diagram 3).

Spikes are divided into two main categories: on-hand spikes; off-hand spikes. An on-hand spike is one in which the spiker's hitting arm is on the same side of the body as the approaching set. This occurs in the right forward position for a left-handed player and in the left forward position for a right-handed player. It is the spike that a player should be best at executing. The ball does not cross in front of the player's body before it is hit. An off-hand spike is one in which the spiker's hitting arm is on the opposite side of the player's body from the approaching set. The ball must cross in front of the player before being hit. This style is employed when a left-handed player is in the left forward position, or a right-handed player is in the right forward position. The on-hand spike is the preferable spike for most players, but in any case, the spiker should always hit the ball with the dominant hand.

All players should be able to master each of the following tasks:

- Spike the ball against the wall at least ten times. To spike, a player stands 6 to 10 feet from a smooth wall, tosses up the ball, and spikes it onto the floor close to the wall. The ball rebounds from the floor and wall and is caught. The spiker then repeats the process.
- Spike five out of ten high sets to the on-hand side into the opponent's court.
- Spike five out of ten high sets to the off-hand side into the opponent's court.

### THE DINK

Another form of attack is the dink. The dink is a change of pace play and can be used as an offensive move, to catch the opponents off-guard, or as an alternative when a spike is not possible because of poor timing or a bad set. The dink is most effective when used as an offensive play.

The approach for the dink is exactly the same as the approach for the spike. In fact, this is essential to disguise the intent of the attacker. At the last minute the spiker holds back on a powerful swing, reaches as high

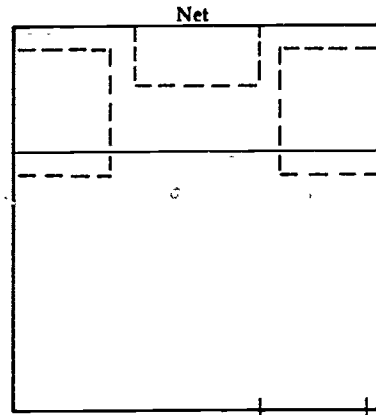

**Diagram 4.** The weak areas of the opponent for the dink. The left and right areas change depending on which side the dink originates. The center area is the same for both sides.

as possible and with a soft fingertip touch from a position on the lower back of the ball, drops the ball over or by the block so that it falls quickly to the floor. The dink must be high enough to clear the opposing block but low enough so that it hits the floor before the opponent's backcourt defensive players can move in to "dig it up." It is essential in dinking that the wrist be held straight to avoid the possibility of a carry.

There are two areas on the court most vulnerable to a dink: over the block and down the line but in front of the attack line; by the block and to the center of the court but close to the net (see Diagram 4).

All players should be able to master each of the following tasks: dink five out of ten sets so that they clear the block and land in front of the attack line; dink five out of ten sets by the block so they hit the floor near the net in the center of the court.

### SERVE RECEPTION

Receiving the serve is extremely important. If a team cannot successfully receive the serve they will never gain the opportunity to serve and score themselves. Serve reception is a team effort.

The W-formation is the most common and most efficient formation for receiving the serve. In this formation five players are ready to receive and one player, the setter,

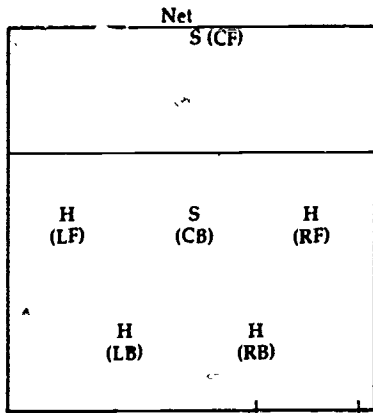

Diagram 5. The W-formation used for serve reception.

avoids receiving under any circumstances and "hides" at the net. Diagram 5 shows this formation using H's to indicate the spikers and S's to indicate the setters. No player should stand directly behind a teammate and all players must have a clear view of the opposing server. Each player on the court has certain responsibilities on serve reception. First, after the serve is hit, the players must determine who will receive it. The person receiving should call for the ball; then all the remaining players should turn and face the receiver. This action is called "opening up." Players should also help each other by calling bad serves out-of-bounds. The RF and RB work as a team calling the right sideline. If the ball is being played by one, the other player judges the ball's position and calls it out if necessary. The LF and LB call the left sideline. The LB and RB are a team for calling the endline. The CF and CB should alert their teammates if a serve is short, i.e., is going to fall in front of the attack line.

In the waiting position for serve reception all players on the left side of the court should have the left foot forward in a slight stride, while all players on the right side of the court should have the right foot forward. The setter standing near the net should not receive the serve under any circumstances. Any ball shoulder height or higher as it approaches the forward line should be received by a back row player. Any serve shoulder height or higher as it

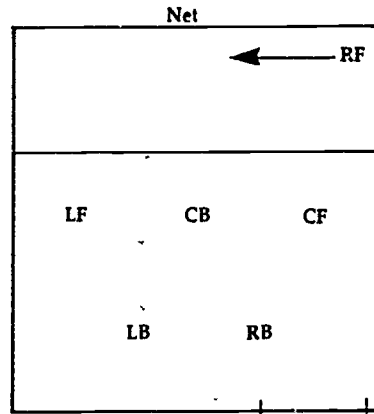

Diagram 6. W-formation when the RF is the setter. At ball contact by the server, the setter moves to the center of the court.

approaches a back row player should be allowed to go out-of-bounds. The setter should always face the left sideline, with his/her right side toward the net.

The sequence of action in receiving the serve should be as follows. The receiving player passes the ball to the setter at the net, who is facing the LF position. The setter then sets one of two hitters, either forward to the LF or backward to the RF. As soon as the set is made the whole team moves into spike coverage.

When the team rotates the setter moves to the RF position. The setter must switch to the center of the court as soon as the ball is contacted on the serve. Diagram 6 shows the W-formation when the setter is the RF.

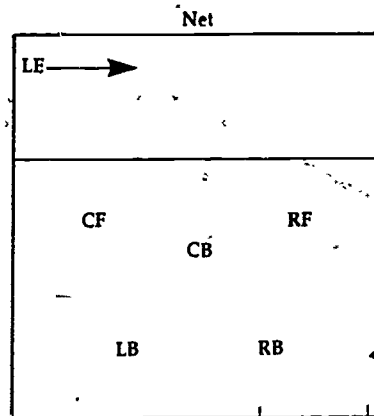

Diagram 7. W-formation when the LF is the setter. The CF must be ahead of the CB.

The setter hides at the net and the CF moves toward the right sideline. The players who switch maintain their new positions until the next serve.

The next rotation finds the setter in the LF position. Diagram 7 shows the W-formation and the switch when the setter is in the LF position. Once the ball is contacted players may switch to any spot on the court. They should be careful, however, not to change positions with teammates until the ball has been served. When the setter switches to the center of the court the center forward stays near the sideline and plays as an outside forward.

### SPIKE COVERAGE

The purpose of covering the spike is to be ready to play the ball off the opponent's block if that block is successful. If a block is successful the ball comes right back at the spiker, usually falling behind him/her. Thus, the area behind the spiker is the one to be covered. Three players move to form a semi-circle around the spiker and the other two players move to fill the remaining spaces. All players must crouch low to have more time to react to the ball. Diagram 8 shows the movement of players when the LF is the spiker.

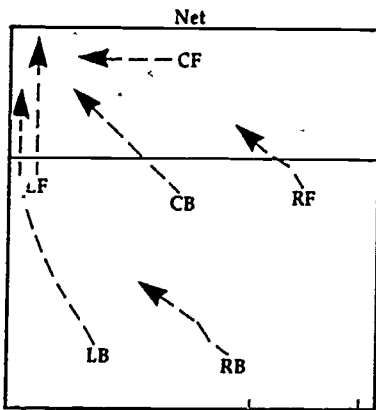

Diagram 8. Spike coverage for the LF spiker.

Diagram 9 shows the movement of players when the RF is spiking.

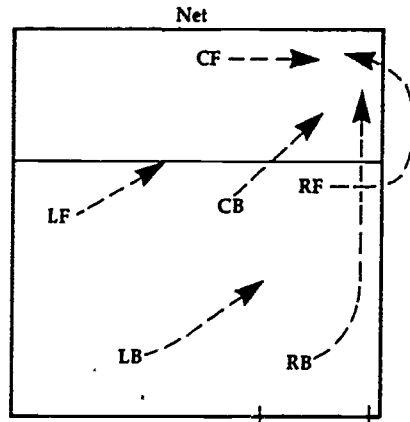

Diagram 9. Movement to spike coverage when the RF is spiking.

The center forward is customarily the setter and will only be called on to spike if there is a broken play.

### THE BLOCK

The block is a team's first line of defense. The best way to stop an opponent's attack is to block it at the net and not allow the ball to come onto the side of the court. A single block is executed by one player. In a double block the center forward joins the outside forward on the side of the opponent's spike and they block together. The purpose of the block is to lessen the net area available to the spiker. A double block is of course more effective than a single block.

The ready position for a blocker is six to twelve inches from the net, with arms bent at the elbow so that the hands are at shoulder height and fairly close to the body. The blocker must concentrate on the opponent's play until the ball is set to the opposing spiker. Then the blocker stops watching the ball and concentrates on that spiker. The blocker gets into position so that one-half of the body overlaps one-half of the spiker's body on the side of the spiker's hitting arm (see Figure 6). The blocker attempts to put one hand on each side of the spiker's hand. The blocker times the block by jumping a split second after the spiker. The blocker reaches as high as possible over the top of the net and into the opponent's court. The shoulders are close to the ears.

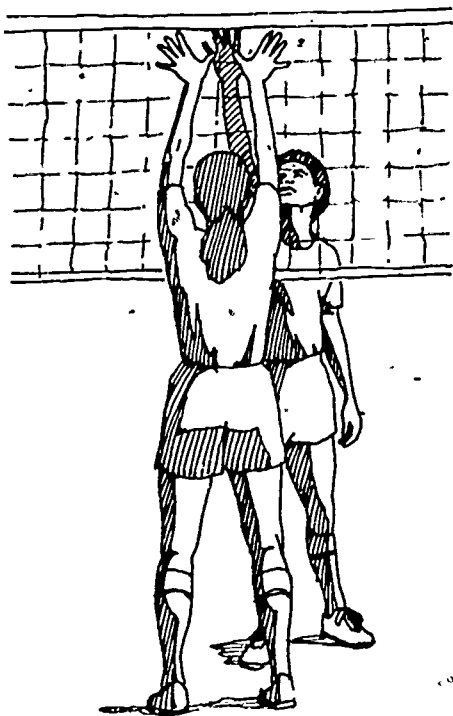

Figure 6. The position of the blocker in relationship to the spiker.

The body pikes slightly to prevent net fouls. The blocker's hands are wide open and turned so that the thumbs are up (see Figure 7). This positioning of the hands covers the maximum amount of space. When the ball contacts the blocker's hand the blocker snaps the wrists, causing the ball to drop quickly onto the opposing court. The blocker must quickly withdraw the hands so that no net foul will be committed in returning to the floor. After the block the player should be immediately ready for the next play.

Figure 8 illustrates the block sequentially. Look for the following points of emphasis:

- the starting position of the blocker;
- the position of the blocker's arms in relationship to the head;
- the wide position of the blocker's fingers;
- the penetration the blocker makes over the net;
- the piking position of the body.

When blocking in the outside position the blocker must be sure to turn the ball into

the opponent's court. The hand closest to the sideline should be turned in, so that the ball will not rebound out-of-bounds after hitting the block. Successful blocking involves a great deal of practice emphasizing timing. Many beginning blockers have a tendency to rush the block, jump too soon, and miss the ball completely. Each player should be able to master each of the following tasks:

- block three out of eight spikes off high sets;
- jump and reach so that both hands are completely over the top of the net;
- watch the spiker rather than the ball on every spike.

## OFFENSE

With the basic skills of volleyball mastered, the offensive and defensive systems can be learned. The least complicated offensive system is the 4-2. Four players predominantly serve as spikers, and two as setters. The setters are directly opposite each other in the lineup, so that there is always one setter in the forward line. The setter in the forward line performs the setting task. The other setter plays as a defensive player in the back row until rotating to the forward line and becoming the working setter.

There are three different formations used on offense. They are serve reception, spike coverage, and free ball. In all of these formations the team is either receiving the ball from the opponent or playing it on their own side. Each of these situations will be covered in detail when discussing the 4-2 offense.

## FREE BALL

When the opposing team is unable to set up for a spike they will usually return the ball in a manner that makes it easy to handle. This is called a free ball. When it appears that the opponents are in trouble, immediately assume the free ball formation. The free ball formation is the same as the W-formation used for serve reception, except that the setter does not have to go to his/her correct rotational position and may



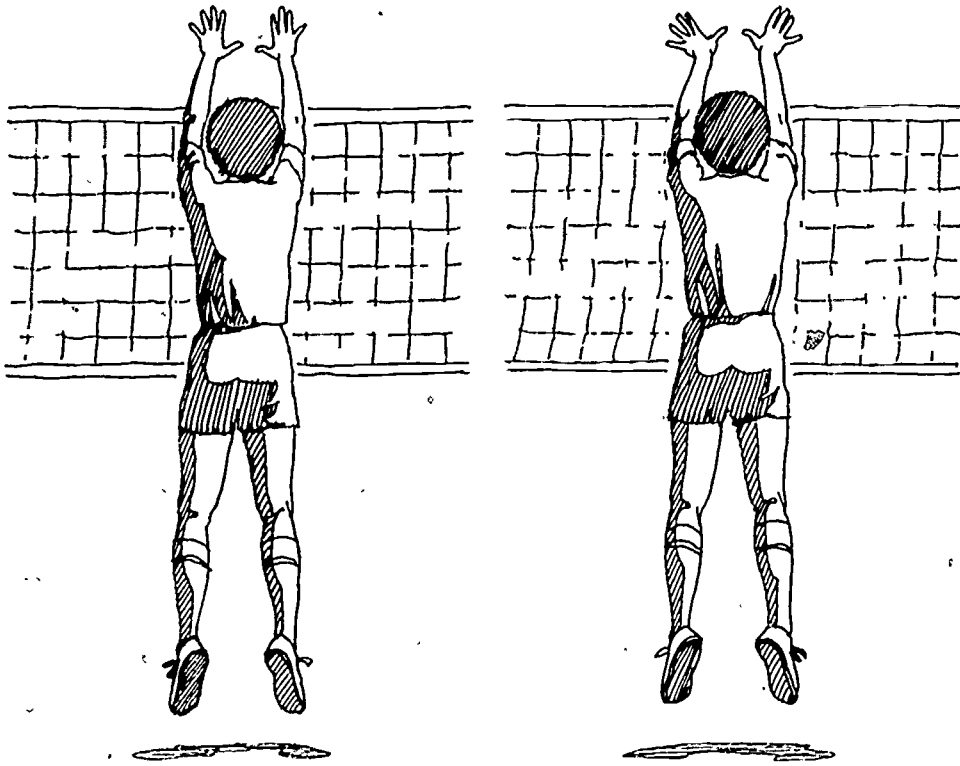

a. The incorrect hand position on the block.

6. The correct thumbs up position. Note the wider area that it covers.

Figure 7.

remain in the center of the court. The team then proceeds as in the serve reception, trying to get a three-hit combination pass, set, and spike.

## DEFENSE

The best defensive system to use in beginning levels of play is the 2-1-3 defense. This is also called the middle-in defense. This defense is especially strong against a team with weak hitters, or one that dinks a good deal.

### BASE DEFENSE

When the opponents are playing the ball the team should be waiting in a base defensive formation. As the opponents attempt to set up a spike, and the team sees that its first action will probably be a block, all three

forwards place themselves at the net in a blocking position. The center back stays in the center of the court, and the other backs stay deep. Diagram 10 illustrates the proper team alignment during base defense. From the base defensive formation the team moves either into free ball formation if the opponents do not spike, or into position to block.

### THE BLOCK DEFENSE

In this defense two players form the block, one player plays close behind the block providing dink coverage, and the remaining three players remain deep to dig spikes. As soon as the team knows from which side the opponents will spike, the CF moves to that side to form a double block with the outside forward. The CB moves behind the block and gets into a low posi-

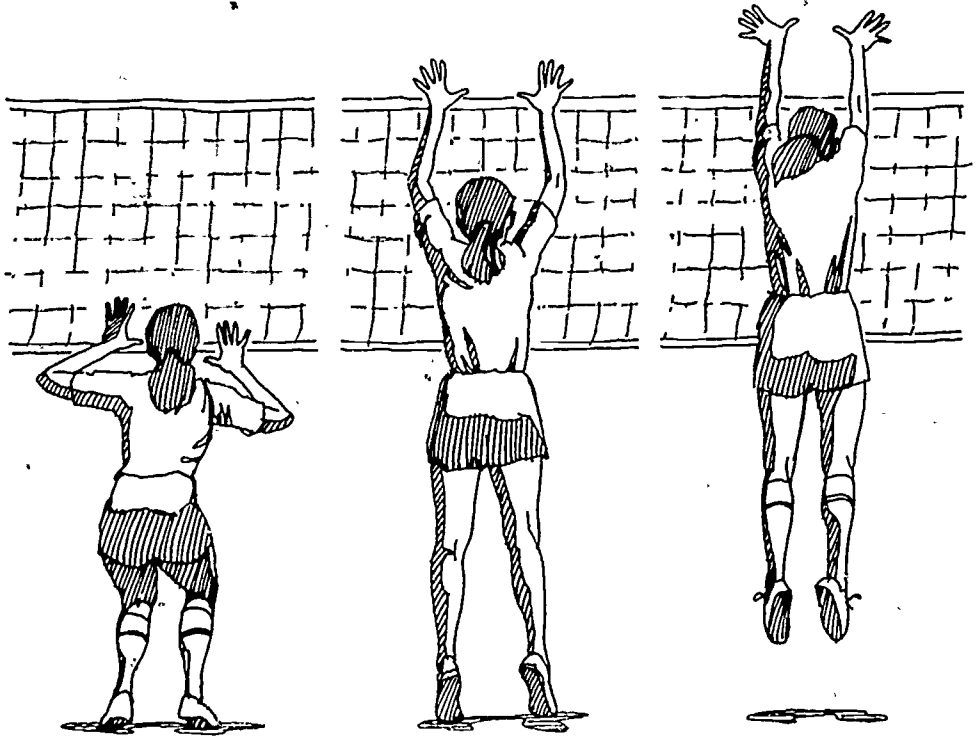

Figure 8. The block.

tion. The remaining three players cover the rest of the court. The back on the same side as the block plays close to the line, and is ready to dig a down-the-line spike. The forward, not involved in the block, moves off the net to the attack line, and is ready to dig sharply angled spikes, play dinks to the

center of the court, and pick up any spikes which roll along the net and fall into the court. The back opposite the block plays in the power alley. This is the part of the court where most spikes are likely to come. This player lines up off the center forward's inside shoulder so that the player sees the spiker's hand and the ball. Diagrams 11 and 12 show the proper court positions for all players when the opposing right forward and left forward are spiking. The shaded area indicates the power alley. The area deep behind the block tends to be the weak area in this offense.

In the beginning levels of play few teams will spike from the CF position.

### SAFETY

Volleyball is a relatively safe game to play. The only protective measure suggested is the use of knee pads. As in any sport, a sufficient warm-up before beginning activity is the best way to decrease

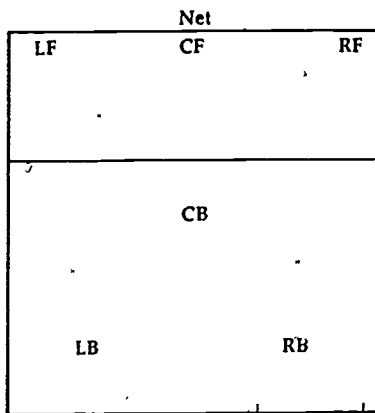

Diagram 10. Base defense when using the 2-1-3 defensive system.

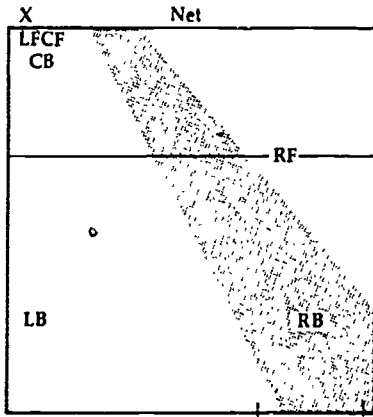

Diagram 11. The proper court coverage when using the 2-1-3 defense and the opposing right forward is spiking.

muscle pulls. The legs and arms are used extensively, and should be thoroughly warmed up before play. The best way to prevent collisions on the court is to communicate with teammates at all times, calling for the ball immediately upon deciding to play it.

## RULES

The court has several markings with which all players should be familiar. Diagram 13 shows a legal volleyball court and its markings.

The correct height of the net for women is 7'4  $\frac{1}{8}$ " (2.24m), and for men 7'11  $\frac{5}{8}$ "

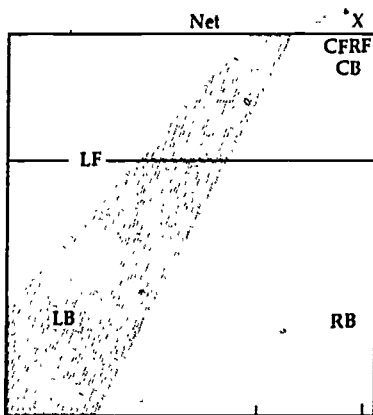

Diagram 12. The proper court coverage when using the 2-1-3 defense and the opposing left forward is spiking.

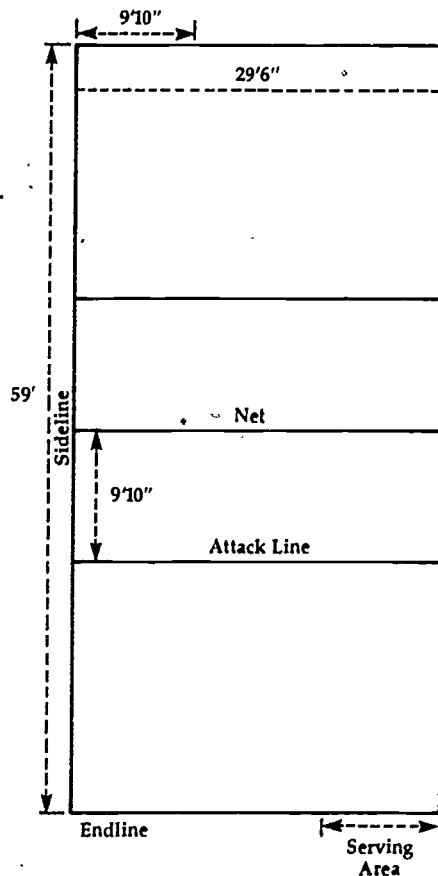

Diagram 13. A legal volleyball court with its markings and measurements.

(2.43m). The court is 59' (18m) long and 29'6" (9m) wide. The attack lines are 9'10" (3m) from the net.

The game is started with a coin toss between the teams' captains. One captain calls the toss. The captain who wins the toss selects either to serve first or to play on the preferred side of the court. The other captain gets the remaining choice.

Matches consist of either best of three or best of five games. Each game is 15 points and the winning team must win by two points. The first serve alternates with each game. A second toss is made for the third game or fifth game which will decide a match.

A playing team is made up of six players. A squad can have no more than twelve players. Once the order of service is established for a game it cannot change until that

game is completed. Players must be in their correct rotational position until the ball is contacted on any serve. At any other time in the game players may play anywhere on their court or off it provided they remain on their own side of the net.

There are several ball handling rules:

1. No player may hit the ball twice in a row unless the first contact is a block.
2. Each team may contact the ball three times on its side. If the first contact is a block it doesn't count as a hit, and three additional contacts are allowed.
3. Part of the ball must be on a team's side of the net before that team may spike; but the team may block a ball attacked by the opposing spiker before it crosses the net.
4. Each contact must give the ball immediate impetus. The ball may not be held, thrown, or carried.
5. The ball may be contacted with any part of the body above and including the waist.

Players must be on the court during the service (the line is part of the court) Players may step on or over the centerline, as long as part of the foot remains on or above that line. It is a fault if any other part of the body contacts the floor on the opponent's court.

The ball is put in play from the serving area. It must go over the legal portion of the net without touching it, and land within the boundaries of the opponent's court. The lines are considered in-bounds. The serve must be contacted with one hand or arm. It must be cleanly hit after it has been released or thrown from the hand or hands of the server.

A team only scores when serving. If the serving team faults, the receiving team gets to serve and no point is made. This action is called a side-out. Points are made by the serving team anytime the receiving team commits a fault.

A player may not touch the net at any time during play. Any ball other than the serve which contacts the net is still in play. If a ball is hit into the net with force causing the net to hit a player, it is not a net fault. If two opposing players hit the net or cross the centerline simultaneously, it is a double fault, and the point is replayed.

Only forwards may block. Backs may not spike from a position in front of the attack line. Players may leave the court in order to play the ball, but the ball must pass over the legal portion of the net to be a good return

## EQUIPMENT

The best volleyball is made of leather with molded seams. It is softer to the touch and does not hurt the arms when played. A good volleyball will cost at least \$20.00.

## TERMINOLOGY

**Attack.** The act of sending the ball to an opponent in a forceful manner. Often used synonymously with spike.

**Attack Line.** The line on the court which is 9'10" (3m) from the centerline.

**Back Set.** A set in which the setter faces away from the intended direction of the ball and sets overhead to a waiting spiker.

**Base Formation.** The position of a team while their opponents play the ball and the team waits to decide their counter move.

**Block.** When a player jumps close to the net extending both arms over the top of the net with the hands in a wide position with fingers spread to prevent an opponent's spike from crossing over the net.

**Bump.** The underhand passing action in which the ball rebounds off the forearms and is directed to a teammate.

**Centerline.** The court marking directly under the net which divides the large court into two equal sides.

**Cross-court Spike.** A spike directed diagonally to the longest part of the opponent's court.

**Dig.** A one- or two-armed defensive save in which a player has difficulty getting to the ball and just passes it high so that a teammate can play it.

**Dink.** A soft off-speed change of pace play in which a spiker attempts to catch the opponents off-guard. The ball is hit with the fingertips of one or two hands so that it just clears the block and drops quickly to the floor.

**Double Fault.** A play in which faults are committed by players on both teams at the same time. The point is replayed.

**Down-the-line Spike.** A spike directed along the sideline closest to the spiker.

**Floater.** A serve which is hit without spin causing it to move up, down, and/or side to side as it responds to air currents.

**Forearm Pass.** Same as bump.

**Free Ball.** Any ball coming from the opponents which is not a spike or attack.

**Heel of the Hand.** The solid part of the hand which is close to the wrist.

**Middle-in.** A defensive formation in which the center back plays directly behind the block to cover against the dink.

**Off-hand.** A spike in which the ball must cross in front of the spiker's body before being contacted by the spiker's dominant hand. The set comes from the spiker's non-dominant side.

**On-hand.** A spike in which the ball is set from the same side of the spiker's body as the dominant hand.

**Opening up.** The action of all players during serve reception who are not going to receive the serve. They all turn and face their teammate who is receiving.

**Overhand Pass.** A pass in which the player plays the ball with open hands in a position six to eight inches above the forehead.

**Power Alley.** That portion of the court where most spikes are aimed. It is the diagonal from the spiker's hand to the opposite corner of the opponent's court.

**Seam.** The space between two receivers during serve reception.

**Serve.** The act of putting the ball in play. The ball is hit from behind the endline and in the serving area so that it clears the net and enters the opponent's court.

**Serving Area.** The right one-third of the endline and behind or outside of the court. The place from which players serve.

**Set.** The placement of the ball to enable the spiker to attack it to hit it into the opponent's court.

**Side-out.** When the serving team makes a fault and the receiving team gains the serve.

**Spike.** A ball which is hit with great force from a position higher than the top of the net so that it drops at a sharp angle to the opponents.

**Target Area.** The area to which the players pass the ball when receiving serve and/or another ball from their opponents. The setter is usually in the target area. In a 4-2 offense this area is the center one-third of the court close to the net.

**Topspin.** A ball which is hit by a player using a wrist snap which causes it to rotate away from the hitter causing it to drop quickly.

**Underhand Pass.** The act of directing the ball by bouncing it off the forearms to a teammate. Same as bump.

## REFERENCES

- Bertucci, Bob, ed. *Championship Volleyball by the Experts*. West Point, NY: Leisure Press, 1979.
- Cherebetiu, Gabriel. *Volleyball Techniques*. Hollywood, CA: Creative Sports Books, 1969.
- Coleman, James E. *Power Volleyball*. North Palm Beach, FL: The Athletic Institute, 1976.
- Cox, Richard H. *Teaching Volleyball*. Minneapolis, MN: Burgess Publishing Company, 1980.
- Egstrom, Glen H., and Schaafsma, Frances. *Volleyball*. 3d ed. Dubuque, IA: Wm. C. Brown Co., 1980.
- Keller, Val. *Point, Game and Match*. San Francisco, CA: USVBA Publications, 1977.
- Matsudaira, Yasutaka. *Winning Volleyball*. Ontario, Canada: Canadian Volleyball Association, 1977.
- Peppler, Mary Jo. *Inside Volleyball for Women*. Chicago, IL: Henry Regnery Company, 1977.
- Prsala, Jan. *Fundamental Volleyball Contacts*. Ontario, Canada: Canadian Volleyball Association, 1971.
- Sandefur, Randy. *Volleyball*. Pacific Palisades, CA: Goodyear Publishing Co., 1970.
- Scates, Allen E. *Winning Volleyball*. 2d ed. Boston, MA: Allyn and Bacon, 1976.
- Scates, Allen E., and Ward, Jane. *Volleyball*. 2d ed. Boston, MA: Allyn and Bacon, 1975.
- Schaafsma, Frances, and Heck, Ann. *Volleyball for Coaches and Teachers*. Dubuque, IA: Wm. C. Brown Co., 1971.
- Slaymaker, Thomas, and Brown, Virginia. *Power Volleyball*. Philadelphia, PA: W. B. Saunders Company, 1970.
- Tennent, Mark. *Volleyball Team Play*. Ontario, Canada: Canadian Volleyball Association, 1977.
- Thijpen, Janet. *Power Volleyball for Girls and Women*. 2d ed. Dubuque, IA: Wm. C. Brown Co., 1974.

*back squat (p. 369)*  
*bench press (p. 373)*  
*breathing (p. 366)*  
*chin and lat machines (p. 373)*  
*curls—regular and reverse (p. 376)*  
*dip (p. 373)*  
*frequency (p. 379)*  
*front squat (p. 369)*  
*grip (p. 366)*  
*incline press (p. 373)*  
*leg and back strength (p. 369)*  
*medicine ball trunk training (p. 379)*  
*military press (p. 369)*  
*muscular endurance (p. 365)*  
*muscular power (p. 365)*  
*muscular strength (p. 365)*  
*pull-over—straight arm (p. 376)*  
*repetitions (p. 379)*  
*shoulder and arm exercises (p. 369)*  
*sit-ups, variations, and horizontal bar swing (p. 378)*  
*spotting (p. 366)*  
*trunk and abdomen exercises (p. 378)*

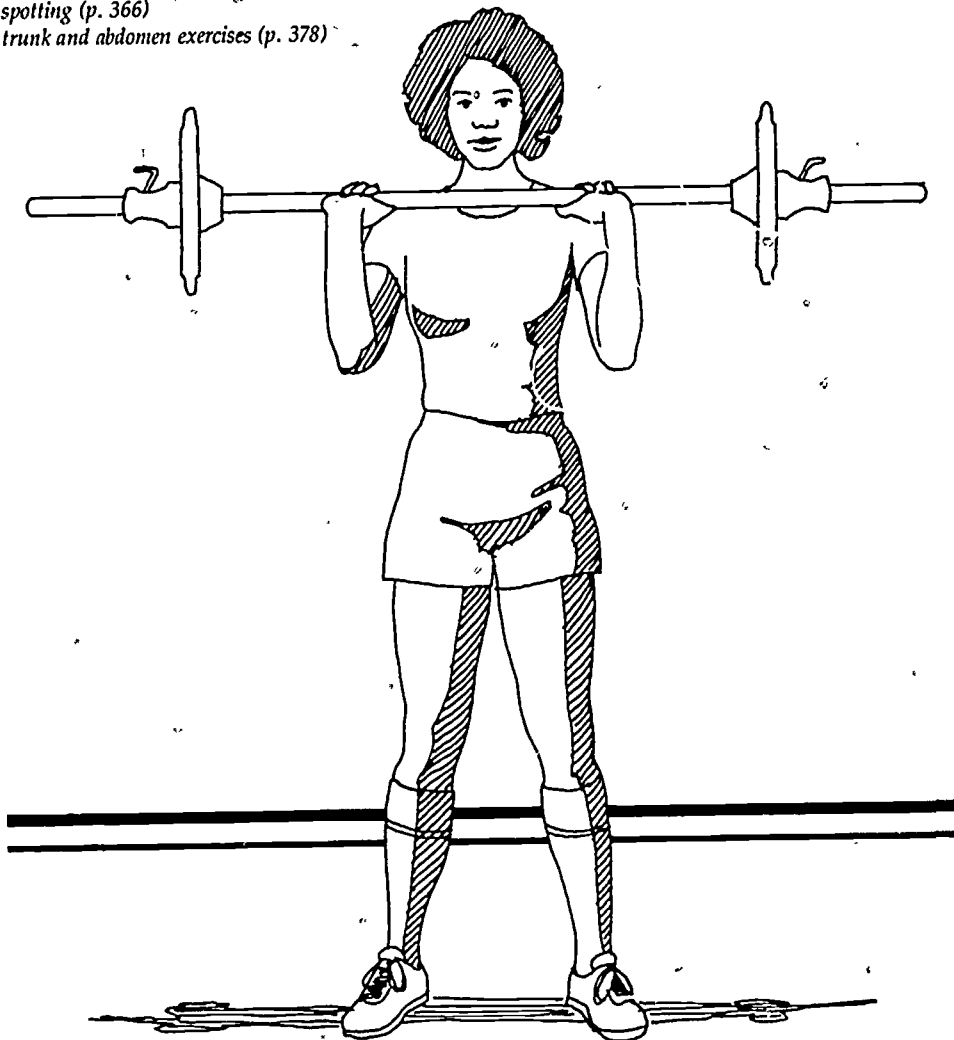

# Weight-training

BOB WARD,  
Dallas Cowboys Football Club,  
Dallas, TX

## INTRODUCTION

Weight-training is one of the most popular forms of conditioning today. A major reason for this popularity is that weight-training can produce positive changes in the structure and function of the body of the participant. Properly developed, a program of weight-training can help him/her to look better physically and perform more effectively in daily life.

## A CHANGING VIEW ON WEIGHT-TRAINING

The present prominence of weight-training has taken many years to achieve. A great many teachers of physical education, as well as coaches, did not approve of weight-training as part of their programs during the 1940s and 1950s. In this period teachers and coaches often even discouraged weight-training. The reasons these educators gave usually related to the supposed negative influences that weight-training had on skilled performance. Since many of those negative effects were based solely on opinion, not scientific investigation, studies were conducted to investigate some of the important questions involved in this issue. The positive results of these scientific investigations have led to an increasing use of weight-training as part of the physical education curriculum in many schools. It appears at this point that weight-training is becoming firmly grounded in the American thought of conditioning. Signs today indicate that an even greater emphasis may be developing in the future.

## THE TOTAL CONDITIONING PROCESS AND WEIGHT-TRAINING

It is important to understand what is to be accomplished through the conditioning program before a systematic program can be developed to achieve these ends. It is very important to understand how weight-training serves as an effective conditioning tool. The following qualities become highly developed through weight-training:

1. *Muscular power*—the ability to do heavy workloads in very short periods of time. The Clean is a commonly used measure of this quality.
2. *Muscular strength*—the ability to develop maximum force or tension in an exercise. This quality is usually measured by doing a one repetition maximum (1RM) for an exercise. The dead lift is an excellent example of total body muscular strength.
3. *Muscular endurance*—the ability to do an exercise, or series of exercises (circuit training), with below maximum weight, for a prolonged period of time. Various exercises can be done for repetitions with a percentage of the 1RM or a percentage of body weight.

## THE DEVELOPMENT OF A FUNCTIONAL STRENGTH WEIGHT-TRAINING PROGRAM

### PURPOSE OF THE PROGRAM

The first principle in program development concerns philosophy or purpose—

the reasons for action. Participants must recognize their present conditioning position and desired destination before an intelligent program can be developed. Once the goal is established, it is possible to set intermediate objectives that are progressively attainable and capable of being measured relative to the time spent in the program.

### ELEMENTS OF A FUNCTIONAL STRENGTH-TRAINING PROGRAM

Studies and coaching experience in weight-lifting and weight-training exercises have shown certain elements to be important in the development of a total weight-training program. Several of the recommended elements are given in the following figures, along with the normal time ranges to be devoted to them. It is recognized that each individual has different training needs and time available. Therefore, use the information given below as a guide for constructing an individualized program.

Element	Recommended % Time
1. Warm-up	5-10 minutes
2. Flexibility	10-20 minutes
3. Leg and back strength	10-20 minutes
4. Arm and shoulder pushing strength	7-15 minutes
5. Arm and shoulder pulling strength	7-15 minutes
6. Muscle endurance integrated into each exercise and/or one day per week circuit training.	
7. Trunk and abdominal strength	5-8 minutes
8. Warm-down	5-10 minutes

### IMPORTANT INFORMATION ON BREATHING, SPOTTING, AND THE GRIP

It is very important that the weight trainer have a good understanding of proper breathing, spotting, and gripping techniques before starting a program; consequently, it is fitting that these be discussed prior to getting into the actual lifting program.

#### Breathing

Proper breathing is one of the most important requirements in weight-training.

Many weight trainers do not practice correct breathing techniques and limit performance by so doing. Here are some essentials of breathing technique:

1. If the exercise weights are light to medium, breathing can easily follow the pattern of *out* on exertion and *in* as the action returns the bar to the starting position.
2. The light to medium breathing technique keeps the internal body pressure at a comfortable exercise level.
3. The lifting of heavy weights, however, demands that the lifter stabilize the trunk to provide a firm foundation for the execution of the exercise. Therefore, the air is taken in prior to the lift and held during the exertion. However, a forceful exhalation does help in making close lifts, and also reduces the possibility of passing out.

#### Spotting

Spotting is a preventive safety measure. Many hazardous situations can be easily avoided by following proper training programs as well as sound spotting principles. Spotters are persons who stand by the lifter to provide assistance when needed. They may help position a heavy weight for the start of an exercise, or help remove it afterward. Their primary function, however, is to prevent injuries by controlling the weight in the event of a slip, or when the lifter cannot complete a lift. Some helpful principles of spotting are given below:

1. Follow intelligent training programs.
2. Properly use and inspect equipment.
3. Pay attention when spotting.
4. Use at least two spotters when working with extremely heavy weights.
5. Use appropriate lifting racks when lifting extremely heavy weights.

#### The Grip

The grip depends primarily on the type of exercise or variation being done. There are six major grips used in weight-training. These grips are: overhand; underhand; alternate; false; hooked, strapped. Some of these are shown in the accompanying illustrations.



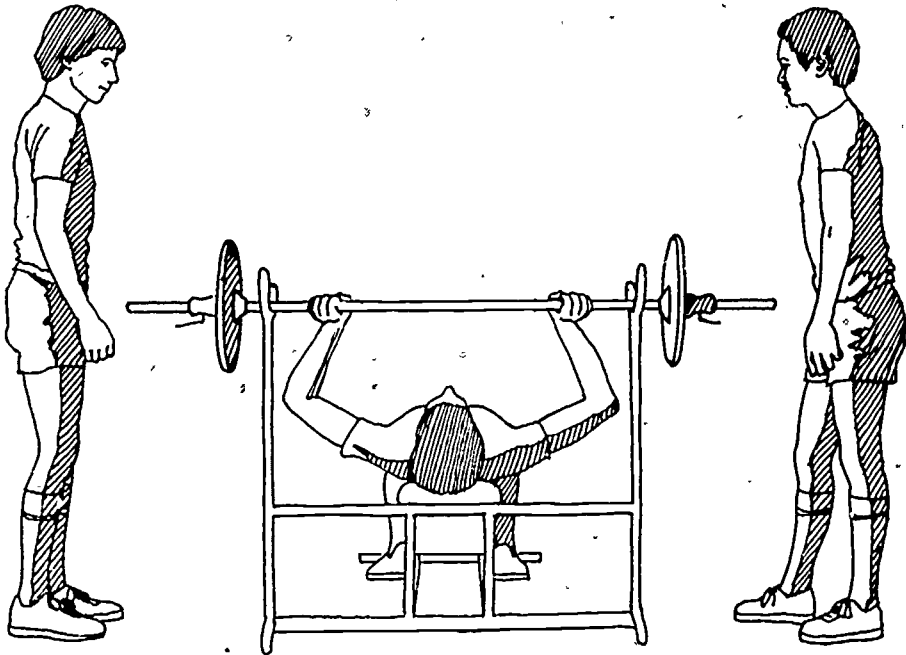

a. The feet are flat on the floor.

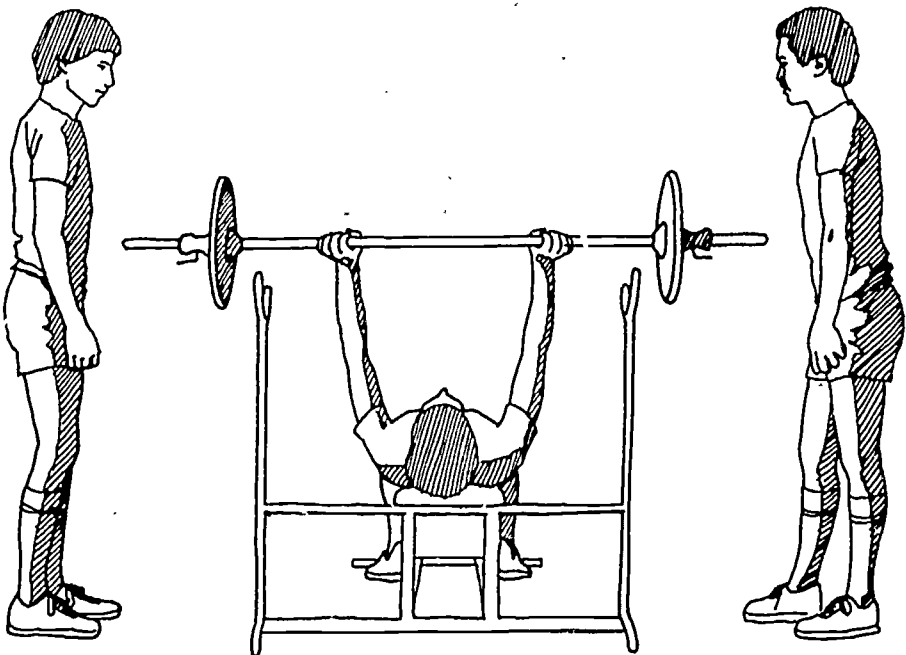

b. The arms are fully extended when taking the barbell from the spotters.

Figure 1. Spotting for the bench press.

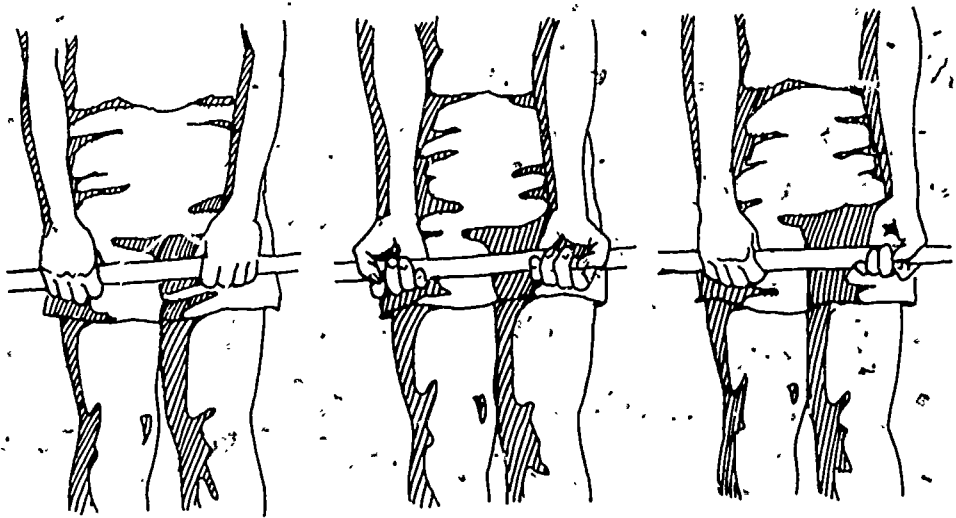

a. Overhand grip.

b. Underhand grip.

c. Alternate grip.

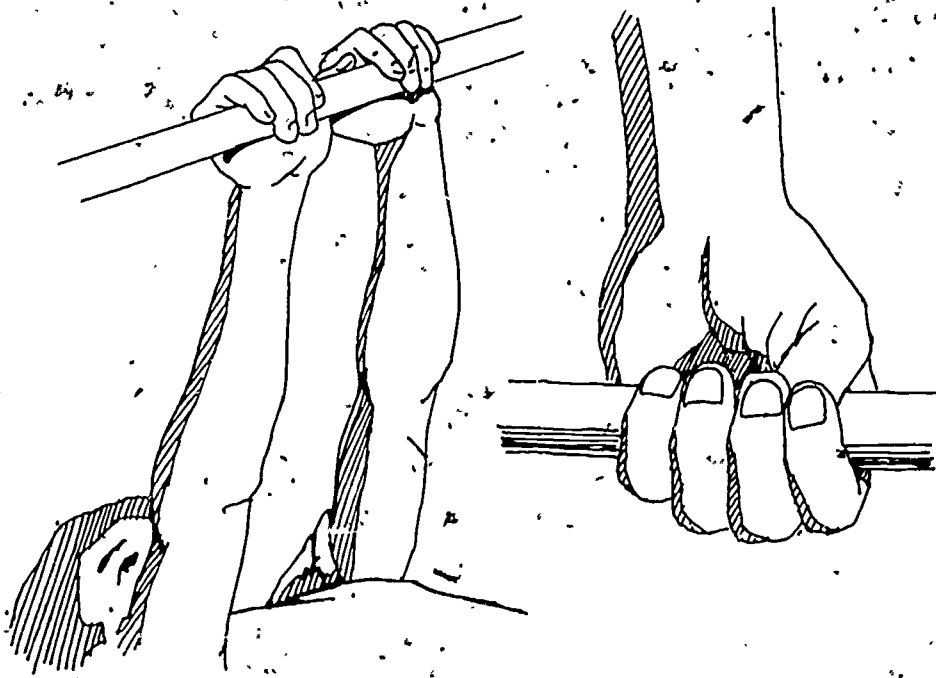

d. False grip.

e. Hooked grip.

Figure 2. The grip.

369

**LEG AND BACK STRENGTH**

This is a supportive or foundational quality. The major objective of these leg and back exercises is to develop tissue strength in the large muscle groups of the body. This strength improves the ability to maintain proper body positions in other exercises and sporting skills. Barbell, dumbbell, and machine exercises such as knee bends of all kinds are included in programs for the development of leg and back strength.

**Exercise: Front Squat**

*Equipment:* Barbell/dumbbell/machine.

*Major Purpose:* To develop supportive strength in the legs and back. Notice that the vertical position of the trunk forces the legs to do more work. This exercise also develops arm and shoulder girdle strength as a secondary objective.

*Steps:*

1. Assume a stance allowing for a comfortable squat to be assumed through the desired range of motion.
2. Rest the weight on the shoulders by bringing the elbows up.
3. The fingers may be loosened so that the bar will primarily rest on the shoulders.
4. The back should remain tight and in as vertical a position as possible throughout the squat.
5. A deep breath at the start will assist in stabilizing the trunk and help maintain a good bar position on the way down.
6. The depth of the squat should be a position at which the tops of the thighs are parallel to the floor.
7. Force the breath out to help finish the squat and to avoid passing out.

**Back Squat**

*Equipment:* Barbell/dumbbell/machine.

*Major*

*Purpose.* To develop supporting strength in the legs and back. Notice that in the back squat, the trunk can move further forward without losing the

weight. This greater forward lean shifts the emphasis to the buttocks.

*Steps:*

1. The stance should allow for a comfortable squat to be assumed through the desired range of motion.
2. Rest the weight on the muscle portion of the back. It is highly recommended that the bar, or back, be padded for comfort and protection.
3. The back should remain tight and kept as straight as possible.
4. A slight turn of the bar in a downward direction makes the squat much easier.
5. A deep breath at the start of the lift helps stabilize the trunk and maintain a good bar position on the way down.
6. The depth of the squat should be to a position at which the tops of the thighs are parallel to the floor.
7. Force the breath out to help finish the squat and avoid passing out.

**SHOULDER AND ARM EXERCISES**

There are two basic kinds of shoulder and arm exercises: pushing; pulling. They complement one another when the shoulder and arm muscle groups are worked in opposite directions, that is, the pushing exercises actively extend the arms, while the pulling exercises actively flex them. A balance in development is maintained by spending an equal amount of training time in each of these areas.

Pushing exercises work the shoulder girdle and arms with actions that extend the arms, together, or individually, away from the body. Jerking motions that use the legs are included in this category. Some other commonly used exercises are the military press, bench press, incline press, and dip.

The amount of the functional strength time recommended for pushing exercises is 7-10% of the total workout time.

**Military Press**

*Equipment:* Barbell/dumbbell/machine.

*Major*

*Purpose:* To develop strength and muscular endurance in the arms and shoulder girdle.

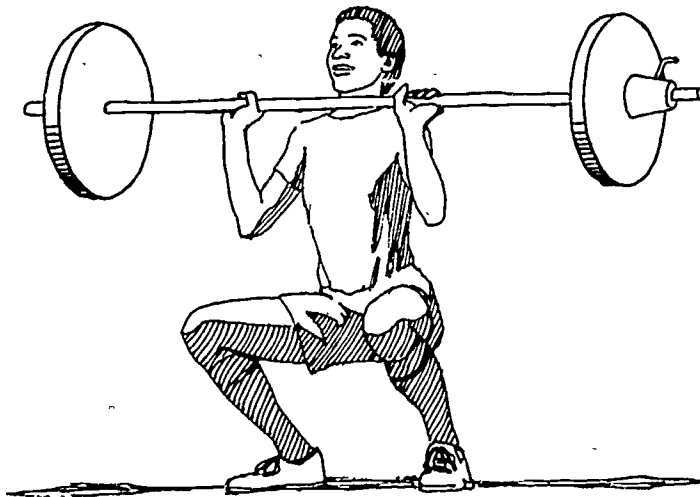
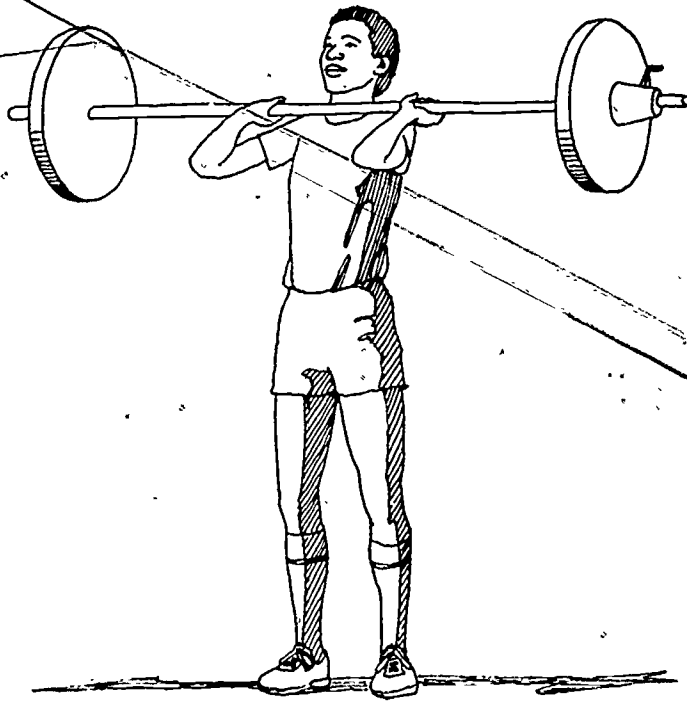

Figure 3. The front squat 371

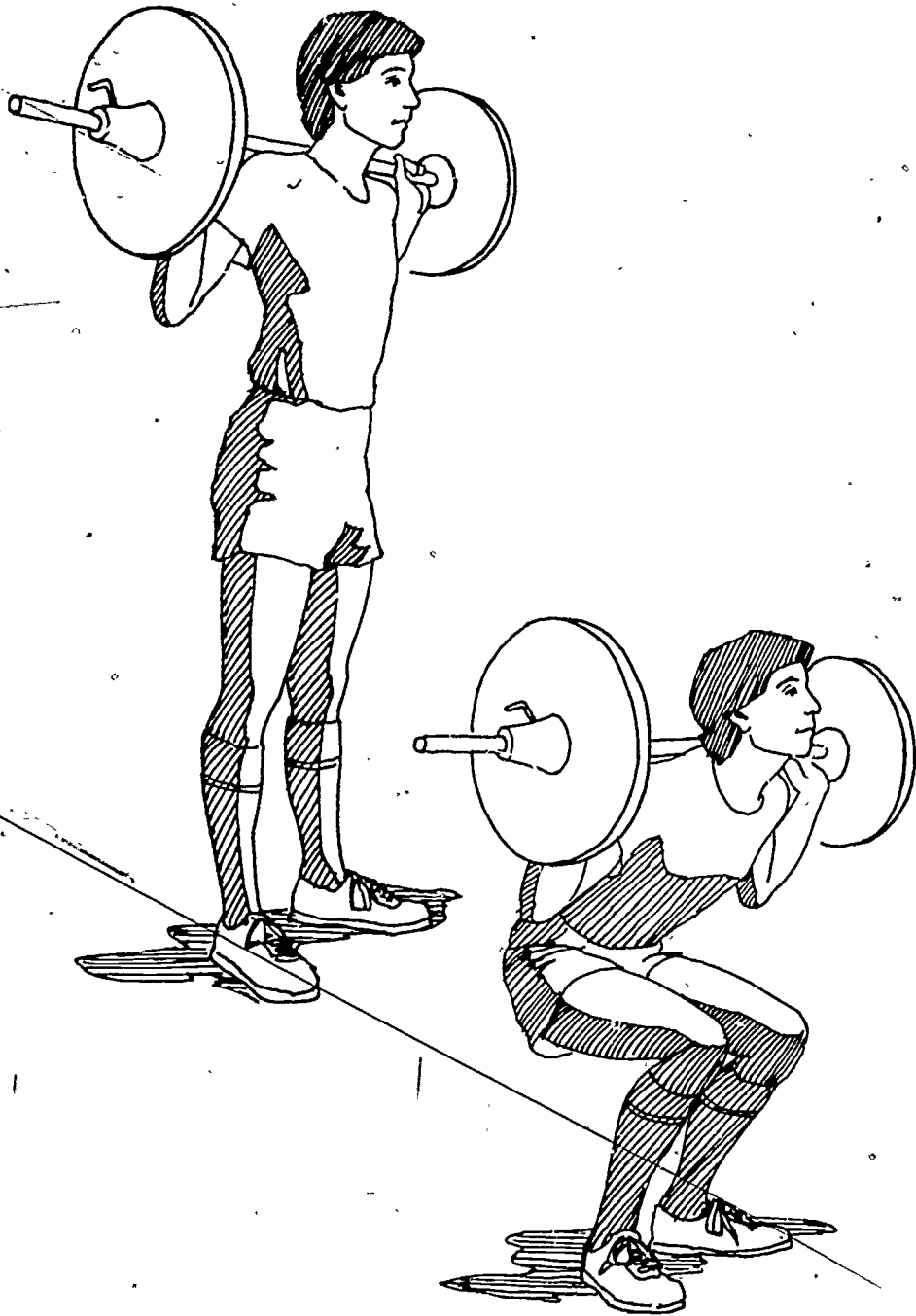

Figure 4. The back squat.

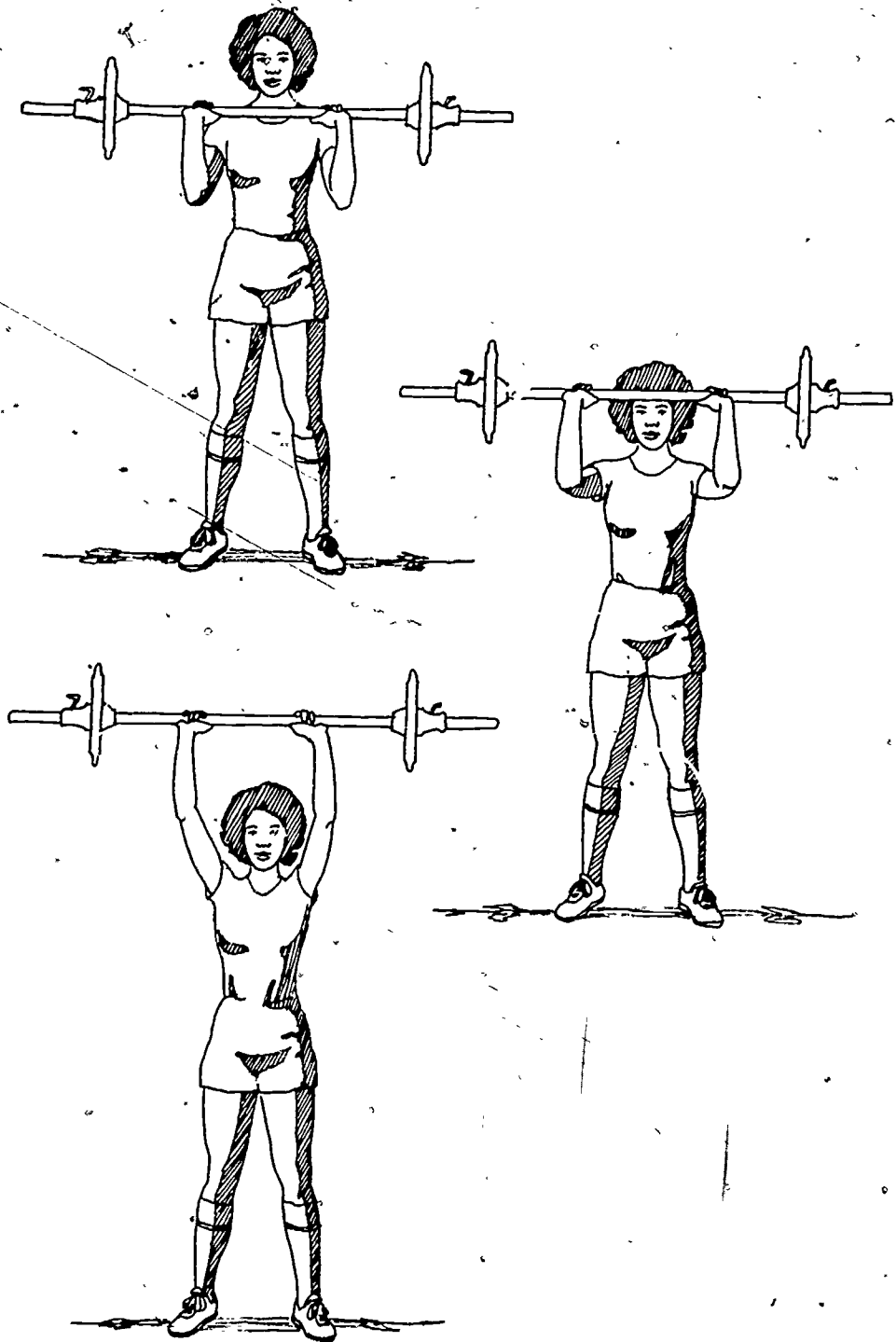

Figure 5. The military press.

**Steps:**

1. The stance should be at a comfortable distance.
2. The grip on the bar is slightly wider than shoulder width.
3. Take a deep breath and hold the trunk tight.
4. Press the bar vertically with the shoulder and arms.
5. Avoid leaning back too far (use a lifting belt).
6. Lock out the arms directly over the shoulders.
7. Force air out to help finish the lift.

**Incline Press**

**Equipment:** Barbell/dumbbell/machine/  
incline bench.

**Major**

**Purpose:** To develop strength and muscular endurance in the arms and shoulder girdle.

**Steps:**

1. The position for this exercise is from a seated or standing incline bench.
2. The grip on the bar is slightly wider than shoulder width; however, this may vary depending on the objective of the exercise.
3. Take a deep breath and hold the trunk tight.
4. Bring the bar down with elbows out. This action places the bar in the proper position, high on the chest.
5. Tap the chest and press the bar up and back over the shoulders.
6. Lock out the arms directly over the shoulders.
7. Force the air out to help the finish of the lift.

**Bench Press**

**Equipment:** Barbell/dumbbell/machine/  
bench.

**Major Purpose:** To develop strength and muscular endurance in the arms and shoulder girdle.

**Steps:**

1. Position for doing this exercise is from a bench with the back on the bench.
2. The grip on the bar is slightly wider than shoulder width; however, this may vary

depending on the objective of the exercise.

3. Take a deep breath and hold the trunk tight.
4. Bring the bar down and touch the chest.
5. Press the bar up and back over the shoulders.
6. Lock out the arms directly over the shoulders, or slightly back toward the head.
7. Force the air out to help the finish of the lift.

**Dip**

**Equipment:** Parallel bar/machine.

**Major Purpose:** To develop the strength and muscular endurance of the arms and shoulder girdle.

**Steps:**

1. The width between the bars can be varied to work different parts of the arms and shoulder girdle.
2. Various gripping positions may be used to focus on certain areas of the arms and shoulder girdle.
3. Additional weight can be added by using a belt and strap or by using a dip machine.
4. Breathe *in* going down and *out* coming up.
5. Establish an even rhythm while doing the exercise.
6. Exercise through the full range of motion.

**PULLING EXERCISES**

Pulling exercises work the shoulder girdle and arms with movements toward the body rather than away from it, and thus can be recognized by active flexion of the arms. Chinning, lat pulldown, pullovers, and curls are examples of pulling exercises. Seven to ten percent of the functional strength time is recommended for pulling exercises.

**Chin Pullup and Lat Pulldown**

**Equipment:** Horizontal bar/any hanging device/lat machine.

**Major Purpose:** To develop strength and fitness of the chest, back, shoulders, and arms.

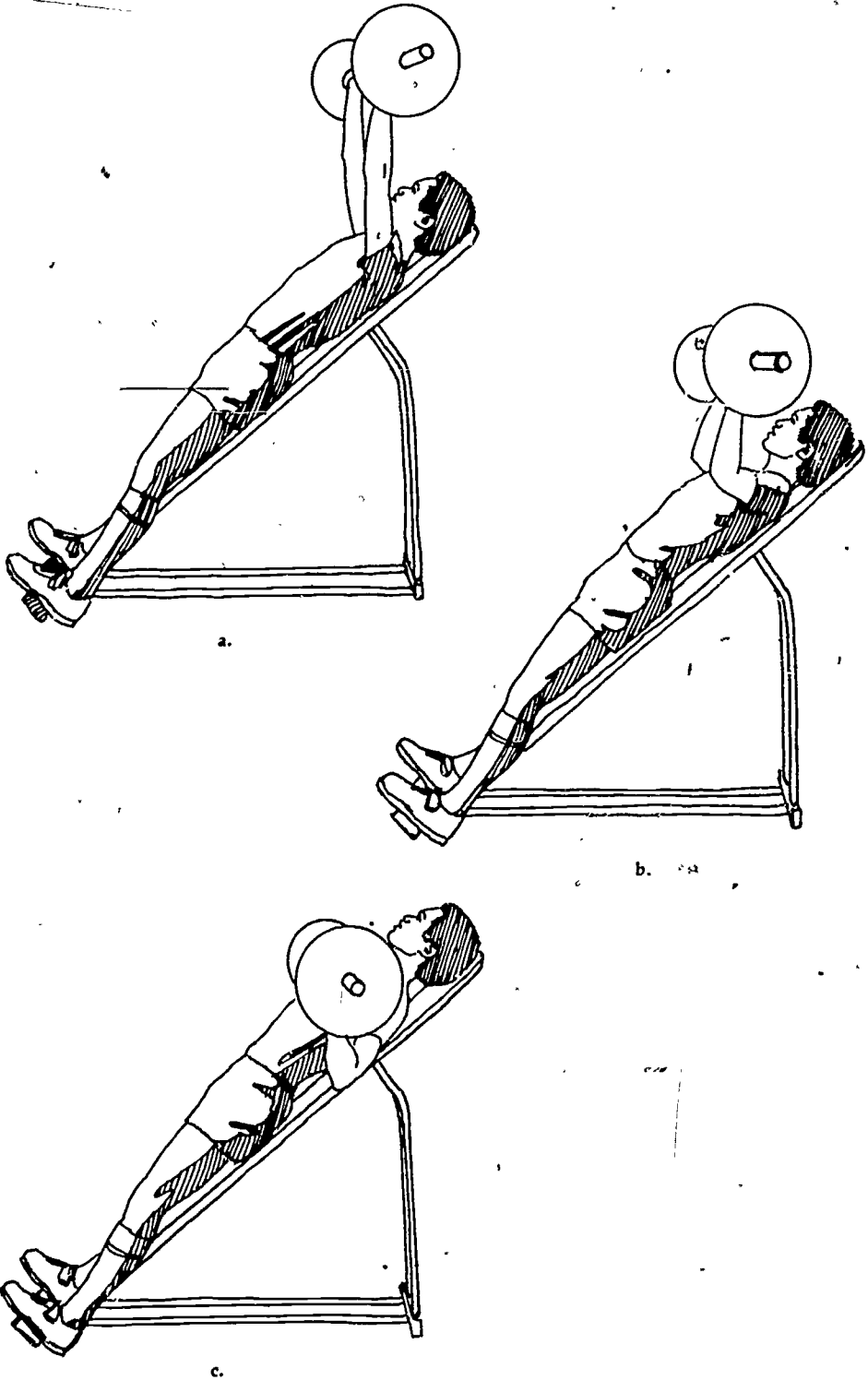

Figure 6. Incline press. 375



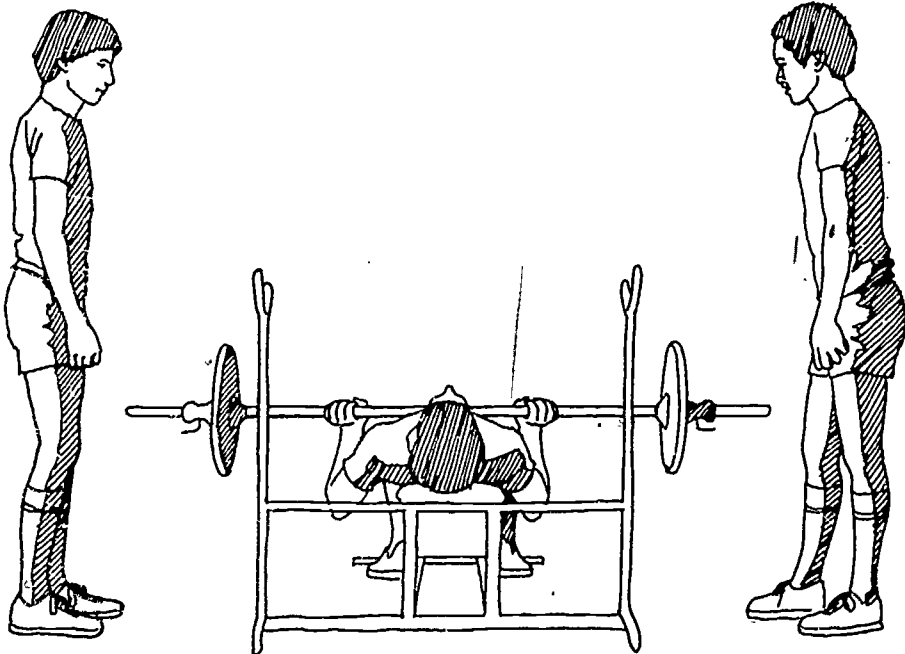
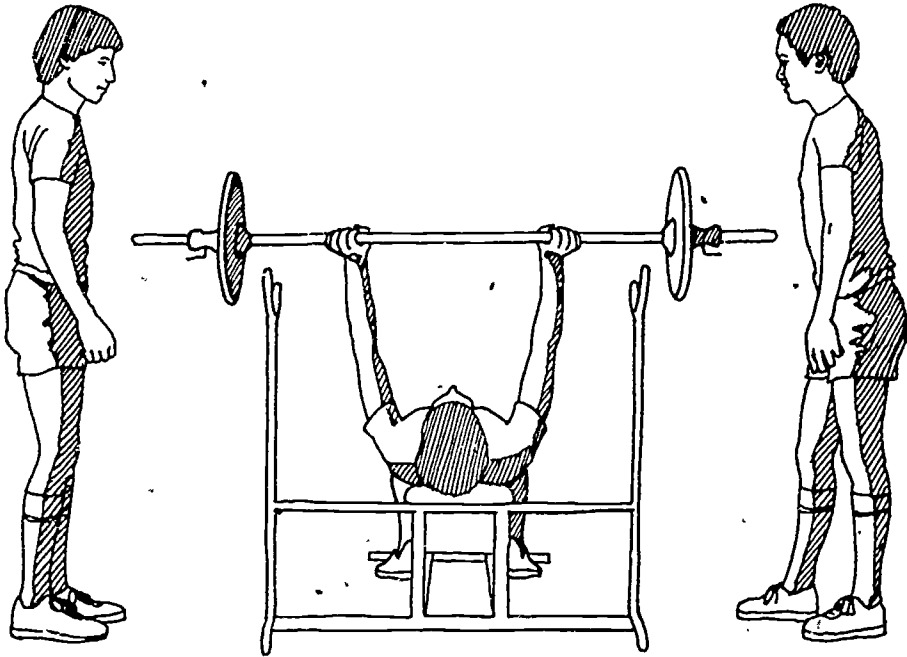
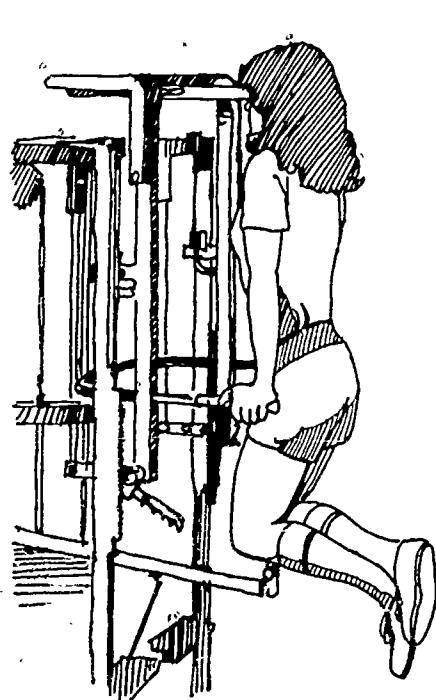
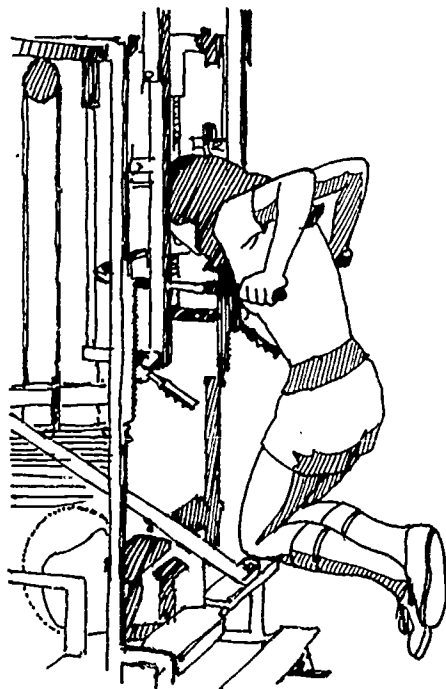

Figure 7. The bench press.



a. Starting positions for the dip on the Nautilus multi-exercise machine.



b. Execution of the dip on the Nautilus multi-exercise machine.

Figure 8. The dip.

#### Steps:

1. The chin is an excellent exercise to develop total upper body pulling fitness.
2. It is recommended that the chin be done in front, back, and on the side of the head with various grips for all-around strength and muscular endurance development.
3. The use of any horizontal or vertical bar, or any device that can be gripped, will also provide variety in muscular development, and also in the training program.

#### Pullover-straight Arm

*Equipment.* Barbell/dumbbell/machine

*Major Purpose:* To develop the strength, muscular endurance, and flexibility of the shoulders, chest, back, and arms.

1. This exercise can be done on the ground for beginners, or on a bench for the intermediate or advanced weight trainer.
2. Grasp the bar with a normal overhand or false grip, slightly wider from hand to hand than shoulder width.

3. Breathe in deeply while moving the bar back to the ground. Exhale as the bar is returned to the starting position.
4. Use light starting weights when first learning this exercise. After the skill and strength begins to develop, it is surprising how strong this action can become.

#### Curls (Regular and Reverse)

*Equipment.* Barbell/dumbbell/machine.

*Major Purpose.* To develop the strength and muscular endurance of the arms.

#### Steps:

1. Take a comfortable stance about shoulder width.
2. Grip the bar about shoulder width.
3. Palms are up for the regular curl, and down for the reverse curl.
4. Elbows are positioned at or near the sides with the arms straight.
5. Breathe in just before raising the bar. Breathe out as the bar is lowered.
6. The curling action begins by flexing the arms, thus bringing the bar to the shoul-

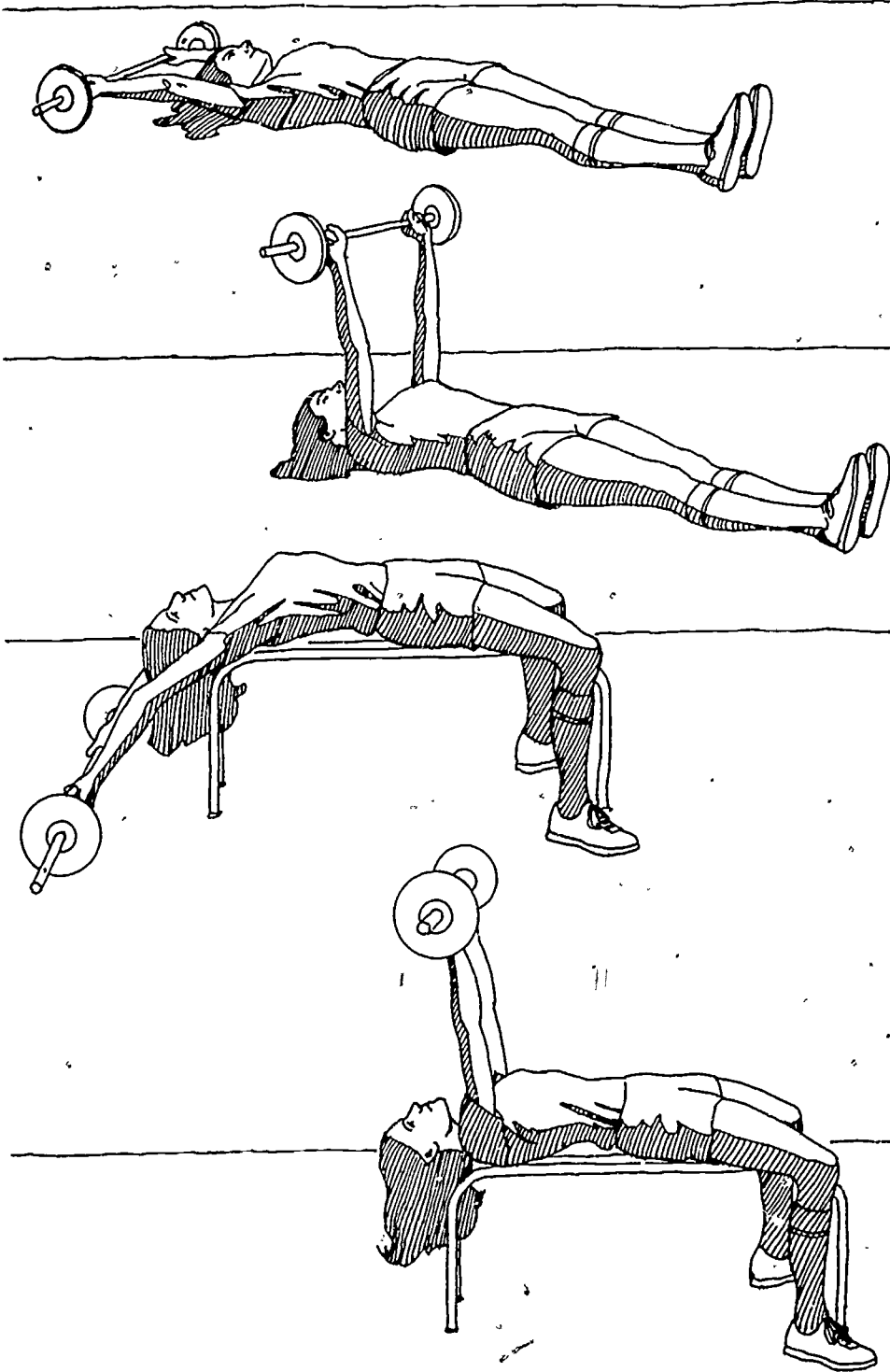

Figure 9. The pullover-straight arm.

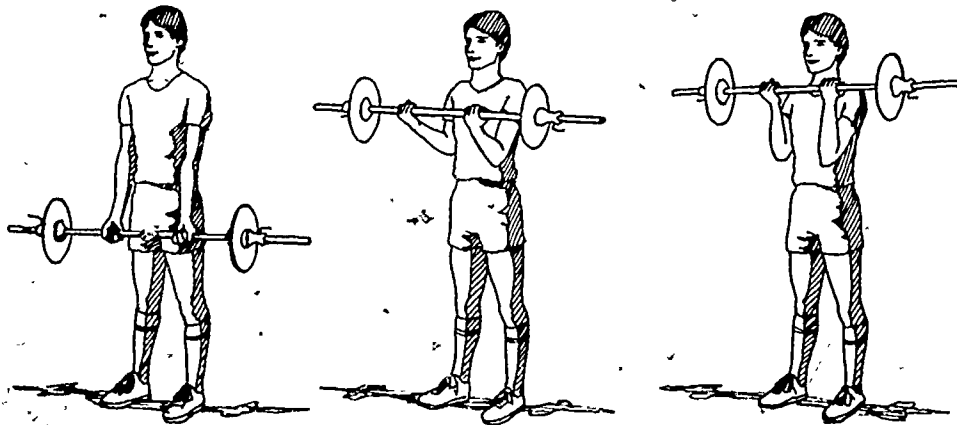

Figure 10. The curl (regular).

ders with the elbows raised. The arms are then extended, returning the bar to the completely straightened starting arm position.

7. Body movement will reduce the focus on the biceps.
8. Establish a good rhythm during the curl.
9. Work the biceps both on the way down as well as up, by letting the bar down slowly.

### MUSCULAR ENDURANCE

The exercise prescription for muscle endurance can take many forms. The major objective to be achieved by this training is to increase overall body stamina. It is best to do a series of exercises that work all body motions for a balanced program.

There are six principles in establishing a muscle endurance program. These are.

1. Stations or exercises (10-15) that make up a circuit.
2. Percent of 1RM is usually 50-60%; however, it may be higher or lower, depending on the objective.
3. Repetitions should range from 12-50 plus, depending on the time assigned and the percentage of 1RM used.
4. Time can be related to energy systems being trained, or to specific time frames in the participant's sport, e.g., length of contest. A 15-60 minute period covers most sporting activities.

5. Interval is the time taken between stations or exercises. Normally, a 10-20 second workout is followed by a 30-60 second interval. It is usually good to train for the specific demands of one's sport. In sports like football featuring interruptions in play, it is appropriate to train for the times of work and rest. In sports that are continuous in nature, careful study should determine appropriate work-rest time intervals.

6. Sets refer to the number of times the exercise, series of exercises, or circuit, is repeated.

### TRUNK AND ABDOMEN EXERCISES

The trunk is the largest segment of the body. It is the crossroad for all sporting skill actions. Therefore, adequate time must be allotted for improving the strength and skill of the many movements it is called upon to do. The recommended percentage of the total functional strength time is 3-5%.

#### Sit-ups, Variations, and Horizontal Bar Swing

*Major Purpose.* To develop the strength and muscle endurance of the trunk.

#### Steps:

1. Begin sit-up exercises by doing partial sit-ups with legs straight or bent.
2. Force air out as the sit-up is being done to work the total trunk.

3. Twisting can be added to all forms of sit-ups to work all sides of the trunk.
4. Advanced trunk training may require that the hip flexors be used in the action. Therefore, make sure that sound techniques are used, and assure proper conditioning before beginning.
5. Keep the low back rounded when doing any sit-up with the feet held down.
6. Return to the upright position as soon as the rounded low back touches the ground.

#### Medicine Ball Trunk Training

*Equipment:* Medicine ball/sand bags/weights.

*Major Purpose:* To develop all aspects of trunk movement.

## DEVELOPING A WEIGHT-TRAINING PROGRAM

### FREQUENCY

For most beginning programs, three or four times a week with a day off after each exercise session is ideal. Since resistance training tends to break down muscle tissue, the rest period is essential to its proper replacement. Time and experience enable the participant to establish the best individual training schedule.

### REPETITIONS

The number of repetitions of each exercise ranges from as few as 1-3 to as many as 50. The specific number selected for any given lift should be based on the present level of training and conditioning, the type of exercise, and the training goal sought. In general, strength-training is accomplished with fewer repetitions (3-8) of a heavier weight, while endurance work and general conditioning calls for more repetitions. A good general guide for beginners is to do three sets of 3-5 repetitions. When ten repetitions can be consistently done at that weight, it is time to increase the resistance.

## GUIDELINES FOR A SAFE, EFFECTIVE WORKOUT

1. Lift with a partner. This will permit rest periods, provide a spotter, and allow the partners to provide information for one another regarding proper form and technique.
2. Warm up gradually. Prepare the body for the stresses involved in a vigorous weight-training workout.
3. Perform all exercises throughout the full range of motion. All exercises should be done to the maximum limits of the movement of the joint involved. Repeated exercise at less than a normal range of motion can result in a restriction of mobility.
4. Don't cheat. Exercises should always be performed in the prescribed manner. Cheating or bringing other muscle groups into play in an exercise results in less exercise for the target muscles, and introduces the possibility of postural and performance problems.
5. Keep records. An exercise record is an important component of any training program. It will help progress to be analyzed and goals to be set. A suggested format would be:

Dates

Lift	1		1		1		1		1						
	1	1	3	3	5	5	8	8	10	10					
Curl lb.	40	40	40	40	40	40	40	40	40	40					
reps.	5	5	3	6	5	4	8	5	5	9	7	7	10	10	9
Press	80	80	80	80	80	80	80	80	80	80	80	80	85	85	85
	8	7	7	10	9	9	10	10	10	10	10	10	5	4	4

6. Don't get over-confident. More injuries occur because a lifter gets careless with a weight that has been successfully handled before than because of attempting an unusually heavy lift. Remember, accidents are usually a result of carelessness. Always stay alert. Use spotters on the lighter weights, as well as those approaching the maximum potential.

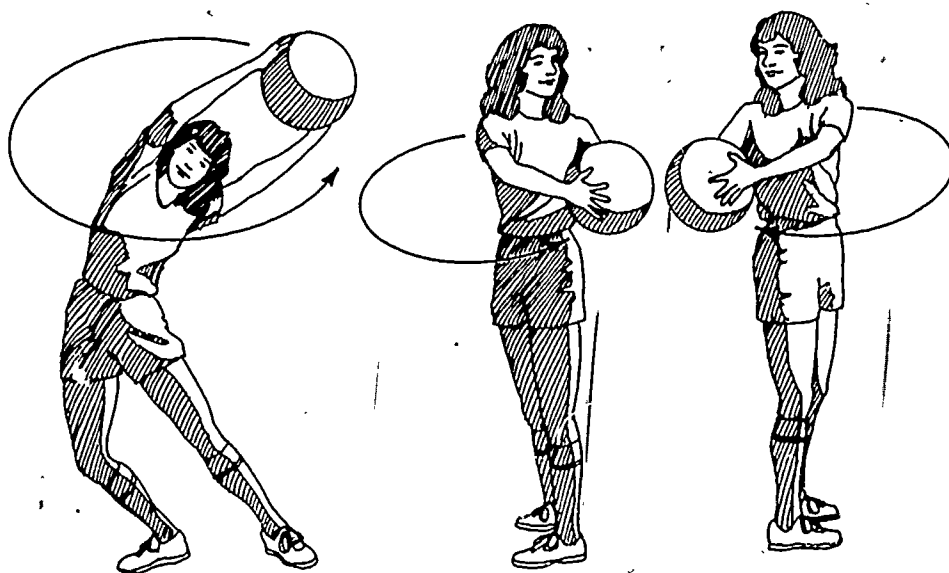
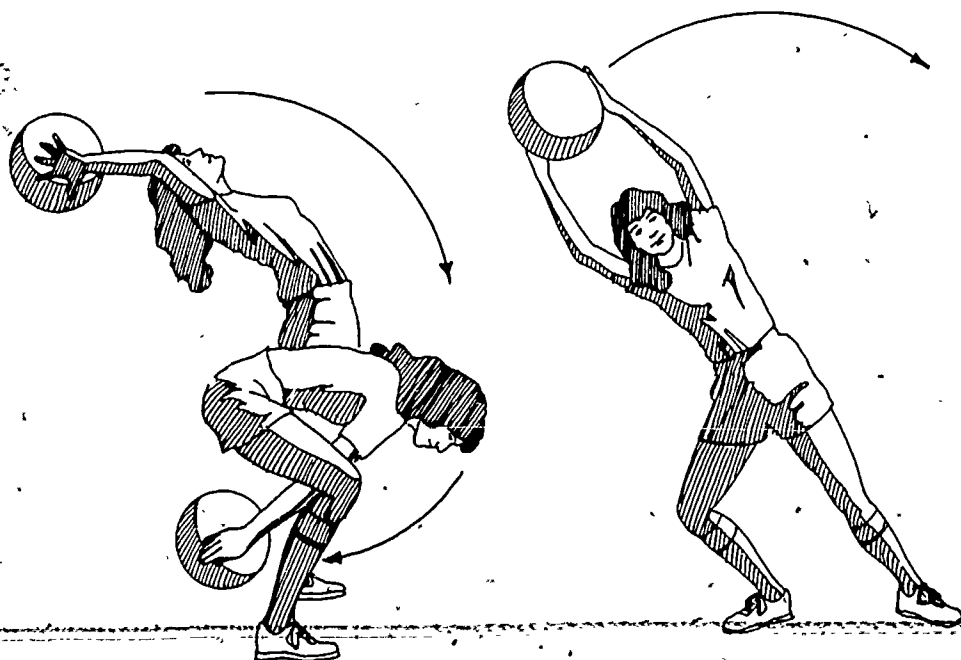
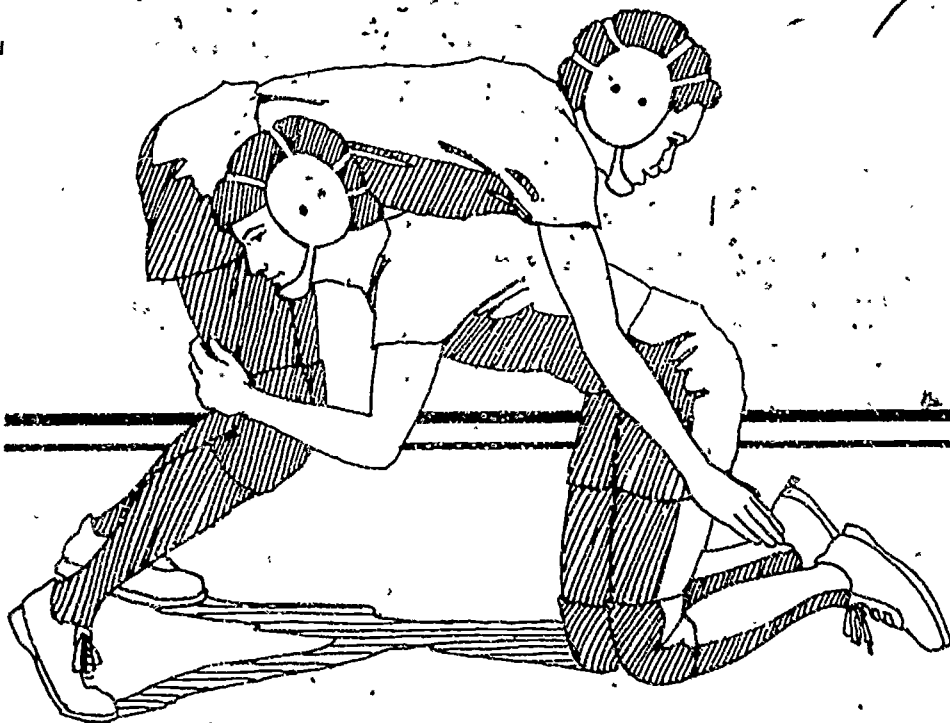

Figure 11. Medicine ball trunk training.

bar arm and half nelson (p. 393)  
bear hug (p. 386)  
breakdowns (p. 386)  
chain wrestling (p. 395)  
counter to double arm drag (p. 393)  
counter to head drag (p. 394)  
counter to heel pick-up (p. 393)  
counter to leg dives (p. 393)  
counter to switches (p. 394)  
crotch and half nelson (p. 393)  
double arm drag (p. 386)  
far ankle and far arm (p. 388)  
far ankle and near waist (p. 388)  
far arm and double bar (p. 388)  
head drag (p. 386)  
heel pick-up (p. 386)  
hiplock and whizzer (p. 390)  
hiplock escape (p. 390)  
referee's position (p. 383)  
single leg dive (p. 384)  
sit-out (p. 390)  
standing escape (p. 390)  
stretcher (p. 388)  
switch (p. 390)  
three-quarter nelson (p. 393)  
tie-up position (p. 383)  
upright position (p. 383)



# Wrestling

IRWIN HESS,  
Kutztown State College,  
Kutztown, PA

## INTRODUCTION

Today's youth possess a desire to be creative; to do something different from others. Wrestling provides such an opportunity. It is a sport in which an individual can not only excel, but one which provides many psychological advantages as well.

Wrestling began during what has been called the "formation of the world cultures, a birth of nations." It was here that individualistic outlets provided a means of self-defense as well as a means of recreational satisfaction. It was a form of military combat during medieval conflicts, a means by which individuals demonstrated the superiority of their strength, stamina, and skill.

The great thing about wrestling is that it affords individuals of varied physical qualities the opportunity to compete. It is not necessarily a sport in which strength is a prerequisite for success. Scientific studies on leverage, balance, and quickness have clearly illustrated their importance in the success of wrestling.

The creation of a National Rules Committee in 1927 resulted in a clarification and modification of the then-existing rules, and greatly stimulated the growth of wrestling as a major spectator sport. Wrestling in this country is primarily freestyle, that is, it permits a contestant to trip and to use holds either above or below the waist. The objective is to pin or hold an opponent's shoulders to the mat, thus terminating the bout. The rules committee has developed a point system which is used to determine winners in bouts where no fall occurs as well as a weight classification system to guarantee evenly matched contests. High school wrestling matches are conducted in the following weight classes. 98 lb., 105 lb., 112 lb.,

119 lb., 126 lb., 132 lb., 138 lb., 145 lb., 155 lb., 167 lb., 185 lb., and unlimited.

## SKILLS AND TECHNIQUES

### BASIC STARTING POSITIONS

There are three basic wrestling positions with which you should be thoroughly familiar.

#### The Upright Position

There are two basic upright stances. In one the wrestler has more of a closed stance but is well-balanced over the knees and has the arms extended so that he/she is prepared for an offensive move as well as a defensive move. The left foot is slightly in front; thus he/she is able to defend one or both legs. It is easier to defend one leg than it is to defend two. The head should be up and the eyes should never be taken off the opponent. The best area to focus on is the area directly below the waistline; this is the one area of the body incapable of being rapidly moved.

In the other upright stance, the wrestler has an open stance with one foot back. This stance permits rapid movement in either direction without changing positions first and thus giving away his/her intentions.

#### The "Tie-up" Position

This technique is used by wrestler attempting to work at a closer range (generally used by individuals who do not possess the speed to work from the outside).

#### The Referee's Position

The bottom wrestler is down on all fours with the palms of the hands 12 inches from the knees. The offensive wrestler then as-



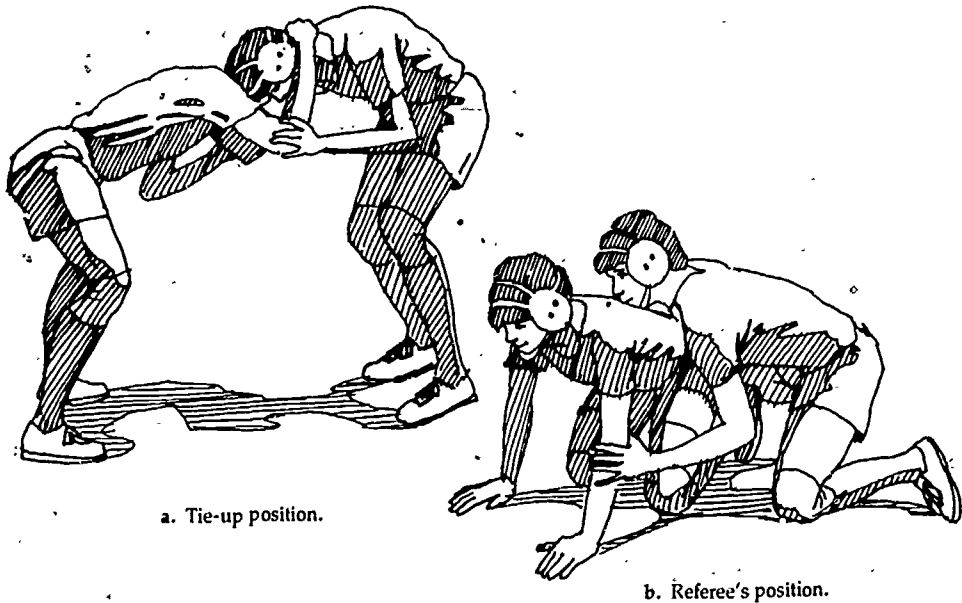

Figure 1. Basic starting positions.

sumes a position: on one side of the opponent. One arm must be loosely placed around the opponent's waist and the other arm should be placed at the bend in the elbow of the opponent. The offensive wrestler may have either the front knee or the back knee off the mat if the foot stays outside the nearest plane of the defensive wrestler. That is, the foot may not cross an imaginary perpendicular line from the nearest edge of the opponent's body to the floor.

### TAKEDOWN SKILLS

There are several ways of taking an opponent down to the mat. As skill is gained you will want to supplement the skills described here. As in all wrestling maneuvers, takedowns are effective only when you move rapidly and catch the opponent off-guard. Practice is required in all these movements. Repetition of movements will create a pattern which will, if done often enough, create a reflex within the body; thus the human instinct will take over

when performing a movement. When learning and practicing, have the opponent offer almost no opposition. As you become more skilled he/she should increase the amount of opposition.

With the exception of a pinning combination, the takedown is probably the most important maneuver in wrestling. More practice time should be allowed for this phase of wrestling than many of the other techniques.

### Single Leg Dive

The single leg dive is attainable from either an upright position or a tie-up position.

1. From the upright position make a quick thrust toward the knees of the opponent and grab behind the opponent's knee joint. The same technique can be used from the tie-up position. Remember, on all tie-up techniques you must shrug your arms free of the opponent before attempting to get at his/her leg and body area.

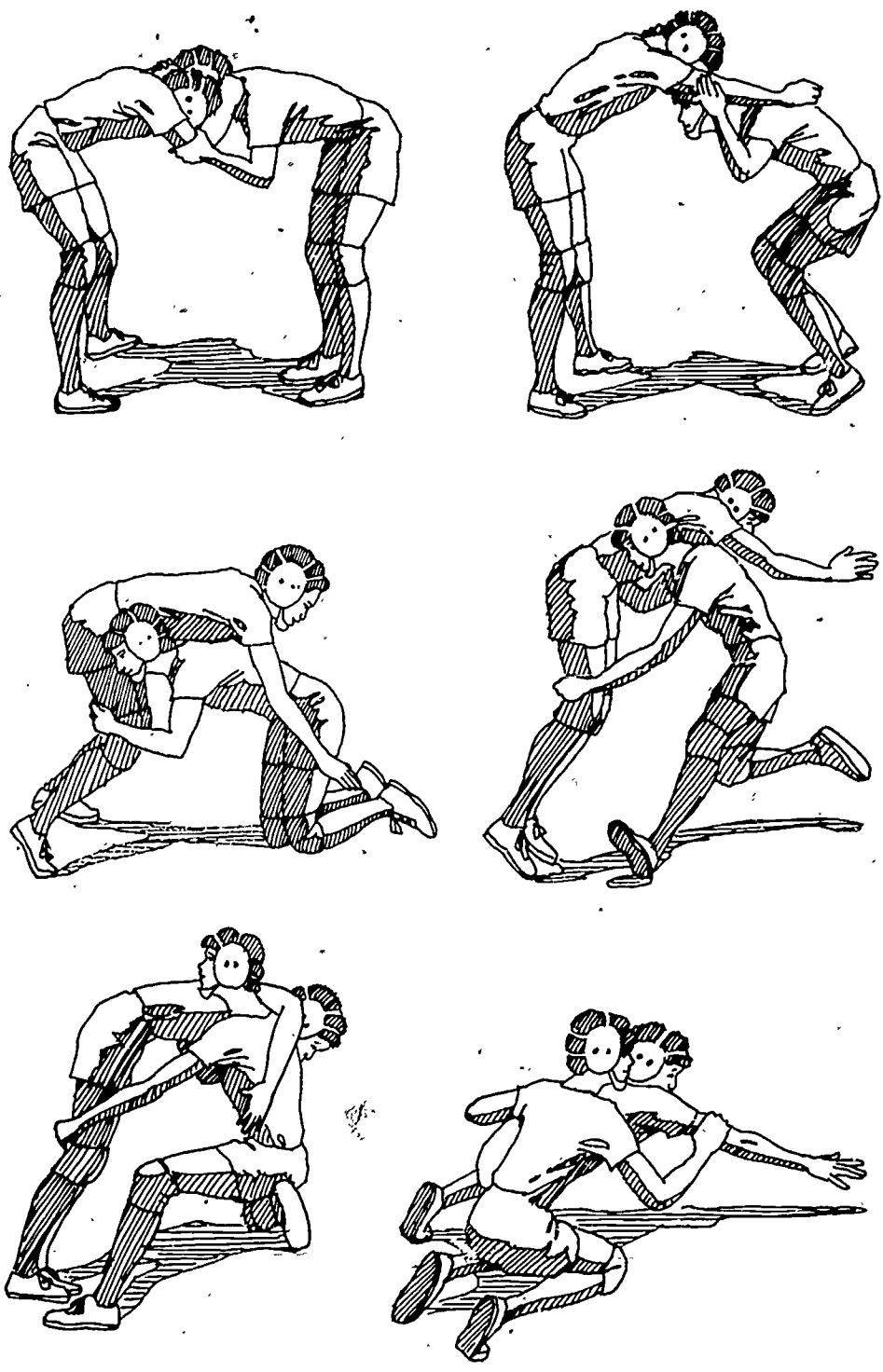

Figure 2. Leg-drive.

2. Drop on both knees with your head on the same side as the leg you grasp. At the same time bring your outside leg forward and pivot on your knee to move behind your opponent.
3. Move the left arm up around his/her waist and straddle his/her right leg as he/she goes forward to the mat.

#### Double Arm Drag

1. From the tie-up position, slide your left arm over the opponent's right arm and grasp him/her just above the elbow.
2. Bring your right hand across and grasp the opponent just below the right armpit. At the same time slide your left hand down to the opponent's right wrist.
3. Pull his/her right arm to your side, applying most of the power with your right hand. At the same time move to his/her right side and hook your right leg around his/her right foot.
4. Release your left hand and grasp his/her right leg at the knee.
5. Pull forward and down with your right hand while swinging your left leg over his/her right leg. You must throw yourself into this maneuver because your weight will initiate the opponent's fall toward the mat to complete the takedown.

#### Heel Pick-up

1. Grasp the opponent's neck with your right hand, and at the same time, slide your left hand to the inside of his/her right arm and grasp his/her upper arm.
2. Drop to your right knee while grasping the opponent's left heel with your left hand.
3. Pull his/her left heel to your left, and, at the same time, snap down hard with your right hand on the opponent's neck.
4. As your opponent touches the mat, release your hold and secure an inside crotch position or other advantage hold depending on what he/she does. Maintain leg control over the opponent, thus preventing him/her from regaining his/her balance and possibly breaking your hold.

#### Head Drag or Duck under

1. From a tie-up position reach for the opponent's neck with your right hand. At the same time slide your left hand to the inside of his/her right arm and grasp his/her upper arm.
2. Holding his/her right arm in place with your left hand, duck quickly under his/her right arm so that his/her elbow is resting on your neck. You must practice the ducking phase of this move because it enables you to get behind the opponent much easier. Don't try to go through his/her arm; go under.
3. At the same time throw your head back, pull down on his/her neck with your right hand, and swing around behind. If you pull hard enough on the opponent's neck with your right hand, he/she will go forward to the mat.

#### Bear Hug

This maneuver has recently become very popular. It is best performed from a tie-up position.

1. The important thing to remember is to keep the opponent's arms above yours. You must penetrate and grasp your hands together around the waist if possible; then move your arms as high as possible without breaking your grip.
2. At this point you can trip your opponent or lift him/her and force him/her to the mat.

#### BREAKDOWNS

From a referee's position on the mat the man with a position of advantage must control the defensive wrestler. The objective of the bottom wrestler is to reverse his/her position and gain control of the opponent. Therefore, it is important to learn basic breakdowns to bring your opponent under control if you are to obtain a fall. This is the preliminary step to securing a fall. Your first objective should be to flatten the opponent out in a prone position. This prevents escaping and puts him/her in a position which permits you to maneuver for a fall. When on top you must remember the wrestler underneath has four points of support. The object is to destroy one or more of these supports and get the oppo-

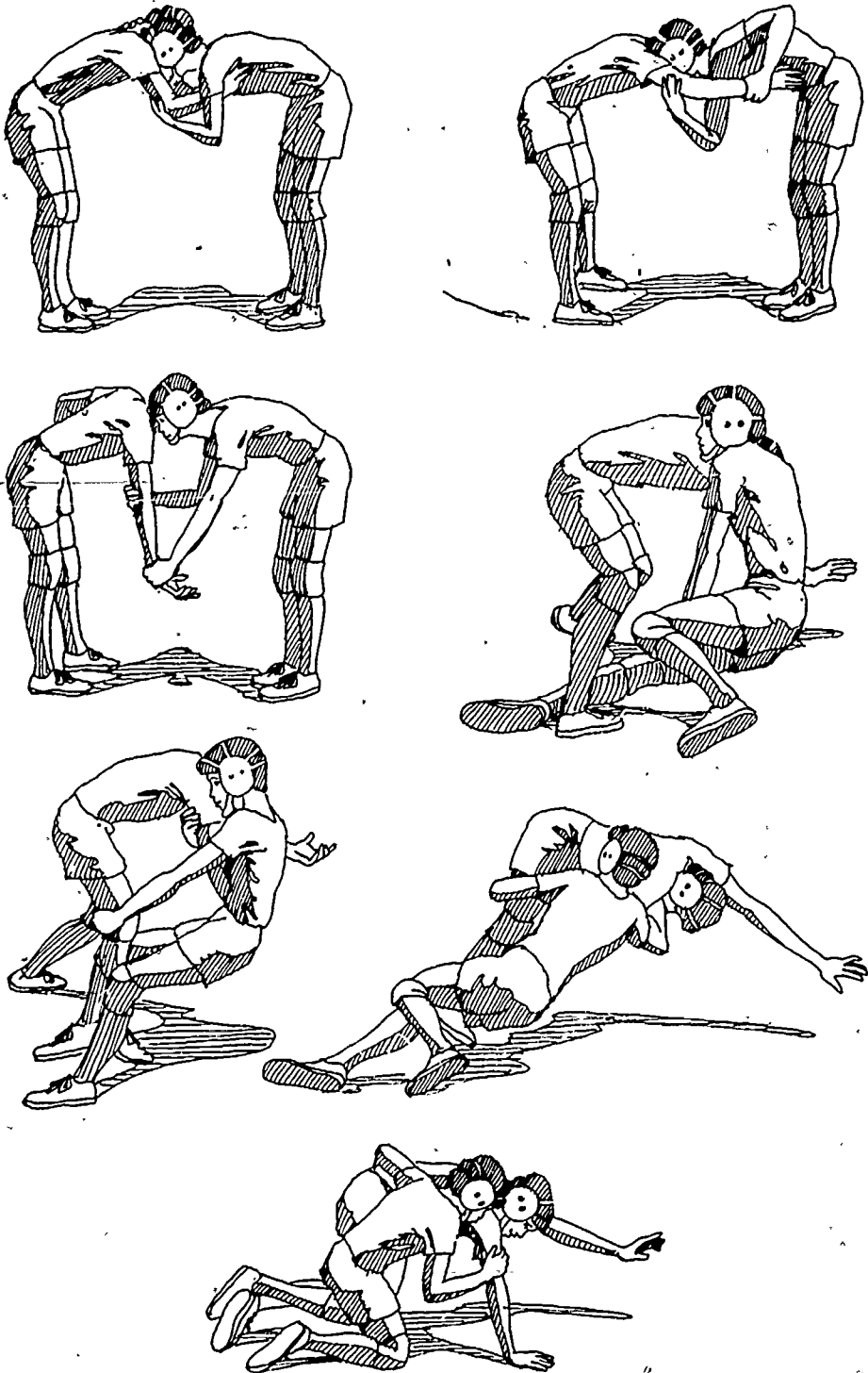

Figure 3. Double arm drag.

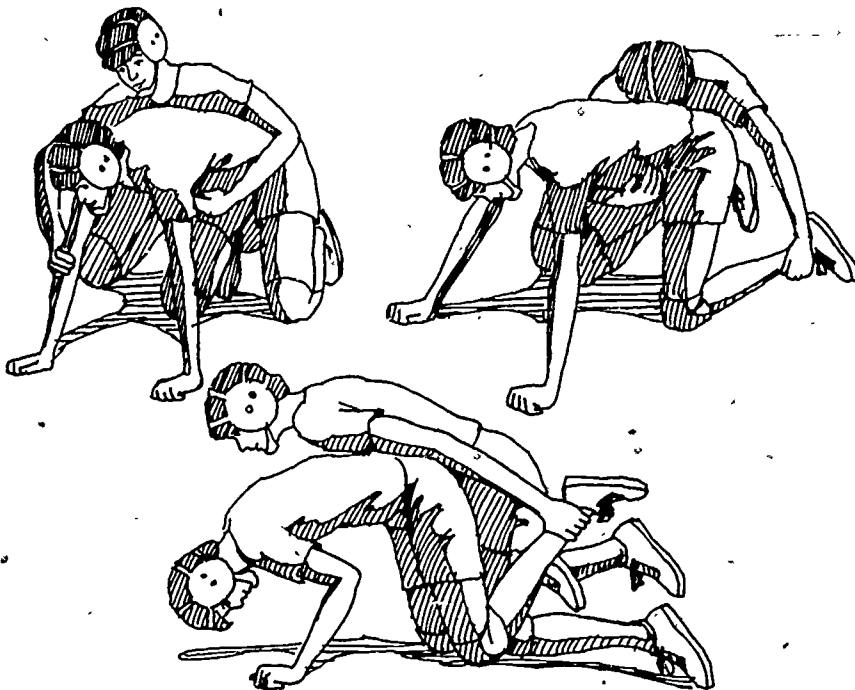

Figure 4. Far ankle and near waist.

nent off-balance. Use your weight and leverage on the breakdown and conserve your strength and energy when possible. Keep your body weight over the opponent's hips to tire him/her.

#### Far Arm and Double-Bar

1. From the top position of the referee's mat position, hook your left leg around the opponent's right ankle. (Remember, always attempt to control the legs of your opponent.)
2. Throw your right arm under his/her right armpit and grasp his/her left arm just below the elbow with your right hand.
3. Pull his/her left arm toward you. At the same time push him/her forward toward his/her left shoulder where the support has been removed and grasp both hands around his/her left wrist. Be careful not to roll him/her too far or he/she will roll you over.

#### Far Ankle and Near Waist

1. Reach across with your left hand and grasp the opponent's ankle while placing your right arm around his/her waist.
2. Pull his left ankle forward. This will either break the opponent down or keep him/her under control.

#### Far Ankle and Far Arm

1. Hook your left leg around the opponent's right ankle; shoot your right hand across under the opponent's right armpit and grasp his/her left arm just above the elbow.
2. Pull his/her left arm toward you, grasping his/her left wrist in both hands.
3. Bring your left arm back and grasp the opponent's left ankle, forcing his/her left shoulder to the mat.

#### Stretcher

1. Hook your left leg around the opponent's right ankle; put your right leg to the inside of his/her right leg.

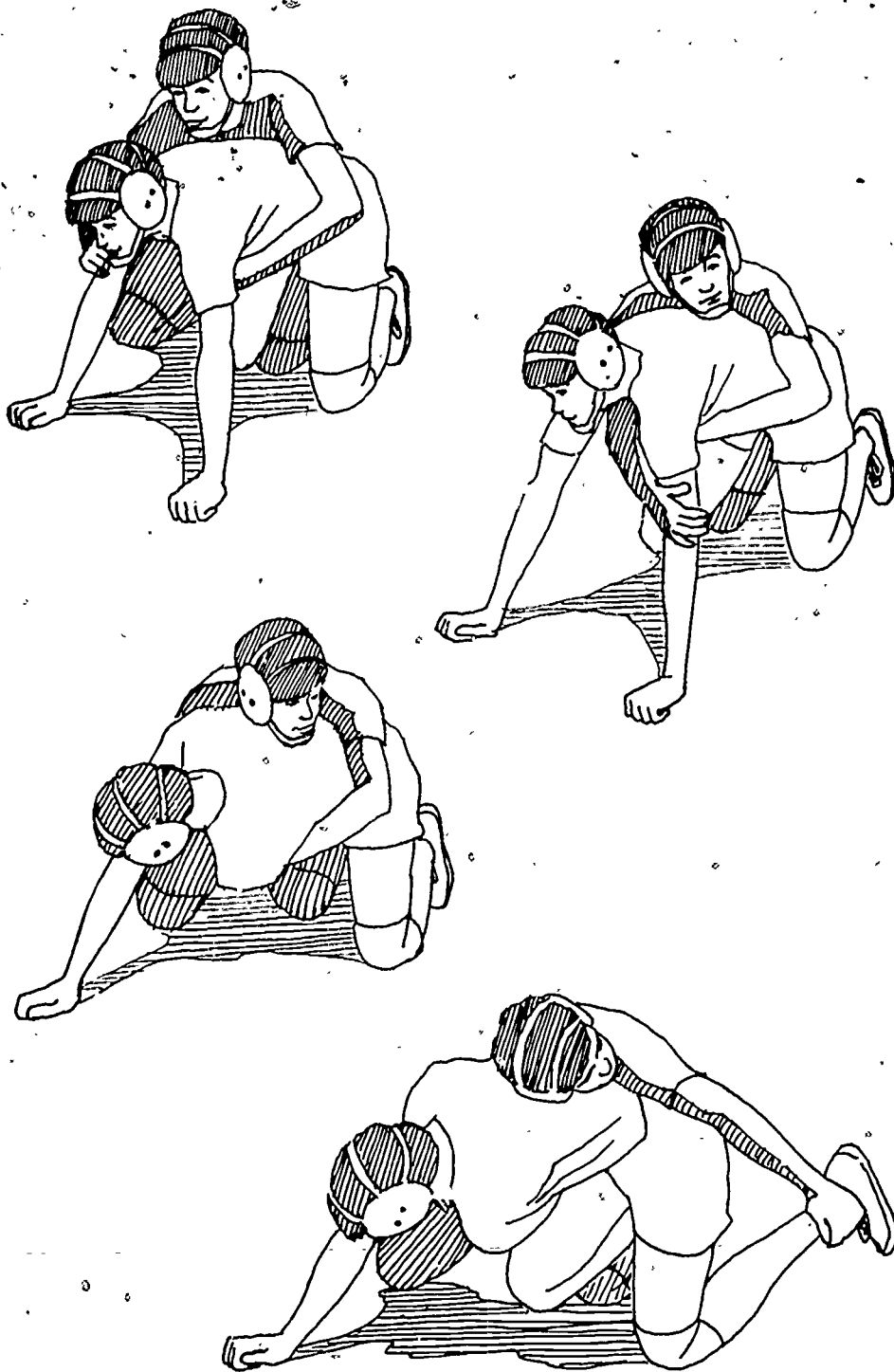

Figure 5. Far ankle and far arm.

2. Step over his/her back and shove your left leg inside his/her left leg. Both your legs are now inside of his/hers.
3. Pull his/her elbows forward with your hands as you drive all of your weight forward to flatten him/her. As you lift your hands, put pressure on the small of his/her back; he/she will move forward into a prone position on the mat.
3. Pivot on your left knee and elbow and turn to face the opponent.
4. Throw your arms out forward ready for action.

#### Standing Escape

1. Jump to both feet while keeping both hands on the mat.
2. Grasp the opponent's right hand with your right hand, being sure to grasp all four fingers.
3. Stand up on both feet and grasp the opponent's left hand with your left hand. At the same time hook your right foot over his/her right leg so that he/she can't lift you.
4. Pull the hands apart and face him/her. Immediately take an alert upright stance.

### REVERSES AND ESCAPES

The real test of wrestling ability is how well you can perform an underneath escape. Escapes are accomplished by luring the opponent through a series of rapid maneuvers.

Since an escape counts one point and a reversal counts two, it is always important to combine a reversal or takedown with the escape. Often when a reverse is secured, the opponent is placed in a situation that will result in a fall or near fall. Four basic escapes with their respective reverses are discussed below. Additional ones may be learned after the simple ones are mastered.

#### Switch

1. Knock the opponent's left hand off your left arm with your right hand.
2. Bring your left hand across to your right side to counter for loss of support.
3. Shift all your weight to your left hand and right foot, raising your right knee off the mat at the same time.
4. Pivot on your right foot and bring your left leg through to your right. At the same time, throw your right arm over the opponent's right arm, grasping the inside of his/her right thigh.
5. Lean back on the opponent's right arm and swing your body out from under the opponent.
6. Take your left hand and reach for a rear crotch hold, pulling the opponent forward as you come on top.

#### Sit-out

1. Bring your right foot forward and shift your weight to your right foot and left hand.
2. Throw your left foot forward as far as possible and drop on your left elbow.

#### Hiplock Escape

1. Hook your left arm over the opponent's right arm.
2. Pull him/her forward and down while snapping his/her right knee off the mat and throwing him/her with your left hip.
3. Pivot on your right knee while the opponent is still off-balance and come even with him/her.

#### Hiplock and Whizzer

1. Hook your left arm over the opponent's right arm.
2. Pull him/her forward and downward as in the hiplock escape.
3. Pivot on your left knee, putting your right arm across and under the opponent's head and left armpit. The right leg is straightened out and ready to drive off.
4. Throw your left leg out from under. At the same time push with the right leg, forcing the opponent backward and to the left.
5. As the opponent falls on his/her back, you can hold him/her down with the weight of your body.

### PINNING COMBINATIONS

After you have developed a fair degree of skill in takedowns, reverses, escapes, rides, and breakdowns, you are ready to begin work on pin holds. It is very important that you have control over your opponent be-

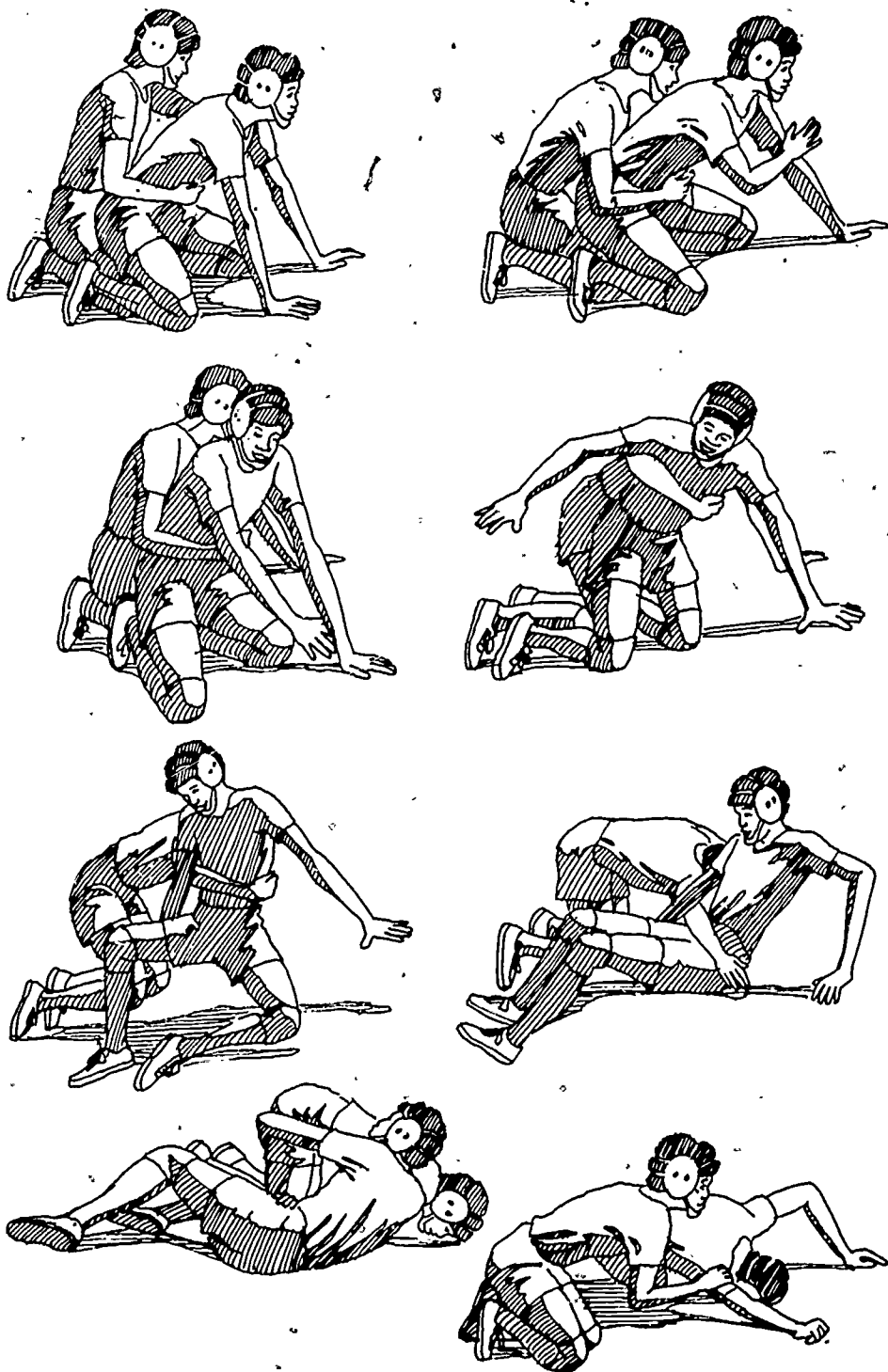

Figure 6. The switch.



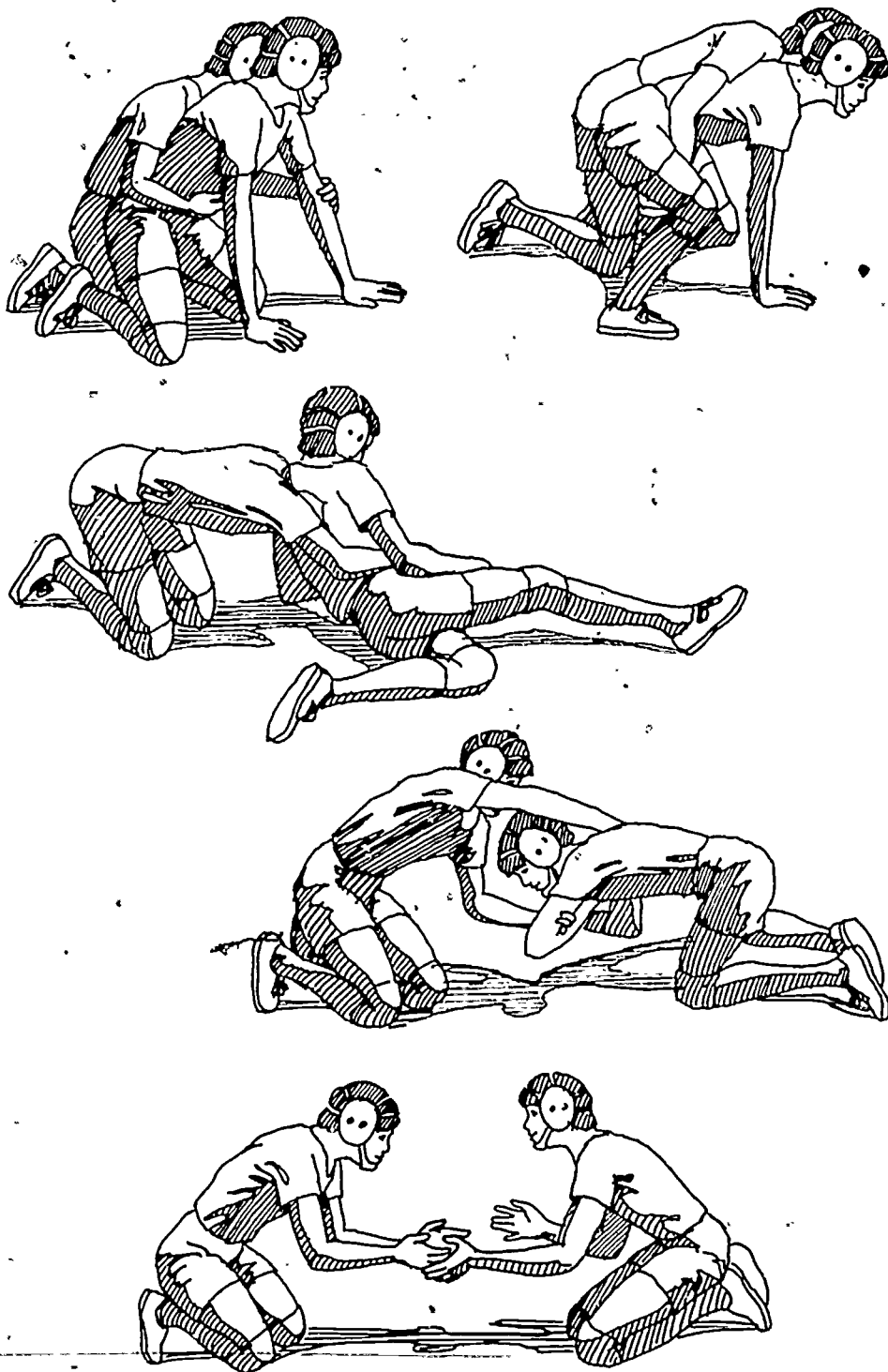

Figure 7. The set-out.

fore attempting to pin him/her. Failure to do so may result in a reversal or a wild tumble which will result in you being pinned. Four of the fundamental pinning combinations are described here.

#### Bar Arm and Half Nelson

1. From the top referee's position hook your left leg around the opponent's right ankle.
2. Take the far arm and double bar position described under breakdowns.
3. Take your right hand off the opponent's left wrist and apply a near half nelson to force the opponent on his/her side.
4. As you start to turn the opponent on his/her left side, unhook his/her right ankle from your left leg.
5. Increase the hold to a full half nelson and apply pressure to force the opponent on his/her left side. The pit of your elbow should now be at the back of the opponent's neck.
6. Now grasp his/her left wrist with your right hand. Both hands are now on his/her left wrist. Keep driving until both of his/her shoulders are on the mat. Keep your body perpendicular to the opponent and your legs spread. This will prevent him/her from hooking your legs with his/hers.

#### Crotch and Half Nelson

1. From the top referee's position, hook your left leg around the opponent's right ankle.
2. Pass your right arm across under the opponent's right armpit, grasping his/her left arm just above the elbow.
3. Pull his/her left arm toward you as you reach with your left hand for a rear crotch hold near the opponent's right knee.
4. Pick the opponent up and put him/her on his/her left side.
5. Use your right arm to place a half nelson, sliding it around the neck until you can grasp his/her left arm with your right hand. At the same time change your left hand from a rear crotch to an inside crotch hold.
6. Keep your body perpendicular to the opponent's and your feet well spread. If he/she turns toward you, drive his/her

shoulders back to the mat. If he/she turns away from you, flatten him/her out.

#### Three-quarter Nelson

1. From the top referee's position hook your left leg around the opponent's right ankle.
2. Bring your left arm from around the opponent's waist and put it through from under his/her right side so that it comes out on the left side of his/her neck.
3. Grasp your own left with your right hand.
4. Clamp down on the opponent's neck, keeping your left leg hooked around his/her right ankle and at the same time pulling his/her right foot forward.
5. Keep pulling his/her head downward and backward and his/her legs forward until his/her head is almost between his/her legs.
6. As the opponent's shoulder touches the mat, shift your own weight backward to prevent him/her from kicking you over.

### COUNTERS FOR TAKEDOWNS

#### Counter to Leg Dives

1. As soon as the opponent drops under you on both knees, fall on him/her with your legs straight out and well spread, making him/her carry all of your weight.
2. Grasp his/her farther ankle with both hands.
3. After he/she is under control, cross his/her face with your right hand, grasping his/her left arm above the elbow.
4. Free your leg by pulling on his/her arm and leg.
5. Swing behind and straddle to a riding position with your right arm across his/her face and your left hand grasping the farther ankle.

#### Counter to Double Arm Drag

After the opponent has pulled you forward, step across his/her body with your right leg, followed by your left leg. This will put your body perpendicular to his/hers.

#### Counter to Heel Pick-up

1. As the opponent ducks his/her head under your right arm to go for your foot, grasp his/her right arm.

2. As he/she reaches for your left foot with his/her left hand, pry up on his/her right arm and grasp his/her left arm just above the elbow with your right hand.
3. Throw your legs backward with your weight, causing the opponent to fall on his/her back.

#### Counter to Head Drag

1. As the opponent ducks his/her head under your right arm to go behind, hook your right arm around his/her right arm.
2. Jerk down to bring his/her right shoulder and hip to the mat. At the same time throw your own right leg high over your opponent, followed by your left leg. This is a good pinning position if your body is perpendicular to the opponent.

#### Counter to Switches

1.
  - a. As the opponent pivots out to switch, catch his/her near arm at the elbow with your right hand.
  - b. As you pull his/her arm out from under him/her, throw your left shoulder and left arm into him/her, forcing him/her down on his/her right side. This is an excellent position to ride.
2.
  - a. When the opponent pivots out to a position where he/she is sitting on his/her buttocks, keep your left knee against his/her left hip, at the same time shifting all of your weight to your left foot and right hand.
  - b. As he/she turns to come on top, apply the same pressure to his/her left arm by prying up on it.
  - c. Keep your left knee against his/her hip and off the mat.
  - d. Start to pivot on your left foot.
  - e. Move your right leg through, putting pressure on his/her left shoulder. All of your weight is now on your left foot and right hand.
  - f. As you put pressure on him/her, swing away from him/her to keep him/her from recountering. You must put enough leverage on the opponent's left shoulder to force it to the mat, then swing away wide and come up on top.

## RULES

Scholastic wrestling matches are divided into three 2-minute periods, the objective being to secure a fall (or pin) by holding the shoulder area of your opponent to the mat for two complete seconds. The first period starts from a standing (or neutral) position, with the objective being to get the opponent down on the mat. If no fall occurs during the first period, the second period then starts from the "referee's position" which has both wrestlers on the mat in a kneeling position. If there is no fall in the second period, the third period again starts with the referee's position.

The point system used in scoring an individual bout is as follows:

Two points	takedown
Two points	reversal from the bottom to the top position, called the position of advantage
One point	escape, in which the bottom wrestler either breaks away from his/her opponent or obtains a neutral position
Three points or two points	near-fall in which the wrestler in the position of advantage is able to hold his/her opponent's shoulders to the mat, but is unable to hold them for the complete two seconds

Team scoring is determined by the outcome of the individual bouts. Team points are awarded the following way:

Six points	Fall (pin)
Six points	Forfeit
Six points	Default
Six points	Disqualification
Decision	
Five points	12 or more points
Four points	8 to 11 points
Three points	8 or less
Two points	Draw

The Rules Committee has established various precautions that help prevent serious injuries. These are found in the National Wrestling Rules Manual under infractions and technical rule violations.

## STRATEGY

To make wrestling satisfying and appealing you should learn just what to do during a match. First you should be in good physical condition and should master basic skills. An effective conditioning program can be accomplished by calisthenics, running, and wrestling. Wrestling must be learned through drills. Holds, riding, and pinning combinations should become a matter of reflex to the individual wrestler. Practice the maneuvers with which you feel confident and learn them well. Some techniques will work well for one person and not as well for another.

Learn the takedowns well, this phase of wrestling will give you control over the opponent. Many wrestling matches are won by the wrestler who has mastered one or two takedown techniques. Do not attempt a lot of different takedowns at the beginning; rather, two or three will enable you to get an opponent to the mat and will increase your confidence in your own ability. After you master these few, you can add to your knowledge of takedown techniques. When you get control over your opponent use your best holds and rides. If you learn to control an opponent, you have the opportunity to relax and conserve your energy for later in the match when it is needed.

By working on various moves and developing these moves into an automatic reflex you will develop the offensive techniques that will help you win matches. Chain wrestling involves the putting together of a series of moves that will keep the opponent off-guard. Good wrestling is the ability to keep the opponent off-balance. By learning a series of chain reactions you can become a more effective wrestler whether you are attempting an escape, reversal, or control of the opponent. By working just one maneuver it is easy for the opponent to counter you and stop you; the more movement given him/her the harder it is to stop you.

## TERMINOLOGY

- Arm Bar.** A lock on the arm of an opponent obtained by circling his/her arm with yours and holding your hand against his/her body.
- Arm Drag.** A quick pull on an opponent's arm, usually above the elbow, in an attempt to pull him/her to the mat.
- Breakdown.** The top wrestler forcing his/her opponent to the mat by taking away his/her supporting points.
- Bridge.** Elevating the body by use of the neck. Sometimes called a wrestler's bridge.
- Crotch Hold.** Holding an opponent by the upper leg near the crotch.
- Drag.** A pulling motion on the upper arm in an attempt to either pull the opponent to the mat or go behind him/her.
- Drill.** Working on a series of maneuvers.
- Escape.** An action by which the wrestler on the bottom breaks free of the top wrestler.
- Fall.** Occurs when a wrestler is held in contact with the mat for an "appreciable time" (two seconds in scholastic wrestling).
- Half Nelson.** A pinning hold that occurs when one arm is placed under an opponent's armpit and comes out over the top of his/her neck.
- Helmet.** Protective covering used to protect a wrestler's ears from being rubbed, thus eliminating the "cauliflower ear."
- Hold.** The technique of grasping an opponent. The grip on an arm or leg which will keep an opponent from moving.
- Neutral Position.** Both wrestlers are either standing or are locked in the same hold.
- Pin.** Occurs when both shoulders of a contestant are held to the mat.
- Pinning Combination.** The technique of securing a "hold" which will result in a pin or fall.
- Referee's Position.** The down position on the mat, in which the bottom wrestler is on his/her knees with the palms of the hands 12 inches from the knees. The offensive wrestler is on top with one knee up or both knees on the mat and one arm around the opponent's waist and his/her other hand at the bend of the elbow of the opponent.
- Reversal.** Occurs when the bottom wrestler maneuvers himself/herself to the top position, or the position of advantage.
- Ride.** An action in which the offensive wrestler effectively counters the moves of the defensive wrestler.
- Sit-out.** A maneuver in which the defensive wrestler assumes a sitting position to escape or reverse the opponent—the beginning of a chain maneuver.
- Takedown.** A situation where one wrestler gets the opponent down to the mat and gains control over him/her.
- Tie-up.** Obtaining a hold or grasping an opponent to work for a takedown.

**REFERENCES**

Boring, Warren J. *Science and Skills of Wrestling*.  
St. Louis, MO: The C. V. Mosby Company,  
1975.

Dratz, J.; Johnson, M.; and McCann, T. *Winning  
Wrestling*. Englewood Cliffs, NJ: Prentice-  
Hall, 1966.

Kapral, Frank. *Championship Wrestling*. En-  
glewood Cliffs, NJ: Prentice-Hall, 1964.

Sasahara, Shozo. *Scientific Approach to Wrestling*.  
Japan: Chuo University Cooperation Press,  
1960.

athletic coach (p. 400)  
athletic trainer (p. 406)  
physical education and/or athletic administrator (p. 407)  
physical education teacher (p. 406)  
physical therapist (p. 400)  
professional athlete (p. 402)  
recreation leader (p. 400)  
sporting goods dealer (p. 404)  
sports journalist or photographer (p. 403)  
sports official (p. 402)



# A Career in Physical Education and Sport

ROBERT D. and JOYCE A. CLAYTON,  
*Ft. Collins, CO*

## INTRODUCTION

"What will you do after high school?" You are continually being asked this question by parents, friends, brothers, and sisters—everyone! While a large percentage of high school graduates go on to college, almost all of the remaining find the need for some type of additional training or education to obtain a career of their choice. Therefore, it is not too early to begin consideration of possible career choices, and the preparation necessary for success. At this point, you probably believe that becoming a physical education teacher, coach, or a professional player, are the only careers in

physical education and sport. Such is not the case! Table 2 outlines seven different categories of positions related to physical education and sport. Some categories require more training than others; some are more rewarding financially; some have more opportunities. Regardless, your current interest in physical education and sport is a beginning toward a meaningful search for a career in this field.

Following Table 2 there are seven tables, each one offering a general description of careers in this category, in addition to summaries of selected jobs. Look at all the tables, you may be amazed at the number of jobs described.

## TABLE 1. TEN CAREER CHOICES IN PHYSICAL EDUCATION AND SPORT

OCCUPATION	BRIEF JOB DESCRIPTION	RECOMMENDED EDUCATIONAL PREPARATION	*COMPENSATION RANGE	*OCCUPATIONAL OUTLOOK
ATHLETIC TRAINER	Works in schools and colleges or with professional athletic teams in the prevention and care of injuries associated with competitive athletics.	College preparation in curriculum approved by the National Athletic Trainers Association and National Certification Examination.	Schools \$4,000-15,000 Professional Teams \$12,000-25,000	Good
SPORTS OFFICIAL	Employed by schools, colleges, sport clubs and recreation departments to conduct athletic contests in all sports. Those with outstanding ability may be eligible for assignment to professional contests.	Training and qualifying examination in each sport. Must hold membership in officials' organization for each sport.	Clubs, schools recreation depts.: \$10-50 per contest Professional \$50-500 per contest	Excellent Part-Time
PROFESSIONAL ATHLETE	Plays baseball, football, basketball, hockey, softball, track & field, tennis, golf, skates or bowls before paying audiences.	High school college for most sports intensive coaching and practice	\$2,500-100,000+	Very few opportunities, heavy competition.
RECREATION LEADER	Organizes and directs leisure activities in public agencies, parks and institutions (e.g., YMCA, Scouting, churches, etc.) and corporations. Works with part time and volunteer workers and supervises their training and activities.	2-4 year college degree in recreation and/or related fields	\$8,000-20,000	Fair
PHYSICAL EDUCATION TEACHER	Prepares lesson plans and tests, works with students evaluating skills, sportsmanship, effort and participation.  Position available with preschool through adult levels.	College degrees and appropriate teaching credentials	\$9,000-25,000	Fair
ATHLETIC COACH	Coaches team or individual sports. May specialize in one sport or one aspect of a sport. Plan, organize practice sessions and strategy. May teach P.E., health or other subjects, makes business arrangements, gives press interviews.  Opportunities exist in schools, colleges, community and professional sports.	College degree with credits in physical education, education and coaching techniques	\$300 (Part-time) to \$75,000+	Excellent for Part-time, Fair for Full-time
SPORTS JOURNALIST OR PHOTOGRAPHER	Works with all media in interpreting the sports world to the public through written, oral or visual communication.  Opportunities exist at local or big city newspapers, TV, radio stations, magazines, or as sports information director at colleges or universities.	College degree with credits in communications  Sports experience helpful  Photography experience	\$4,500-30,000+	Good
SPORTING GOODS DEALER	Sells sporting goods or manages a department or store. Is in charge of purchasing and marketing, supervises office employees and sales personnel. May represent a manufacturer.	College degree or management training programs  Sports experience helpful	\$9,000-25,000+	Excellent
PHYSICAL THERAPIST	Works with patients who have been physically disabled through birth, illness or accident. Evaluates physiological functions and selects therapeutic procedures for treatment.	College degree and state licensing	\$9,000-25,000	Good
PHYSICAL EDUCATION AND/OR ATHLETIC ADMINISTRATOR	Organizes and supervises competitive and/or instructional programs in clubs, schools, colleges & professional events. Has responsibility for transportation, budget, facilities, personnel, equipment, scheduling and community relations. P.E. administrator develops curriculum, athletic director participates in fund raising.	College degrees with credits in administration.  Experience in education and athletics helpful	\$15,000-40,000+	Fair

Footnote to Table: \* Variations in compensation and occupational outlook (availability) depend on geographic area. Occupational outlook and salary estimates realistically reflect employment conditions through 1982 or 1983.



**TABLE 2. CAREER OPPORTUNITIES IN PHYSICAL EDUCATION AND SPORT.**

Performance (Table 3)*	Communication (Table 4)*	Sales (Table 5)*	Management (Table 6)*	Teaching & Coaching (Table 7)*	Fitness & Rehabilitation (Table 8)*	Therapy (Table 9)*
<i>Performer</i> Baseball Basketball Bowling	<i>Writer</i> Newspaper Magazine Book Author	<i>Sporting Goods</i> Retail Stores Wholesalers General	<i>Administrator</i> College Athletic Departments, Professional Teams	<i>Preschool and Elementary</i> Physical Education Adapted Physical Education	<i>Physical Fitness</i>  <i>Private</i>	<i>Corrective Therapy</i>
Dance Football Golf Ice Hockey	Sports Information College Professional Teams	<i>Sport Clothing</i> Retail Stores Wholesalers General Specialty	Athletic Director Ticket Manager Business Manager Equipment Manager Fund Raiser Special Promotions	<i>Middle/Junior High School</i> Physical Education Adapted Physical Education Coach	Health-Spa Corporation Athletic Club	<i>Physical Therapy</i>
<i>Sports Official</i>  Baseball Basketball Field Hockey Football Gymnastics Ice Hockey Soccer Softball Volleyball	<i>Artist</i>  Illustrator Photographer Artist  <i>Broadcaster</i> Radio TV	<i>Books</i> Publishers General Specialty	<i>Agency</i>  YMCA, YWCA Boy Scouts Girl Scouts	<i>High School and College</i>  All jobs above Researcher Physical Education Administrator Athletic Director	<i>Agency</i> YMCA, YWCA City Recreation Department  <i>Cardiac Rehabilitation</i>	<i>Dance Therapy</i>  <i>Recreation Therapist</i>  <i>Athletic Trainer</i>
			<i>Owner-Operator-Manager</i>  Athletic Club Bowling Lanes Dance Studio Fitness Center Golf Course Gymnastics School Health Club Swimming Pool Tennis School	<i>Private Sport Clubs</i>  Bowling Dance Golf Gymnastics Swimming Tennis	Hospital Clinic College or University  <i>Research</i>  Exercise Physiology Laboratory	<i>Adapted Physical Education Teacher</i>

\*See table indicated for a general description of careers in this category, in addition to a discussion of specific job titles.

A CAREER IN PHYSICAL EDUCATION AND SPORT 401



**TABLE 3. CAREER OPPORTUNITIES AS A SPORT PERFORMER.**

While the goal of many might be to become a well-paid and/or famous sport star, very few achieve it, and of those who do, very few spend their entire lives in sports. Thus the wise person prepares for a second career at the same time he/she is hoping to become a professional player or official. Even though the need for new players is great, jobs are limited.

Job Title	Description, Employers; and Sources of Information
Performer	<p>Those sports regularly on TV (basketball, baseball, football, soccer, golf, bowling) provide the greatest opportunity for employment, although the odds are several thousand to one that you will make a living as a performer. While most professional playing careers are short (3-6 years), this varies greatly with the sport. Most professional athletes have at least two years of college. A business background is highly desirable, as high salaries in the few years of competition create a need for sound financial planning. Further information can be obtained by contacting:</p> <ul style="list-style-type: none"> <li>National Basketball Association, 645 Fifth Avenue, New York, New York 10022</li> <li>Association of Professional Baseball Players of America, 337 East San Antonio Drive, Suite 203, Long Beach, California 90807</li> <li>National Football League, 410 Park Avenue, New York, New York 10022</li> <li>International Volleyball Association, 1901 Avenue of the Stars, Suite 610, Los Angeles, California 90067</li> <li>United States Soccer Federation, 350 Fifth Avenue, New York, New York 10001</li> <li>Women's Professional Bowler's Association, 204 West Wacker Drive, Suite 300, Chicago, Illinois 60606</li> <li>Professional Bowlers Association of America, 1720 Merriman Road, Akron, Ohio 44313</li> <li>Ladies Professional Golf Association, 919 Third Avenue, New York, New York 10022</li> <li>Professional Golfers' Association of America, 804 Federal Highway, Lake Park, Florida 33403</li> <li>American Hockey League, 31 Elm Street, Suite 533, Springfield, Massachusetts 01103</li> <li>Association of Tennis Professionals, World Center, Box 58144, Dallas, Texas 75258</li> </ul>
Sports Official	<p>Almost all officials were once players. Thorough knowledge of rules plus the ability to be fair, firm, and consistent are essential characteristics. Officials in the "major leagues" are well paid, but since most seasons are only 5-8 months long having additional employment is common. Every community needs officials at the local level. Further information can be obtained by contacting:</p> <ul style="list-style-type: none"> <li>International Association of Approved Basketball Officials, 1620 Dual Highway East, Hagerstown, Maryland 21740</li> <li>National Association of League Umpires and Scorers (Baseball), Box 1420, Wichita, Kansas 67201</li> <li>National Intercollegiate Soccer Officials Association, 131 Moffitt Boulevard, Islip, New York 11751</li> <li>U. S. Volleyball Association, P.O. Box 77065, San Francisco, California 94107</li> </ul>

**TABLE 4. CAREER OPPORTUNITIES IN SPORTS COMMUNICATION (JOURNALISM).**

Physical education careers in journalism encompass print (writers, book authors), visual (photographers, artists), and audio (radio, TV) aspects. Most sport media positions require training beyond high school. Talent and natural ability are as important as education. The demand for persons in this field will remain steady for the foreseeable future. There are numerous opportunities for gaining experience, e.g., school and local newspapers, local radio stations, etc., before beginning formal training.

Job Title	Description, Employers, and Sources of Information
Writer Book Author	<p>A writer about sports gives the reader a vivid word picture of an activity or event. Jobs are found with newspapers, magazines (many of them specialized, such as <i>Sports Illustrated</i>, <i>Swimming World</i>, or <i>Dance</i>), publishing companies (as book authors), and sports information departments of colleges or professional teams. There are many more sports writing jobs than in the other areas given below. Further information can be obtained by contacting:</p> <p>American Council on Education for Journalism, 563 Essex Court, Deerfield, Illinois 60015</p>
Photographer, Artist, Illustrator	<p>Using camera or physical skill, the visual media specialist enables viewers to see what is taking place during physical activity or performance. Jobs are available with publishing companies (magazines, books, newspapers, and TV stations). Further information can be obtained by contacting:</p> <p>American Council on Education for Journalism, 563 Essex Court, Deerfield, Illinois 60015</p>
Broadcaster	<p>Sportscasters are found on every radio and TV station in the U.S. Their role is to accurately describe the action so that listeners or viewers can easily follow the event. Full-time sports broadcasting is possible only in bigger stations. Broadcasters must be knowledgeable about a wide variety of sport activities. Further information can be obtained by contacting:</p> <p>National Association of Broadcasters, 1771 North Street, N.W., Washington, D.C. 20056</p>

**TABLE 5. CAREER OPPORTUNITIES IN SPORT SALES.**

Salespeople are found in every aspect of modern life. Successful salespeople have a thorough knowledge of their product(s) in addition to an eagerness to meet and talk with people. There will always be a steady demand for salespersons, with great financial rewards to those at the top. Opportunities for part-time work are great, and strongly recommended. While college training is not essential, managers and owners have a business background.

Job Title	Description, Employers, and Sources of Information
Sporting Goods Salesperson	Sporting goods salespeople are found both in retail stores (selling directly to the public), and with wholesalers (traveling salespeople who call on store owners, buyers, and coaches in an attempt to convince them of their products' merits). Some companies specialize, e.g., racket sports, warm-ups, team uniforms, gymnastics, dance supplies, etc., while others offer a full line of equipment (archery, camping, clothing, wrestling, etc.). Stores are found in almost every city, while wholesale dealers are most often headquartered in large cities. Further information may be obtained by contacting:
Sporting Clothing Salesperson	
Retail Stores	
Wholesalers	<p>National Sporting Goods Association, 717 North Michigan Avenue, Chicago, Illinois 60611</p> <p>Sporting Goods' Agents Association, P.O. Box A, Morton Grove, Illinois 60053</p>
Book Salesperson	<p>The traveling salesperson visits stores, college and university bookstores, physical education departments, and sometimes specific sport groups, e.g., gymnastic schools, to show and to discuss books with prospective buyers. The travel may include a large sales territory, e.g., part or all of one state or region. Traveling salespeople are often paid on a commission basis only, having a sales quota to meet. Further information can be obtained by contacting:</p> <p>Association of American Publishers, One Park Avenue, New York, New York 10016</p>

**TABLE 6. CAREER OPPORTUNITIES IN SPORT MANAGEMENT.**

Sport managers are well-trained and experienced business people first, and sports persons second. Job security is not great, as profitability is the key element to success. A strong business background is more important than an athletic background, a combination of the two is best. Formal training (at least a college degree) in one of the business areas (accounting, personnel management, law, public relations) is necessary to reach the top. Managers almost always work their way up, beginning with part-time employment. Numerous sport facilities exist, e.g., dance studios, tennis centers, swimming pools, etc., thus providing opportunity for beginning workers.

Job Title	Description, Employers, and Sources of Information
Administrator College Athletic Departments Professional Teams	Since most businesses exist to make a profit, administrators are hired for their business skill. General managers, athletic directors, business managers, etc., are all dependent upon the team's performance in attracting paying customers. Promotions and public relations experts are essential. Persons seldom enter the top management positions without experience. Further information can be obtained by contacting: General manager or athletic director of a high school, college, or professional sports group.
Agency YMCA YWCA Boys' Club Girls' Club	Executive directors of agencies almost always began as physical or youth directors and were promoted because of personality and business ability. They must be skillful in promotions and public relations. Further information can be obtained by contacting: YMCA, 110 N. Wacker, Chicago, Illinois 60606 YWCA, 600 Lexington Avenue, New York, New York 10022
Owner-Operator-Manager Private Sport Facilities	Sport specialists (SCUBA, gymnastics, dance, etc.) often begin their own schools where they can focus their whole attention on a specific activity. Virtually all towns have at least a dance studio, while numerous "sport schools" exist in big cities. The majority of such schools are only marginally profitable, thus requiring a sound business approach. Further information can be obtained by contacting: Owner/operator/manager of any local sport or dance school.

**TABLE 7. CAREER OPPORTUNITIES IN PHYSICAL EDUCATION TEACHING AND SPORT COACHING.**

Teaching sports is the career of thousands of physical educators, whether in elementary or secondary schools, or in private sport schools. Unfortunately, at the present time, there are more school physical education teachers than there are jobs, this situation will remain for (several) years. However, versatile teachers (ones who can teach many activities to various age groups) will find employment, as will aquatic, gymnastic, tennis, and dance specialists. Job security is great, once a probationary period is passed. Payment for coaching is added to the basic teaching salary. Much physical stamina is required.

Job Title	Description, Employers, and Sources of Information
Physical Education Teacher	<p>Teachers instruct persons (mostly ages 5-18) in various types of sports/movement activities. School facilities vary greatly in quality and quantity, as does student enthusiasm. Young children and adults are sometimes more motivated to learn and to participate than students in grades 7-12. Large classes of mixed ability make for difficult teaching situations. Further information can be obtained by contacting:</p> <p>American Alliance for Health, Physical Education, Recreation and Dance, 1900 Association Drive, Reston, Virginia 22091</p>
Adapted Physical Education Teacher	<p>Adapted physical education teachers work specifically with persons who have physical, social, emotional, or mental problems. The strategy is to adapt games and activities to whatever the person can do, thus permitting him to remain with the peer group whenever possible. Small groups and enthusiastic students are common. Further information can be obtained by contacting:</p> <p>Consultant, Adapted Physical Education, American Alliance for Health, Physical Education, Recreation and Dance, 1900 Association Drive, Reston, Virginia 22091</p>
Coach Team Sports Individual Sports	<p>A coach develops sport skill and understanding in players. A thorough background in the sport, plus the ability to teach and motivate, is highly desirable. Coaching requires an extensive time commitment for practice, travel, and games, which is the reason why few persons coach more than 10 years. Further information can be obtained by contacting:</p> <p>American Alliance for Health, Physical Education, Recreation and Dance, 1900 Association Drive, Reston, Virginia 22091</p>
Athletic Trainer	<p>A trainer supervises the preventive and rehabilitative programs of athletes, acting as a liaison between the coach, player, and physician. Special training while in college followed by a national examination, is required to become certified. The demand for trainers is great, especially for females. Further information can be obtained by contacting:</p> <p>American Alliance for Health, Physical Education, Recreation and Dance, 1900 Association Drive, Reston, Virginia 22091 National Athletic Trainer's Association, 112 South Pitt Street, P.O. Drawer 1865, Greenville, North Carolina 27834</p>
Intramural Director	<p>The intramural director organizes and administers a wide variety of competitive and recreational activities in schools. These are held before school, during lunch, after school, or in the evening. This is an extra job for extra pay for elementary, junior high, and high school teachers, while it may be a half- or full-time job in colleges and universities. Further information can be obtained by contacting:</p> <p>American Alliance for Health, Physical Education, Recreation and Dance, 1900 Association Drive, Reston, Virginia 22091 National Intramural Recreational Sports Association, Dixon Recreation Center, Oregon State University, Corvallis, Oregon 97331</p>

Teacher, Researcher, Scholar (Colleges and Universities)	A person who prefers to teach, research in college physical education departments should possess a Ph.D. or equivalent. He or she often has a background as a physical education teacher/coach in grades K-12 or in college, but wishes to become an expert in one particular aspect, e.g., sport sociology, sport psychology, motor learning, exercise physiology. The ability and desire to do research and write is essential. There will be small but steady demand for such persons in the future. Further information can be obtained by contacting:
College Administrator	The administrator (chairperson, department head, dean) of a physical education organization invariably has had experience in teaching. He or she is organized, detail-oriented, and likes to work with people. Administrators are found in every organization and are the highest paid members of the faculty. Further information can be obtained by contacting: The Physical Education Department at any larger college or university, or public school system
Athletic Director	The administrator (chairperson, department head, dean) of a physical education organization invariably has had experience in teaching. He or she is organized, detail-oriented, and likes to work with people. Administrators are found in every organization and are the highest paid members of the faculty. Further information can be obtained by contacting: The Physical Education Department at any larger college or university, or public school that requires an administrator
Private Sport Club Teacher	The athletic director administers the policies and budget of the entire high school or college athletic program. Almost always, extensive experience in athletics is required. This is a part-time job in most schools, but full-time in large cities, colleges, and universities. Further information can be obtained by contacting: American Alliance for Health, Physical Education, Recreation and Dance, 1900 Association Drive, Reston, Virginia 22091
Physical Education Public School Administrator	A teaching position at a private sport facility, e.g., SCUBA, dance studios, swim school, tennis center, etc., permits a person to specialize in one activity. Excellent teaching and personal relation skills are essential, with playing skill being desirable. Salary and fringe benefits are often lower than in the public schools, unless one is teaching at a very exclusive sports club. Further information can be obtained by contacting: Any sport school or dance studio in your area
	Each school with a staff of two or more has a need for a physical education department chairperson. Often times this position is not compensated, however, good administrative experience can be gained. Further information can be obtained by contacting: Your school's department chairperson

**TABLE 8. CAREER OPPORTUNITIES IN FITNESS AND REHABILITATION.**

The increased emphasis on physical fitness has created a demand for trained fitness specialists. A college degree with specialization in exercise physiology, adult fitness, or cardiac rehabilitation is a necessity. An outgoing personality is desirable, as exercise specialists must convince their clients that exercise (work) is beneficial. In the foreseeable future there will continue to be many opportunities in this area.

Job Title	Description, Employers, and Sources of Information
Physical Fitness Specialist Private Group	These specialists work in fitness programs in health clubs, athletic clubs, or hospitals. Fitness specialists are also salespersons, as their jobs depend upon members continuing to pay for the program. The facilities tend to be very good—new equipment, carpeted exercise areas, music, etc. The programs emphasize fun, enjoyment, and the benefits of exercise.
Agency Groups	YMCA's, college physical education departments, and city recreation departments also employ fitness specialists. The duties are the same as in other situations, but there is usually less pressure to sell memberships and more emphasis on voluntary participation. Further information can be obtained by contacting: YMCA, 110 N. Wacker, Chicago, Illinois 60606 American Association of Fitness Directors in Business and Industry, Room 3030, 400 6th Street, S.W., Washington, D.C. 20201 Director, Exercise Physiology Laboratory of college or university
Cardiac Rehabilitation Specialist	This person works specifically with patients of all ages who have survived a heart attack, or who suffer from heart disease. College or medical technician training is required, preferably earning a certificate from a recognized health-related group. Employment is found in hospitals, clinics, and physical education departments of colleges and universities. Further information can be obtained by contacting: American College of Sports Medicine, 1440 Monroe Street, Madison, Wisconsin 53706
Researcher Consultant Scholar	This person combines talent for research, and ability to advise and teach with a keen interest in cardiorespiratory matters. He or she attempts to discover new methods of improving the physical condition of athletes and non-athletes of all ages. A Ph.D. or M.D. degree is required. Employment opportunities are found in hospitals, research laboratories in college and university physical or athletic training centers. Usually, limited teaching responsibilities are assigned. Consulting with professional athletes or medical groups is quite common. Further information can be obtained by contacting: Director, Exercise Physiology Laboratory of the larger colleges and universities in the U. S. American College of Sports Medicine, 1440 Monroe Street, Madison, Wisconsin 53706 American Physiological Society (Education Office), 9650 Rockville Pike, Bethesda, Maryland 20014



**TABLE 9. CAREER OPPORTUNITIES IN THERAPY.**

Therapy is the alleviation of illness or injury using one or more accepted means of treatment. The job positions require a college degree, in addition to 3-24 months of specialized training, resulting in a certificate. Licensing by a state or national group is sometimes essential, and available only to certified therapists.

Job Title	Description, Employers, and Sources of Information
Corrective Therapist	A corrective therapist assists either physically or mentally disabled patients in overcoming or alleviating their handicaps by using medically-oriented physical education techniques. Jobs may be found in hospitals and clinics, governmental agencies, rehabilitation centers, camps, and schools and colleges. Further information can be obtained by contacting: American Corrective Therapy Association, 6622 Spring Hollow, San Antonio, Texas 78249
Dance Therapist	Using movement and dance, a dance therapist helps patients solve emotional, social, and physical problems. The purpose of such therapy is to use movement and dance as a psychotherapeutic means of physical and emotional expression. Jobs may be found in rehabilitation centers, geriatric centers, psychiatric centers and hospitals, correctional facilities, and mental retardation and developmental centers. Further information can be obtained by contacting: Dance Therapy Association, Suite 230, 2000 Century Plaza, Columbia, Maryland 21044
Recreational Therapist	Drama, sports, nature, games, arts, and crafts are employed by the recreation therapist to assist persons in developing desirable behavioral changes and to promote individual growth and development through the use of social and physical recreational activities. Positions are found in child and day-care centers, nursing homes, retirement homes, city recreation departments, YMCAs, YWCAs, hospitals and clinics, camps, and agencies. Further information can be obtained by contacting: National Therapeutic Recreation Society, 1601 North Kent Street, Arlington, Virginia 22209
Athletic Trainer	See Table 7.
Adaptive Physical Educator	See Table 7.

### EXPLORING POSSIBLE CAREERS IN PHYSICAL EDUCATION AND SPORT

There are at least four steps which should be taken when beginning your search for a meaningful career in physical education and sport. Reading about a career and talking to someone in that particular field are logical. You also need to look at yourself, merely because a job sounds glamorous (or high salaried!) does not mean it is for you. On-the-job experience is surely important, while reading, conversing, and self-examination are essential steps in career exploration, experience is even more important.

### Reading

The tables presented earlier contain sources of information of at least one organization in each job title. Write to the group, they usually have information available about careers in their fields. Additional sources of information are your school counselor, who maintains an extensive library of career materials, or a local worker in that career, who often has information from his/her association or group. Finally, your school or public library has a variety of materials under such topic headings as vocations, careers, jobs, and sport jobs.

### Talking

Regardless of your source, reading available material will provide you with information to be used as the basis for a discussion with someone who is actually employed in that career. The obvious answers (how much education is required?, what is the salary?, what do you do?) may be found in your reading. You need to personally ask if the person likes the job, if there are serious problems, what the future is for new workers, and would he or she select the same job again. These are highly personal questions, but you need some guidance from the best possible source, a professional in your potential career.

If there is no local person in your career category, consider sending a letter to a nearby source, e.g., Sportcaster, Radio Station, WXYZ, Nearby, AK 00000. Often you will receive all the information you seek.

### Self-examination

Sometime during the exploration stage of reading and talking, you should look carefully at yourself. What do you want from a career? Would your preferred job be indoors or out? Would you rather work by yourself, or as a member of a group? Would it be in a large city or small town, etc.? Answers to these and similar questions are important.

Often, as part of a career exploration unit in grades 7-10, you are asked to take a vocational inventory test. This is usually a series of questions, in which you make a best choice among two, three, or four items, e.g., would you rather read a book or repair a machine? teach someone how to dance or dance on the stage? There are no right or wrong answers to these situations, and your results are not graded or compared to your classmates. In most cases your school counselor administers and interprets it. You should take a vocational inventory questionnaire at least once, and preferably twice, during grades 7-11. Interests change, and new career possibilities arise.

Such an inventory is only an indication of your interest and/or aptitude for a specific career. Actually, it may tell you more what

you do not want to do, and narrows your possible vocational choices to 3-5, any one of which might be appealing. Use it as a general guide, rather than as an exact map, to follow.

### Experience

A TV commercial has an employer who says, "no experience, no job." The young man in the commercial then asks, "where will I get experience?" This age-old problem has not been solved, but there is a way in which you might help yourself. Seek someone who is now employed in the field, and offer to assist them. It would be great if you could get paid, but that is not as important as the experience gained. After all, you intend to spend years in a career—would it not make sense to try it out before you spend your money and time in preparation? Depending upon the particular job, assisting could range from simple observation for a period of time, to actually performing part of the job. Regardless, experience will benefit you in two ways:

- give you a chance to find out if the career still has appeal;
- provide experience for future employment.

### REFERENCES

Either your physical education teacher, counselor, or the school or public library should have these books and/or pamphlets. The titles will give you a general idea of their contents.

Each of the below pamphlets discusses the topic indicated.

American Alliance for Health, Physical Education, Recreation and Dance. *Careers in Leisure and Recreation*. Washington, DC American Alliance for Health, Physical Education, Recreation and Dance, 1979.

\_\_\_\_\_. *Careers in Activity and Therapy Fields*. Washington, DC. American Alliance for Health, Physical Education, Recreation and Dance, 1976.

\_\_\_\_\_. *Careers in Physical Education and Sport*. Washington, DC: American Alliance for Health, Physical Education, Recreation and Dance, 1977.

\_\_\_\_\_. *Dance—a Career for You*. Reston, VA: American Alliance for Health, Physical Education, Recreation and Dance, 1981.

\_\_\_\_\_. *Opportunities in Recreation and Leisure*. Washington, DC: American Alliance for Health, Physical Education, Recreation and Dance, 1978.

..... *Professional Preparation in Adapted Physical Education, Therapeutic Recreation, and Corrective Therapy*. Washington, DC: American Alliance for Health, Physical Education and Recreation, 1976.

..... *Your Future as a Teacher of Elementary School Physical Education*. Washington, DC: American Alliance for Health, Physical Education, Recreation and Dance, 1976.

Each of these directories lists colleges and universities that offer programs in the areas indicated.

..... *Dance Directory*. Reston, VA: American Alliance for Health, Physical Education, Recreation and Dance.

..... *Directory of Graduate Physical Education Programs*. Reston, VA: American Alliance for Health, Physical Education, Recreation and Dance.

..... *Directory of Professional Preparation in Recreation, Parks, and Related Areas*. Washington, DC: American Alliance for Health, Physical Education and Recreation, 1973.

..... *Directory of Undergraduate Physical Education Programs*. Reston, VA: American Alliance for Health, Physical Education, Recreation and Dance.

..... *Professional Preparation Directory for Elementary School Physical Education*. Washington, DC: American Alliance for Health, Physical Education and Recreation, 1978.

Each of these AAHPERD publications relates to preparation for teaching careers.

..... *Alternative Professional Preparation in Physical Education*. Washington, DC: American Alliance for Health, Physical Education, Recreation and Dance, 1979.

Clayton, Joyce A., and Clayton, Robert D. *Concepts and Careers in Physical Education*. Minneapolis, MN: Burgess Publishing Company, 1977.

Chapters 11-13 discuss school, school-related, and non-teaching careers in sports and dance.

Coleman, Ken. *So You Want to Be a Sports Broadcaster*. New York: Hawthorne Books, Inc, 1973.

Cornell, Richard, and Hansen, Mary Lewis. *Exploring Dance Careers. A Student Guidebook*. Cambridge: Technical Education Research Center, 1976.

Information on specific jobs in both dance performance and dance education.

Cratty, Bryant. *Career Potentials in Physical Activity*. Englewood Cliffs, NJ: Prentice-Hall, 1971. Sport careers related to teaching, research, coaching, therapy, recreation, and dance are discussed.

Denis, Paul. *Opportunities in the Dance*. Skokie, IL: VGM Career Horizons (National Textbook Company), 1980.

Discusses aspects of many careers in this area.

Fordham, Sheldon L., and Leaf, Carol Ann. *Physical Education and Sports. An Introduction to Alternative Careers*. New York: John Wiley & Sons, 1978.

For students interested in a physical education career other than teaching.

Fenten, Barbara. *Careers in the Sports Industry*. New York: Franklin Watts Company, 1977.

Career opportunities for non-athletes in sports-related fields.

Heitzmann, William. *Opportunities in Sports and Athletics*. Skokie, IL: VGM Career Horizons (National Textbook Company), 1980.

Discusses aspects of many careers in these areas.

Horton, Louise. *Careers in Theatre, Music and Dance*. New York: Franklin Watts Company, 1976.

Career opportunities in the performing arts.

Humphrey, James H. *Physical Education as a Career*. Springfield, IL: C. C. Thomas Company.

Sport and dance teaching, and non-teaching careers are discussed, 1978.

..... *Infusing Career Education into Physical Education and Sport*. Washington, DC: American Alliance for Health, Physical Education, Recreation and Dance, 1979.

Jensen, Clayne R. *Recreation and Leisure Time Careers*. Louisville: Data Courier, Inc.

Jobs, trends, professional training, and education requirements of many leisure-time careers, 1976.

McCall, Joseph R., and McCall, Virginia. *Your Career in Parks and Recreation*. New York: Julian Messner (Simon and Schuster), 1970.

..... *Opportunities in Recreation and Leisure*. Washington, DC: American Alliance for Health, Physical Education, Recreation and Dance, 1978.

..... *Professional Preparation in Adapted Physical Education, Therapeutic Recreation, and Corrective Therapy*. Washington, DC: American Alliance for Health, Physical Education and Recreation, 1976.

..... *Professional Preparation of the Intramural/Recreational Sports Specialist*. Washington, DC: American Alliance for Health, Physical Education and Recreation, 1977.

..... *Weaving Career Education Into Physical Education and Sport: A Handbook*. Reston. American Alliance for Health, Physical Education, Recreation and Dance, 1980.

Toure, Holima. *Careers in Physical Rehabilitation*. New York: Franklin Watts Company, 1977.

Job descriptions, educational requirements, and sources of information in the field of rehabilitation therapy.



### **Neil J. Dougherty IV**

Neil Dougherty, editor of *Physical Education and Sport for the Secondary School Student*, is a full professor and Director of the School of Applied Health Sciences at Rutgers University, New Jersey. A specialist in liability and safety in physical education, Dougherty received his Ed.D. in physical education from Temple University in 1970 and his Master's in education from Rutgers University in 1965. He has served as past president of the New Jersey AAHPERD and of the New Jersey Association of Directors of HPER, and from 1980-81 was vice-president of NAPEHE. Dougherty has been recognized with Honor and Merit awards from the Eastern District of AAHPERD and with a Distinguished Leadership Award from the New Jersey AAHPERD. Neil was the editor for *The Reporter*, the journal of the New Jersey AAHPERD and has co-authored two books.

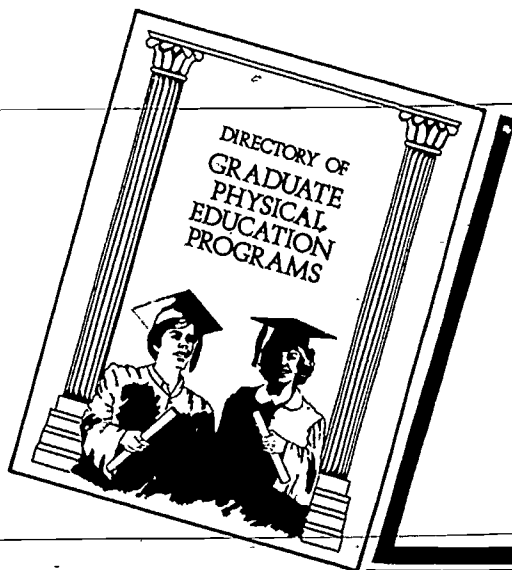
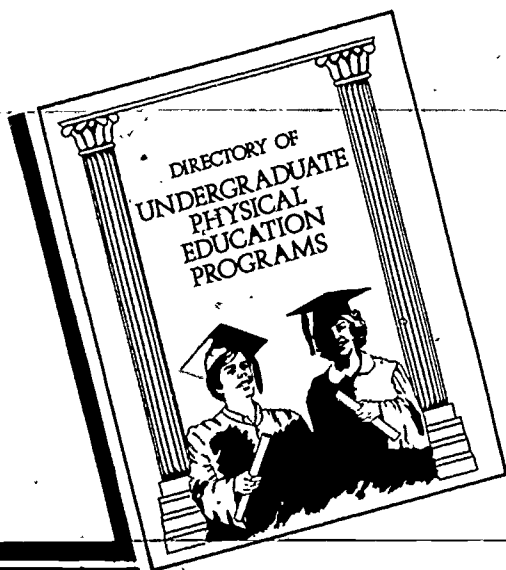

## Directories of Professional Preparation Programs in Physical Education

Two up-to-date directories containing information about United States' colleges and universities which offer degrees in physical education and related fields. Information about each institution includes degrees offered, course requirements, program emphasis, special program options, faculty, degree requirements, financial assistance, and accreditation. General information on each institution is also offered, including tuition, enrollment data, student housing admission requirements, and whom to contact for further information. Additional information on research facilities is provided for each institution listed in the graduate directory.

For price and order information:  
AAHPERD Publication Sales  
1900 Association Drive  
Reston, VA 22091  
(703) 476-3481

412

**Available  
NOW . . .**

**Three volumes of the  
Encyclopedia of  
Physical Education,  
Fitness, and Sports**



An invaluable reference collection, the most complete ever published in the field. The Encyclopedia represents a ten year effort by more than 800 experts in every area of physical education.

These beautiful hardcover volumes are fully illustrated with hundreds of photographs, charts and diagrams, and are completely indexed. The three volume set is now available including:

**Sports, Dance and  
Related Activities**

Edited by  
Reuben B. Frost (1977)

**Training, Environment,  
Nutrition and Fitness**

Edited by  
G. Alan Stull (1980)

**Philosophy, Programs  
and History**

Edited by  
James S. Bosco  
and  
Mary Ann Turner (1981)

For information write: AAHPERD Publication Sales  
1900 Association Drive, Reston, VA 22091  
(703) 476-3481