

Loads on Structures

Load Types

- Dead
- Live
- Wind
- Snow
- Earthquake

Load Combinations

- ASD
- LRFD

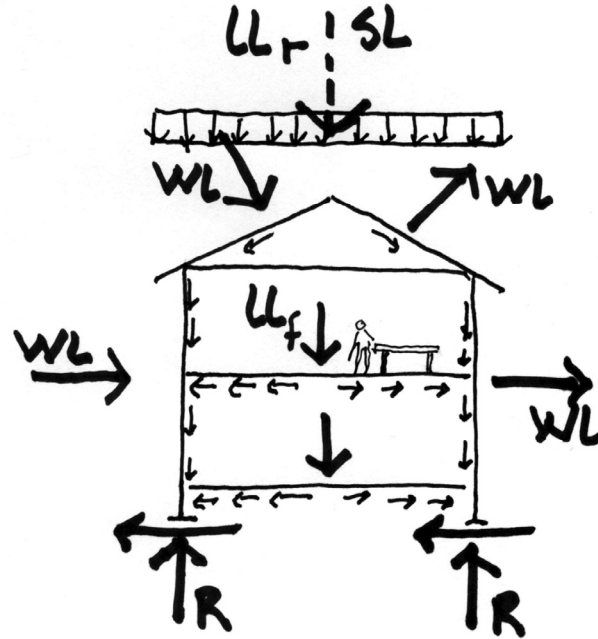

ASCE - 7

ASCE/SEI 7 Minimum Design Loads For Buildings and Other Structures

gives “minimum” loads for:

Ch. 3 - Dead Loads

Ch. 4 - Live Loads

Ch. 5 - Flood Loads

Ch. 6 - Tsunami Loads

Ch. 7 - Snow Loads

Ch. 8 - Rain Loads

Ch. 10 - Ice Loads

Ch. 11-23 Seismic Loads

Ch. 26-31 Wind Loads

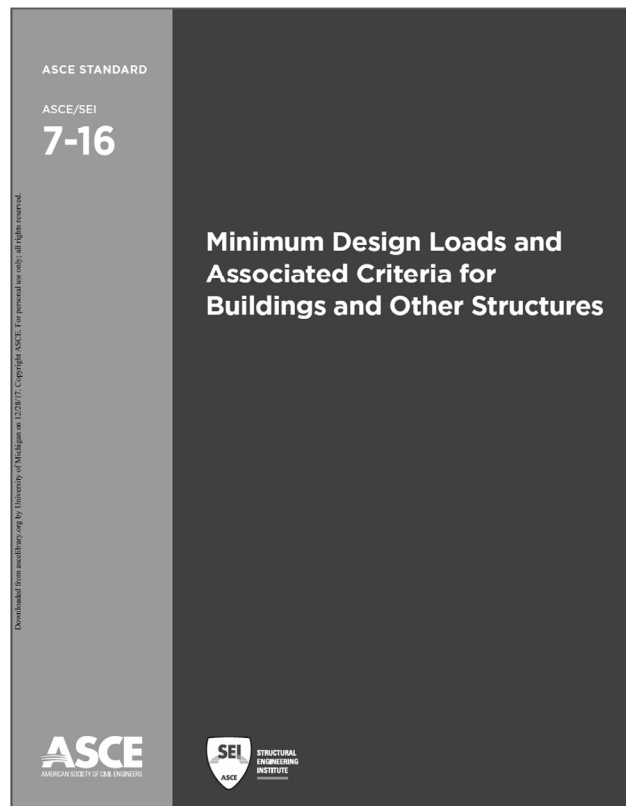

ASCE – 7 Ch. 2 - Load Combinations

Load Types

- Dead Load - D
- Roof Live Load - L_r
- Floor Live Load - L
- Snow Load - S
- Wind Load - W
- Earthquake - E

Allowable Stress Design (ASD)

Not factored

- D
- D + L
- D + (L_r or S)
- D + 0.75 L + 0.75 (L_r or S)
- D + (0.6W)
- D + 0.75L + 0.75(0.6W) + 0.75(L_r or S)
- D + 0.7E_v + 0.7E_h

Strength Design (LRFD)

With gamma (γ) safety factors

- 1.4 D
- 1.2 D + 1.6 L_r + 0.5(L_r or S)
- 1.2 D + 1.6(L_r or S) + (L or 0.5W)
- 1.2 D + 1.0W + L + 0.5(L_r or S)
- 0.9D + 1.0W
- 1.2D + E_v + E_h + L + 0.2S
- 0.9D - E_v + E_h

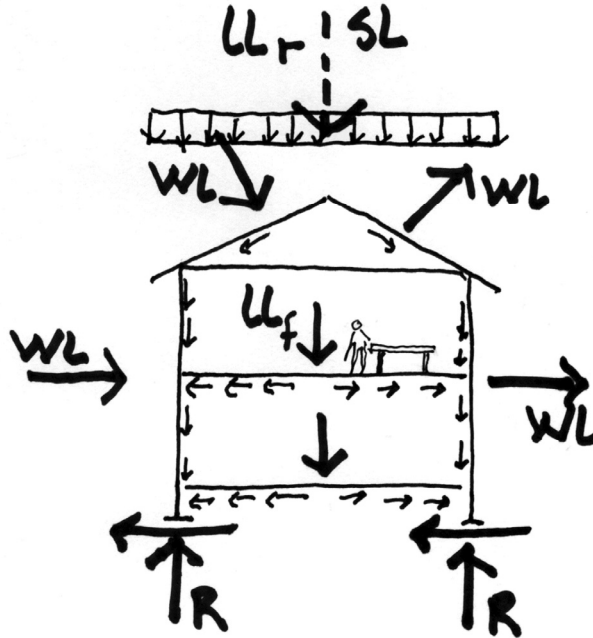

ASCE – 7 Chapter 3 Dead Loads

Ch. 3 - Dead Loads

Ch. 4 - Live Loads

Ch. 5 - Flood Loads

Ch. 6 - Tsunami Loads

Ch. 7 - Snow Loads

Ch. 8 - Rain Loads

Ch. 10 - Ice Loads

Ch. 11-23 Seismic Loads

Ch. 26-31 Wind Loads

CHAPTER 3 DEAD LOADS, SOIL LOADS, AND HYDROSTATIC PRESSURE

3.1 DEAD LOADS

3.1.1 Definition. Dead loads consist of the weight of all materials of construction incorporated into the building including, but not limited to, walls, floors, roofs, ceilings, stairways, built-in partitions, finishes, cladding, and other similarly incorporated architectural and structural items and fixed service equipment, including the weight of cranes and material handling systems.

3.1.2 Weights of Materials and Constructions. In determining dead loads for purposes of design, the actual weights of materials and constructions shall be used, provided that in the absence of definite information, values approved by the Authority Having Jurisdiction shall be used.

3.1.3 Weight of Fixed Service Equipment. In determining dead loads for purposes of design, the weight of fixed service equipment, including the maximum weight of the contents of fixed service equipment, shall be included. The components of fixed service equipment that are variable, such as liquid contents and movable trays, shall not be used to counteract forces causing

overturning, sliding, and uplift conditions in accordance with Section 1.3.6.

EXCEPTIONS:

1. Where force effects are the result of the presence of the variable components, the components are permitted to be used to counter those load effects. In such cases, the structure shall be designed for force effects with the variable components present and with them absent.
2. For the calculation of seismic force effects, the components of fixed service equipment that are variable, such as liquid contents and movable trays, need not exceed those expected during normal operation.

3.1.4 Vegetative and Landscaped Roofs. The weight of all landscaping and handscaping materials shall be considered as dead load. The weight shall be computed considering both fully saturated soil and drainage layer materials and fully dry soil and drainage layer materials to determine the most severe load effects on the structure.

Table 3.2-1 Design Lateral Soil Load

Description of Backfill Material	Unified Soil Classification	Design Lateral Soil Load ^a psf per foot of depth (kN/m ² per meter of depth)
Well-graded, clean gravels, gravel-sand mixes	GW	35 (5.50) ^b
Poorly graded, clean gravels, gravel-sand mixes	GP	35 (5.50) ^b
Silty gravels, poorly graded gravel-sand mixes	GM	35 (5.50) ^b
Clayey gravels, poorly graded gravel-and-clay mixes	GC	45 (7.07) ^b
Well-graded, clean sands; gravel-sand mixes	SW	35 (5.50) ^b
Poorly graded, clean sands, sand-gravel mixes	SP	35 (5.50) ^b
Silty sands, poorly graded sand-silt mixes	SM	45 (7.07) ^b
Sand-silt clay mix with plastic fines	SM-SC	85 (13.35) ^c
Clayey sands, poorly graded sand-clay mixes	SC	85 (13.35) ^c
Inorganic silts and clayey silts	ML	85 (13.35) ^c
Mixture of inorganic silt and clay	ML-CL	85 (13.35) ^c
Inorganic clays of low to medium plasticity	CL	100 (15.71)
Organic silts and silt-clays, low plasticity	OL	^d
Inorganic clayey silts, elastic silts	MH	^d
Inorganic clays of high plasticity	CH	^d
Organic clays and silty clays	OH	^d

^aDesign lateral soil loads are given for moist conditions for the specified soils at their optimum densities. Actual field conditions shall govern. Submerged or saturated soil pressures shall include the weight of the buoyant soil plus the hydrostatic loads.

^bFor relatively rigid walls, as when braced by floors, the design lateral soil load shall be increased for sand and gravel type soils to 60 psf (9.43 kN/m²) per foot (meter) of depth. Basement walls extending not more than 8 ft (2.44 m) below grade and supporting light floor systems are not considered as being relatively rigid walls.

^cFor relatively rigid walls, as when braced by floors, the design lateral soil load shall be increased for silt and clay type soils to 100 psf (15.71 kN/m²) per foot (meter) of depth. Basement walls extending not more than 8 ft (2.44 m) below grade and supporting light floor systems are not considered as being relatively rigid walls.

^dUnsuitable as backfill material.

Dead Load

The weight of material

by density:

MATERIAL	WEIGHT	CATEGORY
Aluminum	170 PCF	Metals/Alloys
Copper (cast)	556 PCF	Metals/Alloys
Iron (wrought)	485 PCF	Metals/Alloys
Lead	710 PCF	Metals/Alloys
Glass (plate)	161 PCF	Mineral
Sand	96 PCF	Mineral
Concrete (reinf.)	150 PCF	Mineral
Brick (common)	120 PCF	Mineral
Douglas Spruce Fir	32 PCF	Timber
White Oak	46 PCF	Timber
White Pine	26 PCF	Timber
Oil	57 PCF	Liquid
Water (39.2° F)	62.428 PCF	Liquid
Snow (fresh fallen)	8 PCF	Powder
Air	0.807	Gas

by area:

MATERIAL	WEIGHT	CATEGORY
Lightweight Concrete	6 - 10 PSF	Floors
1/4" Linoleum Finish	1 PSF	Floors
7/8" Hardwood Finish	4 PSF	Floors
Copper or Tin	1 PSF	Roofing
5-Ply felt and Gravel	6 PSF	Roofing
Asphalt Shingles	3 PSF	Roofing
Clay Tile Shingles	9 - 14 PSF	Roofing
3/4" Plywood Sheathing	3 PSF	Roofing
Wood studs 2 x 4	2 PSF	Partitions
1" Gypsum	5 PSF	Partitions
4" Brick	40 PSF	Walls
6" Hollow Conc. Block	43 PSF	Walls
8" Hollow Conc. Block	55 PSF	Walls
4" Glass Block	18 PSF	Walls
Windows, Glass	8 PSF	Walls

Dead Load

Weight of material

- weight of structure
- weight of permanent fixtures

Because it is known more precisely the safety factor is less: $\gamma = 1.2$

(concrete)

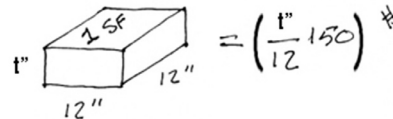
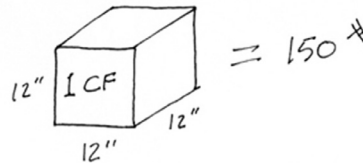

$$PLF = \frac{A_{in^2}}{144} \times 150 PCF$$

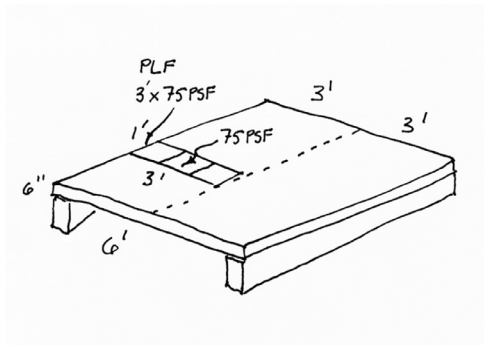
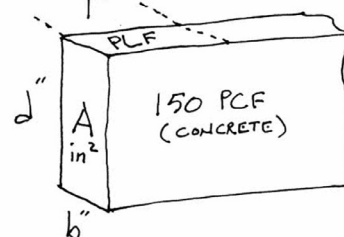

Dead Load

Floor framing

- Joist selfweight

$$PLF = \frac{\text{AREA (IN}^2\text{)}}{144} \times \text{ft} \times \text{DENSITY (PCF)}$$

- Joist weight on floor
on center space in inches (o.c.)

$$PSF = \frac{12}{\text{O.C. (IN)}} \times PLF$$

Wood density by species:
ca. 25 – 50 PCF

$$PLF = \text{LBS/FT}$$

$$PSF = \text{LBS/FT}^2$$

$$PCF = \text{LBS/FT}^3$$

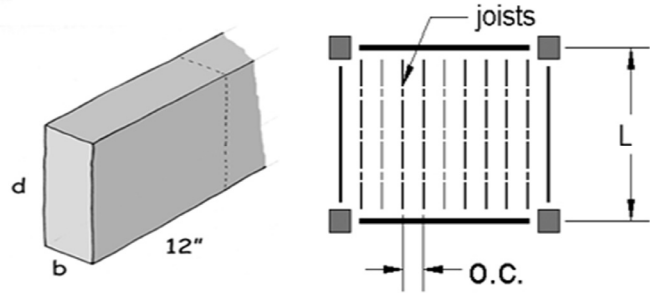
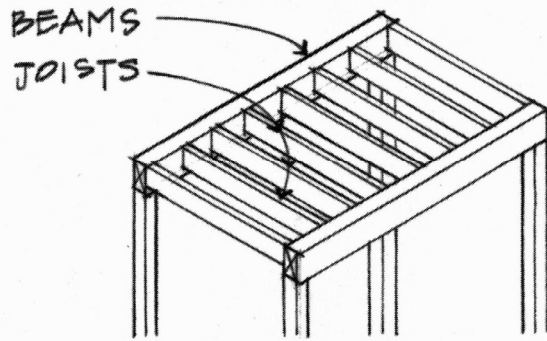

ASCE – 7 Chapter 3 Live Loads

Ch. 3 - Dead Loads

Ch. 4 - Live Loads

Ch. 5 - Flood Loads

Ch. 6 - Tsunami Loads

Ch. 7 - Snow Loads

Ch. 8 - Rain Loads

Ch. 10 - Ice Loads

Ch. 11-23 Seismic Loads

Ch. 26-31 Wind Loads

CHAPTER 4 LIVE LOADS

4.1 DEFINITIONS

The following definitions apply to the provisions of this chapter.

FIXED LADDER: A ladder that is permanently attached to a structure, building, or equipment.

GRAB BAR SYSTEM: A bar and associated anchorages and attachments to the structural system, for the support of body weight in locations such as toilets, showers, and tub enclosures.

GUARDRAIL SYSTEM: A system of components, including anchorages and attachments to the structural system, near open sides of an elevated surface for the purpose of minimizing the possibility of a fall from the elevated surface by people, equipment, or material.

HANDRAIL SYSTEM: A rail grasped by hand for guidance and support and associated anchorages and attachments to the structural system.

HELPPAD: A structural surface that is used for landing, taking off, taxiing, and parking of helicopters.

LIVE LOAD: A load produced by the use and occupancy of the building or other structure that does not include construction or environmental loads, such as wind load, snow load, rain load, earthquake load, flood load, or dead load.

ROOF LIVE LOAD: A load on a roof produced (1) during maintenance by workers, equipment, and materials, and (2) during the life of the structure by movable objects, such as planters or other similar small decorative appurtenances that are not occupancy related. An occupancy-related live load on a roof such as rooftop assembly areas, rooftop decks, and vegetative or landscaped roofs with occupiable areas, is considered to be a live load rather than a roof live load.

SCREEN ENCLOSURE: A building or part thereof, in whole or in part self-supporting, having walls and a roof of insect or sun screening using fiberglass, aluminum, plastic, or similar lightweight netting material, which encloses an occupancy or use such as outdoor swimming pools, patios or decks, and horticultural and agricultural production facilities.

VEHICLE BARRIER SYSTEM: A system of components, including anchorages and attachments to the structural system near open sides or walls of garage floors or ramps, that acts as a restraint for vehicles.

4.2 LOADS NOT SPECIFIED

For occupancies or uses not designated in this chapter, the live load shall be determined in accordance with a method approved by the Authority Having Jurisdiction.

4.3 UNIFORMLY DISTRIBUTED LIVE LOADS

4.3.1 Required Live Loads. The live loads used in the design of buildings and other structures shall be the maximum loads expected by the intended use or occupancy but shall in no case be

less than the minimum uniformly distributed unit loads required by Table 4.3-1.

4.3.2 Provision for Partitions. In office buildings and in other buildings where partition locations are subject to change, provisions for partition weight shall be made, whether or not partitions are shown on the plans. The partition load shall not be less than 15 psf (0.72 kN/m²).

EXCEPTION: A partition live load is not required where the minimum specified live load is 80 psf (3.83 kN/m²) or greater.

4.3.3 Partial Loading. The full intensity of the appropriately reduced live load applied only to a portion of a structure or member shall be accounted for if it produces a more unfavorable load effect than the same intensity applied over the full structure or member. Roof live loads shall be distributed as specified in Table 4.3-1.

4.4 CONCENTRATED LIVE LOADS

Floors, roofs, and other similar surfaces shall be designed to support the uniformly distributed live loads prescribed in Section 4.3 or the concentrated load, in pounds or kilonewtons (kN), given in Table 4.3-1, whichever produces the greater load effects. Unless otherwise specified, the indicated concentration shall be assumed to be uniformly distributed over an area 2.5 ft (762 mm) by 2.5 ft (762 mm) and shall be located so as to produce the maximum load effects in the members.

4.5 LOADS ON HANDRAIL, GUARDRAIL, GRAB BAR, AND VEHICLE BARRIER SYSTEMS, AND ON FIXED LADDERS

4.5.1 Handrail and Guardrail Systems. Handrail and guardrail systems shall be designed to resist a single concentrated load of 200 lb (0.89 kN) applied in any direction at any point on the handrail or top rail to produce the maximum load effect on the element being considered and to transfer this load through the supports to the structure.

4.5.1.1 Uniform Load. Handrail and guardrail systems shall also be designed to resist a load of 50 lb/ft (pound-force per linear foot) (0.73 kN/m) applied in any direction along the handrail or top rail and to transfer this load through the supports to the structure. This load need not be assumed to act concurrently with the concentrated load specified in Section 4.5.1.

EXCEPTIONS: The uniform load need not be considered for the following occupancies:

1. one- and two-family dwellings, and
2. factory, industrial, and storage occupancies in areas that are not accessible to the public and that serve an occupant load not greater than 50.

Live Load

Live Load (on projected area)

Floor live load

- by occupancy
- 40 PSF to ~250 PSF

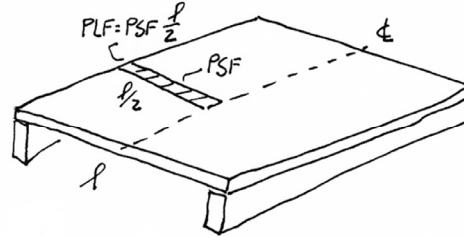

Roof live load

- construction or maintenance
- 12 PSF to 20 PSF (depending on area and slope)
- safety factor $\gamma = 1.6$

Live Load

Floor Loads

OCCUPANCY OR USE	WEIGHT	CATEGORY
Fixed seats (fastened to flr)	60 PSF	Assembly areas & theaters
Lobbies	100 PSF	Assembly areas & theaters
Movable seats	100 PSF	Assembly areas & theaters
Stage floors	150 PSF	Assembly areas & theaters
Balconies (exterior)	100 PSF	
Bowling and poolrooms	75 PSF	Recreational areas
Dance halls & ballrooms	100 PSF	
Dining room & restaurants	100 PSF	
Gyms, main flrs & balconies	100 PSF	
Private rooms and corridors	40 PSF	Hotels and multifamily houses
Public rooms and corridors	100 PSF	Hotels and multifamily houses
Classrooms	40 PSF	Schools
Corridors above first floor	80 PSF	Schools
First floor corridor	100 PSF	Schools
Bleachers	100 PSF	Stadiums/arenas
Fixed seats (fastened to flr)	60 PSF	Stadiums/arenas
Light manufacturing	125 PSF	Manufacturing
Heavy manufacturing	250 PSF	Manufacturing
Habitable sleeping areas	30 PSF	Residential
All other areas (except stairs)	40 PSF	Residential

Roof Live Load

- Minimum L_r between 12 PSF and 20 PSF
- $L_r = 20 R_1 R_2$

Area Reduction:

$$R_1 = \begin{cases} 1 & \text{for } A_t \leq 200 \text{ ft}^2 (18.58 \text{ m}^2) \\ 1.2 - 0.001A_t & \text{for } 200 \text{ ft}^2 < A_t < 600 \text{ ft}^2 \\ 0.6 & \text{for } A_t \geq 600 \text{ ft}^2 (55.74 \text{ m}^2) \end{cases}$$

where A_t = tributary area in ft^2 (m^2) supported by structural member

Slope Reduction:

$$R_2 = \begin{cases} 1 & \text{for } F \leq 4 \\ 1.2 - 0.05 F & \text{for } 4 < F < 12 \\ 0.6 & \text{for } F \geq 12 \end{cases}$$

pitched roof: F = number of inches of rise per ft.
 arch or dome: F = rise-to span ratio multiplied by 32.

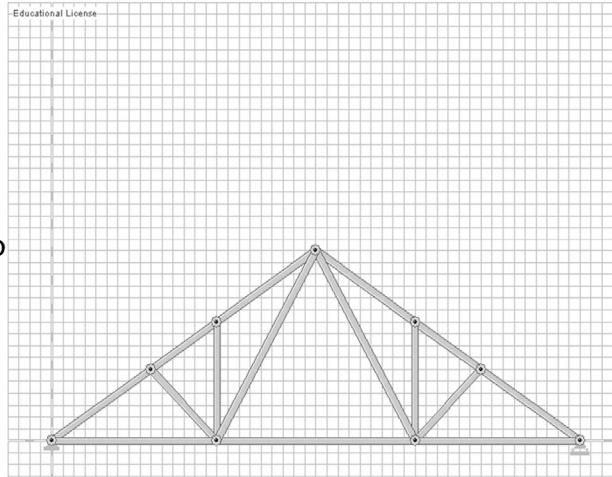

ASCE – 7 Chapter 3 Snow Loads

- Ch. 3 - Dead Loads
- Ch. 4 - Live Loads
- Ch. 5 - Flood Loads
- Ch. 6 - Tsunami Loads
- Ch. 7 - Snow Loads**
- Ch. 8 - Rain Loads
- Ch. 10 - Ice Loads
- Ch. 11-23 Seismic Loads
- Ch. 26-31 Wind Loads

CHAPTER 7 SNOW LOADS

7.1 DEFINITIONS AND SYMBOLS

7.1.1 Definitions

DRIFT: The accumulation of wind-driven snow that results in a local surcharge load on the roof structure at locations such as a parapet or roof step.

FLAT ROOF SNOW LOAD: Uniform load for flat roofs.
FREEZER BUILDINGS: Buildings in which the inside temperature is kept at or below freezing. Buildings with an air space between the roof insulation layer above and a ceiling of the freezer area below are not considered freezer buildings.

GROUND SNOW LOAD: The site-specific weight of the accumulated snow at the ground level used to develop roof snow loads on the structure. It generally has a 50-year mean recurrence interval.

MINIMUM SNOW LOAD: Snow load on low-sloped roofs, including the roof snow load immediately after a single snow storm without wind.

PONDING: Refer to definitions in Chapter 8, Rain Loads.
PONDING INSTABILITY: Refer to definitions in Chapter 8, Rain Loads.

R-VALUE: A measure of the resistance to heat flow through a roof component or assembly per unit area.

SLIPPERY SURFACE: Membranes with a smooth surface, e.g., glass, metal, or rubber. Membranes with an embedded aggregate or mineral granule surface are not considered a slippery surface.

SLOPED ROOF SNOW LOAD: Uniform load on horizontal projection of a sloped roof, also known as the balanced load.

VENTILATED ROOF: Roof that allows exterior air to naturally circulate between the roof surface above and the insulation layer below. The exterior air commonly flows from the eave to the ridge.

7.1.2 Symbols

- C_e = exposure factor as determined from Table 7.3-1.
- C_s = slope factor as determined from Fig. 7.4-1.
- C_t = thermal factor as determined from Table 7.3-2.
- h = vertical separation distance in feet (m) between the edge of a higher roof including any parapet and the edge of a lower adjacent roof excluding any parapet.
- h_b = height of balanced snow load determined by dividing p_b by γ , in ft (m).
- h_c = clear height from top of balanced snow load to (1) closest point on adjacent upper roof, (2) top of parapet, or (3) top of a projection on the roof, in ft (m).
- h_d = height of snow drift, in ft (m).
- h_{d1} or h_{d2} = heights of snow drifts, in ft (m), where two intersecting snow drifts can form.
- h_o = height of obstruction above the surface of the roof, in ft (m).
- I_s = importance factor as prescribed in Section 7.3.3.

- l_d = length of the roof upwind of the drift, in ft (m).
- p_d = maximum intensity of drift surcharge load, in lb/ft^2 (kN/m^2).
- p_f = snow load on flat roofs ("flat" = roof slope $\leq 5^\circ$), in lb/ft^2 (kN/m^2).
- p_g = ground snow load as determined from Fig. 7.2-1 and Table 7.2-1; or a site-specific analysis, in lb/ft^2 (kN/m^2).
- p_m = minimum snow load for low-slope roofs, in lb/ft^2 (kN/m^2).
- p_s = sloped roof (balanced) snow load, in lb/ft^2 (kN/m^2).
- s = horizontal separation distance in ft (m) between the edges of two adjacent buildings.
- S = roof slope run for a rise of one.
- w = width of snow drift, in ft (m).
- w_1 or w_2 = widths of snow drifts, in ft (m), where two intersecting snow drifts can form.
- W = horizontal distance from eave to ridge, in ft (m).
- γ = snow density, in lb/ft^3 (kN/m^3), as determined from Eq. (7.7-1).
- θ = roof slope on the leeward side, in degrees.

7.2 GROUND SNOW LOADS, p_g

Ground snow loads, p_g , to be used in the determination of design snow loads for roofs shall be as set forth in Fig. 7.2-1 for the contiguous United States and Table 7.2-1 for Alaska. Site-specific case studies shall be made to determine ground snow loads in areas designated CS in Fig. 7.2-1 (see also Tables 7.2-2 through 7.2-8). Ground snow loads for sites at elevations above the limits indicated in Fig. 7.2-1 and for all sites within the CS areas shall be approved by the Authority Having Jurisdiction. Ground snow load determination for such sites shall be based on an extreme value statistical analysis of data available in the vicinity of the site using a value with a 2% annual probability of being exceeded (50-year mean recurrence interval).

Snow loads are zero for Hawaii, except in mountainous regions as determined by the Authority Having Jurisdiction.

The importance factor times the ground snow load, $I_s p_g$, shall be used as the balanced snow load for snow accumulation surfaces, such as decks, balconies, and other near-ground level surfaces or roofs of subterranean spaces, whose height above the ground surface is less than the depth of the ground snow, h_c ($h_c = p_g/\gamma$).

7.3 FLAT ROOF SNOW LOADS, p_f

The flat roof snow load, p_f , shall be calculated in lb/ft^2 (kN/m^2) using the following formula:

$$p_f = 0.7 C_e C_t I_s p_g \quad (7.3-1)$$

Snow Load

Snow Load (on projected length)

Ground Snow

- p_g by region
- Ann Arbor 25 psf

Flat Roof

- $p_f = 70\% p_g \times$ condition factors (exposure, thermal, importance)

Sloped Roof

- $p_s = p_f \times$ slope factors
- Balanced (full roof)
- Un-balanced

Safety Factor

- $\gamma = 1.6$

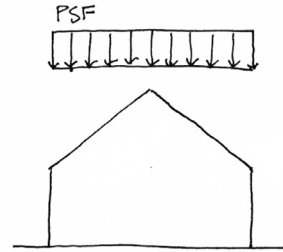

balanced

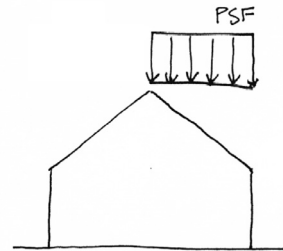

un-balanced

Snow Load

Ground Snow

- p_g by region
- Ann Arbor 25 psf

Flat Roof

- $p_f = 70\% p_g \times$ condition factors (exposure, thermal, importance)

Sloped Roof

- $p_s = p_f \times$ slope factors
- Balanced (full roof)
- Un-balanced

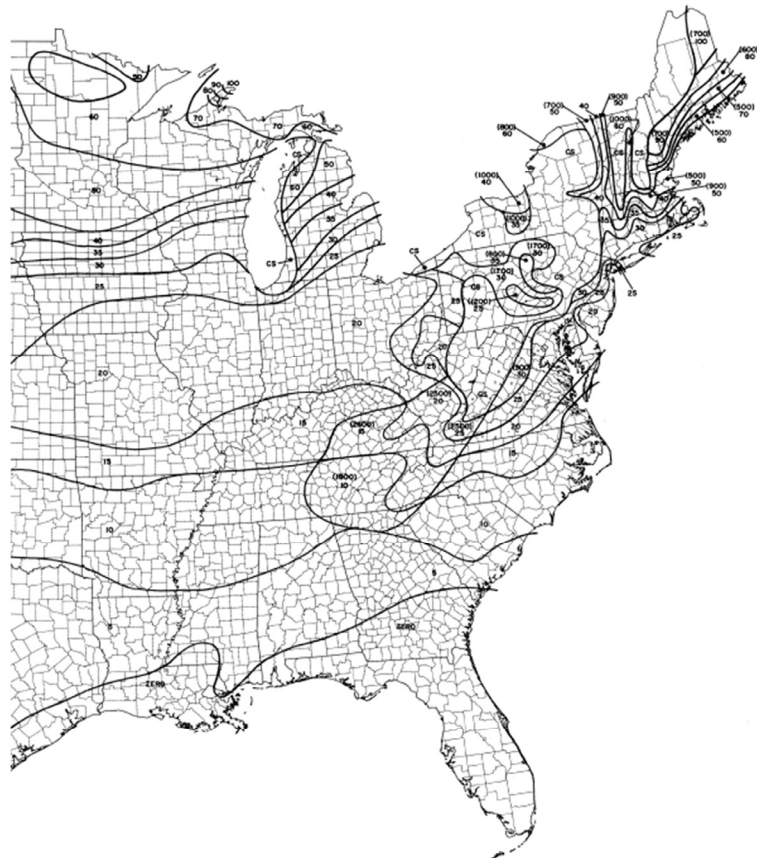
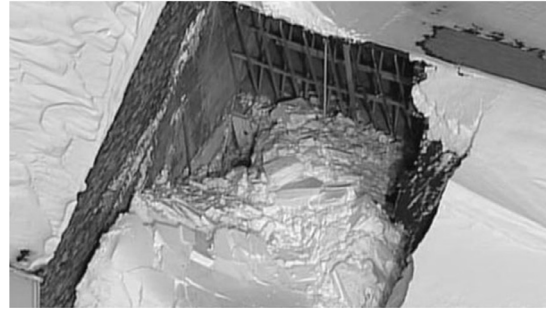
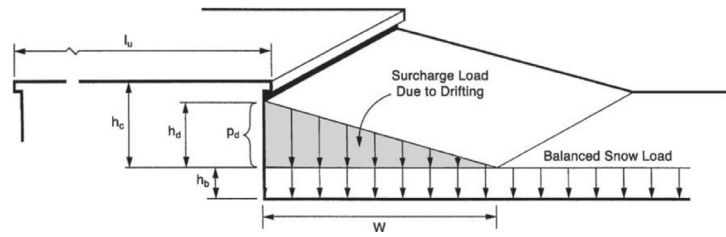

FIGURE 7-1 – continued
GROUND SNOW LOADS, p_g FOR THE UNITED STATES (LB/SQ FT)

Snow Load

Drift Loading

- Windward
- Leeward
- Sawtooth



Ann Arbor



Houghton, Michigan

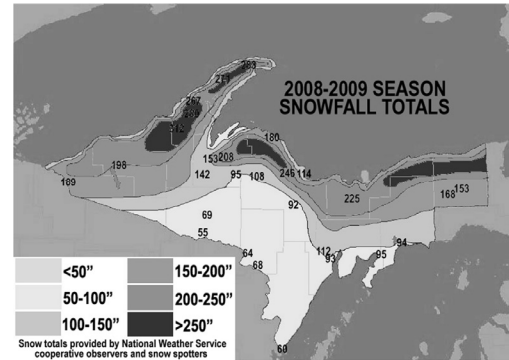

ASCE – 7 Chapter 3 Wind Loads

Ch. 3 - Dead Loads

Ch. 4 - Live Loads

Ch. 5 - Flood Loads

Ch. 6 - Tsunami Loads

Ch. 7 - Snow Loads

Ch. 8 - Rain Loads

Ch. 10 - Ice Loads

Ch. 11-23 Seismic Loads

Ch. 26-31 Wind Loads

CHAPTER 26 WIND LOADS: GENERAL REQUIREMENTS

26.1 PROCEDURES

26.1.1 Scope. Buildings and other structures, including the main wind force resisting system (MWFRS) and all components and cladding (C&C) thereof, shall be designed and constructed to resist the wind loads determined in accordance with Chapters 26 through 31. The provisions of this chapter define basic wind parameters for use with other provisions contained in this standard.

26.1.2 Permitted Procedures. The design wind loads for buildings and other structures, including the MWFRS and C&C elements thereof, shall be determined using one of the procedures as specified in this section. An outline of the overall process for the determination of the wind loads, including section references, is provided in Fig. 26.1-1.

26.1.2.1 Main Wind Force Resisting System. Wind loads for the MWFRS shall be determined using one of the following procedures:

1. Directional Procedure for buildings of all heights as specified in Chapter 27 for buildings meeting the requirements specified therein;
2. Envelope Procedure for low-rise buildings as specified in Chapter 28 for buildings meeting the requirements specified therein;
3. Directional Procedure for Building Appendages (rooftop structures and rooftop equipment) and Other Structures (such as solid freestanding walls and solid freestanding signs, chimneys, tanks, open signs, single-plane open frames, and trussed towers) as specified in Chapter 29; or
4. Wind Tunnel Procedure for all buildings and all other structures as specified in Chapter 31.

26.1.2.2 Components and Cladding. Wind loads on C&C on all buildings and other structures shall be designed using one of the following procedures:

1. Analytical Procedures provided in Parts 1 through 6, as appropriate, of Chapter 30; or
2. Wind Tunnel Procedure as specified in Chapter 31.

26.2 DEFINITIONS

The following definitions apply to the provisions of Chapters 26 through 31:

APPROVED: Acceptable to the Authority Having Jurisdiction.

ATTACHED CANOPY: A horizontal (maximum slope of 2%) patio cover attached to the building wall at any height; it is different from an overhang, which is an extension of the roof surface.

BASIC WIND SPEED, V: Three-second gust speed at 33 ft (10 m) above the ground in Exposure C (see Section 26.7.3) as determined in accordance with Section 26.5.1.

BUILDING, ENCLOSED: A building that has the total area of openings in each wall, that receives positive external pressure, less than or equal to 4 sq ft (0.37 m²) or 1% of the area of that wall, whichever is smaller. This condition is expressed for each wall by the following equation:

$$A_o < 0.01A_w \text{ or } 4 \text{ sq ft } (0.37 \text{ m}^2), \text{ whichever is smaller,}$$

where A_o and A_w are as defined for Open Buildings.

BUILDING, LOW-RISE: Enclosed or partially enclosed building that complies with the following conditions:

1. Mean roof height h less than or equal to 60 ft (18 m).
2. Mean roof height h does not exceed least horizontal dimension.

BUILDING, OPEN: A building that has each wall at least 80% open. This condition is expressed for each wall by the equation $A_o \geq 0.8A_w$, where

A_o = total area of openings in a wall that receives positive external pressure, in ft² (m²); and
 A_w = the gross area of that wall in which A_o is identified, in ft² (m²).

BUILDING, PARTIALLY ENCLOSED: A building that complies with both of the following conditions:

1. The total area of openings in a wall that receives positive external pressure exceeds the sum of the areas of openings in the balance of the building envelope (walls and roof) by more than 10%.
2. The total area of openings in a wall that receives positive external pressure exceeds 4 ft² (0.37 m²) or 1% of the area of that wall, whichever is smaller, and the percentage of openings in the balance of the building envelope does not exceed 20%.

These conditions are expressed by the following equations:

$$A_o > 1.10A_w$$

$$A_o > 4 \text{ ft}^2 (0.37 \text{ m}^2) \text{ or}$$

$$> 0.01A_w, \text{ whichever is smaller, and } A_o/A_w \leq 0.20$$

where A_o and A_w are as defined for Open Building;

A_w = sum of the areas of openings in the building envelope (walls and roof) not including A_o , in ft² (m²); and

A_p = sum of the gross surface areas of the building envelope (walls and roof) not including A_o , in ft² (m²).

Wind Load

Minimum force

10 psf (ASCE-7 6.1.4.1)

Basic pressure equation

$$q = \frac{1}{2} \times \gamma \times v^2$$

ASCE equation

Sec. 6.5.10 eq.6-15

$$q_z = 0.00256 \times K_z K_{zt} K_d \times v^2 \times I$$

Velocity v is in MPH

0.00256 accounts for air density/2 and conversions

Kz = height factor

Kzt = topographic factor

Kd = directionality factor

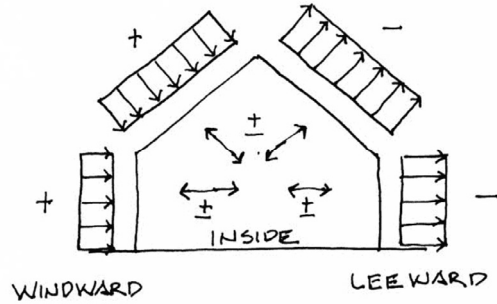

Wind Load (normal to surface)

Pressure load

+ pressing load

- suction load

Safety factor for wind: $\gamma = 1.0$

Wind Load

Wind speed map for category II

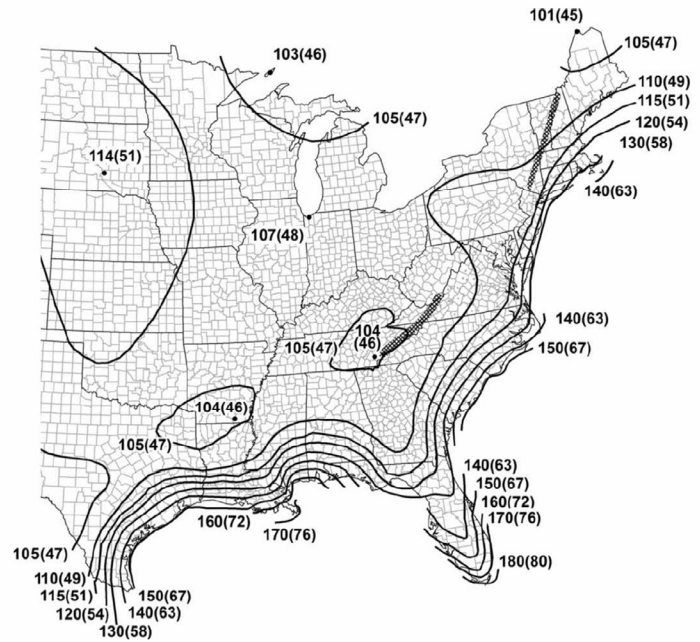
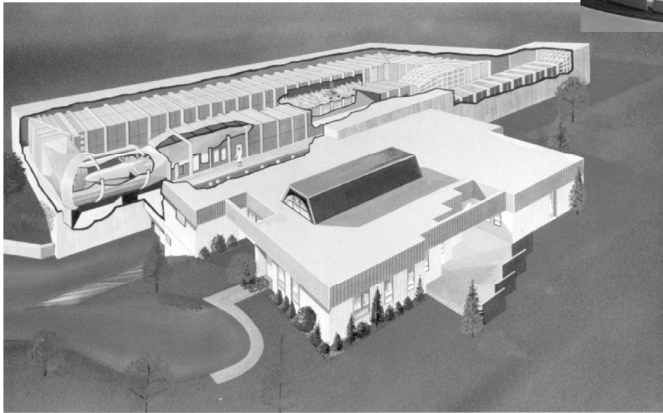

FIGURE 26.5-1B (Continued). Basic Wind Speeds for Risk Category II Buildings and Other Structures

Wind – wind tunnel testing

Boundary Layer Wind Tunnel



BLWTL Facilities
Western University
Ontario, Canada

Wind – CFD

Computational Fluid Dynamics (CFD)
not used for structural calculations

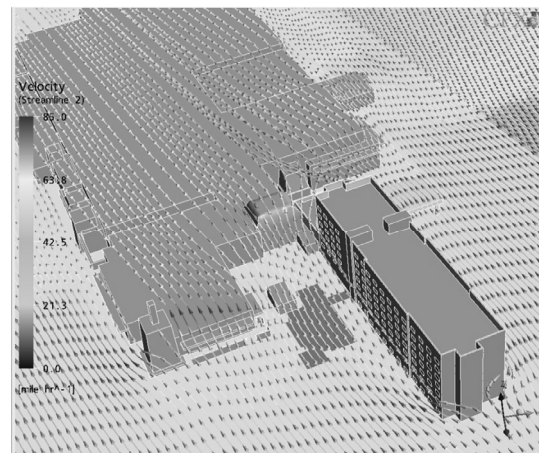
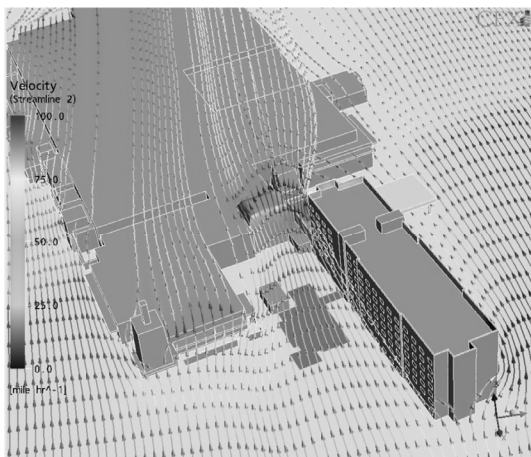

ASCE – 7 Chapters 11-23 Seismic Loads

Ch. 3 - Dead Loads

Ch. 4 - Live Loads

Ch. 5 - Flood Loads

Ch. 6 - Tsunami Loads

Ch. 7 - Snow Loads

Ch. 8 - Rain Loads

Ch. 10 - Ice Loads

Ch. 11-23 Seismic Loads

Ch. 26-31 Wind Loads

CHAPTER 12

SEISMIC DESIGN REQUIREMENTS FOR BUILDING STRUCTURES

12.1 STRUCTURAL DESIGN BASIS

12.1.1 Basic Requirements. The seismic analysis and design procedures to be used in the design of building structures and their members shall be as prescribed in this section. The building structure shall include complete lateral and vertical force-resisting systems capable of providing adequate strength, stiffness, and energy dissipation capacity to withstand the design ground motions within the prescribed limits of deformation and strength demand. The design ground motions shall be assumed to occur along any horizontal direction of a building structure. The adequacy of the structural systems shall be demonstrated through the construction of a mathematical model and evaluation of this model for the effects of design ground motions. The design seismic forces and their distribution over the height of the building structure shall be established in accordance with one of the applicable procedures indicated in Section 12.6, and the corresponding internal forces and deformations in the members of the structure shall be determined. An approved alternative procedure shall not be used to establish the seismic forces and their distribution unless the corresponding internal forces and deformations in the members are determined using a model consistent with the procedure adopted.

EXCEPTION: As an alternative, the simplified design procedures of Section 12.14 are permitted to be used in lieu of the requirements of Sections 12.1, 12.12, and 12.13, subject to all of the limitations contained in Section 12.14.

12.1.2 Member Design, Connection Design, and Deformation Limit. Individual members, including those not part of the seismic force-resisting system, shall be provided with adequate strength to resist the shears, axial forces, and moments determined in accordance with this standard, and connections shall develop the strength of the connected members or the forces indicated in Section 12.1.1. The deformation of the structure shall not exceed the prescribed limits where the structure is subjected to the design seismic forces.

12.1.3 Continuous Load Path and Interconnection. A continuous load path, or paths, with adequate strength and stiffness shall be provided to transfer all forces from the point of application to the final point of resistance. All parts of the structure between separation joints shall be interconnected to form a continuous path to the seismic force-resisting system, and the connections shall be capable of transmitting the seismic force (F_p) induced by the parts being connected. Any smaller portion of the structure shall be tied to the remainder of the structure with elements that have a design strength capable of transmitting a seismic force of 0.133 times the short-period design spectral response acceleration parameter, S_{DS} , times the weight of the

smaller portion or 5% of the portion's weight, whichever is greater. This connection force does not apply to the overall design of the seismic force-resisting system. Connection design forces need not exceed the maximum forces that the structural system can deliver to the connection.

12.1.4 Connection to Supports. A positive connection for resisting a horizontal force acting parallel to the member shall be provided for each beam, girder, or truss, either directly to its supporting elements or to slabs designed to act as diaphragms. Where the connection is through a diaphragm, then the member's supporting element must also be connected to the diaphragm. The connection shall have a minimum design strength of 5% of the dead plus live load reaction.

12.1.5 Foundation Design. The foundation shall be designed to resist the forces developed and to accommodate the movements imparted to the structure and foundation by the design ground motions. The dynamic nature of the forces, the expected ground motion, the design basis for strength and energy dissipation capacity of the structure, and the dynamic properties of the soil shall be included in the determination of the foundation design criteria. The design and construction of foundations shall comply with Section 12.13.

When calculating load combinations using either the load combinations specified in Sections 2.3 or 2.4, the weights of foundations shall be considered dead loads in accordance with Section 3.1.2. The dead loads are permitted to include overlying fill and paving materials.

12.1.6 Material Design and Detailing Requirements. Structural elements, including foundation elements, shall conform to the material design and detailing requirements set forth in Chapter 14.

12.2 STRUCTURAL SYSTEM SELECTION

12.2.1 Selection and Limitations. Except as noted in Section 12.2.1.1, the basic lateral and vertical seismic force-resisting system shall conform to one of the types indicated in Table 12.2-1 or a combination of systems as permitted in Sections 12.2.2, 12.2.3, and 12.2.4. Each system is subdivided by the types of vertical elements used to resist lateral seismic forces. The structural systems used shall be in accordance with the structural system limitations and the limits on structural height, h_u , contained in Table 12.2-1. The appropriate response modification coefficient, R ; overstrength factor, Ω_e ; and deflection amplification factor, C_d , indicated in Table 12.2-1 shall be used in determining the base shear, element design forces, and design story drift.

Each selected seismic force-resisting system shall be designed and detailed in accordance with the specific requirements for the

Earthquake Loads

- Ground Motion
- Measurement
- Amplification
- Building Resistance



Geologic Background

Plate Tectonics

Geologic Faults

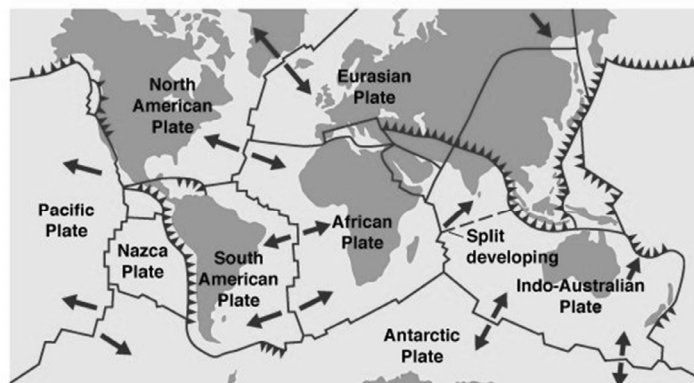

(a) ©1999 Addison Wesley Longman, Inc.

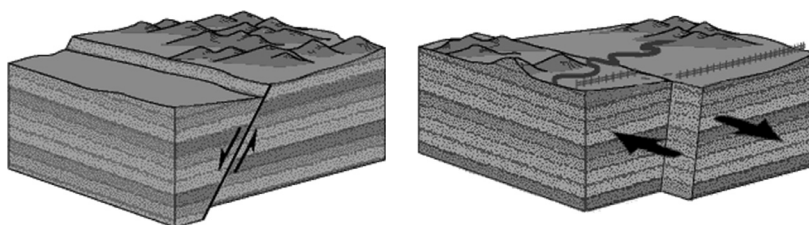

Geologic Background

Fault Location

- Focus (hypocenter)
- Epicenter

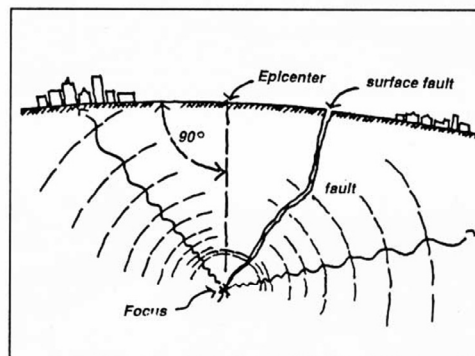

Earthquake location

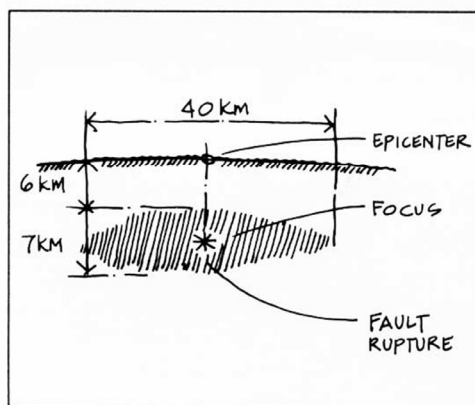

The Loma Prieta fault rupture, 1989

Ground Failure

Landslide
(La Conchita, Calif. 1995)



- Landslides
- Liquefaction
- Subsidence

Liquefaction (Niigata, Japan 1964)



Subsidence (Pierces, Guatemala)

Ground Motion

Primary

- P wave
- hits first
- pressure hammer

Secondary (Shear)

- S wave
- back and forth
- adds to P wave

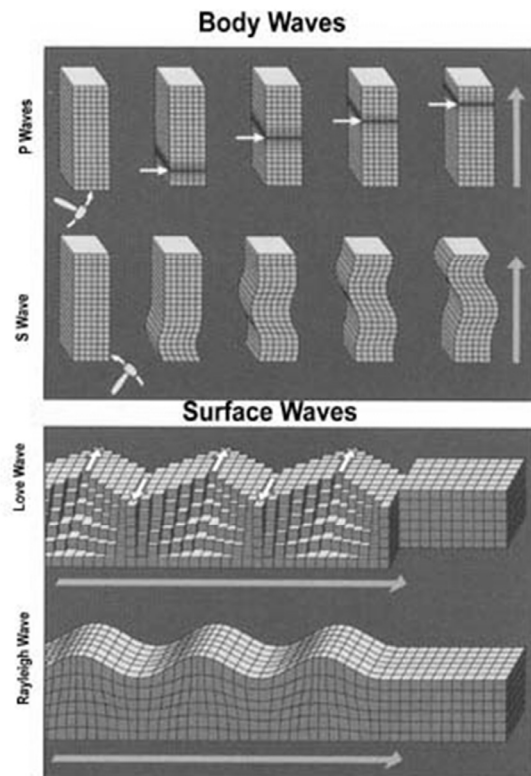

Ground Motion

Acceleration

- Measured in g's (1 g = 32 ft/sec²)
- 0.001 g limit of perception
- 0.1 g weak construction fails
- 0.2 g hard to stand up
- 0.5 g very sever for earthquake



San Francisco, 1906 approximately 0.7g

Measurement

Magnitude

- Richter scale 0 to ~9.5
- Size of the wave
- Accounts for distance attenuation
- Logarithmic (base 10)

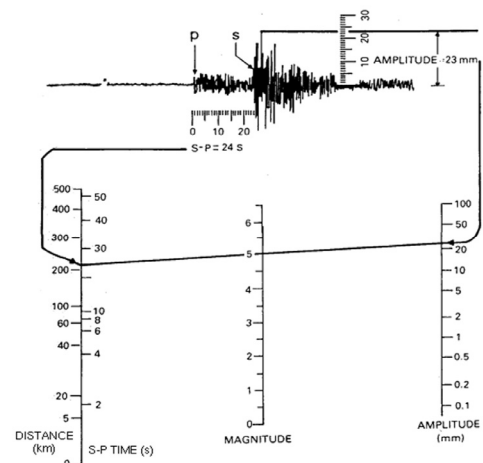

Intensity

- Modified Mercalli scale I to XII
- Relates to effects
- Includes duration
- Differs with location

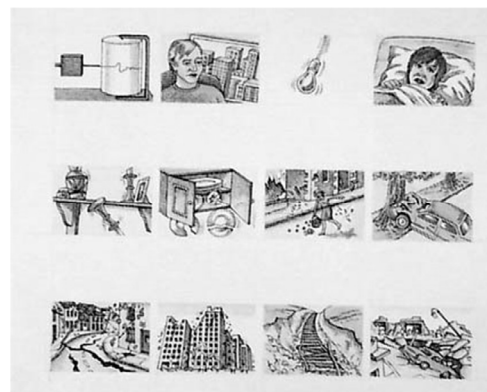

Measurement

Intensity

- Modified Mercalli scale I to XII
- Relates to effects
- Includes duration
- Differs with location



University of Michigan, TCAUP

Modified Mercalli Scale

I. Instrumental	Generally not felt by people unless in favorable conditions.
II. Weak	Felt only by a few people at rest, especially on the upper floors of buildings. Delicately suspended objects may swing.
III. Slight	Felt quite noticeably by people indoors, especially on the upper floors of buildings. Many do not recognize it as an earthquake. Standing motor cars may rock slightly. Vibration similar to the passing of a truck. Duration estimated.
IV. Moderate	Felt indoors by many people, outdoors by few people during the day. At night, some awaken. Dishes, windows, doors disturbed; walls make cracking sound. Sensation like heavy truck striking building. Standing motor cars rock noticeably. Dishes and windows rattle alarmingly.
V. Rather Strong	Felt inside by most, may not be felt by some outside in non-favorable conditions. Dishes and windows may break and large bells will ring. Vibrations like large train passing close to house.
VI. Strong	Felt by all; many frightened and run outdoors, walk unsteadily. Windows, dishes, glassware broken; books fall off shelves; some heavy furniture moved or overturned; a few instances of fallen plaster. Damage slight.
VII. Very Strong	Difficult to stand; furniture broken; damage negligible in building of good design and construction; slight to moderate in well-built ordinary structures; considerable damage in poorly built or badly designed structures; some chimneys broken. Noticed by people driving motor cars.
VIII. Destructive	Damage slight in specially designed structures; considerable in ordinary substantial buildings with partial collapse. Damage great in poorly built structures. Fall of chimneys, factory stacks, columns, monuments, walls. Heavy furniture moved.
IX. Violent	General panic, damage considerable in specially designed structures, well designed frame structures thrown out of plumb. Damage great in substantial buildings, with partial collapse. Buildings shifted off foundations.
X. Intense	Some well built wooden structures destroyed; most masonry and frame structures destroyed with foundation. Rails bent slightly. Large landslides.
XI. Extreme	Few, if any masonry structures remain standing. Bridges destroyed. Rails bent greatly. Numerous landslides, cracks and deformation of the ground.
XII. Catastrophic	Total destruction – Everything is destroyed. Lines of sight and level distorted. Objects thrown into the air. The ground moves in waves or ripples. Large amounts of rock move position. Landscape altered, or levelled by several meters. In some cases, even the routes of rivers are changed.

Structures I

Slide 29 of 33

Characteristics of Period

Frequency

- Cycles / second (Hz)

Period

- Inverse of frequency (sec / 1period)

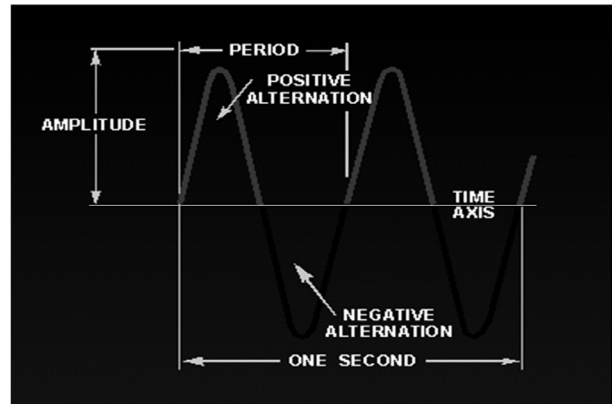

Fundamental Period

- measured in seconds
- approx. = stories/10

Soil approx. 0.5 ~ 2.0

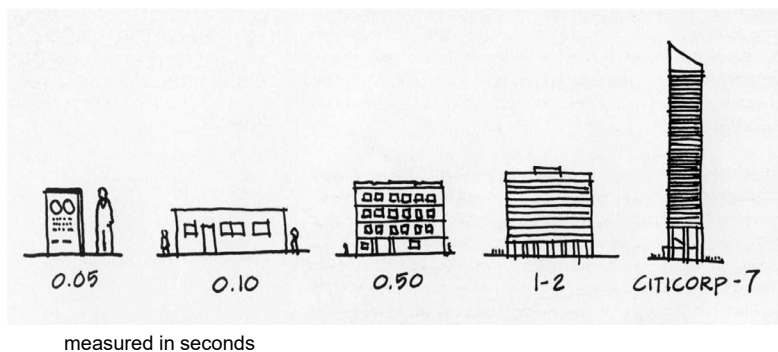

University of Michigan, TCAUP

Structures I

Slide 30 of 33

Amplification

Fundamental Period

- Modes
- Modal shapes
- Modal frequency

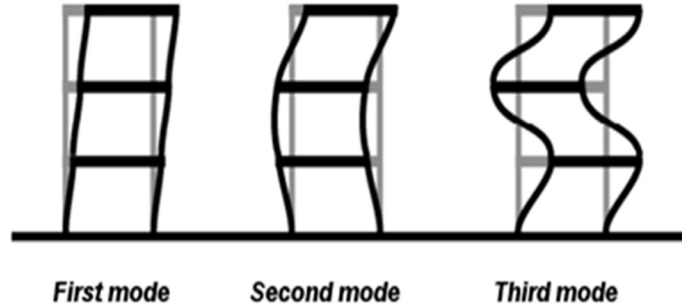

Resonance

Response Spectrum

- Fundamental period of soil
- 0.4 to 1.5 (or 2.0) seconds
- Harder is shorter period (rock)
- Softer is longer period (soil)

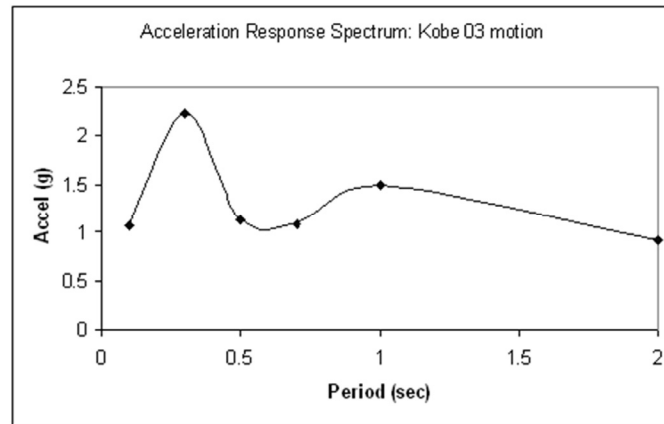

Building Resistance

Damping

- Material
- Partitions

Ductility

- connections

Strength and stiffness

- drift

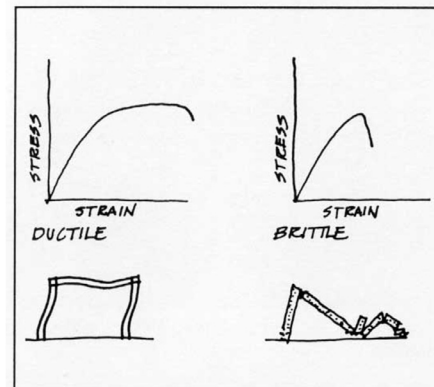

Ductile materials undergo considerable permanent deformation before failure.

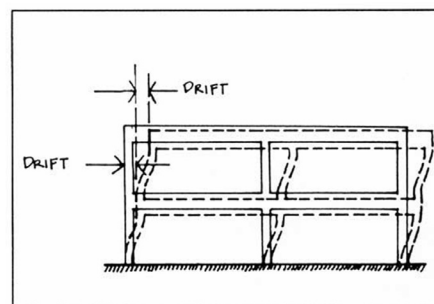

Story-to-story drift

Provisions and Codes

National Earthquake Hazards Reduction Program (NEHRP)

not a code but “provisions”

ASCE 7 Section 9

code based on NEHRP

