



Ministry of Education, Youth & Information



STUDENT CAMPS 2022

MATHEMATICS BOOKLET - STUDENT

GRADE SIX CURRICULUM BASED TASKS

**PREPARED BY CURRICULUM UNIT, MATHEMATICS & EDUCATIONAL
TECHNOLOGY SECTION**

Grade 6 Mathematics Curriculum Based Test – Sample Items – 2022

Question #1

Which problem could the expression below help to solve?

$$\frac{1}{2} \div 8$$

- a) What is the total feed that 2 chickens eat if each chicken is given $\frac{1}{8}$ Kilogram of feed?
- b) How much milk will each child get if 8 children share $\frac{1}{2}$ litre of milk equally?
- c) If each cake requires $\frac{1}{2}$ litre of milk, how much milk will be used to make 8 cakes?
- d) Sixteen children are divided into 2 equal groups. If each child receives 8 pieces of candy, how many pieces of candy are required for each group of children?

Question #2

Sammy drew a number line on his paper.



Jack drew a new point 45% of the distance from point *E* to point *J*. Between which two letters does the new point lie?

- a) *G* and *H*
- b) *I* and *J*
- c) *F* and *G*
- d) *H* and *I*

Question #3

One serving of Ace's crackers has 150 calories and a mass of 30 grams. How many calories are in 6 grams of the crackers?

- a) 5
- b) 10
- c) 25
- d) 30

Grade 6 Mathematics Curriculum Based Test – Sample Items – 2022

Question #4

To clean a tank $\frac{3}{4}$ litre of disinfectant is needed for every 4 litres of water.

How many litres of disinfectant are needed for 40 litres of water?

- a) $7\frac{1}{2}$
- b) 15
- c) $22\frac{1}{2}$
- d) 33

Question #5

This table shows the number of kilometres four friends travel to get to school.

Student	Distance to School (kilometres)
Andie	$1\frac{3}{8}$
Helen	$1\frac{2}{3}$
Michelle	$1\frac{5}{9}$
Troy	$1\frac{4}{9}$

Who travels the greatest distance to school?

- a) Andie
- b) Helen
- c) Michelle
- d) Troy

Question #6

The ratio of nitrogen to potassium in a sample of soil is 12 : 9. The sample has 36 units of nitrogen. How much potassium does the sample have?

- a) 21 units
- b) 27 units
- c) 45 units
- d) 48 units

Grade 6 Mathematics Curriculum Based Test – Sample Items – 2022

Question #7

The **ABC** brand hand sanitizer is sold at four stores. The bottle size and cost are shown in the table below:

Store	Size (millilitres)	Price
Andrea's Store	600	\$650.00
Sandra's Store	540	\$550.00
Cynthia's Store	480	\$530.00
Janet's Store	400	\$450.00

Which store has the lowest price per millilitre?

- a) Andrea's Store
- b) Sandra's Store
- c) Cynthia's Store
- d) Janet's Store

Question #8

Nicole is taking two types of medicine.

- She takes one medicine every 6 hours.
- She takes the other medicine every 4 hours.
- She takes both medicines at 9:00 a.m.

At what time will Nicole take both medicines together again?

- a) 1 : 00 p.m.
- b) 3 : 00 p.m.
- c) 7 : 00 p.m.
- d) 9 : 00 p.m.

Question #9

Jacqueline is 164 centimetres tall. How many metres tall is Jacqueline?

- a) 16 400
- b) 1 640
- c) 16.4
- d) 1.64

Grade 6 Mathematics Curriculum Based Test – Sample Items – 2022

Question #10

Jackie will draw a rectangle with an area of 25 square centimetres. Which set of measurements can Jackie use?

- a) length = 6.25 centimetres, width = 6.25 centimetres
- b) length = 5.75 centimetres, width = 4.75 centimetres
- c) length = 12.5 centimetres, width = 2 centimetres
- d) length = 12.5 centimetres, width = 12.5 centimetres

Question #11

The Hamilton's want to put outdoor carpet on their porch. The diagram below is a representation of their porch.

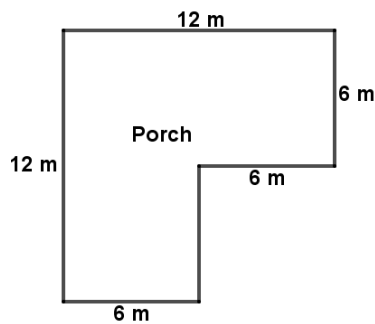

How much carpet will be needed for their porch?

- a) 42 m²
- b) 72 m²
- c) 108 m²
- d) 144 m²

Question #12

The right rectangular prism below is made up of unit cubes

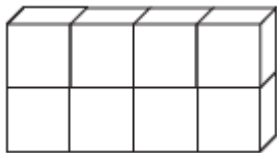

What is the volume of this prism?

- a) 14 cubic centimetres
- b) 8 cubic centimetres
- c) 6 cubic centimetres
- d) 4 cubic centimetres

Grade 6 Mathematics Curriculum Based Test – Sample Items – 2022

Question #13

The shaded area indicates the parking lot at a shopping center.

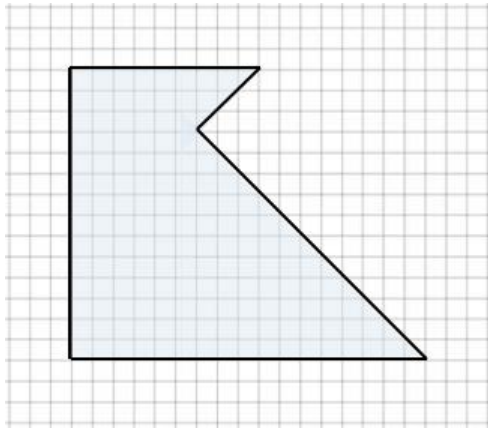

What is the total area of the parking lot?

- a) 84 unit²
- b) 142 unit²
- c) 149 unit²
- d) 238 unit²

Question #14

What is the volume of the right rectangular prism below?

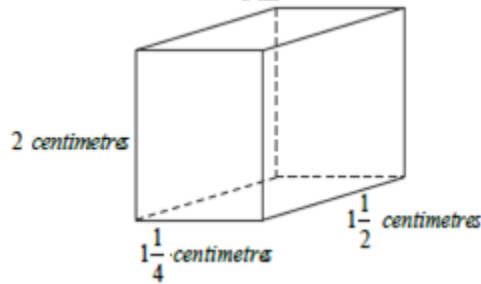

- a) $4\frac{3}{4}$ cubic centimetres
- b) $4\frac{1}{8}$ cubic centimetres
- c) $3\frac{3}{4}$ cubic centimetres
- d) $2\frac{1}{8}$ cubic centimetres

Grade 6 Mathematics Curriculum Based Test – Sample Items – 2022

Question #15

A rectangular prism and its net is shown below.

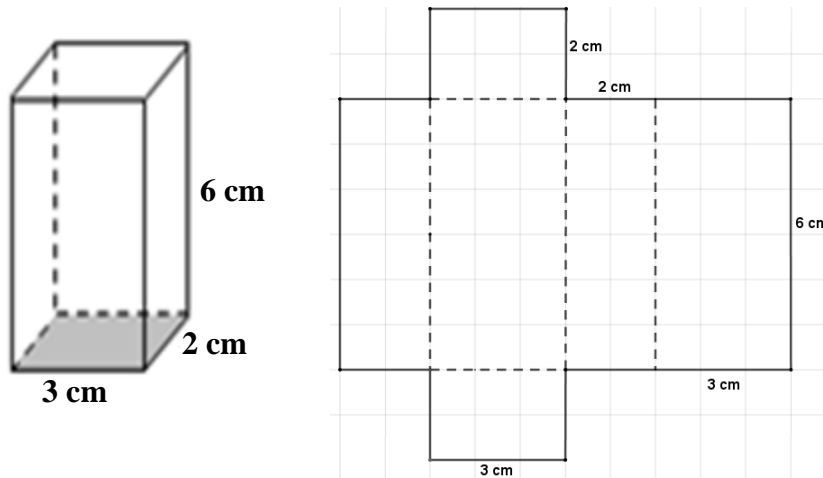

What is the surface area of the prism?

- a) 72 cm^2
- b) 44 cm^2
- c) 40 cm^2
- d) 36 cm^2

Question # 16

Which geometric solid named below has exactly 5 faces, 9 edges and 6 vertices?

- a) Cuboid
- b) Triangular based prism
- c) Pentagonal based pyramid
- d) Triangular based pyramid

Question #17

In the coordinate plane, what is the distance between (3, 1) and (3, 10)?

- a) 0 units
- b) 2 units
- c) 7 units
- d) 9 units

Grade 6 Mathematics Curriculum Based Test – Sample Items – 2022

Question #18

Which point is inside triangle MPQ?

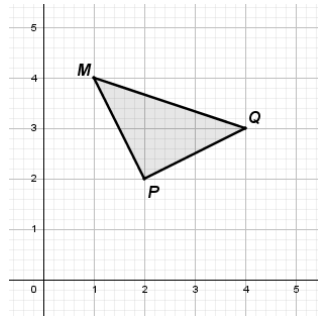

- a) (2, 3)
- b) (3, 2)
- c) (3, 4)
- d) (4, 3)

Question #19

Which diagram represent an object and its image reflected in the line $x = 5$?

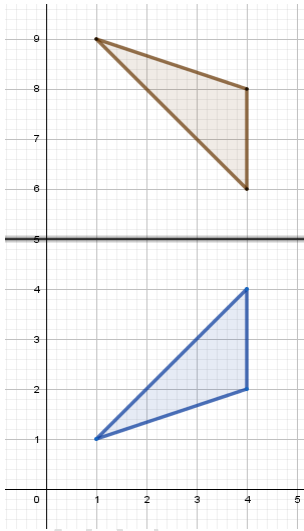

a)

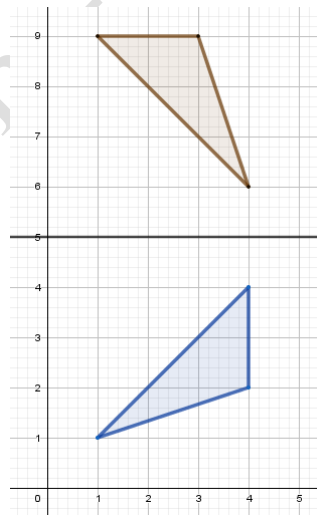

b)

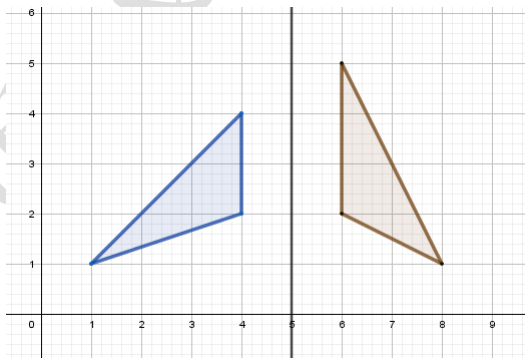

c)

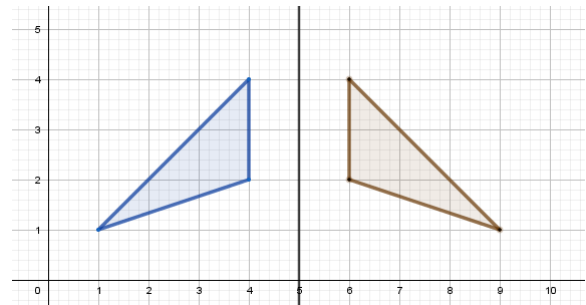

d)

Grade 6 Mathematics Curriculum Based Test – Sample Items – 2022

Question #20



How many lines of symmetry are in the polygon above?

- a) 10
- b) 5
- c) 3
- d) 1

Question #21

Which of the diagrams below represents the net of a triangular prism?

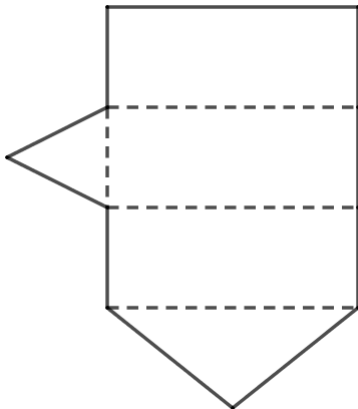

a)

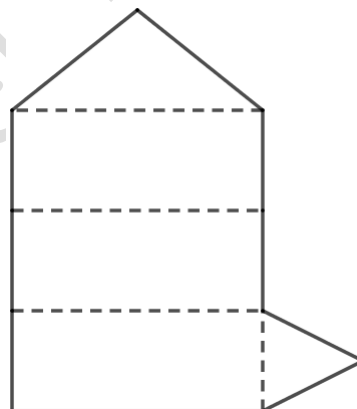

b)

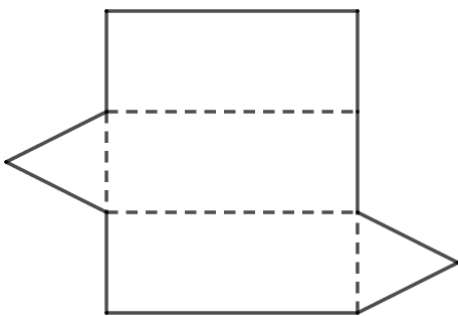

c)

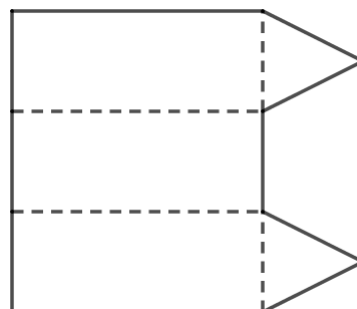

d)

Grade 6 Mathematics Curriculum Based Test – Sample Items – 2022

Question #22

Which can be represented by the expression $17 - 2x$?

- a) 17 less than twice a number x
- b) the difference between 17 and twice a number x
- c) a number x squared, subtracted from 17
- d) 17 less than a number x squared

Question #23

If $m = 32$, what is the value of $3(m + 5)$?

- a) 37
- b) 96
- c) 101
- d) 111

Question #24

Juliet can use the equation $y = 8x + 72$ to calculate her pay, where y represents the amount of pay, and x represents the number of hours worked. How much was Juliet's pay if she worked for 8 hours?

- a) \$64.00
- b) \$88.00
- c) \$136.00
- d) \$160.00

Question #25

Which choice is equivalent to the expression $4(x + 2y)$?

- a) $4x + 8y$
- b) $4x + 2y$
- c) $x + 8y$
- d) $8xy$

Grade 6 Mathematics Curriculum Based Test – Sample Items – 2022

Question #26

Andrea recorded her walking pace in the table below. What equation *best* represents this relationship?

Hours Walked (h)	Kilometres Walked (m)
2.5	8.75
4	14

- a) $h = m + 10$
- b) $h = 3.5m$
- c) $m = h + 10$
- d) $m = 3.5h$

Question #27

The length of a rectangle is 6 units longer than the width, w . Which choice is a correct expression for the sum of the width and the length?

- a) $2w + 6$
- b) $2w + 12$
- c) $4w + 6$
- d) $4w + 12$

Question #28

A baker made 9 cakes using 3 bags of flour. The baker uses the same relationship between cakes made and the number of bags of flour used to make all of their cakes. Which table of values shows the relationship between the number of cakes the baker makes to the number of bags of flour the baker uses.

CAKES BAKED

Cakes	1	2	3	4	5
Bags of Flour	3	6	9	12	15

a)

CAKES BAKED

Cakes	7	8	9	10	11
Bags of Flour	1	2	3	4	5

b)

CAKES BAKED

Cakes	3	6	9	12	15
Bags of Flour	1	2	3	4	5

c)

CAKES BAKED

Cakes	1	2	3	4	5
Bags of Flour	7	8	9	10	11

d)

Grade 6 Mathematics Curriculum Based Test – Sample Items – 2022

Question #29

The data below represents the numbers of books that nine students read.

2, 14, 21, 8, 9, 13, 16, 8, 17

What is the mean number of books read by the nine students?

- a) 8
- b) 12
- c) 13
- d) 19

Question #30

A company that makes boxes finds that 3 out of 20 boxes are damaged. What is the probability that a box is damaged?

- a) $\frac{1}{3}$
- b) $\frac{3}{20}$
- c) $\frac{3}{23}$
- d) $\frac{1}{20}$

Question #31

Katherine earned 84, 92, 84, 75, and 70 on her first 5 tests. What is the minimum grade Katherine needs to earn on the next test to have a mean of 84?

- a) 81
- b) 84
- c) 95
- d) 99

Grade 6 Mathematics Curriculum Based Test – Sample Items – 2022

Question #32

The graph below shows the mode by which 200 students travel to school.

**Pie chart showing mode of travel
students used to get to school.**

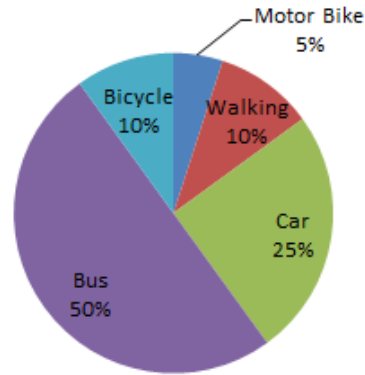

Using the graph, how many more students travelled to school by Cars than Motor Bikes?

- a) 5
- b) 20
- c) 40
- d) 50

Question #33

The diagram shows a Stem and Leaf Plot representing the scores students received on a Language Arts Test marked out of 50.

Stem	Leaf
0	8 9
1	5 7 9
2	2 3 6 6 8 9
3	1 2 4 5 6 8 8 9 9
4	0 3 4 4 7 8
5	0 0

Using the Stem and Leaf Plot, how many students did the Language Arts test?

- a) 6
- b) 9
- c) 25
- d) 28

Grade 6 Mathematics Curriculum Based Test – Sample Items – 2022

Question # 34

A normal die is tossed, what is the probability that a prime number will appear?

- a) $\frac{1}{2}$
- b) $\frac{1}{3}$
- c) $\frac{1}{4}$
- d) $\frac{1}{6}$

Math & Ed. Tech - C.C.U. 2022