

Setup Guide

P-touch PT-P750W

Before using this printer, be sure to read this Setup Guide.

We suggest that you keep this manual in a handy place for future reference.





Introduction

Important Notice

- The contents of this document and the specifications of this product are subject to change without notice.
- Brother reserves the right to make changes without notice in the specifications and materials contained herein and shall not be responsible for any damages (including consequential) caused by reliance on the materials presented, including but not limited to typographical and other errors relating to the publications.
- Screen images in this document may differ depending on your computer's operating system.
- Before using the P-touch labeler, be sure to read all documents included with the P-touch labeler for information about safety and proper operation.

Symbols used in this Guide

The following symbols are used throughout this guide.

 WARNING	Tells you what to do to avoid the risk of injury.
 CAUTION	Tells you about procedures you must follow to avoid minor personal injury or damage to the P-touch labeler.
 Important	Indicates information or directions that should be followed. Ignoring them may result in damage, or failed operations.
 Note	Indicates notes that provide information or directions that can help you better understand and use the product more efficiently.

Trademarks and Copyrights

BROTHER is either a trademark or a registered trademark of Brother Industries, Ltd.

P-TOUCH is a trademark or registered trademark of Brother Industries, Ltd.

© 2014 Brother Industries, Ltd. All rights reserved.

Microsoft, Windows Vista, Windows Server and Windows are either registered trademarks or trademarks of Microsoft Corp. in the United States and/or other countries.

Apple, Macintosh, Mac OS are trademarks of Apple Inc., registered in the United States and other countries.

Android is a trademark of Google Inc.

Google Play is a trademark of Google Inc.

Wi-Fi and Wi-Fi Alliance are registered trademarks of the Wi-Fi Alliance.

WPA, WPA2, Wi-Fi Protected Setup, Wi-Fi Protected Setup logo and Wi-Fi Direct are trademarks of the Wi-Fi Alliance.

IOS is a trademark or registered trademark of Cisco in the U.S. and other countries and is used under license.

The names of other software or products used in this document are trademarks or registered trademarks of the respective companies that developed them.

Each company whose software title is mentioned in this manual has a Software License Agreement specific to its proprietary programs.

Any trade names and product names of companies appearing on Brother products, related documents and any other materials are all trademarks or registered trademarks of those respective companies.

Table of Contents

1	Wireless Network Connection Methods	1
	Confirm Your Network Environment	1
2	Printing from Computers	2
	Available Applications for Use with Computers	2
	Installing P-touch Editor and the Printer Driver	4
	When Printing via a USB Connection	4
	When Printing via a Wireless Network Connection	4
	Establishing a Wireless Network Connection	5
	Using WPS (Wi-Fi Protected Setup™)	5
	Establishing a Connection in the Infrastructure Mode	6
	Establishing a Connection Using Wireless Direct	7
	Using P-touch Editor	8
	Using P-touch Editor (For Windows®)	8
	Using P-touch Editor (For Macintosh)	11
3	Printing from iOS Devices	14
	Available Applications for Use with iOS Devices	14
	Installing Applications	14
	Connecting the P-touch labeler to Your iOS Device	15
	Printing from Your iOS Device	15
4	Printing from Android™ Devices	16
	Available Applications for Use with Android™ Devices	16
	Installing Applications	16
	Connecting the P-touch labeler to Your Android™ Device	17
	When Your Android™ Device Supports NFC (Near Field Communication)	17
	When Your Android™ Device Does Not Support NFC (Near Field Communication)	18
	Printing from your Android™ device	18
5	Printer Setting Tool (for Windows®)	19
	Using the Communication Settings	19
	Settings Dialog Box	20
	Menu Bar	21
	General Tab	24
	Wireless LAN Tab	26
	Wireless Direct Tab	30
	Applying Setting Changes to Multiple Printers	31
	Using the Device Settings	32
	Menu Bar	34

6	Brother P-touch Utility (for Macintosh)	35
	Using the P-touch Utility	35
	Settings Dialog Box	36
	Basic Tab.....	37
	Print Tab.....	38
	Wireless Direct Tab	39
7	Web Based Management	40
	Overview	40
	Configuring the Printer Settings Using Web Based Management (Web Browser).....	41
8	Printing Labels Distributed to Multiple Printers	42
	Distributed Printing	42
A	Appendix	46
	Routine Maintenance.....	46
	Cleaning the Exterior of Your P-touch Labeler	46
	Cleaning the Print Head and Head Roller	46
	Cleaning the Tape Cutter	48
	Troubleshooting	49

Confirm Your Network Environment

The connection method varies according to your network environment and the type of device that you want to connect. Therefore, confirm your network environment before connecting to the network.

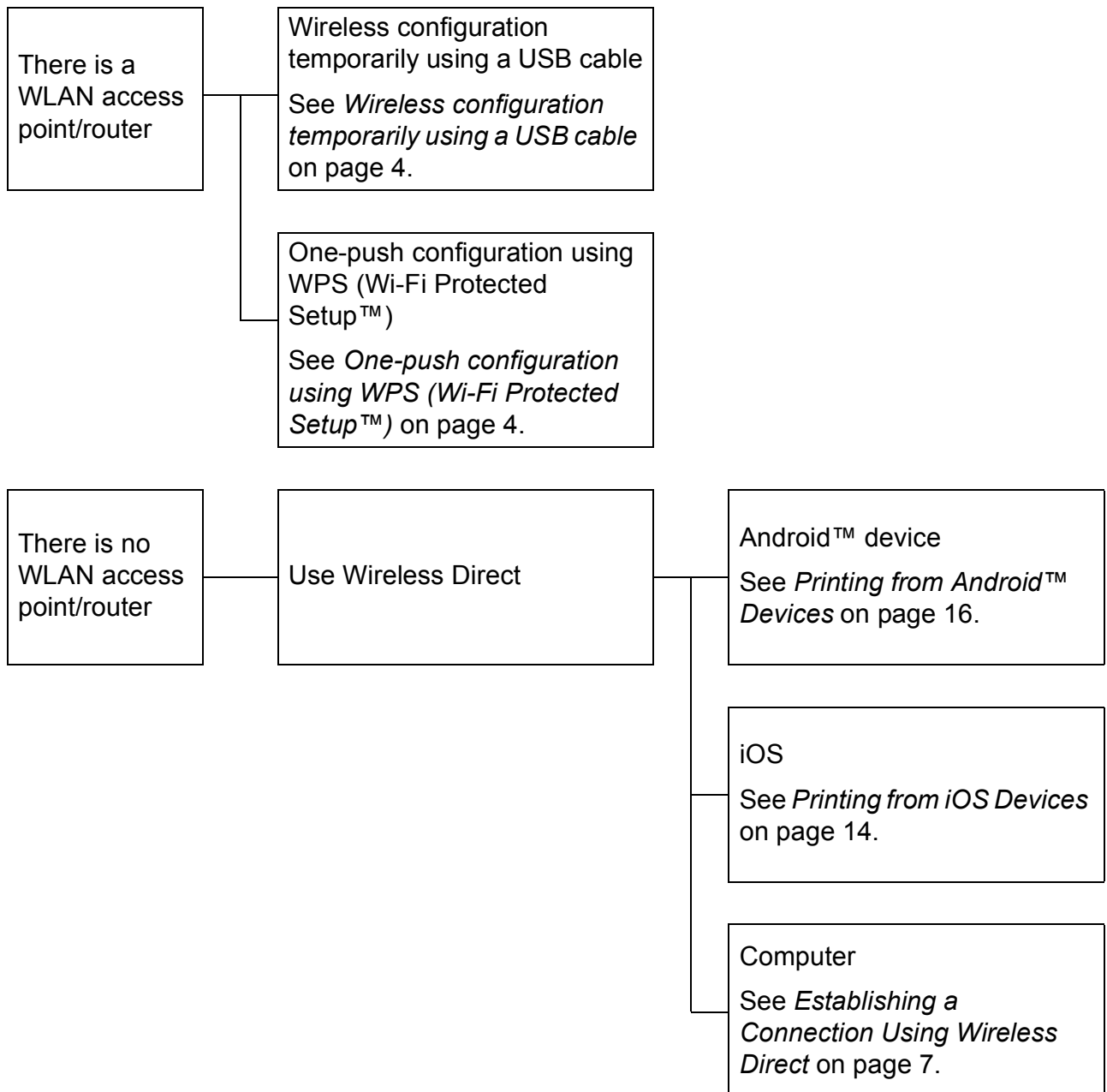

2

Printing from Computers

Available Applications for Use with Computers

In order to use the P-touch labeler effectively, a number of applications and functions are available.

Application	Windows	Macintosh	Features
P-touch Editor Lite	✓	✓	It is not necessary to install a driver or software for P-touch Editor Lite. With P-touch Editor Lite, you can create various simple label layouts quickly and easily. P-touch Editor Lite is only supported when connected using a USB cable.
P-touch Editor	✓	✓	It is necessary to install the driver and P-touch Editor. With P-touch Editor, you can create a wide variety of custom labels in complex layouts by using fonts, templates, and clip art.
P-touch Library	✓		This is installed with P-touch Editor. This application allows you to use your computer to manage P-touch Editor templates and other data. You can use P-touch Library to print templates.
P-touch Update Software	✓	✓	It is necessary to install P-touch Update Software. The software can be upgraded to the latest version.
Printer Setting Tool	✓		This is installed with the printer driver. This application allows you to specify the printer's communication settings and device settings from the computer.
Utility		✓	This is installed with the printer driver. This application allows you to specify the printer's communication settings and device settings from the computer.
Wireless Device Setup Wizard		✓	This application allows you to configure your printer for a wireless network.
BRAdmin Light	✓	✓	This application allows you to configure and manage your network printer from the computer.
BRAdmin Pro	✓		This application allows you to configure and manage your network printer from the computer.

Useful function	Windows	Macintosh	Features
Distributed printing	✓		<p>When printing a large number of labels, printing can be distributed among multiple printers.</p> <p>Since printing is performed at the same time, the total printing time can be reduced.</p> <p>For more information, see <i>Printing Labels Distributed to Multiple Printers</i> on page 42.</p>

For more information, refer to [FAQ's & Troubleshooting] on the Brother Solutions Center (<http://support.brother.com/>).

Installing P-touch Editor and the Printer Driver

When Printing via a USB Connection

To print from your computer, you must install P-touch Editor, the printer driver, and other applications to your computer.

Visit our website described below and download the necessary software. The installation instructions are available on the download page.

- For Windows®: <http://www.brother.com/inst/>
- For Macintosh: The [Downloads] page on the Brother Solutions Center (<http://support.brother.com/>)

When Printing via a Wireless Network Connection



Note

If the P-touch labeler is powered by alkaline or Ni-MH batteries, you cannot establish a wireless network connection. Use the rechargeable Li-ion battery or the AC adapter.

When you want to print via a wireless network connection, it is recommended that you configure the wireless network settings while installing the application.

You can change the wireless network settings later using the Printer Setting Tool. (For Windows® only)

For more information, see *Printer Setting Tool (for Windows®)* on page 19.

The following installation methods are available.

Visit our website described below and download the necessary software. The installation instructions are available on the download page.

- For Windows®: <http://www.brother.com/inst/>
- For Macintosh: The [Downloads] page on the Brother Solutions Center (<http://support.brother.com/>)

Wireless configuration temporarily using a USB cable

It is recommended that you use a computer wirelessly connected to your network for this method.

You can remotely configure the P-touch labeler from the computer on the network using a USB cable.

One-push configuration using WPS (Wi-Fi Protected Setup™)

You can use WPS to configure your wireless network settings quickly, if your WLAN access point/router supports WPS.

Establishing a Wireless Network Connection

This section describes how to configure the wireless network settings and establish a wireless network connection, if you did not configure the wireless network settings during the installation.



Note

If the P-touch labeler is powered by alkaline or Ni-MH batteries, you cannot establish a wireless network connection. Use the rechargeable Li-ion battery or the AC adapter.

Using WPS (Wi-Fi Protected Setup™)

If your WLAN access point/router supports WPS (Wi-Fi Protected Setup™), settings and connections can be configured easily with the press of a button.

- 1 First, confirm that your WLAN access point/router has the WPS symbol.



- 2 Press and hold the Wireless Mode button on the P-touch labeler for more than 5 seconds. After the Wi-Fi lamp starts flashing in 0.5 second intervals, release the button.
- 3 Press the WPS button on your WLAN access point/router.
- 4 When the connection is established, the Wi-Fi lamp is lit.



Note

The printer will try to connect using WPS for 2 minutes. If the Wireless Mode button is pressed and held for 5 seconds during that time, the printer will continue trying to connect for an additional 2 minutes starting from that point.

Establishing a Connection in the Infrastructure Mode

■ For Windows

- 1 Confirm the SSID (network name) and password of your WLAN access point/router beforehand.
- 2 Connect the printer and computer with a USB cable.
- 3 If the Wi-Fi lamp is not lit, press and hold the Wireless Mode button for one second to turn on the wireless LAN function. After the Wi-Fi lamp is lit, release the button. The Wi-Fi lamp flashes.
- 4 Start the Printer Setting Tool on your computer, and click [Communication settings] button.
For details on the Printer Setting Tool, see *Printer Setting Tool (for Windows®)* on page 19.
- 5 In [Wireless Settings] in the [Wireless LAN] tab, confirm that [Communication Mode] is set to [Infrastructure].
- 6 Enter the SSID that you have noted, or click [Search] and select the SSID from the displayed list.
- 7 Enter the password as [Passphrase].



Note

Information to be entered varies depending on the authentication method and encryption mode. Enter necessary information for your network environment.

- 8 Click [Apply].
- 9 When the connection is established, the Wi-Fi lamp is lit.



Note

If you want to change any other network settings, use the Communication settings.
For details on the Communication settings, see *Using the Communication Settings* on page 19.

■ For Macintosh

Use the Wireless Device Setup Wizard, which you can download from the [Downloads] page on the Brother Solutions Center (<http://support.brother.com/>).



Note

If you use the Ad-hoc mode, refer to [FAQ's & Troubleshooting] on the Brother Solutions Center (<http://support.brother.com/>).

Establishing a Connection Using Wireless Direct

Using this method, the P-touch labeler also serves as a wireless network access point.

- 1 Connect the P-touch labeler and computer with a USB cable.
- 2 If the Wi-Fi lamp is not lit, press and hold the Wireless Mode button for one second to turn on the wireless LAN function.
After the Wi-Fi lamp is lit, release the button. The Wi-Fi lamp flashes.
- 3 **For Windows®**
Start the Printer Setting Tool on your computer, and click the [Communication settings] button. Confirm that the [Enable Wireless Direct when Wireless LAN is turned on] checkbox is selected in the [General] tab of the Communication settings.
(This is selected as the factory default.)
See *Using the Communication Settings* on page 19 for details on the Communication settings.
For Macintosh
Start the P-touch Utility with your computer, and confirm that [Wireless Direct] is set to [ON] in the [Wireless Direct] tab.
See *Brother P-touch Utility (for Macintosh)* on page 35 for details on the P-touch Utility.
- 4 In the Wi-Fi settings screen of your computer, select the SSID of the P-touch labeler and enter the password.
- 5 When the connection is established, the NFC lamp is lit.



Note

- The factory default SSID and password are as follows:
SSID: "DIRECT-brPT-P750W****" where "****" is the last four digits of the product serial number.
(You can find the serial number label by opening the cassette cover.)
Password (Network key): 00000000
 - If you want to print the SSID and password, press the Wireless Mode button twice.
(Use 0.94" (24 mm) tape.)
 - You cannot connect to the Internet via a wireless network while using Wireless Direct. If you want to use the Internet, use a wired connection.
-

Using P-touch Editor

You will need to install P-touch Editor and the printer driver to use your P-touch labeler with your computer.

To download the latest driver and software, please visit the Brother Solutions Center at: <http://support.brother.com/>

When printing via a USB connection, check that the Editor Lite lamp is not lit. If the Editor Lite lamp is lit, press and hold down the Editor Lite button until the lamp goes off.

Using P-touch Editor (For Windows®)

Starting P-touch Editor

- 1 For Windows Vista® / Windows® 7 / Windows Server® 2008/2008 R2**
From the Start button, click [All Programs]-[Brother P-touch]-[P-touch Editor 5.1].
When P-touch Editor starts, select whether you want to create a new layout or open an existing layout.

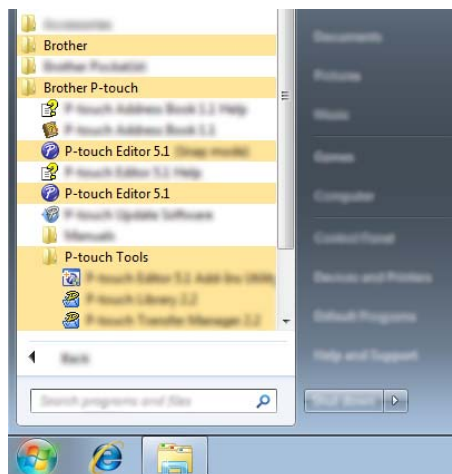

For Windows® 8/ Windows® 8.1 / Windows Server® 2012/2012 R2

Click [P-touch Editor 5.1] on [Apps] screen or double-click [P-touch Editor 5.1] on the desktop.

When P-touch Editor starts, select whether you want to create a new layout or open an existing layout.

Note

- You can also start P-touch Editor using shortcuts, if you chose to create shortcuts during installation.
 - Shortcut icon on the desktop: double-click to start P-touch Editor
 - Shortcut icon in the Quick Launch bar: click to start P-touch Editor
- To change how P-touch Editor functions when it starts, click [Tools]-[Options] in the P-touch Editor menu bar to display the [Options] dialog box. On the left side, select the [General] heading and then the desired setting in the [Operations] list box under [Startup Settings]. The default setting is [Display New View].

2 Select an option in the screen.

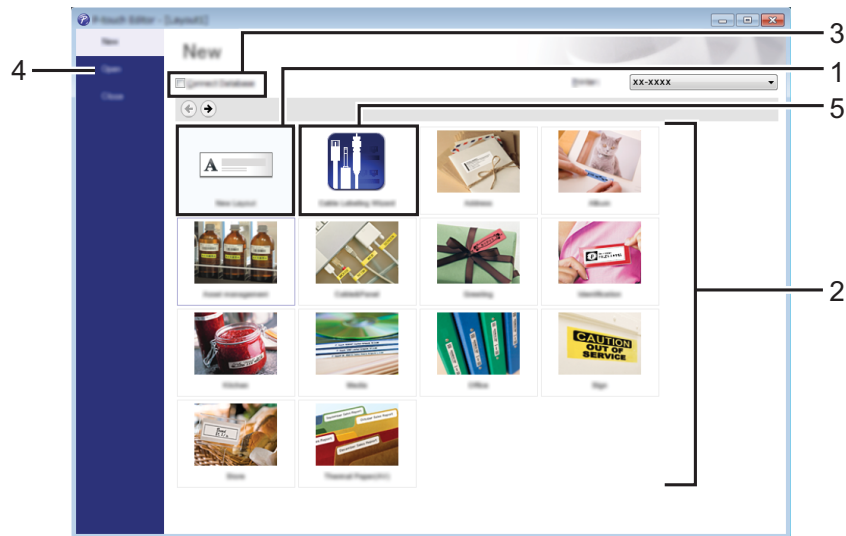

- 1 To create a new layout, click the [New Layout] button.
- 2 To create a new layout using a pre-set layout, select the desired category button.
- 3 To connect a pre-set layout to a database, select the check box next to [Connect Database].
- 4 To open an existing layout, click [Open].
- 5 To open the application for easily creating labels for electrical equipment management, click the [Cable Labeling Wizard] button.

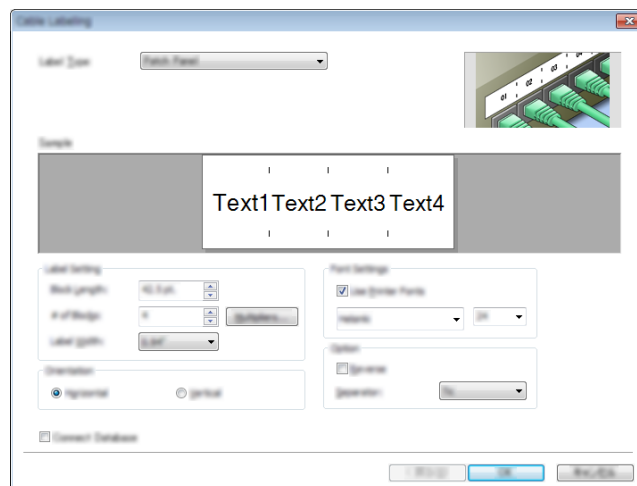

Printing with P-touch Editor

Express mode

This mode allows you to quickly and easily create layouts that include text and images.

The [Express] mode screen is explained below:

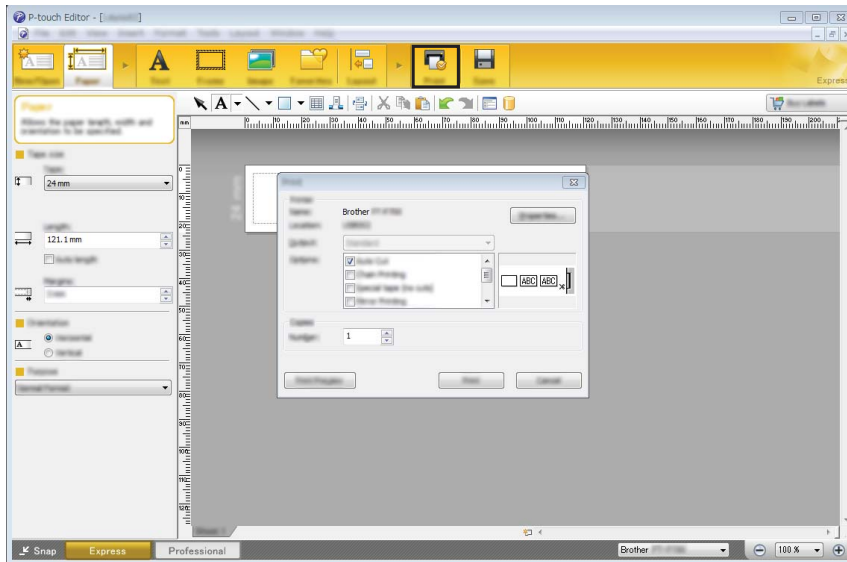

You can print by selecting [Print] from [File] in the menu bar or by clicking the [Print] icon. (Configure the printing settings in the [Print] screen before printing.)

Professional mode

This mode allows you to create layouts using a wide-range of advanced tools and options.

The [Professional] mode screen is explained below:

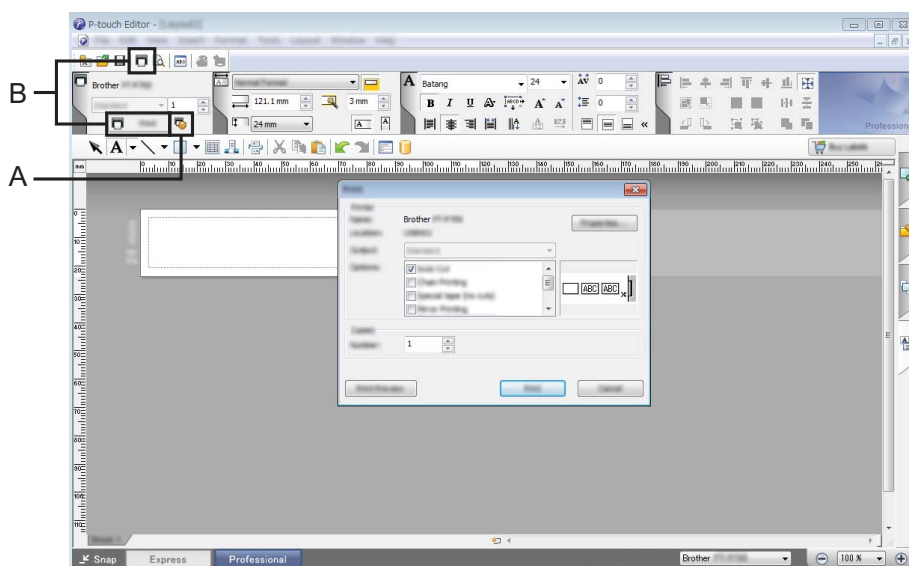

You can print by selecting [Print] from [File] in the menu bar or by clicking the [Print] icon (A). Configure the printing settings in the [Print] screen before printing.

In addition, you can select "B" to start printing without selecting the printing settings.

Snap mode

This mode allows you to capture all or a portion of your computer screen content, print it as an image, and save it for future use.

- 1 Click the [Snap] mode selection button.
The [Description of Snap mode] dialog box is displayed.

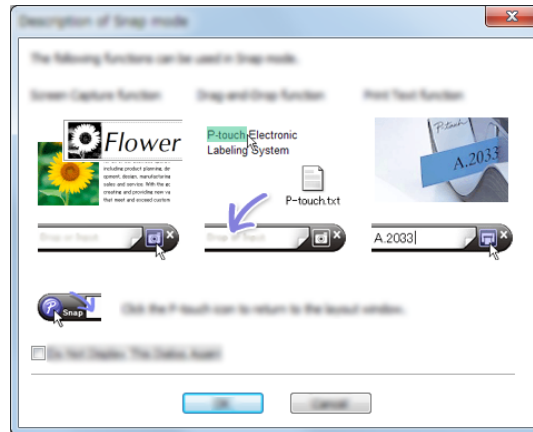

- 2 Click [OK].
The [Snap] mode palette is displayed.



Using P-touch Editor (For Macintosh)

Starting P-touch Editor

- 1 Double-click the [P-touch Editor] icon on the desktop.



Note

The following method can also be used to start P-touch Editor.
Double-click [Macintosh HD] - [Applications] - [P-touch Editor] and then the [P-touch Editor] application icon.

P-touch Editor starts.

If a message is displayed instructing you to choose the CUPS printer driver

When printing, a message may be displayed instructing you to choose the CUPS printer driver depending on the version of your OS. If this occurs, choose the CUPS printer driver using the following procedure.

- 1 Choose the Apple Menu - [System Preferences] – [Print & Scan] or [Printers & Scanners].
- 2 Choose your Brother printer in the [Printers] section.

- 3 Verify which printer driver is used. This can be found next to [Kind].
If “(Model name) - Air Print” is displayed in [Kind], the Air Print printer driver is chosen. The Air Print printer driver does not support P-touch Editor, so you should add the CUPS printer driver.
- 4 Click the [+] button.

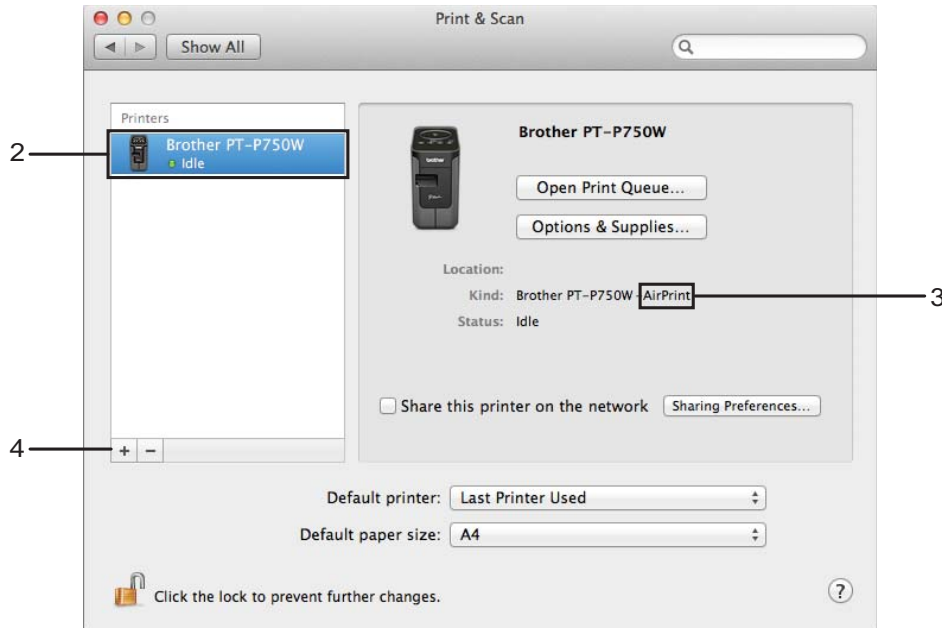

- 5 Click the [Default] icon which is located at the top of the dialog box.
- 6 Choose your machine from the [Name] list.
- 7 Make sure that “Brother XXXXXX CUPS” is selected in the [Use] list.
(Where XXXXXX is your model name.)

 **Note**

If you cannot find “Brother XXXXXX CUPS”, the CUPS printer driver is not installed. Go to the [Downloads] page on the Brother Solutions Center (<http://support.brother.com/>) to download and install the latest CUPS printer driver.

- Click [Add].

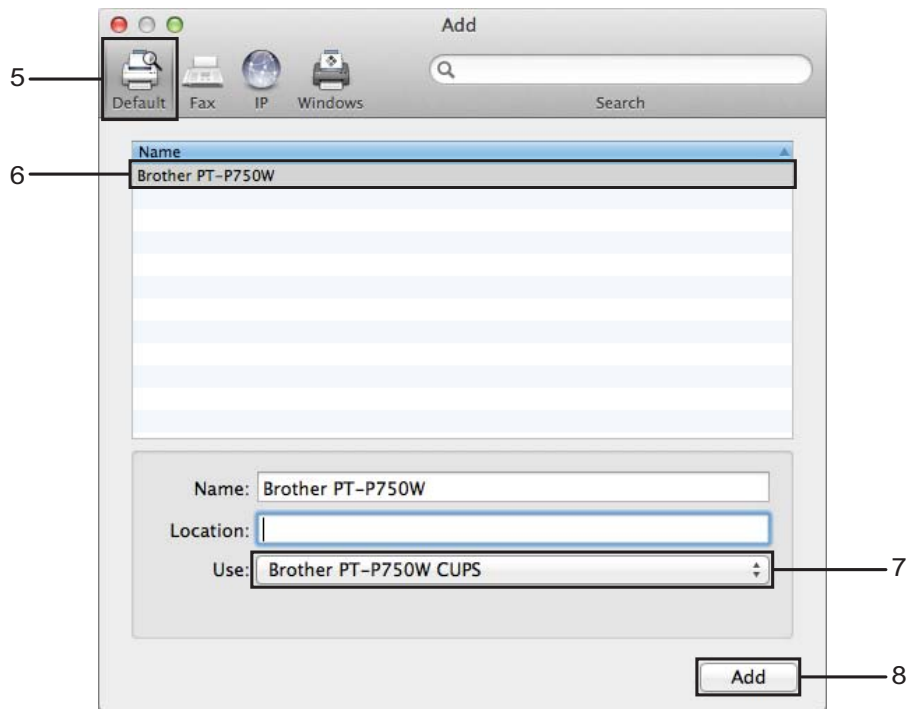

- The printer is now available in the [Printers] section. Choose [Quit System Preferences] from the Apple Menu.

3

Printing from iOS Devices

Available Applications for Use with iOS Devices

Application	Features
iPrint&Label	This application allows you to print directly to your label printer from your Apple iPhone, iPad, and iPod touch.
Mobile Cable Label Tool (Scheduled to be available in August 2014)	This application allows you to print directly to your label printer from your Apple iPhone, iPad, and iPod touch. You can print various cable labels.

For more information, refer to [FAQ's & Troubleshooting] on the Brother Solutions Center (<http://support.brother.com/>).

SDK

A software development kit (SDK) is available. Visit the Brother Developer Center (<http://www.brother.com/product/dev/index.htm>).

Installing Applications

The Brother applications for iOS devices can be downloaded free-of-charge from the App Store.

Connecting the P-touch labeler to Your iOS Device

- 1 Connect the P-touch labeler and computer with a USB cable.
- 2 If the Wi-Fi lamp is not lit, press and hold the Wireless Mode button for one second to turn on the wireless LAN function.
After the Wi-Fi lamp is lit, release the button. The Wi-Fi lamp flashes.
- 3 **For Windows®**
Start the Printer Setting Tool on your computer, and click the [Communication settings] button. Confirm that the [Enable Wireless Direct when Wireless LAN is turned on] checkbox is selected in the [General] tab of the Communication settings.
(This is selected as the factory default.)
See *Using the Communication Settings* on page 19 for details on the Communication settings.
For Macintosh
Start the P-touch Utility with your computer, and confirm that [Wireless Direct] is set to [ON] in the [Wireless Direct] tab.
See *Brother P-touch Utility (for Macintosh)* on page 35 for details on the P-touch Utility.
- 4 In the Wi-Fi settings screen of your iOS device, select the SSID of the P-touch labeler and enter the password.



Note

- The factory default SSID and password are as follows:
SSID: "DIRECT-brPT-P750W****" where "****" is the last four digits of the product serial number.
(You can find the serial number label by opening the cassette cover.)
Password (Network key): 00000000
- If you want to print the SSID and password, press the Wireless Mode button twice.
(Use 0.94" (24 mm) tape.)
- You can also connect the P-touch labeler to an iOS device in the infrastructure mode via a WLAN access point/router.

Printing from Your iOS Device

- 1 Start one of the Brother applications for mobile devices with your iOS device.
(See *Available Applications for Use with iOS Devices* on page 14.)
- 2 After editing the data you want to print, tap [Print].

4

Printing from Android™ Devices

Available Applications for Use with Android™ Devices

Application	Features
iPrint&Label	This application allows you to print directly to your label printer from your Android™ device.
Mobile Cable Label Tool	This application allows you to print directly to your label printer from your Android™ device. You can print various cable labels.

For more information, refer to [FAQ's & Troubleshooting] on the Brother Solutions Center (<http://support.brother.com/>).

SDK

A software development kit (SDK) is available. Visit the Brother Developer Center (<http://www.brother.com/product/dev/index.htm>).

Installing Applications

The Brother applications for Android™ devices can be downloaded free-of-charge from Google Play™.

Connecting the P-touch labeler to Your Android™ Device

Use Wireless Direct to connect the P-touch labeler to your Android™ device. The P-touch labeler serves also as a wireless network access point.

When Your Android™ Device Supports NFC (Near Field Communication)

- 1 If the Wi-Fi lamp is not lit, press and hold the Wireless Mode button for one second to turn on the wireless LAN function.
After the Wi-Fi lamp is lit, release the button. The Wi-Fi lamp flashes.
- 2 **For Windows®**
Start the Printer Setting Tool on your computer, and click the [Communication settings] button. Confirm that the [Enable Wireless Direct when Wireless LAN is turned on] checkbox is selected in the [General] tab of the Communication settings.
(This is selected as the factory default.)
See *Using the Communication Settings* on page 19 for details on the Communication settings.
For Macintosh
Start the P-touch Utility with your computer, and confirm that [Wireless Direct] is set to [ON] in the [Wireless Direct] tab.
See *Brother P-touch Utility (for Macintosh)* on page 35 for details on the P-touch Utility.
- 3 Activate the NFC function of your Android™ device, and touch it to the NFC mark on the P-touch labeler.

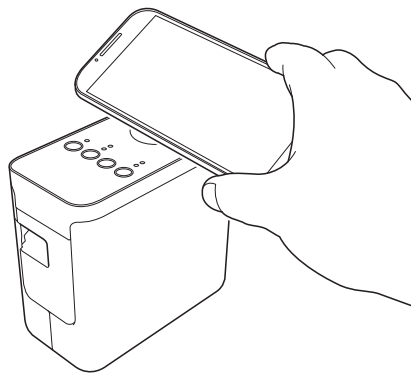

Note

If a dedicated application is not installed on your device, the Google Play homepage will be displayed on the device.

If this occurs, install a dedicated application, and then continue the procedure from step 3. See *Available Applications for Use with Android™ Devices* on page 16.

- 4 When your Android™ device is detected, the NFC lamp on the P-touch labeler goes off for a moment and then is lit again.

When Your Android™ Device Does Not Support NFC (Near Field Communication)

- 1 If the Wi-Fi lamp is not lit, press and hold the Wireless Mode button for one second to turn on the wireless LAN function.
After the Wi-Fi lamp is lit, release the button. The Wi-Fi lamp flashes.
- 2 **For Windows®**
Start the Printer Setting Tool on your computer, and click the [Communication settings] button. Confirm that the [Enable Wireless Direct when Wireless LAN is turned on] checkbox is selected in the [General] tab of the Communication settings.
(This is selected as the factory default.)
See *Using the Communication Settings* on page 19 for details on the Communication settings.
For Macintosh
Start the P-touch Utility with your computer, and confirm that [Wireless Direct] is set to [ON] in the [Wireless Direct] tab.
See *Brother P-touch Utility (for Macintosh)* on page 35 for details on the P-touch Utility.
- 3 Start one of the Brother applications for mobile devices with your Android™ device and tap .
(See *Available Applications for Use with Android™ Devices* on page 16.)
Select a printer from the displayed list.

Note

- The factory default SSID and password are as follows:
SSID: "DIRECT-brPT-P750W****" where "****" is the last four digits of the product serial number.
(You can find the serial number label by opening the cassette cover.)
Password (Network key): 00000000
- If you changed the password using the Communication settings, you must enter it after selecting the printer.
- If you want to print the SSID and password, press the Wireless Mode button twice.
(Use 0.94" (24 mm) tape.)
- You can also connect the P-touch labeler to an Android™ device in the infrastructure mode via a WLAN access point/router.

Printing from your Android™ device

- 1 Start one of the Brother applications for mobile devices with your Android™ device.
(See *Available Applications for Use with Android™ Devices* on page 16.)
- 2 After editing the data you want to print, tap [Print].

By using the Printer Setting Tool, the printer's communication settings and device settings can be specified from the computer.



Note

The Printer Setting Tool is installed at the same time as other software such as the printer driver.

Using the Communication Settings

With [Communication settings] in the Printer Setting Tool, the printer communication information can be specified or changed when connecting the printer and computer with a USB cable. Not only can you change the communication settings for one printer, but you can also easily apply the same settings to multiple printers.

! Important

- Before connecting the USB cable to the computer, check that the Editor Lite lamp is not lit. If the Editor Lite lamp is lit, press and hold down the Editor Lite button until the lamp goes off.
- Make sure that the AC adapter is connected to an AC power outlet.
- Make sure that the printer driver has been installed and is functional.
- Connect this printer to a computer with a USB cable.
With this tool, settings cannot be specified using a wireless LAN connection.

1 Connect the P-touch labeler to the computer.

2 **For Windows Vista® / Windows® 7 / Windows Server® 2008/2008 R2**
From the Start menu, click [All Programs] - [Brother] - [Label & Mobile Printer] - [Printer Setting Tool].

For Windows® 8 / Windows® 8.1 / Windows Server® 2012/2012 R2
On the [Apps] screen, click [Printer Setting Tool].

The main window appears.

- 3 Select the P-touch labeler to be configured from the [Printer] drop-down list and then click [Communication settings]. The [Communication settings] window appears.
- 4 Specify or change the settings.

Settings Dialog Box

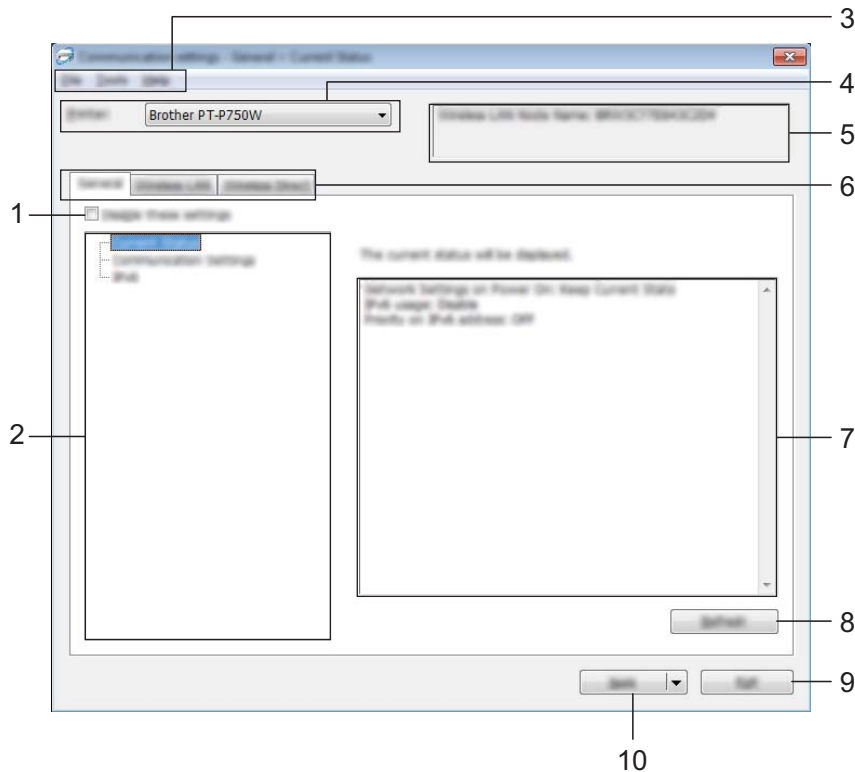

1 Disable these settings

When this check box is selected,  appears in the tab, and the settings can no longer be specified or changed.

The settings in a tab where  appears will not be applied to the printer even if [Apply] is clicked. In addition, the settings in the tab will not be saved or exported when the [Save in Command File] or [Export] command is executed.

To apply, save or export the settings to the printer, be sure to clear the check box.

2 Items

When [Current Status] is selected, the current settings appear in the settings display/change area. Select the item for the settings that you want to change.

3 Menu Bar

Select a command contained in each menu from the list. For details on the menu bar, see *Menu Bar* on page 21.

4 Printer

Selects the printer whose settings are to be changed.

If only one printer is connected, it is unnecessary to make a selection since only that printer will appear.

5 Node Name

Displays the node name. The node name can also be changed. (See *Tools menu* on page 23)

6 Settings Tabs

Click the tab containing the settings to be specified or changed.

If  appears in the tab, the settings in that tab will not be applied to the printer.

7 Settings Display/Change Area

Displays the current settings for the selected item. Change the settings as necessary using the drop-down menus, direct entry or other appropriate methods.

8 Refresh

Click to update the displayed settings with the most recent information.

9 Exit

Exits [Communication settings], and returns to the main window of the [Printer Setting Tool].

! Important

Settings are not applied to printers if the [Exit] button is clicked without clicking the [Apply] button after changing settings.

10 Apply

Click [Apply] to apply the settings to the printer.

To save the specified settings in a command file, select [Save in Command File] from the drop-down menu.

! Important

Clicking [Apply] applies all settings in all tabs to the printer.

If the [Disable these settings] check box is selected, the settings in that tab are not applied.

Menu Bar**File menu**

- **Apply Settings to the Printer**

Applies the settings to the printer.

**Note**

If the [Disable these settings] check box is selected, the settings in that tab are not saved.

- **Save Settings in Command File**

Saves the specified settings in a command file.

The file extension is “.bin”.

Important

- If the [Disable these settings] check box is selected, the settings in that tab are not saved.
- The following information is not saved with the settings commands.
 - Node name
 - IP address, subnet mask and default gateway (when the IP address is set to [STATIC])
- The saved communication settings commands are only intended to be used for applying settings to a printer. The settings cannot be applied by importing this command file.
- Saved command files contain authentication keys and passwords. Take necessary measures to protect saved command files, such as by saving them in a location that cannot be accessed by other users.
- Do not send the command file to a printer whose model was not specified when the command file was exported.

■ Import

- Import from the current computer wireless settings
Imports the settings from the computer.



Note

- Only personal security authentication settings (open system, public key authentication and WPA/WPA2-PSK) can be imported. Enterprise security authentication (such as LEAP and EAP-FAST) and WPA2-PSK (TKIP) settings cannot be imported.
- If multiple wireless LANs are enabled for the computer being used, the first wireless settings (only personal settings) that are detected will be considered for the import data.
- Only settings (communication mode, SSID, authentication method, encryption mode and authentication key) from the [Wireless LAN] tab - [Wireless Settings] pane can be imported.

- Select a Profile to import

Imports the exported file and applies the settings to a printer.

Click [Browse] to display a dialog box for browsing for the file. Select the file to be imported.

The settings in the selected file appear in the settings display/change area.



Note

- All settings, such as wireless settings or TCP/IP settings, can be imported. However, node names cannot be imported.
- Only profiles that are compatible with the selected printer can be imported.
- If the imported profile's IP address is set to [STATIC], change the IP address of the imported profile, if necessary, so that it does not duplicate the IP address of an existing printer on the network whose settings have been completed.

■ Export

Saves the current settings in a file.



Note

If the [Disable these settings] check box is selected, the settings in that tab are not saved.



Important

Exported files are not encrypted.

Tools menu

■ Option Settings

- **Automatically restart the printer after applying new settings.**

If this check box is selected, the printer automatically restarts after communication settings are applied.

If this check box is cleared, printers must be manually restarted.



Note

When configuring multiple printers, you can reduce the time required to change settings by clearing this check box. In this case, we recommend selecting this check box when configuring the first printer so that you can confirm that each setting is operating as intended.

- **Automatically detects the connected printer, and retrieves the current settings.**

If this check box is selected and a printer is connected to the computer, the printer is automatically detected and the printer's current settings are displayed in the [Current Status] page.



Note

If the model of the connected printer is different than that of the printer shown in the [Printer] drop-down list, the settings available on all tabs will change to match the connected printer.

■ Change Node Name

Allows each node name to be changed.

■ Reset to Default Communication Settings

Returns the communication settings to their factory defaults.

Help menu

■ Display Help

Displays the Help.

■ About

Displays the version information.

General Tab

Communication settings

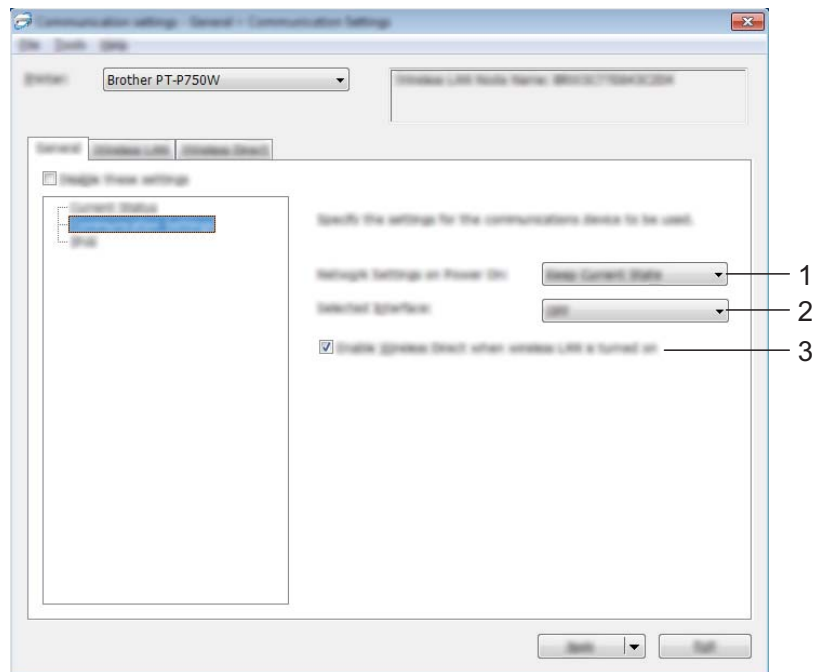

1 Network Settings on Power On

Determines the conditions for connecting via Wireless LAN when the printer is turned on. Select [Wireless LAN by Default], [Off by default] or [Keep Current State].

2 Selected Interface

Select [OFF] or [Wireless LAN].

3 Enable Wireless Direct when Wireless LAN is turned on

Select when you want to use Wireless Direct.

IPv6

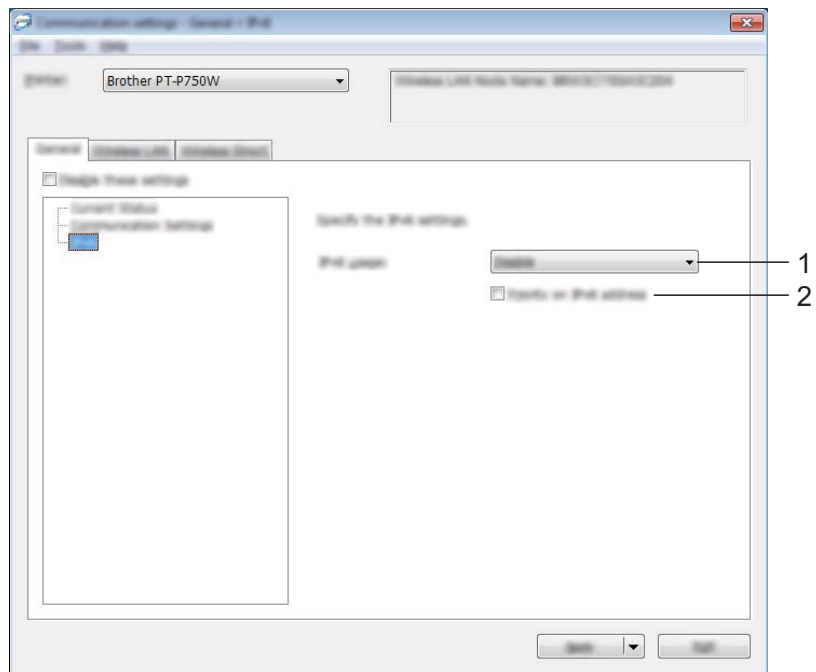

1 IPv6 Usage

Select [Enable] or [Disable].

2 Priority on IPv6 address

Select to give priority to an IPv6 addresses.

Wireless LAN Tab

TCP/IP (Wireless)

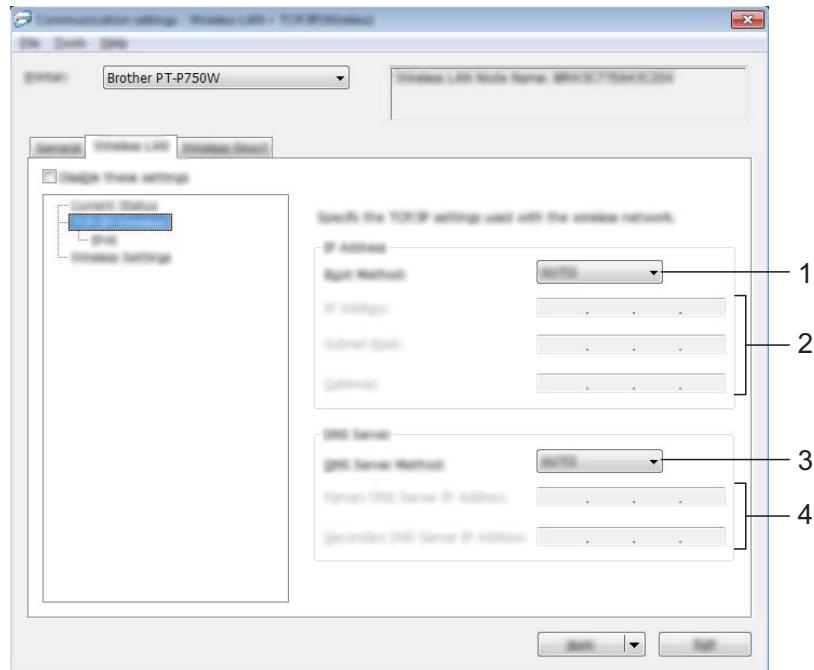

1 Boot Method

Select [STATIC], [AUTO], [BOOTP], [DHCP] or [RARP].

2 IP Address/Subnet Mask/Gateway

Specify the various values.

You can only enter settings when the IP address is set to [STATIC].

3 DNS Server Method

Select [STATIC] or [AUTO].

4 Primary DNS Server IP Address/Secondary DNS Server IP Address

You can only enter settings when the DNS server is set to [STATIC].

IPv6

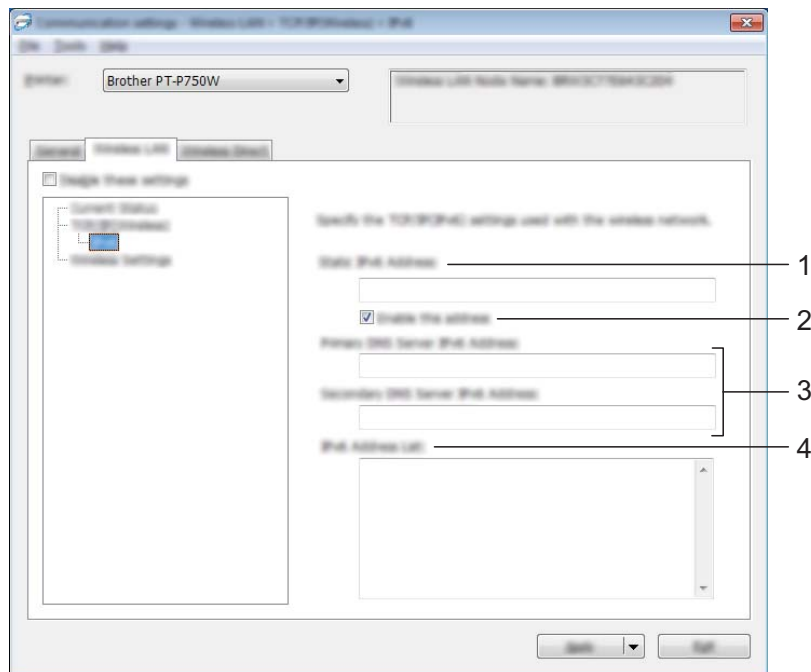

- 1 Static IPv6 Address**
Specify the value.
- 2 Enable this address**
Select to make the specified static IPv6 address effective.
- 3 Primary DNS Server IPv6 Address/Secondary DNS Server IPv6 Address**
Specify the values.
- 4 IPv6 Address List**
Displays the list of IPv6 addresses.

Wireless Settings

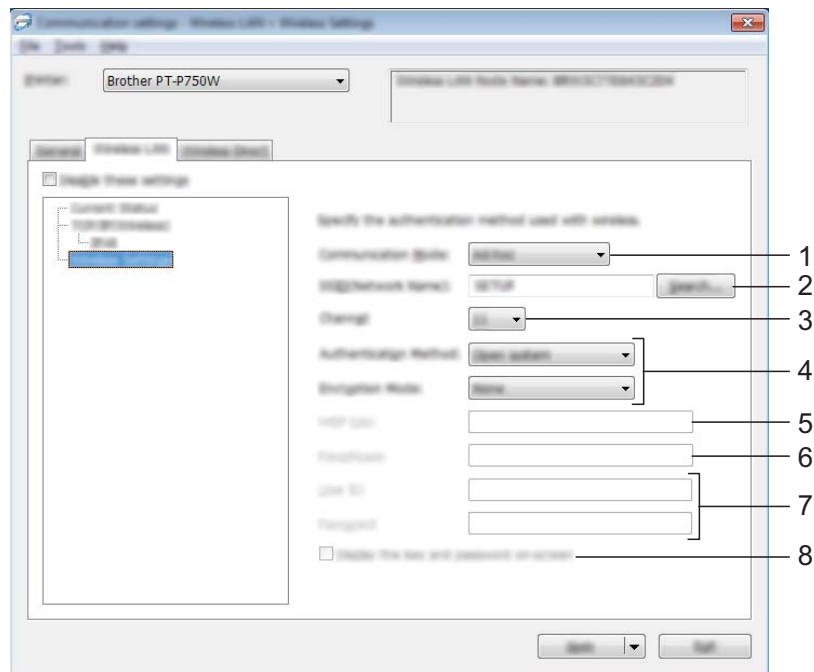

1 Communication Mode

Select [Ad-hoc] or [Infrastructure].

2 SSID (Network Name)

Click the [Search] button to display the SSID selections in a separate dialog box.

3 Channel

Select from the displayed options.

4 Authentication Method/Encryption Mode

The supported encryption modes for the various authentication methods are as shown in *Communication Modes and Authentication Methods/Encryption Modes* on page 29.

5 WEP Key

You can only specify a setting when WEP is selected as the encryption mode.

6 Passphrase

You can only specify a setting when WPA2-PSK, or WPA/WPA2-PSK is selected as the authentication method.

7 User ID/Password

You can only specify settings when LEAP, EAP-FAST, EAP-TTLS or EAP-TLS is selected as the authentication method. In addition, with EAP-TLS, it is not necessary to register a password, but a client certificate must be registered. To register a certificate, connect to the printer from a web browser, and then specify the certificate. For details on using a web browser, see *Web Based Management* on page 40.

8 Display the key and password on-screen

If this check box is selected, keys and passwords will be displayed in plain text (non-encrypted text).

Communication Modes and Authentication Methods/Encryption Modes

- When [Communication Mode] is set to [Ad-hoc]

Authentication Method	Encryption Mode
Open System	None / WEP

- When [Communication Mode] is set to [Infrastructure]

Authentication Method	Encryption Mode
Open System	None / WEP
Shared Key	WEP
WPA2-PSK	AES
WPA/WPA2-PSK	TKIP+AES / AES
LEAP	CKIP
EAP-FAST/NONE	TKIP / AES
EAP-FAST/MS-CHAPv2	TKIP / AES
EAP-FAST/GTC	TKIP / AES
PEAP/MS-CHAPv2	TKIP / AES
PEAP/GTC	TKIP / AES
EAP-TTLS/CHAP	TKIP / AES
EAP-TTLS/MS-CHAP	TKIP / AES
EAP-TTLS/MS-CHAPv2	TKIP / AES
EAP-TTLS/PAP	TKIP / AES
EAP-TLS	TKIP / AES

! Important

To perform higher level security settings:

When performing certificate verification with EAP-FAST, PEAP, EAP-TTLS or EAP-TLS authentication methods, the certificate cannot be specified from the [Printer Setting Tool]. After the printer is configured to connect to the network, specify the certificate by accessing the printer from a web browser.

For details on using a web browser, see *Web Based Management* on page 40.

Wireless Direct Tab

Wireless Direct Settings

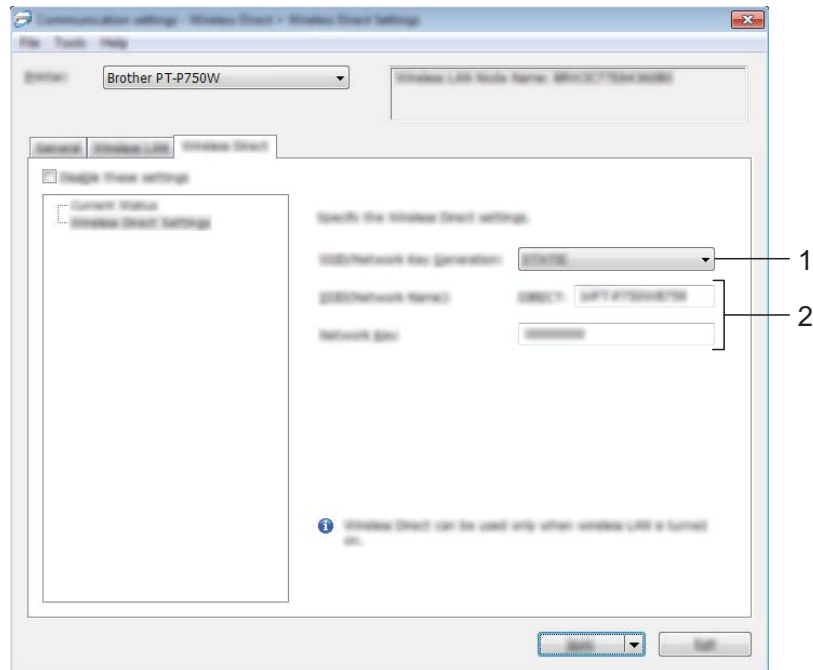

1 SSID/Network Key Generation

Select [AUTO] or [STATIC].

2 SSID (Network Name)/Network Key

Enter the SSID (25 ASCII characters or less) and the network key (63 characters or less) to be used in the Wireless Direct mode.

You can only specify a setting when [STATIC] is selected as the [SSID/Network Key Generation].

Applying Setting Changes to Multiple Printers

- 1 After applying settings to the first printer, disconnect the printer from the computer, and then connect the second printer to the computer.
- 2 Select the newly connected printer from the [Printer] drop-down box.



Note

If the [Automatically detects the connected printer, and retrieves the current settings.] check box in the [Option Settings] dialog box is selected, the printer connected with the USB cable is automatically selected.

For details, see *File menu* on page 21.

- 3 Click the [Apply] button.
The same settings that were applied to the first printer are applied to the second printer.



Note

If the [Automatically restart the printer after applying new settings.] check box is cleared, the printers will not be restarted after the settings are changed, reducing the time required to configure the printers. However, we recommend selecting the [Automatically restart the printer after applying new settings.] check box when configuring the first printer so that you can confirm that a connection with the access point can be correctly established with the settings. For details, see *File menu* on page 21.

- 4 Repeat steps 1 - 3 for all the printers whose settings you wish to change.



Important

If the IP address is set to [STATIC], the printer's IP address will also be changed to the same address as the first printer.

Change the IP address if necessary.



Note

To save the current settings in a file, click [File] - [Export].

The same settings can be applied to another printer by clicking [File] - [Import], then selecting the exported settings file. (See *File menu* on page 21.)

Using the Device Settings

Use [Device settings] in the Printer Setting Tool to change the printer's default settings.

! Important

- Before connecting the USB cable to the computer, check that the Editor Lite lamp is not lit. If the Editor Lite lamp is lit, press and hold down the Editor Lite button until the lamp goes off.
- Make sure that the AC adapter is connected to an AC power outlet.
- Make sure that the printer driver has been installed and is functional.
- Connect this printer to a computer with a USB cable.
With this tool, settings cannot be specified using a wireless LAN connection.

1 Connect the P-touch labeler to be configured to the computer.

2 **For Windows Vista® / Windows® 7 / Windows Server® 2008/2008 R2**
From the Start menu, click [All Programs] - [Brother] - [Label & Mobile Printer] - [Printer Setting Tool].

For Windows® 8 / Windows® 8.1 / Windows Server® 2012/2012 R2

On the [Apps] screen, click [Printer Setting Tool].

The main window appears.

3 Select the P-touch labeler to be configured from the [Printer] drop-down list and then click [Device settings]. The [Device settings] window appears.

4 Specify or change the settings.

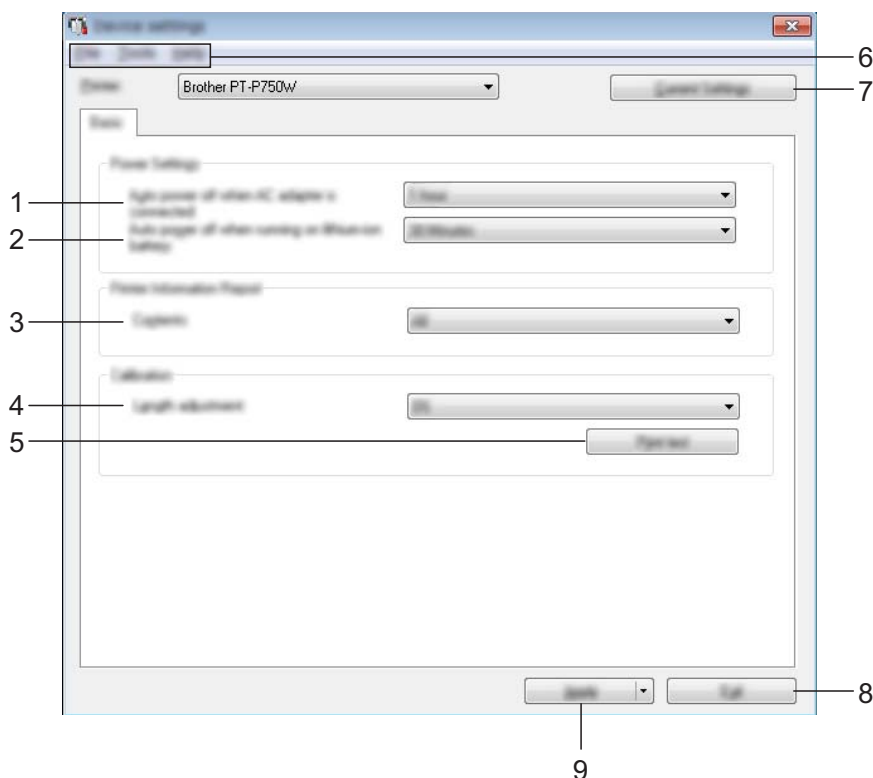

1 Auto power off when AC adapter is connected

Specify the amount of time that passes before the printer turns off automatically.

Available settings: [None], 10/20/30/40/50 minutes, 1/2/4/8/12 hours

2 Auto power off when running on lithium-ion battery

Specify the amount of time that passes before the printer turns off automatically.

Available settings: [None], 10/20/30/40/50 minutes, 1 hour

3 Contents

Specifies the printer information that will be printed.

Available settings: [All], [Usage Log], [Printer Settings]

4 Length adjustment

Adjusts the length of the printed label to correspond to the length of the label displayed on the computer.

Available settings: -3% to +3% (1% increments)

5 Print test

Prints a test label to check the length adjustment results.

6 Menu Bar

Select a command contained in each menu from the list.

For details on the menu bar, see *Menu Bar* on page 34.

7 Current Settings

Click this button to retrieve the settings from the currently connected printer and display them in the dialog box.

8 Exit

Exits [Communication settings], and returns to the main window of the [Printer Setting Tool].

9 Apply

Click [Apply] to apply the settings to the printer.

To save the specified settings in a command file, select [Save in Command File] from the drop-down menu.

- 5** After changing the settings, click [Apply] - [Exit], and then click [Exit] in the main window to finish specifying settings.

Menu Bar

File menu

- **Apply Settings to the Printer**

Applies the settings to the printer. Performs the same operation as when the [Apply] button is clicked.

- **Save Settings in Command File**

Saves the specified settings in a command file. The file extension is ".bin".

The saved command file can be used with the BRAdmin utility to apply the settings to a machine.

- **Import**

Imports the exported file and applies the settings to this tool.

- **Export**

Saves the current settings in a file.

Tool menu

- **Print Information Report**

Prints the printer information.

- **Reset to Factory Defaults**

Returns all printer settings to their factory defaults.

- **Option Settings**

If the [Do not display an error message if the current settings cannot be retrieved at startup.] check box is selected, a message will not be displayed next time.

Brother P-touch Utility (for Macintosh)

By using the P-touch Utility, the printer's communication settings and device settings can be specified from the Macintosh computer when connecting the printer and computer with a USB cable.



Note

The P-touch Utility is installed at the same time as other software such as the printer driver.

Important

- Before connecting the USB cable to the computer, check that the Editor Lite lamp is not lit. If the Editor Lite lamp is lit, press and hold down the Editor Lite button until the lamp goes off.
- Make sure that the AC adapter is connected to an AC power outlet.
- Make sure that the printer driver has been installed and is functional.
- Connect this printer to a computer with a USB cable.
With this tool, settings cannot be specified using a wireless LAN connection.

Using the P-touch Utility

- 1 Connect the P-touch labeler to the computer.
- 2 Click [Macintosh HD] - [Applications] - [Brother] - [P-touch Utilities] - [Brother P-touch Utility.app].
The [Brother P-touch Utility] window appears.

Settings Dialog Box

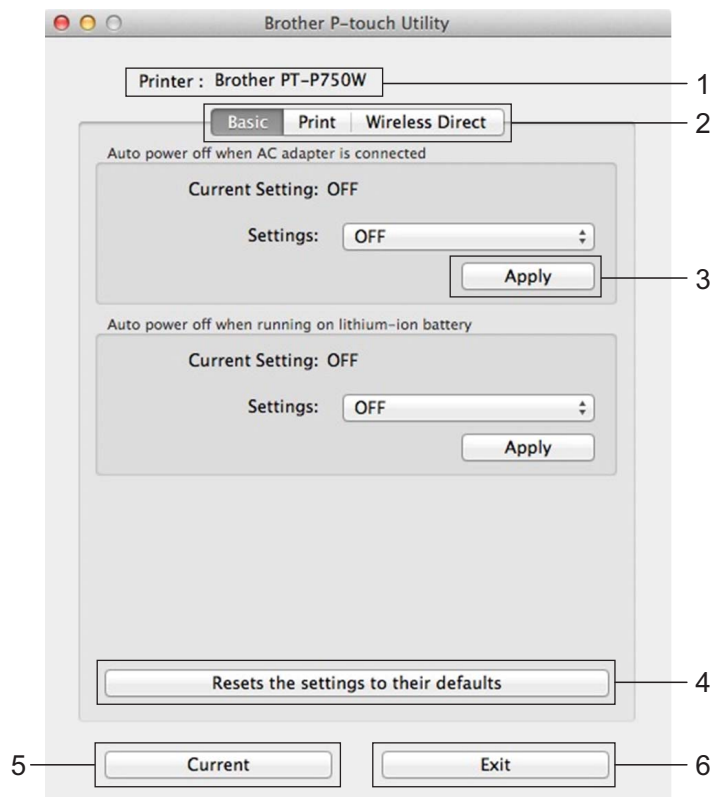

1 Printer

Displays your printer's model name.

2 Setting Tabs

Click the tab containing the settings to be specified or changed.

3 Apply

Sends the setting for each item to the printer.

4 Resets the settings to their defaults

Returns all printer settings to their factory defaults.

5 Current

Retrieves the settings from the currently connected printer and displays them in the dialog box.

6 Exit

Exits the P-touch Utility.

Basic Tab

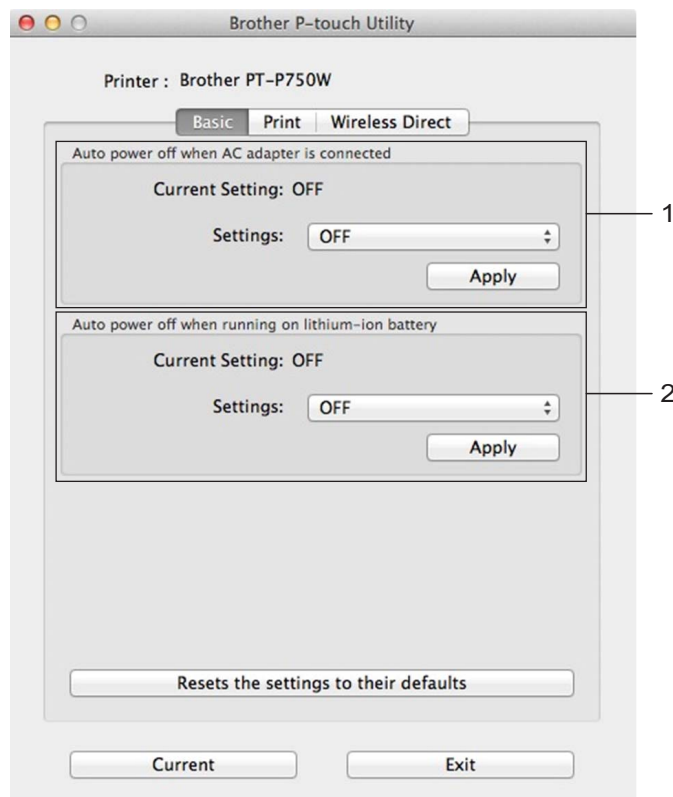

1 Auto power off when AC adapter is connected

Specify the amount of time that passes before the printer turns off automatically.

Available settings: [OFF], 10/20/30/40/50 minutes, 1/2/4/8/12 hours

2 Auto power off when running on lithium-ion battery

Specify the amount of time that passes before the printer turns off automatically.

Available settings: [OFF], 10/20/30/40/50/60 minutes

Print Tab

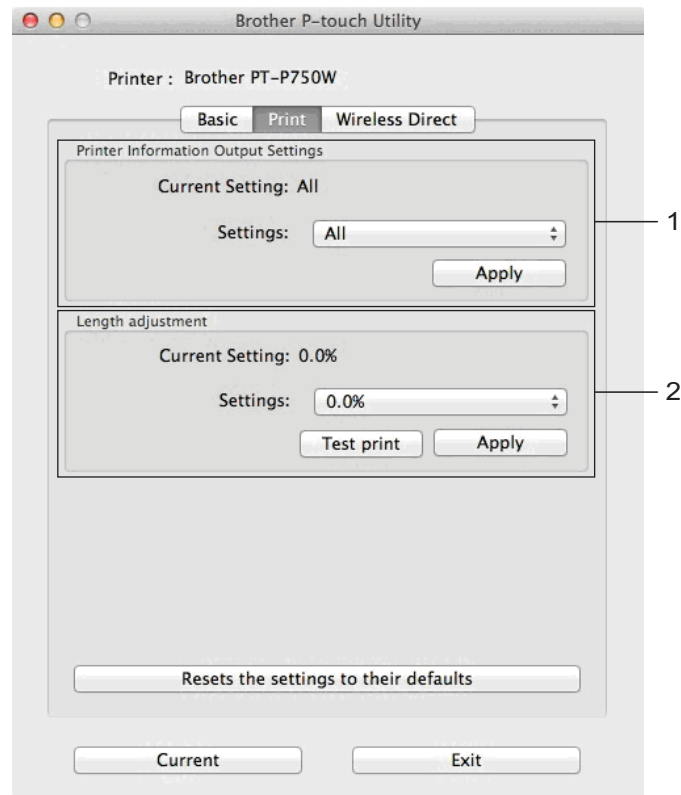

1 Printer Information Output Settings

Specifies the items that will be printed as the printer information.

Available settings:

[All] Prints all of the information included in the usage log and device settings.

[Usage Log] Prints the program version information, missing dot test pattern, printer usage history, and error history.

[Printer Settings] Prints program version, device settings information, network settings information, PDL information.

2 Length adjustment

Adjusts the length of the printed label to correspond to the length of the label displayed on the computer.

Available settings: -3% to +3% (1% increments)

Click [Test print] to print a test label and check the length adjustment.

Wireless Direct Tab

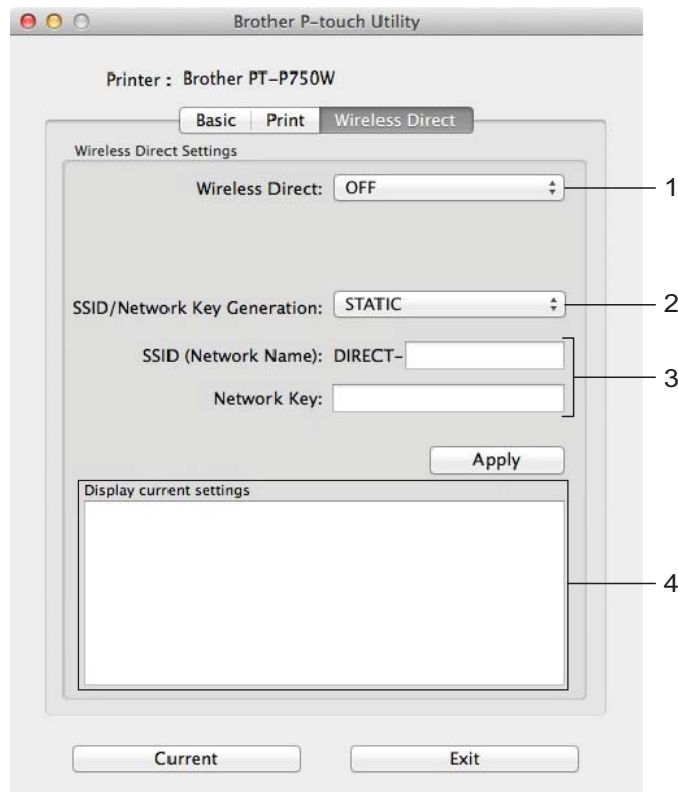

1 Wireless Direct

Turns the Wireless Direct function on or off.

Available settings: [ON], [OFF]

2 SSID/Network Key Generation

Select [AUTO] or [STATIC].

3 SSID (Network Name)/Network Key

Enter the SSID (3 to 25 ASCII characters) and the network key to be used in the Wireless Direct mode. You can only specify a setting when [STATIC] is selected as [SSID/Network Key Generation].

4 Display current settings

Displays the current settings for Wireless Direct. Click the [Current] button to update the displayed settings with the most recent information.

Overview

You can use a standard web browser to manage a printer on your network using HTTP. When using Web Based Management, the following actions are possible:

- Display printer status information
- Change network settings such as TCP/IP information
- Display software version information of the printer and print server
- Change network and printer configuration details



Note

Please make sure that JavaScript and cookies are always enabled in whichever browser you use.

In order to use Web Based Management, your network must use TCP/IP, and the printer and computer must have a valid IP address.

Configuring the Printer Settings Using Web Based Management (Web Browser)

A standard web browser can be used to change your print server settings using the HTTP (Hyper Text Transfer Protocol).

- 1 Type “http://printer_ip_address/” into your browser. (Where “printer_ip_address” is the IP address or the print server name.)
For example (if the printer’s IP address is 192.168.1.2.):
http://192.168.1.2/



Note

If you have edited the hosts file on your computer or are using a Domain Name System, you can also enter the DNS name of the print server. As the print server supports TCP/IP and NetBIOS, you can also enter the NetBIOS name of the print server. The NetBIOS name can be seen on the printer settings page. The NetBIOS name assigned is the first 15 characters of the node name and by default it will appear as “BRWxxxxxxxxxxxx” where “xxxxxxxxxxxx” is the Ethernet address.



- 2 Change the print server settings.



Note

Setting a password:

We recommend setting a login password to prevent unauthorized access to Web Based Management.

- 1 Click [Administrator].
 - 2 Type the password you want to use (up to 32 characters).
 - 3 Re-type the password in the [Confirm new password] box.
 - 4 Click [Submit].
The next time you access Web Based Management, enter a password in the [Login] box, and then click .
- After configuring the settings, logout by clicking .

You can also set a password by clicking [Please configure the password.] on the machine’s web page if you are not setting a login password.

8

Printing Labels Distributed to Multiple Printers

Distributed Printing

When printing a large number of labels, printing can be distributed among multiple printers. Since printing is performed at the same time, the total printing time can be reduced.



- Printing can be distributed to printers connected via a USB connection or wireless network connection.
- The number of pages to be printed is automatically divided among the selected printers. If the specified number of pages cannot be evenly divided among the printers, it will be divided in the order of the printers listed in the dialog box when the print settings are specified in step 4.

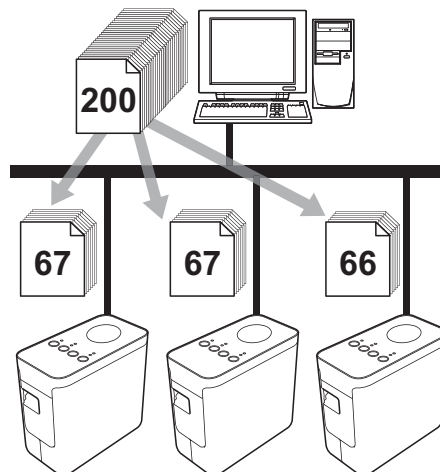

- 1 From the [File] menu in P-touch Editor 5.1, click [Print].
- 2 Click [Properties...].

- 3 Select the [Advanced] tab, select the [Distributed Printing] check box, and then click [Settings].

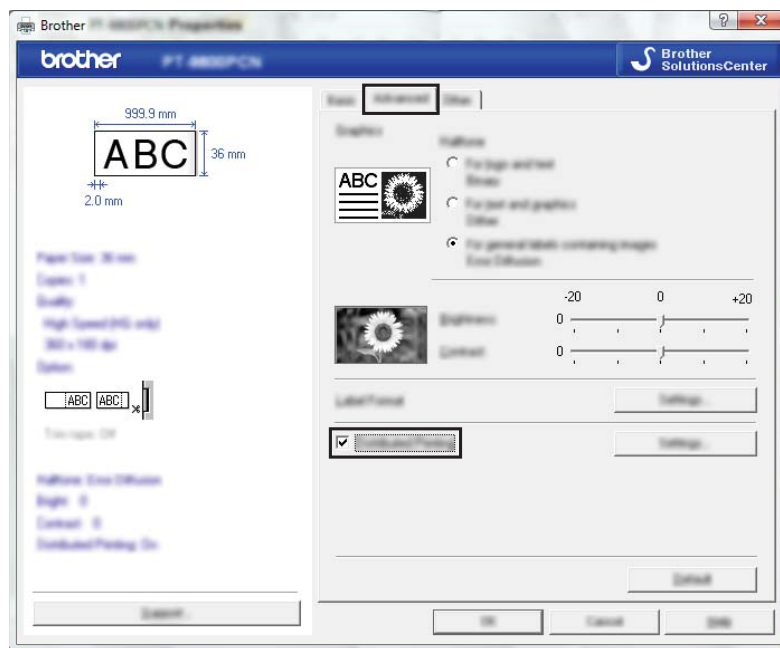

- 4 In the [Distributed Printing Settings] dialog box, select the printers to be used for distributed printing.

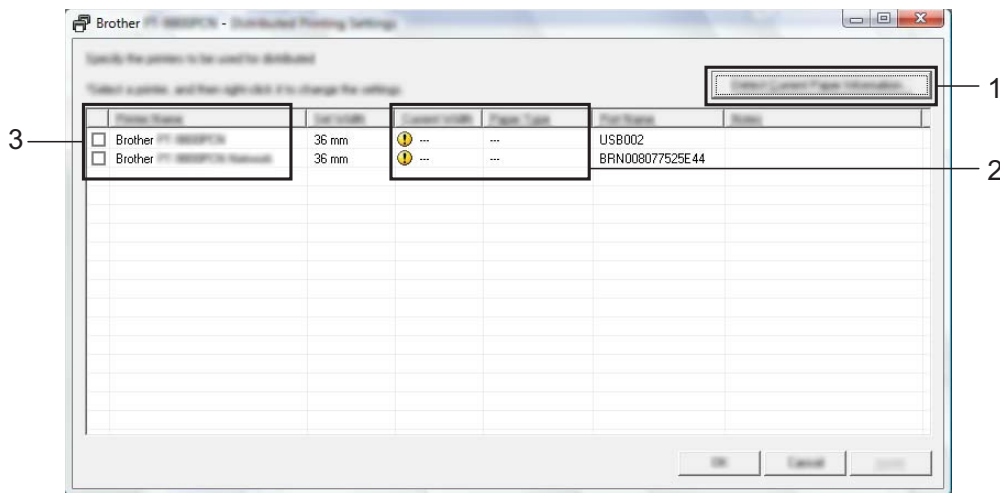

- 1 Click [Detect Current Paper Information...].
- 2 The current printer information that was detected appears below [Current Width] and [Paper Type].
- 3 Select the check box beside the [Printer Name] to be used for distributed printing.

Note

If the selected tape width is different from that displayed beside [Current Width], appears beside the setting below [Current Width]. Load the printer with tape of the width specified [Set Width].

- 5 Specify the tape width to be used for printing.

A. If only one printer has been selected

In the dialog box from step 4, select the printer whose setting is to be specified, and then either double-click it or right-click it and click [Settings]. From the [Set Width] drop-down list, select the tape width.



Note

Information to be displayed in the dialog box from step 4 can be entered in the [Notes] text box.

B. If multiple printers have been selected

In the dialog box from step 4, select the printers whose settings are to be specified, and right-click them and click [Settings]. From the [Set Width] drop-down list, select the tape width. The same tape width setting is applied to all selected printers.

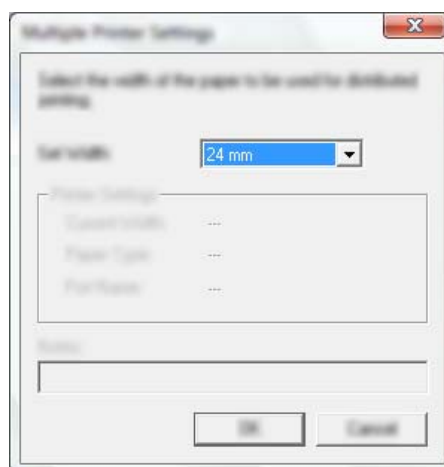

Note

The settings below [Printer Settings] and [Notes] are not available.

- 6 Click [OK] to close the tape width setting window.

- 7 Click [OK] to close the [Distributed Printing Settings] window. Setup is completed.
- 8 Click [OK] to start distributed printing.



Note

- It may not be possible for information to be detected for a printer connected using a USB hub or print server.
Before printing, enter the settings manually, and check if the printer can be used for printing.
 - Depending on whether a router is used and the security features in use, such as a firewall, it may not be possible to use this function.
 - We recommend performing a connection test for your operating environment. For more information, contact a sales representative.
-

A

Appendix

Routine Maintenance

Your P-touch labeler should be cleaned on a regular basis to maintain its performance.



Note

Always disconnect the AC adapter before cleaning your P-touch labeler.

Cleaning the Exterior of Your P-touch Labeler

Wipe any dust and marks from the main unit using a soft, dry cloth.

Use a slightly dampened cloth with water on difficult to remove marks.



Important

Do not use paint thinner, benzene, alcohol or any other organic solvent. These may deform the case or damage the appearance of your P-touch labeler.

Cleaning the Print Head and Head Roller

Streaks or poor quality characters on printed labels generally indicates that the print head and head roller is dirty. Clean the print head using a dry cotton swab or optional print head cleaning cassette (TZe-CL4).



Note

See the instructions provided with the print head cleaning cassette for directions on how to use it.



WARNING

Do not touch the print head directly with your bare hands. The print head may be hot.

■ Print head

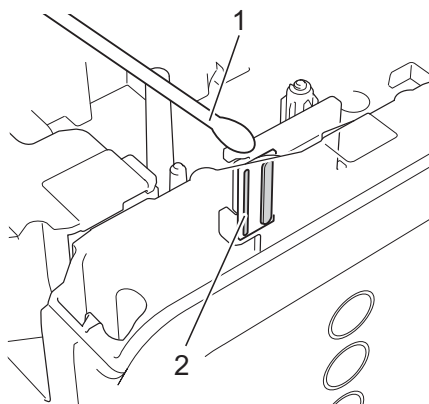

- 1 Cotton swab
- 2 Print head

■ Head roller

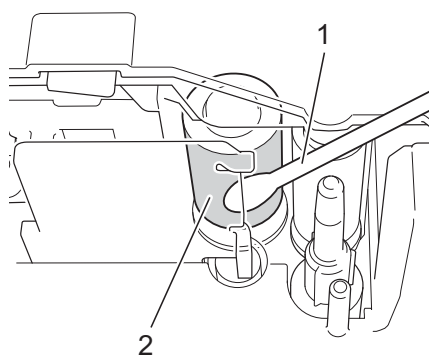

- 1 Cotton swab
- 2 Head roller

Cleaning the Tape Cutter

About once every year, wipe the cutter blades using a cotton swab moistened with ethanol or isopropyl alcohol. Tape adhesive can build up on the cutter blade after repeated use, taking the edge off the blade which may result in the tape jamming in the cutter.

⚠ CAUTION

Do not touch the cutter blade with your finger.

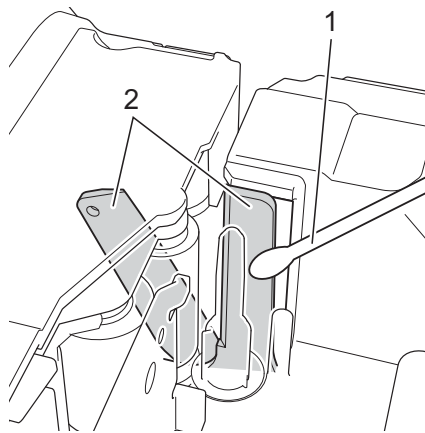

- 1 Cotton swab
- 2 Cutter blades

Troubleshooting

If you think there is a problem with your P-touch labeler, check the chart below and follow the troubleshooting tips.

If you need additional help, the Brother Solutions Center offers the latest FAQs and troubleshooting solutions.

Visit us at <http://support.brother.com/g/d/d5p2/>.

■ Basic Operations

Problem	Solution
After exiting P-touch Editor Lite, how do I restart the program while the P-touch labeler is still on?	<ul style="list-style-type: none"> ■ Disconnect and then reconnect the USB cable while the P-touch labeler is on. ■ (For Windows®) Launch P-touch Editor Lite from [My Computer].
I cannot turn the P-touch labeler on.	Check to see that the batteries are installed correctly, or that the included power adapter is securely connected.
I cannot exit P-touch Editor Lite.	Check to see if an error message is displayed, and try to resolve it. Please note that the software cannot be exited while labels are being printed.
A blank horizontal line appears through the printed label.	<p>Streaks or poor quality characters on printed labels generally indicate that the print head is dirty. Clean the print head using a cotton swab or optional print head cleaning cassette (TZe-CL4). See <i>Cleaning the Print Head and Head Roller</i> on page 46.</p> <p>* Do not touch the print head directly with your bare hands.</p>
The label is difficult to cut.	<p>Clean the cutter blade using a cotton swab. See <i>Cleaning the Tape Cutter</i> on page 48.</p> <p>* Do not touch the cutter blade directly with your bare hands.</p>
When the label is printed out, there is too much margin (space) on both sides of the text. (When using P-touch Editor Lite)	When margins are set to [Large], labels print with approx. 1" (25 mm) margins on each side of the printed text. Reduce this margin by changing the setting to [Small]. In P-touch Editor Lite, right-click the mouse and select [Margins] from the displayed menu. Change the setting to [Small].
The P-touch labeler does not print, or the printed characters are not formed properly.	<ul style="list-style-type: none"> ■ Check that the tape cassette has been inserted correctly. ■ If the tape cassette is empty, replace it. ■ Check the cassette cover is properly closed.
The power turns off when you try to print.	<ul style="list-style-type: none"> ■ The batteries may be weak. Replace them. ■ Check that the batteries are correctly inserted. ■ An incorrect adaptor is being used; the recommended adaptor is the AD-E001.
The tape does not feed properly, or the tape gets stuck inside the P-touch labeler.	<ul style="list-style-type: none"> ■ Check that the end of the tape feeds under the tape guides. ■ The Feed & Cut button was used while printing. Do not touch the Feed & Cut button during printing.

Problem	Solution
I want to reset the P-touch labeler.	With the P-touch labeler off, press and hold the Feed & Cut button while holding down the Power button. When the Editor Lite lamp starts flashing and the Status lamp lights orange, press the Feed & Cut button six times while continuing to hold down the Power button. The P-touch labeler will be reset to the factory settings.
The ink ribbon is separated from the ink roller.	<p>If the ink ribbon is broken, replace the tape cassette. If not, leave the tape uncut and remove the tape cassette, then wind the loose ink ribbon onto the spool as shown in the figure.</p> <div data-bbox="903 633 1098 831" data-label="Image"> <p>The diagram shows a top-down view of a P-touch tape cassette. A hand is shown winding a loose ink ribbon onto a central spool. A leader line with the number '1' points to the spool.</p> </div> <p>1 Spool</p>
The P-touch labeler stops while printing a label.	<ul style="list-style-type: none"> ■ Replace the tape cassette if striped tape is visible, as this indicates that you have reached the end of the tape. ■ Replace all batteries or connect the AC adapter directly to the P-touch labeler. ■ The print head may be too hot. Wait for a while, and then try printing again.
The label is not cut automatically.	Check the option setting in the printer driver. For more information about the cutting options, see the FAQs on the Brother Solutions Center. Alternatively, press the Feed & Cut button to feed and cut the tape.
I want to confirm whether I am using the latest version of the software.	Use the P-touch Update Software provided to confirm whether you are using the latest version of the software. For more information about the P-touch Update Software, see the FAQs on the Brother Solutions Center.

■ Network

First check the following:



The rechargeable Li-ion battery is installed or the AC adapter is connected. You cannot establish a wireless network connection when the P-touch labeler is powered by alkaline or Ni-MH.
The access point (for wireless), router or hub is turned on and its link light is flashing.
All protective packaging has been removed from the P-touch labeler.
The cassette cover is fully closed.
The tape cassette is inserted correctly in the tape cassette compartment.

I cannot complete the wireless network setup configuration.

Question	Solution
Are your security settings (SSID/Network Key) correct?	<p>Reconfirm and choose the correct security settings.</p> <ul style="list-style-type: none"> ■ The manufacturer's name or model number of the WLAN access point/router may be used as the default security settings. ■ See the instructions supplied with your WLAN access point/router for information on how to find the security settings. ■ Ask the manufacturer of your WLAN access point/router or ask your Internet provider or network administrator.
Are you using MAC Address filtering?	<p>Confirm that the MAC Address of the P-touch labeler is allowed in the filter. You can find the MAC Address in [Communication settings] of the Printer Setting Tool. See <i>Using the Communication Settings</i> on page 19 for details about [Communication settings].</p>
Is your WLAN access point/router in stealth mode? (not broadcasting the SSID)	<ul style="list-style-type: none"> ■ You should enter the correct SSID name during the installation or when using [Communication settings] in the Printer Setting Tool. ■ Check the SSID name in the instructions supplied with your WLAN access point/router and reconfigure the wireless network setup.
Is your P-touch labeler correctly connected to the WLAN access point/router?	<p>Check if the Wi-Fi lamp or the NFC lamp is lit.</p>

The P-touch labeler cannot print over the network.

The P-touch labeler is not found on the network even after successful installation.

Question	Solution
Is your P-touch labeler assigned with an available IP address?	<ul style="list-style-type: none"> ■ Confirm the IP address and the Subnet Mask. Verify that both the IP addresses and Subnet Masks of your computer and the P-touch labeler are correct and located on the same network. For more information on how to verify the IP address and the Subnet Mask, ask the network administrator. ■ (Windows®) Confirm your IP address, Subnet Mask and other network settings with [Communication settings] in the Printer Setting Tool. See <i>Using the Communication Settings</i> on page 19 for details about [Communication settings].
Did your previous printing job fail?	<ul style="list-style-type: none"> ■ If the failed printing job is still in your computer's print queue, delete it. ■ Double-click your printer icon in the following folder and then choose [Cancel All Documents] in the [Printer] menu: (Windows Vista®)  , [Control Panel], [Hardware and Sound] and then [Printers]. (Windows Server® 2008)  , [Control Panel] and then [Printers]. (Windows® 7 / Windows Server® 2008 R2)  , [Devices and Printers] and select your printer from [Printers and Faxes]. (Windows® 8 / Windows® 8.1 / Windows Server® 2012/2012 R2) [Apps] screen, [Control Panel], [Hardware and Sound], [Devices and Printers] and select your printer from [Printers and Faxes].
Is your P-touch labeler correctly connected to the WLAN access point/router?	Check if the Wi-Fi lamp or the NFC lamp is lit.
I have checked and tried all the above, however the P-touch labeler does not print. Is there anything else I can do?	Uninstall the printer driver and the software, and then reinstall them.

I want to check that my network devices are working correctly.

Question	Solution
Is your P-touch labeler, access point/router or network hub turned on?	Make sure you have confirmed all instructions in <i>First check the following:</i> on page 51.
Where can I find the P-touch labeler network settings, such as IP address?	Check [Communication settings] in the Printer Setting Tool. See <i>Using the Communication Settings</i> on page 19 for details about [Communication settings].
Is your P-touch labeler correctly connected to the WLAN access point/router?	Check if the Wi-Fi lamp or the NFC lamp is lit.

Others

Question	Solution
I want to reset the P-touch labeler's network settings.	<p>With the P-touch labeler off, press and hold the Feed & Cut button while holding down the Power button. When the Editor Lite lamp starts flashing and the Status lamp lights orange, press the Feed & Cut button twice while continuing to hold down the Power button. The network settings will be reset to the factory settings.</p> <p>To turn off the APIPA setting and reset the network settings, press the Feed & Cut button four times.</p>

brother

Printed in China

LAF797001

