



# OWNER'S MANUAL

## MODEL 695 BOLT ACTION SLUG SHOTGUN

IMPORTANT "SAFETY WARNINGS" — NOTE THE SYMBOL



These safety warnings are for your protection as well as the safety of others. Disregarding information in this manual may result in serious injury or death.



Be certain this owner's manual is available for reference and is kept with this firearm if transferred to another party. If manual is lost or misplaced, write directly to Mossberg for a free replacement copy.



After performing any work on your firearm such as cleaning, adjustments, disassembly or installation of any accessory, the firearm should be re-checked for proper functioning before firing live ammunition.



Firearms are complicated mechanisms. Any modification, alteration, or improper fitting of parts may result in a dangerous malfunction, damage to the firearm and injury to the shooter and other persons. The firearm's owner must accept full responsibility for the correct reassembly and functioning of the firearm after any disassembly or replacement of parts.



If you do not understand any of the material in this manual or have any questions, contact a qualified gunsmith or: O.F. Mossberg & Sons, Inc., directly.



Do not attempt to load or use any firearm until you read and understand the information contained in its owner's manual. Before handling your firearm, you should learn how it operates and how to maintain it. This includes knowing its basic parts, how the manual safety and other safety features operate, how to safely open and close the action and how to safely load and unload ammunition from the firearm. Improper use and handling is dangerous and could cause serious injury or death to you or those around you. All users of the firearm must become thoroughly familiar with the instructions in this manual.

---

### O.F. MOSSBERG & SONS, INC.

P.O. BOX 497 • 7 GRASSO AVENUE, NORTH HAVEN, CT 06473  
PHONE (800) 363-3555  
[www.mossberg.com](http://www.mossberg.com)

*Safety and safe firearms handling is everyone's responsibility.*



As the owner of a firearm, you must undertake the full-time responsibility of safe firearms handling for your own safety and the safety of those around you:

- Keep all firearms and ammunition out of the reach of children.
- Store your firearms and ammunition separately.
- Never store a loaded firearm.
- Never leave a loaded firearm unattended.
- Never transport a loaded firearm in a vehicle.
- Unload your firearm when you have stopped shooting and when you have to climb a tree, fence, cross a slippery surface or have to transport it in a vehicle.
- Do not load your firearm before you are in a place where it is safe to shoot, and keep your finger off the trigger until you are ready to shoot.
- Never shoot at water, rocks or any hard surfaces. Shots may glance off such surfaces and cause injuries.
- Do not use alcohol or drugs before or while handling firearms.
- Do not touch the trigger while the safety button is being engaged or disengaged.



Always point the muzzle of your firearm in a safe direction, regardless of whether the firearm is loaded or unloaded. You should become thoroughly familiar with the function and operation of this firearm and the instructions supplied with it.



Always treat every firearm as if it were loaded. Give your firearm to someone with the action open (bolt fully rearward) and safety in the “ON” (SAFE) position, after you verify the firearm is unloaded. Insist on the same procedure when receiving a firearm from someone else. Learn the location of all the safety features of your firearm and how they operate.



Wear eye and ear protection when shooting. Shooting without proper ear protection can cause hearing damage. The use of eye protection during any type of shooting is important to protect your vision.

Due to the heavy recoil of a shotgun, maintain an adequate distance between the rear of the scope and your face at all times. Be certain the scope installation does not interfere with access to, or the proper functioning of the safety.



**We specifically disclaim any responsibility for damage or injury whatsoever occurring in connection with, or as a result of, the use of faulty, or non-SAAMI standard or “remanufactured” or hand-loaded (reloaded) ammunition. Additionally, we disclaim any responsibility for damage or injury which results from any modifications or changes that are not a part of the firearm as delivered from the factory.**



Learn to clean your firearm thoroughly and make certain no oil, grease, or other materials are blocking the barrel. Obstructions of any kind can cause damage to the firearm resulting in personal injury.



Practice proper firearm maintenance and safety. Make sure all exposed metal surfaces are coated with a thin film of oil, especially after being exposed to damp weather. (See proper section of this manual for cleaning instructions.) Do not plug barrel or store in a fabric-lined case which will absorb lubricants from the firearms. Before using after storage, follow complete instructions stated in this manual for refamiliarization with the firearm. A thorough inspection and function test should be performed before going into the field. Have your gun periodically checked by a qualified gunsmith.

**A note about the warnings and information contained in this manual:**

We strongly suggest that you check with your local licensed retailer or state police for additional information concerning firearms ownership, or hunting or target shooting rules that may be required by local law or regulation. Since such rules and regulations are subject to change, local authorities are in the best position to advise you on such matters.

**TABLE OF CONTENTS**

	<b>Page</b>
The Mechanical Safety .....	2
Assembly .....	2,3
Loading the Shotgun .....	3,4
Firing the Shotgun .....	4
Unloading the Shotgun .....	4,5
Cleaning and Lubrication .....	5
Function Testing .....	6
Sight Adjustments .....	6,7
Service Instructions .....	8
Warranty Information .....	9
Parts List .....	10
Exploded View .....	11
Notes .....	12,13
<i>The Basic Rules of Safe Firearms Handling</i> .....	Back Cover

Read and understand this entire manual and its safety warnings before firing the shotgun.

## OPERATING INSTRUCTIONS



Remember, a firearm's manual safety is a mechanical device which can never replace safe gun handling practices.



Never rely on any mechanical safety device to prevent the dangers of careless handling or pointing a firearm in an unsafe direction.

### MECHANICAL SAFETY

The safety is located at the rear of the bolt (Fig. 1) and must be manually moved to the desired position by the shooter.

Rotated fully left  
Safety "on"

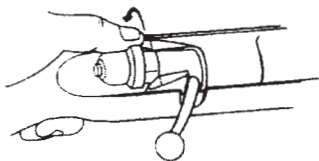

Rotated fully right  
Safety "off"

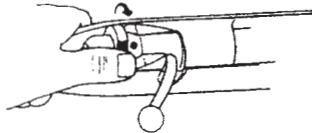

Fig. 1

To put the safety in the "ON" (SAFE) position, rotate safety cap fully to the left (counterclockwise, approximately 1/5 turn). To put the safety in the "OFF" (FIRE) position, rotate safety cap fully to the right (clockwise, approximately 1/5 turn). The red dot is a training aid, used only to show the direction of the "ON" (SAFE) position and should not be used as indicator that the safety is "on" or "off".

### ASSEMBLY

Model 695 Bolt Action Shotguns are shipped in three major components: stock assembly, barreled action assembly and bolt assembly.

Inspect the inside of the barrel to ensure it is free of any excess oil, grease or any obstructions.

Fit the barreled action to the stock assembly by positioning and inserting the trigger guard into the corresponding slot of the stock assembly.

Tighten the takedown screw securely with a proper size flat-head screwdriver. The takedown screw is located forward of the magazine.



Make certain the takedown screw is tight before shooting to ensure the action assembly is firmly bedded to the stock. A loose takedown screw can cause product damage resulting in personal injury.

## TO INSTALL BOLT ASSEMBLY

---



Make sure there is no ammunition in the chamber or in the magazine.

1. With the bolt handle in the "up" position, align both extractors with extractor slots in receiver.

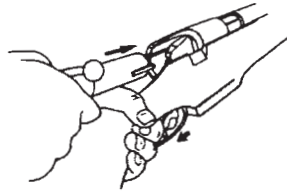

2. Pull and hold trigger back while sliding bolt into receiver. Release trigger when bolt face is visible in the receiver port.

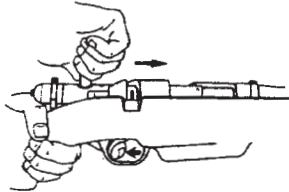

3. Close bolt by pushing the bolt handle fully forward then rotate the bolt handle down.

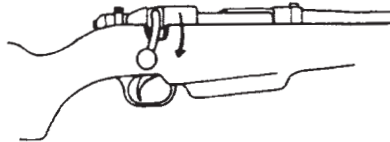

Rotate the safety cap full to the left (counterclockwise) to the safety "ON" (SAFE) position (see Fig. 1).

The bolt can be operated with the safety "ON" (SAFE). Keep the safety in the fully "ON" (SAFE) position until you are absolutely ready to fire. Become familiar with operating the bolt and safety mechanism; always keep the firearm pointed in a safe direction.

## LOADING

---

The Model 695 has a total capacity of three shots; two in the magazine, one in the chamber. It is designed for 12 gauge, 2 3/4" and 3" sabot style slugs. "Rifled" slugs and shotshells are not recommended for use in rifled barrels.



Before loading, move the safety to the "ON" (SAFE) position.



During loading never allow fingers or any objects to contact the trigger. Keep the muzzle pointed in a safe direction at all times.

Open the bolt by lifting up on the bolt handle and pulling it fully rearward.



Inspect the chamber and bore of the barrel for any obstruction, excessive oil or grease. The chamber is the rear portion of the barrel which contains the cartridge. Failure to do so may result in gun damage and/or personal injury when the shotgun is fired.



Do not load shotgun until ready for use! Unload shotgun when shooting has been completed! The safety button should always be in the “ON” (SAFE) position whether the firearm is loaded or not.



Check to be certain that the ammunition selected is the same type of cartridge as designated on the left side of the barrel.

The magazine capacity is two (2) rounds. Put one shell at a time into the magazine, brass-end rearward. Depress each shell down into the magazine and fully rearward, under the feed lips. With the shotgun safety still “on” and the bolt still open, slide the magazine through the stock using the angle bar for alignment. Push the magazine as far as it will go into the cavity—then give it a final tap to ‘snap’ the magazine into position.

Three-round capacity is achieved by depressing the first two shells into the magazine and placing the additional shell into the chamber. Depress the exposed shell in the magazine, allowing clearance over the shell while closing the bolt.

---

---

## FIRING



Discharging firearms in poorly ventilated areas, cleaning firearms, or handling ammunition may result in exposure to lead and other substances known to cause birth defects, reproductive harm, and other serious physical injury. Have adequate ventilation at all times. Wash hands thoroughly after exposure.

With the shotgun pointed in a safe direction and held in the proper firing position, move the safety right to its “OFF” (FIRE) position. Pulling trigger through its full travel to the rear, will fire the gun.



Should the shotshell fail to fire, keep the gun pointed in a safe direction. Rotate the safety cap fully to the left to the “ON” (SAFE) position. Remove the misfired shotshell and segregate from other ammunition. Do not attempt to refire a misfired round.



If at any time during firing, the report of any given round is noticeably louder or softer than previous rounds fired, STOP! Do not load or fire additional rounds until you have put safety in the “ON” (SAFE) position, then safely unload your firearm and inspect it for possible damage or obstruction in the chamber or bore.

After the shotgun is fired, raise the bolt handle and pull back as far as it will go. This motion will eject the spent casing.

To feed the next shotshell, push the bolt lever fully forward, then down. The shotgun is again ready to fire.

Each brand and type of ammunition can produce different accuracy results in each barrel. It is best to try as many types and brands of ammunition as possible to determine which performs best in your shotgun.

---

---

## TO UNLOAD



Rotate the safety cap fully to the left (counterclockwise) to the “ON” (SAFE) position (Fig. 1). During unloading, never allow fingers or any other object to contact the trigger. Keep the muzzle pointed in a safe direction at all times.

Raise the bolt handle and pull back as far as it will go. This motion will extract and eject a live, or spent shell from the chamber. Immediately verify that the barrel chamber is empty. Leave the bolt open, remove the magazine from the shotgun then lift out all live shells from the magazine.



Do not remove ammunition from the magazine by working the bolt back and forth; correct anyone exhibiting this practice as the trigger may be accidentally pulled and discharge may occur.



Re-check the chamber and magazine to be certain gun is unloaded.

---

---

## TO REMOVE THE BOLT



Rotate the safety cap fully to the left (counterclockwise) to the “ON” (SAFE) position (Fig. 1); keep the muzzle pointed in a safe direction.

Raise the bolt handle and pull back bolt as far as it will go. Inspect and remove all ammunition in the magazine or chamber. Hold the trigger back and pull the bolt handle to the rear to release the bolt assembly from the receiver.

---

---

## CLEANING AND LUBRICATION

With proper care, your Mossberg® shotgun will provide you with years of dependable service. Your firearm should be inspected and cleaned periodically to insure that it remains in good condition. Clean your firearm as soon as possible after use. This is especially important if your firearm has been exposed to moisture.

Use the instructions and equipment provided in a quality gun cleaning kit.

For maximum performance and continued satisfaction with your shotgun, periodic cleaning and lubrication are essential. Always be sure that the safety button is in the “ON” (SAFE) position (Fig. 2) and that the firearm is unloaded before cleaning or lubricating your shotgun. Wear eye protection during cleaning.

Normal use requires only that the mechanisms be free of excessive shooting residue. Very little lubrication other than a light oiling of external surfaces to prevent rust is needed.

If the shotgun is to be stored for a long period of time, it should be thoroughly cleaned and oiled. Do not plug barrel or store in a fabric-lined case that will absorb lubricant from the shotgun.

Scrub bore and chamber with bore brush solvent and follow with cleaning patches until barrel is clean. A final pass with a lightly oiled patch will provide a protective coating. Clean and remove any deposits in the barrel.

All metal parts should be cleaned with gun solvent and lightly lubricated with gun oil. Over lubrication should be avoided. Use only lubricants specifically designed for firearms. Avoid the use of abrasives which may damage the metal finish.

The bolt can be removed from the barreled action, and the barreled action can be removed from the stock, but further disassembly should be performed by a certified gunsmith only.



Make sure the barrel is free of obstructions and excessive lubricant after cleaning.

Camo guns: Caution should be exercised to avoid exposure of camouflage pattern to strong solvents.

## FUNCTION TESTING

---

---



AFTER PERFORMING ANY WORK ON YOUR FIREARM SUCH AS CLEANING OR DISASSEMBLY AND REASSEMBLY OR INSTALLATION OF AN ACCESSORY: make sure no cleaning patches or other materials are blocking the barrel. Check your firearm for proper functioning before loading or firing live ammunition.

- a. Rotate the safety cap fully counterclockwise to the “ON” (SAFE) position (Fig. 1).
- b. Be sure the firearm is completely unloaded and pointed in a safe position at all times.

Open and close the bolt several times to check for free movement of the action assembly.

Close the bolt and leave the safety in the “ON” (SAFE) position. Pull the trigger rearward fully. The firing pin should not release.

Remove your finger from the trigger. Move the safety to the “OFF” (FIRE) position. The firing pin should not release.

Leave the safety in the “OFF” (FIRE) position.

Pull the trigger fully rearward. The firing pin should release.

Rotate the safety cap fully to the left (counterclockwise) to the “ON” (SAFE) position. Open the action by moving the bolt lever up and fully rearward.



IF YOUR FIREARM DOES NOT PERFORM AS DESCRIBED IN ANY OF THE ABOVE STEPS, CONTACT O.F. MOSSBERG & SONS, INC. IMMEDIATELY. DO NOT ATTEMPT TO USE THE FIREARM.



Firearms are complicated mechanisms. Any modification, alterations, or improper fitting of parts may result in a dangerous malfunction, damage to the firearm and injury to the shooter and other persons. The shotgun's owner must accept full responsibility for the correct reassembly and functioning of the firearm after any disassembly or replacement of parts.



**If you do not understand any of the material in this manual or have any questions, contact a qualified gunsmith or contact: O.F. Mossberg & Sons, Inc.**

## SIGHT ADJUSTMENT – RIFLE SIGHT BARRELS

---

---



BEFORE MAKING ANY SIGHT ADJUSTMENTS:

- a. Move the safety cap fully to the left to the “ON” (SAFE) position and keep muzzle pointed in a safe direction.
- b. Open the bolt, visually and physically check chamber, elevator and magazine to be certain the firearm is unloaded.



## RIFLE SIGHT ADJUSTMENTS

---

---

### IRON SIGHTS:

Elevation may be adjusted by loosening the small screw in the center of the rear sight. This will allow the sight blade to be moved upward or downward as required.

Windage may be adjusted by moving the rear sight base to the left or right in the dovetail slot in the barrel. Place a wooden dowel or other object that will not damage the finish, against the side of the sight base. Tap the dowel with a hammer until the desired sight location is achieved.

Remember: Move the rear sight in the same direction you would like the shot to move. For example, if the point of impact is lower and left of the point of aim, move the rear sight upward and to the right.

## SERVICE INSTRUCTIONS

Should your firearm, or any component of your firearm, require service kindly follow these instructions:

**Please note that the entire firearm must be returned to us before we can perform any type of service.**

We reserve the right to refuse service on Mossberg firearms which have had modification and/or removal of metal from the firearm, including, but not limited to, the barrel, chamber, receiver, and trigger assembly, or safety mechanism. We must restore the firearm to factory original mechanical condition and charge for this work.

To send your firearm to Mossberg for service:



- 1. Make absolutely certain your gun is unloaded.**
- 2. Do not send ammunition with your gun.**

Send the complete firearm without add-on accessories.

Remove all accessories from your firearm such as scopes, slings, swivels, mounts, etc. Please package the gun securely (be certain gun parts cannot shift harming the firearm finish during shipment) in a suitable shipping container and ship the gun via UPS or your chosen carrier, prepaid and insured, to:

Mossberg Service Center  
101 Powdered Metal Drive  
North Haven, CT 06473  
Attn: Service Dept.

**We do not accept C.O.D. shipments.**

Include with your firearm a clear description of the problem and service you wish for us to perform. **Please give us a clear ship-to address**, (no P.O. box numbers), your daytime phone number and if possible, fax number. We suggest you place your correspondence inside the package.

If you have questions, please call us at 1-203-230-5400 or email us at [Service@Mossberg.com](mailto:Service@Mossberg.com)

**To order parts from us** – You may call your order to us at 1-203-230-5400 or you may fax your order to 1-203-230-5479, or you can mail us your order at the above address.

Please provide your name, address, city, state, zip and phone number. We'll need Model #, Serial #, Gauge, Finish, Part #, and Part Name. We have a \$7.50 (U.S.) minimum parts order charge. We accept most major credit cards, money orders, and bank drafts.

**Service outside of the U.S.A.**

For Mossberg firearm parts and service requirements outside of the United States, customers are requested to contact the closest Mossberg stocking dealer/distributor.

# **MOSSBERG WARRANTY**

## **695 BOLT ACTION SLUG SHOTGUN**

### **TEN (10) YEAR LIMITED WARRANTY**

**Limited Warranty:** O.F. Mossberg & Sons, Inc. ("Mossberg") warrants to you, the original retail purchaser of a new Mossberg® 695 Bolt Action Slug Shotgun (the "Mossberg firearm"), that the Mossberg firearm will be free of defects in material or manufacture for a period of ten (10) years from the date of your purchase of the new Mossberg firearm (the "Warranty Period") in the United States or Canada. This is the only express warranty on the Mossberg firearm. MOSSBERG MAKES NO OTHER WARRANTIES OF ANY KIND OR CONDITIONS, INCLUDING, BUT NOT LIMITED TO ANY IMPLIED WARRANTY OF MERCHANTABILITY OR FITNESS FOR A PARTICULAR PURPOSE. This Limited Warranty gives you specific legal rights, and you may have other rights that vary from State to State.

**Purchaser's Remedy:** During the Warranty Period, Mossberg will, at its sole option, (1) repair the Mossberg firearm or any part thereof that, upon examination and testing by Mossberg, does not conform to the Limited Warranty without charge to you for parts or labor, or (2) replace the Mossberg firearm with a new or similar model. THIS REMEDY SHALL BE YOUR EXCLUSIVE AND SOLE REMEDY FOR ANY BREACH OF WARRANTY. MOSSBERG SHALL NOT BE RESPONSIBLE FOR ANY OTHER EXPENSES, LOSSES OR INCONVENIENCE THAT YOU MAY SUSTAIN AS A RESULT OF THE PURCHASE, USE, MALFUNCTION OR DEFECTIVE CONDITION OF THE MOSSBERG FIREARM. Mossberg reserves the right to inspect, examine and/or test the Mossberg firearm to assess any claim made under the Limited Warranty.

**EXCLUSIONS:** THIS WARRANTY DOES NOT COVER THE COSMETIC APPEARANCE OF THE MOSSBERG FIREARM OR ANY DAMAGE CAUSED BY:

- (1) NORMAL WEAR AND TEAR;
- (2) FAILURE TO PERFORM PROPER CARE AND MAINTENANCE;
- (3) ACCIDENTS, ABUSE OR NEGLIGENCE;
- (4) BARREL OR BORE OBSTRUCTIONS;
- (5) FAILURE TO FOLLOW THE INSTRUCTIONS AND WARNINGS THAT ACCOMPANY THE MOSSBERG FIREARM; OR
- (6) THE USE OF DEFECTIVE, NON-SAAMI STANDARD, REMANUFACTURED, HAND-LOADED, AND/OR RELOADED AMMUNITION.

IN ADDITION, ANY UNAUTHORIZED REPAIRS, ALTERATIONS OR MODIFICATIONS TO THE MOSSBERG FIREARM WILL AUTOMATICALLY VOID THE LIMITED WARRANTY.

**LIMITATION OF DAMAGES:** EXCEPT WHERE PROHIBITED BY LAW, MOSSBERG WILL NOT BE LIABLE FOR ANY LOSS OR DAMAGE WHATSOEVER ARISING FROM THE USE OF THIS MOSSBERG FIREARM, WHETHER DIRECT, INDIRECT, SPECIAL, INCIDENTAL, CONSEQUENTIAL OR PUNITIVE, REGARDLESS OF THE LEGAL THEORY ASSERTED, INCLUDING CONTRACT, WARRANTY, NEGLIGENCE, OR STRICT LIABILITY. SOME JURISDICTIONS DO NOT ALLOW LIMITATIONS ON HOW LONG AN IMPLIED WARRANTY LASTS, OR THE EXCLUSION OF INCIDENTAL OR CONSEQUENTIAL DAMAGES, SO THE ABOVE LIMITATIONS MAY NOT APPLY TO YOU.

**Warranty Service:** To obtain service under this Limited Warranty, you must follow the instructions found in the "Service Instructions" section of the Owner's Manual and return the Mossberg firearm to the authorized Product Service Center. You are responsible for all shipping costs to the Product Service Center. Mossberg will not accept COD shipments of any Mossberg firearm for service. After repair or replacement, the Mossberg firearm or a similar model will be returned to you, return postage paid by Mossberg. If we replace the Mossberg firearm, we will keep the firearm that you returned to Mossberg.

**Modification of Warranty:** No agent, representative, distributor, or authorized dealer of Mossberg firearms has any authority to modify the terms or conditions of the Limited Warranty in any way. The Limited Warranty may only be modified in writing by an authorized officer of Mossberg.

**THIS LIMITED WARRANTY IS EFFECTIVE JANUARY 1, 2003.**

## PARTS LIST

Item No.	Description	Item No.	Description
* 1.	Safety Cap Ret. Ring	12.	Ejector Screw
** 2.	Bolt Complete (includes 1-9)	13.	Recoil Pad Screw
3.	Index Plunger Spring	14.	Recoil Pad
4.	Index Plunger	15.	Buttstock
5.	Extractor Pin (L.H.)	16.	Takedown Screw
6.	Extractor Pin (R.H.)	* 17.	Magazine Follower Asm.
7.	Extractor Spring	* 18.	Magazine Shell
8.	L.H. extractor	19.	Magazine Complete (17,18)
9.	R.H. extractor	** 20.	Barrel, receiver, trigger housing (include 10,11,12)
10A.	Rear Sight	21.	Scope bases (not shown)
10B.	Front Sight		
11.	Ejector		

Items marked with a double asterisk (\*\*) are restricted to the factory for installation.  
 Items marked with an asterisk (\*) are installed or sold only to Authorized Distributors.

# EXPLODED VIEW

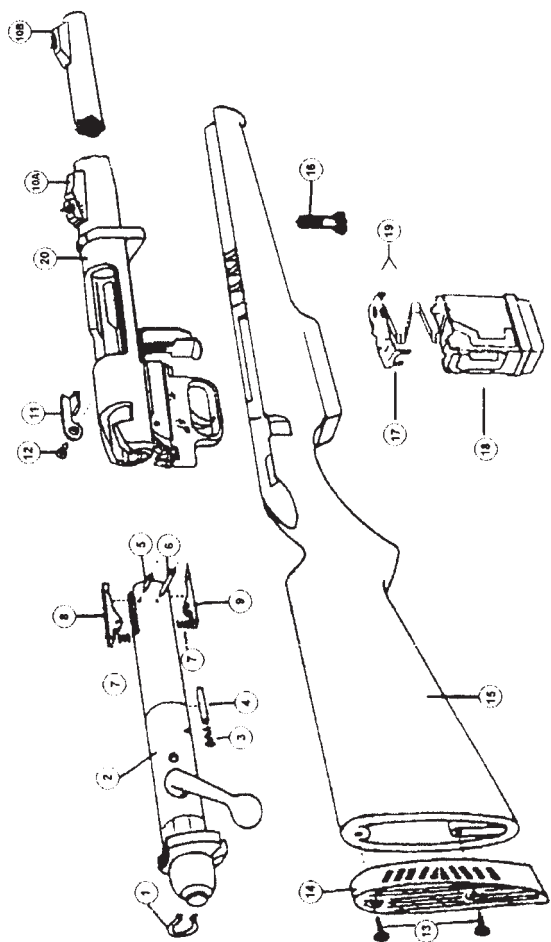

## **NOTES**

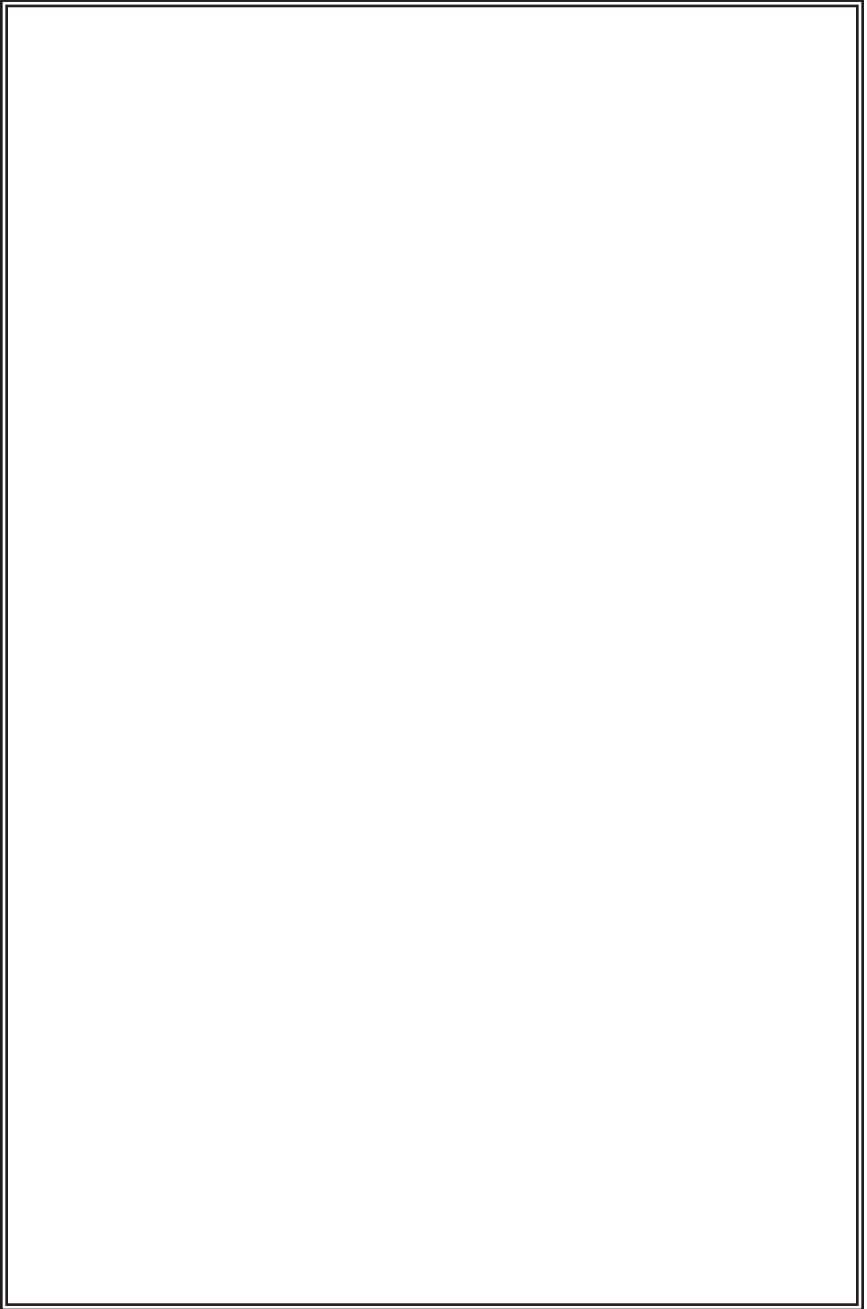
A large, empty rectangular box with a double-line border, occupying most of the page. It is intended for the user to write notes.

## **NOTES**

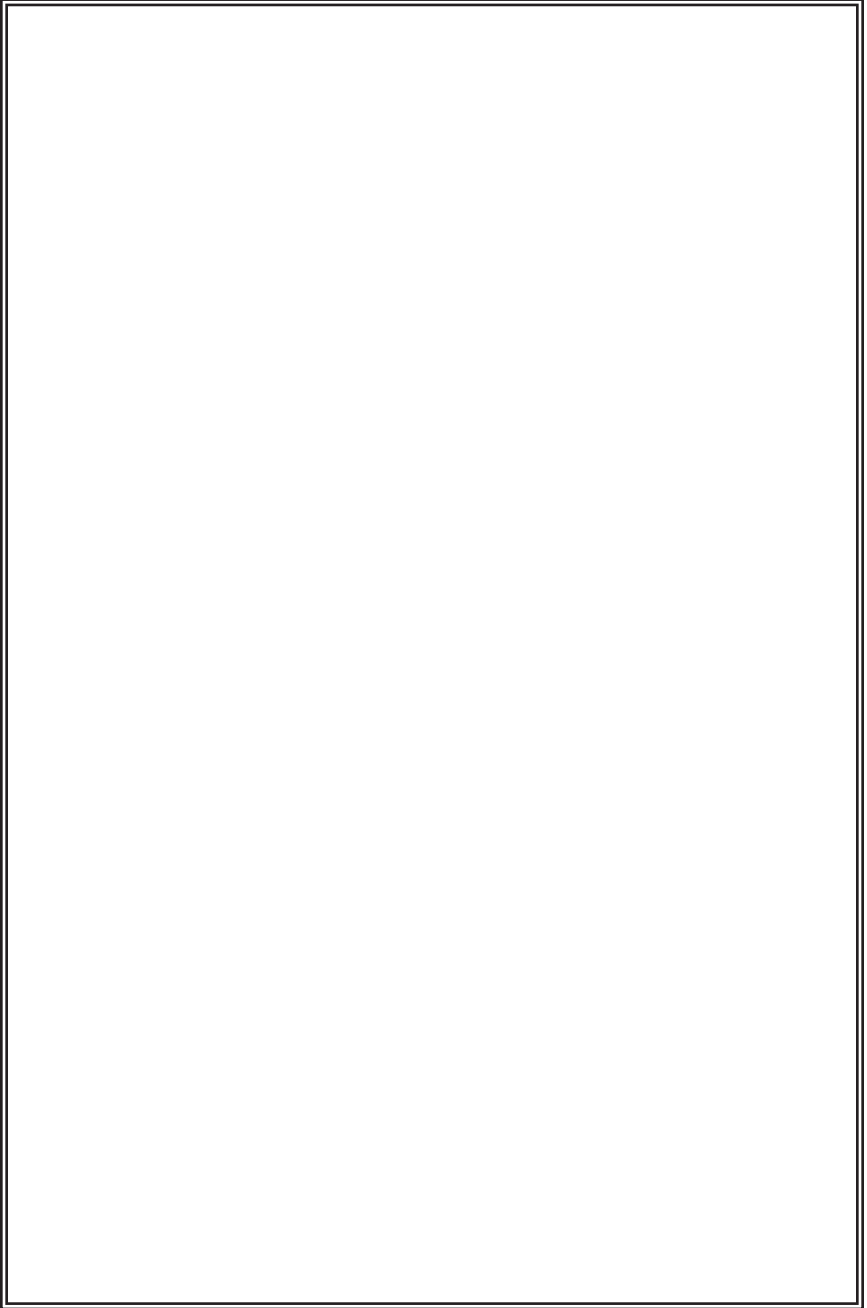
A large, empty rectangular box with a double-line border, occupying most of the page. It is intended for the user to write notes.

# **FIREARMS SAFETY DEPENDS ON YOU. MAKE NO MISTAKE ABOUT IT!**

From the time an individual picks up a firearm, that individual shooter becomes a part of a system over which he has complete control. He is the only part of the system that can make a gun safe – or unsafe. Hunting and target shooting are among the safest of all sports. This booklet is intended to make them even safer – by re-emphasizing and reaffirming the basics of safe gun handling and storage and by reminding each individual shooter that he or she is the key to firearms safety. You can help meet this responsibility by enrolling in hunter safety or shooting safety courses. You must constantly stress safety when handling firearms, especially to children and non-shooters. Newcomers in particular must be closely supervised when handling firearms with which they may not be acquainted. Don't be timid when it comes to gun safety. If you observe anyone violating any safety precautions, you have an obligation to suggest safer handling practices, such as those in this booklet. Please read these rules carefully and follow the safety procedures outlined. Firearms safety is up to you. Make no mistake about it.

- 1. ALWAYS KEEP THE MUZZLE POINTED IN A SAFE DIRECTION**
- 2. FIREARMS SHOULD BE UNLOADED WHEN NOT ACTUALLY IN USE**
- 3. DON'T RELY ON YOUR GUN'S "SAFETY"**
- 4. BE SURE OF YOUR TARGET AND WHAT'S BEYOND IT**
- 5. USE CORRECT AMMUNITION**
- 6. IF YOUR GUN FAILS TO FIRE WHEN THE TRIGGER IS PULLED, HANDLE WITH CARE**
- 7. ALWAYS WEAR EYE AND EAR PROTECTION WHEN SHOOTING**
- 8. BE SURE THE BARREL IS CLEAR OF OBSTRUCTIONS BEFORE SHOOTING**
- 9. DO NOT ALTER OR MODIFY YOUR GUN, AND HAVE GUNS SERVICED REGULARLY**
- 10. LEARN THE MECHANICAL AND HANDLING CHARACTERISTICS OF THE FIREARM YOU ARE USING**

*Courtesy of  
Sporting Arms and Ammunition Manufacturers' Institute, Inc.*