

This document is regularly updated. The latest version can be accessed at <https://ronaldobutrus.com/revisionnotes.html>. Latest update: 10 April 2022.

PHYSICS REVISION NOTES

FOR CAMBRIDGE INTERNATIONAL A-LEVEL
PHYSICS

SIMPLE, CLEAR & MEMORABLE

Ronaldo Butrus

CONTENTS

1	PHYSICAL QUANTITIES AND UNITS.....	4
2	KINEMATICS.....	6
3	DYNAMICS.....	7
4	FORCES, DENSITY AND PRESSURE.....	9
5	WORK, ENERGY AND POWER.....	11
6	DEFORMATION OF SOLIDS.....	12
7	WAVES.....	14
8	SUPERPOSITION.....	18
9	ELECTRICITY.....	23
10	D.C. CIRCUITS.....	26
11	PARTICLE PHYSICS.....	32
12	MOTION IN A CIRCLE.....	35
13	GRAVITATIONAL FIELDS.....	36
14	TEMPERATURE.....	39
15	IDEAL GASES.....	41
16	THERMODYNAMICS.....	44
17	OSCILLATIONS.....	45
18	ELECTRIC FIELDS.....	48
19	CAPACITANCE.....	52
20	MAGNETIC FIELDS.....	54
21	ALTERNATING CURRENTS.....	59
22	QUANTUM PHYSICS.....	60
23	NUCLEAR PHYSICS.....	63
24	MEDICAL PHYSICS.....	65
25	ASTRONOMY AND COSMOLOGY.....	68

USING THIS BOOK

1.1 THIS IS A SPECIFICATION TOPIC

1.1.1 This is a specification subtopic

1.1.1.1 This is a section of a specification subtopic

1 – Physical Quantities and Units

1 PHYSICAL QUANTITIES AND UNITS

1.1 Physical quantities

- All physical quantities consist of a numerical magnitude and a unit.

1.2 SI units

- The main SI base quantities and their units are:
 - o **mass** (kg)
 - o **length** (m)
 - o **time** (s)
 - o **current** (A)
 - o **temperature** (K)
- Units of other quantities are **derived** from the base units above:

$$\begin{aligned}\text{E.g. speed} &= \frac{\text{distance}}{\text{time}} \\ &= \frac{[m]}{[s]} \\ &= [m][s^{-1}] \\ &= [m s^{-1}]\end{aligned}$$

- To check the **homogeneity** of equations (if they are equivalent), you can use the units of the different quantities:

$$\begin{aligned}\text{E.g. to compare } mgh \text{ and } \frac{1}{2}mv^2: \\ mgh &= [kg] [ms^{-2}] [m] \\ &= [kg m^2 s^{-2}] \\ \frac{1}{2}mv^2 &= [kg] ([m s^{-1}])^2 \\ &= [kg][m^2 s^{-2}] \\ &= [kg m^2 s^{-2}]\end{aligned}$$

Both sides of the equation are identical, meaning we can use both equations for energy.

Prefix	Symbol	Value
pico	<i>p</i>	$\times 10^{-12}$
nano	<i>n</i>	$\times 10^{-9}$
micro	μ	$\times 10^{-6}$
milli	<i>m</i>	$\times 10^{-3}$
centi	<i>c</i>	$\times 10^{-2}$
deci	<i>d</i>	$\times 10^{-1}$
kilo	<i>k</i>	$\times 10^3$
mega	<i>M</i>	$\times 10^6$
giga	<i>G</i>	$\times 10^9$
tera	<i>T</i>	$\times 10^{12}$

1.3 Errors and uncertainties

- Types of errors:
 - o **systematic errors:** an error caused by an inaccuracy in the system, e.g. calibration.
 - o **random errors:** an error caused by a lack of precision, changes in experimental conditions or value judgments in measurements. Repeat readings reduce the effect of random error on the mean.

- Accuracy and precision:
 - o **accuracy:** how close to the 'real value' a measurement is
 - o **precision:** how close measurements of the same value are to each other

- No measurement can be made to absolute precision; there is always some uncertainty:
 - o **absolute uncertainty:** a numerical uncertainty, e.g. 2.5 ± 0.1 s
 - o **percentage uncertainty:** an uncertainty expressed as a percentage of the reading, e.g. for 2.5 ± 0.1 s, this would be 4%.

- Combining uncertainties:
 - o for quantities that are added or subtracted: add absolute uncertainties
 - o for quantities that are multiplied or divided: add percentage uncertainties
 - o for quantities that are exponentiated: multiply percentage uncertainty by power

1.4 Scalars and vectors

- **Scalar quantities:** magnitude only, e.g. speed, mass, energy
- **Vector quantities:** magnitude and direction, e.g. velocity, force, acceleration

- Adding and subtracting coplanar vectors:

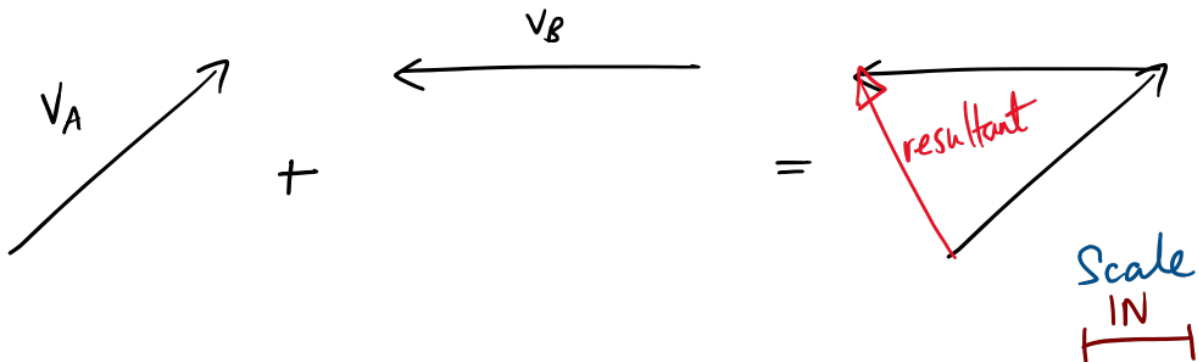

- Resolving vectors to represent them as two perpendicular components:

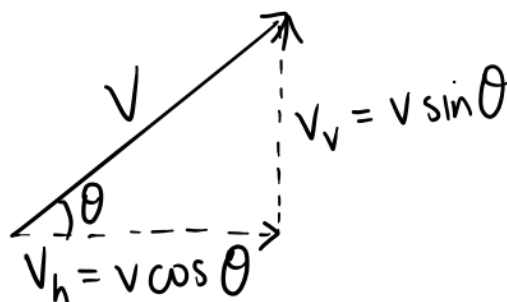

2 – Kinematics

2 KINEMATICS

2.1 Equations of motion

- **Distance** is a measure of length along a path travelled by a particle.
 - **Displacement** is a measure of change of position, given by magnitude and direction.
 - **Speed** is a measure of how fast a particle is moving.
 - **Velocity** is speed in a given direction.
 - **Acceleration** is the rate of change of velocity.
-
- Displacement is equal to the area under a velocity-time graph.
 - Velocity is equal to the gradient of a displacement-time graph.
 - Acceleration is equal to the gradient of a velocity-time graph.

$$v = u + at \quad (\text{derived from velocity} = \text{displacement} / \text{time})$$

$$a = \frac{v-u}{t} \quad (\text{rate of change of velocity})$$

$$s = ut + \frac{1}{2}at^2 \quad (\text{derived from area under uniform acceleration v-t graph})$$

$$s = vt - \frac{1}{2}at^2 \quad (\text{derived from area under uniform acceleration v-t graph})$$

$$v^2 - u^2 = 2as \quad (\text{derived from } v = u + at \text{ where } a = \frac{v-u}{t})$$

- An experiment to determine the acceleration of free fall using a falling object:
 - o Attach electromagnet with ball-bearing to a clamp stand and place a trapdoor underneath the ball.
 - o Connect a timer to the electromagnet and trap door.
 - o Measure distance h between the bottom of the electromagnet and the top of the trapdoor.
 - o When the current to the electromagnet switches off, the ball drops and the timer starts.
 - o When the ball hits the trapdoor the timer stops.
 - o Record the time t and repeat the experiment for different values of h .
 - o Plot a graph of $2s$ against t^2 .
 - o Draw a straight line of best fit.
 - o The acceleration is equal to the gradient of the line of best fit.
- In motion due to a uniform velocity in one direction and a uniform acceleration in a perpendicular direction, the components of the velocity can be treated separately.
- Therefore, acceleration in one direction does not affect the velocity in the perpendicular direction.
- This is an example of projectile motion.

3 DYNAMICS

3.1 Momentum and Newton's laws of motion

- **Mass** is the property of an object that resists change in motion.
- **Linear momentum** is given by the product of mass and velocity.

$$p = mv$$

- **Force** is the rate of change of momentum.

$$F = \frac{\Delta p}{\Delta t}$$

Newton's First Law

Every object continues in its state of rest, or with uniform velocity, unless acted on by a resultant force.

Newton's Second Law

For an object of constant mass, its acceleration is directly proportional to the resultant force applied to it.

$$F = ma$$

Newton's Third Law

Whenever one object exerts a force on another, the second object exerts an equal and opposite force on the first.

- **Weight** is the effect of gravitational field on a mass.

$$W = mg$$

3.2 Non-uniform motion

- Frictional forces and viscous/drag forces (such as air resistance) act in the direction opposite to the direction of motion.
- When an object falls in a uniform gravitational field with air resistance:
 - o speed increases
 - o force due to air resistance increases
 - o until it is equal and opposite to weight
 - o the resultant force approaches zero
 - o the object reaches its terminal (constant) velocity

3 – Dynamics

3.3 Linear momentum and its conservation

Principle of Conservation of Momentum

If no external force acts on a system, the total momentum of the system remains constant.

- In collisions, the momentum of a system is always conserved but some change in kinetic energy may take place.
- Collisions can be:
 - **perfectly elastic:** relative speed of approach is equal to relative speed of separation
 - **inelastic:** relative speeds of approach and separation differ
 - **perfectly inelastic:** maximum amount of kinetic energy is lost (particles coalesce)

4 FORCES, DENSITY AND PRESSURE

4.1 Turning effect of forces

- The **weight** of an object may be taken as acting on a single point known as its centre of gravity.
- The **moment** of a force is given by the product of the force and the perpendicular distance of the line of action of the force to the pivot.

$$T = Fd$$

where T is the moment of the force
 F is the force
 d is the perpendicular distance of the line of action of the force to the pivot

- A **couple** is a pair of forces that acts to produce rotation only.
- The **torque** of a couple is given by the product of one of the forces and the perpendicular distance between the two forces.

$$T = Fd$$

where T is the torque of the couple
 F is (one) force
 d is the perpendicular distance between the two forces

4.2 Equilibrium of forces

Principle of Moments

For a body in rotational equilibrium, the sum of the clockwise moments about the point is equal to the sum of the anticlockwise moments about that point.

- A system is in equilibrium if:
 - there is **no resultant force**
 - there is **no resultant torque**
- A **vector triangle** can be used to show three coplanar forces (joined tip to tail) are in equilibrium.

4 – Forces, Density & Pressure

4.3 Density and pressure

- **Density** is measured in mass per unit volume (i.e. kg m^{-3}).
- **Pressure** is measured in force per unit area (i.e. N m^{-2} or Pascal (Pa)).
- **Hydrostatic pressure** is given by:

$$\Delta p = \rho g \Delta h$$

where Δp is the difference in hydrostatic pressure (Pa)
 ρ is the density (kg m^{-3})
 g is the gravitational field strength (N kg^{-1})
 Δh is the difference in height (m)

- **Upthrust** is a force acting on an object in a fluid due to a difference in hydrostatic pressure.
- This is equal and opposite to the weight of the fluid displaced by the object.

Archimedes' Principle: $F = \rho g V$

where F is the upthrust (Pa)
 ρ is the density (kg m^{-3})
 g is the gravitational field strength (N kg^{-1})
 V is the volume of the fluid displaced (m^3)

5 WORK, ENERGY AND POWER

5.1 Energy conservation

- **Work done** is the energy transferred by moving a point in the direction of a force applied at that point, given by the product of the force and displacement.

$$W = Fs$$

Principle of Conservation of Energy

Energy cannot be created or destroyed. It can only be converted from one form to another.

- The **efficiency** of a system is the ratio of useful energy output from the system to the total energy input.
- **Power** is work done per unit time.

$$P = \frac{W}{t}$$

- Using the equation for work done:

$$\frac{W}{t} = F \frac{s}{t} \quad \frac{W}{t} \text{ is power. } \frac{s}{t} \text{ is velocity.}$$

$$P = Fv \quad (\text{power needed to move force } F \text{ at constant velocity } v)$$

5.2 Gravitational potential energy and kinetic energy

- For gravitational potential energy changes in a uniform gravitational field:

$$W = Fs$$

$$W = (mg)\Delta h$$

$$\Delta E_p = mg\Delta h$$

- Consider an object of mass m moving with constant acceleration a where $F = ma$.
- The velocity of the object changes from u to v in a distance s .

$$v^2 - u^2 = 2as$$

$$\text{Let } u = 0:$$

$$v^2 - u^2 = 2 \left(\frac{F}{m} \right) s$$

$$mv^2 - mu^2 = 2Fs$$

$$\frac{1}{2}mv^2 - \frac{1}{2}mu^2 = Fs$$

$$W = \frac{1}{2}m(v^2 - u^2)$$

$$E_k = \frac{1}{2}mv^2$$

6 – Deformation of Solids

6 DEFORMATION OF SOLIDS

6.1 Stress and Strain

- Deformation is caused by **tensile** or **compressive** forces.
- Terms relating to deformation:
 - o **load**: force exerted on a body
 - o **extension**: increase in length due to load
 - o **compression**: decrease in length due to load
 - o **limit of proportionality**: the point at which Hooke's law is no longer true when stretching a material
- **Hooke's Law**: *the extension of a body is directly proportional to the applied force.*

$$F \propto x \Rightarrow F = kx$$

where F is the force (N)
 k is the spring constant ($N\ m^{-1}$)
 x is the extension (m)

- Stress, strain and Young modulus:
 - o **stress** (σ): force per unit cross-sectional area of the wire
 - o **strain** (ε): extension per unit of the unloaded length of the wire
 - o **Young modulus** (E): stress / strain

	Formula (words)	Formula (symbols)	Units
stress (σ)	$\frac{\text{force}}{\text{cross-sectional area}}$	$\frac{F}{A}$	Pa
strain (ε)	$\frac{\text{extension}}{\text{unloaded length}}$	$\frac{x}{L}$	-
Young modulus (E)	$\frac{\text{stress}}{\text{strain}}$	$\frac{FL}{Ax}$	Pa

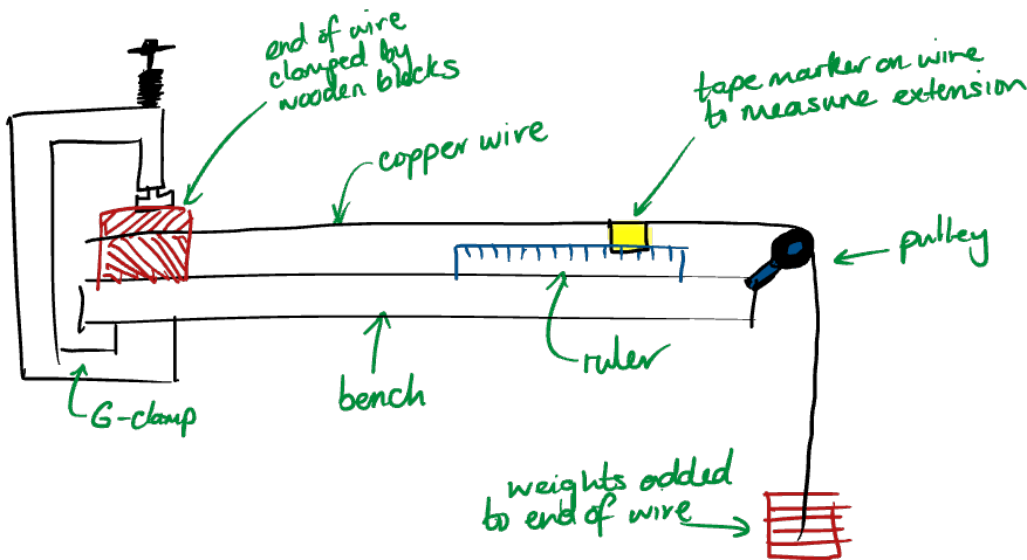

- Determining the Young modulus of a metal in the form of a wire:
 - clamp one end of the wire between two wooden blocks held by a G-clamp
 - let the other end hang from a horizontally level pulley
 - attach very small weight to provide some tension for initial measurements
 - place a fixed ruler on the table adjacent to the wire
 - attach a tape marker to the wire
 - record the current distance along the ruler
 - incrementally add weights and record changes in length (and therefore the extension for that load) until the wire breaks (for breaking stress and strain values)
 - plot a strain (x) – stress (y) graph
 - the gradient of the linear region is the best estimate for the Young modulus of the wire
 - a line of worst fit can be used to calculate an uncertainty in the value

6.2 Elastic and plastic behaviour

- Types of deformation:
 - **elastic:** spring will return to its original length when the load is removed
 - **plastic:** spring will not return to its original length when the load is removed

elastic limit: the point at which the spring ceases to show proportionality (i.e. the deformation transitions from elastic to plastic)

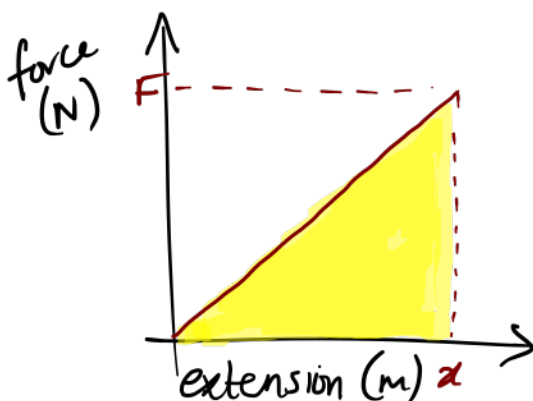

The **area** under a force-extension graph within its limit of proportionality represents the **work done**:
 average force = $\frac{F}{2}$
 distance = x

$$E = \frac{1}{2}Fx$$

$$\Rightarrow E = \frac{1}{2}(kx)(x) \Rightarrow E = \frac{1}{2}kx^2$$

7 WAVES

7.1 Progressive waves

- Wave motion:
 - o **in ropes:** swaying a rope from side to side illustrates a transverse wave
 - o **in springs:** sending impulses illustrates a longitudinal wave, and swaying from side to side illustrates a transverse wave
 - o **in ripple tanks:** ripples on the water surface illustrate transverse waves
- Terms relating to waves:
 - o **displacement:** distance of a particle in a wave from its equilibrium position
 - o **amplitude:** maximum displacement in a wave from its equilibrium position
 - o **phase difference:** the fraction of a cycle that passes between an object being at maximum displacement in a given direction and another object being at maximum displacement in that direction
 - o **period (T):** time taken for one wavelength to pass a point on a wave, in seconds (s)
 - o **frequency (f):** number of waves that pass a given point in one second, in Hertz (Hz)
 - o **wavelength (λ):** distance between one point and the next corresponding point on a wave, in metres (m)
 - o **speed:** wave speed, $v = \frac{\lambda}{T} = \frac{1}{T}\lambda = f\lambda \Rightarrow v = f\lambda$

- A **cathode-ray oscilloscope (CRO)** can be used to measure potential difference and short time intervals:
 - o a potential difference applied to the x and y inputs controls the movement of the trace in the horizontal and vertical directions respectively
 - o y -sensitivity is measured in volts per centimetre ($V\text{ cm}^{-1}$)
 - o the rate at which the time-base voltage drags the spot across the screen is measured in either seconds per division ($s\text{ div}^{-1}$) or divisions per second (div s^{-1})
 - o E.g. assuming a y -sensitivity of 2 V div^{-1} and a time-base of 0.05 s div^{-1} :

Amplitude of larger pulse is 2 divisions, so $2 \times 2 = 4\text{ V}$.
 Amplitude of smaller pulse is 1 division, so $1 \times 2 = 2\text{ V}$.

Time interval between the two larger pulses is 4 divisions, so $4 \times 0.05 = 0.2\text{ s}$.

$$\text{Frequency, } f = \frac{1}{\text{Period, } T} = \frac{1}{0.2} = 5\text{ Hz}$$

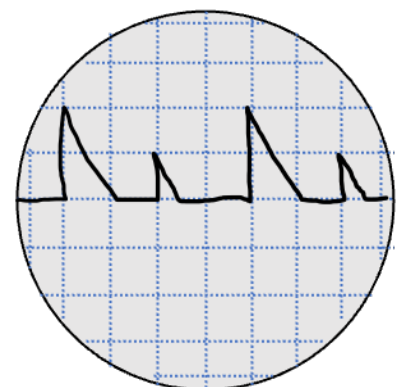
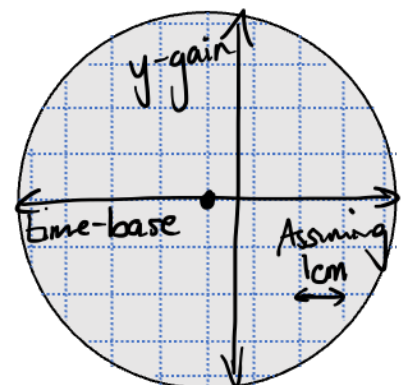

- Energy is transferred by a progressive wave, e.g. water waves on the sea carry energy from where they form to where they crash onto the shore.
- The intensity of a wave is the energy transmitted per unit time per unit area at right angles to the wave velocity.

$$\text{intensity} = \frac{\text{power}}{\text{area}} \quad I = \frac{P}{A} \quad \text{in watts per metre squared (W m}^{-2}\text{)}$$

$$\text{intensity} \propto (\text{amplitude})^2 \quad I \propto x_0^2$$

7.2 Transverse and longitudinal waves

- Types of waves:
 - o **transverse**: oscillations perpendicular to direction of energy transfer
 - o **longitudinal**: oscillations parallel to direction of energy transfer

Longitudinal waves

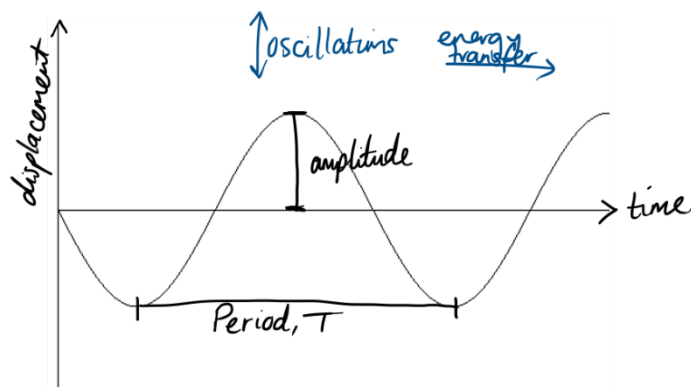
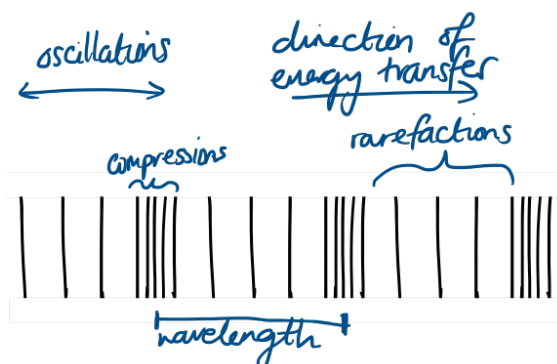

Transverse waves

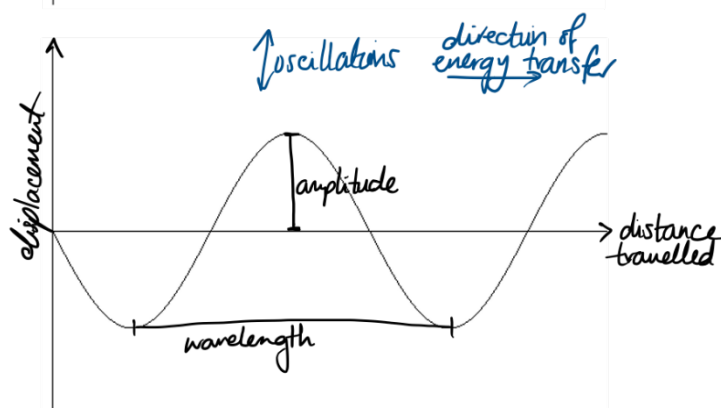

7 – Waves

7.3 Doppler effect for sound waves

- **Doppler effect:** when a source of sound waves moves relative to a stationary observer, the observed frequency is different from the source frequency.

$$f_0 = \frac{f_s v}{v + v_s} \quad (\text{for a stationary observer})$$

where f_s is the source frequency
 v_s is the source velocity
 v is the wave velocity
 f_0 is the observed frequency.

The directional component of the velocities must be relative.

7.4 Electromagnetic spectrum

- All electromagnetic waves are transverse waves that travel with the same speed c in free space where $c \approx 3 \times 10^8 \text{ ms}^{-1}$.

Type of radiation	Approximate wavelengths in free space (metres)
Radio waves	10^3
Microwaves	10^{-2}
Infrared	10^{-5}
Visible light	10^{-7}
Ultraviolet	10^{-8}
X-rays	10^{-10}
Gamma rays	10^{-12}

- Wavelengths in the range 400 – 700nm in free space are visible to the human eye.

7.5 Polarisation

- Transverse waves are **polarised** if they are vibrating in one plane only.
- Polarising filters only transmit waves that are polarised parallel to their transmission axis.

Malus' Law: $I = I_0 \cos^2 \theta$

where I_0 is the maximum intensity (W m^{-2})
 I is the intensity of the transmitted light (W m^{-2})
 θ is the angle between the polarised light and the transmission axis



8 – Superposition

8 SUPERPOSITION

8.1 Stationary waves

- Principle of superposition

When two or more waves cross at a point, the displacement at that point is equal to the sum of the displacements of the individual waves.

- Stationary waves are formed when two waves of the same type and frequency, travelling in opposite directions, meet.

Stationary waves in a stretched string:

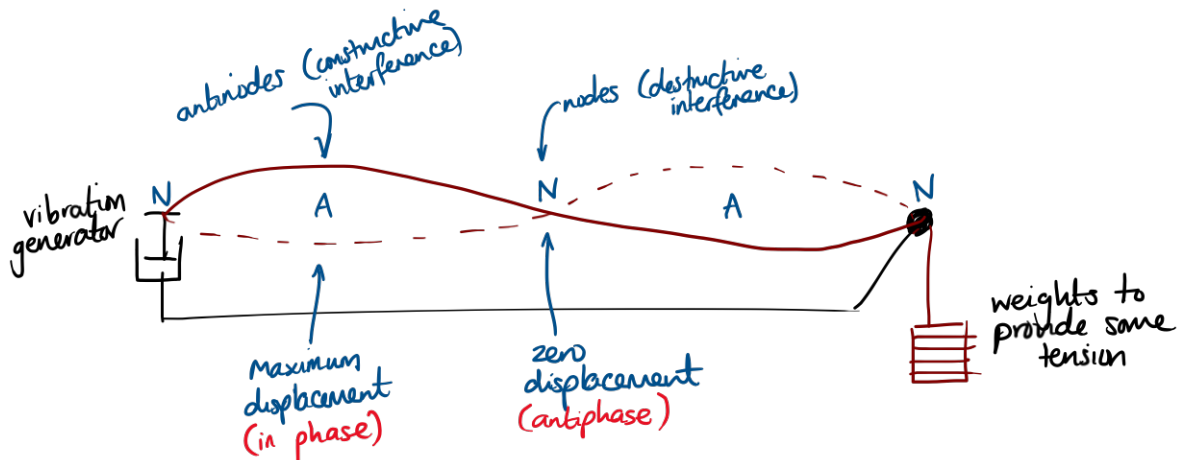

Stationary waves using microwaves:

- the microwave (food-heating device) generates standing microwaves
- antinodes have a lot of energy
- this energy is transferred to the food
- the dish rotates so that the antinodes can heat the food as uniformly as possible

Stationary waves in air columns:

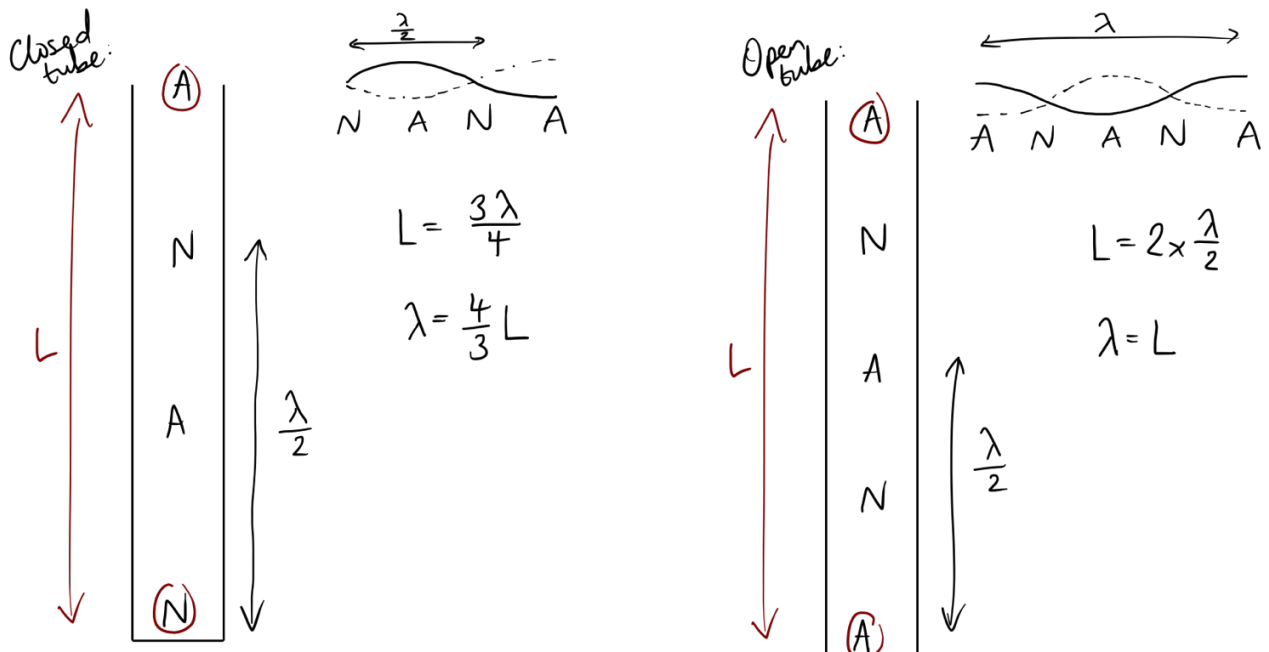

8.2 Diffraction

- **Diffraction** is the spreading of waves after passing through a gap.
- Diffraction can be demonstrated by observing water in a ripple tank:

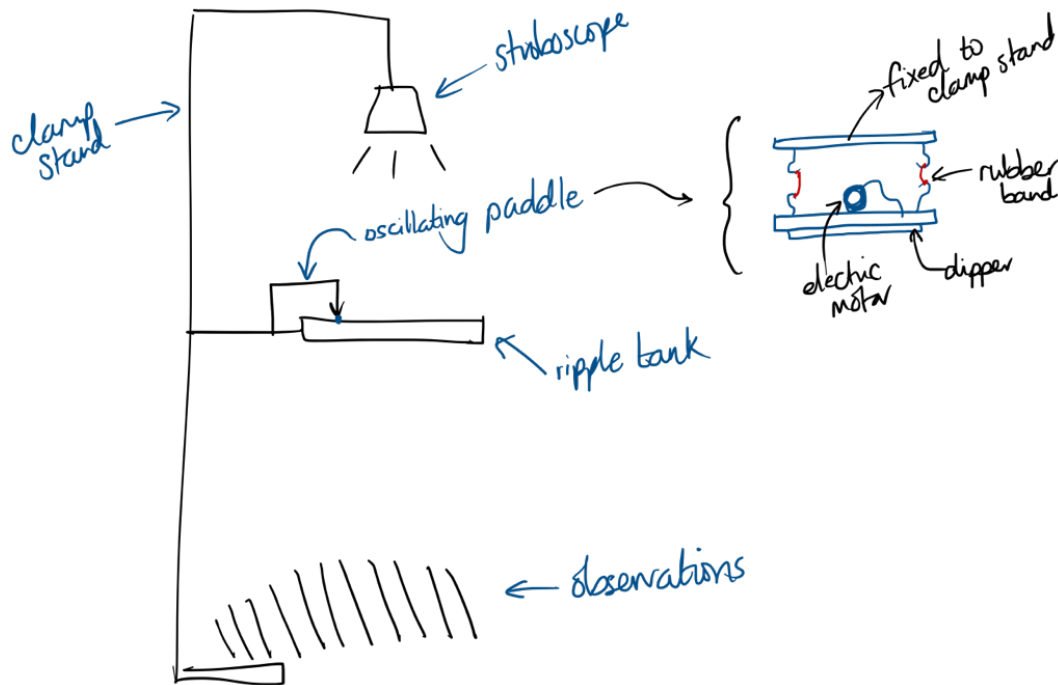

This apparatus can be used to observe the movement of water waves in a ripple tank. Placing obstacles (below) will cause diffraction to occur.

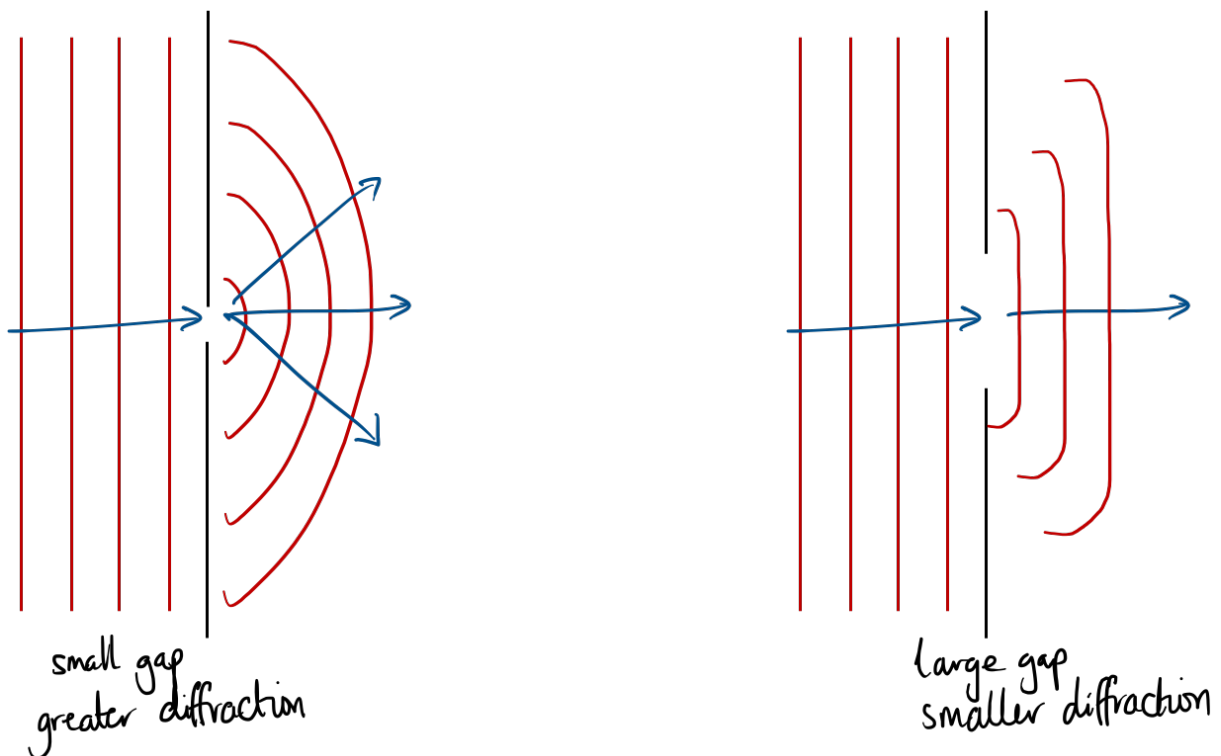

- The gap size must be comparable to the wavelength for diffraction to occur.

8 – Superposition

8.3 Interference

- **Interference** is when two waves of the same type meet and their displacements add or subtract:
 - o if they are **in phase** the amplitudes are added (**constructive interference**)
 - o if they are **in antiphase** the amplitudes are subtracted (**destructive interference**)
- **Coherent** waves have the *same frequency* and a *constant phase difference*.

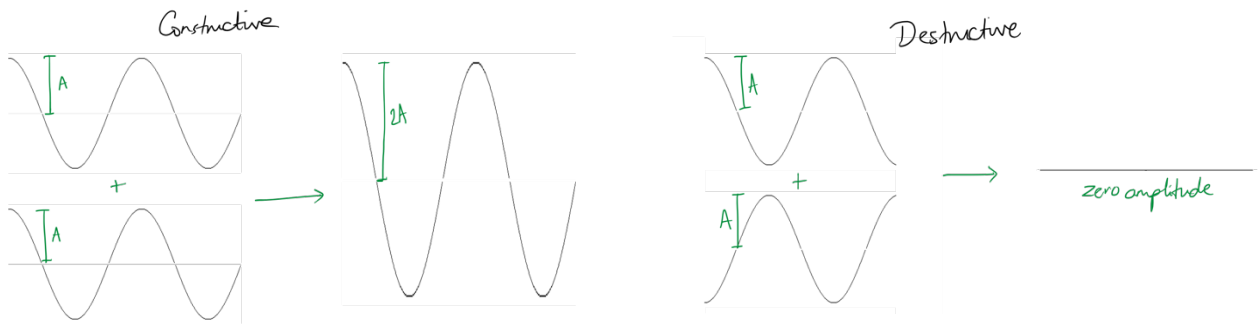

Interference patterns in sound waves:

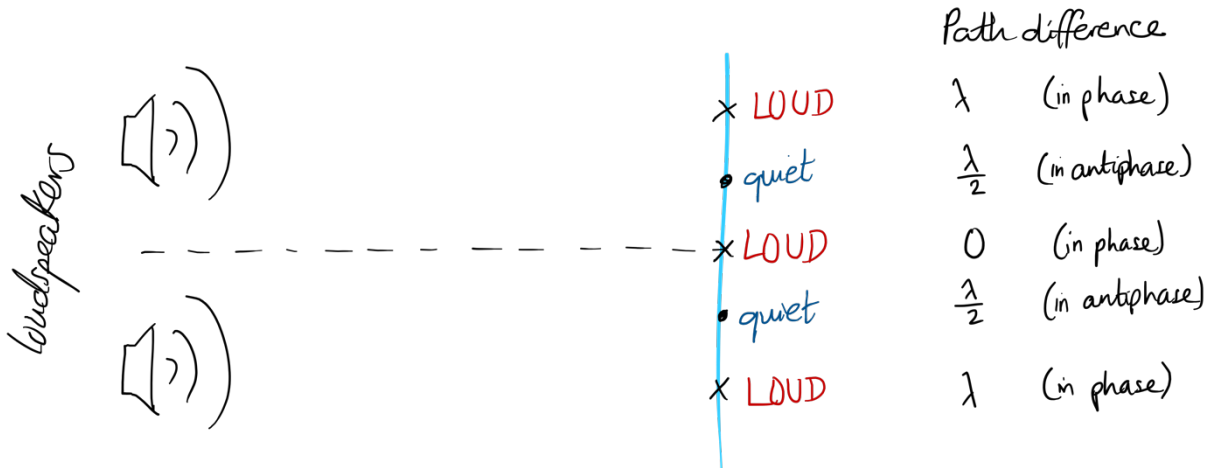

Interference patterns in water waves:

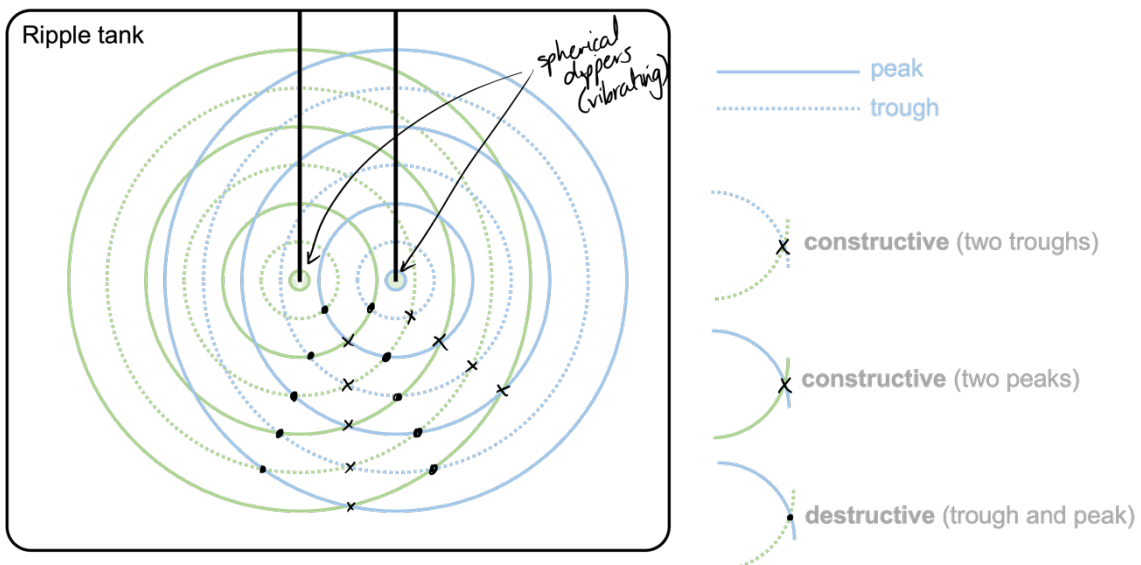

Interference patterns in microwaves:

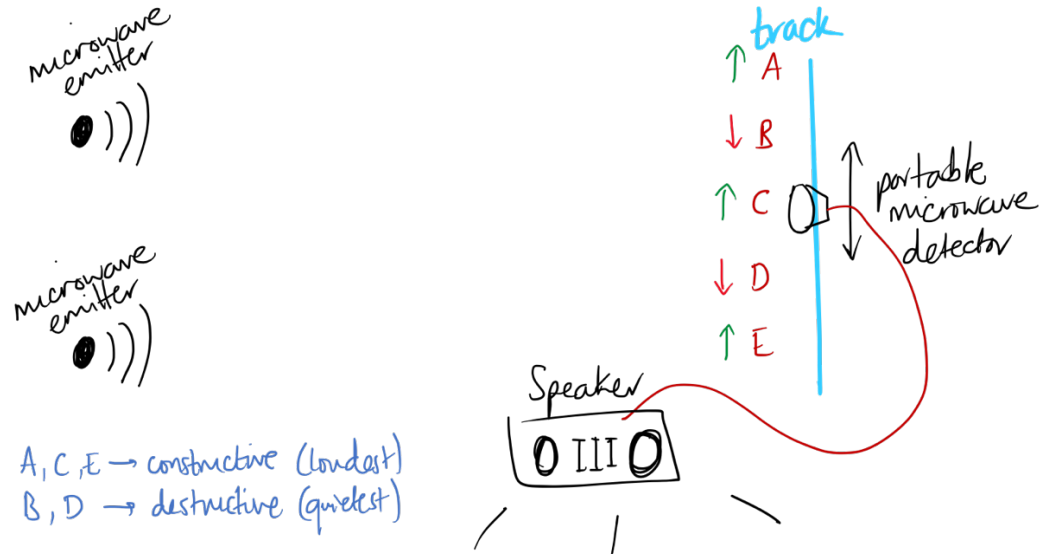

Interference patterns in light waves:

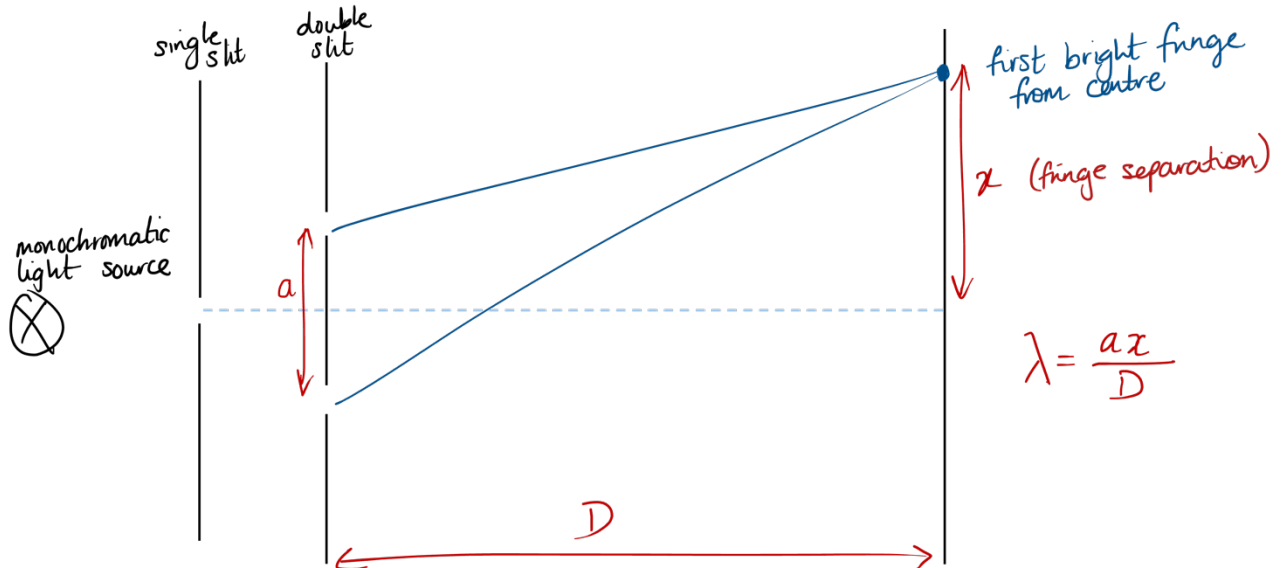

8 – Superposition

8.4 The diffraction grating

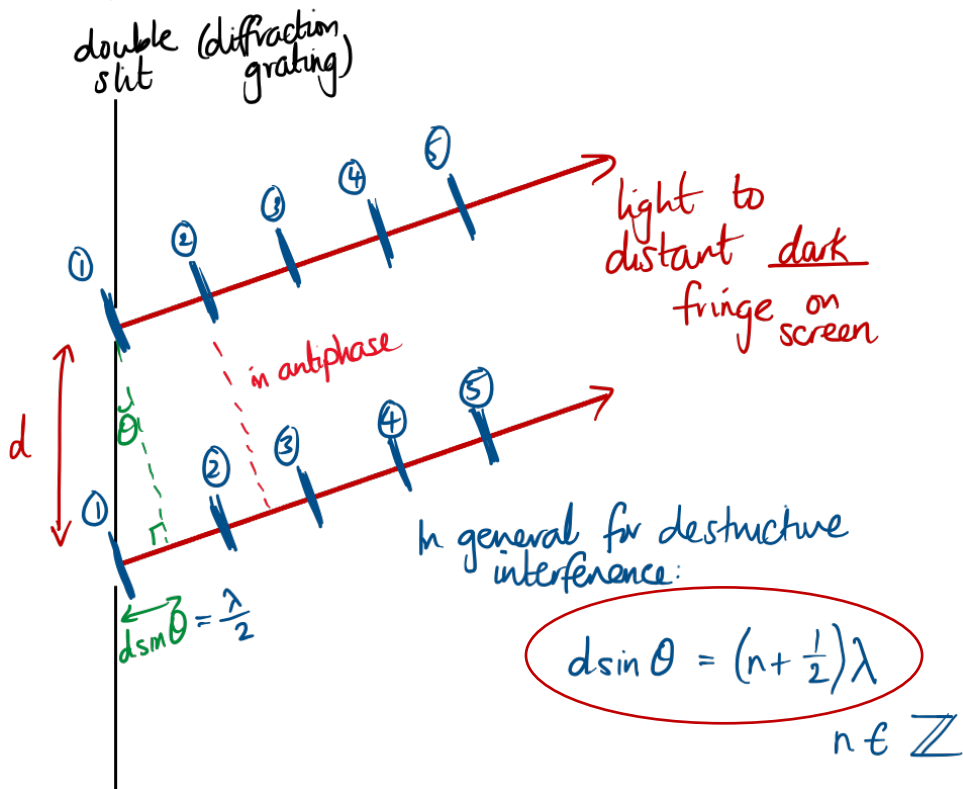
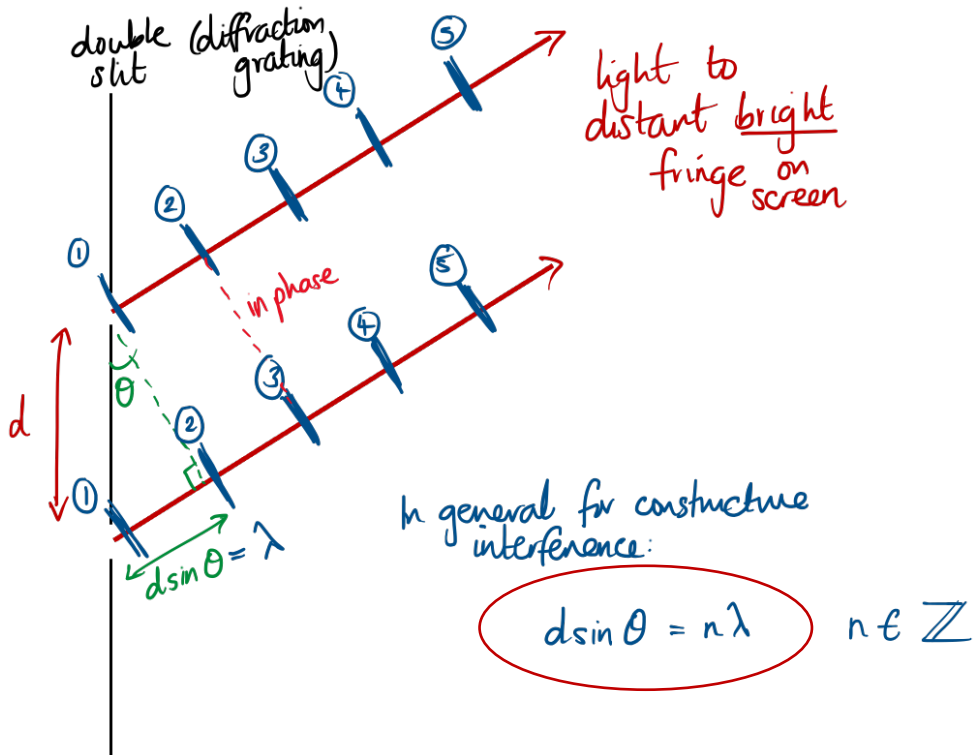

- To find the maximum number of fringes, set θ to 90.
- Remember to account for the middle fringe and those on the other side.

9 ELECTRICITY

9.1 Electric current

- An **electric current** is a flow of charge carriers.
- The charge on charge carriers is **quantised**, i.e. it only exists in discrete amounts.

$$Q = It$$

- For a current-carrying conductor:

$$I = A n v q$$

where

- I is the current through the conductor
- A is the cross-sectional area
- n is the number density of charge carriers
- v is the average drift velocity
- q is the charge of one electron

9.2 Potential difference and power

- The **potential difference** across a component is the energy transferred per unit charge.

$$V = \frac{W}{Q}$$

$$P = VI$$

$$P = (IR)I = I^2R$$

$$P = V \frac{V}{R} = \frac{V^2}{R}$$

9 – Electricity

9.3 Resistance and resistivity

- **Resistance** is the opposition to the flow of electrons within a material, expressed as a ratio of the potential difference V across a conductor to the current I in it.

$$V = IR$$

- **Ohm's Law:** for a metallic conductor at a constant temperature, the current in the conductor is proportional to the potential difference across it.

Type of conductor	I - V graph	Explanation
metallic conductor at constant temperature		<p>At a constant temperature, current is directly proportional to potential difference.</p> <p>$I \propto V$ (obeys Ohm's Law)</p>
semiconductor diode		<p>The diode conducts when the current is in the direction of the arrowhead on its circuit symbol. It has a very high resistance for small potential differences and its resistance decreases constantly after a set potential difference. They are not directly proportional.</p>
filament lamp		<p>As potential difference increases:</p> <ul style="list-style-type: none"> - current increases - temperature increases - atoms in metal filament vibrate more so resist the passage of electrons more - resistance increases

- **Resistivity** is a property of a metal that defines how strongly it resists the flow of current.

For a given current-carrying conductor:

$$R = \frac{\rho L}{A}$$

where

- R is the resistance
- ρ is the resistivity
- L is the length
- A is the cross-sectional area

- For a **light-dependent resistor (LDR)**:
 - as light intensity increases
 - resistance decreases
- For a **thermistor** (with a negative temperature coefficient):
 - as temperature increases
 - resistance decreases

10 – D.C. Circuits

10 D.C. CIRCUITS

10.1 Practical circuits

cell

a single electrical energy source which uses chemical reactions to produce a current



switch

a device used for making or breaking electric current through a circuit



battery of cells

multiple cells



or

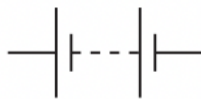

earth

a wire providing a low resistance path to the ground (so that in the event of a fault current passing through a metal case will pass to the ground instead of through a person)



power supply

supplies power to at least one electrical load



electric bell

a device that uses electromagnets to produce a repetitive sound



a.c. power supply

a power supply that uses an alternating current



buzzer

a device that makes a sound when an electric current passes through it



junction of conductors

a point where three or more circuit paths meet



microphone

a device that converts sound waves into electrical signals



lamp

a device for producing illumination



loudspeaker

a device that converts electrical signals into sound waves

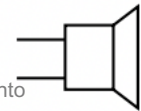

fixed resistor

a resistor whose resistance does not change with changes in voltage or temperature

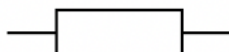

motor

a device which produces a rotational force when a current passes through it

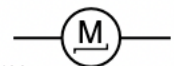

variable resistor

a resistor whose resistance can be adjusted

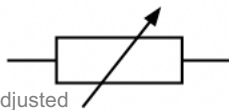

generator

a device that produces a current when a rotational force is applied to it



thermistor

a resistor whose resistance decreases as temperature increases



ammeter

used to measure the magnitude of a current through a component



light-dependent resistor

a resistor whose resistance decreases as light intensity increases

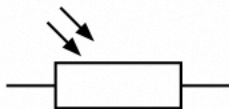

voltmeter

used to measure potential difference across a component



heater

a device that converts electric current into heat



galvanometer

used to measure the magnitude and direction of current through a component



potentiometer

used to measure current through a component

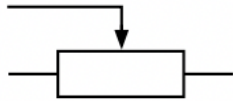

oscilloscope

a device that graphically displays the potential difference across itself



diode

a device that allows electric current to flow in one direction only



capacitor

a device that stores electric charge in an electric field

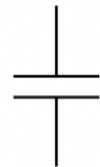

light-emitting diode

a diode that emits light in forward bias

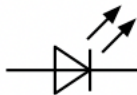

- The **electromotive force (e.m.f.)** of a source is the energy transferred per unit charge in driving charge around a complete circuit.
- **Internal resistance** is the resistance between the terminals of a power supply.
- **Terminal potential difference** is the potential difference across the terminals of a cell when a current is being delivered.

By conservation of energy, the electromotive force of a source is made up of :

- o a p.d. across an external resistor (load) of resistance R and
- o a p.d. across an internal resistance r

$$E = V_{load} + V_{power\ supply}$$

$$E = V_R + V_r$$

$$V_R = IR \quad \text{and} \quad V_r = Ir, \text{ so}$$

$$E = IR + Ir$$

- A power supply with a high internal resistance will result in a lower terminal potential difference, and vice versa.

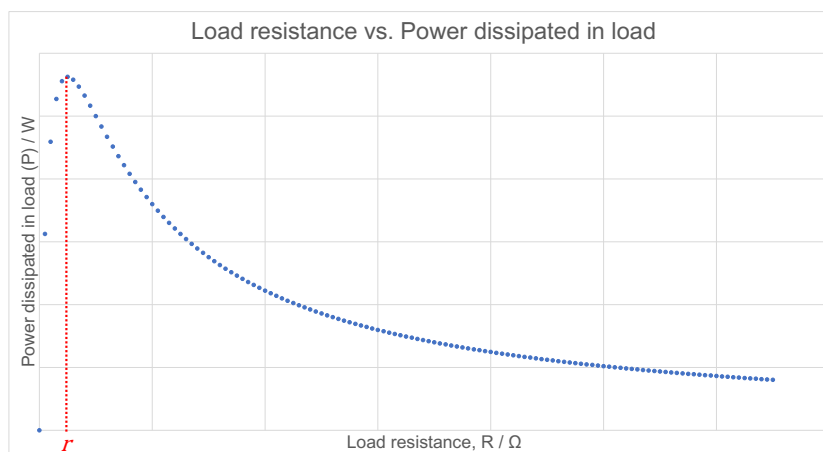

- A battery delivers maximum power to a circuit when the load resistance of the circuit is equal to the internal resistance of the battery.

10 – D.C. Circuits

10.2 Kirchhoff's laws

- **Kirchhoff's first law:** *the sum of the currents entering a junction in a circuit is always equal to the sum of the currents leaving the junction*

$$I = I_1 + I_2 + I_3 + \dots$$

- **Kirchhoff's second law:** *the sum of the electromotive forces in a closed circuit is equal to the sum of the potential differences*

$$V = V_1 + V_2 + V_3 + \dots$$

$$E = IR_1 + IR_2 + IR_3 + \dots$$

- Two or more resistors in series:

$$V = V_1 + V_2 + V_3 + \dots$$

$$\Rightarrow IR = IR_1 + IR_2 + IR_3 + \dots$$

$$\Rightarrow R = R_1 + R_2 + R_3 + \dots$$

- Two or more resistors in parallel:

$$I = I_1 + I_2 + I_3 + \dots$$

$$\Rightarrow \frac{V}{R} = \frac{V}{R_1} + \frac{V}{R_2} + \frac{V}{R_3} + \dots$$

$$\Rightarrow \frac{1}{R} = \frac{1}{R_1} + \frac{1}{R_2} + \frac{1}{R_3} + \dots$$

10.3 Potential dividers

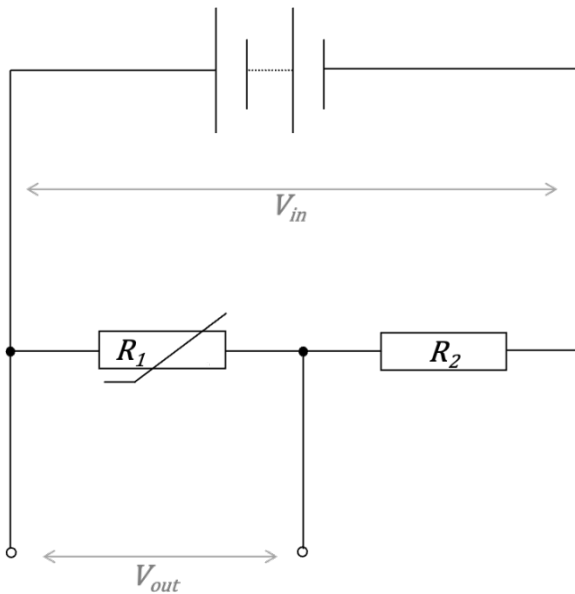

$$V_{out} = V_{in} \frac{R_1}{R_1 + R_2}$$

As R_1 increases, R_1 consumes a **larger** proportion of the total potential difference, so V_{out} increases.

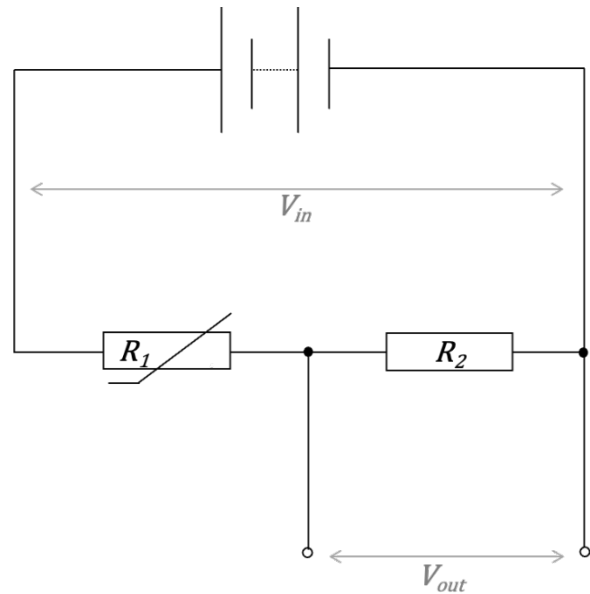

$$V_{out} = V_{in} \frac{R_2}{R_1 + R_2}$$

As R_1 increases, R_2 consumes a **smaller** proportion of the total potential difference, so V_{out} decreases.

- How a potential divider circuit works:
 - a fixed resistor and a variable resistor are connected in series
 - the variable resistor may take the form of an LDR, thermistor or similar
 - a component can be connected across one of the resistors (V_{out})
 - the potential difference across this component can be adjusted as needed
- **Thermistors** and **light-dependent resistors** can be used instead of a regular variable resistor to provide a potential difference that is dependent on temperature and light intensity.
- This can be useful in systems relating to heating, streetlighting or even phone brightness sensors.

10 – D.C. Circuits

- Potentiometer:
 - o a device that behaves as an adjustable potential divider
 - o wiper controls how much of the resistor is 'used' and therefore the resistance
 - o output voltage depends on the resistance
 - o can be used as a means of comparing potential differences (using a galvanometer)

Potentiometer **circuit**:

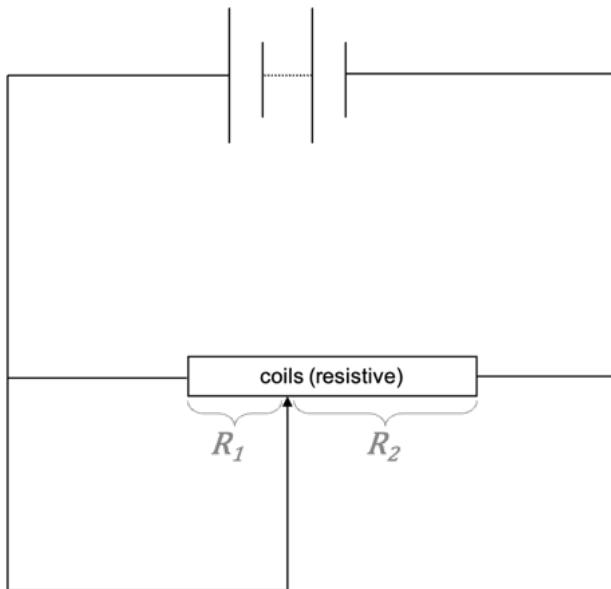

Potentiometer **diagram**:

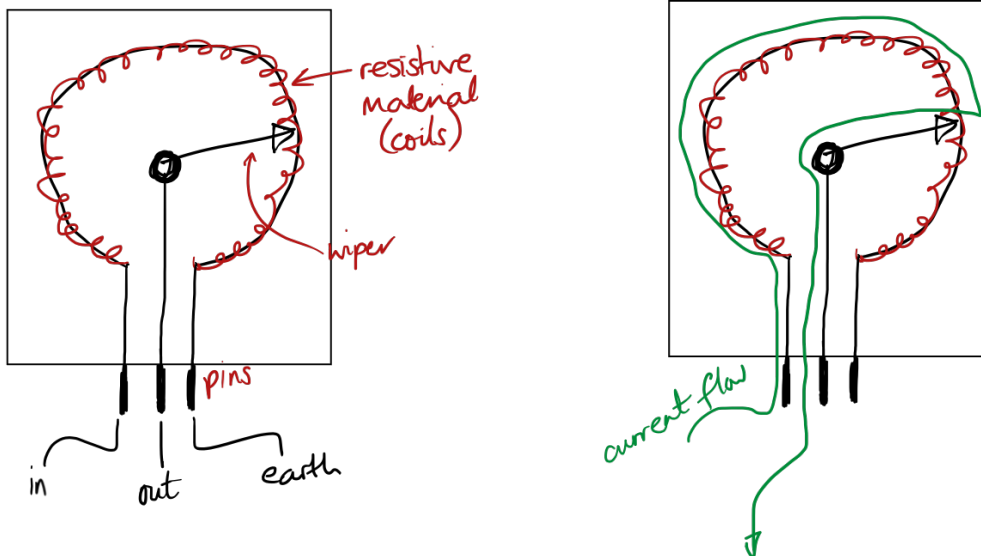

- A **galvanometer** is an analogue current-measuring instrument which shows both the magnitude and direction of the current flowing through it.
- A galvanometer can be used with a potential divider in null methods to compare potential differences:
 - the two-way switch is set to A
 - the wiper position is adjusted along a resistive wire until the galvanometer reads zero
 - at this point (balance point), the p.d. across l_A is 'balanced' by the e.m.f. of A
 - there is no current flowing through cell A
 - the same process is repeated for B
 - resistance is directly proportional to the length of the resistive wire
 - therefore the ratios of e.m.f.'s and lengths are equal: $\frac{E_A}{E_B} = \frac{l_A}{l_B}$

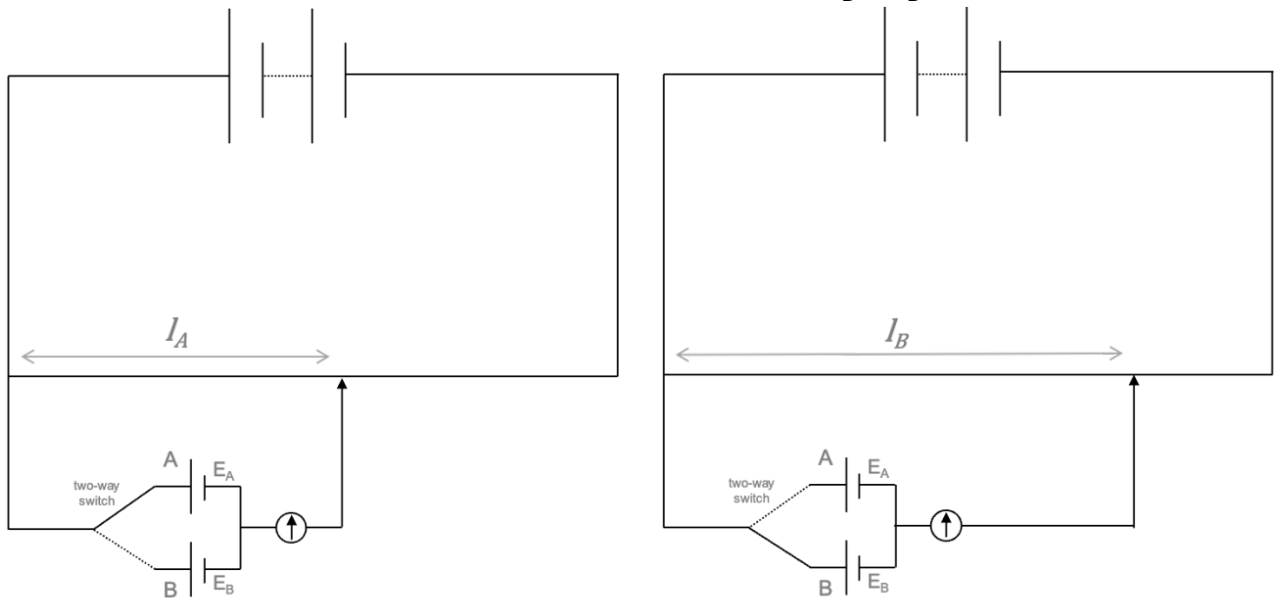

11 – Particles Physics

11 PARTICLE PHYSICS

11.1 Atoms, nuclei and radiation

- The α -scattering experiment:

Observations	Conclusions
most went straight through or were deviated by small angles ($<10^\circ$)	most of atom is empty space
very few were deviated by large angles ($>90^\circ$)	mass and charge concentrated in (very small) nucleus

- Nuclear model of the atom:
 - o mass and positive charge concentrated in nucleus
 - o nucleus is about 1 / 10 000 size of atom
 - o nucleus made up of protons and neutrons
 - o electrons orbit nucleus at fixed energy levels

nucleon number = no. of **protons + neutrons**

proton number = no. of **protons**

- **Isotopes** are forms of the same element with different numbers of neutrons in their nuclei.
- A **nuclide** is a class of nuclei that have a particular nucleon and proton number.
- Nuclides can be notated as ${}^A_Z X$ where A is the nucleon number and Z is the proton number.
- In nuclear processes, the nucleon number and charge are conserved.
- An **antiparticle** has the same mass but opposite charge to the corresponding particle.
- A positron is the antiparticle of an electron.

Type of radiation	Composition	Mass	Charge
α	helium nucleus (2 protons + 2 neutrons)	4u	+ 2e
β^-	electron	u / 2000	- e
β^+	positron (<i>positive electron</i>)	u / 2000	+ e
γ	short-wavelength electromagnetic waves	0	0

- The unified atomic mass unit (u) is a unit of mass where $1u = 1.66 \times 10^{-27}$ kg.
- The force responsible for decay is **weak nuclear force**.

Type of decay	Nature	General equation	Energy
α	nucleus emits two protons and two neutrons	${}^A_Z X \rightarrow {}^{A-4}_{Z-2} Y + \frac{4}{2} \alpha$ ${}^{238}_{92} \text{U} \rightarrow {}^{234}_{90} \text{Th} + \frac{4}{2} \alpha$	discrete energies that are equal for a particular radioactive nuclide
β^-	a neutron transforms into a proton, electron and antineutrino	${}^A_Z X \rightarrow {}^A_{Z+1} Y + {}^0_{-1} e + {}^0_0 \bar{\nu} + \text{energy}$ ${}^{214}_{82} \text{Pb} \rightarrow {}^{214}_{83} \text{Bi} + {}^0_{-1} e + {}^0_0 \bar{\nu} + \text{energy}$	continuous range of energies because even though the total decay energy is constant for a particular nuclide, the amount of energy transferred to the (anti)neutrino varies
β^+	a proton transforms into a neutron, positron and neutrino	${}^A_Z X \rightarrow {}^A_{Z-1} Y + {}^0_1 e + {}^0_0 \nu + \text{energy}$ ${}^{30}_{15} \text{P} \rightarrow {}^{30}_{14} \text{Si} + {}^0_1 e + {}^0_0 \nu + \text{energy}$	

11 – Particles Physics

11.2 Fundamental particles

- A **quark** is a fundamental particle and there are six flavours (types) of quark.
- Antiquarks have the opposite charge of their respective quark.

QUARKS		ANTIQUARKS	
flavour	charge	flavour	charge
up (u)	$+\frac{2}{3}e$	anti-up (\bar{u})	$-\frac{2}{3}e$
down (d)	$-\frac{1}{3}e$	anti-down (\bar{d})	$+\frac{1}{3}e$
strange (s)	$-\frac{1}{3}e$	anti-strange (\bar{s})	$+\frac{1}{3}e$
charm (c)	$+\frac{2}{3}e$	anti-charm (\bar{c})	$-\frac{2}{3}e$
bottom (b)	$-\frac{1}{3}e$	anti-bottom (\bar{b})	$+\frac{1}{3}e$
top (t)	$+\frac{2}{3}e$	anti-top (\bar{t})	$-\frac{2}{3}e$

- Protons and neutrons are not fundamental particles because they are composed of quarks.

proton:

	u	u	d
charge:	$+e$	$+\frac{2}{3}e$	$+\frac{2}{3}e$
			$-\frac{1}{3}e$

neutron:

	u	d	d
charge:	0	$+\frac{2}{3}e$	$-\frac{1}{3}e$
			$-\frac{1}{3}e$

- Subatomic particles are categorised as:
 - o **hadrons:**
 - affected by **strong nuclear force** (holds protons and neutrons together)
 - in the nucleus (protons and neutrons)
 - made up of quarks
 - **baryons** consist of three quarks
 - **mesons** consist of one quark and one antiquark
 - o **leptons:**
 - not affected by strong force
 - not in the nucleus (electrons and antineutrinos)
 - are fundamental particles

12 MOTION IN A CIRCLE

12.1 Kinematics of uniform circular motion

- One radian ($1^c \approx 57.3^\circ$) is equal to the angle subtended at the centre of a circle by an arc equal in length to the radius.
- **Angular displacement** is the change in angle (rad).
- **Angular speed** is the rate of change in angle (rad s^{-1}).
- **Angular frequency** is the number of complete rotations/oscillations per second (rad s^{-1}):

$$\omega = \frac{2\pi}{T}$$

- **Tangential velocity** is the linear speed of an object in circular motion:

$$v = \omega r$$

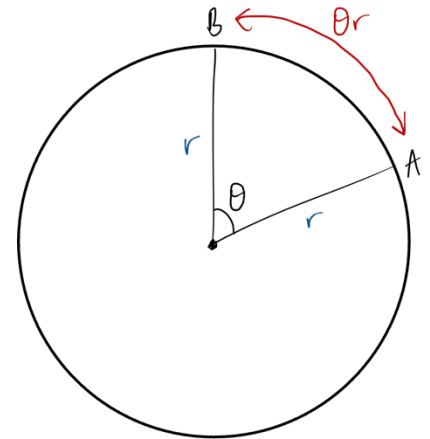

12.2 Centripetal acceleration

- **Centripetal acceleration** is caused by a force of constant magnitude that is always perpendicular to the direction of motion. This causes circular motion with a constant angular speed.

$$a = r\omega^2 \quad F = mr\omega^2$$

$$a = \frac{v^2}{r} \quad F = \frac{mv^2}{r}$$

13 – Gravitational fields

13 GRAVITATIONAL FIELDS

13.1 Gravitational field

- A **gravitational field** is an example of a field of force.
- Gravitational field is equal to force per unit mass (i.e. N kg^{-1}).

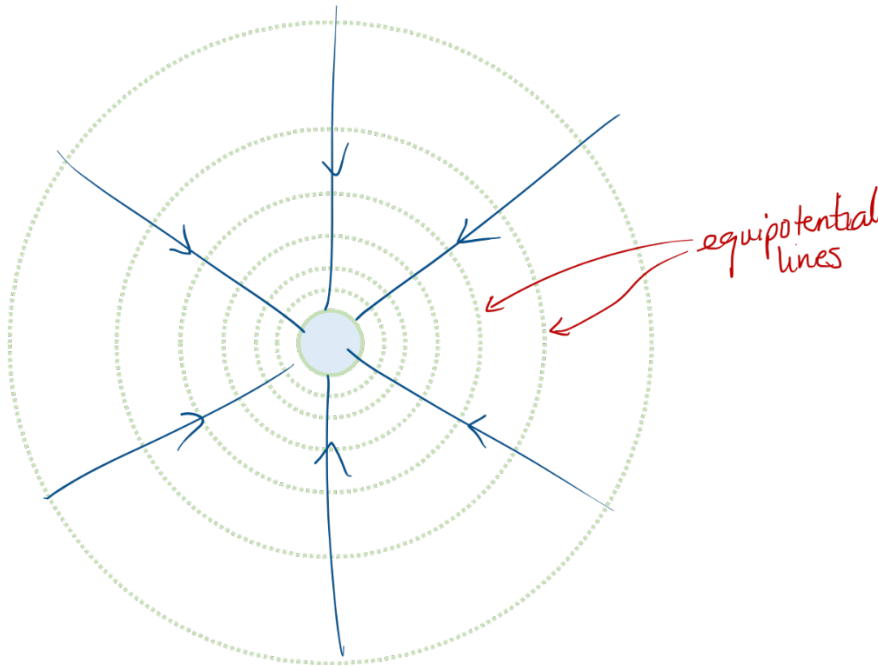

13.2 Gravitational force between point masses

- For a point outside a uniform sphere, the mass of the sphere may be considered to be a point mass at its centre.

Newton's Law of Gravitation: the force between two point masses is directly proportional to the product of their masses and inversely proportional to the square of their separation distance, given by:

$$F = \frac{Gm_1m_2}{r^2} \quad \text{alternatively:} \quad F = \frac{GMm}{r^2}$$

- Circular orbits in gravitational fields can be analysed by relating the *gravitational force* ($F = \frac{Gm_1m_2}{r^2}$) to the *centripetal acceleration* it causes ($F = ma$).
- A satellite in a **geostationary orbit** remains at the same point above the Earth's surface:
 - has an orbital period of 24 hours
 - orbits from west to east
 - positioned directly above the Equator

13.3 Gravitational field of a point mass

- **Gravitational field strength** due to a point mass can be derived from *Newton's law of gravitation* and the *definition of gravitational field*.

$$g = \frac{F}{m}$$

$$g = \frac{\frac{GMm}{r^2}}{m}$$

$$g = \frac{GM}{r^2}$$

- For small changes in height near the Earth's surface, g is approximately constant because a small change in height is small enough to consider negligible compared to the distance to the centre of mass of the Earth, i.e. $\Delta h \ll r$.

13.4 Gravitational potential

- **Gravitational potential** at a point is the work done per unit mass in bringing a small test mass from infinity to the point.

Gravitational potential in the field due to a point mass is given as

$$\phi = -\frac{GM}{r}$$

- How the concept of gravitational potential leads to the gravitational potential energy of two point masses:
 - o let there be two objects of masses M and m respectively, r metres apart
 - o gravitational potential is work done per unit mass in bringing these masses together
 - o the energy stored in the objects which is overcoming this work done is called gravitational potential energy.

Gravitational potential energy of an object of mass m :

$$E_p = -\frac{GMm}{r} \quad \text{and} \quad E_p = mgh$$

Additional but
worth noting

$$E_{total} = E_{potential} + E_{kinetic}$$

Escape velocity can be found by:

$$E_{kinetic} \geq E_{potential} \quad \Rightarrow \quad \frac{1}{2}mv^2 - \frac{GMm}{r} \geq 0 \quad \Rightarrow \quad v_{esc} = \sqrt{\frac{2GM}{r}}$$

13 – Gravitational fields

Equation summary

$$F = \frac{GMm}{r^2} \quad E_p = -\frac{GMm}{r}$$

$$g = \frac{GM}{r^2} \quad \phi = -\frac{GM}{r}$$

- Gravitational force is the rate of change of gravitational potential energy.

$$F = \frac{dE_p}{dr} \quad \Rightarrow \quad F = \frac{d}{dr} \left(-\frac{GMm}{r} \right)$$

$$E_p = \int F \, dr \quad \Rightarrow \quad E_p = \int \frac{GMm}{r^2} \, dr$$

- Gravitational field strength is the rate of change of gravitational potential.

$$g = \frac{d\phi}{dr} \quad \Rightarrow \quad g = \frac{d}{dr} \left(-\frac{GM}{r} \right)$$

$$\phi = \int g \, dr \quad \Rightarrow \quad \phi = \int \frac{GM}{r^2} \, dr$$

14 TEMPERATURE

14.1 Thermal equilibrium

- Thermal energy is transferred from a region of higher temperature to a region of lower temperature.
- Regions of equal temperature are in **thermal equilibrium**.

14.2 Temperature scales

- A physical property that varies with temperature may be used to measure temperature, e.g.:
 - o density of a liquid
 - o volume of a gas at constant pressure
 - o resistance of a metal
 - o e.m.f. of a thermocouple
- A **thermocouple** is a device where one end of each of two wires of different metals are twisted together and the other ends are connected to the terminals of a sensitive voltmeter.
- The scale of thermodynamic temperature does not depend on the property of any particular substance.
- $T/K = \theta/^{\circ}C + 273.15$
- The lowest possible temperature is zero kelvin on the thermodynamic temperature scale.
- This is known as **absolute zero**, where particles have zero kinetic energy.

14 – Temperature

14.3 Specific heat capacity and specific latent heat

- **Specific heat capacity** is the thermal energy per unit mass to raise the temperature of a substance by 1K.

$$Q = m c \Delta T$$

where Q is the thermal energy
 m is the mass of the substance
 c is the specific heat capacity
 T is the thermodynamic temperature

- **Specific latent heat** is the thermal energy per unit mass required to change the state of a substance without changing its temperature.
- The **specific latent heat of fusion** is for changes between the solid and liquid states.
- The **specific latent heat of vaporisation** is for changes between the liquid and gas states.

$$Q = m L$$

where Q is the thermal energy
 m is the mass of the substance
 L is the specific latent heat

15 IDEAL GASES

15.1 The mole

- Amount of substance is an SI base quantity with the base unit **mol**.
- One mole of any substance is the amount containing a number of particles of that substance equal to the **Avogadro constant** N_A .

15.2 Equation of state

- A gas obeying $pV \propto T$, where T is the thermodynamic temperature, is an **ideal gas**.

Equation of state for an ideal gas:

$$pV = nRT \quad \text{or} \quad pV = NkT$$

where

- n is the amount of substance (number of moles)
- N is the number of molecules
- p is the pressure
- V is the volume
- T is the thermodynamic temperature
- R is the gas constant
- k is the Boltzmann constant given by $k = \frac{R}{N_A}$

15.3 Kinetic theory of gases

- The basic assumptions of the kinetic theory of gases:
 - a gas consists of a very large number of molecules moving in random directions and random speeds
 - all molecules behave as identical, hard, perfectly elastic spheres
 - there are no forces of attraction or repulsion between molecules
 - volume of the molecules is negligible with the volume of the containing vessel
 - time of collisions between molecules is negligible compared to the time between collisions
- How molecular movement causes pressure:
 - a molecule of mass m is moving at a speed $c_x \text{ ms}^{-1}$
 - it has a momentum $p = mc_x \text{ kg ms}^{-1}$
 - when it collides with the wall of its containing vessel the velocity changes direction
 - it has a new momentum $p = -mc_x \text{ kg ms}^{-1}$
 - $\Delta p = -2mc_x \text{ kg ms}^{-1}$
 - the impulse experienced by the wall is equal and opposite (i.e. $2mc_x \text{ kg ms}^{-1}$)

15 – Ideal Gases

- In an ideal gas, the mean-square speeds in each direction are equal:
 $\langle c_x^2 \rangle = \langle c_y^2 \rangle = \langle c_z^2 \rangle$
 $\langle c_x^2 \rangle = \frac{1}{3} \langle c^2 \rangle$
- In a container of length L m, it will take $\frac{L}{c_x}$ seconds to move between the two walls perpendicular to the x -axis and $\frac{2L}{c_x}$ seconds to make a round trip back to the same wall.

At a collision with the wall, the pressure can be calculated from the force and area:

$$F = \frac{\Delta p}{\Delta t} = \frac{2mc_x}{2L/c_x} = \frac{mc_x^2}{L}$$

$$p = \frac{F}{A} = \frac{mc_x^2/L}{WH} = \frac{mc_x^2}{LWH}$$

Since $V = LWH$ and there are N molecules

$$p = \frac{Nmc_x^2}{V}$$

$$pV = Nmc_x^2$$

Since $\langle c_x^2 \rangle = \frac{1}{3} \langle c^2 \rangle$

$$pV = \frac{1}{3} Nm \langle c^2 \rangle$$

Comparing the two equations for pV

$$pV = \frac{1}{3}Nm\langle c^2 \rangle = NkT$$

$$\frac{1}{3}m\langle c^2 \rangle = kT$$

$$m\langle c^2 \rangle = 3kT$$

$$\frac{1}{2}m\langle c^2 \rangle = \frac{3}{2}kT$$

Therefore the **average translational kinetic energy** of a molecule is given by

$$E_k = \frac{3}{2}kT$$

c_{rms} can be found by:

$$(c_{rms} = \sqrt{\langle c^2 \rangle})$$

$$\frac{1}{2}m\langle c^2 \rangle = \frac{3}{2}kT$$

$$\langle c^2 \rangle = \frac{3kT}{m}$$

$$\sqrt{\langle c^2 \rangle} = \sqrt{\frac{3kT}{m}}$$

Equation summary

$$pV = nRT$$

$$pV = NkT$$

$$pV = \frac{1}{3}Nm\langle c^2 \rangle = NkT$$

$$E_k = \frac{3}{2}kT$$

$$c_{rms} = \sqrt{\langle c^2 \rangle} = \sqrt{\frac{3kT}{m}}$$

$$\langle c_x^2 \rangle = \langle c_y^2 \rangle = \langle c_z^2 \rangle$$

$$\langle c_x^2 \rangle = \frac{1}{3}\langle c^2 \rangle$$

16 – Thermodynamics

16 THERMODYNAMICS

16.1 Internal energy

- Internal energy:
 - o is determined by the state of the system
 - o can be expressed as the sum of a random distribution of kinetic and potential energies associated with the molecules of a system.
- As the temperature of an object increases, its internal energy increases.
- In an ideal gas there are no intermolecular forces (i.e. no potential energies) so the internal energy is equal to the kinetic energy of the gas.

16.2 The first law of thermodynamics

- When the volume of a gas changes at constant pressure:
 - o work is done on the gas in order to change the volume (e.g. by pushing a piston)
 - o the kinetic energy of the gas increases
 - o the internal energy of the gas increases
 - o work is done by the gas on the atmosphere to overcome external pressure

$$W = p \Delta V$$

where W is the work done by the gas
 p is the pressure of the surroundings
 ΔV is the change in volume

- **The first law of thermodynamics:**

$$\Delta U = q + W$$

where ΔU is the increase in internal energy
 q is the heating of the system (energy transferred to the system by heating)
 W is the work done on the system

17 OSCILLATIONS

17.1 Simple harmonic oscillations

- Terms relating to oscillations:
 - **displacement:** distance from the equilibrium position
 - **amplitude:** maximum displacement
 - **period:** time taken for one complete oscillation
 - **frequency:** number of oscillations per unit time
 - **angular frequency:** rate of change of angle where one rotation is 2π radians
 - **phase difference:** the fraction of a cycle that passes between a particle being at maximum displacement in a given direction and another particle being at maximum displacement in that direction
- **Simple harmonic motion** occurs when acceleration is proportional to displacement from a fixed point and in the opposite direction.
- The acceleration of a particle in simple harmonic motion at displacement x is given by:

$$a = -\omega^2 x$$

The solution to $a = -\omega^2 x$ is given by:

$$x = x_0 \sin \omega t$$

It follows that the acceleration of a particle in simple harmonic motion is given by:

$$a = -a_0 \sin \omega t \quad \text{or} \quad a = -\omega^2 x_0 \sin \omega t$$

- The velocity of a particle in simple harmonic motion is given by $\frac{dx}{dt}$, i.e.

$$v = v_0 \cos \omega t \quad \text{or} \quad v = \omega x_0 \cos \omega t \quad \text{or} \quad v = \pm \omega \sqrt{x_0^2 - x^2}$$

where

a is the acceleration of the particle

ω is the angular frequency

t is a given time

x is the displacement at time t

x_0 is the amplitude of the oscillation

v is the velocity at time t

v_0 is the maximum speed

a is the acceleration at time t

a_0 is the maximum magnitude of the acceleration

17 – Oscillations

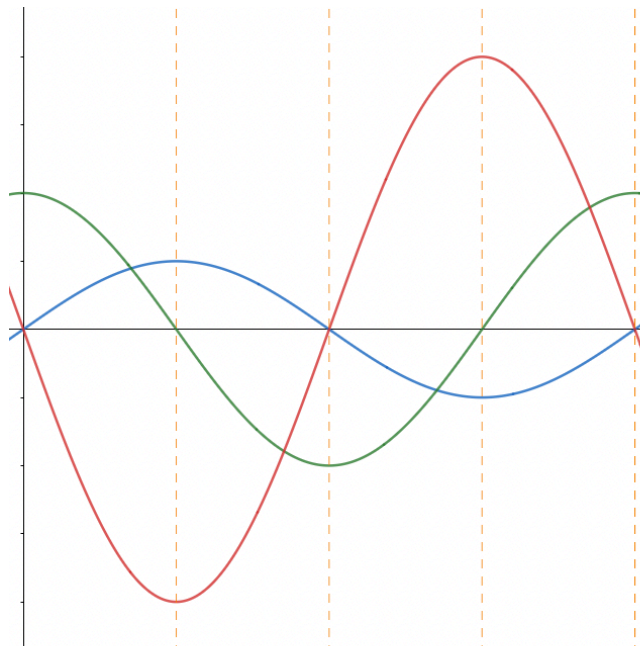

This graph shows the **displacement**, **velocity** and **acceleration** of a particle in simple harmonic motion.

At zero displacement, there is zero acceleration (changing direction) and maximum velocity in the direction of the new acceleration.

At maximum displacement, there is maximum acceleration (magnitude) and zero velocity.

17.2 Energy in simple harmonic motion

- During simple harmonic motion, energy is transferred between a particle's kinetic and potential energy stores:
 - o at zero displacement, the particle has maximum kinetic energy
 - o at maximum displacement, the particle has maximum potential energy
 - o the total energy of the particle is given by $E_k + E_p$
- The total energy of a system undergoing simple harmonic motion is given by:

$$E = \frac{1}{2}m\omega^2x_0^2$$

where E is the energy of the system
 m is the mass of the particle
 ω is the angular frequency
 x_0 is the amplitude of the oscillation

17.3 Damped and force oscillations, resonance

- Damping is caused by a resistive force acting on an oscillating system.
- Terms relating to damping:
 - **light damping:** causes amplitude to decrease gradually
 - **critical damping:** causes amplitude to be reduced to zero in the shortest time possible, without oscillation
 - **heavy damping:** causes exponential reduction in displacement, more slowly than critical damping

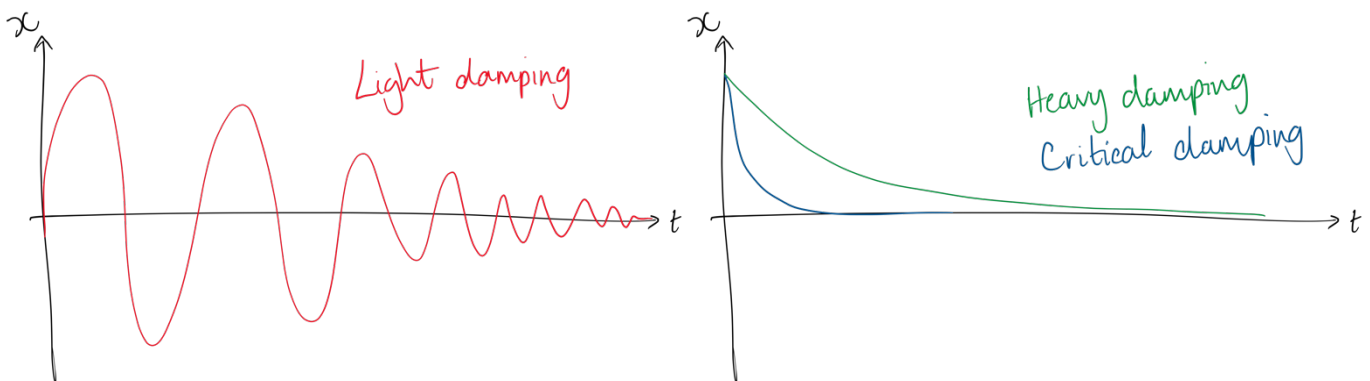

- **Resonance** involves a maximum amplitude of oscillations.
- This occurs when an oscillating system is forced to oscillate at its natural frequency.

Equation summary

$$x = x_0 \sin \omega t$$

$$v = v_0 \cos \omega t \quad \text{or} \quad v = \omega x_0 \cos \omega t$$

$$a = -a_0 \sin \omega t \quad \text{or} \quad a = -\omega^2 x_0 \sin \omega t \quad \text{or} \quad a = -\omega^2 x$$

$$E = \frac{1}{2} m \omega^2 x_0^2$$

18 – Electric Fields

18 ELECTRIC FIELDS

18.1 Electric fields and field lines

- An **electric field** is a region of space where a stationary charge experiences a force.
- **Electric field** is force per unit positive charge.
- The force on a charge in an electric field is given by:

$$F = qE$$

where F is the force on the charge
 q is value of the charge
 E is the electric field strength at that point

- An electric field can be represented by means of field lines:
 - o lines must meet charges/charged plates at right angles

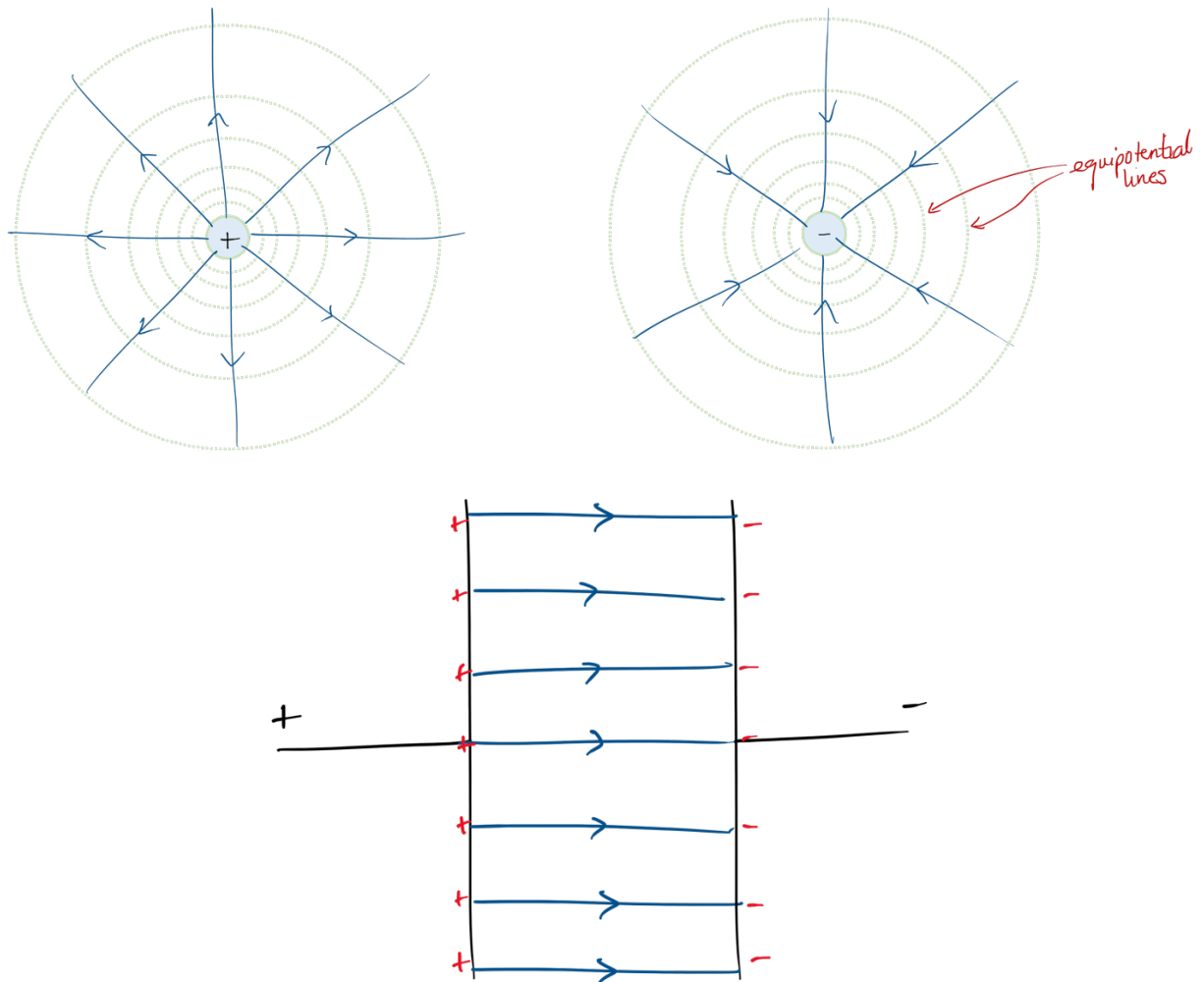

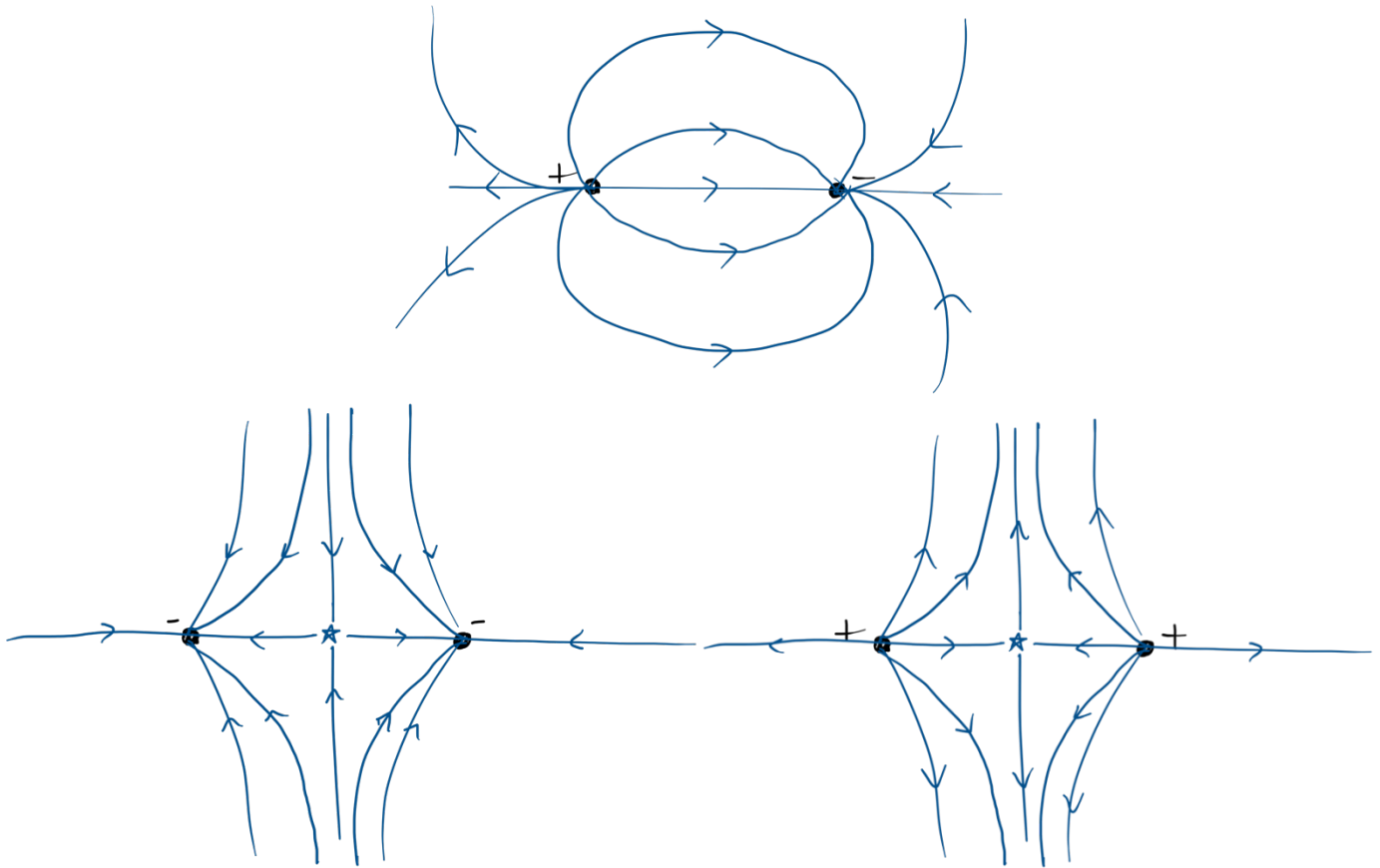

18.2 Uniform electric fields

- The field strength of the uniform field between charged parallel plates is given by:

$$E = \frac{\Delta V}{\Delta d}$$

where E is the electric field strength
 ΔV is the potential difference
 Δd is the distance

- For charged particles experiencing a uniform electric field with an initial velocity:
 - **parallel to the field direction:** the final velocity can be calculated from the kinetic energy transferred by the work done by the field on the particle.
 - **perpendicular to the field direction:** the vertical component experiences a constant force (and therefore constant acceleration) towards one of the plates

18 – Electric Fields

18.3 Electric force between point charges

- For a point outside a spherical conductor, the charge on the sphere may be considered to be a point charge at its centre.

Coulomb's Law: the force between two point charges in free space is proportional to the product of their charges and inversely proportional to the square of their separation distance, given by:

$$F = \frac{Q_1 Q_2}{4\pi\epsilon_0 r^2}$$

where F is the force between the two point charges
 Q_1 and Q_2 are the values of the charges
 ϵ_0 is the permittivity of free space
 r is distance between the point charges

18.4 Electric field of a point charge

- The electric field strength due to a point charge in free space is given by:

$$E = \frac{Q}{4\pi\epsilon_0 r^2}$$

18.5 Electric potential

- **Electric potential** at a point is the work done per unit positive charge in bringing a small test charge from infinity to the point.
- The electric field at a point is equal to the negative of potential gradient at that point, hence:

$$V = \frac{Q}{4\pi\epsilon_0 r}$$

- The electric potential energy of two point charges is the work done to bring together two isolated point charges q and Q so that their separation is r metres, given by:

$$E_p = \frac{Qq}{4\pi\epsilon_0 r}$$

Equation summary

$$F = qE \quad (\text{force on a charge in electric field})$$

$$E = \frac{\Delta V}{\Delta d} \quad (\text{electric field strength of uniform field})$$

$$F = \frac{Q_1 Q_2}{4\pi\epsilon_0 r^2} \quad (\text{force between two point charges in free space})$$

$$E = \frac{Q}{4\pi\epsilon_0 r^2} \quad (\text{electric field strength due to a point charge in free space})$$

$$V = \frac{Q}{4\pi\epsilon_0 r} \quad (\text{electric potential in the field due to a point charge})$$

$$E_p = \frac{Qq}{4\pi\epsilon_0 r} \quad (\text{electric potential energy of two point charges})$$

19 – Capacitance

19 CAPACITANCE

19.1 Capacitors and capacitance

- Capacitance is:
 - o in **isolated spherical conductors**: the ratio of charge to potential for a conductor
 - o in **parallel plate capacitors**: the charge stored on one plate per unit potential difference between the plates

$$C = \frac{Q}{V}$$

where C is the capacitance
 Q is the charge
 V is the potential difference

- Combining capacitors in series:

$$V_T = V_1 + V_2$$

$$\Rightarrow \frac{Q_T}{C_T} = \frac{Q_1}{C_1} + \frac{Q_2}{C_2} \quad (Q_T = Q_1 = Q_2)$$

$$\Rightarrow \frac{1}{C_T} = \frac{1}{C_1} + \frac{1}{C_2}$$

- Combining capacitors in parallel:

$$Q_T = Q_1 + Q_2$$

$$\Rightarrow V_T C_T = V_1 C_1 + V_2 C_2 \quad (V_T = V_1 = V_2)$$

$$\Rightarrow C_T = C_1 + C_2$$

19.2 Energy stored in a capacitor

- Electric potential energy stored in a capacitor can be determined from the area under its potential-charge graph.

$$W = \frac{1}{2} QV = \frac{1}{2} CV^2$$

19.3 Discharging a capacitor

- For a capacitor discharging through a resistor, **potential difference, charge and current** exponentially decrease.

$$V = V_0 e^{-\frac{t}{RC}} \quad Q = Q_0 e^{-\frac{t}{RC}} \quad I = I_0 e^{-\frac{t}{RC}}$$

- The time constant for a capacitor discharging through a resistor is given by

$$\tau = RC$$

where R is the load resistance
 C is the capacitance

20 – Magnetic Fields

20 MAGNETIC FIELDS

20.1 Concept of a magnetic field

- A **magnetic field** is a region of space where a moving charge experiences a force.
- It is a field force produced either by moving charges or permanent magnets.

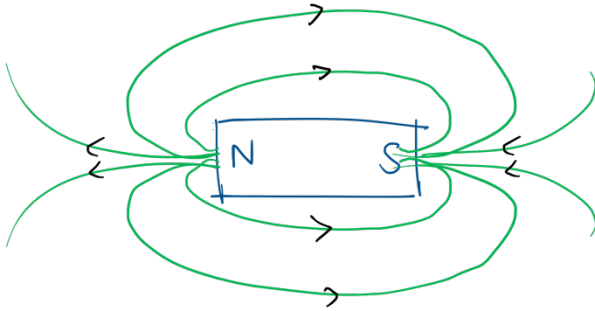

20.2 Force on a current-carrying conductor

- A force might act on a current-carrying conductor placed in a magnetic field.

$$F = BIL \sin \theta$$

where

F is the force acting on the current-carrying conductor

B is the magnetic flux density of the magnet causing the magnetic field

I is the current through the conductor

θ is the angle between the conductor and the direction of the magnetic field

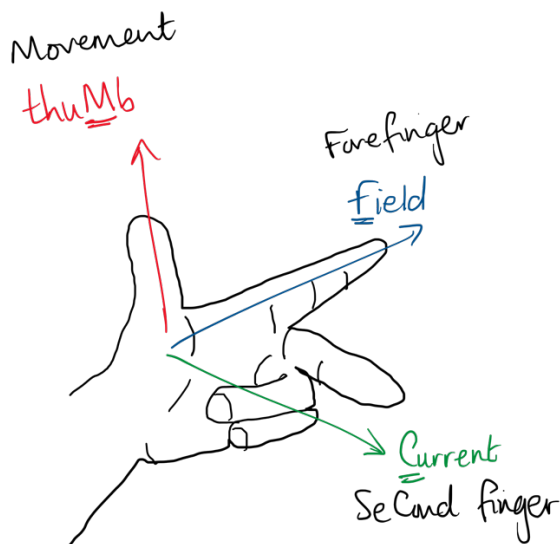

Fleming's Left Hand Rule

- **Magnetic flux density** is the force acting per unit current per unit length on a wire placed at right-angles to the magnetic field.

20.3 Force on a moving charge

$$F = BQv \sin \theta$$

where B is the magnetic flux density of the magnet causing the magnetic field
 Q is the size of the moving charge
 v is the speed of the moving charge
 θ is the angle between the conductor and the direction of the magnetic field

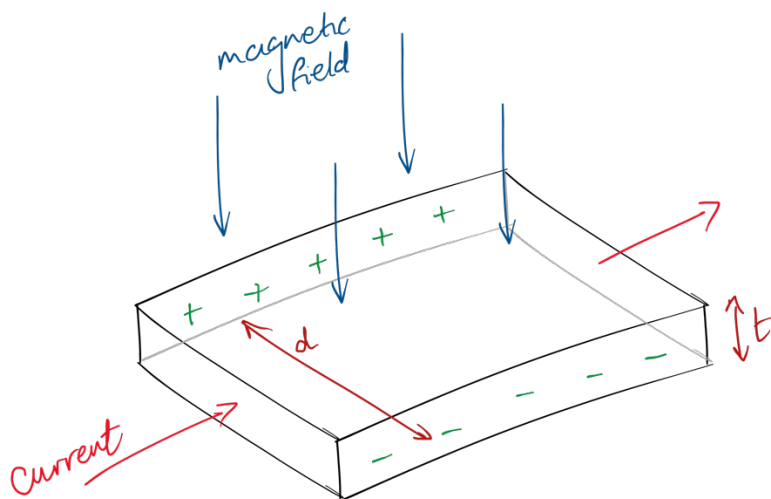

- Hall Voltage:
 - when there is a current in the conductor, charge carriers will move perpendicular to the magnetic field
 - by Fleming's Left Hand Rule, positive charges will 'move' to one side of the conductor, i.e. electrons will move to the other side of the conductor
 - a potential difference (Hall voltage) will develop across the conductor.

Force on each charge carrier (due to electric field strength E):

$$F_E = qE$$

$$F_E = q \left(\frac{V_H}{d} \right)$$

Force on each charge carrier (due to magnetic field of flux density B):

$$F_B = Bqv$$

When the electric field has been established, $F_E = F_B$ and so:

$$q \left(\frac{V_H}{d} \right) = Bqv$$

$$\frac{V_H}{d} = Bv$$

where $I = Anvq = (td)nv \Rightarrow d = \frac{I}{tnq}$:

$$V_H = \frac{BI}{ntq}$$

20 – Magnetic Fields

$$V_H = \frac{BI}{ntq}$$

where B is the magnetic flux density
 I is the current through the conductor
 n is the number density of charge carriers
 t is the thickness of the conductor
 q is the charge on an electron

- How a **Hall probe** is used to measure magnetic flux density:
 - o a thin slice of semiconductor is placed perpendicular to the direction of magnetic field
 - o the control unit passes a certain current through the semiconductor
 - o hall voltage is displayed on the control unit (where $V_H \propto B$)
 - o to ensure the slice is perpendicular to the magnetic field lines, it is rotated until the maximum reading is shown.

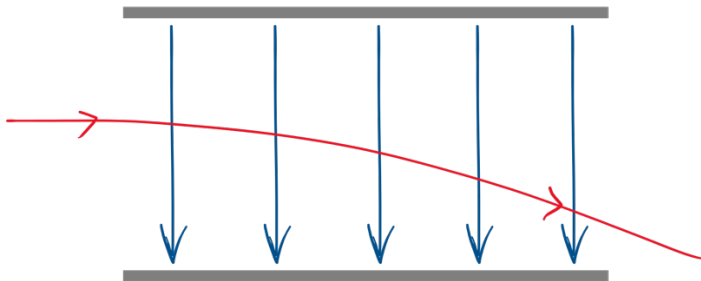

- A charged particle moving in a uniform magnetic field perpendicular to the direction of its motion:
 - o for a charge q the perpendicular force due to the electric field is $F = qE$
 - o there is a vertical acceleration of the particle
 - o it follows a parabolic path

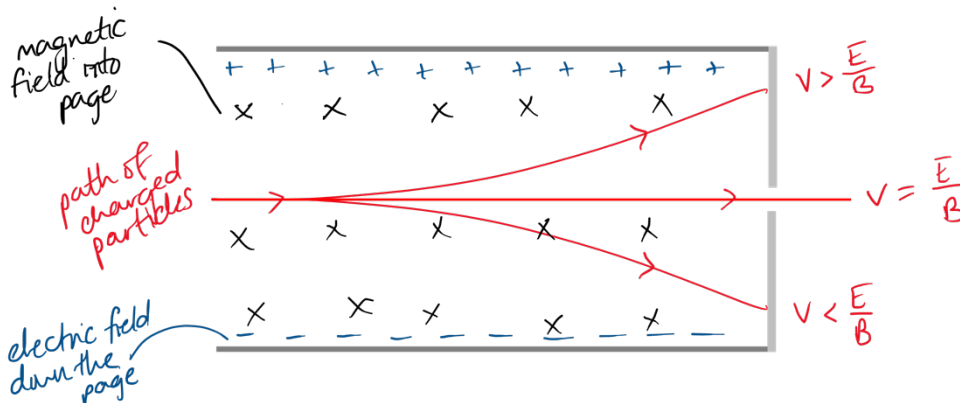

- Velocity selection:
 - o suppose an electric and magnetic field act in the same region, in opposite directions
 - o $Bqv = qE$
 - o $Bv = E$
 - o $v = \frac{E}{B}$
 - o for charge carriers with velocity v they will not be deflected
 - o for charge carriers with velocities greater or less than v they will be deflected

20.4 Magnetic fields due to currents

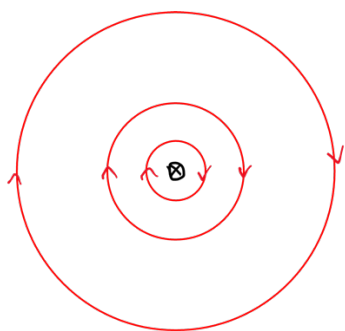

Magnetic field pattern due to current in **long straight wire**

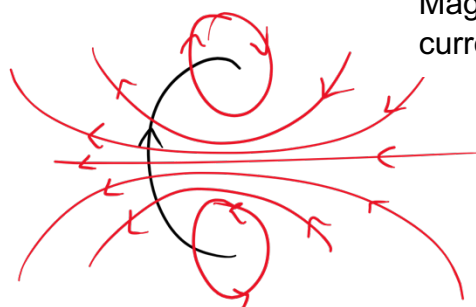

Magnetic field pattern due to current in **flat circular coil**

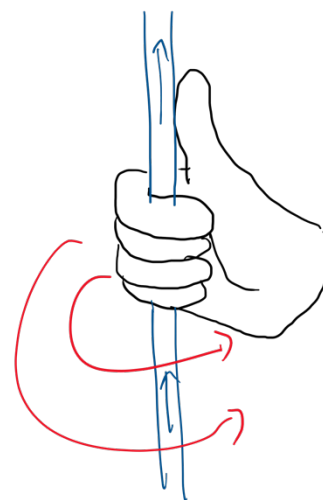

Right hand grip rule

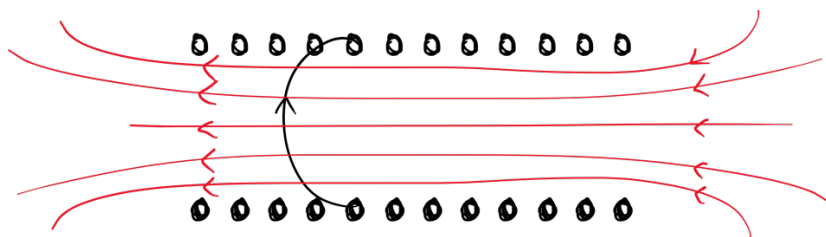

Magnetic field pattern due to current in **long solenoid**

- The magnetic field due to the current in a solenoid is increased by a **ferrous core** which concentrates the flux.
- Forces between current-carrying conductors:
 - o a current-carrying conductor has a magnetic field around it
 - o if a second current-carrying conductor is placed parallel to the first, the second conductor experiences a force due to the magnetic field of the first conductor
 - o if the currents are in the same direction, the conductors move together
 - o if the currents are in opposite directions, the conductors move apart

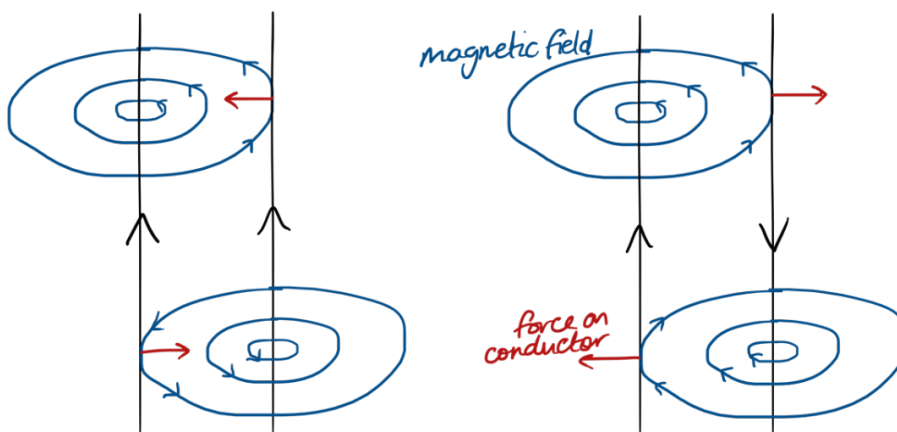

20 – Magnetic Fields

20.5 Electromagnetic induction

- **Magnetic flux** is the product of the magnetic flux density and cross-sectional area perpendicular to the direction of the magnetic flux density.

$$\Phi = BA$$

- **Magnetic flux linkage** is given by the product of the magnetic flux and number of turns in the coil.

$$N\Phi = BAN$$

- When the wire is moved through the magnetic field, an e.m.f. is induced, indicated by the current displayed on the galvanometer.
- The magnitude of the galvanometer reading (and induced e.m.f.) is increased by:
 - o moving the wire faster relative to the magnet
 - o increasing the number of turns on the loop

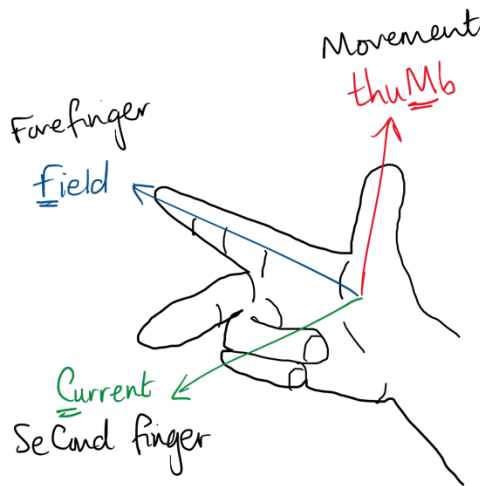
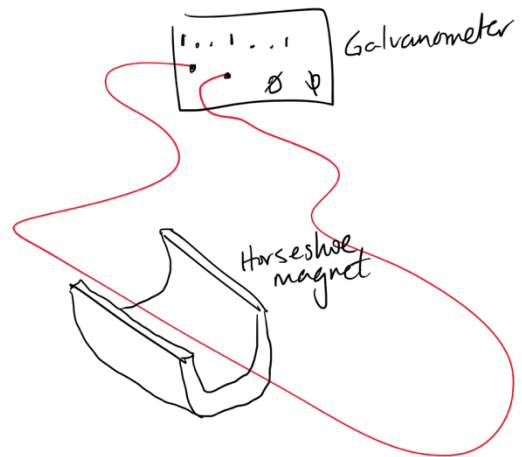

Fleming's Right Hand Rule

- **Faraday's Law:** the e.m.f. induced is proportional to the rate of change of magnetic flux linkage.
- **Lenz's Law:** the direction of the induced e.m.f. is such as to cause effects to oppose the change producing it.

$$E = -\frac{d}{dt}(N\Phi)$$

where

- o E is the induced e.m.f.
- o $N\Phi$ is the magnetic flux linkage

21 ALTERNATING CURRENTS

21.1 Characteristics of alternating currents

- A sinusoidally alternating current or voltage can be represented by equations of the form:

$$x = x_0 \sin \omega t$$

- Mean power in a resistive load is half the maximum power for a sinusoidal alternating current.
- Mean current and voltage is zero.
- The root-mean-square (r.m.s.) value of an alternating current or voltage is the value of the direct current or direct voltage that would deliver the same power.

$$I_{rms} = \frac{I_0}{\sqrt{2}} \quad V_{rms} = \frac{V_0}{\sqrt{2}}$$

21.2 Rectification and smoothing

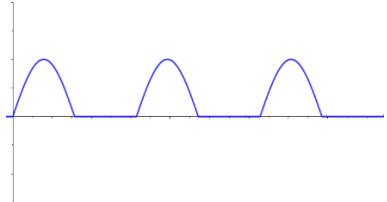
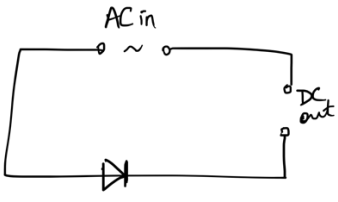
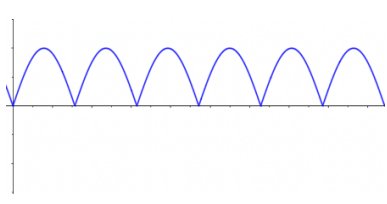
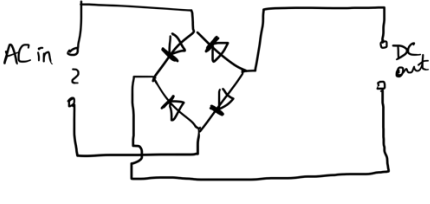
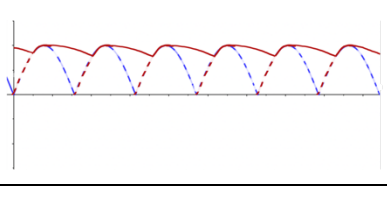
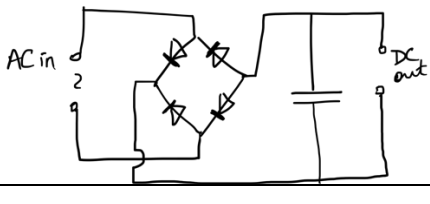
Method	Graph	Circuit	Explanation
Half-wave rectification			Single diode only lets current flow in one direction.
Full-wave rectification			Four diodes (bridge rectifier) cause current to take different route every half wave so half of wave is reversed.
Full-wave rectification with smoothing capacitor			Capacitor charges up on rising part of cycle and discharges as output p.d. falls.

- The smoothing effect can be increased by increasing the time constant RC, and therefore the time taken for the capacitor to discharge, i.e.:
 - o **increasing capacitance**
 - o **increasing load resistance**

22 – Quantum Physics

22 QUANTUM PHYSICS

22.1 Energy and momentum of a photon

- Electromagnetic radiation has a particulate nature.
- A **photon** is a quantum of electromagnetic energy, its energy given by:

$$E = hf \quad \text{or} \quad E = \frac{hc}{\lambda}$$

where h is Planck's constant
 f is the frequency of the electromagnetic wave
 λ is the wavelength of the electromagnetic wave
 c is the speed of light ($3.0 \times 10^8 \text{ ms}^{-1}$)

- The **electronvolt** (eV) is a unit of energy: $1 \text{ eV} = 1.60 \times 10^{-19} \text{ J}$
- A photon has momentum p , given by:

$$p = \frac{E}{c}$$

22.2 Photoelectric effect

- Photoelectrons may be emitted from a metal surface when it is illuminated by electromagnetic radiation.
- Each metal has a different:
 - o **threshold frequency**: if the frequency is less than this, no electrons will be emitted no matter how bright the light source is
 - o **threshold wavelength**: if the wavelength is more than this, the frequency will be less than the threshold frequency.
- How photoelectric emission works:
 - o an electromagnetic wave is directed at a metal surface
 - o photons (discrete packets) of energy are absorbed by the electrons in the metal
 - o if a photon has energy greater than the work function energy of the metal, it will be emitted from the surface
 - o the number of electrons emitted depends on light intensity.

- The energy of a photon is equal to the sum of the work function of the metal and its kinetic energy:

$$hf = \phi + \frac{1}{2} m v_{max}^2$$

where h is Planck's constant
 f is the frequency of the electromagnetic wave
 ϕ is the work function energy of the metal
 $\frac{1}{2} m v_{max}^2$ is the maximum kinetic energy of the emitted electron

- As the intensity of the electromagnetic wave is increased:
 - o more photons reach the metal surface
 - o these have the same energy as at a lower intensity
 - o more electrons are emitted
 - o each electron has the same maximum kinetic energy as before (this is independent of light intensity because the initial energy of the photon remains unchanged)
 - o photoelectric current is proportional to intensity

22.3 Wave-particle duality

- Different phenomena suggest different natures of electromagnetic radiation:
 - o **photoelectric effect:** provides evidence for a particulate nature
 - o **interference** and **diffraction:** provide evidence for a wave nature.
- The photoelectric effect provides evidence for a particulate nature because:
 - o negligible time delay between illumination of the surface and emission of an electron
 - o electrons are not emitted below the threshold frequency
 - o rate of electron emission is proportional to intensity
 - o maximum kinetic energy of electrons is dependent on the frequency
 - o maximum kinetic energy of electrons is independent of intensity
- Electron diffraction:
 - o electrons are emitted from a hot cathode and accelerated towards a thin slice of graphite (which acts as a diffraction grating)
 - o bright rings are observed on the fluorescent screen
 - o these are maxima (i.e. the electrons constructively interfered)
 - o this behaviour would not be expected for the assumed particulate nature of electrons
 - o electron diffraction is evidence for the wave nature of particles
- The **de Broglie wavelength** is the wavelength associated with a moving particle, given by:

$$\lambda = \frac{h}{p}$$

where p is momentum of the moving particle

22 – Quantum Physics

22.4 Energy levels in atoms and line spectra

- There are discrete electron energy levels in isolated atoms (e.g. atomic hydrogen).
- When an electron falls from a higher energy level to a lower energy level, it emits a photon.
- When an atom absorbs a photon, an electron moves from a lower to a higher energy level.
- The energy in the photon is determined by the change in energy level, where each jump will have a specified change in energy.
- For an atom with four energy levels, there are six possible wavelengths an emitted photon can have ($1 + 2 + 3$).
- If the light produced by an element such as this one is passed through a prism to separate it into its component wavelengths, an **emission line spectrum** is formed:

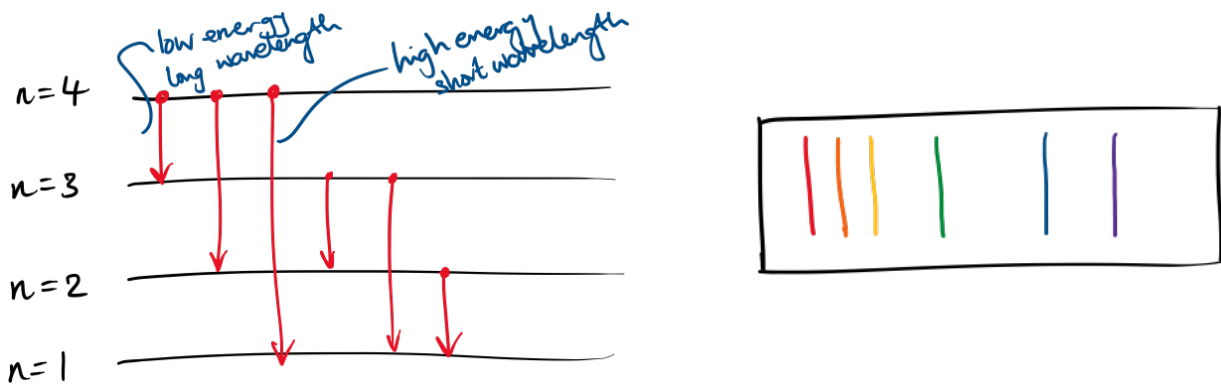

- If light was passed through an element such as this one, certain wavelengths will be absorbed by the atom and electrons will move to higher energy levels.
- If the light was then passed through a prism to separate it into its component wavelengths, an **absorption line spectrum** is formed:

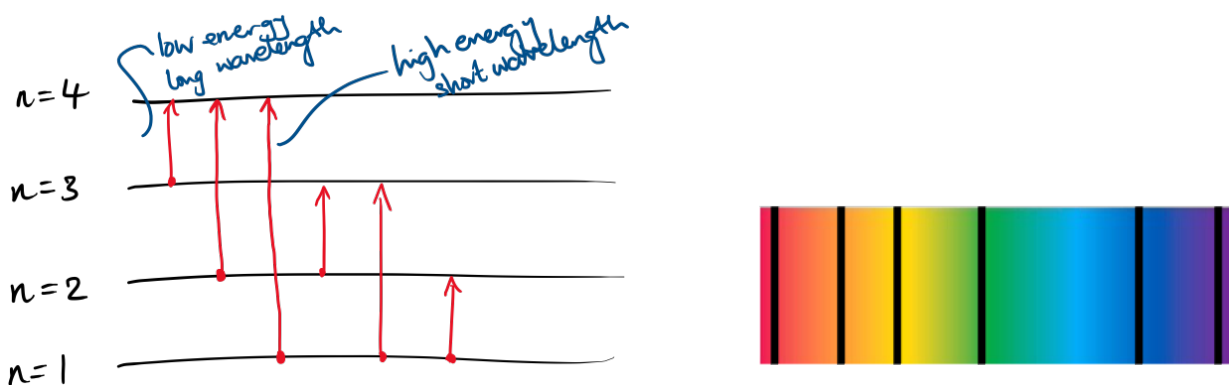

$$hf = E_1 - E_2$$

where E_1 and E_2 are the initial and final energies of an electron and subsequently hf is the energy of the photon emitted/absorbed.

23 NUCLEAR PHYSICS

23.1 Mass defect and nuclear binding energy

- The equivalence between energy and mass is represented by:

$$E = mc^2$$

where E is energy
 m is mass
 c is the speed of light

- The **mass defect** is the difference between the mass of an isotope and the mass of its component nucleons.
- **Binding energy** is the energy needed to separate a nucleus into its separate nucleons.
- Binding energy per nucleon can be used as a more comparable measure of stability across nucleons:

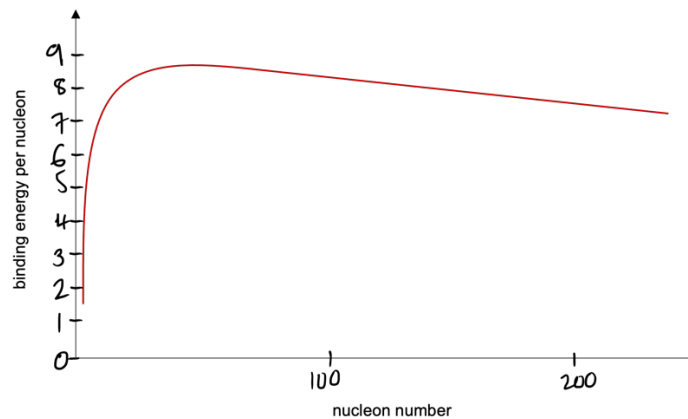

- The most stable nuclei have the highest binding energy per nucleon, and are least likely to decay.
- **Nuclear fusion** is when two nuclei combine to form a single nucleus.
- **Nuclear fission** is when a single large nucleus divides to form smaller nuclei.
- For a nucleus to become more stable, it either undergoes fusion or fission to get 'closer' to the most stable nuclei:
 - o **smaller nucleon number:** undergoes fusion to become larger
 - o **larger nucleon number:** undergoes fission to become smaller
- Energy released in nuclear reactions can be calculated using:

$$E = c^2\Delta m$$

23 – Nuclear Physics

23.2 Radioactive decay

- Fluctuations in count rate provide evidence for the random nature of radioactive decay.
- Radioactive decay is both:
 - o **spontaneous**: not affected by external factors such as temperature or pressure
 - o **random**: time of decay cannot be predicted
- **Activity** is the number of nuclei of the isotope that decay per second.
- The **decay constant** is the probability per unit time of the decay of a nucleus.

$$A = \lambda N$$

where A is the activity
 λ is the decay constant
 N is the number of nuclei

- The **half life** of a radioactive isotope is the time taken for its activity to halve:

$$\lambda = \frac{0.693}{t_{\frac{1}{2}}} \quad (\text{derived from } x = x_0 e^{-\lambda t})$$

where $t_{\frac{1}{2}}$ is the half life (time taken for activity to halve)

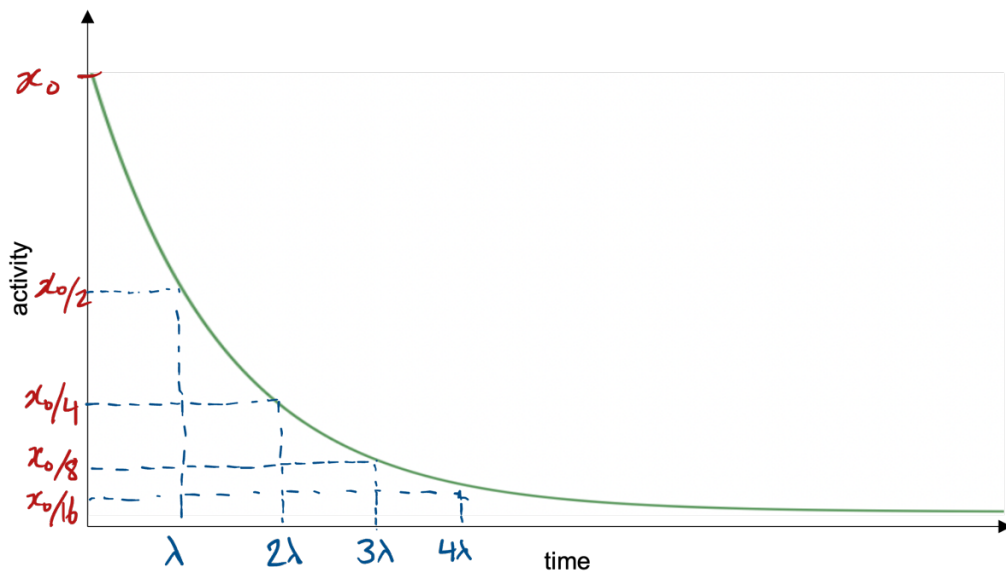

- Radioactive decay has an exponential nature where

$$x = x_0 e^{-\lambda t}$$

where x is the activity, number of decayed nuclei or received count rate
 x_0 is the initial value of x (at $t = 0$)
 λ is the decay constant
 t is the time

24 MEDICAL PHYSICS

24.1 Production and use of ultrasound

- A **piezoelectric transducer** may be used to generate ultrasound waves.
- Production of ultrasound:
 - a **piezo-electric crystal** changes shape when a p.d. is applied across it
 - the crystal generates an e.m.f. when its shape changes
 - the crystal vibrates with oscillations in the ultrasound range of frequencies (>20kHz)
 - cutting the crystal to a certain size can cause resonance (maximum amplitude of oscillations)
- Detection of ultrasound:
 - when the ultrasound wave returns, it causes the crystal to vibrate
 - this produces an alternating p.d. across the crystal
 - the p.d. can be processed by a computer
- Using ultrasound:
 - the piezoelectric transducer produces pulses of ultrasound
 - pulses are reflected at boundaries between tissues
 - reflected pulses are detected by the transducer
 - the time taken for the reflected wave to be detected can be used to calculate its distance (depth)
 - this is used to obtain diagnostic information about internal structures
- The **specific acoustic impedance** of a medium is the product of the speed of sound in the medium and its density.

$$Z = \rho c$$

where Z is the specific acoustic impedance of the medium
 ρ is the density of the medium
 c is the speed of sound in the medium

- The **intensity reflection coefficient** of a boundary between two media is given by:

$$\frac{I_R}{I_0} = \frac{(Z_1 - Z_2)^2}{(Z_1 + Z_2)^2}$$

where $\frac{I_R}{I_0}$ is the intensity reflection coefficient
 Z_1 and Z_2 are the specific acoustic impedances of the media

24 – Medical Physics

- **Attenuation** is the reduction of wave intensity as it travels through a medium due to energy absorption in a medium:

$$I = I_0 e^{-\mu x}$$

where I is the transmitted intensity
 I_0 is the incident (initial) intensity
 μ is the attenuation/absorption coefficient
 x is the thickness of the medium

24.2 Production and use of X-rays

- X-rays are produced by electron bombardment of a metal target:
 - o a p.d. is used to accelerate the electrons
 - o high-speed electrons strike a metal target, causing rapid loss of kinetic energy
 - o this causes the emission of X-ray photons
 - o aluminium filters are used to absorb long-wavelength photons which would otherwise add to the radiation dose without being able to penetrate the person
- The **hardness** of an X-ray beam is its penetrative ability.
- Beams with greater hardness have shorter wavelengths.

- The minimum wavelength of X-rays produced from the accelerating potential difference is given by:

$$\lambda_0 = \frac{hc}{eV}$$

where λ_0 is the minimum wavelength
 e is the charge on the electron
 V is the accelerating p.d.

- X-rays are used in imaging internal body structures:
 - o they penetrate soft tissues (skin, fat, muscle etc.) with little loss of intensity
 - o they lose much more intensity when reaching bone
 - o photographic film is lighter in areas corresponding to the position of bones and darker (when developed) in areas of soft tissue
 - o **contrast** is the difference in the degree of blackening of the structures
- **Computed Tomography (CT) scanning:**
 - o combines multiple X-ray images taken in the same section from different angles to obtain a 2D image of the section
 - o repeats this process along an axis
 - o combines multiple 2D images to produce a 3D image of an internal structure

24.3 PET scanning

- A **tracer** is a substance containing radioactive nuclei that can be introduced into the body and is then absorbed by the tissue being studied.
- Tracers that undergo β^+ decay are used in **positron emission tomography** scanning.

- **Annihilation** occurs when a particle interacts with its antiparticle.
- The mass-energy and momentum are conserved in the process.

- Annihilation in PET scanning:
 - o positrons are emitted by the decay of the tracer
 - o these annihilate when they interact with electrons in the tissue
 - o this produces a pair of gamma-ray photons travelling in opposite directions

- The total energy of the emitted gamma-ray photons is given by the sum of the:
 - o **mass-energy** of the positron and electron
 - o **kinetic energies** of the positron and electron

- How PET scanning works:
 - o tracer introduced into the body
 - o absorbed by tissue being studied
 - o positrons decayed by the tracer annihilate with electrons in the tissue
 - o two gamma-ray photons are produced
 - o these travel outside the body and can be detected
 - o arrival times of gamma-ray photons can be processed to create an image of the tracer concentration in the tissue

25 ASTRONOMY AND COSMOLOGY

25.1 Standard candles

- **Luminosity** is the total power of radiation emitted by a star.
- The inverse square law for the radiant flux intensity of a source:

$$F = \frac{L}{4\pi d^2}$$

where F is the radiant flux intensity
 L is its luminosity
 d is the distance from the source

- A **standard candle** is an object of known luminosity.
- Standard candles can be used to determine distances to galaxies by relating measured radiant flux intensity (apparent brightness) and luminosity.

25.2 Stellar radii

- **Wien's displacement law:**

$$\lambda_{max} \propto \frac{1}{T}$$

where λ_{max} is the wavelength of the peak intensity of radiation
 T is the peak surface thermodynamic temperature of a star

- **Stefan-Boltzmann law** for a spherical object emitting black-body radiation:

$$L = 4\pi\sigma r^2 T^4$$

where L is its luminosity
 σ is the Stefan-Boltzmann constant
 r is its radius
 T is its thermodynamic temperature

25.3 Hubble's law and the Big Bang theory

- **Redshift:** lines in the emission spectra for distant objects show an increase in wavelength from their known values.
- For the redshift of electromagnetic radiation from a source moving relative to an observer:

$$\frac{\Delta\lambda}{\lambda} \approx \frac{\Delta f}{f} \approx \frac{v}{c}$$

- Why redshift leads to the idea that the Universe is expanding:
 - redshift data suggests nearly all galaxies are moving away from Earth
 - the further away a galaxy is, the larger its redshift is
 - this means galaxies must be moving away from Earth at an increasing rate
 - and therefore the Universe is expanding at an ever-increasing rate

- **Hubble's law:**

$$v \approx H_0 d$$

where v is the radial speed of a galaxy
 H_0 is the Hubble constant
 d is the distance to the galaxy

PHYSICS

-
- | | |
|----|-------------------------------|
| 1 | PHYSICAL QUANTITIES AND UNITS |
| 2 | KINEMATICS |
| 3 | DYNAMICS |
| 4 | FORCES, DENSITY AND PRESSURE |
| 5 | WORK, ENERGY AND POWER |
| 6 | DEFORMATION OF SOLIDS |
| 7 | WAVES |
| 8 | SUPERPOSITION |
| 9 | ELECTRICITY |
| 10 | D.C. CIRCUITS |
| 11 | PARTICLE PHYSICS |
| 12 | MOTION IN A CIRCLE |
| 13 | GRAVITATIONAL FIELDS |
| 14 | TEMPERATURE |
| 15 | IDEAL GASES |
| 16 | THERMODYNAMICS |
| 17 | OSCILLATIONS |
| 18 | ELECTRIC FIELDS |
| 19 | CAPACITANCE |
| 20 | MAGNETIC FIELDS |
| 21 | ALTERNATING CURRENTS |
| 22 | QUANTUM PHYSICS |
| 23 | NUCLEAR PHYSICS |
| 24 | MEDICAL PHYSICS |
| 25 | ASTRONOMY AND COSMOLOGY |
-