

At Utility Supply Group, everything we do is focused on the needs of our customers.

We carry only the highest quality products to ensure your satisfaction, including our Heritage™ brand of RV electrical pedestals. The Heritage Rv Pedestals Are Specifically Designed For Direct Burial Or Pad Mount For Underground Feed. All Have Dual 350mcm Lugs For Loop Feeding. Surface Mount Boxes Have A Rain Tight Hub Opening For Adding A Meter Kit Or Pagoda Light Kit.

MH75P-3

Metered 50/30/20 RV Pedestal—Loop Feed

- UL listed, 100 Amp, 120/240V, Single Phase
- Galvanized, Powder Coated Outdoor 3R enclosure w/ hub opening & lockable cover
- Line & Neutral Lugs: (2) #6-350MCM; Ground 2/0 (Pedestal)
- Receptacles & circuit breakers pre wired with copper conductors
- Light includes LED Bulb, Photocell and Door Lens, for loop feed wiring

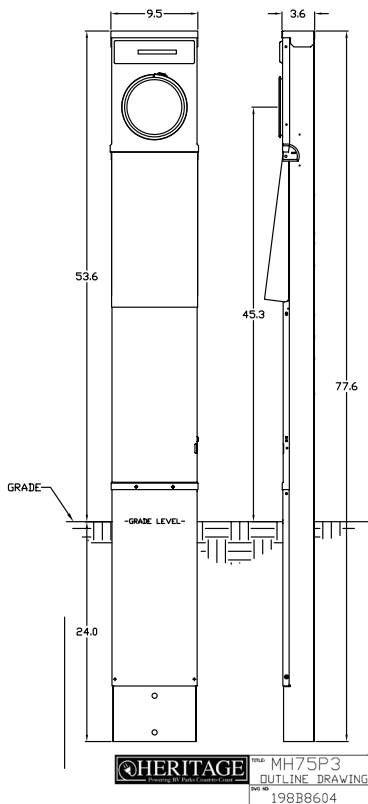

H75P-3

Unmetered 50/30/20 RV Pedestal—Loop Feed

- UL listed, 100 Amp, 120/240V, Single Phase
- Galvanized, Powder Coated Outdoor 3R enclosure w/ hub opening & lockable cover
- Line & Neutral Lugs: (2) #6-350MCM; Ground 2/0 (Pedestal)
- Receptacles & circuit breakers pre wired with copper conductors
- Light includes LED Bulb, Photocell and Door Lens, for loop feed wiring

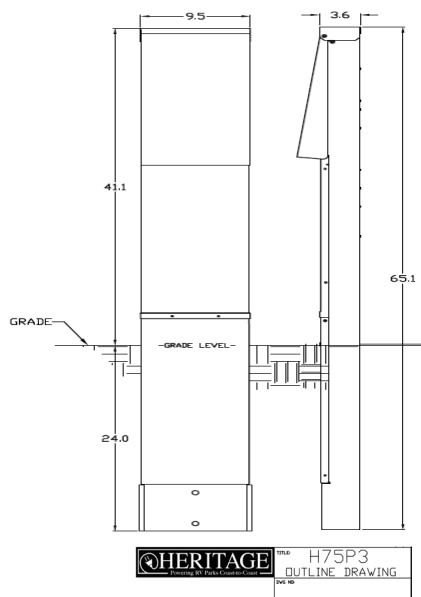

RV PEDESTAL-LOOP FEED

- UL listed, 100 Amp, 120/240V, Single Phase
- Galvanized, Powder Coated Outdoor 3R enclosure w/ hub opening & lockable cover
- Line & Neutral Lugs: (2) #6-350MCM; Ground 2/0 (Pedestal)
- Receptacles & circuit breakers pre wired with copper conductors
- Light includes LED Bulb, Photocell and Door Lens, for loop feed wiring

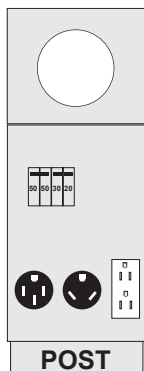

MH75P-3
• Metered 50/30/20

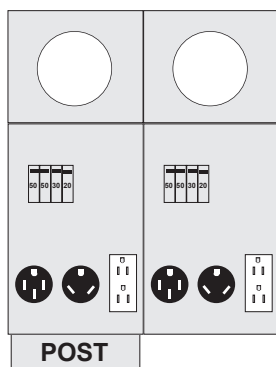

MH75B-3
• Metered 50/30/20

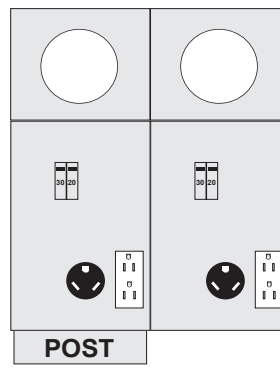

MH41B-3
• Metered 30/20

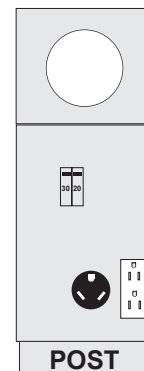

MH41P-3
• Metered 30/20

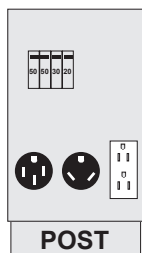

H75P-3
• 50/30/20

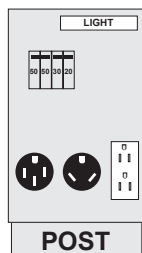

H75P-3L
• Lighted 50/30/20

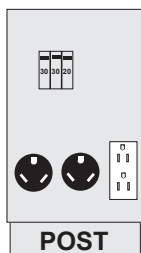

H61P-3
• 30/30/20

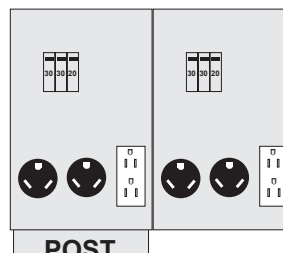

H61B-3
• 30/30/20

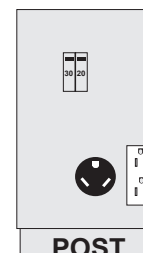

H41P-5
• 30/20

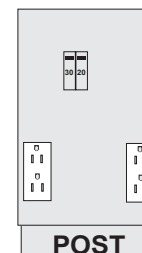

H11P-3
• 20/20

Catalog#	Description	H x W x D (in)	Loop	Mounting	REC 1	REC 2	REC 3
MH75P-3	Metered 50/30/20 Pedestal	78x9x5	Y	Burial	50A	30A	20A GFCI REC
MH75P-3L	Lighted Metered 50/30/20 Pedestal	78x9x5	Y	Burial	50A	30A	20A GFCI REC
MH75PD-3	Metered 50/30/20 Pad Mount Pedestal	78x9x9	Y	Pad	50A	30A	20A GFCI REC
MH75B-3	Metered 50/30/20 Back to Back Pedestal	78x9x9	Y	Burial	50A	30A	20A GFCI REC
MH41P-3	Metered 30/20 Pedestal	78x9x5	Y	Burial	-	30A	20A GFCI REC
MH41B-3	Metered 30/20 Back to Back Pedestal	78x9x9	Y	Burial	-	30A	20A GFCI REC
Catalog#	Description	H x W x D (in)	Loop	Mounting	REC 1	REC 2	REC 3
H75P-3	Unmetered 50/30/20 Pedestal	66x9x5	Y	Burial	50A	30A	20A GFCI REC
H75P-3L	Lighted Unmetered 50/30/20 Pedestal	66x9x5	Y	Burial	50A	30A	20A GFCI REC
H75PD-3	Unmetered 50/30/20 Pad Mount Pedestal	42x9x9	Y	Pad	50A	30A	20A GFCI REC
H75B-3	Unmetered 50/30/20 Back to Back Pedestal	66x9x9	Y	Burial	50A	30A	20A GFCI REC
H41P-5	Unmetered 30/20 Pedestal	62x7x4	Y	Burial	-	30A	20A GFCI REC
H41B-3	Unmetered 30/20 Back to Back Pedestal	66x9x9	Y	Burial	-	30A	20A GFCI REC
H61P-3	Unmetered 30/30/20 Pedestal	66x9x5	Y	Burial	30A	30A	20A GFCI REC
H61B-3	Unmetered 30/30/20 Back to Back Pedestal	66x9x9	Y	Burial	30A	30A	20A GFCI REC
H11P-3	Unmetered 20/20 Pedestal	66x9x5	Y	Burial	20A GFI	-	20A GFCI REC

SURFACE MOUNT BOXES

- UL listed, 100 Amp, 120/240V, Single Phase
- Galvanized, Powder Coated Outdoor 3R enclosure w/ hub opening & lockable cover
- Line & Neutral Lugs: (2) #12-1/0 unmetred (1) #6-1/0 metered
- Receptacles and circuit breakers pre-wired w/copper conductors
- Light includes LED Bulb, Photocell & Door Lens, for loop feed wiring

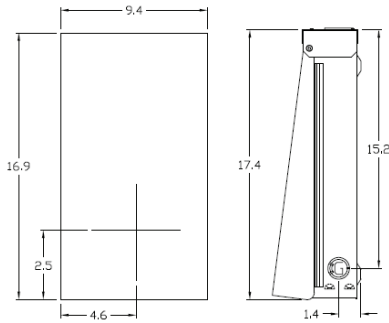

H75SM-3
• Unmetered 50/30/20-Loop Feed



MH75SM-3
• Metered 50/30/20- Non Loop Feed

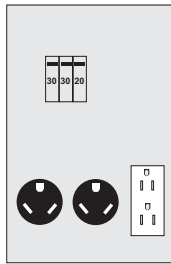
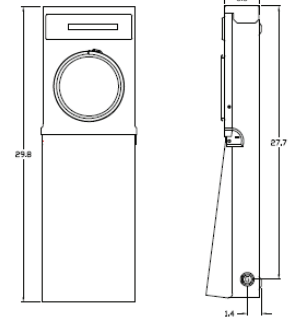

H61SM-3
• 30/30/20 AMP

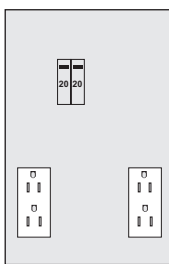

H11SM-3
• 20/20

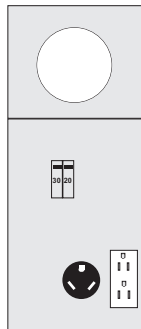

MH41SM-3
• Metered 30/20

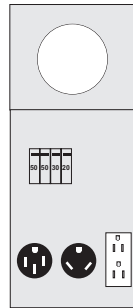

MH75SM-3
• Metered 50/30/20

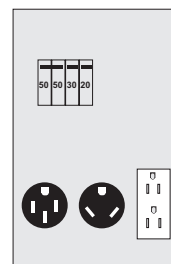

H75SM-3
• 50/30/20

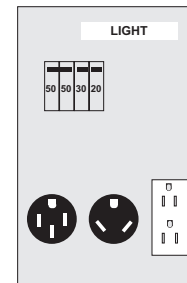

H75SM-3L
• Lighted 50/30/20

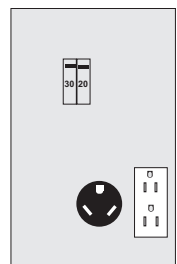

H41SM-3
• 30/20

Catalog #	Description	H×W×D(in)	Loop Feed	Rec 1	Rec 2	Rec 3
H75SM-3	Unmetered 50/30/20 Surface Mount	17×9×5	Y	50A 240V	30A 120V	20A 120V GFCI REC
H75SM-3L	Lighted Unmetered 50/30/20 Surface Mount	17×9×5	Y	50A 240V	30A 120V	20A 120V GFCI REC
H41SM-3	Unmetered 30/20 Surface Mount	17×9×5	Y	30A 120V	20A 120V GFCI REC	-
H41SM-3L	Lighted Unmetered 30/20 Surface Mount	17×9×5	Y	30A 120V	20A 120V GFCI REC	-
H75SM-3L	Lighted Unmetered 50/30/20 Surface Mount	17×9×5	Y	50A 240V	30A 120V	20A 120V GFCI REC
H13SM-3*	Unmetered 30 Surface Mount	9×7×4	N	-	30A 120V	*
H11SM-3	Unmetered 20/20 Surface Mount	17×9×5.5	Y	20A 120V GFCI REC	-	20A 120V GFCI REC

*Not for use as RV Site Power, No GFCI 20 amp power.

Catalog #	Description	H×W×D(in)	Loop Feed	Rec 1	Rec 2	Rec 3
MH41SM-3	Metered 30/20 Surface Mount	31×9×5	N	-	30A 120V	20A 120V GFCI REC
MH75SM-3	Metered 50/30/20 Surface Mount	31×9×5	N	50A 240V	30A 120V	20A 120V GFCI REC
MH75SM-3L	Lighted Metered 50/30/20 Surface Mount	31×9×5	N	50A 240V	30A 120V	20A 120V GFCI REC

RV PEDESTAL-LOOP FEED

- UL listed, 100 Amp, 120/240V, Single Phase
- Galvanized, Powder Coated Outdoor 3R enclosure w/ hub opening & lockable cover
- Line & Neutral Lugs: (2)#12-1/0; Ground #12-2 (Surface Mount-for loop feed wiring)
- Line & Neutral Lugs: (2) #6-350MCM; Ground 2/0 (Pedestal-for loop feed wiring)
- Receptacles and circuit breakers pre-wired w/copper conductors
- Light includes LED Bulb, Photocell and Door Lens

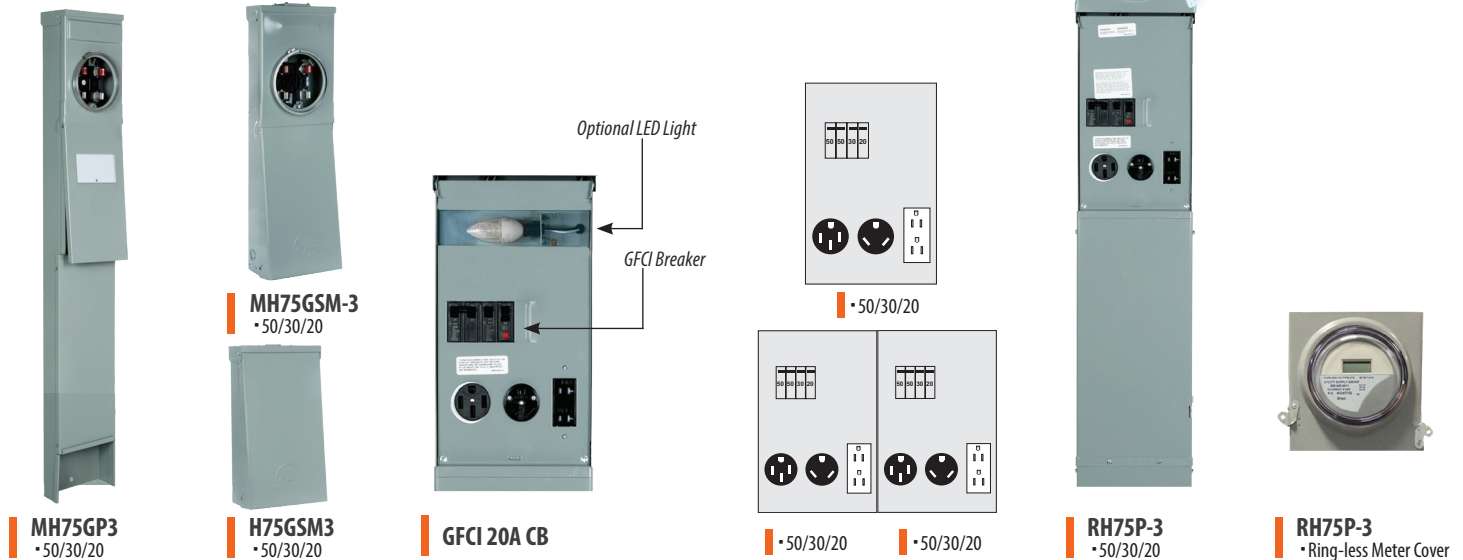

G-SERIES-LOOP/NON-LOOP FEED

20 Amp GFCI Circuit Breaker

Catalog#	Description	H x W x D (in)	Loop	Mounting	REC 1	REC 2	REC 3
H75GSM-3	Unmetered 50/30/20 Surface Box	17x9x5	Y	Surface	50A	30A	20A GFCI BKR
H75GSM-3L	Lighted Unmetered 50/30/20 Surface Box	17x9x5	Y	Surface	50A	30A	20A GFCI BKR
H75GP-3	Unmetered 50/30/20 Pedestal	66x9x5	Y	Burial	50A	30A	20A GFCI BKR
H75GP-3L	Lighted Unmetered 50/30/20 Pedestal	42x9x5	Y	Burial	50A	30A	20A GFCI BKR
H75GPD-3	Unmetered 50/30/20 Pad Mount Pedestal	66x9x9	Y	Pad	50A	30A	20A GFCI BKR
H75GB-3	Unmetered 50/30/20 Back to Back Pedestal	66x9x9	Y	Burial	50A	30A	20A GFCI BKR
MH75GP-3	Metered 50/30/20 Pedestal	78x9x5	Y	Burial	50A	30A	20A GFCI BKR
MH75GP-3L	Lighted Metered 50/30/20 Pedestal	78x9x5	Y	Burial	50A	30A	20A GFCI BKR
MH75GPD-3	Metered 50/30/20 Pad Mount Pedestal	54x9x9	Y	Pad	50A	30A	20A GFCI BKR
MH75GB-3	Metered 50/30/20 Back to Back Pedestal	78x9x9	Y	Burial	50A	30A	20A GFCI BKR
MH75GSM-3	Metered 50/30/20 Surface Box	31x9x5	N	Surface	50A	30A	20A GFCI BKR

R-SERIES-LOOP FEED

Ring-less Type Meter Socket

Catalog#	Description	H x W x D (in)	Loop	Mounting	REC 1	REC 2	REC 3
RH75P-3	Metered 50/30/20 Pedestal	78x9x5	Y	Burial	50A	30A	20A GFCI REC
RH75P-3L	Lighted Metered 50/30/20 Pedestal	78x9x5	Y	Burial	50A	30A	20A GFCI REC
RH75PD-3	Metered 50/30/20 Pad Mount Pedestal	54x9x5	Y	Pad	50A	30A	20A GFCI REC
RH75B-3	Metered 50/30/20 Back to Back Pedestal	78x9x9	Y	Burial	50A	30A	20A GFCI REC
RH75GP-3	Metered 50/30/20 Pedestal	78x9x5	Y	Burial	50A	30A	20A GFCI BKR
RH75GP-3L	Lighted Metered 50/30/20 Pedestal	78x9x5	Y	Burial	50A	30A	20A GFCI BKR
RH75GB-3	Metered 50/30/20 Back to Back Pedestal	78x9x9	Y	Burial	50A	30A	20A GFCI BKR