

# Notebook PC User Guide



© Copyright 2005 Hewlett-Packard  
Development Company, L.P.

Microsoft and Windows are U.S. registered  
trademarks of Microsoft Corporation.  
Bluetooth is a trademark owned by its  
proprietor and used by Hewlett-Packard  
Company under license. SD Logo is a  
trademark of its proprietor.

The information contained herein is subject  
to change without notice. The only  
warranties for HP products and services  
are set forth in the express warranty  
statements accompanying such products  
and services. Nothing herein should be  
construed as constituting an additional  
warranty. HP shall not be liable for  
technical or editorial errors or omissions  
contained herein.

First Edition December 2005

Document Part Number: 397375-001

# Table of contents

## 1 Notebook Tour

Components .....	1
Top components .....	2
Keys .....	2
TouchPad .....	3
Buttons and switches .....	4
Lights .....	6
Display components .....	7
Front components .....	7
Rear components .....	8
Right-side components .....	8
Left-side components .....	10
Bottom components .....	11
Wireless antennae (select models only) .....	12
Additional hardware components .....	13
Labels .....	14
Specifications .....	15
Operating environment .....	15
Rated input power .....	15
Expansion port input/output signals .....	16

## 2 TouchPad and Keyboard

TouchPad .....	17
Using the TouchPad .....	18
Using an external mouse .....	18
Setting TouchPad preferences .....	18
Keyboard .....	19
Hotkeys .....	19
Hotkey quick reference .....	20
Hotkey procedures .....	20
Display and clear system information (fn+esc) .....	20
Open the Help and Support Center (fn+f1) .....	21
Open the Print Options window (fn+f2) .....	21
Open a Web browser (fn+f3) .....	21
Switch the screen image (fn+f4) .....	22
Initiate standby (fn+f5) .....	22
Initiate QuickLock (fn+f6) .....	23
Decrease screen brightness (fn+f7) .....	23
Increase screen brightness (fn+f8) .....	23

Play, pause or resume an audio CD or a DVD (fn+f9) .....	23
Stop an audio CD or a DVD (fn+f10) .....	23
Play previous track or section of an audio CD or a DVD (fn+f11) .....	23
Play next track or section of an audio CD or a DVD (fn+f12) .....	23
Quick Launch Buttons software .....	24
Accessing the Quick Launch Buttons control panel .....	24
Setting tiling preferences .....	24
Setting advanced preferences .....	24
Displaying the Quick Launch Buttons icon .....	25
Setting button assignments on an external keyboard .....	25
Keypads .....	26
Using the embedded numeric keypad .....	26
Enabling and disabling the embedded numeric keypad .....	26
Switching key functions on the embedded numeric keypad .....	27
Using an external numeric keypad .....	27
Enabling or disabling num lock mode as you work .....	27

### 3 Power

Power control and light locations .....	29
Power sources .....	31
Connecting the AC adapter .....	32
Standby and hibernation .....	33
Standby .....	33
Hibernation .....	33
Initiating standby, hibernation or shutdown .....	34
When you leave your work .....	34
When a reliable power supply is unavailable .....	34
When using wireless communication or readable or writable media (select models only) .....	35
Default power settings .....	36
Turning the computer or display on or off .....	36
Using emergency shutdown procedures .....	36
Initiating or resuming from standby .....	37
Initiating or restoring from hibernation .....	38
Power options .....	39
Accessing Power Options Properties .....	39
Displaying the Power Meter icon .....	39
Setting or changing a power scheme .....	40
Setting a security prompt .....	40
Processor performance controls .....	41
Battery packs .....	42
Inserting or removing a battery pack .....	42
Charging a battery pack .....	43
Monitoring the charge of the battery pack .....	44
Obtaining accurate charge information .....	44
Displaying charge information on the screen .....	44
Viewing charge displays .....	44
Interpreting charge indicators .....	44
Managing low-battery conditions .....	45
Identifying low-battery conditions .....	45

Low-battery condition .....	45
Critical low-battery condition .....	45
Resolving low-battery conditions .....	46
When external power is available .....	46
When a charged battery pack is available .....	46
When no power source is available .....	46
When the computer cannot restore from hibernation .....	46
Calibrating a battery pack .....	47
When to calibrate .....	47
How to calibrate .....	47
Step 1: Charging the battery pack .....	47
Step 2: Discharging the battery pack .....	48
Step 3: Recharging the battery pack .....	49
Conserving battery power .....	49
Conserving power as you work .....	49
Selecting power conservation settings .....	50
Storing a battery pack .....	50
Disposing of a used battery pack .....	50

#### 4 Drives

Drive care .....	51
IDE drive light .....	52
Hard drive .....	53
Optical drives .....	56
Inserting an optical disc .....	57
Removing an optical disc (with power) .....	58
Removing an optical disc (without power) .....	59
Avoiding standby or hibernation .....	60

#### 5 Multimedia

Multimedia hardware .....	61
Using the optical drive .....	61
Identifying the installed optical drive .....	61
Inserting an optical disc .....	62
Removing an optical disc (with power) .....	63
Removing an optical disc (without power) .....	63
Using media activity hotkeys .....	65
Using the QuickPlay buttons .....	66
Using the audio features .....	68
Using the audio-in (microphone) jack .....	69
Using the audio-out (headphone) jack .....	69
Using S/PDIF digital audio (select models only) .....	69
Adjusting the volume .....	70
Using the video features .....	71
Using the external monitor port .....	71
Using the S-Video-out jack .....	72
Remote control (select models only) .....	73
HP Mobile Remote Control (PC Card version) .....	74
Inserting the battery (PC Card version) .....	74
Storing the remote control in the PC Card slot .....	77

Button quick reference (PC Card version) .....	78
HP Mobile Remote Control (PC Card version) component functions .....	80
HP Mobile Remote Control (ExpressCard version) .....	81
Inserting the battery (ExpressCard version) .....	81
Storing the remote control in the ExpressCard slot .....	84
Button quick reference (ExpressCard version) .....	85
HP Mobile Remote Control (ExpressCard version) component functions .....	88
Troubleshooting the remote control .....	88
Multimedia software .....	89
Identifying preinstalled multimedia software .....	89
Installing multimedia software from a CD (select models only) .....	89
Using multimedia software .....	90
Using QuickPlay software .....	90
Protecting playback .....	91
Protecting the CD or DVD write process .....	91
Changing DVD region settings .....	92
Observing the copyright warning .....	92

## 6 External Media Cards

Digital Media Slot cards (select models only) .....	93
Inserting a digital card .....	94
Stopping or removing a digital card .....	95
PC Cards (select models only) .....	96
Configuring a PC Card .....	96
Inserting a PC Card .....	97
Stopping or removing a PC Card .....	97
ExpressCards .....	99
Selecting an ExpressCard .....	99
Configuring an ExpressCard .....	99
Inserting an ExpressCard .....	100
Stopping or removing an ExpressCard .....	102

## 7 External Devices

Using a USB device .....	103
Connecting a USB device .....	103
Stopping a USB device .....	104
Required USB software .....	104
Using a 1394 device (select models only) .....	105
Connecting a 1394 device .....	105
Stopping a 1394 device .....	105
Required 1394 software .....	105
Using the expansion port .....	106

## 8 Memory Modules

Adding or replacing memory modules .....	107
Effects of increasing memory .....	111
Video memory settings (select models only) .....	112

<b>9 Wireless (Select Models Only)</b>	
Wireless features .....	113
Identifying an 802.11 wireless device .....	113
Wireless controls .....	114
802.11 wireless devices (select models only) .....	115
Setting up a WLAN in your home .....	116
Connecting to a WLAN in your home .....	117
Connecting to a public WLAN .....	117
Using wireless security features .....	117
Bluetooth wireless devices (select models only) .....	118
<b>10 Modem and Local Area Network</b>	
Modem .....	119
Connecting the modem cable .....	120
Connecting a country-specific modem cable adapter .....	121
Selecting a location setting .....	121
Viewing the current country selection .....	121
Adding new locations when traveling .....	122
Solving travel connection problems .....	123
Using preinstalled communication software .....	124
Local area networks .....	125
<b>11 Security</b>	
Security features .....	127
Passwords .....	128
Guidelines for setting passwords .....	128
Passwords set in Windows .....	129
QuickLock .....	129
Passwords set in the Setup Utility .....	130
Administrator password .....	130
Managing an administrator password .....	130
Entering an administrator password .....	131
Power-on password .....	131
Managing a power-on password .....	131
Entering a power-on password .....	131
Antivirus software .....	132
Firewall software .....	132
Critical updates .....	132
Optional security cable .....	133
<b>12 Setup Utility</b>	
Setup Utility access .....	135
Setup Utility language .....	136
Setup Utility defaults .....	137
Setup Utility menus .....	138
Main menu .....	138
Security menu .....	138
System Configuration menu .....	139
Diagnostics menu .....	139

## 13 Software Update and Recovery

Software updates .....	141
HP Software Update .....	141
Software updates and the HP Web site .....	142
Accessing computer information .....	142
Downloading a BIOS update .....	143
Installing a BIOS update .....	144
Downloading and installing other software .....	145
System recovery .....	146
Safeguarding your information .....	146
Using System Restore .....	146
Creating a restore point .....	146
Restoring to a restore point .....	147
Reinstalling applications .....	147
Reinstalling applications from the hard drive .....	147
Reinstalling applications from discs .....	147
Repairing the operating system .....	148
Reinstalling the operating system .....	149
Back up your system .....	149
Reinstall the operating system .....	150
Reinstalling device drivers and other software .....	151
Update reinstalled software .....	151

## 14 Routine Care

Hardware maintenance .....	153
Battery pack .....	154
Disposing of a used battery pack .....	154
TouchPad and keyboard .....	155
Display .....	155
Drives .....	156
Using Disk Defragmenter .....	156
Using Disk Cleanup .....	156
Regular tune-ups .....	157
Traveling and shipping .....	158

## 15 Troubleshooting

Quick checklist .....	159
The computer will not start up. ....	159
The computer screen is blank. ....	160
The software is functioning abnormally. ....	160
The computer is turned on, but is not responding. ....	161
The computer is extremely warm. ....	161
An external device is not working. ....	161
The computer cannot connect to a wireless local area network (WLAN). ....	162
Customer Care .....	163
Preparing to contact Customer Care .....	163
Contacting Customer Care by e-mail or telephone .....	163
Taking the computer to a service partner .....	163



**16 Electrostatic Discharge**

Preventing electrostatic discharge .....165  
    Handling drives .....165  
    Handling internal components .....165  
Grounding methods .....166

**Index.....167**



# 1 Notebook Tour

## Components

This chapter explains the hardware features of the computer.

To see a list of installed hardware in the computer:

1. Select **Start > My Computer**.
2. In the left pane of the System Tasks window, select **View system information**.
3. Select **Hardware** tab > **Device Manager**.

You can also add hardware or modify device configurations using Device Manager.



---

**NOTE** Components included with the computer may vary by region and by model. The illustrations in this chapter identify the standard features included in most computer models.

---

## Top components

### Keys

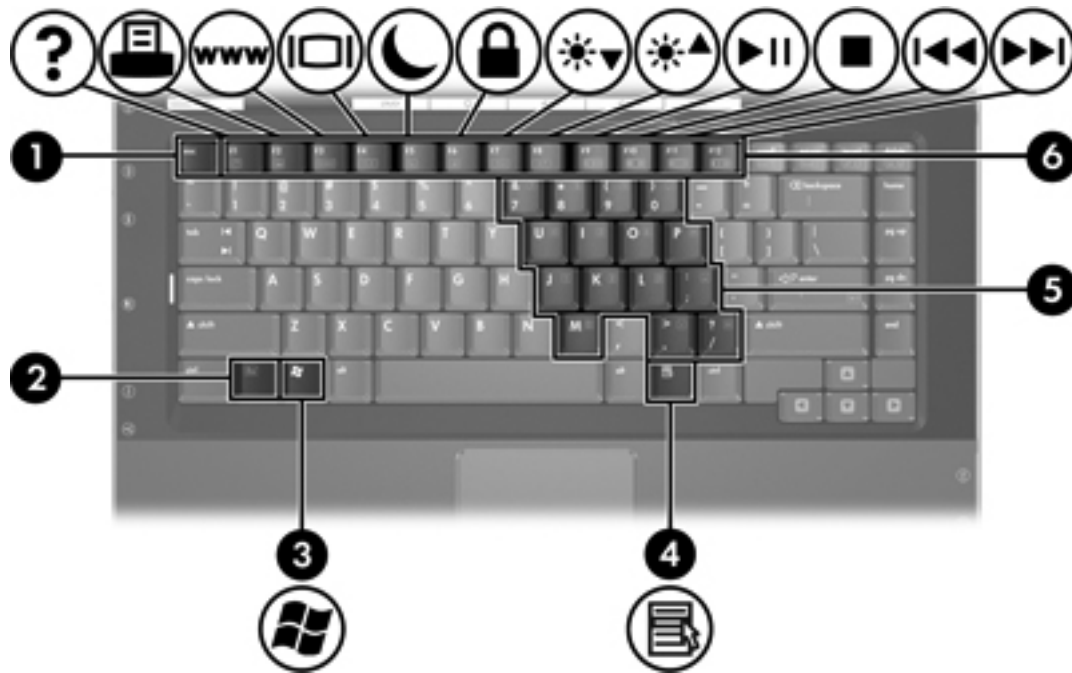

Component	Description
(1) <code>esc</code> key	Displays system information when pressed in combination with the <code>fn</code> key.
(2) <code>fn</code> key	Executes frequently used system functions when pressed in combination with a function key or the <code>esc</code> key.
(3) Windows logo key	Displays the Microsoft Windows Start menu.
(4) Windows applications key	Displays a shortcut menu for items beneath the pointer.
(5) Embedded numeric keypad keys	Can be used like the keys on an external numeric keypad.
(6) Function keys	Execute frequently used system functions when pressed in combination with the <code>fn</code> key.

## TouchPad

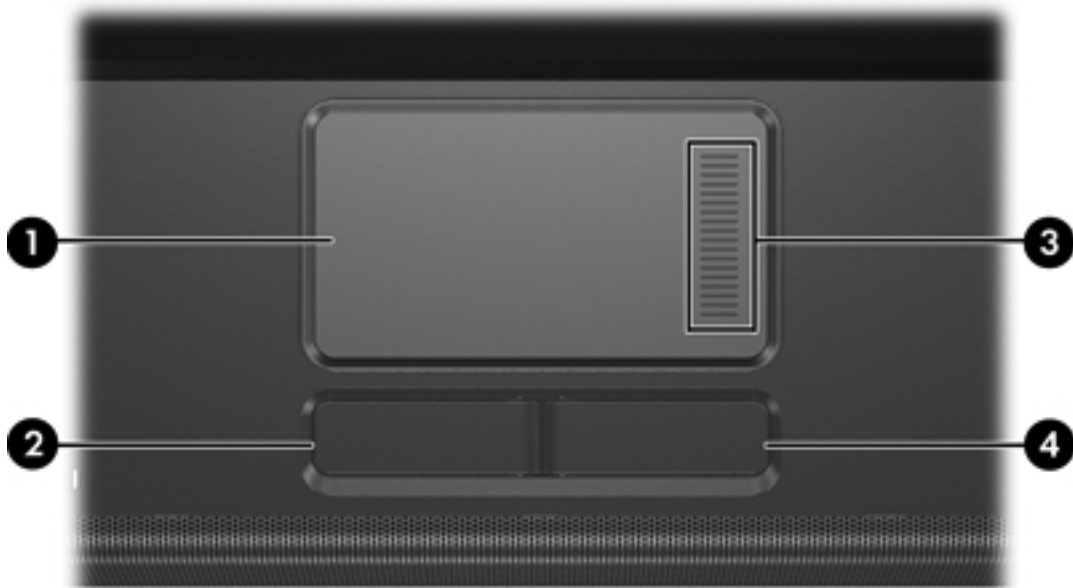



Component	Description
(1) TouchPad*	Moves the pointer and selects or activates items on the screen. Can be set to perform other mouse functions, such as scrolling, selecting, and double-clicking.
(2) Left TouchPad button*	Functions like the left button on an external mouse.
(3) TouchPad scroll zone*	Scrolls up or down.
(4) Right TouchPad button*	Functions like the right button on an external mouse.

\*This table describes default settings. To view and change TouchPad preferences, select **Start > Control Panel > Printers and Other Hardware > Mouse**.

## Buttons and switches



Component	Description
(1) Power button*	<p>When the computer is</p> <ul style="list-style-type: none"> <li>• Off, press to turn on the computer.</li> <li>• On, press to enter hibernation.</li> <li>• In standby, briefly press to exit standby.</li> <li>• In hibernation, briefly press to exit hibernation.</li> </ul> <p>If the computer has stopped responding and Microsoft® Windows® shutdown procedures cannot be used, press and hold the power button for at least 5 seconds to turn off the computer.</p>
(2) DVD button	<p>If QuickPlay is <i>not</i> installed and the computer is</p> <ul style="list-style-type: none"> <li>• On, opens the default DVD application to start a DVD in the optical drive.</li> <li>• Off, no function.</li> <li>• In standby, resumes from standby into Windows.</li> <li>• In hibernation, restores from hibernation into Windows.</li> </ul> <p>If QuickPlay <i>is</i> installed and the computer is</p> <ul style="list-style-type: none"> <li>• On, opens the default DVD application to start a DVD in the optical drive.</li> <li>• Off, opens QuickPlay to start a DVD in the optical drive.</li> </ul>

Component	Description
	<ul style="list-style-type: none"> <li>In standby, resumes from standby into Windows.</li> <li>In hibernation, restores from hibernation into Windows.</li> </ul>
	 <p><b>NOTE</b> Refer to the QuickPlay documentation for details on using QuickPlay.</p>
(3) Media button	<p>If QuickPlay is <i>not</i> installed and the computer is</p> <ul style="list-style-type: none"> <li>On, opens the music application or Media menu, allowing you to select a multimedia application.</li> <li>Off, no function.</li> <li>In standby, resumes from standby into Windows.</li> <li>In hibernation, restores from hibernation into Windows.</li> </ul> <p>If QuickPlay <i>is</i> installed and the computer is</p> <ul style="list-style-type: none"> <li>On, opens the music application or Media menu, allowing you to select a multimedia application.</li> <li>Off, opens the music application or the Media menu, allowing you to select a multimedia application.</li> <li>In standby, resumes from standby into Windows.</li> <li>In hibernation, restores from hibernation into Windows.</li> </ul>
(4) Wireless button*	<p>Turns the wireless functionality on or off, but does not create a wireless connection.</p>  <p><b>NOTE</b> To establish a wireless connection, a wireless network must already be set up.</p>
(5) Volume down button	Decreases system volume.
(6) Volume mute button	Mutes system sound.
(7) Volume up button	Increases system volume.

\*This table describes default settings.

## Lights

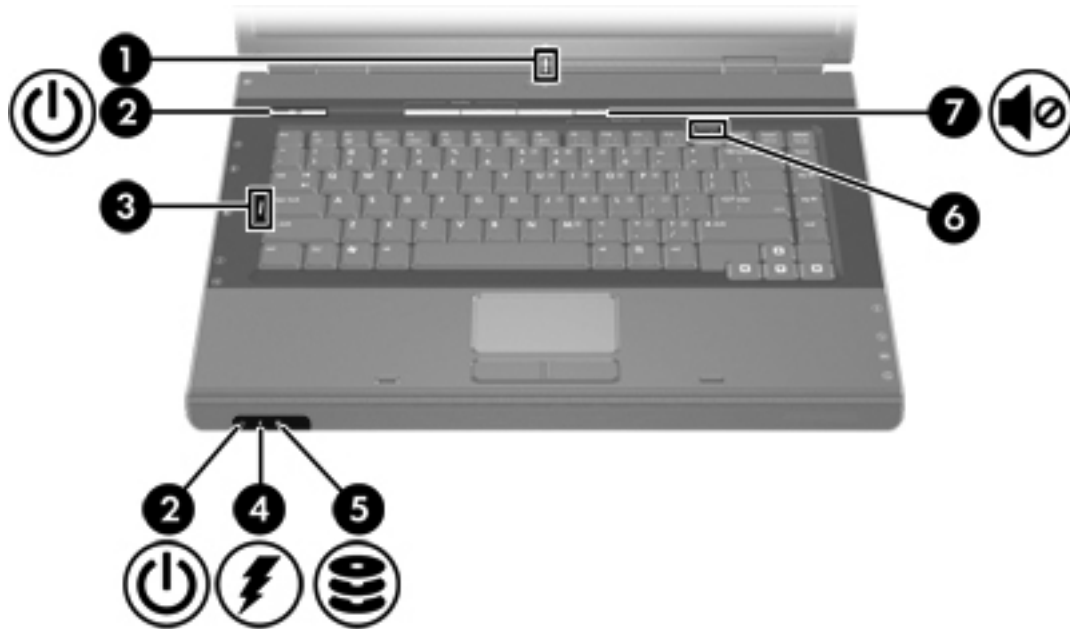

Component	Description
(1) Wireless light	On: An integrated wireless device, such as a wireless local area network (LAN) device and/or a Bluetooth® device is turned on.
(2) Power lights* (2)	On: The computer is on. Blinking: The computer is in standby. Off: The computer is off or in hibernation.
(3) Caps lock light	On: Caps lock is on.
(4) Battery light	On: A battery pack is charging or is close to full charge capacity. Blinking: A battery pack that is the only available power source has reached a low-battery condition. When the battery reaches a <i>critical</i> low-battery condition, the battery light begins blinking rapidly. Off: If the computer is plugged into an external power source, the light is turned off when all batteries in the computer are fully charged. If the computer is not plugged into an external power source, the light stays off until the battery reaches a low-battery condition.
(5) IDE (Integrated Drive Electronics) drive light	Blinking: The hard drive or optical drive is being accessed.
(6) Num lock light	On: Num lock is on or the embedded numeric keypad is enabled.
(7) Volume mute light	On: System sound is turned off.

\*There are 2 power lights. Both display the same information. The light on the power button is visible only when the computer is open; the other power light is always visible on the front of the computer.



## Display components



Component	Description
(1) Display release latch	Opens the computer.
(2) Internal display switch	Initiates standby if the display is closed while the notebook is turned on.

**CAUTION** The internal display switch is magnetic. Keep diskettes and other magnetic media away from magnetic fields, which can erase data.

## Front components



Component	Description
(1) Infrared lens	Links the computer to an optional remote control.
(2) Speakers (2)	Produce system sound.
(3) Display release latch	Opens the computer.

## Rear components



Component	Description
(1) Wireless light	On: An integrated wireless device, such as a wireless local area network (LAN) device and/or a Bluetooth® device is turned on.
(2) Vent*	Provides airflow to cool internal components.

**CAUTION** To prevent overheating, do not obstruct vents. Use the computer only on a hard, flat surface. Do not allow another hard surface, such as an adjoining optional printer, or a soft surface, such as pillows or thick rugs or clothing, to block airflow.

**NOTE** The computer fan starts up automatically to cool internal components and prevent overheating. It is normal for the internal fan to cycle on and off during routine operation.

\*The computer has 3 vents. The other vents are located on the bottom of the computer.

## Right-side components

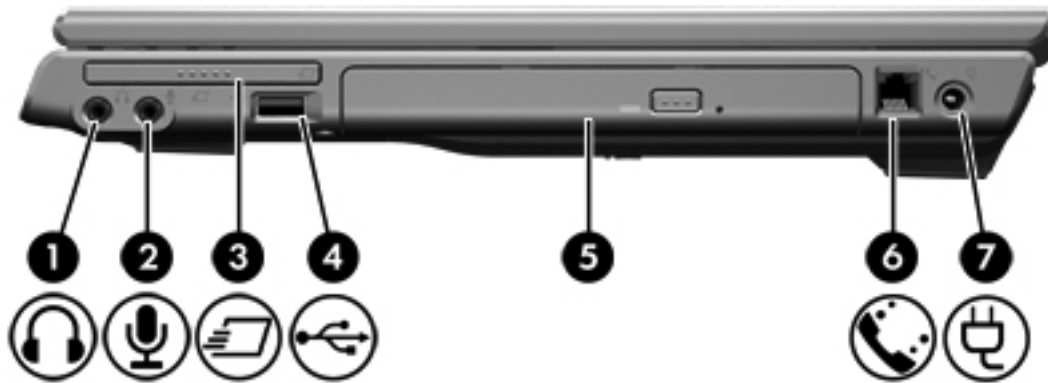



Component	Description
(1) Audio-out (headphone) jack	Produces system sound when connected to optional powered stereo speakers, headphones, ear buds, a headset, or television audio.

**NOTE** On select models, the headphone jack can also be used to output S/PDIF digital audio.

<b>Component</b>	<b>Description</b>
(2) Audio-in (microphone) jack	Connects an optional computer headset microphone or a microphone.
(3) ExpressCard slot	Supports optional ExpressCard/54 or ExpressCard/34 cards.
(4) USB port (select models only)	Connects an optional USB device.
(5) Optical drive	Reads an optical disc.
(6) RJ-11 (modem) jack	Connects a modem cable.
(7) Power connector	Connects an AC adapter or an optional power adapter.

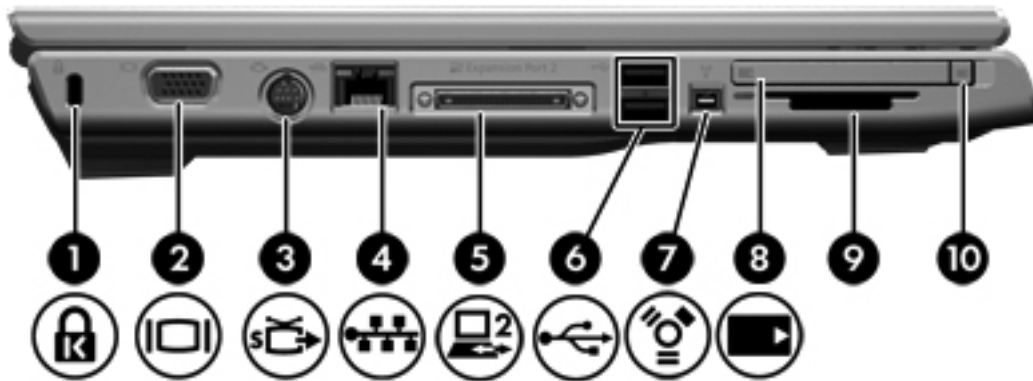
## Left-side components



Component	Description
(1) Security cable slot	Attaches an optional security cable to the computer.
	<p> <b>NOTE</b> The security cable is designed to act as a deterrent, but may not prevent the computer from being mishandled or stolen.</p>
(2) External monitor port	Connects an external monitor.
(3) S-Video-out jack	Connects an optional S-Video device such as a television, VCR, camcorder, overhead projector, or video capture card.
(4) RJ-45 (network) jack	Connects a network cable.
(5) Expansion port 2	Connects the computer to an optional expansion product.
(6) USB ports (2)	Connect an optional USB device.
(7) 1394 port (select models only)	Connects an optional IEEE 1394 device, such as a camcorder.
(8) PC Card slot (select models only)	Supports optional Type I or Type II PC Cards.
(9) Digital Media Slot (select models only)	Supports 7 optional digital card formats: Secure Digital (SD) Memory Card, Secure Digital Input/Output (SD I/O), MultiMediaCard (MMC), Memory Stick (MS), Memory Stick Pro (MSP), SmartMedia (SM), and xD-Picture Card (XD).
(10) PC Card slot eject button	Ejects the PC Card from the PC Card slot.

## Bottom components

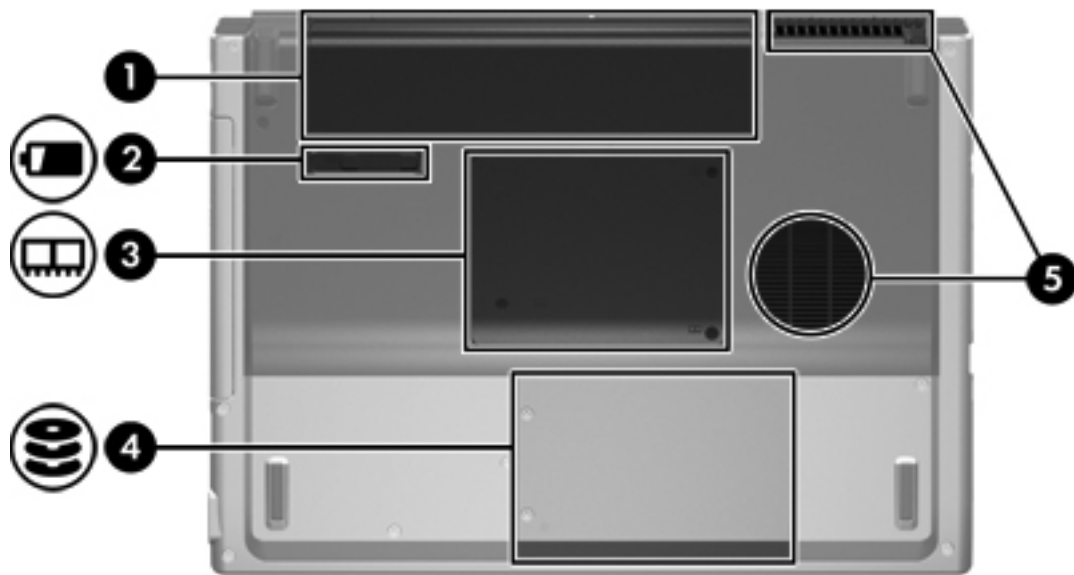

Component	Description
(1) Battery bay	Holds the primary battery pack.*
(2) Battery pack release latch	Releases the battery pack from the battery bay.
(3) Memory module compartment	Contains the memory module slots.
(4) Hard drive bay	Holds the hard drive.
(5) Vents (2)†	Enable airflow to cool internal components.

**CAUTION** To prevent overheating, do not obstruct vents. Use the computer only on a hard, flat surface. Do not allow another hard surface, such as an adjoining optional printer, or a soft surface, such as pillows or thick rugs or clothing, to block airflow.

**NOTE** The computer fan starts up automatically to cool internal components and prevent overheating. It is normal for the internal fan to cycle on and off during routine operation.

\*Battery packs vary by model.

†The computer has 3 vents. One other vent is located on the rear of the computer.

## Wireless antennae (select models only)

On select computer models, there are at least 2 wireless antennae that send and receive wireless device signals. They are not visible from the outside of the computer. For optimal transmission, keep the areas immediately around the antennae free from obstructions.



## Additional hardware components



Component	Description
(1) Battery pack*	Powers the computer when the computer is not connected to external power.
(2) AC adapter	Converts AC power to DC power.
(3) Power cord*	Connects an AC adapter to an AC outlet.
(4) Country-specific modem cable adapter (select models only)	Adapts the modem cable to a non-RJ-11 telephone jack.
(5) Modem cable*	Connects an internal modem to an RJ-11 telephone jack or to a country-specific modem adapter.

\*Modem cables, battery packs, and power cords vary in appearance by region and country.

## Labels

The labels affixed to the computer provide information you may need when you troubleshoot system problems or travel internationally with the computer.

- Service tag—Provides the product name, serial number (S/N), and other specifics about the computer. Have this information available when you contact Customer Care. The service tag label is affixed to the bottom of the computer.
- Microsoft Certificate of Authenticity—Contains the Microsoft Windows Product Key. You may need the Product Key to update or troubleshoot the operating system. This certificate is affixed to the bottom of the computer.
- Regulatory label—Provides regulatory information about the computer. The regulatory label is affixed inside the memory module compartment.
- Modem approval label—Provides regulatory information about the modem and lists the agency approval markings required by some of the countries in which the modem has been approved for use. You may need this information when traveling internationally. The modem approval label is affixed inside the memory module compartment.
- Wireless certification labels—Provide information about optional wireless devices available on select models, and the approval markings of some of the countries in which the devices have been approved for use. An optional device may be a wireless local area network (WLAN) device or an optional Bluetooth® device. If the computer model includes one or more wireless devices, a certification label is included with the computer. You may need this information when traveling internationally. Wireless certification labels are affixed inside the memory module compartment.



# Specifications

## Operating environment

The operating environment information in the following table may be helpful if you plan to use or transport the computer in extreme environments.

Factor	Metric	U.S.
<b>Temperature</b>		
Operating	10°C to 35°C	50°F to 95°F
Nonoperating	-20°C to 60°C	-4°F to 140°F
<b>Relative humidity (noncondensing)</b>		
Operating	10% to 90%	10% to 90%
Nonoperating	5% to 95%	5% to 95%
<b>Maximum altitude (unpressurized)</b>		
Operating (14.7 to 10.1 psia*)	-15 m to 3,048 m	-50 ft to 10,000 ft
Nonoperating (14.7 to 4.4 psia*)	-15 m to 12,192 m	-50 ft to 40,000 ft

\*Pounds per square inch absolute (psia) is another unit of measurement for altitude.

## Rated input power

The power information in this section may be helpful if you plan to travel internationally with the computer.

The computer operates on DC power, which can be supplied by an AC or a DC power source. Although the computer can be powered from a stand-alone DC power source, it should be powered only with an AC adapter or a DC power cord supplied by or approved for an HP computer.

The computer is capable of accepting DC power within the following specifications.

Input Power	Rating
Operating voltage	18.5 V dc to 19.0 V dc
Operating current	3.5 A or 4.74 A or 4.9 A

This product is designed for IT power systems in Norway with phase-to-phase voltage not exceeding 240 V rms.

## Expansion port input/output signals

The expansion port signal information in this section may be helpful if you plan to use an optional expansion product that connects to the expansion port on the computer.

The expansion port is illustrated in the "[Left-side components](#)" section.

The following table identifies the input and output signals supported by the expansion port on the computer.

Feature	Support
USB 2.0	Yes
10/100 Ethernet	Yes
Gigabit Ethernet	No
IEEE 1394 (4-pin port)	Yes
Infrared (for remote control only)	Yes
Power inputs	65W - 135W maximum
Composite TV*	Yes
S-Video TV	Yes
Component TV*	No
S/PDIF audio	Yes
DVI	No
Headphone/speaker audio-out	Yes
Microphone audio-in	Yes

\* Requires the use of an optional expansion product.

## 2 TouchPad and Keyboard

### TouchPad

The following illustration and table describe the computer TouchPad.



Component	Description
(1) TouchPad*	Moves the pointer and selects or activates items on the screen. Can be set to perform other mouse functions, such as scrolling, selecting, and double-clicking.
(2) Left TouchPad button*	Functions like the left button on an external mouse.
(3) TouchPad scroll zone*	Scrolls up or down.
(4) Right TouchPad button*	Functions like the right button on an external mouse.

\*This table describes default settings. To view and change TouchPad preferences, select **Start > Control Panel > Printers and Other Hardware > Mouse**.

## Using the TouchPad

To move the pointer, slide your finger across the TouchPad surface in the direction you want the pointer to go. Use the left and right TouchPad buttons as you would the left and right buttons on an external mouse. To scroll up and down using the TouchPad scroll zone, slide your finger up or down over the grooved lines on the TouchPad.

## Using an external mouse

An external USB mouse can be connected to the computer using one of the USB ports on the computer. A USB mouse can also be connected to the system using the connectors on an optional expansion product.

## Setting TouchPad preferences

Mouse Properties in Microsoft® Windows® allows you to customize settings for pointing devices, including

- TouchPad tapping, which enables you to tap the TouchPad once to select an object or twice to double-click an object (enabled by default).
- Edge motion, which enables you to continue to scroll even though your finger has reached the edge of the TouchPad (disabled by default).
- Button preference, which allows you to switch between left-hand and right-hand use (right-hand preference is enabled by default).

Other features, such as mouse speed preferences and mouse trails, are also found in Mouse Properties.

To access Mouse Properties, select **Start > Control Panel > Printers and Other Hardware > Mouse**.

# Keyboard

The following sections provide information on the keyboard features of the notebook.

## Hotkeys

Hotkeys are combinations of the **fn** key (1) and either the **esc** key (2) or one of the function keys (3).

The icons on the **f1** through **f12** keys represent the hotkey functions. Hotkey functions and procedures are discussed in the following sections.

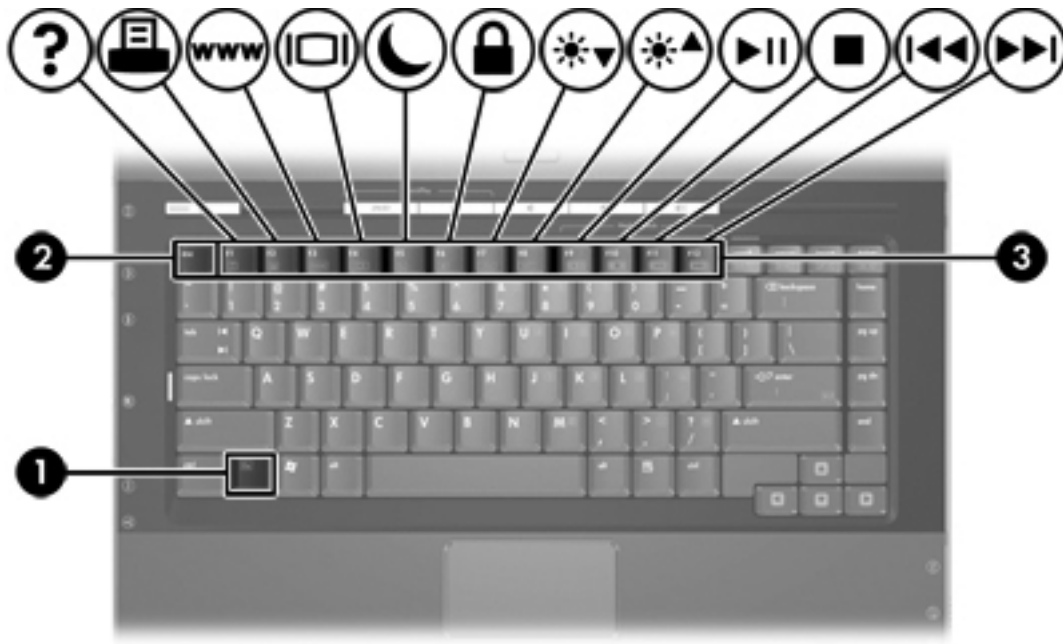

## Hotkey quick reference

Function	Key Combination
Display and clear system information.	fn+esc
Open the Help and Support Center.	fn+f1
Open the Print Options window.	fn+f2
Open a Web browser.	fn+f3
Switch the screen image between the computer display and an external display.	fn+f4
Initiate standby.	fn+f5
Initiate QuickLock.	fn+f6
Decrease screen brightness.	fn+f7
Increase screen brightness.	fn+f8
Play, pause, or resume an audio CD or a DVD.	fn+f9
Stop an audio CD or a DVD.	fn+f10
Play the previous track or section on an audio CD or a DVD.	fn+f11
Play the next track on an audio CD or a DVD.	fn+f12

## Hotkey procedures

To use a hotkey command on the computer keyboard, either

- Briefly press the **fn** key, and then briefly press the second key of the hotkey command.  
– or –
- Press and hold down the **fn** key, briefly press the second key of the hotkey command, and then release both keys at the same time.

### Display and clear system information (fn+esc)

Press **fn+esc** to display information about system hardware components and the system BIOS version number. Press **fn+esc** a second time to remove the system information from the screen.

In the Windows **fn+esc** display, the version of the system BIOS (basic input-output system) is displayed as the BIOS date. On some computer models, the BIOS date is displayed in decimal format. The BIOS date is sometimes called the system ROM version number.

## Open the Help and Support Center (fn+f1)

Press **fn+f1** to open the Help and Support Center.

In addition to providing information about your Windows operating system, the Help and Support Center provides

- Information about your computer, such as model and serial number, installed software, hardware components, and specifications.
- Answers to questions about using your computer.
- Tutorials to help you learn to use computer and Windows features.
- Updates for your Windows operating system, drivers, and the software provided on your computer.
- Checkups for computer functionality.
- Automated and interactive troubleshooting, repair solutions, and system recovery procedures.
- Links to HP support specialists.

You can also access the Help and Support Center by selecting **Start > Help and Support**.

## Open the Print Options window (fn+f2)

Press **fn+f2** to open the Print Options window of the active Windows application.

## Open a Web browser (fn+f3)

Press **fn+f3** to open your default Web browser.

Until you have set up your Internet or network services, the **fn+f3** hotkey opens the Windows Internet Connection Wizard.

After you have set up your Internet or network services and your Web browser home page, you can press **fn+f3** to quickly access your home page and the Internet.

## Switch the screen image (fn+f4)

Press **fn+f4** to switch the screen image among display devices connected to the system. For example, if a monitor is connected to the computer, each time you press **fn+f4** the image switches among the computer display, the monitor display, and a simultaneous display on both the computer and the monitor.

Most external monitors receive video information from the computer using the external VGA video standard. The **fn+f4** hotkey can also toggle images among other devices receiving video information from the computer, such as S-Video.

The following video transmission types, with examples of devices that use them, are supported by the **fn+f4** hotkey:

- LCD (computer display)
- External VGA (most external monitors)
- S-Video (televisions, camcorders, VCRs, and video capture cards with S-Video-in jacks, on select models)
- Composite video (televisions, camcorders, VCRs, and video capture cards with composite-video-in jacks)



---

**NOTE** Composite video devices can be connected to the system only by using an optional expansion product.

---

## Initiate standby (fn+f5)

Press **fn+f5** to initiate standby.

When standby is initiated, your information is stored in random access memory (RAM), the screen is cleared, and power is conserved. While the computer is in standby, the power light blinks.



---

**CAUTION** To reduce the risk of information loss, save your work before initiating standby.

---

The computer must be turned on before you initiate standby. If the computer is in hibernation, you must restore from hibernation before you can initiate standby.



---

**NOTE** To restore from hibernation, briefly press the power button.

---

To resume from standby, briefly press the power button, use the TouchPad, press any key on the keyboard, or press the Media button, DVD button, or a TouchPad button.

The function of the **fn+f5** hotkey can be changed. For example, you can set the **fn+f5** hotkey to initiate hibernation instead of standby.



---

**NOTE** In all Windows operating system windows, references to the *sleep button* apply to the **fn+f5** hotkey.

---



## Initiate QuickLock (fn+f6)

Press **fn+f6** to initiate the QuickLock security feature.

QuickLock protects your information by displaying the operating system Log On window. While the Log On window is displayed, the computer cannot be accessed until a Windows user password or a Windows administrator password is entered.



**NOTE** Before you can use QuickLock, you must set a Windows user password or a Windows administrator password. For instructions, refer to the Help and Support Center.

To use QuickLock, press **fn+f6** to display the Log On window and lock the computer. Then follow the instructions on the screen to enter your Windows user password or your Windows administrator password and access the computer.

## Decrease screen brightness (fn+f7)

Press **fn+f7** to decrease screen brightness. Hold down the hotkey to decrease the brightness level incrementally.

## Increase screen brightness (fn+f8)

Press **fn+f8** to increase screen brightness. Hold down the hotkey to increase the brightness level incrementally.

## Play, pause or resume an audio CD or a DVD (fn+f9)

The **fn+f9** hotkey functions only when an audio CD or a DVD is inserted. If the audio CD or the DVD is

- Not playing, press **fn+f9** to begin or resume the play.
- Playing, press **fn+f9** to pause the play.

## Stop an audio CD or a DVD (fn+f10)

Press **fn+f10** to stop the play of an audio CD or a DVD.

## Play previous track or section of an audio CD or a DVD (fn+f11)

While an audio CD or a DVD is playing, press **fn+f11** to play the previous track of the CD or the previous section of the DVD.

## Play next track or section of an audio CD or a DVD (fn+f12)

While an audio CD or a DVD is playing, press **fn+f12** to play the next track of the CD or the next section of the DVD.

## Quick Launch Buttons software

You can use the Quick Launch Buttons control panel to

- Set preferences for tiling windows on the Windows desktop.
- Set advanced preferences, including
  - Setting preferences for the display of the Quick Launch Buttons icon.
  - Setting button assignments for the Easy Access buttons on an optional external keyboard.

The following sections provide instructions for setting preferences within the control panel. For additional on-screen information about any item on the control panel, select the help button in the upper-right corner of the window. The help button is identified with a question-mark icon.

### Accessing the Quick Launch Buttons control panel

You can access the Quick Launch Buttons control panel from the Start button or from an icon that you can display in the notification area, at the far right of the taskbar, or on the Windows desktop.

To access the Quick Launch Buttons control panel from the Start button, select **Start > Control Panel > Printers and Other Hardware > Quick Launch Buttons**.

### Setting tiling preferences

To set tiling preferences on the Windows desktop:

1. Open the Quick Launch Buttons control panel:
  - Select **Start > Control Panel > Printers and Other Hardware > Quick Launch Buttons**.
  - or –
  - Double-click the Quick Launch Buttons icon in the notification area, at the far right of the taskbar, or on the Windows desktop.
2. Click the **Quick Tile** tab.
3. Click **Vertical Tile** or **Horizontal Tile**, and then click the applications to tile in the **Applications currently running** box.
4. To save your preferences and close the display, click **OK**.

### Setting advanced preferences

You can set icon and external keyboard assignments in the Quick Launch Button control panel.

## Displaying the Quick Launch Buttons icon

To show or hide the Quick Launch Buttons Properties icon in the notification area, at the far right of the taskbar, or on the Windows desktop:

1. Open the Quick Launch Buttons control panel:
  - Select **Start > Control Panel > Printers and Other Hardware > Quick Launch Buttons**.
  - or –
  - Double-click the Quick Launch Buttons icon, either in the notification area, at the far right of the taskbar, or on the Windows desktop.
2. Click the **Advanced** tab. On the Advanced tab you can display or hide the Quick Launch Buttons icon in the notification area or on the Windows desktop.
  - To display the icon, select the **Show icon on the taskbar** or **Show icon on the desktop** check box.
  - To hide the icon, clear the **Show icon on the taskbar** or **Show icon on the desktop** check box.
3. To save your preferences and close the display, click **OK**.

## Setting button assignments on an external keyboard

If you are using an optional HP external keyboard that features Easy Access buttons, you can set Easy Access button assignments and schemes on the Settings tab.

The Settings tab is disabled and hidden by default. To display and enable the Settings tab in the Quick Launch Buttons control panel:

1. Open the Quick Launch Buttons control panel:
  - Select **Start > Control Panel > Printers and Other Hardware > Quick Launch Buttons**.
  - or –
  - Double-click the **Quick Launch Buttons** icon in the notification area, at the far right of the taskbar, or on the Windows desktop.
2. Click the **Advanced** tab. Then:
  - To display and enable the Settings tab, select the **Allow users to modify button assignments on external keyboard** check box.
  - or –
  - To disable and hide the Settings tab, clear the **Allow users to modify button assignments on external keyboard** check box.



---

**NOTE** If you enable the Settings tab, you must close the Quick Launch Buttons Properties dialog box, and then open it again in order to see the Settings tab.

---

3. To save your preferences and close the display, click **OK**.

For information about managing Easy Access button assignments and schemes, refer to your external keyboard documentation.

# Keypads

The computer has an embedded numeric keypad and also supports an optional external numeric keypad or an optional external keyboard that includes a numeric keypad.

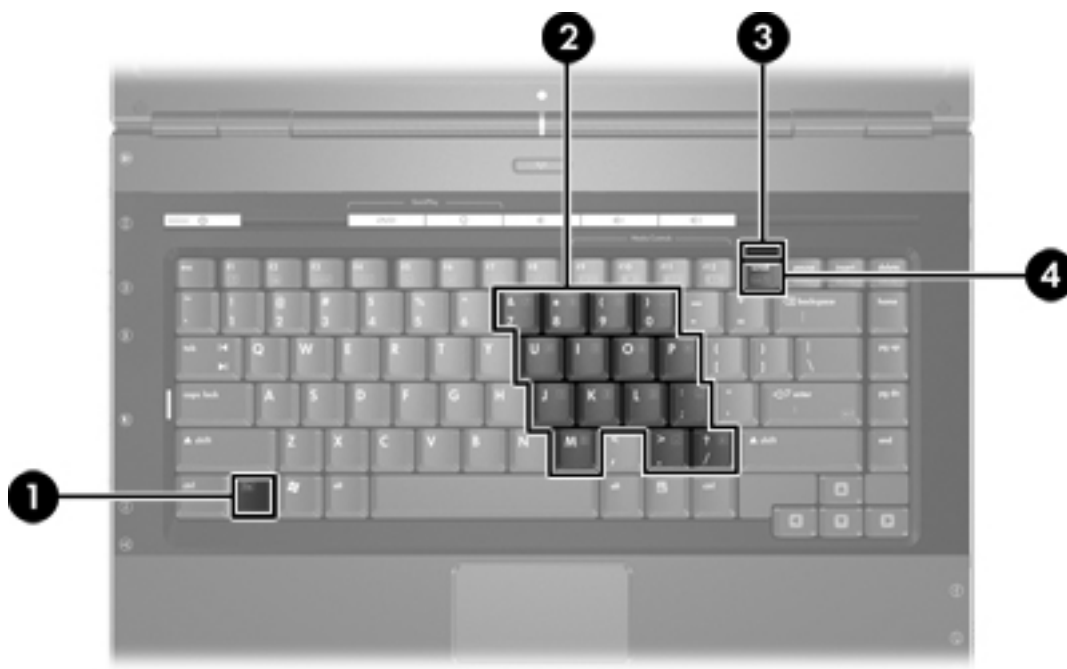

Component
(1) <a href="#">fn</a> key
(2) Embedded numeric keypad
(3) num lock light
(4) <a href="#">num lk</a> key

## Using the embedded numeric keypad

The 15 keys of the embedded numeric keypad can be used like the keys on an external keypad. When the embedded numeric keypad is turned on, each key on the keypad performs the function indicated by the icon in the upper-right corner of the key.

## Enabling and disabling the embedded numeric keypad

Press [fn+num lk](#) to enable the embedded numeric keypad. The num lock light is turned on. Press [fn+num lk](#) again to return the keys to their standard keyboard functions.



**NOTE** The embedded numeric keypad will not function while an external keyboard or keypad is connected to the computer or to an optional expansion product.

## Switching key functions on the embedded numeric keypad

You can temporarily alternate the functions of keys on the embedded numeric keypad between their standard keyboard functions and their keypad functions by using the **fn** key or the **fn+shift** key combination.

- To change the function of a keypad key to keypad functions while the keypad is off, press and hold the **fn** key while pressing the keypad key.
- To use the keypad keys temporarily as standard keys while the keypad is on:
  - Press and hold the **fn** key to type in lowercase.
  - Press and hold **fn+shift** to type in uppercase.

## Using an external numeric keypad

Most keys on most external keypads function differently according to whether num lock mode is on or off. (By default num lock mode is off.) For example:

- When num lock is on, most keypad keys type numbers.
- When num lock is off, most keypad keys function like the arrow, page up, or page down keys.

When num lock on an external keypad is turned on, the num lock light on the computer is turned on. When num lock on an external keypad is turned off, the num lock light on the computer is turned off.

If an external keypad is connected, the embedded numeric keypad cannot be turned on.

## Enabling or disabling num lock mode as you work

To turn num lock on or off on an external keypad as you work, press the **num lk** key on the external keypad, not on the computer.



# 3 Power

## Power control and light locations

The following illustration and table identify and describe the power control and light locations.



**NOTE** Your computer may look slightly different from the illustrations in this section.

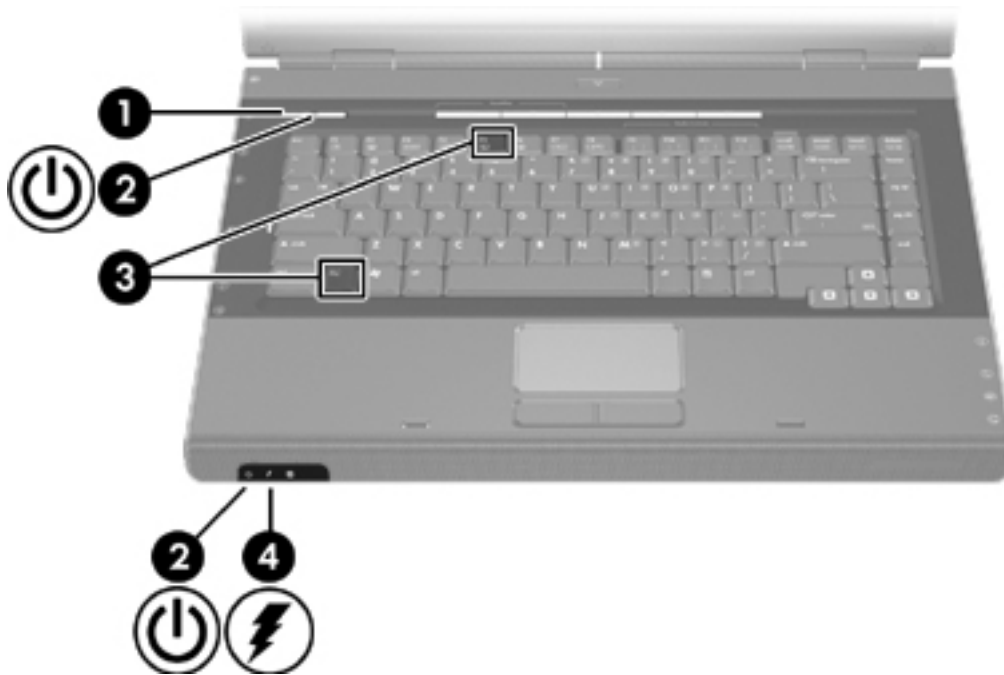

Component	Description
(1) Power button	<p>When the computer is</p> <ul style="list-style-type: none"><li>• Off, press to turn on the computer.</li><li>• On, press to enter hibernation.</li><li>• In standby, briefly press to exit standby.</li><li>• In hibernation, briefly press to exit hibernation.</li></ul> <p>If the computer has stopped responding and Microsoft® Windows® shutdown procedures cannot be used, press and hold the power button for at least 5 seconds to turn off the computer.</p>

Component	Description
(2) Power lights* (2)	<p>On: The computer is on.</p> <p>Blinking: The computer is in standby.</p> <p>Off: The computer is off or in hibernation.</p>
(3) fn+f5	Initiates standby.
(4) Battery light	<p>On: A battery pack is charging or is close to full charge capacity.</p> <p>Blinking: A battery pack that is the only available power source has reached a low-battery condition. When the battery reaches a <i>critical</i> low-battery condition, the battery light begins blinking rapidly.</p> <p>Off: If the computer is plugged into an external power source, the light is turned off when all batteries in the computer are fully charged. If the computer is not plugged into an external power source, the light stays off until the battery reaches a low-battery condition.</p>

\*There are 2 power lights. Both display the same information. The light on the power button is visible only when the computer is open; the other power light is always visible on the front of the computer.



# Power sources

The computer can run on internal or external AC power. The following table indicates the best power sources for common tasks.

Task	Recommended power source
Work in most software applications	<ul style="list-style-type: none"><li>• Charged battery pack in the computer</li><li>• External power supplied through one of the following devices:<ul style="list-style-type: none"><li>• AC adapter</li><li>• Optional expansion product (select models only)</li><li>• Optional power adapter</li></ul></li></ul>
Charge or calibrate a battery pack in the computer	External power supplied through <ul style="list-style-type: none"><li>• AC adapter</li><li>• Optional expansion product (select models only)</li><li>• Optional power adapter</li></ul> <p> <b>WARNING!</b> Do not charge the computer battery pack on board aircraft. Charging the battery pack may damage aircraft electronic systems.</p>
Install or modify system software or write to a CD or DVD	External power supplied through <ul style="list-style-type: none"><li>• AC adapter</li><li>• Optional expansion product (select models only)</li><li>• Optional power adapter</li></ul>

## Connecting the AC adapter



**WARNING!** To reduce the risk of electric shock or damage to the equipment:

Plug the power cord into an AC outlet that is easily accessible at all times.

Disconnect power from the computer by unplugging the power cord from the AC outlet (not by unplugging the power cord from the computer).

If provided with a 3-pin attachment plug on the power cord, plug the cord into a grounded (earthed) 3-pin outlet. Do not disable the power cord grounding pin; for example, by attaching a 2-pin adapter. The grounding pin is an important safety feature. It is possible to receive an electric shock from a system that is not properly grounded.

To connect the computer to external AC power:

1. Plug the AC adapter into the power connector on the computer (1).
2. Plug the power cord into the AC adapter (2).
3. Plug the other end of the power cord into an AC outlet (3).



# Standby and hibernation

Standby and hibernation are energy-saving features that conserve power and reduce startup time. They can be initiated by you or by the system. For more information, refer to "[Initiating standby, hibernation or shutdown.](#)"

## Standby



---

**CAUTION** To avoid a complete battery discharge, do not leave the computer in standby for extended periods. Connect the computer to an external power source.

---

Standby reduces power to system components that are not in use. When standby is initiated, your work is stored in random access memory (RAM), and then the screen is cleared. When the computer is in standby, the power lights blink. When you resume from standby, your work returns to the screen where you left off.



---

**CAUTION** To reduce the risk of information loss, save your work before initiating standby.

---

## Hibernation



---

**CAUTION** If the configuration of the computer is changed during hibernation, resuming from hibernation may not be possible. When the computer is in hibernation:

Do not connect the computer to or disconnect the computer from an expansion product.

Do not add or remove memory modules.

Do not insert or remove any hard drives or optical drives.

Do not connect or disconnect external devices.

Do not insert or remove an external media card, such as a MultiMediaCard, a PC Card (select models only), or an ExpressCard.

---

Hibernation saves your work to a hibernation file on the hard drive, and then shuts down the computer. The power lights are turned off. When you restore from hibernation, your work returns to the screen where you left off. If a power-on password has been set, the password must be entered to restore from hibernation.



---

**CAUTION** To reduce the risk of information loss, save your work before initiating hibernation.

---

You can disable hibernation. However, if hibernation is disabled and the system reaches a low-battery condition, the system will not automatically save your work while power is on or when standby has been initiated.

Use **Power Options** in Microsoft® Windows® Control Panel to reenable hibernation:

1. Select **Start > Control Panel > Performance and Maintenance > Power Options > Hibernate** tab.
2. Be sure that the **Enable hibernation** check box is selected.

To set the time interval after which the system initiates hibernation:

1. Select **Start > Control Panel > Performance and Maintenance > Power Options**.
2. Click one of the intervals in the **System hibernates** list.

## Initiating standby, hibernation or shutdown

The following sections explain when to initiate standby or hibernation and when to shut down the computer.



---

**NOTE** You cannot initiate any type of networking communications or perform any computer functions while the computer is in standby or hibernation.

---

### When you leave your work

When standby is initiated, your work is stored in random access memory (RAM), and then the screen is cleared. When the computer is in standby, it uses less power than when it is on. Your work returns instantly to the screen when you resume from standby.

Hibernation saves your work to a hibernation file on the hard drive, and then shuts down the computer. When the computer is in hibernation, it uses much less power than when it is in standby.

When the computer will be unused and disconnected from external power for an extended period, shut down the computer and remove the battery pack to extend the life of the battery pack. For details on battery pack storage, refer to "[Storing a battery pack](#)."

### When a reliable power supply is unavailable

Be sure that hibernation remains enabled, especially if you are operating the computer on battery power and do not have access to an external power supply. If the battery pack fails, hibernation saves your work to a hibernation file and shuts down the computer.

It is recommended that if you pause your work when the power supply is uncertain, you take one of the following actions:

- Save your work, and then initiate standby.
- Initiate hibernation.
- Shut down the computer.

## When using wireless communication or readable or writable media (select models only)



---

**CAUTION** To prevent possible audio and video degradation, or loss of audio or video playback functionality, do not initiate standby or hibernation while reading or writing to a CD, DVD, or external media card. To prevent loss of information, do not initiate standby or hibernation while writing to a CD, DVD, or external media card.

---

Standby and hibernation interfere with the use of infrared and Bluetooth communication, and media. Note the following guidelines:

- If the computer is in standby or hibernation, you cannot initiate an infrared or Bluetooth transmission.
- If standby or hibernation is accidentally initiated during playback of a medium such as a CD, DVD, or external media card
  - Your playback may be interrupted.
  - You may see the following warning message: "Putting the computer into hibernation or standby may stop the playback. Do you want to continue?" Click **No**.
  - You may need to restart the media to resume audio and video playback.

# Default power settings

This section explains the default standby, hibernation, and shutdown procedures. For information about changing the function of the power features on the computer, refer to "[Power options](#)."

The controls and lights discussed in this section are illustrated in "[Power control and light locations](#)."

## Turning the computer or display on or off

Task	Procedure	Result
Turn on the computer.	Press the power button.	<ul style="list-style-type: none"><li>• The power lights are turned on.</li><li>• The operating system loads.</li></ul>
Shut down the computer.	<ol style="list-style-type: none"><li>1. Save your work and close all open applications.</li><li>2. Shut down the computer through the operating system by selecting <b>Start &gt; Turn Off Computer &gt; Turn Off</b>.</li></ol> <div style="border: 1px solid #00a0e3; padding: 5px; margin-top: 10px;"> <b>NOTE</b> If the system is unresponsive and you are unable to shut down the computer with these procedures, refer to "<a href="#">Using emergency shutdown procedures</a>."</div>	<ul style="list-style-type: none"><li>• The power lights are turned off.</li><li>• The operating system shuts down.</li><li>• The computer is turned off.</li></ul>
Turn off the display while the power is on.	Close the computer.	Closing the computer activates the display switch, which initiates standby.

## Using emergency shutdown procedures



**CAUTION** Emergency shutdown procedures result in the loss of unsaved information.

If the computer is unresponsive and you are unable to use normal Windows shutdown procedures, try the following emergency procedures in the sequence provided:

- Press **ctrl+alt+delete**. Then, select **Shut Down > Turn Off**.
- Press and hold the power button for at least 5 seconds.
- Disconnect the computer from external power and remove the battery pack.

## Initiating or resuming from standby

Task	Procedure	Result
Initiate standby.	<ul style="list-style-type: none"><li>• With the computer on, press the hotkey to initiate standby.</li><li>• Select <b>Start &gt; Turn Off Computer &gt; Stand by</b>.  In Windows XP Professional, if <b>Stand by</b> is not displayed:<ol style="list-style-type: none"><li>a. Press the down arrow.</li><li>b. Select <b>Stand by</b> from the list.</li><li>c. Click <b>OK</b>.</li></ol></li><li>• Close the computer.</li></ul>	<ul style="list-style-type: none"><li>• The power lights blink.</li><li>• The screen clears.</li></ul>
Allow the system to initiate standby.	<p>No action required.</p> <ul style="list-style-type: none"><li>• If the computer is running on battery power, the system initiates standby after 10 minutes of computer inactivity. (Default setting)</li></ul> <p>Power settings and timeouts can be changed using Power Options in Windows Control Panel.</p>	<ul style="list-style-type: none"><li>• The power lights blink.</li><li>• The screen clears.</li></ul>
Resume from user-initiated or system-initiated standby.	<ul style="list-style-type: none"><li>• Press the power button.</li><li>• If the display was closed while the computer was in standby, open the display.</li></ul>	<ul style="list-style-type: none"><li>• The power lights are turned on.</li><li>• Your work returns to the screen.</li></ul>

## Initiating or restoring from hibernation

Hibernation cannot be initiated unless it is enabled. Hibernation is enabled by default.

To verify that hibernation remains enabled, Select **Start > Control Panel > Performance and Maintenance > Power Options > Hibernate** tab. If hibernation is enabled, the **Enable hibernation** check box is selected.

Task	Procedure	Result
Initiate hibernation.	<ul style="list-style-type: none"><li>• Press the power button.</li><li>– or –</li><li>• Select <b>Start &gt; Turn Off Computer</b>. Then, hold down the <b>shift</b> key as you select <b>Hibernate</b>.</li></ul> <p>In Windows XP Professional, if hibernate is not displayed:</p> <ol style="list-style-type: none"><li>a. Press the up or down arrow.</li><li>b. Select <b>Hibernate</b> from the list.</li><li>c. Click <b>OK</b>.</li></ol>	<ul style="list-style-type: none"><li>• The power lights are turned off.</li><li>• The screen clears.</li></ul>
Allow the system to initiate hibernation (with hibernation enabled).	<p>No action required. If the computer is running on battery power, the system initiates hibernation</p> <ul style="list-style-type: none"><li>• After 30 minutes of computer inactivity.</li><li>• When the battery pack reaches a critical low-battery condition.</li></ul> <p>Power settings and timeouts can be changed using Power Options in Windows Control Panel.</p>	<ul style="list-style-type: none"><li>• The power lights are turned off.</li><li>• The screen clears.</li></ul>
Restore from user-initiated or system-initiated hibernation.	Press the power button.*	<ul style="list-style-type: none"><li>• The power lights are turned on.</li><li>• Your work returns to the screen.</li></ul>

\*If the system initiated hibernation because of a critical low-battery condition, connect external power or insert a charged battery pack before you press the power button. (The system may not respond if the discharged battery pack is the only power source.)



# Power options

You can change many default power settings in Windows Control Panel. For example, you can set an audio alert to warn you when the battery pack reaches a low-power condition, or you can change the default settings for the power button.

By default, when the computer is on:

- Pressing the **fn+f5** hotkey, called the "sleep button" by the operating system, initiates standby.
- By default, the display switch turns off the display and initiates standby. The display switch is activated by closing the display.

## Accessing Power Options Properties

To access Power Options Properties:

- Right-click the **Power Meter** icon in the notification area, at the far right of the taskbar, and then click **Adjust Power Properties**.  
– or –
- Select **Start > Control Panel > Performance and Maintenance > Power Options**.

## Displaying the Power Meter icon

By default, the Power Meter icon appears in the notification area, at the far right of the taskbar. The icon changes shape to indicate whether the computer is running on battery or external power.

To show the Power Meter icon in the notification area:

1. Select **Start > Control Panel > Performance and Maintenance > Power Options**.
2. Click the **Advanced** tab.
3. Select the **Always show icon on the taskbar** check box.
4. Click **Apply** and then click **OK**.

To remove the Power Meter icon from the notification area:

1. Right-click the **Power Meter** icon in the notification area, and then click **Adjust Power Properties**.
2. Click the **Advanced** tab.
3. Clear the **Always show icon on the taskbar** check box.
4. Click **Apply** and then click **OK**.



**NOTE** If you cannot see an icon you have placed in the notification area, at the far right of the taskbar, click the arrow in the notification area to view hidden icons.

## Setting or changing a power scheme

The Power Schemes tab in the **Power Options Properties** dialog box assigns power levels to system components. You can assign different schemes, depending on whether the computer is running on battery or external power.

You can also set a power scheme that initiates standby or turns off the display or hard drive after a time interval that you specify.

To set a power scheme:

1. Right-click the **Power Meter** icon in the notification area, and then click **Adjust Power Properties**.
2. Click the **Power Schemes** tab.
3. Select the power scheme you want to modify, and adjust options in the lists on the screen.
4. Click **Apply**.

## Setting a security prompt

You can add a security feature that prompts you for a password when the computer is turned on, resumes from standby, or restores from hibernation.

To set a password prompt:

1. Right-click the **Power Meter** icon in the notification area, and then click **Adjust Power Properties**.
2. Click the **Advanced** tab.
3. Select the **Prompt for password when computer resumes from standby** check box.
4. Click **Apply**.

# Processor performance controls



**CAUTION** To prevent overheating, do not obstruct vents. Use the computer only on a hard, flat surface. Do not allow another hard surface, such as a printer, or a soft surface, such as pillows, thick rugs, or clothing, to block the airflow. Overheating can damage the computer and reduce processor performance.



**NOTE** In some cases, a computer may operate at a higher speed on external power than on battery power. If the battery power is extremely low, the computer may attempt to conserve power by reducing processor speed and graphics performance.

Windows XP enables you to manage the processor performance controls by selecting a power scheme. The processing speed can be set for optimal performance or for optimal power conservation.

Processor performance controls are managed in the **Power Options Properties** dialog box. To access Windows XP processor performance controls, Select **Start > Control Panel > Performance and Maintenance > Power Options > Power Schemes** tab.

The power scheme you select determines how the processor performs when the computer is plugged into external power or is running on battery power. Each power scheme for external power or battery power sets a specific processor state.

After a power scheme has been set, no other intervention is required to control the performance of the computer processor. The following table describes the processor performance on external and battery power for the available power schemes.

Power scheme	Processor performance while on external power	Processor performance while on battery power
Home/Office Desk	Always runs at the highest performance state.	Performance state is determined based on CPU demand.
Portable/Laptop (default) *	Performance state is determined based on CPU demand.	Performance state is determined based on CPU demand.
Presentation	Performance state is determined based on CPU demand.	CPU performance is lower on battery power, then steadily decreases as the battery discharges.
Always On	Always runs at the highest performance state.	Always runs at the highest performance state.
Minimal Power Management	Performance state is determined based on CPU demand.	Performance state is determined based on CPU demand.
Max Battery	Performance state is determined based on CPU demand.	CPU performance is lower on battery power, then steadily decreases as the battery discharges.

\* It is recommended that you use the Portable/Laptop power scheme.

## Battery packs

When a charged battery pack is in the computer and the computer is not plugged into external power, the computer runs on battery power. When the computer is plugged into external AC power, the computer runs on AC power.

If the computer contains a charged battery pack and is running on external AC power supplied through the AC adapter, the computer switches to battery power if the AC adapter is disconnected from the computer.

You can keep a battery pack in the computer or in storage, depending on how you work. Keeping the battery pack in the computer whenever the computer is plugged into external AC power enables the battery pack to charge and also protects your work in case of a power outage. However, a battery pack in the computer slowly discharges when the computer is turned off and not plugged into external power.

### Inserting or removing a battery pack



**CAUTION** To prevent loss of information when removing a battery pack that is the sole power source, initiate hibernation or turn off the computer before removing the battery pack.

To insert a battery pack:



**NOTE** Battery packs may vary in appearance.

1. Turn the computer upside down on a flat surface with the battery bay to the left.
2. Insert the battery pack into the battery bay (1) and rotate it until it is seated (2).

The battery pack release latch automatically locks the battery into place.

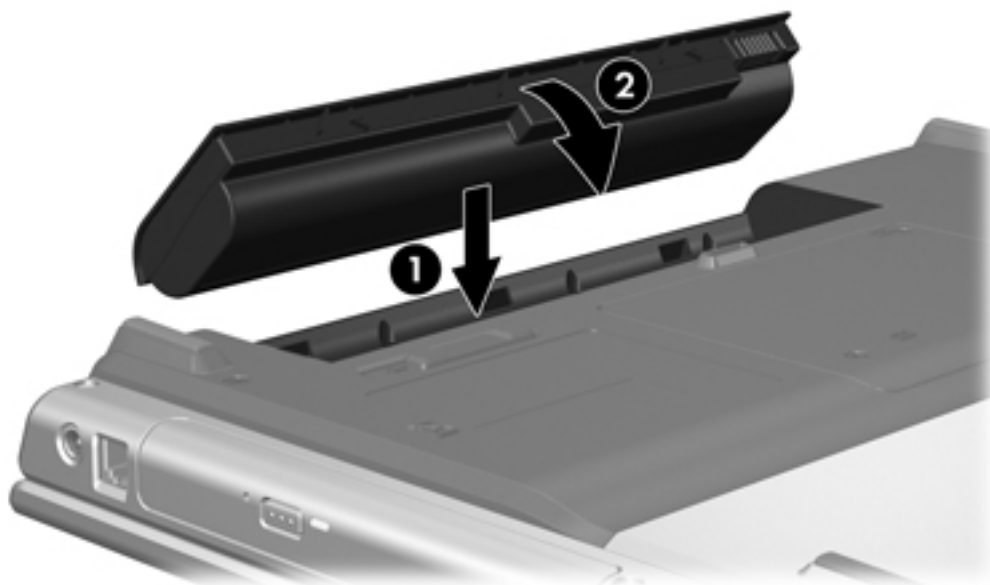

To remove a battery pack:

1. Turn the computer upside down with the battery bay to the left.
2. Slide the battery pack release latch (1) to release the battery pack.
3. Pivot the battery pack (2) away from the computer and remove it from the computer (3).



## Charging a battery pack

To prolong battery life and optimize the accuracy of battery charge displays:



**WARNING!** Do not charge the computer battery pack on board aircraft. Charging the battery pack may damage aircraft electronic systems.

- If you are charging a new battery pack:
  - Charge the battery pack while the computer is connected to external power through the AC adapter.
  - When you charge the battery pack, charge it fully before turning on the computer.
- If you are charging an in-use battery pack:
  - Allow the battery pack to discharge to about 10 percent of a full charge through normal use before charging it.
  - When you charge the battery pack, charge it fully before turning on the computer.

A battery pack inserted in the computer charges whenever the computer is connected to external power through an AC adapter, an optional expansion product, or an optional power adapter.

A battery pack inserted in the computer charges whether the computer is off or in use, but the battery pack charges faster while the computer is off. Charging may be delayed if a battery pack is new, has been unused for 2 weeks or more, or is much warmer or cooler than room temperature.

The battery light displays charge status:

- On: the battery pack is charging.
- Blinking: the battery pack has reached a low-battery condition and is not charging.
- Blinking rapidly: The battery pack has reached a critical low-battery condition and is not charging.
- Off: the battery pack is fully charged or not installed.

For information about determining the amount of charge in a battery pack, refer to "[Monitoring the charge of the battery pack.](#)"

## Monitoring the charge of the battery pack

This section explains several ways to determine the amount of charge in a battery pack.

### Obtaining accurate charge information

To increase the accuracy of all battery charge indicators:

- Allow a battery pack to discharge to about 10 percent of a full charge through normal use before charging it.
- When you charge a battery pack, charge it fully before turning on the computer.
- If a battery pack has been unused for one month or more, calibrate the battery pack instead of simply charging it. For calibration instructions, refer to "[Calibrating a battery pack.](#)"

### Displaying charge information on the screen

This section explains how to access and interpret battery charge indicators.

#### Viewing charge displays

To view information about the status of any battery pack in the computer:

- Double-click the **Power Meter** icon in the notification area, at the far right of the taskbar.  
– or –
- Select **Start > Control Panel > Performance and Maintenance > Power Options > Power Meter**.

#### Interpreting charge indicators

Most charge indicators report battery status as both a percentage and as the number of minutes of charge remaining:

- The percentage indicates the approximate amount of charge remaining in the battery pack.
- The time indicates the approximate running time remaining on the battery pack *if the battery pack continues to provide power at the current level*. For example, the time remaining will decrease when you start playing a DVD and will increase when you stop playing a DVD.

When a battery pack is charging, a lightning bolt icon may be superimposed over the battery icon on the Power Meter screen.

## Managing low-battery conditions

The information in this section describes the alerts and system responses set at the factory. Some low-battery condition alerts and system responses can be changed using Power Options in Windows Control Panel. Preferences set using Power Options do not affect lights.

### Identifying low-battery conditions

This section explains how to identify low-battery and critical low-battery conditions.

#### Low-battery condition

When a battery pack that is the sole power source for the computer reaches a low-battery condition, the battery light blinks.

#### Critical low-battery condition

If a low-battery condition is not resolved, the computer enters a critical low-battery condition, and the battery light blinks rapidly.

In a critical low-battery condition:

- If hibernation is enabled and the computer is on or in standby, the computer initiates hibernation.
- If hibernation is disabled and the computer is on or in standby, the computer remains briefly in standby, and then shuts down and loses any unsaved information.

To verify that hibernation is enabled:

1. Select **Start > Control Panel > Performance and Maintenance > Power Options > Hibernate**.
2. Be sure that the **Enable hibernation support** check box is selected.

## Resolving low-battery conditions



---

**CAUTION** To reduce the risk of losing information when the computer reaches a critical low-battery condition and has initiated hibernation, do not restore power until the power lights are turned off.

---

### When external power is available

To resolve a low-battery condition when external power is available, connect one of the following adapters:

- AC adapter
- Optional expansion product
- Optional power adapter

### When a charged battery pack is available

To resolve a low-battery condition when a charged battery pack is available:

1. Turn off the computer or initiate hibernation.
2. Insert a charged battery pack.
3. Turn on the computer.

### When no power source is available

To resolve a low-battery condition when no power source is available:

- Initiate hibernation.  
– or –
- Save your work and shut down the computer.

### When the computer cannot restore from hibernation

To resolve a low-battery condition when the computer lacks the power to restore from hibernation:

1. Insert a charged battery pack or plug the computer into external power.
2. Restore from hibernation by pressing the power button.



# Calibrating a battery pack

## When to calibrate

Even if a battery pack is heavily used, it should not be necessary to calibrate it more than once a month. It is not necessary to calibrate a new battery pack. Calibrate a battery pack under the following conditions:

- When battery charge displays seem inaccurate
- When you observe a significant change in battery run time
- When the battery pack has been unused for one month or more

## How to calibrate

Three steps are involved in calibrating a battery pack: fully charging, fully discharging, and then fully recharging.

### Step 1: Charging the battery pack

A battery pack can charge whether the computer is off or in use, but it will charge faster when the computer is off.



---

**WARNING!** Do not charge the computer battery pack on board aircraft. Charging the battery pack may damage aircraft electronic systems.

---

To charge the battery pack:

1. Insert the battery pack into the computer.
2. Connect the computer to an AC adapter, optional power adapter, or optional expansion product, and then plug the adapter or device into external power.

The battery light on the computer is turned on.

3. Leave the computer plugged into external power until the battery pack is fully charged.

The battery light on the computer is turned off.

## Step 2: Discharging the battery pack

Before you begin a full discharge, disable hibernation.

To disable hibernation:

1. Select **Start > Control Panel > Performance and Maintenance > Power Options > Hibernate**.
2. Clear the **Enable hibernation** check box.
3. Click **Apply**.

The computer must remain on while the battery pack is being discharged. The battery pack can discharge whether or not you are using the computer but will discharge faster while the computer is in use.

- If you plan to leave the computer unattended during the discharge, save your information before beginning the discharge procedure.
- If you use the computer occasionally during the discharge procedure and have set energy-saving timeouts, expect the following performance from the system during the discharge process:
  - The monitor will not turn off automatically.
  - Hard drive speed will not decrease automatically when the computer is idle.
  - System-initiated hibernation will not occur.

To fully discharge a battery pack:

1. Right-click the **Power Meter** icon in the notification area, at the far right of the taskbar, and then click **Adjust Power Properties**.

– or –

Access the Power Schemes tab by selecting **Start > Control Panel > Performance and Maintenance > Power Options > Power Schemes** tab.

2. Record the 4 settings listed in the **Running on batteries** and **Plugged In** columns so that you can reset them after the calibration.
3. Set the 4 options to **Never**.
4. Click **OK**.
5. Disconnect the computer from its external power source, but do *not* turn off the computer.
6. Run the computer on battery power until the battery pack is fully discharged. The battery light begins to blink when the battery pack has discharged to a low-battery condition. When the battery pack is fully discharged, the battery light is turned off and the computer shuts down.

### Step 3: Recharging the battery pack

To recharge the battery pack:

1. Plug the computer into external power and maintain external power until the battery pack is fully recharged. When the battery pack is recharged, the battery light on the computer is turned off.  
  
You can use the computer while the battery pack is recharging, but the battery pack will charge more quickly if the computer is off.
2. If the computer is off, turn it on when the battery pack is fully charged and the battery light is turned off.
3. Access the Power Schemes tab by selecting **Start > Control Panel > Performance and Maintenance > Power Options > Power Schemes** tab.
4. Reenter the settings that you recorded for the items in the **Plugged In** column and the **Running on Batteries** column.
5. Click **OK**.



---

**CAUTION** After calibrating the battery pack, reenabling hibernation. Failure to reenabling hibernation may result in a complete battery discharge and potential information loss.

To reenabling hibernation, select **Start > Control Panel > Performance and Maintenance > Power Options > Hibernate**. Select the **Enable hibernation** check box, and then click **Apply**.

---

## Conserving battery power

Using the battery conservation procedures and settings described in this section extends the time that a battery pack can run the computer from a single charge.

### Conserving power as you work

To conserve power as you use the computer:

- Turn off wireless and local area network (LAN) connections and exit modem applications when you are not using them.
- Disconnect external devices that you are not using that are not plugged into an external power source.
- Stop or remove any optional external media cards that you are not using.
- Remove a CD or DVD that you are not using.
- Use the **fn+f7** and **fn+f8** hotkeys to adjust screen brightness as you need it.
- Use optional powered speakers instead of the internal speakers, or adjust system volume as you need it.
- Turn off a device connected to the S-Video-out jack.
- If you leave your work, initiate standby or hibernation, or shut down the computer.

## Selecting power conservation settings

To set the computer to conserve power:

- Select a short wait for the screen saver and select a screen saver with minimal graphics and motion.

To access screen saver settings:

Select **Start > Control Panel > Appearance and Themes > Choose a screen saver**.

- Select a Power Scheme with low power-use settings. For more information, refer to "[Setting or changing a power scheme](#)."

## Storing a battery pack



**WARNING!** To avoid potential safety issues, use only the battery pack provided with the computer, a replacement battery pack provided by HP, or a compatible battery pack purchased as an accessory from HP.

---



**CAUTION** To prevent damage to a battery pack, do not expose it to high temperatures for extended periods of time.

---

If a computer will be unused and disconnected from external power for more than 2 weeks, remove the battery pack and store it separately.

To prolong the charge of a stored battery pack, place it in a cool, dry place.

Calibrate a battery pack before using it if it has been stored for one month or more.

## Disposing of a used battery pack



**WARNING!** To reduce the risk of fire or burns, do not disassemble, crush, or puncture a battery pack; short the external contacts on a battery pack; or dispose of a battery pack in fire or water. Do not expose a battery pack to temperatures above 60°C (140°F).

---

Refer to the *Regulatory, Safety, and Environmental Notices* for battery disposal information.

# 4 Drives

## Drive care

Drives are fragile computer components that must be handled with care. The following cautions apply to all drives. Additional cautions are included with the procedures to which they apply.



**CAUTION** To reduce the risk of damage to the computer, damage to a drive, or loss of information, observe these precautions:

Initiate standby before you move a computer or external hard drive from one location to another.

Before handling a drive, discharge static electricity by touching the unpainted metal surface of the drive.

Do not touch the connector pins on a removable drive or on the computer.

Handle a drive carefully; do not drop or compress the drive.

Before removing or inserting a drive, shut down the computer. If you are unsure whether the computer is off or in hibernation, turn the computer on, and then shut it down through the operating system.

Do not use excessive force when inserting a drive into a drive bay.

Do not type on the keyboard or move the computer when the drive is writing to a medium. The write process is sensitive to vibration.

When the battery pack is the only source of power, ensure that the battery pack is sufficiently charged before writing to a medium.

Avoid exposing a drive to temperature or humidity extremes.

Avoid exposing a drive to liquids. Do not spray it with cleaning products.

Remove the medium from a drive before removing the drive from the drive bay, or traveling with, shipping, or storing a drive.

If a drive must be mailed, place the drive in a bubble-pack mailer or other suitable protective packaging and label the package "FRAGILE."

Avoid exposing a drive to magnetic fields. Security devices with magnetic fields include airport walk-through devices and security wands. The airport security devices that check carry-on luggage, such as conveyor belts, use x-rays instead of magnetism and will not damage a drive.

## IDE drive light

The IDE drive light blinks when either the primary hard drive or an optical drive is being accessed.

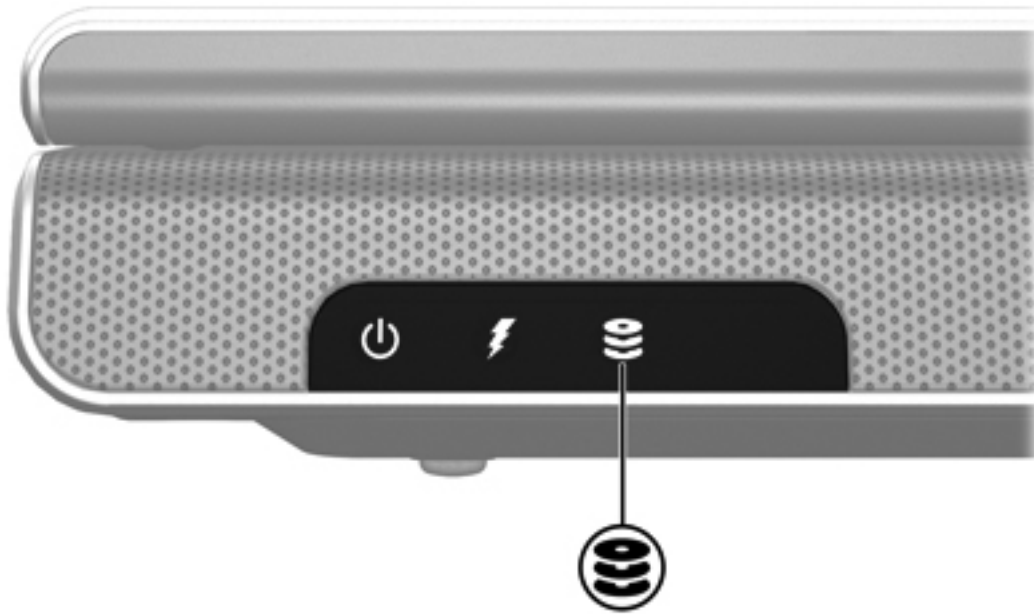

# Hard drive



**CAUTION** To prevent system lockup and loss of information:

Shut down the computer before removing the hard drive from the hard drive bay. Do not remove the hard drive while the computer is on, in standby, or in hibernation.

If you are not sure whether the computer is off or in hibernation, turn the computer on by pressing the power button. Then shut down the computer through the operating system.

To remove the hard drive:

1. Save your work.
2. Shut down the computer and close the display.
3. Turn the computer upside down, with the hard drive bay toward you.
4. Loosen the 2 hard drive cover screws (1).
5. Lift the hard drive cover away from the computer (2).

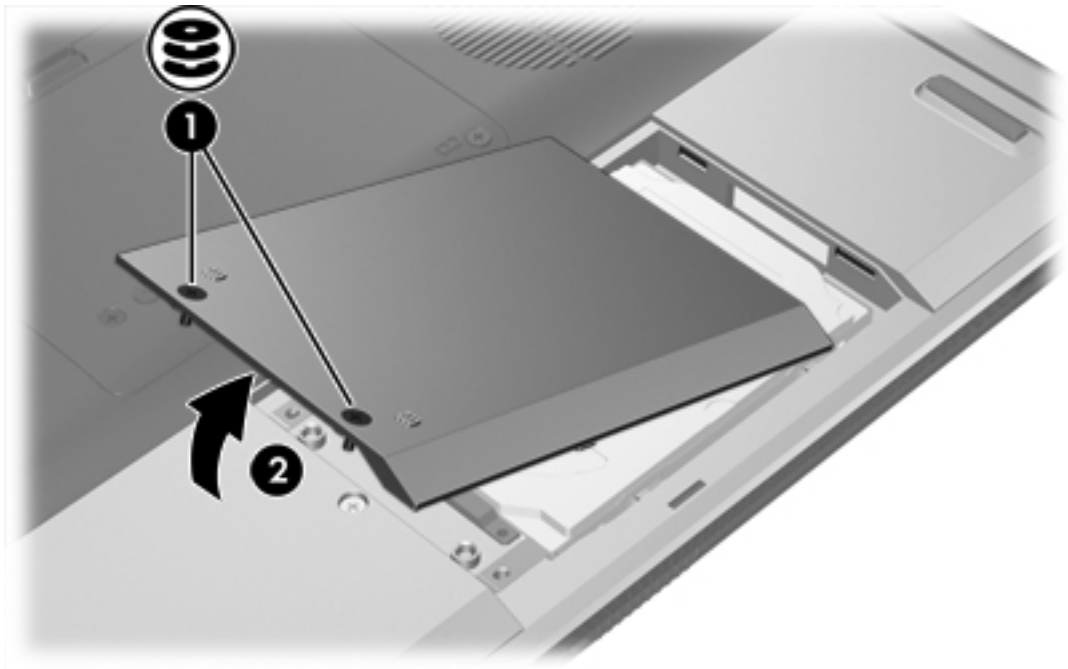

6. Remove the two hard drive screws (1)

7. Disconnect the hard drive **(2)** by sliding it to the right.

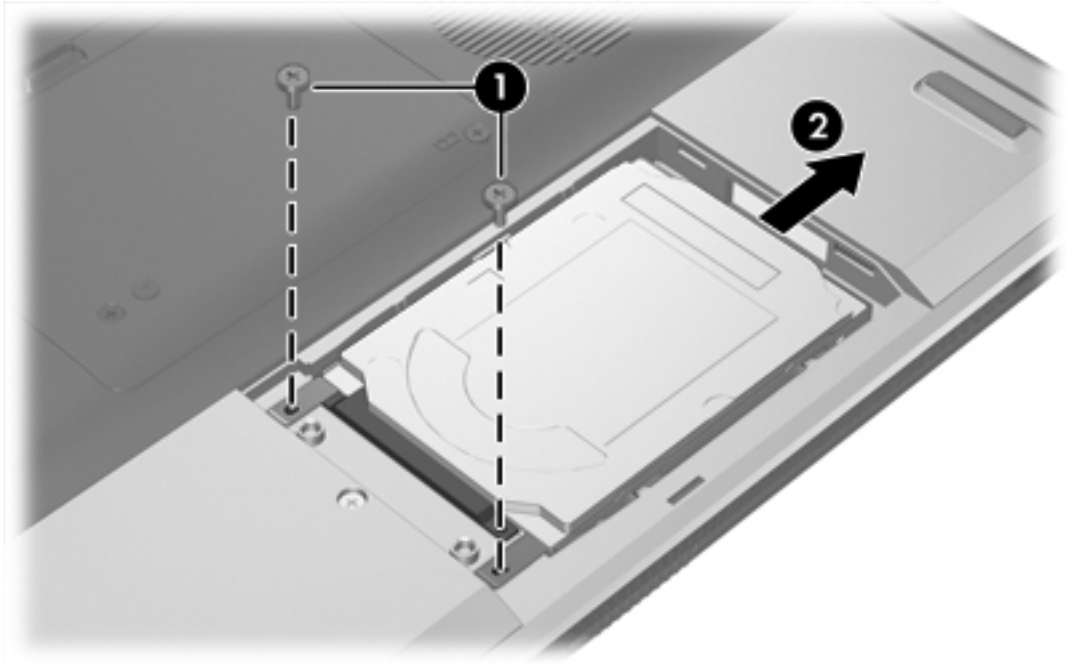

8. Lift the hard drive away from the computer **(3)**.

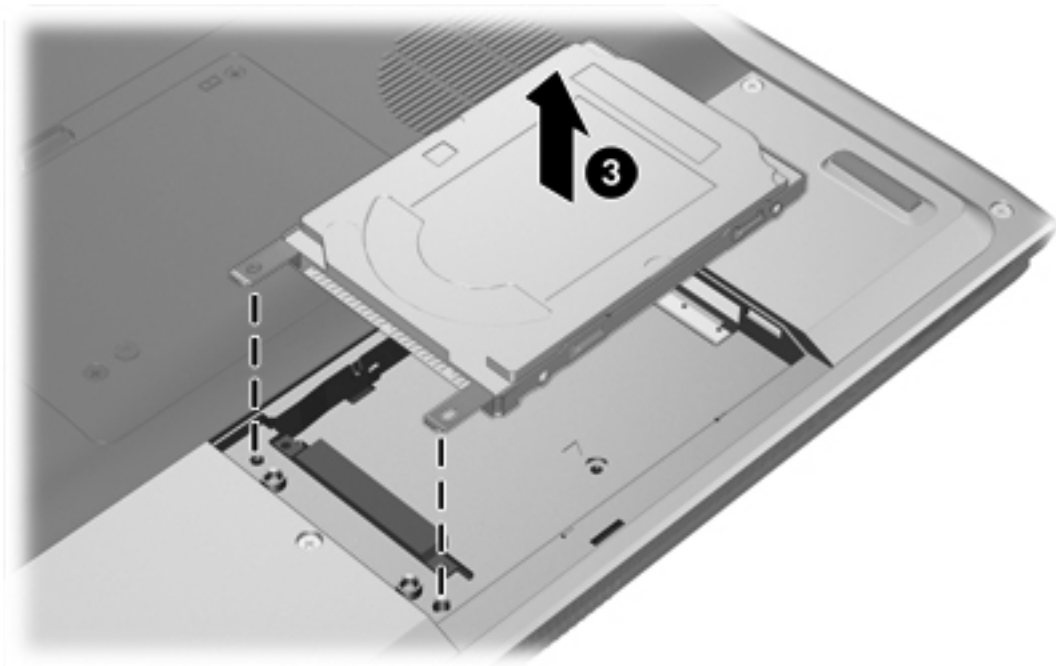

To install a hard drive:

1. Lower the hard drive into the hard drive bay **(1)**.
2. Slide the hard drive toward the hard drive connector **(2)** until it is fully seated.



3. Replace the two hard drive screws (3).

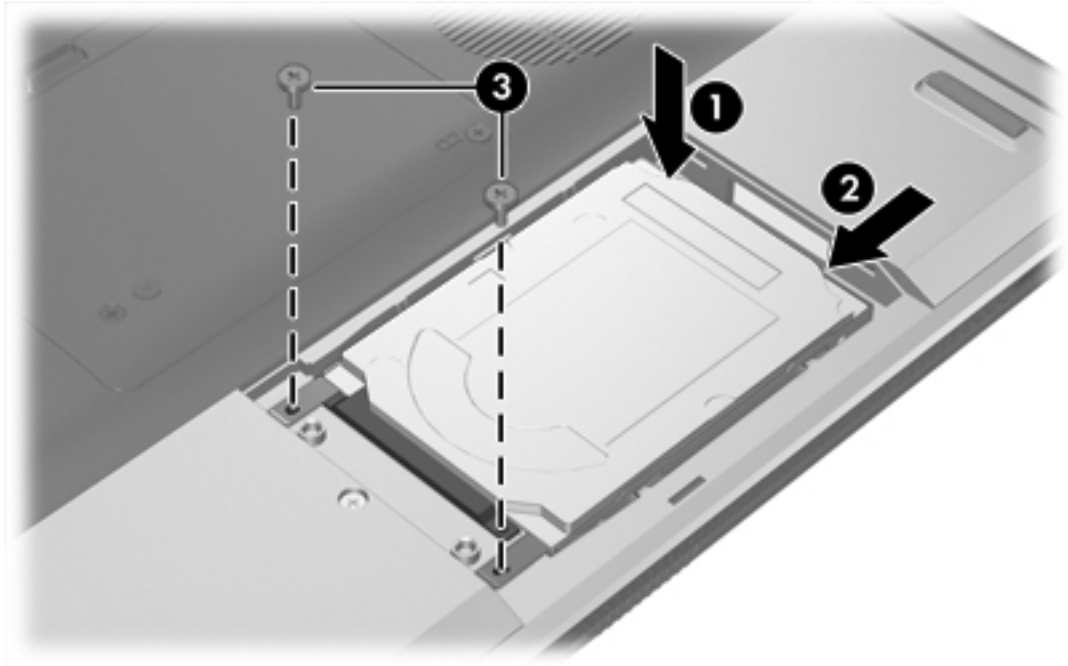

4. Align the tabs (1) on the hard drive cover with the notches on the computer.
5. Close the cover (2).
6. Tighten the hard drive cover screws (3).

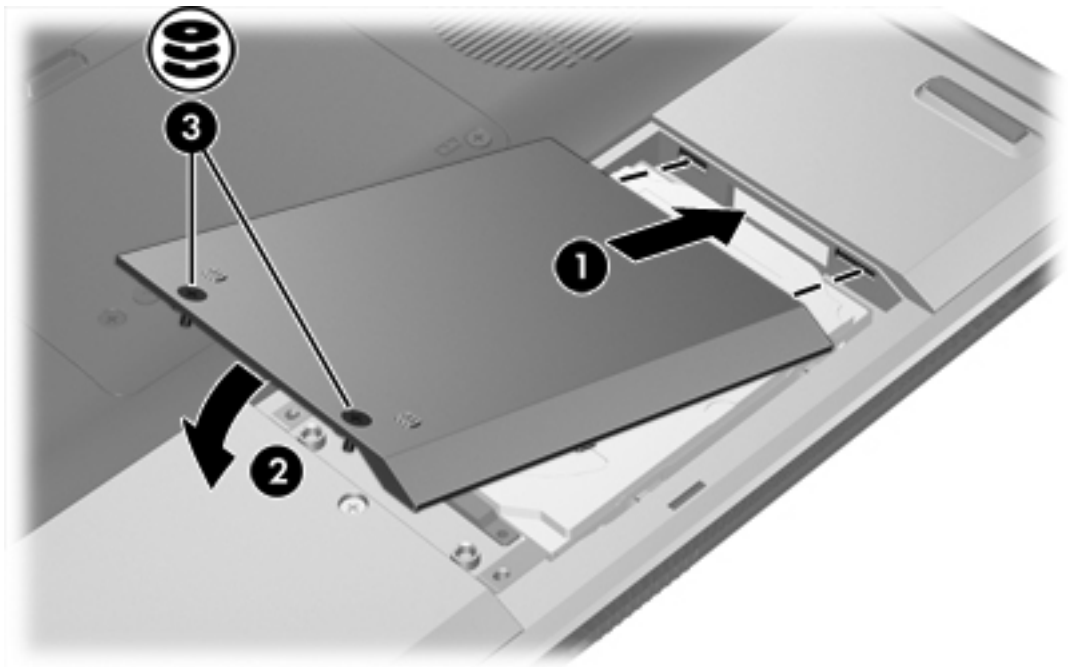

## Optical drives

An optical drive, such as a DVD-ROM drive, supports optical discs (CDs and DVDs). These discs are used to store or transport data and to play music and movies. DVDs have a higher capacity than CDs.

The computer can read or write to optical drives as described in the following table.

Type of Optical Drive	Read CD and DVD-ROM	Write to CD-RW	Write to DVD $\pm$ RW/R	LightScribe
DVD/CD-RW Drive	Yes	Yes	No	No
DVD $\pm$ RW Double Layer	Yes	Yes	Yes	No
LightScribe DVD $\pm$ RW Double Layer	Yes	Yes	Yes	Yes

Some of the optical drives listed may not be supported by your computer. The listed drives are not necessarily all of the supported optical drives.

## Inserting an optical disc

1. Turn on the computer.
2. Press the release button (1) on the drive bezel to release the media tray.
3. Pull out the tray (2).
4. Hold the CD or DVD by the edges to avoid touching the flat surfaces, and position the disc over the tray spindle, with the label-side up.



**NOTE** If the tray is not fully accessible, tilt the disc carefully to position it over the spindle.

5. Gently press the disc (3) down onto the tray spindle until the disc snaps into place.

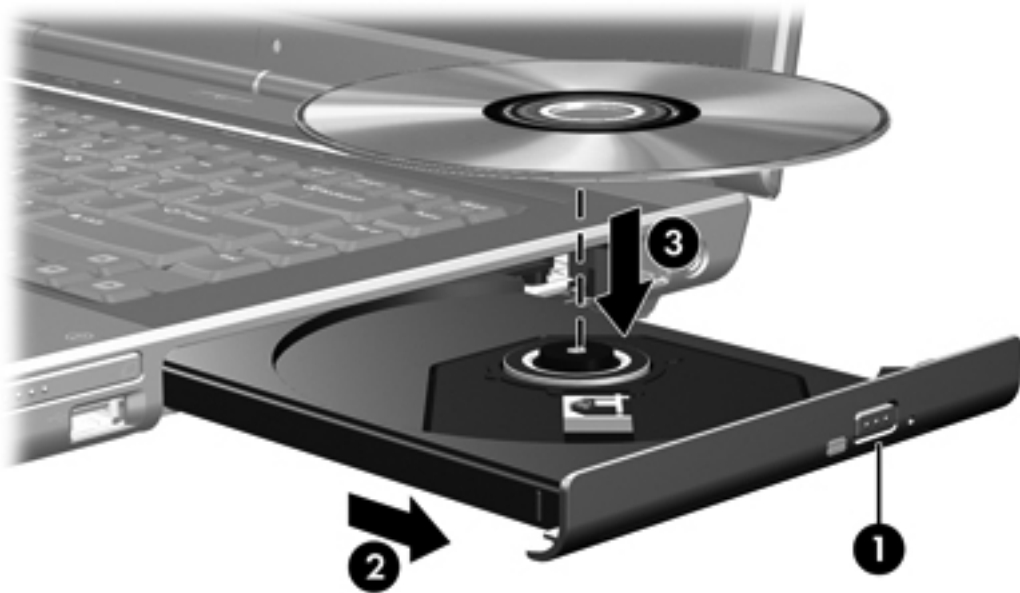

6. Close the media tray.



**NOTE** After you insert a disc, a short pause is normal. If you have not selected a default media player, an AutoPlay dialog box opens. It prompts you to select how you want to use the media content.

## Removing an optical disc (with power)

If the computer is running on external or battery power:

1. Turn on the computer.
2. Press the release button (1) on the drive bezel to release the media tray, and then pull out the tray (2).
3. Remove the disc (3) from the tray by gently pressing down on the spindle while lifting the outer edges of the disc. Hold the disk by the edges and avoid touching the flat surfaces.



**NOTE** If the tray is not fully accessible, tilt the disc carefully as you remove it.

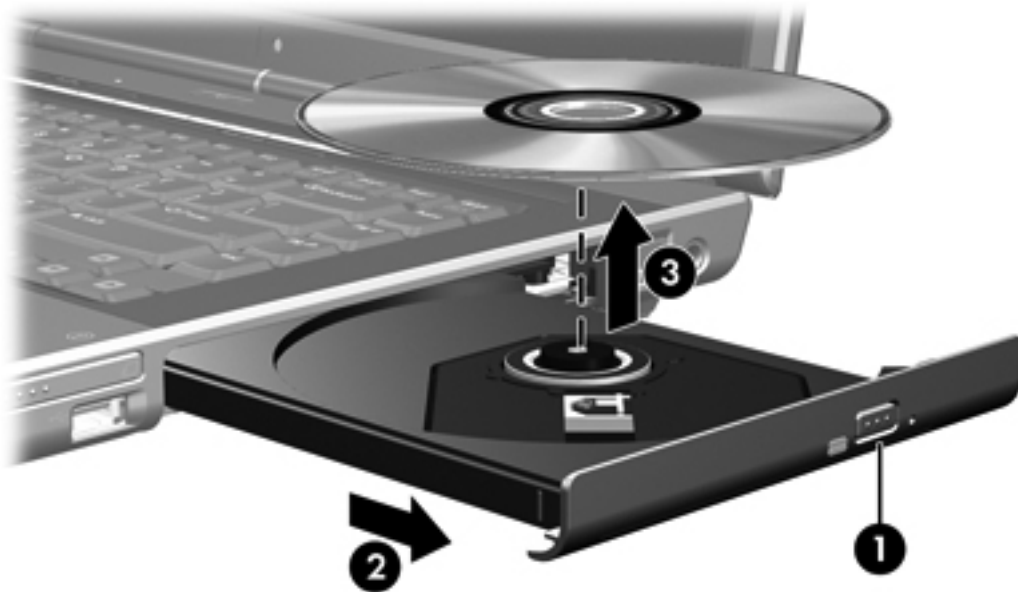

4. Close the media tray and place the disc in a protective case.

## Removing an optical disc (without power)

If external or battery power is unavailable:

1. Insert the end of a paper clip (1) into the release access in the front bezel of the drive.
2. Press in gently until the tray is released, and then pull out the tray (2).
3. Remove the disc (3) from the tray by gently pressing down on the spindle while lifting the outer edges of the disc. Hold the disk by the edges and avoid touching the flat surfaces.



**NOTE** If the tray is not fully accessible, tilt the disc carefully as you remove it.



4. Close the media tray and place the disc in a protective case.

## Avoiding standby or hibernation

---



**CAUTION** To prevent possible audio and video degradation, or loss of audio or video playback functionality, do not initiate standby or hibernation while reading or writing to a CD or DVD.

To prevent loss of data, do not initiate standby or hibernation when writing to a CD or DVD.

---

If standby or hibernation is accidentally initiated during playback of a drive medium (such as a CD or DVD):

- Your playback may be interrupted.
- You may see the following warning: "Putting the computer into hibernation or standby may stop the playback. Do you want to continue?" Click **No**.
- You may need to restart the CD or DVD to resume audio and video playback.

# 5 Multimedia

## Multimedia hardware

### Using the optical drive

The optical drive allows you to play, copy, and create CDs or DVDs, depending on the type of installed drive and installed software.

### Identifying the installed optical drive

To view the type of optical drive installed in the computer:

- ▲ Select **Start > My Computer**.

The type of optical drive installed in the computer is displayed under Devices with Removable Storage.

## Inserting an optical disc

1. Turn on the computer.
2. Press the release button (1) on the drive bezel to release the media tray.
3. Pull out the tray (2).
4. Hold the CD or DVD by the edges to avoid touching the flat surfaces, and position the disc over the tray spindle, with the label-side up.



**NOTE** If the tray is not fully accessible, tilt the disc carefully to position it over the spindle.

5. Gently press the disc (3) down onto the tray spindle until the disc snaps into place.



6. Close the media tray.



**NOTE** After you insert a disc, a short pause is normal. If you have not selected a default media player, an AutoPlay dialog box opens. It prompts you to select how you want to use the media content.



## Removing an optical disc (with power)

If the computer is running on external or battery power:

1. Turn on the computer.
2. Press the release button (1) on the drive bezel to release the media tray, and then pull out the tray (2).
3. Remove the disc (3) from the tray by gently pressing down on the spindle while lifting the outer edges of the disc. Hold the disk by the edges and avoid touching the flat surfaces.

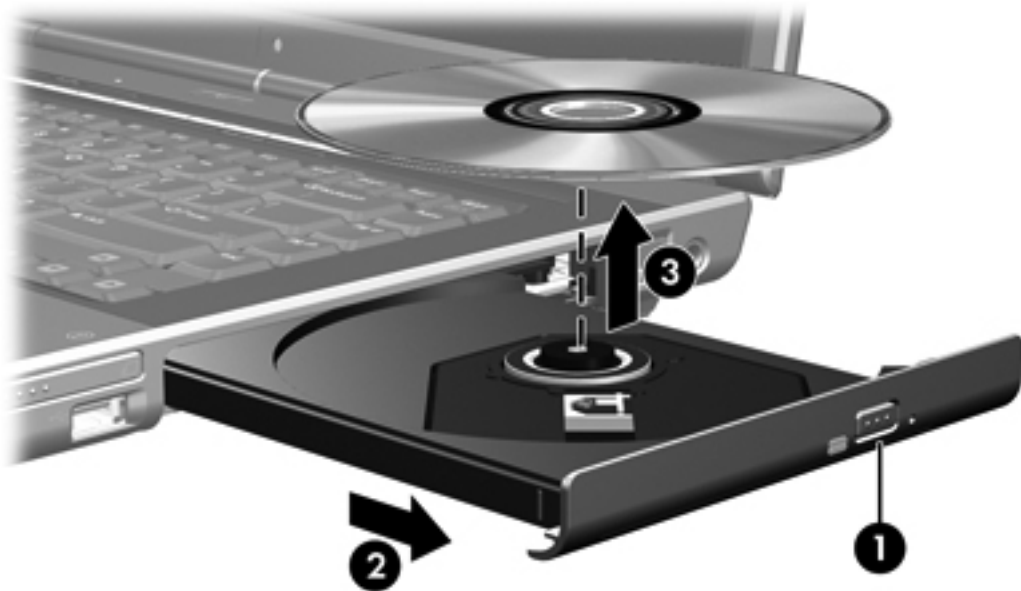

**NOTE** If the tray is not fully accessible, tilt the disc carefully as you remove it.

4. Close the media tray and place the disc in a protective case.

## Removing an optical disc (without power)

If external or battery power is unavailable:

1. Insert the end of a paper clip (1) into the release access in the front bezel of the drive.
2. Press in gently until the tray is released, and then pull out the tray (2).

3. Remove the disc **(3)** from the tray by gently pressing down on the spindle while lifting the outer edges of the disc. Hold the disk by the edges and avoid touching the flat surfaces.



**NOTE** If the tray is not fully accessible, tilt the disc carefully as you remove it.



4. Close the media tray and place the disc in a protective case.

## Using media activity hotkeys

Media activity hotkeys are combinations of the **fn** key (1) and 4 of the function keys. You can use these keys to control the play of an audio CD or a DVD that is inserted in the optical drive.



**NOTE** To control the play of an inserted video CD, use the media activity controls in your video CD player application.

- To play, pause, or resume an inserted audio CD or a DVD, press **fn+f9** (2).
- To stop an inserted audio CD or a DVD that is playing, press **fn+f10** (3).
- To play the previous track of an audio CD or the previous chapter of a DVD that is playing, press **fn+f11** (4).
- To play the next track of an audio CD or the next chapter of a DVD that is playing, press **fn+f12** (5).



## Using the QuickPlay buttons







**NOTE** DVD and Media button functions vary, depending on the software installed on your computer. Refer to the QuickPlay online Help for details.

The DVD button (1) and Media button (2) allow you to play DVDs, watch movies, and listen to music with the touch of a button.



DVD and Media buttons function according to the following table.

Component	Description
<b>Default button functions <i>without</i> QuickPlay software (select models only)</b>	
(1) DVD button	<p>When the computer is</p> <ul style="list-style-type: none"><li>• On, opens the default DVD application to start a DVD in the optical drive.</li><li>• Off, no function.</li><li>• In standby, resumes from standby into Windows.</li></ul> <p> <b>NOTE</b> This button does not affect the hibernation file or the procedure for restoring from hibernation.</p>
(2) Media button	<p>When the computer is</p> <ul style="list-style-type: none"><li>• On, opens the music application or Media Menu allowing you to select a multimedia application.</li><li>• Off, no function.</li><li>• In standby, resumes from standby into Windows.</li></ul> <p> <b>NOTE</b> This button does not affect the hibernation file or the procedure for restoring from hibernation.</p>

Component	Description
<b>Default button functions with QuickPlay software (select models only)</b>	
(1) DVD button	<p>When the computer is</p> <ul style="list-style-type: none"> <li>On, opens the default DVD application to start a DVD in the optical drive.</li> <li>Off, opens QuickPlay to start a DVD in the optical drive.</li> <li>In standby, resumes from standby into Windows.</li> </ul> <p> <b>NOTE</b> This button does not affect the hibernation file or the procedure for restoring from hibernation.</p>
(2) Media button	<p>When the computer is</p> <ul style="list-style-type: none"> <li>On, opens music application or the Media Menu allowing you to select a multimedia application.</li> <li>Off, opens music application or the Media Menu allowing you to select a multimedia application.</li> <li>In standby, resumes from standby into Windows.</li> </ul> <p> <b>NOTE</b> This button does not affect the hibernation file or the procedure for restoring from hibernation.</p>

## Using the audio features

The following illustration and table describe the audio features of the computer.



Component	Description
(1) Volume down button	Decreases computer sound.
(2) Volume mute button	Turns off computer sound.
(3) Volume up button	Increases computer sound.
(4) Audio-in (microphone) jack	Connects an optional computer headset or microphone.
(5) Audio-out (headphone) jack	Connects optional optional powered stereo speakers, headphones, ear buds, headset, or television audio.
	 <b>NOTE</b> On select models, this jack can also be used to transmit S/PDIF digital audio.
(6) Speakers (2)	Produce computer sound.

## Using the audio-in (microphone) jack

The computer is equipped with a microphone jack that supports an optional monaural (single sound channel) microphone. Select models support a stereo (dual sound channel) microphone.



---

**NOTE** When connecting a microphone to the microphone jack, use a microphone with a 3.5-mm plug.

---

## Using the audio-out (headphone) jack



---

**WARNING!** To reduce the risk of personal injury, adjust the volume before putting on headphones, earbuds, or a headset.

---

In addition to connecting headphones, the headphone jack is used to connect the audio function of an audio/video device such as a television or VCR. On select models, the computer can also transmit S/PDIF digital audio signals through the audio-out jack.

When connecting a device to the headphone jack use only a 3.5-mm stereo plug.



---

**NOTE** When a device is connected to the headphone jack, the internal speakers are disabled.

---

## Using S/PDIF digital audio (select models only)

S/PDIF (Sony/Philips Digital Interface) or digital audio provides enhanced audio performance, including surround sound and other high-end audio output.

For digital audio connections, connect the S/PDIF digital audio plug to the digital audio connector on your audio/video equipment.



---

**NOTE** In order to use S/PDIF with your headphone jack, you will need an optional mini TOS link cable and/or adapter.

---

## Adjusting the volume

You can adjust the volume using the following controls:

- Computer volume buttons:
  - To mute or restore volume, press the volume mute button.
  - To decrease the volume, press the volume down button.
  - To increase the volume, press the volume up button.
- Microsoft® Windows® volume control:
  - a. Click the **Volume** icon in the notification area, at the far right of the taskbar.
  - b. Increase or decrease the volume by moving the slider up or down. Select the **Mute** check box to mute the volume.

– or –

- a. Double-click the **Volume** icon in the notification area.
- b. In the **Volume Control** column, increase or decrease the volume by moving the **Volume** slider up or down. You can also adjust the balance or mute the volume.

If the **Volume** icon is not displayed in the notification area, follow the steps below to place it there:

- a. Select **Start > Control Panel > Sounds, Speech, and Audio Devices > Sounds and Audio Devices**.
- b. Click the **Volume** tab.
- c. Select the **Place volume icon in the taskbar** check box.
- d. Click **Apply**.

Volume can also be adjusted within some applications.



## Using the video features

The computer includes the following video features:

- S-Video-out jack that connects a range of video components that allow you to maximize your multimedia features
- External monitor port that connects a television, monitor, or projector to the computer

### Using the external monitor port

The external monitor port connects an external display device to the computer.

To connect a display device to the computer, connect the device cable to the external monitor port.



---

**NOTE** If a properly connected external display device does not display an image, press **fn +f4** to transfer the image to the device.

---

## Using the S-Video-out jack

The 7-pin S-Video-out jack connects the computer to an optional S-Video device such as a television, VCR, camcorder, overhead projector, or video capture card.

The computer can support one S-Video device connected to the S-Video-out jack, while simultaneously supporting an image on the computer display or on any other supported external display.



**NOTE** To transmit video signals through the S-Video-out jack, you need an S-Video cable, available from most electronics retailers. If you are combining audio and video functions, such as playing a DVD movie on your computer and displaying it on your television, you also need a standard audio cable connected to the headphone jack, available from most electronics retailers.

**NOTE** The S-Video connection provides a higher quality image than a composite-video connection.

To connect a video device to the S-Video-out jack:

1. Plug one end of the S-Video cable into the S-Video-out jack on the computer.



2. Connect the other end of the cable to the video device, as instructed in the documentation included with the device.
3. Press the **fn+f4** keys to switch the image between display devices connected to the computer.



**NOTE** If the S-Video-out jack on the computer is not accessible because the computer is connected to an optional expansion product, connect the S-Video cable to the S-Video-out jack on the expansion product.

## Remote control (select models only)

This section provides information on using the HP Mobile Remote Control (shipped with select computer models only). Two different remote control models are covered in this section: one that fits in the PC Card slot and one that fits in the ExpressCard slot.



**NOTE** Depending on your computer model, you may not have both a PC Card slot and an ExpressCard slot. Refer to the computer user guide.

The following illustration identifies the 2 remote controls.



- 
- (1) HP Mobile Remote Control (PC Card version)

For more information, refer to "[HP Mobile Remote Control \(PC Card version\)](#)."

- 
- (2) HP Mobile Remote Control (ExpressCard version)

For more information, refer to "[HP Mobile Remote Control \(ExpressCard version\)](#)."

---

## HP Mobile Remote Control (PC Card version)

The following sections provide information on the PC Card remote control. For information on the ExpressCard remote control, refer to "[HP Mobile Remote Control \(ExpressCard version\)](#)."



### Inserting the battery (PC Card version)



---

**WARNING!** Risk of explosion if battery is replaced by an incorrect type. Dispose of used batteries according to the instructions.

---

To insert the battery into the HP Mobile Remote Control (PC Card version):

1. On the back of the remote control, turn the battery compartment cover counterclockwise (1) and remove it (2).

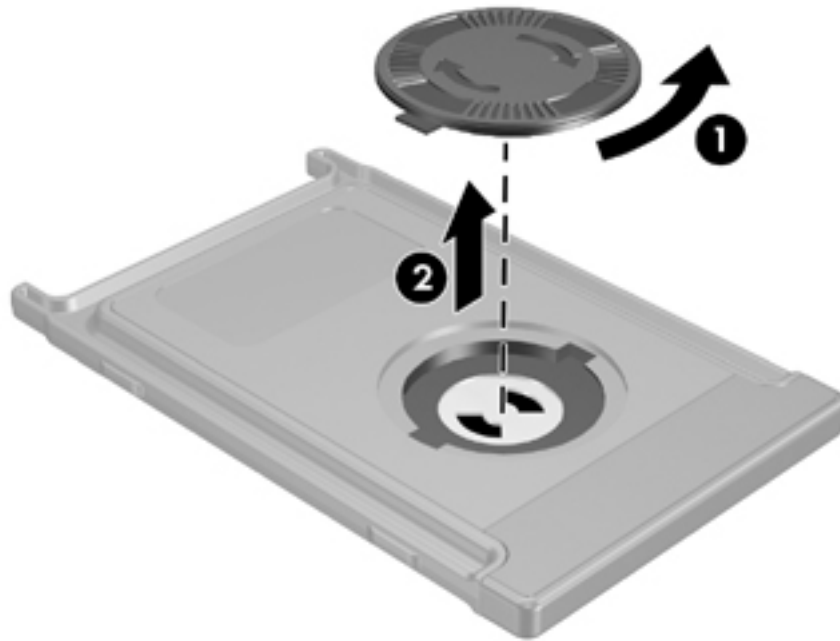

2. With the positive side of the battery facing up, insert the battery into the compartment.

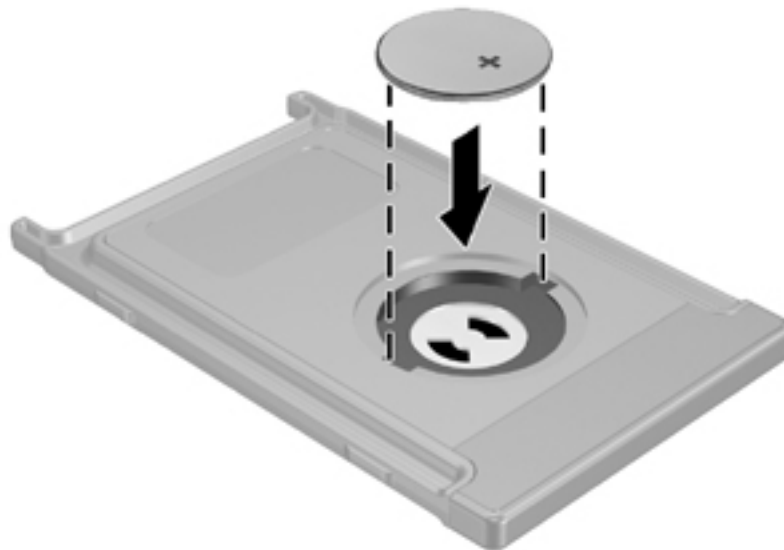

3. Insert the tabs on the battery compartment cover into the slots in the battery compartment and turn the cover clockwise to close.

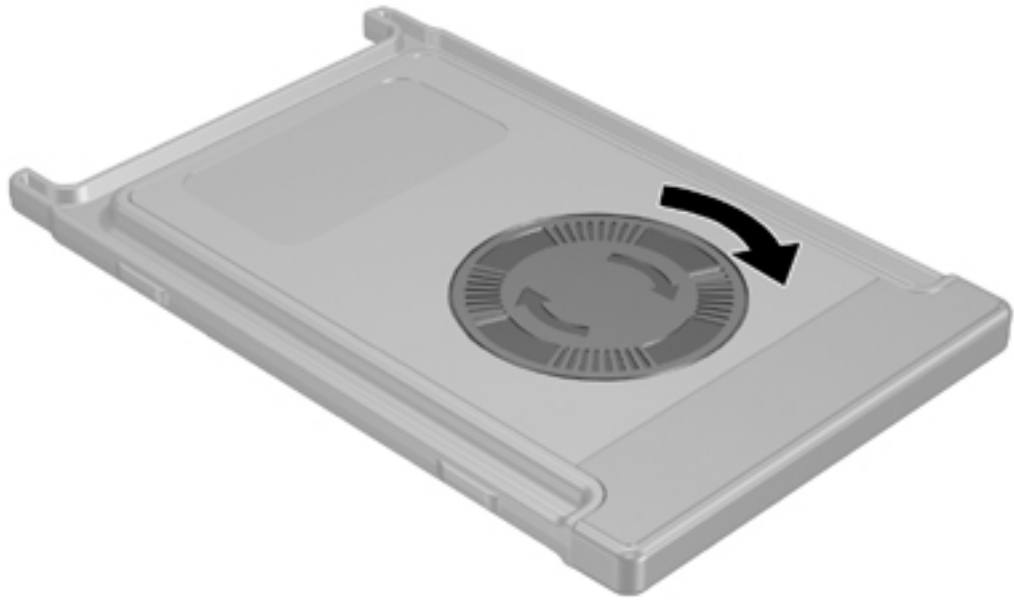

## Storing the remote control in the PC Card slot

The HP Mobile Remote Control (PC Card version) can be stored in the PC Card slot of the computer for convenience and safety.



**CAUTION** To prevent damage to the computer and remote control, do not insert the PC Card version of the remote control or a PC Card into the ExpressCard slot (select computer models only).

The PC Card slot or slot insert may display the following icon.



To store the remote control:



**NOTE** Your computer model may look different than the illustrations in this section. Refer to the computer user guide for the location of the PC Card slot.

1. Remove the PC Card slot insert.
2. Gently slide the remote control into the PC Card slot until it is firmly in place.



**CAUTION** If the remote control does not easily slide into the slot, be sure you are inserting the remote control into the correct slot.

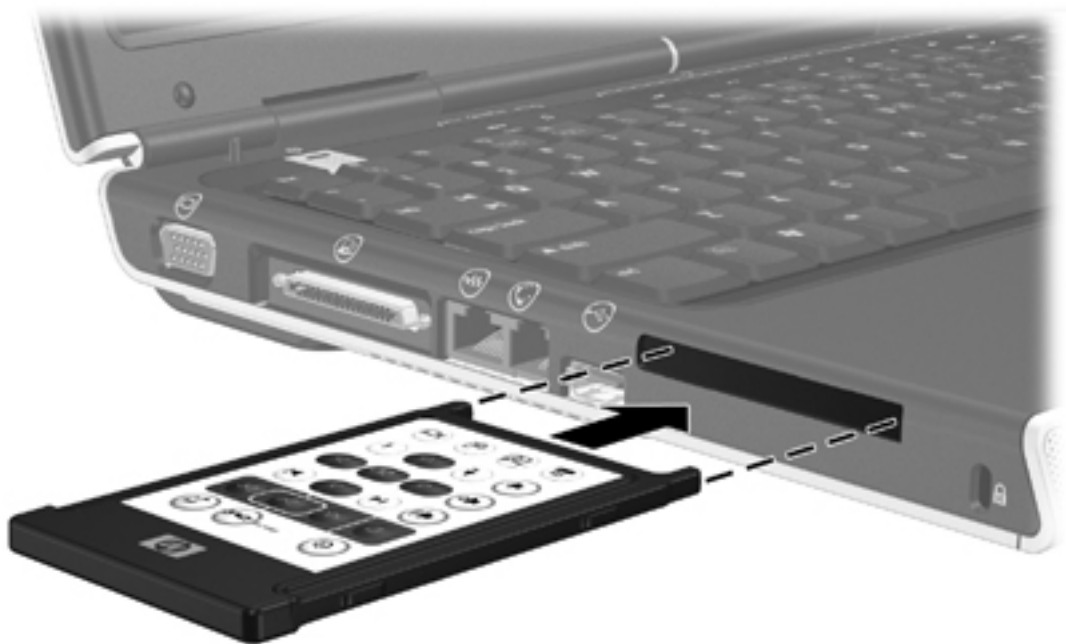

To remove the remote control from the PC Card slot:

1. Press the PC Card slot eject button to release the remote control.
2. Pull the remote control out of the slot.



## Button quick reference (PC Card version)

This section provides information on the button functions of the HP Mobile Remote Control (PC Card version).



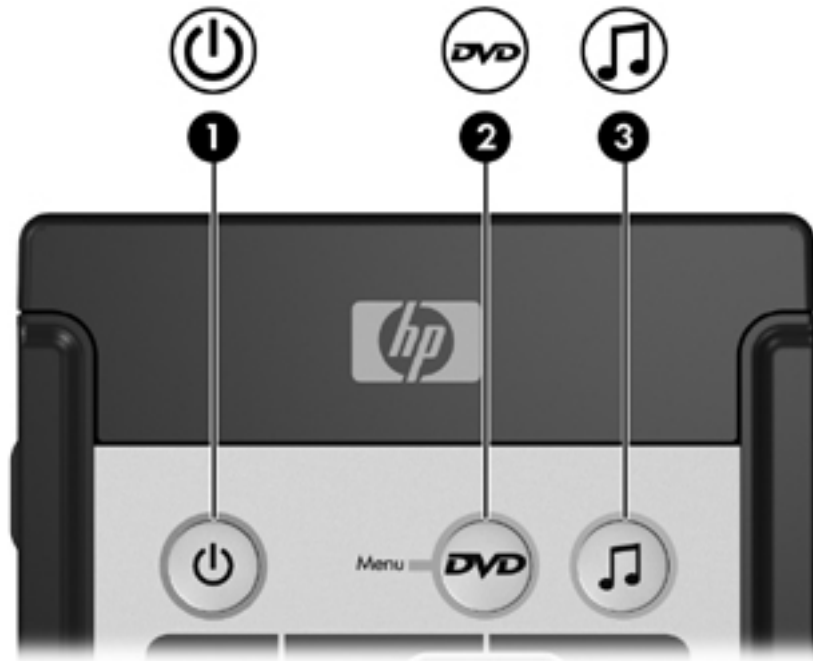









When the computer is off:









- Press the power button **(1)** to start the computer in Windows.
- Press the DVD Menu button **(2)** to open QuickPlay DVD mode (select computer models only).
- Press the Music button **(3)** to open QuickPlay music mode (select computer models only).



Button	Function in Microsoft® Windows®	Function in QuickPlay (select models only)
	<p>If the computer is</p> <ul style="list-style-type: none"> <li>• On, briefly press to initiate hibernation.</li> <li>• In standby, briefly press to resume from standby.</li> <li>• In hibernation, briefly press to restore from hibernation.</li> </ul>	<p>Press to turn QuickPlay off.</p>
	<p>If the computer is</p> <ul style="list-style-type: none"> <li>• On, press to open the default Windows DVD player.</li> <li>• On and playing a DVD, press to view the menu of the DVD.</li> <li>• In standby, press briefly to resume from standby.</li> <li>• In hibernation, press to open QuickPlay DVD mode (select computer models only).</li> </ul>	<ul style="list-style-type: none"> <li>• In QuickPlay music mode, press to switch to QuickPlay DVD mode.</li> <li>• When a DVD is playing, press to view the menu of the DVD.</li> </ul>



Button	Function in Microsoft® Windows®	Function in QuickPlay (select models only)
Music 	<ul style="list-style-type: none"> <li>In Windows, press to open the default Windows music player.</li> <li>In standby, press briefly to resume from standby.</li> <li>In hibernation, press to open QuickPlay music mode (select computer models only).</li> </ul>	In QuickPlay DVD mode, press to switch to QuickPlay music mode.
Stop 	Press to stop the current media activity, such as playing, rewinding, etc.	Press to stop the current media activity, such as playing, rewinding, etc.
Rewind 	Press to rewind the selected media.	Press to rewind the selected media.
Play/Pause 	<ul style="list-style-type: none"> <li>Media not playing, press to play the media.</li> <li>Media playing, press to pause the media.</li> </ul>	<ul style="list-style-type: none"> <li>Media not playing, press to play the media.</li> <li>Media playing, press to pause the media.</li> </ul>
Fast Forward 	Press to fast forward the selected media.	Press to fast forward the selected media.
Volume Up 	Press to increase system volume.	Press to increase system volume.
Volume Down 	Press to decrease system volume.	Press to decrease system volume.
Mute 	<ul style="list-style-type: none"> <li>Press to mute system volume.</li> <li>If muted, press to restore system volume.</li> </ul>	<ul style="list-style-type: none"> <li>Press to mute system volume.</li> <li>If muted, press to restore system volume.</li> </ul>
Previous 	Press to go back to the previous track or chapter.	Press to go back to the previous track or chapter.
Next 	Press to go to the next track or chapter.	Press to go to the next track or chapter.
Up 	Navigation. Press to scroll up.	Navigation. Press to scroll up.
Left 	Navigation. Press to scroll left.	Navigation. Press to scroll left.

Button	Function in Microsoft® Windows®	Function in QuickPlay (select models only)
Ok 	Navigation. Press to select an item on the screen.	Navigation. Press to select an item on the screen.
Right 	Navigation. Press to scroll right.	Navigation. Press to scroll right.
Down 	Navigation. Press to scroll down.	Navigation. Press to scroll down.
Back 	Press to emulate the “back” function of the <b>alt +left</b> arrow command in the active application.	<ul style="list-style-type: none"> <li>• In music mode, press to move up one directory level in the My Music display.</li> <li>• In DVD mode, this button is inactive.</li> </ul>
Information 	Press to view information about a selected item in an application (if available).	<p>Press to display battery and volume status.</p> <p>If playing a DVD, the DVD title, chapter, and time information is also displayed.</p>
Print 	Press to open the print options window of the active application.	None
Photo 	Press to open the default Windows picture application.	None
Media 	Press to open the default Windows media application.	None
Switch Screens 	Press to switch the computer image between the computer display and an external display.	Press to switch the computer image between the computer display and an external display.

### HP Mobile Remote Control (PC Card version) component functions

The infrared lens on the remote control links the remote control to the computer. The link requires a line-of-sight path between the infrared lens on the remote control and the infrared lens on the computer.

Things to remember:

- The HP Mobile Remote Control operates within Microsoft® Windows®, QuickPlay (select computer models only), and InterVideo Home Theater software (select computer models only). Each button responds according to which application is active.



---

**NOTE** Refer to the InterVideo Home Theater on-screen help for remote control information.

**NOTE** For information on using QuickPlay, refer to the QuickPlay online Help.

---

- Some remote control buttons perform the same functions as computer buttons. For example, the DVD button on the remote control and the DVD button on the computer have the same functions and can be used interchangeably.
- Some remote control buttons perform the same functions as computer hotkeys. Refer to the computer user guide for information on supported hotkeys.
- Other remote control buttons provide functions that are not duplicated by computer buttons or preset key combinations.

## HP Mobile Remote Control (ExpressCard version)

The following sections provide information on the ExpressCard remote control. For information on the PC Card remote control, refer to "[HP Mobile Remote Control \(PC Card version\)](#)."



### Inserting the battery (ExpressCard version)



---

**WARNING!** Risk of explosion if battery is replaced by an incorrect type. Dispose of used batteries according to the instructions.

---

To insert the battery into the HP Mobile Remote Control (ExpressCard version):

1. On the back of the remote control, lift the battery compartment cover (1) and remove it (2).

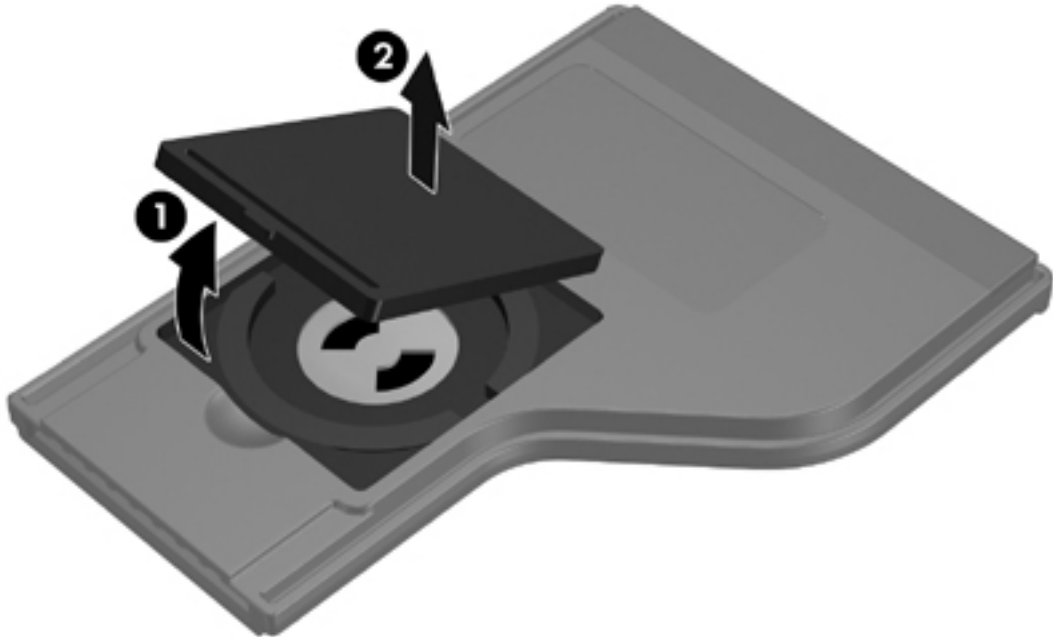

2. With the positive side of the battery facing up, insert the battery into the compartment.

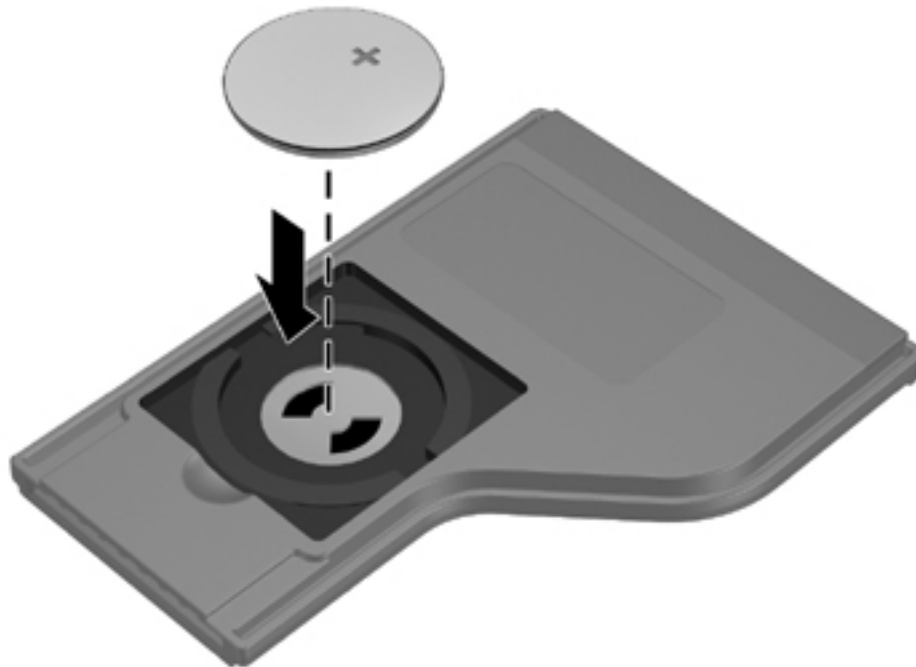

3. Replace the battery compartment cover.

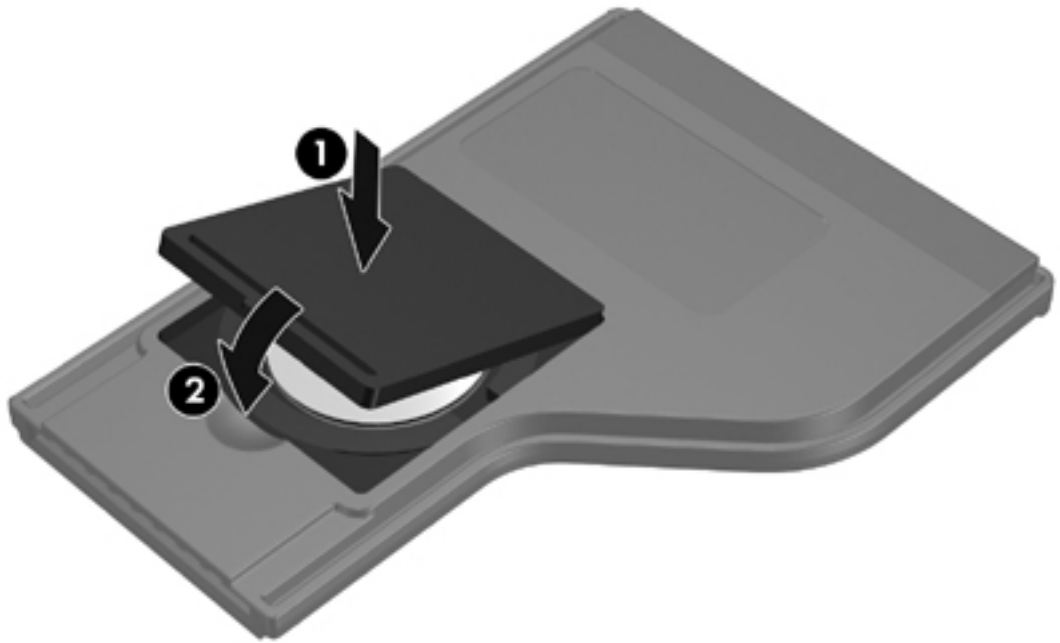

## Storing the remote control in the ExpressCard slot

The HP Mobile Remote Control (ExpressCard version) can be stored in the ExpressCard slot of the computer for convenience and safety.



**CAUTION** To prevent damage to the computer and remote control, do not insert the ExpressCard version of the remote control or an ExpressCard into the PC Card slot (select computer models only).

The ExpressCard slot or slot insert may display the following icon.



To store the remote control:



**NOTE** Your computer model may look different than the illustrations in this section. Refer to the computer user guide for the location of the ExpressCard slot.

1. Remove the ExpressCard slot insert.
2. Gently slide the remote control into the ExpressCard slot until it is firmly in place. Ensure that it lies flush with the edge of the computer.



**CAUTION** If the remote control does not easily slide into the slot, be sure you are inserting the remote control into the correct slot.



To remove the remote control from the ExpressCard slot:

- If the ExpressCard slot has an eject button:
  - Press the ExpressCard slot eject button to release the remote control.
  - Pull the remote control out of the slot.
- If the ExpressCard slot does not have an eject button:
  - Gently push in on the remote control to release it.
  - Pull the remote control out of the slot.

### Button quick reference (ExpressCard version)







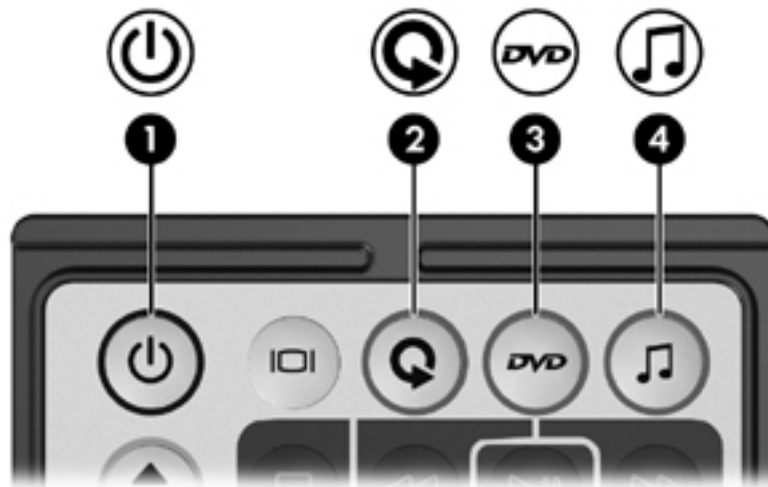

This section provides information on the button functions of the HP Mobile Remote Control (ExpressCard version).

When the computer is off:













- Press the power button **(1)** to start the computer in Windows.
- Press the Media button **(2)** to open QuickPlay (select computer models only).
- Press the DVD Menu button **(3)** to open QuickPlay DVD mode (select computer models only).
- Press the Music button **(4)** to open QuickPlay music mode (select computer models only).



Button	Function in Microsoft® Windows®	Function in QuickPlay (select models only)
Power 	If the computer is <ul style="list-style-type: none"> <li>• On, briefly press to initiate hibernation.</li> <li>• In standby, briefly press to resume from standby.</li> <li>• In hibernation, briefly press to restore from hibernation.</li> </ul>	Press to turn QuickPlay off.
Switch Screens	Press to switch the computer image between the computer display and an external display.	Press to switch the computer image between the computer display and an external display.

Button	Function in Microsoft® Windows®	Function in QuickPlay (select models only)
		
Media	Press to open QuickPlay (select computer models only) or the default music application.	None
		
DVD Menu	<p>If the computer is</p> <ul style="list-style-type: none"> <li>On, press to open the default Windows DVD player.</li> <li>On and playing a DVD, press to view the menu of the DVD.</li> <li>In standby, press briefly to resume from standby.</li> <li>In hibernation, press to open QuickPlay DVD mode (select computer models only).</li> </ul>	<ul style="list-style-type: none"> <li>In QuickPlay music mode, press to switch to QuickPlay DVD mode.</li> <li>When a DVD is playing, press to view the menu of the DVD.</li> </ul>
		
Music	<p>If the computer is</p> <ul style="list-style-type: none"> <li>On, press to open the default music player.</li> <li>In standby, press briefly to resume from standby.</li> <li>In hibernation, press to open QuickPlay music mode (select computer models only).</li> </ul>	In QuickPlay DVD mode, press to switch to QuickPlay music mode.
		
Channel/ Page Up	<ul style="list-style-type: none"> <li>Press to change channels in ascending order.</li> <li>Press to emulate the <b>pg up</b> key on a keyboard.</li> </ul>	Press to navigate backward a page.
		
Channel/ Page Down	<ul style="list-style-type: none"> <li>Press to change channels in descending order.</li> <li>Press to emulate the <b>pg dn</b> key on a keyboard.</li> </ul>	Press to navigate forward a page.
		
Stop	Press to stop the current media activity, such as playing, rewinding, etc.	Press to stop the current media activity, such as playing, rewinding, etc.
		
Rewind	Press to rewind the selected media.	Press to rewind the selected media.
		
Play/Pause	<ul style="list-style-type: none"> <li>Media not playing, press to play the media.</li> <li>Media playing, press to pause the media.</li> </ul>	<ul style="list-style-type: none"> <li>Media not playing, press to play the media.</li> <li>Media playing, press to pause the media.</li> </ul>
		
Fast Forward	Press to fast forward the selected media.	Press to fast forward the selected media.



Button	Function in Microsoft® Windows®	Function in QuickPlay (select models only)
Previous 	Press to go back to the previous track or chapter.	Press to go back to the previous track or chapter.
Next 	Press to go to the next track or chapter.	Press to go to the next track or chapter.
Up 	Navigation. Press to scroll up.	Navigation. Press to scroll up.
Left 	Navigation. Press to scroll left.	Navigation. Press to scroll left.
Ok 	Navigation. Press to select an item on the screen.	Navigation. Press to select an item on the screen.
Right 	Navigation. Press to scroll right.	Navigation. Press to scroll right.
Down 	Navigation. Press to scroll down.	Navigation. Press to scroll down.
Back 	Press to emulate the “back” function of the <b>alt +left</b> arrow command in the active application.	<ul style="list-style-type: none"> <li>• In music mode, press to move up one directory level in the My Music display.</li> <li>• In DVD mode, this button is inactive.</li> </ul>
Information 	Press to view information about a selected item in an application (if available).	<p>Press to display battery and volume status.</p> <p>If playing a DVD, the DVD title, chapter, and time information is also displayed.</p>
Volume Down 	Press to decrease system volume.	Press to decrease system volume.
Mute 	<ul style="list-style-type: none"> <li>• Press to mute system volume.</li> <li>• If muted, press to restore system volume.</li> </ul>	<ul style="list-style-type: none"> <li>• Press to mute system volume.</li> <li>• If muted, press to restore system volume.</li> </ul>
Volume Up 	Press to increase system volume.	Press to increase system volume.

## HP Mobile Remote Control (ExpressCard version) component functions

The infrared lens on the remote control links the remote control to the computer. The link requires a line-of-sight path between the infrared lens on the remote control and the infrared lens on the computer.

Things to remember:

- The HP Mobile Remote Control operates within Microsoft® Windows®, QuickPlay (select computer models only), and InterVideo Home Theater software (select computer models only). Each button responds according to which application is active.



**NOTE** Refer to the InterVideo Home Theater on-screen help for remote control information.

**NOTE** For information on using QuickPlay, refer to the QuickPlay online Help.

- Some remote control buttons perform the same functions as computer buttons. For example, the DVD button on the remote control and the DVD button on the computer have the same functions and can be used interchangeably.
- Some remote control buttons perform the same functions as computer hotkeys. Refer to the computer user guide for information on supported hotkeys.
- Other remote control buttons provide functions that are not duplicated by computer buttons or preset key combinations.

## Troubleshooting the remote control

Refer to the following table for help in troubleshooting remote control problems.

Problem	Possible solution
My remote control is not working.	<ul style="list-style-type: none"><li>• Be sure you have a clear line of sight from the remote control to the IR port on the computer or expansion product.</li><li>• Be sure that you are within range of the IR port on the computer or expansion product.</li><li>• Be sure the battery is properly installed and has a charge. Replace the battery if necessary.</li><li>• Be sure you are using the remote control with a supported computer or expansion product.</li></ul>
My remote control will not fit into the slot for storage.	Be sure you are inserting the remote control into the proper slot on the computer. A PC Card remote control must be inserted into the PC Card slot and an ExpressCard remote control must be inserted into the ExpressCard slot.
I cannot remove the remote control from the slot.	Depending on your remote control model, refer to the removal instructions in either " <a href="#">Storing the remote control in the PC Card slot</a> " or " <a href="#">Storing the remote control in the ExpressCard slot</a> ."

# Multimedia software

The computer includes preinstalled multimedia software. Some models may be shipped with additional multimedia software on an optical disc.

Depending on the hardware and software included with the computer, the following multimedia tasks may be supported:

- Playing digital media, including audio and video CDs, audio and video DVDs, and Internet radio
- Creating or copying data CDs
- Creating, editing, and burning audio CDs
- Creating, editing, and burning a video or movie to a DVD or video CD



---

**NOTE** For details about using software included with the computer, refer to the software user guides. These guides may be provided on CD or as online help files within the specific application. User guides may also be found on the software manufacturer's Web site.

---

## Identifying preinstalled multimedia software

To view and access the preinstalled multimedia software on the computer:

- ▲ Select **Start > All Programs**.

You can also reinstall multimedia software on the computer. Select **Start > All Programs > Software Setup**.

## Installing multimedia software from a CD (select models only)

To install multimedia software from a CD included with the computer:

1. Insert the multimedia software CD into the optical drive.
2. When the installation wizard opens, follow the installation instructions on the screen.
3. Restart the computer if prompted.

Repeat the installation procedure for all multimedia software on CD that you want to install.

## Using multimedia software

To use the multimedia software installed on the computer:

1. Select **Start > All Programs**, and then open the multimedia application you want to use. For example, if you want to use Windows Media Player to play an audio CD, select **Windows Media Player**.



---

**NOTE** Some applications may be located in subfolders.

---

2. Insert the media disc, such as an audio CD, into the optical drive.
3. Follow the instructions on the screen.

– or –

1. Insert the media disc, such as an audio CD, into the optical drive.

An AutoPlay dialog box opens.

2. Click the multimedia task you want to perform from the list of installed multimedia applications.
3. Click **OK**.



---

**NOTE** The AutoPlay dialog box allows you to select a default multimedia application for the media disc. After you select a multimedia application from the list, click the **Always do the selected action** box.

---

## Using QuickPlay software

QuickPlay software allows you to play movies or open other media without starting the computer or launching the operating system.

For details on using QuickPlay software, refer to the QuickPlay online Help.

## Protecting playback

To prevent the loss of playback or playback quality:

- Save your work and close all open applications before playing a CD or a DVD.
- Do not connect or disconnect hardware while playing a disc.

To prevent the loss of playback while the computer is in Windows, do not initiate standby or hibernation while playing a disc. If standby or hibernation is initiated while a disc is in use, you may see the warning message “Putting the computer into Hibernation or Standby might stop the playback. Do you want to continue?” If this message is displayed, select No. After you select No:

- Playback may resume.  
– or –
- Playback may stop and the screen may clear. To return to playing the CD or DVD, press the power button and then restart the disc.

## Protecting the CD or DVD write process



**CAUTION** To prevent loss of information and damage to a disc:

Before writing to a disc, connect the computer to a reliable external power source. Do not write to a disc while the computer is running on battery power.

Before writing to a disc, close all open applications except the disc software you are using.

Do not copy directly from a source disc to a destination disc or from a network drive to a destination disc. Instead, copy from a source disc or network drive to your hard drive, and then copy from your hard drive to the destination disc.

Do not use the computer keyboard or move the computer while the computer is writing to a disc. The write process is sensitive to vibration.

---

## Changing DVD region settings

Most DVDs that contain copyrighted files also contain region codes. The region codes help protect copyrights internationally.

You can play a DVD containing a region code only if the region code on the DVD matches the region setting on your DVD drive.

If the region code on a DVD does not match the region setting on your drive, the following message is displayed when you insert the DVD: “Playback of content from this region is not permitted.” To play the DVD, you must change the region setting on your DVD drive. DVD region settings can be changed through the operating system or through some DVD players.



**CAUTION** The region settings on your DVD drive can be changed only 5 times.

The region setting you select the fifth time becomes the permanent region setting on the DVD drive.

The number of allowable region changes remaining on the drive is displayed in the **Changes remaining** field on the **DVD Region** tab. The number in the field includes the fifth and permanent change.

---

To change settings through the operating system:

1. Select **Start > My Computer**.
2. Right-click in the window and select **Properties > Hardware** tab > **Device Manager**.
3. Click **DVD/CD-ROM drives**, right-click the DVD drive for which you want to change region settings, and then click **Properties**.
4. Make the desired changes on the **DVD Region** tab.
5. Click **OK**.

## Observing the copyright warning

It is a criminal offense, under applicable copyright laws, to make unauthorized copies of copyright-protected material, including computer programs, films, broadcasts, and sound recordings. Do not use this computer for such purposes.

# 6 External Media Cards

## Digital Media Slot cards (select models only)

Optional digital cards provide secure data storage and convenient data sharing. SD I/O cards provide extended input/output functions, such as wireless LAN and digital TV tuning. These cards are often used with digital-media-equipped cameras and PDAs as well as with other computers.

The Digital Media Slot (select models only) supports the following digital card formats:

- Secure Digital (SD) Memory Card
- Secure Digital Input/Output (SD I/O)
- MultiMediaCard (MMC)
- Memory Stick (MS)
- Memory Stick Pro (MSP)
- SmartMedia (SM)
- xD-Picture Card (XD)



---

**CAUTION** To avoid damaging the digital card or the computer, do not insert any type of adapter into the Digital Media Slot.

---

## Inserting a digital card



**CAUTION** To prevent damage to the digital card connectors, use minimal force to insert a digital card.

---

To insert a digital card:

1. Hold the digital card label-side up, with the connectors facing the computer.
2. Gently slide the card into the Digital Media Slot until the card is seated.

The operating system will issue a sound to indicate that a device has been connected.



**NOTE** The first time you insert a digital card, the "Found New Hardware" message is displayed in the notification area, at the far right of the taskbar.

---

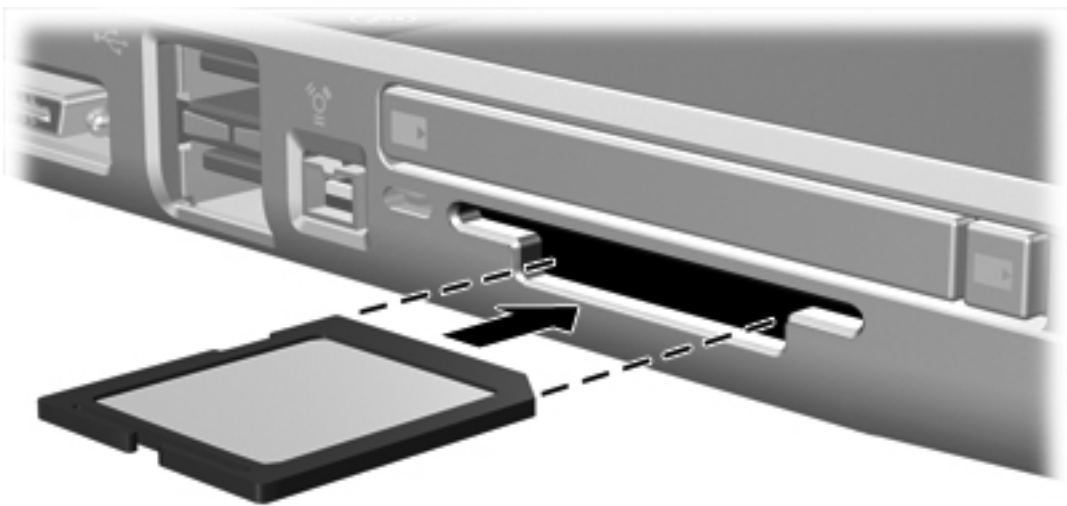



## Stopping or removing a digital card

 **CAUTION** To prevent loss of data or an unresponsive system, stop the digital card before removing it.

To stop or remove a digital card:

1. Close all files and applications that are associated with the digital card.



**NOTE** To stop a data transfer, click **Cancel** in the operating system Copying window.

2. To stop the digital card:

- a. Double-click the **Safely Remove Hardware** icon in the notification area, at the far right of the taskbar.



**NOTE** To display the Safely Remove Hardware icon, click **Show Hidden Icons** in the notification area.

- b. Click the digital card listing.
  - c. Click **Stop**.
3. Gently pull the card out of the slot.

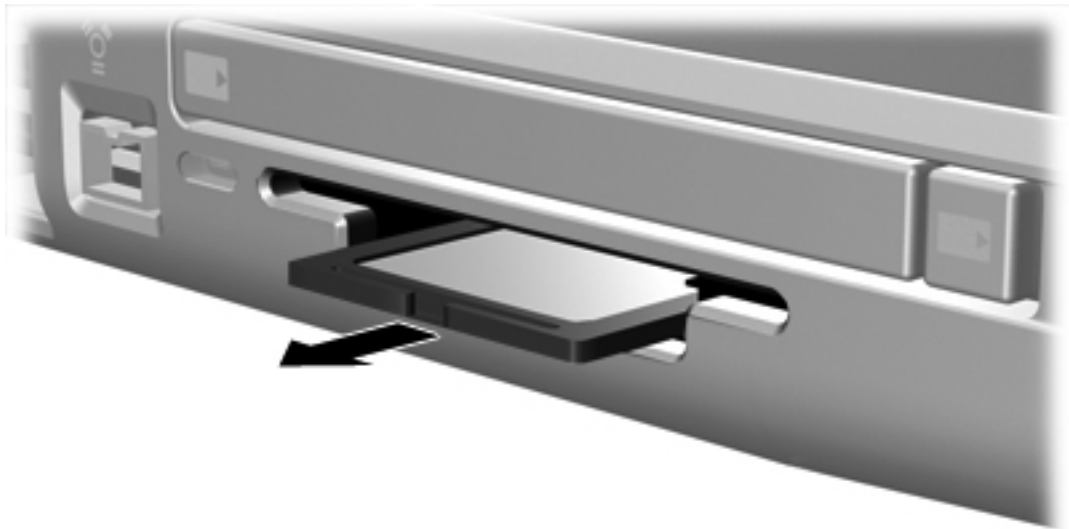

## PC Cards (select models only)

A PC Card is a credit card-sized accessory designed to conform to the standard specifications of the Personal Computer Memory Card International Association (PCMCIA). The PC Card slot (select models only) supports

- 32-bit (CardBus) and 16-bit PC Cards.
- Type I and Type II PC Cards.



---

**NOTE** Zoomed video PC Cards are not supported.

---

### Configuring a PC Card



---

**CAUTION** To prevent loss of support for other PC Cards, install only the software required for the device. If you are instructed by the PC Card manufacturer to install device drivers:

Install only the device drivers for your operating system.

Do not install other software, such as card services, socket services, or enablers, supplied by the PC Card manufacturer.

---

## Inserting a PC Card



**CAUTION** To prevent damage to the computer and external media cards, do not insert an ExpressCard into a PC Card slot or a PC Card into an ExpressCard slot.

**CAUTION** To prevent damage to the connectors:

Use minimal force to insert a PC Card.

Do not move or transport the computer when a PC Card is in use.

To insert a PC Card:

1. Hold the PC Card label-side up, with the connectors facing the computer.
2. Gently slide the card into the PC Card slot until the card is seated.

The operating system will issue a sound to indicate that a device has been detected.



**NOTE** The first time you insert a PC card, the "Found New Hardware" message is displayed in the notification area, at the far right of the taskbar.

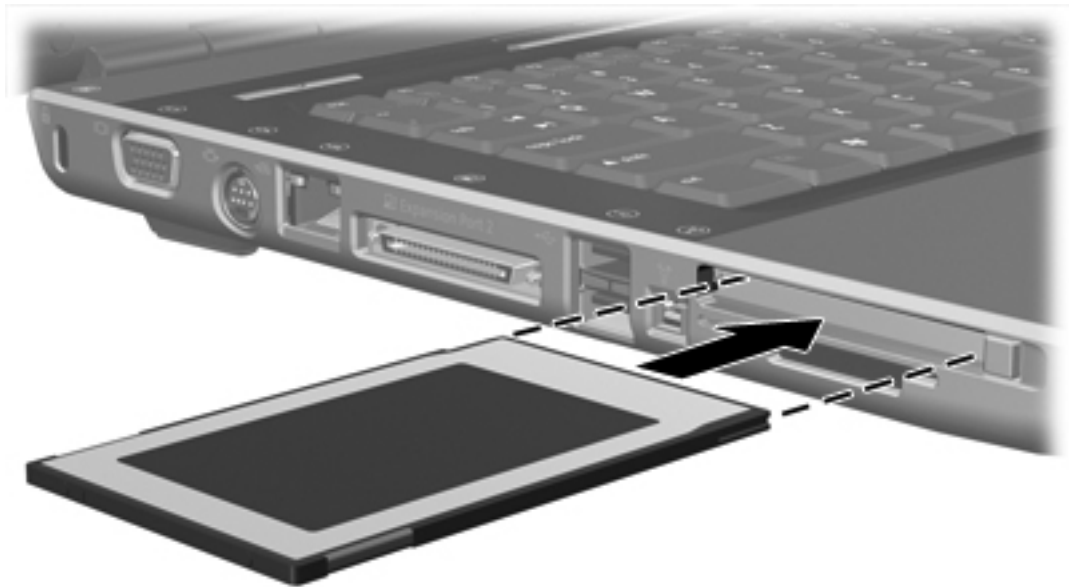

## Stopping or removing a PC Card



**CAUTION** To prevent loss of data or an unresponsive system, stop a PC Card before removing it.

To stop or remove a PC Card:

1. Close all applications and complete all activities that are associated with the PC Card.



---

**NOTE** To stop a data transfer, click **Cancel** in the operating system Copying window.

---

2. To stop the PC Card:

- a. Double-click the **Safely Remove Hardware** icon in the notification area, at the far right of the taskbar.



---

**NOTE** To display the Safely Remove Hardware icon, click **Show Hidden Icons** in the notification area.

---

- b. Click the PC Card listing.
  - c. Click **Stop**.
3. To remove the PC Card

- a. Press the PC Card slot eject button **(1)**. (This action extends the button into position for releasing the PC Card.)
- b. Press the eject button again to release the PC Card.
- c. Gently pull the card **(2)** out of the slot.

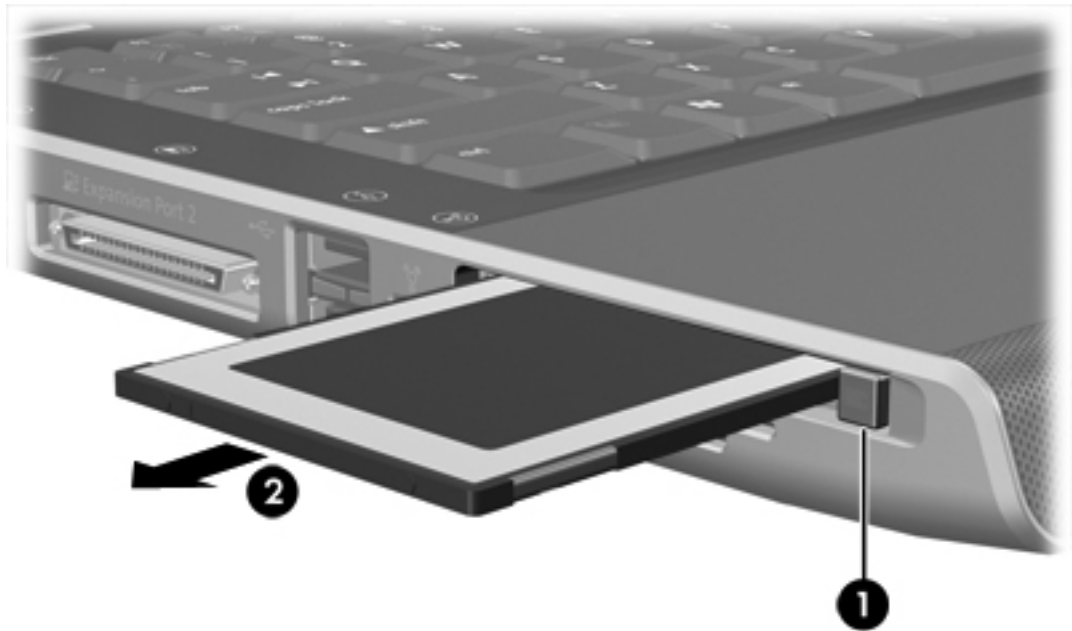

---

**NOTE** An inserted PC Card uses power even when idle. To conserve power, stop or remove a PC Card when it is not in use.

---

# ExpressCards

An ExpressCard is a next-generation, high-performance PC Card, which must be inserted into the ExpressCard slot.

Like standard PC Cards, ExpressCards are designed to conform to the standard specifications of the Personal Computer Memory Card International Association (PCMCIA).



---

**NOTE** An ExpressCard can also add TV tuner functionality to the computer. For more information, refer to the manufacturer's user guide.

---

## Selecting an ExpressCard

ExpressCards use one of 2 interfaces and are available in 2 sizes. The ExpressCard slot on the computer supports both interfaces and both sizes. For example, you can use

- An ExpressCard with either a USB interface or a PCI Express interface.
- A full-size ExpressCard, called *ExpressCard/54* (1), or a smaller ExpressCard, called *ExpressCard/34* (2).

The ExpressCard procedures described in the following sections are the same for both interfaces and both sizes.

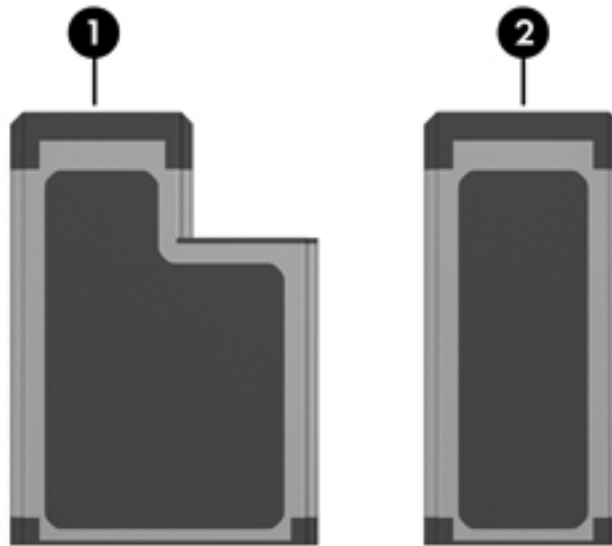

## Configuring an ExpressCard



---

**CAUTION** To prevent loss of support for other ExpressCards, install only the software required for the device. If you are instructed by the ExpressCard manufacturer to install device drivers:

Install only the device drivers for your operating system.

Do not install other software, such as card services, socket services, or enablers, supplied by the ExpressCard manufacturer.

---

## Inserting an ExpressCard



**CAUTION** To prevent damage to the computer and external media cards, do not insert an ExpressCard into a PC Card slot or a PC Card into an ExpressCard slot.

**CAUTION** To prevent damage to the connectors:

Use minimal force to insert an ExpressCard.

Do not move or transport the computer when an ExpressCard is in use.

The ExpressCard slot may contain a protective insert. The insert must be released and then removed before you can insert an ExpressCard.

1. To release and remove the ExpressCard slot insert:
  - a. Press the insert **(1)** firmly inward, and then quickly release it.
  - b. Gently pull the insert out of the slot **(2)**.



2. To insert an ExpressCard:
  - a. Hold the card label-side up, with the connectors facing the computer.

- b. Gently slide the card into the ExpressCard slot until the card is seated.

The operating system will issue a sound to indicate that a device has been connected.



**NOTE** The first time you insert an ExpressCard, the "Found New Hardware" message is displayed in the notification area, at the far right of the taskbar.



## Stopping or removing an ExpressCard



**CAUTION** To prevent loss of data or an unresponsive system, stop the ExpressCard before removing it.

To stop or remove an ExpressCard:

1. Close all applications and complete all activities that are associated with the ExpressCard.



**NOTE** To stop a data transfer, click **Cancel** in the operating system Copying window.

2. To stop the ExpressCard:

- a. Double-click the **Safely Remove Hardware** icon in the notification area, at the far right of the taskbar.



**NOTE** To display the Safely Remove Hardware icon, click **Show Hidden Icons** in the notification area.

- b. Click the ExpressCard listing.
  - c. Click **Stop**.
3. To remove the ExpressCard:
    - a. Press the ExpressCard **(1)** firmly inward, and then quickly release it.
    - b. Gently pull the card out of the slot **(2)**.

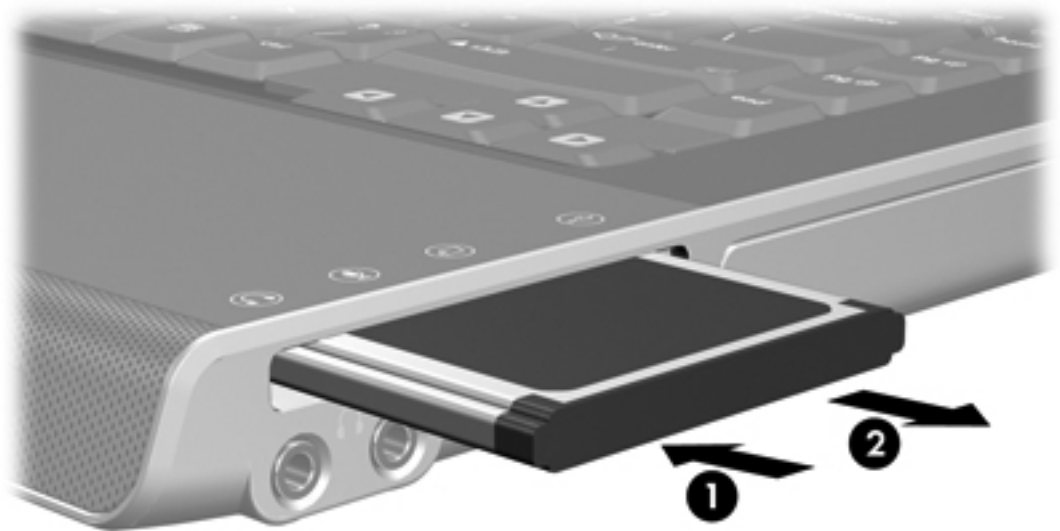

**NOTE** An inserted ExpressCard uses power even when idle. To conserve power, stop or remove an ExpressCard when it is not in use.



# 7 External Devices

## Using a USB device

Universal Serial Bus (USB) is a hardware interface that can be used to connect an optional external device, such as a USB keyboard, mouse, drive, printer, scanner, or hub, to the computer or to an optional expansion product. A hub provides additional USB ports for the system and can be connected to the computer or to another hub.

The computer has 2 standard USB ports on the left side of the computer. A third USB port on the right side of the computer is available on select models only. An optional expansion product provides additional USB ports that can be used with the computer. The USB ports on the computer support USB 2.0 and USB 1.1 devices.

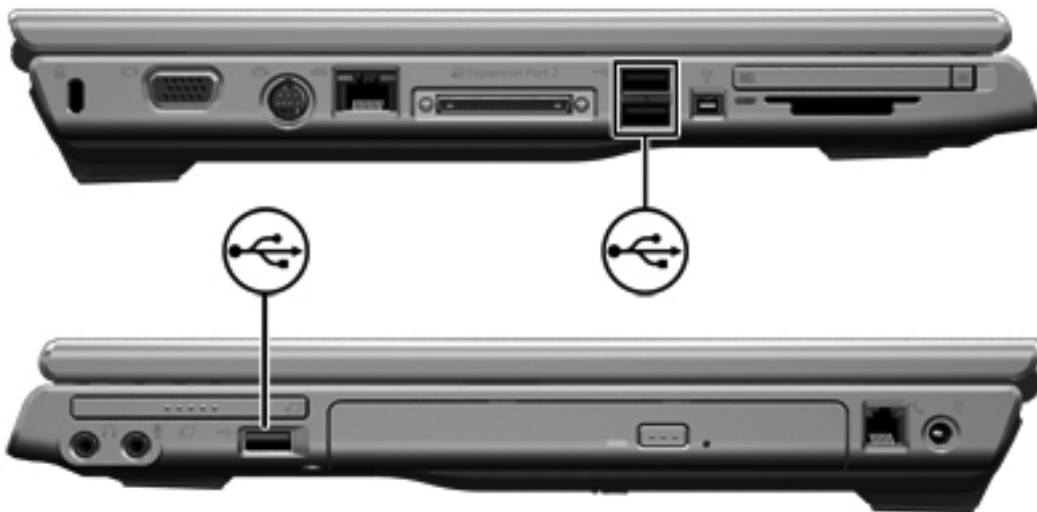

### Connecting a USB device



**CAUTION** To prevent damage to the USB connectors, use minimal force to connect a USB device.

To connect a USB device to the computer, connect the USB cable of the device to the USB port. The operating system will issue a sound to indicate that a device has been connected.



**NOTE** The first time you connect a USB device, the "Found New Hardware" message is displayed in the notification area, at the far right of the taskbar.

## Stopping a USB device



---

**CAUTION** To prevent loss of information or an unresponsive system, stop the USB device before removing it.

---

To stop a USB device:

1. Double-click the **Safely Remove Hardware** icon in the notification area, at the far right of the taskbar.
2. Click the USB device listing.



---

**NOTE** To display the Safely Remove Hardware icon, click **Show Hidden Icons** in the notification area.

---

3. Click **Stop**.

## Required USB software

Some USB devices may require additional support software, which is usually included with the device. For more information about device-specific software, refer to the user guide for the device.

## Using a 1394 device (select models only)

IEEE 1394 is a hardware interface that can be used to connect a high-speed multimedia or data storage device to the computer. Scanners, digital cameras, and digital camcorders often require a 1394 connection.

The 1394 port, illustrated below, supports IEEE 1394a devices.



### Connecting a 1394 device



**CAUTION** To prevent damage to the 1394 port connectors, use minimal force to connect a 1394 device.

To connect a 1394 device to the computer, connect the 1394 cable of the device to the 1394 port. The operating system will issue a sound to indicate that a device has been connected.



**NOTE** The first time you connect a 1394 device, the "Found New Hardware" message is displayed at the bottom right of the screen in the notification area.

### Stopping a 1394 device



**CAUTION** To prevent loss of information or an unresponsive system, stop the 1394 device before removing it.

To stop a 1394 device:

1. Double-click the **Safely Remove Hardware** icon in the notification area, at the far right of the taskbar.
2. Click the 1394 device listing.



**NOTE** To display the Safely Remove Hardware icon, click **Show Hidden Icons** in the notification area.

3. Click **Stop**.

### Required 1394 software

You may have to load device-specific drivers and other software before using some 1394 devices. For more information about device-specific software, refer to the user guide for the device.

## Using the expansion port

The expansion port on the left side of the computer allows you to connect the computer to an optional expansion product. An optional expansion product provides additional ports and connectors that can be used with the computer.



# 8 Memory Modules

## Adding or replacing memory modules

The computer has one memory module compartment, which is located on the bottom of the computer. The memory capacity of the computer can be upgraded by adding a memory module to the vacant expansion memory module slot or by upgrading the existing memory module in the primary memory module slot.



---

**WARNING!** To reduce the risk of electric shock and damage to the equipment, unplug the power cord and remove all battery packs before installing a memory module.

---



---

**CAUTION** Electrostatic discharge (ESD) can damage electronic components. Before beginning any procedure, ensure that you are discharged of static electricity by touching a grounded metal object.

---

To add or replace a memory module:

1. Shut down the computer. (If you are not sure whether the computer is off or in hibernation, turn the computer on by pressing the power button. Then shut down the computer through the operating system.)
2. Disconnect all external devices connected to the computer.
3. Disconnect the power cord.
4. Turn the computer upside down.
5. Remove the battery pack from the computer.
6. Loosen the 2 memory module compartment cover screws **(1)**.

7. Lift the memory module compartment cover (2) away from the computer.

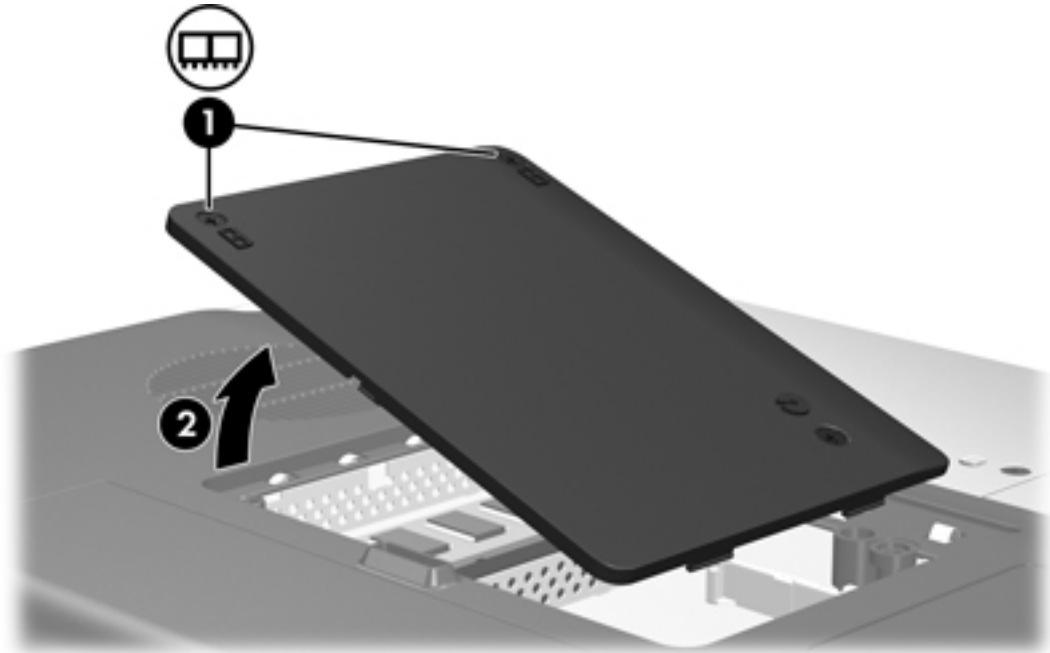

8. To remove a memory module:
  - a. Pull away the retention clips (1) on each side of the memory module . (The memory module tilts up.)
  - b. Grasp the edge of the memory module (2) and gently pull the module out of the memory module slot. (To protect a memory module after removal, place it in an electrostatic-safe container.)

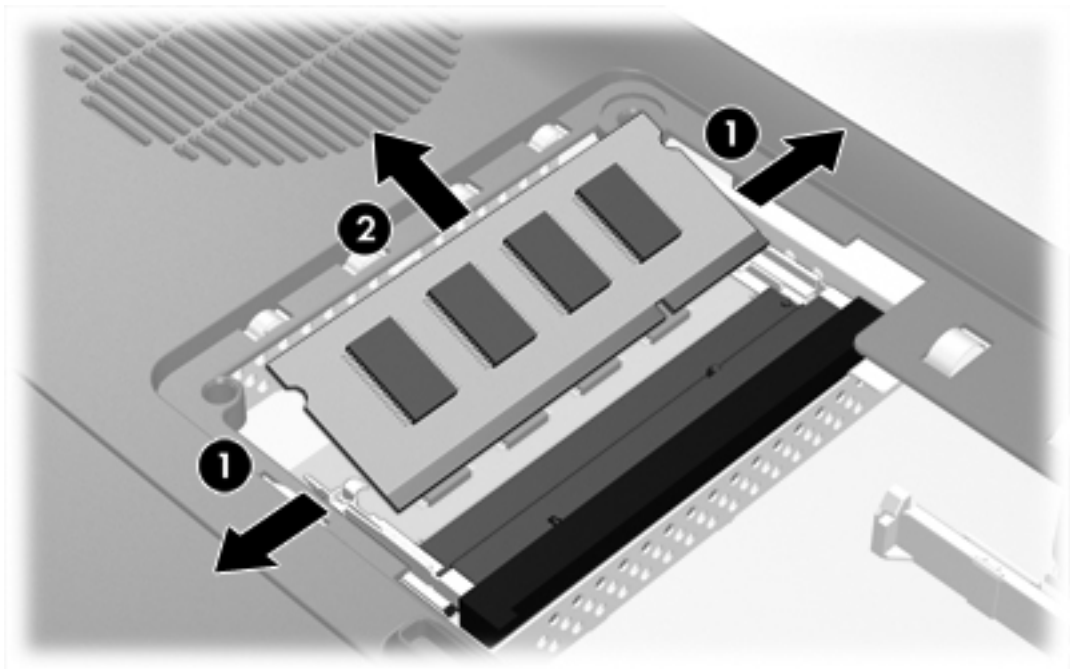

9. To insert a memory module:
  - a. Align the notched edge (1) of the memory module with the tab in the memory module slot.
  - b. With the memory module at a 45-degree angle from the surface of the memory module compartment, press the module (2) into the memory module slot until it is seated.
  - c. Press the memory module (3) down until the retention clips snap into place.

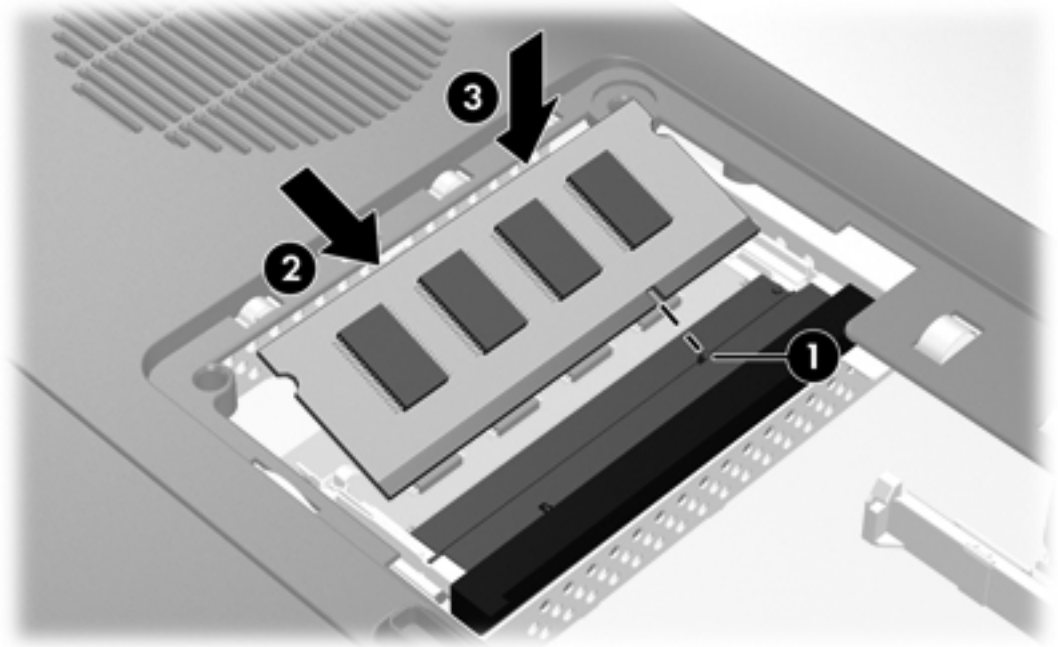

10. Align the tabs (1) on the memory module compartment cover with the notches on the computer.
11. Close the cover (2).

12. Tighten the memory module compartment cover screws (3).

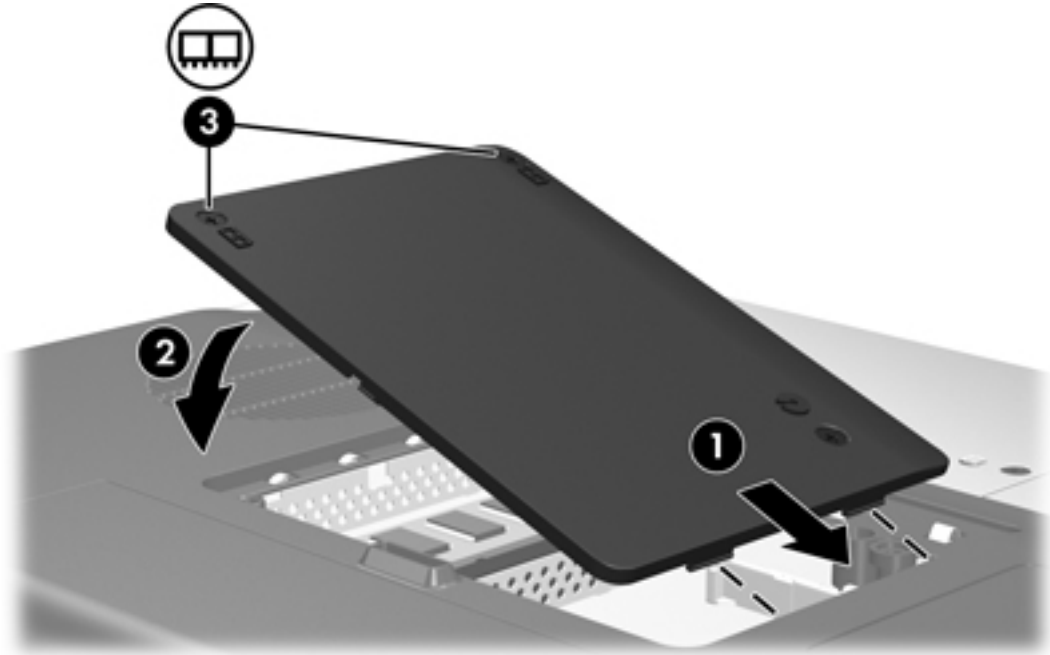

13. Replace the battery pack.
14. Reconnect external power and external devices.
15. Turn on the computer.



## Effects of increasing memory

When random access memory (RAM) increases, the operating system increases the hard drive space reserved for the hibernation file.

If you experience problems with hibernation after increasing memory, verify that the hard drive has enough free space to accommodate a larger hibernation file.

To display the amount of space required by the hibernation file:

- ▲ Select **Start > Control Panel > Performance and Maintenance > Power Options > Hibernate** tab.

To display the amount of memory in the system:

- Select **Start > Control Panel > Performance and Maintenance > System > General** tab.  
– or –
- Press **fn+esc**.

To display the amount of free space on the hard drive:

1. Select **Start > My Computer**.
2. Right click the primary hard drive listing, and then click **Properties**.

## Video memory settings (select models only)



**NOTE** Video memory capacity and settings vary by model. Video memory settings can be changed on select models only and should only be changed by advanced users.

On select models, you can improve the video performance of the computer while using graphics-intensive applications, such as 3-D games, by changing the default shared video memory setting. This setting affects the amount of memory reserved for graphics functions.

1. If you are not sure whether the computer is off or in hibernation, press the power button.  
The computer starts up or is restored from hibernation.
2. Display the setup message:
  - If the computer is on, restart it through the operating system.
  - If the computer is off, turn it on.
3. Press **f10** while the “Press <F10> to enter Setup” message is displayed in the lower-left corner of the screen.
4. Use the arrow keys to select the **System Configuration** menu.  
Memory information and settings are displayed.
5. To change the shared video memory setting, use the navigation and selection information at the bottom of the screen to choose your **Video Memory** preference.
6. To set your preference and exit the Setup Utility, press **f10** and then follow the instructions on the screen.

Your preferences go into effect when the computer restarts.

# 9 Wireless (Select Models Only)

## Wireless features

A wireless computer includes 802.11 or Bluetooth® wireless capability or both.

These devices differ in the following ways:

- An 802.11 wireless computer can connect to wireless local area networks (WLANs) in corporate offices, your home, and public places such as airports, restaurants, coffee shops, hotels, and universities. Hotspots are public places where you can access a wireless network. Contact your Internet service provider (ISP) or search the Web for a list of hotspots near you.
- A Bluetooth wireless computer can connect to other Bluetooth wireless-enabled devices such as computers, phones, printers, headsets, speakers, and cameras.



---

**NOTE** The computer may look different from the illustrations in this guide. The location and number of buttons, lights, and jacks vary by model.

---

## Identifying an 802.11 wireless device

You may need to know the name of the integrated 802.11 wireless device installed in the computer. To identify an 802.11 wireless device:

1. Display the names of the network devices on the computer:
  - a. Select **Start > My Computer**.
  - b. Right-click in the My Computer window.
  - c. Select **Properties > Hardware tab > Device Manager > Network Adapters**.
2. Identify the 802.11 wireless device from the list that is displayed:
  - The listing for an 802.11 wireless device includes the term *wireless*, *wireless LAN*, *WLAN*, or *802.11*.
  - If no 802.11 wireless device is listed, either the computer does not have an integrated 802.11 wireless device, or the driver for the 802.11 wireless device is not properly installed.

## Wireless controls

The wireless button enables and disables 802.11 and Bluetooth wireless devices, and the wireless light indicates the state of the wireless devices.

The following illustration shows the wireless button (1) and associated wireless light (2). The wireless light is on by default.

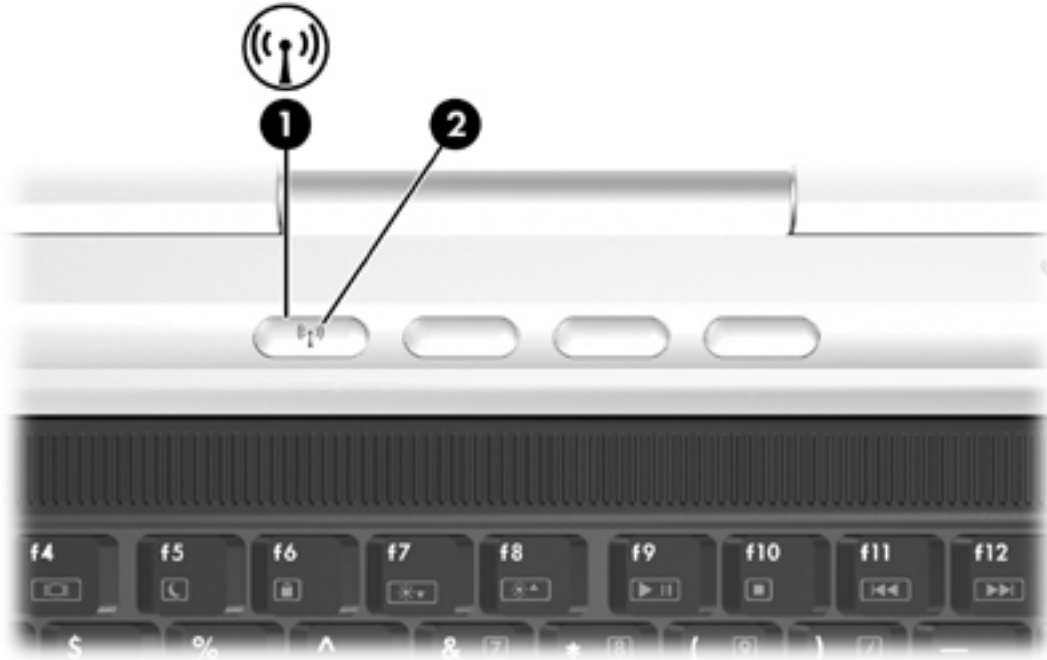

**NOTE** The location of the wireless button and light varies by model.

You can enable and disable the wireless devices with the wireless button. You can also enable and disable the wireless devices in the Setup Utility.

Select models also include the Wireless Assistant utility. With the Wireless Assistant, you can turn on or off the 802.11 or Bluetooth devices individually. For more information, refer to the Wireless Assistant online Help.

## 802.11 wireless devices (select models only)

A computer with an 802.11 wireless device can access a wireless local area network (commonly referred to as wireless network, wireless LAN, or WLAN), which is composed of other computers and accessories linked by a wireless router or a wireless access point:

- A home or small office WLAN typically uses a wireless router, which enables several wireless and wired computers to share an Internet connection, a printer, and files without additional pieces of hardware or software.



---

**NOTE** The terms *wireless access point* and *wireless router* are often used interchangeably.

---

- A large-scale WLAN, such as a corporate or public WLAN, typically uses wireless access points that can handle a large number of computers and accessories and can separate critical network functions.

802.11 wireless devices include:

- 802.11b
- 802.11b/g
- 802.11a/b/g

Computers with 802.11 wireless devices may support 1 or more of 3 industry standards:

- 802.11b supports data rates of up to 11 Mbps and operates at a frequency of 2.4 GHz.
- 802.11g supports data rates of up to 54 Mbps and operates at a frequency of 2.4 GHz. An 802.11g WLAN device is backward compatible with 802.11b devices, so they can operate on the same network.
- 802.11a supports data rates of up to 54 Mbps and operates at a frequency of 5 GHz. 802.11a is not compatible with 802.11b and 802.11g.

For information on identifying the wireless device in the computer, refer to "[Identifying an 802.11 wireless device.](#)"

## Setting up a WLAN in your home

Microsoft® Windows® XP supports WLAN with the Wireless Network Connection feature.

To set up a WLAN and connect to the Internet in your home, you need the following equipment:

- A broadband modem (either DSL or cable) **(1)** and high-speed Internet service purchased from an Internet service provider (ISP).
- A wireless router (purchased separately) **(2)**.
- The wireless computer **(3)**.

The illustration below shows an example of a wireless network installation that is connected to the Internet.



As your network grows, additional wireless and wired computers can be connected to the network to access the Internet.



**NOTE** If you need technical assistance to install your home WLAN, contact the router manufacturer or your ISP.

## Connecting to a WLAN in your home

To connect to your WLAN:

1. Be sure that the 802.11 wireless device is on. If it is on, the wireless light is on. If the wireless light is off, turn on the wireless device.
2. Be sure that your router is correctly installed and configured. For instructions, refer to your router user guide.
3. Use the Wireless Network Connection feature of Microsoft Windows XP to connect the computer to the WLAN.



---

**NOTE** Functional range for subsequent WLAN connections will vary, depending on the computer WLAN implementation, router manufacturer, and interference from walls and other electronic devices.

---

For more information about connecting to a WLAN in your home:

- Refer to information from your ISP and the user guide included with your wireless router and other WLAN equipment.
- Access the information and Web site links provided in the Help and Support Center.

## Connecting to a public WLAN

Contact your ISP or search the Web for a list of public WLANs near you. Web sites that list public WLANs include Cisco Hotspot Locator, Hotspotlist, and Geektools.

When you are within range of a public WLAN, a Wireless Network Connection interactive message is displayed at the bottom of the computer screen. Check with each public WLAN location for cost and connection requirements.

## Using wireless security features

When you set up your home WLAN or access an existing public WLAN, be sure that security features are protecting the WLAN. If you do not enable security on your WLAN, an unauthorized wireless user can access your information and use your Internet connection without your knowledge.

The most common security levels are Wi-Fi Protected Access (WPA)-Personal and Wired Equivalent Privacy (WEP). In addition to enabling WPA-Personal or WEP security encryption on the router, you may want to use one or more of the following security measures:

- Change the default network name (SSID) and password.
- Use a firewall.
- Set security on your Web browser.
- Enable MAC address filtering on the router.

## Bluetooth wireless devices (select models only)

A Bluetooth wireless device provides short-range wireless communications that replace the physical cable connections that traditionally link electronic devices such as

- Network access points.
- Computers (desktop, notebook, PDA).
- Phones (cellular, cordless, smart phone).
- Imaging devices (printer, camera).
- Audio devices (headset, speakers).

The devices are represented in the Bluetooth for Windows software by graphical icons.

The Bluetooth for Windows software provides the following functions:

- Personal Information Management (PIM) item transfer—Enables the exchange of information files such as business cards, calendar items, notes, and message items between Bluetooth computers or devices.
- PIM synchronization—Synchronizes PIM data between a Bluetooth wireless device and a computer, PDA, or cell phone using Bluetooth.
- File Transfer—Enables the exchange of files between Bluetooth computers or devices.
- Network access (Personal Area Networking Profile)—Enables 2 or more Bluetooth devices to form an ad hoc (peer-to-peer) network. Provides a mechanism that enables a Bluetooth device to access a remote network through a network access point. The network access points can be traditional LAN data access points or group ad hoc networks that represent a set of devices that are attached only to one another.
- Dial-up networking—Connects Bluetooth devices to the Internet.
- Bluetooth serial port—Transfers data over the Bluetooth link using a virtual COM port.
- Hands-Free—Enables a vehicle-embedded, hands-free unit or a computer serving as a hands-free unit to establish a wireless connection to a cellular phone and to act as the Bluetooth cellular phone audio input and output mechanism.
- Basic imaging—Provides a wireless connection between a Bluetooth-enabled camera and other Bluetooth devices. The camera can be controlled remotely by a computer, and images can be transferred from a camera to be stored on a computer or to be printed.
- Human interface device—Provides a wireless connection to other Bluetooth devices, such as keyboards, pointing devices, gaming devices, and remote monitoring devices.
- Fax—Provides a Bluetooth connection that enables a computer to send or receive a fax message using a Bluetooth cellular phone or modem.
- Headset—Provides a wireless connection between a headset and a computer or cellular phone. The headset acts as the device's audio input and output mechanism and increases mobility.



# 10 Modem and Local Area Network

## Modem

The modem in the computer must be connected to an analog telephone line using a 6-pin, RJ-11 modem cable. In some countries, a country-specific modem cable adapter is also required. Jacks for digital PBX systems may resemble analog telephone jacks, but they are not compatible with the modem.



**WARNING!** Connecting the internal analog modem to a digital line can permanently damage the modem. Immediately disconnect the modem cable if you accidentally connect it to a digital line.

If the modem cable contains noise suppression circuitry **(1)**, which prevents interference from TV and radio reception, orient the circuitry end **(2)** of the cable toward the computer.



**NOTE** The computer may look different from the illustrations in this guide. The location of the modem jack varies by model.

## Connecting the modem cable

**!** **WARNING!** To reduce the risk of electric shock, fire, or damage to the equipment, do not plug a modem or telephone cable into the RJ-45 (network) jack.

To connect a modem cable:

1. Plug the modem cable into the modem jack (1) on the computer.
2. Plug the modem cable into the RJ-11 telephone wall jack (2).

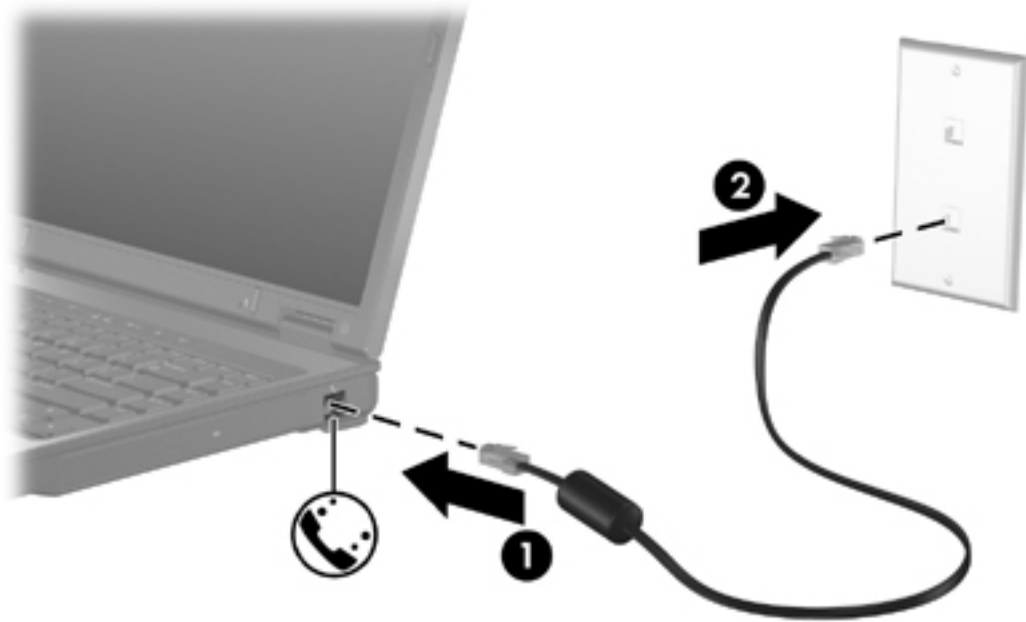

## Connecting a country-specific modem cable adapter

Telephone jacks vary by country. To use the modem and the modem cable outside the country in which you purchased the computer, you must obtain a country-specific modem cable adapter.

To connect the modem to an analog telephone line that does not have an RJ-11 telephone jack:

1. Plug the modem cable into the modem jack **(1)** on the computer.
2. Plug the modem cable into the country-specific modem cable adapter **(2)**.
3. Plug the country-specific modem cable adapter **(3)** into the telephone wall jack.

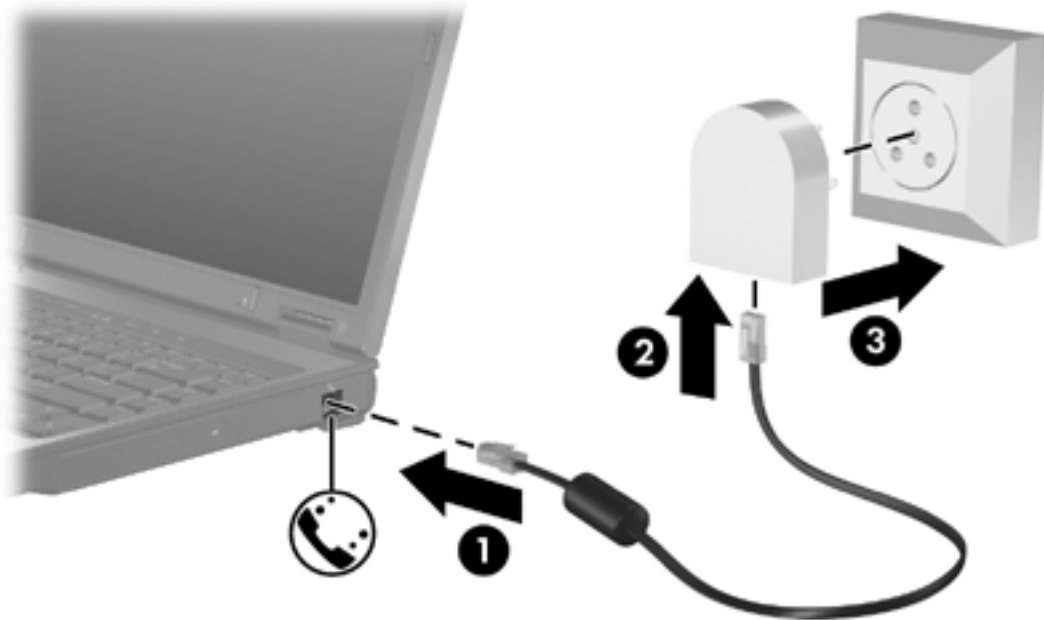

## Selecting a location setting

### Viewing the current country selection

To view the current country setting for the modem:

1. Select **Start > Control Panel**.
2. Click **Date, Time, Language, and Regional Options**.
3. Click **Regional & Language Options**.
4. Under **Location**, view your present location.

## Adding new locations when traveling

By default, the only location setting available to the modem is a location setting for the country in which you purchased the computer. As you travel to different countries, set the internal modem to a location setting that meets the operating standards of the country in which you are using the modem.

As you add new location settings, they are saved by the computer so that you can switch among settings at any time. You can add multiple location settings for any country.



**CAUTION** To prevent losing your home country settings, do not delete your current modem country settings. To enable modem use in other countries while preserving your home country configuration, add a new configuration for each location in which you will use the modem.

**CAUTION** To prevent configuring the modem in a way that violates the telecommunications regulations and laws of the country you are visiting, select the country in which the computer is located. The modem may not function properly if the correct country selection is not made.

To add a location setting for the modem:

1. Select **Start > Control Panel > Network and Internet Connections**.
2. On the upper menu in the left pane of the Network and Internet Connections window, click **Phone and Modem Options**.
3. On the **Dialing Rules** tab, click **New**. (The New Location window is displayed.)
4. In the **Location name** box, type a name (home, work, etc.) for the new location setting.
5. Click a country or region from the **Country/Region** drop-down list. (If you select a country or region that is not supported by the modem, the Country/Region selection for *USA* or *UK* is displayed by default.)
6. Click **OK** to save your new location setting. (The Dialing Rules window is displayed.) Then
  - To set your new location setting as the current location, click **OK**.
  - To select another location setting as the current location setting, click your preference from the settings in the **Location** list, and then click **OK**.



**NOTE** You can use the preceding procedure to add location settings for places within your own country as well as in other countries. For example, you could add a setting named "Work" that includes dialing rules for accessing an outside line.

## Solving travel connection problems

If you experience modem connection problems when using the computer outside of the country in which you purchased it, try the following suggestions.

- **Check the telephone line type.**

The modem requires an analog, not a digital, telephone line. A line described as a PBX line is usually a digital line. A telephone line described as a data line, fax machine line, modem line, or standard telephone line is usually an analog line.

- **Check for pulse or tone dialing.**

An analog telephone line supports one of 2 dialing modes: pulse dialing or tone dialing. These dialing mode options are selected in the Phone and Modem Options settings. The dialing mode option selected must match the dialing mode supported by the telephone line in your location.

To determine the dialing mode supported by a telephone line, dial a few digits on the telephone, and then listen for clicks (pulses) or tones. Clicks indicate that the telephone line supports pulse dialing. Tones indicate that the telephone line supports tone dialing.

To change the dialing mode in your current modem location setting:

- a. Select **Start > Control Panel > Network and Internet Connections**.
  - b. On the upper menu in the left pane of the Network and Internet Connections window, click **Phone and Modem Options**.
  - c. Click the **Dialing Rules** tab.
  - d. Select your modem location setting.
  - e. Click **Edit**.
  - f. Click either **Tone** or **Pulse**.
  - g. Click **OK** twice.
- **Check the telephone number you are dialing and the response of the remote modem.**

Dial a telephone number, make sure there is a response from the remote modem, and then hang up.

- **Set the modem to ignore dial tones.**

If the modem receives a dial tone it does not recognize, it does not dial and displays a “No Dial Tone” error message.

To set the modem to ignore all dial tones before dialing:

- a. Select **Start > Control Panel > Network and Internet Connections**.
- b. On the upper menu in the left pane of the Network and Internet Connections window, click **Phone and Modem Options**.
- c. Click the **Modems** tab.
- d. Click the listing for the modem.
- e. Click **Properties**.

- f. Click **Modem**.
- g. Clear the check box for **Wait for dial tone before dialing**.
- h. Click **OK** twice.

If you continue to receive the “No Dial Tone” error message after clearing the **Wait for dial tone before dialing** check box:

1. Select **Start > Control Panel > Network and Internet Connections**.
2. On the upper menu in the left pane of the Network and Internet Connections window, click **Phone and Modem Options**.
3. Click the **Dialing Rules** tab.
4. Select your current modem location setting.
5. Click **Edit**.
6. Select your current location from the **Country/Region** drop-down list. If you select a country or region that is not supported by the modem, the Country/Region selection for *USA* or *UK* is displayed by default.
7. Click **Apply** and then **OK**.
8. In the Phone and Modem Options window, click the **Modems** tab.
9. Click the listing for the modem, and then click **Properties**.
10. Clear the check box for **Wait for dial tone before dialing**.
11. Click **OK** twice.

## Using preinstalled communication software

To use preinstalled modem software for terminal emulation and data transfer:

1. Select **Start > All Programs > Accessories > Communications**.
2. Click a fax or terminal emulation program or Internet connection wizard.

## Local area networks

Connecting to a local area network (LAN) requires an 8-pin, RJ-45 network cable (not included). If the network cable contains noise suppression circuitry **(1)**, which prevents interference from TV and radio reception, orient the circuitry end of the cable **(2)** toward the computer.



---

**NOTE** The computer may look different from the illustrations in this guide. The location of the network jack varies by model.

---

To connect the network cable:

1. Plug the network cable into the network jack **(1)** on the computer.

2. Plug the other end of the cable into a network wall jack (2).

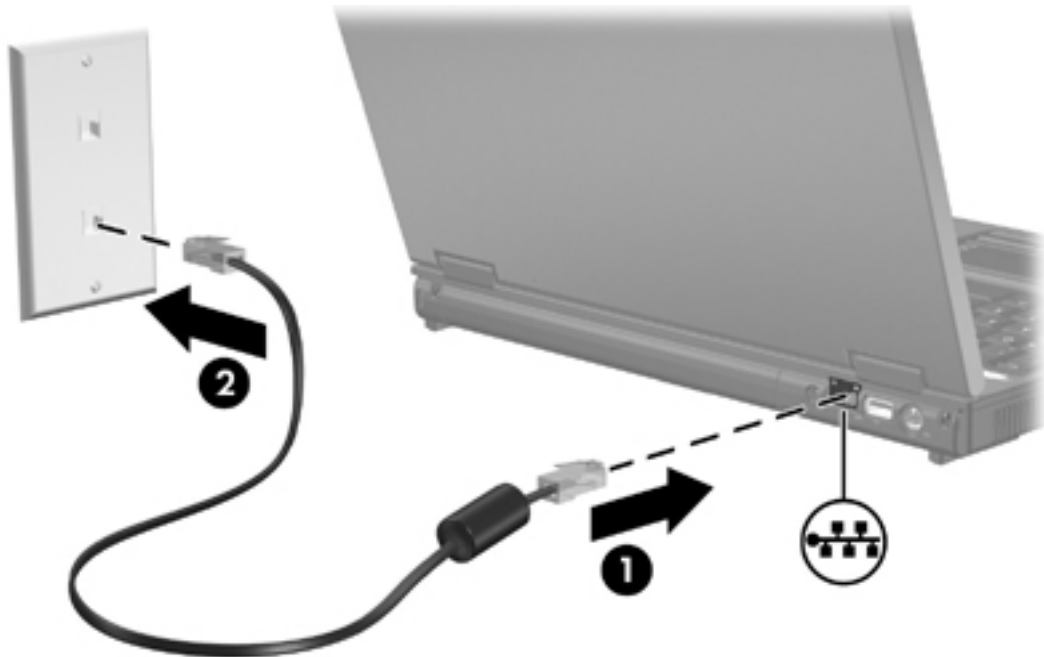

---

 **WARNING!** To reduce the risk of electric shock, fire, or damage to the equipment, do not plug a modem or telephone cable into the RJ-45 (network) jack.

---



# 11 Security

## Security features

Standard security features provided by the Microsoft® Windows® operating system and the non-Windows Setup Utility can protect your personal settings and information from a variety of risks.

Follow the procedures in this chapter for using

- Passwords
- Antivirus software
- Firewall software
- Critical security updates
- Optional security cable



**NOTE** Security solutions are designed to act as deterrents, but they may not be able to deter software attacks or prevent the computer from being mishandled or stolen.

To protect against	Use this security feature
Unauthorized use of the computer	<ul style="list-style-type: none"><li>• QuickLock</li><li>• Power-on password</li></ul>
Computer viruses	Norton Internet Security software
Unauthorized access to information	<ul style="list-style-type: none"><li>• Firewall software</li><li>• Windows updates</li></ul>
Unauthorized access to the Setup Utility, BIOS settings, and other system identification information	Administrator password
Ongoing or future threats to the computer	Critical security updates from Microsoft
Unauthorized access to a Windows user account	User password
Unauthorized removal of the computer	Security cable slot (used with an optional security cable)

# Passwords

A password is a group of characters that you choose to secure the computer information. Several types of passwords can be set, depending on how you want to control access to your information. Passwords can be set in Windows or in the non-Windows Setup Utility preinstalled on the computer.



**CAUTION** To prevent being locked out of the computer, record each password you set. Because most passwords are not displayed as they are set, changed, or deleted, it is essential to record each password immediately and store it in a secure place.

## Guidelines for setting passwords

You can use the same password for a Setup Utility feature and for a Windows security feature. You can also use the same password for more than one Setup Utility feature.

A password set in the Setup Utility

- Can be any combination of up to 8 letters and numbers and is not case sensitive.
- Must be set and entered with the same keys. For example, if you set a password with keyboard number keys, your password will not be recognized if you subsequently try to enter it with the embedded numeric keypad.



**NOTE** Select models include a separate numeric keypad, which functions exactly like the keyboard number keys.

- Must be entered at a Setup Utility prompt. A password set in Windows must be entered at a Windows prompt.

Tips for creating and saving passwords:

- When creating passwords, follow requirements set by the program.
- Write down your passwords and store them in a secure place away from the computer.
- Do not store passwords in a file on the computer.
- Do not use your name or other personal information that could be easily discovered by an outsider.

The following tables list Windows and Setup Utility passwords and describe their functions.

## Passwords set in Windows

Password	Function
Administrator password	Protects administrator-level access to computer contents.   <b>NOTE</b> This password cannot be used to access the Setup Utility contents.
User password	Protects access to a Windows user account. It also protects access to the computer contents and must be entered when you resume from standby or restore from hibernation.
QuickLock	Protects access to the computer by displaying the Windows operating system <b>Log On</b> dialog box.

### QuickLock



QuickLock protects the computer by requiring a password to be entered in the Windows **Log On** dialog box before you access the computer.

Before you can use QuickLock, you must set a user password or administrator password in Windows.

After you set a user or administrator password:

- Initiate QuickLock by pressing **fn+f6**.
- Exit QuickLock by entering your Windows user or administrator password.

## Passwords set in the Setup Utility

Passwords	Function
Administrator password*	<ul style="list-style-type: none"><li>Protects access to the Setup Utility.</li><li>After this password is set, it must be entered each time you access the Setup Utility.</li></ul> <p> <b>CAUTION</b> If you forget the administrator password, you cannot access the Setup Utility.</p>
Power-on password*	<ul style="list-style-type: none"><li>Protects access to the computer contents.</li><li>After this password is set, it must be entered each time you turn on the computer, restart, or restore from hibernation.</li></ul> <p> <b>CAUTION</b> If you forget your power-on password, you cannot turn on the computer, restart, or restore from hibernation.</p>

\*For details about each of these passwords, refer to the following sections.

### Administrator password

The administrator password protects the configuration settings and system identification information in the Setup Utility. After this password is set, you must enter it each time you access the Setup Utility.

The administrator password

- Is not interchangeable with an administrator password set in Windows.
- Is not displayed as it is set, entered, changed, or deleted. Make sure you record your password and store it in a secure place.

### Managing an administrator password

To set, change, or delete this password:

- Open the Setup Utility by turning on or restarting the computer, and then pressing **f10** while the setup message is displayed in the lower-left corner of the screen.
- Use the arrow keys to select **Security > Administrator Password**, and then press **enter**.
  - To set an administrator password, type your password in the **Enter New Password** and **Confirm New Password** fields, and then press **enter**.
  - To change an administrator password, type your current password in the **Enter Current Password** field, type a new password in the **Enter New Password** and **Confirm New Password** fields, and then press **enter**.
  - To delete an administrator password, type your current password in the **Enter Current Password** field, and then press **enter** 4 times.
- To save your preferences and exit the Setup Utility, press **f10**, and then follow the instructions on the screen.

Your preferences go into effect when the computer restarts.

## Entering an administrator password

After an administrator password has been set, you will be prompted to enter your password each time you access the Setup Utility.

At the **Enter Password** prompt, type in the administrator password (using the same keys you used to set your password), and then press **enter**. After 3 unsuccessful attempts to enter the administrator password, you must restart the computer and try again.

## Power-on password

The power-on password prevents unauthorized use of the computer. After this password is set, it must be entered each time you turn on the computer or restart or restore from hibernation. A power-on password is not displayed as it is set, entered, changed, or deleted.

## Managing a power-on password

To set, change, or delete this password:

1. Open the Setup Utility by turning on or restarting the computer, and then pressing **f10** while the setup message is displayed in the lower-left corner of the screen.
2. Use the arrow keys to select **Security > Power-On password**, and then press **enter**.
  - To set a power-on password, type your password in the **Enter New Password** and **Confirm New Password** fields, and then press **enter**.
  - To change a power-on password, type your current password in the **Enter Current Password** field, type a new password in the **Enter New Password** and **Confirm New Password** fields, and then press **enter**.
  - To delete a power-on password, type your current password in the **Enter Current Password** field, and then press **enter** 4 times.
3. To save your preferences and exit the Setup Utility, press **f10**, and then follow the instructions on the screen.

Your preferences go into effect when the computer restarts.

## Entering a power-on password

At the **Enter Password** prompt, type your password (using the same keys you used to set your password), and then press **enter**. After 3 unsuccessful attempts to enter your password, you must restart the computer and try again.

## Antivirus software

When you use the computer for e-mail, network, or Internet access, you expose it to computer viruses that can disable the operating system, applications, or utilities, or cause them to function abnormally.

Antivirus software can detect most viruses, destroy them, and in most cases, repair any damage they have caused. To provide ongoing protection against newly discovered viruses, antivirus software must be kept up to date.

Norton Internet Security software is preinstalled on the computer. The software includes 60 days of free updates. It is strongly recommended that you protect the computer against new viruses beyond 60 days by purchasing extended update service. Instructions for using and updating Norton Internet Security software and for purchasing extended update service are provided within the application. To view and access Norton Internet Security, select **Start > All Programs**.

## Firewall software

When you use the computer for e-mail, network, or Internet access, unauthorized persons may be able to gain access to information about you, the computer, and your information. Use the firewall software preinstalled on the computer to protect your privacy.

Firewall features include logging, reporting, and automatic alarms to monitor all incoming and outgoing traffic. Refer to the firewall user guide or contact your firewall manufacturer for more information.



---

**NOTE** Under some circumstances, a firewall can block access to Internet games, interfere with printer or file sharing on a network, or block authorized e-mail attachments. To temporarily solve the problem, disable the firewall, perform the task that you want to perform, and then reenable the firewall. To permanently resolve the problem, reconfigure the firewall.

---

## Critical updates



---

**CAUTION** To protect the computer from security breaches and computer viruses, install the online critical updates from Microsoft as soon as you receive an alert.

---

Additional updates to the operating system and other software may have become available *after* the computer was shipped. To be sure that all available updates are installed on the computer:

- Run Windows Update monthly to install the latest software from Microsoft.
- Obtain updates, as they are released, from the Microsoft Web site and through the updates link in the Help and Support Center.

## Optional security cable



**NOTE** The security cable is designed to act as a deterrent, but may not prevent the computer from being mishandled or stolen.

To install a security cable:

1. Loop the security cable around a secured object.
2. Insert the key (1) into the cable lock (2).
3. Insert the cable lock into the security cable slot on the computer (3), and then lock the cable lock with the key.

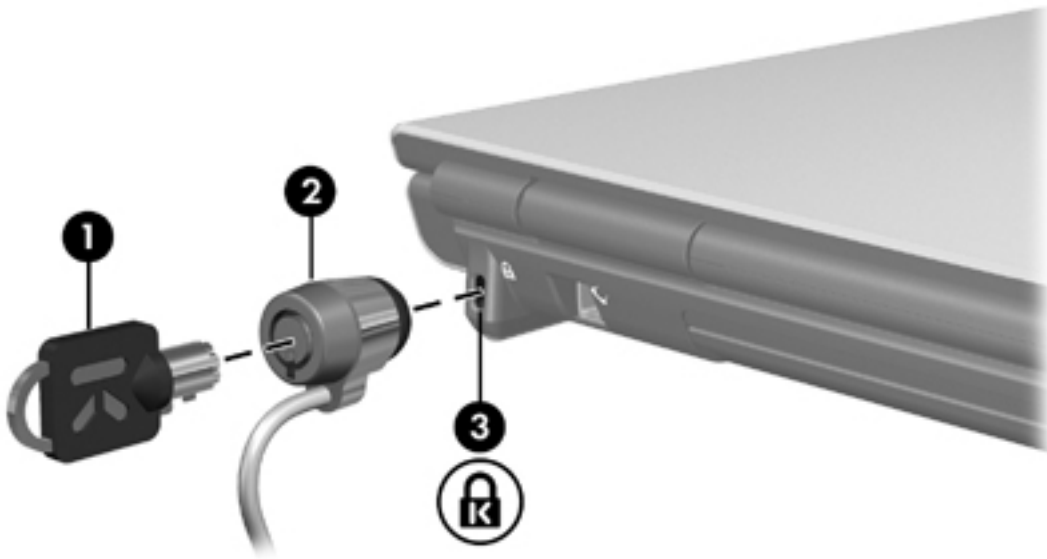

**NOTE** The location of the security cable slot varies by model.





# 12 Setup Utility

## Setup Utility access

The Setup Utility allows you to view system information, manage computer settings, and change system defaults.

The Setup Utility is a preinstalled, ROM-based utility that can be used even when the operating system is not working properly. If the operating system is working, the computer restarts the operating system after you exit the Setup Utility.



**NOTE** To navigate in the Setup Utility:

You must use the keyboard arrow keys to navigate and make selections. Pointing devices are not supported in the Setup Utility.

An external keyboard connected to a USB port can be used to navigate the Setup Utility.

To access the Setup Utility:

1. Open the Setup Utility by turning on or restarting the computer, and then pressing **f10** while the “Press <F10> to enter setup” message is displayed in the lower-left corner of the screen.
2. To view general help information, press **f1**.
3. Select the **Main, Security, System Configuration, or Diagnostics** menu. An overview of Setup Utility features is provided later in this chapter.

To exit the Setup Utility:

- To exit the Setup Utility without saving your preferences, use the arrow keys to select **Exit > Exit Discarding Changes**, and then press **enter**.
- To save your preferences and exit the Setup Utility:
  - Use the arrow keys to select **Exit > Exit Saving Changes**, press **enter**, and then follow the instructions on the screen.
  - or –
  - Press **f10**, and then follow the instructions on the screen.

Your preferences go into effect when the computer restarts.

## Setup Utility language

To select a language:

1. Open the Setup Utility by turning on or restarting the computer, and then pressing **f10** while the “Press <F10> to enter setup” message is displayed in the lower-left corner of the screen.
2. Use the arrow keys to select **System Configuration > Language Support**, and then press **enter**.
3. Press **f5** or **f6** to change a language, or press **enter** to select a language.
4. Save your preferences and exit the Setup Utility:
  - Use the arrow keys to select **Exit > Exit Saving Changes**, press **enter**, and then follow the instructions on the screen.  
– or –
  - Press **f10**, and then follow the instructions on the screen.

Your preferences go into effect when the computer restarts.

# Setup Utility defaults

To return all settings in the Setup Utility to the values that were set at the factory:

1. Open the Setup Utility by turning on or restarting the computer, and then pressing **f10** while the “Press <F10> to enter setup” message is displayed in the lower-left corner of the screen.
2. To reset the Setup Utility factory defaults:
  - Press **f9**.
  - or –
  - Use the arrow keys to select **Exit > Load Setup Defaults**, and then press **enter**.
3. When the **Setup Confirmation** dialog box is displayed, press **enter**.
4. To save your preferences and exit the Setup Utility:
  - Use the arrow keys to select **Exit > Exit Saving Changes**, press **enter**, and then follow the instructions on the screen.
  - or –
  - Press **f10**, and then follow the instructions on the screen.

Your preferences go into effect when the computer restarts.



---

**NOTE** Your password, security, and language settings are not changed when you restore the factory default settings.

---

# Setup Utility menus

## Main menu

---

Select	To do this
System information	<ul style="list-style-type: none"><li>• View and change the system time and date.</li><li>• View identification information about the computer.</li><li>• View specification information about the processor, memory size, system BIOS, and keyboard controller version (select models only).</li></ul>

---

## Security menu

---

Select	To do this
Administrator Password	Enter, change, or delete an administrator password.
Power-On Password	Enter, change, or delete a power-on password.

---

## System Configuration menu

Select	To do this
Video Memory (select models only)	View information about the video memory.
Language Support	Change the Setup Utility language.
Boot Order	Set the boot order for the diskette drive, CD-ROM drive, hard drive, and network adapter.
Embedded WLAN Device Radio	Enable/disable an embedded wireless LAN device.
Embedded Bluetooth® device (select models only)	Enable/disable an embedded Bluetooth device (select models only).
Enhanced SATA support	Enable/disable enhanced SATA mode.
Boot Options	Set the following boot options: <ul style="list-style-type: none"><li>• <b>f10 and f12 Delay (sec)</b>—Set the delay for the f10 and f12 functions of the Setup Utility in intervals of 5 seconds each (0, 5, 10, 15, 20).</li><li>• <b>CD-ROM boot</b>—Enable/disable boot from CD-ROM.</li><li>• <b>Floppy boot</b>—Enable/disable boot from external diskette drive (select models only).</li><li>• <b>Internal Network Adapter boot</b>—Enable/disable boot from Internal Network Adapter.</li></ul>

## Diagnostics menu

Select	To Do This
Hard Disk Self-Test	Run a comprehensive self-test on the hard drive.   <b>NOTE</b> On models with two hard drives, this menu option is called the Primary Hard Disk Self-Test.
Secondary Hard Disk Self-Test (select models only)	Run a comprehensive self-test on a secondary hard drive.



# 13 Software Update and Recovery

## Software updates

Updated versions of the software provided with the computer may be available through the HP Software Update utility or on the HP Web site.



---

**CAUTION** If the computer is connected to a network, it is recommended that you consult with your network administrator before installing any software updates, especially system BIOS updates.

---

### HP Software Update

HP Software Update is a utility included on the computer that automatically checks for software updates from HP. It automatically runs every 30 days and provides a list of software updates and support alerts for the computer.

To run HP Software Update:

- ▲ Select **Start > All Programs > HP > HP Software Update**.

## Software updates and the HP Web site

Most software on the HP Web site is packaged in compressed files called *SoftPaqs*.

Some download packages contain a file named *Readme.txt*, which contains information regarding installing and troubleshooting the file. *Readme.txt* files included with the *SoftPaqs* are provided in English only.)

### Accessing computer information

Before you access updates from the HP Web site, collect the following information:

- The product *category* is computer.
- The product *family* name, *series* number, and *serial* number (S/N) are provided on the service tag.

To determine whether available BIOS updates contain later BIOS versions than those currently installed on the computer, you need to know the version of the system BIOS currently installed.



---

**NOTE** The BIOS initializes the operating system, determines how the computer will interact with the hardware devices, and provides for information transfer among hardware devices, including the time and date. The computer system BIOS is stored on the system ROM.

---

BIOS version information (also known as ROM date and System BIOS) can be displayed by pressing **fn+esc** (if you are already in Windows) or by opening the Setup Utility.

To use the Setup Utility for displaying BIOS information:

1. Open the Setup Utility by turning on or restarting the computer, and then pressing **f10** while the “Press <F10> to enter Setup” message is displayed in the lower-left corner of the screen.
2. If the Setup Utility does not open with the system information displayed, use the arrow keys to select the **Main** menu.

When the Main menu is selected, BIOS and other system information is displayed.

3. To exit the Setup Utility, use the arrow keys to select **Exit > Exit Discarding Changes**, and then press **enter**.



## Downloading a BIOS update



---

**CAUTION** To prevent damage to the computer or an unsuccessful installation, download and install a BIOS update only when the computer is connected to reliable external power using the AC adapter. Do not download or install a BIOS update while the computer is running on battery power, connected to an optional expansion product, or connected to an optional power source. During the download and installation:

Do not disconnect power from the computer by unplugging the power cord from the AC outlet.

Do not shut down the computer or initiate standby or hibernation.

Do not insert, remove, connect, or disconnect any device, cable, or cord.

---

To download a BIOS update:

1. Visit the HP Web site at <http://www.hp.com> and click the software and drivers download link.
2. Follow the instructions on the screen to identify the computer and access the BIOS update you want to download.
3. At the download area:
  - a. Identify the newest BIOS update that is later than the BIOS version currently installed on the computer. Make a note of the date, name, or other identifier. You may need this information to locate the update later, after it has been downloaded to your hard drive.
  - b. Follow the instructions on the screen to download your selection to the hard drive.



---

**NOTE** Make a note of the path to the location on your hard drive where the BIOS update will be downloaded. You will need to access this path when you are ready to install the update.

---

## Installing a BIOS update



---

**NOTE** If you connect the computer to a network, consult the network administrator before installing any software updates, especially system BIOS updates.

---

BIOS installation procedures vary. Follow any instructions that are displayed on the screen after the download is complete. If no instructions are displayed:

1. Open Microsoft® Windows® Explorer by selecting **Start > All Programs > Accessories > Windows Explorer**.
2. In the left pane of the Windows Explorer window:
  - a. Click **My Computer** and then your hard drive designation. (The hard drive designation is typically Local Disk C.)
  - b. Using the hard drive path you recorded earlier, open the folder on your hard drive that contains the update.
3. Double-click the file that has an .exe extension (for example, *filename.exe*).

The BIOS installation begins.

4. Complete the installation by following the instructions on the screen.



---

**NOTE** After a message on the screen reports a successful installation, you may delete the downloaded file from your hard drive.

---

## Downloading and installing other software

To download and install software other than a BIOS update:

1. Visit the HP Web site at <http://www.hp.com> and click the software and drivers download link.
2. Follow the instructions on the screen to find the software you want to update.
3. At the download area, select the software you want and follow the download instructions on the Web page.



---

**NOTE** Make a note of the path to the location on your hard drive where the software will be downloaded. You will need to access this path when you are ready to install the software.

---

4. When the download is complete, open Windows Explorer by selecting **Start > All Programs > Accessories > Windows Explorer**.
5. In the left pane of the Windows Explorer window:
  - a. Click **My Computer** and then your hard drive designation. (The hard drive designation is typically Local Disk C.)
  - b. Using the hard drive path you recorded earlier, open the folder on your hard drive that contains the software.
6. Double-click the file that has an .exe extension (for example, *filename.exe*).

The installation begins.

7. Complete the installation by following the instructions on the screen.



---

**NOTE** After a message on the screen reports a successful installation, you may delete the download package from your hard drive.

---

# System recovery

The computer system recovery process provides several ways to recover optimal system functionality. For best results, attempt to recover optimal computer functionality by using the following procedures *in the order described here*.

## Safeguarding your information

Software or devices added to the computer can cause your system to become unstable. To safeguard your documents, store personal files in the My Documents folder and periodically create a backup copy of the My Documents folder.

## Using System Restore

System Restore is an operating system feature that allows you to reverse undesirable changes to the computer by restoring the computer to an earlier state, called a *restore point*. A restore point is a “snapshot” of your software, drivers, and operating system files at a particular time. The computer automatically creates restore points at regular intervals and may create additional restore points when you change your personal settings or add software or hardware.

You can manually create additional restore points to provide increased protection for your system files and settings. It is recommended that you manually create restore points

- Before you add or extensively modify software or hardware.
- Periodically, whenever the system is performing optimally.

Restoring to any restore point does not affect your information files. For example, restoring your system software to an earlier state will not affect documents or e-mails that you saved after that time.



---

**NOTE** If you do not like the results of your restoration, you can reverse the restoration.

---

## Creating a restore point

To create a restore point:

1. Click **System Restore** in the Help and Support Center.  
The System Restore window opens.
2. Click **Create a restore point**, and then click **Next**.
3. Follow the on-screen instructions.

## Restoring to a restore point

To restore the computer to a previous date and time when it was functioning optimally:

1. Click **System Restore** in the Help and Support Center.  
The System Restore window opens.
2. Click **Restore my computer to an earlier time**, and then click **Next**.
3. Follow the on-screen instructions.

## Reinstalling applications

Applications preinstalled or preloaded on the computer can be reinstalled by using the *Recoverydisc* or a third-party software disc.



---

**NOTE** In most cases, the applications preloaded on the computer, such as those available in the Software Setup utility, can be reinstalled from your hard drive. To access the Software Setup utility, select **Start > All Programs > Software Setup**.

---

The application reinstallation process replaces corrupted system files within the application and reinstalls deleted system files within the application.

- In most cases: If the application you are reinstalling is still installed on the computer, the reinstallation process does not affect your settings within the application.
- In all cases: If an application has been deleted from the computer, the reinstallation process reinstalls the application or utility to the factory image but cannot restore your personal settings.

## Reinstalling applications from the hard drive

To reinstall a preloaded application or utility from your hard drive:

1. Select **Start > All Programs > Software Setup**, and then follow the instructions on the screen.
2. When you are prompted to select the software you want to reinstall, select or clear the appropriate check boxes.

## Reinstalling applications from discs

To reinstall applications from a disc:

1. Insert the disc into the optical drive.
  - If Autorun is enabled, an installation wizard opens.
  - If Autorun is disabled, select **Start > Run**. Enter  
`x:\setup.exe`  
where *x* is your optical drive designation  
and then click **OK**.
2. When the installation wizard opens, follow the installation instructions on the screen.
3. Restart the computer if prompted.

## Repairing the operating system

To attempt an operating system repair without deleting your personal information, use the *Operating System* disc that was shipped with the computer:



---

**NOTE** When repairing the operating system, be sure to use the disc that contains the language that was preinstalled on the computer.

**NOTE** If the computer does not have an optical drive, you may need to connect it to an optional external optical drive.

---

1. Plug the computer into external power through the AC adapter and turn on the computer.
2. Immediately insert the *Operating System* disc into the computer.
3. Press and hold the power button for at least 5 seconds to turn off the computer.
4. Press the power button again to turn on the computer.
5. When prompted, press any key to start from the disc.

After a few minutes, you may need to select your language to enable the Setup Wizard to open.



---

**NOTE** On the "Welcome to Setup" page, do not press **R** (step 8 in this procedure) until you have completed steps 6 and 7.

---

6. Press **enter** to continue.

A licensing agreement page is displayed.

7. Press **f8** to accept the agreement and continue.

The "Setup" page is displayed.

8. Press **R** to repair the selected Windows installation.

The repair process begins. This process may take up to 2 hours to complete.

The computer restarts in Windows after the process is complete.

## Reinstalling the operating system

If you could not solve the problem by repairing the operating system as described in the previous section, it may be necessary to reinstall the operating system.



---

**CAUTION** To prevent the loss of all of your personal information, back up your files before reinstalling the operating system. Reinstalling the operating system deletes all personal information, settings, and software on the computer.

---

After you complete the reinstallation:

- You must reinstall all drivers required for computer functionality.
- To fully restore your system, you will also need to
  - Reinstall all of your additional software.
  - Update all of your reinstalled software, including the operating system.



---

**NOTE** When reinstalling the operating system, be sure to use the disc that contains the language that was preinstalled on the computer.

---

## Back up your system

You can choose any of the following solutions to back up your system:

- Purchase optional system backup software.
- Copy personal information to storage devices other than the hard drive.
- Use the system backup utility available in Windows XP Professional.

If you plan to select the items you want to back up, rather than backing up your entire system, the following suggestions may be helpful:

- On many computers, files are stored by default in the My Documents folder. If you created information files in other locations, be sure to check all the possible locations.
- Templates are often stored in the folders of their associated applications.
- If you have customized the settings in a window, toolbar, or menu bar, you may want to take a screen shot of that element. The screen shot could be a time-saving reference when you begin resetting your preferences. A screen shot is a copy of an element on the screen. To copy the element from the screen and paste it into a Word document:
  - a. Display the element on the screen.
  - b. Copy the element or the entire screen:
    - To copy only the active window, press **alt+fn+prt sc**.
    - To copy the entire screen, press **fn+prt sc**.
  - c. To paste the copied images into a document, open Word, and then select **Edit > Paste**.

## Reinstall the operating system



---

**NOTE** During the reinstallation, you may be prompted for the Product Key. The Product Key is provided on the Microsoft Certificate of Authenticity label on the bottom of the computer.

**NOTE** During the reinstallation, it is normal for some computer models to pause occasionally for several minutes and to restart several times. These normal pauses are indicated by an hourglass icon.

---

To reinstall the operating system using the *Operating System* disc included with the computer:



---

**NOTE** If the computer does not have an optical drive, you may need to connect it to an optional external optical drive.

---

1. Plug the computer into external power through the AC adapter, and turn on the computer.
2. Immediately insert the *Operating System* disc into the computer.
3. Press and hold the power button for at least 5 seconds to turn off the computer.
4. Press the power button again to turn on the computer.
5. When prompted, press any key to start from the disc.

After a few minutes, you may need to select your language to enable the Setup Wizard to open.

6. Press **enter** to continue.

A licensing agreement page is displayed.

7. Press **f8** to accept the agreement and continue.

The "Setup" page is displayed.

8. Press **esc** to continue installing a new copy of the operating system instead of repairing it.
9. Press **enter** to set up the operating system.
10. Press **C** to continue setup using this partition.
11. Select **Format the partition using the NTFS file system (Quick)**, and then press **enter**.



---

**CAUTION** Formatting this drive deletes all current files.

---

12. Press **F** to format the drive.

The reinstallation process begins. This process may take up to 2 hours to complete.

The computer restarts in Windows when the process is complete.



## Reinstalling device drivers and other software

After the operating system installation process is complete, you must reinstall drivers.

To reinstall drivers, use the *Recoverydisc* included with the computer:

1. While running Windows, insert the *Recoverydisc* into the optical drive.
2. If Autorun is not enabled:
  - a. Select **Start > Run**.
  - b. Then type `D:\SWSETUP\APPINSTL\SETUP.EXE`  
where *D* indicates the optical drive.
3. Follow the on-screen instructions for installing the drivers.

After the drivers are reinstalled, you must reinstall any software you added to the computer. Follow the installation instructions provided with the software.

### Update reinstalled software

It is strongly recommended that you update all reinstalled software. Depending on the settings you used on your former configuration, some software may have been automatically updated without your knowledge. Use the following update procedures as soon as the computer is connected to the Internet.

To access update links for the operating system and other software provided on the computer, visit the HP website at <http://www.hp.com> and click the software and drivers download link.

To update optional software, follow the instructions included with the software. Many applications include an update feature that you can access from a Help button or menu item within the application.



# 14 Routine Care

## Hardware maintenance

The computer is designed for durability and long operating life. Follow the routine care guidelines described in this chapter to extend the life of the computer and maintain its peak performance.

- Carry and store the computer in a portable carrying case.



**CAUTION** To reduce the risk of damage to the display, do not place anything on top of the computer, even when it is in the carrying case.

---

- Avoid exposing the computer to direct sunlight, extreme temperatures, or ultraviolet light for extended periods.



**CAUTION** Do not expose the computer or drives to temperature or humidity extremes.

---

- Keep the computer clean. Dust buildup can raise the temperature of internal components.



**WARNING!** To avoid potential discomfort or burns, do not block the air vents or use the computer on your lap for extended periods. The computer is designed to run demanding applications at full power. As a result of increased power consumption, it is normal for the computer to feel warm or hot when used continuously. The computer complies with the user-accessible surface temperature limits defined by the International Standard for Safety of Information Technology Equipment (IEC 60950).

---



**CAUTION** To reduce the risk of electric shock or damage to the computer:

Always disconnect the computer from the AC outlet and disconnect peripherals from the computer before attempting to clean the computer or any of its components.

Do not spray liquids on the computer keyboard, display, or drives, or allow liquids to drip onto them.

**CAUTION** To prevent overheating, do not obstruct vents. Use the computer only on a hard, flat surface. Do not allow another hard surface, such as a printer, or a soft surface, such as pillows, thick rugs, or clothing, to block the airflow.

---

## Battery pack



---

**WARNING!** To avoid potential safety issues, use only the battery pack provided with the computer, a replacement battery pack provided by HP, or a compatible battery pack purchased as an accessory from HP.

---



---

**CAUTION** To prevent damage to a battery pack, do not expose it to high temperatures for extended periods of time.

---

If a computer will be unused and disconnected from external power for more than 2 weeks, remove the battery pack and store it separately.

To prolong the charge of a stored battery pack, place it in a cool, dry place.

Calibrate a battery pack before using it if it has been stored for one month or more.

## Disposing of a used battery pack



---

**WARNING!** When a battery pack has reached the end of its useful life, do not dispose of the battery pack in general household waste. Follow the local laws and regulations in your area for computer battery pack disposal.

In Europe, dispose of or recycle the battery packs by using the public collection system or by returning them to HP, your service partner, or their agents.

**WARNING!** To reduce the risk of fire or burns, do not disassemble, crush, or puncture a battery pack; short the external contacts on a battery pack; or dispose of a battery pack in fire or water. Do not expose a battery pack to temperatures above 60°C (140°F).

---

## TouchPad and keyboard

Dirt and grease on the TouchPad can cause the pointer to jump around on the screen. To avoid this, clean the TouchPad with a damp cloth, and wash your hands frequently when using the computer.



---

**WARNING!** To reduce the risk of electric shock or damage to internal components, do not use a vacuum cleaner attachment to clean the keyboard. A vacuum cleaner could deposit household debris on the keyboard surface.

---

Clean the keyboard regularly to prevent keys from sticking and to remove dust, lint, and particles that can become trapped beneath the keys. A can of compressed air with a straw extension can be used to blow air around and under the keys to loosen and remove debris.



If the computer keyboard includes a pointing stick, you may need to periodically clean or change the replacement cap. (Replacement caps are included with select models.)

## Display

To remove smudges and lint, frequently clean the display with a soft, damp, lint-free cloth. If the screen requires additional cleaning, use premoistened antistatic wipes or an antistatic screen cleaner.



---

**CAUTION** To prevent permanent damage to the computer, never spray water, cleaning fluids, or chemicals on the display.

---

## Drives

Drives are fragile components that must be handled carefully. Follow the guidelines in this section to protect the drives.



---

**CAUTION** To reduce the risk of damage to the computer, damage to a drive, or loss of information, observe these precautions:

Before handling a drive, discharge static electricity by touching the unpainted metal surface of the drive.

Do not touch the connector pins on a removable drive or on the computer.

Handle a drive carefully; do not drop or compress the drive.

Do not use excessive force when inserting a drive into a drive bay.

Do not type on the keyboard or move the computer while the drive is writing to a medium. The write process is sensitive to vibration.

When the battery pack is the only source of power, ensure that the battery pack is sufficiently charged before writing to a medium.

---

### Using Disk Defragmenter

As you use the computer, the hard disk files become fragmented. Disk Defragmenter consolidates the fragmented files and folders on the hard disk so that it can run more efficiently.

To run Disk Defragmenter:

1. Select **Start > All Programs > Accessories > System Tools > Disk Defragmenter**.
2. Click a volume, and then click **Defragment**.

For additional information, access the Disk Defragmenter online Help.

### Using Disk Cleanup

Disk Cleanup searches the hard disk for unnecessary files that you can safely delete to free up disk space and help the computer to run more efficiently.

To run Disk Cleanup:

1. Select **Start > All Programs > Accessories > System Tools > Disk Cleanup**.
2. Follow the instructions on the screen.

## Regular tune-ups

To keep the computer hardware and software running like new, perform these simple tasks periodically.

- **Install and/or update the antivirus software.** Protect against current security threats to the computer by installing antivirus software. Keep the antivirus software up to date to protect against the ongoing threat of new viruses.
- **Install and update software that detects and removes spyware.** Spyware tools allow you to detect and prevent electronic encroachment into the computer system by outside parties.
- **Enable service reminders.** Subscriber's Choice is a free service that allows you to receive instant e-mail notification about product updates, software drivers, and creative ideas to help you get more out of the computer.
- **Create a backup strategy.** A virus or an electrical outage could damage or destroy your information. Back up your files onto a CD-RW, DVD+RW, or USB drive to protect the security of your files.
- **Create a restore point.** In the event of a computer problem, these benchmarks allow you to go back in time to a point before the computer encountered a problem.
- **Create a PC tune-up schedule.** Create weekly and monthly reminders to back up files, update virus software, and perform hardware and software maintenance.

## Traveling and shipping

The computer is built to go with you for work and play. For best results, follow the traveling and shipping tips described here.

- To prepare the computer for traveling or shipping:
  - a. Back up your information.
  - b. Remove all optical discs and all external media cards, such as PC Cards, Secure Digital (SD) Memory Cards, ExpressCards, and so on.



**CAUTION** To reduce the risk of damage to the computer, damage to a drive, or loss of information, remove the medium from a drive before removing the drive from a drive bay, and before shipping, storing, or traveling with a drive.

---

- c. Turn off and then disconnect all external devices.
  - d. Shut down the computer.
- Take along a backup of your information. Keep the backup separate from the computer.
  - When traveling by air, carry the computer as hand luggage, and do not check it in with the rest of your bags.



**CAUTION** Avoid exposing a drive to magnetic fields. Security devices with magnetic fields include airport walk-through devices and security wands. The airport security devices that check carry-on luggage, such as conveyor belts, use x-rays instead of magnetism and will not damage a drive.

---

- If you plan to use the computer during a flight, check with the airline in advance. In-flight computer use is at the discretion of the airline.
- If the computer will be unused and disconnected from external power for more than 2 weeks, remove the battery pack and store it separately.
- If you are shipping the computer or a drive, place it in a bubble-pack mailer or other suitable protective packaging and label the package “FRAGILE.”
- If the computer has a wireless device or a cell phone device installed, such as an 802.11 b/g, a Global System for Mobile Communications (GSM), or a General Packet Radio Service (GPRS) device, the use of these devices may be restricted in some environments. Such restrictions may apply aboard airplanes, in hospitals, near explosives, in hazardous locations, and so on. If you are uncertain of the policy that applies to the use of a particular device, ask for authorization to use it before you turn it on.
- If you are traveling internationally:
  - Check the computer-related customs regulations for each country on your itinerary.
  - Consult with Customer Care about power cord and adapter requirements for each location in which you plan to use the computer. Voltage, frequency, and plug configurations vary.



**WARNING!** To reduce the risk of electric shock, fire, or damage to the equipment, do not attempt to power the computer with a voltage converter kit sold for appliances.

---



# 15 Troubleshooting

## Quick checklist

If you experience computer problems, follow the troubleshooting steps below:

1. Refer to the information in this section.
2. Access additional information about the computer and Web site links through the Help and Support Center.



---

**NOTE** Although many checkup and repair tools require an Internet connection, other tools can help you fix a problem when the computer is offline.

---

3. Contact Customer Care for any further assistance. Refer to the "[Customer Care](#)" section in this chapter.

### The computer will not start up.

To turn on the computer, press the power button. When the computer is turned on, the power light is turned on.

If the computer and the power light are not turned on when you press the power button, adequate power may not be available to the computer.

The suggested actions below may help you determine the reason the computer will not start up:

- If the computer is plugged into an AC outlet, verify that the AC outlet is providing adequate power by plugging another electrical device into the outlet.
- If the computer is running on battery power or is plugged into an external power source other than an AC outlet, plug the computer into an AC outlet using the AC adapter. Make sure the power cord and AC adapter connections are secure.
- If the computer is running on battery power:
  - Remove the primary battery pack and travel battery pack (if applicable) and plug the computer into an AC outlet using the AC adapter. If the computer starts up, one of the battery packs may need to be replaced.
  - If the battery light on the front of the computer is blinking, the battery pack has reached a low-battery condition, which may not allow the computer to start up. Plug the computer into an AC outlet using the AC adapter to start the computer and allow the battery to charge.

## The computer screen is blank.

If you have not turned off the computer but the screen is blank, the computer may be in standby or hibernation, may not be set to display the image on the computer screen, or the display switch or ambient light sensor (select models only) may not be functioning properly.

The suggested actions below may help you determine the reason the computer screen is blank.

- To resume from standby or restore from hibernation, briefly press the power button.

Standby and hibernation are energy-saving features that can turn off the display. Standby and hibernation can be initiated by the system while the computer is in Microsoft® Windows® but is not in use or has reached a critical low-battery condition. To change these and other power settings, select **Start > Control Panel > Performance and Maintenance > Power Options**.

- To transfer the image to the computer screen, press [fn+f4](#).

On most models, when an optional external display device, such as a monitor, is connected to the computer, the image can be displayed on the computer screen or the external display, or on both devices simultaneously. When you press [fn+f4](#) repeatedly, the image alternates among the computer display, one or more external display devices, and simultaneous displays on all devices.

- Press the display switch on the computer to confirm that it moves freely.
- If the computer has a magnetic display switch (select models only), be sure that the computer is not near a strong magnetic field and that no magnetized items (for example, a magnetized screw driver) are laying on the computer.
- If the computer has an ambient light sensor (select models only), make sure that the sensor is not obstructed.

## The software is functioning abnormally.

If the software becomes unresponsive or responds abnormally:

- Restart the computer:
  - In Windows XP Home, select **Start > Turn Off Computer > Restart**.
  - In Windows XP Professional, select **Start > Turn Off Computer > Restart > OK**. (The Turn Off Computer button may be called the Shut Down button, depending on the network connection.)

If you cannot restart the computer using these procedures, refer to the next section, "[The computer is turned on, but is not responding](#)."
- Run a virus scan.
- If the computer feels unusually warm, allow it to cool to room temperature. For more information about computer overheating, refer to "[The computer is extremely warm](#)." later in this chapter.
- If you are using an optional wireless mouse, make sure that the mouse battery has an adequate charge.

## The computer is turned on, but is not responding.

If the computer is turned on, but is not responding to software applications or keyboard commands, try first to shut down the computer through the operating system by selecting **Start > Turn Off Computer > Turn Off**. (In Windows XP Professional, the Turn Off Computer button may be called the Shut Down button, depending on the network connection.)

If the computer remains unresponsive, try the emergency shutdown procedures in the following sequence:

1. If the computer is in Windows, press **ctrl+alt+delete**. Then, select **Shut Down > Turn Off**.
2. If you cannot shut down the computer by using **ctrl+alt+del**, press and hold the power button for at least 5 seconds.
3. If you are unable to shut down the computer by using the power button, unplug the computer from external power and remove the battery pack.



---

**NOTE** If you cannot turn the computer back on after shutting it down, refer to "[The computer will not start up.](#)"

---

## The computer is extremely warm.

It is normal for the computer to feel warm to the touch while it is in use. But if the computer feels **extremely** warm, it may be overheating because a vent is blocked.

If you suspect that the computer is overheating, allow the computer to cool to room temperature. Then be sure to keep all vents free from obstructions while you are using the computer.



---

**CAUTION** To prevent overheating, do not obstruct vents. Use the computer only on a hard, flat surface. Do not allow another hard surface, such as a printer, or a soft surface, such as a pillow or a thick rug or clothing, to block airflow.

---

## An external device is not working.

If an external device does not function as expected:

- Turn on the device as instructed in the device user guide. Some devices, such as monitors and printers, may not be powered by the computer, and must be turned on before the computer is turned on.
- Verify that
  - All device connections are secure.
  - The device is receiving electrical power.
  - The device, especially if it is an older one, is compatible with the operating system. For compatibility information, refer to the Web site of the device manufacturer.
  - The correct drivers are installed and updated. Drivers may be available on a CD included with the device or on the Web site of the device manufacturer.

## **The computer cannot connect to a wireless local area network (WLAN).**

If the computer cannot connect to a WLAN:

- Verify that the computer is within optimal range of a wireless router (access point).
- Verify that the wireless light on the computer is turned on.
- Verify that the computer wireless antennae are free from obstructions.
- Verify that the wireless router and broadband modem are working correctly.

# Customer Care

If you are unable to find the help you need by using the Help and Support Center, you may need to contact Customer Care.

## Preparing to contact Customer Care

For the fastest possible resolution of your problem, have the computer and the following information available when you call or e-mail:

- Product name located on the display or keyboard.
- Serial number (S/N) listed on the service tag.
  - The service tag label is on the bottom of the computer.
  - To display the service tag information on the computer screen, click **My Computer** in the Help and Support Center.
- Date the computer was purchased.
- Conditions under which the problem occurred.
- Error messages that have been displayed.
- The manufacturer and model of a printer connected to the computer.
- Operating system version number and registration number.

To display the operating system version number and registration number, click **My Computer** in the Help and Support Center. (On some models, the registration number may be identified in the Operating System table as the *Product Id*).

## Contacting Customer Care by e-mail or telephone

If the computer is connected to the Internet, you can get help by e-mail or access Customer Care telephone numbers through the Help and Support Center.

## Taking the computer to a service partner

If Customer Care advises you to take the computer to a service partner, be sure to provide the service partner with the information listed in "[Preparing to contact Customer Care](#)," earlier in this section. In addition, be sure to delete all passwords or to disclose all passwords to the service partner so that they can access the computer.



# 16 Electrostatic Discharge

## Preventing electrostatic discharge

Electrostatic discharge is the release of static electricity when two objects come into contact—for example, the shock you receive when you walk across the carpet and touch a metal door knob.

A discharge of static electricity from fingers or other electrostatic conductors may damage electronic components. Before handling electrostatic-sensitive components, discharge static electricity by using one of the methods described in this chapter.

### Handling drives



---

**CAUTION** To prevent damage to the computer, damage to a drive, or loss of information, observe these precautions:

Before handling the drive, discharge static electricity by touching the unpainted metal surface of the drive.

Do not touch the drive connector pins on the drive or on the computer.

---

### Handling internal components

For best results when handling internal components, have everything needed for the installation within reach so that you do not need to leave the area after beginning the procedure. If you must leave the area during the procedure, remember to reground yourself before resuming the procedure.



---

**CAUTION** To prevent damage to the computer when you are removing or installing internal components, observe these precautions:

Keep components in their electrostatic-safe containers until you are ready to install them.

Use nonmagnetic tools.

Before touching an electronic component, discharge static electricity by using one of the grounding methods described in this chapter.

Avoid touching pins, leads, and circuitry. Handle electronic components as little as possible.

If you remove a component, place it in an electrostatic-safe container.

---

## Grounding methods

If removal or installation instructions direct you to unplug the computer, unplug it *after* being properly grounded and *before* removing a cover. Use one or both of the following grounding methods:

- Touch the exterior unpainted metal surface of a device that is connected to an electrical outlet by a grounding plug.
- Use a wrist strap connected by a ground cord to the computer chassis. Wrist straps are flexible grounding straps with a minimum of one megohm  $\pm 10$  percent resistance in the ground cords. To provide proper ground, wear the strap snugly against your skin.

If you need more information about static electricity or assistance with component removal or installation, contact Customer Care.



# Index

## Symbols/Numerics

- 1394 cable 105
- 1394 devices
  - connecting 105
  - description 105
  - software and drivers 105
  - stopping 105
- 1394 port 10, 105
- 802.11 device
  - description 113
  - identifying 113

## A

- AC adapter
  - connecting 32
  - identifying 13
- administrator password 129
- altitude specifications 15
- antennae 12
- antivirus software 132
- applications key, Windows 2
- audio features 68
- audio-in (microphone) jack 9, 68, 69
- audio-out (headphone) jack 8, 68, 69

## B

- battery
  - inserting into remote (ExpressCard version) 81
  - inserting into remote (PC Card version) 74
- battery bay 11, 14
- battery charge information 44
- battery light 43, 45
- battery light, identifying 6, 30
- battery pack
  - battery power vs. AC power 42
  - calibrating 47

- charging 43, 47
- conserving power 49
- disposing of 50
- identifying 13
- inserting 42
- low-battery conditions 45
- monitoring charge 44
- recharging 49
- removing 42
- storing 50
- using 42
- battery pack disposal 154
- battery pack maintenance 154
- battery pack release latch 11, 42
- bays
  - battery 11, 14
  - hard drive 11
- BIOS update
  - downloading 143
  - installing 144
- BIOS version 142
- blank computer screen 160
- Bluetooth device 35, 113, 118
- Bluetooth for Windows software 118
- Bluetooth label 14
- buttons
  - DVD 4, 66
  - Media 5, 66
  - mute 5
  - PC Card slot eject 10
  - power 4, 29
  - Quick Launch Buttons software 24
  - QuickPlay 66
  - remote control (ExpressCard version) 85
  - remote control (PC Card version) 78
  - setting use preferences 18

- TouchPad 3, 17
- volume 5
- volume down 68, 70
- volume mute 68, 70
- volume up 68, 70
- wireless 5

## C

- cable
  - 1394 105
  - LAN 125
  - modem 120
  - RJ-11 (modem) 13
  - security 133
  - USB 103
- calibration, battery 47
- caps lock light 6
- Certificate of Authenticity label 14
- charging battery packs 43
- checklist, troubleshooting 159
- compartments, memory module 11
- components
  - bottom 11
  - display 7
  - front 7
  - left-side 10
  - rear 8
  - right-side 8
  - top 2
- composite video 22
- computer display, turning on or off 36
- computer information 142
- computer screen blank 160
- connecting external power 32
- connector, power 9
- conservation, power 49
- copyright warning 92
- cord, power, identifying 13

- country-specific modem cable adapter 121
- critical low-battery condition 45
- critical updates, software 132
- Customer Care 163

## D

- default power settings 36
- default settings, Setup Utility 137
- device driver installation 151
- digital cards. *See* Digital Media Slot cards, ExpressCards, PC Cards
- Digital Media Slot 10
- Digital Media Slot cards
  - inserting 94
  - removing 95
  - stopping 95
  - supported types 93
- Disk Cleanup software 156
- Disk Defragmenter software 156
- display
  - image, switching 20, 22
  - maintenance 155
  - screen brightness hotkeys 20, 23
- display release latch 7
- drive media 35
- drivers
  - ExpressCards 99
  - PC Cards 96
- drives
  - caring for 51
  - IDE drive light 52
  - maintenance 156
  - optical 9
- DVD button 4, 66
- DVD region settings 92

## E

- edge motion 18
- eject button, PC Card slot 10
- electrostatic discharge
  - grounding methods 166
  - handling drives 165
  - handling internal components 165
  - preventing 165
- emergency shutdown procedures 36

- environmental specifications 15
- expansion port
  - description 106
  - identifying 106
- ExpressCard slot
  - storing remote control 84
- ExpressCards
  - description 99
  - inserting 100
  - removing 102
  - software and drivers 99
  - stopping 102
  - supported types 99
- external media cards. *See* Digital Media Slot cards, ExpressCards, PC Cards
- external monitor port 10, 71

## F

- firewall software 132
- fn key
  - hotkeys 19
  - identifying 2
- fn+f5 key 30
- function keys
  - hotkeys 19
  - identifying 2

## G

- grounding methods 166

## H

- hard drive
  - displaying amount of free space 111
  - installing 54
  - maintenance 156
  - removing 53
- hard drive bay, identifying 11
- hardware maintenance 153
- headphone (audio-out) jack 8
- Help and Support Center hotkey 20, 21
- hibernation
  - defined 33
  - enabling/disabling 33
  - initiated during critical low-battery condition 45
  - initiating 38
  - restoring from 38
  - when to use 33

- writing to CD or DVD 60
- hibernation file 33, 111
- home setup of WLAN 116
- hotkeys
  - audio CD or DVD controls 20, 23
  - decreasing screen brightness 20, 23
  - description 19
  - displaying system information 20
  - increasing screen brightness 20, 23
  - initiating QuickLock 20, 23
  - initiating standby 20, 22
  - media activity 65
  - opening Help and Support Center 20, 21
  - opening Print Options window 20, 21
  - opening Web browser 20, 21
  - quick reference 20
  - switching screen image 20, 22
  - using 20
- HP Software Update 141
- hubs 103
- humidity specifications 15

## I

- IDE drive light 6, 52
- IEEE 1394 port 10
- infrared communication 35
- infrared lens 7
- Internet connection setup 116

## J

- jacks
  - audio-in (microphone) 9, 68, 69
  - audio-out (headphone) 8, 68, 69
  - RJ-11 (modem) 9
  - RJ-45 (network) 10
  - S-Video-out 10, 71, 72

## K

- keyboard
  - hotkeys 19
  - maintenance 155
- keyboard, external
  - setting button assignments 25
- keypad keys 2

- keypad, embedded
  - enabling and disabling 26
  - identifying 26
  - switching key functions 27
  - using 26
- keypad, external
  - num lock mode 27
  - using 27
- keys
  - esc 2
  - fn 2
  - function 2
  - keypad 2
  - Windows applications 2
  - Windows logo 2
- L**
- labels
  - Bluetooth 14
  - Microsoft Certificate of Authenticity 14
  - modem approval 14
  - regulatory 14
  - service tag 14
  - wireless certification 14
  - WLAN 14
- language, Setup Utility 136, 139
- latches
  - battery pack release 11
  - display release 7
- lights
  - battery 6, 30
  - caps lock 6
  - IDE drive 6, 52
  - mute 6
  - num lock 6
  - power 6, 30
  - wireless 6, 8
- LightScribe 56
- local area network (LAN)
  - cable required 125
  - connecting cable 125
- lock, security cable 10
- low-battery condition 45
- M**
- maintenance
  - battery pack 154
  - battery pack disposal 154
  - Disk Cleanup 156
  - Disk Defragmenter 156
  - display 155
  - drives 156
  - hardware 153
  - HP Software Update 141
  - keyboard 155
  - TouchPad 155
  - media activity hotkeys 65
  - Media button 5, 66
  - media controls, hotkeys 20, 23
  - memory
    - adding or replacing memory modules 107
    - displaying amount in system 111
    - increasing 111
    - settings 112
    - video memory 112
  - memory module compartment 11
  - memory module compartment cover
    - removing 108
    - replacing 109
  - memory modules
    - adding 107
    - replacing 107
  - Memory Stick (MS) 10, 93
  - Memory Stick Pro (MSP) 10, 93
  - microphone (audio-in) jack 9
  - microphones, supported 69
  - Microsoft Certificate of Authenticity label 14
  - modem approval label 14
  - modem cable
    - connecting 120
    - country-specific cable adapter 121
    - noise suppression circuitry 119
  - modem software
    - setting/adding location 121
    - travel connection problems 123
  - monitor port, external 10
  - mouse, external
    - setting preferences 18
    - using 18
  - multimedia software
    - described 89
    - identifying 89
    - installing 89
    - using 90
  - MultiMediaCard (MMC) 10, 93
  - mute button 5, 68, 70
  - mute light 6
  - N**
  - network (RJ-45) jack 10
  - network cable 125
  - noise suppression circuitry, modem cable 119
  - num lock light 6
  - num lock mode, external keypad 27
  - O**
  - operating environment
    - specifications 15
  - operating system
    - Microsoft Certificate of Authenticity label 14
    - Product Key 14
    - reinstallation 149, 150
    - repairing 148
  - Operating System disc 148
  - optical disc
    - inserting 57, 62
    - removing, with power 58, 63
    - removing, without power 59, 63
  - optical drive
    - identifying 61
    - supported types 56
  - optical drive, identifying 9
  - optional power adapter 31, 47
  - overheated computer 161
  - P**
  - passwords
    - administrator 129, 130
    - guidelines 128
    - power-on 131
    - QuickLock 129
    - Setup Utility 130
    - user 129
    - Windows 129
  - passwords, security 40
  - PC Card slot
    - storing remote control 77
  - PC Card slot eject button 10
  - PC Cards
    - description 96
    - inserting 97
    - removing 97

- software and drivers 96
  - stopping 98
  - supported types 96
  - pointing devices. *See* TouchPad
  - ports
    - 1394 10, 105
    - expansion 10, 106
    - external monitor 10, 71
    - USB 9, 10, 103
  - power
    - connecting 32
    - conserving 49
    - control and light locations 29
    - schemes 40
    - setting preferences 39
    - sources 31
  - power button 4, 29
  - power connector 9
  - power cord 13
  - power light 6, 30
  - Power Meter icon 39
  - power settings 36
  - power supply 34
  - Print Options window hotkey 20, 21
  - processor performance controls 41
  - Product Key 14
  - product name and number, computer 14
  - public WLAN connection 117
- Q**
- Quick Launch Buttons software 24
  - QuickLock hotkey 20, 23
  - QuickLock password 129
  - QuickPlay
    - using with remote control (ExpressCard version) 85
    - using with remote control (PC Card version) 78
  - QuickPlay buttons 66
- R**
- rated input power specifications 15
  - readable media 35
  - recovery, system 146
  - regulatory information
    - modem approval label 14
    - regulatory label 14
    - wireless certification labels 14
  - reinstallation of applications 147
  - release latch
    - battery pack 11
    - display 7
  - remote control, ExpressCard
    - button quick reference 85
    - inserting battery 81
    - overview 73, 81
    - storing 84
  - remote control, PC Card
    - button quick reference 78
    - inserting battery 74
    - overview 73, 74
    - storing 77
  - reset (emergency shutdown procedures) 36
  - restore point 146
  - RJ-11 (modem) cable 13
  - RJ-11 (modem) jack 9
  - RJ-45 (network) jack 10
- S**
- S-Video 22
  - S-Video-out jack 10, 71, 72
  - S/PDIF digital audio 69
  - screen blank 160
  - screen brightness hotkeys 20, 23
  - screen image, switching 20, 22
  - screen saver 50
  - scroll zone, TouchPad 17
  - scrolling zones, TouchPad 3
  - Secure Digital (SD) Memory Card 10, 93
  - Secure Digital Input/Output (SD I/O) 10, 93
  - security
    - features 127
    - password guidelines 128
    - Windows passwords 129
    - wireless 117
  - security cable 133
  - security cable slot 10
  - security passwords 40
  - serial number, computer 14
  - service tag 14
  - Setup Utility
    - accessing/exiting 135
    - administrator password 130
    - default settings 137
    - Diagnostics menu 139
    - language 136
    - Main menu 138
    - passwords 130
    - power-on password 131
    - Security menu 138
    - System Configuration menu 139
  - shipping the computer 158
  - shutdown procedures 36
  - shutting down 36
  - slots
    - Digital Media 10
    - ExpressCard 9
    - memory module 11
    - PC Card 10
    - security cable 10
  - SmartMedia (SM) 10, 93
  - SoftPaq 142
  - software
    - 1394 105
    - abnormal behavior 160
    - antivirus 132
    - BIOS update 143
    - Bluetooth for Windows 118
    - critical updates 132
    - device driver reinstallation 151
    - Disk Cleanup 156
    - Disk Defragmenter 156
    - downloading/installing other software 145
    - ExpressCards 99
    - firewall 132
    - HP Software Update 141
    - HP Web site 142
    - modem 121
    - multimedia 89
    - operating system reinstallation 149, 150
    - operating system repair 148
    - PC Cards 96
    - Power Meter 39
    - Quick Launch Buttons 24
    - regular tune-ups 157
    - reinstalling application 147
    - restore point 146
    - safeguarding information 146
    - Setup Utility 135
    - SoftPaq 142
    - system backup 149

- System Restore 146
  - updates 141, 151
  - USB devices 104
  - speakers 7, 68
  - specifications
    - operating environment 15
    - rated input power 15
  - standby
    - defined 33
    - hotkey 20, 22
    - initiating 37
    - resuming from 37
    - writing to CD or DVD 60
  - system backup 149
  - system information
    - hotkey 20
  - system information hotkey 20
  - system recovery 146
  - System Restore software 146
- T**
- temperature specifications 15
  - temperature, storage, battery pack 50
  - tiling preferences 24
  - TouchPad
    - identifying 17
    - maintenance 155
    - setting preferences 18
    - using 18
  - TouchPad buttons 17
  - TouchPad scroll zone 17
  - TouchPad tapping 18
  - traveling with the computer
    - battery pack temperature considerations 50
    - environmental specifications 15
    - modem approval label 14
    - tips 158
    - wireless certification labels 14
  - troubleshooting
    - abnormal software behavior 160
    - blank computer screen 160
    - computer not starting up 159
    - Customer Care 163
    - modem 123
    - nonworking external device 161
    - overheated computer 161
    - quick checklist 159
    - unresponsive computer 161
    - wireless network (WLAN) 162
  - tune-ups, regular 157
  - turning off the computer 36
  - TV tuner support 99
- U**
- unresponsive system, emergency shutdown procedures 36
  - updates, software 141
  - USB cable, connecting 103
  - USB devices
    - connecting 103
    - description 103
    - required software 104
    - stopping 104
  - USB hubs 103
  - USB ports, identifying 9, 10, 103
  - user password 129
- V**
- vents 8, 11
  - video features 71
  - video memory 112
  - video transmission types 22
  - volume buttons 5
  - volume down button 68, 70
  - volume mute button 68, 70
  - volume up button 68, 70
  - volume, adjusting 70
- W**
- Web browser hotkey 20, 21
  - Windows applications key 2
  - Windows logo key 2
  - Windows operating system
    - information backup 149
    - reinstallation 149, 150
    - repairing 148
  - Windows passwords 129
  - wireless antennae 12
  - wireless button 5, 114
  - wireless certification label 14
  - wireless controls
    - button 114
    - light 114
  - wireless device
    - 802.11 113
    - Bluetooth 113
    - wireless network (WLAN) 115
  - wireless light 6, 8, 114
  - wireless network (WLAN)
    - description 115
    - equipment needed 116
    - functional range 117
    - home connection 117
    - public WLAN connection 117
    - security 117
    - troubleshooting 162
  - WLAN. See wireless network (WLAN)
  - WLAN label 14
  - writable media 35
- X**
- xD-Picture Card (XD) 10, 93





