

**THE CELL THEORY**

- although different living things may be as unlike as a violet and an octopus, they are all built in essentially the same way. The most basic similarity is that all **living things are composed of one or more cells**. This is known as the **Cell Theory**.
  - our knowledge of cells is built on work done with **microscopes**
  - English scientist **Robert Hooke** in 1665 first described cells from his observations of cork slices. Hooke first used the word "cell".
  - Dutch amateur scientist **Antonie van Leeuwenhoek** discovered microscopic animals in water
  - German scientists Schleiden and Schwann in 1830's were first to say that *all organisms are made of one or more cells*.
  - German biologist **Virchow** in 1858 stated that all cells come from the *division of pre-existing cells*.
  - Cells are the building blocks of life.
- The Cell Theory can be summarized as:*

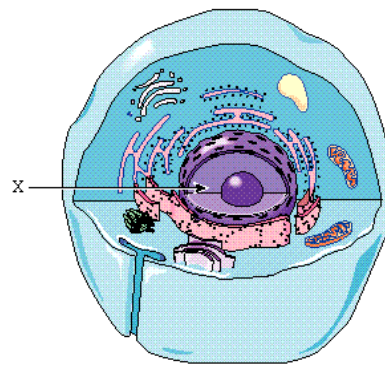

1. All living organisms are made up of one or more cells
2. The cell is the basic unit of life
3. All cells come from the division of pre-existing cells

- cells come in many **shapes** and **sizes**, although most are **microscopic**:
  - most cells are small, about 0.001 cm in length (1/100 of a mm, or 10  $\mu\text{m}$ ).
  - the smallest cells of the microorganism **mycoplasma** are 0.3  $\mu\text{m}$  in size
  - Some cells are large. e.g. some giant algal cells may be several centimeters long. A chicken's egg is a single cell.
  - **40,000 red blood cells** would fill the letter "O" on a page of type. You produce about 2.5 million new red blood cells every second! Each square cm of your skin contains about **150,000 skin cells**.
  - Human beings are composed of about **50 to 100 trillion cells**.
- cells **carry on all the processes associated with life**, such as **reproducing** and **interacting** with the environment.

**Microscopy**

- The study of cell **structure** includes the fields of **CYTOLOGY** (for cells) and **HISTOLOGY** (for tissues), whereas the function of cells is studied in **CELL PHYSIOLOGY**, **BIOCHEMISTRY**, and **CYTOGENETICS**.
- The first instrument used in studying cell structure was the **light microscope**, which remains an important tool today. The **TRANSMISSION ELECTRON MICROSCOPE** and the **SCANNING ELECTRON MICROSCOPE** have vastly increased our knowledge.
- Before an object can be viewed, it is necessary to **stain** the material and cut it into samples **thin enough** for a light beam or an electron beam to penetrate them.
- First, the tissue is treated, to "**fix**" the structures so they will not be altered by the staining and slicing. Usually this is done by using chemicals such as **ALCOHOL** and **FORMALDEHYDE**.
- **Stains** have been developed that react differently with different cell structures, depending on their chemical composition or enzymatic activity. The use of stains containing **radioactive atoms**, known as **AUTORADIOGRAPHY**, often involves feeding cells specific compounds with radioactive atoms and then observing the distribution of radioactive events on a **photographic film** emulsion.

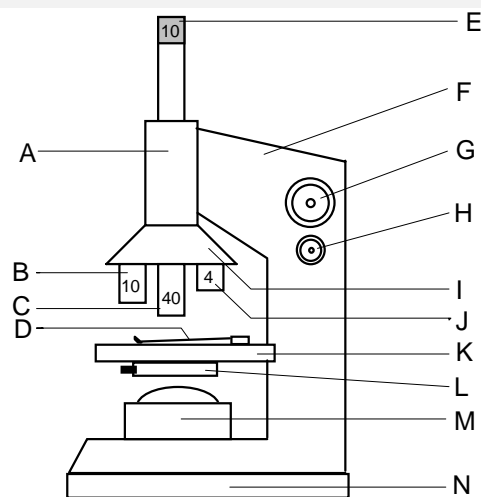

**Relative Powers of Microscopes**

1. **Compound Light Microscope**: maximum **resolving power** = 200 nm (maximum useful magnification = ~1000 X)
2. **Transmission Electron Microscope**: maximum resolving power = 0.5 nm (maximum useful magnification = >30,000 X)
3. **Scanning Electron Microscope**: Gives vivid 3-D images, but less magnification than transmission EM

## EUCARYOTIC CELL STRUCTURE

- You should still recall some aspects of cell structure. At the most basic Level, the cell's overall structure can be viewed as:

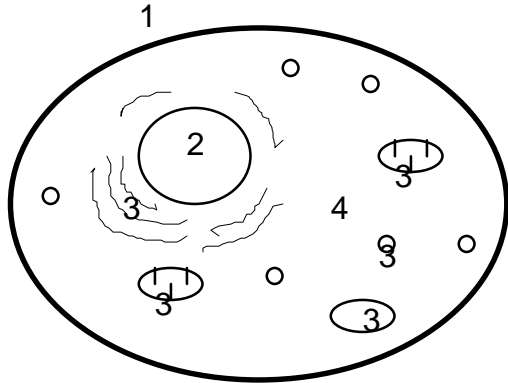

1. Cell Membrane
2. Nucleus
3. Organelles
4. Cytoplasm

1. **Cell Membrane:** the thin layer which separates the cell contents from it's environment. Plant cells also have a **cell wall** surrounding the cell membrane.
2. **Nucleus:** specialized structure within the cell which contains DNA and controls cell functioning and reproduction.
3. **Organelles:** small bodies with specific structures and functions within the cell.
4. **Cytoplasm:** the liquid substance between the nucleus and the cell membrane, in which the organelles are located.

Now Let's Have a DETAILED look at CELL ORGANELLES

### The Cell Membrane and the "Fluid Mosaic" Model

- the cell membrane functions in transport of materials in and out of cell, recognition, communication, and homeostasis.

#### The Fluid Mosaic Model:

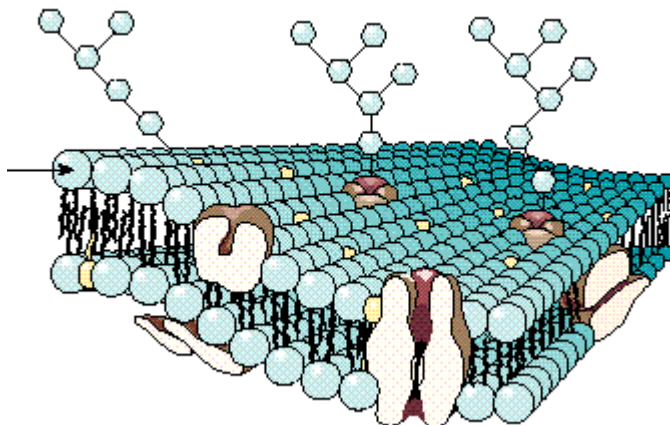

Please Label this Diagram

- Cells are surrounded by a thin membrane of **lipid** and **protein**, about **100 angstroms** ( $100 \times 10^{-10}$  m) thick.
- scientists today agree upon **The Fluid Mosaic Model** of membrane structure. The cell membrane is a remarkable structure that has properties of a solid and a liquid.
- It forms a "**fluid sea**" in which **proteins** and other molecules like **other lipids** or **carbohydrates** are suspended (like icebergs) or

anchored at various points on its surface.

- the "sea" or "fluid" part is composed of **side by side phospholipids arranged in a bilayer** (called a **lipid bilayer**).
- The solid part (the "mosaic") is the variety of proteins etc. embedded in the bilayer.
- each phospholipid has a **hydrophobic tail** and a **hydrophylic head**.
- the membrane has consistency of **light machine oil**.
- the membrane is **SELECTIVELY PERMEABLE** (*will let some substances in but not others of the same size*).

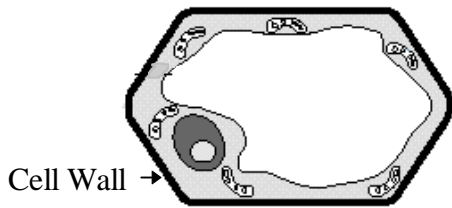

- **Plant Cells** also have a **Cell Wall** surrounding their cell membrane.
- the cell wall is made up of a large number of **cellulose fibers** cemented together (like the cellulose fibers in paper). **Small molecules** have little difficulty penetrating the cell wall, while **larger molecules** may not be able to pass through. (the cell wall is said to be **semi-permeable**)

### The Nucleus: the Cell's CPU



- the nucleus is a **large, centrally located organelle** surrounded by **nuclear envelope**. The nuclear envelope is a **double membrane** (2 phospholipid bilayers thick) that has **pores** in it for molecules to enter and exit). The envelope is very **porous** and is a **continuation of the membranes** of the **endoplasmic reticulum**. The pores, called **nuclear pores**, allow selected molecules into and out of the nucleus. It is also believed that these pores are the routes by which genetic messages (RNA) pass into the cytoplasm.
- is the **control center** or "**brain**" of cell. Contains the DNA and is site of manufacture of RNA. The DNA is contained by a number of **chromosomes**, which consist of long strands of DNA tightly wound into **coils** with **proteins** called **histones**. The combination of DNA and

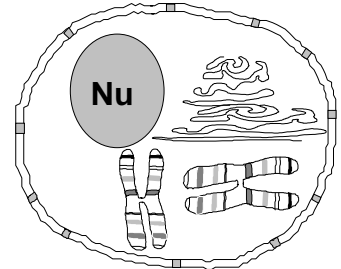

histone proteins is known as **CHROMATIN**. **Chromosomes** function in **packaging of DNA** during nuclear division and **control of gene expression**

- The nucleus, therefore, determines the **metabolism, growth, differentiation, structure, and reproduction** of cell.
- The nucleus contains one or more **DARK-STAINING** discrete structures, known as **NUCLEOLI**, which are **sites of RIBOSOMAL RIBONUCLEIC ACID (rRNA) SYNTHESIS**.

### Endoplasmic Reticulum (ER)

- the ER is a system of **MEMBRANOUS TUBULAR CANALS** that begins just outside the nucleus and branches throughout the cytoplasm.
- if **ribosomes** are attached to the ER, it is called **ROUGH Endoplasmic Reticulum**. The function of rough ER is **protein synthesis**.
- if no ribosomes are attached to the ER, it is called **SMOOTH Endoplasmic Reticulum**. The function of smooth ER is **synthesis of lipids** (Lipids are required for the growth of the cell membrane and for the membranes of the organelles within the cell and are often used to make **hormones**) and also to **detoxify drugs** and **chemicals** in the cell (takes place in peroxisome vesicles which are often attached to smooth ER).

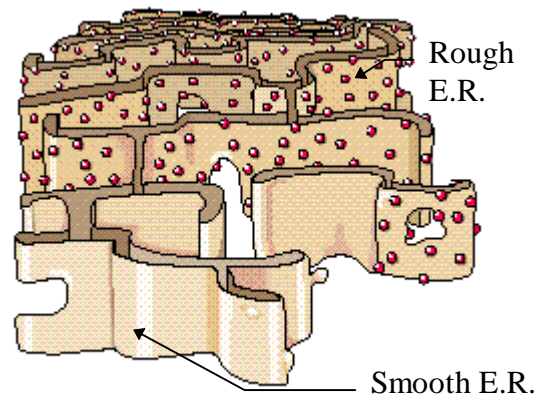

- The endoplasmic reticulum membranes provide an **increase in surface area** where chemical reactions can occur.
- The channels of the reticulum provide both **storage space** for products synthesized by the cell and **transportation routes** through which material can travel through other parts of the cell. The endoplasmic reticulum is also the cell's **membrane factory**. **Phospholipids** and **cholesterol**, the main components of membranes throughout the cell, are synthesized in the smooth ER.
- Most of the proteins leaving the endoplasmic reticulum are still **not mature**. They must undergo **further processing** in another organelle, the **Golgi apparatus**, before they are ready to perform their functions within or outside the cell.

## Ribosomes

- consist of **rRNA** and **proteins**
- each ribosome is made of 2 **non-identical subunits**
- rRNA is produced in the nucleolus and joined with proteins -- then migrate through the nuclear pore to the cytoplasm for final assembly
- ribosomes attach themselves to the endoplasmic reticulum
- function is **site** for **PROTEIN SYNTHESIS**

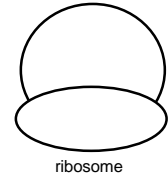

## Polysomes

- **free-floating structures** within the cytoplasm
- generally produce proteins they will be used **inside** the cell
- consist of **clusters of ribosomes** bunched together, each of which is transcribing the same type of protein

## Golgi Apparatus

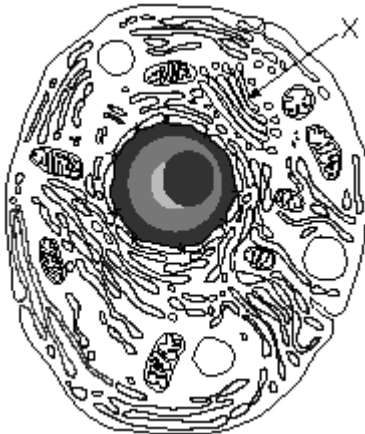

- The Golgi Apparatus ("X" in diagram), named after an Italian anatomist of the nineteenth century, are **stacks of flattened, hollow cavities** enclosed by membranes, which are often **continuous with the membranes of the endoplasmic reticulum**.
- located near to the nucleus and ER.
- The **stack** is made of a half-dozen or more **sacculles**. Looks like a **flattened stack** of hollow tubes. Each sac in the organelle contains **enzymes** that **modify proteins** as they pass through.
- Thus, the Golgi apparatus functions in **modification, assembly, packaging, storage** and **secretion** of substances.
- it receives newly manufactured protein (from

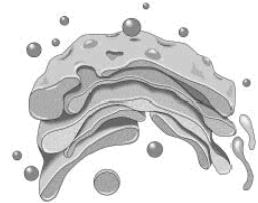

the ER) on its inner surface. Within the Golgi apparatus, the proteins are **sorted out, labeled, and packaged into vesicles** that "**pinch off**" the outer surface of the sacculles. These vesicles can then be transported to where they are needed within the cell, or can move to the cell membrane for export to the outside of the cell by **exocytosis**.

## Vacuoles and Vesicles: Storage Depots

- A **VESICLE** is a small **vacuole**
- vacuoles and vesicles are formed by: 1) pinching off from the Golgi apparatus 2) endocytosis of the cell membrane 3) extension of the ER membrane (for example, the large central vacuole of a plant cell).
- are used for **transport** and **storage** of materials
- **Plant cells** usually have one large **Central Vacuole**.

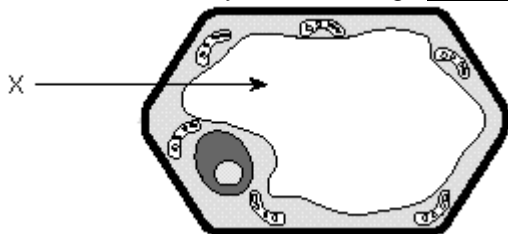

- the plant cell's central vacuole functions in 1) water storage 2) food storage 3) waste storage 4) cell support
- is thought to be an extension of the ER membrane

## Lysosomes: Cellular "Stomachs"

- **special vesicles** which are formed by the Golgi apparatus.
- **contain powerful hydrolytic enzymes**
- functions in 1) **cellular digestion** 2) **autodigestion** or disposal of damaged cell components like mitochondria 3) **breakdown of a whole cell** (by releasing their contents into the cell cytoplasm). For this reason, they are sometimes called "**suicide sacs**."

- Lysosomes are known to contain over **40 different enzymes** that can **digest almost anything** in the cell, including **proteins, RNA, DNA, and carbohydrates**.
- Lysosomes also appear to perform other digestive processes, such as those connected with **phagocytosis** and **pinocytosis**.

- Lysosomes help **destroy invading bacteria**.

- **PEROXISOMES** are also single-membrane organelles. Peroxisomal enzymes remove hydrogen atoms from small molecules and join the hydrogen atoms to oxygen to form **hydrogen peroxide**, and then break it down into water and oxygen.

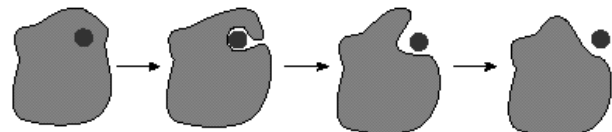

## Mitochondria: the Cell's Powerhouse

- Mitochondria are the **largest organelles** in an animal cell, after the nucleus.
- Are sausage-shaped or filamentous structures surrounded by a **double-layered membrane**. Mitochondria vary in diameter from 0.5 to 1 micrometer and in length up to 7 micrometers. (about the size of bacteria).
- The mitochondrion has **two membranes**: an outer and an inner. The inner is convoluted into shelf-like folds called **crístae**. The enzymes responsible for cellular respiration are arranged, in assembly-line fashion, on the **crístae**. This is where **energy is produced**.
- function is **AEROBIC ENERGY METABOLISM** (also called **CELLULAR RESPIRATION**). Converts **glucose** and **fatty acids** to **ATP**, the cell's primary energy molecule, as well as lesser amounts of other energy rich molecules. The overall formula for cellular respiration is:

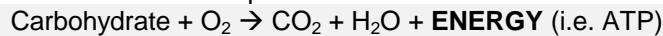

- In the end, **38 molecules of ATP** (adenosine triphosphate) are formed for every molecule of sugar that is used up in respiration.
- Besides supplying energy, mitochondria **also help control the concentration of water, calcium, and other charged particles (ions)** in the cytoplasm.
- Mitochondria have some of their **own DNA molecules** and **ribosomes** that resemble those of **prokaryotic** cells.
- Human mitochondrial DNA is a closed, circular molecule **16,569** nucleotide pairs long.
- Mitochondria are also **self-replicating**. They "reproduce" by splitting in half.
- mitochondria** may have evolved from bacteria that once developed a close relationship with primitive eucaryotic cells, and then lost the capacity to live outside the cell.
- Another interesting characteristic of human mitochondria is fact that all of a person's mitochondria are descendants of those of his or her **mother**.

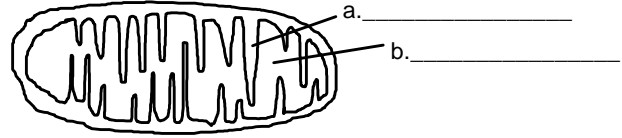

## Chloroplasts & Plastids: Food Makers for the World

- found in plant cells only.
- membrane-bound structures that usually contain **pigments** and give plant cells their colours. The **most prominent plastid** is the **CHLOROPLAST**.
- some plastids are **storage bodies** for **starch, proteins, oils**.

### Chloroplast

- these are the **double-membrane bound organelles** in which **PHOTOSYNTHESIS** (the conversion of light energy to carbohydrates) occurs. **Chlorophyll** is the chemical that absorbs the energy of the sun to provide the energy required for reducing **CO<sub>2</sub>** to **Glucose**.

- Process is basically the **opposite** of cellular respiration:

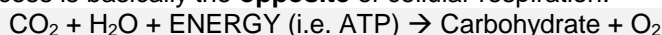

- inside the chloroplast are membranous stacks of **grana** (look like **pancakes!**) where the chlorophyll is located. Each pancake is call a **thylakoid**.

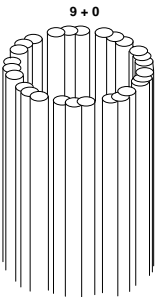
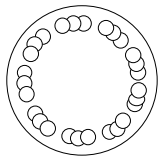
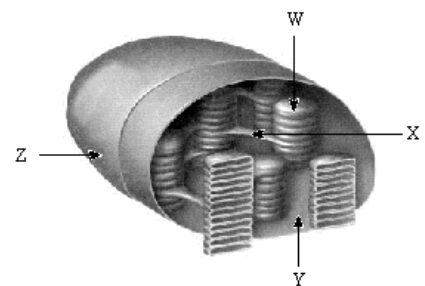

CENTRIOLES & BASAL BODIES

### Centrioles



- Animal cells have two cylindrical bodies, called **centrioles**, located **near the nucleus**. The centrioles appear as sets of triple tubules. Centrioles play a part in cell division.
- Centrioles are short cylinders with a **9+0 pattern of microtubular triplets**.
- each animal cell has one pair of centrioles lying at right angles to each other next to the nucleus
- centrioles **give rise to basal bodies**. **Basal bodies direct the formation of cilia and flagella**
- assist in the **formation of the spindle apparatus** in cell division.

### The Cytoskeleton

- The **network of filamentous proteins structures** within the cell that **help it maintain shape, anchor organelles**, or **help the organelles move** as necessary. The primary constituents of the cytoskeleton are **microtubules** and **microfilaments**.

### Microtubules & Microfilaments

- Microtubules are hollow, cylindrical aggregates of tubelike structure that help give the cell shape and form; they are also involved in other cell processes.
- made up of 13 rows of globular proteins arranged to form a hollow tube
- serve in moving materials within the cell, cell movement, cytoskeleton structure.
- Microfilaments are long, thin, contractile rods that appear to be responsible for the movement of cells (both external and internal movement).
- made up of double filaments arranged in a helical pattern, with each filament consisting of numerous globular proteins joined together.
- serve in anchoring organelles and moving them within the cell, cell movement, cytoskeleton structure.

### Cilia

- short, hairlike projections that function in **cell movement** (e.g. *Paramecium*, cells of human respiratory tract)
- consists of a **membrane-bound cylinder**, with **9+2** arrangement of microtubules.
- shorter** than **flagella**
- beat stiffly**, like **oars**

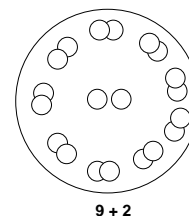

### Flagella

- longer than cilia**, but with same basic anatomy as cilia (membrane-bound cylinder, with 9+2 arrangement of microtubules).
- beat in undulating **whip-like fashion**
- function in **cell movement** (e.g. sperm cells, *Euglena*)

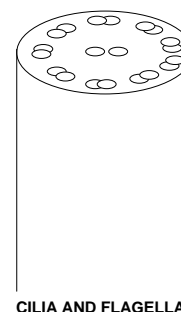

CILIA AND FLAGELLA

### PROKARYOTIC VS. EUKARYOTIC CELLS

- Two classes of cells exist: the **PROKARYOTES** and the **EUKARYOTES**.
- The **Prokaryotes** include the **bacteria** and the **blue-green algae** (the **Monera** kingdom).
  - These are all **single-celled organisms** that **lack both a true nucleus and other membrane-bounded cellular substructures**. Prokaryotic DNA is usually **circular**.
- The **Eukaryotes** include **plants, animals, protozoa, and fungi**.
  - These cells **contain nuclei and other membrane-bound organelles**. The genetic material is organized into chromosomes.

Structure	Prokaryotic	Eukaryotic	
		Animal	Plant
Cell Membrane	YES	YES	YES
Cell Wall	YES	NO	YES
Nucleus	NO	YES	YES
Mitochondria	NO	YES	YES
Chloroplasts	NO	NO	YES
ER	NO	YES	YES
Ribosomes	YES, (small)	YES, large	YES, large
Vacuoles	NO	YES, small	YES
Lysosomes	NO	YES, usually	NO, usually
Cytoskeleton	NO	YES	YES
Centrioles	NO	YES	NO

### THE SURFACE AREA TO VOLUME RATIO & CELL SIZE

- Cells cannot get too large. When cells get too large, they must divide. One of the main reasons that cells do this is because of the way that a cell's volume changes with respect to its cell surface area.
- Suppose a cell measures 1 mm square. Its surface to volume ratio is 6:1

**Surface area (for a square): area of one face x 6**  
**Volume: length x width x height**

- In the above example: SA = 1 mm x 1 mm x 6 = 6 mm<sup>2</sup>. Volume: 1 x 1 x 1 = 1 mm<sup>3</sup>.

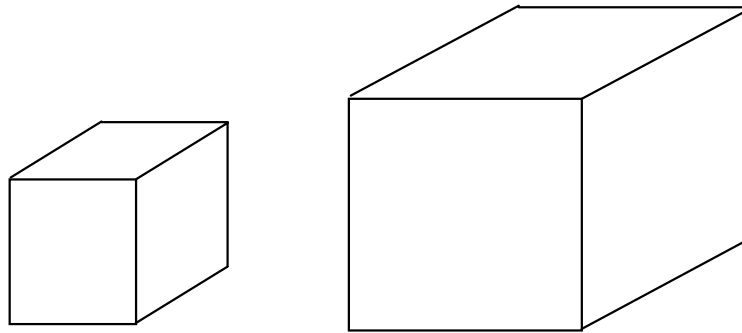

S.A.=6 mm<sup>2</sup>  
V = 1 mm<sup>3</sup>  
SA:V = 6:1

S.A.=24 mm<sup>2</sup>  
V = 8 mm<sup>3</sup>  
SA:V = 3:1

- Now, if you **double** the size of the cell to 2 mm across, the SA increases to 2 mm x 2 mm x 6 = 24 mm<sup>2</sup>. Volume increases to 2 mm x 2 mm x 2 mm = 8 mm<sup>3</sup>. The surface area to volume ratio decreases to 24:8 or 3:1. As the size **doubled**, the SA:V ratio **decreased** by half.
- As the size of a cell **increases**, its surface to volume ratio **decreases**. This means that, as a cell gets **larger**, **each cubic unit of cytoplasm is serviced by proportionally less cell membrane**. Why is this significant?

Cell Size	Surface area	Volume	SA:V ratio
1	6	1	6:1
2	24	8	3:1
4	96	64	1.5:1
8	384	512	0.75:1

- Cells rely on **diffusion** for materials (such as nutrients) to get into the cell. Diffusion is not a highly rapid or efficient means of distributing materials over long cellular distances. No portion of even the largest active cells is more than 1 mm from the cell membrane.
- How do cells get around the limits of the surface to volume ratio?
  - Divide
  - Slow down metabolism:** e.g. unfertilized chicken eggs
  - Get long and thin** rather than round and fat: e.g. nerve cells

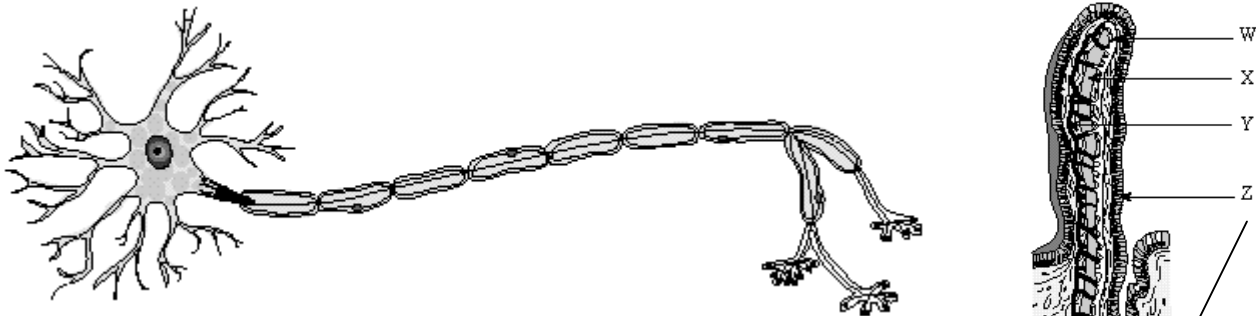

- Folds in the cell membrane:** e.g. microvilli of intestinal epithelial cells

