

***Revision notes for Chemistry
O Level***

TABLE OF CONTENTS

- 3** | CHAPTER 1
The Particulate Nature of Matter
- 4** | CHAPTER 2
Experimental Techniques
- 5** | CHAPTER 3
Atoms, Elements and Compounds
- 7** | CHAPTER 4
Stoichiometry
- 8** | CHAPTER 5
Electricity and Chemistry
- 9** | CHAPTER 6
Chemical Energetics
- 10** | CHAPTER 7
Chemical Reactions
- 12** | CHAPTER 8
Acids, Bases and Salts
- 14** | CHAPTER 9
The Periodic Table
- 15** | CHAPTER 10
Metals

16 | CHAPTER 11
Air and Water

18 | CHAPTER 12
Sulfur

18 | CHAPTER 13
Carbonates

19 | CHAPTER 14
Organic Chemistry

1. THE PARTICULATE NATURE OF MATTER

1.1 Kinetic Particle Theory

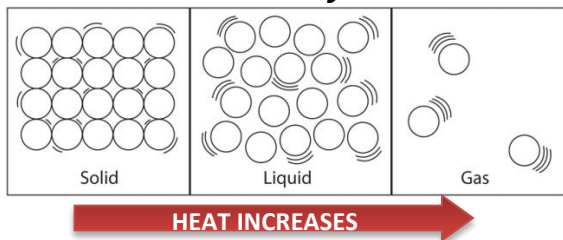

- When a solid is heated, particles vibrate faster about a fixed point causing particles to move further apart and so solid expands
- When particles gain sufficient energy to overcome strong forces of attraction, they move out of their fixed position and can slide over each other in a continuous random motion – solid has melted.
- Particles in liquid have energy to move around but are still close to each other and do not have enough energy to overcome the forces that hold them close to each other.
- If more heat's supplied, particles move faster until they have enough energy to overcome the forces of attraction. Particles escape the liquids surface and move around in continuous rapid motion – the liquid has boiled
- In the vapor, the particles move in rapid random motion. This movement is due to collision of vapor particles with air particles.

1.2 States of Matter

SOLID	LIQUID	GAS
<ul style="list-style-type: none"> • Strong forces of attraction between particles • Fixed pattern (lattice) • Atoms vibrate but can't change position ∴ fixed volume and shape 	<ul style="list-style-type: none"> • Weaker attractive forces than solids • No fixed pattern, liquids take up the shape of their container • Particles slide past each other. 	<ul style="list-style-type: none"> • Almost no intermolecular forces • Particles far apart, and move quickly • Collide with each other and bounce in all directions

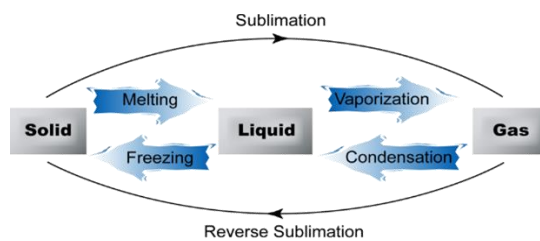

PROCESS	HEAT ENERGY	EXO/ENDOTHERMIC
Melting	Gained	Endothermic
Boiling	Gained	Endothermic
Condensing	Lost	Exothermic
Freezing	Lost	Exothermic
Sublimation	Gained	Endothermic
Reverse sublimation	Lost	Exothermic

1.3 Heating Curve

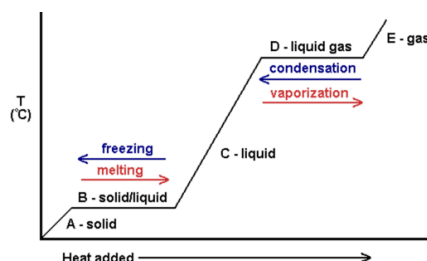

1.4 Diffusion

- Diffusion is the spreading of one substance through another from a region of high concentration to a region of low concentration due to the continuous random motion of particles.
- Evidence for diffusion:
 - In liquids: potassium manganate (VII) in a beaker of water
 - In gases: a gas jar of air and a gas jar of bromine connected
- Factors that affect the rate of diffusion:
 - Temperature increases → rate of diffusion increases
 - Lower density gas → rate of diffusion is higher

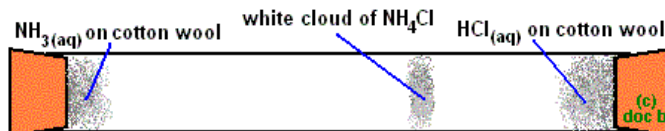





2. EXPERIMENTAL TECHNIQUES

2.1 Measurement

VARIABLE	APPARATUS
• Time	• Stopwatch or Clock; Unit = S
• Temperature	• Thermomemeter (liquid in glass, thermistor or thermocouple); Unit = K
• Mass	• Balance; Unit = kg

Measuring Volume:

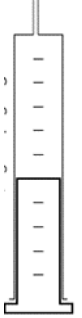
				
Beaker	Burette	Pipette	Measuring Cylinder	Gas Syringe

2.2 Critertia of Purity

- Paper chromatography:
 - Drop substance to center of filter paper and allow it to dry
 - Drop water on substance, one drop at a time
 - Paper + rings = chromatogram.
 - Principle: Difference in solubility separates different pigments
 - Substances travel across paper at different rates which is why they separate into rings
 - Method works because different substances travel at different levels of attraction to it

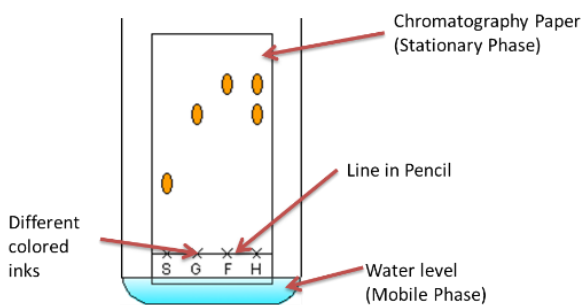

- Stationary phase is material on which separation takes place
- Mobile phase consists of the mixture you want to separate, dissolved in a solvent.

- Interpreting simple chromatograms:
 - Number of rings/dots = number of substances
 - If two dots travel the same distance up the paper they are the same substance.
 - You can calculate the Rf value to identify a substance, given by the formula:

$$R_f \text{ Value} = \frac{\text{Distance moved by solute}}{\text{Distance moved by solvent}}$$

- To make colourless substances visible, use a locating agent:
 - Dry paper in oven
 - Spray it with locating agent
 - Heat it for 10 minutes in oven
- Assesing purity from m.p./b.p:
 - Pure substances have a definite, sharp m.p./b.p.
 - Substance+impurity has lower m.p. and higher b.p.
 - More impurity means bigger change

2.3 Filtration

- Mixture goes in a funnel with filter paper, into a flask.
- Residue is insoluble and stays at top.
- Filtrate goes through

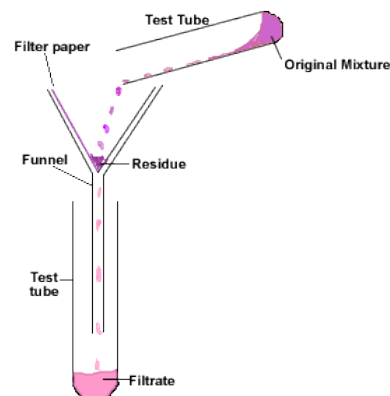

2.4 Crystallization

- Some water in the solution is evaporated so solution becomes more concentrated.
- A drop is placed on a slide to check if crystals are forming.
- Solution is left to cool and crystallise.
- Crystals are filtered to remove solvent.

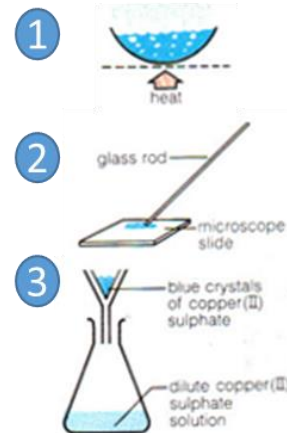

2.5 Simple Distillation

- Impure liquid is heated
- It boils, and steam rises into the condenser
- Impurities are left behind

Condenser is cold so steam condenses to the pure liquid and it drops into the beaker

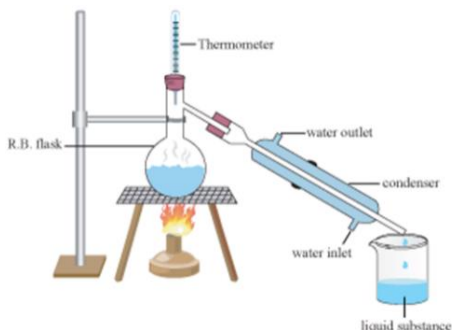

2.6 Fractional Distillation

- Removes a liquid from a mixture of liquids, because liquids have different b.p.s
- Mixture is heated to evaporate substance with lowest b.p.
- some of the other liquid(s) will evaporate too.
- A mixture of gases condense on the beads in the fractional column.
- So the beads are heated to the boiling point of the lowest substance, so that substance being removed cannot condense on the beads.
- The other substances continue to condense and will drip back into the flask.

The beaker can be changed after every fraction

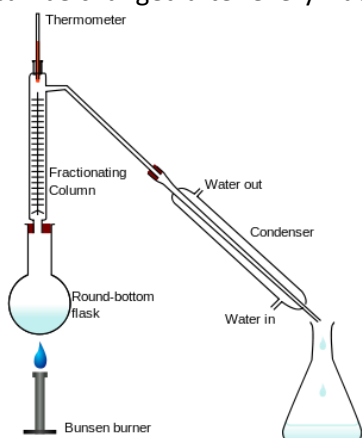

2.7 Separating Mixture of Two Solids

- Can be done by dissolving one in an appropriate solvent
- Then filter one and extract other from solution by evaporation

If one solid is magnetic, can use a magnet e.g. sand and iron fillings

SOLVENT	IT DISSOLVES...
Water	Some salts, sugar
White spirit	Gloss paint
Propanone	Grease, nail polish
Ethanol	Glues, printing inks, scented substances

2.8 Choosing a Suitable Method

METHOD OF SEPARATION	USED TO SEPARATE
Filtration	A solid from a liquid
Evaporation	A solid from a solution
Crystallization	A solid from a solution
Simple Distillation	A solvent from a solution
Fractional Distillation	Liquids from each other
Chromatography	Different substances from a solution

3. ATOMS, ELEMENTS AND COMPOUNDS

3.1 Atomic Structure and the Periodic Table

PARTICLE	RELATIVE CHARGE	MASS (ATOMIC MASS)
Proton	+1	1
Neutron	0	1
Electron	-1	1/1836

- **Proton number:** number of protons in an atom (and number of electrons in an atom)
- **Nucleon number:** number of protons + neutrons in an atom.
- In the periodic table
 - The proton number increases by 1 when you go to the right
 - When you go one element down, you increase proton number by 8 in the first 3 periods (transition elements not included)
- **Isotopes:** atoms of same element with different no. of neutrons
 - E.g. Carbon 12 and Carbon 14.
 - Two types: non-radioactive isotopes and radioactive-isotopes which are unstable atoms that break down giving radiations
 - Medical use: cancer treatment (radiotherapy) – rays kill cancer cells using cobalt-60
 - Industrial use: to check for leaks – radioisotopes (tracers) added to oil/gas. At leaks radiation is detected using a Geiger counter.

- Electrons are arranged in electron shells.
- Atoms want to have full outer shells (full set of valency electrons), this is why they react.
- Noble gases have full outer shells so they have no need to react.
- Electron shell structure: 2, 8, 8, 18.
- More reactive elements have a greater desire to have a full outer shell, so also form more stable compounds.

3.2 Bonding: the Structure of Matter

- **Element:** substance that cannot be split into anything simpler, in a chemical reaction. Each element has a unique proton number.
- **Mixture:** two or more elements mixed together but not chemically combined
- **Compound:** substance in which two or more different elements are chemically combined

METALS	NON-METALS
Strong	Brittle
Good conductors of heat & electricity	Poor conductors of heat & electricity (except graphite)
High m.p. and b.p.	Lower m.p. and b.p. than metals
High density	Low density
Forms basic oxides	Forms acidic oxides
Forms cations in reactions	Forms anions in reactions
Malleable and ductile	
Sonorous	
Some are magnetic	

- **Alloy:** Mixture of two or more metals or mixture of one or more metal with a non-metal, to improve its properties

3.3 Ions and Ionic Bonds

- Chemical bond formed by transfer of e^- s from one atom to another
- Metals lose e^- s to form cations, non-metals gain e^- s to form anions
- Positive cations & negative anions attract to each other
- Strong electrostatic force of attraction between positive cations and negative anions is called ionic bonding

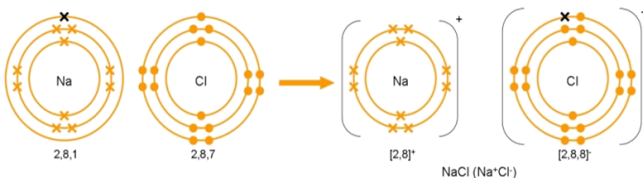

PROPERTY

REASON

Form giant lattice	Cations and anions attract
High m.p. and b.p.	Strong bonds between ions
Don't conduct electricity when solid	Ions can't move
Conduct electricity when molten/aqueous	Ions can move
Usually soluble in water	Not required

3.4 Molecules and Covalent Bonds

- When atoms share e^- s to obtain a noble gas electron structure, covalent bonding arises.
- Covalent bonding takes place between non-metals only

SINGLE BOND

DOUBLE BOND

TRIPLE BOND

$H-H$ 	$O=O$ 	$N\equiv N$
$2e^-$ shared (1 from each atom)	$4e^-$ shared (2 from each atom)	$6e^-$ shared (3 from each atom)

PROPERTY

REASON

Low m.p. and b.p.	Weak intermolecular forces of attraction between molecules
Usually liquid, gas or low m.p solid	
Don't conduct electricity	No mobile ions/electrons
Usually insoluble in water	Not required

- **Example:**

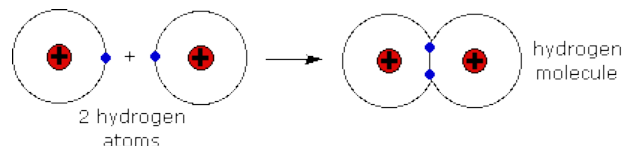

3.5 Macromolecules

DIAMOND

GRAPHITE

SILICON DIOXIDE

<ul style="list-style-type: none"> • Four bonds • High m.p. • Doesn't conduct • Used for cutting as is strongest substance 	<ul style="list-style-type: none"> • Three bonds • Made of flat sheets • Held together by weak forces so is soft \therefore used as a lubricant • Conducts electricity as it has one free e^- 	<ul style="list-style-type: none"> • Makes up sand • Each Si is bonded to 4 oxygen atoms, and each oxygen is bonded to 2 silicon atoms • \therefore it has a high m.p. and is hard, like diamond

- Melting point: high - structure made up of strong covalent bonds
- Electrical: don't conduct electricity - have no mobile ions or electrons, except for graphite
- Strength: hard - exists in tetrahedral structure but graphite is soft

3.6 Metallic Bonding

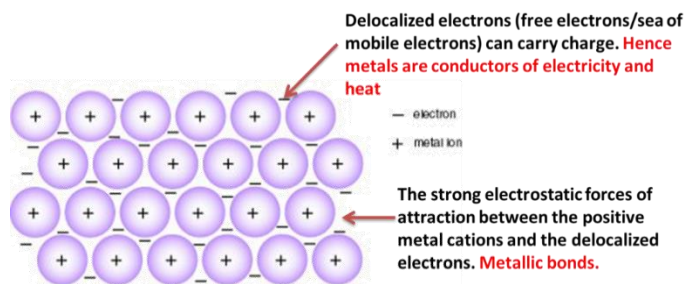

The layers are held together by the delocalized electrons. When force is applied, these electrons act like glue holding the structure in shape. Hence metals are malleable and ductile

Positive ions held together by electrons – acts like glue

4. STOICHIOMETRY

- Balancing equations: a chemical equation is balanced when there are equal number of atoms and charges on both sides of the equation
- State symbols:
 - (s) = solid
 - (l) = liquid
 - (g) = gas
 - (aq) = aqueous solution

4.1 Valency Table

NAME	FORMULA	VALENCY
Nitrate	NO ₃ ⁻	1
Hydroxide	OH ⁻	1
Acetate/ ethanoate	CH ₃ COO ⁻	1
Carbonate	CO ₃ ²⁻	2
Sulphate	SO ₄ ²⁻	2
Silicate	SiO ₃ ²⁻	2
Phosphate	PO ₄ ³⁻	3

4.3 Ending of Names

- Compound ending with **-ide** only contain two different elements
- Compound ending with **-ate** contain oxygen

4.4 Masses

- **Relative atomic mass (A_r):** mass of one atom of an element relative to one twelfth of the mass of one atom of Carbon-12
- **Relative molecular mass (M_r):** sum of relative atomic masses of all the atoms in one molecule of the compound

4.5 The Mole Concept

- A mole of a substance is the amount that contains the same number of units as the number of carbon atoms in 12 grams of carbon-12
- A mole is the A_r or M_r expressed in grams e.g. 1 mole of Carbon-12 is equal to 12 grams.
- It is equal to 6.02 × 10²³ atoms, this number is called Avogadro's constant.

4.6 Number of Moles

$$\text{Number of Moles} = \frac{\text{mass}}{\text{molar mass}}$$

4.7 Moles in Gases

$$\text{Volume} = \text{No. of Moles} \times 24 \text{ dm}^3$$

4.8 Concentration

$$\text{Concentration} = \frac{\text{no. of moles}}{\text{volume}}$$

- Moles per dm³
 - 1 mol/dm³ = 1M
- Grams per dm³, g/dm³

4.9 Molecular Formulae

- The formula using the actual number of atoms in a molecule

4.10 Empirical Formulae

- This is the simplest ratio of the atoms in a compound
- For example:
 - Molecular formula of ethanol = C₂H₅OH
 - Empirical formula of ethanol = C₂H₆O
- To find out the empirical formula you:
 - Make the percent ratio into the simplest whole number ratio (NOTE: if given %, use them as grams)
 - Divide the coefficients of each element symbol by the lowest coefficient

4.11 Percentages

- **Percentage purity** = $\frac{\text{mass of product (pure)}}{\text{mass of compound (impure)}} \times 100$
- **Percentage yield** = $\frac{\text{actual mass obtained}}{\text{calculated mass}} \times 100$

5. ELECTRICITY AND CHEMISTRY

- Decomposition of an electrolyte with the help of electric current
- **Electrolyte:**
 - Aq. solution of ionic substance or molten ionic salt
 - Conducts electricity due to the presence of mobile ions
- **Electrodes:**
 - Rods which help current enter the electrolyte
 - Inert electrodes: do not take part in the reaction
 - Reactive electrodes: take part in the reaction

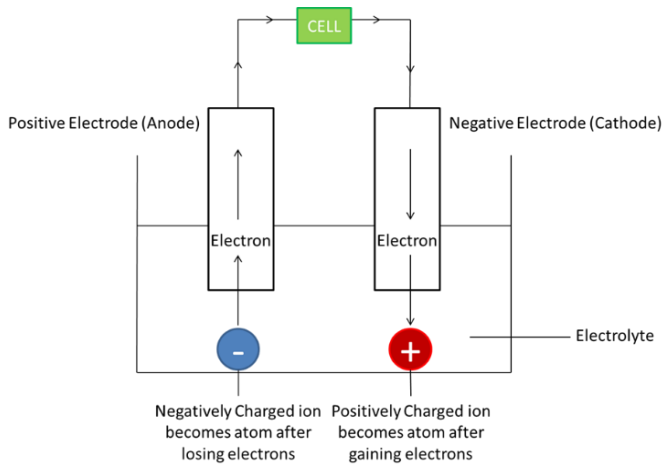

5.1 Principle

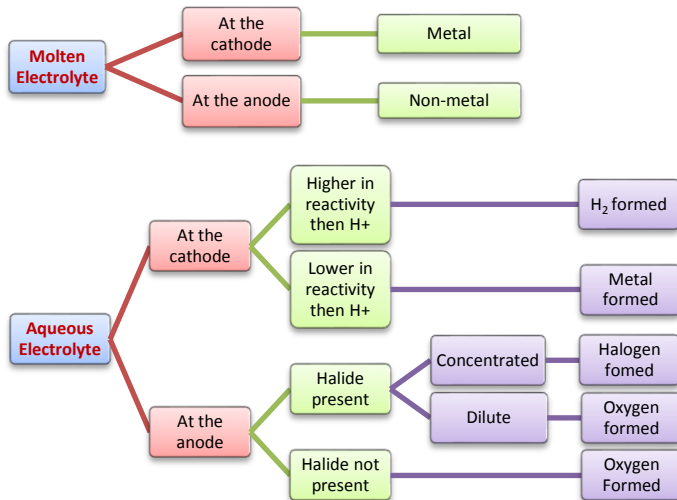

5.2 Examples

ELECTROLYTE	AT CATHODE	AT ANODE
Molten lead(II) bromide	Lead	Bromine
Concentrated hydrochloric acid	Hydrogen	Chlorine
Concentrated aqueous sodium chloride	Hydrogen	Chlorine

5.3 Electroplating

- Coating one metallic object with another metal using electrolysis
- For electroplating, you need:
 - Anode made of metal you want to electroplate object with
 - Ions of same metal as anode in solution
 - Object to be plated at cathode
- Used to:
 - Make things look better
 - Prevent corrosion

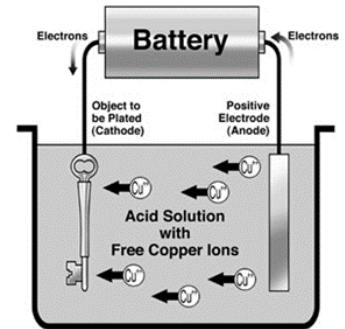

5.4 Uses

ALUMINUM	COPPER	PLASTIC & CERAMICS
<ul style="list-style-type: none"> • Used for electricity cables because: <ul style="list-style-type: none"> ○ Light ○ Non-corrosive ○ Good conductor ○ Cheaper than copper • Cables have steel core, for strength 	<ul style="list-style-type: none"> • Used in electrical wires as it is: <ul style="list-style-type: none"> ○ A very good conductor (not best) ○ Ductile 	<ul style="list-style-type: none"> • Used as insulators because they: <ul style="list-style-type: none"> ○ Don't conduct electricity ○ Conduct heat poorly • Plastic used for casing in plugs • Ceramics used to support cables in electricity pylons

5.6 Refining Metals

- This is purifying impure metals
- Rules:
 - Cathode: thin strip of pure metal
 - Anode: impure metal
 - Electrolyte: Aqueous Salt Solution of metal
- **Example:**

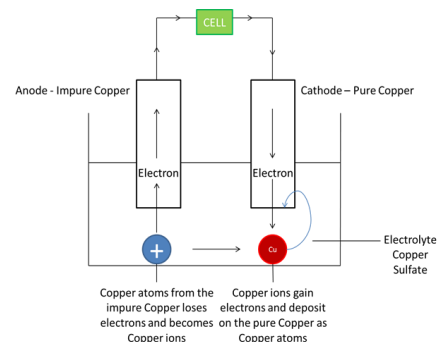

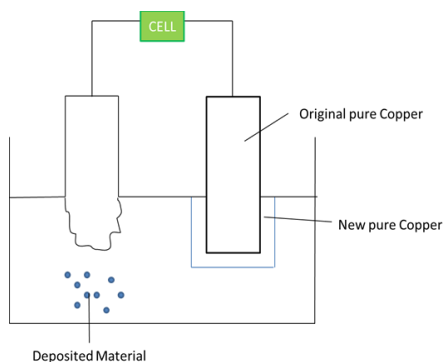

- Reaction at Anode: $\text{Cu} - 2\text{e}^- \rightarrow \text{Cu}^{2+}$ (mass decreases)
- Reaction at Cathode: $\text{Cu}^{2+} + 2\text{e}^- \rightarrow \text{Cu}$ (mass increases)

5.7 Basics

- Electrolysis is a way to decompose compounds, using electricity.
- Reduction of positive cations happens at the cathode
- Oxidation of negative anions happens at the anode
- For example:
 - At the anode: $2\text{Cl}^- \rightarrow \text{Cl}_2 + 2\text{e}^-$
 - At the cathode: $2\text{H}^+ + 2\text{e}^- \rightarrow \text{H}_2$

5.8 Extraction of Aluminium

- The main ore of aluminium is bauxite – high m.p.
- Aluminium (III) oxide (alumina) is dissolved in molten **cryolite** (Na_3AlF_6) – this mixture has a lower m.p. (industrially preferred)

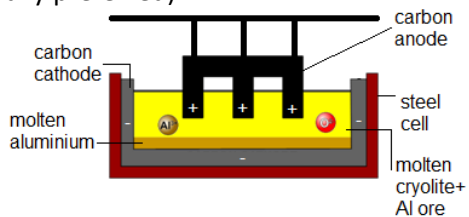

- During electrolysis aluminium is produced at the carbon cathode and oxygen at the carbon anode.
- Due to the high temp. the oxygen reacts with the graphite anode to form CO_2 and so anode had to be periodically replaced

5.9 Electrolysis of Brine

- Brine is concentrated NaCl solution
- Ions present: Na^+ , H^+ , Cl^- and OH^-

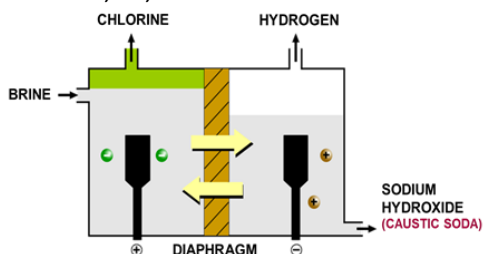

AT THE ANODE

- Made of titanium
- Chlorine gas evolved
- Unreacted ions (Na^+ , H^+ and OH^-) move through porous membrane due to difference in liquid pressure
- Net flow to the right

AT THE CATHODE

- Made of steel
- Hydrogen cations reduced to H_2 molecules
- Left Na^+ and OH^- which is aqueous sodium hydroxide

6. CHEMICAL ENERGETICS

6.1 Energetics of a Reaction

- Exothermic reaction: one that releases heat energy into the surrounding
- Endothermic reaction: one which absorbs heat energy from the surroundings
- Bond breaking is endothermic
- Bond making is exothermic

EXOTHERMIC REACTION

- Energy given out to the surroundings
- Surroundings become hot
- Bond making – exothermic

ENDOTHERMIC REACTION

- Energy is taken in from the surroundings
- Surroundings become cold
- Bond breaking – endothermic

6.2 Energy Level Diagrams

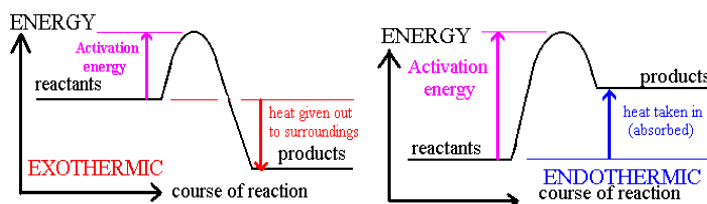

6.3 Bond Energy

- This is the amount of energy consumed or liberated when a bond is broken or formed in kJ/mol

$$\Delta H = \text{Bond Breaking} + \text{Bond Forming}$$

- If overall heat energy is negative, reaction is exothermic
- If overall heat energy is positive, reaction is endothermic

6.4 Production of Energy

- A fuel is a substance which can be conveniently used as a source of energy.
- Burning fuels (like oil) to form oxides is an exothermic reaction.
- The heat from burning fuels is used in power plants to create steam from water and turn turbines.

- In order for any material to combust three things must be present:
 - Fuel
 - Heat
 - Oxygen
- A good fuel would:
 - Be cheap
 - Be available in large quantities
 - Be a liquid at room temperature
 - Produce a large amount of energy when combusted
 - Not produce polluting gases

6.5 Hydrogen

- Burns explosively with oxygen, so it is used in rockets.
- In a fuel cell, it combines with oxygen without burning.
- Produced by reacting methane gas with steam

ADVANTAGES	DISADVANTAGES
<ul style="list-style-type: none"> • Produces a lot of energy • Abundant on earth (sea) • Less pollutant • Renewable fuel 	<ul style="list-style-type: none"> • Difficult to transport as it is a gas at room temperature • Forms explosive mixture with air – very dangerous

6.6 Simple Cells

- A cell is a device which converts chemical energy into electrical energy and is composed of two metals of different reactivity connected by an external circuit and an electrolyte
- The process works due to the different reactivity of metals
- Consists of a negative pole (the more reactive metal) and a positive pole (less reactive metal) and an electrolyte.
- The greater the difference in reactivity of the two metals, the greater the voltage will be.
- The electrons flow because one metal is more reactive, so it has a stronger drive to give up its electrons.
- The atoms give up electrons and enter the solution as ions.

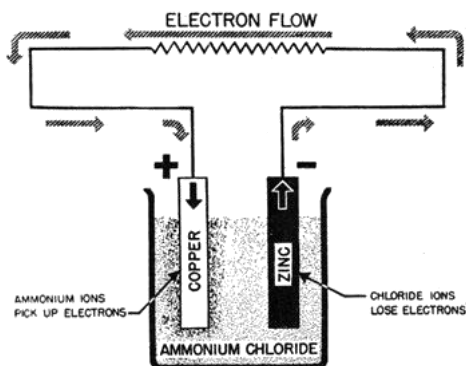

6.7 Radioactive Isotopes

- Uranium-235 can be used in nuclear power stations to produce electricity
- The radioactive isotope is bombarded by neutrons resulting in a lot of heat being produced
- Small amount of radioactive fuel produces large amount of heat
- Advantages: lots of energy is from a small amount and no CO₂
- Disadvantage: radioactive waste produced and non-renewable

7. CHEMICAL REACTIONS

7.1 Collision Theory

- Collisions are needed for a chemical reaction to take place
- Successful collisions have enough activation energy at moment of impact to break preexisting bonds and form new bonds

7.2 Rates of Reaction

- Rate of a chemical reaction is the concentration of reactant used up or product made in a given time.
- Unit = (mol/dm³)/s

7.3 Concentration

- Increasing concentration of reactants increases rate of reaction
- This is because there are more particles per unit volume, so the collision rate between reacting particles increases, therefore the successful collision rate increases, which results in an increased rate of reaction.

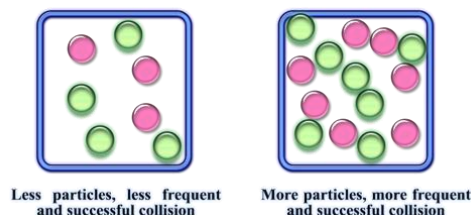

7.4 Temperature

- Increasing temperature increases the rate of reaction
- This is because average kinetic energy of particles increase which means they are moving faster & also more particles have an energy greater/equal to activation energy, therefore successful collision rate increases, resulting in increased rate of reaction

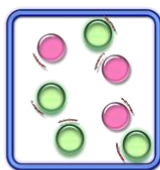

Particles have less energy, less frequent and successful collision

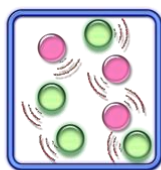

Particles have high energy, more frequent and successful collision

7.5 Particle Size

- Decreasing the particle size (increasing surface area) increases the rate of reaction
- This is because there are more reactant particles exposed to collide, so the collision rate increases, therefore the successful collision rate increases, resulting in an increased rate of reaction



Less particles, less frequent and successful collision

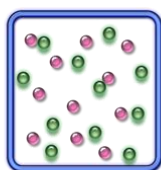

More particles, more frequent and successful collision

- Large surface area can mean danger. For example, flour dust and wood dust have large surface areas, and are combustible. A spark from a machine, or a lit match, can cause an explosion. This also applies to gases from mines.

7.6 Pressure in Gaseous System

- Increasing the pressure in a gaseous system increases the rate of reaction
- The distance between particles is reduced under pressure
- There are more particles per unit volume, so the collision rate increases, therefore the successful collision rate increases, resulting in an increased rate of reaction.

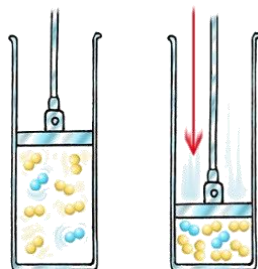

7.7 Catalyst

- A catalyst is a substance (usually a transition metal) which speeds up a chemical reaction, but remains unchanged at the end
- Adding a catalyst increases the rate of reaction
- A catalyst allows the reaction to go by an alternative pathway with lower activation energy
- More particles will have an energy greater than or equal to the activation energy, therefore successful collision rate increases resulting in increased rate of reaction

- For gaseous reactants, if catalyst is solid metal, the catalyst provides a surface for reaction to take place on
- The larger the surface area of the metal catalyst, the larger the area for reaction to take place therefore higher rate of reaction

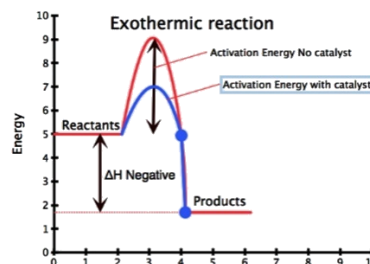

- Enzymes are protein molecules. They are biological catalysts which speed up reactions but remain chemically unchanged at the end
- Enzymes function best at optimum temperature and pH level otherwise they may denature and completely stop functioning

7.8 Measuring Rates of Reaction Experimentally

GAS EVOLVED	MASS LOSS	COLOUR CHANGE
Volume of gas produced (cm ³)	Mass of system (g)	
If a gas evolves, measure volume of gas produced per unit time using a gas syringe	If a gas evolves, measure loss in mass per unit time by placing on a balance then putting a cotton wool on top to allow gas to pass but not to enter	If a color change occurs we can measure the time taken to go cloudy

7.9 Light Causing a Chemical Reaction

- A photochemical reaction is one where light causes a reaction to occur. The higher the light intensity the higher the rate of the reaction.
- Photosynthesis:** light provides energy for the reaction and chlorophyll is a dye that absorbs light.

$$\text{carbon dioxide} + \text{water} \rightarrow (\text{light} + \text{chlorophyll}) \rightarrow \text{glucose} + \text{oxygen}$$

$$6\text{CO}_2 + 6\text{H}_2\text{O} \rightarrow (\text{light} + \text{chlorophyll}) \rightarrow \text{C}_6\text{H}_{12}\text{O}_6 + 6\text{O}_2$$

- **Silver salts in photographic film:** Silver bromide breaks down, where light strikes the film, so silver is reduced. Silver ions are reduced to silver.

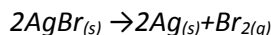

7.10 Reversible Reactions

- A reversible reaction is a reaction in which reactants form products and the product(s) can then react or decompose to form the reactants
- Example: $CuSO_4 \cdot 5H_2O$ (blue) \rightleftharpoons $CuSO_4$ (white) + H_2O
- (to get anhydrous, heat it, & to get hydrated form, add water)
- There are two types of equilibrium: static and dynamic.
- At dynamic equilibrium:
 - Rate of forward reaction = rate of reverse reaction
 - Concentrations of all reactants and products remain constant
 - System is closed, and on large scale everything is constant

7.11 Equilibrium

- **Le Châtelier's Principle:** if conditions of an equilibrium are changed, the position of equilibrium moves to oppose change
- **Temperature:** Temperature lowered; equilibrium moves in exothermic direction. Temperature raised; equilibrium moves in endothermic direction.
- **Pressure:** Pressure raised; equilibrium moves to side with fewest gas molecules. Pressure lowered; equilibrium moves to side with most gas molecules.
- **Concentration:** Decreasing reactant concentration or increasing product concentration; equilibrium moves to reactant side. Increasing reactant concentration or decreasing product concentration; equilibrium moves to product side.

7.12 Redox

- A redox reaction is one in which one species has been oxidized and another species has been reduced

OXIDATION MEANS:

REDUCTION MEANS:

- | | |
|---------------------|---------------------|
| • Loss of electrons | • Gain of electrons |
| • Gain of oxygen | • Loss of oxygen |
| • Loss of hydrogen | • Gain of hydrogen |

OIL RIG

- Reducing agents are oxidized and oxidizing agents are reduced
- Potassium iodide is a reducing agent & will go from colorless to red-brown, so is oxidized to produce I_2
 $H_2O_2 + 2KI + H_2SO_4 \rightarrow I_2 + K_2SO_4 + 2H_2O$

- Potassium manganate is an oxidising agent and will go from purple to colourless
- To test for an oxidising agent, add a reducing agent (KI) and to test for a reducing agent, add an oxidising agent ($KMnO_4$)

8. ACIDS, BASES AND SALTS

8.1 Properties of Acids

- An acid is a compound which when dissolved in water produces hydrogen ions (H^+) and are described as proton donors (H^+)
- Acids turn blue litmus indicator paper (or solution) red.
- Have pH 1 to 6
- Acid + metal \rightarrow salt + hydrogen gas
- Acid + base \rightarrow salt + water
- Acid + metal carbonate \rightarrow salt + carbon dioxide + water
- Strong acids completely ionize in water producing lots of H^+ ions
- Weak acids partially ionize in water producing few H^+ ions

8.2 Properties of Bases

- Bases are insoluble substances which neutralize acids to form a salt and water only and are proton acceptors
- Alkalis turn red litmus indicator paper (or solution) to blue.
- Have pH 8 to 14.
- Base + acid \rightarrow salt + water (+ CO_2 when base is a metal carbonate)
- Base + ammonium salt \rightarrow salt + ammonia gas + water
- Strong alkalis completely ionize in water producing lots of OH^- ions
- Weak alkalis partially ionize in water producing OH^- ions

8.3 Neutral

- Neutral substances are pH 7.
- Acidity in soil:
 - Plants grow at a pH near 7.
 - If it is too acidic or alkaline they will not grow.
 - Acidic soil is fixed by adding lime.

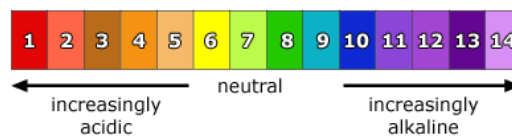

- pH is the concentration of H^+ ions per dm^3 of solution

8.4 Indicators

INDICATOR	COLOR IN ACID	COLOR IN ALKALINE
Phenolphthalein	Colorless	Pink
Methyl orange	Pink	Yellow
Methyl red	Red	Yellow
Red litmus	Red	Blue
Blue litmus	Red	Blue

8.5 Types of Oxides

- Metal oxides are basic e.g. iron oxide and magnesium oxide
- Non-metal oxides are acidic e.g. sulphur oxide and carbon dioxide
- Aluminum, zinc and lead form amphoteric oxides e.g. zinc oxide
- Oxides which are neither acidic or basic are neutral e.g. water and carbon monoxide

8.6 Preparation of Salts

- A salt is a substance formed when all the replaceable hydrogen ions of an acid are replaced by metal ions or the ammonium ion
 - Salts can either be soluble or insoluble

SOLUBLE SALTS	INSOLUBLE SALTS
All sodium, potassium and ammonium salts	
All nitrates	
Chlorides	Except silver and lead
Sulphates	Except barium, lead and calcium
Potassium, sodium and ammonium carbonates	All other carbonates

8.7 Type of Salts

TYPE OF SALT REQUIRED	ACID USED
Sulphate	Sulphuric acid
Nitrate	Nitric acid
Chloride	Hydrochloric acid
Ethanoate	Ethanoic acid

8.8 Starting with a Metal

- Add excess metal to an acid
- When bubbling (hydrogen) stops the reaction is done
- Filter off excess metal

8.9 Starting with an Insoluble Base

- Add insoluble base to acid and heat gently, it will dissolve
- Keep adding until no more dissolves (reaction is done)
- Filter out the insoluble (excess) base

8.10 Starting with an Alkali (Titration):

- Put a certain amount alkali in a flask
- Add phenolphthalein
- Add acid from a burette, stirring, until it goes colorless
- Find out how much acid you used
- Repeat, to be more accurate
- Evaporate water from neutral solution

8.11 Precipitation

- Mix the two soluble salts, so they react together
- Filter the mixture to separate the products produced (soluble and insoluble salt produced)
- Wash the insoluble salt on the filter paper
- Dry the insoluble salt in a warm oven

8.12 Test for Aqueous Cations

CATION	EFFECT OF AQ. NAOH	EFFECT OF AQ. AMMONIA
ALUMINUM (Al ³⁺)	White soluble precipitate formed giving a colorless solution	White precipitate formed
AMMONIUM (NH ₄ ⁺)	Ammonium gas produced turns damp red litmus blue	
CALCIUM (Ca ²⁺)	White precipitate formed	No precipitate/ slight white precipitate Light blue soluble precipitate formed giving dark blue solution
COPPER (Cu ²⁺)	Light blue precipitate formed	Green precipitate formed
IRON(II) (Fe ²⁺)	Green precipitate formed	Green precipitate formed
IRON(III) (Fe ³⁺)	Red-brown precipitate formed	Red-brown precipitate formed
ZINC (Zn ²⁺)	White soluble precipitate formed giving a colorless solution	White soluble precipitate formed giving a colorless solution

8.13 Test for Anions

ANION	TEST	TEST RESULT
CARBONATE (CO ₃ ²⁻)	Add dilute nitric acid	Bubble gas through limewater—from colorless to cloudy
CHLORIDE (Cl ⁻)	Add nitric acid, then aqueous silver nitrate	White precipitate formed
BROMIDE (Br ⁻)	Add nitric acid, then aq. silver nitrate	Cream precipitate formed
IODIDE (I⁻)	Add nitric acid, then aqueous silver nitrate	Bright yellow precipitate formed
NITRATE (NO ₃ ⁻)	Add aqueous sodium hydroxide then add aluminum	Gas produced turns damp red litmus paper blue
SULPHATE (SO ₄ ²⁻)	Add dilute nitric acid, then add aq. barium nitrate	White precipitate formed

8.14 Test for Gases

GAS	TEST AND TEST RESULT
Ammonia (NH ₃)	Damp red litmus paper turns blue
Carbon dioxide (CO ₂)	Bubble gas through—from colorless to cloudy
Chlorine (Cl ₂)	Bleaches red/blue litmus paper
Hydrogen (H ₂)	Place lighted splint, squeaky pop
Oxygen (O ₂)	Place glowing splint, splint relights

9. THE PERIODIC TABLE

- The Periodic table is a method of classifying elements.
- They are arranged in order of increasing atomic number.
- Made up of rows called periods and columns called groups
- Metals are to the left and non-metals are to the right.
- Elements in the same group have similar properties.
- Group number tells us the number of valency electrons and the period number tells us about the number of electron shells

9.1 Periodic Trends

- Non-metals are on the right side of the periodic table, and metals are on the left.
- Down a period of metals they become more reactive
- With non-metals, going down a period, the non-metal becomes less reactive

9.2 Alkali Metals

- Lithium, sodium and potassium

CHEMICAL PROPERTIES	PHYSICAL PROPERTIES
<ul style="list-style-type: none">• Form ionic compounds• React violently with chlorine• Burst into flames when heated with oxygen:<ul style="list-style-type: none">○ A red flame for lithium○ A yellow flame for sodium○ A lilac flame for potassium• Produce soluble white compounds.• React with cold water.	<ul style="list-style-type: none">• Good conductors of heat and electricity.• Are soft, compared to other metals.• They have low densities for metals.• They have low melting and boiling points compared to most metals.

Patterns

- Reactivity, density & softness increases down the group
- Melting and boiling points decreases down the group.
- Reactivity increases as more electron shells means there is weaker attraction between nucleus & valency electron so is lost more easily.

9.3 Halogens

PROPERTIES	PATTERNS
<ul style="list-style-type: none">• Form colored gases, at RTP:<ul style="list-style-type: none">○ Fluorine is a yellow gas○ Chlorine is a green gas○ Bromine is a red liquid○ Iodine is a black solid• Are poisonous• Brittle and crumbly when solid• Do not conduct electricity• Form diatomic molecules	<ul style="list-style-type: none">• Down the group; size, mass and density increases• Down the group, color darkens• Reactivity decreases down the group, because it has to gain an electron, so the closer the electron is to the positive nucleus the more easily it will be gained, so atoms with fewer shells• Will react more easily.

9.4 Transition Metals

- High melting points (except mercury)
- Malleable and ductile
- Good conductors of heat & electricity (silver is the best)
- High density
- Have no trend in reactivity

- Can be used as catalysts
- Form colored compounds
- Can form complex ions as they have variable valences

9.5 Noble Gases

PROPERTIES	USES
<ul style="list-style-type: none"> • Density increases down the group • M.p. and b.p. increases down the group • Don't conduct electricity • Don't take part in chemical reactions 	<ul style="list-style-type: none"> • Helium- filling balloons and aircrafts because it is lighter than air and will not catch fire. • Argon – filling (tungsten) light bulbs to stop the filament reacting with oxygen. • Neon – is used in advertising signs because it glows red.

10. METALS

10.1 Properties of Metals

PHYSICAL	CHEMICAL
<ul style="list-style-type: none"> • High density • Shiny when polished • Malleable • Ductile • High m.p. And b.p. • Conductor of heat & electricity 	<ul style="list-style-type: none"> • Form basic oxides • Form positive ions

10.2 Alloys

- An alloy is two or more metals, or a metal and non-metal which have been made molten and then mixed together
- Alloys are used because they have improved qualities for a particular job over the pure metals

ALLOY	MADE FROM	SPECIAL PROPERTIES	USES
Brass	Copper and zinc	Stronger and more resistant to corrosion	Electrical fittings, car radiators
Bronze	Copper and tin	Harder, stronger and sonorous	Statues, springs, coins
Stainless steel	Iron, chromium and nickel	Does not rust	Kitchen sinks, cutlery, chemical plant

- Metals are often used as alloys because they have an increased range of uses and mixture of atoms gives an irregular structure which stops layers sliding over each other easily; they are stronger
- This is what the structure of an alloy (a) looks like, compared to a pure metal (b).

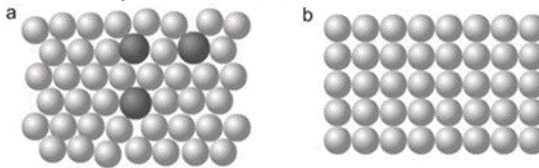

10.3 Reactivity Series

- | | |
|---------------------|---|
| K - Potassium | • This places metals in order of their readiness to take part in chemical reactions |
| Na - Sodium | |
| Ca – Calcium | |
| Mg – Magnesium | • Everything above hydrogen can displace hydrogen from its acid, and hydrogen cannot reduce their oxides. |
| Al – Aluminum | • Metals above carbon, their oxides cannot be reduced by carbon. |
| C – Carbon | • More reactive metals will react with cold water, and less reactive will react slowly or not react with steam. |
| Zn – Zinc | • Aluminum seems unreactive because it forms an oxide layer which protects it |
| Fe – Iron | |
| Pb – Lead | |
| H – Hydrogen | |
| Cu – Copper | |
| Ag – Silver | |
| Au – Gold | |

10.4 Displacement Reactions

- These are reactions in which metals compete for oxygen or anions
- The more reactive metal will displace the less reactive metal from oxygen or an anion.
- If more reactive metal has oxygen or an anion, no reaction occurs
- The bigger the difference in reactivity between the two metals, the faster the reaction

10.5 Thermal Decomposition

GROUP	METAL CARBONATE	METAL HYDROXIDE	METAL NITRATE
<i>Group I (except lithium)</i>	Do not decompose	Do not decompose	Metal nitrite and oxygen
<i>Group II, lithium & transition metals</i>	Metal oxide and carbon dioxide	Metal oxide and water	Metal oxide, nitrogen dioxide and oxygen

10.6 Extraction of Metals

METAL	EXTRACTION METHOD
K - Potassium Na - Sodium Ca - Calcium Mg - Magnesium Al - Aluminum	Reduction via electrolysis
CARBON	
Zn - Zinc Fe - Iron Pb - Lead	Reducing via heating with Carbon or Carbon Monoxide
HYDROGEN	
Cu - Copper Ag - Silver Au - Gold	Occur naturally

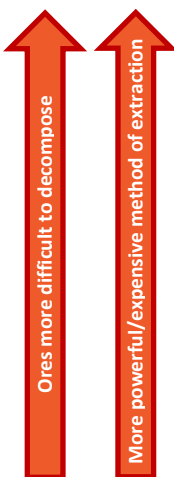

10.7 Extracting Iron

- Ore = hematite (Fe_2O_3)
- Uses of slag
 - To make roads
 - To make cement
- Coke burns with air
carbon + oxygen → carbon dioxide
- Carbon dioxide reacts with coke
carbon dioxide + carbon → carbon monoxide
- Carbon monoxide reduces Iron(III) oxide to iron
iron(III) oxide + carbon monoxide → iron + carbon dioxide
- The limestone reacts with impurities to form slag
calcium carbonate + silicon dioxide → calcium silicate + carbon dioxide

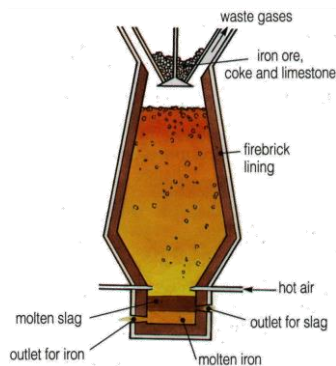

10.8 Iron to Steel

- Molten iron from blast furnace is poured into an oxygen furnace.
- Calcium oxide is added, and a jet of oxygen is turned on.
- The calcium oxide neutralizes acidic impurities, forming slag that is skimmed off and oxygen burns the other impurities away.
- The carbon content is checked continually until it is just right then the oxygen is turned off.
 - Mild Steel (0.25% carbon) – Used in machinery and car bodies
 - Medium carbon steel (0.5%) – Used in railway lines
 - High carbon steel (1.5% carbon) – Used in knives and blades

10.9 Extracting Zinc

- Ore = Zinc Blende = Zinc Sulphide (ZnS)
- Zinc blende is roasted in air to convert it to zinc oxide
- Zinc oxide is reduced using coke to zinc and carbon monoxide in the furnace
- As zinc is volatile, the gaseous metal is distilled leaving less-volatile impurities behind.
Zinc is condensed and liquid is run into mould.

10.10 Uses of Metal

- Aluminum
 - Airplane/Cars (Strong/Low density/resistant to corrosion)
 - Cans/Foil (Resistant to corrosion/malleable)
 - Overhead cable (Good conductor of electricity/ductile)
- Zinc
 - Galvanizes Iron = coats it to stop it rusting
 - Alloys – brass/bronze
 - Batteries
 - Sacrificial Protection
- Copper
 - Electrical Wiring (Good conductor of electricity/Ductile)
 - Cooking utensils (Malleable/good conductor of heat)
 - Roofs (hard wearing against weather)

11. AIR AND WATER

11.1 Tests for Water

TEST	TYPE OF TEST	POSITIVE RESULT
Blue Cobalt(II) Chloride Paper	Chemical	Paper turns from blue to pink
Anhydrous Copper(II) Sulphate powder	Chemical	From white powder to blue crystals
Test m.p. and b.p.	Physical	m.p. at 0°C and b.p. at 100°C

11.2 Purification of Water

- Water is pumped into screens, which remove solid floating debris.
- Aluminum sulfate is added to coagulate (stick together) small pieces of clay so that they are easily removed.
- The water is then filtered through coarse sand to remove larger, insoluble debris.
- The water encounters more flocculants (chemicals that make particles move down to bottom of tank) and is filtered again through fine sand.

- Chlorine gas is bubbled through the water to kill bacteria. This makes the water slightly acidic, so to reverse this appropriate amounts of sodium hydroxide (an alkali) is added.
- Some countries also add fluorine

11.3 Use of Water

AT HOME	IN INDUSTRY
<ul style="list-style-type: none"> • Drinking • Cooking • Washing • On farms for animals & crops 	<ul style="list-style-type: none"> • Dissolve • wash and cool things • In power stations where steam is used to turn turbines

11.4 Air

- Clean air is composed of approximately
 - 79% nitrogen
 - 20% oxygen
 - Remainder: noble gases, water vapor & carbon dioxide

11.5 Pollutants in Air

POLLUTANT	SOURCE	PROBLEMS CAUSED
Carbon Monoxide CO	Incomplete combustion of carbon-containing substances	Reacts with haemoglobin, preventing it from carrying oxygen; death due to oxygen starvation
Sulphur Dioxide SO ₂	From combustion of fossil fuels which contain sulfur	Irritates eyes and throat, causes respiratory problems and causes acid rain
Oxides of Nitrogen NO _x	From car exhausts	Causes respiratory problems and forms acid rain
Lead compounds	From burning of petrol as lead is added to it for better performance	Causes damage to brain and nerve cells in young children

11.6 Fractional Distillation of Air

- Air is filtered to remove dust
- Water vapor and carbon dioxide removed, (because they would freeze and block the pipes):
 - air is cooled until water vapor condenses
 - then passes over absorbent beads to trap carbon dioxide

- It is compressed, causing it to heat up. Cooled by recycling cold air
- The cold compressed air is passed through a jet, into a larger space. It expands rapidly, making it very cold.
- This is repeated, cooling the air more. By -200°C it is liquid except for neon and helium. These gases are removed. They can be separated from each other by absorption on charcoal.
- The liquid air is pumped into the fractioning column. There it is slowly warmed up. The gases boil off one by one, and are collected in tanks or cylinders.
- **Sources of methane:** oil and natural gas, decomposition of vegetation, and waste gases from digestion in animals

11.7 Catalytic Convertor

- In the combustion engine, insufficient amounts of oxygen lead to incomplete combustion of the carbon containing fuel
- Gases produced: (a) carbon monoxide (b) oxides of nitrogen
- A catalytic convertor catalyzes the reduction of NO₂ to nitrogen gas N₂ and catalyzes the oxidation of CO to CO₂

11.8 Rust Prevention

- Coating with something to prevent contact with air and moisture
 - Plastic, paint and grease
 - Electroplating with tin or chromium
 - Galvanising: dipping in molten zinc
- Sacrificial protection: attaching a piece of metal that is more reactive than iron to object, commonly magnesium or zinc. This will corrode in the place of iron.

11.9 Fertilizer

- NPK used in fertilizers because:
 - Nitrogen is needed for chlorophyll and other proteins.
 - Phosphorus helps roots grow and crops ripen.
 - Potassium helps make proteins and resist diseases.
- All alkalis (except ammonia) will react with ammonium compounds, removing ammonia, for example:

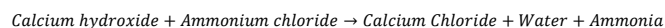

11.10 Greenhouse Gases

- The greenhouse gases are: carbon dioxide and methane.
- They stop heat escaping in to space.
- Too much greenhouse gases leads to climate change.
- This will cause the ice poles to melt, rising sea levels, more droughts, storms, floods and famine; global warming

11.11 Formation of Carbon Dioxide

- Carbon dioxide is produced whenever carbon or any of its compound are completely burned in excess oxygen
- It is also formed as a product of respiration
- It is produced as product of reaction between an acid and carbon
- From the thermal decomposition of a carbonate

11.12 Haber Process

- Industrial manufacture of ammonia NH₃

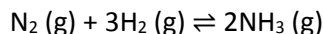

- Raw materials:
 - Nitrogen: from the air
 - Hydrogen: methane + steam → carbon dioxide + hydrogen
- Essential conditions:
 - Temperature: 450°C
 - Pressure: 200atm
 - Catalyst: Iron

11.13 Carbon Cycle

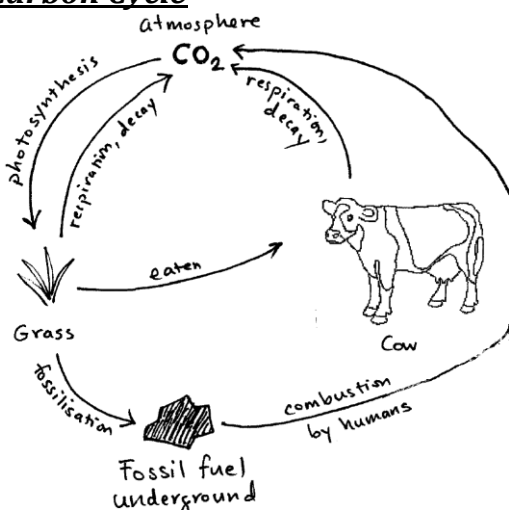

12. SULFUR

12.1 Sources

- Found as an element, in large underground beds
- Found around the rims of volcanoes.
- It occurs in metal ores e.g. lead sulphide
- Sulphur compounds also occur naturally in the fossil fuels e.g. coal

12.2 Uses

SULFUR	SULFUR DIOXIDE
<ul style="list-style-type: none"> • As a food preserver; kills bacteria • As a bleach in the manufacture of wood pulp for paper • In car batteries as electrolyte • In manufacture of sulphuric acid (through Contact process) 	<ul style="list-style-type: none"> • Manufacture of sulphuric acid • To bleach wool, silk and wood pulp for making paper • As a sterilising agent in making soft drinks and jam, and in drying fruit; stops growth of bacteria and moulds.

12.3 Contact Process

- Sulphur is first burned in air producing sulphur dioxide
- It is then mixed with more air and passed over four separate beds of catalyst, Vanadium (V) oxide, at 450°C to form sulphur trioxide
- It is then dissolved in concentrated sulphuric acid forming a thick fuming liquid called oleum
- It is then mixed carefully with water to form concentrated sulphuric acid.
- Essential conditions:
 - Catalyst: Vanadium (V) oxide
 - Temperature: 450°C
 - Pressure: 2atm

12.4 Properties of Sulphuric Acid

- Forms salts called sulphates
- When concentrated, it's a dehydrating agent, and a thick oily liquid
- It turns blue litmus red
- It is a strong acid and has the properties of a typical strong acid: reacts with bases, low pH, high conductivity

13. CARBONATES

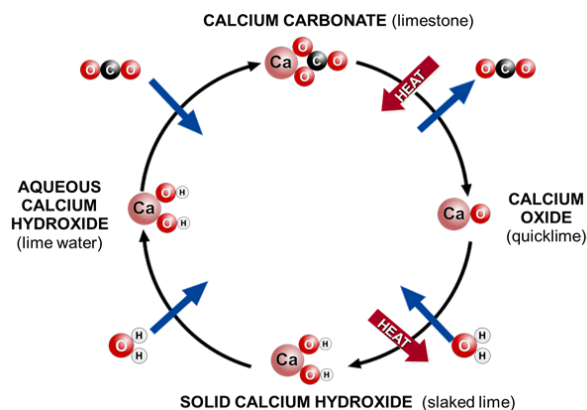

- Lime is manufactured by limestone by heating
- $\text{CaCO}_3 + \text{heat} \rightarrow \text{CaO} + \text{CO}_2$

- **Uses of quick lime:**

- Making steel from iron
- To neutralise acidity in soil
- Drying agent in industry

- **Uses of slaked lime and lime:**

- Neutralise acidity in soil, and in lakes affected by acid rain,
- Neutralising acidic industrial waste products, e.g. flue gas desulphurisation

- **Uses of limestone:**

- **Making cement:** made by mixing limestone with clay, heating mixture strongly in a kiln, adding gypsum (calcium sulphate), and grinding up the final solid to give a powder
- **Making iron from iron ore:** limestone reacts with sand) forming slag (calcium silicate), which is then used for road building.

14. ORGANIC CHEMISTRY

14.1 Homologous Series

- **Homologous series:** 'family' of similar compounds with similar properties due to the presence of the same functional group.
- Characteristics of a homologous series:
 - all the compounds fit the same general formula
 - the chain length increases by 1 each time
 - as the chain gets longer, the compounds show a gradual change in properties
- **Structural isomers:** have the same chemical formula, but different structures, they can be straight or branched

14.2 Fuels

- **Fuels to know:**

- **Coal**
- **Natural gas:** main constituent is methane
- **Petroleum:** a mixture of hydrocarbons which can be separated into fractions

14.3 Uses of Petroleum Fractions

- **Refinery gas:** bottled gas for heating and cooking
- **Gasoline fraction:** fuel (petrol) in cars
- **Naphtha fraction:** making chemicals
- **Kerosene/paraffin fraction:** jet fuel, lamps
- **Diesel oil/gas oil fraction:** fuel in diesel engines
- **Fuel oil fraction:** fuel in ships and home heating systems
- **Lubricating fraction:** lubricants, waxes and polishes
- **Bitumen:** making roads

14.4 Name of Compounds

Name ending → compound-type name

- "ane" → alkane
- "ene" → alkene
- "ol" → alcohol
- "oic acid" → carboxylic acid
- "yl", "oate" → ester

14.5 Alkanes

General formula = C_nH_{2n+2}

METHANE (N=1)	ETHANE (N=2)
<pre> H H-C-H H</pre>	<pre> H H H-C-C-H H H</pre>
PROPANE (N=3)	BUTANE (N=4)
<pre> H H H H-C-C-C-H H H H</pre>	<pre> H H H H H-C-C-C-C-H H H H H</pre>

- Each carbon atoms in an alkane has four covalent single bonds – this makes them quite unreactive.

Combustion:

- Complete combustion: enough oxygen supply so water and carbon dioxide form.
- e.g. $CH_4 + 2O_2 \rightarrow CO_2 + 2H_2O$
- Incomplete: is not enough oxygen to burn them cleanly so either carbon monoxide and water or carbon and water form.
e.g. $2CH_4 + 3O_2 \rightarrow 2CO + 4H_2O$ or
e.g. $CH_4 + O_2 \rightarrow C + 2H_2O$

Chlorine substitution:

- Sunlight or light is necessary
- A chlorine atom replaces a hydrogen atom
- This can happen to all hydrogen atoms if there is enough chlorine.

e.g. $CH_4 + Cl_2 \rightarrow (\text{light}) \rightarrow HCl + CH_3Cl / CH_2Cl_2 / CHCl_3 / CCl_4$

Compounds = chloromethane / di/tri/tetrachloromethane

14.6 Alkenes

General formula = C_nH_{2n}

Functional group: C=C bond

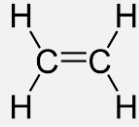
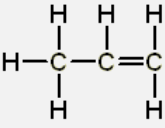
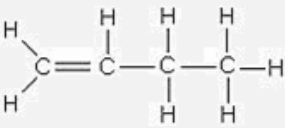
(N=1) N/A	ETHENE (N=2) 
PROPENE (N=3) 	BUT-1-ENE (N=4) 

Cracking:

- Thermal decomposition reaction, in which an alkene (and sometimes hydrogen) are produced from an alkane.
- Cracking always produces short chain compound with a C=C bond
e.g. Cracking of ethane will give ethene and hydrogen

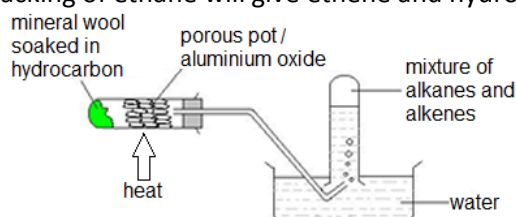

- Butane \rightarrow Ethane + Ethene ; $C_4H_{10} \rightarrow C_2H_6 + C_2H_4$

SATURATED HYDROCARBONS	UNSATURATED HYDROCARBONS
<ul style="list-style-type: none"> Have NO double bonds Do not react with aqueous bromine, so the mixture stays orange. 	<ul style="list-style-type: none"> Have double bonds React with aqueous bromine, turning the mixture from orange to colourless.

14.7 Addition Polymerisation

- A polymer is a compound with very long carbon chains made up of monomer units.
- Poly(ethene) / Polythene: is a polymer produced from ethene by addition polymerization

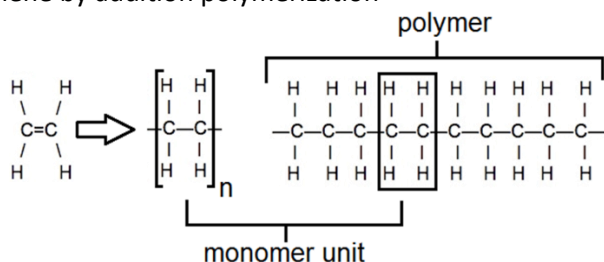

Double bond splits and polymer is formed

14.8 Alkenes' Addition Reactions

- With bromine:** (the test for saturation)
e.g. ethene (g) + bromine (aq) \rightarrow 1,2-dibromomethane (l)
- With steam:** forms alcohols with heat, pressure and a catalyst
e.g. ethene (g) + steam (g) \rightleftharpoons ethanol (l)
- With hydrogen:** double bond breaks down to form an alkane with heat, pressure and a catalyst
e.g. ethene (g) + hydrogen (g) \rightarrow ethane (g)

14.9 Alcohols

General formula = $C_nH_{2n+1}OH$

Functional group: OH

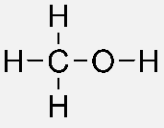
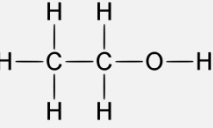
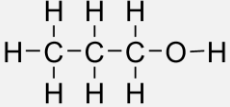
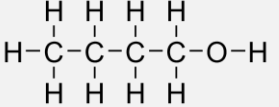
METHANOL (N=1) 	ETHANOL (N=2) 
PROPANOL (N=3) 	BUTANOL (N=4) 

Formed by:

FERMENTATION	CATALYTIC ADDITION OF STEAM TO ETHENE
<ul style="list-style-type: none"> Enzymes in yeast break down glucose to ethanol and carbon dioxide, giving out heat Can be done with substances that contain cellulose, starch or glucose Done by grinding source (e.g. grapes) and adding enzymes to break down cellulose and starch into glucose. Leave it to ferment. Fractional distillation is used to get ethanol from the mixture 	<ul style="list-style-type: none"> Ethene is obtained by cracking long-chain alkenes from oil. The ethene reacts with steam (reversibly) in the following conditions: <ul style="list-style-type: none"> 570°C 60-70atm Catalyst = phosphoric acid Low temperature gives a better yield, but high temperature is used to give a better rate of reaction.

	ADVANTAGES	DISADVANTAGES
FERMENTATION	<ul style="list-style-type: none"> Renewable source Good use of waste organic material 	<ul style="list-style-type: none"> Lots of material needed so big tanks needed Fractional distillation is expensive Slow process Batch process
FROM ETHENE	<ul style="list-style-type: none"> Fast Continuous process Pure ethanol Smaller containers 	<ul style="list-style-type: none"> Oil is a non-renewable resource Lot of energy to make steam and get right conditions Lot of ethene is unreacted, (and then recycled)

• Ethanol burns well in oxygen, giving out plenty of heat, as well as carbon dioxide and water.

• Ethanol is used as a:

- Solvent: to dissolve things than water cannot. Evaporates easily, so used as solvent in glues, printing inks & perfumes
- Fuel: added to or instead of petrol, because it burns cleanly

14.10 Carboxylic Acids

General formula = $C_nH_{2n+1}COOH$

Functional group: COOH

METHANOIC ACID (N=1)	ETHANOIC ACID (N=2)
PROPANOIC ACID (N=3)	BUTANOIC ACID (N=4)

Properties of Ethanoic Acid:

- Weak acid with high pH and low dissociation
- Formed by:
 - Oxidation of ethanol
 - With acidified potassium manganate (VII)
- Carboxylic acids react with alcohols to give esters, in a condensation reaction, for example:
- Ethanoic acid + ethanol \rightleftharpoons ethyl ethanoate + water (alcohol = -yl & carboxylic acid = -oate)

14.11 Macromolecules

• Large molecules built up from small units (monomers).

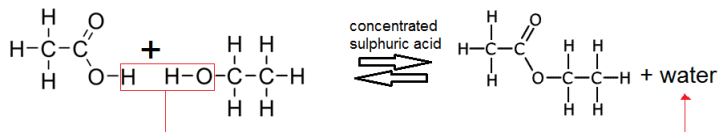

• Different macromolecules have different units and/or different linkages

Example of:

SMALL UNITS (MONOMERS)	LINKAGES	MACROMOLECULES
<ul style="list-style-type: none"> glucose amino acids fatty acids and glycerol 	<ul style="list-style-type: none"> amide ester 	<ul style="list-style-type: none"> protein starch lipids

	USE	STRUCTURE
POLYTHENE	<ul style="list-style-type: none"> Plastic bags and gloves, clingfilm (low density), mugs, bowls, chairs, dustbins (high density) 	
POLYCHLOROETHANE (PVC)	<ul style="list-style-type: none"> Water pipes, wellingtons, hoses, covering for electricity cables 	
POLYPROPENE	<ul style="list-style-type: none"> Crates, ropes 	
POLYSTYRENE	<ul style="list-style-type: none"> Used as expanded polystyrene in fast-food cartons, packaging, and insulation for roofs and walls 	
TEFLON	<ul style="list-style-type: none"> Coated on frying pans to make them non-stick, fabric protector, windscreen wipers, flooring 	

Making nylon:

- Uses: ropes, fishing nets and lines, tents, curtains
- Monomers are:

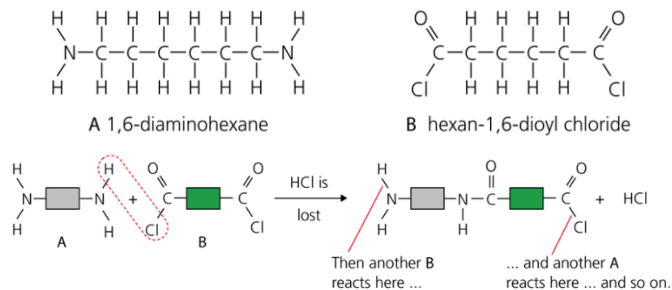

- No double bonds break, instead single bonds break, and new single bonds form.
- The monomers are able to join to each other by eliminating a small molecule: hydrogen chloride.
- This reaction continues at each the two monomers.
- Thousands of molecules join together, giving a macromolecule:

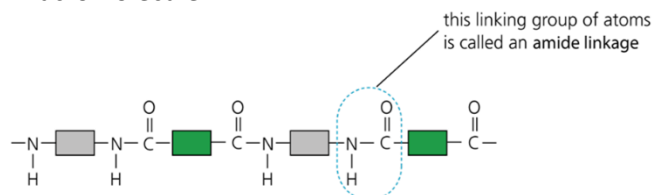

Making terylene

- Uses: clothing (especially mixed with cotton), thread
- Monomers are:

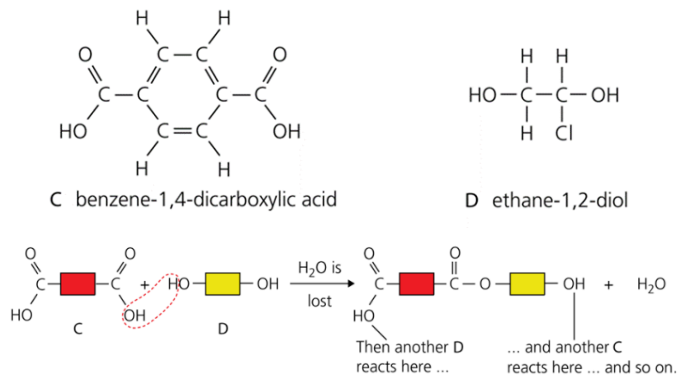

- The monomers join by eliminating a water molecule. Thousands of molecules join up, giving a macromolecule

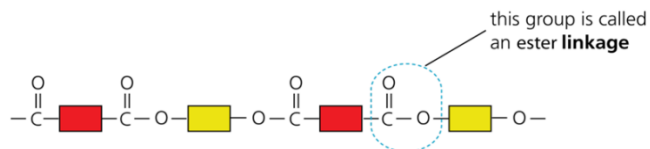

14.12 Pollution from Plastics

- Choke birds, fish and other animals that try to eat them. Or they fill up the animals' stomachs so that they can't eat proper food, and starve to death.
- They clog up drains and sewers and cause flooding.

- They collect in rivers, and get in the way of fish. Some river beds now contain a thick layer of plastic
- They blow into trees and onto beaches. So the place looks a mess. Tourists become put off.

14.13 Natural Macromolecules

- Food's main constituents are proteins, fats and carbohydrates.

Proteins:

- Proteins contain the same linkages (amide links) as nylon, but with different units. Their structure is:

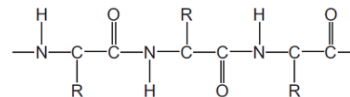

- In digestion proteins are broken down into amino acids (hydrolysis).

Fats:

- Fats are esters possessing the same linkage as Terylene (ester links) but with different units.
- Soap is a product of the hydrolysis of fat. It is done using sodium hydroxide (as opposed to acid, in digestion). The hydrolysis gives glycerol and the sodium salts of fatty acids. The salts are used as soaps.

Carbohydrates:

- Complex carbohydrates: are a large number of joined sugar units (monosaccharide like glucose). The sugar units are represented like this:



They join together in a condensation polymerization

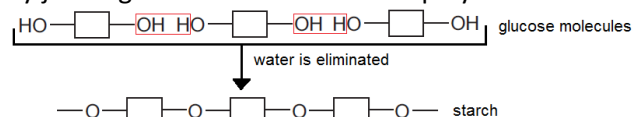

- In digestion, the hydrolysis (Decomposition of a chemical compound by reaction with water) of starch happens in the mouth by the enzyme amylase to make glucose

Hydrolysis:

- Starch → glucose
- Proteins → amino acids
- Fats → fatty acids and glycerol
- But if hydrolysis is not complete, macromolecules are not completely broken down so you get a mixture of molecules of different sizes
- **Identification:**
 - Chromatography can be used to identify products & substances
 - However, amino acids and sugars are colourless when dissolved in water, so a locating agent is used.
 - Substances can be identified using R_f values or by matching them with spots which are horizontal

Experimental Techniques

APPARATUS

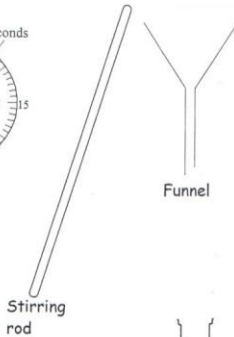
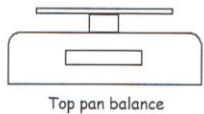
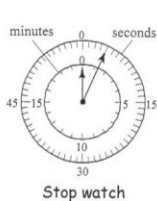
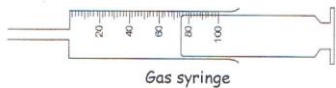

Funnel

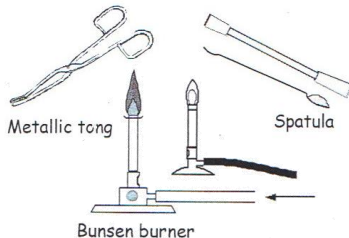
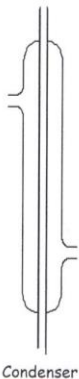
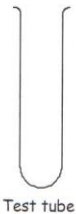
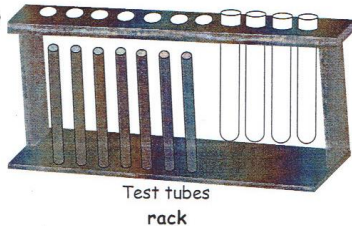

Metallic tong

Spatula



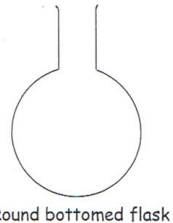
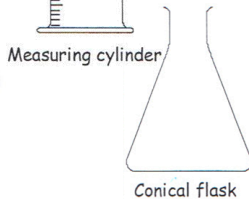
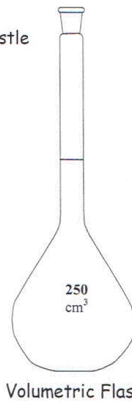
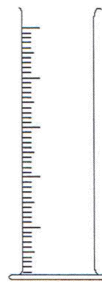
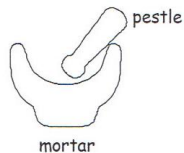
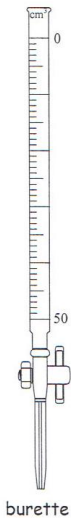
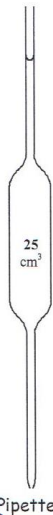
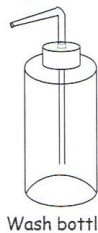
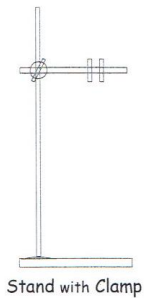

EXPERIMENTS

- Reducing Copper(III) Oxide to Copper

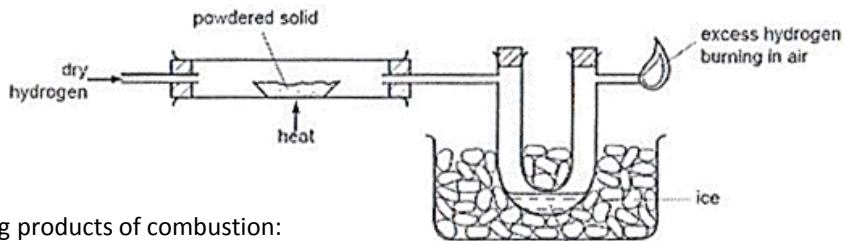

- Testing products of combustion:

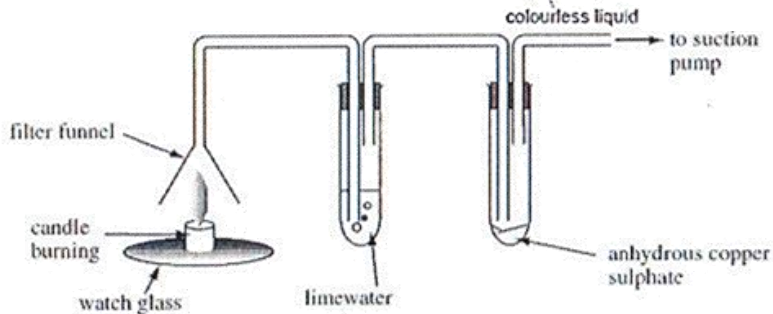

EXPERIMENTS

- Showing that oxygen and water is needed for rusting iron

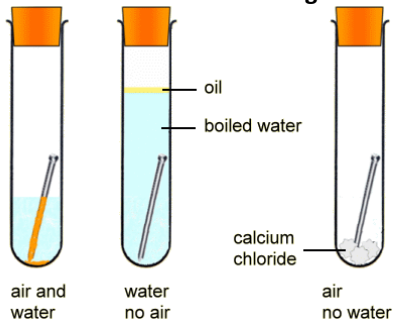

- Showing that air is 21% Oxygen

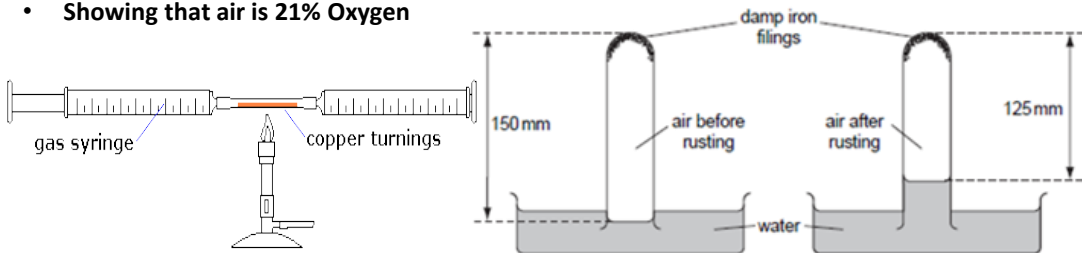

RATES OF REACTION

- **Testing factors affecting rate of reaction**

- Different temperature acid
- Different size of particle/reactant
- Concentration of acid

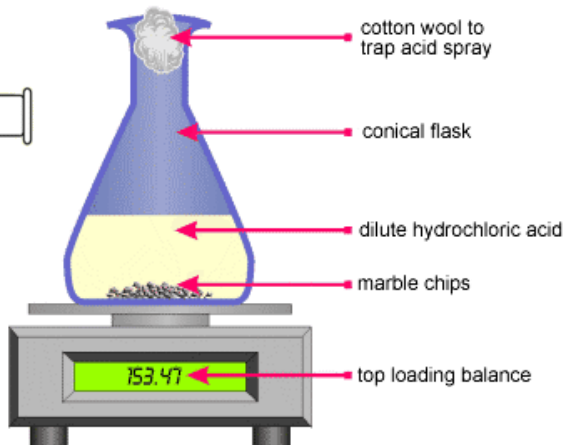
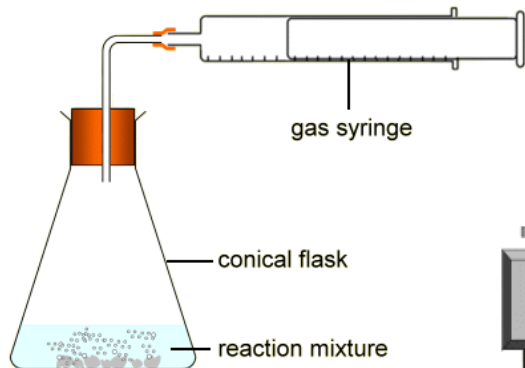

RATES OF REACTION

- Time how long it takes for the cross to disappear from view
 - You can change the temperature and concentration of acid used

- **Keep constant:**

- Diameter of beaker
- The Cross
- Volume

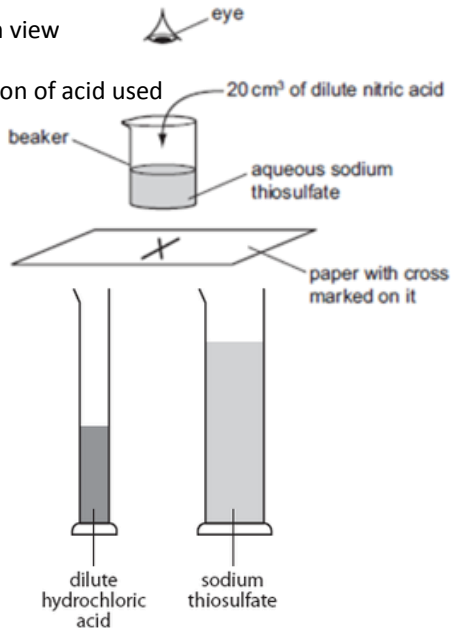
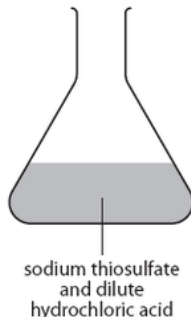
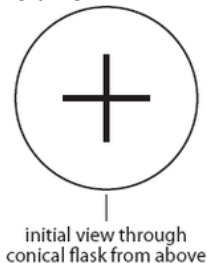

ENERGY IN ALCOHOL

- Find the amount of energy given when an alcohol is burnt:

- You need to know:

- Mass of water
- Change in mass of burner containing alcohol
- Specific heat capacity of water
- Temperature change of water
- The molecular mass of the alcohol

- $\frac{\text{Change in mass}}{\text{Molecular mass}} = \text{Number of moles burnt}$

- $\text{Change in temperature} \times \text{mass of water} \times \text{SHC of water} = \text{Energy}$

- $\frac{\text{Energy}}{\text{Moles burnt}} = \text{amount of energy per mole (J/mol)}$

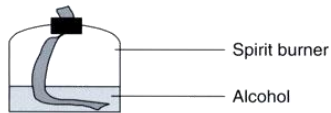
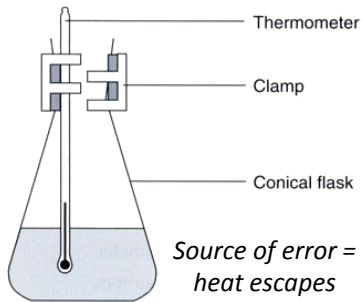

FINDING CONCENTRATION

- Acid and base titration to find the concentration of a solution:
- Measure volume of acid then pour into conical flask
- Record initial volume of base in burette
- Slowly add base from burette, stirring each time
- When indicator neutral, record final volume of base
- Find amount of base used: Final – Initial
- Find moles of base used by *volume* × *concentration*
- Use balanced equation to find how many moles of acid are needed to neutralize the base

- $$\frac{\text{Number of moles of Acid Needed}}{\text{Volume of Acid Used}} = \text{Concentration of Acid}$$

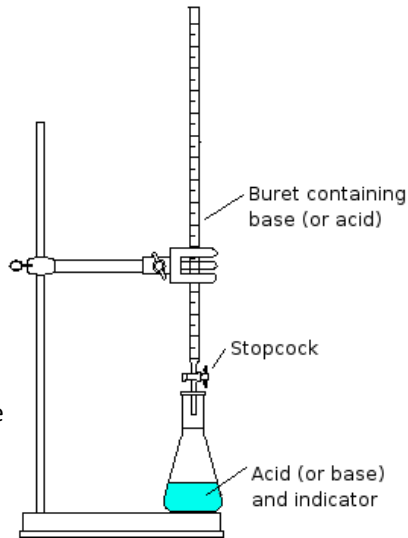

FLAME TESTS

- **Lithium** = Red
- **Sodium** = Yellow
- **Potassium** = Lilac
- **Iron** = Gold
- **Magnesium** = Bright White
- **Source of errors for flame tests:**
 - The test cannot detect low concentrations of most ions.
 - Brightness of the flames varies from one sample to another.
 - Impurities or contaminants affect the test results.
 - The test cannot differentiate between all elements or compounds

CHROMATOGRAPHY

- **Principle: Difference in solubility separates different pigments**
 - Drop substance to center of filter paper and allow it to dry
 - Drop water on substance, one drop at a time
 - Paper + rings = chromatogram.
- **Stationary phase:** material on which the separation takes place
- **Mobile phase:** mixture you want to separate, dissolved in a solvent.
- **Interpreting simple chromatograms:**
 - Number of rings/dots = number of substances
 - If two dots travel the same distance up the paper they are the same substance.

CHROMATOGRAPHY

- You can calculate the Rf value to identify a substance, given by the formula:

$$R_f \text{ Value} = \frac{\text{Distance moved by solute}}{\text{Distance moved by solvent}}$$

- To make colorless substances visible
 - Dry chromatogram in an oven
 - Spray it with a locating agent
 - Heat it for 10 minutes in the oven

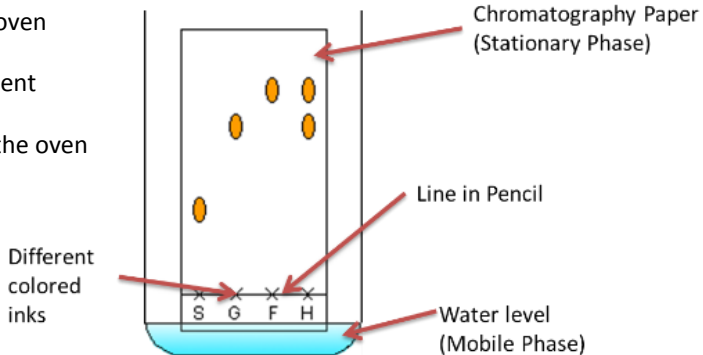

SEPARATION METHODS

- **Filtration**

- Mixture goes in a funnel with filter paper, into a flask.
- Residue is insoluble and filtrate goes through

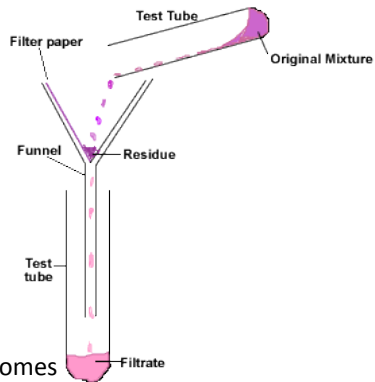

- **Crystallization**

- Some water in the solution is evaporated so solution becomes more concentrated.
- Solution is left to cool and crystallise.
- Crystals are filtered to remove solvent.

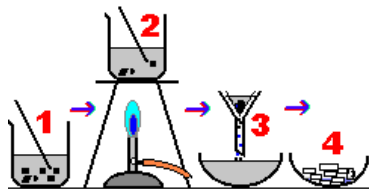

- **Simple distillation:**

- Impure liquid is heated
- It boils, and steam rises into the condenser
- Impurities are left behind
- Condenser is cold so steam condenses to the pure liquid and it drops into the beaker

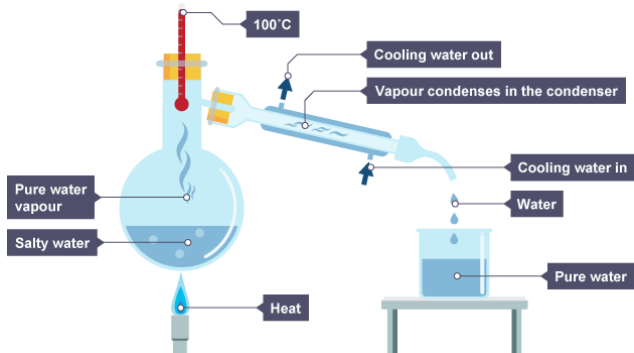

- **Fractional distillation:**

- Removes a liquid from a mixture of liquids, because liquids have different b.p.s
- Mixture is heated to evaporate substance with lowest b.p.
- some of the other liquid(s) will evaporate too.
- Beads are heated to boiling point of lowest substance, so that substance being removed cannot condense on beads.
- Other substances continue to condense and will drip back into the flask
- The beaker can be changed after every fraction.

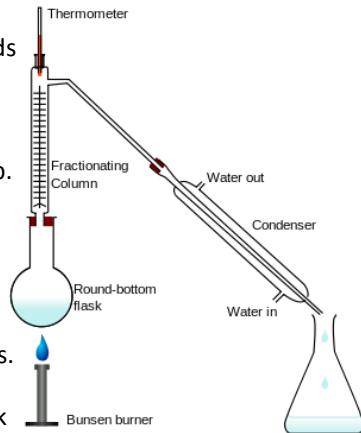

SEPARATION METHODS

- **Separating mixture of two solids:**

- Can be done by dissolving one in an appropriate solvent
- Then filter one and extract other from solution by evaporation
- If one solid is magnetic, can use a magnet e.g. sand and iron

Solvent	It dissolves...
Water	Some salts, sugar
White spirit	Gloss paint
Propanone	Grease, nail polish
Ethanol	Glues, printing inks, scented substances, chlorophyll

- **Choosing a suitable method:**

Method of separation	Used to separate
Filtration	A solid from a liquid
Evaporation	A solid from a solution
Crystallization	A solid from a solution
Simple Distillation	A solvent from a solution
Fractional Distillation	Liquids from each other
Chromatography	Different substances from a solution

MAKING SALTS

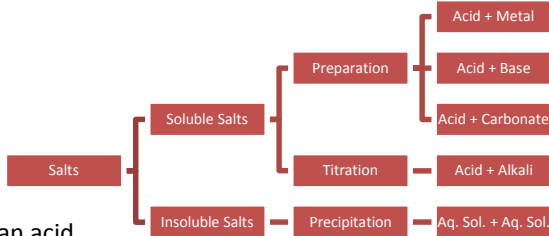

- **Starting with a metal:**

- Add excess metal to an acid
- When bubbling (hydrogen) stops the reaction is done
- Filter off excess metal

- **Starting with an insoluble base:**

- Add insoluble base to acid and heat gently, it will dissolve
- Keep adding until no more dissolves (reaction is done)
- Filter out the insoluble (excess) base

MAKING SALTS

- **Titration:**

- Pipette 25 cm³ of alkali and transfer in a flask and add phenolphthalein
- Add acid from a burette, stirring, until it goes colourless
- Find out how much acid you used and repeat, to be more accurate
- Evaporate water from neutral solution

- **Precipitation:**

- Mix the two soluble salts, so they react together
- Filter the mixture to separate the products produced (soluble and insoluble salt produced)
- Wash the insoluble salt on the filter paper
- Dry the insoluble salt in a warm oven

SALTS AND INDICATORS

- Solubility of salts:**

Soluble Salts	Insoluble Salts
All sodium, potassium and ammonium salts	The rest
All nitrates	N/A
Chlorides	Except silver and lead
Sulphates	Except barium, lead and calcium
Potassium, sodium and ammonium carbonates	All other carbonates

- Indicators:**

Indicator	Color in acid	Color in alkaline
Phenolphthalein	Colorless	Pink
Methyl orange	Pink	Yellow
Methyl red	Red	Yellow
Red litmus	Red	Blue
Blue litmus	Red	Blue

- pH Scale:**

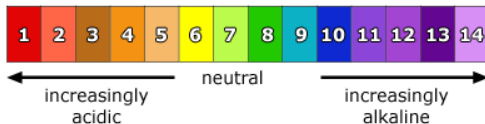

TEST FOR ANIONS AND CATIONS

Cation	Sodium Hydroxide	Ammonia
Aluminum (Al^{3+})	Soluble white ppt.	White ppt.
Ammonium (NH_4^+)	Ammonium gas - damp red litmus turns blue	N/A
Calcium (Ca^{2+})	White ppt.	No ppt.
Copper (Cu^{2+})	Light blue ppt.	Light blue soluble ppt.
Iron(II) (Fe^{2+})	Green ppt.	Green ppt.
Iron(III) (Fe^{3+})	Red-brown ppt.	Red-brown ppt.
Zinc (Zn^{2+})	White soluble ppt.	White soluble ppt.

Anion	Test	Test result
Carbonate (CO_3^{2-})	Add dilute nitric acid	Limewater goes cloudy
Chloride (Cl^-)	Add nitric acid, then aqueous silver nitrate	White ppt.
Bromide (Br^-)		Cream ppt.
Iodide (I^-)		Yellow ppt.
Nitrate (NO_3^-)	Add aqueous sodium hydroxide then add aluminum	Gas produced turns damp red litmus paper blue
Sulphate (SO_4^{2-})	Add nitric acid, then add aqueous barium nitrate	White ppt.

OTHER TESTS



Gas	Test and test result
Ammonia (NH ₃)	Damp red litmus paper turns blue
Carbon dioxide (CO ₂)	Bubble gas through limewater - from colorless to cloudy
Chlorine (Cl ₂)	Bleaches red/blue litmus paper
Hydrogen (H ₂)	Place lighted splint, squeaky pop
Oxygen (O ₂)	Place glowing splint, splint relights

Substance	Test and test result
Water	White anhydrous copper (II) sulphate crystals turns blue
	Blue cobalt chloride paper turns pink
Alkene	Add to bromine water; from orange to colourless
Alkane	Add to bromine water; remains orange
Acid	Blue litmus paper turns red
	Add a metal carbonate; bubbles of CO ₂
Base	Red litmus paper turns blue

PREPARING GASES IN THE LAB

To make....	Place in flask:	Add....	Reaction
CO₂	CaCO ₃ (marble chips)	Dilute HCl	$\text{CaCO}_3(\text{s}) + \text{HCl}(\text{aq}) \rightarrow \text{CaCl}_2(\text{aq}) + \text{H}_2\text{O}(\text{l}) + \text{CO}_2(\text{g})$
Cl₂	Manganese (IV) oxide (as an oxidising agent)	Conc. HCl	$2\text{HCl}(\text{aq}) + [\text{O}] \rightarrow \text{H}_2\text{O}(\text{l}) + \text{Cl}_2(\text{g})$
H₂	Pieces of zinc	Dilute HCl	$\text{Zn}(\text{s}) + \text{HCl}(\text{aq}) \rightarrow \text{ZnCl}_2(\text{aq}) + \text{H}_2(\text{g})$
O₂	Manganese (IV) oxide (as a catalyst)	Hydrogen peroxide	$2\text{H}_2\text{O}_2(\text{aq}) \rightarrow 2\text{H}_2\text{O}(\text{l}) + \text{O}_2(\text{g})$

COLLECTING GASES

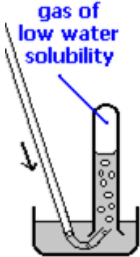
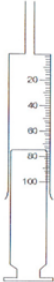
Method	Downward displacement of air	Upward displacement of air	Over water	Gas syringe
Use when...	Gas more dense than air	Gas less dense than air	Gas is sparingly soluble in water	To measure the volume
Apparatus				
Examples	Carbon dioxide, chlorine, sulphur dioxide, hydrogen chloride	Ammonia, hydrogen	Carbon dioxide, hydrogen, oxygen	Any gas