

Ron's Machine Shop

Shandon, Ohio

Specialists in
Antique Engine
Rebuilding



RON'S
MACHINE SHOP
ANTIQUE ENGINE REBUILDERS

SALTY DOG
MUSEUM



Over 40 Years Serving the
Antique Car Hobby!

Prices subject to change without notice. Rev. 9/22



How to Find Us

US Post Office Address: P.O. Box 114
Shandon, OH 45063

UPS/FEDEX Address: 4995 Cincinnati-Brookville Road
Hamilton, OH 45013

GPS Information: Hamilton, OH 45013.
Our Coordinates are: N39° 19.745' W84°43.258'

Hours: 7-4pm Monday—Thursday and 7-12pm Friday
Hours are subject to change, Please call ahead

From I-74

- Take Exit #1 to *New Haven Road*
- Go North on *New Haven Road*
- Pass Lohman's Green Houses and Pet Supply
- and turn left on *Edgewood Road*
- Continue through 2 stop signs and turn right on *Howard Road*
- At stop sign, turn left onto *Race Lane Road*
- Turn right on *Alert New London Road*
- At stop sign, turn left on *Chapel Road*
- At stop sign, turn right onto *Ohio-126*
- Ron's Machine Shop will be on your right
- just past the big red trailers at Diamond Heavy Haul

From I-275

- Take Exit #33 and go north on *US-27/Ohio-126/Colerain Ave*
- Continue on *US-27* and take the *Ohio-126/Ohio-128* exit
- where you will turn left onto *Ohio-126/Ohio/128*
- At the second light, BP on corner, turn right
- following *Ohio-126* and **keep left**
- Watch for the *Ohio-126* sign when you turn.
- Ron's Machine Shop will be 4 miles ahead on your Left.

Visit us on the web:
ronsmachineshop.com

E-mail your questions to:
ronsmachineshop@fuse.net



Valves and Lifters for Model T



Complete Modern Valve Set

- All the parts you need to redo your valves
- 8 stainless steel valves for Long Life!
- 8 new valve springs for improved performance and longer valve life
- 8 new valve retainers
- 16 new valve keepers

\$139.95 per set

Single Lock Adjustable Lifters



Standard / T-3058-F
 .452" dia. / T-3058-G*
 .467" dia. / T-3058-H*
 *Oversize to fit worn blocks
Made in the USA!

\$125.00 set of 8

Hardened Model T Valve Seats

- New style valve seats improve engine performance
- Hardened valve seats last twice as long
- No need to use fuel additives

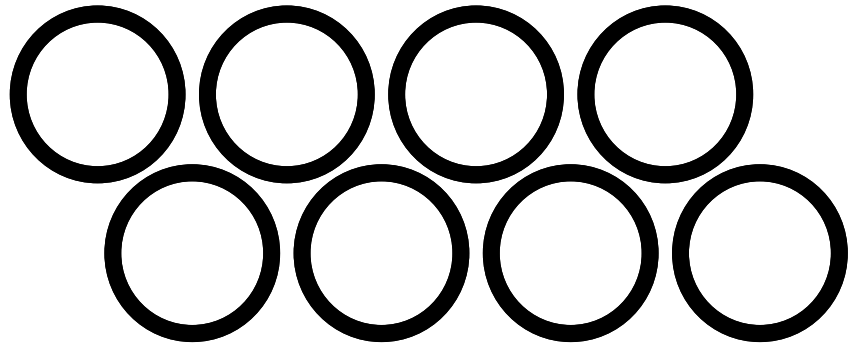

\$40.00 set of 8

Visit us on the web:
ronsmachineshop.com

E-mail your questions to:
ronsmachineshop@fuse.net

Phone: 513-738-7353 • Fax: 513-738-0300



Connecting Rods, Pistons and Rings for Model T

Model T Rod Sets

- Each set is matched by weight
- All new lead free babbitt
- Better than original
- Journal cut to any size
- Choice of "X" grooved or standard

\$375.00 per set*

*Sold on exchange only. Exchange rods must be light weight with matched cap.



Aluminum Pistons Made in the USA!

- Sold in sets from Standard to .125" OS
- Complete with wrist pins
- Gives better pickup than cast iron pistons
- Better performance and less stress

\$150.00 set of 4

*Grant or Hasting Rings Available

Model T Main Caps

Babbitt cut to any size you need

Rear Main Cap	\$75.95
Center Main Cap	\$67.95
Front Main Cap	\$67.95

*exchange price



Visit us on the web:
ronsmachineshop.com

E-mail your questions to:
ronsmachineshop@fuse.net



Timing Gears, Cams and Camshaft Bearings for Model T

Timing Gears

Made in the USA!

- Accurately Machined
- Much stronger than fiber gears
- Better performance with higher horsepower engines
- Aluminum gear will run a little quieter than Bronze Gear

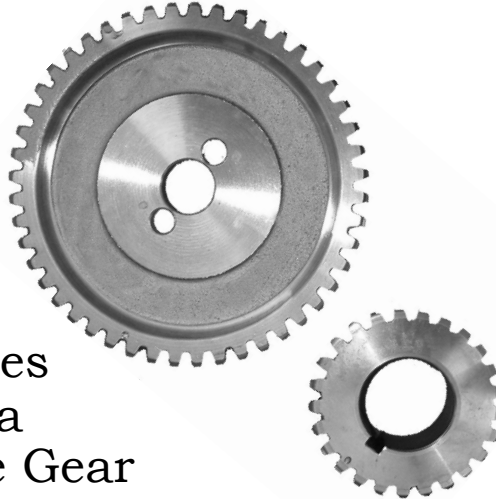

Aluminum
\$60.00 each

Bronze
\$175.00 each
(limited availability)

Nylon
\$64.95 each
(STD or Advanced Timing available)

Steel Crank Gear
\$20.00 each

Camshafts Made in the USA!



Stock Grind \$125.00

- Just like it came from the factory

*exchange price

The New 250 Grind

- A new cam ground slightly better than stock
- Close to original

The New 280 Grind

- Much more superior than stock grind
- Better performance on hills and flat ground

The New 290 Grind

- Higher lift for more performance

Cam Bearings

Made to FORD blue prints at Ron's Machine Shop!

Front Cam Bearing 1909-24 (long) T-3042
 Front Cam Bearing 1925-27 (short) T-3042-B
 Center Cam Bearing 1909-27 T-3043

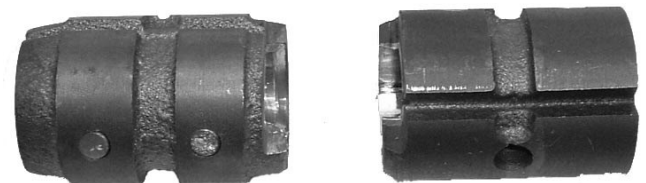

\$165.00 each
All New Casting & Babbitt
No core required



Rear Cam Bushing 1909-27
Bronze with Oil Grooves
\$45.95 each

Visit us on the web:
ronsmachineshop.com

E-mail your questions to:
ronsmachineshop@fuse.net

Phone: 513-738-7353 • Fax: 513-738-0300



Short Block

Your Model T Engine Rebuilt!

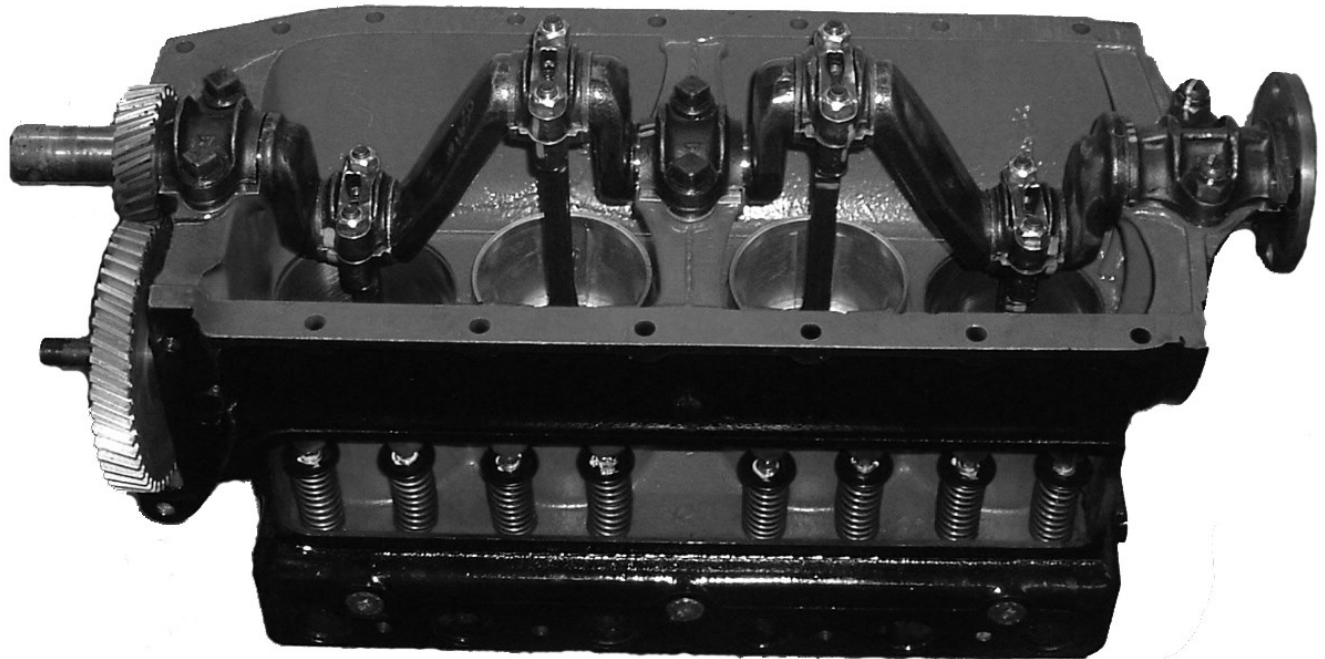

Complete short block for \$3525.00*

- Disassemble
- Degrease
- Magnaflux Block
- Resurface Block
- Paint
- Bore and Hone Cylinders
- New Aluminum Pistons and Rings
- Pour and Align Bore Mains
- New Stainless Steel Valves
- Install Alloy Valve Seats
- New Adjustable Lifters
- Re grind Camshaft
- New Cam Bearings and Bushing
- Re grind Crankshaft
- New Aluminum Timing Gear
- New Steel Crankshaft Gear
- Rebabbitt Rods, X'ed Oil Grooves with Dippers

*Please note that NOT included in a Short and Long Block prices are crack repair, repair of broken head studs and cylinder sleeving. If a block is not rebuildable, a fee is charged for disassembly, cleaning, hot tank and magnaflux.

Engines which are installed and maintained according to our instructions include a one year warranty. If there is any problem with an engine, it must be returned to us at customer's expense. We are not responsible for any labor due to removing and installing the engine. If we find that the problem is due to our workmanship, we will repair or replace at no extra charge. Warranty begins on day of pickup.

Visit us on the web:
ronsmachineshop.com

E-mail your questions to:
ronsmachineshop@fuse.net

Phone: 513-738-7353 • Fax: 513-738-0300



Rebuilt Transmission for Model T

A rebuilt transmission will include:

1. Degreasing
2. Disassembly & inspection
3. Re-Bushing
4. Recharging of the magnets
5. Magnet assembly machined for easy installation
6. New ring gear
7. Rebuilt & Fully Balanced Flywheel
8. New clutch spring reduces slipping in high gear
9. New Jack Rabbit Clutch for a more positive neutral
10. Polished drums to increase band life
11. Rebabbitted ball cap
12. **Balanced, Assembled & adjusted**

Add \$2500.00
New T Drums and Gears, Shaft, Triple Gears and Driven Gear



\$1950*

*Rebuild your Transmission

*If a core is not rebuildable, a fee is charged for disassembly, cleaning, hot tank and magnaflux.



Kevlar Band Linings

- Made of 100% Dupont Kevlar
- Woven like original cotton bands
- Withstand temperatures of up to 450 degrees
- Offers smooth positive action
- Will not wear drums prematurely
- Adjustment is seldom required
- Possibly the last set you will ever need!

1909-25 Set / T-3416-K \$135.00
1926-27 Set / T-3416-DK \$150.00

4th Main Bearings

Babbitt cut to any size you need



\$110.00 each

Model T Ball Cap Dimensions

Size	I.D.	Shaft Size
STD	1.564	1.558-1.561
.003	1.561	1.555-1.558
.005	1.559	1.553-1.556
.010	1.554	1.548-1.551

*Ford Specified .004-.006 clearance

Visit us on the web:
ronsmachineshop.com

E-mail your questions to:
ronsmachineshop@fuse.net

Phone: 513-738-7353 • Fax: 513-738-0300



Full Block

Your Model T Engine Rebuilt!

Includes Short Block Assembly and Transmission Assembly plus:

- Gasket Set
- Rebuilt Magneto Coil
- Set Clearance between Magneto Coil and Magnets
- Straighten Oil Pan on KRW Fixture
- New Large Inside Oil Tube for increased volume to front of engine
- Disassemble, Clean, Paint, Assemble Hogshead and Pedals
- New Pedal Springs
- New Band Nuts and Washers
- New Slow Speed Connector
- New Kevlar Band Set installed
- Magnaflux and Resurface Head, install with new Bolts and Copper Head Gasket
- New Cam Nut
- New Aluminum Adjustable Front Crank Pulley
- Modern Oil Seals
- Drain Plug with Copper Gasket
- Clean, inspect, and Paint all covers and Install
- Fully Assembled with Correct Colors
- All New Hardware or restored original, your choice

‡Price does not include starter, generator, carburetor, timer, manifolds, etc. All options are extra.



Completely Assembled, Adjusted, **Balanced Engine** and Transmission ready for Installation.

\$5975.00‡ base price

*Please note that NOT included in a Short and Long Block prices are crack repair, repair of broken head studs and cylinder sleeving. If a block is not rebuildable, a fee is charged for disassembly, cleaning, hot tank and magnaflux.

Engines which are installed and maintained according to our instructions include a one year warranty. If there is any problem with an engine, it must be returned to us at customer's expense. We are not responsible for any labor due to removing and installing the engine. If we find that the problem is due to our workmanship, we will repair or replace at no extra charge. Warranty begins on day of pickup.

Visit us on the web:
ronsmachineshop.com

E-mail your questions to:
ronsmachineshop@fuse.net

Phone: 513-738-7353 • Fax: 513-738-0300



Miscellaneous Model T Prices

Install O.S. Pedals Shafts.....325.00
Includes: O.S shafts, seals and labor

Install STD Pedal Shafts.....125.00
includes: shaft, roll pins, seals, labor

 Install Std. Pedal Shaft (each).....45.00

 Install O.S Pedal Shaft (each).....110.00

Ball Joint Repair on oil pan.....200.00

Repair Oil Pan on original KRW Fixture. Hourly
Aluminum Head

Prus Model T Head 8:1.....425.00

Rebuilt Carburetor

 NH 1919-25 (core required).....125.00

 NH 1926-27 (core required).....130.00

Texas T Distributor.....329.95

Wire kit, plug holders,
coil and bracket.....50.95

TW Brush Style Timer.....84.95

Anderson Timer.....64.95

New Exhaust Manifold.....85.00

High Volume Aluminum Intake.....99.00

Rebuilt Model T Wood Coils.....69.95
Rebuildable core required .

Rebuilt Rear Axle (base price)3000.00
Includes stock parts and labor
Rebuildable core required .

Scat Crankshaft Forged Counterbalanced

 Stock, undrilled.....1695.00

 Stock, drilled.....1950.00

 Stroker, undrilled.....1695.00

 Stroker, drilled.....1950.00

Heavy Duty Main Caps.....250.95

Heavy Duty Main Bolts.....99.95

Oil Pan Spacer for Scat Stroker.....125.00

Rebuilt Model T Field Coil Single Stack....295.00

Balanced T Flywheel.....125.00

New Slow T Drum old gear.....325.00

New Reverse Drum old gear.....325.00

New Brake Drum old gear 09-25...450.00

New Brake Drum old gear 26-27....500.00

 Install New Drums
 with old gears (each).....30.00

New Slow Speed Drum.....725.00

New Reverse Speed Drum.....740.00

New Brake Drum 09-25.....840.00

New Brake Drum 26/27.....845.00

Rebuilt Starter (core required).....325.00

Rebuilt Generator(core required)....325.00



God Bless America!

Here at Ron's Machine Shop we strive at buying or making high quality parts for the engines we rebuild.

Prices subject to change without notice

Visit us on the web:
ronsmachineshop.com

E-mail your questions to:
ronsmachineshop@fuse.net

Phone: 513-738-7353 • Fax: 513-738-0300



Annual Car Show Salty Dog Museum

SHANDON STRAWBERRY FESTIVAL

CAR SHOW

2ND SATURDAY OF JUNE

SHANDON, OHIO

NORTHWEST OF CINCINNATI

8:00 AM - 4:00 PM

Hosted in conjunction with the
Historic Shandon Strawberry Festival
featuring homemade ice cream and
strawberry shortcake, antiques, crafts, and gifts.



**OPEN TO ALL ANTIQUE,
CLASSIC AND CUSTOM CARS**

FREE DASH PLAQUES

FREE REGISTRATION

FREE DOOR PRIZES

For more information call 513-738-7353
ronsmachineshop@fuse.net
visit: saltydogmuseum.com

Located at Ron's Machine Shop
4995 Cincinnati-Brookville Road
Shandon, OH 45063

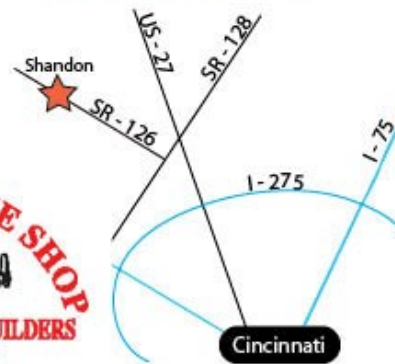

Visit the Salty Dog Museum located right next door to Ron's Machine Shop in
Shandon, OH. Dedicated to Preserving the History of the Antique Car Hobby.

www.saltydogmuseum.com

Visit us on the web:
ronsmachineshop.com

E-mail your questions to:
ronsmachineshop@fuse.net



Valve Kits for Model A and B

Improves Performance and Increases Horsepower!

Big Valve Kit*

- 4 Big Stainless Valves for more airflow: 0.167" larger
- 4 STD stainless size valves
- One piece USA valve guides for more accurate valve performance
- 16 new valve keepers
- 8 new valve retainers

Complete Big Valve Set for
\$210.00



Improved Modern Valve Kit

- All the parts you need to redo your valves
- No machining required
- One piece USA valve guides for more accurate valve performance
- 16 new valve keepers
- 8 new valve retainers
- 8 new stainless valves

Complete Modern set for
\$195.00

*Big valves are 0.167" larger than standard valves to increase air flow into the engine.

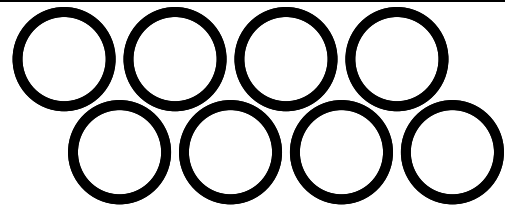

Model A Hardened Valve Seats sold separately for stock or big valve kits

\$35.00 per set of 8

Visit us on the web:
ronsmachineshop.com

E-mail your questions to:
ronsmachineshop@fuse.net

Phone: 513-738-7353 • Fax: 513-738-0300



Oil Pump and Pressure Plate for Model A and B

Rebuilt Model A and Model B Oil Pump

- Rebuilt high volume oil pump
- New bushings
- New spring
- New gears and shaft
- Plate refaced
- Ready to install



High Volume Oil Pump Rebuild Kit Includes:

- New gears with high volume shaft
 - New bushings
- \$45.00 per kit

Ready to install for only
\$175.00* each

*Rebuildable core required.

Rebuilt Model A Pressure Plate

Rebuilt and ready to install for only

\$185.00* each

*Rebuildable core required.

New clutch disc only
\$38.50



Visit us on the web:
ronsmachineshop.com

E-mail your questions to:
ronsmachineshop@fuse.net



Flywheels for Model A and B

- 7 lbs. lighter than a stock Model A flywheel
- Resurfaced for better clutch performance
- Balanced to reduce vibration
- New ring gear for better starting
- New 8N Ford 3 finger V-8 pressure plate
- New clutch disc
- New pilot bearing

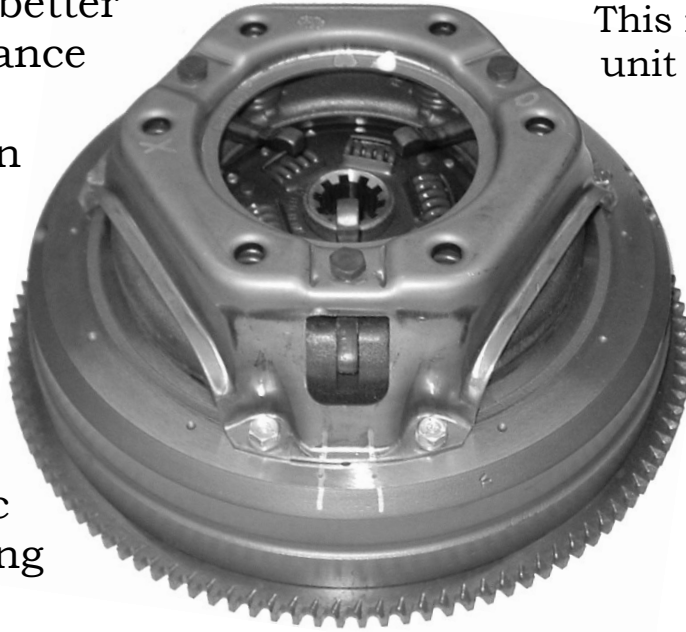

V-8 Flywheel Conversion for Model A and Model B

This is a dynamically balanced unit with flywheel, clutch disc and pressure plate.

The entire unit for only

\$455.00*

*with a rebuildable core exchange



Stock Model A or Model B Flywheel

- Rebuilt pressure plate
- New clutch disc
- Ground and dynamically balanced
- New ring gear
- New pilot bearing

\$350.00*

Visit us on the web:
ronsmachineshop.com

E-mail your questions to:
ronsmachineshop@fuse.net

Phone: 513-738-7353 • Fax: 513-738-0300



Model A and Model B Crankshafts

Standard and Counter Balanced



Counter Balanced
\$1700 New SCAT

- Reground rod and main bearing journals to provide a longer bearing life
- Journals designed for use with babbitt or insert bearings
- Dynamically balanced for a smoother running engine
- Counter balanced to reduce vibration
- Flange ground to ensure flywheel alignment and reduce vibration

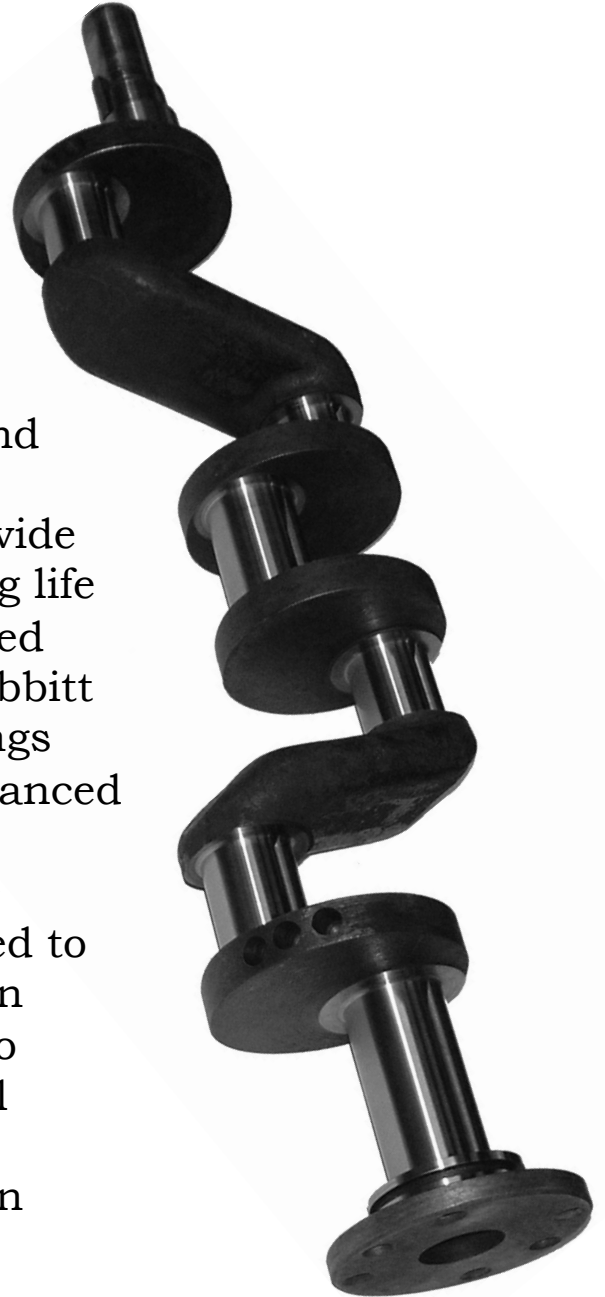

Stock Reground
\$250.00 core required

Visit us on the web:
ronsmachineshop.com

E-mail your questions to:
ronsmachineshop@fuse.net



Rod Sets for Model A and Model B

Connecting Rods with



- **Matched by weight to reduce vibration**
- Complete with new wrist pin bushings
- All new Lead Free Babbitt
- Better than original
- Babbitt Bearing cut to any size

\$375.00 per set*

*exchange price

Visit us on the web:
ronsmachineshop.com

E-mail your questions to:
ronsmachineshop@fuse.net

Phone: 513-738-7353 • Fax: 513-738-0300



High Compression Heads for Model A

High Compression Head

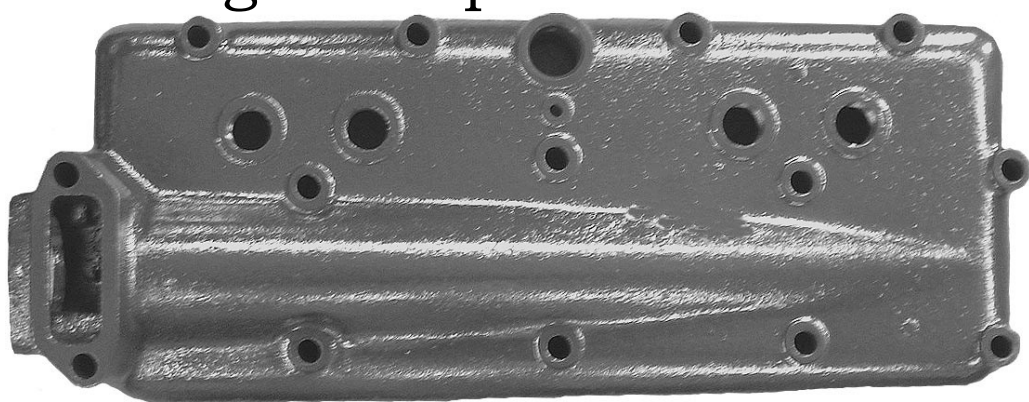

Give your Model A a little more power to make it over the hills.

Police Style
5.5:1 Compression
or 6:1 Compression
\$350.00

- Cast Iron •Original appearance
- No modifications required to engine

Est. 1981 - "Over 35 Years Serving the Antique Car Hobby!"

Thank You!



Salty Dog Museum

Dedicated to keeping the Antique Car Hobby going for future Generations down the road.
(2017 Lizzy & Clara Miller)
We are very active in our local Model T Club chapter and National clubs. Please say Hi when you see us on Tour!



BUILDING ENGINES THAT LAST IS WHAT WE DO BEST!

Shop: 513-738-7353
4995 Cincinnati-Brookville Road
PO BOX 114 Shandon, OH 45063
ronsmachineshop@fuse.net
BJ & Casey Miller
ronsmachineshop.com



Tickin' Through Time
Est. 2006 Manufactured by Casey Miller
Maker's of the Original
Hidden Turn Signal Kit for
Antique Cars
Keep your car safer and more enjoyable!
Contact Casey @ Ron's for more information or visit our website

Come check us out at Hershey Fall Swap Meet C4Y 27-31

Visit us on the web:
ronsmachineshop.com

E-mail your questions to:
ronsmachineshop@fuse.net



Insert Bearings

Your Model A or Model B Engine

Completely
Inserted

Model A
Short Block or
Full Block

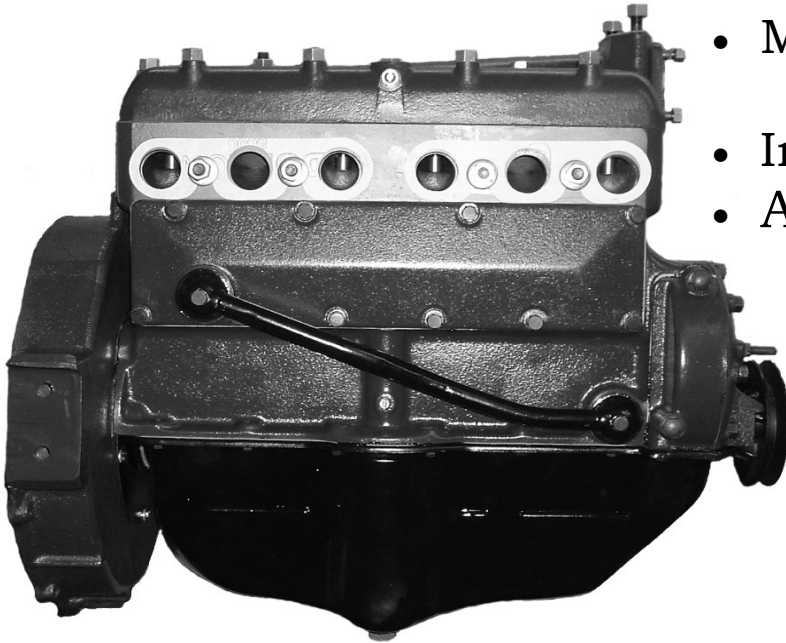

Full Block
\$4800.00

Full Pressure Available
Call for information

Includes all standard short block or full block plus:

- Surface Oil Pan Rails for total alignment
- Drill Location Pins in Main Caps to hold bearing location
- Align Bore to accept Inserts
- Machine End Locks in Block to hold insert bearings in place
- Install Bronze Thrust Plates
- All New Inserted Rods

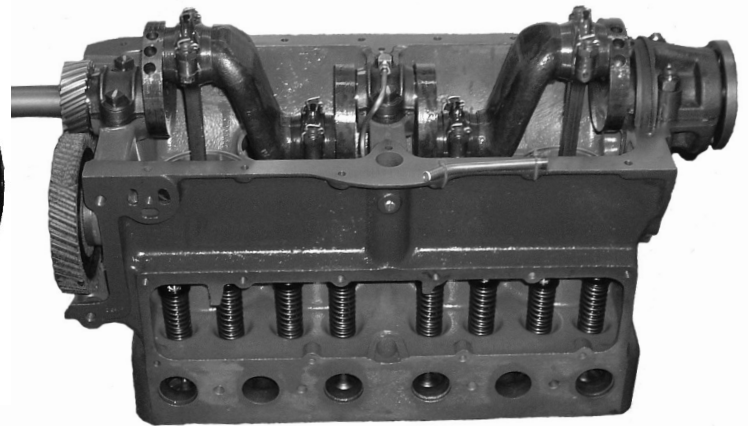

Short Block
\$4350.00

Engines which are installed and maintained according to our instructions include a one year warranty. If there is any problem with an engine, it must be returned to us at customer's expense. We are not responsible for any labor due to removing and installing the engine. If we find that the problem is due to our workmanship, we will repair or replace at no extra charge. Warranty begins on day of pickup.

Visit us on the web:
ronsmachineshop.com

E-mail your questions to:
ronsmachineshop@fuse.net

Phone: 513-738-7353 • Fax: 513-738-0300



Short Block

Your Model A or Model B
Engine Rebuilt

Complete
Model A or Model B
Short Block
for
\$3295.00

Babbitt
Bearings

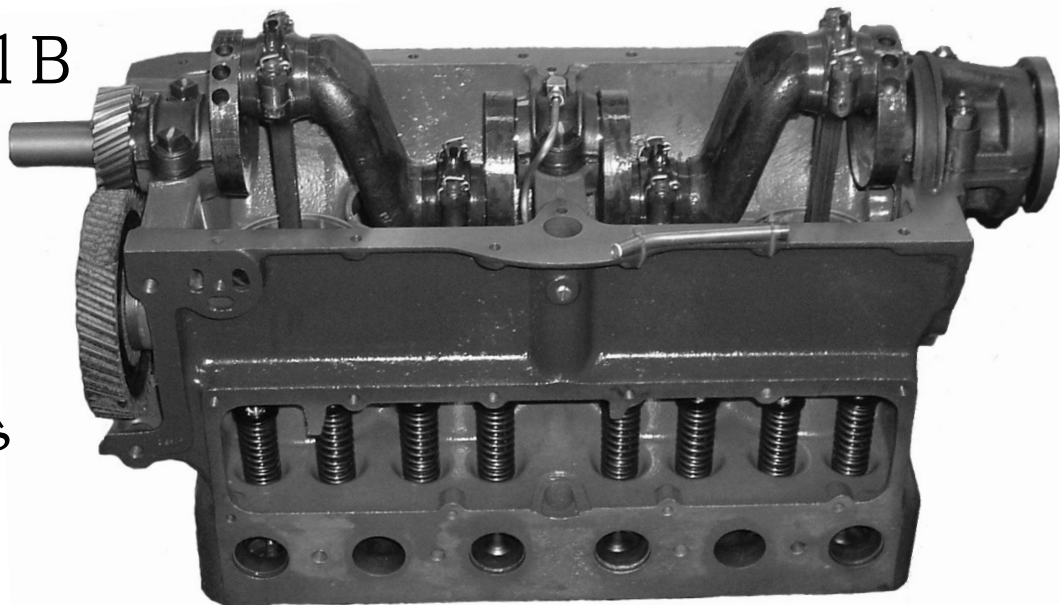

Includes:

- Disassembled
- Cleaned and Magnafluxed
- Block Blast Beaded
- Resurfaced
- Block Bored and Honed
- Rebabbitted & Align Bored
- New Pistons, Pins and Rings
- New Shims
- 8 Hardened Valve Seats
- Stainless Steel Valves
- One Piece Valve Guides
- New Retainers, Keepers, Valve Springs
- New Self Locking Adjustable Tappets
- Reground Crankshaft
- Reground Camshaft (Touring Grind Cam)
- New Cam Nut
- New Crankshaft and Camshaft Gears
- Oil Line to Center Main Bearing
- Painted Antique Ford

*Please note that NOT included in a Short and Long Block prices are crack repair, repair of broken head studs and cylinder sleeving. If a block is not rebuildable, a fee is charged for disassembly, cleaning, hot tank and magnaflux.

Engines which are installed and maintained according to our instructions include a one year warranty. If there is any problem with an engine, it must be returned to us at customer's expense. We are not responsible for any labor due to removing and installing the engine. If we find that the problem is due to our workmanship, we will repair or replace at no extra charge. Warranty begins on day of pickup.

Visit us on the web:
ronsmachineshop.com

E-mail your questions to:
ronsmachineshop@fuse.net

Phone: 513-738-7353 • Fax: 513-738-0300



Long Block

Your Model A or Model B
Engine Rebuilt

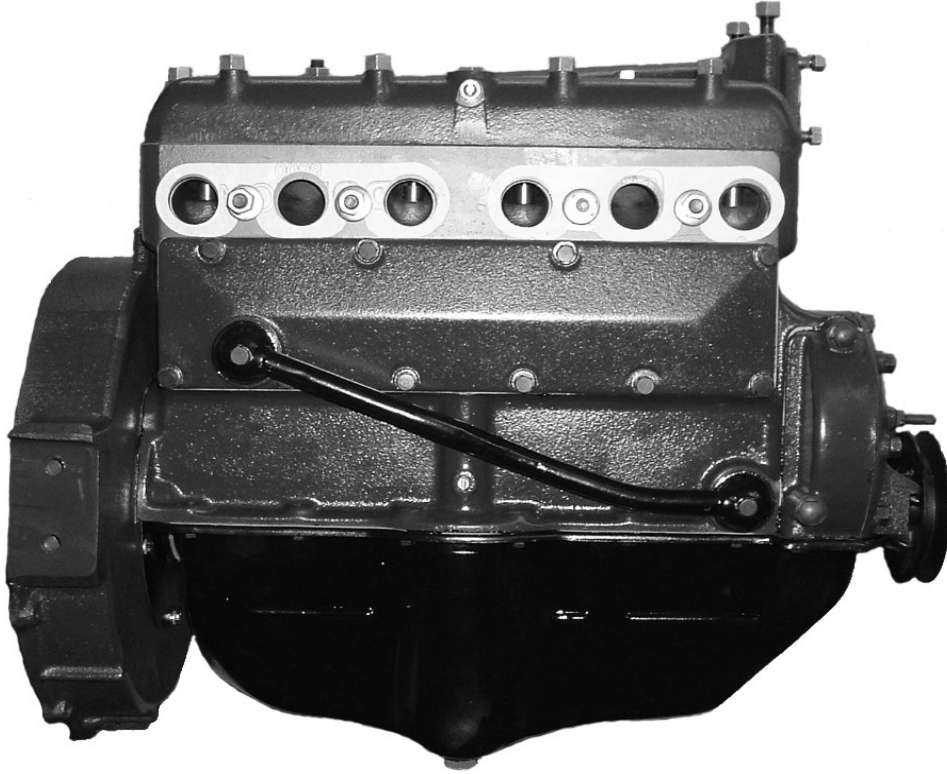

Complete
Model A
or
Model B
Full Block
for
\$3895.00

*Babbitt
Bearings*

Includes short block plus:

- New head studs and manifold studs, washers, nuts and bolts
- Clean, Resurface, Magnaflux, Paint and Install Cylinder Head
- New Gasket set with best quality Head Gasket
- Rebuilt High Volume Oil Pump and Drive Gear
- Install New Crank Pulley and Ratchet Nut
- Clean, Hot Tank, Paint and Install Valve Cover, Front Covers, Oil Pump, Oil Pan and Oil Return Tube
- Assembled with correct colors and finishes on all components

*Please note that NOT included in a Short and Long Block prices are crack repair, repair of broken head studs and cylinder sleeving. If a block is not rebuildable, a fee is charged for disassembly, cleaning, hot tank and magnaflux.

Engines which are installed and maintained according to our instructions include a one year warranty. If there is any problem with an engine, it must be returned to us at customer's expense. We are not responsible for any labor due to removing and installing the engine. If we find that the problem is due to our workmanship, we will repair or replace at no extra charge. Warranty begins on day of pickup.

Visit us on the web:
ronsmachineshop.com

E-mail your questions to:
ronsmachineshop@fuse.net

Phone: 513-738-7353 • Fax: 513-738-0300



Over 90 Years and 4 Generations Later...We Keep the Engines Going!



Visit us on the web:
ronsmachineshop.com

E-mail your questions to:
ronsmachineshop@fuse.net



Miscellaneous Model A Prices

Rebuilt A Distributor.....150.00
with modern points .

A&B Pour and Cut Main Caps.....250.00
Includes: rear, center and front

A&B Rear Main Cap poured only.....50.00

A&B Front/Center Cap poured only.....40.00

A&B Rear Main Cap poured and cut.....95.00

A&B Front/Center Cap poured and cut...80.00
*Note to cut to size we set up Model A Block
on the Precision Line Boring Machine to cut
the main caps .

Install Insert Mains.....950.00
(Includes: Bearings, Pin Caps, Resurface Pan Rails) .

Counter-Balance Crankshaft Only.....725.00
(Not Ground Not Balanced)

Larger Performance Intake Valves:.....225.00
Stainless Valve installed in block

King Pin R&R (parts not included).....65.00

Rebuilt Bell Housing.....275.00
Includes: pedal/clutch, shaft & bushings

Rebuilt Transmission (core required)....1500.00
Tower is rebuilt with new lever, spring, retainer,
and plunger kit. The balance of the transmission is
rebuilt using all new components. Drain plug is in-
cluded.

Rebuilt Transmission Tower.....250.00
(Core required) .

Rebuilt Starter 6Volt (core required).....250.00

Rebuilt Starter 12 Volt (core required).....250.00

Rebuilt Starter with Bendix.....add 45.00

Rebuilt Generator (core required).....250.00

New Leakless Waterpump.....150.00

Scat Model A Crankshafts Forged.....1695.00
Counter Balanced drilled, undrilled, stock or
stroker .

New Exhaust Manifold.....100.00

New Intake Manifold.....95.00

Rebuilt Zenith Carburetor.....250.00
(core required) .

Electric Fuel Shut Off Kit.....129.00
Model A Ford 28-31 & Late 31 .

Hidden Turn Signal Kit.....180.00
6V+or-/12V-or+ available .



**Here at Ron's Machine Shop we strive at buying or making high quality parts
for the engines we rebuild.**

Prices subject to change without notice

Visit us on the web:
ronsmachineshop.com

E-mail your questions to:
ronsmachineshop@fuse.net

Phone: 513-738-7353 • Fax: 513-738-0300



Shop Services and Parts

We rebuild all types of Antique Engines.

Please call Casey to get a price on your next engine or project.

Engine Blocks (4 Cyl.) (call for larger size engines)

Hot Tank	\$ 50.00
Bead Blast	\$ 60.00
Bore and Hone per cylinder	\$ 55.00
Hone Only per cylinder	\$ 25.00
Sleeve per Cylinder	\$150.00
Resurface	\$ 85.00
Helicoils for 1st	\$ 45.00
thereafter	\$ 25.00
Install Valve Seats (each)	\$ 15.00
Install Valve Guides (each)	\$ 10.00
Install Valve Guide Liner	\$ 25.00
Model T,A&B Valve Job	\$175.00
Magnaflux	\$ 30.00
Pour and Align Bore (T, A & B*)	\$875.00
Includes center oil line on Model A	
*Line Bore Other Blocks	Hourly
Pour Main Bearing Shell (pair)	\$ 85.00

Connecting Rods

Float Pin to Rod (each)	\$ 25.00
Recondition Rods (each)	\$ 50.00

Cylinder Heads (4 Cyl.) (call for larger size head work)

Hot Tank	\$ 30.00
Bead Blast	\$ 35.00
Magnaflux	\$ 20.00
Resurface	\$ 75.00
4Cyl. Valve Job	\$200.00
Most V6 Valve Job	\$300.00
Most V8 Valve Job	\$400.00

Assemble Complete Engine Hourly

We have the most complete rebabbiting facilities in the country, with all the necessary equipment and machinery to handle almost any babbitting of mains and rods for antique, classic and obsolete engines. Our expert, experienced machinists produce a guaranteed, quality product we know will please you.

Intake & Exhaust Manifold

Resurface Model A	\$ 125.00
Other Manifolds	Hourly

Crack Repair (per inch) \$ 70.00

Flywheel

2 Step (Model A)	\$ 85.00
Flat Flywheel	\$ 70.00
Balance with clutch	\$ 95.00
Clutch Disc	\$ 40.00



Please stop by when you are in the Cincinnati area. We love for customers to check us out and get to see all of us here in action. With the Salty Dog Museum next door to us we have a great place to see how we keep the antique car hobby going and as well as preserving the antique car hobby for future generations. This wouldn't be possible without our customers. Thank you!

Visit us on the web:
ronsmachineshop.com

E-mail your questions to:
ronsmachineshop@fuse.net



Specialty Connecting Rods

We can pour nearly any size
connecting rod or
main bearing for early cars,
tractors and
stationary engines!

Oldsmobile, Chevrolet, Packard, John Deere,
and many others



Non-FORD **Rod Pricing:**

Up to 2" \$110.00_{ea}

2" to 3" \$155.00_{ea}

3" to 4" \$200.00_{ea}

One-time Set-Up Fee \$150.00
Call for larger size pricing.

*Extra charges may apply for hinge
rods and wrist pin bushing work

Visit us on the web:
ronsmachineshop.com

E-mail your questions to:
ronsmachineshop@fuse.net

Phone: 513-738-7353 • Fax: 513-738-0300

Specialty Engines

Building engines that last is what we do best!

Since 1981 our shop has been serving the antique car hobby with a top of the line Babbitt shop and full service machine shop.

Call Casey for a quote on rebuilding your antique car or fire truck or tractor engine. Visit us on Facebook for more pictures and what's happening at the shop!



1938 Steyr



1909 Oldsmobile



**Model B
with
Riley
2 Port**

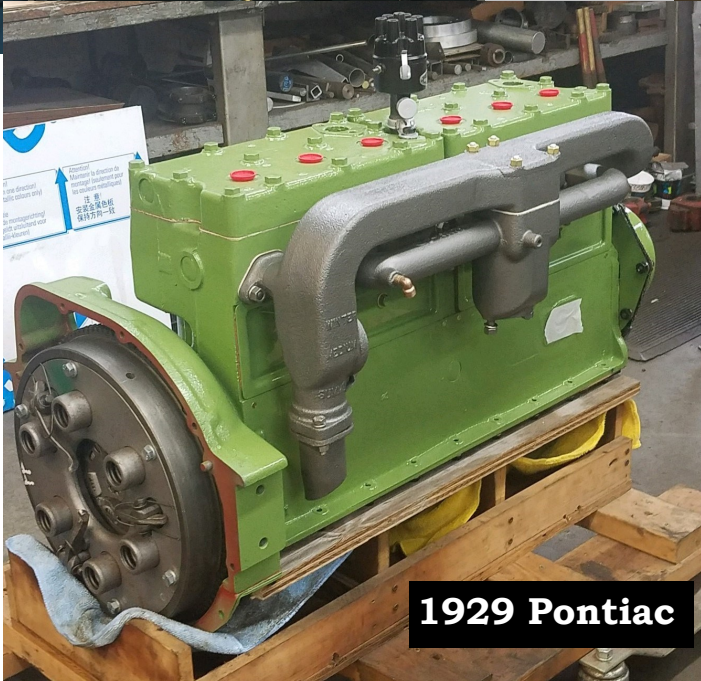

1929 Pontiac



Hall-Scott