



Please write clearly in block capitals.

Centre number

Candidate number

Surname _____

Forename(s) _____

Candidate signature _____

A-level PHYSICS

Paper 1

Thursday 15 June 2017

Morning

Time allowed: 2 hours

Materials

For this paper you must have:

- a pencil and a ruler
- a scientific calculator
- a Data and Formulae booklet.

Instructions

- Use black ink or black ball-point pen.
- Fill in the boxes at the top of this page.
- Answer **all** questions.
- You must answer the questions in the spaces provided. Do not write outside the box around each page or on blank pages.
- Do all rough work in this book. Cross through any work you do not want to be marked.
- Show all your working.

Information

- The marks for questions are shown in brackets.
- The maximum mark for this paper is 85.
- You are expected to use a scientific calculator where appropriate.
- A Data and Formulae Booklet is provided as a loose insert.

For Examiner's Use	
Question	Mark
1	
2	
3	
4	
5	
6	
7	
8–32	
TOTAL	



J U N 1 7 7 4 0 8 1 0 1

Section A

Answer **all** questions in this section.

0 1

An isotope of potassium ${}_{19}^{40}\text{K}$ is used to date rocks. The isotope decays into an isotope of argon (Ar) mainly by electron capture.

0 1 . 1

The decay is represented by this equation:

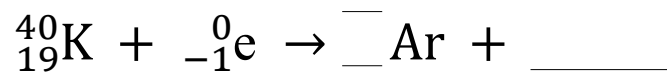

Complete the equation to show the decay by filling in the gaps.

[2 marks]

0 1 . 2

Explain which fundamental interaction is responsible for the decay in question 01.1.

[2 marks]

0 1 . 3

One decay mechanism for the decay of ${}_{19}^{40}\text{K}$ results in the argon nucleus having an excess energy of 1.46 MeV. It loses this energy by emitting a single gamma photon.

Calculate the wavelength of the photon released by the argon nucleus.

[3 marks]

wavelength = _____ m



0 1 . 4

The potassium isotope can also decay by a second decay process to form a calcium-40 nuclide (${}^{40}_{20}\text{Ca}$).

Suggest how the emissions from a nucleus of decaying potassium can be used to confirm which decay process is occurring.

[3 marks]

10

Turn over for the next question

Turn over ►



0 2

Figure 1 shows an arrangement used by a student to investigate vibrations in a stretched nylon string of fixed length l . He measures how the frequency f of first-harmonic vibrations for the string varies with the mass m suspended from it.

Figure 1

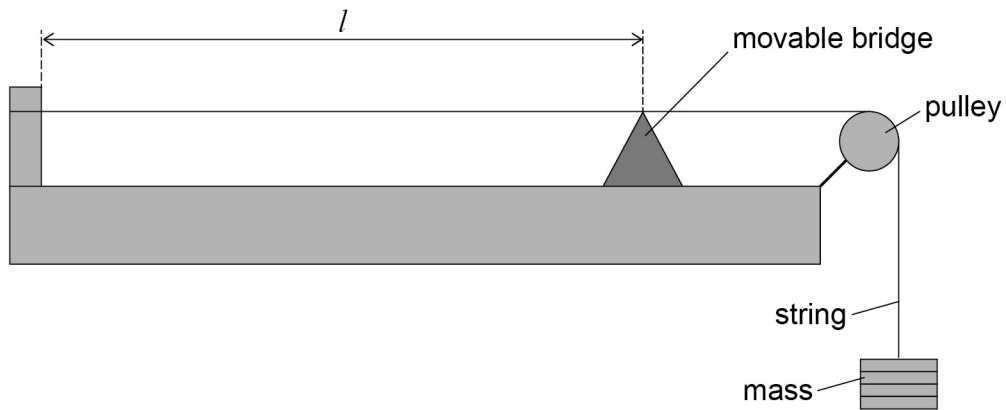

Table 1 shows the results of the experiment.

Table 1

m / kg	f / Hz
0.50	110
0.80	140
1.20	170

0 2 . 1

Show that the data in **Table 1** are consistent with the relationship

$$f \propto \sqrt{T}$$

where T is the tension in the nylon string.

[2 marks]



0	2	.	2
---	---	---	---

The nylon string used has a density of 1150 kg m^{-3} and a uniform diameter of $5.0 \times 10^{-4} \text{ m}$.

Determine the length l of the string used.

[3 marks]

$l =$ _____ m

0	2	.	3
---	---	---	---

The student uses the relationship in question **02.1** to predict frequencies for tensions that are much larger than those used in the original experiment.

Explain how the actual frequencies produced would be different from those that the student predicts.

[2 marks]

7

Turn over ►



0	3
---	---

Figure 2 shows a ray of monochromatic green light incident normally on the curved surface of a semicircular glass block.

Figure 2

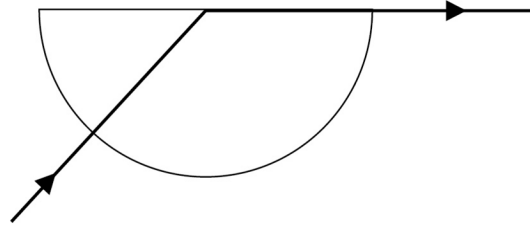

0	3	.	1
---	---	---	---

The angle of refraction of the ray at the plane surface is 90° .

Refractive index of the glass used = 1.6

Calculate the angle of incidence of the ray on the flat surface of the block.

[1 mark]

angle of incidence = _____ degrees



0 3 . 2

A thin film of liquid is placed on the flat surface of the glass block as shown in Figure 3.

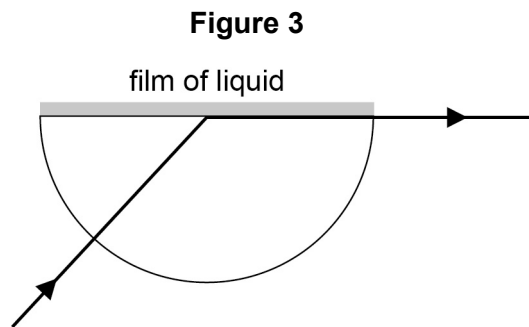

The angle of incidence is changed so that the angle of refraction of the green light ray at the glass–liquid interface is again 90° . The angle of incidence is now 58° .

Calculate the refractive index of the liquid.

[2 marks]

refractive index = _____

0 3 . 3

The source of green light is changed for one that contains only red and blue light. For any material red light has a lower refractive index than green light, and blue light has a higher refractive index than green light. The angle of incidence at the glass–liquid interface remains at 58° .

Describe and explain the paths followed by the red and blue rays immediately after the light is incident on the glass–liquid interface.

[3 marks]

6

Turn over ►



There are no questions printed on this page

**DO NOT WRITE ON THIS PAGE
ANSWER IN THE SPACES PROVIDED**



0 4

An engineer wants to use solar cells to provide energy for a filament lamp in a road sign.

The engineer first investigates the emf and internal resistance of a solar cell under typical operating conditions.

The engineer determines how the potential difference across the solar cell varies with current. The results are shown in the graph in **Figure 4**.

Figure 4

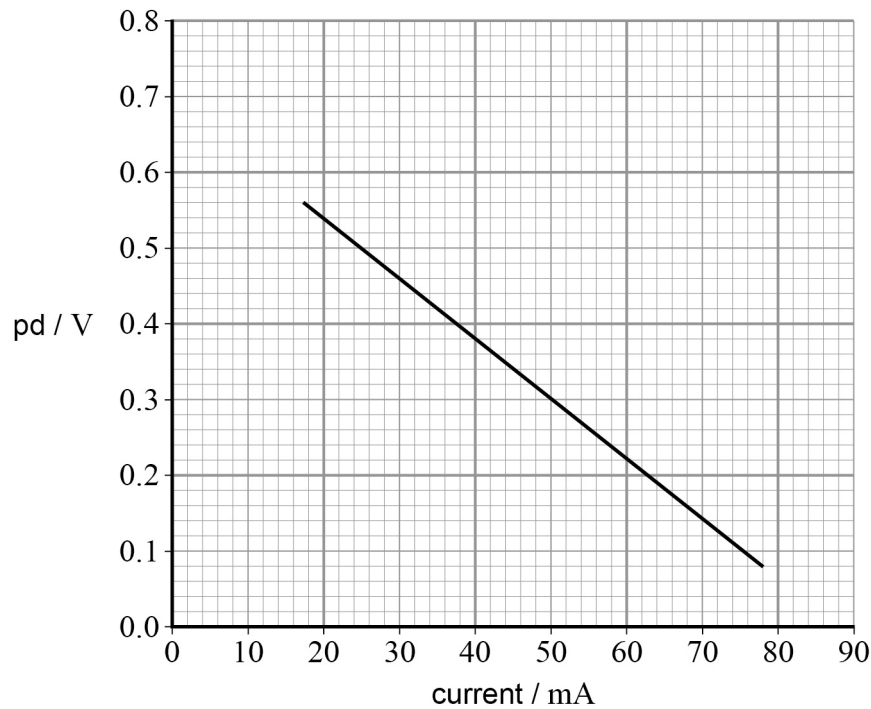

The engineer uses the graph to deduce that when operating in typical conditions a single solar cell produces an emf of 0.70 V and has an internal resistance of 8.0Ω .

0 4 . 1

Explain how the engineer uses the graph to obtain the values for the emf and internal resistance of the solar cell.

[2 marks]

Question 4 continues on the next page

Turn over ►



To operate effectively the lamp in the road sign needs a minimum current of 75 mA. At this current the resistance of the filament lamp is 6.0Ω .

The engineer proposes to try the two circuits shown in **Figure 5** and **Figure 6**.

Figure 5

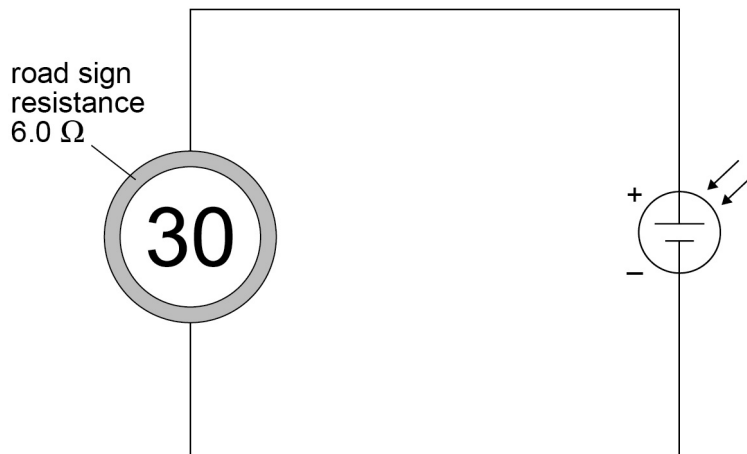
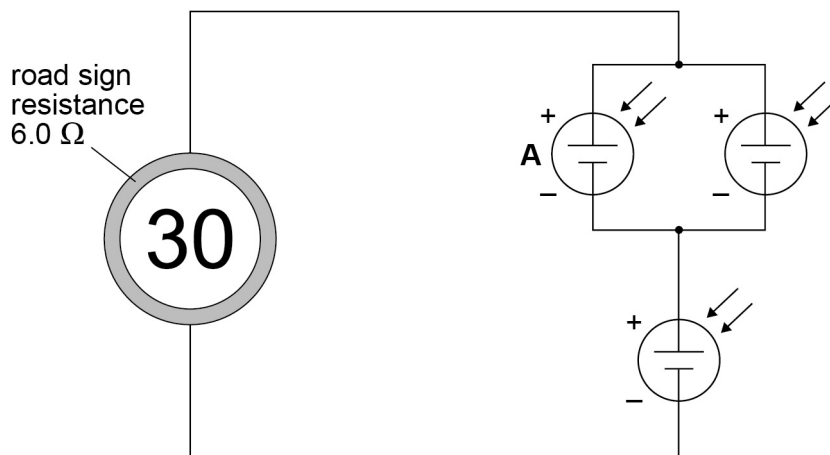

Figure 6



0 4 . 2

Deduce, using calculations, whether the circuits in **Figure 5** and **Figure 6** are suitable for this application.

[4 marks]

0 4 . 3

Solar cells convert solar energy to useful electrical energy in the road sign with an efficiency of 4.0%.

The solar-cell supply used by the engineer has a total surface area of 32 cm^2 .

Calculate the minimum intensity, in W m^{-2} , of the sunlight needed to provide the minimum current of 75 mA to the road sign when it has a resistance of 6.0Ω .

[3 marks]intensity = _____ W m^{-2}

9

Turn over ►

0 5

Figure 7 shows two of the forces acting on a uniform ladder resting against a vertical wall. The ladder is at an angle of 60° to the ground.

Figure 7

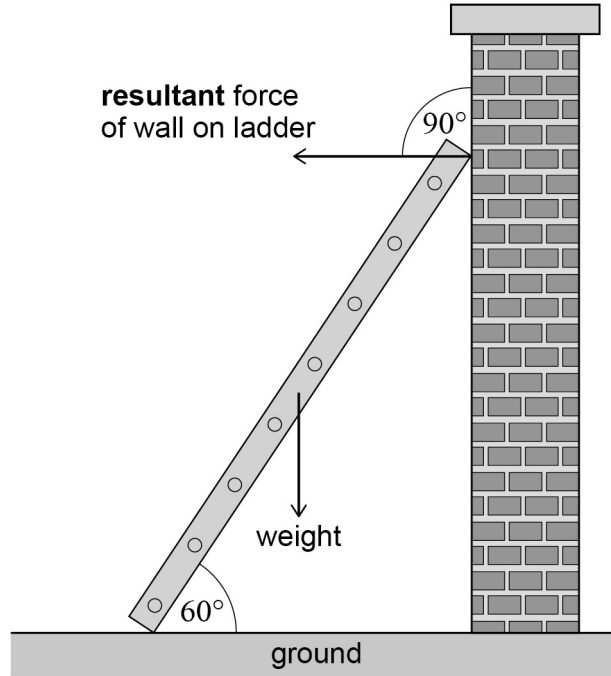

0 5 . 1

Explain how **Figure 7** shows that the friction between the ladder and the wall is negligible.

[1 mark]

0 5 . 2

The forces acting on the ladder are in equilibrium.

Draw an arrow on **Figure 7** to show the direction of the resultant force from the ground acting on the ladder. Label your arrow **G**.

[2 marks]



0 5 . 3

The ladder is 8.0 m long and weighs 390 N.

Calculate the magnitude of the resultant force from the wall on the ladder.

[2 marks]

resultant force = _____ N

0 5 . 4

Suggest the changes to the forces acting on the ladder that occur when someone climbs the ladder.

[3 marks]

8

Turn over ►



0 6

Figure 8 shows a model of a system being designed to move concrete building blocks from an upper to a lower level.

Figure 8

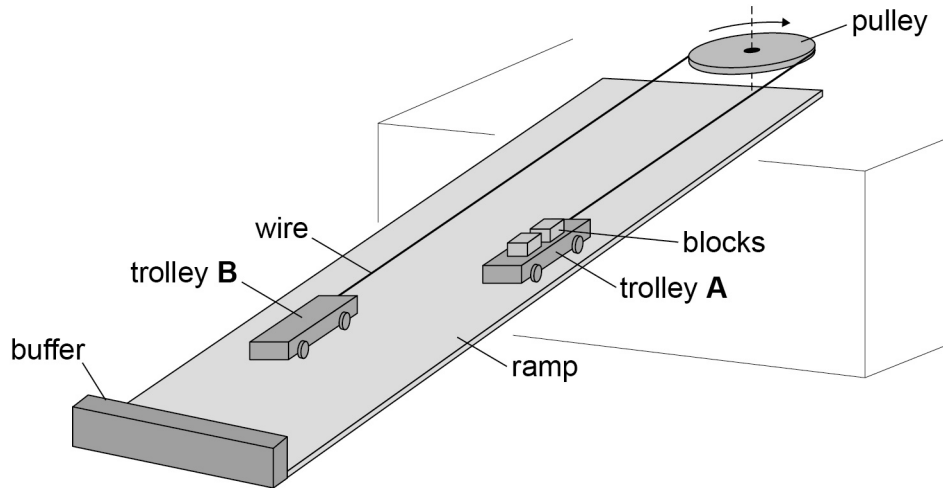

The model consists of two identical trolleys of mass M on a ramp which is at 35° to the horizontal. The trolleys are connected by a wire that passes around a pulley of negligible mass at the top of the ramp.

Two concrete blocks each of mass m are loaded onto trolley **A** at the top of the ramp. The trolley is released and accelerates to the bottom of the ramp where it is stopped by a flexible buffer. The blocks are unloaded from trolley **A** and two blocks are loaded onto trolley **B** that is now at the top of the ramp. The trolleys are released and the process is repeated.

Figure 9 shows the side view of trolley **A** when it is moving **down** the ramp.

Figure 9

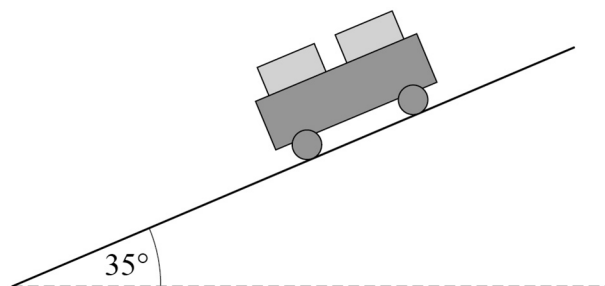

0 6 . 1

The tension in the wire when the trolleys are moving is T .

Draw and label arrows on **Figure 9** to represent the magnitudes and directions of any forces and components of forces that act on trolley **A** parallel to the ramp as it travels down the ramp.

[1 mark]

0 6 . 2

Assume that no friction acts at the axle of the pulley or at the axles of the trolleys and that air resistance is negligible.

Show that the acceleration a of trolley **B** along the ramp is given by

$$a = \frac{mg \sin 35^\circ}{M + m}$$

[2 marks]

0 6 . 3

Compare the momentum of loaded trolley **A** as it moves downwards with the momentum of loaded trolley **B**.

[2 marks]

Question 6 continues on the next page

Turn over ►



0 6 . 4

In practice, for safety reasons there is a friction brake in the pulley that provides a resistive force to reduce the acceleration to 25% of the maximum possible acceleration.

The distance travelled for each journey down the ramp is 9.0 m.

The following data apply to the arrangement.

Mass of a trolley M = 95 kg

Mass of a concrete block m = 30 kg

Calculate the time taken for a loaded trolley to travel down the ramp.

[3 marks]

time = _____ s

0 6 . 5

It takes 12 s to remove the blocks from the lower trolley and reload the upper trolley.

Calculate the number of blocks that can be transferred to the lower level in 30 minutes.

[2 marks]

number = _____

10



Turn over for the next question

**DO NOT WRITE ON THIS PAGE
ANSWER IN THE SPACES PROVIDED**

Turn over ►



0 7

A student is investigating forced vertical oscillations in springs. Two springs, **A** and **B**, are suspended from a horizontal metal rod that is attached to a vibration generator. The stiffness of **A** is k , and the stiffness of **B** is $3k$. Two equal masses are suspended from the springs as shown in **Figure 10**.

Figure 10

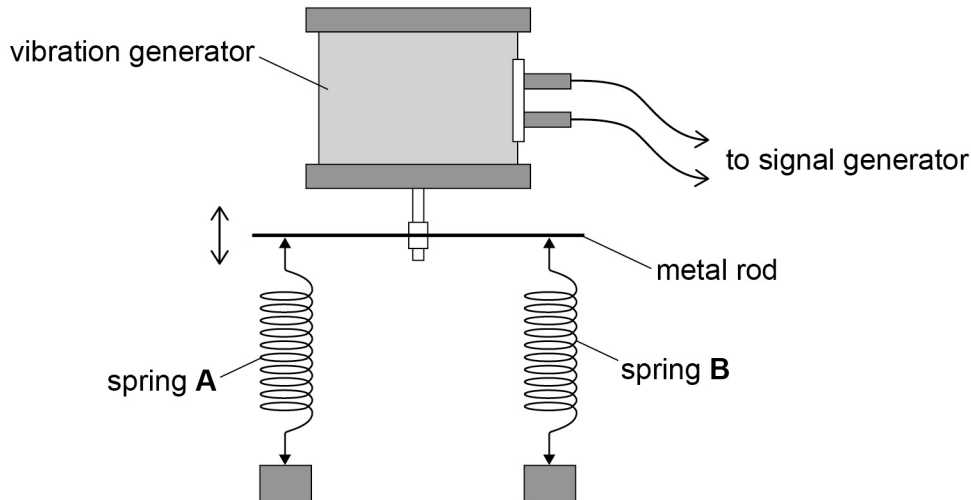

The vibration generator is connected to a signal generator. The signal generator is used to vary the frequency of vibration of the metal rod. When the signal generator is set at 2.0 Hz, the mass attached to spring **A** oscillates with a maximum amplitude of 2.5×10^{-2} m and has a maximum kinetic energy of 54 mJ.

0 7 . 1

Deduce the spring constant k for spring **A** and the mass m suspended from it.

[4 marks]

$$k = \text{_____} \text{ N m}^{-1}$$

$$m = \text{_____} \text{ kg}$$



0 7 . 2

Calculate the frequency at which the mass attached to spring **B** oscillates with maximum amplitude.

[2 marks]

frequency = _____ Hz

0 7 . 3

Figure 11 shows how the amplitude of the oscillations of the mass varies with frequency for spring **A**.

Figure 11

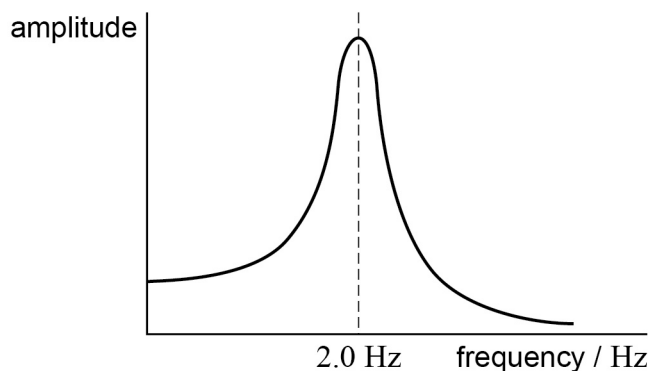

The investigation is repeated with the mass attached to spring **B** immersed in a beaker of oil.

A graph of the variation of the amplitude with frequency for spring **B** is different from the graph in **Figure 11**.

Explain **two** differences in the graph for spring **B**.

[4 marks]

Difference 1 _____

Difference 2 _____

10

END OF SECTION A

Turn over ►



Section B

Each of Questions 8 to 32 is followed by four responses, A, B, C and D.
For each question select the best response.

Only **one** answer per question is allowed.

For each answer completely fill in the circle alongside the appropriate answer.

CORRECT METHOD



WRONG METHODS



If you want to change your answer you must cross out your original answer as shown.



If you wish to return to an answer previously crossed out, ring the answer you now wish to select as shown.



You may do your working in the blank space around each question but this will not be marked.
Do **not** use additional sheets for this working.

0 8

An atom of ${}^{16}_7\text{N}$ gains 3 electrons.

What is the specific charge of the ion?

[1 mark]

A $1.80 \times 10^7 \text{ C kg}^{-1}$

B $-1.80 \times 10^7 \text{ C kg}^{-1}$

C $4.19 \times 10^7 \text{ C kg}^{-1}$

D $-4.19 \times 10^7 \text{ C kg}^{-1}$



0 9

Which diagram represents the process of beta-plus decay?

[1 mark]

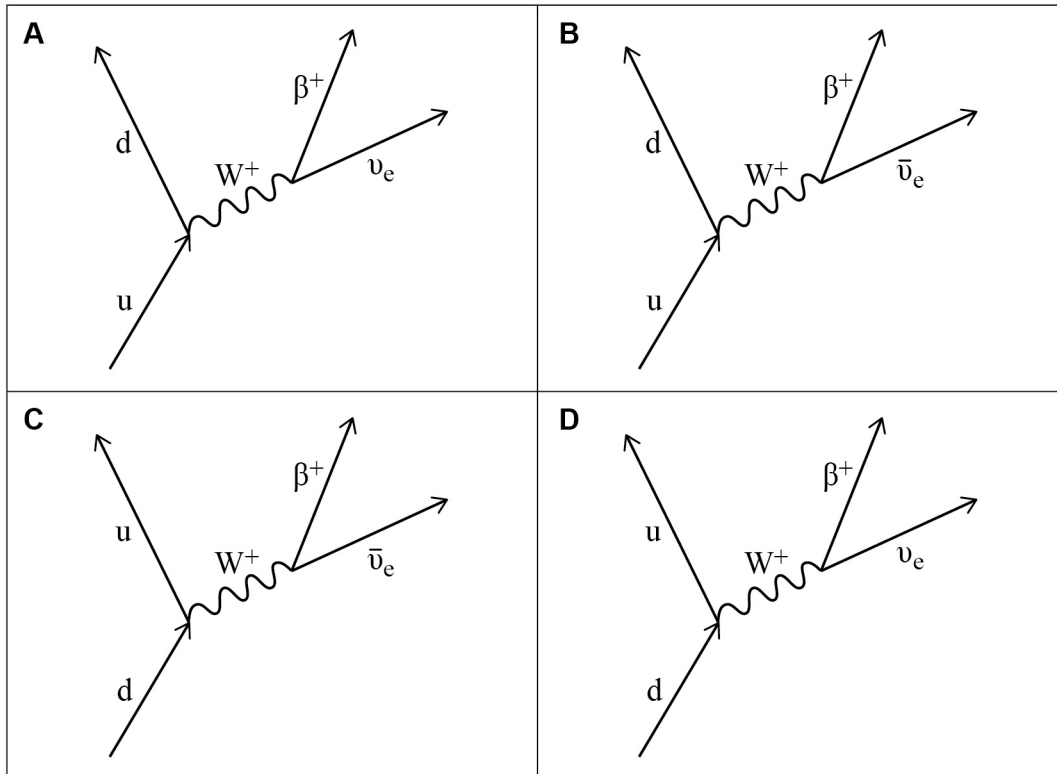

A

B

C

D

Turn over for the next question

Turn over ►



1 0

A beam of light of wavelength λ is incident on a clean metal surface and photoelectrons are emitted. The wavelength of the light is halved but energy incident per second is kept the same.

Which row in the table is correct?

[1 mark]

	Maximum kinetic energy of the emitted photoelectrons	Number of photoelectrons emitted per second	
A	Increases	Unchanged	<input type="checkbox"/>
B	Decreases	Increases	<input type="checkbox"/>
C	Increases	Decreases	<input type="checkbox"/>
D	Decreases	Unchanged	<input type="checkbox"/>

1 1

Electrons moving in a beam have the same de Broglie wavelength as protons in a separate beam moving at a speed of $2.8 \times 10^4 \text{ m s}^{-1}$.

What is the speed of the electrons?

[1 mark]

- A** $1.5 \times 10^1 \text{ m s}^{-1}$
- B** $2.8 \times 10^4 \text{ m s}^{-1}$
- C** $1.2 \times 10^6 \text{ m s}^{-1}$
- D** $5.1 \times 10^7 \text{ m s}^{-1}$



1	2
---	---

The diagram shows an energy level diagram for a hydrogen atom.

Electrons with energy 13.0 eV collide with atoms of hydrogen in their ground state.

What is the number of different wavelengths of electromagnetic radiation that could be emitted when the atoms de-excite?

[1 mark]

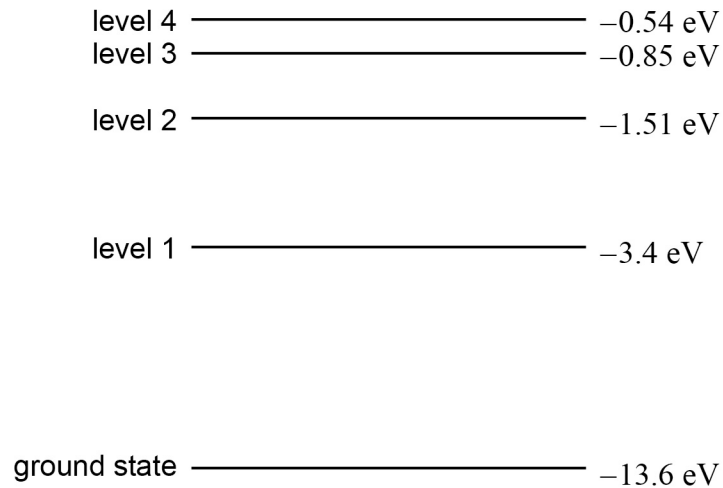

A 0

B 3

C 6

D 7

Turn over for the next question

Turn over ►



1 3

The graph shows how the vertical height of a travelling wave varies with distance along the path of the wave.

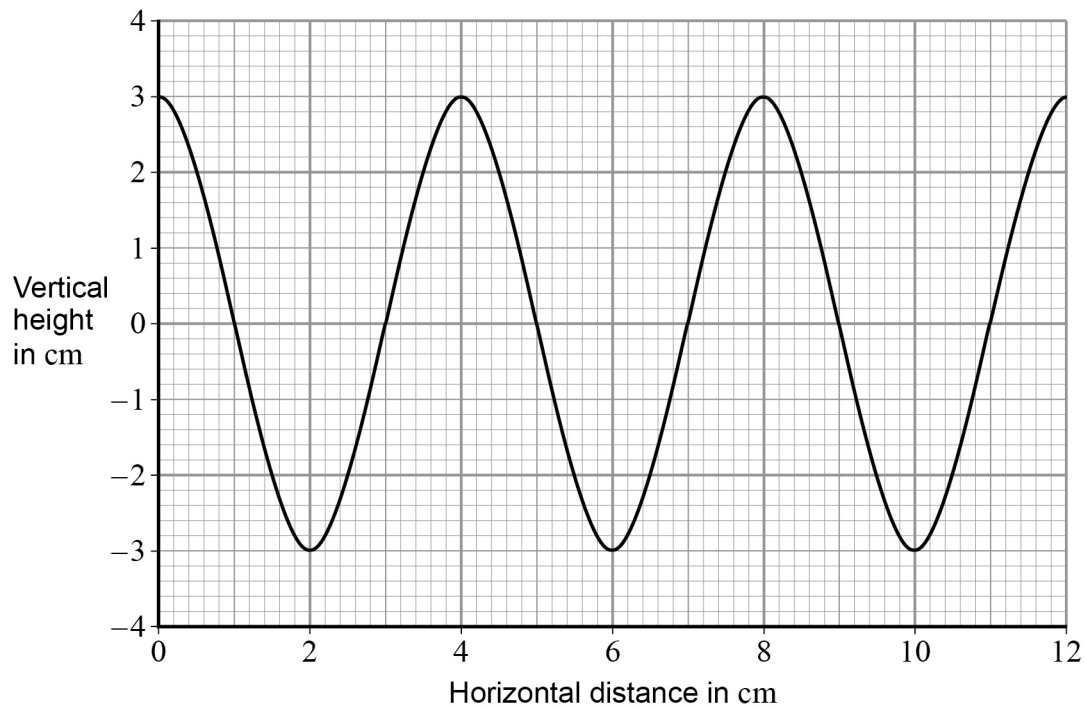

The speed of the wave is 20 cm s^{-1} .

What is the period of the wave?

[1 mark]

- A** 0.1 s
B 0.2 s
C 5.0 s
D 10.0 s

1 4

Which statement is **not** correct for ultrasound and X-rays?

[1 mark]

- A** Both can be refracted
B Both can be diffracted
C Both can be polarised
D Both can be reflected



1 5

A stationary wave is set up on a stretched string of length l and diameter d . Another stationary wave is also set up on a second string made from the same material and with the same tension as the first.

What length and diameter are required for the second string so that both strings have the same first-harmonic frequency?

[1 mark]

	Length of second string	Diameter of second string	
A	$2l$	$2d$	<input type="checkbox"/>
B	l	$2d$	<input type="checkbox"/>
C	$\frac{l}{2}$	$2d$	<input type="checkbox"/>
D	l	$\frac{d}{2}$	<input type="checkbox"/>

1 6

When a monochromatic light source is incident on two slits of the same width an interference pattern is produced.

One slit is then covered with opaque black paper.

What is the effect of covering one slit on the resulting interference pattern?

[1 mark]

- A** The intensity of the central maximum will increase
- B** The width of the central maximum decreases
- C** Fewer maxima are observed
- D** The outer maxima become wider

Turn over for the next question

Turn over ►



1 | 7

When light of wavelength 5.0×10^{-7} m is incident normally on a diffraction grating the fourth-order maximum is observed at an angle of 30° .

What is the number of lines per mm on the diffraction grating?

[1 mark]

A 2.5×10^2

B 2.5×10^5

C 1.0×10^3

D 1.0×10^6

1 | 8

A light uniform rigid bar is pivoted at its centre. Forces act on the bar at its ends and at the centre.

Which diagram shows the bar in equilibrium?

[1 mark]

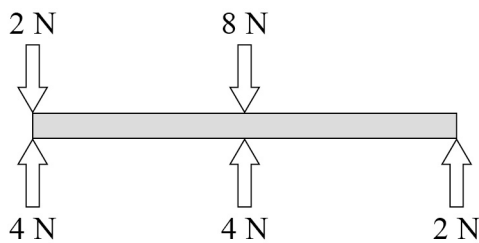
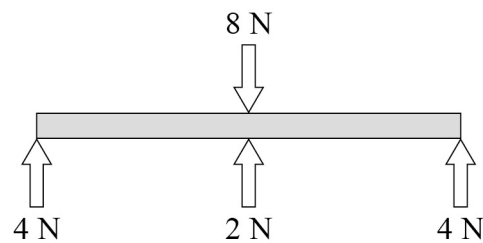
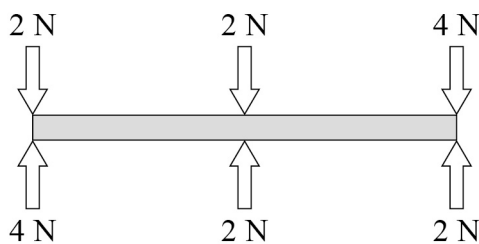
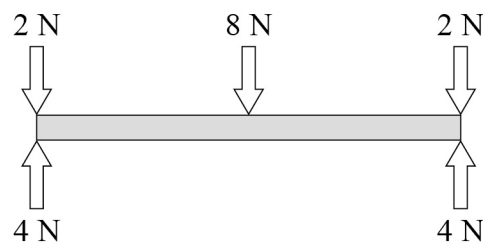
**A****B****C****D****A****B****C****D**

1 9

Which row gives two features of graphs that provide the same information?

[1 mark]

	Feature 1	Feature 2	
A	Gradient of a displacement–time graph	Area under a velocity–time graph	<input type="checkbox"/>
B	Gradient of a displacement–time graph	Area under an acceleration–time graph	<input type="checkbox"/>
C	Gradient of a velocity–time graph	Area under a displacement–time graph	<input type="checkbox"/>
D	Gradient of a velocity–time graph	Area under an acceleration–time graph	<input type="checkbox"/>

2 0A rocket of mass 12 000 kg accelerates vertically upwards from the surface of the Earth at 1.4 m s^{-2} .

What is the thrust of the rocket?

[1 mark]**A** $1.7 \times 10^4 \text{ N}$ **B** $1.0 \times 10^5 \text{ N}$ **C** $1.3 \times 10^5 \text{ N}$ **D** $1.6 \times 10^5 \text{ N}$ **Turn over for the next question****Turn over ►**

2 1

Figure 12 shows the path of a projectile launched from ground level with a speed of 25 m s^{-1} at an angle of 42° to the horizontal.

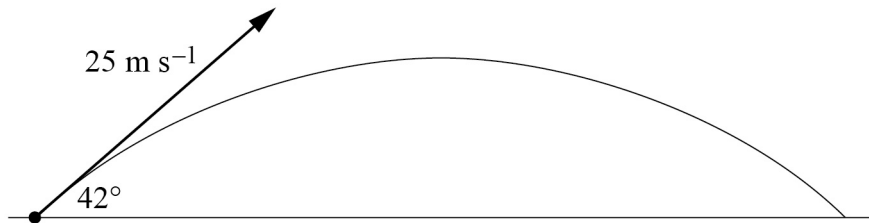
Figure 12

What is the horizontal distance from the starting point of the projectile when it hits the ground?

[1 mark]**A** 23 m**B** 32 m**C** 47 m**D** 63 m**2 2**

A car of mass 580 kg collides with the rear of a stationary van of mass 1200 kg.

Following the collision, the van moves with a velocity of 6.20 m s^{-1} and the car recoils in the opposite direction with a velocity of 1.60 m s^{-1} .

What is the initial speed of the car?

[1 mark]**A** 5.43 m s^{-1} **B** 11.2 m s^{-1} **C** 12.8 m s^{-1} **D** 14.4 m s^{-1} 

2 | 3

Which graph best represents the velocity–time graph for a ball that is dropped from rest and bounces repeatedly?

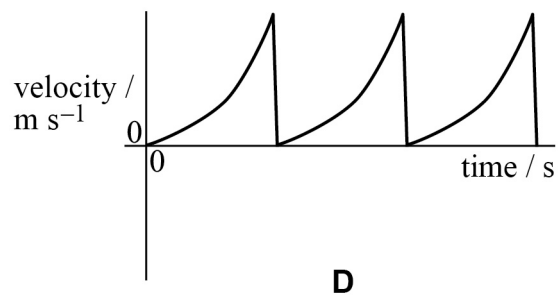
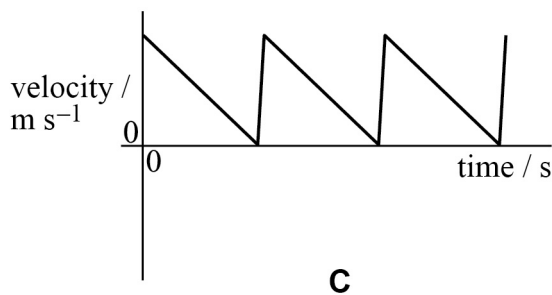
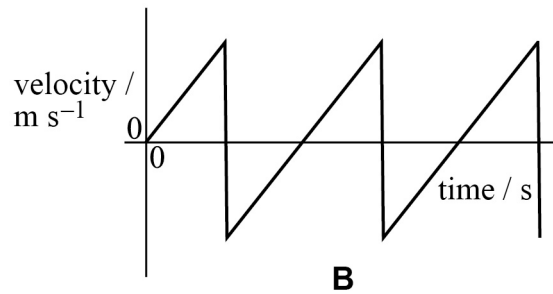
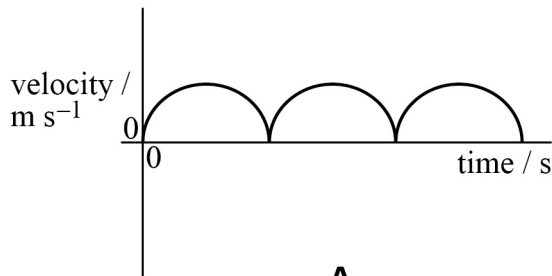
[1 mark]**A****B****C****D****2 | 4**

A sample of wire has a Young modulus E . A second sample of wire made from an identical material has three times the length and half the diameter of the first sample.

What is the Young modulus of the second sample of wire in terms of E ?

[1 mark]**A** $0.25E$ **B** E **C** $6E$ **D** $12E$ **Turn over ►**

2 **5**

In the circuit below, the potential difference across the light emitting diode (LED) is 1.8 V when it is emitting light.

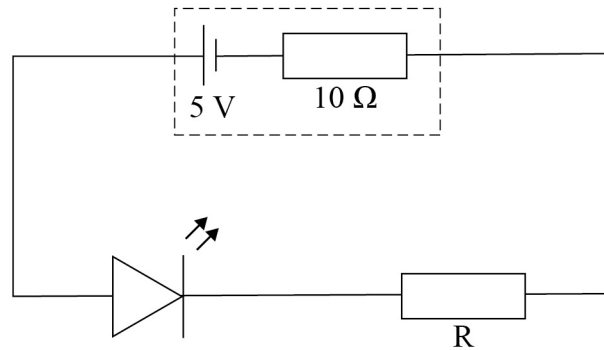

The current in the circuit is 20 mA.

What is the value of the resistor R?

[1 mark]

- A** 80 Ω
- B** 90 Ω
- C** 150 Ω
- D** 160 Ω

2 **6**

The combined resistance of n identical resistors connected in parallel is R_n .

Which statement correctly describes the variation of R_n as n increases?

[1 mark]

- A** R_n decreases linearly as n increases
- B** R_n decreases non-linearly as n increases
- C** R_n increases linearly as n increases
- D** R_n increases non-linearly as n increases



2 7

The table shows the resistivity, length and cross-sectional area of wires P and Q.

	resistivity	length	cross-sectional area
wire P	ρ	L	A
wire Q	$\frac{\rho}{4}$	L	$\frac{A}{2}$

The resistance of wire P is R .

What is the total resistance of the wires when they are connected in parallel?

[1 mark]

- A $\frac{R}{9}$
- B $\frac{R}{3}$
- C $\frac{2R}{3}$
- D $\frac{3R}{2}$

Turn over for the next question

Turn over ►



2 8

The circuit shown is used to supply a variable potential difference (pd) to another circuit.

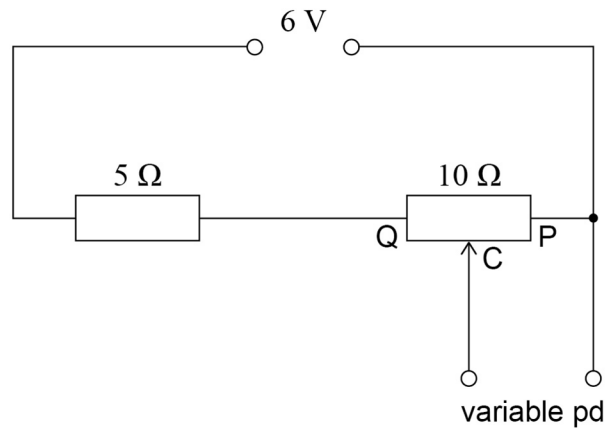

Which graph shows how the pd supplied V varies as the moving contact C is moved from position P to position Q?

[1 mark]

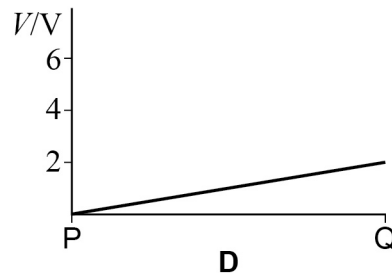
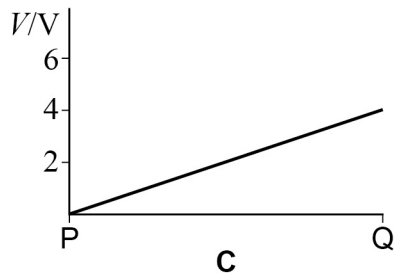
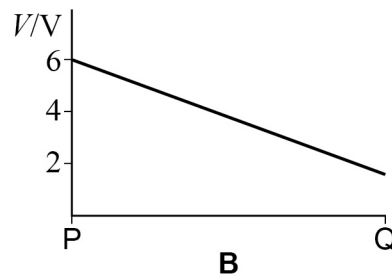
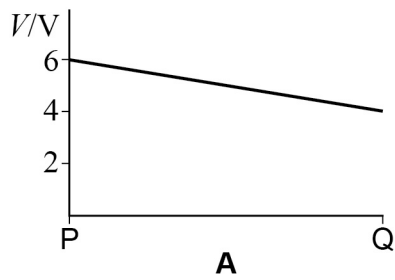

A

B

C

D



2 | 9

In this resistor network, the emf of the supply is 12 V and it has negligible internal resistance.

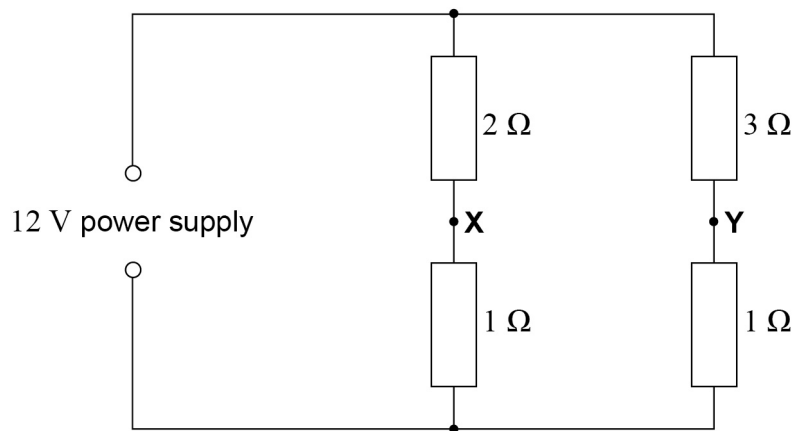

What is the reading on a voltmeter connected between points X and Y?

[1 mark]

A 0 V

B 1 V

C 3 V

D 4 V

Turn over for the next question

Turn over ►



3	0
---	---

A bob of mass 0.50 kg is suspended from the end of a piece of string 0.45 m long. The bob is rotated in a vertical circle at a constant rate of 120 revolutions per minute.

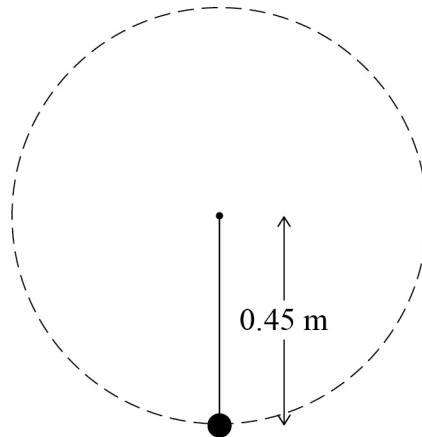

What is the tension in the string when the bob is at the bottom of the circle?

[1 mark]

- A 5.8 N
- B 31 N
- C 36 N
- D 40 N



3 1

Which graph best shows how the kinetic energy of a simple pendulum varies with displacement from the equilibrium position?

[1 mark]

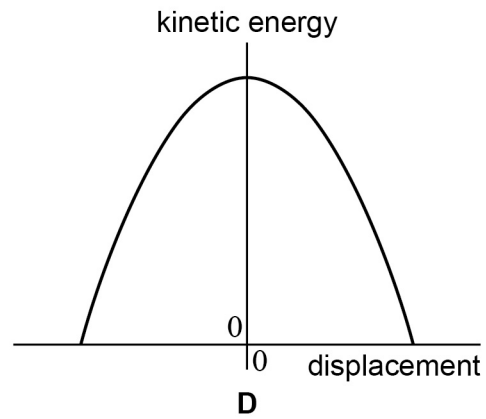
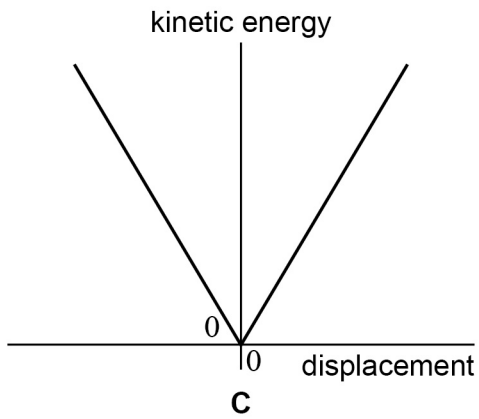
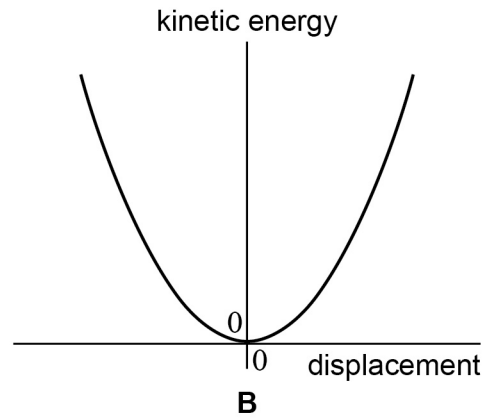
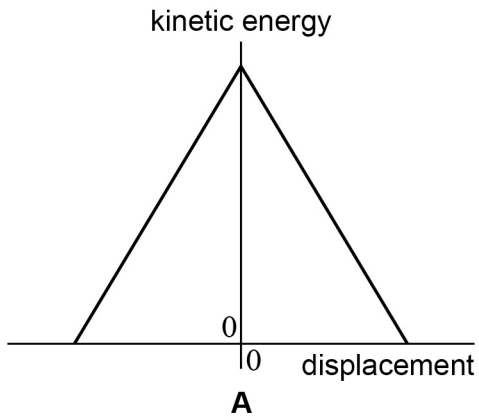
**A****B****C****D**

Turn over for the next question

Turn over ►



3 2

The graph shows how the displacement of a particle performing simple harmonic motion varies with time.

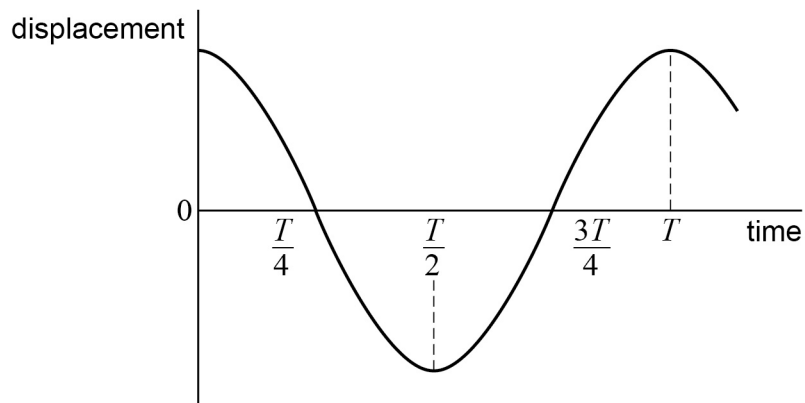

Which statement is **not** correct?

[1 mark]

- A** The speed of the particle is a maximum at time $\frac{T}{4}$
- B** The potential energy of the particle is zero at time $\frac{3T}{4}$
- C** The acceleration of the particle is a maximum at time $\frac{T}{2}$
- D** The restoring force acting on the particle is zero at time T

END OF QUESTIONS

Copyright Information

For confidentiality purposes, from the November 2015 examination series, acknowledgements of third party copyright material will be published in a separate booklet rather than including them on the examination paper or support materials. This booklet is published after each examination series and is available for free download from www.aqa.org.uk after the live examination series.

Permission to reproduce all copyright material has been applied for. In some cases, efforts to contact copyright-holders may have been unsuccessful and AQA will be happy to rectify any omissions of acknowledgements. If you have any queries please contact the Copyright Team, AQA, Stag Hill House, Guildford, GU2 7XJ.

Copyright © 2017 AQA and its licensors. All rights reserved.

