

Peer-to-Peer Public Money System

– Focusing on Payments –

Yokei Yamaguchi
Kaoru Yamaguchi, Ph.D. *

Japan Futures Research Center
Awaji Island 656-1325, Japan
E-mail: director@muratopia.net

Keywords: Debt Money, Public Money, Accounting System Dynamics, Monetary Reform, Bitcoin, Peer-to-Peer Transaction, Blockchain

*Throughout our history no economic problem has been more passionately discussed than the money problem. Probably none has had the distinction of suffering so much from general misunderstanding... As a result, not only is our monetary system now wholly inadequate and, in fact, unable to fulfill its function; but the few reforms which have been adopted during the past three decades have been **patch-work**, leaving the basic structure still unsound.*

— Irving Fisher, et al. [4, 1939, emphasis added]

Abstract

The global financial crisis in 2008 triggered by the bankruptcy of Lehman Brothers evidenced an undeniable proof that our debt money system does not fulfill its function. In that same year, two historical publications took place coincidentally that provided foundations for rethinking the debt money system of more than 250 years old: ASD (Accounting System Dynamics) macroeconomic model [18, 2008] and Bitcoin [9, 2008].

Since then, a full-reserve banking system as the alternative to the debt money system, first proposed by Irving Fisher [3, 1935] after the Great Depression, has been developed into the public money system [23, 2013] based on the ASD modeling method. The public money system has

*This paper is presented at the 2nd Asia-Pacific Region System Dynamics Conference of the System Dynamics Society at the National University of Singapore, Feb. 20, 2017. It is dedicated to the memory of Jay W. Forrester, professor emeritus of management at MIT Sloan school, who passed away at the age of 98 on November 16th, 2016. The scientific discipline of System Dynamics he established in 1950s continued to encourage our research on macroeconomic modeling to this day. The first author is a graduate student of the EMSD (European Joint Master in System Dynamics) program, and the second author is a director of the Japan Futures Research Center. This research is partially supported by the research fund of the Japan Futures Research Center: www.muratopia.net.

been shown to eliminate monetary instability and bank runs, and achieve liquidation of national debt as its byproduct. But it has lacked a system design of peer-to-peer transaction, first proposed by Bitcoin [9, 2008].

This paper presents an integrated design of new monetary system: *Peer-to-Peer Public Money System*. With simple ASD models, it first identifies 6 different domestic payment methods under the current debt money system, and shows that complicated layers of payment methods cause income inequality between financiers and non-financiers through transaction fees and will remain under the public money system. On the other hand, the peer-to-peer public money system proposed in this paper provides a peer-to-peer transaction, supported by distributed ledger technology, with public money as legal tender and eliminates the structural cause of such income inequality. Finally, the paper proposes the need for the development of worldwide protocol to achieve the implementation of our proposed system.

1 Introduction: The Year 2008

The world economy has been operating under the fractional reserve banking system since no later than the middle of 14th century after its introduction by private Venetian bankers [4, 1939]. This is a system in which private commercial banks are legally allowed to create deposits out of nothing against someone's debt at interest. Every aspect of our lives has come to rely almost exclusively on this type of deposits created by private banks. This is why the present system is called the debt money system.

The year 2008 became the epoch-making year for this debt money system. Firstly, the so-called Lehman Shock of financial crisis hit our global economy, providing the final proof, following the Great Depression in 1929, that the debt money system does not work. Secondly, two papers were published in that year, which could fundamentally transform the current debt money system into a new economic system of public money; that is, the paper on the accounting system dynamics macroeconomic model by Kaoru Yamaguchi [18, 2008], which became a theoretical foundation for the proposal of public money system, and the one on Bitcoin by Satoshi Nakamoto [9, 2008], which provided technological breakthrough of peer-to-peer transaction system.

ASD Macroeconomic Model

Yamaguchi [14, 2003] proposed the Principle of Accounting System Dynamics, a new simulation modeling method that combines Accounting System - a robust double-entry bookkeeping foundation of social science - and System Dynamics - a dynamical foundation of differential equation in natural science. By applying the method, the author has developed a series of macroeconomic modeling step-by-step; [15, 2005], [16, 2006], [17, 2007]. Then at the 26th international conference of the system dynamics society held in Athens, Greece, July 20-24, 2008, the author presented a complete ASD open macroeconomic model as cited

above.

Lehman Shock took place on the 15th of September, less than two months after the presentation of the paper. Being deeply distressed by this economic disaster, the author began to search for a new economic system which will be free from the failure of the current debt money system; [19, 2009], [20, 2010], [21, 2011], [22, 2012], [24, 2014], [26, 2015], [27, 2016]. His research has been led by the so-called Chicago Plan of monetary reform [4, 1939], which is briefly covered in Section 5 below.

In the same author's book [23, 2013], the public money system is proposed as the alternative system to the current debt money system. This alternative system is further introduced in the context of Japan [25, 2015]. The upper part of Figure 1 briefly illustrates how the proposal of the public money system has evolved since the year 2008.

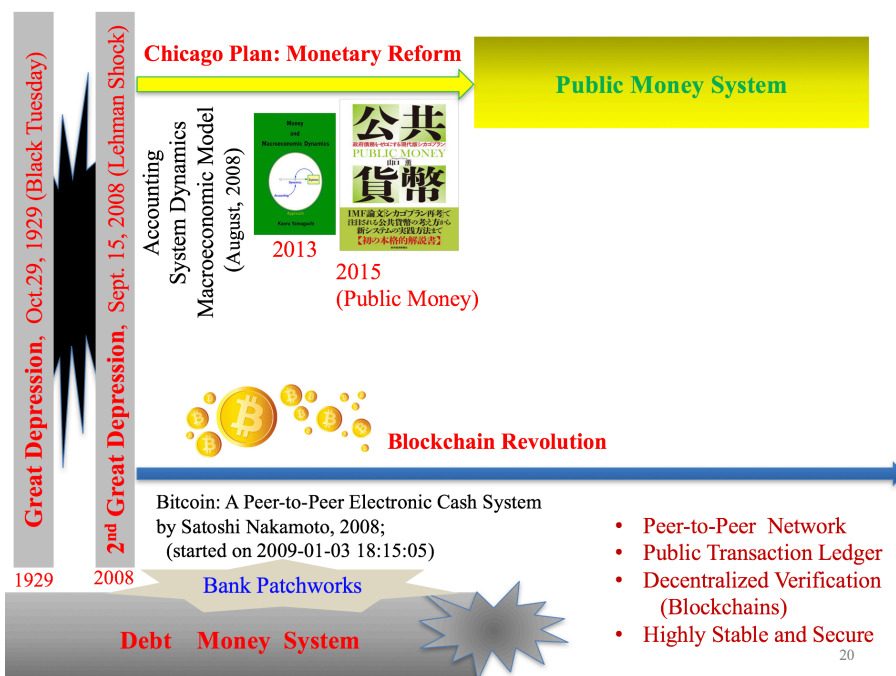

Figure 1: Proposal of Public Money System and Bitcoin

Bitcoin

On October 31 of 2008, Satoshi Nakamoto, a pseudonymous author, submitted a 9 page paper in a mailing list of cryptography: Bitcoin: A Peer-to-Peer Electronic Cash System [9, 2008]. Then, in January of 2009, the source code, later known as the Bitcoin reference code, was made open-source. Specifically, on Jan. 3, 2009, the genesis block, the very first block in ever-increasing blockchain for

bitcoin transactions was successfully mined on the internet, breaking the dawn of unprecedented history of peer-to-peer transaction system. The essence of this peer-to-peer electronic cash system is summarized elegantly in the first sentence of the original paper.

A purely peer-to-peer version of electronic cash would allow online payments to be sent directly from one party to another without going through a financial institution [9, 2008].

Bitcoin is the first decentralized electronic cash system on the internet that has practically solved "double-spending" problem, by combining the existing technologies of cryptography and the innovative idea of blockchain, distributed public ledgers. As described in [1, 2015], Bitcoin "includes four key innovations brought together in a unique and powerful combination." (p.3):

- A decentralized peer-to-peer network (the bitcoin protocol)
- A public transaction ledger (the blockchain)
- A decentralized mathematical and deterministic currency issuance (distributed mining)
- A decentralized transaction verification system (transaction script)

Since then the blockchain technology applications are transforming the way we communicate and organize our society, including payment system. The lower part of Figure 1 briefly illustrates how the blockchain technology has been evolving since the year 2008. According to the journal, *Economist*, it is the most innovative technology since the invention of double-entry bookkeeping accounting and joint stock ownership more than 200 years ago, and "could transform how the economy works":

The notion of shared public ledgers may not sound revolutionary or sexy. Neither did double-entry book-keeping or joint-stock companies. Yet, like them, the blockchain is an apparently mundane process that has the potential to transform how people and businesses co-operate. Bitcoin fanatics are enthralled by the libertarian ideal of a pure, digital currency beyond the reach of any central bank. – *The Economist*, Oct. 31st 2015 [2, 2015]

Indeed, Blockchain technology is now affecting not only electronic payment but also "everything of value and importance to humankind" as specifically pointed out:

Some scholars have argued that the invention of double-entry bookkeeping enabled the rise of capitalism and the nation-state. This new digital ledger of economic transactions can be programmed to record virtually everything of value and importance to humankind: birth and death certificates, marriage licenses, deeds and titles of

ownership, educational degrees, financial accounts, medical procedures, insurance claims, votes, provenance of food, and anything else that can be expressed in code (p.7). [13, 2016].

As illustrated in the lower part of Figure 1, however, financial and banking applications of distributed ledger technology are now being developed and implemented upon the failed system of debt money, which was identified to entail system design failures of monetary instability, banking crisis and accumulation of government debt [27, 2016]. Consequently, we have emphasized in Section 6 that applications of cryptocurrency under the present monetary system are *patchworks*, leaving the basic structure of failed system still unsound. Main benefits of such applications will be lost when its ground is permanently shaking.

What is needed is a re-design of the current failed system from ground level in order to address its inherent problems of using distributed ledger technology under the current system. The purpose of this paper is to show that such a re-design already exists and to advocate a peaceful transition to its peer-to-peer public money systems.

2 What are Money and Bitcoin?

2.1 Money as Legal Tender

Bitcoin was originally referred to as "peer-to-peer electronic cash" by Satoshi Nakamoto [9, 2008]. Then it began to be called cryptocurrency, digital currency, virtual currency, digital money and digital cash without much care in their usage. Is it really cash, currency or money? Accordingly, we begin by strictly defining what money and Bitcoin are.

Money is nothing but information of value which can be exchanged for goods and services, and the stability of its purchasing power must be maintained over a period of time. Information in general needs media that carries it. As such, it does not concern how it is represented on what kind of media, be it tangible or intangible, except that its unit of measure is defined by law (legal tender) as stated by Aristotle (384-322 BC) in ancient Greece. He observed money as follows:

and this is why it has the name *nomisma* - because **it exists not by nature, but by law (*nomos*)** and it is in our power to change it and make it useless [28, p.34].

Contrary to his recognition, money has historically been explained in terms of its physical properties, even though it has changed its form of media from physical to an abstract one through the development of information technology. For example, money in Japan is strictly defined in terms of government coins, Bank of Japan notes and reserves at the central bank (which are essentially electronic digits in the ledgers of Bank of Japan's database), all of which have

no intrinsic values. Table 1 from Yamaguchi [23, p.131] classifies various media of money into two categories; that is, public money and debt money. Public money is the one issued by the consent of the public, while debt money is issued privately at interest.

| Classification of Money | | | |
|--|---|--|--------------------------------|
| | Public Money | Debt Money | |
| Media | Money as Legal Tender | | Functional-Money |
| Non-metal Commodities | Shell, Cloth (Silk) Woods, Stones, etc | | |
| Metal Coinage | Non-precious Metal Coins Gold, Silver & Copper Coins | | Metal Ingots (such as Gold) |
| Paper Notes | Public Money Admin. and Government Notes | Goldsmith Certificates Central Bank Notes | |
| Electronic Card & Substitutes | Electronic Cash (Intangible Digits) | | Deposits (Credits by Loans) |
| Distributed ledger (Permissionless/-ed) | Peer-to-Peer Electronic Money | (not in use yet) | Bitcoins (Digital Ingot) |

Table 1: Public Money vs Debt Money

Today, as one can see from Table 1, almost all of medium of exchange used in daily transactions are expressed in the form of deposits (electronic digits) at commercial banks, starting roughly around 1970's. Unfortunately, however, Adam Smith (1723-1790), known as the father of economics, reversed the definition of money by Aristotle as follows:

By the money price of goods it is to be observed, I understand always, *the quantity of pure gold and silver* for which they are sold, without any regard to denomination of the coin. [28, p.313].

In this way, Adam Smith reversed the definition of *money as legal tender* and defined it as commodity. This erroneous logical step by the father of economics planted a dogma into the minds of people until this day. Advancing his idea more axiomatically, many macroeconomics textbooks define money as the entity that meets the following three functions; (1) unit of account, (2) medium of exchange and (3) store of value. According to this axiom of money, gold and silver can be best qualified as ideal money because, *by nature*, their physical property perfectly meets these three functions of money. This reversed definition of money has become a root cause of confusion even among professional economists, not to mention the public who are heavily influenced by them. Unfortunately, the same logical deduction is widespread among cryptocurrency enthusiasts.

2.2 Bank Deposits as Functional-Money

According to the standard economics textbooks, money we use daily is called *money stock* as one measurement of monetary aggregates. It is defined as

$$\text{Money Stock} = \text{Currency in Circulation} + (\text{Private Bank}) \text{ Deposits} \quad (1)$$

Money stock thus defined is the total amount of money available in the economy as medium of exchange, regulating transactions and economic activities. The word *currency* appears for the first time in this definition of money stock. It is strictly defined (such as in Japan) as

$$\text{Currency} = \text{Coins} + \text{Central Bank Notes} \quad (2)$$

Therefore, currency is the same as "cash", and by definition it is *legal tender* in the sense that no one can reject to receive it for payments.

How about deposits? Are they also *money as legal tender*? According to Masaaki Shirakawa, a former governor of the Bank of Japan, the answer is negative.

Contrary to the central bank notes, creditors can refuse to accept bank deposits as the payments of debt obligations because of credit risks associated with bankruptcies of debtors' banks. However, in normal times, bank deposits **function as money** because of creditors' confidence that bank deposits can be converted to central bank notes [12, p.13] (translated by the authors).

In this sense, bank deposits created by commercial banks are neither money as *legal tender* nor *currency*. That is why they are called *functional-money* in Table 1. Yet, they are widely accepted as the most important means of payments, because their convertibility with legal tender is presumed at least by the recipients of such transactions during normal times. Accordingly, many people, including economists and bankers, mistakenly regard deposits as currency. Let us emphasize in this paper that bank deposits are nothing but *functional-money* created by commercial banks, and it should by no means be confused with *currency*. This distinction of money from functional-money sets the first stage in rethinking our current monetary system as we shall see in Section 3.

2.3 Bitcoin as Functional-Money

Since the introduction of bitcoin, many confusions have emerged as to the usage of the word 'money'. Before bitcoin, electronic money (digits) saved in electronic card and other substitutes in exchange for currency (cash) were the only digital currency or e-cash.¹

¹Debit cards and credit cards such as Visa are not e-cash. They are payment instruments used in exchange for deposits at banks through card companies (nonbank payment service providers) through transfer of bank deposits as we will see in Section 4.

Bitcoin is often referred to as digital currency, cryptocurrency, electronic currency, virtual currency, digital money, and so on as if it is currency or cash. Indeed, if it is not cash, how could peer-to-peer transactions take place? Therefore, bitcoin is interpreted as "a peer-to-peer electronic cash" in the title of the paper by Satoshi Nakamoto.

Yet, from our strict definition of currency discussed above, bitcoin must be distinguished from legal tender, thus it cannot be currency because we can refuse to accept it in payments. In this sense, it would be more appropriate to regard it as "digital ingot" or "crypto ingot" generated by miners similar to gold ingot, which can only be accepted as long as both parties in transaction agree. Consequently, it is defined as functional-money, similar to deposits, according to our classification of money in Table 1.

In the next section, based on the definition laid out above, we will review the debt money system in detail.

3 Debt Money System

3.1 The Origin: Fractional Reserve Banking

The history of fractional reserve banking practices can at least be traced all the way back to the Venetian private bankers in the middle of the 14th century [4, 1939]. Since then the age of free banking took place in which commercial banks issued their own bank notes against deposits of precious metals such as gold and silver. For various historical contexts and political reasons, fragmented private banking systems began to be centralized through central banking system around the 17th century. Sooner or later, gold standard was established, but industrialized nations in the west suffered from the deflation caused by gold standard. Eventually, they were forced to abolish it and made transitions into fiat currency system one after another. This transition into fiat currency system under the fractional reserve banking, from another perspective, was a completion of *Debt Money System* in which money stock created by commercial banks would no longer be limited by physical amount of gold and silver.

3.2 System Structure of Debt Money

System structure of the debt money is summarized in Table 2, which is adopted and slightly modified from [23, Chapter 15]. It is a fully centralized system in which bank notes are issued by the privately-owned central banks in many nations, and bank deposits (functional-money) are created by commercial banks out of nothing and destroyed to nothing.

3.3 System Behaviors of Debt Money

Behaviors of the debt money system are also summarized in Table 3 which is taken from [23, Chapter 15]. Debt money system triggers monetary and financial instabilities, which in turn causes boom and bust, followed by the accumulation

| | Public Money System (proposed) | Debt Money System (current) |
|---------------------------|---|---|
| Money Issuer Its Owner | Public Money Administration Government (Public) | Central Bank Private Commercial Banks |
| Bank Reserves | 100% Reserve | Fractional Reserve |
| Money Supply | Public Money directly put into Circulation as Economy grows (Banking business unaffected) | Base Money: by Central Bank Deposits: by Bank Loans Money in Circulation: by Public |
| Issuance of Money | Interest-free | Interest-bearing Debt |
| Economic Policies | Public Money Policy (Direct Public Money Injection) | Monetary Policy: Central Bank Fiscal Policy: Government |

Table 2: Public Money vs Debt Money System Structures

of government debt due to the fiscal policy that tries to recover from economic recessions. As a result, it inevitably leads to income inequality in favor of financiers, and entails environmental destructions by forced economic growth. Accordingly, the debt money system is concluded to have built-in system design failures [23, 2013], [27, 2016]. Let us discuss three design failures below in detail.

| | Public Money System (proposed) | Debt Money System (current) |
|------------------------|--|---|
| Monetary Stability | Stable Money Supply Stable Price Level | Bubbles and Credit Crunches Inflation & Deflation |
| Financial Stability | No Bank-runs | Business Cycles, Banking Crisis (Booms and Depressions) |
| Employment | Full Employment | Involuntary Unemployment |
| Government Debt | No Government Debt | Built-in Debt Accumulation → Recession & Unemployment |
| Inequality | Income Inequality between Workers and Capitalists | Income Inequality between Financiers and Non-financiers |
| Sustainability | Sustainability is Possible | Accumulated Debt (Private and Public) → Forced Growth → Environmental Destruction |

Table 3: Public Money vs Debt Money System Behaviors

a. Instability of Functional-Money Stock

Since monetary stability is one of the most important aspects of system re-design proposed here, let us first consider it according to [27, 2016]. Under the debt money system, new deposits are created out of nothing when commercial banks make new loans. As such, deposits are destroyed to nothing when those loans are repaid. That is to say, money stock, mainly consisting of deposits for daily transactions, is *endogenously* created and destroyed. This leads to the inherent

instability of money stock especially during the period of economic boom and bust. Its inevitable results are bank runs, credit defaults, bankruptcies and foreclosures followed by higher rate of unemployment and long term recessions.²

In this way, current debt money system of fractional reserve banking has built-in system design failure that inherently causes monetary instability. Under the system, what will happen if liquidity preferences of bank customers and lending behaviors of profit-seeking banks are simultaneously changed in the economy? Figure 2 adopted from [27, 2016] illustrates a simulation experiment of these combined effects on the money stock. The fluctuation of money stock (line 2) continues irrespective of complete stability observed in base money (line 1).

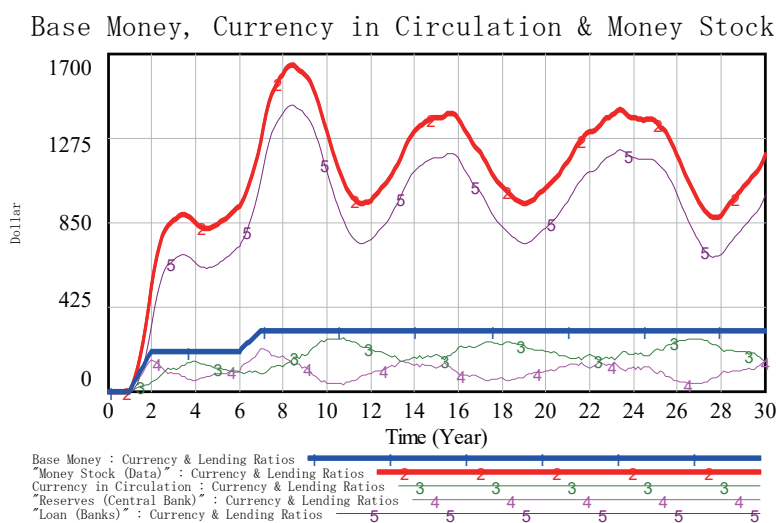

Figure 2: Amplified Instability of Money Stock under Stable Base Money

This simulation shows that while base money (= currency in circulation + central bank reserves) is entirely stable, compound changes in currency ratio and lending ratio trigger wilder instability of money stock. This amplified behaviors of the system reminds us of "bullwhip effect" in supply chain management; that is, roaring factory production in upper stream caused by relatively small changes in retail sales (demand in downstream) as stressed by Jay W. Forrester [5, 1961]. System dynamics practitioners would strongly agree that this is an example of *system behavior originating from its underlying structure*.

²Instability of functional-money stock in the U.S before and during the Great Depression was observed and is documented by Irving Fisher [3, 1935]

b. Government Debt Accumulation

Under the present system, government is obliged to borrow money from private sector, mainly from commercial banks and non-bank financial institutions (and indirectly from the central bank through open market purchases). Therefore, government is destined to accumulate its debts and pay compounding interests, resulting in huge transfer of national income from non-financiers to financiers every year.

In 2008, our global economy was hit by another financial crisis, followed by long-term recessions. Private sectors stopped borrowing functional-money created by banks, and government was forced to borrow, instead, for maintaining the level of money stock, leading to further increase in its outstanding debts caused by compounding interests. These accumulated debts will surely trigger another type of crisis; debt crisis. In system dynamics, whenever an event is observed repeatedly and becomes a pattern, there must be a specific structure of system, we tend to suspect, that produces such a pattern of events. Following this analytic approach, Yamaguchi [23, 2013] explored system structure of the current debt money system by applying the method of accounting system dynamics and identified it as a *debt-end* system. In short, current global debt money system is far from sustainable path and, sooner or later, destined to crash.

c. Income Inequality between Financiers and Non-financiers

Under this debt money system, commercial banks and central bank collectively administer both payment system and money creation process. To be more specific, they earn vast amount of interest revenues by creating deposits (functional-money) and lending them. Furthermore, various transaction fees are charged from intermediary process in payments. By this system design, the current system inevitably brings about inequalities between interest-earning financiers and non-financiers. This system behavior will be explored more precisely in this paper after we examine 6 different payment methods of the current debt money system in the following section.

4 Payments under Debt Money System

In this section we will explore payment methods that are available under the current debt money system. Payments are done with currency (cash) and demand deposits. Accordingly, they are divided into two categories; payments with cash and payments with deposits. Payments with deposits are further broken down into the one that goes through banks and the other that goes through nonbank financial institutions. Figure 3 illustrates these different methods; payments with cash (① and ②), payments through banks (③ and ④), and payments through nonbanks (⑤ and ⑥). Figure 18 in the Appendix presents the overview of all payments, including Bitcoin.

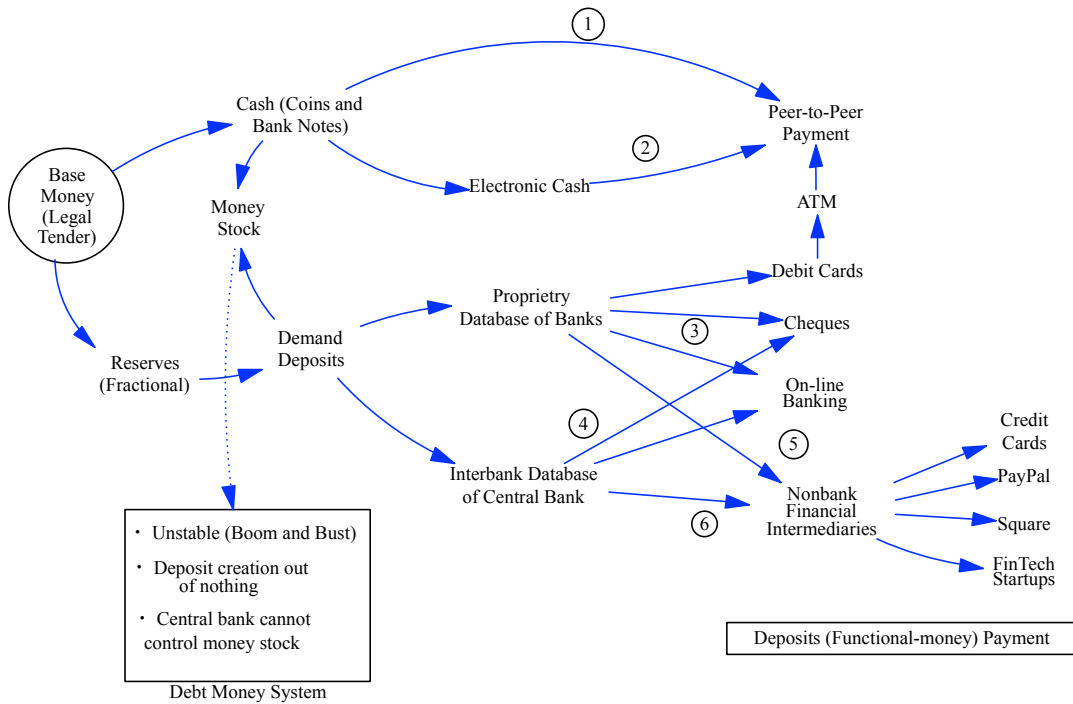

Figure 3: Overview of Debt Money Payment Systems

4.1 With Cash and Electronic Cash

① Payments with Cash

Money Stock consists of cash and deposits. In Japan, Currency in Circulation (cash) constitutes only as much as 15% and the remaining 85% are deposits. Firstly, let us explore how cash is used for transactions. Figure 4 is a simple Accounting System Dynamics model of transaction with cash. Cash moves from buyers to sellers, while goods and services co-flow in an opposite direction.

② Payments with Electronic Cash

Cash can be substituted by electronic cash. Electronic digits are stored in electronic cards as prepaid money in exchange for currency (coins and bank notes), and used for transactions. As payments with electronic cash become more convenient, this type of payment is getting widely used. Figure 19 in the Appendix presents simulation model of this payment method.

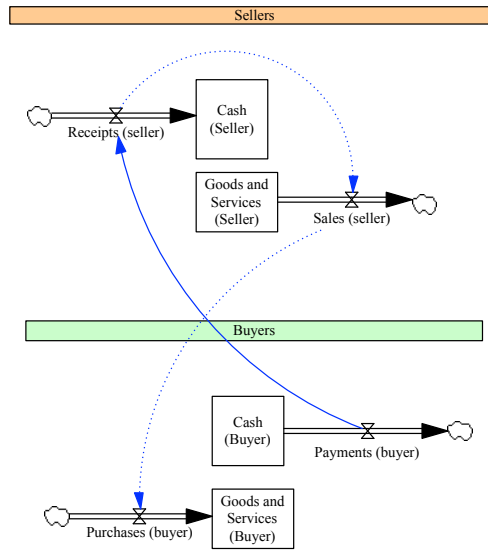

Figure 4: Payment System (1) with Cash: Peer-to-Peer

4.2 With Deposits through Banks as Intermediaries

③ Payments through Banks

Deposits (as functional-money) are created out of nothing as electronic digits in the database of banks. They are used for payments by transferring them between the accounts of buyers and sellers of a single bank or in multiple banks, which are then settled through their inter-bank database at the central bank.

Traditionally, most payments are done through cheques, and recently by on-line banking. If buyers and sellers reserve their checking accounts in the same bank, their transactions can be easily done through the proprietary database of the same bank. This payment is modeled in Figure 20 in the Appendix.

④ Payments Settled through Central Bank

If buyers and sellers have their checking accounts at different banks, their transactions have to be cleared through the inter-bank payment system and settled through the central bank reserves. This payment is modeled in Figure 21 in the Appendix.

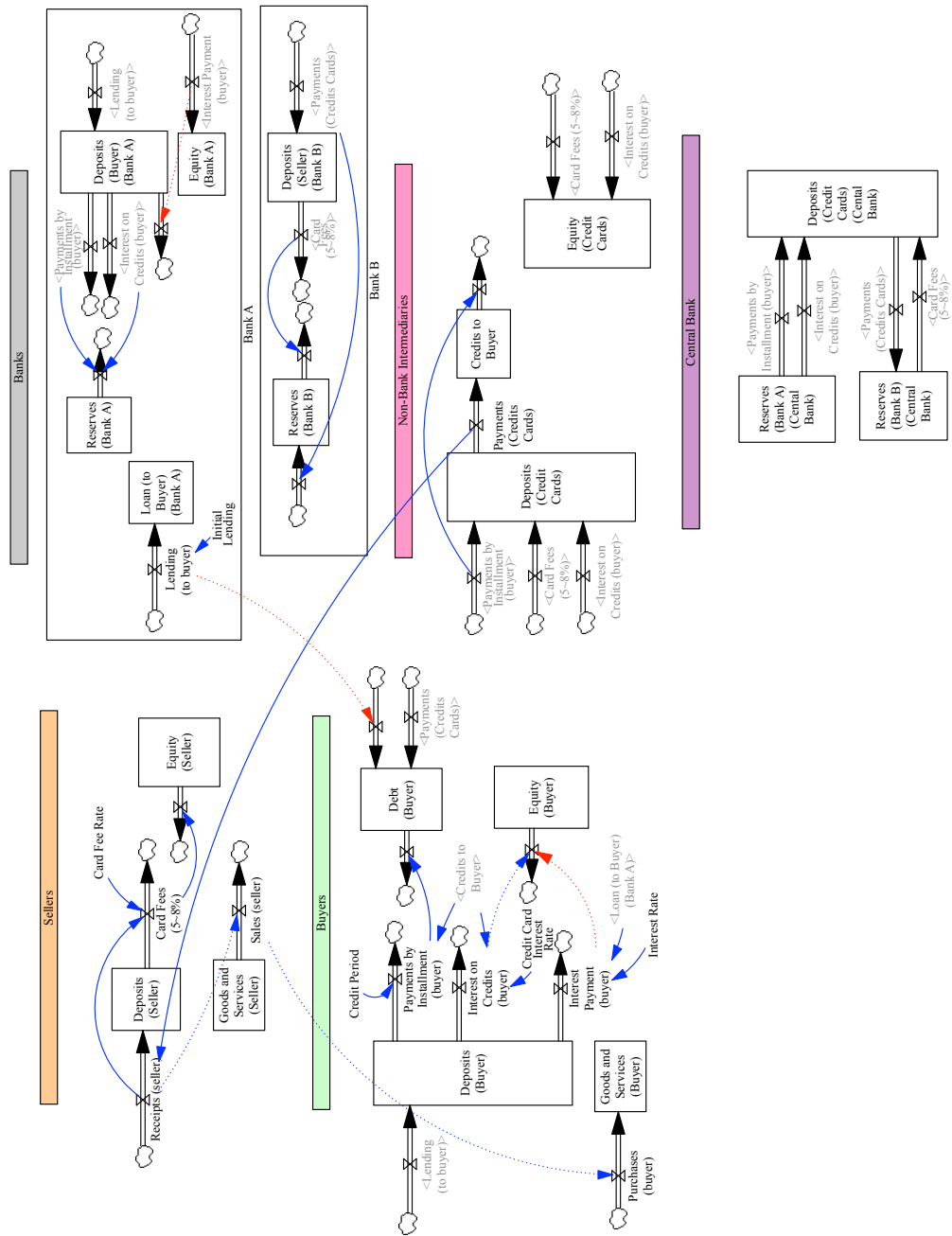

Figure 5: Payment System (6) through Nonbank Intermediaries and Multiple Banks

4.3 With Deposits: Non-banks as Intermediaries

⑤ Payments through Nonbanks and Banks

Recent innovations in FinTech are advancing the area of payments with deposits; that is, payments by smart phones such as iPhone and laptops. Some well-known examples are PayPal, ApplePay, Square Reader(NFC) and Square Stand. Traditional service charge for credit card is between 5% and 8%. Square now offers only 3.25% for similar services. All other credit cards are forced to reduce their service charges of 4% - 5% to around 3%. In this way FinTech revolution is advancing the efficiency of credit card payments.

When buyers and sellers as well as nonbank intermediaries such as credit card companies have their checking and deposits accounts within the same bank, their transactions are done through the proprietary database of the same bank. This payment is illustrated in Figure 22 in the Appendix.

⑥ Payments through Nonbanks and Central Bank

When buyers, sellers and nonbank intermediaries such as credit card companies keep their checking and deposits accounts at different banks, their transactions are cleared through the inter-bank database at the central bank. This payment model is exhibited in Figure 5.

4.4 Income Inequality caused by Payments

c. Income Inequality (continued from Section 3)

We are now ready to continue our assertion of the previous section on the income inequality as a system design failure of debt money. Under the debt money system, most transactions are done through deposits accounts. When borrowers take loans at interest, interest payments go out of their equity and flow into the equity of banks as retained earnings. When buyers use credit cards and pay back by installments, they have to pay higher interest because they are getting loans from nonbank intermediaries who are essentially getting loans from banks as credit facility.

At the same time, sellers or merchants have to pay card fees to nonbank intermediaries for the services they received from them. In this way, equities of buyers and sellers (non-financiers) move to equities of nonbank intermediaries and banks (financiers).

To sum, income redistribution is forcefully done from non-financiers to financiers under the current system. This is another type of income inequality under the current debt money system by way of transaction fees in addition to the one we have seen in Section 3. Figure 6 is produced by running "the payment system model through nonbank intermediaries and multiple banks" exhibited in Figure 5. It shows how equities flow from non-financiers (lines 1 and 2) to financiers (lines 3 and 4) when buyers purchase goods and services of 10 (thousand) yen every 3 months for two years (line 6).

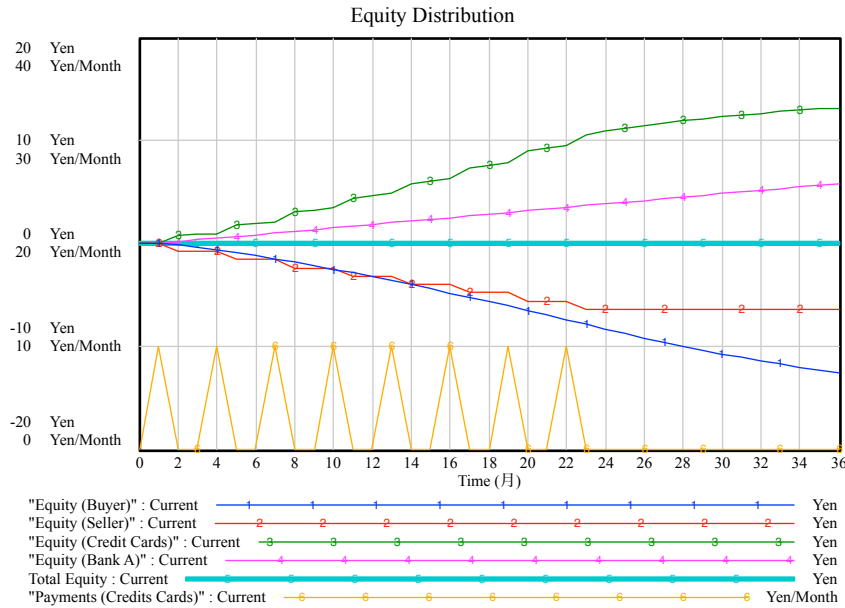

Figure 6: Income Inequality between Financiers and Non-financiers

In this way, the current debt money system has built-in system design failures such as (a) monetary instability, (b) government debt accumulation, and (c) income inequality.

5 Public Money System

5.1 The Origin: Chicago Plan and 100% Money

The Great Depression in 1929 was the first major economic disaster caused by the system design failures of the debt money. Having recognized this, eight economists at the University of Chicago³ proposed an alternative system design called "The Chicago Plan for Banking Reform" in 1933 [11]. The Chicago Plan was vehemently carried on by Irving Fisher from Yale University [3, 1935] and his group of five economists⁴ as "A PROGRAM FOR MONETARY REFORM" in

³They are; G.V. Cox, Aaron Director, Paul Douglas, A.G. Hart, F.H. Knight, L.W. Mints, Henry Schulz, and H.C. Simons. Their proposal was handed over, through Henry A. Wallace, Secretary of Agriculture, to the President Franklin D. Roosevelt on March 16, 1933. Unfortunately it failed to be implemented. Instead, the Banking Act of 1933, known as Glass-Steagal Act, which was less restrictive to bankers, was legalized on June 16, 1933, by FDR. See [11, 1995]. The Act was repealed in 1999 by the President Bill Clinton, which was claimed to have triggered the financial crisis in 2008.

⁴They are; Paul H. Douglas, University of Chicago; Frank D. Graham, Princeton University; Earl J. Hamilton, Duke University; Willford I. King, New York University; and Charles

[4, 1939] and later by Milton Friedman [6, 1960]. The authors of this program stressed the moral aspect of fractional reserve banking and found out that the behaviors of those bankers who earn “handsome profits” by lending out other people’s deposits were a *breach of trust* against the public.

The monetary reform thus proposed as the Chicago Plan aimed to introduce 100% required reserve ratio for demand deposits such that

$$\text{Money Stock} = \text{Base Money} \tag{3}$$

Under this full reserve (100% money) system, all functional-money (bank deposits) created by commercial banks will be backed by money (legal tender). This way, all money stock becomes equal to base money (that is, legal tender).

Based on the Chicago Plan and full reserve system, public money system is proposed in [23, 2013] and [27, 2016] as the alternative system design to overcome the failed system design of debt money. A transition process to the public money system is briefly revisited in the following sections.

5.2 System Structure of Public Money

System structure of the public money as an alternative system design is compactly summarized in Table 2 shown above. Its gists are as follows:

- Public money is issued by the public money administration as equity of the government, not by loans of commercial banks.
- 100% reserve ratio is required for demand deposits.
- Public money is put into circulation to sustain economic growth and welfare at interest-free.

Figure 7 illustrates a transition from the debt money system to the public money system. It shows that macroeconomic theory of public money is an integration of two alternative theories proposed in 1935 after the Great Depression in 1929; that is, 100% Money by Irving Fisher [3, 1935] and The General Theory of Employment, Interest and Money by John M. Keynes [7, 1935].

Banks as Genuine Intermediaries of Public Money

Under the proposed public money system commercial banks are no longer creators of deposits (functional-money). They become genuine intermediaries of public money. As a result, their main sources of income consists of the followings.

R. Whittlesey, Princeton University.

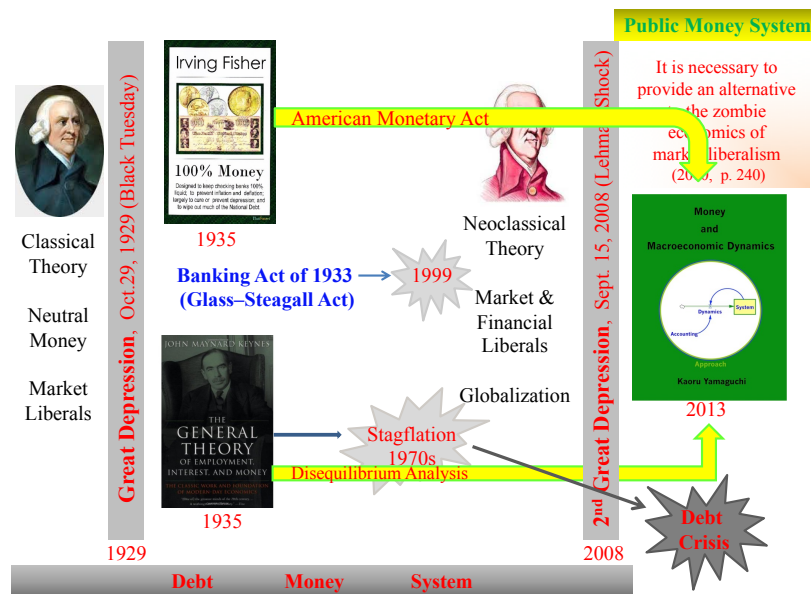

Figure 7: From Debt Money to Public Money System

Earned Interest Income

If demand deposits are fully required to be kept at banks, how can banks find extra money for making loans? Loanable funds come from three sources: (1) their own money (from retained earnings), (2) time deposits and (3) repaid loans. Time deposits are nothing but extra amount of deposits that are not needed for daily short-term transactions (savings)⁵ and become a main source of loanable funds for commercial banks, connecting savers and borrowers in the economy.

Service Charges

Commercial banks are now required to fully hold reserves against customers' demand deposits. Consequently, depositors can safely use their money in their banks at anytime. In exchange for this custodial payment services, depositors are asked to pay service charges to their banks just like the present-day ATM service fees. These service charges in turn become one of the stable source of earned income for the commercial banking sector. In this way a robust and stable financial foundation will be established.

⁵A detailed accounting representation of this transaction is laid out in the paper [27, 2016]. Since this paper only focuses on the payment methods, revenues such as earned interest income from investment activities are not discussed further here.

Moreover, this business model of genuine intermediaries of money provides banks with economic incentives for putting more weights in real investments that will result in stable returns from economic growth, rather than financial investments that end up with zero-sum gambles. Consequently, commercial banks seek for real investment opportunities in more productive markets, making them more competitive and efficient. Interest rates are, thus, determined in real and competitive markets. In this respect, the public money administration will be free from complex monetary policies of interest rate operations as presently done by the central banks.

Issuance of Public Money

Who should create money, then, in place of the privately-owned central banks and commercial banks? Issuance of public money (legal tender) is the prerogative of the Public (or the government). Thus, its issuer has to be a *public* organization, politically independent from the influences of the government and vested interest groups. And, at the same time, it must be a sole entity under the publicly-elected legislative branch of the representative government such as the Congress in the United States, the Parliament in the United Kingdom and the Diet in Japan. Such an organization is called the *Public Money Administration* (PMA) in Yamaguchi [23, 2013].⁶

To make this alternative system design workable by avoiding political pressures of printing more money and causing inflation, the following two conditions have to be strictly met (two conditions of Public Money Administration).

- C1. The Public Money Administration plays a role of *supply side* of public money, while the executive branch of the government (Department of Treasury in the U.S, Ministry of Finance in Japan, etc.) plays a role of *demand side*. The amount of public money is determined by the interplay of demand and supply sides.
- C2. Transparency of both information and decision processes of public money issuance has to be fully guaranteed to the public.

To implement the conditions of C1 and C2, an organizational structure of demand and supply side of public money is proposed in [25, 2015] as illustrated in Figure 8 as a case example in Japan. According to the proposal, the Public Money Administration is established under the direct supervision of the Diet as an politically independent organization from the influences of other branches of the government and politicians as well as special interest groups and lobbyists.

Some suggested spending policies of public money are outlined as follows.

- Public investment in education and research (tuition-free higher education etc.) as human and future investment.

⁶Chapter 15 of his book compares system structures and behaviors of debt money and public money systems, and Chapter 16 presents a generic transition process from the debt money system to the *public money* system. The transition process in the specific case of Japan is proposed in [25, 2015].

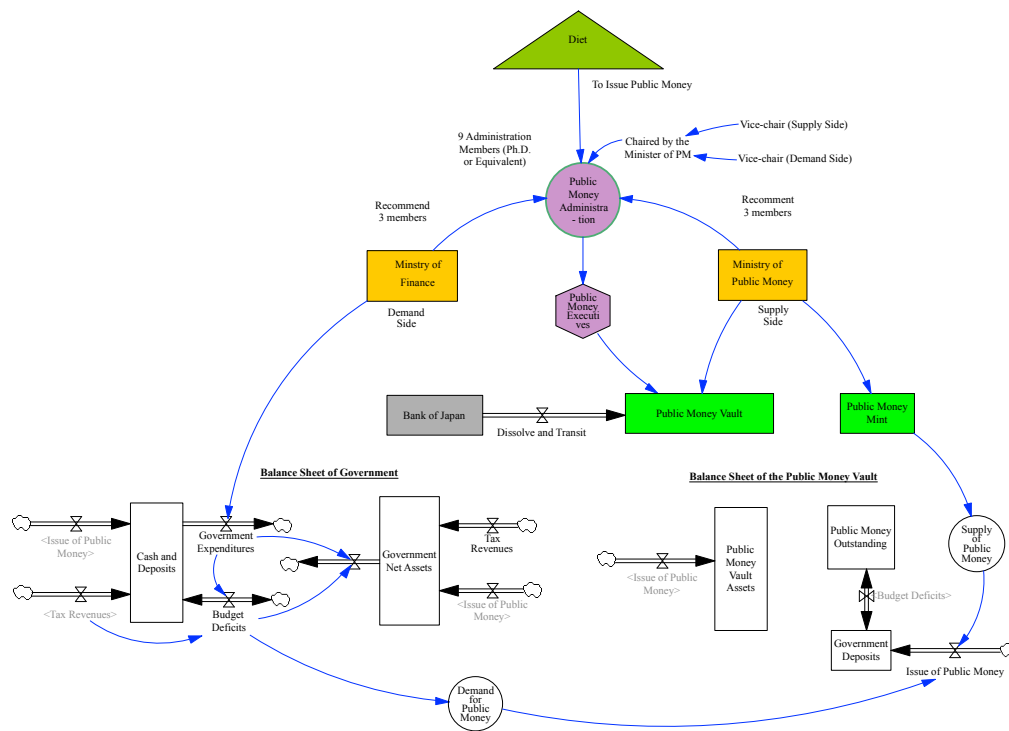

Figure 8: Organization of Public Money Administration in Japan

- Investment for constructing 21st century infrastructures such as IT network, green energies, and green transportation.
- Universal medical and healthcare program and other social welfare programs.

Note that the Public Money Administration is an entity exclusively responsible for the management of money stock and nothing else. The nation's financial system remains entirely untouched under the public money system except the detachment of money creation process by commercial banks under the present system.

5.3 System Behaviors of Public Money

Table 3 compactly summarizes the behaviors of the public money system. Under the public money system, three major system design failures are shown to be removed; that is, (a) monetary and financial instability, (b) accumulated government debts, and (c) income inequality between financiers and non-financiers.

a. Monetary and Financial Stability

Let us first examine the failure (a) of monetary and financial instability. Figure 9, taken from [27, 2016], shows that 100% required reserve ratio is introduced and attained at time 20. At that time, money stock (line 2) becomes equal to base money (line 1), meaning that every deposit in depositors' bank accounts becomes legal tender.

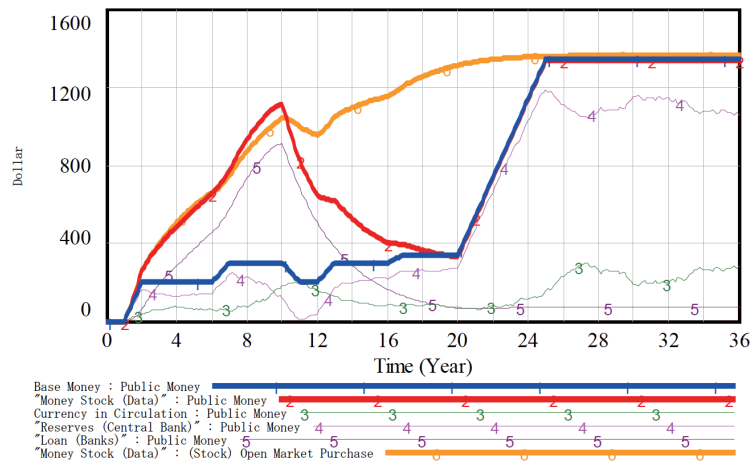

Figure 9: Public Money Put into Circulation at $t=18$ for 5 years

Accordingly, instability in money stock illustrated in Figure 2 is stabilized and it would no longer be affected by the changes in liquidity preferences of depositors, lending behaviors of banks, and debt repayments, as shown in Figure 9. Definitely, bank runs do not occur. As a next step, public money of \$200 per year is assumed to be newly issued (line 1) at $t=18$ for 5 years, totaling the input amount of \$1,000.

These two steps can be done as fast as overnight, for instance. In this way, the original level of money stock (line 6) under the previous debt money system is orderly restored and be replaced by the newly created public money. If more money stock is needed for the expanded economic activities and social welfare, adequate amount of additional public money is surely put into circulation by the Public Money Administration.

b. Liquidation of Government Debt

Concerning the failure (b) of accumulated government debts, government now becomes debt-free as its securities are getting paid off with public money whenever they become due [20, 2010], [21, 2011], [22, 2012]. Government securities may also be substituted for attaining 100% reserve ratio during the transition process. Consequently, government becomes free-hand to pursue its public policies without being constrained by the burden of national debts and interest

payments.

c. Income Inequality

Concerning the failure (c) of income inequality, it is better to explore methods of payment first as we did in the previous section, to find out how the structural cause of income inequality between financiers and non-financiers remains the same even under the public money system.

5.4 Payments under Public Money

Income Inequality by transactions fees still remains

Under the public money system, monetary stability is restored and government debts are liquidated [20, 2010], [23, 2013] [27, 2016]. Yet, payment methods do not change drastically; that is, payment methods ① through ⑥ discussed in Section 4 remain the same. In other words, income inequality between bankers and non-bankers are reduced by the amount of interests previously concentrated to bankers through government debts and private debts, since deposits (and debts) are no longer created by banks out of nothing.

Yet, nonbank financiers continue to charge transaction fees so that income inequality between financiers and non-financiers by way of transaction fees still remains as before.

What is needed to reduce the remaining income inequality in the public money system is the design of peer-to-peer transaction, which now became possible by the distributed ledger technology first introduced in Bitcoin [9, 2008].

6 Bitcoin and Blockchain Revolution

6.1 Payments with Bitcoin

⑦ Payments with Bitcoin

It is pointed out in Section 2 that bitcoin is neither legal tender nor currency by all means; that is, it must be functional-money just like the present-day bank deposits. Accordingly, if we want to use bitcoin in broader economy, it must be exchanged for currency, or deposits. This aspect of Bitcoin as transaction medium is briefly illustrated in Figure 10 as overview of payments with Bitcoin. Therefore, it is better to be called digital (or crypto) ingot, similar to gold ingot. Gold ingots have been historically used to clear trade balances, and are traded as investment commodities nowadays. In this sense, it is appropriate to interpret Bitcoin as digital ingot, which plays a role of functional-money, similar to bank deposits that could be legally refused to accept as a means of transaction payments. Indeed, Figure 10 demonstrates how it is constrained as a means of exchange.

Figure 23 in the Appendix presents its detailed payment system. Even though Bitcoin payments are peer-to-peer and in this sense the same as cash payments in Figure 4, it requires additional Bitcoin exchangers, similar to gold traders.

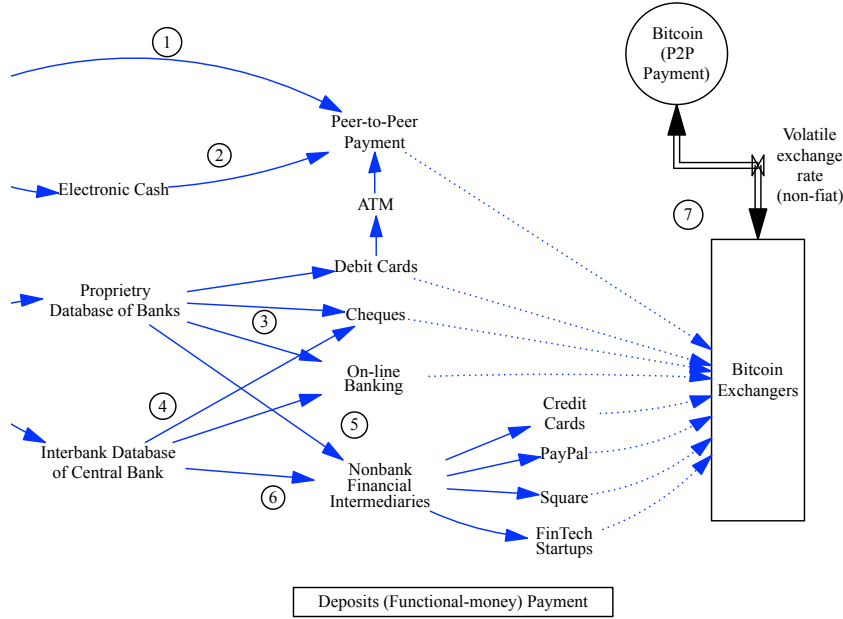

Figure 10: Overview of Debt Money and Bitcoin Payments

6.2 How Bitcoin Transactions Work?

Distributed Public Ledger

Until the introduction of Bitcoin, the only payment method with digital currency is by electronic cash stored in prepaid cards or other substitutes as illustrated in Figure 19 in the Appendix. This was due to the difficulty of avoiding the so-called *double-spending* problem and *Byzantine Generals Problem* in the field of distributed computing. Bitcoin practically provided a breakthrough to these challenges with an brilliant idea of public ledger through proof of work.

In system dynamics modeling, cash flow of peer-to-peer transaction can be easily captured by stock-flow diagram as in Figure 11, whose dynamic equations are written as follows:

$$\begin{aligned}
 \text{Inflow}_t &= \text{Receipt from } A_t + \text{Receipt from } B_t \\
 \text{Outflow}_t &= \text{Payment to } C_t + \text{Payment to } D_t \\
 \text{Stock}_{t+1} &= \text{Stock}_t + \text{Inflow}_t - \text{Outflow}_t, \quad t = 0, 1, 2, \dots
 \end{aligned} \tag{4}$$

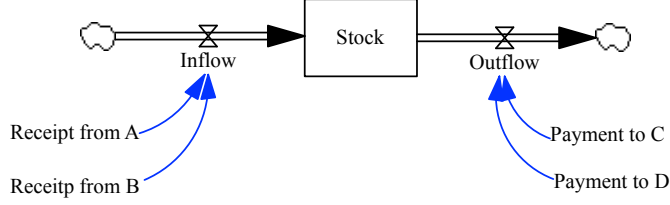

Figure 11: Stock-Flow Presentation of Transaction Ledger

Without losing generality, these equations of stock-flow relation are broken down and re-arranged into an accounting ledger of inputs and outputs relation at a discrete time $t = 0, 1, 2, \dots$ such that

$$\text{Inputs}_t \begin{cases} \text{Stock(unspent)}_t \\ \text{Receipt from A}_t \\ \text{Receipt from B}_t \end{cases} \implies \text{Outputs}_t \begin{cases} \text{Payment to C}_t \\ \text{Payment to D}_t \\ \text{Stock(unspent)}_{t+1} \end{cases} \quad (5)$$

This is how the stock-flow relation in system dynamics is transformed into transaction ledger. In Bitcoin network, new transactions are first propagated across the network and stored in transaction pools of Full Bitcoin nodes located world-wide. Verified transactions are collected and put into a *block* every 10 minutes on average. The so-called miner who has solved the mathematical problem (finding a nonce) first is given the right to create a candidate block and propagate it to the network, generating a specified amount of new Bitcoin as a reward. Once it is validated by participating nodes, the new block is then added on top of the previous chain of blocks called *blockchain*.

As new block is added in this way, validity of the transactions in the latest block is reinforced by having the subsequent blocks built upon the previous block. No centralized authority of trusted third parties such as banks is needed in such system design. This vividly contrasts with privacy model and payments system under the debt money system described above, in which every transaction in our economy has to be executed through the centralized and trusted third parties.

This decentralized peer-to-peer networks of trust realized by blockchain technology are transforming the payment methods in finance. A fundamental difference between the debt money system and Bitcoin is that any records of transaction are maintained by centralized institutions in the debt money system, whereas in Bitcoin they are shared as a global public ledger.

6.3 Impediments of Bitcoin Payments

Volatility of Bitcoin Value

Though peer-to-peer Bitcoin transaction seems to be getting popular, we want to point out briefly the two fundamental impediments that Bitcoin payments are facing under the current debt money system; that is, volatility of Bitcoin value and its supply limitation.⁷ Let us take a look at the volatility issue first.



Figure 12: Bitcoin Price Volatility in the last 2 years. Source: blockchain.info

Figure 12 is the time series data of Bitcoin price for the last two years. Bitcoin price has been fluctuating as if it is gold price. Due largely to this volatility of price, it has not been so seriously used as a means of transaction, instead it has been regarded as an investment target similar to gold.

Limitation of Bitcoin Supply

Bitcoin protocol is programmed such that its maximum amount is attained at 21,000,000 BTC. Figure 13 shows how Bitcoin has been supplied since its start on January 3, 2009. We have been puzzled why maximum amount of Bitcoin is predetermined from its inception. Why did Satoshi Nakamoto fix the maximum amount?

⁷In addition to these economic problems, Bitcoin faces technical problems as a result of proof-of-work approach; that is, coin generation and block construction process are intertwined, concentrating the important functions of the system into the block constructors (five professional mining pools). More specifically, they are: 1) high energy costs due to massive computations, 2) risk of validator concentration of power, and 3) ambiguity in forming a unique blockchain (forking) and limited scalability. To overcome these issues, entirely new protocols have been proposed such as *Algorand* (algorithmic randomness) [8, 2016].

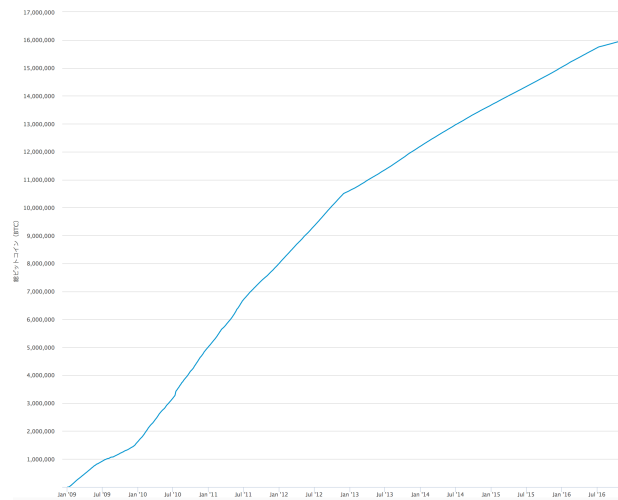

Figure 13: Bitcoin Supply since its start in Jan. 2009. Source: blockchain.info

Fortunately, we have encountered one of his early posts on the internet, where he clearly expresses why Bitcoin had to have the predetermined amount of supply in order to avoid the trusted third party. As a result, he continues, volatility of its value becomes an inevitable consequence of its system design, which can be, however, solved as a technical problem.

... indeed there is nobody to act as central bank or federal reserve to adjust the money supply as the population of users grows. That would have required a trusted party to determine the value, because I don't know a way for software to know the real world value of things. If there was some clever way, or *if we wanted to trust someone to actively manage the money supply to peg it to something, the rules could have been programmed for that* (italicized by the authors).

In this sense, it's more typical of a precious metal. Instead of the supply changing to keep the value the same, the supply is predetermined and the value changes. As the number of users grows, the value per coin increases. It has the potential for a positive feedback loop; as users increase, the value goes up, which could attract more users to take advantage of the increasing value[10, 2009].

While central banks today cannot adjust money supply contrary to the general beliefs, it is now clear why he has chosen to predetermine the maximum amount of Bitcoin supply. He purposefully programmed the original Bitcoin protocol such that its value continues to go up to attract more Bitcoin users, with a hope that Bitcoin will survive and continue to prosper.

Yet, predetermined amount of supply sooner or later imposes deflationary trend of its quantity in the face of increasing demands, pushing up Bitcoin

prices as gold price used to be. This reminds us of the historical collapse of gold standard in 1930s, and the collapse of gold-dollar convertibility in 1971. In other words, as long as its supply is limited, Bitcoin continues to face challenges against a sound means of exchange under a growing economy.

However, Satoshi Nakamoto, the original developer of Bitcoin, suggests that it is technically possible to make Bitcoin as a stable means of exchange if we could find a trusted party who is able to actively manage the supply of money. This is indeed a promising insight in designing peer-to-peer public money systems in the next section.

6.4 Blockchain Applications as Patchworks

Due to the impediments discussed above, the use of Bitcoin has been limited. The recent focus has been more on blockchain technology itself behind Bitcoin. As pointed out in Section 1, applications of distributed ledger technology have been mushrooming not only as Alt(ernative) Coins but also as "virtually everything of value that can be expressed in code". Alt Coins, even though they take different approaches from Bitcoin, are destined to face similar challenges against a sound means of exchange. As long as applications of blockchain technology are developed on top of debt money system, they are nothing but *blockchain patchworks* since they were not designed to address systemic problems facing the debt money system caused by its system design failures (Figure 14).

What is needed is the integration of system designs proposed in the public money system and peer-to-peer transaction system through distributed public ledger technology.

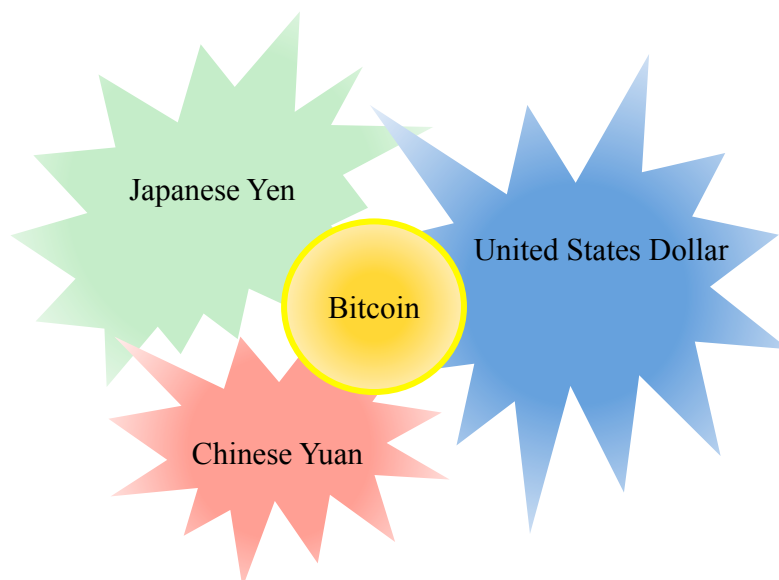

Figure 14: Debt Money System and Bitcoin

7 Peer-to-Peer Public Money Systems

In this section, we present an integrated design of *Peer-to-Peer Public Money System* under the technological assumption of distributed public ledger and public-key cryptography. It is hereafter called p2p public money, or *Electronic Public Money* (EPM) system interchangeably.

7.1 The Ultimate System Design of Monetary Reform

In Section 3, system structure and behaviors of the current debt money system were revisited. It was identified that the present system creates systemic failures such as monetary instability, government debt accumulation, and income inequality as a result of its structural design. Then, in Section 5, the public money system was revisited as its alternative system. However, in Section 5.4, we found that income inequality caused by transaction fees persists as long as the basic structure of the system remains the same. In Section 6, we briefly

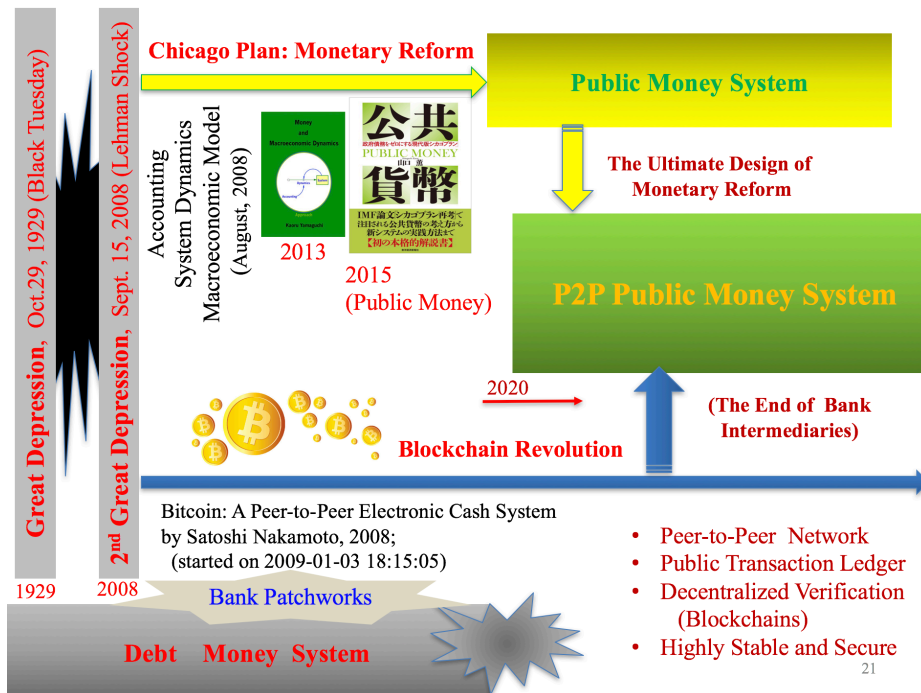

Figure 15: Unified System Design of Peer-to-Peer Public Money

revisited system design of Bitcoin with a focus on its design as a payment system. However, Bitcoin itself and other cryptocurrencies, with all technological applications they have inspired, are identified as supplementary systems built upon the far larger debt money system. What is now needed is a re-design of the

present debt money system to overcome the shortcomings of debt money system with a new system design of peer-to-peer transaction. Figure 15 illustrates how the two separate proposals are converged into an unified system design.

7.2 System Structure of Peer-to-Peer Public Money

The essence of system re-design of public money system is the separation of money creation process from private investment activities, both of which are done by private commercial banks under the present system. This holds true in the peer-to-peer public money system. Thus, it is featured as follows.

- Electronic public money (EPM) as legal tender is issued exclusively by the Public Money Administration as equity of the government.
- EPM is put into circulation to sustain economic growth and welfare at interest-free.

It is worth remarking here that the second feature of the system structure of public money explained in Section 5.2 is missing; that is, "100% reserve ratio is required for demand deposits". Under the p2p public money system, demand deposits are no longer needed as a means of payments simply because payments are directly done peer-to-peer between buyers and sellers, or payers and payees. Consequently, banks are forced to stop playing as genuine intermediaries.

Even so, private financial system will remain the same for foreseeable future under the new system as in public money system until the transition to new system is completed. Accordingly, it is fair to say that as long as demand deposits exist,

- Commercial banks are required to hold public money against its demand deposits (100% reserve ratio).

That is to say, all functional-money which is created as debts by commercial banks are replaced by legal tender as explained in Section 5.3. As a result, public money now consists of coins, notes (replacing former central bank notes) and electronic public money.

Issuance of Electronic Public Money

In order to sustain economic growth and welfare, EPM is issued by the (supply side of) Public Money Administration, which plays the ultimate role of *a trusted party* suggested by Satoshi Nakamoto [10, 2009] as already discussed in Section 6.3. PMA is a public institution, established under the direct supervision of legislative branch of the government, that is directly responsible for managing the amount of EPM stock (supply) as discussed in Section 5. This vividly contrasts with Bitcoin whose total amount of issuance is predetermined, or that of the current debt money system where deposits are endogenously created by commercial banks and overall money stock cannot be controlled effectively even by the central bank in the system.

7.3 Payments under Peer-to-Peer Public Money System

Under the p2p public money system we can directly send and receive EPM (legal tender, thus with finality) across physical borders with very little or no transaction fees as shown in Figure 16. These transactions are immediately recorded on the distributed EPM public ledgers supported by distributed public ledger technology.

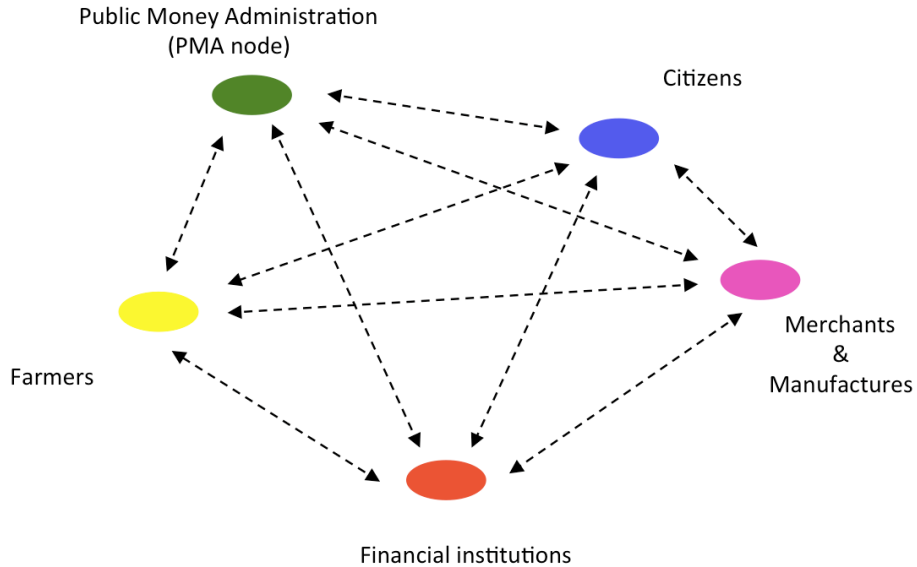

Figure 16: Network Nodes in EPM system

As a result, payment methods under the debt money and public money system such as ② through ⑥ analyzed in Section 4 will be eventually forced out of the payment service markets. Similarly, compared with Figure 14, payments with Bitcoin ⑦ may not survive in the long run as a means of international payment as foreseen in Figure 17.

7.4 New Protocol for Peer-to-Peer Public Money

To implement the p2p public money system world-wide, new EPM protocol needs to be developed that can support this large peer-to-peer transaction system. Since the introduction of Bitcoin [9, 2008], several approaches for attaining network-wide consensus on a single distributed payment system have been proposed. Choosing a specific protocol means applying specific properties to the network of payments. This involves technological discussions that are beyond the reach of our current research here. Therefore in this paper, we outline a high-level system configuration that must be incorporated into the design of EPM protocol.

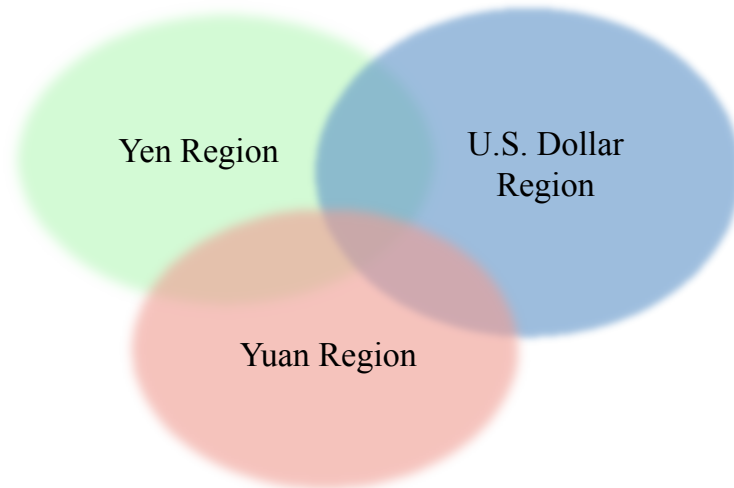

Figure 17: Emerging EPM Regions

1. **EPM Supply** EPM is newly issued and put into circulation by the PMA. How should newly issued EPM be recorded into the public ledger, then? In the proposed EPM protocol, a generation of newly issued EPM and block validation process must be separated to overcome technical problems facing the "proof of work" approach while trying to achieve a permissionless system. This is one of the most important protocol design to be incorporated.
2. **EPM in Circulation** To meet fiscal budgetary balance, government must collect taxes. One possible way to implement this fiscal policy in the EPM system is through *uniform tax rate* (see remark 1 below), which could be built into public ledgers as transaction fees against all transactions.
3. **EPM Block Verification** Who should be responsible for verifying a new block and how? This must be determined together with the level of security the EPM protocol is designed to provide.

To avoid the concentration of power in PMA node (money issuance node), the PMA has to be managed independently but in a perfectly democratic way, including the comprehensive disclosure of all information and its decision processes (two conditions of the PMA discussed in Section 5.2). The EPM protocol that we envisage, thus, must be carefully designed both as technical protocol and as an organizational management one, which in turn must be reflected upon the overall governance of the EPM system both within and across EPM regions. Figure 16 above illustrates a completely new monetary system of *peer-to-peer public money* where only the issuance of money is centrally administered by the PMA with full information disclosure.

Remark 1: Unified Tax System

A uniform tax rate (UTR) discussed in the above item 2 can be introduced as a fractional transaction fees that are fairly levied against all transactions made in the EPM region, just like present day highway tolls or mobile phone bills. For instance, in case of fiscal deficit, this *uniform tax rate* is increased to meet its budgetary balance. This uniform tax rate policy is conducted by the Ministry of Finance (MoF) in the context of Japan.

If the economy is in recession, increasing the UTR has limited effectiveness and even worsens the depressed economy. In such a case, the PMA issues new EPM, which will be put into circulation through fiscal policy. Recall that the final decision as to how much additional EPM needs to be issued is independently determined from the fiscal needs of spending policies as explicated in Section 5.2. Under the public money system, the demand side of the PMA, such as, say, MoF, needs to disclose information to justify its new demand for EPM. In this way both the supply side of PMA and demand side interplay between each another as a check and balance management of public money stock in circulation to keep money issuance away from fiscal (and governmental) dominance.

The introduction of the EPM system simplifies the current complicated tax system. Tax collection and its law enforcement agency such as Internal Revenue Service in the US will no longer be needed, saving significant amount of tax-levying costs.

Moreover, this tax scheme provides an effective system for addressing tax-haven evasion because whoever and wherever EPM are sent, tax is proportionately levied according to the amount of transactions without identifying senders and receivers.

Remark 2: EPM Regions

The effective region of EPM spans across physical borders of nation-states. Transactions of EPM can be made available everywhere on the planet as long as its users accept each nation-state's EPM just as central bank notes today are used everywhere in transactions with cash. Gradually, EPM regions of all nationality begin to emerge world-wide. Figure 17 above illustrates how each EPM region starts to emerge and begin to overlap as if diverse colors of floral petals open up internationally.

Remark 3: Foreign Exchange Markets

Under the peer-to-peer public money system, users across different EPM regions can exchange EPM on a peer-to-peer basis. As such, the current foreign exchange markets will expand even to individuals who previously had no choice but to pay unnecessary high transaction fees to the service providers. Expansion of foreign exchange markets makes foreign remittances easier, faster and with significantly low cost. In addition to the foreign exchange markets within national borders, people living in ethnic community outside of their original country may start using EPM from their country-region of origin.

How should such foreign exchange services be smoothly handled across different EPMS? This is an important foreign exchange protocol to be agreed. Yet, this protocol needs to be differently developed from the EPM protocol by new startups of foreign exchange service. In other words, the development of foreign exchange protocol is entirely left to private sectors to promote their business opportunities.

7.5 Behaviors of World-wide P2P Public Money System

Behaviors of the public money system discussed in Section 5.3 are similarly observed under the p2p public money system such as monetary and financial stability, liquidation of government debt and income equality, which are listed as the first three bullet points outlined below. Income inequality will be more drastically eliminated because payment methods ① through ⑥ discussed in Section 4 will be simplified into one peer-to-peer payment method under the p2p public money system.

Moreover, a world-wide network of p2p public money systems will attain the following cross-national behaviors.

- Stabilization of monetary system and its increased resiliency to the banking crisis and financial shocks (No bank runs, no need for too-big-to-fail policy as a result of fault tolerant system design).
- Liquidation of government debts within each EPM region.
- Elimination of income inequality between financiers and non-financiers.
- Easy acceleration of capital inflow into socially responsible investments and environmental projects.
- Expansion of peer-to-peer micropayment and micro-lending business through cross-boarder investments, stimulating investments on community projects and small and medium-sized businesses.
- Reduction of over-indebtedness and social unrests in favor of a sustainable growth path within EPM regional economies.

Conclusion

In the year 2008, two papers were published: ASD macroeconomic model and Bitcoin, which have influenced the way the present system of debt money can be re-designed. Each paper separately provided foundations in re-designing a new monetary system proposed in this paper. Specifically the ASD macroeconomic model has developed into the proposal of public money system to overcome systemic failures facing the current debt money system, namely, monetary instability, government debt accumulation and income inequality through transaction

fees. Bitcoin, on the other hand, has gradually gotten accepted as functional-money (crypto-currency), while inspiring numerous applications of blockchain technology.

Yet, it is argued that Bitcoin is not currency as legal tender, and accordingly destined to encounter impediments such as volatility of its value and supply limitation along with economic calamities of the present debt money system on which Bitcoin is dependent upon. To fully utilize the main benefits of public money system and peer-to-peer transaction system supported by distributed ledger technology, we have proposed a unified design of *peer-to-peer public money system*.

In this paper, this integrated system design is approached with a focus on payment methods. Specifically six different payments are identified under the current debt money system, and simple System Dynamics models are constructed accordingly. It is argued that these payments may, to a certain degree, remain even under the public money system. Then, it is argued that they will gradually be simplified into one peer-to-peer payment method under the p2p public money system, which eventually eliminates income inequality between financiers and non-financiers. Finally the need for the development of world-wide EPM protocol is proposed in order to implement this system. This paper would like to conclude with our immediate call for the world-wide EPM system forum to advance such EPM protocol openly and interdisciplinarily among blockchain researchers and engineers, economists, bankers and policy makers.

| |
|--|
| World-wide EPM System Forum – Electronic (p2p) Public Money – |
|--|

References

- [1] Andreas M. Antonopoulos. *Mastering Bitcoin – Unlocking Digital Cryptocurrencies*. O'Reilly Media, Inc., 1005 Gravenstein Highway North, Sebastopol, CA 95472 USA, 2015.
- [2] The Economist. The trust machine, 2015.
- [3] Irving Fisher. *100% Money*. The City Printing Company, New Haven, third edition, 1945. First edition (1935) available through ThaiSunset Publications, 2011.
- [4] Irving Fisher, Paul Douglas, Frank D. Graham, Earl J. Hamilton, Willford I. King, and Charles R. Whittlesey. A Program for Monetary Reform (mimeograph), July, 1939. Included in the Editor's Appendix to "100% Money by Irving Fisher", ThaiSunset Publications, 2011.
- [5] Jay W. Forrester. *Industrial Dynamics*. Pegasus Communications, Inc., Originally published by MIT Press, Waltham, MA, USA, 1961.

- [6] Milton Friedman. *A Program For Monetary Stability*. Fordham University Press, New York, 1960, 1992.
- [7] John Maynard Keynes. *The General Theory of Employment, Interest, and Money*. Harcourt Inc., London, New York, San Diego, 1964.
- [8] Silvio Micali. Algorand - The Efficient Public Ledger. <https://arxiv.org/pdf/1607.01341.pdf>.
- [9] Satoshi Nakamoto. Bitcoin: A Peer-to-Peer Electronic Cash System <https://bitcoin.org/bitcoin.pdf>.
- [10] Satoshi Nakamoto. P2p foundation original post: 2009-02-18 20:50:00 utc, <http://satoshi.nakamotoinstitute.org/posts/p2pfoundation/3/>.
- [11] Ronnie J. Phillips. *The Chicago Plan & New Deal Banking Reform*. M.E. Sharpe, Inc., London, New York, 1995.
- [12] Masaaki Shirakawa. *Modern Monetary Policy in Theory and Practice: Central Banking and Financial Markets (in Japanese)*. Nihon Keizai Shinbun, 2008.
- [13] Don Tapscott and Alex Tapscott. *Blockchain Revolution – How the Technology Behind Bitcoin is Changing Money, Business, and the World*. Penguin Random house LLC, 375 Huddon Street, New York, New York 10014, 2016.
- [14] Kaoru Yamaguchi. Principle of Accounting System Dynamics– Modeling Corporate Financial Statements –. In *Proceedings of the 21st International Conference of the System Dynamics Society*, New York, 2003. System Dynamics Society.
- [15] Kaoru Yamaguchi. Aggregate Demand Equilibria and Price Flexibility : SD Macroeconomic Modeling (2). In *Proceedings of the 23rd International Conference of the System Dynamics Society*, Boston, USA, 2005. The System Dynamics Society.
- [16] Kaoru Yamaguchi. Integration of Real and Monetary Sectors with Labor Market: SD Macroeconomic Modeling (3). In *Proceedings of the 24th International Conference of the System Dynamics Society*, Nijmegen, The Netherlands, 2006. The System Dynamics Society.
- [17] Kaoru Yamaguchi. Balance of Payments and Foreign Exchange Dynamics: SD Macroeconomic Modeling (4). In *Proceedings of the 25th International Conference of the System Dynamics Society*, Boston, USA, 2007. The System Dynamics Society.
- [18] Kaoru Yamaguchi. Open Macroeconomies as a Closed Economic System: SD Macroeconomic Modeling Completed. In *Proceedings of the 26th International Conference of the System Dynamics Society*, Athens, Greece, 2008. The System Dynamics Society.

- [19] Kaoru Yamaguchi. Logical vs Historical Time in a Price Adjustment Mechanism. In *Proceedings of the 27th International Conference of the System Dynamics Society*, Albuquerque, New Mexico, 2009. The System Dynamics Society.
- [20] Kaoru Yamaguchi. On the Liquidation of Government Debt under a Debt-free Money System: Modeling the American Monetary Act. In *Proceedings of the 28th International Conference of the System Dynamics Society*, Seoul, Korea, 2010. The System Dynamics Society.
- [21] Kaoru Yamaguchi. Workings of a Public Money System of Open Macroeconomies: Modeling the American Monetary Act Completed. In *Proceedings of the 29th International Conference of the System Dynamics Society*, Washington D.C., USA, 2011. The System Dynamics Society.
- [22] Kaoru Yamaguchi. On the Monetary and Financial Stability under a Public Money System: Modeling the American Monetary Act Simplified. In *Proceedings of the 30th International Conference of the System Dynamics Society*, St. Gallen, Switzerland, 2012. The System Dynamics Society.
- [23] Kaoru Yamaguchi. *Money and Macroeconomic Dynamics – Accounting System Dynamics Approach*. Japan Futures Research Center, Awaji Island, Japan (Edition 3.1, 2016 is available at <http://www.muratopia.org/Yamaguchi/MacroBook.html>), 2013.
- [24] Kaoru Yamaguchi. From Debt Money to Public Money System – Modeling a Transition Process Simplified. In *Proceedings of the 32nd International Conference of the System Dynamics Society*, Delft, Netherlands, 2014. The System Dynamics Society.
- [25] Kaoru Yamaguchi. *Public Money – Modern Version of the Chicago Plan that Liquidates Government Debt (in Japanese)*. Toyo Keizai Shinpo-sha, Tokyo, Japan, 2015.
- [26] Kaoru Yamaguchi and Yokei Yamaguchi. ASD Macroeconomic Model of Japan on the Flow of Funds and National Accounts –Report on its Early Stage Development. *Proceedings of the 33rd International Conference of the System Dynamics Society, Cambridge, Massachusetts, USA*, July 2015.
- [27] Kaoru Yamaguchi and Yokei Yamaguchi. Heads and Tails of Money Creation and its System Design Failures – Toward the Alternative System Design –. *Proceedings of the 34th International Conference of the System Dynamics Society, Delft, The Netherlands*, July 18th 2016.
- [28] Stephen Zarlenga. *The Lost Science of Money: The Mythology of Money - the Story of Power*. American Monetary Institute, New York, 2002.

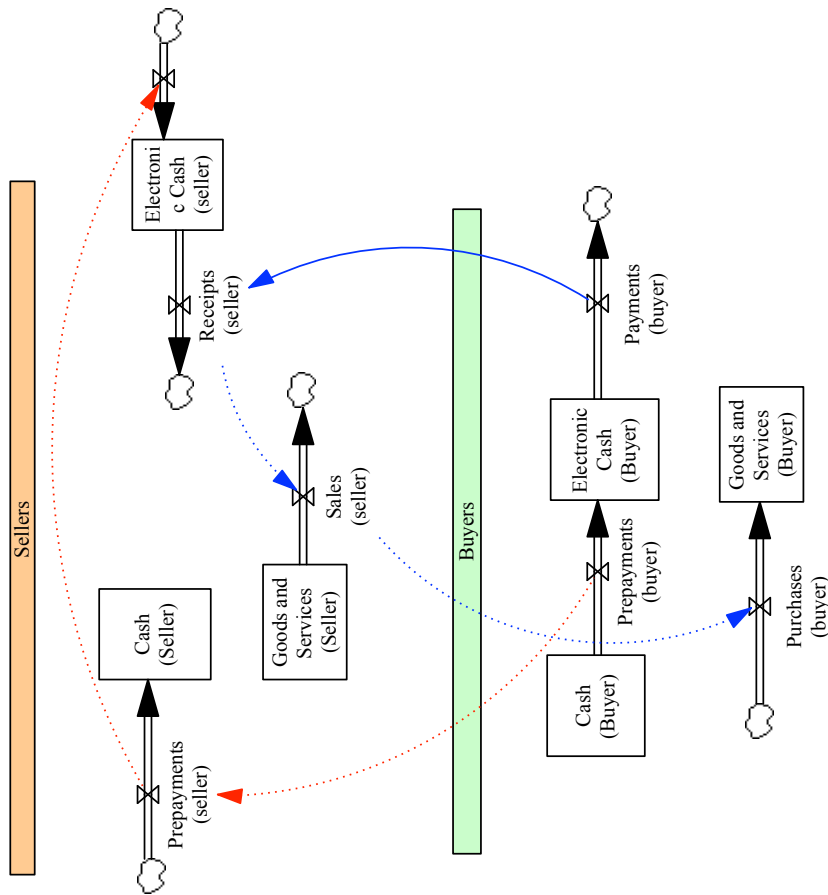

Figure 19: Payment System (2) with Electronic Cash

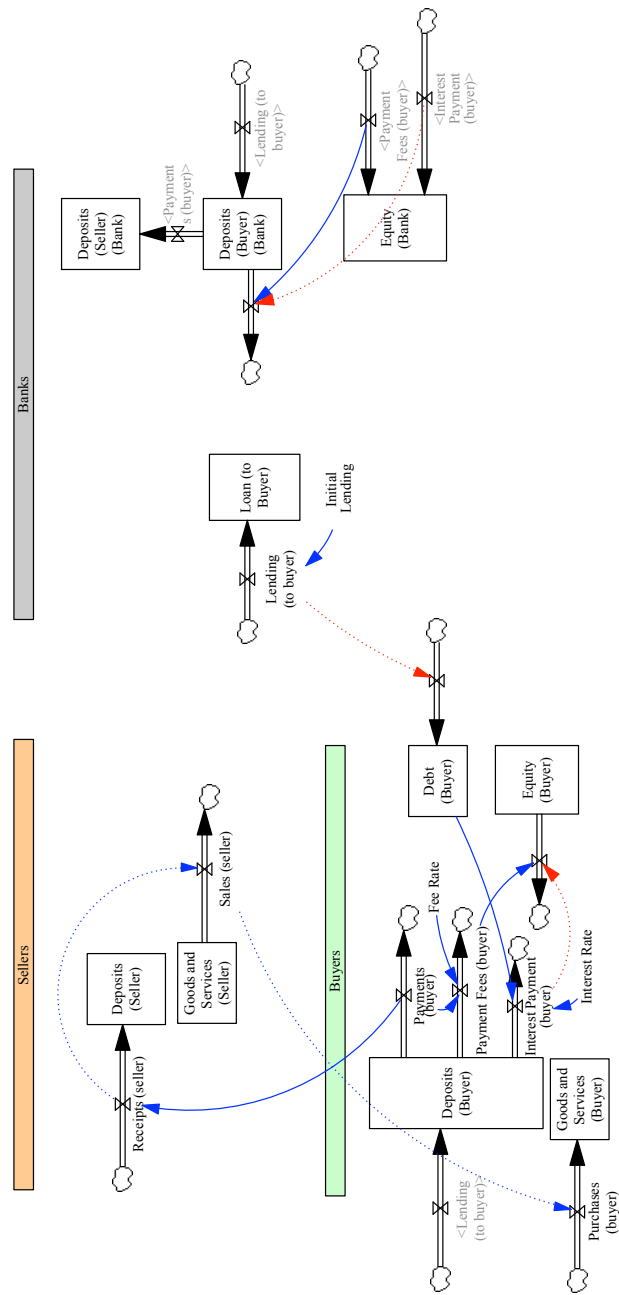

Figure 20: Payment System (3) with Bank Deposits

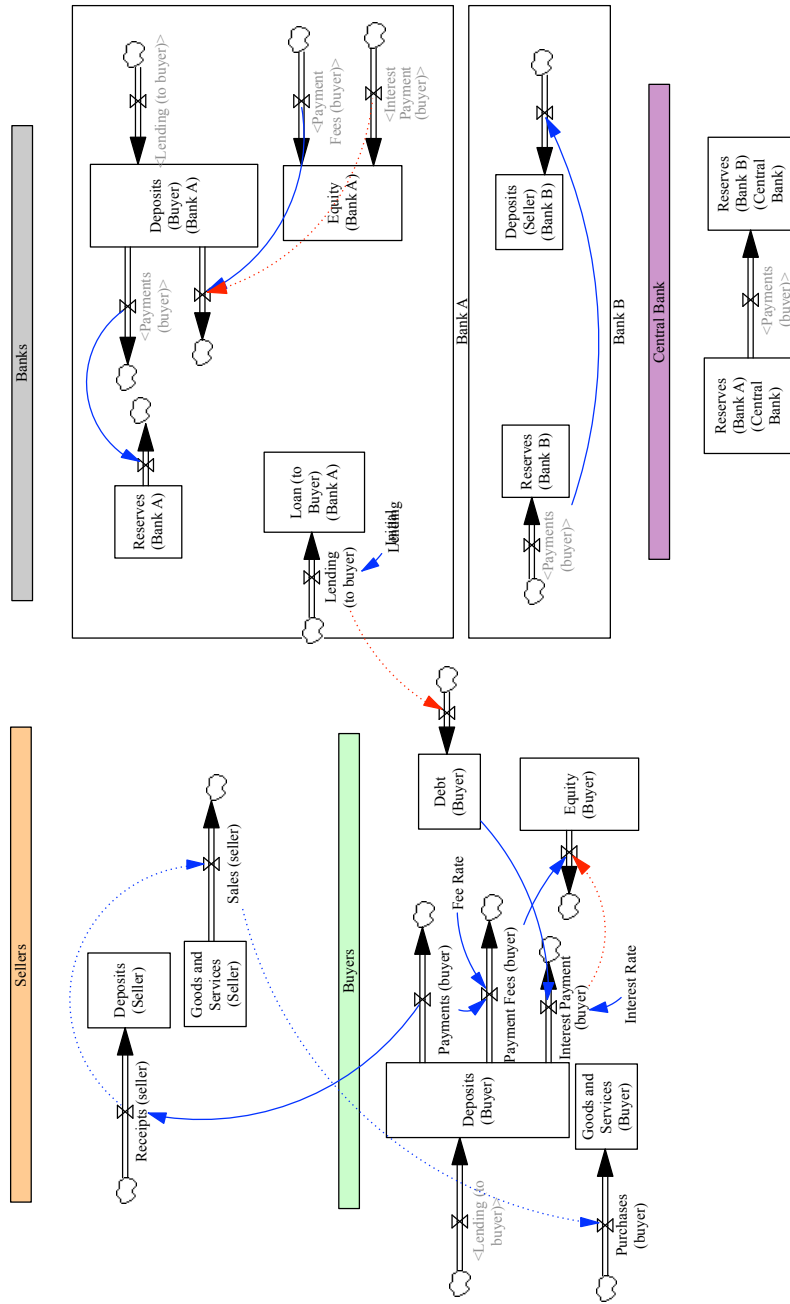

Figure 21: Payment System (4) with Multiple Bank Deposits

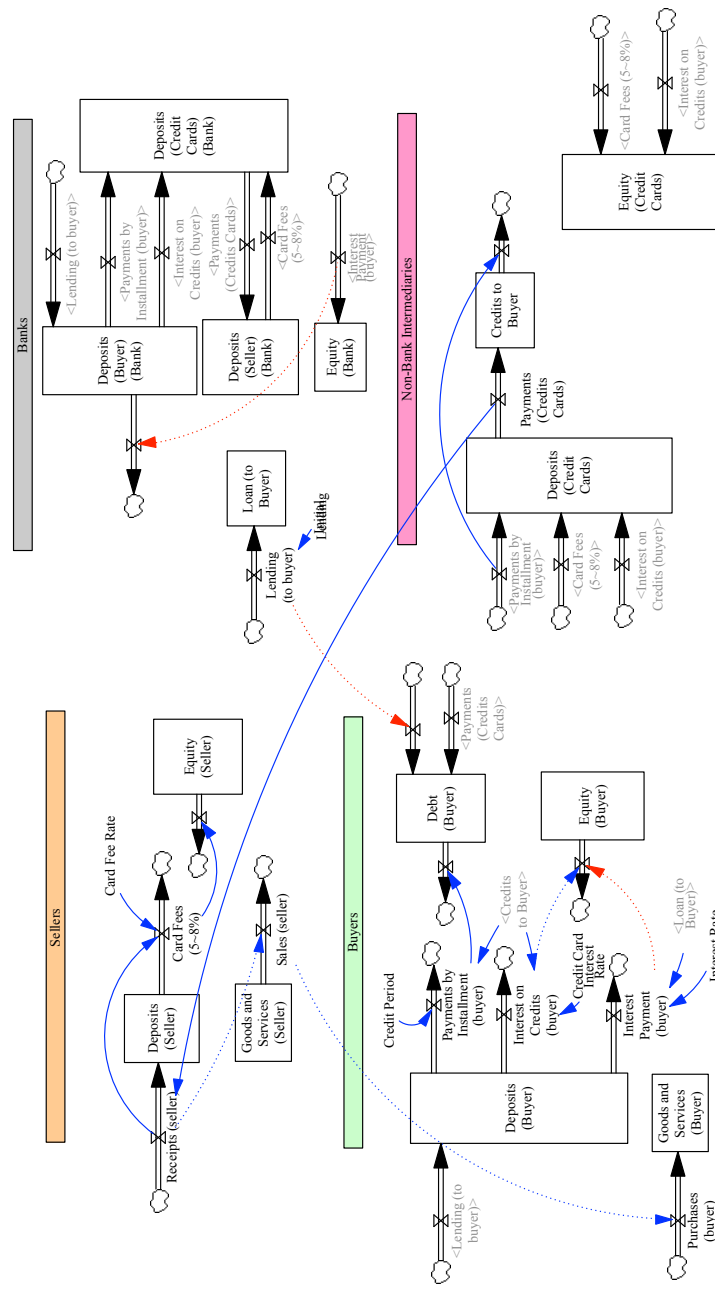

Figure 22: Payment System (5) through Nonbank Intermediaries (Credit Cards)

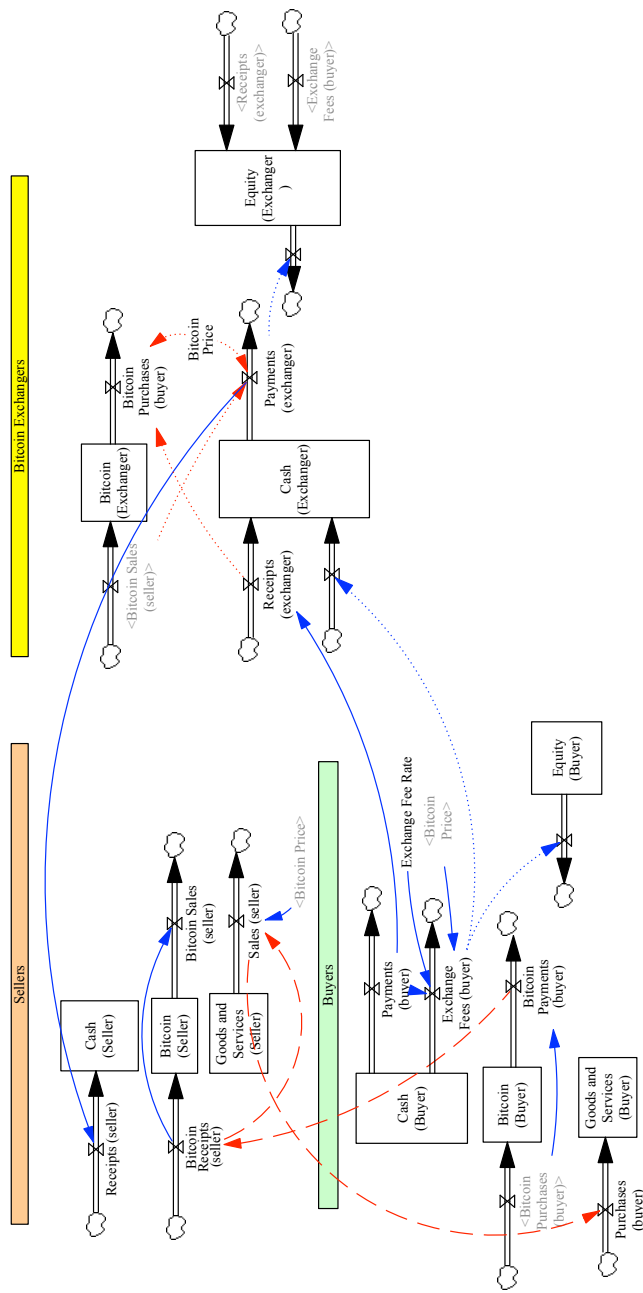

Figure 23: Payment System with Bitcoin: Peer-to-Peer