



JTC-1116 VW, AUDI SPARK PLUG ELECTRIC WIRE REMOVER

- The tool is designed to separate the electric wire from spark plug.
- Applicable: VW



JTC-1216 1/2" x M10S CYLINDER HEAD BOLT TOOL

- The 140mm length allows easy access to recessed head bolts.
- Comes with 1/2" drive for use with a torque wrench.
- Used for VW, AUDI cylinder head bolts.

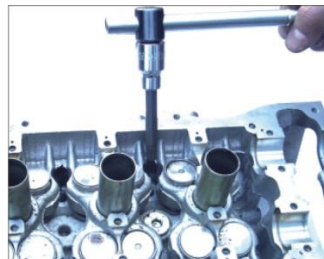

JTC-1303 VW OIL SCREW SOCKET M16H

- Operated by 17 m/m wrench
- Special design for using in narrow spaces.
- Applicable: VW, AUDI oil screws
- Size: M16H tamperproof





JTC-1327 EXHAUST SPRING CLAMP REMOVER / INSTALLER

- Essential for safe, controlled removal of clamps attaching exhaust to manifold.
- Special design provides "leverage" required to expand the strong spring clamps.
- Applications: VW, AUDI



JTC-1367 TRANSMISSION / GEARBOX SOCKET (1/2" x M16H)

- Special tamperproof design for removing and installing the oil release bolt on the transmission and gearbox.
- Applicable: AUDI A3 / A4 / A6 and GOLF IV / LT.
- Length: 60mm



JTC-1368 VW, AUDI MULTI-SPLINE SOCKET (M14)

- Special design for removing and installing the bolts of the upper ball joint.
- Applicable: VW, AUDI
- Length: 60mm





JTC-1427 VW, AUDI V-BELT PULLEY REMOVER

- Special design to stop the pulley and remove the centre bolts and the V-belt pulley at the generator.
- Use with 17mm wrench.
- Applicable: VW GOLF, VENTO, PASSAT, AUDI A3, and VOLVO.



JTC-1428 VW, AUDI CAMSHAFT ALIGNMENT TOOL SET

- Convenient for working and fixing on crankshaft and making crankshaft fix.
- Applicable: VW, AUDI 1.4 / 1.6L, and VW LUPO, POLO, GULF IV, BORA / AUDI A2



JTC-1431 VW, AUDI CAMSHAFT ALIGNMENT TOOL SET

- Contents:
 - Injection pump locking pin
 - Tensioner locking tool
 - Crankshaft locking tool
- For use on AUDI, VOLKSWAGEN, SEAT, SKODA WITH TDI PD, and V6 engine.

JTC-1431



車上零件:
038105263F



JTC AUTO TOOLS
2600 Northlake Dr. Suite F,
Suwanee, GA, 30024



JTC-1432 VW AIRBAG REMOVER

- To remove driver's airbag from steering wheel.
- Applicable: 1999-04 new body style VW PASSAT, JETTA, GOLF and BEETLE.



JTC-1443 VW 3-IN-1 BOSCH TIMING TOOL

- Suitable for timing Bosch VE injection pumps.
- Includes M8, M10, and M12 adapters.
- Use in conjunction with Dial gauge.
- Applicable: Bosch VE fuel pump, Diesel Kiki, and Nippondenso pumps.



JTC-1518 CRANKSHAFT LOCKING PIN

- Special design to fix crankshaft angle.
- Corrects timing adjustment.
- Size: M12 X P1.5
- Applicable: V6, V8 engine



JTC AUTO TOOLS
 2600 Northlake Dr. Suite F,
 Suwanee, GA, 30024



JTC-1519 CRANKSHAFT LOCKING PIN

- Special design to fix the crankshaft angle.
- Corrects timing adjustment.
- Size: M18 X P1.5
- Applicable: V6, V8 engine



JTC-1525 VW, AUDI BELT TENSION ADJUSTER

- Curved design for using on the narrow space for vehicle.
- Adjust angles while its two knurled points holding on the axle center of idle.
- Application: VW, AUDI, SKODA, SEAT
- VM number: V159



JTC-1526 VW, AUDI FUEL TANK LID WRENCH

- 3-slot points to fit on the lid fuel tank.
- Use with 1/2" Drive Wrench.
- Application: VW, AUDI, SKODA, SEAT



JTC AUTO TOOLS
 2600 Northlake Dr. Suite F,
 Suwanee, GA, 30024



JTC-1547 CRANKSHAFT LOCKING TOOL

- Special design to lock the crankshaft on VW-AUDI, SEAT, SKODA, and 2.0 TDI ENGINE.

JTC-1547

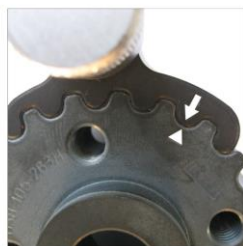

車上零件:
038105263H



JTC-1562 3/4" x M18 IMPACT SOCKET

- Specially designed for fixing the rear wheel axle screws.
- Applicable: VW, AUDI
- Length: 88mm



JTC-1718 VW, AUDI STRUT NUT SOCKET

- Use for removing and installing the top shock retaining nut on most FWD, VW and AUDI.
- Fits into slot in the top of the strut retaining nut 22mm (7 / 8") hex for use with a wrench.



JTC AUTO TOOLS
2600 Northlake Dr. Suite F,
Suwanee, GA, 30024



JTC-4029 VW OIL SCREW SOCKET M14

- As narrow space, operate the designed tool with 14mm wrench to remove oil screw.
- Size: M14
- Total length: 30mm
- Applicable: VW, AUDI



JTC-4033 VW, AUDI CAMSHAFT ALIGNMENT TOOL (4.2)

- For locking camshafts when checking valve timing.
- Applicable: AUDI A6L, A8L 4.2 engine
- Engine model: V8 BAT 4.2 engines
- VM number: T40046

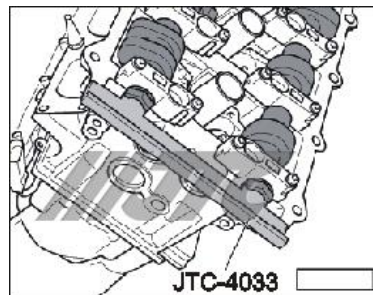

JTC-4034 VW, AUDI ENGINE TIMING TOOL SET (4.2)

- Special designed to install Hall sender screens into crankshaft adjuster when setting the crankshaft timing.
- Applicable: AUDI A6L, A8L 4.2 engine
- Engine model: V8 BAT 4.2 engines
- VM number: T40047

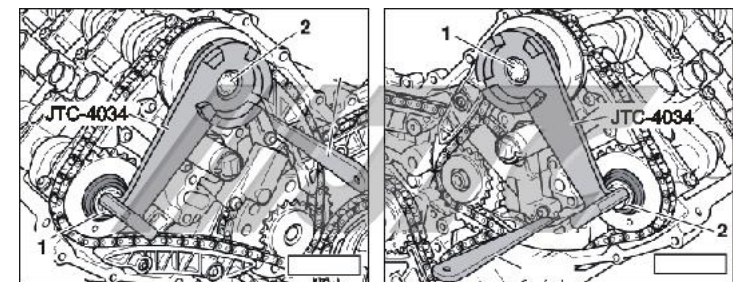

JTC AUTO TOOLS
 2600 Northlake Dr. Suite F,
 Suwanee, GA, 30024



**JTC-4036 VW, AUDI ENGINE TIMING TOOL SET
(4-VALVE, W8, W12)**

- Special designed to hold and align the camshaft.
- Applicable: Golf 1998 ~, Bora 1999 ~, Passat 1997 ~, Sharan 1996 ~, Touareg 2003 ~, Phaeton 2003 ~, Transporter 1991 ~, AUDI A8 1994 ~, AUDI TT 1999 ~
- Engine model: 6-cylinder injection engine (4-valve), 8 cylinder injection engine (W8), 12-cylinder injection engine (W12)
- VM number: T10068A

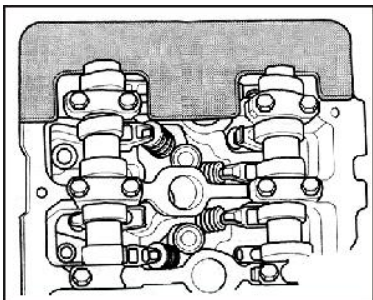

JTC-4037 VW, AUDI ENGINE TIMING TOOL SET (TFSI)

- Special designed to align camshafts when adjusting timing.
- Applicable: AUDI A6 2005~, Q5 2.0T, A6L 3.0T
- Engine model: 6-cylinder Petrol direct injection 2.8L 4V engine, Mechanics
- VM number: T40133



JTC-4051 VW, AUDI INJECTOR SEAT CLEANING SET

- Suitable for 2.0 TDI engine from VAG group.
- To clean the contact surface between the injector and engine head when making the replacement.
- Include cutter holder can made straight and correct to attach when cleaning.
- Insert the extension bar in to the cutter for deep-hole cleaning.





JTC-4083 VW, AUDI 7-SPEED DSG CLUTCH INSTALLER & REMOVER

- Specially designed to install and remove the clutch of gearbox.
- Applicable: VW, AUDI 7-speed clutch gearbox



JTC-4086 VW, AUDI TIMING TOOL SET (V6, 3.2FSI)

- Special designed set of tools for alignment camshaft locking and adjusting.
- With a camshaft adjusting socket.
 - VW number: T40058
- With 2 camshaft stopping pins
 - VW number: T40071
- Applicable:
 - VAG A4/ A6/ A8 3.2 FSI with engine AUK
 - A6L/ Quattro 2.4 with engine BDW

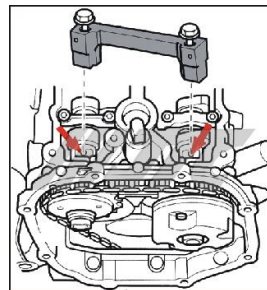

JTC-4087 VW, AUDI TIMING TOOL SET (TFSI)

- A complete set for alignment, adjustment the camshaft, replacement the timing chain and etc.
- To improve your working speed with this complete set.
- Applicable: AUDI Q5 2.0, A6L 2.8, 3.0T



JTC AUTO TOOLS
2600 Northlake Dr. Suite F,
Suwanee, GA, 30024



JTC-4089 CRANKSHAFT LOCKING PIN

- Special design to fix the crankshaft angle.
- Corrects timing adjustment.
- Size: M14 X P1.5
- Applicable: 2.0, 2.4, 2.8, 3.0, 3.2 FSI



JTC-4094 VW, AUDI 6-PCS SOCKET SET (12PT)

- Specially designed for using in suspension struts, brake, calipers, transmission screws, oil screws, and wheel bearing area etc. of VW, AUDI group.
- Contents:
 - 4 pcs 1/2" Dr. x 78mmL: M12, M14, M16, M18
 - 1 pc 14mm hex Dr. x M14 30mm L
 - 1 pc 17mm hex Dr. x M16H 32mm L (tamperproof)



JTC-4102 VW, AUDI CAMSHAFT ADJUSTING SOCKET (A3)

- Special 2-inner pins designed to turn the camshaft into position.
- Applicable: AUDI A3, 1.8L 4V, TFSI engine 2004 >
- VW number: T10352



JTC AUTO TOOLS
 2600 Northlake Dr. Suite F,
 Suwanee, GA, 30024



JTC-4108 VW, AUDI DRIVE SPROCKET SETTING TOOL

- Secure position of high pressure pump chain drive sprocket using setting tool.
- Used on vehicles with mechanical vacuum pump.
- Applicable: Passat 2006 >, Touareg 2003 >, AUDI Q7 2007 >, and diesel engine.
- VM number: T10363

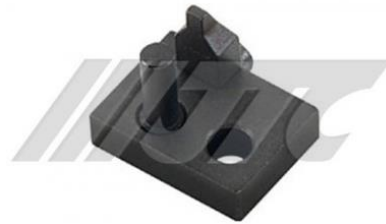
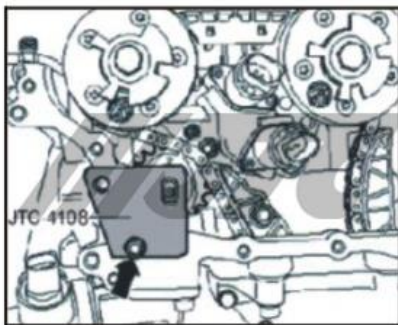

JTC-4109 VW, AUDI DRIVE SPROCKET SETTING TOOL

- Secure position of high pressure pump chain drive sprocket using setting tool.
- Used in vehicles without mechanical vacuum pump.
- Applicable: Passat 2006 >, Touareg 2003 >, AUDI Q7 2007 >, and diesel engine.
- Used when adjusting valve timing on 3.0, 3.6 liter 6-cylinder 4V engine.
- Engine type: BLV, BHL, BHK
- VM number: T10332

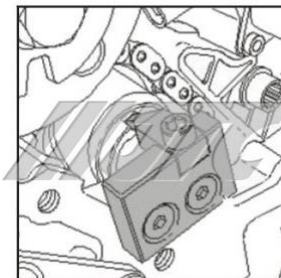

JTC-4112 VW, AUDI FUEL TANK LID REMOVER

- Specially designed to remove fuel tank lid for diesel and petrol cars.
- Applicable: VW, AUDI, A6L, A8





JTC-4121 VW, AUDI TIMING ALIGNMENT TOOL

- Used for V6 engines, to adjust valve position and fix gear wheel of camshaft.
- Applicable:
 - VW Passat 2006 ~
 - Touareg 2003 ~
 - Phaeton 2006 ~
 - AUDI Q7 2007 ~
- VM number: 3036



JTC-4140 VW, AUDI CAMSHAFT ADJUSTING SOCKET

- Special 2-inner pins designed to turn the camshaft adjusting valve.
- Applicable: AUDI A6, Q5 2008 > TFSI engine with chain 4V, 2.0T.
- VM number: 10352 / 1



JTC-4141 VW, AUDI CRANKSHAFT PULLEY HOLDING TOOL

- Special designed to hold the crankshaft pulley for removing and installing the crankshaft central bolt.
- Applicable:
 - AUDI A3, A6, Q5 2004 >
 - TFSI engine with chain 1.8T, 2.0T 4V



JTC-4152 VW, AUDI DIESEL INJECTOR REMOVER KIT

- Specially designed to remove the seized diesel injector from VAG TDi engines.
- Applicable: VAG TDi 1.6 (2010 >), and 2.0 (2011 >).
- Patented.



JTC-4172 VW, AUDI TIMING TOOL SET (TDi V6 & V8)

- Specially designed tool for camshaft locking and adjusting.
- Applicable:
 - VAG 2.7/3.0 TDi V6, and 4.0/4.2 TDi V8 Chain Drive
 - AUDI: A4, A5, A6, A8, Q5, Q7 diesel engine
 - VW: Phaeton, Touareg diesel engine



JTC-4180 VW, AUDI FLYWHEEL HOLDER

- To fix flywheel plate for removing and installing pulley.
- Applicable: VW, AUDI
- VM code: 3067

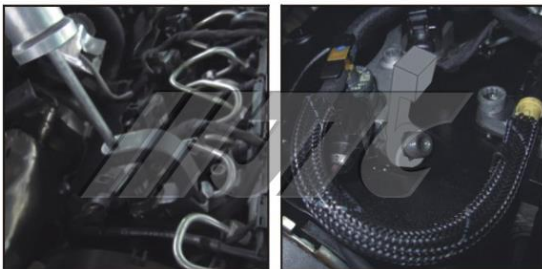



JTC-4185 VW, AUDI CAMSHAFT ALIGNMENT TOOL SET (7 PCS)

- Contents:
 - Injection pump locking pin
 - Tensioner locking tool,
 - Crankshaft locking tool
- To use on VW, AUDI, SEAT, SKODA with 1.9, 2.0 TDI PD DOHC engine.



JTC-4188 VW, AUDI VALVE SPRING COMPRESSOR

- This tool is used for removing the valve springs of VAG cars.
- Applicable: 4 cylinder 1.8L Turbo (5V) AUDI A4 and PASSAT B5 engines.
- VM number: 3362



JTC-4216 VW, AUDI CAMSHAFT TIMING ALIGNMENT TOOL (1.2 FSI)

- For alignment camshaft locking and adjusting.
- Applicable: VW Polo, Golf, Beetle, Caddy, SKODA, AUDI 1.2FSI engine
- VM number: T10414



JTC AUTO TOOLS
 2600 Northlake Dr. Suite F,
 Suwanee, GA, 30024



JTC-4230 VW, AUDI CAMSHAFT ALIGNMENT PIN SET

- Specially designed to push the sliding pieces onto camshaft.
- Applicable: Audi A4 (08 ~), Q5 (09 ~) 4 -cylinder Petrol direct injection 2.0 turbo, 4V engine.
- VM number: T40196



JTC-4259 VAG FLYWHEEL LOCKING TOOL

- Designed for VAG group 1.9 TDI diesel engine for flywheel locking.
- Applicable: VW and SKODA 1.9 TDI engine use



JTC-4282 VAG OIL SEAL PULLER (25mm)

- Designed for removing oil seal on VAG engine.
- VM number: T40195





JTC-4283 VAG OIL SEAL PULLER (27mm)

- Designed to remove camshaft oil seal.
- Applicable: VW LUPO1.4, NEW POLO 1.4
- VM number: T10018



JTC-4284 VAG OIL SEAL PULLER (32mm)

- Specially designed to remove crankshaft, and camshaft position sensor seals.
- Applicable: VAG all engines except diesel
- VM number: 3203



JTC-4285 VAG OIL SEAL PULLER 32MM (LONG)

- Designed to remove two sides front camshaft oil seals.
- Applicable: VW VR6, AUDI V6
- VM number: 3240



JTC AUTO TOOLS
 2600 Northlake Dr. Suite F,
 Suwanee, GA, 30024



JTC-4286 VAG OIL SEAL PULLER (35mm)

- Designed to remove front crankshaft pulley seal at the vibration damper.
- Applicable: VW & AUDI late models
- VM number: 2085



JTC-4287 VAG OIL SEAL PULLER (55mm)

- Designed to remove front crankshaft pulley seal at the vibration damper.
- Applicable: VW & AUDI late models
- VM number: 2085



JTC-4305 VAG WHEEL HUB BEARING TOOL SET

- Specially designed for installing and removing the wheel hub bearing.
- Operational on car
- External diameter of 4 bearing fixing discs: $\phi 62$, $\phi 66$, $\phi 72$, $\phi 85$
- Applicable: VW Lupo , Polo, T5 Touareg , Skoda, SEAT



INSTALL



REMOVE



JTC AUTO TOOLS
 2600 Northlake Dr. Suite F,
 Suwanee, GA, 30024



JTC-4308 AUDI WHEEL HUB BEARING TOOL SET-90mm

- Specially designed for installing and removing the wheel hub bearing.
- Operational on car.
- External diameter of bearing fixing discs: $\phi 90\text{mm}$
- Applicable: AUDI A4 / S4, A6 / S6, A8 / S8, R8

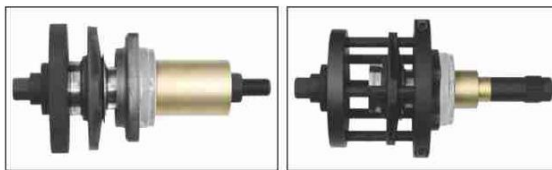

INSTALL

REMOVE



JTC-4320 VAG CAMSHAFT BELT PULLEY PULLER (6 STANDS)

- Special puller designed to remove 5 and 6 spokes for camshaft pulleys.
- Applicable: VW / Skoda / AUDI:
 - (a) 4 & 6 cylinder TDI engines, V6-V8 engines
 - (b) 4-cylinder injection engine (2.0 liter FSI engine)



JTC-4322 VAG DUAL-CHARGING ENGINE IDLE WHEEL WRENCH (TSi)

- Special angle with 16mm open end designed for rotating the idle wheel to replace the belt easily.
- Applicable: VW, AUDI, 1.4 TSi, FTSi
- VM number: T10241



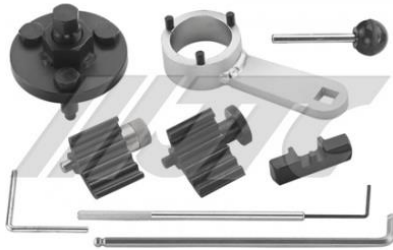

JTC-4330 VAG ENGINE TIMING TOOL SET (TDI)

- Special designed set for alignment camshaft locking and adjusting.
- VM number: 1-T20102, 2-T10050, 3-T10100, 4-T40098, 5-T10265, 6-T10264, 7-T10051, 8/9-T10052, 10-T10255
- Applicable: AUDI, VW, SEAT 1.6, 2.0 TDi engine from 2007
- Engine code: FCA, CAAA, CAAB, CAAC, CAYB, CAYC, CAGA, CAHA, CAGB, CAHB, CAGC, CAVA, CBAB, CBAC, CBBB, CBAA, CBDA, CBDC, CBDD, CCHA, CFFB



JTC-4351 VAG INJECTOR REMOVER SET (TSI)

- Specially designed to remove the sized injector from VAG engines.
- To pull out the injector with slide hammer.
- Applicable: VW, AUDI 1.2T, 1.4T, 1.6T, 1.8T, 2.0T, 3.0T, 3.6, 4.2 on FSI, TFSI, TSI engine



JTC-4367 VAG CAMSHAFT PULLEY FIXING TOOL

- Special designed to fix the inlet camshaft and outlet camshaft pulley.
- Applicable: VW, AUDI 1.8, 2.0 TFSI and TSI engine.
- Engine code: CABD, CAEA, CDNB, CDNA, CAWA, CBFA, CCTA, CCIA, CAEB, CDNC, CDHA, CABA, BYT, BZB, CDAA, CABB, CDHB
- VM number: T40271 / 1, T40271 / 2

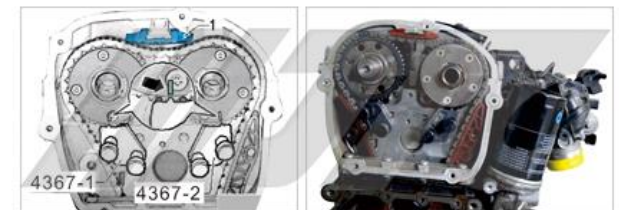



JTC-4381 VAG TIMING TOOL SET (EA211)

- Use to correct the camshaft and crankshaft timing position.
- Use while changing the time belt.
- Applicable: VAG series EA211 FSI, TSI, TFSI engine (1.0L, 1.2L, 1.4L, and 1.6L)
- VM number: T10340, T10494, T10499, T10487, T10476, T10477



JTC-4382 VAG TIMING TOOL SET (EA888)

- Use to correct the camshaft and crankshaft timing position.
- Applicable: 2006~2013 VAG series TSI, TFSI EA888 engine (1.8L, 2.0L): BYT, BZB, CABA, CABB, CABD, CADA, CAEA, CAEB, CAWA, CAWB, CBFA, CCTA, CCZA, CCZB, CCZC, CDAA, CDAB, CDHA, CDHB, CDNB, CDNC, CDND, CESA, CETA, CFKA, CGYA, CJEB, CISA, CJSB.
- VM number: T10352, /1, /2, T10368, T40196, T10354, T10060A, T40011, T40098, T40267, T40271.

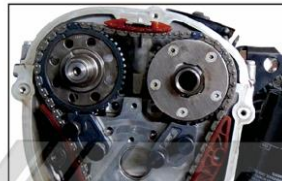

JTC AUTO TOOLS
 2600 Northlake Dr. Suite F,
 Suwanee, GA, 30024



JTC-4386 VAG CAMSHAFT ADJUSTING SOCKET

- Special 2 inner pins designed to turn the camshaft adjusting valve.
- Applicable: VAG TSI, TFSI Engine
- VM number: T10352-2





JTC-4387 VAG CAMSHAFT ROTATING ALIGNMENT TOOL (1.8, 2.0 TSI)

- Specially designed to rotate the camshaft in TDC position.
- Checking and adjustment of timing.
- Applicable: VAG 1.8, 2.0 TSI engine
- VM number: FVNST9143-A, FVNST9143-B



JTC-4398 VAG DOOR HANDLE REMOVAL / INSTALLATION TOOL

- For simple loosening of the locking hook which is difficult to reach when removing door handles without a locking cylinder.
- Applicable: VW, AUDI, SEAT, SKODA, etc.
- VM number: T10389



JTC-4411 VAG TIMING TOOL SET (1.2, 1.4, 1.6, 2.0, 2.4, 3.2)

- Specially designed set of tools for alignment camshaft locking and adjusting.
- Attached with a dial indicator to correct the timing position of the camshaft.
- Applicable:
 - VAG SERIES VW, AUDI, SKODA, SEAT, etc.
 - 1.2, 1.4, 1.6, 2.0, 2.4, 3.2 FSI engine

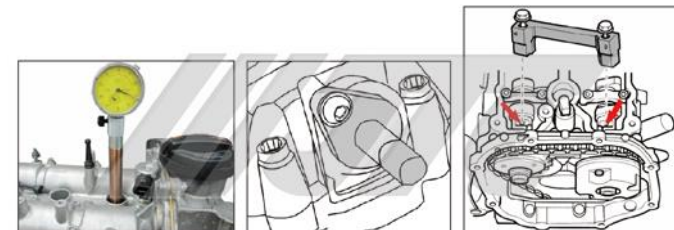

JTC AUTO TOOLS
 2600 Northlake Dr. Suite F,
 Suwanee, GA, 30024



JTC-4412 VAG TIMING TOOL SET (1.8, 2.0)

- Specially designed set of tools for alignment camshaft locking, and adjusting.
- To take and plug-on of the ignition coil off with power-output stage at VW, AUDI fuel injection engines.
- Applicable:
 - VAG SERIES VW, AUDI, SKODA, SEAT, etc.
 - 1.8L, 2.0L, FSI TSI TFSI engine



JTC-4417 CIGARETTE LIGHTER RELEASE TOOL

- Use for removing 12 volt socket.
- Application:
 - Audi A4 2001 / Audi A4 2008/ Audi Q5 2008/ Audi A6 2005/ Audi Q7 2007
 - VAG SERIES VW, AUDI, SKODA, SEAT, etc.
- VM number: T40148



VIDEO OF INSTRUCTION



JTC-4418 VAG OIL SEAL PULLER (2 PCS)

- Use to remove oil seal of crankshaft and camshaft.
- 2 pcs, suitable for various kinds of oil seals.
- VM number: T20143

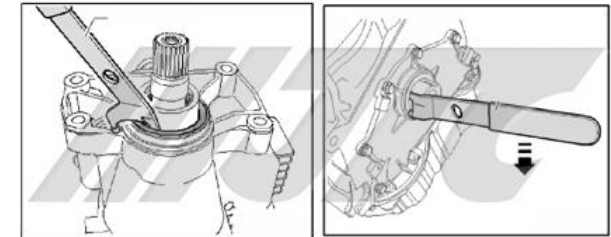

JTC AUTO TOOLS
 2600 Northlake Dr. Suite F,
 Suwanee, GA, 30024



JTC-4420 AUDI CAMSHAFT ADJUSTER KEY (4.2 FSI)

- Used for adjusting and fastening camshaft.
- Fastening capacity: more than 60Nm
- Applicable: Audi RS4 2006 >, Audi A6 2005 >, Audi A8 2003 > 8-cylinder, 4V, 4.2L, FSI engine
- VM number: T40079

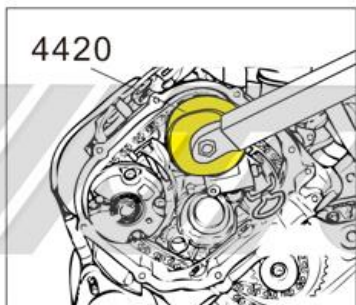

JTC-4421 VAG CAMSHAFT INSTALLATION / FIXING TOOL

- Use for location of sliding pieces on camshaft.
- 4 – cylinder gas direct injection, 2.0 liter turbo, 4V engine For Example : Audi A4 2008 >, Audi Q5 2009 > Repair Group 15
- VM number: T40191

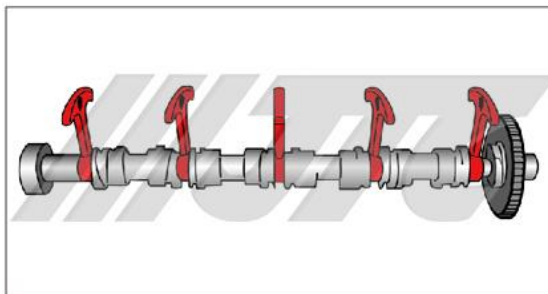

JTC-4450 VAG BELT TENSIONER ADJUSTER (TFSI)

- Specially designed adjuster to push back the timing chain tensioner without removing the front engine cover when renewing or replacing the timing chain.
- Applicable: VAG generation III 1.8 & 2.0 TFSI 4 cylinder engine
- Engine code:
 - CDAA/CDHA/CDHB/CJEB/CDAB/CGYA on 1.8 engines
 - CCZA/CDNB/CDNC/CFKA/CCZC/CPSA/CESA/CETA/CCZB/CDND/CCZD on 2.0 engines
- VM number: T40243

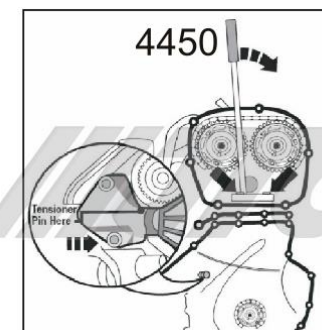

JTC AUTO TOOLS
 2600 Northlake Dr. Suite F,
 Suwanee, GA, 30024



JTC-4456 AUDI WHEEL SCREW LOCK SOCKET SET (20PCS)

- This tool enables you to permit servicing of customer vehicles, even customer has lost the key.
- Applicable: AUDI after 2006
- VM number: T40073
- Contents: A(801), B(802), C(803), D(804), E(805), F(806), G(807), H(808), J(809), L(810), M(811), N(812), O(814), P(813), R(815), S(816), T(817), V(818), W(819), X(820).



JTC-4457 VW WHEEL SCREW LOCK SOCKET SET (20PCS)

- This tool enables you to permit servicing of customer vehicles, even customer has lost the key.
- Applicable: VW Passat after 2006, Golf generation 6 and 7, Tiguan, Sharan
- Contents: #521, #522, #523, #524, #525, #526, #527, #528, #529, #530, #531, #532, #533, #534, #535, #536, #537, #538, #539, #540.
- VM number: T10313



JTC-4471 VAG IGNITION COIL REMOVER

- Specially designed to remove the pencil-type ignition coil without damage it.
- Applicable: VAG 1.2, 1.4, 1.8 and 2.0 FSi, TFSi, TSi Petrol engines since 2013.
- VW number: T10530

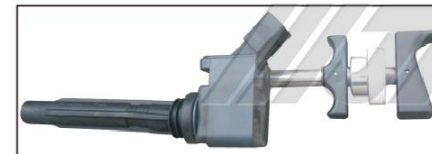



JTC-4472 VAG AIR CONDITIONER TUBE REMOVER

- Designed for quick release the fasteners on the air conditioner tube.
- Applicable: Audi A5 after 2007
- VM number: T40149



JTC-4473 VAG REAR LOWER CONTROL ARM BUSH REMOVER/INSTALLER (11 PCS)

- Operational on car.
- Specially designed to remove the rear lower control arm brush.
- Applicable: AUDI A3, VW Golf 4/ BORA/ New Beetle



JTC-4474 VAG LOWER CONTROL ARM BUSH REMOVER/INSTALLER (17 PCS)

- Specially designed to remove the lower control arm bush directly from the car.
- Applicable:
 - AUDI A3/S3 04~12; TT/ TTS 07~12
 - VW Golf 5/ Plus/ Variant/ 4motion 05~12
 - VW Jetta/ Syncro / EOS/ Beetle 06~12



JTC AUTO TOOLS
 2600 Northlake Dr. Suite F,
 Suwanee, GA, 30024



JTC-4475 VW T5 REAR LOWER CONTROL ARM BUSH REMOVER / INSTALLER

- Operational on car.
- Specially designed to remove the rear lower control arm bush.
- Applicable: VW T5



JTC-4501 VAG CAMSHAFT ROTATION SOCKET (1.8, 2.0 TFSI)

- Used to rotate and hold intake camshaft when adjusting the timing chain.
- Applicable:
 - 4-cylinder 1.8 and 2.0 4V TFSI Engine
 - AUDI : A4 2008~, A5 Cabriolet 2009~, A5 Coupe 2008~, Q5 2008~, A3 2012~
 - SEAT: Alhambra 2011~, Exeo 2009~, Altea 2009~, Leon 2009~, Altea XL 2009~, Altea Freetrack 2009~
- VM number: T40266

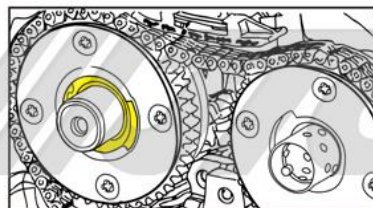

JTC-4502 VAG BALANCER SHAFT PULLER

- Use for removing the balancer shaft on 4 cylinder injection engine (1.8, 2.0L-chain drive)
- Connector teeth M8 x 1.25, can be used with JTC-4883 or JTC-4893
- Applicable:
 - VW: Golf 2004 >, Passat 2006 >, Passat CC 2009 >, Tiguan 2008 >, EOS 2006 >....
 - AUDI: A3 2004 >, A4 2008 >, A5 2008 >, TT 2007 >....
 - SEAT: Alhambra 2011 >, Exeo 2009 >, Leon 2006 >, Toledo 2005 >, Altea 2005 >, Altea XL 2007 >, Altea Freetrack 2007 >...
- VM number: T10394

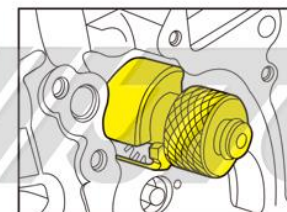

JTC AUTO TOOLS
 2600 Northlake Dr. Suite F,
 Suwanee, GA, 30024



JTC-4503 VAG DIESEL FUEL FILTER COVER INSTALLER

- This tool is designed to press the filter cover into the seal seat evenly.
- Applicable: VW, AUDI, SKODA and SEAT diesel vehicles; Multicar M27 / M28

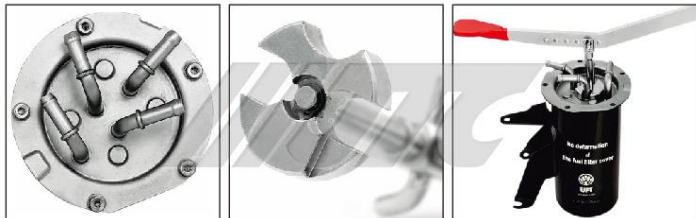

JTC-4504 VAG DUAL-PURPOSE DIESEL FILTER COVER INSTALLER

- This tool is designed to press the filter cover into the seal seat evenly.
- Replaceable top, can be adapted to different kind of filter.

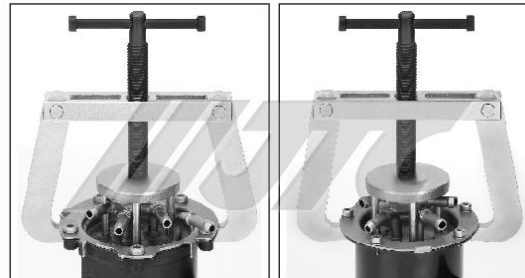

JTC-4505 VAG CLUTCH PEDAL PIN REMOVAL PLIERS

- Specially designed to release the clutch master cylinder piston rod.
- Provide a quick and easy way to remove the clutch master cylinder and pedal support bracket.
- Applicable:
 - Vauxhall / Opel : Astra-J, Signum, Vectra-C
 - Audi : A1 (8X), A3 (8P), A4 (B7), A6 (C6)
 - VW: Golf (1K1), Passat (3B6), Eos (1F), etc.
- VM number : T10005



JTC AUTO TOOLS
 2600 Northlake Dr. Suite F,
 Suwanee, GA, 30024



JTC-4506 VAG CONNECTOR REMOVER

- This tool provides correct and easy way to remove the VAG push and pull connectors.
- Capable to remove electrical connector located at MAF sensor, coil packs, headlights / fog lights, level sensors, MAP sensors, etc.
- Applicable: VAG group



JTC-4507 VAG PLASTIC OIL DRAIN SCREW REMOVER / INSTALLER

- Specially designed tool for removing and installing the special plastic oil drain screw (M14x1.5x22L).
- By using this tool can prevent damage to the screw.
- For VAG screw number: 06L103801
- Applicable: VW, AUDI, SKODA, SEAT 1.2, 1.4, 1.8, 2.0 TFSI; 1.6, 2.0 TDI.



**4507P
OIL DRAIN SCREW**



JTC-4508 VAG EXHAUST RELIEF VALVE LOCATOR (1.8, 2.0 TFSI)

- Used to lock the waste gate when adjusting the charge pressure electric actuator of the exhaust turbocharger.
- Applicable: 4 cylinder 1.5L, 2.0L 4V TFSI engine
- VM number: T40290

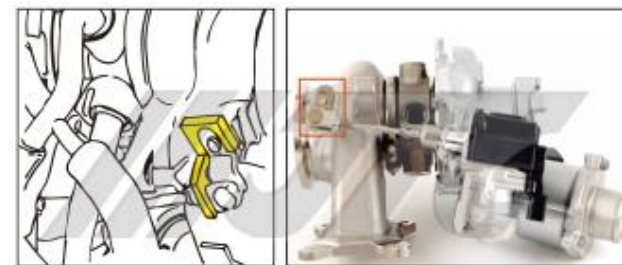



JTC-4509 VAG 6 PCS OIL SEAL GUIDE TOOL SET

- Special tool for precise installing the O-rings and positioning the pump/nozzle unit.
- By using this tool can prevent damage to the cylinder head, pump and nozzle unit.
- Applicable:
 - VW Phaeton and Touareg from 2003
 - T5 from 2004 (5 and 10 cylinder diesel engines)
 - Touareg from 2004
 - Audi A3 from 2004 (4-cylinder / 4 valve diesel engines)



JTC-4518 VAG BRAKE CALIPER SOCKET (10PT)

- Use for removing and installing the brake caliper.
- Size: 3/8" DR 9mm x 10PT, 31mm (L)
- Applicable: Porsche, VW Touareg, Audi Q7



JTC-4561 VAG, PORSCHE WHEEL SCREW LOCK SOCKET SET (20PCS)

- This tool enables you to permit servicing of customer vehicles, even customer has lost the key.
- Applicable for installing and removing locks of most VAG and PORSCHE models.
- Contents: #50, #51, #52, #53, #54, #55, #56, #57, #58, #59, #60, #61, #62, #63, #64, #65, #66, #67, #68, #69
- VM number: T10190





JTC-4562 VAG CAMSHAFT ALIGNMENT TOOL SET (1.4TSI)

- Specially designed to secure the camshaft when checking and adjusting the timing.
- Applicable:
 - VAG 4-cyl. Injection engine 1.4L direct injection engine with turbocharger
 - AUDI A3, Golf, Octavia, Leon after 2013
- VM number: T10504



JTC-4615 VW, AUDI IGNITION COILS PULLER (1.4, 1.6)

- To take and plug-on of the ignition coil off with power-output stage at VW, AUDI fuel injection engines.
- The front hook removes ignition coil off well from damage itself.
- Applicable: VW Bora, Golf, new Beetle, Passat, Polo, Touran 1.4/1.6L, Lupo 4-Zyl, FSI, Phaeton and T4, BBY. BKY 1.4



JTC-4616 VW, AUDI IGNITION COILS PULLER (1.8, 2.0)

- To take and plug-on of the ignition coil off with power-output stage at VW, AUDI fuel injection engines.
- The front hook removes ignition coil off well from damage itself.
- Applicable: VW 8-and 12 cylinder engines e.g. Phaeton, B5 1.8T, GTI. FSI 2.0



JTC AUTO TOOLS
 2600 Northlake Dr. Suite F,
 Suwanee, GA, 30024



JTC-4617 VW, AUDI IGNITION COILS PULLER (2.3, 3.2)

- To take and plug-on of the ignition coil off with power-output stage at VW, AUDI fuel injection engines.
- The front hook removes ignition coil off well from damage itself.
- Applicable: VW Bora, Golf, Passat, Sharan, Touran, R32 Phaeton and T5, V5 2.3, V6 3.2



JTC-4647 CAMSHAFT DRIVE BELT PULLEY PULLER

- Special puller designed for pulling camshaft pulley wheels.
- Applicable: 4 & 6 cylinder, V6 & V8 engines on VW and AUDI petrol engine

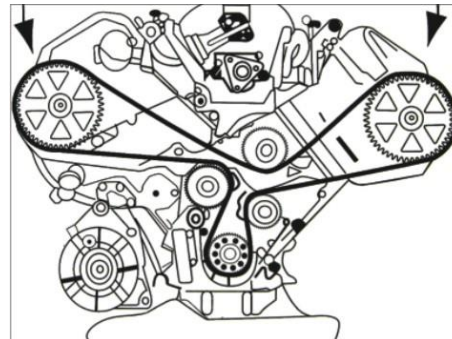

JTC-4648 VW, AUDI BELT PULLEY HOLDER

- Special design to hold the belt pulley on VW, AUDI.
- Applicable:
- VW: Lupo, Polo/Classic, Golf, Bora, & Caddy
- AUDI: A2



JTC-4649 VW, AUDI REAR SUSPENSION TOOL

- Special design for replacing the rear axle mounting bushes, whilst in situ on the vehicle and without the need for removing the rear axle assembly.
- Its fine thread and thrust bearing allows the bush to be fitted quickly and easily without causing damage.
- Applicable: AUDI A3/ VW Golf IV/ Bora 1.4/ 1.6/ 1.8/ 2.0 and 1.9d (2001 later)



JTC-4652 VW, AUDI CAMSHAFT ALIGNMENT TOOL

- A specially designed tool to align and hold the camshaft.
- Applicable: AUDI 3.0L V6 5V, 2002-2005 AUDI A4 & 2002-2004 AUDI A6
- VM number: T40030



JTC-4653 VW, AUDI CAMSHAFT ALIGNMENT PLATE

- Special designed to align the camshafts to proper position when adjusting and assembling.
- Applicable: VW- Passat, VR-6

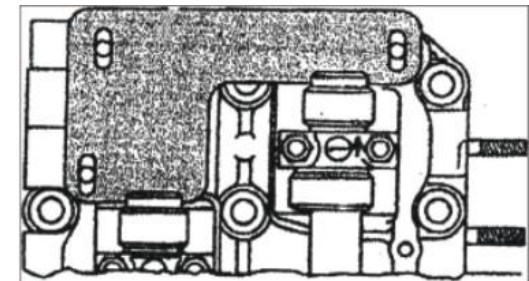



JTC-4654 VW, AUDI V8 CAMSHAFT ALIGNMENT TOOL

- Special designed to align the camshafts at TDC position when adjusting and assembling.
- Applicable: VW. AUDI V8 5-valve
- VM number: T40005



JTC-4664 VW, AUDI CAM CHAIN TENSIONER HOLDER

- Special design to hold the chain and tensioner in position during assembling and disassembling.
- Applicable: VW-AHA, APH, ATQ, AUG, AWM, AWP, AWV, BKF, AND BNU 1998-2006. AUDI-AHA, AMB, AMU, APB, ART, ATC, ATQ, AWM, AWN, AWP, BBD, BCY. BEA, BEL, AND BFM
- VM number: 3366

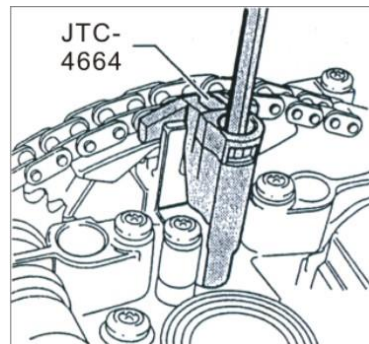

JTC-4671 VW, AUDI BELT TENSION ADJUSTER

- Special angle designed to adjust the belt tension on the free roller.
- Applicable: VW, AUDI





JTC-4673 VW, AUDI CAMSHAFT ALIGNMENT TOOL

- Special designed to set camshaft in the correct position.
- Applicable:
 - VW: Passat(98~04)
 - AUDI: A4, A6, A8, All road (97~08)

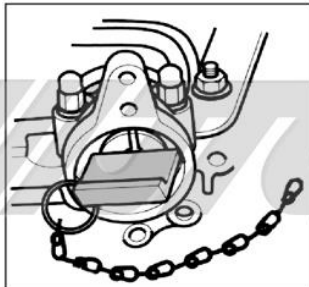

JTC-4674 VW, AUDI CAMSHAFT ALIGNMENT TOOL-DIESEL

- Special designed to set camshaft in the correct position for diesel engine.
- Applicable: Polo, Golf, Bora, Beetle, Caddy (at ~04) etc.



JTC-4679 DIESEL FUEL PUMP TIMING SET

- Special designed to reset the timing position on diesel engine with fuel pump.
- Applicable: Alfa Romeo, Audi, BMW, Fiat, Ford, Isuzu, Iveco, Lancia, Land Rover, Mazda, Mitsubishi, Nissan, Renault, Rover, and VW etc.



JTC AUTO TOOLS
 2600 Northlake Dr. Suite F,
 Suwanee, GA, 30024



JTC-4681 AUDI TRANSMISSION DIPSTICK

- Designed to measure the oil level of transmission.
- Full length: 695mm
- Applicable: AUDI 100



JTC-4697 VW, AUDI DIFFERENTIAL FILTER WRENCH

- Size: 46mm X 12 PT & 5mm hex key
- Applicable:
 - AUDI-TT
 - VW Bora, GolfIV, Sharan, Skoda-Octavia



JTC-4710 VW CRANKSHAFT SEALING FLANGE REMOVING & INSTALLING TOOL

- Special design tool to renew crankshaft sealing flange.
- Applicable: 16v, 1.4, 1.6 engine of VW, AUDI, SKODA, SEAT





JTC-4742 OIL FILTER KEY (VW, AUDI)

- This tool is especially applicable for removal oil filter with special adapter.
- Applicable: VW, Audi diesel engine with MANN -, Mahle -, and Knecht - filters
- 1/2" Drive or 22mm wrench



JTC-4743 VW, AUDI CAMSHAFT PULLEY REMOVER

- Special design for removing the camshaft pulley on diesel engine TD, TDI etc.
- Applicable: VW, AUDI, SKODA, SEAT
- VM number: T10052



JTC-4748 BELT TENSION ADJUSTER (VW, AUDI)

- Specially designed to loosen the tensioning roller when changing the poly-V belt.
- Applicable: VW Polo, Golf, Passat, T4 and AUDI.



JTC-4769 VW ENGINE TIMING TOOL SET (1.2L)

- Installation and removal of camshaft / variable camshaft timing unit.
- Checking and adjusting of timing.
- Applicable: Petrol engines: VW Polo, Fox, Skoda Fabia, SEAT Ibiza / Cordoba 1.2L engine, 2 and 3 cylinder, 6 / 12 V
- VM number: T10123, T10122, T10120, T10121

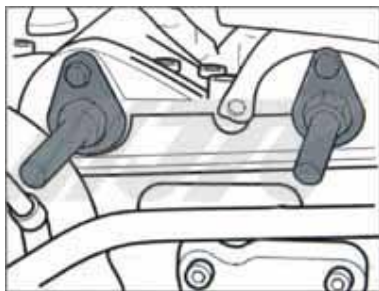

JTC-4778 VW, AUDI SPECIAL WRENCH (V6, TDI, TURBO)

- 3/8" DR X 12mm, 12PT.
- Special angle wrench for TDI, TURBO system etc.
- Applicable: VW, AUDI, V6, TDI, Diesel engines.



JTC-4807 VW CRANKSHAFT SEALING FLANGE REMOVER & INSTALLER (DIESEL)

- Specially designed tool to renew crankshaft sealing flange.
- Applicable : For 16V, 20V, 1.9, 2.0 diesel engine since 2006
- Golf, TOURAN, and AUDI A3 4-cylinder Diesel engine 4-valve for fitting sealing flange with integrated sender wheel.

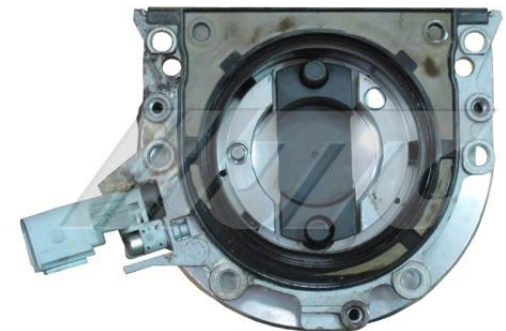



JTC-4824 AUDI ENGINE OIL DIPSTICK

- The tool is designed to measure the oil level of engine.
- Applicable: 2009 AUDI A4, A5 and A6 with Engines 2.0L TFSI, 3.2L FSI and 4.2L FSI, and 2.0, 2.7, 3.0 TDI, 1.8, 2.0, 3.0 TFSI, 3.2, 4.2 FSI.



JTC-4844 AUDI CAMSHAFT ADJUSTING SOCKET

- Special groove nut socket turns the camshaft adjuster into position.
- Camshaft Adjusting Socket is used to adjust variable valve timing on the exhaust side camshaft to basic position.
- Applicable : AUDI AVK (2000~2004) BBK
AUDI 3.0L V6
- AM number: T40028



JTC-4847 VW, AUDI TIMING TOOL SET (2.0 FSI)

- With camshaft tools, chain tensioner retainer, locking pins and tensioner bolt.
- For 2.0 FSI petrol engines since 2003.
- Applicable:
 - AUDI A3 2.0 FSI and FSI SOHC engine codes: AWA , BHD, BMB
 - VW GOLF 2.0 FSI and 2.0 FSI SOHC and Touran 2.0 FSI SOHC engine codes: AWA, AXW



JTC AUTO TOOLS
2600 Northlake Dr. Suite F,
Suwanee, GA, 30024



JTC-4854 VW, AUDI BUSH REMOVER / INSTALLER

- Special design to remove and install the bush.
- Applicable: VAG series



JTC-4879 SPARK PLUG CABLE PULLER FOR VW, AUDI

- Removing and installing spark plug connectors.
- Spark plug socket remover for new beetle and cars with 2.0 engine AZJ. LOCKING, VW GOLF IV & V with 1.6 engine, VW AUDI, BORA, MERCEDES, SMART, etc.
- Length : 264mm
- Made of stainless steel.



JTC-4881 VW, AUDI HOSE CLAMP PLIERS (CURVED)

- Special large clamp designed for lower water hose clamp.
- Max clamp capacity: 55mm
- Larger handle for easier removing the hard clamp.
- Applicable: VW & AUDI





JTC-4882 VW, AUDI FUEL HOSE CLIP PLIERS

- For use on three ended hose clip which are fitted on fuel line.
- Clamp capacity: 18 ~ 28 mm
- Applicable: VW, AUDI, SEAT, AND SKODA etc.

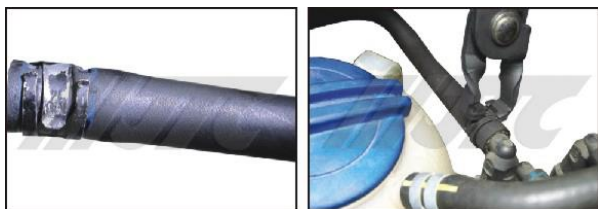

JTC-4892 VW, AUDI FUEL PEDAL REMOVER

- Special design to push out the lock of fuel pedal for remove or replace new pedal.
- Applicable: VW, AUDI electrical fuel pedal.
- VM number: T10238



JTC-4893 VW, AUDI INJECTOR REMOVER (FSI)

- Use “U” sleeve or two jaws hook to fix the injector and then pull out with slide hammer.
- Applicable: VW, AUDI FSI engine

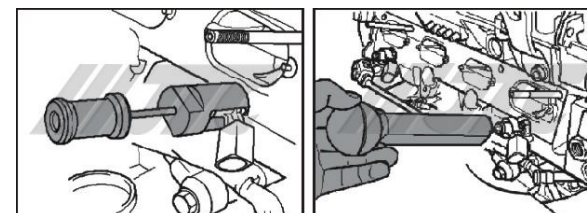

JTC AUTO TOOLS
 2600 Northlake Dr. Suite F,
 Suwanee, GA, 30024



JTC-4895 AUDI DIESEL INJECTOR REMOVER (TDI)

- Special two jaws design to fix the injector and pull out with slide hammer.
- Applicable: VW, AUDI TDI engine



JTC-4911 VW, AUDI FUEL PUMP WRENCH

- Specially designed wrench to remove and install the fuel pump on AUDI.
- Using the wrench, turn inner section of surge housing approx. 15° to the left up to the stop and withdraw fuel pump assembly complete with the inner housing section.
- Applicable: AUDI 90, A4, S4, A6, S6, RS6, and VW Passat



JTC-4921 VW, AUDI 7-SPEED DSG MECHATRONIC UNIT REMOVER

- Specially designed to remove load from plungers of mechatronic unit when you insert the tool between clutch lever and gear housing.
- Applicable : VW, AUDI 7-speed dual clutch gearbox.





JTC-4928 VW, AUDI TIMING TOOL SET (3.2 FSI)

- Special designed set of tools for alignment camshaft locking, and adjusting.
- Applicable:
 - VAG A4/ A6/ A8 3.2 FSI with engine AUK
 - A6L/ Quattro 2.4 with engine BDW



JTC-4930 VW DIESEL ENGINE TIMING TOOL SET- BELT

- Special designed set of tools for camshaft locking, and adjusting.
- Applicable : VW-Transporter, LT, Crafter
- Engines : 2.4D, 2.5SDI, 2.5TDI, 2.5TDI Common Rail

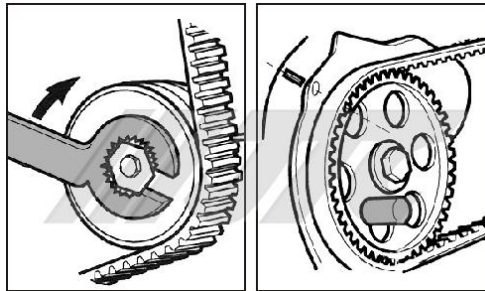

JTC-4739A 36-PCS TIMING TOOL SET-VW, AUDI

- The complete set can correct timing when replacing the timing belt of petrol and diesel engine.
- Applicable: AUDI A4, A6, A8, A11 (97-08), and VW since 98.
- Engine codes: AFB, AKE, AKN, AYM, BAU, BCZ, BDG, BDH, BFC etc.



JTC AUTO TOOLS
 2600 Northlake Dr. Suite F,
 Suwanee, GA, 30024



JTC-4768A VW, AUDI TIMING TOOL SET (1.4, 1.6 FSI)

- Installing and removal of camshaft / variable camshaft timing unit.
- Checking and adjustment of timing.
- Applicable: VW Polo, Golf, Touran, Caddy, Skoda, Octavia AUDI A3 and VW, AUDI (1.4, 1.6FSI, TSI) etc.

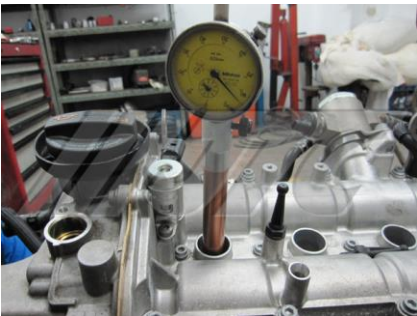

JTC AUTO TOOLS
2600 Northlake Dr. Suite F,
Suwanee, GA, 30024