

Classic

AIRBOATS

Airboats, Airboat Kits, Airboat Hulls, Auto Engines, Airboat Accessories and Much More



Turn-Key
Airboats
Crank It Up and Ride



Custom
Airboats
Create Your
Dream Boat



GM
Vortec
Engines
Awesome
Powerplants



New
Rotator
Technology
Gear-to-Gear Breakthrough

Props
Turbo Tech Advances Performance

2010 - 2011 Airboaters Wholesale Catalog
Classic Airboats, Inc.

TABLE OF CONTENTS

Airboats & Airboat Kits.....	4-11	Oil Cooling System.....	39
Boat-In-A-Box®	12-13	Hull Accessories	40-41
Optional Equipment Installed.....	14-15	GM Marinized Engines.....	42-45
Trailers & Trailer Accessories	16-17	Reduction Units, Drives & Hardware	46-47
Airboat Hulls.....	18-21	Chevy-In-A-Box®	48-51
Prop Guards & Engine Stands	22	Custom Boat-In-A-Box®	52-53
Seats & Seat Stands.....	23-25	Cooling System	54-55
Fuel System.....	26-27	Pulley System.....	56-57
Rudders & Steering Accessories	28-29	Fuel System.....	57-58
Instrument Panels & Gauges	32-34	Electrical System.....	57-59
Battery Accessories	35	Aircraft Parts & Accessories	60-63
Exhaust System	36-38	Propellers & Propeller Hardware	64-68



FREE TODAY - 1-800-228-7977



STANDARD EQUIPMENT ON ALL TURNKEY BOATS

- All welded aluminum airboat hull with 5 aluminum "T" bar stringers for durability and toughness.
- Fiberglass hulls constructed for strength and durability, black gelcoat finish. (Colors may be extra)
- Rear operated single seat—for optional seating turn to Pages 14-15. (Additional cost)
- Styled instrument console with lighted marine gauges to include: tachometer, oil pressure gauge, temperature gauge, voltmeter, hour meter, keyed ignition switch, rubber booted toggle switches for navigation light and accessories.
- Aluminum fuel tank contoured for good looks with gauge - Coast Guard approved.
- Rigging is etched primed and coated with black enamel paint.
- Natural aluminum finish on rudders, hull and fuel tank.
- Armor structured engine stand built with vibration reducing rubber mounting system.
- Fully upholstered single rear seat with rain cover.
- Protective propeller guard covered with 2" x 4" wire mesh.
- Cable steering system complete with dual aluminum foam filled air foil rudders.
- Aluminum floor boards on seat stand painted with non-skid.
- Cable fed throttle assembly, complete.
- Running lights.
- Platform bow with non-skid carpeting. (Aluminum Hulls Only)
- Propeller mounted & matched to hull & engine.
- Stainless steel airboat exhaust system. With flex pipe and thru transom exhaust.
- Heavy duty engine cooling system for all automotive apps.
- Marine alternator and battery securely mounted.
- Below deck storage compartment for your gear.

COMPLETE TURNKEY AIRBOATS



Our extra wide 7'6" and 8' airboats provide you with a luxury ride like you've never had before. Our dual operator seating allows you to take your favorite wife or friend along, sitting right next to you. It's fun and a great adventure!

Since our last catalog, **GM Powertrain** has been busy developing new Vortec Engines for the greatest ride and performance you can get. To make those GM Engines run even better, we have redesigned and improved our reduction unit now called the Rotator.



As we have said before, our idea of performance is not to go fast, but to go where you want to go. Keep it safe and use our 4x4 marinized engine technology to get you there safely.

Photos may show optional equipment

BOAT-IN-A-BOX® —The Ultimate Kit

Boat-In-A-Box®



The Boat-In-A-Box® is a new concept from Classic Airboats to help the "Do-It-Yourselfers" save money. We have expanded our coverage of kit airboats to include the complete package of parts and pieces. Since the parts and pieces are unassembled, we decided to call it a Boat-In-A-Box®! It's a great concept brought to you by Classic Airboats. For extras, see optional equipment installed on pages 14 & 15.

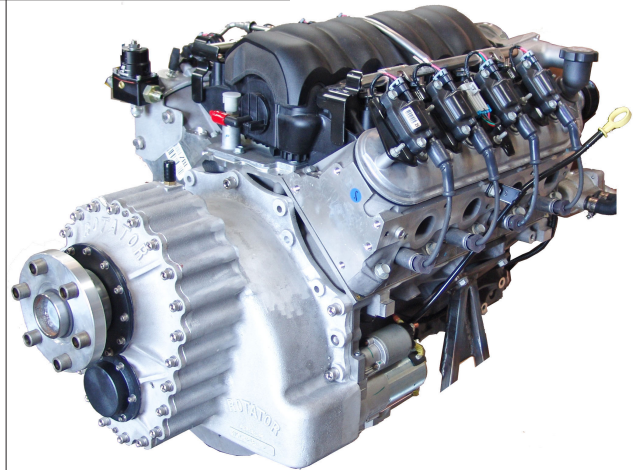

Photos may show optional equipment

BOAT-IN-A-BOX® — WHAT YOU GET

In it's simplest form, the Boat-In-A-Box® is a Super Kit of your choice plus a GM Powertrain Engine of your choice. It includes a polymer bottom installed, single operator seat (front or rear), and 2-man passenger seating (front or rear) installed and all of the parts and pieces to finish your complete, ready to run airboat. Yes, it's 4x4 and ready to take you on a thrilling ride and adventure. Includes special pricing on parts and pieces for great savings. The more you buy, the bigger the savings. That's Classic's way of saying thank you for shopping for your airboat needs with us.

With the Boat-In-A-Box® You Get Discount Pricing on the GM Marinized Engine, Rotator Gear-To-Gear Reduction Unit, Plus Discount Pricing on Your Parts and Pieces.

Call For Pricing

HULLS

*Everything you need for your hull—Build your own airboat
We Ship your parts & pieces—Classic will even give you a helping hand
That's why we have a Technical Services Department—It's for you, so give us a call*

We have several hull designs so we can meet all your airboat needs. Tell us what you want to use your boat for and we will help you select the hull that gets the job done.





We cut and bend with the best equipment to produce high quality hulls.

Our Ice Boat hulls are reinforced at key areas to ensure durability in even the harshest of environments:

On the transom plate and the full bottom length of the transom

At the bottom of the buckhead.

On the side at the hull bottom.

On the sides of the transom.



TRADITIONAL CLASSIC AIRBOAT COMBINATION HULL

14-12070	12' x 7' Aluminum Hull.....	3005.00 ea.
14-13070	13' x 7' Aluminum Hull.....	3429.00 ea.
14-13768	13' x 7'6" or 8' Aluminum Hull.....	3690.00 ea.
14-14070	14' x 7' Aluminum Hull.....	3695.00 ea.
14-14768	14' x 7'6" or 8' Aluminum Hull.....	3972.00 ea.
14-15070	15' x 7' Aluminum Hull.....	3951.00 ea.
14-15768	15' x 7'6" or 8' Aluminum Hull.....	4271.00 ea.
14-16768	16' x 7'6" or 8' Aluminum Hull.....	4608.00 ea.
14-18768	18' x 7'6" or 8' Aluminum Hull.....	5152.00 ea.

MARSH MASTER HULL

14-07012	12' x 7' Aluminum Hull.....	3305.00 ea.
14-07013	13' x 7' Aluminum Hull.....	3729.00 ea.
14-76813	13' x 7'6" or 8' Aluminum Hull.....	3990.00 ea.
14-07014	14' x 7' Aluminum Hull.....	3995.00 ea.
14-76814	14' x 7'6" or 8' Aluminum Hull.....	4272.00 ea.
14-07015	15' x 7' Aluminum Hull.....	4251.00 ea.
14-76815	15' x 7'6" or 8' Aluminum Hull.....	4571.00 ea.
14-76816	16' x 7'6" or 8' Aluminum Hull.....	4908.00 ea.
14-76818	18' x 7'6" or 8' Aluminum Hull.....	5352.00 ea.

ICE BOAT HULL OPTIONS FOR GLADES EASYRIDER HULLS

We offer an Ice Boat option for our hulls designed to operate in snow and frozen water. The additions to the hull includes:

- Full Polymer Bottom
- Reinforcement Trip Chimes
- Polymer on Sides 10" High
- Reinforced Transom
- Reinforced Bow Roll
- Heavy Duty Aluminum Bottom

Does not include price of hull.

53-14151	14' x 7' & 15' x 7' Ice Hull Options	3247.00 ea.
53-16181	16' x 8' & 18' x 8' Ice Hull Options	3923.00 ea.



HULL ACCESSORIES



There are substitutes and lesser quality polymers out there, but it only makes sense and saves you money to slide your ride on the best. Don't get stuck with a substitute, make sure it's UHMW.

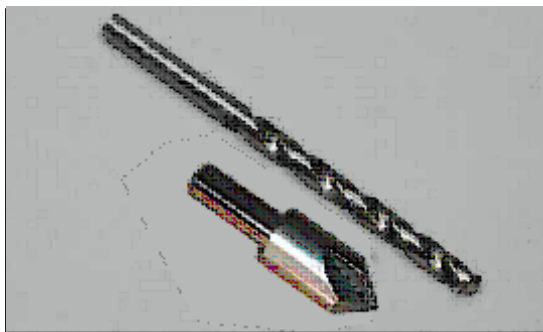

POLYMER COUNTER-SINK & DRILL BIT

If you are going to do the job yourself, do it right, and that means using the right tools. Use our counter-sink & drill bit to get your polymer on right and tight in record time.

35-35107	Phillips head electric drill bit	3.95 ea.
35-35108	Polymer Counter-Sink	14.95 ea.
35-35109	Polymer drill bit.....	1.85 ea.
35-35111	Computer drawn no nuts instructions.....	6.00 ea.



UHMW POLYMER—GREY, WHITE, & BLACK

Ultra high molecular weight/UHMW, 5' x 10' sheet. It's one of the all time major advancements in airboat technology.

35-35106	1/4" Polymer 5' x 10' UHMW.....	330.00 ea.
35-801614	1/4" Polymer 80" x 13' UHMW.....	599.17 ea.
35-802414	1/4" Polymer 80" x 20' UHMW	762.00 ea.
35-801656	5/16" Polymer 80" x 13' UHMW.....	962.00 ea.
35-35012	1/2" Polymer 5' x 10' UHMW	550.00 ea.



STAINLESS STEEL NUTS & NO NUTS POLYMER SCREWS

Since polymer was introduced, we have tried many different ways to attach it to the bottom of our boats. We have found our stainless steel, self tapping Phillips head screws to be the best. Where you put the screws and how many you use are also very important. That's why we have computer drawn plans to help you.

35-14112	1/4 x 1 1/2 stainless steel screws (A)	0.12 ea.
35-14114	1/4 x 1 1/4 stainless steel screws (B)	0.11 ea.
35-14100	1/4 x 1 stainless steel screws (C).....	0.10 ea.
35-14034	1/4 x 3/4 stainless steel screws (D).....	0.09 ea.
35-14058	1/4 x 3/8 stainless steel screws (E)	0.08 ea.
35-14012	1/4 x 1/2 stainless steel screws (F).....	0.07 ea.
35-00014	1/4 stainless steel washers (I).....	0.02 ea.
35-14000	1/4 nylock nuts (J).....	0.07 ea.

STAINLESS STEEL NO NUTS FIBERGLASS POLYSCREWS

Yes, you can install polymer on fiberglass hulls without using nuts & bolts. Our special self tapping stainless steel screws make a clean, neat, installation. Tight screw pattern recommended.

35-14910	1/4 x 1 stainless steel screws (G)	0.11 ea.
35-14934	1/4 x 3/4 stainless steel screws (H)	0.10 ea.
35-14125	1/4 x 1 1/4 stainless steel screws (not shown)	0.12 ea.



ICE BOAT HULL OPTIONS

We offer an Ice Boat option for our hulls designed to operate in snow and frozen water. The additions to the hull includes:

- Full Polymer Bottom
- Reinforcement Trip Chimes
- Polymer on Sides 10" High
- Reinforced Transom
- Reinforced Bow Roll
- Heavy Duty Aluminum Bottom
- Reinforced Sides

Does not include price of hull.

53-14151 14' x 8' & 15' x 8' Ice Hull Options	3247.00 ea.
53-16181 16' x 8' & 18' x 8' Ice Hull Options	3923.00 ea.



STEEL FLEX EPOXY RESIN & HARDENER

A great way to treat your aluminum or fiberglass bottom. Not quite as slick as polymer, but not as expensive either. Used for years in the airboat industry for friction reduction and abrasion protection. Once you put it on, don't change your mind because it ain't coming off.

35-35105 Steel Flex Resin & Hardener	110.00 gal
35-35150 Steel Flex Just Right Resin Brush.....	9.75 ea.

ZEREX SLICK BOTTOM (BANANA PEEL IN A CAN) ALUMINUM OR FIBERGLASS

It's a new product that looks like it's going to be a real winner. Slick and durable for speed and action on the hill.

35-12018 Zerex Slick-Em.....NA	
35-12518 Zerex 1/2 Gallon.....NA	



EXHAUST TRANSM DUMPS

Manufactured from 2 1/2" O.D. or 3" O.D. stainless steel exhaust tubing with stainless steel tabs for mounting.

35-35801 Transom Dump 2 1/2"	35.00 pr.
35-35835 Transom Dump 3"	39.00 pr.
35-35035 Transom Dump 3 1/2"	43.00 pr.



ELECTRICAL TRIM TAB UNIT

With the flick of a finger you can trim your airboat just like you want it, fast or slow. You can feel the balance of our tested and proven trim plates. No drag means you have the best.

35-01010 Trim Unit Complete (Includes items below)	295.00 ea.
35-01011 Trim Motor only.....	210.00 ea.
35-01012 Trim Motor Foot, Bottom	24.95 ea.
35-01120 Trim Motor Bracket, Top.....	27.95 ea.
35-01013 Trim Motor Pin	9.00 ea.
35-01014 Stainless Hinge	18.70 ea.
35-01015 Aluminum Trim Plate	48.00 ea.
35-35313 Switch, 2-Way Momentary with Trim Tab Joystick.....	3.95 ea.



TRIM TAB JOYSTICK

This extension for momentary trim tab switch is very convenient.

35-35323 Extension Handle	3.50 ea.
---------------------------------	----------

BILGE PUMP

High discharge rate, low amperage draw, water cooled housing to quicken heat dissipation, stainless steel motor shaft, removable power heads for easy cleaning. Quick release base mount, durable and tough, molded ABS resin housing.

35-37000 3700 GPH 1 1/2" Out	168.00 ea.
35-36301 2000 GPH 4 3/8" H 1 1/8" Hose	75.00 ea
35-36304 3/4" Hose	0.95 ft.
35-36303 1 1/8" Hose	1.35 ft.
35-37001 1 1/2" Hose	1.25 ft.
35-36406 3/4" Through Hull Drain	5.95 ea.
35-36305 1 1/8" Through Hull Drain	7.95 ea.
35-37002 1 1/2" Through Hull Drain	7.95 ea.
35-36302 Transom Mounting Bracket	38.00 ea.
35-36407 Aluminum Bilge Bracket & Trim.....	20.00 ea.



PROP GUARDS & ENGINE STANDS



PROP GUARDS

Basic framework constructed of steel tubing covered with 13 gauge metal wire (2" x 4"). 3" clearance between propeller and guard when using recommended prop. Guard extends to the side and the bottom of the boat and is swept back to allow maximum room in the cargo area, plus full access to the fuel tank and battery . (Primed)



CLASSIC PROP GUARDS: PRIMED WITH 2x4 WIRE

30-40040	Lycoming 6 Cylinder & Continental 6 Cylinder Aircraft.....	980.00 ea.
30-40010	Lycoming 4 Cylinder & Continental 4 Cylinder Aircraft.....	980.00 ea.
30-40000	GM Direct Drives, All	980.00 ea.
30-35000	GM Belt Drive Units, All.....	980.00 ea.
30-40050	GM's with Gear-to-Gear Rotator.....	980.00 ea.



ENGINE STANDS

The perfect engine stand is one not over engineered and thus unnecessarily heavy or under engineered so it won't hold up. It must combine strength, durability and be as light as possible. Classic gives you all of that and more.

NOTE

Although *Classic Airboats* uses gigs and fixtures, no two hulls or riggings are exactly the same. Therefore, it may be necessary to do some fitting when you receive our fabricated rigging.



CLASSIC ENGINE STANDS: PRIMED

30-40020	Lycoming 4 Cylinder Aircraft.....	600.00 ea.
30-40030	Lycoming 6 Cylinder Aircraft Dynafocal Mount.....	600.00 ea.
30-40080	Continental 6 Cylinder & 4 Cylinder Ground Power Units	600.00 ea.
30-40080	Continental 6 Cylinder Aircraft.....	600.00 ea.
30-40052	Belt Drive All V-8's	600.00 ea.
30-40070	Gear-to-Gear Rotator V-8 and V-6 GM's.....	600.00 ea.
30-40041	Direct Drive, Chevy V-8's & V-6's 90; Buick & Cadillac	600.00 ea.

SEAT STANDS

Classic optional seating has been developed over the years as a result of our efforts to accommodate our customers to the fullest. We offer just about every combination possible. We can put you up high and your passengers down low or vice versa. We even specialize in ice boat seating to accommodate our winter airboaters. Pick what suits you for the best ride of your life. Constructed of quality materials and ruggedly built with that extra touch for appeal, everything fits together for installation in a matter of minutes. No welding necessary. Our bracing is especially designed to provide you with a roomy cargo area directly under your seat. All seats come with convenient handles and all metal work is primed. Seating is designed to fit our aluminum & fiberglass 15' hulls with 40" C to C stringers. Our 11' & 12' fiberglass hulls have 27½" C to C stringers. All seating comes primed with floor boards and tote cages when applicable (1"x2" wire).



SINGLE SEAT REAR OPERATOR

30-10000 Single Seat Rear Operator, Primed495.00 ea.
Includes Tote Cage & Floor Boards

REAR OPERATOR FOR CENTER CONSOLE

30-20000 Duel Rear Operator, Primed.....575.00 ea.
Includes Tote Cage & Floor Boards

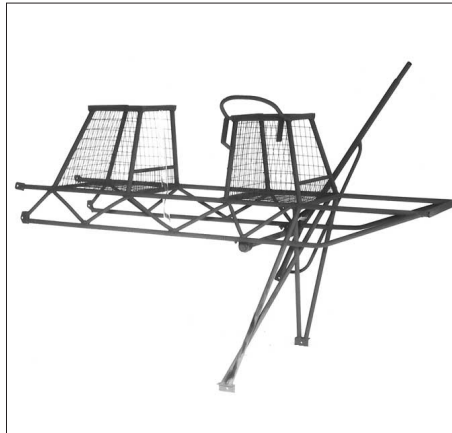

FRONT OPERATOR REAR PASSENGER

30-01002 Front Operator Rear Passenger, Primed..560.00 ea.
Includes Tote Cage & Floor Boards

FRONT OPERATOR FOR CENTER CONSOLE

Rear passenger seating of choice.
30-02002 Duel Front Operator, Primed.....675.00 ea.
Includes Tote Cage & Floor Boards



PASSENGER SEATING HIGH

30-00033 3 Man Bench Seat High, Primed.....395.00 ea.
30-00032 2 Man Bench Seat High, Primed.....295.00 ea.
Includes Tote Cage & Floor Boards
30-00043 4 Man Bench Seat High, Primed.....490.00 ea.



PASSENGER SEATING MEDIUM HIGH

30-00023 3 Man Bench Seat
Med High Primed.....320.00 ea.
30-00022 2 Man Medium High240.00 ea.
Includes Tote Cage & Floor Boards
30-00033 3 Man Bench Seat, Med High, Primed380.00 ea.



3 MAN LOW BENCH SEAT

30-00013 3 Man Low Bench Seat.....280.00 ea.
No Tote Cage & Floor Boards
30-00014 4 Man Low Bench Seat.....295.00 ea.
No Tote Cage & Floor Boards



1 & 2 MAN LOW BENCH SEATS

30-00011 1 Man Low Bench Seat210.00 ea.
30-00012 2 Man Low Bench Seat230.00 ea.
No Tote Cage & Floor Boards

CUSTOM COLOR SEATS

Our custom color seats are made of the same high quality pleated vinyl/leather as our old stand-by black series. The seat cushions are padded with 2" of comfort foam and are offered in the colors below. All seats come with a sturdy fiberglass shell, black only and matching rain cover. Allow two to three weeks to fill order. Fiberglass shells are black. Allow 2-3 weeks for delivery.



GREEN



BLUE



WHITE



DARK BROWN



CAMO CALL

COMPLETE SEATS, CUSHIONS AND RAIN COVERS

35-36401	Single, Complete with Rain Cover	223.50 ea.	35-36602	Double, Rain Cover Only	52.00 ea.
35-36501	Single, Cushion Only	97.50 ea.	35-36403	Triple, Complete with Rain Cover	378.00 ea.
35-36601	Single, Rain Cover Only	46.00 ea.	35-36503	Triple, Cushion Only	195.00 ea.
36-36405	Big Man, Complete with Rain Cover	278.50 ea.	35-36603	Triple, Rain Cover Only	58.00ea.
36-36505	Big Man, Cushion Only	122.50 ea.	36-36404	Four Man, Complete with Rain Cover	500.00ea.
36-36605	Big Man, Rain Cover Only	38.00 ea.	36-36504	Four Man, Cushion Only	228.00 ea.
35-36402	Double, Complete with Rain Cover	279.50 ea.	36-36604	Four Man, Rain Cover Only	72.00ea.
35-36502	Double, Cushion Only	149.00 ea.			

SEATS & COVERS

Our high quality seats are designed for rugged use and durability. They are made of sturdy fiberglass and are covered with a high quality, pleated vinyl/leather fabric. For the ultimate in comfort, we add 2" of foam padding for your seat and back. And, we keep it all dry with a full "Snap-On" rain cover. Ride in comfort, look good and feel good when you ride. Black shell, cushion and rain cover.



SINGLE SEAT
AVAILABLE WITH
VERTICAL PLEATE
LINES (AS SHOWN)
OR HORIZONTAL

SINGLE SEAT ▶

Sturdy fiberglass shell with foam padded leather grained vinyl seat cushion. The ultimate in comfort and good looks. (18" x 18" x 18")

35-35401	Single Seat Complete with Rain Cover ...	185.00 ea.
35-35406	Single Seat Fiberglass Shell Only.....	88.00 ea.
35-35410	Single Foam Seat Cushion	88.00 ea.



DOUBLE SEAT ▶

Sturdy fiberglass shell with foam padded leather grained vinyl seat cushion. The ultimate in comfort and good looks. (18" x 18" x 36")

35-35403	Double Seat Complete with Rain Cover .	259.00 ea.
35-35408	Double Seat Fiberglass Shell Only	117.00 ea.
35-35412	Double Foam Seat Cushion.....	129.00 ea.



BIG MAN SINGLE ▶

Ideal for that real man who demands comfort and ease of access. Sturdy fiberglass shell with foam padded leather grained vinyl seat cushion. The ultimate in comfort and good looks. (18" x 18" x 22")

35-35402	Big Man Seat Complete with Rain Cover.	228.00 ea.
35-35407	Big Man Seat Fiberglass Shell Only	108.00 ea.
35-35411	Big Man Foam Seat Cushion	109.00 ea.



TRIPLE SEAT ▶

Sturdy fiberglass shell with foam padded leather grained vinyl seat cushion. The ultimate in comfort and good looks. (18" x 18" x 48")

35-35404	Triple Seat Complete with Rain Cover	338.00 ea.
35-35409	Triple Seat Fiberglass Shell Only.....	137.00 ea.
35-35413	Triple Foam Seat Cushion	169.00 ea.



FOUR MAN SEAT ▶

New seating option for the family that loves to airboat. (18" x 18" x 60")

35-35544	Four Man Seat	460.00 ea.
35-35344	Four Man Foam Seat Cushion	188.00 ea.
35-35444	Four Man Shell	160.00 ea.



FOLD DOWN SEAT ▶

Lightweight fold down seat made of ABS plastic. It's great for an extra seat that can be folded down when not in use. Pad not included. (18" x 18" x 18")

35-35430	Fold Down Seat	105.00 ea.
----------	----------------------	------------

RAIN COVERS ▶

For very obvious reasons, we offer Classic Rain Covers for your seats. We suggest you also take them with you in case you get caught in the rain while boating. A dry seat for your ride home is almost as good as a hot shower. Made of black leather grained vinyl. Fits all Classic seats.

35-35503	Single Rain Cover.....	35.00 ea.
35-35504	Big Man Single Rain Cover	36.00 ea.
35-35505	Double Rain Cover	38.00 ea.
35-35506	Triple (3 Man) Rain Cover	58.00 ea.
35-35540	Four Man Rain Cover	68.00 ea.



FUEL SYSTEM & ACCESSORIES

ALUMINUM FUEL TANKS ▶

Coast Guard approved all aluminum welded fuel tanks, comes with 3/8" pick-up and vent ports. Tank is contoured for attractive appearance and to accommodate easy installation under engine stand. Comes with fuel cap and mechanical fuel gauge.

35-35601	20 Gal Fuel Tank & Mechanical Fuel Gauge.....	289.00 ea.
	8"H X 32"L X 19"W	
35-35602	30 Gal Fuel Tank & Mechanical Fuel Gauge.....	298.00 ea.
	12"H X 32"L X 19"W	
35-35603	40 Gal Fuel Tank & Mechanical Fuel Gauge.....	387.00 ea.
	16"H X 32"L X 19"W	



RACOR FUEL FILTER & WATER SEPARATOR

A multi-port head for each installation simplifies mounting in cramped quarters. The see-thru bowl resists discoloration from additives and ultraviolet light—A see-thru that says see-thru. Fuel filter/water separator with mounting head, spin-on element and see-thru bowl. 30 gph, 1/4 NPTF ports.

728-2014	Fuel Filter/Water Separator	120.00 ea.
728-2015	Mini-Fuel Filter/Water Separator.....	NA
728-3228	Replacement Filter	49.95 ea.
728-3201	See-Thru Bowl.....	28.75 ea.



GAS TANK ISOLATING MOUNTING KIT

Used to secure tank & eliminate vibration.

35-35632	Gas Tank Mounting Kit.....	12.00 kit
----------	----------------------------	-----------



MECHANICAL FUEL GAUGE & CAP

Totally mechanical fuel gauge & cap. Dependable & accurate with no wires, fuses or circuits.

35-35604	40 Gal. Gas Gauge & Cap	26.80 ea.
35-35605	30 Gal. Gas Gauge & Cap	26.80 ea.
35-35606	20 Gal. Gas Gauge & Cap	26.80 ea.



SEE-THRU FUEL FILTER

Full flow and cleanable see thru filter comes in 3/16" ID hose. A proven in-line filter which will give years of reliable service.

35-35631	See-Thru Filter	17.30 ea.
61-61999	Paper Low Milron See Thru.....	6.50 ea.

FUEL SYSTEM & ACCESSORIES



MIRA PUSH/PULL THROTTLE CABLE

	Standard	
61-61560	6' Throttle Cable35.00 ea.
61-61570	7' Throttle Cable35.00 ea.
61-61580	8' Throttle Cable35.00 ea.
61-61590	9' Throttle Cable35.00 ea.
61-61510	10' Throttle Cable35.00 ea.
61-61511	11' Throttle Cable48.00 ea.
61-61512	12' Throttle Cable49.00 ea.
61-61513	13' Throttle Cable50.00 ea.
61-61514	14' Throttle Cable51.00 ea.
61-61515	15' Throttle Cable52.00 ea.
61-61517	17' Throttle Cable54.00 ea.

THROTTLE CABLE ACCESSORIES

61-61530	Tie Rod Ends for Cable6.00 ea.
61-61540	Cable Hold Clamps for Cable9.50 ea.
61-61541	Throttle Return Spring (Stainless Steel)3.50 ea.

ELECTRIC FUEL PUMP & FILTER BACKUP FOR MECHANICAL FUEL PUMP

Perfect as a backup fuel pump system. If you have a mechanical fuel pump, you may never need your electrical one; but if you do, it may save you a long walk home. It's also great as a primer pump for quick, easy starts. Requires no regulation. 12 volt, 7 psi, E/W mounting bracket. Installation for 3/8" ID fuel line.

61-40700 Electric Fuel PumpNA ea.



GM-AC HIGH PERFORMANCE ELECTRIC FUEL PUMP

High quality fuel pump for high performance engines. Mounted in rubber grommets comes with mounting bracket. Ideal for our high horsepower small blocks and big blocks.

61-15899 72 GPH Fuel Pump122.00 ea.



FUEL FILTER SIERRA

Fuel filter element is replaceable and it can be hooked up in tandem. Complete unit comes with aluminum mounting head, block off nut, and replaceable filter. OMC compatible.

727-6002	Complete Filter Kit33.95 kit
727-6001	Replacement Filter14.50 ea.

FOOT PEDAL THROTTLE ASSEMBLY WITH BELL CRANK

For auto or aircraft engines. Gives instant & positive control over your speed and engine HP.

35-35201	Foot Pedal Assembly Complete (A, B, C) (no cable or cable ends)65.00 ea.
35-35202	Foot Pedal Assembly (A)29.00 ea.
35-35203	Bell Crank Assembly (B)29.00 ea.
35-35206	Rod Arm & Two Heim End Links (C)19.00 ea.

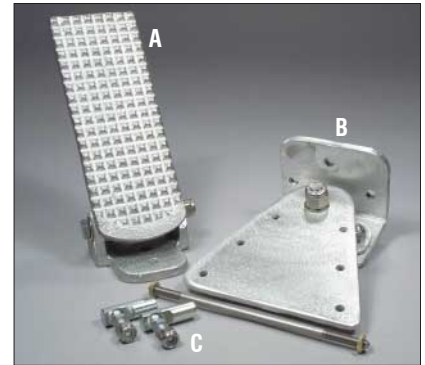

FOOT PEDAL & THROTTLE ASSEMBLY

This throttle assembly is a compact unit made in 3 pieces of cast aluminum.

753-2131 Throttle Assembly Kit For Auto & Aircraft65.00 kit

HOLLEY HIGH PERFORMANCE ELECTRIC FUEL PUMP

Designed for the airboater who wants to modify his auto application for maximum performance. 12 volt electrical high pressure, 14 psi, 100 gallon per hour. Includes universal regulator.

61-62406 Holley, Blue186.00 ea.
61-62407 Holley, RedNA



GM-AC MANUAL FUEL PUMP—SMALL BLOCK

High volume low pressure (5 to 7 psi ±) manual fuel pump necessary on reduction unit applications. Use with high output Chevy small block motors—rated @ 70 GPH. Do not lean out your motor with too small a fuel pump.

61-15323	Fuel Pump59.25 ea.
61-06901	Fuel Pump Nut and Bolt Kit3.50 kit
30-14938	Fuel Pump Brass Kit7.50 kit
61-00006	Fuel Pump & Fuel Filter Clamp Kit3.50 kit

RUDDERS & STEERING ACCESSORIES

FOAM FILLED ALUMINUM RUDDERS

This is one of those items we have not been able to improve on in 16 years. Easy to operate, gives you instant positive turning ability. Contoured air-foil designed for efficiency and good looks. Our 4' & 5' rudders are foam filled and come with a trim tab for straight, effortless handling.



35-35713 4' Air Foil Rudders, Double SeamNA



35-35714 4' Air Foil Rudders, Deluxe Single Seam.....397.00 pr.
35-35713 5' Air Foil Rudders, Deluxe Single Seam.....515.00 pr.



HEIM BALL JOINT PIVOT STEERING LINKAGE

Classic now uses this exclusively in their steering systems. This eliminates virtually all linkage play, giving you a positive hand-to-rudder feel for responsive steering. $\frac{3}{8}$ " FINE THREAD.

$\frac{3}{8}$ " HEIM BALL JOINTS (FINE THREAD)

35-35381	Polymer Bearing with Stud (A)	8.25 ea.
35-35385	Polymer Bearing No Stud(B)	6.95 ea.
35-35386	Stainless Bearing, No Stud (C)	14.00ea.
35-35383	Steel Bearing with Stud (D)	8.25 ea.
35-35384	Steel Bearing, No Stud (E)	6.95 ea.
35-35381SS	Stainless Bearing with Stud.....	16.25 ea.



RUDDERS & STEERING ACCESSORIES



MOUNTING WASHER FOR STEERING

Do-It-Yourself large mounting washer.

35-00380	Mounting Washer 3/8".....	4.75 ea.
35-00516	Mounting Washer 5/16".....	4.75 ea.



CABLE MOUNTING BRACKET FOR STEERING

35-35038	Cable Mounting Bracket 3/8".....	38.00 ea.
35-35516	Cable Mounting Brackets 5/16".....	35.00 ea.



ARGUTO BEARINGS AND LOCK RINGS FOR STEERING STICK

These are items you can expect to last forever and be maintenance free. They are a must for positive steering control.

35-35733	Polymer Bearing for 1" I.D. EMT.....	8.25 ea.
35-35738	Lock Ring for 1" I.D. EMT.....	4.50 ea.
35-35739	Stainless with Poly Bearing for 1 1/4" O.D. Pipe.....	26.00 ea.
35-35740	Stainless Lock Ring for 1 1/4" O.D. Pipe.....	15.00 ea.



STEERING STICK GRIP

For comfort and feel we furnish Classic steering sticks with a foam rubber cushioned; no slip grip.

35-35720	Steering Grip.....	2.95 ea.
35-35730	Easy Grip Tape.....	3.95 roll



STAINLESS STEEL PUSH PULL STEERING CABLE

Our stainless steering cables are the best for solid feel, strength and durability. They give you a positive feel with little or no backlash for instant command transfer to your rudder. Use heim cable ends 3/16" and 3/8" found on page 28.

TOP OF THE LINE 3/16" ALL STAINLESS (Including Farrell & Nut)

35-35707	7' Steering Cable.....	216.00 ea.	35-35715	15' Steering Cable.....	255.00 ea.
35-35708	8' Steering Cable.....	216.00 ea.	35-35716	16' Steering Cable.....	262.00 ea.
35-35709	9' Steering Cable.....	224.00 ea.	35-35717	17' Steering Cable.....	270.00 ea.
35-35710	10' Steering Cable.....	230.00 ea.	35-35718	18' Steering Cable.....	275.00 ea.
35-35711	11' Steering Cable.....	234.00 ea.			
35-35712	12' Steering Cable.....	238.00 ea.			
35-35713	13' Steering Cable.....	245.00 ea.			
35-35714	14' Steering Cable.....	251.00 ea.			



RUDDER RODS

3/8" steel or stainless steel rudder rods come with one end threaded and the other end with a welded tab for easy installation and mounting.

35-35715	5' Steel Rudder Rods.....	30.00 pr.
35-35716	4' Steel Rudder Rods.....	28.00 pr.
35-35735	5' Stainless Steel Rudder Rods.....	53.00 pr.
35-35736	4' Stainless Steel Rudder Rods.....	48.00 pr.



RUDDER BUSHINGS

Polymer, (Lifetime UHMW), all manufactured to our specifications which eliminates rudder clatter and slop. The polymer/Teflon is our favorite for it requires no lubrication and is polymer/Teflon tough.

35-35717	Polymer 3/8" I.D. 3/8" O.D.....	3.95 ea.
35-35799	Polymer 3/8" I.D. 1/2" O.D.....	3.95 ea.



STEERING STICK

The Classic Steering Stick is made of 1" ID EMT primed steel. It is designed to give you great feel and lots of leverage for easy steering.

35-35607	Bell Crank Steering Stick.....	60.00 ea.
35-35753	Cable Steering Stick.....	60.00 ea.

STEERING BELL CRANK ASSEMBLY WITH ARGUTO BEARINGS & SET COLLARS

The designs of our bell crank steering system has had 20 years of proven success. It is a mechanical system that gives positive response with a light touch.

35-35702	Bell Crank Primed Long Neck.....	79.00 ea.
35-35701	Bell Crank Primed Short Neck.....	79.00 ea.

DRAG LINK STEERING COMPONENTS

Our drag link steering system has been used for over 20 years. It's tried and proven. Drag link comes with threaded ends. 3/8" SAE, primed and locking nuts. Be sure to give us the length you need.

35-35703	Drag Link Between Stick & Bell Crank.....	39.00 ea.
35-35705	Drag Link Between Rudders Mild Steel.....	36.00 ea.
35-35706	Drag Link Bell Crank To Rudders Mild Steel.....	32.00 ea.

CLASSIC AIRBOATS



Page 47



Page 37



Page 47



Page 46



Page 27



Page 27



Page 32



Pages 26 & 35



Page 59



Pages 57 & 58



Page 35



Page 41



Page 41



Page 67

INSTRUMENT PANELS



COMPLETE INSTRUMENT PANEL WITH WIRING HARNESS

Includes: Tachometer, oil pressure, voltmeter, water or oil temperature gauge and hour meter. Also includes accessory outlet and toggle switches for KC lights, bilge, power trim, navigation lights and mags (aircraft). Your Classic instrument panel application and its monitoring gauges are the eyes and ears of your engine and electrical system. *Engine sending units not included.*

35-35301	Auto Engine Application, Electric Gauges	425.00 set
35-35302	Aircraft Engine Application, Mechanical Gauges	450.00 set
35-35501	Rain Cover	28.00 set



TRIM TAB JOYSTICK HANDLE

This extension for momentary trim tab switch is very convenient.

35-35323	Extension Handle	3.50 ea.
----------	------------------------	----------



Shown with optional compass installed.

ALUMINUM CENTER CONSOLE

Our dual operator aluminum center console is custom fabricated to fit our dual operator seating. All essential gauges, auxiliary switches, and accessories are placed for ease of use and functionality.

35-13530	Dual Operator Aluminum Center Console	525.00 ea.
711-0663	Mounted Compass with Back Light	78.00 ea.
35-23530	Center Console Shell, No Holes Drilled	125.00 ea.
35-33530	Center Console Shell with Gauge Holes	150.00 ea.



AIRCRAFT MECHANICAL TACHOMETER

Our Classic mechanical tachometer is a must and comes with backlighting. 3500 rpm full sweep tach plus built-in hour metering divided into tenths. Essential for proper service, repair and maintenance of your engine.

61-61501	Mechanical Aircraft Tachometer	79.00 ea.
66-66502	Tach Cable Per Foot	7.50 ft



INSTRUMENT PANEL ENCLOSURE AND PANEL TRIM

Heavy duty enclosed fiberglass instrument panel enclosure. Keeping your engine gauge and switches away from the elements is very important for reliability. Custom styled for modern sleek look.

35-35323	Instrument Panel Shell Only	48.00 ea.
35-35303	Instrument Panel Enclosure Unfitted, Includes Back Plate and Trim	98.00 ea.
35-35304	Instrument Panel Enclosure Drilled and Fitted for Gauges w/Back Plate & Panel Trim	155.00 ea.
35-35328	Instrument Panel Trim	4.50 ft.

TELEFLEX & FARIA MARINE GAUGES

It's been said that the difference between a driver and an operator is an operator watches gauges. Just like you or me coming down with a cold, most of the time an engine gives you some hint that trouble is coming. That's why we offer a wide selection of gauges and suggest you keep an eye on them. All our gauges are top of the line, high grade marine instruments. They are back lighted and ruggedly constructed. They are full sweep and easy to read, day or night. Our gauges are accurate and dependable. So be a good doctor and monitor all your engine's vital signs.

TELEFLEX MARINE GAUGES



VOLTMETER AND AMP METER

35-35306 Voltmeter.....19.95 ea.
35-35326 Amp MeterNA



AIRCRAFT TACH W/HOUR METER MECH

61-61501 Mech Aircraft Tach.....79.00 ea.
66-66502 Mech Tach Cable.....7.50 ft.



AUTOMOTIVE TACHOMETER

35-35309 Electric Auto Tach.....59.95 ea.



OIL PRESSURE GAUGE MECHANICAL

35-35308 Oil Pressure Gauge39.95 ea.



TEMPERATURE GAUGE MECHANICAL

35-35305 Temperature Gauge..45.95 ea.



HOBBS HOUR METER

35-35310 Electric Hobbs Hour Meter..36.70 ea.



HOBBS CIRCULAR HOUR METER

35-35321 Electric Hobbs Circular Hour Meter36.71 ea.



TEMP GAUGE MECHANICAL

35-35305 Oil Temp Gauge39.50 ea.
30-38512 Lycoming Brass Adapter ..43.50 ea.

FARIA MARINE ELECTRIC GAUGES - THE CHOICE OF AMERICA'S LEADING AIRBOAT MANUFACTURER

Faria has been in continuous production of marine instruments for over 30 years and offers the 3 R's for airboating: Rugged, Reliable and Readable marine instruments with quality, second to none at competitive prices. The dual reading (American/Metric) dials with bold, bright white numerals against a nonglare background, sculpted bright white pointer and low profile bezels make the Faria instruments simple and CLASSIC.

FARIA WATER & OIL TEMPERATURE SENDING UNITS FOR ELECTRIC GAUGES

Water and oil temp, sending units, single station for use with most marine temp, electrical and oil temp gauges.

35-74518 1/8" Male Pipe.....9.50 ea.
35-74514 1/4" Male Pipe.....9.75 ea.
35-74538 3/8" Male Pipe.....10.75 ea.
35-74550 1/2" Male Pipe.....10.75 ea.

OIL PRESSURE GAUGE SENDING UNIT KIT FOR MECHANICAL

35-74601 Sending Unit Kit (Includes: Brass Fittings and 6' Nylon Hose Oil Line)14.95 ea.
35-74612 Oil Line Only\$.42 ft.

OIL PRESSURE GAUGE SENDING UNIT FOR ELECTRICAL GAUGES

35-37452 0-80 PSI16.50 ea.

OIL PRESSURE GAUGE THICK WALL RUBBER HOSE

Thick wall heavy duty black rubber 1/4" I.D.

35-74616 Oil Pressure Line 1/4"1.45 ft.
35-18014 Brass Fittings for 1/4" Hose ...3.70 ea.
35-18000 Brass Coupling 1/4"1.25 ea.



OIL PRESSURE GAUGE 0-80

35-95720 Oil Pressure Gauge19.00 ea.



OIL TEMP GAUGE

35-91121 Oil Temp Gauge19.00 ea.



AUTO TACH 0-6000 RPM

35-35628 AutoTach..59.00 ea.



AIRCRAFT TACH 0-4000 RPM

Runs off alternator.
35-35339 Tach..... NA



WATER TEMP GAUGE 100-250

35-91120 Water Temp Gauge19.00 ea.



VOLTMETER

35-91380 Voltmeter .19.00 ea.

MARINE GAUGE PACKAGES & SWITCHES



ELECTRIC MARINE GAUGE PACKAGE

Includes Tach, Volt, Oil Temp or Water Temp, Oil Pressure Plus two marine sending units.
 61-35011 Auto Package of 4 Gauges with Sending Units179.00 ea.
 66-54011 Aircraft Package of 4 Gauges with Sending Unit, Tach Runs Off Alternator.....189.00 ea.



MECHANICAL MARINE GAUGE PACKAGE

Includes Tach, Volt, Oil Temp or Water Temp, Oil Pressure, with Oil Line.
 61-35022 Auto Package of 4 Gauges with Oil Line169.00 ea.
 66-54022 Aircraft Package of 4 Gauges, Includes HR meter in Tach (tach cable not included)179.00 ea.



TRIM TAB JOYSTICK HANDLE

This extension for momentary trim tab switch is very convenient.
 35-35323 Extension Handle2.95 ea.

ON/OFF TOGGLE SWITCH (A) ▶

On/Off Toggle switch (all weather). 12 volts, positive click.
 35-35312 On/Off Toggle Switch3.95 ea.

TWO-WAY MOMENTARY SWITCH (B) ▶

Two-way Momentary Switch, Center Position off with six slip on lugs. 12 volt, perfect for any two-way trim system.
 35-35313 Trim Tab Switch12.45 ea.

IN-LINE FUSE HOLDER (C) ▶

In-line fuse holder with instrument panel mounting capability. 30 amp, 12 volt, all weather and easy to change.
 35-35311 Mounted Fuse Holder6.50 ea.

SPECIAL PRICING

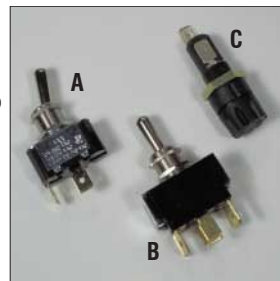

THREE POSITION MARINE IGNITION SWITCH

Three position, 3-pole ignition key switch, on-off and accessory position. Also has a rubber water protection over key slot. NOTE: Mag switches must be installed separate when used for aircraft.
 35-35317 3-Position Ignition Key Switch11.75 ea.

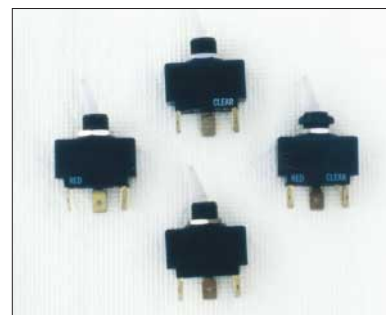

LIGHTED TOGGLE SWITCHES ▶

Color code your accessories. Toggle switch post lights designated color when switch is on; lights clear when off. It's convenient and looks great at night. Eliminate the problem of left on switches.

35-35318 Clear Toggle Switch6.50 ea.
 35-35319 Amber Toggle Switch6.50 ea.
 35-35320 Red Toggle Switch6.50 ea.
 35-35329 Green Toggle Switch6.50 ea.



TOGGLE SWITCH BOOTS

All airboats are going to experience bad weather. Our water resistant screw on toggle switch boots are ideal for protecting your electrical system when you need it most.

CLEAR RUBBER BOOTS (A & B)

Water protective cover for push button circuit breaker or push button switch—screw on.
 35-35314 Clear Rubber, Boot Short (A)2.95 ea.
 35-35316 Clear Rubber, Boot Long (B)2.95 ea.

BLACK RUBBER BOOTS (C & D)

Water protective switch—screw on.
 35-35315 Full Boot Black (C)2.00 ea.
 35-36209 1/2 Boot Black (D)2.00 ea.

CIGARETTE PLUGS

36-36808 Cigarette Plug, Female8.50 ea.
 35-36209 Cigarette Plug, Male9.50 ea.

BATTERY ACC. & FUEL LINES/HOSES

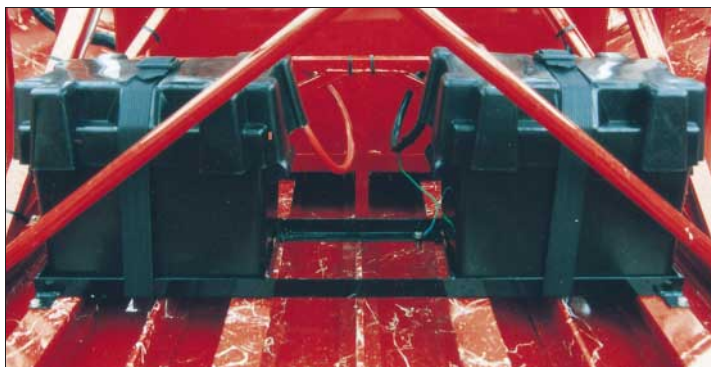

◀ BATTERY BOXES

Coast Guard approved, vented and acid proof. Most people don't think of a battery box as a safety feature, but it is. Prevents shorts or sparks from an open hot wire and it makes your rig look great.

35-36204 Battery Box w/Strap and Strap Mounting Bracket.....11.50 ea.

TRIPLE BATTERY BOX BRACKET FOR BATTERY PLUS TOOLS

Great for storage. Put your battery in the middle and your tools and stuff on the ends.

35-36214 Triple Box Bracket, Primed.....69.00 ea.

SINGLE BATTERY BRACKET

35-36201 Single-Primed.....40.00 ea.

DUAL BATTERY AND STORAGE BRACKETS SIDE BY SIDE

35-36202 Dual Side by Side Battery Bracket, Primed.....55.00 ea.

35-36203 Dual End to End Battery Bracket, Primed.....55.00 ea.



◀ COAST GUARD REQUIRED NAVIGATION LIGHT SYSTEM

These lights offer low candlepower to eliminate night blinding, but still identify your boat hull to others.

35-35902 Red.....4.50 ea.
35-35903 Green.....NA
35-35904 Clear.....4.50 ea.
35-90204 Red, Green, Clear Kit.....12.95 kit



▲ EXPANSION TANK HOSE

Designed for use with radiator system only. Rubber reinforced with nylon, low pressure hose.

35-36703 3/8" Reinforced Hose.....1.25 ft.



◀ 4-POSITION DUAL AND SINGLE BATTERY SWITCH

Increase flexibility, amperage availability, long battery life, segregate starter from accessory, plus charging duties. It's a battery saver on the dual switch. Runs on one battery and saves the other for a spare.

35-36207 Dual Battery Switch.....42.75 ea.
35-36208 Single Battery Switch.....42.55 ea.



◀ CHROMALEX BOW LIGHTS

Space age, high compact, plastic plated durable housing, black base, red and green lenses in a non-corrosive 12 volt socket. Bulb included. A must. Coast Guard required.

35-35901 Chromalex Bow Lights.....21.50 ea.



◀ RADIATOR HOSE

It's bad enough to have a radiator hose go out in your automobile. It can be a lot worse in your boat. That's why we sell only the best quality marine hose available. It's 2-ply with a steel core and made of heat resistant rubber. Continuous length—no splices. Custom cut.

35-36708 1 1/2" Radiator Hose.....4.70 foot
35-36709 1 3/4" Radiator Hose.....4.95 foot



▲ BATTERY BOOTS AND CABLE

Battery Boots (Black and Red) silicone impregnated.

One of those items that pays big dividends, helps eliminate shorts and sparks that cause burns, fire and battery drain. Cable #1 gauge (not the ordinary automotive style) custom length swaged and permanently installed copper battery terminal ends.

35-36206 Black Cable.....4.25 ft.
35-36213 Black Boot.....1.95 ea.
35-36210 Red Cable.....4.25 ft.
35-36205 Red Boot.....1.95 ea.
35-36215 Lg. Red Boot.....3.50 ea.
35-36216 Lg. Black Boot.....3.50 ea.



▲ CLEAR VENT HOSE 1" ID CRANKCASE VENT HOSE FOR AIRCRAFT ENGINES

All aircraft engines build crankcase pressure that must be vented. Classic recommends the clear hose so you can monitor moisture and oil venting that may indicate engine problem.

35-367012 1" I.D. Vent Hose.....1.75 ft.

RECOVERY TANK HOSE

35-36702 3/8" I.D. Clear Std.\$.75 ft.
30-38038 Brass Fitting, Straight Barb .2.65 ea.
30-38938 Brass Fitting, 90° Barb.....4.25 ea.



▲ STANDARD 3/8" I.D. RUBBER HOSE (A)

All lines are made of the highest quality rubber and nylon cord reinforcement with single strand nylon cord. Not to be used as fuel line.

35-35706 Std 3/8" I.D. Type B Hose....1.25 ft.

▲ COAST GUARD APPROVED 3/8" I.D. RUBBER FUEL LINE (B)

Coast Guard Approved two nylon cord hose for installation to the fuel pump pressure side.

35-36224 CG App. 3/8" I.D. Type A.....1.60 ft.

▲ STANDARD 1/4" I.D. RUBBER FUEL LINE (C)

Fuel line 1/4" ultra standard
56-50008 CG App. 1/4" I.D. Type A.....1.25 ft.

CUSTOM HEADERS & ACCESSORIES

For the polished look of perfection our custom headers can dress up the best of airboats. Our precision cut stainless steel flanges are clean precise and durable. All the cuts and angles are smooth and equal. Welded by craftsmen using the tigid process produces a welding bead that's strong, clean and smooth and looks great. Classic custom tigid headers are a great way to dress you engine package.



▲ CHEVY CUSTOM HEADERS V6 AND 350 1½" TUBES

61-25350	350 V8 2½" dumps.....	430.00 pr.
61-35030	350 V8 3" dumps.....	430.00 pr.
61-25262	V6 2½" dumps.....	430.00 pr.
61-30262	V6 3" dumps.....	430.00 pr.
61-61813	Chevy Small Block Bolt Set (12).....	52.80 set
61-35000	Long Tube, S.B. High Perf. Headers.....	595.00 pr.



▲ CHEVY CUSTOM HEADERS 454 AND 502 2" TUBES

Maximum Performance Effort

When you need the most, go all out with our 2" header pipes let your big block breath easy.

61-45430	454 and 502 3" dumps.....	429.00 pr.
61-35454	454 and 502 3½" dumps.....	429.00 pr.
61-62454	Chevy Big Block Set (16).....	52.50 set
61-50200	Long Tube, B.B. High Perf. Headers.....	595.00 set



▲ LYCOMING CUSTOM HEADERS (2 HOLE) 1½" TUBES

66-25540	6 Cylinder straight 2½" dumps.....	285.00 pr.
66-25541	6 Cylinder angle 2½" dumps.....	285.00 pr.
66-25360	4 Cylinder straight 2½" dumps.....	229.00 pr.
66-25361	4 Cylinder angle 2½" dumps.....	229.00 pr.

BUICK CUSTOM HEADERS 1¾" TUBES

61-25455	455 V8 2½" dumps.....	430.00 pr.
61-30455	455 V8 3" dumps.....	430.00 pr.
61-61815	Buick Header Bolt Set (14).....	44.00 set

CADILLAC CUSTOM HEADERS 1¾" TUBES

61-25500	Caddy V8 2½" dumps.....	430.00 pr.
61-30500	Caddy V8 3" dumps.....	430.00 pr.
61-61816	Caddy & Bolt Set (16).....	48.50 set

CONTINENTAL CUSTOM HEADERS (2 HOLE) 1½" TUBES

66-25470	6 Cylinder 0470 2½" dumps.....	249.00 pr.
66-25520	6 Cylinder 0520 2½" dumps.....	249.0 pr.
66-25320	4 Cylinder GPU and AC 2½" dumps.....	229.00 pr.
66-25090	4 Cylinder 90 HP 2½" dumps.....	229.00 pr.



▲ GLASS PACK RESONATORS

Resonators for aircraft and auto applications. Includes transom mounting system. They are designed to reduce engine noise without adversely affecting engine performance. (Please specify 2½" or 3" dumps). 2½" ID x 18" Long

35-35888	Glass Pack Resonators.....	129.00 pr.
----------	----------------------------	------------





HEAVY DUTY HIGH QUALITY STAINLESS STEEL FLEX HOSE

Our heavy duty flex tubing is made of the highest quality non-magnetic stainless steel. Flex pipe is required by the Coast Guard, so make it last by getting the best.

35-35804	Stainless Flex Hose 2 1/2".....	11.00 ft.
35-35805	Stainless Flex Hose 3".....	12.00 ft.
35-35350	Stainless Flex Hose 3 1/2".....	13.00 ft.
35.35400	Stainless Flex House 4".....	14.00 ft.



STAINLESS BULLET MUFFLERS FOR AIRCRAFT AND AUTOMOTIVE

Bullet mufflers are the newest advancement in light weight, neat, effective airboat mufflers. Uniquely designed by Classic Airboat to be a leader in the effort to quiet engine noise. Order your Bullet Muffler/Collector welded right to your header or band clamp them just below your existing header collector for the inline fit that looks professionally engineered.

Collector Mounted Stainless Mufflers

61-25061	6" Bullet Muffler with 2 1/2" OD outlet (extra long for mounting)	200.00 pr.
61-30061	6" Bullet Muffler with 3" OD outlet (extra long for mounting)	200.00 pr.
61-35061	6" Bullet Muffler with 3 1/2" OD outlet (Currently not available)	NA

Transom Mounted Stainless Bullet Mufflers

61-25143	14" Bullet Muffler with 2 1/2" outlets (Currently not available).....	NA
61-30143	14" Bullet Muffler with 3" outlets (Currently not available).....	NA
61-35143	14" Bullet Muffler with 3 1/2" outlets (Currently not available).....	NA



STAINLESS FULL SIZE MUFFLERS/TURBO

Be a good neighbor and reduce engine noise with our carefully selected noise reducing turbo and full size mufflers. Our stainless steel versions are high quality and are as pretty as a muffler can look. All mufflers come with a "transom dump

extension" for mounting your muffler through the transom. If your transom is a straight back transom we will weld mounting tabs on the extension for your convenience. For angle back transoms we include the mounting tabs but do not weld them on the extension. (Please specify Flex Pipe size.)

35-35924	Stainless Steel Turbo Muffler In-line	350.00 pr.
35-63043	Stainless Steel Full Muffler In-line	425.00 pr.
35-63013	Galvanized Full Muffler In-line.....	NA pr.
35-35822	Galvanized Turbo Muffler In-line	NA pr.



EXHAUST TRANSDUMPS ▶

Manufactured from 2 1/2" O.D. or 3" O.D. stainless steel exhaust tubing with stainless steel tabs for mounting.

35-35801	Transom Dump 2 1/2"	38.50 pr.
35-35835	Transom Dump 3"	43.00 pr.
35-35035	Transom Dump 3 1/2"	45.00 pr.
35-35040	Transom Dump 4"	49.50 pr.

HEADER GASKETS & ACCESSORIES



STANDARD EXHAUST GASKETS

Our industry standard exhaust gaskets are made of high quality material and are proven products.

61-59000	Chevy Small Block.....	18.90 pr.
61-05911	Chevy Big Block	19.90 pr.



COPPER HEAVY DUTY EXHAUST GASKETS

For tough header gaskets your choice should be copper.

61-04211	Chevy Small Block.....	57.50 pr.
61-04013	Chevy Big Block	57.50 pr.



Big Block

AUTOMOTIVE EXHAUST HEADER BOLTS

These special bolts are equipped with special locking rings that help eliminate the possibility that header bolts can loosen, causing blown header gaskets.

61-61813	Chevy Sml. Block Bolt Set (12)	52.50 set
61-61815	Buick Header Bolt Set (14).....	52.50 set
61-61816	Caddy & Bolt Set (16).....	52.50 set
62-62454	Chevy Big Block Set (16)	52.50 set



Small Block



STYLISH AIRCRAFT EXHAUST BAND CLAMPS FOR FLEX HOSE

Stainless Steel Band Clamps for aircraft and auto applications. Connects Flex Exhaust tubing to headers, transom dump, mufflers or glass packs.

35-35860	Stainless Band Clamp 2 1/2"	10.02 ea.
35-35870	Stainless Band Clamp 3"	10.02 ea.
35-35835	Stainless Band Clamp 3 1/2"	10.90 ea.
35-35840	Stainless Band Clamp 4"	10.75 ea.



EXHAUST PIPE U-CLAMPS FOR STAINLESS STEEL FLEX HOSE

Match our Stainless Steel Flex Pipe with our hard-to-find Stainless Steel or Zinc Plated U-Clamps and eliminate that unsightly corrosive problem.

35-35806	Stainless Steel U-Clamp 2 1/2"	10.02 ea.
35-35830	Stainless Steel U-Clamp 3"	10.02 ea.
35-35802	Zinc Plated U-Clamp 2 1/2"	1.95 ea.
35-35803	Zinc Plated U-Clamp 3"	3.25 ea.
35-35835	Zinc Plated U-Clamps 3 1/2"	4.00 ea.

OILER COOLERS & ACCESSORIES

OIL COOLER

Excessive heat is an engine killer. That's why we recommend our proven oil cooler to give your engine that extra safety factor and temperature. A must for aircraft engines. Free flow fin design for maximum heat dispensation and cool oil.

61-62201	Large Oil Cooler 24" x 12" Fins	249.00 ea.
61-62202	Small Oil Cooler 24" x 8" Fins	189.00 ea.

OIL COOLER MOUNTING KIT

Complete kit with special mounting hardware. This is the ideal way to mount an oil cooler, making it secure and vibration free. We have tried many methods and this is the best.

61-62003I Cooler Mounting Kit	22.00 kit
----------	----------------------------------	-----------



OIL COOLER BRASS TO COOLER

30-12058	1/2" Pipe 5/8" Hose Straight (A)	2.40 ea.
30-12038	1/2" Pipe 3/8" Hose Straight (B)	3.60 ea.
30-34112	3/4" Pipe 1/2" Bushing (C)	2.30 ea.
30-12938	1/2" Pipe x 3/8" Hose 90° Elbow (D)	6.45 ea.
30-12912	1/2" Pipe x 1/2" Hose 90° Elbow (E)	5.80 ea.
30-12958	1/2" Pipe x 5/8" Hose 90° Elbow (D)	6.20 ea.



OIL COOLER ADAPTERS

The lifeline of your engine depends on keeping the running temperature of your engine as low as possible. Our cooler adapter, made of marine quality aluminum, allows you to install an auxiliary oil cooler for the extra margin of safety.

61-62211	Chevy Big Block	56.00 ea.
61-62211	Chevy Small Block	56.00 ea.
61-62225	Cadillac	56.00 ea.
61-62225	Buick	56.00 ea.

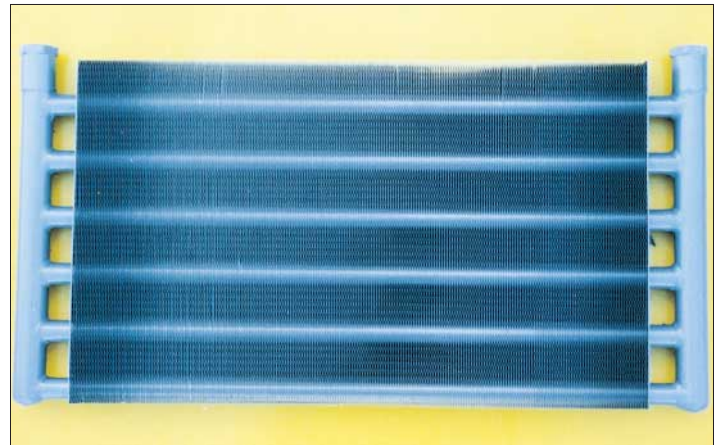

OIL LINE HIGH PRESSURE

Don't substitute on your oil line hose. Use our 2-ply, 150 psi hose that is made for heat and oil resistant rubber tubing. Hose is cheap, engines are expensive.

35-36704	1/2" Oil Line Hose	1.40 ft
35-36758	3/8" Oil Line Hose	1.88 ft



ROTATOR AND K-OIL FOR PURRPOWER

Protect your gear-to-gear reduction unit with our highest quality selected gear oil available. We know for sure that some gear oils are better than others and we some don't work at all. We have not tested all the oils out there in the market place, but we do know one thing for sure, our high quality oil works. Do not substitute other gear oils—use only factory recommended products to maintain warranty.

61-02543	K-Way Oil	14.95 qt.
61-02120	Rotator Oil	14.95 qt.

BISHOP'S ORIGINAL AUTO AND AIRCRAFT ENGINE TREATMENT-THE BEST

Put an end to dry starts while adding to performance. Designed to bond a solid super tough, micro thin, dry metalloid fusion lubricant to metal surfaces in combustion engines. Will not clog oil ports, filters, no build-up or tolerance changes. Reduces metal wear and heat. Increases HP, mileage and engine life. Why isn't Slick 50 FAA Approved? Bishop's gas additive boost octane rating and helps keep carburetor and fuel injector clean. Plus lubricates tap end and improves mileage a plus.

725-0102	Aircraft Engine Treatment	46.50 qt.
725-0333	Gas Additive	16.95 ea.



GM 100% SYNTHETIC OIL FILTER

For max clean up of engine oil. At 12 microns it can reduce engine wear by 75% compared to regular filters.

61-13454	GM Chevy's	14.50 ea.
----------	------------------	-----------

HULL ACCESSORIES



GRASS RAKES

For the guy who likes to tread where he probably shouldn't, our grass rake is just the ticket. It's extra strong, and the angle of attack is just right to knock down those weeds in front of you.

35-35901	Grass Rake (No Skin)	495.00 ea.
35-35902	Grass Rake (With Skin) (Full Aluminum Face)	695.00 ea.



ICE BOAT HULL OPTIONS

We offer an Ice Boat option for our hulls designed to operate in snow and frozen water. The additions to the hull includes:

- Full Polymer Bottom
- Reinforcement Trip Chimes
- Polymer on Sides 10" High
- Reinforced Transom
- Reinforced Bow Roll
- Heavy Duty Aluminum Bottom

Does not include price of hull.

53-14151	14' x 7' & 15' x 7' Ice Hull Options	3295.00 ea.
53-16181	16' x 8' & 18' x 8' Ice Hull Options	3795.00 ea.



Mounting Bracket

BILGE PUMP

High discharge rate, low amperage draw, water cooled housing to quicken heat dissipation, stainless steel motor shaft, removable power heads for easy cleaning. Quick release base mount, durable and tough, molded ABS resin housing.

35-37000	3700 GPH 1 1/2" Out	149.97 ea.
35-36301	2000 GPH 4 3/8" H 1 1/8" Hose	65.00 ea.
35-36302	Transom Mounting Bracket	38.00 ea.
35-36407	Aluminum Bilge Bracket & Trim	20.00 ea.

BILGE PUMP EVACUATION HOSE

Flexible, corrugated, UV inhibited, weather resistant, will not collapse, holds its shape around curves and bends. This prevents hose kinks and allows maximum bilge pump flow.



35-36304	3/4" Hose	0.95 ft.
35-36303	1 1/8" Hose	1.35 ft.
35-37001	1 1/2" Hose	1.25 ft.
35-36406	3/4" Through Hull Drain	5.95 ea.
35-36305	1 1/8" Through Hull Drain	7.95 ea.
35-37002	1 1/2" Through Hull Drain	7.95 ea.

STAINLESS STEEL BOW EYE

1/2" Polished Stainless Steel U-bolt with backup plates and locking nuts. Looks great and makes loading and unloading from a trailer a snap.

35-36001	Stainless Steel Bow Eye	14.50 ea.
----------	-------------------------	-----------



CHROMALEX BOW LIGHTS

Space age, high compact, plastic plated durable housing, black base, red and green lenses in a non-corrosive 12 volt socket. Bulb included. A must. Coast Guard required.

35-35901	Chromalex Bow Lights	12.50 ea.
----------	----------------------	-----------



DECK LIDS — GREY

Impact resistant, UV inhibited, non-skid tread pattern double hinged. Secure those stowaway items with the perfect weather resistant hatch cover. Grey.

35-36501	Large 13 ¹ / ₂ " x 30"	98.00 ea.
35-36502	Medium 13 ³ / ₈ " x 23"	85.00 ea.
35-36503	Small 13 ³ / ₈ " x 14 ³ / ₈ "	75.00 ea.
35-36512	Ice Chest or Live Well Insert-Med.	39.00 ea.
35-36513	Ice Chest or Live Well Insert-Small	35.00 ea.



FLUSH MOUNT TACKLE BOX

Our flush mount fishing tackle box has pull-out draws that are out of the way when you need your room. Matches our handsome deck lids.

35-36570	Fishing Tacklebox (8" x 12")	NA
----------	------------------------------	----



EASY LOCK TRANSOM DRAIN PLUG

Made of solid brass with silicone impregnated neoprene rubber gasket that is adjustable for easy in and out fit.

35-36101	1" Standard Drain Plug	4.00 ea.
35-36102	1 ¹ / ₄ " Standard Drain Plug	5.90 ea.



HARD-TO-FIND BRASS FITTINGS

30-34158	3/4" to 5/8" Adaptor	4.16 ea.
30-34112	3/4" to 1/2" Bushing	2.68 ea.
30-34112	3/4" to 1/2" Adaptor	2.68 ea.
30-12138	1/2" to 3/8" Adaptor	3.40 ea.
30-03838	3/8" Close Nipple	1.24 ea.
30-12438	3/8" Pipe Flare 45 x 1/2" Hose	6.12 ea.
30-12212	1/2" Tube Fml Flare Swivel x 1/2" Hose	6.12 ea.
30-38938	3/8" Pipe x 3/8" Hose 90° Elbow	6.22 ea.
30-12958	1/2" Pipe x 3/8" Hose 90° Elbow	7.16 ea.
30-12938	1/2" Pipe x 3/8" Hose 90° Elbow	8.19 ea.
30-38912	3/8" Pipe x 1/2" Hose 90° Elbow	8.10 ea.
30-12912	1/2" Pipe x 1/2" Hose 90° Elbow	7.75 ea.
30-14000	1/4" Coupling	2.24 ea.
30-38000	3/8" Coupling	2.56 ea.
30-12000	1/2" Coupling	3.20 ea.
30-14014	1/4" Pipe 1/4" Hose Straight	2.90 ea.
30-14038	1/4" Pipe 3/8" Hose Straight	3.10 ea.
30-38014	3/8" Pipe 1/4" Hose Straight	2.52 ea.
30-38038	3/8" Pipe 3/8" Hose Straight	2.16 ea.
30-38012	3/8" Pipe 1/2" Hose Straight	2.60 ea.
30-12038	1/2" Pipe 3/8" Hose Straight	2.80 ea.
30-12012	1/2" Pipe 1/2" Hose Straight	3.04 ea.
30-12058	1/2" Pipe 5/8" Hose Straight	3.08 ea.
30-00038	Petcock	7.90 ea.
30-03800	Petcock Bushing to 1/2"	1.90 ea.



TRIM TABS

With the flick of a finger you can trim your airboat just like you want it, fast or slow. You can feel the balance of our tested and proven trim plates. No drag means you have the best.

35-01010	Trim Unit Complete (Includes items below)	285.00 ea.
35-01011	Trim Motor Only	190.00 ea.
35-01012	Trim Motor Foot Top	27.95 ea.
35-01021	Trim Motor Foot Bottom	23.95 ea.
35-01013	Trim Motor Pin Top or Bottom	9.55 ea.
35-01014	Stainless Hinge	18.70 ea.
35-01015	Aluminum Trim Plate	58.00 ea.
35-35313	Switch, 2-Way Momentary Marine Switch	11.00 ea.
35-35323	Extension Handle for 2-Way Momentary Switch Joystick	9.50 ea.



DECK LIDS — BLACK

Our deck lids are water tight and come in black for a good color combo. They are one piece with turn latches. The easiest ones we have found to install.

35-36550	Large (10" x 30")	149.00 ea.
35-36560	Medium (16" x 18")	109.00 ea.

GM Powertrain Engine Technology New Vortec Advantage

What is Vortec?

"Vortec" is a brand of GM Powertrain engines that delivers more horsepower and greater fuel efficiency than comparable competitors' engines. The name Vortec originated in the 1986 4.3 V-6 engine that used a combination of "vortex" and "GM technology" to create a vortex inside the combustion chamber. GM Powertrain engineers incorporated this phenomenon into their engine to achieve a better air-to-fuel mixture in the combustion process. The result is what has now developed into Vortec Engines; engines with significantly increased horsepower and improved fuel efficiency. For example, the 1996 Chevrolet Silverado went from 180 hp in the previous model year to 250 hp, while improving fuel economy from 15 mpg to 18 mpg. Unlike typical engines, Vortec Engines deliver both power and efficiency.

Uncompromised Power

GM Vortec Engine are powerful, efficient, durable, low-maintenance engines for people who expect their vehicles, boats, and equipment to perform for years under demanding conditions. By creating the Vortec brand, GM Powertrain is supplying OEMs with another tool to use in selling their application. Customers will recognize the Vortec brand as representing the best in commercial engine technology, a technology with no compromises.

Word Hard — Play Hard

GM is applying the same technology found in its world-class trucks to Vortec marine and industrial engines. This includes improvements in cylinder head design, control systems and sensors, and durability. Whether on the road, water, or job site, OEMs can count on GM Vortec Engines to deliver all the performance needed for as long as it is needed.



STRAIGHT TALK ABOUT ENGINES

Before you rebuild an engine for your airboat, check with us to make sure you are getting your horse powers' worth. Many times we see airboaters start to build an engine they think will have more hose power than our factory motors, only to find out they do not. Our small blocks turn 78Wx50L paddle props and our big blocks turn 78Wx60L paddle props. 78Wx50L and 78Wx60L are real producers. So make sure when you plan an engine you get the results you are looking for. We suggest you talk about the ability of your motor to turn a given size prop, not horse power. That gets to the nitty gritty of where airboat performance really comes from.

Classic can help, so call! To build more horse power and turn more prop than our factory motors, you must spend more money than what an engine would cost from Classic—That's a Fact!

New Vortec GM Engines and Rotator Gear-To-Gear Transfer Give You the Ultimate in Airboat Drive Marinized Technology

Electrical System



Page 59

Pulley System



Pages 56-57

Reduction Units



Page 46

Cooling System



Pages 54-55

Mounting Hardware



Page 47

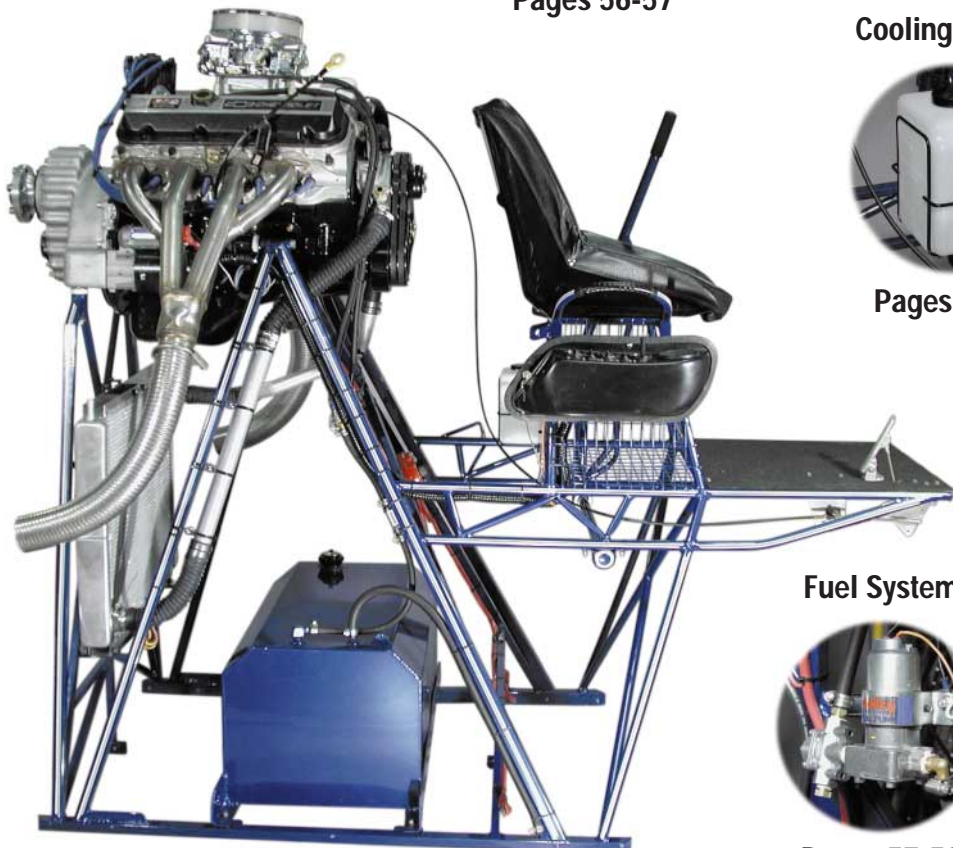

Fuel System



Pages 57-58

GM POWERTRAIN—BIG BLOCKS

New GM Vortec Engines Marinized for Airboats

Working hard to increase boating pleasure

For more than 40 years, GM has been a leader in marine engines. Its first official entry into the marine market was in 1958 with a 284-cid, 185-hp Chevrolet engine. In 1960, a group was formed within GM to fully support marine original equipment manufacturers (OEMs). Today, GM Powertrain supplies a wide array of engines to several OEMs.

The marine environment puts special demands on an engine, so GM Powertrain has focused on the marine market segment. Corrosion-resistant alloys, engine oil sealing systems, marine-specific camshaft designs, a cooling system that works with both salt and fresh water are only a few of the GM-powered features that have benefited marine OEMs for many years.

All GM Powertrain engine plants meet or exceed QS 9000 quality process standards. In addition, a GM-powered marine engine customer can take added comfort in knowing that all components are backed by the GM Service Parts Organization.

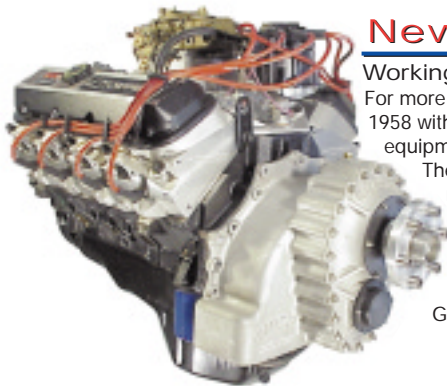

GM 8.1L VORTEC 8100 EFI Complete Turn-Key ENGINE

70-60997 502HP Chevy 8.1L Vortec 8100
with Marinized Rotator Gear-to-Gear.....\$ CALL
60-60997 502HP Chevy 8.1L Vortec 8100
Replacement Engine\$ CALL



CHEVY 502 THUMPER MOTOR HIGH PERFORMANCE WITH CAST HEADS

70-02620 450HP Chevy 502 Thumper
with Marinized Rotator Gear-to-Gear...CALLea.
60-02620 450HP Chevy 502 Thumper
Replacement Engine.....CALLea.



ZZ 572 620 HP DELUXE & BASE

61-98793 ZZ 572/620 HP Deluxe CALLea.
70-98793 ZZ 572/620 HP Deluxe W/Rotator CALLea.
61-98792 ZZ 572/620 HP Base CALLea.
70-98792 ZZ 572/620 HP Base W/Rotator CALLea.



CHEVY 454 MUSCLE MOTOR HIGH PERFORMANCE WITH CAST HEADS

70-02618 425HP Chevy 454 Muscle with
Marinized Rotator Gear-to-GearCALLea.
60-02618 425HP Chevy 454 Muscle
Replacement Engine.....CALLea.



CHEVY 502/502 HIGH PERFORMANCE RAT MOTORS WITH VORTEC ALUMINUM HEADS

70-71171 502HP Chevy 502/502 Rat Engine
Premium Kit Unassembled with Marinized
Rotator Gear-to-GearCALL ea.
70-96962 502HP Chevy 502/502 Rat Engine
Premium Kit Assembled with Marinized
Rotator Gear-to-GearCALLea.
60-71171 502HP Chevy 502/502 Rat Replacement Engine
Premium Kit UnassembledCALLea..
60-96962 502HP Chevy 502/502 Rat Replacement Engine
Premium Kit AssembledCALLea..
70-71204 502HP Chevy 502/502 Rat Engine
Base Kit Unassembled with Marinized
Rotator Gear-to-GearCALLea..
(excludes intake manifold, intake gaskets, and intake bolts kit)
70-96963 502HP Chevy 502/502 Rat Engine
Base Kit Assembled with Marinized
Rotator Gear-to-GearCALLea..
(excludes intake manifold, intake gaskets, and intake bolts kit)
60-71204 502HP Chevy 502/502 Rat Replacement Engine
Base Kit Unassembled.....CALLea..
(excludes intake manifold, intake gaskets, and intake bolts kit)
60-96963 502HP Chevy 502/502 Rat Replacement Engine
Base Kit AssembledCALLea..
(excludes intake manifold, intake gaskets, and intake bolts kit)
70-97323 510HP Chevy 502 Fuel Injected Ram Jet
with Marinized Rotator Gear-to-Gear.CALLea..
60-97323 510HP Chevy 502 Fuel Injected Ram Jet
Replacement EngineCALLea..

Marinize your New Chevy Engine with a Rotator Gear-to-Gear Reduction Unit (page 46.)

Other Marinizing optional parts and accessories for your GM Engines are found on pages 54-59.

A combination of technology and unique parts makes our Airboat Auto Applications a proven success!



CHEVY ZZ 383 425 HP STROKER MOTOR WITH VORTEC ALUMINUM HEADS

- 70-98772 425HP Chevy 383 CID V-Aluminum Stroker with Marinized Rotator Gear-to-GearCALLea.
 60-98772 425HP Chevy 383 CID V-Aluminum Stroker Replacement Engine (No Manifold).....CALLea.



ROTATOR GEAR-TO-GEAR—HEAVY DUTY REDUCTION UNIT

- 61-21200 Gear-to-Gear Rotator, 2.12:1 Ratio.....2649.00 ea.
 61-23700 Gear-to-Gear Rotator, 2.37:1 Ratio.....2749.00 ea.
 61-26800 Gear-to-Gear Rotator, 2.68:1 Ratio.....2849.00 ea.
 61-32600 Gear-to-Gear Rotator, 3.26:1 Ratio.....2749.00 ea.



CHEVY 350 CORVETTE Z24 WITH ALUMINUM HEADS

- 70-02609 355HP Chevy 350 Z24 with Marinized Rotator Gear-to-GearCALLea.
 60-02609 355HP Chevy 350 Z24 Replacement EngineCALLea..



GM VORTEC 6000 LY6 EFI MARINE ENGINE WITH VORTEC HEADS (Complete & Pre Run)

- 70-80623 380 HP LY6 EFI Marine Engine with Marinized Rotator Gear-to-Gear...CALL ea.
 60-80623 380 HP LY6 EFI Marine Engine Replacement Engine.....CALL ea.



CHEVY 350 HO DELUXE 330 H.P. WITH VORTEC CAST HEADS

- 70-96968 330HP Chevy 350 HO Deluxe with Marinized Rotator Gear-to-Gear ...v.
 60-96968 330HP Chevy 350 HO Deluxe with Vortec Cast Heads Replacement EngineCALLea.

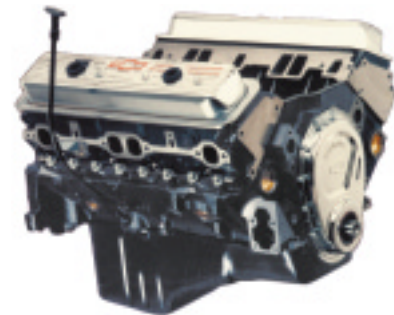

CHEVY 350 HO 330 H.P. WITH VORTEC HEADS

- 70-46041 330HP Chevy 350 HO Base with Marinized Rotator Gear-to-Gear...CALLea.
 (excludes intake manifold, intake gaskets, and intake bolts kit)
 60-46041 330HP Chevy 350 HO Base Replacement Engine.....CALLea.
 (excludes intake manifold, intake gaskets, and intake bolts kit)



CHEVY 350 FAST BURN 385 H.P. WITH VORTEC ALUMINUM HEADS

- 70-96769 385HP Chevy 350 with Marinized Rotator Gear-to-Gear....CALLea.
 60-96769 385HP Chevy 350 Replacement Engine.....CALLea.



CHEVY 350 290 HP "Preformer" WITH CAST HEADS

- 70-99529 290HP Chevy 350 "PREFORMER" Steel Heads with Marinized Rotator Gear-to-Gear ...CALLea.
 (excludes intake manifold, intake gaskets, and intake bolts kit)
 60-99529 290HP Chevy 350 "PREFORMER" Steel Heads Replacement Engine.....CALLea.
 (excludes intake manifold, intake gaskets, and intake bolts kit)

Some pictures may differ from final release package.
 GM engine and engine parts prices effective as of
 04/01/08 and are subject to change without notice.

REDUCTION UNITS & DRIVES

THE ROTATOR GEAR-TO-GEAR AND GM BRING NEW DREAMS

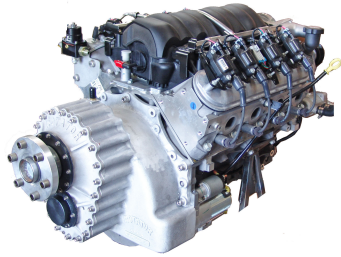

The Rotator Gear-to-Gear has turned the corner and Classic Airboats is proud to be a distributor of the Rotator Gear-to-Gear products. After 10 years of proven development, we now have a great addition to the technological development and evolution of the airboat. The Rotator Gear-to-Gear brings the auto engine to maturity and puts its economy, power and toughness within reach of every airboater. We invite you to the factory to see for yourself that everyone who loves airboats has new and exciting choices.

**The Rotator Gear-to-Gear 2" Gears , Quieter & Rated to 1000 HP
NOW AVAILABLE: NEW 1.70:1 RATIO**



▲ ROTATOR GEAR-TO-GEAR—HEAVY DUTY REDUCTION UNIT

61-21200	Gear-to-Gear Rotator, 1.70:1 Ratio	2649.00 ea.	61-26800	Gear-to-Gear Rotator, 2.68:1 Ratio	2849.00 ea.
61-23700	Gear-to-Gear Rotator, 2.12:1 Ratio	2649.00 ea.	61-32600	Gear-to-Gear Rotator, 3.26:1 Ratio	2649.00 ea.
61-17000	Gear-to-Gear Rotator, 2.37:1 Ratio	2749.00.00 ea.			

▲ BELT DRIVE REDUCTION UNIT

61-62103	CH-3 Drive Unit, 2:1 Ratio, with 1280-80-127 HPPD Plus Belt	2,950.00 Delivered ea.
61-62133	CH-3 Drive Unit 2.3:1 Ratio, with 1256-8M-127 Blackhawk Belt	3,025.00 Delivered ea.

BELT DRIVE REPAIR KITS

63-00535	Lower Assembly, CH2 or CH3	730.00 ea.
63-00357	Lower Pulley, CH2 or CH3	468.00 ea.
63-00023	Lower Assembly Pulley Fence	32.00 ea.
63-00112	Lower Shaft, CH2 or CH3	170.00 ea.
63-00087	Lower Bearing MFC24 or MFC24TC	136.00 ea.
63-20060	Upper Bearing, ER35 for CH2	99.00 ea.
63-30068	Upper Bearing, ER39 for CH3	125.00 ea.
63-00021	Flex Plate Hardware Only	25.00 ea.
63-00067	Standard Large Flex Plate & Hardware	105.00 ea.
63-00072	Generation 5 Flex Plate & Hardware	108.00 ea.
63-00050	Flex Plate and Bell Housing Hardware Package	50.00 ea.
63-00167	Propeller Hub, CH2-CH3 Upper Unit	230.00 ea.
63-24150	Belt 4", CH2 HPPD	225.00 ea.
63-24184	Belt 4", PolyChain	480.00 ea.
63-35173	Belt 5", CH3 HPPD	268.00 ea.
63-35273	Belt 5", CH3 Blackhawk	320.00 ea.
63-50704	COG Belt 4" 5 07XH400	245.00 ea.
63-50705	COG Belt 5" 5 07XH500	385.00 ea.
63-63005	COG Belt 5" 6 30XH500	442.00 ea.



MOTOR MOUNTS & HARDWARE



Complete Kit (Aluminum)

FRONT MOTOR MOUNTS AND KITS

Tried and proven motor mounts that withstand the rigors of airboat use. They are exceptionally easy to install—just bolt on and go. With safety and weight as a priority our motor mounts are designed and engineered for airboat thrust dynamics. These aluminum front motor mounts are light weight, a perfect combination with your aluminumized Chevy Marineized Engine—Chevy's only.

61-61010	Aluminum Front Motor Mount, (Currently not available).....	NA
61-61020	Aluminum Front Motor Mount Kit (Currently not available).....	NA
	All Chevy Small Block, Big Block, and V-6	
61-61101	Front Motor Mount, All Chevy Small Block, Big Block, and V-6 (2)	125.00 pr.
61-61120	Front Motor Kit (Includes Mounts, Bushings, & Hardware), All Chevy Small Block, Big Block, and V-6	148.50 kit
61-61107	Front Motor Mount, Buick 455 (2) (not shown)	125.00 pr.
61-61110	Front Motor Mount, Cadillac 472 and 500 CID (2) (not shown)	145.00 pr.



FRONT MOTOR MOUNT BUSHINGS AND HARDWARE

61-61301	Front Rubber Cone Bushing (4) & Special Mounting Washers (4)	19.00 set
61-61401	Front Mounting Hardware: 1/2" x 7" Bolts (2), 1/2" Washers (2), 1/2" Lock Nuts (2), All GM Powertrain Engines	9.00 set
61-62340	Front Rubber Cones Bushings & Mounting Hardware Complete (all pictured)	28.00 kit

DO-IT-YOURSELF COMPONENTS FOR FRONT & REAR MOTOR MOUNTS



61-66209	Rubber Cone Bushing, Black (A)	4.00 ea.
61-20966	Polymer Cone Bushing, White (B)	6.25 ea.
35-36602	Motor Mount Steel Cone Bushing, 2" L x 1 1/8" O.D. x 3/4" I.D. (weld to motor mount) (C)	12.75 ea.
35-36603	Engine Stand Thick Wall Tubing Mount, 3" L x 1" O.D. x 1/2" I.D. (weld to engine stand) (D)	5.50 ea.
80-12750	Bolt, 1/2" x 7", All Front Mounts (E)	2.20 ea.
61-01200	Special Mounting Washer, Extra Thick, 1/2" (F).....	.90 ea.
81-12000	Lock Nut, 1/2" (G).....	.40 ea.
80-12500	Bolt, 1/2" x 5", Rotator Rear Bolt Mounting.....	2.10 ea.
80-12950	Bolt, 1/2" x 9/16", Belt Drive Rear Bolt Mounting.....	2.90 ea.
80-00012	Lock Washer, 1/2" (H).....	.25 ea.
80-12000	Flat Washer, 1/2", (I).....	.20 ea.
35-36630	Motor Mount Steel Cone Bushing, 3" L (not shown, same as C)	18.50 ea.
35-36036	Engine Stand to Motor Mount Do-it-Yourself Kit: (D not included)	56.80 set
	Steel Mounts (2 ea. C), Rubber Bushings (4 ea. B), Mounting Washers (4 ea. F), Flat Washer (2 ea. I), Bolt (2 ea. E), Locknut (2 ea. G), Lockerwasher (2 ea. H)	

ROTATOR GEAR-TO-GEAR REAR MOUNTING HARDWARE & ACCESSORIES

61-61033	Rotator Rear Bushings (4) and Special Mounting Washers (4)	19.00 set
61-61401	Rotator Rear Hardware Kit: 1/2" x 5" Bolts (2), 1/2" Lock Nuts (2), 1/2" Special Flatwashers (4)	8.00 kit
61-40133	Rotator Rear Bushing and Hardware Kit Complete	23.00 kit
61-61402	Rotator Poly Damper Plate, Aluminum	185.00 ea.
61-61403	Rotator Bell Housing Allen Head Bolt45 ea.
61-58125	Rotator Flexplate Mounting Kit with Spacer, Special Flange Bolts & Nuts Set (6) 7.90 kit	
61-38125	Rotator Bell Housing Mounting Kit with Allen Head Bolt, Nuts & Lockwashers (10)	3.90 kit



BELT DRIVE REAR MOTOR MOUNTING HARDWARE AND BUSHINGS

Rear mount rubber bushings include special cap washers (extra thick) and rubber bushings with steel insert for no shift alignment and stability.

61-61303	Belt Drive Rear Bushings (4) with Heavy Duty Special Cup Washer (4) for No Shift Stability.....	58.00 kit
61-61403	Belt Drive Rear Mounting Hardware: 1/2" x 9/16" Bolts (2), 1/2" Lock Nuts (2), 1/2" Flat Washers (2)	2.00 kit
61-40030	Belt Drive Bushing & Hardware Kit Complete	60.00 kit



DIRECT DRIVE REAR MOTOR MOUNTS

Chevrolet, Buick and Cadillac direct drive applications.

61-61113	Direct Drive Rear Mounts, Chevy Small Block, Big Block	125.00 ea.
61-61115	Direct Drive Rear Mounts, Cadillac and Buick	125.00 ea.

DIRECT DRIVE REAR MOUNTS, BUSHINGS, & HARDWARE

61-61301	Rear Rubber Cone Bushing (4) & Special Mounting Washers (4)	22.00 set
61-61401	Rear Mounting Hardware: 1/2" x 7" Bolts (2), 1/2" Special Washers (2), 1/2" Lock Nuts (2), All GM Powertrain Engines	6.00 set
61-62340	Rear Mount Rubber Cones Bushings & Mounting Hardware.....	24.00 set



ROTATOR AND K-OIL FOR PURRPOWER

Protect your gear-to-gear reduction unit with our highest quality selected gear oil available. We know for sure that some gear oils are better than others and we some don't work at all. We have not tested all the oils out there in the market place, but we do know one thing for sure, our high quality oil works. Do not substitute other gear oils—use only factory recommended products to maintain warranty.

61-02120	Rotator Oil	14.95 qt.
61-02543	K-Way Oil	14.95 qt.

RADIATORS & ACCESSORIES



ALUMINUM RADIATOR FOR AIRBOATS

Designed special for airboats. Airboats require maximum cooling. This is a proven, efficient system we designed and developed of 20 years ago.

- 61-31019 NASCAR All-Aluminum Radiator, 31" W x 19" H285.00 ea.
 61-31024 NASCAR All-Aluminum Radiator, Heavy Duty, Large, 31" W x 24" H485.00 ea.

RADIATOR COMPONENTS

- 61-36789 Radiator Mounting Instruction Computer Drawing5.00 ea.



ALUMINUM RACING RADIATOR

Light weight for fast airboats.

- 61-28012 Racing RadiatorCALL



RADIATOR MOUNTING KIT

Airboat radiators must be "soft" mounted. We do this by floating the radiator in a special rubber mounting system that lets the engine stand "work" without twisting the radiator.

- 61-36705 Radiator Mounting Kit.....38.00 kit



RADIATOR HOSES—SEAMLESS, NO JOINTS

It takes approximately 6' of radiator hose to complete the "in" and "out" installation.

- 61-36701 1-Piece Radiator Hose from Engine to Radiator, 1 1/2"4.75 ft.
 61-36702 1-Piece Radiator Hose from Engine to Radiator, 1 3/4"4.95 ft.



RADIATOR & EXPANSION TANK CLAMPS

We recommend our double clamp system whenever there is enough room for two hose clamps.

- 35-29028 Radiator Double Hose Clamp Kit—#24 (8) and #28 (8) Clamps.....16.00 set
 35-06004 Expansion Tank & Overflow Double Hose Clamp Kit
 —#6 (8) and #4 (4) Clamps 1"7.75 set
 35-00024 Radiator Hose Clamps #24 1 1/2"1.00 ea.
 35-00028 Radiator Hose Clamps #28 1 3/4"1.00 ea.
 35-00006 Expansion Tank Tank Hose Clamps #6 (8) 3/8" Hose1.36 set
 35-00012 Expansion Tank to Overflow Tank Hose Clamps #4 (4) 1/2" Hose1.10 set
 35-00060 Expansion Tank Hose Clamp #6 5/8"ç.80 ea.
 35-00004 Expansion Tank to Overflow Tank Hose Clamp #4 1/4"ç.70 ea.



RADIATOR ALUMINUM TUBE SYSTEM

A combination of flexible rubber radiator hoses used as connector to aluminum radiator tubing for water passage to and from engine and radiator.

61-25808	Out 90° Flex Hose 1½" x 1½" x 25" (A)	34.80 ea.
61-26611	In Straight 1½" x 1½" x 19" (B)	24.90 ea.
61-36501	In Flex Hose 1¾" x 13" (C)	20.50 ea.
61-25474	Out 1½" x 12" (D)	16.50 ea.
Tubes:		
61-12112	Top Aluminum Tube 1½"	31.50 ea.
61-20134	Bottom Aluminum Tube 1¾"	32.50 ea.
61-31119	Carbureted Tube System Complete	165.00 set
61-31110	LS Tube System Complete	225.00 Set
35-29028	Radiator Double Hose Clamp—#24 (8) and #28 (8) Clamps	16.00 set

OVERFLOW RECOVERY TANK

This overflow bottle collects coolant overflow caused by hot engines and returns it when the engine cools. The cooling system always remains full so the engine is always performing at maximum efficiency.

61-61703	Overflow Recovery Tank	18.50 ea.
61-36704	Overflow Recovery Tank Hose	ç. 60 ft.
35-00012	Expansion Tank to Overflow Tank Hose Clamps #4 (4) ½" Hose	3.00 set



ALUMINUM EXPANSION TANK

The life of your engine is the cooling system and that's why we developed the best cooling system around, designed 20 years ago to keep your engine running cool. We got it right a long time ago, so why change? Don't experiment, go with proven technology that works.

61-61702	Aluminum Expansion Tank	85.00 ea.
35-36702	Expansion Tank Overflow Hose ¾" x 8'	6.00 ea.
61-36703	Expansion Tank Hose, ¾"	1.20 ft.
35-36706	Expansion Tank Hose ¾" x 15'	16.00 ea.
30-12058	Expansion Tank Hose Brass ½" x ¾"	4.80 set
61-61701	Expansion Tank Cap	7.50 ea.

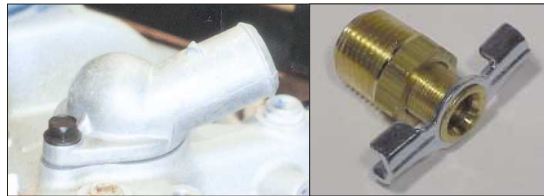

COOLING SYSTEM GOOSENECK & PETCOCK ANTI-AIR LOCK

Cooling system gooseneck for Chevy engines. Essential for proper alignment of upper radiator hose to lower radiator mount.

61-77660	Gooseneck No Pet Hole	19.50 ea.
61-88753	Gooseneck with Pet Hole	23.95 ea.
30-46087	Petcock for Intake Bleed Off	5.90 ea.
30-28117	Petcock Bushing for Oversize Fit	1.90 ea.
61-77661	Gooseneck Gasket	3.00 ea.

THERMOSTATS

We recommend a 160° thermostat for cold weather climates. In warm southern climates we use a restrictor plate. Our recommendation is to keep your engine water no less than 150° and no more than 175°.

61-30100	Hot Weather Restrictor Plate (A)	7.50 ea.
61-30106	Marine Thermostat, 160°, Specially Modified for Airboats (B)	8.50 ea.
61-05135	Thermostat Gasket	1.70 ea.

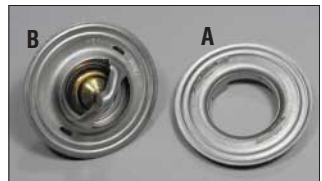

PULLEY SYSTEM & ACCESSORIES



DOUBLE BELT TOP PULLEYS

Hard to find double belt pulleys for a clean, compact installation.

61-03159	Pulley Double Belt For Small Block with Short Leg Aluminum Waterpump, 8-hole Flange, Large Centering Hole	67.00 ea.
61-05641	Pulley Double Belt for Small Block with Cast Iron Water Pump, Small Centering Hole.....	67.00 ea.
61-94650	Belts, Duel, Big Block.....	30.00 ea.
61-94510	Belts, Duel, Small Block	30.00 ea.



DOUBLE BELT BOTTOM PULLEYS

Our bottom pulleys are specially selected to give your installation the right ratio so your water pump doesn't turn too fast or too slow.

61-58533	Bottom Pulley, Small Block	44.50 ea.
61-21923	Bottom Pulley, Big Block	44.50 ea.



HARMONIC BALANCE BOLT & WASHER

61-40024	Harmonic Balance Bolt, Small Block	2.75 ea.
61-01829	Harmonic Balance Washer, Small Block.....	2.88 ea.
61-19218	Harmonic Balance Bolt, Big Block.....	3.00 ea.
61-64814	Harmonic Balance Washer, Big Block	2.88 ea.

HARMONIC BALANCER TIMING TAPE

61-01591	Timing Tape	8.25 ea.
----------	-------------------	----------



ALTERNATOR & WATER PUMP MOUNTING SYSTEM FOR CHEVYS

DUAL BELTS = DOUBLE PROTECTION FOR YOUR ENGINE

Complete system includes: top and bottom water pump pulleys, alternator bracket, slide arm and double belts (alternator, alternator pulley, and water pump NOT INCLUDED). We sell this as a complete system because each component from the pulleys to the mounting brackets are matched so that your marine alternator and water pump belts will track true for long life and dependable service. The double belt feature gives you another margin of safety and durability. Use short neck water pump.

61-23159	Small Block, Complete Alternator & Water Pump Pulley System with Duel Belts for Aluminum Water Pump	169.00 ea.
61-95641	Small Block, Complete Alternator & Water Pump Pulley System with..... Duel Belts for Cast Water Pump	169.00 ea.
61-21923	Big Block, Complete Alternator & Water Pump Pulley System with	169.00 ea.
61-58157	Big Block, Complete Alternator & Water Pump Pulley System with	169.00 ea.
61-62702	Marine Alternator w/Arrestor and Bush Guard & Double Pulley	149.00 ea.
61-62703	Pulley Double Belt For Alternator—Pulley Only.....	21.50 ea.
61-94650	Belts, Duel, Big Block	30.00 ea.
61-94510	Belts, Duel, Small Block	30.00 ea.
61-62704	Alternator Nut and Bolt Kit	2.98 kit

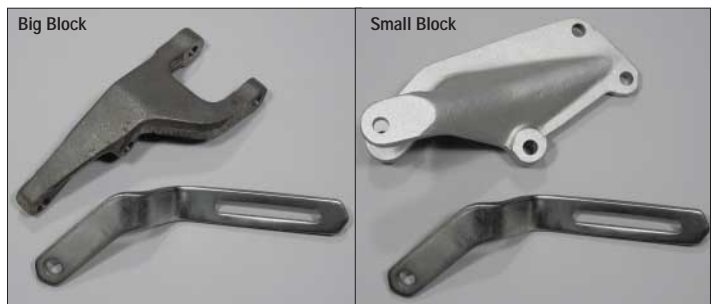

ALTERNATOR BRACKET & SLIDE ARM

Our alternator bracket and slide arm are the key to our alternator and water pump mounting system. They are a one of a kind, specially made for airboat-marine use. It is a clean, compact, double protection system for a great look.

61-90075	Alternator Bracket, Aluminum, Small Block	37.00 ea.
61-90087	Alternator Bracket, Big Block	37.00 ea.
61-99009	Slide Arm, Small Block & Big Block.....	24.41 ea.

FLEX PLATES FOR NEW GM ENGINES

Our new GM Engines are externally balanced. Make sure you get the right flex plate with the proper external weight.

61-88765	Small Block, 12 $\frac{3}{4}$ " External Balance, New Gen. Engines	49.00 ea.
61-85035	Big Block High Performance, 14" Ext. Balance Forged Crank..	89.00 ea.
61-01992	Big Block, 14" External Balance Cast Crank	69.00 ea.
61-39756	Flex Plate Bolts, Big Block.....	\$.88 ea.
61-27207	Flex Plate Bolts, Small Block.....	\$.84 ea.



PULLEY SYSTEM & ACCESSORIES

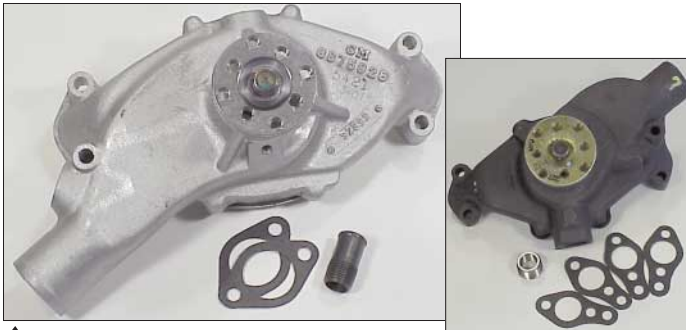

HEAVY DUTY-SHORT LEG ALUMINUM & CAST WATER PUMPS

All water pumps look the same, but they aren't. Our heavy duty, short neck water pump is designed to sustain high RPM's and the rigors of marine use. It's lightweight, adds cooling capacity and is affordable.

SMALL BLOCK WATER PUMPS

61-62708	Chevy Small Block Water Pump, Aluminum, Short Neck	120.35 ea.
61-58137	Chevy Small Block Water Pump, Cast Iron, Short Neck	59.00 ea.
61-03159	Double Belt Pulley for Short Leg Aluminum Water Pump—8 hole Flange	29.96 ea.

61-14601	Water Pump Nut and Bolt Kit	2.45 kit
----------	-----------------------------------	----------

BIG BLOCK WATER PUMPS

61-45452	Chevy Big Block Water Pump, Cast Iron, Short Neck	111.25 ea.
61-58915	Chevy Big Block Water Pump, Aluminum, Short Neck	157.00 ea.

Sometimes it takes our shim kit to make your water pump pulley's align and fit.

61-06129	Pulley Shim Kit Chevy 350, 454, V6	9.75 ea.
61-30106	Marine Thermostat, 160°, Specially Modified for Airboats	6.75 ea.
30-46087	Petcock, Airlock Vent	5.80 ea.
30-28117	Petcock Bushing	2.50 ea.
61-30060	Waterpump Gasket, Big Block	5.00 pr.
61-05152	Waterpump Gasket, Small Block	5.00 pr.

HOLLEY HIGH PERFORMANCE ELECTRIC FUEL PUMP

Designed for the airboater who wants to modify his auto application for maximum performance. 12 volt electrical high pressure, 14 psi, 110 GPH. Includes universal regulator.

61-62406	Holley Fuel Pump, Blue	187.00 ea.
61-62407	Holley Fuel Pump, Red	NA ea.
61-06901	Fuel Pump Nut and Bolt Kit	1.10 kit
30-14938	Fuel Pump Brass Kit	5.80 kit
61-00006	Fuel Pump & Fuel Filter Hose Clamp Kit (Fuel Tank to Carb) #6 (7)	4.50 kit

HOLLY HIGH VOLUME MANUAL FUEL PUMP—DELUXE PERFORMER

Use on all Chevy small block V-8's. Comes with 7 psi shut off pressure with a free flow rate of 110 GPH.

61-55612	Manuel Pump	59.50 ea.
61-06901	Fuel Pump Nut & Bolt Kit	2.10 kit
30-14938	Fuel Pump Brass Kit	7.80 kit
61-00006	Fuel Pump & Filter Hose Clamp Kit	6.50 kit



Rear View



SINGLE & DOUBLE PULLEY ALTERNATOR

Our alternator system is designed for ease of installation and safety. It's a one pole design with spark arrestor. The single pole eliminates "hot" wires running all over your airboat. As just one hot wire goes from the alternator directly to the battery.

61-62702	Double Pulley Alternator	149.00 ea.
61-62703	Double Belt Pulley for Alternator—Pulley Only	21.50 ea.
61-62704	Alternator Nut and Bolt Kit	3.75 kit

FUEL SYSTEM & ACCESSORIES

Prices on Carburetors Change Constantly, Please Call for the Latest Pricing

HOLLEY CARBURETORS ▶

Each and every marinized airboat that is manufactured in our factory leaves with a double pumper carburetor and carb spacer (except direct drive.)

61-44120	Holly 500 2BBL	460.00 ea.
61-47770	Holly 650 DBL Pumper	441.00 ea.
61-47790	Holly 750 DBL Pumper	583.00 ea.
61-47810	Holly 850 DBL Pumper	633.00 ea.
61-44000	Holly Gasket	4.00 ea.
61-85506	Holly 740 Vacuum Secondary	NA ea.

PCV VALVE & CRANK VENT ▶

35-48779	PCV Valve	3.80 ea.
35-35308	Crank Case Vent	1.90 ea.



◀ OIL FILTER ADAPTER & DIPSTICKS

61-52301	Oil Filter Adapter	12.50 ea.
61-13454	GM Synthetic Oil Filter	14.50 ea.
61-18765	Big Block Dipstick	10.50 ea.
61-51417	Big Block Dipstick Tube	12.75 ea.
61-77153	Small Block Dipstick	10.25 ea.
61-55724	Small Block Dipstick Tube	12.50 ea.



FUEL SYSTEM & COMPONENTS



HOLLEY CARBURETOR SPACERS

A must for our high performance airboat engines. Get better air and fuel mixture with this simple addition to your carburetor installation.

61-01932	Spacer B 4BBL (open hole)24.50 ea.
61-02087	4BBL to 2BBL36.00 ea.
61-02135	2BBL54.00 ea.
61-19320	Spacer Holly to Quad Manifold54.00 ea.



DUAL FUEL LINE

61-61506	Dual Fuel Line24.50 ea.
----------	----------------	----------------



THROTTLE SPRINGS

61-61541	Throttle Springs, Stainless Steel3.75 ea.
----------	-----------------------------------	---------------



FUEL FILTER & FUEL LINES

Sometimes insurance is cheap—this keeps your fuel clean and you can see what's going on.

35-36220	Fuel Filter5.80 ea.
35-36224	C.G. Approved 3/8" ID Type A1.30 ft.
56-50008	C.G. Approved 1/4" ID Type A1.10 ft.

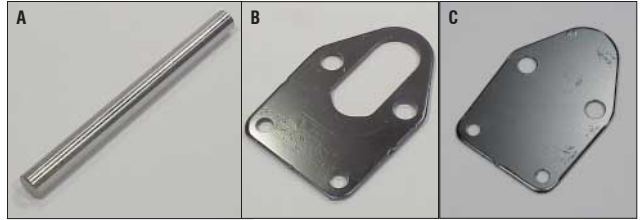

FUEL PUMP ROD, FUEL PUMP MOUNTING & BLOCK OFF PLATE

61-04817	Fuel Pump Rod (A)8.75 ea.
61-19599	Fuel Pump Mounting Plate (B)6.74 ea.
61-94069	Fuel Pump Block Off Plate (C)4.20 ea.
61-08438	Fuel Pump Gasket1.20 ea.

GM-AC ELECTRIC FUEL PUMP

High vol heavy duty pump with vibration resistant mounting system. Ideal to feed our high performance Chevy 350's, 454's and 502's. PSI limits are 6-8 with 72 GPH. Use as primary pump or a back up. Very dependable 12 volt rotary motor—long life. Do not lean out your motor with too small a fuel pump.

61-15899	Electric Fuel Pump122.00 ea.
----------	--------------------	-----------------



GM-AC MANUAL FUEL PUMP

High volume low pressure (5 to 7 psi ±) manual fuel pump necessary on reduction unit applications. Use with high output Chevy small block motors—rated @ 70 GPH. Do not lean out your motor with too small a fuel pump.

61-15323	Fuel Pump59.25 ea.
61-06901	Fuel Pump Nut and Bolt Kit2.10 kit
30-14938	Fuel Pump Brass Kit7.80 kit
61-00006	Fuel Pump & Fuel Filter Clamp Kit6.50 kit



AUTOMOTIVE AIR CLEANER

9" Cleaner with replacement element. Can be used with plastic rain cover #90.

61-61526	9" Air Cleaner, Complete with Filter26.00 ea.
61-61527	Fiberglass Darth Vader Carburetor & Engine Cover129.00 ea.

CARBURETOR RAIN COVER

Automotive carburetor rain cover, essential for protection from foul weather and rain.

61-61528	Carburetor Rain Cover with Washer4.75 ea.
----------	-----------------------------------	---------------



FLAME AND SPARK ARRESTORS FOR YOUR CARBURETORS

Made of lightweight aluminum and they fit right inside our air cleaner, filter, rain hat combo. Be safe. It's better than a ticket.

61-72001	Holley42.50 ea.
61-72010	Quadjet42.50 ea.

ELECTRICAL SYSTEM & COMPONENTS

GM STARTER AND ALTERNATOR



- 61-62501 Starter Long & Short Bolt Rebuild, Small Blocks, 12³/₄" Flex.....139.00 ea.
- 61-62515 Starter Long Bolt, Big Blocks, 14" Flex.....139.00 ea.
- 61-62702 Marine Alternator w/Spark Guard and Double Pulley.....149.00 ea.



FLYWEIGHT STARTER 10 LBS.

Add performance to your airboat. Our quality hamburger starters are for the special airboater that know by reducing weight you gain overall performance. Saves up to 15lbs of weight. Flyweight starter fits all Chevy small blocks and big blocks plus other GM motors.

- 61-61146 Flyweight High Torque Mini Starter.....220.00 ea.
- 61-55702 Flyweight Gear Starter249.00 ea.

STARTER BOLTS SHORT & LONG

Our starter bolts are not just any old bolt, they're specially tapered to squeeze fit the starter into place and hold it there for clean starts every time.

- 61-97278 Starter Bolt Short.....4.80 ea.
- 61-87873 Starter Bolt Long.....5.20 ea.



- 61-91544 HEI Electric Distributor Lock Down Bolt.....1.90 ea.



DISTRIBUTOR LOCK DOWN

- 61-96197 HEI Electric Dist. Lock Down.....3.80 ea.

DISTRIBUTOR LOCK DOWN BOLT



HEI ELECTRONIC DISTRIBUTOR

The GM HEI Electronic Distributor is simply the best you can buy for the money. Over the years we have experimented with several ignition systems and when we found the HEI, the experiment was over. That was 10 years ago and we never looked back.

- 61-03436 HEI Distributor.....265.00 ea.

CUSTOM FIT SPARK PLUG WIRES COPPER SOLID

Our spark plug wires are designed for airboats and custom made to our specifications. No more burned wires from exhaust pipes because our extra length lets you run your spark wires under your exhaust header system for an out the way clean look.



- 61-35088 Custom Fit Spark Plug Wires Copper Solid, Small Block.....39.00 set
- 61-45488 Custom Fit Spark Plug Wires Copper Solid, Big Block39.00 set



AC DELCO SPARK PLUGS

Be careful with the heat range on your airboat marine engines. We use AC Delco factory plugs for long life and dependability. Call and let us help you with your spark plug selection.

- 61-14210 MR43LTS Marine Plug for Aluminum Heads2.40 ea.
- 61-14169 MR42LTS Marine Plug for Aluminum Heads2.40 ea.
- 61-13796 FR3LS Plug for Aluminum Heads1.90 ea.
- 61-14167 FR2LS Plug for Aluminum Heads1.90 ea.
- 61-13438 MR43T Marine Plug for Steel Heads2.40 ea.
- 61-13438 FR43T Plug for Steel Heads.....1.90 ea.
- 61-64642 R43XLS Rapid Fire for 502/502 Aluminum Heads3.90 ea.



LYCOMING 4 CYLINDER ENGINE FRONT MOTOR MOUNT BUSHINGS AND HARDWARE

66-66210	Rubber Bushing Set (as pictured).....	31.60 set
66-66211	Mounting Hardware (1 Bolt, 1 Washer, 1 Lock Nut).....	1.00 ea.
61-66209	Rubber Bushings	4.00 ea.
61-20966	Polymer Cone Bushings, White	6.25 ea.



LYCOMING 0540 ALUMINUM REPLACEMENT EARS

Aircraft ears like elephant ears are not pretty, but they are necessary. The style ear hole manufactured by Classic allows us to offer you a less expensive but as effective method of securing your engine to the engine stand and isolating engine vibration.

66-66340	Replacement Ears, Set of 4.....	NA
66-66203	Replacement Ear	NA
66-66206	6 Cylinder Bushings Kit with Special Washers, Nuts and Bolts for SMALL Ear	98.00 set



OVERHAUL MANUAL FOR AIRCRAFT ENGINES

Don't get caught short with the knowledge it takes to do a complete and thorough engine overhaul. This is a must for all professional and amateur mechanics.

60-64204	Lycoming Overhaul Manual.....	88.00 ea.
60-64205	Continental Overhaul Manual	86.00 ea.
60-64206	GPU Continental Overhaul Manual	86.00 ea.



LYCOMING 0540 6 CYLINDER FRONT MOTOR MOUNT BUSHINGS

This bushing kit secures the engine to the aluminum replacement ears. Aircraft mounting hardware does work, but it's very expensive. Our Classic mounting system is designed for marine use to reduce engine vibration and it's affordable.

66-66206	6 Cylinder Bushings, Special Washers, Nuts and 6" Bolts. (SMALL EAR).....	98.00 kit
66-66207	6 Cylinder Bushings Kit with Special Washers, Nuts and 6 1/2" Bolts.....	98.00 kit
66-66229	Special Cup Washers.....	5.00 ea.

NOTE: Precise bolt lengths are necessary to avoid damage to engine. It may be necessary to trim bolt lengths and rubber bushings for damage free fit.



LYCOMING 6 CYLINDER & 4 CYLINDER REAR MOTOR MOUNT WITH ALTERNATOR MOUNT

This is one of those impossible items to find in the open market. It bolts on simply and quickly and also provides a built in bracket for mounting your alternator. No bushings or hardware.

66-66101	6 Cylinder and 4 Cylinder Scalloped Mount 3 Hole (A).....	89.00 ea.
66-66102	6 Cylinder and 4 Cylinder Flat Mount (B) (4 Bolts 3/8").....	89.00 ea.
66-66499	Alternator Slide Arm for Above Engine Mount	18.00 ea.

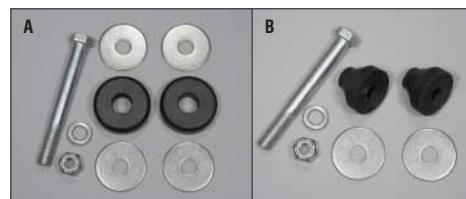

LYCOMING 6 CYLINDER AND 4 CYLINDER REAR MOTOR MOUNT BUSHINGS

You won't find these in your local hardware store, so take advantage of a tried and proven way to secure your engine to your engine stand. Fits our scalloped and flat Lycoming mounts.

66-66201	Rubber Bushings Kit with Hardware (A)...	13.30 kit
66-66202	Bushing Kit with Hardware (B)	9.50 kit



HOLLEY CARB MANIFOLD CONVERSION

Convert your Continental GPU to a Holley 4BBL or 2BBL Holley Carburetor for more power and gas mileage.

66-60500	Manifold Conversion Holley 2 BBL Exchange	290.00 ea.
66-60650	Manifold Conversion Holley 4 BBL Exchange	290.00 ea.



CONTINENTAL PROP ADAPTER AND FLYWHEEL

Multi-purpose, comes with "V" groove for your alternator belt. 7" diameter, 2" thick machined aluminum. Includes centering boss for your crankshaft and centering boss for your flywheel.

42-22070	"V" Groove Prop Adapter	230.00 ea.
66-67370	Alternator Belt for "V" Groove.....	9.00 ea.
66-69100	Flywheel and Ring Gear Drilled & Fitted	68.00 ea.

CONTINENTAL ENGINE BRASS FITTINGS FOR OIL COOLER

30-28133	3/8" Close Nipple	¢.90 ea.*
30-28060	3/8" Coupling.....	1.95 ea.*
30-32043	1/2" Hose x 3/8" Male Pipe 90°	5.45 ea.*
30-10455	1/2" Hose x 3/8" Pipe Flare 45°	4.65 ea.
30-28202	1/4" Hex Pipe Plug.....	¢.75 ea.
30-30255	1/2" Hose x 3/8" Pipe Female Flare Swivel.....	3.90 ea.*
30-28201	1/8" Hexplug.....	¢.48 ea.*
30-32047	3/8" x 1/8" Barb x MP 90°	6.50 ea.*
30-32038	1/4" x 1/8" Barb MP 90°	1.60 ea.*
30-0000	Complete Continental Oil Cooler Brass Kit – Plus Oil, Fuel and Plug Fittings. – Total 14 pieces	45.00 kit*

*Items required to install oil cooler.



AIRCRAFT EXHAUST GASKETS

66-77611	Exhaust Gasket, Lycoming 2-Hole Blow Proof (A).....	6.75 pr.
66-75118	Exhaust Gasket, Lycoming 2-Hole Copper (B).....	3.10 pr.
66-627429	Exhaust Gasket Blow Proof, Continental, 2-Hole (C)	6.75 pr.
66-30365	Exhaust Gasket, Continental (D)	6.00 pr.



CONTINENTAL GPU HEADERS 1 1/2" TUBES

Our 6 cylinder headers can make some H.P. difference, so go with the best. Stainless steel tubing and flanges—2 1/2" collectors.

66-47025	6 Cylinder GPU 2 1/2" Dumps.....	249.00 pr.
66-32025	4 Cylinder GPU 2 1/2" Dumps	200.00 pr.



SPARK AND FLAME ARRESTOR FOR CONTINENTAL

66-00000	Spark and Flame Arrestor.....	125.00 ea.
----------	-------------------------------	------------



LYCOMING FUEL PUMPS

We now have reconditioned to new Lycoming fuel pumps for your 4 cylinder and 6 cylinder motors. No more aircraft run outs and airboat serviceable. We mean all new internal parts: We also have new auto converted pumps to fit Lycoming 4 cylinder and 6 cylinder engines.



LYCOMING AIRCRAFT PUMPS NEW/REBUILT

Fits both 4 cylinder and 6 cylinder motors. Available for carbureted and fuel injected motors.

66-66315	Lycoming mechanical fuel pump low pressure 4 cylinder and 6 cylinder motors.....	165.00 ea.
66-66319	Lycoming mechanical fuel pump high pressure for 4 cylinder and 6 cylinder fuel injected motors	165.00 ea.



STARTER MOUNTING BRACKET

Bolts to the top of the engine using existing studs. FAST and EASY.

66-70022	GM Starter Bracket.....	95.00 ea.
61-62501	GM Starter	139.00 ea.
61-62702	Alternator-Marine	149.00 ea.



CONTINENTAL FRONT AND REAR MOTOR MOUNTS AND ALTERNATOR MOUNTING BRACKET

A two-in-one easy mount made of steel and ready for you to bolt on the alternator.

66-60010	Rear Motor Mount and Alternator Bracket.....	145.00 set
66-60250	Front Motor Mounts	175.00 set

CONTINENTAL FRONT AND REAR MOTOR MOUNT BUSHING AND HARDWARE

Vibration reducing system that holds engine secure.

66-60290	Hardware	3.00 ea.
66-66210	Rubber Bushing Set.....	28.00 set
66-66211	Mounting Hardware	11.67 set
61-66209	Rubber Bushings	3.95 ea.



LYCOMING AND CONTINENTAL 4 CYLINDER HEADERS-2 HOLE

Special parallel construction increases H.P. and reduces engine heat. Stainless, 1 1/4" OD thick-walled, welded to 2 1/2" and 3" dumps. Manufactured specifically for airboat applications.

66-36125	Lycoming Angle Valve, 2 1/2" Flex.....	200.00 pr.
66-36025	Lycoming Straight Valve, 2 1/2" Flex....	200.00 pr.
66-32025	Continental GPU and Aircraft 2 1/2"	200.00 pr.
66-09025	Continental 90 HP 2 1/2"	200.00 pr.



LYCOMING AND CONTINENTAL 6 CYLINDER HEADERS-2 HOLE

Special parallel construction increases H.P. and reduces engine heat. Stainless, 1 1/4" OD thick-walled, welded to 2 1/2" and 3" dumps. Manufactured specifically for airboat applications.

66-54125	Lycoming Angle Valve, 2 1/2" Flex.....	249.00 pr.
66-54025	Lycoming Straight Valve, 2 1/2" Flex.....	249.00 pr.
66-54130	Lycoming Angle Valve, 3" Flex	249.00 pr.
66-54030	Lycoming Straight Valve, 3" Flex	249.00 pr.
66-47025	Continental 0470 2 1/2" Flex	249.00 pr.
66-52025	Continental 0520 2 1/2" Flex	249.00 pr.



LYCOMING STARTERS FEATHERWEIGHT

Comes with Lycoming mount for easy, quick installation. Nothing to add or buy, just bolt on. All the bolt holes are right there. It's lightweight at only 9 lbs., high torque and very popular.

66-12201	Coarse, 122 Teeth Ring Gear	302.00 ea.
66-14901	Fine, 149 Teeth Ring Gear	302.00 ea.
66-12291	High Torque 2.1 Ratio, 122 Teeth	302.00 ea.
66-14991	High Torque 2.1 Ratio, 149 Teeth	302.00 ea.

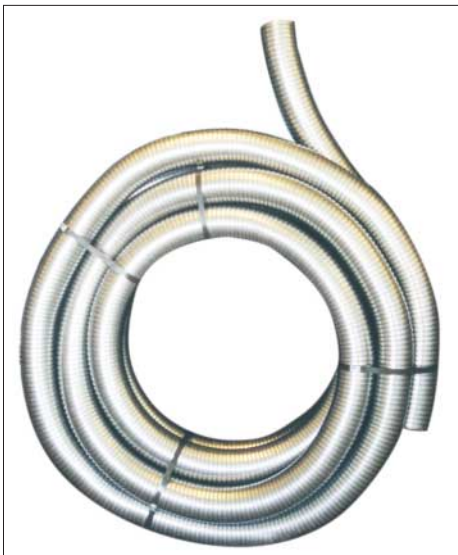

HEAVY DUTY, HIGH QUALITY STAINLESS STEEL FLEX HOSE

Our heavy duty flex tubing is made of the highest quality, non-magnetic stainless steel. Flex pipe is required by the Coast Guard, so make it last by getting the best. Match our Stainless Steel Flex Pipe with our hard-to-find Stainless Steel or Zinc Plated U-Clamps and eliminate that unsightly corrosive problem.

35-35804	Stainless Flex, 2 1/2"	11.00 ft.
35-35805	Stainless Flex, 3"	12.00 ft.



HIGH QUALITY STAINLESS BAND CLAMPS AND U-CLAMPS

Stainless steel band clamps and U-Clamps for aircraft applications. Connects flex exhaust to header, transom dumps, mufflers and glass packs.

35-35212	Stainless U-Clamp, 2 1/2"	10.02 ea.
35-35830	Stainless U-Clamp, 3"	10.02 ea.
35-35860	Stainless Band Clamps, 2 1/2"	10.02 ea.
35-35870	Stainless Band Clamps, 3"	10.02 ea.



AIRCRAFT RINGS

Like new replaceable coarse or fine tooth starter ring gear can be used with Classic auto starter adapter or aircraft starter. Coarse has 122 teeth; fine has 149 teeth. (When available only.)

66-66409	Coarse Ring Gears, 122 Teeth	95.00 set
66-66410	Fine Ring Gears, 149 Teeth.....	95.00 set



BENDIX MAG COIL

We have brand new Bendix Red Coils at great savings!

66-66750	Red Coil	125.00 ea.
----------	----------------	------------



FUEL CUT OFF SOLENOID FOR FUEL INJECTION ENGINE

Eliminate "No Start" that plague injected aircraft engines. Flip a switch for total control of your fuel. Eliminates lean/rich cable.

66-66111	Shut-off Valve Electric 1/4" (A)	70.00 ea.
66-66121	Shut-off Valve Electric, Large 3/8" (B)	65.00 ea.



FLAME AND SPARK ARRESTOR FOR AIRCRAFT APPLICATIONS

Standard air cleaners work fine, keeps the Coast Guard off your back, but will not prevent fires. Ours come with mounting bracket and bolts, ready for mounting.

- 66-66326 MA 3-4 Flame and Spark Arrestor.....75.00 ea.
66-66328 MA 4-5-6 Flame and Spark Arrestor.....52.00 ea.

LYCOMING ENGINE GASKETS

- 66-66224 Carburetor Gasket MA4 to 6¢.79 ea.
66-13792 Crank Seal, One Piece.....19.00 ea.
66-76940 Crank Seal, Split Piece.....38.00 ea.
66-75118 Exhaust Gasket, 2-hole Copper3.10 ea.
66-77611 Exhaust Gasket, 2-hole Blow Proof.....7.75 ea.
66-60096 Fuel Pump Gasket.....¢.89 ea.
66-02053 Governor Plate Gasket.....¢.60 ea.
66-18661 Mag Gasket1.98 ea.
66-75906 Valve Cover Gasket, Straight 6 hole2.35 ea.
66-76036 Valve Cover Gasket, Angle 8 hole7.75 ea.
66-61173 Oil Screen Housing Gasket.....¢.72 ea.
66-12795 Oil Screen Housing Gasket.....1.60 ea.
66-8313 Vacuum Pump Gasket.....¢.50 ea.
66-71973 Intake Gasket¢.85 ea.
66-70310 "O" Ring Push Rod Tube, Straight.....¢.58 ea.
66-15280 "O" Ring Push Rod Tube, Angle3.85 ea.
66-69551 Accessory Gasket.....¢.78 ea.
66-69003 Intake Hose.....3.95 ea.

CONTINENTAL ENGINE GASKETS

- 66-53220 Cylinder Base "O" Ring 0470.....3.40 ea.
66-536740 Intake "O" Ring GPU.....6.95 ea.
66-536410 Push Rod Tube Seal GPU1.88 ea.
66-641607 Push Rod Tube Seal 05201.95 ea.
66-534610 Push Rod Tube Seal¢.76 ea.
66-627429 Exhaust Gasket Blow Pump, 2-Hole8.70 ea.
66-60096 Fuel Pump Gasket.....¢.98 ea.
66-530162 Valve Cover, 6 Hole GPU 02001.40 ea.
66-534857 Valve Cover, 8 Hole 0470-05201.40 ea.
66-352058 Lifter Housing GPU 0470-0520¢.88 ea.
66-646234 Valve Cover, 7-Hole GPU 04709.50 ea.
66-21477 Cylinder Base "O" Ring 0-200.....¢.29 ea.
66-00000 Intake Hose GPU4.25 ea.
66-21051 Carburetor Gasket.....¢.65 ea.
66-629925 Intake Gasket 0360, 2 Hole.....¢.65 ea.
66-630824 Intake Gasket 0470, 3 Hole.....1.10 ea.
66-535324 Mag Gasket 0200-0300.....¢.85 ea.
66-534750 Mag Gasket 0470-520.....¢.85 ea.
66-641607 Angle Push Rod Seal.....1.80 ea.
66-536740 GPU Intake O Ring28.00 ea.

LYCOMING OIL TEMPERATURE GAUGE ADAPTER

- Use with Teleflex manual oil temperature gauge.
30-38512 Brass adapter for accessory housing (Hard to find brass).....42.00 ea.



HIGH DOLLAR SPARK PLUG WIRES AT LOW PRICES

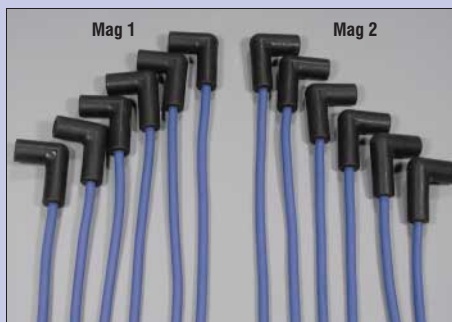

SPARK PLUG WIRE SET FOR AIRCRAFT

Solid copper wires for the ultimate in spark delivery. Wrapped in a 100% silicone jacket for the best wire protection available. Wires are cut extra long for easy, good looking, routing and convenience. Comes with mag ends.

- 66-66012 6 Cylinder 12 Wire Dual Mag 7MM39.00 set
66-66008 4 Cylinder 8 Wire Dual Mag 7MM24.00 set
66-61006 6 Cylinder 6 Wire One Mag 7MM24.00 set
66-41004 4 Cylinder 4 Wire One Mag 7MM14.00 set
66-16000 D-16 Spark Plugs3.25 ea.
35-36712 Clear 1" Aircraft Ven Hose1.30 ea.



LEAN/RICH CABLE FOR AIRCRAFT ENGINES

A must when you use automobile fuel in an aircraft engine. This eliminates engine run on, turning backwards and kickback. If you do not have this item, you may damage your engine and your mags.

- 66-66301 Complete Cable 12'.....58.00 ea.
66-66303 Cable Lock End Nut4.50 ea.

AIRCRAFT THROTTLE CABLE

Everyone has to have one, so get the best mechanical throttle cable with sure feel and positive response.

- 66-66302 Interior Aircraft Throttle Cable.....1.20 ft.
66-66303 Cable Split Nut Clamps5.50 ea.
66-66304 Cable Housing2.88 ft.
66-66305 Cable Eyelets.....1.50 ea.



AIRCRAFT MECHANICAL TACHOMETER

We recommend the Classic aircraft mechanical tachometer. Driven for long life and accuracy, lubrication is not required. 12 volts with backlighting. 3500 rpm full sweep tach plus built-in hour metering divided into tenths. Essential for long engine life, warranty, service, repair and maintenance.

- 61-61501 Mechanical Aircraft Tachometer59.00 ea.



MECHANICAL TACHOMETER CABLE

Maintenance free, no lubrication required and manufactured to your specifications.

- 66-66502 Mechanical Tachometer Cable7.50 ft.

LYCOMING FUEL PUMPS

We now have reconditioned to new Lycoming fuel pumps for your 4 cylinder and 6 cylinder motors. No more aircraft run outs and airboat serviceable. We mean all new internal parts: We also have new auto converted pumps to fit Lycoming 4 cylinder and 6 cylinder engines.



LYCOMING AIRCRAFT PUMPS NEW/REBUILT

Fits both 4 cylinder and 6 cylinder motors. Available for carbureted and fuel injected motors.

- 66-66315 Lycoming mechanical fuel pump low pressure 4 cylinder and 6 cylinder motors.....165.00 ea.
66-66319 Lycoming mechanical fuel pump high pressure for 4 cylinder and 6 cylinder fuel injected motors165.00 ea.

SENSENICH PROPELLER COMPANY, INC.

CARBON FIBER AIRBOAT PROPELLER PRICES

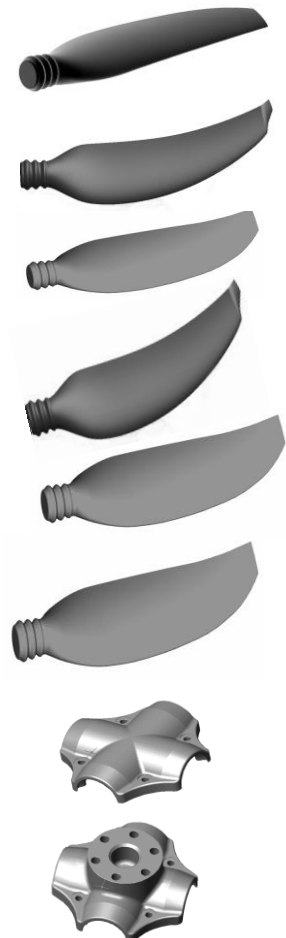

Blade Style	Hubs								
	2 Blade Short Hub	2 Blade Medium Hub	2 Blade Long Hub	3 Blade Short Hub	3 Blade Medium Hub	3 Blade Long Hub	4 Blade Short Hub	4 Blade Long Hub	5 Blade Short Hub
"H" Short Narrow Blade (LH Only)	66", 69", 70" \$1710	69", 71", 72" \$1710	71", 73", 74" \$1760	69", 71", 72" \$2335	71", 73", 74" \$2635	N/A	70", 72", 74" \$3105	74", 76", 78" \$3350	74", 76", 78" \$4000
"NGH" Short Narrow Blade (LH Only)	70" \$1785 retail	72" \$1785 retail	74" \$1835 retail	72" \$2470 retail	74" \$2765 retail	76" \$3065 retail	74" \$3285 retail	78" \$3530 retail	78" \$4230 retail
"Q" Short Medium Blade (LH Only)	68", 70" \$1875	70", 72" \$1875	72", 74" \$1925	70", 72" \$2735	72", 74" \$3005	74", 76" \$3225	72", 74" \$3590	N/A	N/A
"NGR" Long Wide Blade (LH & RH) <i>reduction drive only!</i>	78" \$2175	80" \$2175	82" \$2225	80" \$3170	82" \$3455	84" \$3685	82" \$4175	86" \$4785	86" \$5750
"R" Long Wide Blade (LH & RH) <i>reduction drive only!</i>	76", 77", 78" \$1975	78", 79", 80" \$1975	80", 81", 82" \$2025	78", 79", 80" \$2870	80", 81", 82" \$3155	82", 83", 84" \$3385	80", 81", 82" \$3775	84", 85", 86" \$4385	84", 85", 86" \$5250
"S" Superwide (LH & RH) <i>reduction drive only!</i>	76", 77", 78" \$2320	78", 79", 80" \$2320	80", 81", 82" \$2370	78", 79", 80" \$3400	80", 81", 82" \$3680	82", 83", 84" \$4190	80", 81", 82" \$4485	84", 85", 86" \$5085	84", 85", 86" \$6220

Hardware Only	Hubs Only (Includes Hardware)								
	2 Blade Short	2 Blade Medium	2 Blade Long	3 Blade Short	3 Blade Medium	3 Blade Long	4 Blade Short	4 Blade Long	5 Blade Short
Clamp Kit and Mount Kit									
\$40	\$760	\$760	\$815	\$1,065	\$1,340	\$1,565	\$1,360	\$1,960	\$2,630

Blades Only (Specify Tip Weight)					
"H" Narrow Blade	"NGH" Narrow Blade	"Q" Medium Blade	"NGR" Wide Blade	"R" Wide Blade	"S" Super Wide Blade
\$520 retail	\$550 retail	\$575 retail	\$705 retail	\$605 retail	\$785 retail

SENSENICH PROPELLER COMPANY, INC.

Mar-13

SABER BLADE PRICING

RETAIL

Plates and Complete Hubs - Standard

<u>DIAMETER</u>	<u>Retail Price</u> <u>Plates Only</u>	<u>Retail Price</u> <u>Complete Hub</u>
2 Blade 72"	\$220.00	\$275.00
3 Blade 72"	\$255.00	\$335.00
4 Blade 72"	\$315.00	\$405.00
5 Blade 72"	\$335.00	\$435.00
5 Blade 80"	\$385.00	\$495.00
6 Blade 72"	\$345.00	\$455.00
6 Blade 80"	\$395.00	\$515.00
8 Blade 80"	\$420.00	\$545.00
9 Blade 80"	\$430.00	\$565.00
10 Blade 80"	\$435.00	\$585.00
12 Blade 80"	\$450.00	\$625.00

Plates and Complete Hubs - Turbo

<u>DIAMETER</u>	<u>Retail Price</u> <u>Plates Only</u>	<u>Retail Price</u> <u>Complete Hub</u>
6 Blade 72"	\$515.00	\$685.00
6 Blade 80"	\$590.00	\$770.00
8 Blade 80"	\$630.00	\$810.00
10 Blade 80"	\$650.00	\$860.00
12 Blade 80"	\$670.00	\$905.00

Hub Parts

<u>PART NUMBER</u>	<u>Retail Price</u>	<u>Description</u>
A-1616	\$60.00 / Set	Hub Plate Spacer - LXL Style
A-1615	\$20.00 / Blade	Pitch Block
SAB-CK	\$8.00 / Blade	Pitch Block Clamping Kit - Bolt, Nuts & Washers

Complete Propellers - Standard

<u>DIAMETER</u>	<u>Retail Price</u>
2 Blade 66" - 72"	\$990.00
3 Blade 66" - 72"	\$1,405.00
4 Blade 66" - 72"	\$1,825.00
5 Blade 66" - 72"	\$2,170.00
5 Blade 74" - 80"	\$2,220.00
6 Blade 66" - 72"	\$2,545.00
6 Blade 74" - 80"	\$2,600.00
8 Blade 74" - 80"	\$3,345.00
9 Blade 74" - 80"	\$3,720.00
10 Blade 74" - 80"	\$4,100.00
12 Blade 74" - 80"	\$4,865.00

Complete Propellers - Turbo

<u>DIAMETER</u>	<u>Retail Price</u>
6 Blade 66" - 72"	\$2,775.00
6 Blade 74" - 80"	\$2,855.00
8 Blade 74" - 80"	\$3,610.00
10 Blade 74" - 80"	\$4,375.00
12 Blade 74" - 80"	\$5,145.00

BLADES ONLY

<u>MODEL</u>	<u>Retail Price</u>	<u>Description</u>
L68W	\$360.00	Left Hand Blade 33" Long
L68W-1	\$360.00	Left Hand Blade With 1" Cutoff - 32" Long
L68W-2	\$360.00	Left Hand Blade With 2" Cutoff - 31" Long
L68W-3	\$360.00	Left Hand Blade With 3" Cutoff - 30" Long
R68W	\$360.00	Right Hand Blade 33" Long
R68W-1	\$360.00	Right Hand Blade With 1" Cutoff - 32" Long
R68W-2	\$360.00	Right Hand Blade With 2" Cutoff - 31" Long
R68W-3	\$360.00	Right Hand Blade With 3" Cutoff - 30" Long

Other custom hubs/setup's available. Call for pricing

SENSENICH WOOD PROPELLER COMPANY, INC.

FIXED PITCH KEVLAR TIPPED

WOOD AIRBOAT PROPELLER PRICES

Narrow Blades

<u>DIAMETER</u>	<u>HUB THICKNESS</u>	<u>RETAIL PRICES</u>
60"	3-1/2"	\$640
66" - 68"	3-1/2"	\$640
70" - 72"	4-1/2"	\$725
74" - 78"	4-1/2"	\$835

Wide Blades

<u>DIAMETER</u>	<u>HUB THICKNESS</u>	<u>RETAIL PRICES</u>
66" - 68"	3-1/2"	\$805
66" - 68"	4-1/2"	\$870
70" - 72"	4-1/2"	\$870
74"	4-1/2"	\$940
76" - 78"	4-1/2"	\$980
80" - 84"	4-1/2"	\$1,045
86" - 90"	4-1/2"	\$1,095

WELDED WIRE ON LEADING EDGE \$50



WARP DRIVE PROPELLERS

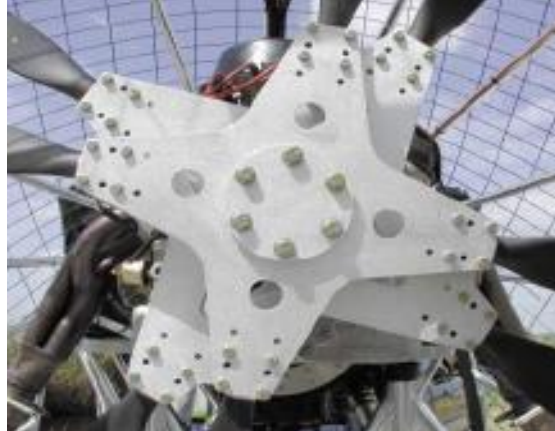
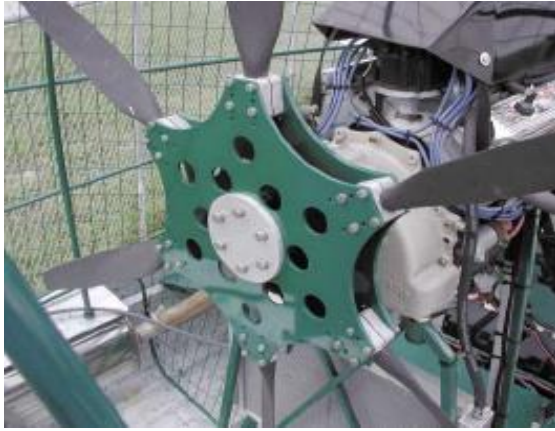

41-72372SD	3 BLADE UP TO 72"	\$1,275.00
41-74474SD	4 BLADE UP TO 74"	\$1,680.00
41-75574SD	5 BLADE UP TO 74"	\$2,025.00
41-82582SD	5 BLADE UP TO 82"	\$2,075.00
41-74674SD	6 BLADE UP TO 74"	\$2,335.00
41-74674TB	6 BLADE TURBO UP TO 74"	\$2,460.00
41-82682SD	6 BLADE UP TO 82"	\$2,395.00
41-82682TB	6 BLADE TURBO UP TO 82"	\$2,520.00
41-74874SD	8 BLADE UP TO 74"	\$2,995.00
41-74874TB	8 BLADE TURBO UP TO 74"	\$3,120.00
41-82882SD	8 BLADE UP TO 82"	\$3,065.00
41-82882TB	8 BLADE TURBO UP TO 82"	\$3,190.00
41-74974TB	9 BLADE TURBO UP TO 74"	\$3,325.00
41-741074SD	10 BLADE UP TO 82"	\$3,645.00
41-741074TB	10 BLADE TURBO UP TO 74"	\$3,325.00
41-741274SD	12 BLADE UP TO 82"	\$4,305.00
41-741274TB	12 BLADE TURBO UP TO 82"	\$4,430.00
41-74000	INDIVIDUAL BLADE	\$330.00
	CLAMPING BLOCKS (PER BLADE)	\$8.00
	CLAMPING BOLTS 5/16 (PER BLADE)	\$6.00
	HUB SPACERS 6 EA.	\$8.00



PROPELLER ADAPTERS & HARDWARE

PROP ADAPTERS FOR AUTO AND AIRCRAFT ENGINES

These prop adapters are for LXL bolt pattern (standard) 4 3/4" bolt circle—6 bolts 1/2" bore=2.255 6" & 7" Dia. 2" Thick



42-01018	Buick 455, 6"	199.00 ea.
40-01005	Cadillac 425, 472, 500, 6"	199.00 ea.
40-01001	Chevy 250-400, 6"	199.00 ea.
40-01002	New Chevy 350, 6"	199.00 ea.
40-01020	Continental 0470 Aircraft 4 3/8" circle, 6"	199.00 ea.
40-01021	Continental 0360 Aircraft 4" circle, 6"	199.00 ea.
40-01090	G.P.U. 90, 220, 150—4 3/8" circle, 7"	199.00 ea.

CRANKSHAFT BOLTS FOR USE WITH OUR PROP ADAPTERS—CAP HEAD

92-7612	Bolt	¢.65 ea.
---------	------	----------

BLANK PROP ADAPTERS-6" DIAMETER 2" THICK

Drill your own crankshaft holes. Adapter comes with LXL bolt pattern. Ready for prop mounting.

40-00000	Blank Adapter	159.00 ea.
40-10001	LXL Spacer Extends Prop 2 inches	179.00 ea.

WARP DRIVE PROP ACCESSORIES

42-68002	Spacer (Separates Plates)	7.00 ea.
42-68003	Clamping Blocks (Holds Blades)	16.00 pr.
42-56325	Clamping Hardware: Bolt (1), Lock Nut (1), Washers (2)	1.75 set
42-68004	Clamping Blocks (2) and Special Hardware Bolts (4), Lock Nuts (4), Washers (4)	23.00 set



CONTINENTAL PRO ADAPTER 220 G.P.U. W/V-BELT GROOVE

This prop adapter is a 3 in 1 money saver. It has a "V-Groove" for your alternator, and it accommodates an auto flywheel & ring gear for your starter. It's a must package at a real savings.

42-70220	"V-Groove Adapter"	210.00 ea.
42-12203	Flywheel & Ring Gear Drilled & Fitted	58.70 ea.



PROP ADAPTER FOR STACKED OR DUAL PROP

Classic knows that dual props reduce noise and under certain conditions can increase thrust significantly. Our adapter is an inexpensive way to enter new areas of prop efficiency. Dual props are recommended for commercial workhorse applications. Uses standard bolt pattern. 4 3/4" - 6 @ 1/2" Bore 2.255".

42-43462	Stacked Prop or Dual Prop	258.60 ea.
----------	---------------------------	------------

STEEL THREADED REPLACEMENT DOWELS FOR PROP HUB

They are what you screw your propeller into.

Part #	Length	Dia.	Thread	Price
40-07001	1 1/2" Standard	.750	1/2-20	11.75 ea.
40-07002	1 1/2" Oversize	.781	1/2-20 Oversize	11.75 ea.
40-34238	2 3/8" Belt Drive	.750	1/2-20	11.75 ea.

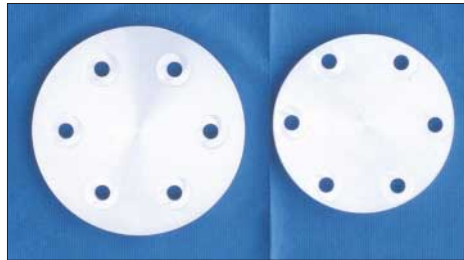

ALUMINUM PROP PLATES

Machined aluminum face plates for your prop, very professionally finished.

6" & 7" DIAMETER MACHINED ALUMINUM PROP PLATES LYCOMING LXL BOLT PATTERN

Recommended for paddle propellers. LXL bolt pattern.

Part #	Width	Hole Size	# Bolts	Bolt Circle	Price
40-47557	1/2"	1/2"	6	4 3/4"	32.00 ea.
Lycoming LXL Bolt Pattern					
40-47550	1/2"	1/2"	6	4 3/4"	28.00 ea.
Lycoming LML Bolt Pattern					
40-47538	1/2"	3/8"	6	4 3/4"	28.00 ea.



PROP BOLTS & WASHERS

Prop bolts are grade 8 fine thread. Metric prop bolts are grade 8.8 fine thread.

Part #	Dia.	Length	Price
81-12400	1/2"	4"	1.55 ea.
81-12412	1/2"	4 1/2"	1.60 ea.
81-12500	1/2"	5"	1.65 ea.
81-12512	1/2"	5 1/2"	1.75 ea.
81-12600	1/2"	6"	1.85 ea.
81-12612	1/2"	6 1/2"	2.30 ea.
81-12700	1/2"	7"	2.70 ea.
81-12000	1/2"	Washer, Stainless Steel	¢.40 ea.
81-00012	1/2"	Lockwasher, Stainless Steel	¢.60 ea.

PROP BOLT & WASHER KITS

40-12600	6" x 1/2" Prop Bolts for Rotator (6), 1/2" Flat Washers (6), 1/2" Lock Washers (6) For Rotator	16.00 set
40-12650	6 1/2" x 1/2" Prop Bolts for Belt Drive (6), 1/2" Flat Washers (6), 1/2" Lock Washers (6) For Belt Drive	18.00 set
40-12450	4 1/2" x 1/2" Prop Bolts for Warp Drive (6), 1/2" Flat Washers (6), 1/2" Lock Washers (6) For Belt Drive	14.00 set
40-12400	4" x 1/2" Prop Bolts for Warp Drive (6), 1/2" Flat Washers (6), 1/2" Lock Washers (6) For Rotator	14.00 set



CAT'S EYE NEVER-NITE

Cat's Eye Never-Nite helmet light with 385,000+ candlepower. Aircraft landing light and cut-off switch. Replaceable, sealed beam bulb. If you're not using a Cat's Eye, you're in the dark.
700-3851 Cat's Eye Never-Nite.....NA ea.



CAT'S EYE NIGHT RIDER

All-purpose night light mounted on a hard hat with a sealed beam bulb with 180,000+ candlepower. Aircraft landing light and cut-off switch, durable and fully adjustable.
700-1852 Cat's Eye Night Rider.....NA ea.

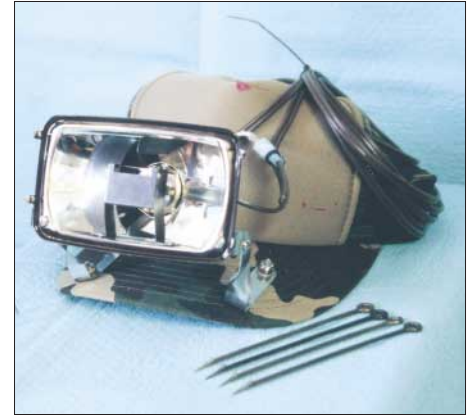

CAT'S EYE FROGGER MAN

Lightweight cap light. Ideal for frog gigging and fully adjustable to all head sizes. It has a replaceable Halogen bulb.
700-1003 Cat's Eye Frogger Man, 100 Watt.....NA ea.



CAT'S EYE RATCHET

This is the real light heavyweight of hat lights. 385,000+ candlepower, packed into an easy-to-wear package. Adjusts easily to all sizes with a ratchet adjustment.
700-3854 Cat's Eye Ratchet, 150 Watt.....109.00 ea.
700-1855 Cat's Eye Ratchet, 100 Watt.....89.00 ea.



FEATHERWEIGHT RATCHET

700-0130 Featherweight Ratchet.....109.00 ea.



PANTHER VISION LIGHT

Night light for all boaters and great for night vision whether you are pleasure riding or frog gigging.

700-1006 PANTHER VISION LIGHT.....39.00 ea.
See more detailed information at www.classicairboats.com



CAT'S EYE LITE NIGHT RIDER

700-0000 Cat's Eye Lite Night Rider.....89.00 ea.



CAT'S EYE BAT LIGHT

This three-in-one package is the ultimate in airboating head gear. Ear protection built right in. A 385,000 or 180,000 candlepower light and heavy duty helmet. Fully adjustable and comfortable. NEXT TIME YOU GRAB YOUR HELMET LIGHT, MAKE SURE IT'S THE BAT LIGHT.
700-3857 Cat's Eye Bat Light, 385,000 CPNA ea.
700-1858 Cat's Eye Bat Light, 180,000 CPNA ea.

REPLACEMENT BULBS

700-1300 Featherweight Replacement Bulb,
Approx. 385,000 Candle Power23.00 ea.
700-1000 Featherweight Replacement Bulb,
Approx. 185,000 Candle Power20.00 ea.

LIGHTS, GIGS, EAR MUFFS, MISC.



▲ HIGH INTENSITY REPLACEMENT LAMPS

Replacement lamps for KC lights, hat lights and any other application you may have. Comes as a standard size 7.5 amp, 12 volt sealed beam and is ideal for night running.

35-01000 Small 100 Watt, 185,000 CP38.00 ea.
35-01500 Large 150 Watt, 385,000 CP36.00 ea.



▲ K-C OFF ROAD LIGHTS—PAIR PACK 385,000 CANDLEPOWER

The LC Series are our most popular lights. They're available in long range sealed beam and quartz halogen models and offer the appearance many enthusiasts look for at an economical price. Includes 2 daylighters, switch kit, and happy face style covers.

727-0628 Chrome LC Series Off Road Lights198.00 pr.
722-0621 Black LC Series Off Road Lights198.00 pr.
722-0651 Stainless Steel Off Road Lights218.00 pr.



▲ K-C COMPETITION LIGHTS, 385,000 CANDLEPOWER

Daylighters are the leading off-road light, featuring K-C's own shock mount system to withstand the rigid needs of world-class competition.

722-1621 6" Chrome Daylighters99.80 ea.
722-1628 6" Black Daylighters99.80 ea.
722-1651 6" Stainless Steel Daylighters109.50 ea.



◀ DAVE CLARK EAR MUFFS

Overhead protection with chrome plated adjustable head band is one of the most popular ear muffs ever sold. They are also a standard in target shooting equipment - Very good!

702-3440 Dave Clark Ear Muffs39.40 ea.

EAR MUFFS ▶

Padded ear muffs for high noise environment. Deluxe molded has adjustable head band. This is our best value. Lightweight, adjustable and very efficient.

702-914 Ear Muffs14.35 ea.



◀ Fire Com Communications

Firecom's wireless headset enhances communication and delivers vital hearing protection. The protective design reduces ambient noise and meets NFPA 1500 standards. (Over Helmet Headset Shown, Intercom shows front and back view)
CALL FOR PRICING



▲ LIGHTNING STRIKE FROG GIG ALUMINUM

Frog gigs need to be strong and lightweight with a good tine that stays sharp, so have fun while you get something good to eat.

736-1010 Lightning Strike Frog Gig34.95 ea.
736-0010 Replacement Frog Gig Tines1.25 ea.
736-1100 Fiberglass Gig Pole64.95 ea.
700-1003 Panther Vision Hat Light39.50 ea.

FULL FITTED BOAT COVERS & BIMINIS



OUR CUSTOM BOAT COVERS AND BIMINI TOPS ARE HAND MADE AND CONTOURED FOR A CUSTOM AIRBOAT FIT.



Call for Pricing

INDEX

Air Cleaner.....	58	Flame & Spark Arrestors.....	58, 61, 63	Instrument Panels.....	14, 32	Reduction Units	
Airboat Kits.....	10-13, 52-53	Flex Hose.....	37, 62	KC Lights.....	15, 70	Belt Drive.....	46
Airboats.....	4-9	Foot Pedals.....	27	Mag Coil.....	62	Rotator Gear-to-Gear.....	47
Aircraft Rings.....	62	Fuel		Motor Mounts.....	47	Mounting Hardware.....	47
Alternator Brackets.....	56	Filters.....	26-27, 58	Aircraft.....	60-61	Rotator Oil.....	39, 47
Battery		Gauge.....	26	Mufflers.....	15, 37	Rudders.....	28
Boxes.....	35	Lines.....	35, 58	Navigation Lights.....	35, 40	Seat Stands.....	23
Cable.....	35	Fuel Pumps.....	27, 57-58	Oil Cooler.....	39	Seats.....	24-25
Switch.....	35	Rod, Mounting, Plate.....	58	Mounting Kit.....	39	Spark Plug Wires.....	59, 63
Bilge Pump.....	15, 21	Aircraft.....	61	Brass.....	39	Spark Plugs.....	59
Evacuation Hose.....	40	Fuel Tanks.....	26	Adapter.....	57	Spare Tire.....	17
Boat-In-A-Box®.....	12-13, 52-53	Mounting Kit.....	26	Oil Filter.....	39	Starters.....	59
Bow Eye.....	40	Gigs.....	70	Adapter.....	57	Bolts.....	59
Carburetors.....	57	GM Powertrain Engines.....	42-45, 48-51	Overflow Recovery Tank.....	55	Aircraft.....	61-62
Spacers.....	58	Gooseneck.....	55	Petcock.....	55	Steel Flex Bottom.....	14, 21
Rain Cover.....	58	Grass Rakes.....	40	Polymer.....	14, 20	Steering Cable.....	29
Chevy-In-A-Box®.....	48-51	Gauges.....	32-34, 63	Screws.....	20	Steering Linkage.....	28-29
Cut Off Solenoid.....	62	Harmonic Balancer		Prop Guards.....	22	Switches.....	34
Deck Lids.....	15, 41	Bolt & Washer.....	56	Propellers.....	64-67	Boots.....	34
Distributor.....	59	Tape.....	56	Hardware.....	68	Thermostats.....	55
Lock Down.....	59	Hat Lights.....	69	Pulley System.....	56	Throttle Cable.....	27
Lock Down Bolt.....	59	Headers.....	36	PVC Valve & Crank Vent.....	57	Springs.....	58
Drain Plug.....	41	Aircraft.....	61-63	Radiators.....	54	Aircraft.....	63
Ear Muffs.....	70	Bolts.....	38	Hoses.....	54-55	Trailers.....	16-17
Engine Stands.....	22	Gaskets.....	38	Mounting Kit.....	54	Trim Tab.....	15, 21, 41
Exhaust Clamps.....	38, 62	Hoses.....	35	Rain Covers.....	25	Joy Stick.....	21, 32, 34
Exhaust Transom Dumps.....	21, 37	Hulls.....	19			Wench.....	16
Expansion Tank.....	55	Ice Boat Options.....	14, 19, 21, 40			Zerex Bottom.....	14, 21

HOW TO ORDER:

BY MAIL

Simply use Classic Airboat order forms included as part of this catalog, or send a letter to Classic Airboat, 306 Shearer Blvd., Cocoa, Florida 32922. Be sure to print your name, address and zip code. Give us your Area Code, daytime and evening telephone numbers. Provide complete ordering information (page #, description, quantity, item #, color (if appl.) and price). Be sure to **Include Your Payment Along With Your Order.** To figure handling and shipping charges, please refer to our E-Z handling and shipping rates. If you're using a credit card, please be sure to include credit card number and expiration date. For complete airboats, airboat kits and large components, it will be necessary to call our sales department.

BY TELEPHONE

Call toll free 1-800-228-7977. Our sales office hours are 9:00 am to 5:00 pm daily, Monday thru Friday, and Saturday from 9:00 am to 12:00 noon (EST). If you have technical questions, please call us at 1-407-633-4026.

METHODS OF PAYMENT

We require full payment to accompany all orders for parts and accessory items. For complete Classic Airboats and Airboat Kits, we require a 50% deposit with balance in full, due one week before shipment. All payments to be in U.S. funds and drawn on U.S. banks. At Classic, we do accept Visa and MasterCard (include credit card name, number and expiration date). If payment is made with a personal or company check, the name, address, check # and telephone number must be preprinted on the check and only first party checks will be accepted. Certified checks, money orders and blank drafts are also acceptable. We will not be responsible for cash sent thru the mail. We do accept COD orders.

ORDER SHIPMENT INFORMATION

Upon receipt of your order, we will make every effort to get your order to you quickly. Parts and accessory orders can usually be shipped within a week, but some items may take longer, possibly up to three weeks. Because of current production scheduling considerations, orders for complete Classic Airboat Kits, Hulls, Seat Stand Riggings and Engine Guards may take up to ninety (90) days.

PREPAID UPS MAIL ORDER

INCLUDING PACKAGE PROTECTION PLAN

Mail order customers in the 48 contiguous United States (excluding Hawaii, Puerto Rico and Alaska) can use

shipment, handling and insurance rates shown above when the full amount of the order is prepaid and when shipment is not for truck shipped items. The Classic package protection plan eliminates the risk of lost or damaged packages. Damaged shipments can be replaced without lengthy delays normally encountered with the claims filing procedure. Upon receipt of your order, open it immediately to check for damage. If it is damaged or broken, call our customer service 1-800-228-7977. Do not destroy or throw away the original packing material or box. To use these rates, simply total the prices of your items ordered and locate the shipment charge to include in your order payment.

SHIPPING, HANDLING & PACKAGE

PROTECTION PLAN RATES FOR UPS ONLY

Up to 25.00	3.50
25.01 to 50.00	4.75
50.01 to 75.00	6.75
75.01 to 100.00	7.25
100.01 to 150.00	9.00
150.01 to 200.00	10.50
200.01 to 300.00	13.25
300.01 to 400.00	16.75
400.01 to 500.00	18.75
500.01 & up	20.75

From Cocoa, Florida

The majority of our shipments for parts and accessory items are handled by UPS. They will attempt to deliver an order to your address three (3) times before returning it to Classic Airboats, Inc. If no one is at the shipping address to accept parcels, a card will be left to notify you with further instructions for delivery. Unless otherwise specified, Classic Airboats will ship all parts and accessory items, which can be shipped by UPS, by UPS ground services.

UPS OFFERS OTHER TYPES OF DELIVERY

UPS Oversized - will be shipped at an oversize rate.

UPS Second Day Air - is faster than UPS ground service. Normally delivered in two (2) business days.

Overnight Delivery - UPS Overnight is available. Please call our customer services 1-800-228-7977 for exact prices. The part or parts cannot exceed 70 lbs. or have a length and girth measurement greater than 130" with maximum length of 108". Airboats, airboat kits and bulk items such as hulls, guards or engine stands will be necessarily shipped by common carrier (truck).

Truck Shipment - Because of weight and/or size restrictions, certain parts and accessory items cannot be shipped by UPS and necessarily will be forwarded by Common Carrier. All Airboat and Airboat Kit orders are

FOB - Cocoa, FL. You are welcome to come down and visit at our factory and pick up your order. We are only about an hour's drive from Florida's world famous Disney World and about half an hour from the historic and fascinating Kennedy Space Center.

SALES TAX INFORMATION

U.S. and foreign orders shipped out of the state of Florida are exempt from sales tax. A 6% sales tax will be added to all in Florida sales.

TERMS, POLICIES & SERVICES LIMITED WARRANTY

Classic Airboat warrants all manufactured parts and/or accessories to be 100% free from material and/or manufacturing defects for 90 days and will replace same free of charge in case of failure, unless otherwise stated. Classic Airboat will not be responsible for any damage or loss caused by delays, failures or any other consequential damages arising from any cause whatsoever, not for the labor, transportation or any other charges incurred in the replacement or repair of a defective item. Warranties on all products other than custom manufactured are warranted in accordance with the manufacturer's terms and are not the responsibility of Classic Airboat. Copies of these warranties are available upon request.

PRICING & PRICING CHANGES

You can order with confidence that if the price of an item you have ordered has been reduced, you will be notified and extended the lower cost. If an item has been increased, you may be charged the higher pricing. If a price change is significant, we will contact you before shipping your order.

All prices, part numbers, weights, specifications, terms and policies in this catalog are subject to change without prior notice.

CUSTOM MANUFACTURED ITEMS

All items in this catalog that are manufactured specifically for Classic Airboats are considered "Custom Manufactured." These items are not returnable for refund. However, custom manufactured items are covered under the Classic Airboat Limited Warranty. Policy against material or manufacture defects (See Limited Warranty elsewhere in this catalog).

REFUSAL OF ORDER

Customers will be charged for all shipping charges and a 15% restocking charge on all refused shipments. No further order will be processed until previous matters are resolved.

RETURNS, EXCHANGES & REPAIRS

Our goal is to handle any returns or exchanges as fast as we handled your original orders. We will accept the return of any warranted items custom manufactured (except special order items) for exchange or credit towards a new order. Send your items for exchange insured and postage paid or call our sales department at 1-800-228-7977 for instruction for return. Sorry, we are not permitted to make monetary adjustments and refunds on defective merchandise on behalf of other manufacturers. However, after use, defective equipment should be returned prepaid for us for examination, test and exchange or replacement by the manufacturer.

OUT OF STOCK MERCHANDISE POLICY

We will always make every effort to maintain sufficient merchandise inventory to satisfy your orders, but sometimes scheduling and circumstances beyond our control may cause a temporary out-of-stock condition. If this occurs, the items will be placed on back order to ship within thirty (30) days. If within 30 days an item cannot be shipped, you will be notified of a revised ship date.

TECHNICAL INFORMATION SERVICES

Have technical problems and questions? Just call us at 1-407-633-4026 and speak to one of our technical services technicians. Technical Services hours are 9:00 am to 5:00 pm weekly/Saturday 9:00 am to 12:00 noon EST.

CUSTOMER SERVICE -

CALL 1-407-633-4026

We are here from 9:00 am to 5:00 pm EST, Monday thru Friday and Saturdays 9:00 am to 12:00 noon to assist and help solve any order problems you may encounter.

CATALOG INFORMATION

All statements and recommendations contained in this catalog are based on information we believe to be complete and accurate, but complete accuracies are hereby not guaranteed. Descriptive, typographic, photographic or pricing errors are subject to correction. All rights are hereby reserved. Copyright applied for. Printed in the U.S.A.

Any purchase made within one year of receipt of this catalog will automatically place you on Classic Airboats complementary mailing list. If you wish to purchase additional copies of this catalog, you may do so by remitting \$3.00 to Classic Airboat, 306 Shearer Blvd, Cocoa, Florida 32922.