



# PERFORMANCE ENGINES

## CATALOG





**WHEN PASSION  
BECOMES POWER.  
WHEN LONGEVITY  
BECOMES LEGACY.  
WHEN THE RUMBLE  
BECOMES A ROAR.  
THAT'S WHEN  
YOU'VE UNLEASHED  
YOUR VEHICLE'S  
ULTIMATE  
PERFORMANCE.**

# TABLE OF CONTENTS

## 06 GEN III HEMI® ENGINES

**345 / 6.1L / 6.2L / 392 / 426**

- 09 Crate HEMI® Engines
- 12 Crate HEMI® Engine Kits
- 14 Crate HEMI® Engine Accessories
- 16 Blocks
- 17 Crankshafts & Hardware
- 18 Pistons & Connecting Rods
- 18 Camshafts
- 19 Cylinder Heads, Gaskets & Hardware
- 19 Valvetrain

## 20 GEN II HEMI® ENGINES

**426 / 572**

- 22 Engine Hardware
- 22 Blocks
- 22 Crankshafts & Hardware
- 23 Timing Chains & Sprockets
- 23 Vibration Dampers
- 23 Forged Aluminum Pistons
- 24 Camshafts, Lifters & Hardware
- 25 Cylinder Heads, Gaskets & Hardware
- 26 Valvetrain Hardware
- 26 Rocker Arms, Shafts, Stands & Hardware
- 27 Valve Covers & Hardware
- 28 Oiling Components
- 29 Engine Cooling
- 29 Engine Installation Components
- 30 Intake Manifolds, Hardware & Gaskets

## 32 BIG BLOCK ENGINES

**361 / 383 / 400  
413 / 426 / 440**

- 34 Engine Hardware
- 34 Crankshafts & Hardware
- 35 Timing Chains & Sprockets
- 36 Vibration Dampers
- 36 Camshafts, Lifters & Hardware
- 38 Cylinder Heads, Gaskets & Hardware
- 38 Intake Manifolds, Hardware & Gaskets
- 40 Valves & Valvetrain Hardware
- 42 Valve Covers & Hardware
- 44 Oiling Components
- 45 Cooling Systems

## 46 SMALL BLOCK ENGINES

**273 / 318 / 340  
360 / 5.2L / 5.9L**

- 48 Engine Hardware
- 48 Timing Chains & Sprockets
- 48 Crankshafts & Hardware
- 50 Vibration Dampers
- 51 Camshafts, Lifters & Hardware
- 52 Cylinder Heads, Gaskets & Hardware
- 54 Valvetrain Hardware
- 55 Rocker Arms, Shafts, Stands & Hardware
- 56 Valve Covers & Hardware
- 58 Intake Manifolds, Hardware & Gaskets
- 60 Oiling Components
- 60 Cooling Systems

## 62 PERFORMANCE GAUGES

- 64 Gauges
- 67 Gauge Pods

\*Many images shown throughout the catalog are representative of the product. Actual product may vary.

# WHY MOPAR®?

## WHY US? THAT'S A GOOD QUESTION.

For starters, we are the same people who have designed, engineered and manufactured world-renowned cars – and their engines – for 80 years, so our expertise has been built over time and proven on the street and the strip. We invented many of the classic cars you know and revere. **We built the HEMI® Engine into the legend** that it is. We respect the spirit of restoration but have the guts to innovate.



## ORIGINAL EQUIPMENT vs. REVERSE-ENGINEERED.

You need correct measurements to build the absolute best parts and to provide the highest level of performance. Aftermarket parts providers can spend countless hours reverse-engineering their parts. They try to work backward in hopes of getting it right. **But only Mopar® knows** and utilizes the *exact* measurements down to the valve seals. No matter if you are looking for performance gains or working to restore an engine to last a lifetime, precision matters – and you can trust us to deliver.

## WE ARE THE EXPERT'S EXPERTS.

Being the OEM gives our team exclusive access to generations of FCA data and real-world testing. With Mopar®, we provide **the most precise-fitting parts**, unrivaled engineering, an integrated design approach, and innovative testing facilities and resources. These are clear advantages we have over all aftermarket companies, which give us the capability to push your car's power and torque to the next level.

## YOU CAN HEAR, SEE AND FEEL THE DIFFERENCE.

The difference in design, testing, engineering and quality between Mopar® and the aftermarket is absolutely clear when it comes down to your engine's **power, longevity and overall quality**. And in the end, that's what performance is all about.

## WE BUILD THE BEST PARTS – TO BUILD THE BEST ENGINES.

Many aftermarket providers seem to lose sight of one of the most important aspects of making an incredible part – the rest of the engine. At Mopar®, we're all about **performance without compromise**. That means our engine parts will enhance your vehicle without compromising everything else you like about your car. Is an individual part made with high-quality material and does it meet specifications? How does it fit and function within the system it's connected to? We make sure our parts go above and beyond answering these questions.

## WE TEST LIKE WINNING DEPENDS ON IT. PERIOD.

Imagine a Mopar® performance part and an aftermarket part side by side. They may look similar, but are they really? We put our performance parts through a **rigorous testing process**. And we take full advantage of the considerable FCA US LLC partnerships, resources and state-of-the-art testing facilities at our disposal. We're proud to say that all our performance parts pass our demanding standards before we even think about giving the OK to sell them to you.

- Extensive temperature testing in extreme cold and hot weather
- Corrosion tanks that simulate all-weather conditions
- X-raying of raw materials and finished parts to confirm a high level of quality
- Comprehensive crash testing for overall safety
- Simulated mileage tests to ensure optimal performance over time

# GEN III HEMI® ENGINES

**345 / 6.1L / 6.2L**  
**392 / 426**



Looking for legendary power? You're in the right place. The Gen III HEMI® Engine combines state-of-the-art technology with the free-flowing cylinder head design from the original 426 HEMI® Engine to deliver the raw horsepower, epic torque and an adrenaline-pumping sound that you've always wanted. From crate engines to bolt-on parts, Mopar® is ready to take your car to the next level – and beyond.



Crate HEMI® Engines **09**

Crate HEMI® Engine Kits **12**

Crate HEMI® Engine Accessories **14**

Blocks **16**

Crankshafts & Hardware **17**

Pistons & Connecting Rods **18**

Camshafts **18**

Cylinder Heads, Gaskets & Hardware **19**

Valvetrain **19**





# CRATE HEMI<sup>®</sup> ENGINES

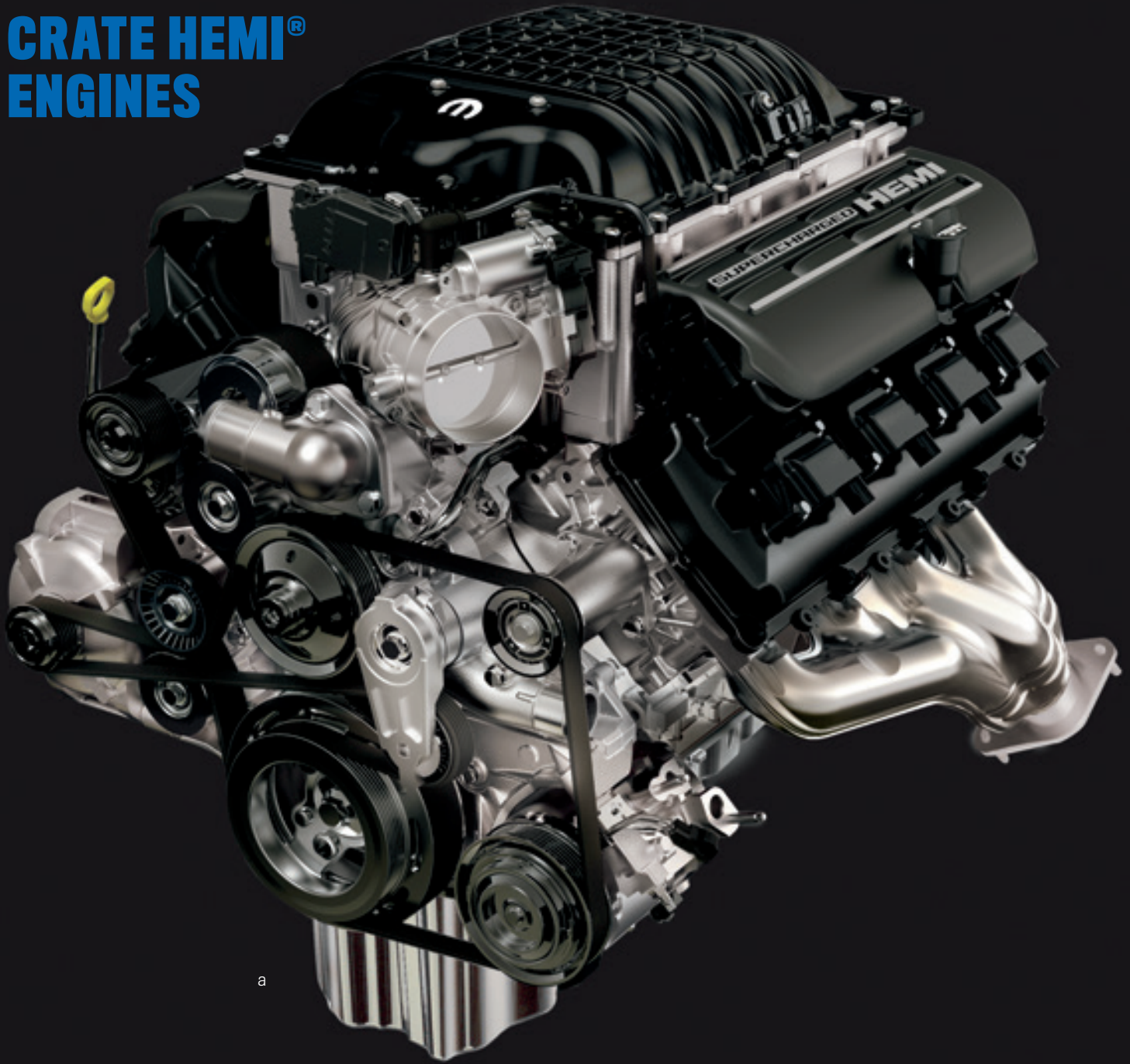

a

## 426 SUPERCHARGED CRATE HEMI<sup>®</sup> ENGINE

And now, the 426 HEMI<sup>®</sup> Engine itself – the one that started it all – is back with 426 cubic inches and 1,000 supercharged horsepower of hair-raising awesomeness. The 426 Supercharged HEMI<sup>®</sup> Engine is the first Mopar<sup>®</sup> crate engine with 1,000 horsepower. Along with its 950 lb.-ft. of torque, the complete engine assembly includes a water pump, flywheel, front sump oil pan, supercharger with throttle body, fuel injectors and coil packs.

### Features:

- 426 cu. in.
- 4.125 in. Bore
- 4.0 in. Stroke
- Cast Aluminum Block with 4-Bolt Powder Metal Caps
- Forged Steel Crank Material
- 3.0L Supercharger with Max 15 psi
- Forged 4340 H-Beam with ARP 2000 Bolts
- Forged Aluminum Piston Material
- Nodular Iron Camshaft
- Aluminum, Hemispherical Chamber Cylinder Heads
- 54.3mm Intake Valve Size
- 42mm Exhaust Valve Size
- 9.5:1 Compression Ratio
- 6,800 Peak RPM

426 Supercharged Crate HEMI<sup>®</sup> Engine, P/N **P5160194** (Fig. a)

<sup>1</sup>Not legal on pollution-controlled vehicles or vehicles registered for highway use.



b

## 6.2L SUPERCHARGED CRATE HEMI® ENGINE

You've asked for it and Mopar® delivered. The 6.2L Hellcrate Crate HEMI® Engine exerts a monstrous 707 hp and 650 lb.-ft. of torque. This complete engine assembly includes a water pump, flywheel and clutch, front sump oil pan, intake manifold with throttle body, fuel injectors and coil packs.

### Features:

- 376 cu. in.
- 103.9mm Bore
- 90.9mm Stroke
- Cast Iron Block with 4-Bolt Powder Metal Main Caps
- Forged Steel Crank Material
- Connecting Rods and Floating Pins with Diamond-Like Coating
- Forged Piston Material
- Nodular Iron Camshaft
- Valve/Lift duration @ 0.15mm. Int: 14.25 (0.561) mm - 278 deg. Hollow stems, Exh: 14.0 (0.551) mm - 304 deg. Sodium-filled stems
- 356 Aluminum, Hemispherical Chamber Cylinder Heads
- 54.3mm Intake Valve Size
- 42mm Exhaust Valve Size
- 9.5:1 Compression Ratio
- 6,200 Max RPM

6.2L Supercharged Crate HEMI® Engine, P/N **68303089AA** (Fig. b) . . . . . \$20,020.00

## 392 CRATE HEMI® ENGINE

Step up to the next level of performance with the SRT® 6.4L HEMI® Engine. With 485 hp and 475 lb.-ft. of torque, this complete engine assembly includes a water pump, flywheel and clutch, front sump oil pan, intake manifold with throttle body, fuel injectors and coil packs.

### Features:

- 392 cu. in.
- 103.9mm Bore
- 94.6mm Stroke
- Cast Iron Block with 4-Bolt Powder Metal Caps
- Forged Steel Crank Material
- Powdered Metal, Floating Pin Connecting Rods
- Hypereutectic Aluminum Piston Material
- Nodular Iron Camshaft
- Aluminum, Hemispherical Chamber Cylinder Heads
- 54.3mm Intake Valve Size
- 42mm Exhaust Valve Size
- 10.9:1 Compression Ratio
- 6,400 Peak RPM

6.4L Crate HEMI® Engine

P/N '68303090AA (Fig. c) . . . . . \$9,960.00



## 345 CRATE HEMI® ENGINE

Now you can own the same legendary 5.7L HEMI® Engine found in the 2015 and newer Dodge Challenger. With 383 hp and 417 lb.-ft. of torque, this complete engine assembly includes a water pump, flywheel and clutch, front sump oil pan, intake manifold with throttle body, fuel injectors and coil packs.

### Features:

- 345 cu. in.
- 99.5mm Bore
- 90.9mm Stroke
- Cast Iron Block (P/N 53021214DR) with 4-Bolt Powder Metal Caps
- Nodular Iron Crank Material
- Powdered Metal Connecting Rods
- Nodular Iron Camshaft
- Aluminum, Hemispherical Chamber Cylinder Heads
- 52.1mm Intake Valve Size
- 39.4mm Exhaust Valve Size
- 10.5:1 Compression Ratio
- 5,600 Peak RPM

5.7L HEMI® Engine

P/N '68303088AA (Fig. d) . . . . . \$6,480.00

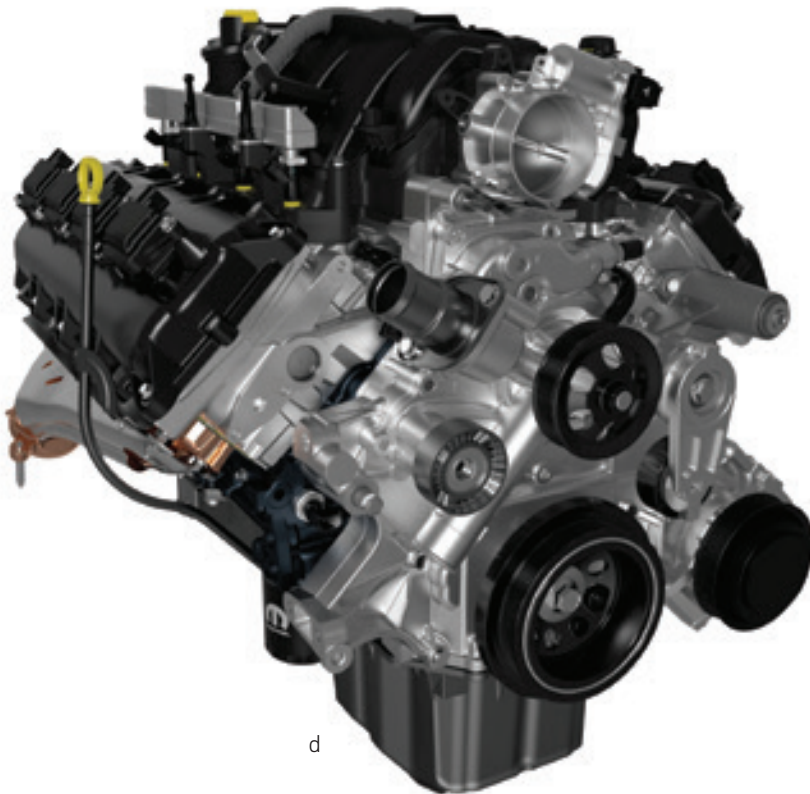

<sup>1</sup>Not legal on pollution-controlled vehicles or vehicles registered for highway use.

# CRATE HEMI® ENGINE KITS

## CRATE HEMI® “EC” ENGINE KITS

Now you can install HEMI® Engine power into your 1976–1995 emissions-controlled vehicle. Like our existing 392 and 345 Crate HEMI® Engine Kits, this kit includes everything you need to “plug and play” a modern HEMI® Engine into your project vehicle, with the addition of catalytic converters, two more oxygen sensors, an Evaporative Emission Control System (EVAP) purge solenoid, charcoal canister and air filter.

|                                 |            |
|---------------------------------|------------|
| 392 Crate HEMI® “EC” Engine Kit |            |
| <b>P/N 77072458AC</b> (Fig. d)  | \$3,295.00 |
| 345 Crate HEMI® “EC” Engine Kit |            |
| <b>P/N 77072459AC</b>           | \$3,295.00 |

## CRATE HEMI® ENGINE KITS

These Crate HEMI® Engine Kits are intended for older vehicles used on public highways, as well as off-road vehicles that are not used on public highways. Crate HEMI® Engine Kits are not intended for marine applications. Engines sold separately: 6.2L Supercharged Crate HEMI® Engine (P/N '68303089AA); 392 Crate HEMI® Engine (P/N '68303090AA); 345 Crate HEMI® Engine (P/N '68303088AA).

(See representative image: Fig. e)

### KITS INCLUDE:

- Accelerator Pedal
- Engine Wiring Harness
- Chassis Harness
- Power Distribution Center
- Fuel Pump Control Module (6.2L Supercharged Crate HEMI® Engine and 426 Supercharged Crate HEMI® Engine only)
- Ground Jumper
- O2 Sensors
- PCM
- Charge Air Temp. Sensor

|  |            |
|--|------------|
| 426 Supercharged Crate HEMI® Engine Kit  |            |
| <b>P/N '77072500</b>                     |            |
| 6.2L Supercharged Crate HEMI® Engine Kit |            |
| <b>P/N '77072452AB</b>                   | \$2,265.00 |
| 392 Crate HEMI® Engine Kit               |            |
| <b>P/N '77072454AF</b>                   | \$1,795.00 |
| 345 Crate HEMI® Engine Kit               |            |
| <b>P/N '77072455AF</b>                   | \$1,795.00 |



d



e

<sup>1</sup>Not legal on pollution-controlled vehicles or vehicles registered for highway use.

# CRATE HEMI® ENGINE ACCESSORIES

Complete your Crate HEMI® Engine Kit with these other simple solutions for modernizing your classic Mopar® ride.

## FEAD BASICS KIT

426 and 6.2L Supercharged Crate HEMI® Engine FEAD Basics Kit  
Includes alternator, power steering pump, pulleys and hardware.

**P/N 77072492** . . . . . \$696.00

392 and 345 Crate HEMI® Engines FEAD Basics Kit  
Includes alternator, tensioner, belt, idler pulleys and hardware.

**P/N 77072445** (Fig. f) . . . . . \$644.00

## 392 AND 345 CRATE HEMI® ENGINES POWER STEERING EXPANSION PACK

Make steering a snap! Use this expansion pack to reduce steering effort and get an overall smoother, more enjoyable ride.

New Power Steering Pump, Belt and Hardware

**P/N 77072448** (Fig. g) . . . . . \$232.00

## A/C EXPANSION KITS

Hot under the collar? Build your custom A/C solution using our fixed-displacement air conditioning pump.

426 and 6.2L Supercharged Crate HEMI® Engine A/C Expansion Kit  
New A/C Compressor, Wiring Pigtail, Belt and Hardware

**P/N 77072493** . . . . . \$387.00

392 and 345 Crate HEMI® Engines A/C Expansion Kit  
New A/C Compressor, Wiring Pigtail, Belt and Hardware

**P/N 77072446AB** (Fig. h) . . . . . \$360.00



f



h



g

## 45-DEGREE OIL FILTER

Make oil changes easier and cleaner by reducing cross-member interference of the oil filter.

Adapter, Oil Filter, Seals and Hardware

**P/N 77072447** (Fig. i) . . . . . \$98.00

## REAR SUMP OIL PAN KIT

Take the guesswork out of selecting an oil pan with this all-in-one solution. This kit gives you everything you need to use a rear pickup style pan. No additional parts are necessary for installation.

Oil Pan, Gaskets, Pickup Tube, Oil Indicator, Seals and Hardware

**P/N 77072450AB** (Fig. j) . . . . . \$200.00



## TREMEC TRANSMISSION

Known in its original equipment form as the "TR-6060," the Magnum is an aftermarket version of the same transmission found in many of today's most celebrated factory muscle cars, including the Dodge Challenger and Dodge Viper. Able to withstand a massive 700 lb.-ft. of torque while providing unbelievably crisp shifts.

Manual 6-Speed Transmission

**P/N PW100003AB** (Fig. k) . . . . . \$5,250.00



## EXHAUST MANIFOLD KIT

In a tight spot? Need an exhaust manifold solution for your 6.2L Supercharged/392/345 Crate HEMI® Engine project car build? These Jeep® Grand Cherokee SRT®-derived exhaust manifolds take up less room and offer a straight-down flange for compact installations.

Manifold, gaskets and hardware

**P/N 77072462** (Fig. l) . . . . . \$419.00

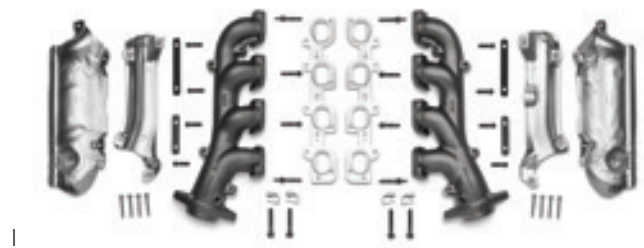

<sup>1</sup>Not legal on pollution-controlled vehicles or vehicles registered for highway use.

# BLOCKS

Starting an engine build from scratch? We've got factory-style blocks and hardware to give you a solid foundation.

## ALUMINUM BLOCKS

Gen III HEMI® Engine Aluminum Blocks are 100 pounds lighter than 6.4L production cast iron blocks!

They are designed to accommodate all parts from a 6.4L Gen III HEMI® Engine. (See representative image: Fig. m)

### FEATURES:

- Water jackets have been completely redesigned to accommodate a siamese bore. Extensive computational fluid dynamics (CFD) studies have been performed to balance thermal conditions for consistent and reliable performance.
- Crankcase clearance designed for a 4.125" stroke crankshaft. A 4.250" stroke will fit with machining around the oil drain-backs.
- Lifter bores can be opened to 1.060" for a bushed-style lifter.

Aluminum, 6.1L Bare Block,  
4.050" Finish Bore, No Lifter  
**P/N 'P5160139** . . . . . \$5,395.00

Aluminum, 6.1L Bare Block,  
4.055" Finish Bore  
**P/N 'P5160142** . . . . . \$5,650.00

Aluminum, 6.4L Block,  
4.085" Rough Bore, No Lifter  
**P/N 'P5160143** . . . . . \$5,395.00

Aluminum, 6.4L Bare Block,  
4.090" Finish Bore  
**P/N 'P5160144** . . . . . \$5,650.00

Aluminum, 7.0L Bare Block,  
4.120" Rough Bore, No Lifter  
**P/N 'P5160145** . . . . . \$5,395.00

Aluminum, 7.0L Bare Block,  
4.125" Finish Bore  
**P/N 'P5160146** . . . . . \$5,650.00

Aluminum, Race Bare Block, 4.120"  
Rough Bore with Lifter Bore  
**P/N 'P5160169** . . . . . \$5,900.00

Aluminum, Race Bare Block, 4.085"  
Rough Bore with Lifter Bore  
**P/N 'P5160170** . . . . . \$5,900.00

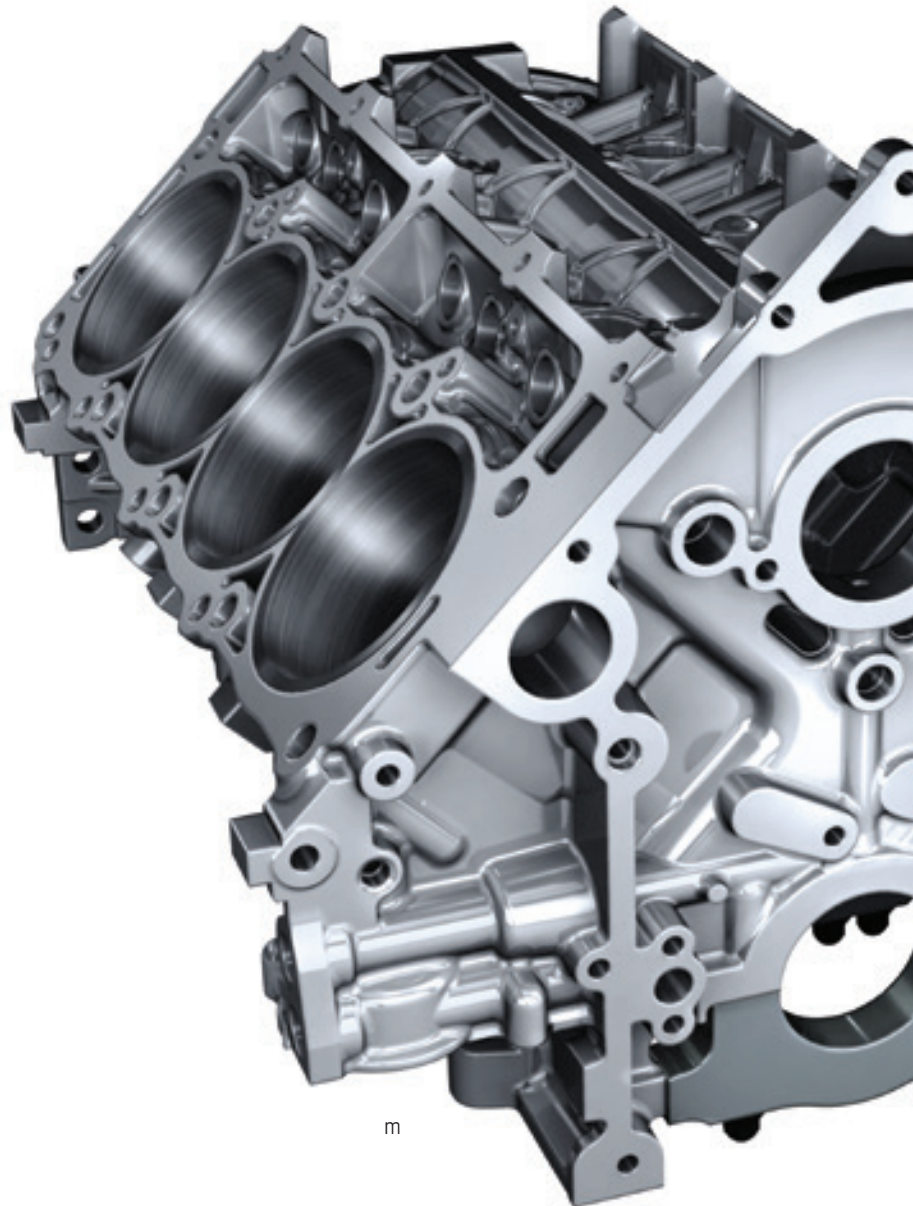

m





## CRANKSHAFTS & HARDWARE

If you're planning to make big power, better have a Mopar<sup>®</sup> Crankshaft with new attaching hardware to withstand the severe duty.

### FORGED STEEL CRANKSHAFT

High-strength, premium quality 4140 Forged Steel Crankshaft machined from proprietary forgings. For use in high-performance and race applications. Crank nose is machined for full-length damper key and features 2.100" rod throws and a Gen III HEMI<sup>®</sup> Engine eight-bolt flange, 3.795" stroke. For 6.1L HEMI<sup>®</sup> Engine block-based stroker applications.

4140 Forged Steel Crankshaft, 3.795" Stroke, 2.100" Rod Journals,  
392 Crate HEMI<sup>®</sup> Engine, **P/N 1P5153578** (Fig. n) . . . . . \$2,500.00

### CRANKSHAFT TRIGGER WHEEL KIT

Crankshaft Trigger Wheel Kit, includes Fasteners,  
6.1L/392 Crate HEMI<sup>®</sup> Engine. Does not fit 5.7L Crankshafts. **P/N P5155041** . . . . . \$63.00

### VIBRATION DAMPERS - SFI-APPROVED

ATI super damper, SFI-approved for street and race applications. Built specifically for high-performance applications, the ATI super damper provides balanced dampening of torsional crankshaft vibrations at all RPM. Comes with 360-degree, laser-etched timing marks. 5% O.D.

Damper, Crank, SFI, 5.7L HEMI<sup>®</sup> Engine Truck, Timing Cover, **P/N 1P5153631** . . . . . \$810.00

<sup>1</sup>Not legal on pollution-controlled vehicles or vehicles registered for highway use.

# PISTONS & CONNECTING RODS

Increase strength and durability and reduce reciprocating weight with Mopar® Pistons and Rods. (See representative image: Fig. o)

## PISTONS

Features intake valve notch and 10.5:1 compression ratio.

Forged aluminum. Designed for production 4.055" bore and 3.795" stroke. Uses full-floating 0.927" Pin. 10.5:1 compression ratio. Uses Stock Piston Rings. 6.1L/392 Crate HEMI® Engine Set, **P/N 1P5153635**. . \$1,495.00

## CONNECTING ROD BOLT KIT

5.7L Crate HEMI® Engine, **P/N 1P5153480**. . . . . \$145.00

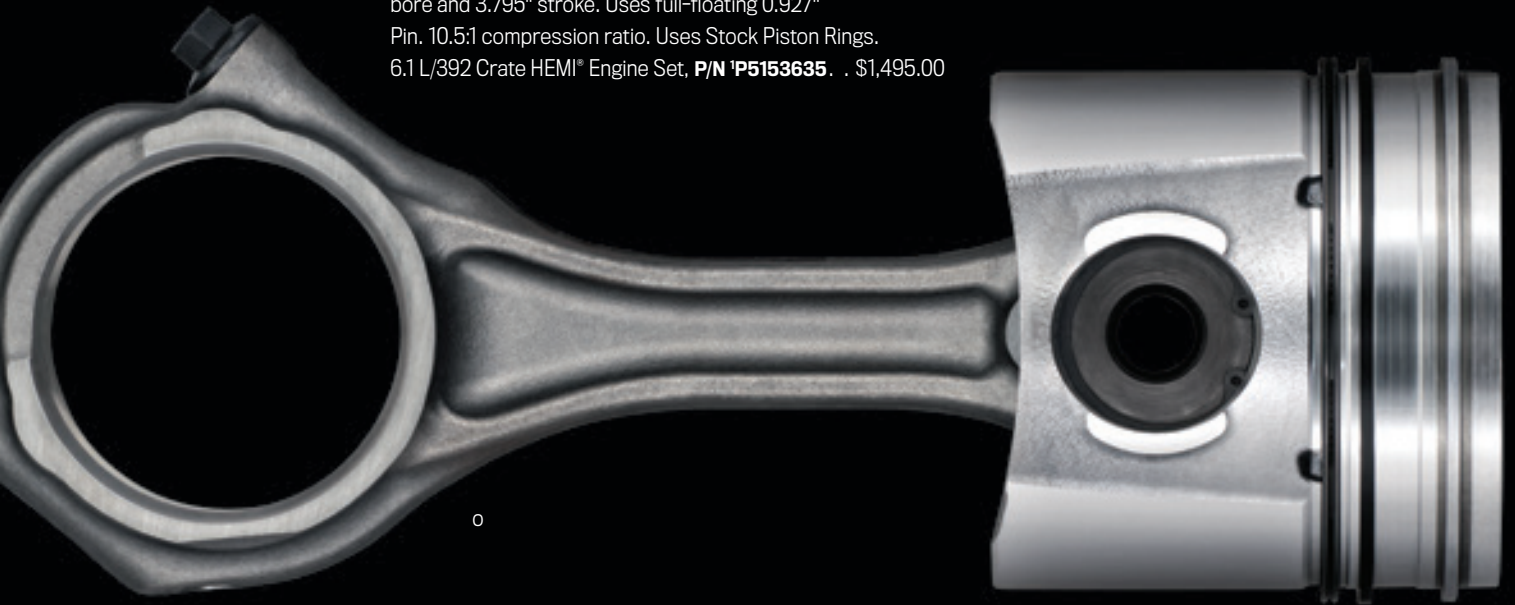

o

# CAMSHAFTS

The Mopar® Performance Camshaft is based on the popular COMP series of camshafts with slightly modified cam timing to increase low-end torque without sacrificing high-end power (thanks to an optimized VCT calibration). The cam measures 222/230 at 0.050" (270/282 at 0.006") and has just under 0.600" lift with a 115-degree lobe separation angle.

## STAGE 2 PERFORMANCE CAMSHAFT WITH PHASE LIMITER

2009-2016 5.7L Eagle/GEN III HEMI® Engine  
**P/N 5160018** (Fig. p) . . . . . \$1,060.00



p

# CYLINDER HEADS, GASKETS & HARDWARE

Mopar® Cylinder Heads are where it all comes together – spark, fuel and air. This is where the power is made. Cast iron or aluminum, Mopar® has the heads to top off your engine build.

## PARTIAL-MACHINED CYLINDER HEADS

2011-2016, 6.4L, LH, P/N 05037449BF . . . . . \$938.00

## RAW CYLINDER HEAD CASTING

2011-2016, 6.4L, P/N 05037448BG . . . . . \$955.00

2011-2016, 6.4L, P/N 05037369BD . . . . . \$437.00

## CYLINDER HEAD HARDWARE

Stud Set, 6.1L HEMI® Engine, P/N P5155517 . . . . . \$499.00

## MOPAR® PERFORMANCE STAGE 3 PORTED CYLINDER HEAD SET

Open up the potential of your 2009-Current 5.7L Eagle GEN III HEMI® Engine with these CNC-ported Stage 3 Cylinder Heads. Features include new improved castings, improved airflow (25 intake/20 exhaust CFM over stock) and Mopar® Performance Springs P/N P5160074. These components work in concert with the Mopar® Performance Camshaft P/N P5160018 for the 5.7L/6.4L HEMI® Engine to provide added performance and rigidity.

2009-2017, 5.7L "Eagle" HEMI® Engine  
P/N P5160027 (Fig. q) . . . \$2,575.00



q

# VALVETRAIN

## TIE BARS

Tie bars are intended to increase the stiffness of the rocker shaft attachment to the cylinder head. Tie bars also help enhance cylinder head durability and valvetrain stability when running the increased RPM and load required by motorsport applications. They are designed to work with current production rocker shaft assemblies and attaching fasteners. Note that when used with production plastic valve covers, the covers will require a slight clearance notch to be added at each end. (See representative image: Fig. r)

2006-2008 5.7L HEMI® Engine, 2006-2010 6.1L HEMI® Engine, P/N P5155654 . . . . . \$424.00

2009-2016 5.7L Eagle, 2011 6.4L P/N P5155655 . . . . . \$411.00



r



s

## VALVE SPRINGS

The Mopar® Performance Valve Spring is the culmination of over a year's worth of design, engineering and testing. The result is a spring that reliably controls the valvetrain even when it is subjected to aggressive and high-lift camshaft profiles (up to 0.625" lift), such as the Mopar® Performance 5.7L Cam (P/N P5160018).

2009-2017 5.7L Eagle, 2016 6.4L SRT® Apache GEN III HEMI® Engine, Valve Spring Kit, P/N P5160074 (Fig. s) . . . \$262.00

<sup>1</sup>Not legal on pollution-controlled vehicles or vehicles registered for highway use.



# GEN II HEMI<sup>®</sup> ENGINES 426 / 572



Legends aren't built overnight but over generations. The HEMI® Engine ruled the streets, the strip and the circle track in the 1960s and early 70s – and Mopar® was right there for all of it. Today, it's our goal to not only keep the original 426 Race HEMI® Engine and the 426 Street HEMI® Engine legacies alive but to see them thrive. Mopar® offers a full range of Gen II HEMI® Engine Performance Parts and we're driven to bring the original HEMI® Engine spirit into the 21st century – just like you.

Engine Hardware **22**

Blocks **22**

Crankshafts & Hardware **22**

Timing Chains & Sprockets **23**

Vibration Dampers **23**

Forged Aluminum Pistons **23**

Camshafts, Lifters & Hardware **24**

Cylinder Heads, Gaskets & Hardware **25**

Valvetrain Hardware **26**

Rocker Arms, Shafts, Stands & Hardware **26**

Valve Covers & Hardware **27**

Oiling Components **28**

Engine Cooling **29**

Engine Installation Components **29**

Intake Manifolds, Hardware & Gaskets **30**

# ENGINE HARDWARE

These round, press-in engine core plugs fit original style standard or Mopar® Race Cast Iron Blocks.

## CORE PLUGS

Brass, 426 HEMI® Engine and Big Block

**P/N P5249708** . . . . . \$32.30

## ENGINE TEARDOWN GASKET SET

All gaskets needed for complete HEMI® Engine teardown, including oil pan, cylinder head, valve cover, timing chain case cover, intake manifold and oil pump.

1966 and Newer 426 HEMI® Engine, Set

**P/N P3412083** . . . . . \$156.00



# BLOCKS

Starting an engine build from scratch? We've got factory-style blocks and hardware to give you a solid foundation.

## CAST IRON GEN II HEMI® ENGINE BLOCKS

Cast Iron Siamese-Bore 426 HEMI® Engine Blocks give engine builders the flexibility for a larger bore. Blocks can be bored to the stock size of 4.25" but are specifically designed to be bored larger. Mopar® recommends that you sonic check each block if you plan to exceed as-shipped bore diameters.

Cast Iron, 4.250" Finished Bore

**P/N P5160149AC** . . . . . \$3,800.00

Cast Iron, 4.500" Finished Bore

**P/N P5160150AC** . . . . . \$3,800.00

Cast Iron, 4.245" Rough Bore

**P/N P5160151AC** . . . . . \$3,800.00

Cast Iron, 4.245" Rough Bore Without Lifters

**P/N P5160152AC** . . . . . \$3,800.00

# CRANKSHAFTS & HARDWARE

If you're planning to make big power, better have a Mopar® Crankshaft with new attaching hardware to withstand the severe duty.

## FORGED CRANKSHAFTS - MACHINED

High-strength, high-quality forged crankshafts machined from 4340 steel. For high-performance race applications. Eight-bolt flange.

3.75" Stroke, Full Radius, Eight-bolt, Balanced, 426 HEMI® Engine/Wedge/RB Engine, Race

**P/N P5007251** . . . . . \$1,360.00

4.15" Stroke, Full Radius, Eight-bolt, Balanced, 426 HEMI® Engine/ Wedge/RB Engine, Race 1966 and Newer 426 HEMI® Engine

**P/N P5007250** . . . . . \$1,495.00

## CRANK BOLT SET

Used to attach the vibration damper to the crankshaft.

2.25" Length, 426 HEMI® Engine/Big Block/Small Block/with Aftermarket Dampers

**P/N P5249557AB** . . . . . \$11.46



# VIBRATION DAMPERS

Reduce the chance of any vibration from your crankshaft rotation with a Mopar® Vibration Damper. Standard OE bolt patterns apply.

## VIBRATION DAMPERS - SFI-APPROVED

Features a steel ring and a universal six-bolt front pulley mount pattern.

1966-1971 426 HEMI® Engine, Steel Vibration Damper  
**P/N 1P5249699** (Fig. b) . . . . . \$458.00

## DAMPER DEGREE TIMING TAPE

Marked in 90° increments. Self-adhesive strip adheres to the crank vibration damper for clear identification of marks. Permits initial total spark advance up to 60° instead of only 10°-15° as on the chain case timing tab.

**P/N 1P4529070AB** . . . . . \$9.75

## OIL SLINGER

Protects seal from excessive oil contact. Forces lubricant oil into chain.

496 HEMI® Engine/Big Block/Small Block/Slant Six/3.9L V6  
**P/N P5249636** . . . . . \$9.75

# TIMING CHAINS & SPROCKETS

Timing is everything in engines too. Add new timing chains and sprockets to your engine, then cover it with factory covers and seals.

## DOUBLE ROLLER CHAIN AND SPROCKET

Provide added durability and decreased rotational friction versus the production silent chains. Three machined keyways in crank sprocket to adjust cam timing. Kits include magnafluxed sprockets and roller timing chain.

3-Bolt Mount, B/RB/HEMI® Engine  
**P/N 1P5249269** (Fig. a) . . . . . \$115.00

## TIMING CHAIN COVER

Includes cover, seal and gasket, Chrome  
**P/N 1P4349816AB**. . . . . \$54.00

## BOLT SET, TIMING CHAIN, CHROME

Engine chrome dress-up projects are incomplete without chrome bolts.

Bolt Set, Front Timing Cover, Chrome  
**P/N P4452795** . . . . . \$29.10

## FRONT COVER SEAL AND GASKET

Front Cover Seal, 426 HEMI® Engine/Big Block  
**P/N P4876280** . . . . . \$14.60

Front Cover Gasket, 426 HEMI® Engine/Big Block  
**P/N P4876769** . . . . . \$9.75

a

b

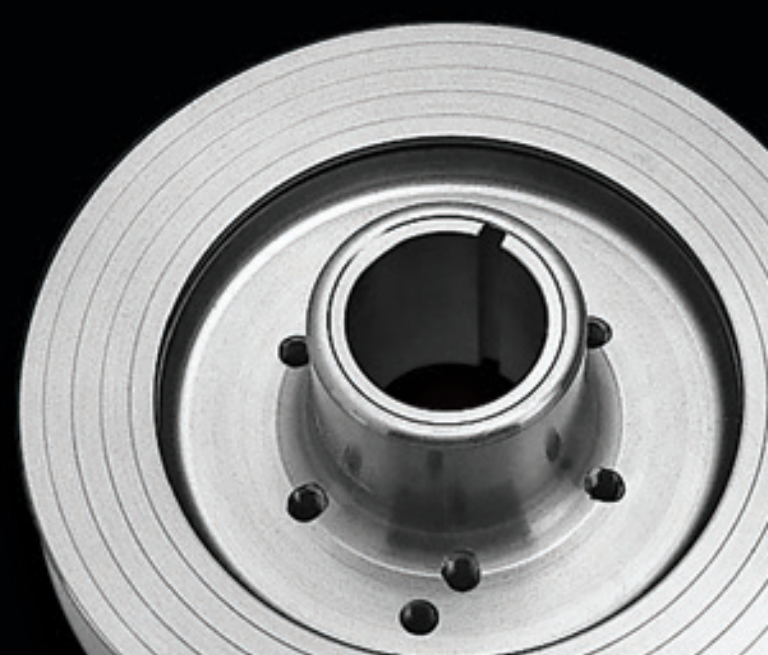

# FORGED ALUMINUM PISTONS

Features valve notches and floating pin. Top and second rings measure 1/16" while oil rings measure 3/16".

4.500" Bore, 4.500" Stroke, 6.860" Rod, 12.5:1 compression ratio,  
 426 HEMI® Engine, **P/N 1P4876026** . . . . . \$100.00

<sup>1</sup>Not legal on pollution-controlled vehicles or vehicles registered for highway use.

# CAMSHAFTS, LIFTERS & HARDWARE

From mild to wild, Mopar® has camshafts, lifters and hardware that provide the right combination of power and idle quality for any application. (See representative image: Fig. c)

## CAMSHAFTS, PURPLE SHAFT

All Mopar® Purple Shaft Performance Camshafts are designed, developed, dyno'd and track-tested by engineers for increased power and RPM potential while maintaining reliability and the best possible low-speed characteristics, including torque and idle quality. Each package contains the camshaft, tappets and instruction sheet. For 426-based HEMI® Engines. Duration @ 0.050" 241° Intake/241° Exhaust. Intake Centerline 106°. Lift 0.484" Intake/0.475" Exhaust. Recommended Springs P/N P3690933

- Hydraulic, 1970-1971 Street, Purple, **P/N 'P4529315AE** . . . . . \$415.00
- Mechanical, 1966-1969 Street, Purple, **P/N 'P4529316AE** . . . . . \$415.00

## HYDRAULIC, HIGH-PERFORMANCE CAMSHAFTS

- 0.566/0.544 Lift, 280/288 Adv. Duration, **P/N 'P5155620** . . . . . \$415.00
- 0.569/0.548 Lift, 286/294 Adv. Duration, **P/N 'P5155621** . . . . . \$415.00
- 0.574/0.551 Lift, 292/300 Adv. Duration, **P/N 'P5155622** . . . . . \$415.00
- 0.502/0.486 Lift, 278/278 Adv. Duration, **P/N 'P5155618** . . . . . \$415.00
- 0.534/0.517 Lift, 292/292 Adv. Duration, **P/N 'P5155619** . . . . . \$415.00

## MECHANICAL, HIGH-PERFORMANCE CAMSHAFTS

- 0.811/0.793 Lift, 322/337 Adv. Duration, **P/N 'P5155626** . . . . . \$415.00
- 0.822/0.793 Lift, 317/337 Adv. Duration, **P/N 'P5155625** . . . . . \$415.00
- 0.518/0.502 Lift, 270/270 Adv. Duration, **P/N 'P5155623** . . . . . \$415.00

## MECHANICAL TAPPET

- Sold individually.
- 0.0005" Undersize, **P/N 'P2843177** . . . . . \$15.30

## ROLLER TAPPET SET

- Includes matched pair of roller tappets with guide bar.
- For Brushed Lifter Bores, HEMI® Engine/Big Block. Set.
- (Limited Quantity) **P/N 'P4452920** . . . . . \$65.00

## HYDRAULIC TAPPET

- Sold individually.
- HEMI® Engine/Big Block, **P/N 'P4006767AB** . . . . . \$8.55

## PUSHRODS

Engineered to be installed in your HEMI® Engine rebuilding project. Pushrods are 3/8" diameter and sold individually for service (426 HEMI® Engine).

- Hydraulic Pushrod, Overall Length 11.62" Exhaust  
**P/N 'P4529548** . . . . . \$15.75
- Mechanical Pushrod, Overall Length 10.81" Intake  
**P/N 'P44529549** . . . . . \$15.75

(Hydraulic pushrods are made to 1970-1971 OEM lengths for use with OEM height lifters. Check overall lengths for your application before purchase.)

## CAMSHAFT BEARINGS

- Complete set.
- Babbitt Camshaft Bearings, 426 HEMI® Engine/Big Block Engines  
**P/N P5249711** . . . . . \$54.00

## OFFSET CAMSHAFT BUSHING SET

Includes five bushings: 2°, 4°, 6°, 8° offset, and one on-center bushing. Color guide only – check installations with dial indicator. Gold = 2°, Copper = 4°, Silver = 6°, Black = 8°.

- 426 HEMI® Engine/Big Block/Slant Six Engines  
**P/N P3690936** . . . . . \$33.20

## CAMSHAFT SPROCKET ATTACHING HARDWARE

- Bolt, for One-Bolt Mounting, 426 HEMI® Engine/Big Block Engines  
Sold individually, **P/N P6030269** . . . . . \$3.30
- Bolt, for Three-Bolt Mounting, 426 HEMI® Engine/Big Block Engines  
Sold in set of three, **P/N P5007801** . . . . . \$35.00
- Bolt Sprocket, for Three-Bolt Mounting, 383/440/426  
Sold individually, **P/N P2120930** . . . . . \$13.75





# CYLINDER HEADS, GASKETS & HARDWARE

Mopar® Cylinder Heads are where it all comes together – spark, fuel and air. This is where the power is made. Cast iron or aluminum, Mopar® has the heads to top off your engine build.

## CYLINDER HEADS, ALUMINUM

Interchangeable with production cast iron head and offers a weight reduction of 50 lbs. per engine set. Features include single plug per cylinder (capability for dual), common 2.25" intake and 1.94" exhaust valve machining, 170cc combustion chamber, valve seats and guide inserts. Includes valves, springs, retainers and keepers.

Bare, 426 HEMI® Engine, **P/N 1P5153779** . . . . . \$1,300.00

## CYLINDER HEADS, CAST IRON

Designed for more power. Stiffer and stronger than original; increased material permits porting for improved airflow. Features the same outward appearance as the original 1966-1971 heads, except for shape of alternator boss. All components attach the same as original (intake and exhaust valves, valve guides, seats, rocker gear, etc.). Features 170cc combustion chamber and 2.25" intake and 1.94" exhaust valve machining.

Assembly, as used on 426 Crate HEMI® Engine  
**P/N 1P4876855** . . . . . \$1,455.00

## CYLINDER HEAD GASKET, COMPOSITE MATERIAL

Can be used for standard and high-compression (up to 12.5:1) 426-based HEMI® Engines. These premium, high-quality head gaskets offer maximum sealing and have a thickness of 0.040" to 0.042". Sold in pairs.

4.250"-4.310" Bore Range, **P/N P4529456**. . . . . \$200.00

4.380"-4.500" Bore Range, **P/N P4876071**. . . . . \$202.00

## CYLINDER HEAD HARDWARE

Bolt Set for current replacement blocks. Includes Head Bolts, Washers, Nuts and Studs (4.50" long) for one Cylinder Head, 426 HEMI® Engine.

**P/N P5155279** . . . . . \$340.00

Hardware Kit, includes Dowels (10)/and Freeze Plugs (4), 426 HEMI® Engine.

**P/N P5249570** . . . . . \$21.95



<sup>1</sup>Not legal on pollution-controlled vehicles or vehicles registered for highway use.



d



e

## VALVETRAIN HARDWARE

Making big power requires internal components that can withstand the punishment. Choose from valvetrain hardware designed for everything from street restoration applications to full-out race gear.

### VALVE SEALS

Made of high-temp Viton® material, these valve seals feature a full or semi-umbrella shape for best dual-purpose use. Not recommended for use with dual valve springs. (See representative image: Fig. d)

- Valve Seals, 5/16" Valve Stem, 0.530" Guide, 426 HEMI® Engine and 5.2L/5.9L Magnum/Jeep® Brand Engines.  
Sold in sets of 16, **P/N 'P5249661** . . . . . \$20.50
- Valve Seals, 5/16" Valve Stem, Intake, **P/N 'P4876709** . . . . . \$20.50

### VALVE SPRINGS

High-pressure valve springs can be used on exhaust and intake valves. Feature a shorter, fully compressed height and allow for increased valve lift. With a single spring, the damper is installed inside the main spring; with a dual spring, the damper is installed between the inner and outer springs. Check the actual retainer listing for added installed height, materials and lock size. For 426-based HEMI® Engines. (See representative image: Fig. e)

- Single Valve Spring, 0.430"/0.460" Lift, **P/N 'P4286812** (Fig. e) . . . . \$13.20
- Single Valve Spring, 0.440"/0.500" Lift, **P/N 'P3690933** . . . . . \$11.10
- Double Valve Spring, 0.590"/0.640" Lift, **P/N 'P4876064** . . . . . \$15.15

### VALVE SPRING RETAINERS

Available in three levels of performance: Steel for restoration, Chrome Moly for heavy-duty applications and Titanium for top-level race performance. Sold individually.

- Steel, 5/16", Single, Standard Height, 7°, **P/N P4452769** . . . . . \$19.10
- Chrome Moly, 5/16", Single/Dual, Standard Height, 7°  
**P/N P4529288** . . . . . \$14.50
- Titanium, 3/8", Triple, .060" Increase, 10°, **P/N P4286775** . . . . . \$25.00



f

## ROCKER ARMS, SHAFTS, STANDS & HARDWARE

Start your engine build with a fresh set of rocker arms, shafts and hardware to guarantee your valve gear is singing in perfect harmony.

### ROCKER ARMS, MECHANICAL

Made of SAE 1041 forged steel, featuring hardened valve tip pads (to help prevent scuffing) and internal bushings. Can serve as a replacement for original production rockers. Fits both cast iron and aluminum 426 HEMI® Engine heads. Sold individually. May require grinding on block and head for pushrod clearance.

- 1.65 Ratio, Exhaust, **P/N 'P4529708AC** (Fig. f) . . . . \$154.00
- 1.70 Ratio, Exhaust, **P/N 'P4529707AC** . . . . . \$111.00

### ROCKER ARM SET

Designed and patented by HEMI® Engine legend Ray Barton. If your HEMI® Engine is running all-out, you need a full-roller rocker system that maintains valvetrain geometry throughout the RPM and rocker arm travel ranges. Provides easy access to valve springs on race day so you can make critical adjustments and changes quickly. Case hardened and tempered shafts, 7/16" diameter adjusters and jam nuts.

- Roller, Aluminum, Race, 426 HEMI® Engine,  
Set, **P/N 'P5153782** . . . . . \$5,815.00
- 1.55 Ratio, Exhaust, **P/N 'P5249604AB** . . . . . \$163.00

# VALVE COVERS & HARDWARE

Your engine project will get noticed with a set of Mopar® Valve Covers in black wrinkle finish or chrome, cast aluminum or stamped steel.

## VALVE COVERS, CAST ALUMINUM, BLACK WRINKLE

Painted black wrinkle and finned with HEMI® logo cast in. For single-plug cylinder head applications. Uses Street HEMI® Engine valve cover rail. Gaskets included. Takes P/N P5249949 Oil Cap.

1966 and Later Street HEMI® Engine, Set.  
P/N P5007796 (Fig. g) . . . . . \$975.00

## VALVE COVERS, OE STAMPED STEEL, BLACK WRINKLE

These Original Equipment (OE) valve covers have a bold and classic look for all 1970-1971 426 HEMI® Engines. They offer better gasket sealing and durability due to the rubber coated alternator wiring looms and spark plug wire brackets. Set includes: left and right valve covers, hold-down studs and nuts, chrome oil fill cap and grommets for PCV and breather.

1970-1971 426 HEMI® Engine, Set.  
P/N P4510577AB . . . . . \$679.00

## VALVE COVERS

Cast Aluminum, Black, 572 HEMI® Engine. Set.  
P/N P5155433 . . . . . \$472.00

Cast Aluminum, Orange 572 HEMI® Engine. Set.  
P/N P5155432 . . . . . \$482.00

Gasket, Valve Cover, Rubber-Reinforced Cork, Replacement, 1966 and Newer Street HEMI® Engines, Two per Set. P/N P4120353 . . . . . \$46.80

## BREATHER CAP, CHROME

For use with stamped steel HEMI® Engine valve covers, both black wrinkle and chrome.

1964-1969 426 HEMI® Engines, Push-In.  
P/N P4529896 . . . . . \$53.60



## ROCKER SHAFTS

Chrome rocker shafts for use with mechanical valve gear. Sold individually. Exhaust, On-Center, 426 HEMI® Engine, P/N P5249632 . . . . . \$172.00

## ROCKER SHAFT SPRINGS

For use on all production-based HEMI® Engine valve gear. Used to locate rockers on the shaft. Includes 14 long springs and two short springs. Package contains one engine set.

426 HEMI® Engine, P/N P4452827 . . . . . \$37.00

## ROCKER SHAFT STAND

Blue anodized, extruded aluminum rocker shaft supports for 426 HEMI® Engines. Complete engine set includes 10 pieces, plus hardware.

426 HEMI® Engine, P/N P5249505 . . . . . \$1,435.00

## ROCKER SHAFT END PLUGS

Sold as a set of four. Does not fit aftermarket rocker shafts.

426 HEMI® Engine/Big Block, P/N P5249633 . . . . . \$9.75

## ROCKER SHIM PACKAGE

Use to improve adjustable rocker arm-to-valve tip alignment, 0.015" thick. 12 per set, for 426 HEMI® Engine.

Set, 0.015" Thick, 0.878" I.D., 1.246" O.D., P/N P3690896 . . . . . \$13.60

<sup>†</sup>Not legal on pollution-controlled vehicles or vehicles registered for highway use.

# OILING COMPONENTS

Oil is the lifeblood of your high-horsepower engine. Keep it flowing with Mopar® Oil Pickups, Pumps, Oil Pans and more.

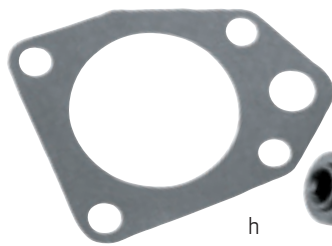

h



## OIL PICKUP AND SCREEN ASSEMBLIES

- Eight-Quart, use with Oil Pan P/N P5007816.  
**P/N P5007818** . . . . . \$60.00
- Five-Quart, 1966-1969 426 HEMI® Engines.  
**P/N P4529566** . . . . . \$32.30
- Six-Quart, 1970-1971 426 HEMI® Engines.  
Use with Oil Pan P/N P4529884.  
**P/N P4529567** . . . . . \$38.55

## OIL PUMP ASSEMBLY

- This high-output assembly provides a 25% increase in oil volume. Ideal replacement for stock pump in high-performance applications.  
Use with P/N 02084355 Service Gasket.  
**P/N P4286590** (Fig. h) . . . . . \$121.00

## OIL PRESSURE RELIEF SPRING

- Delivers up to 70 lbs. of oil pressure. Includes cap. Use to oil the pump assembly.  
B/RB/HEMI® Engines, **P/N P4286571** . . . . . \$6.60

## OIL PUMP PRIMING SHAFT

- Special hardened steel priming shaft fits on any 3/8" or larger drill. Pressurizes oil galleries to ensure against dry starts and engine damage. **P/N P4286800** . . . . . \$9.75

## DISTRIBUTOR DRIVE GEAR ASSEMBLIES

- Features a hardened tip shaft with full radius blend from hex to round and pinned gears.  
Flat Tappet Cams, **P/N P3571071** . . . . . \$106.00  
Flat Tappet Cams, Milodon Oil System, **P/N P3412064** . . . . \$105.00  
Roller Tappet, Aluminum-Bronze Gear, **P/N P3690875** . . . . \$165.00  
Roller Tappet, Aluminum-Bronze Gear, Milodon Oil System, **P/N P3690876** . . . . . \$227.00

## OIL FILTER - PERFORMANCE

- Engineered to meet the demands of heavy-duty and high-performance applications. Filter is black with Mopar® Omega M logo.  
6-/8-Cylinder Engines.  
**P/N P4452890** (Fig.i) . . . . . \$11.45

## OIL PANS

- Includes factory-engineered and approved oil pan, drain plug and washer. Center sump style is used on passenger car applications.  
Eight-Quart, HEMI®/Big Block Engines.  
**P/N P5007816** (Fig. j) . . . . . \$193.00

## WINDAGE TRAYS

- Designed to provide improved engine lubrication by reducing interior windage at higher engine speed. Packages include tray and two pan gaskets. (See representative image: Fig. k)  
3.75" Stroke, **P/N P4120998** . . . . . \$32.30  
4.15" Stroke, **P/N P5007345** . . . . . \$79.00

## OIL PAN GASKETS

- For Big Block and HEMI® Engine applications. Note that two are required for Windage Tray applications.  
Race, Set of two. **P/N P4452099** . . . . . \$16.25  
Sold individually. **P/N P3412049** . . . . . \$14.60

## OIL PAN BOLT SET

- 426 HEMI® Engine/Big Block/Small Block.  
Set of 20 Bolts. **P/N 4120613** . . . . . \$14.60



j



i



k

## ENGINE COOLING

Keep your cool with Mopar® Water Pumps, Thermostats and Fan packages.

### WATER PUMP INSTALLATION KIT

Includes water pump gasket, pump housing gasket, plugs, water pump screws, and long and short housing screws.

**P/N P5007449** ..... \$43.60

### THERMOSTAT HOUSING, CHROME

This high-quality chrome thermostat housing is made of heavy-duty material. Includes gasket and two chrome bolts.

Up to 1978, V8, Water Neck, **P/N P4286759AB** ..... \$20.45

## ENGINE INSTALLATION COMPONENTS

Mopar® offers these much-needed parts to make your 426 HEMI® Engine original production or crate engine installation easier. Each part sold individually, unless noted.

Bracket, Coil, 426 HEMI® Engine.  
**P/N P4510285** ..... \$25.85

Brackets, Engine Mounting, LH/RH,  
426 HEMI® Engine, Engine Set.  
**P/N P4510287** ..... \$331.00

Insulator, Right Hand, 426 HEMI® Engine.  
**P/N P4510289** ..... \$46.95

Pulley, Crank Spacer, 3/16" Thick, 426 HEMI® Engine.  
**P/N P4510283** ..... \$88.00

Pulley, Crank, Belt Groove with Power Steering,  
426 HEMI® Engine. (Limited Quantities)  
**P/N P4510281** ..... \$238.00

Pulley, Crank, without Power Steering,  
426 HEMI® Engine.  
**P/N P4510286** ..... \$228.00

Pulley, Water Pump, 426 HEMI® Engine.  
**P/N P4510282** ..... \$215.00

# INTAKE MANIFOLDS, HARDWARE & GASKETS

Make sure your engine breathes right with a Mopar® Intake Manifold that accepts standard carburetors, in single- or dual-plane configurations.

## SINGLE-PLANE INTAKE MANIFOLD

For HEMI® Engines with serious airflow requirements. This single-plane intake manifold was designed for 500-plus-inch HEMI® Engines or for applications intending to make over 600 horsepower. The intake manifold can be the limiting factor in a heavy-breathing engine like a Mopar® HEMI® Engine. Don't let your top end get all bottled up. Increased plenum volume over most dual-plane manifolds. Smooth transition to intake runners from plenum increases airflow velocity. Integral valley cover pan cleans things up nicely. Carburetor flange machined for 4150-series Holley.

Aluminum, Holley 4150 Series, 426 HEMI® Engine.

**P/N 'P5153781** ..... \$728.00

## DUAL-QUAD INTAKE MANIFOLD - HOLLEY CARB

This new aluminum inline dual-quad HEMI® Engine intake manifold is based on the marine version and is built from the original tooling. Machined to accept aftermarket AFB or Holley carburetors (P/N P4452778 rear, P/N P4452779 front). Will fit production 426 HEMI® Engine heads and has provisions for manifold heat and power brakes. It retains the stock height of the production 1966-1971 Street HEMI® Engine AFB intake manifold. Production AFB air cleaner baseplate/lid will need to be changed or modified. Some OE and aftermarket linkage components and fuel lines are needed to complete the installation.

Cross Ram, Aluminum, 426 HEMI® Engine.

**P/N 'P4510633** (Fig. m)..... \$725.00

## INLINE DUAL-QUAD INTAKE MANIFOLD - AFB CARB

Designed specifically for the 426 Street HEMI® Engine, this popular 1966-1971 manifold uses original Carter AFB carburetors and maintains mounting bosses for throttle return brackets. Features factory casting numbers and Pentastar logo.

Aluminum, 426 Street HEMI® Engine.

**P/N 'P5153737** ..... \$495.00

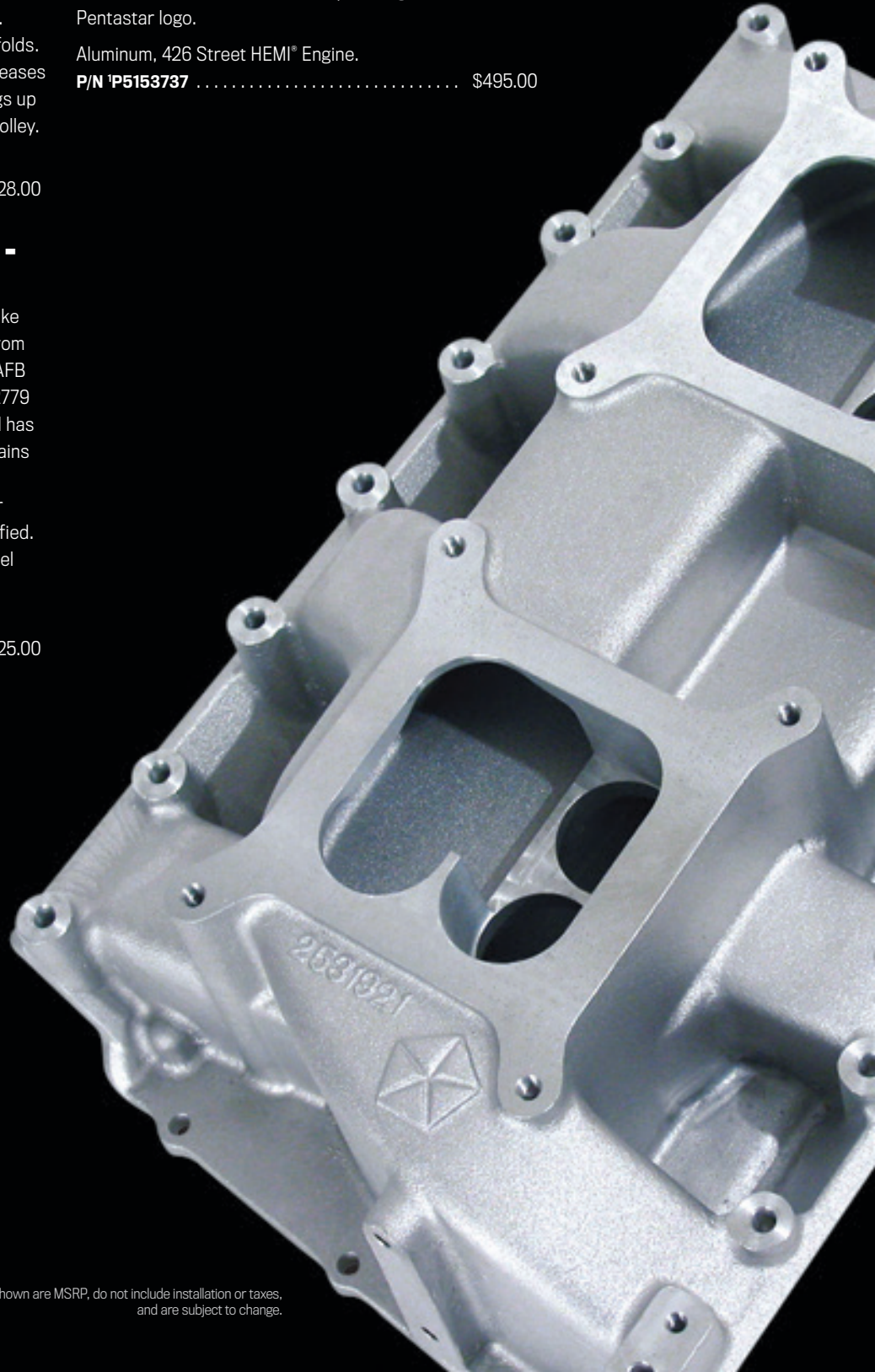

m

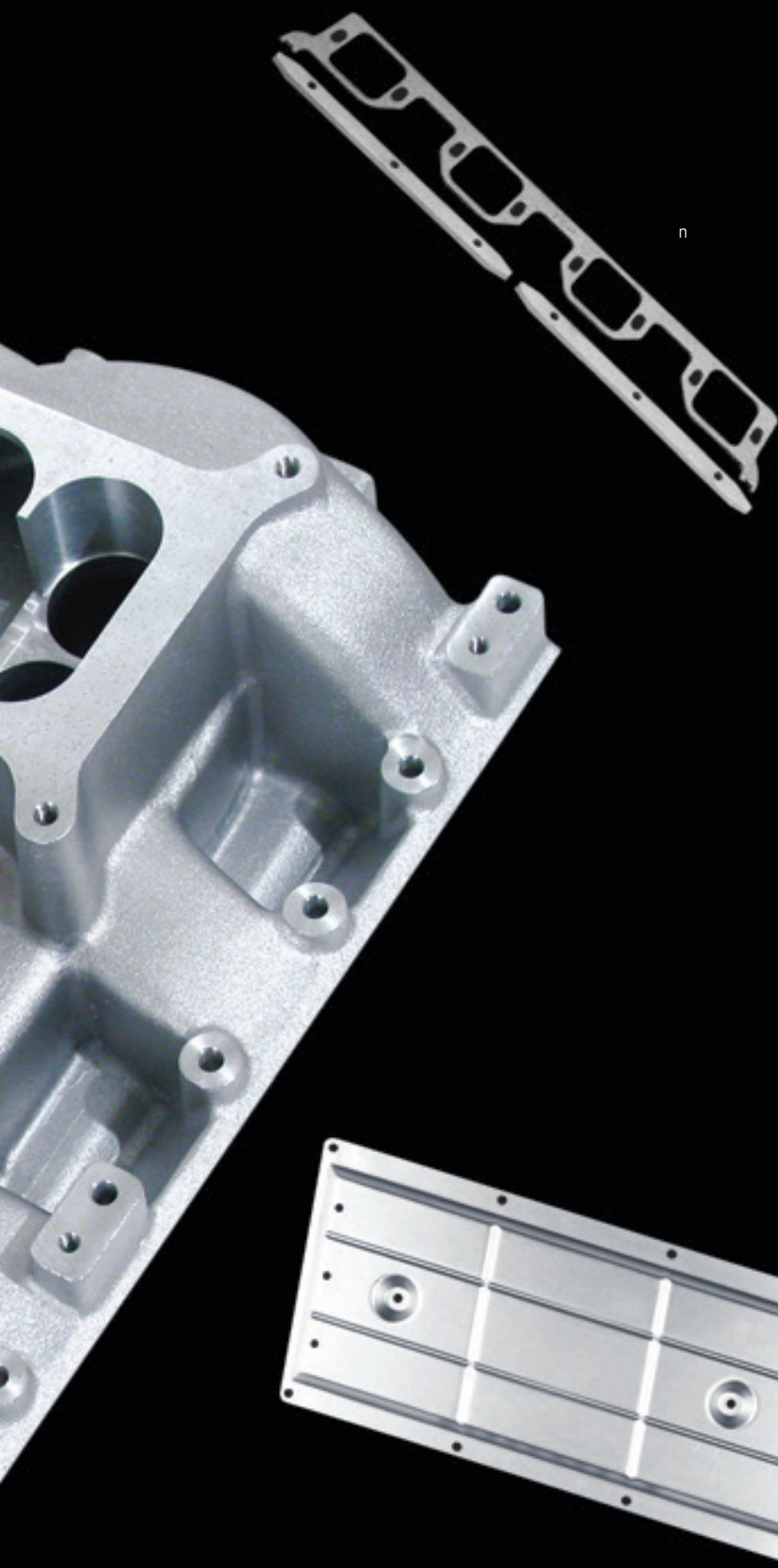

## DUAL-PLANE INTAKE MANIFOLD - SIX PACK

This intake manifold is designed to allow the use of three (3) two-barrel Six Pack carburetors on a 426-cid Chrysler HEMI® Engine. This intake manifold has mounting bosses on the driver's side that are the same as the stock style dual four-barrel HEMI® Engine intake. The carburetor pads have the same dimensions and position as a 1969-1971 440-cid Chrysler Six Pack. This intake manifold can be used with the 440 carburetors, fuel line kit, linkage kit and air cleaner. Be sure to check for hood clearance with the air cleaner.

426 HEMI® Engine, P/N **P5153738** . . . . . \$725.00

## INTAKE MANIFOLD GASKET SETS

Custom-fit set comes complete to service one engine. Includes gaskets and end seals. (See representative image: Fig. n)

0.060" Thick, 426 HEMI® Engine. (Except D4D6), Set.  
**P/N P4120086** . . . . . \$17.45

0.090" Thick, 426 HEMI® Engine. (Except D4D6), Set.  
**P/N P4529534** . . . . . \$27.00

Gasket, Cross Ram, for Removable Top.  
**P/N P5007334** . . . . . \$14.95

## INTAKE MANIFOLD HEAT SHIELD

Original equipment for all 426 Street HEMI® Engine intake manifolds. Bolts to the bottom of the intake manifold to prevent hot engine oil from heating the manifold and robbing horsepower. Also fits Aluminum Dual-Plane Intake Manifold P/N P4876188 and Aluminum Dual-Quad Intake Manifold P/N P5153737.

426 HEMI® Engine, P/N **P4529431** (Fig. o) . . . . . \$90.00

## INTAKE MANIFOLD PLUG PACKAGE

Includes eight intake manifold plugs. Used in 426 HEMI® Engine and Cross Ram intake manifolds.

Cross Ram, HEMI® Engine and Max Wedge.  
**P/N P5249926** . . . . . \$327.00

<sup>1</sup>Not legal on pollution-controlled vehicles or vehicles registered for highway use.

# BIG BLOCK ENGINES

361 / 383 / 400  
413 / 426 / 440





No matter if you're looking to impress the crowd when you pop your hood, or if you're just in it for the raw horsepower, Mopar® has the performance parts to keep your Chrysler big block engine roaring. From blocks to crankshafts to valve covers to intake manifolds, we have everything you need for large displacement and big power.



Engine Hardware **34**

Crankshafts & Hardware **34**

Timing Chains & Sprockets **35**

Vibration Dampers **36**

Camshafts, Lifters & Hardware **36**

Cylinder Heads, Gaskets & Hardware **38**

Intake Manifolds, Hardware & Gaskets **38**

Valves & Valvetrain Hardware **40**

Valve Covers & Hardware **42**

Oiling Components **44**

Cooling Systems **45**

# ENGINE HARDWARE

Starting an engine build from scratch? We've got factory-style hardware to give you a solid foundation.

## CORE PLUGS

Round, press-in engine block core plugs fit original style or Mopar® Race Cast Iron Blocks.

Brass, 426 HEMI® Engine and Big Block

**P/N P5249708** . . . . . \$32.30

# CRANKSHAFTS & HARDWARE

If you're planning to make big power, better have a Mopar® Crankshaft with new attaching hardware to withstand the severe duty.

## FORGED RACE CRANKSHAFTS

High-strength, high-quality Forged Steel Cranks machined from 4340 steel. For high-performance race applications. Eight-bolt flange "RB" main journal size. Full radius, balanced, 426 HEMI®/Wedge/RB Race Engines. (See representative image: Fig. a)

3.75" Stroke

**P/N P5007251** . . . . . \$1,375.00

4.15" Stroke

**P/N P5007250** . . . . . \$1,375.00

## CRANK KEY PACKAGE

Used to locate the crank sprocket on the nose of the crankshaft. Contains two keys.

426 HEMI® Engine/Big Block/Small Block/Slant Six

**P/N P5249822** . . . . . \$6.75

2.25" Length, 426 HEMI® Engine/Big Block/Small Block/with Aftermarket Dampers

**P/N P5249557AB** . . . . . \$11.45

a





b



## TIMING CHAINS & SPROCKETS

Timing is everything in engines too. Add new timing chains and sprockets to your engine, then cover it with factory covers and seals.

### DOUBLE ROLLER CHAIN AND SPROCKET

High-strength double roller chain provides added durability and decreased rotational friction versus the production silent chain. Has three matched keyways on crank sprocket to adjust cam timing. Kit includes magnafluxed sprockets and roller timing chains.

3-Bolt Mount, B/RB/HEMI® Engine  
P/N **P5249269** . . . . . \$115.00

### TIMING CHAIN AND COVER, CHROME

Package includes cover, seal and gasket. Front.

P/N **P4349816AB**. . . . . \$54.00

### BOLT SET, TIMING CHAIN AND COVER, CHROME

Engine chrome dress-up projects are incomplete without chrome bolts.

P/N **P4452795** . . . . . \$29.10

### FRONT COVER SEAL AND GASKET

Front Cover Seal, 426 HEMI® Engine/Big Block/Small Block

P/N **P4876280** . . . . . \$14.60

Front Cover Gasket, HEMI® Engine/Big Block

P/N **P4876769**. . . . . \$9.75

<sup>1</sup>Not legal on pollution-controlled vehicles or vehicles registered for highway use.

# VIBRATION DAMPERS

Reduce the chance of any vibration from your crankshaft rotation with a Mopar® Vibration Damper. Standard OE bolt patterns apply.

## VIBRATION DAMPERS - SFI-APPROVED

Feature a steel ring and a universal, symmetrical six-bolt front pulley mount pattern.

440 Forged Crank, 1962-1970 361/383 "B"  
 Forged Crank, 413/426 Wedge, **P/N 1P5249694** (Fig. c) . . . . . \$475.00

## DAMPER DEGREE TIMING TAPE

Improve timing accuracy. Marked in 90° increments. Self-adhesive strip adheres to the crank vibration damper for clear identification of marks. Permits reading spark advance up to 60° instead of only 10°-15° as on chain case timing tab.

**P/N P4529070AB**. . . . . \$9.75

## OIL SLINGER

Protects the front seal from excessive oil contact. Forces lubricant oil into chain.

426 HEMI® Engine/Big Block/Small Block/Slant Six/3.9L V6  
**P/N P5249636** . . . . . \$9.75

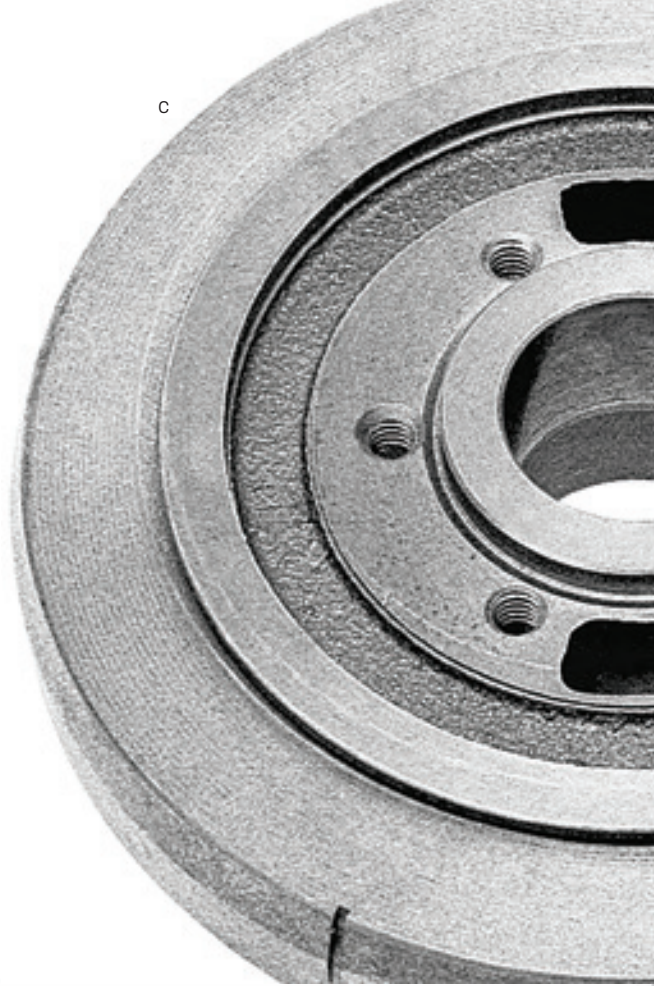

# CAMSHAFTS, LIFTERS & HARDWARE

From mild to wild, Mopar® has camshafts, lifters and hardware that provide the right combination of power and idle quality for any application. (See representative image: Fig. d)

## CAMSHAFTS, PURPLE SHAFT, HYDRAULIC

All Mopar® Performance Cams are designed, developed, dyno'd and track-tested by engineers. Cams are developed for increased power and RPM potential while maintaining reliability and the best possible low-speed characteristics, including torque and idle quality. Purple Shaft Cams offer the best horsepower-to-dollar-spent value. Package contains the cam, tappets and instruction sheet.

Note: For all flat tappet camshafts, Mopar® recommends the use of a high zinc oil for maximum durability.

268/284 Adv. Duration, **P/N 1P4452783AE** . . . . . \$428.00  
 268/284 Adv. Duration, **P/N 1P4529270AE** . . . . . \$428.00  
 272/272 Adv. Duration, **P/N 1P4286677AE** . . . . . \$415.00  
 280/280 Adv. Duration, **P/N 1P4452993AE** . . . . . \$400.00  
 284/284 Adv. Duration, **P/N 1P5007697AE** . . . . . \$428.00  
 292/292 Adv. Duration, **P/N 1P4120237AE** . . . . . \$595.00  
 292/292 Adv. Duration, **P/N 1P5007698AE** . . . . . \$415.00

## CAMSHAFTS, PURPLE SHAFT, MECHANICAL

284/284 Adv. Duration, **P/N 1P4120659AE** . . . . . \$428.00  
 296/296 Adv. Duration, **P/N 1P4120661AE** . . . . . \$428.00  
 312/312 Adv. Duration, **P/N 1P4120663AE** . . . . . \$428.00  
 324/324 Adv. Duration, **P/N 1P4349268AE** . . . . . \$528.00



## CAMSHAFT SPROCKET ATTACHING HARDWARE

Bolt for One-Bolt Mounting, 426 HEMI® Engine/Big Block.  
Sold individually, **P/N P6030269** . . . . . \$3.30

Bolt for Three-Bolt Mounting, 426 HEMI® Engine/Big Block.  
Set of three, **P/N P5007801** . . . . . \$34.55

Bolt for Three-Bolt Mounting, 383/440/426. Sold individually.  
**P/N P2120930**. . . . . \$13.75

## OFFSET CAMSHAFT BUSHING SET

Set includes five bushings; 2°, 4°, 6°, 8° offset, and one on-center bushing.  
Color guide only – check installations with dial indicator. Gold = 2°,  
Copper = 4°, Silver = 6°, Black = 8°.

426 HEMI® Engine/Big Block/Slant Six  
**P/N P3690936** . . . . . \$33.20



## HYDRAULIC TAPPET

Sold individually. HEMI® Engine/Big Block, **P/N P4006767AB** . . . . . \$8.55

## MECHANICAL

Sold individually. 0.0005" Undersize, **P/N P2843177AB** . . . . . \$15.30

## PUSHRODS, MECHANICAL/HYDRAULIC

Pushrods are 3/8" diameter and are sold as complete engine sets or individually for service. For use with adjustable rocker arms and hydraulic tappet cams.

Hydraulic Pushrod, 9.31" Length, RB Engine. Set of 16.  
**P/N P4529559** . . . . . \$67.00

Hydraulic Pushrod, 9.31" Length, RB Engine. Sold individually.  
**P/N P4529545** . . . . . \$10.70

Mechanical Pushrod, 9.20" Length, Ball and Cup Style,  
RB Engine. Set of 16. **P/N P4529560** . . . . . \$135.00

Mechanical Pushrod, 9.20" Length, Ball and Cup Style,  
RB Engine. Sold individually. **P/N P4529546** . . . . . \$19.10

RB Engines. Set of 16. **P/N P4876392** . . . . . \$153.00

<sup>1</sup>Not legal on pollution-controlled vehicles or vehicles registered for highway use.

# CYLINDER HEADS, GASKETS & HARDWARE

Mopar® Cylinder Heads are where it all comes together – spark, fuel and air. This is where the power is made. Cast iron or aluminum, Mopar® has the heads to top off your engine build.

## CYLINDER HEADS, ALUMINUM

Head casting number 452 is complete with valves and springs (2.14" intake and 1.81" exhaust). Flow is 290 cfm intake and 217 cfm exhaust at 0.600" lift. These ready-to-bolt-on heads use a straight plug design so you can use stock exhaust manifolds or many popular aftermarket headers. For 361 and 440 Engines.

Includes Valves and Springs, Straight Plug, 84cc,  
2.14" Intake, 1.81" Exhaust, B/RB Engines

P/N 'P5153524 (Fig. e) . . . . . \$1,495.00

## ALUMINUM CYLINDER HEADS, STAGE VI

2.14" Intake, 1.81" Exhaust

P/N 'P4529335 . . . . . \$1,055.00

CNC-Ported, 2.18" Intake, 1.81" Exhaust

P/N 'P4876383 . . . . . \$2,840.00

CNC-Ported, 2.25" Intake, 1.81" Exhaust, Max Wedge

P/N 'P4876386 . . . . . \$2,750.00



# INTAKE MANIFOLDS, HARDWARE & GASKETS

Make sure your engine breathes right with a Mopar® Intake Manifold that accepts standard carburetors in single- or dual-plane configurations.

## SINGLE-PLANE INTAKE MANIFOLDS

Engineered for use with standard cylinder heads. Requires no attaching modifications. Perfect for Bracket, Super Stock or general high-performance applications. Offers a 5-10 horsepower advantage over other single-plane manifolds. Carburetor flange accepts standard Holley four-barrel carburetor. Made of aluminum.

4500 Carburetor, 361/383/400 with Stage IV, V or Production Heads

P/N 'P4529724 . . . . . \$258.00

Four-Barrel Carburetor, 361/383/400 with Stage IV, V or Production Heads

P/N 'P4529462 . . . . . \$276.00

## SINGLE-PLANE INTAKE MANIFOLDS - RACE

Aluminum, 4150-Style Carburetor, RB, Max Wedge,

Stock Cylinder Heads, P/N 'P4876337 . . . . . \$388.00

Aluminum, 4500 Carburetor, RB, Max Wedge Stage VI Heads

P/N 'P4876129 . . . . . \$490.00

Aluminum, Four-Barrel Carburetor, RB, Max Wedge Stage VI Heads

P/N 'P4876128 . . . . . \$254.00

## DUAL-PLANE INTAKE MANIFOLDS - SIX PACK

Aluminum, 361/383/400 with Stage IV, V or Production Heads

P/N 'P4529055 . . . . . \$532.00

Aluminum, 413/426W/440 with Stage IV, V or Production Heads

P/N 'P4529056 . . . . . \$514.00

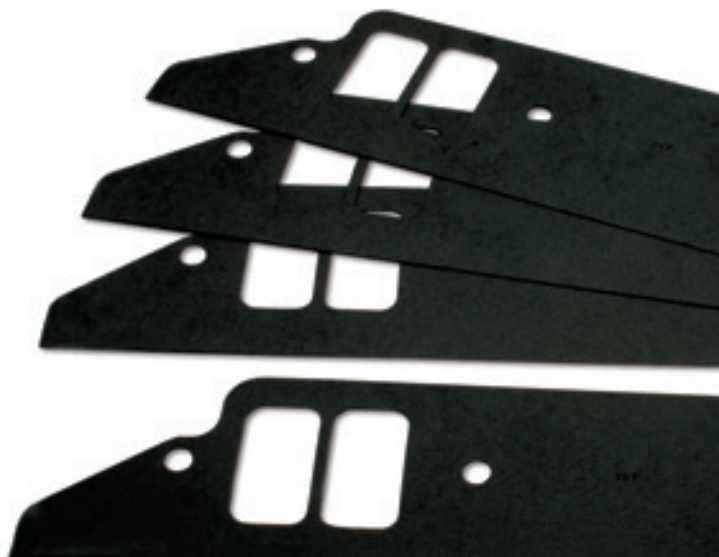



## ALUMINUM CYLINDER HEADS, STAGE VII

These heads have a flow rate of 325 cfm intake, 226 cfm exhaust, at 0.700" lift. Raised port, 75cc, angled plug, 2.20" intake, 1.81" exhaust, 100cc exhaust, B/RB Engines.

Max Wedge, 290cc Intake

**P/N P5153823** . . . . . \$1,175.00

Wedge, 280cc Intake

**P/N P5153654** . . . . . \$1,070.00

## CYLINDER HEAD GASKETS, COMPOSITE

Thick composite material gaskets (0.040" to 0.042", unless otherwise noted) can be used for replacement or competition applications up to 12.5:1 compression ratio. Sold as an engine set.

Up to 4.380" Bore

**P/N P4349559** . . . . . \$93.00

## CYLINDER HEAD GASKETS, STEEL

Multi-Layer Steel, 0.025" Thick, B/RB Wedge Engine Set

**P/N P5155237** . . . . . \$172.00

Single Layer Production Style, 0.020" Thickness, Engine Set

**P/N P4286754** . . . . . \$27.50

## INTAKE MANIFOLD GASKETS

Custom-fit set comes complete to service one engine. Includes gaskets, end seals, O-rings and distributor seal (where applicable). (See representative image: Fig. f; does not represent Composite Gasket)

0.030" Thick, Big Port with Stage VI Heads, Set, **P/N P5249483** . . . . . \$16.75

0.030" Thick, Big Block with Stage VI Heads, Set, **P/N P5249433** . . . . . \$21.10

0.045" Thick, Big Block with Stage VI Heads, Set, **P/N P5249467** . . . . . \$21.10

0.045" Thick, Big Port with Stage VI Heads, Set, (Limited Quantities)  
**P/N P5249484** . . . . . \$18.00

0.060" Thick, Composite Material, Max Wedge, **P/N P5249643** . . . . . \$18.40



f

## INTAKE MANIFOLD GASKET, HEAT BLOCK-OFF

Stainless steel intake manifold gasket heat block-off keeps exhaust heat from transferring to the intake manifold for a cooler, denser fuel-air mixture.

B Engines, **P/N P4286825** . . . . . \$27.50

RB Engines, **P/N P4286826** . . . . . \$35.60

361/383/400 with Stage IV, V or Production Heads, Race, Set  
**P/N P4452103** . . . . . \$30.75

413/426W/440 with Stage IV, V or Production Heads, Race, Set  
**P/N P4452105** . . . . . \$32.30

## INTAKE MANIFOLD HARDWARE

Plug Package, Cross Ram, HEMI® Engine and Max Wedge.

Includes Eight Intake Manifold Plugs. **P/N P5249926** . . . . . \$327.00

Hardware Kit, Max Wedge, Cross Ram Intake Manifold

**P/N P5007330**. Includes Bolts and Plugs (Limited Quantities).

**P/N P5153338** . . . . . \$203.00

<sup>1</sup>Not legal on pollution-controlled vehicles or vehicles registered for highway use.

# VALVES & VALVETRAIN HARDWARE

Making big power requires internal components that can withstand the punishment. Choose from valvetrain hardware designed for everything from street restoration applications to full-out race gear.

## VALVES

Stainless steel valves have swirl-polished underheads that have no flat or ski-jump areas. Each features a 3/8" stem diameter and one square groove.

|   |         |
|---|---------|
| Exhaust, 1.74" Diameter, 4.87" Stem Length<br><b>P/N 1P5249201</b> (Fig. g) . . . . .             | \$20.50 |
| Exhaust, 1.81" Diameter, 4.87" Stem Length<br><b>P/N 1P5249202</b> . . . . .                      | \$22.70 |
| Exhaust, 1.88" Diameter, 4.87" Stem Length (Limited Quantities)<br><b>P/N 1P4876398</b> . . . . . | \$21.70 |
| Intake, 2.08" Diameter, 4.86" Stem Length<br><b>P/N 1P5249199</b> . . . . .                       | \$21.15 |
| Intake, 2.14" Diameter, 4.86" Stem Length<br><b>P/N 1P5249200</b> . . . . .                       | \$22.00 |
| Intake, 2.18" Diameter, 4.86" Stem Length<br><b>P/N 1P5249866</b> . . . . .                       | \$17.60 |

## VALVE SEALS

Made of high-temp Viton® material, these Valve Seals feature a full or semi-umbrella shape for best dual-purpose use. Helps prevent oil seepage down valve guides. Not recommended for use with dual-valve springs. Sold in sets of 16.

|   |         |
|---|---------|
| 3/8" Stem, Big Block/Small Block<br><b>P/N 1P4120492</b> (Fig. h) . . . . . | \$19.70 |
|---|---------|

## ROCKER SHAFT END PLUGS

Sold as a set of four. Press-in. These do not fit aftermarket rocker shafts.

|   |        |
|---|--------|
| 426 HEMI® Engine/Big Block<br><b>P/N P5249633</b> . . . . . | \$9.75 |
|---|--------|

## ROCKER SHAFT HOLD-DOWN

Billet aluminum rocker shaft hold-downs provide greater rocker shaft stiffness, which helps rocker shaft maintain roundness when torque is applied. Roundness is important with mechanical rockers and high spring loads. Heads may need to be machined to use hold-downs. Anodized blue.

|                               |          |
|-------------------------------|----------|
| <b>P/N P5249714</b> . . . . . | \$128.00 |
|-------------------------------|----------|



h



g





## VALVE KEEPERS (SPLIT LOCKS)

Feature a 3/8" stem diameter and can be used for restoration or performance applications. Sold in sets of 16 pieces. Two sets required for all V8 engines.

7°, Single Groove

**P/N 'P4120618** . . . . . \$54.00

## VALVE SPRINGS

High-pressure valve springs can be used on exhaust and intake valves for all high-performance applications. They feature a shorter fully compressed height and allow for increased valve lift. Springs maintain spring load at a higher RPM. A must for high-performance cams. Sold individually.

Single, 0.430"/0.460" Lift

**P/N 'P4286812** (Fig. i) . . . . . \$13.20

Single, 0.440"/0.500" Lift

**P/N 'P3690933** . . . . . \$11.10

Double, 0.590"/0.640" Lift

**P/N 'P4876064** . . . . . \$15.15

## VALVE SPRING RETAINERS

Available in two levels of performance: Chrome Moly for restoration and heavy-duty applications, and Titanium for top-level race performance. Sold individually.

Chrome, 3/8", Single, Std Height, 7°. (Limited Quantities)

**P/N P4452033** . . . . . \$9.45

Chrome, 5/16", Single/Dual, Std Height, 7°

**P/N P4529288** . . . . . \$14.50

Steel, 5/16", Single, Std Height, 7°

**P/N P4452769** . . . . . \$19.10

Titanium, 3/8", Triple, .060" Increase, 10°. (Limited Quantities)

**P/N P4286775** . . . . . \$25.00



<sup>1</sup>Not legal on pollution-controlled vehicles or vehicles registered for highway use.

# VALVE COVERS & HARDWARE

Your engine project will get noticed with a set of Mopar® Valve Covers in black wrinkle finish or chrome, cast aluminum or stamped steel. (See representative image: Fig. j)

## VALVE COVERS, CAST ALUMINUM, BLACK WRINKLE

High-strength cast aluminum valve covers are more rigid than stamped steel, offering better anti-leak properties. Pentastar logo is cast into each cover. Set includes two valve covers, two oil filler caps and baffle package.

Set  
**P/N P5007614** . . . . . \$179.00

## VALVE COVERS, ALUMINUM, "AS CAST"

Sold "as cast" so you can set up the breathers the way you want them, and there's no paint to remove if welding is done. Pentastar logo is cast into each cover. Cast covers are more rigid than stamped steel, which helps prevent valve cover leaks. Set includes two valve covers and oil filler caps.

Set  
**P/N P5007615** . . . . . \$156.00

## VALVE COVERS, CAST ALUMINUM, POLISHED

Polished to a chrome-like shine that's perfect for that show-car look. Features Pentastar logo. Set includes two valve covers and two oil filler caps (does not include baffling).

Set  
**P/N P5007616** (Fig. k) . . . . . \$199.00

## VALVE COVERS, CHROME, DIRECT CONNECTION

Big Block. Set.  
**P/N P4349633AB** . . . . . \$158.00

## VALVE COVERS, FABRICATED ALUMINUM

Max Wedge, Big Block. Set.  
**P/N P5155526** . . . . . \$335.00

## GASKETS, VALVE COVER

Rubber-Reinforced Cork, for Cast Valve Covers.  
 Set  
**P/N P4452091** . . . . . \$23.75





k

### BAFFLE AND SCREW PACKAGES

For cast aluminum valve covers only.

Big Block/Small Block/Truck/Magnum/Jeep® Brand Engines

**P/N P5007052** . . . . . \$9.75

### VALVE COVER HARDWARE

Includes 12 chrome-plated screws and washers, one chrome-plated oil filler cap and two rubber grommets.

Accessory Set, Big Block/Small Block

**P/N P4120272** . . . . . \$21.10

Grommet and Plug Set, Big Block/Small Block

**P/N P5007419** . . . . . \$9.75

Bolt Set, Chrome, Big Block/Small Block, 12 Pieces

**P/N P5007458** . . . . . \$40.40

Washer Package, Chrome, 12 Pieces

**P/N P4349620** . . . . . \$11.45

### VALVE COVER, RETAINING SCREW SET

Includes 12 black retaining screws. For cast aluminum valve covers only.

Big Block/Small Block

**P/N P5007053** . . . . . \$22.65

### BREATHER CAPS, CHROME

For use with Mopar® Cast Aluminum Valve Covers to fill extra valve cover holes. Push-in-style breather cap requires the use of Grommet Set P/N P4529882.

Push-In-Style Chrome

**P/N P4529881** . . . . . \$9.75

Twist-On, Bottom Vented, Chrome

**P/N P4529880** . . . . . \$9.75

Grommet, Rubber

**P/N P4529882** . . . . . \$6.60

<sup>1</sup>Not legal on pollution-controlled vehicles or vehicles registered for highway use.

# OILING COMPONENTS

Oil is the lifeblood of your high-horsepower engine. Keep it flowing with Mopar® Oil Pickups, Pumps, Oil Pans and more.

## OIL PANS

Includes factory-engineered and approved oil pan, drain plug and washer. Center sump style is used on passenger car applications while the rear sump style is used for pickups. Windage trays may be used if desired. See the oil pickup and screen assemblies for specific application information. Listed quart capacity is with filter installed.

- Five-Quart, Center Sump, RB Engines, **P/N P5155628** . . . . . \$156.00
- Six-Quart, Center Sump, Stock Style, must use  
Oil Pickup P/N P5007848, Stamped, **P/N P5007807AB** . . . . . \$190.00
- Eight-Quart, Center Sump, HEMI® Engine/Big Block  
**P/N P5007816** (Fig. l) . . . . . \$193.00

## OIL PAN BOLT SET

426 HEMI® Engine/Big Block/Small Block. Set of 20 Bolts.  
**P/N P4120613** . . . . . \$14.60

## OIL PAN GASKETS

For Big Block and HEMI® Engine applications. Note that two are required for Windage Tray applications.

- Gasket, Oil Pan, Race. Set of Two. **P/N P4452099** . . . . . \$16.25
- Gasket, Oil Pan. Sold individually. **P/N P3412049** . . . . . \$14.60

## OIL PICKUP AND SCREEN ASSEMBLIES - SIX-QUART

Factory-original, reissued oil pickup and screen assemblies. Standard pickups are 3/8" while race styles require hole enlargement in stock blocks.

Note: P/N P4529564 does not fit the 440 Six Pack.

- 1/2" Pipe, B Engines, **P/N P5249817** . . . . . \$80.00
- 3/8" Pipe, B Engines, **P/N P4529564** . . . . . \$32.30
- 3/8" Pipe, RB Engines, **P/N P4529565** . . . . . \$35.95



## OIL PICKUP AND SCREEN ASSEMBLIES - EIGHT-QUART

Factory-original reissue. Standard pickups are 3/8", race style requires hole enlargement in stock blocks.

- 1/2" Pipe, use with Oil Pan P/N P5007816, **P/N P5007818** . . . . . \$60.00
- 3/8" Pipe, use with Oil Pan P/N P5007816, **P/N P5007817** . . . . . \$60.00

## OIL PICKUP ADAPTERS

For new replacement Wedge blocks with bolt-on pickup bosses. Use when running 1/2" oil pickup. Replaces stock 3/8" boss.

- 3/8", Wedge, **P/N P5155063** . . . . . \$83.00
- 1/2", Wedge, **P/N P5155064** . . . . . \$83.00

## VALLEY TRAYS

Keeps engine oil in the tappet chamber and off the intake manifold.

- RB Engines, **P/N P4876848** . . . . . \$63.00
- Engines with Raised Port P/N P5153654 or P/N P5153823  
Heads, for B Blocks, **P/N P5153821AB** . . . . . \$88.00
- Engines with Raised Port P/N P5153654 or P/N P5153823  
Heads, for RB Blocks, **P/N P5153822AB** . . . . . \$92.00

## WINDAGE TRAYS

Designed to provide improved engine lubrication by reducing interior windage at higher engine speed. Package includes tray and two pan gaskets.

- 3.75" Stroke, **P/N P4120998** . . . . . \$32.30
- 4.15" Stroke, **P/N P5007345** . . . . . \$79.00

## OIL PUMP ASSEMBLY

Provides a 25% increase in oil volume. Ideal replacement for stock pump in high-performance applications.

- Use with P/N 02084355 Service Gasket, **P/N P4286590** (Fig. m) . . . . \$121.00

## OIL PRESSURE RELIEF SPRING

Increases engine oil pressure over stock spring for high-performance applications. Delivers up to 70 lbs. of oil pressure. Includes cap and instructions.

- B/RB/HEMI® Engines.  
**P/N P4286571** . . . . . \$6.60

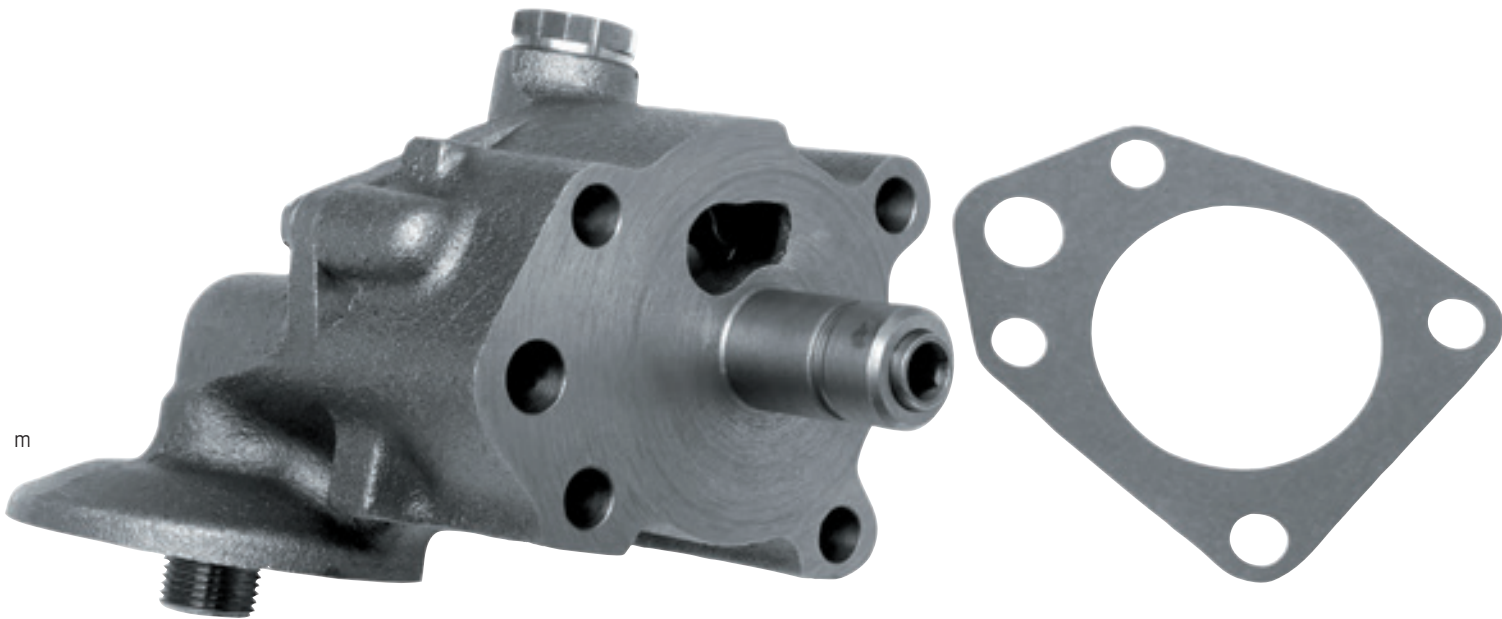

m

### DISTRIBUTOR DRIVE GEAR ASSEMBLIES

Features a hardened tip shaft with full radius blend from hex to round and pinned gears.

- Flat Tappet Cams, **P/N P3571071** . . . . . \$106.00
- Flat Tappet Cams, Milodon Oil System, **P/N P3412064** . . . . . \$105.00
- Roller Tappet, Aluminum-Bronze Gear, **P/N P3690875** . . . . . \$165.00
- Roller Tappet, Aluminum-Bronze Gear, Milodon Oil System  
**P/N P3690876** . . . . . \$235.00

### DIPSTICK AND TUBE, CHROME

- Big Block, **P/N P4349629** . . . . . \$22.65

### OIL FILTER - PERFORMANCE

Engineered to meet the demands of heavy-duty and high-performance applications. Black with Mopar® Omega M logo.

- 6-/8-Cylinder Engines, **P/N P4452890** . . . . . \$11.45

### OIL PUMP PRIMING SHAFT

Don't fire up that engine without pre-lubing (priming) it thoroughly with oil. Special hardened steel shaft fits on any 3/8" or larger drill. Insert shaft into hole where distributor fits. Pressurizes oil galleys to ensure against dry starts and engine damage. Fits all V8 engines.

- Shaft, Oil Pump Priming, **P/N P4286800** . . . . . \$9.75

## COOLING SYSTEMS

Keep your cool with Mopar® Water Pumps, Thermostats and Fan packages.

### WATER PUMP INSTALLATION KIT

Includes water pump gasket, pump housing gasket, plugs, water pump screws, plus long and short housing screws.

- P/N P5007449** . . . . . \$43.60

### THERMOSTAT HOUSING, CHROME

This high-quality chrome thermostat housing is made of heavy-duty material. Includes gasket and two chrome bolts.

- Up to 1978, V8, Water Neck.  
**P/N P4286759AB** . . . . . \$20.45

<sup>†</sup>Not legal on pollution-controlled vehicles or vehicles registered for highway use.



# SMALL BLOCK ENGINES

273 / 318 / 340  
360 / 5.2L / 5.9L



Engine Hardware **48**

Timing Chains  
& Sprockets **48**

Crankshafts &  
Hardware **48**

Vibration Dampers **50**

Camshafts, Lifters  
& Hardware **51**

Cylinder Heads,  
Gaskets & Hardware **52**

Valvetrain Hardware **54**

Rocker Arms, Shafts,  
Stands & Hardware **55**

Valve Covers &  
Hardware **56**

Intake Manifolds,  
Hardware & Gaskets **58**

Oiling Components **60**

Cooling Systems **60**

Small block, big power. It's part of what makes your car a legend. Whether you're restoring, replacing or building from scratch, Mopar® has the small block components to pack more attitude into smaller, lighter engines. Ever dreamed of dropping a big bore "LA" Small Block with CNC-ported heads into your favorite ride? You can. It's time to get to work – and Mopar® is right there with you.

# ENGINE HARDWARE

## ENGINE TEARDOWN GASKETS

Engine teardown gasket set includes all gaskets needed for complete engine teardown: oil pan, cylinder head, valve cover, timing chain case cover, intake manifold and oil pump gaskets.

|  |          |
|--|----------|
| 340/360 Small Block<br><b>P/N P4120692</b> . . . . .                   | \$135.00 |
| 5.2L Magnum Jeep® Brand Engines/Truck<br><b>P/N P4876248</b> . . . . . | \$165.00 |

## FRONT COVER GASKET

|   |         |
|---|---------|
| 5.2L/5.9L Dodge Truck Magnum and Jeep® Brand Engines<br><b>P/N P4876052</b> . . . . . | \$15.00 |
|---|---------|

# TIMING CHAINS & SPROCKETS

Timing is everything in engines too. Add new timing chains and sprockets to your engine, then cover it with factory covers and seals.

## DOUBLE ROLLER CHAIN AND SPROCKET

High-strength double roller chain provides added durability and decreased rotational friction versus production silent chain.

|   |         |
|---|---------|
| One-Bolt Mount, Three Matched Keyways, Small Block/<br>5.2L/5.9L Magnum/Jeep® Brand Engines<br><b>P/N P5249267</b> (Fig. a) . . . . . | \$80.00 |
|---|---------|

## TIMING CHAIN TENSIONER

Stabilizes cam timing by reducing timing chain slack. Can be used in place of Thrust Plate P/N P5249637.

|  |         |
|--|---------|
| Small Block/3.9L/5.2L/5.9L Truck/Magnum/Jeep® Brand Engines<br><b>P/N P5007709</b> . . . . . | \$40.50 |
|--|---------|

## FRONT COVER SEAL

|  |         |
|--|---------|
| 426 HEMI®/Big Block/Small Block Engines<br><b>P/N P4876280</b> . . . . . | \$15.00 |
|--|---------|

# CRANKSHAFTS & HARDWARE

If you're planning to make big power, better have a Mopar® Crankshaft with new attaching hardware to withstand the severe duty. (See representative image: Fig. b)

## FORGED CRANKSHAFTS

Surface-hardened forged crankshafts feature radiused fillets at main and rod journals, six-bolt flange, 4340 steel.

|   |            |
|---|------------|
| 3.58" Stroke, 318/340 Main<br><b>P/N P5007253</b> . . . . . | \$958.00   |
| 3.58" Stroke, 360 Main<br><b>P/N P5007255</b> . . . . .     | \$1,160.00 |
| 4.00" Stroke, 318/340 Main<br><b>P/N P5007252</b> . . . . . | \$1,195.00 |
| 4.00" Stroke, 360 Main<br><b>P/N P5007254</b> . . . . .     | \$1,195.00 |

## CAST CRANKSHAFTS

Special heavy-duty cast crankshafts with radiused fillets. Feature six-bolt pattern on crank flange. Requires balancing. 4.00" stroke cranks require clearancing on block.

|   |          |
|---|----------|
| 3.58" Stroke, 318/340 Main<br><b>P/N P5007257</b> . . . . .         | \$423.00 |
| 3.58" Stroke, 360 Main Small Block<br><b>P/N P5007259</b> . . . . . | \$499.00 |
| 4.00" Stroke, 318/340 Main<br><b>P/N P5007256</b> . . . . .         | \$506.00 |
| 4.00" Stroke, 360 Main Small Block<br><b>P/N P5007258</b> . . . . . | \$956.00 |



**TIMING CHAIN COVERS**

Production, includes seal and gasket, 9.6000" Deck,  
Small Block and V6, **P/N P5249930AB** . . . . . \$85.00

Sand Cast, Race, 9.00"-9.20" Deck, Race Water  
Pump/Front Motor Plate, **P/N P4876632** . . . . . \$458.00

**BOLT SET, CHROME, FRONT TIMING COVER**

Package includes a complete set of Chrome Bolts  
for Timing Chain Covers, **P/N P4529256** . . . . . \$50.00



a

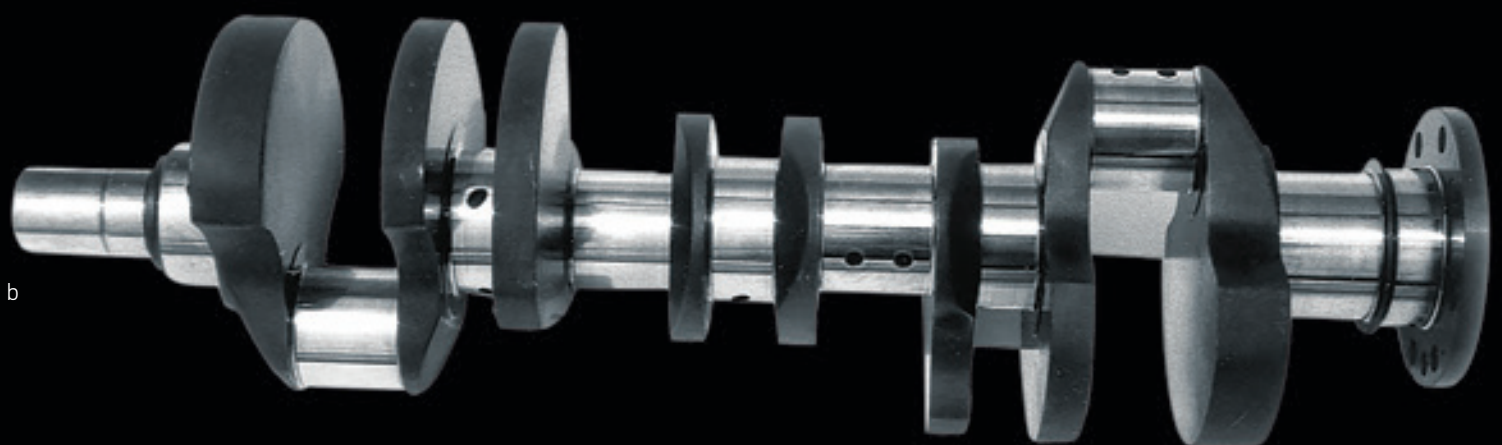

b

**CRANK BOLT SET**

Heavy-duty bolts used to attach the vibration damper.

2.25" Length  
**P/N P5249557AB** . . . . . \$11.45

**CRANK KEY PACKAGE**

Used to locate the crankshaft sprocket on the nose of the crankshaft.  
Contains two keys.

426 HEMI® Engine/Big Block/Small Block/Slant Six  
**P/N P5249822** . . . . . \$6.60

<sup>1</sup>Not legal on pollution-controlled vehicles or vehicles registered for highway use.

# VIBRATION DAMPERS

Reduce the chance of any vibration from your crankshaft rotation with a Mopar® Vibration Damper. Standard OE bolt patterns apply. (See representative image: Fig. c)

## VIBRATION DAMPER - SFI-APPROVED

Features a steel ring and a universal front pulley mount pattern.

P/N **1P5249690** . . . . . \$392.00

## VIBRATION DAMPER

Production-style crank vibration damper is designed for all production-balanced small block engines. Not SFI-approved.

5.9L Truck Magnum/Jeep® Brand Engines, 360 Magnum Crate Engines

P/N **1P5007187AB** . . . . . \$246.00

Externally Balanced, 1971-1992 360 A Engines, pre-Magnum Short Blocks P/N P4876907 and P/N P4876908

P/N **1P5007301** . . . . . \$145.00

Internally Balanced, 1967-1991 273/318, 1968-early 1972 340 Forged Crank

P/N **1P4452816** . . . . . \$232.00

## DAMPER DEGREE TIMING TAPE

Improve timing accuracy with this damper degree timing tape. Marked in 90° increments. Self-adhesive strip adheres to the crank vibration damper for clear identification of marks. Permits reading up to 60° instead of only 10°-15° as on chain case timing tab.

P/N **P4529070AB** . . . . . \$9.75

## OIL SLINGER

Protects Front Seal from excessive oil contact. Forces Lubricant Oil into Chain.

P/N **P5249636** . . . . . \$9.75

c

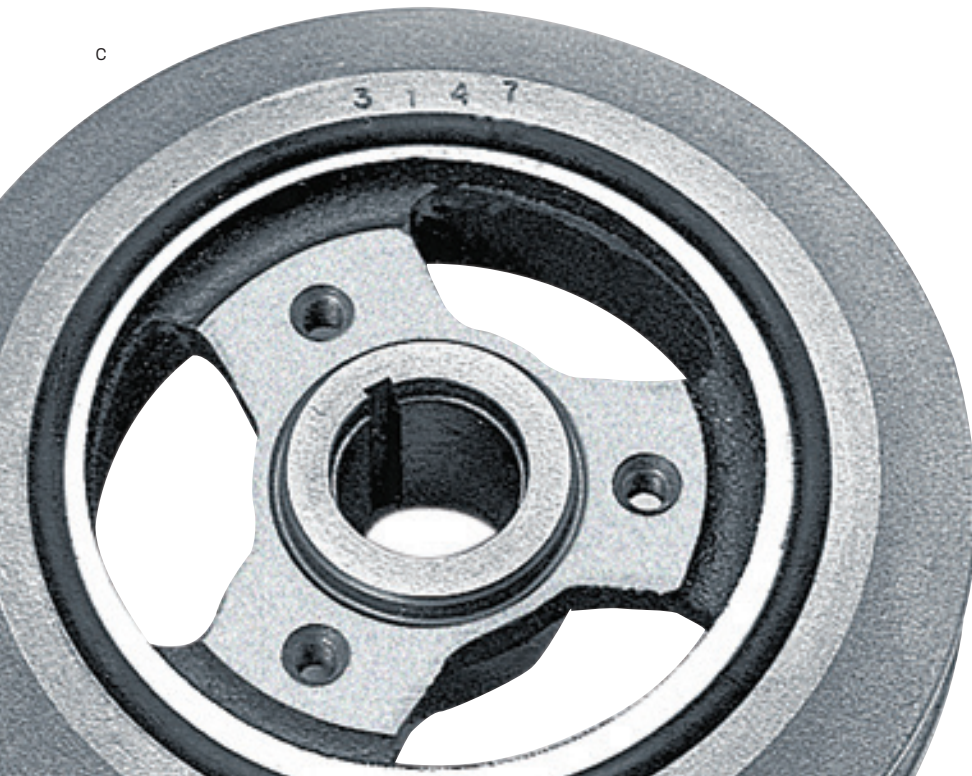

e



d

# CAMSHAFTS, LIFTERS & HARDWARE

From mild to wild, Mopar® has camshafts, lifters and hardware that provide the right combination of power and idle quality for any application. (See representative image: Fig. d)

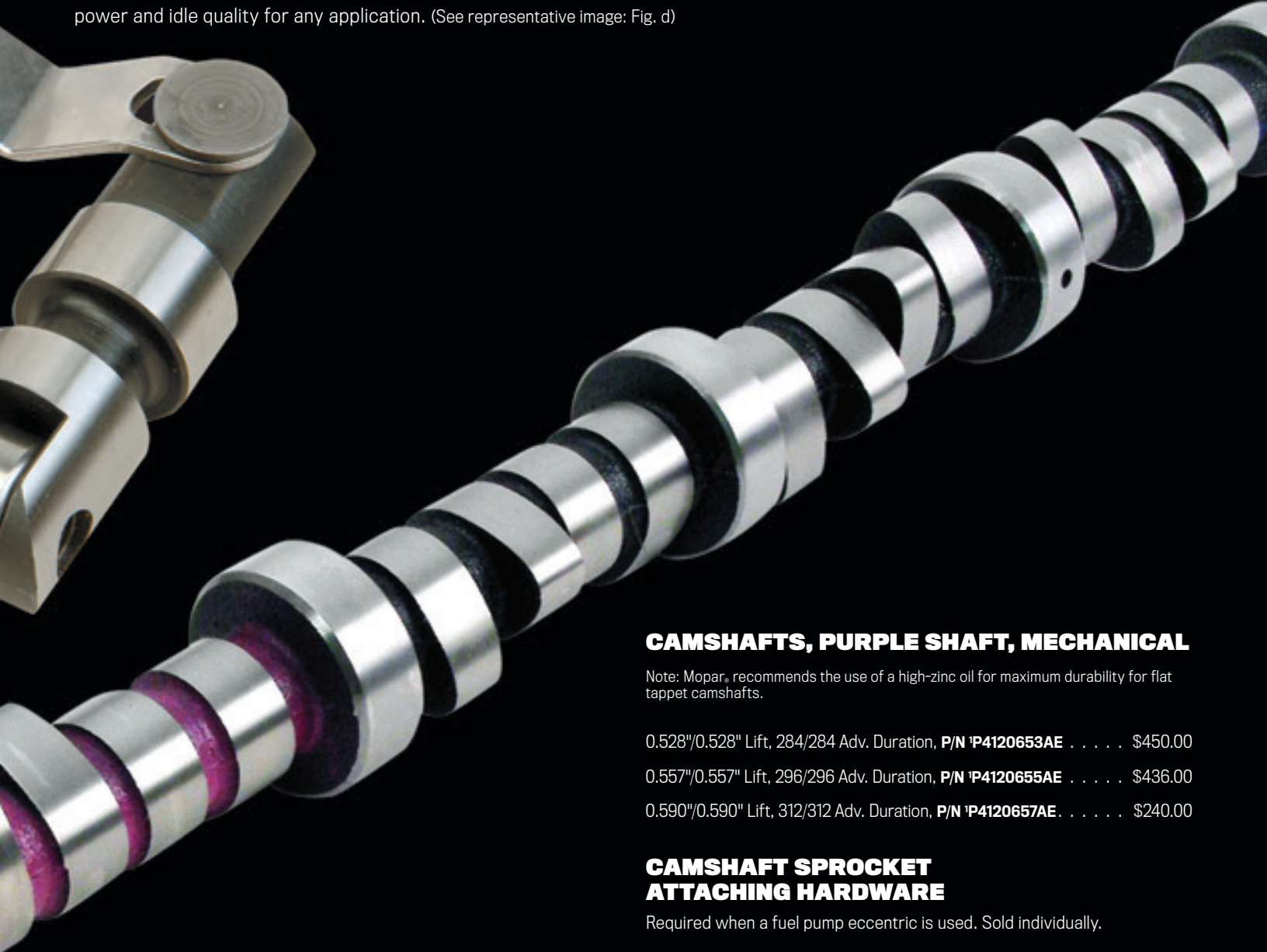

## CAMSHAFTS, PURPLE SHAFT, HYDRAULIC

Note: Mopar® recommends the use of a high-zinc oil for maximum durability for flat tappet camshafts.

- 0.410"/0.425" Lift, 248/256 Adv. Duration, P/N 'P4452757AE . . . . . \$314.00
- 0.429"/0.444" Lift, 228/235 Adv. Duration, P/N 'P4452782AE . . . . . \$314.00
- 0.430"/0.450" Lift, 260/268 Adv. Duration, P/N 'P4452759AE . . . . . \$415.00
- 0.450"/0.455" Lift, 268/272 Adv. Duration, P/N 'P4452761AE . . . . . \$315.00
- 0.474"/0.474" Lift, 280/280 Adv. Duration, P/N 'P4452992AE . . . . . \$400.00
- 0.484"/0.484" Lift, 284/284 Adv. Duration, P/N 'P4120231AE . . . . . \$399.00
- 0.508"/0.508" Lift, 292/292 Adv. Duration, P/N 'P4120233AE . . . . . \$314.00

## CAMSHAFTS, PURPLE SHAFT, MECHANICAL

Note: Mopar® recommends the use of a high-zinc oil for maximum durability for flat tappet camshafts.

- 0.528"/0.528" Lift, 284/284 Adv. Duration, P/N 'P4120653AE . . . . . \$450.00
- 0.557"/0.557" Lift, 296/296 Adv. Duration, P/N 'P4120655AE . . . . . \$436.00
- 0.590"/0.590" Lift, 312/312 Adv. Duration, P/N 'P4120657AE . . . . . \$240.00

## CAMSHAFT SPROCKET ATTACHING HARDWARE

Required when a fuel pump eccentric is used. Sold individually.

- Hardware Package, Camshaft Sprocket, P/N P4529838. . . . . \$17.90

## MECHANICAL TAPPET

- 0.0005" Undersize. Sold individually. P/N 'P2843177AB . . . . . \$15.30

## HYDRAULIC TAPPET

- 340 Engine. Sold individually. P/N 'P3614321AB . . . . . \$8.95

## HYDRAULIC ROLLER TAPPETS

- 5.2L/5.9L Truck Magnum/Jeep® Brand Engines. Sold individually. P/N 'P4876054 (Fig. e). . . . . \$13.20
- 5.2L/5.9L Truck Magnum/Jeep® Brand Engines. Magnum Crate. Set of 16. P/N 'P5249862 . . . . . \$140.00

<sup>1</sup>Not legal on pollution-controlled vehicles or vehicles registered for highway use.

# CYLINDER HEADS, GASKETS & HARDWARE

Mopar® Cylinder Heads are where it all comes together – spark, fuel and air. This is where the power is made. Cast iron or aluminum, Mopar® has the heads to top off your engine build.

## CYLINDER HEADS, LA

Aluminum, 63cc Combustion Chamber, 2.020"/1.600" Valves with HP Springs, 1967-1992 LA 318/360 Engines, **P/N 'P5153849** (Fig. f) . . . \$983.00

Super Commando, Machined and Assembled with 2.080"/1.600" Valves (5/16" Stem) with HP Springs, use Rocker Arm Set P/N P5153995, **P/N 'P5153850** . . . \$1,400.00

Super Commando, Bare, used in P/N P5153850, **P/N 'P5155128**. . . \$752.00

## CYLINDER HEADS, CAST IRON, W2 RACE

Features flat-machined rocker pads that require the use of T&D race rocker arms and long valves. Heads must be oiled through the tappets and hollow pushrods. Older style rocker stands and rocker systems do not work with these heads.

Race, 2.02" Intake, 1.60" Exhaust, 48° Tappet, 47cc Chamber, W2 **P/N 'P5007708AB** . . . \$620.00

Race, 2.02" Intake, 1.60" Exhaust, 59° Tappet, 65cc Chamber, W2 **P/N 'P5249769** . . . \$700.00

## CYLINDER HEADS, RAISED PORT, W9

Partially machined W9 Cylinder Head with raised intake and exhaust ports. Recommended for use in Sprint cars and Midget cars.

### Features:

- High-strength, lightweight A356 aluminum alloy casting
- Ports raised significantly higher than standard W9 cylinder heads
- Machined deck, intake surface, head bolts and valve cover rail
- Ports are cast small to allow for flexibility in porting (requires porting)
- Chamber is cast filled in to allow very small machined chamber (requires machining)
- Requires machining for valve guides, spark plugs, intake screws, porting, valve spring pockets, rocker stands and injectors
- Recommended valve length: 6.040" intake and 6.060" exhaust
- Six-bolt head attachment design
- Recommended for use with T&D rocker arms with 0.750" offset (custom order)

Extra Stiffening Ribs, Small Block, A4 Midget Block, W9RP **P/N 'P5007904AB** (Fig. g) . . . \$1,345.00

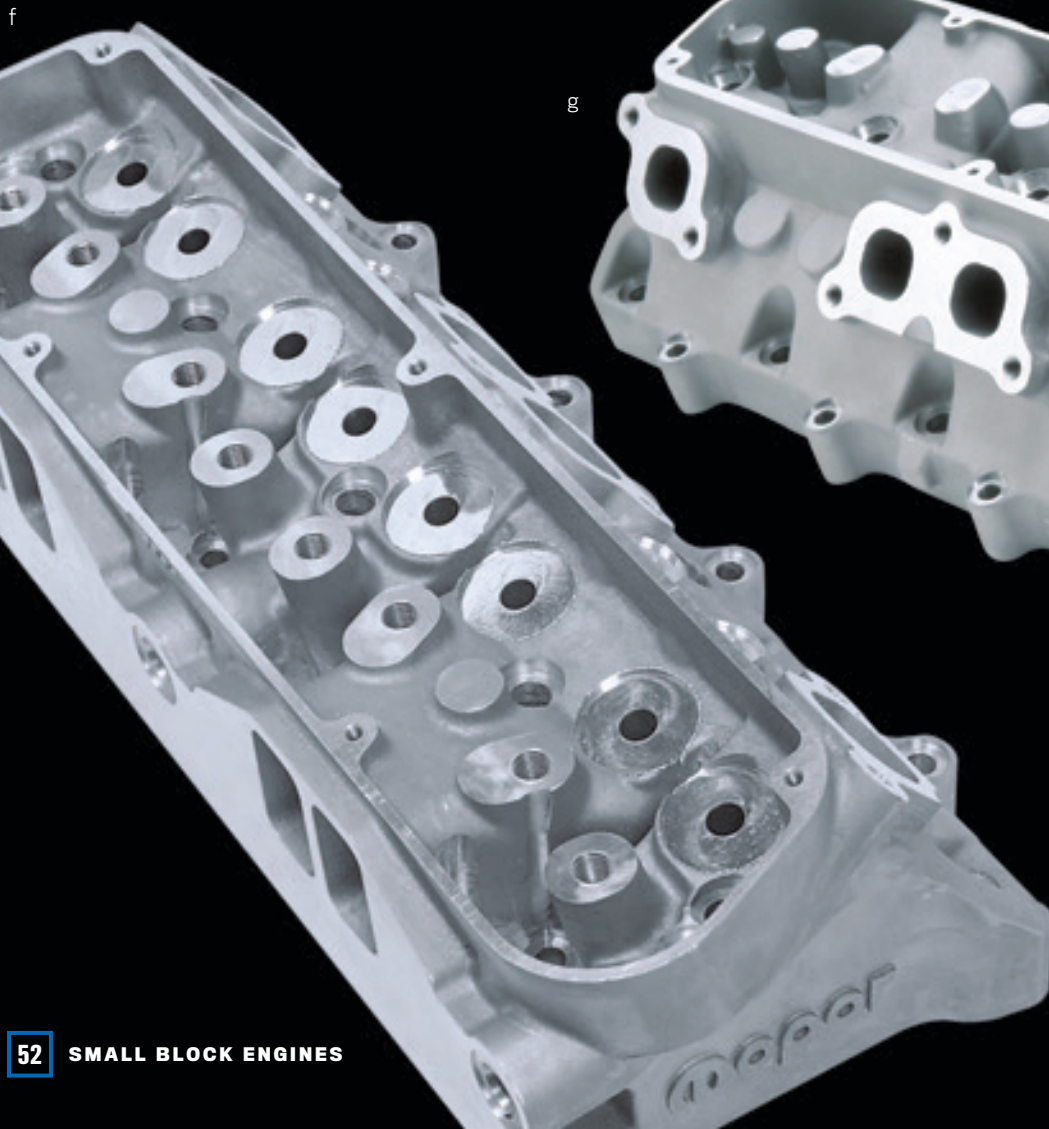



### CYLINDER HEADS, MAGNUM

Features higher airflow and performance over cast iron (stock) Magnum cylinder heads. Uses Magnum vertical-style intake manifold attachment and production exhaust flange pattern.  
No heat crossover.

Aluminum with Valves and Springs. 58cc Combustion Chamber, 2.020"/1.600" Valves. Requires the use of 1.6:1 Roller Rocker Arms (P/N P5153852), Pushrods (P/N P5153848), and Taller Than Stock Valve Covers (P/N P5007617 or P/N P5007618).

**P/N P5153847** . . . . . \$1,555.00

Cast Iron, Bare, 1.920" Intake, 1.624" Exhaust, 62cc Chamber, 172cc Intake Runner, **P/N P515469** . . . . . \$555.00

### GASKETS, CYLINDER HEAD, COMPOSITE

Can be used for replacement or competition applications up to 12.5:1 compression ratio. Small block four-bolt pattern. Sold as an engine set. (See representative image: Fig. h)

Up to 4.06" Bore, 0.040" to 0.042" Compressed Thickness, Small Block, **P/N P4349557** . . . . . \$88.00

Up to 4.125" Bore, up to 12.5:1 Compression Ratio, Small Block. **P/N P4120094**. . . . . \$76.00

### LOW-COMPRESSION RATIO COMPOSITION MATERIAL GASKET

Not recommended for compression ratios over 10.5:1.

Up to 4.060" Bore; 0.040" Thickness, **P/N P4120093**. . . . . \$30.75

### HEAD BOLT SETS

Includes all required head bolts.

With Washers, use with Cylinder Heads P/N P5153849 and P/N P5153850, **P/N P5153851** . . . . . \$105.00

318/340/360 LA Engines up to 1992, **P/N P4120471** . . . . . \$166.00

Magnum, Small Block/5.2L/5.9L Truck Magnum/Jeep® Brand Engines **P/N P4876759**. . . . . \$156.00

### HEAD STUD KITS

Kits contain studs, nuts and washers for changeover of stock head bolts. (See representative image: Fig. i)

Aluminum Block, W9 Heads, **P/N P4876757AB**. . . . . \$423.00

Aluminum Block, W9 Raised Port Cylinder Head (AB and A4 Engine Blocks with W9RP Cylinder Heads) (Limited Quantities), **P/N P5007912** . . . . . \$1,235.00

### HARDENED WASHER SETS

For use with head bolts and main caps. Sold in sets of 20.

3/8", **P/N P4120456**. . . . . \$20.45

### EXHAUST MANIFOLD HEAT SHIELD - 340

Driver's Side, 340, **P/N P2946105**. . . . . \$211.00

<sup>1</sup>Not legal on pollution-controlled vehicles or vehicles registered for highway use.

# VALVETRAIN HARDWARE

Making big power requires internal components that can withstand the punishment. Choose from valvetrain hardware designed for everything from street restoration applications to full-out race gear.

## VALVES (See representative image: Fig. j)

|   |         |
|---|---------|
| Exhaust, 1.625" Diameter, 4.93" Stem Length, 3.9L/5.2L/5.9L<br>Magnum/Jeep® Brand Engines<br><b>P/N 'P5249876</b> . . . . .     | \$21.95 |
| Exhaust, 1.65" Diameter, 4.97" Stem Length, 340/360 Small Block<br><b>P/N 'P5249188</b> . . . . .                               | \$17.30 |
| Exhaust, 1.65" Diameter, 5.29" Stem Length, W2/W5 Heads<br><b>P/N 'P5249198</b> . . . . .                                       | \$17.30 |
| Intake, 2.02" Diameter, 4.91" Stem Length, 3.9L/5.2L/5.9L<br>Truck Magnum/Jeep® Brand Engines<br><b>P/N 'P5249878</b> . . . . . | \$24.15 |
| Intake, 1.88" Diameter, 4.98" Stem Length, 340/360 Small Block<br><b>P/N 'P4876397</b> . . . . .                                | \$19.70 |
| Intake, 1.92" Diameter, 4.91" Stem, 3.9L/5.2L/5.9L Magnum/Jeep®<br>Brand Engines, <b>P/N 'P5249875</b> . . . . .                | \$25.10 |
| Intake, 1.97" Diameter, 4.91" Stem, 3.9L/5.2L/5.9L Magnum/Jeep®<br>Brand Engines, <b>P/N 'P5249877</b> . . . . .                | \$24.15 |
| Intake, 2.08" Diameter, 4.98" Stem Length, 340/360 Small Block<br><b>P/N 'P5249186</b> . . . . .                                | \$19.90 |
| Intake, 2.08" Diameter, 5.28" Stem Length, W2/W5 Heads<br><b>P/N 'P5249196</b> . . . . .  | \$19.10 |
| X-Long, Intake, Race, 2.15" Diameter, 5.4065" Overall Length<br><b>P/N 'P4876580</b> . . . . .                                  | \$13.30 |

## VALVE SEALS

Sold in sets of 16. Does not apply to 0.530" guide.

|  |         |
|--|---------|
| 3/8" Stem, Big Block/Small Block<br><b>P/N 'P4120492</b> . . . . .   | \$19.70 |
| 5/16" Stem, 0.530" Guide, 426 HEMI® Engine and 5.2L/5.9L<br>Magnum/Jeep® Brand Engines<br><b>P/N 'P5249661</b> . . . . . | \$19.70 |

## VALVE KEEPERS (SPLIT-LOCK)

Features a 3/8" stem diameter and is available in 7° and 10° angles. Set includes 16 pieces (two sets required for V8 Engines).

|   |         |
|---|---------|
| 7°, Single Groove<br><b>P/N 'P4120618</b> . . . . . | \$54.00 |
|---|---------|



k

## VALVE SPRING RETAINERS

Sold individually.

|  |         |
|--|---------|
| Chrome Moly, 7°, 8mm Stem Diameter, Single, 2.2L/2.5L SOHC<br>and 5.2L/5.9L Magnum Engines<br><b>P/N 'P4452032</b> . . . . . | \$12.15 |
|--|---------|

## VALVE SPRINGS

High-pressure Valve Springs can be used on exhaust and intake valves for all high-performance applications. (See representative image: Fig. k)

|  |         |
|--|---------|
| 3.9L/5.2L/5.9L Magnum, Jeep® Brand Engines/Truck Engines<br><b>P/N 'P5249464</b> . . . . . | \$14.60 |
| 5.2L/5.9L Magnum, Jeep® Brand Engines/Truck Engines<br><b>P/N 'P4876062</b> . . . . .      | \$10.70 |
| Single, 0.380"/0.450" Lift<br><b>P/N 'P4286813</b> . . . . .                               | \$10.35 |
| Single, 0.430"/0.460" Lift<br><b>P/N 'P4286812</b> . . . . .                               | \$13.20 |
| Single, 0.430"/0.500" Lift<br><b>P/N 'P4120249</b> . . . . .                               | \$10.95 |
| Single, 0.440"/0.500" Lift<br><b>P/N 'P3690933</b> . . . . .                               | \$11.10 |
| Double, 0.500"/0.620" Lift<br><b>P/N 'P3412068</b> . . . . .                               | \$10.35 |
| Double, 0.590"/0.640" Lift<br><b>P/N 'P4876064</b> . . . . .                               | \$15.15 |

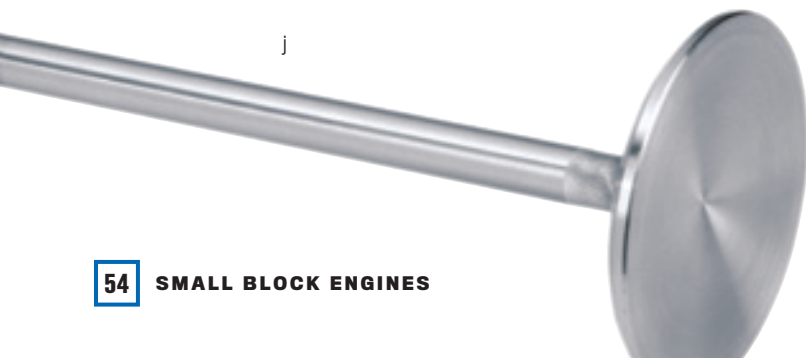

j

# ROCKER ARMS, SHAFTS, STANDS & HARDWARE

Start your engine build with a fresh set of rocker arms, shafts and hardware to guarantee your valve gear is singing in perfect harmony.

## ROCKER ARMS, HYDRAULIC

Package set includes 16 heavy-duty hydraulic rocker arms (eight right, eight left), rocker shaft retainers and hold-down bolts. Rocker shafts not included. (See representative image: Fig. l)

- Production, 1.5 Ratio, Package, P/N **'P4529742** . . . . . \$370.00
- Service, 1.5 Ratio, Left. Sold individually, P/N **'P4529475**. . . . . \$10.70
- 1.5 Ratio, Right. Sold individually, P/N **'P4529474** . . . . . \$10.70

## ROCKER ARM SYSTEM, PRO RACE

Complete rocker arm system made of high-strength aluminum, including shafts and bolts. Requires hollow pushrods and tappets for oiling. High-ratio rockers may require grinding on block and head for clearance. Not for street use.

- 0.550" Offset, 1.6 Ratio, One Head Only, W9, P/N **'P5007470** (Fig. m) . . . \$852.00

## ROCKER ARM SPACER SET

- 0.015" Thick, .878" I.D., 1.246" O.D., Set of 12, P/N **'P3690896**. . . . . \$13.60

## ROCKER SHAFTS

- Hydraulic Valve Gear, On-Center. Sold individually, P/N **'P4510636** . . . \$42.15



## ROCKER SHAFT STANDS

Designed to upgrade cast aluminum rocker stands, these units will not flex, crack or crush. Each set contains 10 stands (six narrow and four wide) and mounting bolts.

- Billet Aluminum, W2/W5 Heads, P/N **'P5249049** . . . . . \$186.00

## ROCKER SHAFT HOLD-DOWN

Billet aluminum rocker shaft hold-down provides greater rocker shaft stiffness, which helps rocker shaft maintain roundness when torque is applied.

- Standard Small Block Heads, P/N **'P5249712** . . . . . \$128.00

## ROCKER SHAFT RETAINERS AND BOLTS

Manufactured to Mopar® original equipment specifications to ensure high quality. For use on all cylinder heads with cast-in rocker stands.

- Rocker Shaft Retainers and Bolts, P/N **'P4529740** . . . . . \$103.00

## ROCKER ARMS, ROLLER

Can be used as heavy-duty replacements with standard or high-performance hydraulic camshafts. High-ratio rockers will increase valve lift – use matching valve spring, and check piston-to-valve clearance. Not for use with Cylinder Head P/N P5153847.

- 1.7:1 Ratio, 5.2L/5.9L Dodge Truck Magnum/Jeep® Brand Engines. Fits Production and R/T Heads, P/N **'P5007404** . . . . . \$634.00

<sup>1</sup>Not legal on pollution-controlled vehicles or vehicles registered for highway use.

# VALVE COVERS & HARDWARE

Your engine project will get noticed with a set of Mopar® Valve Covers in black wrinkle finish or chrome, cast aluminum or stamped steel.

## VALVE COVERS, ALUMINUM, "AS CAST"

Cast aluminum covers are more rigid than stamped steel, which helps prevent valve cover leaks. Sold "as cast" so you can set up the breathers required. There's no paint to remove if welding is done. Pentastar logo is cast into each cover. Set includes two valve covers and oil filler caps. (See representative image: Fig. n)

|  |          |
|--|----------|
| Valve Cover, Aluminum, "As Cast," Set<br><b>P/N P5007612AB</b> . . . . .   | \$142.00 |
| Gasket, Valve Cover, Five-Bolt Rubber with Steel Shim Reinforcement 318/340/360 A Engines up to 1992. Set<br><b>P/N P5249581AB</b> . . . . . | \$70.00  |
| Gasket, Valve Cover, Race, Set<br><b>P/N P4452089</b> . . . . .  | \$27.50  |



n

## VALVE COVERS, CAST ALUMINUM, POLISHED

Polished to a chrome-like shine that's perfect for that show-car engine look. Features Pentastar logo. Set includes two valve covers, two oil filler caps and baffle package.

|  |          |
|--|----------|
| Valve Cover, Cast Aluminum, Polished, Set<br><b>P/N P5007613AB</b> . . . . . | \$188.00 |
| Gasket, Valve Cover, Race, Set<br><b>P/N P4452089</b> . . . . .              | \$27.50  |

## VALVE COVERS, CAST ALUMINUM, MOPAR® MAGNUM

Polished cast aluminum valve cover sets are more rigid than stamped steel for better anti-leak properties. Features Magnum logo. Each set includes all grommets and a quarter-turn oil filler cap. Gaskets must be ordered separately.

|  |          |
|--|----------|
| Valve Cover, Cast Aluminum, Polished, 5.2L/5.9L Truck Magnum Engines, Set<br><b>P/N P5007618</b> . . . . .                       | \$283.00 |
| Gasket, Valve Cover, 10-Bolt Mold Rubber Steel Shim, 5.2L/5.9L Truck Magnum Engines, Set of Two<br><b>P/N P5249660</b> . . . . . | \$25.90  |

## VALVE COVERS, CAST ALUMINUM, BLACK WRINKLE

High-strength Cast Aluminum Valve Covers are more rigid than stamped steel, offering better anti-leak properties. Pentastar logo is cast into each cover. Set includes two valve covers, two oil filler caps and baffle package. (See representative image: Fig. o)

|   |          |
|---|----------|
| "LA" Small Block Valve Cover Kit, Black Wrinkle Paint, Set<br><b>P/N P5007611AB</b> . . . . .   | \$168.00 |
| 5.2L/5.9L Truck Magnum Engines, 1993 and up, Set<br><b>P/N P5007617</b> . . . . .   | \$162.00 |
| 1993-1998 5.2L/5.9L Jeep® Brand Engines, Set<br><b>P/N P5007619</b> . . . . .   | \$165.00 |
| Gasket, Valve Cover, Five-Bolt Rubber with Steel Shim Reinforcement, 318/340/360 A Engines up to 1992, Set<br><b>P/N P5249581AB</b> . . . . . | \$70.00  |
| Gasket, Valve Cover, Race, Set<br><b>P/N P4452089</b> . . . . .   | \$27.50  |
| Black, Small Block<br><b>P/N P5155525</b> . . . . .   | \$335.00 |



o





p

**VALVE COVERS, CHROME**

Dress up your engine compartment with these high-quality, chrome-plated stamped steel valve covers. Set includes two valve covers and grommets. Does not include gaskets, screws or baffling. (See representative image: Fig. p)

- "Direct Connection" Logo, Small Block, Set  
**P/N P4349632AB** . . . . . \$150.00
- Gasket, Valve Cover, Race, Set  
**P/N P4452089** . . . . . \$27.50

**VALVE COVER HARDWARE, CHROME**

For stamped steel valve covers only. Accessory set includes 12 chrome-plated screws and washers, one chrome-plated oil filler cap and two rubber grommets.

- Valve Cover Accessory Set, Big Block/Small Block  
**P/N P4120272** . . . . . \$21.10
- Grommet and Plug Set, Valve Cover, Big Block/Small Block  
**P/N P5007419** . . . . . \$9.75
- Bolt Set, Valve Cover, Chrome, Big Block/Small Block, 12 Pieces  
**P/N P5007458** . . . . . \$40.40

**VALVE COVERS, WIDE**

Five-bolt cover features reversed-lip design that allows the cover to be wider on stock production gasket surface. Extra width allows for larger valve springs and longer rocker arms. Pentastar logo featured on each cover. Use with Stud Package P/N P4876676. (See representative image: Fig. q)

- Stock Production Small Blocks and W2/W5/W7/W9 Flanges, Set  
**P/N P4876124** . . . . . \$352.00
- Five-Bolt Rubber with Steel Shim Reinforcement, 318/340/360 A Engines up to 1992, Set  
**P/N P5249581AB** . . . . . \$70.00

**BAFFLE AND SCREW PACKAGE**

For cast aluminum valve covers only.

- Big Block/Small Block/Truck Magnum/ Jeep® Brand Engines  
**P/N P5007052** . . . . . \$9.75

**BOLT SET - VALVE COVER**

Package includes 12 retaining bolts.

- Big Block/Small Block  
**P/N P5007053** . . . . . \$22.65

**BOLT SET - CHROME**

Fit 5.2L/5.9L Magnum Valve Cover Packages P/N P5007617 and P/N 5007618. Designed for cast aluminum valve covers only. Set includes 20 bolts (10 per cover).

- Cast Aluminum Valve Cover, Small Block/5.2L/5.9L/Truck Magnum/Jeep® Brand Engines  
**P/N P5007620** . . . . . \$43.60

**BREATHER CAPS, CHROME**

- Push-In Style, Chrome  
**P/N P4529881** . . . . . \$9.75
- Twist-On, Bottom-Vented, Chrome  
**P/N P4529880** . . . . . \$9.75
- Breather Cap, with Tube  
**P/N P4120446** . . . . . \$25.90
- Grommet, Rubber, use with Breather Cap P/N P4529881  
**P/N P4529882** . . . . . \$6.60

**GROMMET - PCV & BREATHER**

Set includes one grommet for PCV and one that can be used for plug or opened for breather.

- Grommet, Cast Aluminum Valve Cover, 5.2L/5.9L Truck Magnum/Jeep® Brand Engines, Set  
**P/N P5249642** . . . . . \$9.75

q



<sup>1</sup>Not legal on pollution-controlled vehicles or vehicles registered for highway use.

# INTAKE MANIFOLDS, HARDWARE & GASKETS

Make sure your engine breathes right with a Mopar® Intake Manifold that accepts standard carburetors, in single- or dual-plane configurations.

## SINGLE-PLANE INTAKE MANIFOLDS

Aluminum, Single-Plane, Victor Style, Big Port and Standard Holley Four-Barrel Carburetor, LA Engine with Super Commando Heads

**P/N 'P5155314** . . . . . \$479.00

Intake Manifold, Aluminum, Single-Plane, Four-Barrel Carburetor, 5.2L/5.9L Truck Magnum/Jeep® Brand Engines, Magnum Crate Engines

**P/N 'P5007380AB** . . . . . \$363.00

Intake Manifold, Aluminum, Single-Plane, Four-Barrel Carburetor, Large Oval Port, 9.200" Deck, W2 Cylinder Heads

**P/N 'P4876829AB** . . . . . \$759.00

Intake Manifold, Aluminum, Single-Plane, Four-Barrel Carburetor, Oval Port, Water Heat 9.600" Deck, W2 Cylinder Heads

**P/N 'P4529408AB** . . . . . \$383.00

## DUAL-PLANE INTAKE MANIFOLDS (See representative image: Fig. r)

Intake Manifold, Aluminum, Dual-Plane, Four-Barrel Carburetor, 1967-1991, Standard Heads

**P/N 'P4876335AB** . . . . . \$294.00

Intake Manifold, Aluminum, Dual-Plane, Four-Barrel Carburetor, 9.200" Deck, W2 Cylinder Heads

**P/N 'P5249572AB** . . . . . \$492.00

Intake Manifold, Aluminum, Dual-Plane, Four-Barrel Carburetor, 9.600" Deck, W2 Cylinder Heads

**P/N 'P5155426** . . . . . \$438.00

## DUAL-PLANE INTAKE MANIFOLD - SIX PACK

Intake Manifold, Aluminum, Dual-Plane, Six Pack, Rectangle Port (1967-1991 Small Block), **P/N 'P4529054** (Fig. s) . . . . . \$310.00

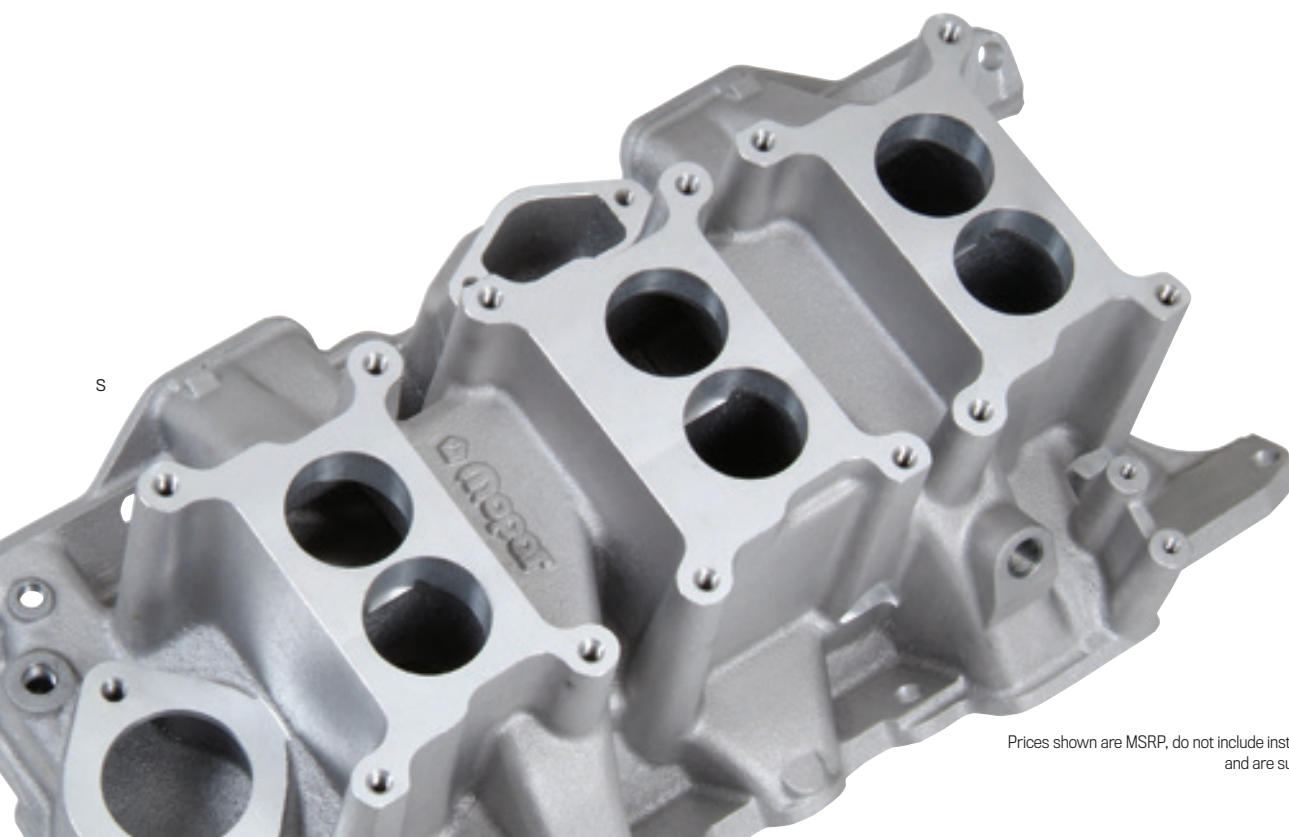
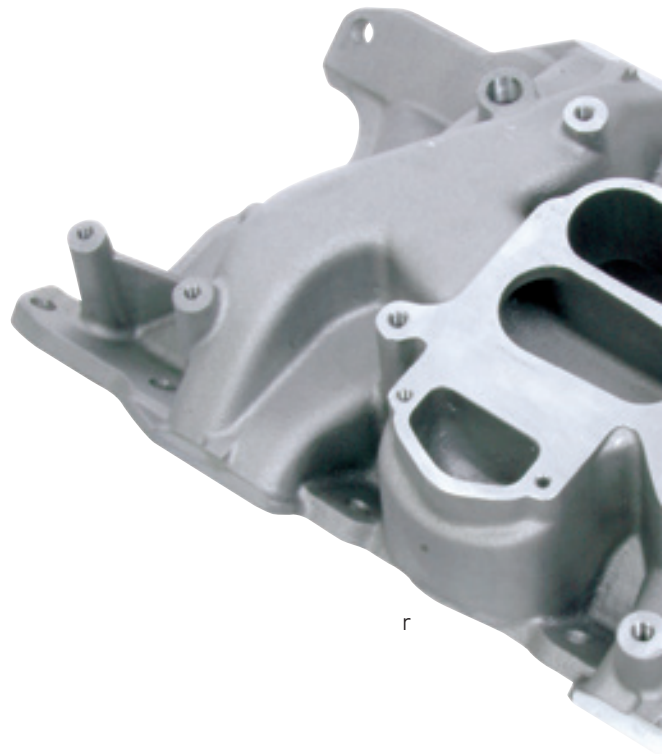

Prices shown are MSRP, do not include installation or taxes, and are subject to change.

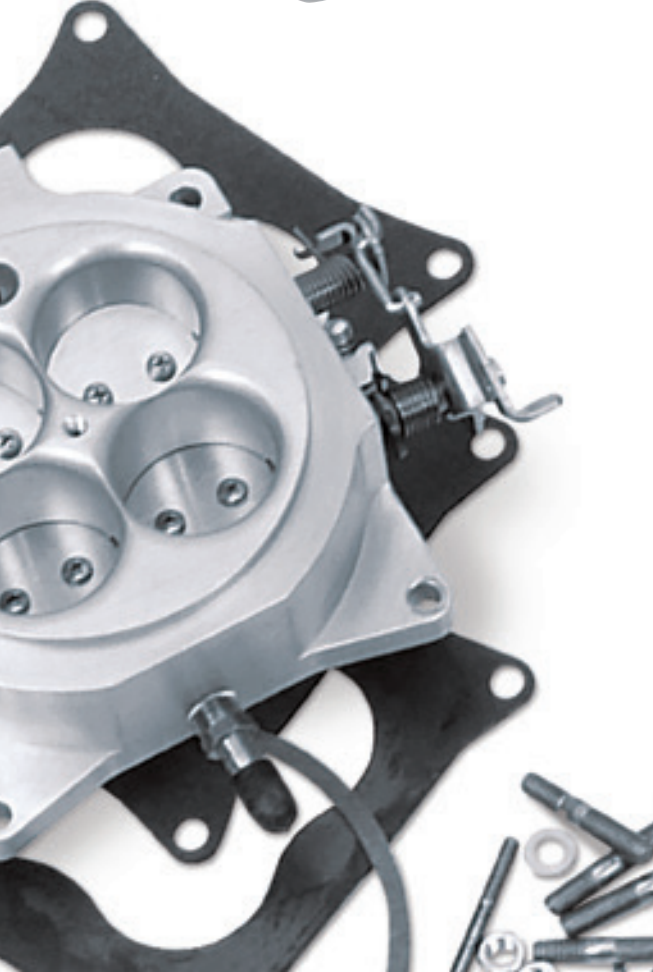

### **ALUMINUM SINGLE-PLANE INTAKE - MPI**

Can be used as a direct replacement for production engines. Allows use of air conditioning and all factory accessories. Designed to use production throttle body, injectors, fuel rail and other hardware from your stock intake. Available in EGR and non-EGR. Replacement for stock.

Installation Kit, Intake Manifold, Two-Barrel Intake only, 5.2L/5.9L Truck  
Magnum/Jeep® Brand Engines

**P/N 'P5007638** . . . . . \$88.00

### **THROTTLE BODY - 360 MAGNUM**

Note: Pinout is different from Delphi IAC and Mopar® IAC.

Throttle Body, Service Part for 360 Fuel Injection Kits

**P/N 'P5153702** (Fig. t) . . . . . \$550.00

### **INTAKE MANIFOLD GASKET SETS**

Custom-fit for use with small block cylinder heads. Complete kit to service one engine, including gaskets, end seals, O-rings and distributor seal (where applicable).

Gasket, Intake Manifold, 5.9L Magnum Jeep® Brand Engines/Truck

**P/N P4876049** . . . . . \$42.05

Gasket, Intake Manifold, Small Block, 0.060" Thick

**P/N P4452101** . . . . . \$25.90

Gasket, Intake Manifold, W2, Heads, 0.030" Thick

**P/N P4120210AB** . . . . . \$18.40

Gasket, Intake Manifold, W2 Heads, 0.045" Thick

**P/N P4120211AB** . . . . . \$21.10

Gasket, Intake Manifold, W2 Heads, 0.055" Thick

**P/N P4007571AB** . . . . . \$21.15

Gasket, Intake Manifold, Standard LA, 0.055" Thick

**P/N P4007570AB** . . . . . \$18.75

Gasket, Intake Manifold, Standard LA, 0.055" Thick, with Heat Block-Off Plate

**P/N P4286569AB** . . . . . \$28.10

### **INTAKE MANIFOLD ATTACHING BOLTS**

A complete package of bolts required to attach the intake manifold to the cylinder heads. Engine set.

Bolt Package, Intake Manifold, 5/16"x2 3/4", 1992-1998 5.2L/5.9L Magnum,  
Jeep® Brand Engines/Truck

**P/N P4876772** . . . . . \$9.75

t

\*Not legal on pollution-controlled vehicles or vehicles registered for highway use.

# OILING COMPONENTS

Oil is the lifeblood of your high-horsepower engine. Keep it flowing with Mopar® Oil Pickups, Pumps, Oil Pans and more.

## OIL PANS

Includes oil pan and pickup, drain plug and washer.

Five-Quart, Rear Sump, 273/318/340 Small Block  
**P/N P5249062AB** (Fig. u) . . . . . \$102.00

Five-Quart, Rear Sump, 360 Small Block and 5.9L Magnum  
**P/N P5249060AB** . . . . . \$211.00

## OIL PAN BOLT SET

426 HEMI® Engine/Big Block/Small Block, Set of 20 Bolts  
**P/N P4120613** . . . . . \$14.60

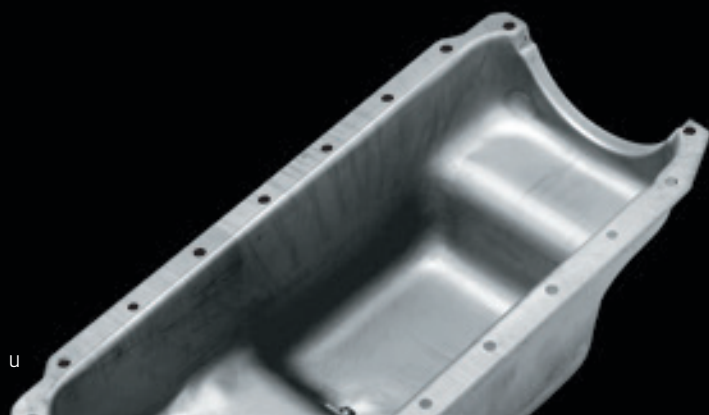

u

## OIL PAN GASKETS

1970-1990 318/340 Small Block  
**P/N P4452097** . . . . . \$14.60

360 Small Block  
**P/N P4007573** . . . . . \$14.60

5.9L Dodge Truck Magnum/Jeep® Brand Engines  
**P/N P5249932** . . . . . \$31.30

Race, 360 Small Block  
**P/N P4452093** . . . . . \$13.75

Reusable, 318/340 Small Block  
**P/N P4007572** . . . . . \$11.45

## OIL PICKUP AND SCREEN ASSEMBLIES

Center Sump Pans P/N P5249059 and P/N P5249061 (Small Block)  
**P/N P4529563** . . . . . \$35.80

## OIL PRESSURE RELIEF SPRING

Small Block/2.2L/2.5L/3.9L V6, Set  
**P/N P3690944** . . . . . \$6.60

# COOLING SYSTEMS

Keep your cool with Mopar® Water Pumps, Thermostats and Fan packages.

## WATER PUMPS

Mopar® Aluminum Water Pumps feature basic high-flow designs. The six-blade pump is recommended for use with cast iron cylinder heads and for drag racing applications. The eight-blade pump is recommended for use with aluminum cylinder heads and for circle track applications. Passenger-side lower hose inlet (1970 and up). (See representative image: Fig. w)

Water Pump, Aluminum, 6-Blade, **P/N P5249558** . . . . . \$83.00

Water Pump, Aluminum, 8-Blade, **P/N P5249559** . . . . . \$99.00

## BOLT SET, WATER PUMP, CHROME

Engine chrome dress-up projects just aren't complete without chrome bolts.

Bolt Set, Chrome, Water Pump, 1969-1992 A Engine, **P/N P4529256** . . . \$50.00

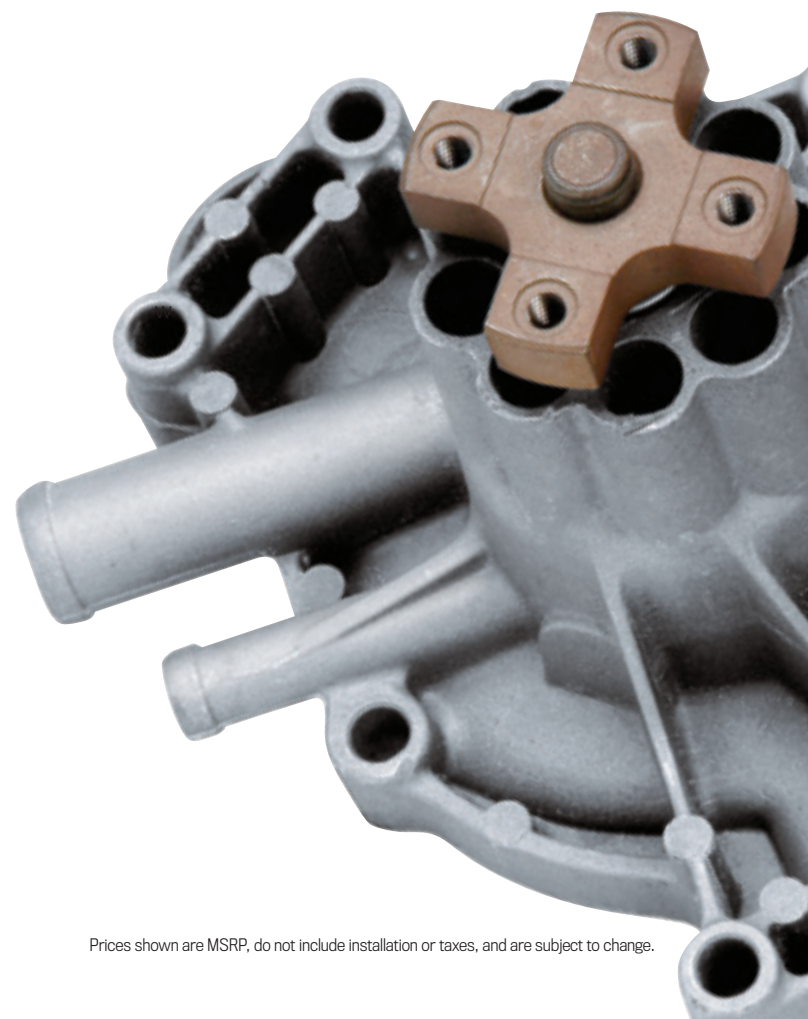

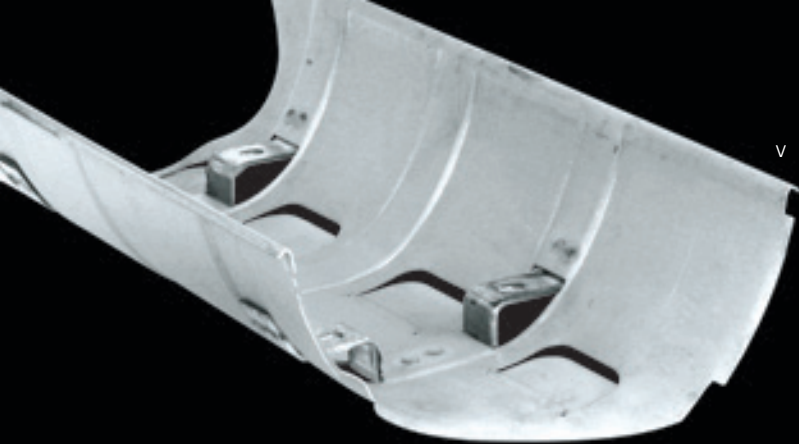

v

**WINDAGE TRAY**

- 318/340/360 Small Block  
**P/N P4529790** (Fig. v) . . . . . \$105.00
- Hardware Kit, 318/340/360 Small Block  
**P/N P3690939** . . . . . \$85.00

**OIL PUMP ASSEMBLY**

- Small Block, 3.9L V6  
**P/N P4286589** . . . . . \$95.00

**DISTRIBUTOR DRIVE GEAR ASSEMBLIES**

- Billet Roller Cam, Aluminum-Bronze Gear  
**P/N P3690874** . . . . . \$280.00
- Oil Pump, Distributor Gear, HD  
**P/N P3690715** . . . . . \$70.00

**TUBE AND PEEN TOOL PACKAGE**

- Small Block  
**P/N P4120603** . . . . . \$57.00

**RIGHT ANGLE OIL FILTER GASKET**

- Oil Filter Adapter Gasket for P/N P5249624AB  
**P/N P5249320** . . . . . \$9.75

**OIL PUMP PRIMING SHAFT**

- Shaft, Oil Pump Priming  
**P/N P4286800** . . . . . \$9.75

**DIPSTICK AND TUBE, CHROME**

- Dipstick and Tube, Chrome, Center Sump Pan, Small Block Passenger Cars, **P/N P4349628** . . . . . \$22.65

**OIL FILTER - PERFORMANCE**

- Oil Filter, High-Performance, Black Finish, 6-/8-Cylinder Engines  
**P/N P4452890** . . . . . \$11.45

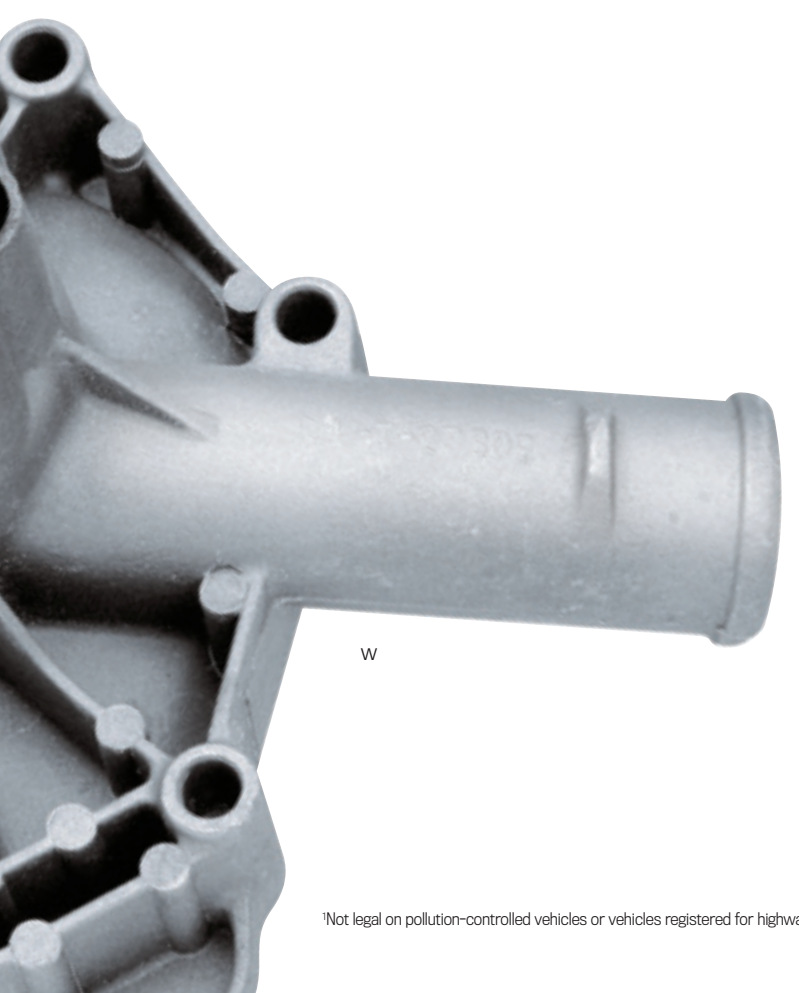

w

**THERMOSTAT HOUSING, CHROME**

This high-quality housing is made of heavy-duty material. Includes gasket and two chrome bolts.

- Water Neck, Chrome, Up to 1978, V8, **P/N P4286759AB** . . . . . \$20.45

**THERMOSTAT**

Heavy-duty Mopar® thermostat can handle increased heat management duties in high-performance engines. Replacement gasket included.

- Thermostat, 195 Degree, 1979 and up, **P/N P4876308** . . . . . \$9.45

**BYPASS HOSE**

Designed to go from the intake manifold to the water pump. Made of heavy-duty silicone rubber. Includes two clamps.

- Bypass Hose, 1970-1991 Small Block, **P/N P4876373** . . . . . \$14.60
- Bypass Fitting, Intake Manifold, Adapts Bypass Hose to Manifold, 1970-1991 Small Block, **P/N P4876374** . . . . . \$25.90

\*Not legal on pollution-controlled vehicles or vehicles registered for highway use.

# PERFORMANCE GAUGES





Gauges

64

Gauge Pods

67

With our performance gauges, you can get your driveline's vital signs in a glance for an overall better driving experience. It's these details that matter when it comes to making your ride safer and perfecting your vehicle's performance.

# GAUGES

Mopar® Performance Gauges are created using race-proven Auto Meter components and are now infused with superior LED through-the-dial OE quality lighting to provide at-a-glance readings, day or night.

## FULL SWEEP ELECTRONIC

Powered by digital, microprocessor-controlled, rugged stepper motor drives and laboratory grade sending units, Full Sweep Electric Gauges are the BEST gauges available. Extreme durability and readability of 270-degree sweep mechanical gauges are combined with easy installation and safe operation. Short-sweep electrics are track-tested and race proven, these units employ precision senders to keep hazardous fluids out of the driver compartment and perform gauge calibration and sensor diagnostics at power-up for extreme accuracy every time. Most units are compatible with Auto Meter Data Logger for the ultimate race information center.



a



## SHORT SWEEP ELECTRONIC

Advanced 90-degree air core movements and simple three-wire installation characterize these high-performance instruments. Electrical signals collect data generated from hazardous fluids in the engine compartment to ensure precision. It's all the information you need – and nothing you don't.

## MECHANICAL

Bronze Bourdon tube, 270-degree sweep movements and durable nylon gearing have made these rugged and long-lasting gauges a proven high-performance favorite for more than 25 years. These mechanical gauges require no electrical power for operation, which makes them an ideal choice for vehicles with no- or low-powered electrical systems.

## FUEL LEVEL

(Representative image for Fuel Level Gauges: Fig. a)

- Fuel Level, Full Sweep, Electronic  
2 1/16", Black Dial, **P/N 77060043** . . . . . \$159.00
- Fuel Level, Full Sweep, Electronic  
2 1/16", White Dial, **P/N 77060042** . . . . . \$165.00

## OIL TEMPERATURE

- Oil Temperature, Full Sweep, Electronic  
2 5/8", Range: 140–280°F, **P/N P5155503** . . . . . \$240.00

## BOOST VACUUM

- Boost Vacuum, Diesel, Full Sweep, Electronic  
2 1/16", Range: 0–30 psi, Black Dial  
**P/N 77060061** . . . . . \$251.00
- Boost Vacuum, Diesel, Full Sweep, Electronic  
2 1/16", Range: 0–30 psi, White Dial  
**P/N 77060060** . . . . . \$251.00
- Boost Vacuum, Diesel, Full Sweep, Mechanical  
2 1/16", Range: 0–35 psi, White Dial  
**P/N 77060030** . . . . . \$96.00
- Boost Vacuum, Diesel, Full Sweep, Mechanical  
2 1/16", Range: 0–35 psi, Black Dial  
**P/N 77060031** . . . . . \$81.00
- Boost Vacuum, Diesel, Full Sweep, Mechanical  
2 1/16", Range: 20 psi/30" hg, Black Dial  
**P/N 77060033** . . . . . \$102.00
- Boost Vacuum, Diesel, Full Sweep, Mechanical  
2 1/16", Range: 20 psi/30" hg, White Dial  
**P/N 77060032** . . . . . \$102.00





b

## OIL PRESSURE

(Representative image for Oil Pressure Gauges: Fig. b)

|   |          |
|---|----------|
| Oil Pressure, Full Sweep, Electronic<br>2 5/8", Range: 0-100 psi, White Dial<br><b>P/N P5155501</b> . . . . .   | \$334.00 |
| Oil Pressure, Full Sweep, Mechanical<br>2 1/16", Range: 0-100 psi, Black Dial<br><b>P/N 77060035</b> . . . . .  | \$93.00  |
| Oil Pressure, Full Sweep, Mechanical<br>2 1/16", Range: 0-100 psi, White Dial<br><b>P/N 77060034</b> . . . . .  | \$93.00  |
| Oil Pressure, Short Sweep, Electronic<br>2 1/16", Range: 0-100 psi, Black Dial<br><b>P/N 77060045</b> . . . . . | \$115.00 |
| Oil Pressure, Short Sweep, Electronic<br>2 1/16", Range: 0-100 psi<br><b>P/N 77060044</b> . . . . .             | \$115.00 |

## SPEEDOMETER

(Representative image for Speedometers: Fig. c)

|   |          |
|---|----------|
| Speedometer, In-Dash, Full Sweep, Electronic<br>3 3/8", Range: 0-160 mph, Black Dial<br><b>P/N 77060055</b> . . . . . | \$331.00 |
| Speedometer, In-Dash, Full Sweep, Electronic<br>3 3/8", Range: 0-160 mph, White Dial<br><b>P/N 77060054</b> . . . . . | \$331.00 |

## PYROMETER

|   |          |
|---|----------|
| Pyrometer, Full Sweep, Electronic<br>2 1/16", Range: 0-1,600°F, Black Dial<br><b>P/N 77060047</b> . . . . . | \$215.00 |
| Pyrometer, Full Sweep, Electronic<br>2 1/16", Range: 0-1,600°F, White Dial<br><b>P/N 77060046</b> . . . . . | \$222.00 |



c

<sup>1</sup>Not legal on pollution-controlled vehicles or vehicles registered for highway use.



d

**TACHOMETERS**

(Representative image for Tachometers: Fig. d)

- Tachometer, In-Dash Mount, Full Sweep, Electronic  
3 3/8", Range: 0-10,000 rpm, Black Dial  
**P/N 77060057** . . . . . \$226.00
- Tachometer, In-Dash Mount, Full Sweep, Electronic  
3 3/8", Range: 0-10,000 rpm, White Dial  
**P/N 77060056** . . . . . \$226.00
- Tachometer, Pedestal Mount with Shift Light, Full Sweep,  
Electronic 3 3/8", Range: 0-10,000 rpm, Black Dial  
**P/N 77060059** . . . . . \$274.00
- Tachometer, Pedestal Mount with Shift Light, Full Sweep,  
Electronic 3 3/8", Range: 0-10,000 rpm, White Dial  
**P/N 77060058** . . . . . \$283.00
- Tachometer, Pedestal Mount with Shift Light,  
Full Sweep, Electronic 5", Range: 0-10,000 rpm, White Dial  
**P/N P5155500** . . . . . \$402.00

**TRANSMISSION TEMPERATURE**

- Transmission Temperature, Full Sweep, Electronic  
2 5/8", Range: 100-260°F, White Dial  
**P/N P5155885** . . . . . \$240.00
- Transmission Temperature, Short Sweep, Electronic  
2 1/16", Range: 100-260°F, White Dial  
**P/N 77060048** . . . . . \$193.00
- Transmission Temperature, Short Sweep, Electronic  
2 1/16", Range: 100-260°F, Black Dial  
**P/N 77060049** . . . . . \$164.00

**VOLTMETERS**

(Representative image for Voltmeters: Fig. e)

- Voltmeter, Short Sweep, Electronic  
2 1/16", Range: 8-18 Volts, Black Dial  
**P/N 77060051** . . . . . \$83.00
- Voltmeter, Short Sweep, Electronic  
2 1/16", Range: 8-18 Volts, White Dial  
**P/N 77060050** . . . . . \$83.00
- Voltmeter, Short Sweep, Electronic  
2 5/8", Range: 8-18 Volts, White Dial  
**P/N P5155504** . . . . . \$118.00

**COOLANT TEMPERATURE**

(Representative image for Coolant Temperature Gauges: Fig. f)

- Water Temperature, Full Sweep, Electronic  
2 1/16", Range: 100-260°F, Black Dial  
**P/N 77060053** . . . . . \$196.00
- Water Temperature, Full Sweep, Electronic  
2 1/16", Range: 100-260°F, White Dial  
**P/N 77060052** . . . . . \$196.00
- Water Temperature, Full Sweep, Electronic  
2 5/8", Range: 100-260°F, White Dial  
**P/N P5155502** . . . . . \$240.00
- Water Temperature, Short Sweep, Electronic  
2 1/16", Range: 100-250°F, Black Dial  
**P/N 77060039** . . . . . \$90.00
- Water Temperature, Short Sweep, Electronic  
2 1/16", Range: 100-250°F, White Dial  
**P/N 77060038** . . . . . \$93.00



f



e

## GAUGE PODS

These Gauge Pods from Mopar® Performance are available for the popular 2-1/16" gauges. Premium grade automotive ABS is formed and trimmed to perfectly fit each application, giving a clean, factory look. Easy installation with little or no modifications to the vehicle's interior. Not recommended for vehicles equipped with an A-Pillar mounted air bag.

### GAUGE PODS - SINGLE

Gauge Pod, Single, A-Pillar Mount, Black Finish.  
 2003-2005, Neon SRT4®,  
 2000-2005, Neon, **P/N P4510560** (Fig. g) . . . . . \$33.05

### GAUGE PODS - DUAL

Gauge Pod Kit, Dual, A-Pillar Mount, Black Finish.  
 2003-2005, Neon SRT4®,  
 2000-2005, Neon, **P/N P4510559** . . . . . \$40.00

Gauge Pod, Dual, A-Pillar Mount, Black Finish.  
 2004-2008, Magnum/300/Charger, **P/N 77060062** . . \$98.00

Gauge Pod, Dual, Overhead Mount, Black Finish.  
 2003-2008, Ram, **P/N 77060069** . . . . . \$83.90

### GAUGE PODS - TRIPLE

Gauge Pod Kit, Triple, A-Pillar Mount, Black Finish.  
 2000-2005, Neon, **P/N 77060064** . . . . . \$85.00

Gauge Pod Kit, Triple, A-Pillar Mount, Tan Finish.  
 2003-2008, Ram, **P/N 77060068** . . . . . \$113.00

Gauge Pod, Triple, Overhead Mount, Black Finish.  
 2003-2005, Ram, **P/N 77060070** . . . . . \$79.00

### GAUGE PODS - QUAD

Gauge Pod, Quad, Overhead Mount, Black Finish.  
 2003-2005, Ram, **P/N 77060071** . . . . . \$89.10

### SPEEDOMETER COMPONENTS

Speedometer Cable, Black Finish  
 1968-1975, Ram A/B/E-Bodies  
 (without cruise control), **P/N 04897646AA** . . . . . \$103.00

g



<sup>†</sup>Not legal on pollution-controlled vehicles or vehicles registered for highway use.

# LIMITED WARRANTIES

Mopar® Basic  
Limited Warranty

70

Mopar® Performance  
Parts Limited  
Warranty & Emissions  
Statement

70

Note to Dealer

71

At Mopar®, it's our obsession to deliver the highest-quality parts. We test our parts to the extreme and with all the resources we have available, for added assurance. Every new vehicle is covered by an extensive warranty, and Mopar® provides an industry-leading Basic Limited Warranty for Mopar® parts. See the Dealer for additional parts warranty information.

## **MOPAR® BASIC LIMITED WARRANTY**

Except as noted below, Mopar® Parts and Magneti Marelli Offered by Mopar® parts installed by an authorized FCA US LLC dealership, including Chrysler, Dodge, Jeep®, Ram, FIAT® and Alfa Romeo locations are warranted against defects in workmanship or materials for 24 months/unlimited miles for both parts and labor. Mopar® Parts sold wholesale to an automotive service facility and installed by a professional technician are warranted against defects in workmanship or materials for 24 months/unlimited miles for parts and up to \$150.00 in labor. Mopar® Parts and Magneti Marelli Offered by Mopar® parts sold over-the-counter for vehicle owner or do-it-yourself installation are warranted against defects in workmanship or materials for 24 months/unlimited miles for parts exchange only.

Mopar® Parts and Magneti Marelli Offered by Mopar® parts replaced on an FCA US LLC vehicle still covered by the FCA US LLC New Vehicle Basic Limited Warranty are warranted for the remainder of the 3-Year/36,000-Mile New Vehicle Basic Limited Warranty, or for the Mopar® 24-Month Basic Limited Warranty from the original installation date, whichever is more favorable to the customer.

The Mopar® Basic Limited Warranty covers the cost of towing a vehicle to the nearest authorized FCA US LLC dealership if the failure of a covered part causes the vehicle to be inoperative. If a Mopar® part or a Magneti Marelli Offered by Mopar® part is installed in an FCA US LLC vehicle by an authorized FCA US LLC dealer, and if, while that part is still under warranty, it causes other parts to be damaged or to fail, those other parts will be repaired or replaced under warranty, regardless of whether the other parts were covered by an FCA US LLC warranty at the time of failure. These warranties are the only express warranties made by FCA US LLC for Mopar® Parts and Accessories and Magneti Marelli Offered by Mopar® parts. Except where prohibited by law, this warranty is the sole and exclusive remedy. No person, including a dealer or employee of FCA US LLC or its affiliated corporations, has the authority to vary or change these warranties.

Mopar® Parts and Magneti Marelli Offered by Mopar® parts sold with a separate manufacturer's warranty are not eligible for the Mopar® warranty. Warranty information on these parts is provided with the part or in its packaging. Examples include: Garmin navigation, TomTom navigation, Katzkin leather, Koss headphones, truck bedliners, paint sealant and fabric protection.

## **EXCEPTIONS**

The following Mopar® products have time and mileage limitations or warranty coverage that differs from the general coverage described above: Mopar® Batteries, Magneti Marelli Offered by Mopar® Batteries, Mopar® Collision Parts, Mopar® Windshield Made with Corning Gorilla Glass, Mopar® Catalytic Converters, Mopar® Gaskets and Seals, Magneti Marelli Offered by Mopar® Catalytic Converters, Mopar® Powertrain, Mopar® Remanufactured Powertrain, Mopar® HEMI® Engine Crate Engine Kit, Mopar® Performance Parts, Mopar® Lifetime Limited Warranty on Value Line Brake Pads/Shoes, Value Line Shocks/Struts and Value Line Mufflers, Magneti Marelli Offered by Mopar® Brake Pads/Shoes and Shocks/Struts.

## **MOPAR® PERFORMANCE PARTS LIMITED WARRANTY & EMISSIONS STATEMENT**

### **NOTICE**

Federal and many state laws prohibit the removal, modification or rendering inoperative of any part or element of design affecting emissions or safety on motor vehicles used for transporting persons or property on a public street or highway. Violation may result in a fine imposed for each vehicle impacted. Many performance parts listed in this catalog cannot be used on vehicles used on public streets or highways. These parts may be used only on vehicles used solely in sanctioned off-highway events. No other applications for these parts are intended or implied. Those parts that have been granted an exemption by the California Air Resources Board (CARB) or meet the EPA requirements of memorandum 1A are legal for highway use in California, New York and Massachusetts and are noted as such.

### **NO PARTS WARRANTY - "AS IS"**

Mopar® Performance Parts with part numbers beginning with "P" are sold "as-is" without warranty coverage of any kind by Mopar®, unless otherwise noted.

Mopar® Performance Gen II crate engine assemblies are warranted for "parts only" "as delivered" against defects in materials or workmanship for 90 days from the date of purchase. The following covered components for Mopar® Performance engine assemblies, which prove to be defective in materials or workmanship, will be replaced on an exchange basis for 90 days: cylinder blocks and all internal parts; cylinder head assemblies; intake manifold; core plugs; valve covers; oil pan; timing gear and/or chain and cover; water pump; gaskets and seals.

Other parts listed with a "PW" prefix part number are covered under a 12-Month Limited Warranty. "PW" prefix parts installed by an authorized dealer are warranted against normal defects in material and workmanship for 12 months/unlimited miles from the date of purchase for both parts and labor. "PW" prefix parts NOT installed by an authorized dealer are warranted against normal defects in material and workmanship for 12 months/unlimited miles from the date of purchase for parts (exchange) only. The warranty does not cover labor charges or applicable taxes. CUSTOMER MUST KEEP ORIGINAL RECEIPT.

The limited warranty period starts on the day the part is sold, as reported on the sales receipt, to the consumer. The limited warranty is not transferable. When the vehicle is sold or otherwise disposed of (i.e., the vehicle is no longer titled in consumer's name), the limited warranty ends. CONSUMER MUST KEEP ORIGINAL RECEIPT.

Implied warranties, such as warranties of merchantability, are excluded. (An implied warranty of merchantability means that the part is reasonably fit for the general purpose for which it was sold.) The entire risk as to quality and performance of such parts is with the buyer. Should such parts prove defective following their purchase, the buyer and not the manufacturer, distributor or retailer, assumes the entire cost of all necessary servicing or repair. Chrysler, Dodge, Jeep® and Ram vehicle and parts warranties are voided if the vehicle or parts are used for competition. The addition of performance parts does not by itself void a vehicle's warranty. However, added performance parts (parts not originally supplied on the vehicle from the factory) are not covered by the vehicle's warranty, and any failure that they may cause is not covered by the vehicle's warranty.

Mopar® Limited Warranties do not cover any incidental or consequential damages connected with the failure of the part under warranty. Such damages include lost time, inconvenience, the loss of the use of your vehicle, the cost of rental cars, gasoline, telephone, travel or lodging; the loss of personal or commercial property; or the loss of revenue. Some states do not allow the exclusion or limitation of incidental or consequential damages, so the above limitations or exclusions may not apply to you.

Your warranties can also be restricted by FCA US LLC, as set forth in the New Vehicle Limited Warranty. If your New Vehicle Limited Warranty is restricted by FCA US LLC, coverage under your Mopar® Parts and Accessories Limited Warranties may also be restricted or denied.

## **EMISSIONS STATEMENT**

Mopar® Performance customers are responsible for complying with applicable federal state and local environmental laws and regulations. Many Mopar® Performance Parts and components are designed to be equipped in vehicles that are operated not on streets or highways (such as vehicles intended for competition or off-road use). Motor vehicles designed for transport on streets or highways and equipped with such parts may cause such motor vehicles to be out of compliance with applicable emissions standards. It may be a violation of federal and state law to operate such motor vehicles equipped with such parts, except where vehicles equipped with such parts are operated not on streets or highways and where such vehicles lack features customarily associated with safe and practical highway use.

If you install such parts on a motor vehicle, and your motor vehicle fails a required state or local inspection and maintenance (I/M) emissions test, including any test required to maintain or renew your motor vehicle's registration, or if your motor vehicle is subject to an emissions recall, in either case, FCA US LLC may not be required to repair your motor vehicle under the emissions warranty, and you may be required to remove those parts and replace them with other parts at your own expense in order to obtain repairs necessary to pass the I/M emissions test or to ensure your motor vehicle is compliant with applicable emissions standards after the recall repair.

## **NOTE TO DEALER**

### **MOPAR® WARRANTY REGISTRATION AND REPLACEMENT PROCEDURES**

The Dealer must notify FCA US LLC whenever you install Accessory Upgrades. Transmit the Option Update via DealerCONNECT Service Tab > Vehicle Option Update.

### **NOTE TO INTERNATIONAL DEALERS AND DISTRIBUTORS**

The accessories in this catalog were designed, engineered and approved for use in the United States and may not comply fully with regulations in your country. Before ordering these accessories, please confirm that they meet all local regulations. Special discounts, display items, promotional offers and supplier ship direct (SSD) shipments apply only to the United States.

