

Looking for something with a touch of elegance?

We can special order a large variety of doors, like the ones seen here and many others. Ask your sales representative for more information.

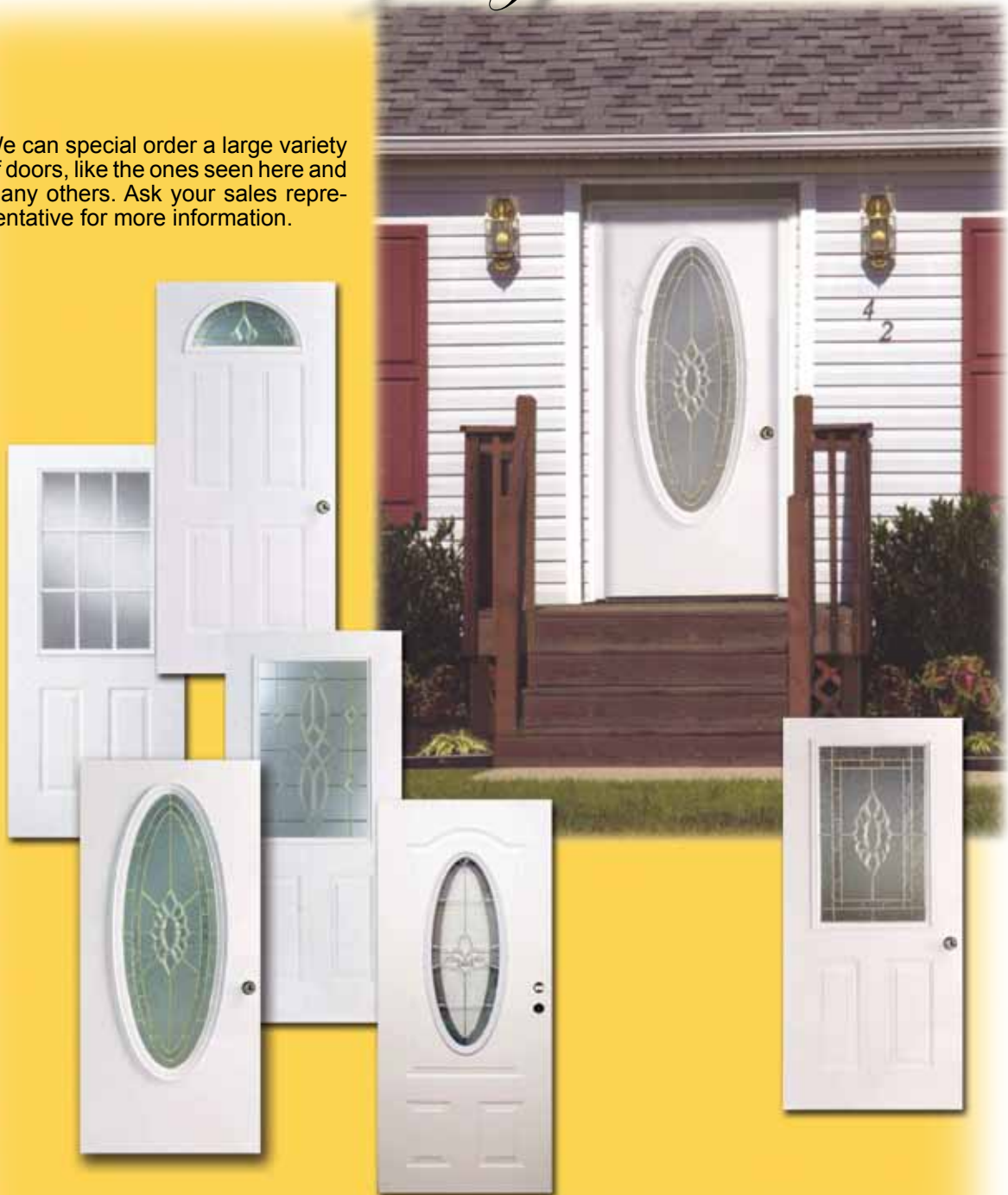

Special Order Doors

Taking Measurements For a Door:

There are many ways to measure for a door replacement, but Elixir recommends you measure your rough opening and select the replacement size which is closest to it.

For example, your rough opening measures 32-1/4" x 76-1/4". ALWAYS BACK DOWN TO THE NEAREST SIZE and order size 32" x 76".

To determine if your door is right or left handed, simply look at it from the outside of the home to see which side the hinges are on.

Installing the Door:

1. Make certain all mounting surfaces (siding seams included) are securely fastened and flat around perimeter of door opening.
2. Apply a suitable non-hardening sealant tape (such as Elixir 10-B Mobile Seal) to the backside of the door's mounting flange.
3. Do not remove any shipping clips or fasteners and keep the door closed and locked during the installation. Opening the door prior to the installation will destroy the pre-squaring by the manufacturer.
4. Insert the door assembly carefully into the rough opening. Make certain the door sill is secure on the floor. Move door to hinge side until it is firmly against hinge side stud.
5. Proceed to fasten door with screws. Drive the first 3 screws into the outer frame in the middle at the hinge side. Then, drive the next 3 screws in the middle of the outer frame on the lock side. Then, secure the balance of the hinge side, across the sill, up the lock side and the header.
6. Remove the shipping clips and open the door. Install the appropriate hardware.
7. If it is a house-type door with storm door, make certain 2 long screws are put through the storm door plunger bracket fastened to the jamb. This is to anchor the bracket securely to your hinge side stud.
8. If the house-type inner door is secured to the outer frame with butt type hinges (steel six-panel door only), run one long screw through each hinge on the jamb side to penetrate the hinge side stud.
9. The house-type door has an adjustable stop. Adjust the stop to the exterior of the inner door to insure a good seal.

If the above steps are followed, the door will be sealed and operate properly.

Steps 1, 2, 3 & 4

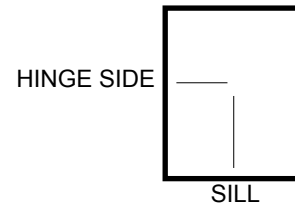

Steps 5 & 6

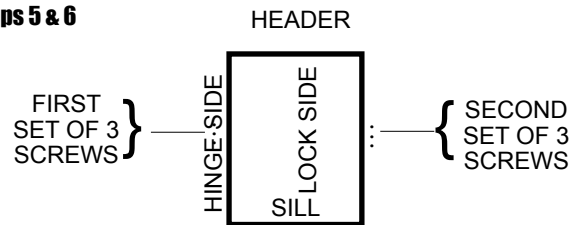

Steps 6 & 7

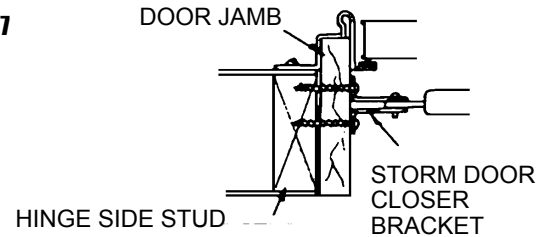

Steps 8

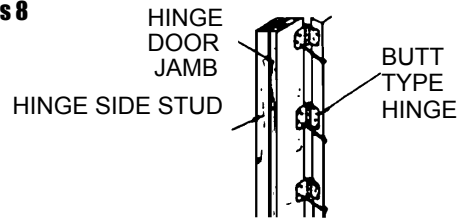

Steps 9

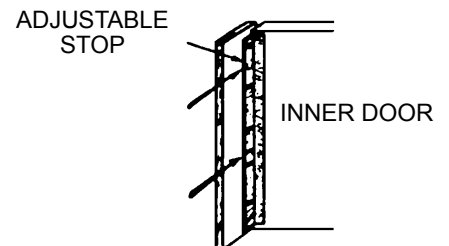

Series 9000 Vinyl Steel Combo Door - Six Panel Style



Shown with all glass white storm and six-panel door

Door Features:

Vinyl Laminated Galvanized Steel

- Our Thickest Gauge of Long Lasting Steel
- Upgrade from Series 8000 Steel

Double Seal

- Folded Steel Edge with Weather Stripping
- Lifetime Warranty Weather-Stripping
- Protects Against Air, Light and Water
- Easy Installation

Polyurethane Foam Core

- Highly Energy Efficient R-Values

Quality Wood Jambs

- Finger Jointed Solid Pine

Three-Finger Vinyl Sweep

Factory Installed Swivel Latch Bolt

Doors with windows below are drilled for deadbolt. All other stocked 6 panel doors have knocker, viewer and drilled for a dead bolt.



3/4 Oval Light Door



Six Panel Style						3/4 Oval Light	Fan Light	Fan Light	
Jamb Width:	4"	4"	4"	4"	6.5"	4.5"	4"	4"	
Door Inside:	White	White	White	White	White	White	White	White	
Door Outside:	White	White	White	White	White	White	White	White	
Storm Color:	White	White	Mill	White	White	White	White	White	
Storm Style:	Full View All Glass	Full View	Standard	Standard	Standard	Full View All Glass	Standard	Full View All Glass	
32 x 76	L/H				0211131	0211216			
	R/H				0211132	0211217			
34 x 76	L/H	0211755	0211150 0211153	0211121	0211122	0211140	0211761	0211757	0211759
	R/H	0211756	0211151 0211152	0211120	0211123	0211141	0211760	0211766	0211758
34 x 78	L/H		0211154		0211144			0211752	
	R/H		0211162		0211145			0211747	
34 x 80	L/H		0211148		0211146	0211142		0211762	
	R/H		0211149	0211124	0211147	0211143		0211763	
36 x 76	L/H	0211160							
	R/H	0211161							
36 x 80	L/H	0211753			0211186				
	R/H	0211754							
38 x 76	L/H		0211163						
	R/H		0211164						
38 x 80	L/H		0211156		0211318	0211103*			
	R/H		0211157		0211319	0211102*			
38 x 82	L/H		0211158						
	R/H		0211159						

*6" Jams

Optional Hardware Sold on Page C-12

For storm door features, see page C-14

Series 8000 Vinyl Steel Housetype Combination Door



(Pictured) Elegant white door with white standard storm door. Door is drilled for deadbolt.. 4" jambs. Other sizes and designs are available by special order.

Vinyl Laminated Galvanized Steel

- Long Lasting
- 60% Thicker than Series 6000 Doors
- More Dent and Scratch Resistant

Double Seal

- Folded Steel Edge with Weather Stripping
- Protects Against Air, Light and Water

Adjustable Door Stop

Three-Finger Vinyl Sweep

Sloped Threshold

Factory Installed Swivel Latch Bolt

Polyurethane Foam Core

- Highly Energy Efficient R-Values

Quality Wood Jambs

- Finger Jointed Solid Pine

0210970 Fan Lite, 32" x 76" LH

0210971 Fan Lite, 32" x 76" RH

Optional Hardware Sold on Page C-12

Series STR 7000 Residential Vinyl Steel Combination Door Energy Rating

The Six panel and 4 panel STR Series 7000 Elixir Doors are Energy star rated to conform to the performance ratings in the chart below.



National Fenestration Rating Council



ELIXIR INDUSTRIES
SINCE 1948

Entrance Door
Product Lines
ESB-M-1 Steel Entry Door

Product Description ₁	U-Factor/Solar Heat Gain Coefficient (SHGC)			
	1/4 Lite ≤ 410 in ²	1/2 Lite ≤ 900 in ²	3/4 Lite ≤ 1100 in ²	Full Lite > 1100 in ²
2/a1-D/na/air/0.764	0.22/0.12	0.29/0.24	0.32/0.29	0.36/0.37
2/a8-D/na/air/0.764	0.21/0.12	0.28/0.24	0.31/0.29	0.36/0.37
2/a8-D/na/air/0.514	0.21/0.12	0.28/0.24	0.31/0.29	0.35/0.37
2/a8-D/na/air/0.514 grids	0.21/0.12	0.28/0.23	0.31/0.27	0.36/0.34
2/a8-D/na/air/0.264	0.22/0.12	0.30/0.24	0.33/0.29	0.38/0.37
2/a8-D/na/air/0.264 grids	0.22/0.12	0.30/0.23	0.34/0.27	0.39/0.34
ESB-M-1 Embossed Door	0.14/0.01			
2/a1-D/na/air/0.764 grids	0.22/0.12	0.29/0.23	0.32/0.27	0.36/0.34
2/a8-D/na/air/0.764 grids	0.21/0.12	0.28/0.23	0.31/0.27	0.36/0.34
2/a8-D/na/air/0.514 grids	0.21/0.12	0.28/0.23	0.31/0.27	0.35/0.34
2/a1-D/0.204(2)/air/0.764 LE	0.20/0.10	0.26/0.20	0.28/0.24	0.31/0.31
2/a8-D/0.204(2)/air/0.764 LE	0.20/0.10	0.25/0.20	0.27/0.24	0.30/0.31
2/a8-D/0.204(2)/air/0.264 LE	0.21/0.10	0.27/0.20	0.29/0.24	0.33/0.31
2/a8-D/0.204(2)/air/0.264 LE Grd	0.21/0.10	0.28/0.19	0.30/0.23	0.34/0.29
2/a1-D/0.204(2)/air/0.764 LE Grd	0.20/0.10	0.26/0.19	0.28/0.23	0.31/0.29
2/a8-D/0.204(2)/air/0.764 LE Grd	0.20/0.10	0.25/0.19	0.27/0.23	0.30/0.29
2/a5-D/na/air/0.323 deco	0.20/0.11	0.25/0.22	0.27/0.26	0.30/0.33

Manufacturer stipulates that these ratings conform to applicable NFRC procedures for determining whole product performance. NFRC ratings are determined for a fixed set of environmental conditions and a specific product size. NFRC does not recommend any product and does not warrant the suitability of any product for any specific use. Consult manufacturers literature of other product performance information. www.nfrc.org

₁ glazing layers / spacer type / lowE emissivity (surface) / gap fill / gap width

NOTE:

Energy performance ratings are subject to change. For current ratings visit www.energystar.gov

Series STR 7000 Residential Vinyl Steel Combination Door



Shown with full-view white storm door

Decorative Fan Light Series 7000 Combo



Oval Frosted Series 7000 Combo



4 Panel w/ Fan: sunburst window with beveled glass, floral pattern and brass caning replace top two panels.

Elegant white door with frosted oval window comes with brass kickplate and white all-glass storm door. Door is drilled for deadbolt. Entrance lock and deadbolt are available in brass. Keyed alike for convenience. 4.5" jamb. Other sizes and designs are available by special order. 0211210 & 0211211 shown above.

Door Features:

Vinyl Laminated Galvanized Steel

- Our Thickest Gauge of Long Lasting Steel
- Upgrade from Series 8000 Steel

Lifetime Warranty Weather-Stripping

- Protects Against Air, Light and Water

Residential 1-3/4" Door

- Our Very Best Door

Polyurethane Foam Core

- Highly Energy Efficient R-Values

Quality Wood Jamb

- Finger Jointed Solid Pine

Six-Finger Vinyl Sweep

Factory Installed Swivel Latch Bolt



ELIXIR
INDUSTRIES
SINCE 1948

Series STR 7000 Residential Vinyl Steel Combination Door

		Six Panel Door*			4 Panel w/Fan*	Platinum Inlaid Oval	Frosted Glass Oval	9-Lite	
Jamb Width:		4"	4"	6.5"	4"			4"	6.5"
Door Inside:		White	White	White	White	White	White	White	White
Door Outside:		White	White	White	White	White	White	White	White
Storm Color:		White	White	White	White	White	White	White	White
Storm Style:		Full View	Standard	Standard	Full View	Full View	All Glass	Standard	White
34 x 76	L/H	0211750	0211722	0211740	0211206	0211197	0211210	0211247	0211248
	R/H	0211751	0211723	0211741	0211205	0211198	0211211	0211246	0211249
34 x 78	L/H								
	R/H								
34 x 80	L/H	0211748	0211746	0211742					
	R/H	0211749		0211743					

 * Energy Star rated. (See chart on C-4)

Series 6000 Housetype Combination Door

Door Features:

- **Painted Galvanized Steel**
Long Lasting
- **Double Seal**
Folded Steel Edge with Weather Stripping
Protects Against Air, Light and Water
- **Adjustable Door Stop**
- **Factory Installed Swivel Latch Bolt**
- **Sloped Threshold**
- **Polyurethane Foam Core**
Highly Energy Efficient R-Values
- **Quality Wood Jambs**
Finger Jointed Solid Pine

10" x 10" Diamond Series



10" x 10" Diamond (window) Series with Mill Finish Standard Storm Door.
Details on page C-7

Door Color Options:

Exterior: White or Cream
Interior: White, Cream or Dark

Quality Wood Jambs



Blank Style



Blank Style Door (no window) with White Standard Storm Door – Shown on Left.
Details below.

**Optional Hardware Sold
on Page C-12**

		<h3>Series 6000 Blank Style Combination Door</h3>				
Features		Knocker, Viewer & Deadbolt	Knocker & Viewer	Knocker & Viewer	Knocker & Viewer	Knocker, Viewer & Deadbolt
Outside:		White	White	White	White	White
Inside:		Dark	Dark	White	White	White
Storm Color:		Mill	White	Mill	White	White
Storm Style:		Standard Storm Door	Standard Storm Door	Standard Storm Door	Standard Storm Door	Standard Storm Door
32 X 76	L/H			0211202	0212109	
	R/H			0211201	0212108	
34 X 76	L/H	0211098	0211106	0211219	0211207	0211091
	R/H	0211099		0211220	0211208	0211093
34 x 80	L/H			0211214		
	R/H			0211215		

6000 Series		10" x 10" Diamond Window						Cottage Window		
Jamb Width:		4"	4"	4"	4"	4"	6.5"	6.5"	4"	6.5"
Outside:		White	White	White	White	White	White	White	White	White
Inside:		Dark	Dark	White	White	White	White	Dark	White	White
Storm Color:		White	Mill	Mill	White	White	White	Mill	White	White
Storm Style:		Standard	Standard	Standard	Standard	Full View	Standard	Standard	Standard	Standard
32 X 72	L/H		0211051	0210870	0210880					
	R/H		0211052	0211056	0210881					
32 X 74	L/H		0210923	0210930	0212100					
	R/H		0210924		0212101					
32 x 76	L/H	0211079	0211065	0210872	0210874 0212112**			0211118		
	R/H	0211078	0211066	0210873	0210875 0212113**			0211119		
32 x 78	L/H		0211075							
	R/H									
32 x 80	L/H				0211308					
	R/H				0211309					
34 x 76	L/H	0211083	0211031	0210876	0210878 0212110**	0210886	0211180 0211091*	0211110	0211136*	0211167
	R/H	0211084	0211082	0210877	0210879 0212111**	0210888	0211181	0211111	0211137*	0211166
34 x 78	L/H	0211088	0210911	0211300	0211304			0211112	0211138*	
	R/H	0211089	0210910	0211301	0211305				0211139*	
34 x 80	L/H	0211086	0211030	0211302	0211306		0211182	0211114		0211165
	R/H		0211090	0211303	0211307		0211183	0211115		
36 x 76	L/H				0210882					
	R/H				0210883					
36 x 80	L/H		0211116	0211312	0211311					
	R/H		0211117	0211313	0211310					
38 x 76	L/H			0211316	0212106					
	R/H			0211317	0212107					
38 x 80	L/H					0210928	0211101*			
	R/H					0210929	0211100*			

* With knocker/viewer, deadbolt bore

** With deadbolt bore

For storm door features,
see page C-14



ELIXIR
INDUSTRIES
SINCE 1948

6000 Series Fan Window

Classic white door with fan-shaped window is white inside and out with matching white jambs. Drilled for deadbolt.

- 0210914** 34" x 76" LH; Full View White Storm
- 0210915** 34" x 76" RH; Full View White Storm
- 0210917** 34" x 76" LH; Std. White Storm
- 0210921** 34" x 76" RH; Std. White Storm
- 0211233** 34" x 76" LH; Std. White Storm with 4.5" Jambs
- 0211234** 34" x 76" RH; Std. White Storm with 4.5" Jambs



Series 400 Vinyl Steel Exterior Door

Door Features:

Vinyl Laminated Galvanized Steel

- Long Lasting
- 60% Thicker than Series 200 Doors
- More Dent and Scratch Resistant
- Withstands Winds in Excess of 140 MPH

Double Seal

- Folded Steel Edge with Weather Stripping
- Protects Against Air, Light and Water

Factory Installed Swivel Latch Bolt

Polyurethane Foam Core

- Highly Energy Efficient R-Values

Adjustable Striker Plates



Fan Window



Series 400, LH Door (shown above) w/ Cottage Window

Door w/Fan Window

0210960 34" x 76" LH White/White w/Dead Bolt Bore

0210961 34" x 76" RH White/White w/Dead Bolt Bore



Door w/Cottage Window

0210976 36" x 80" LH White/White, Mill Frame, (shown at right)



Door w/10" X 10" Diamond Window

0210965 32" x 74" LH White/White

0210966 36" x 80" LH Gray/Gray

0210967 36" x 80" RH Gray/Gray

0210968 36" x 80" RH White/White

0210969 36" x 80" LH White/White



Door w/10" x 10" Square Window

0210819 34" x 72" LH White/White w/Mill Finish Door Frame

0210959 34" x 72" RH White/White w/Mill Finish Door Frame



Blank, Series 400, LH Door

Blank Door Series 400, (No Window)

0210964 36" x 80" LH White/White, White Frame

0210978 36" x 80" LH White/White, Mill Frame (shown at right)

0210973 32" x 74" LH White/White, Mill Frame

Fiberglass Extra Wide Single Door

Often used for portable buildings.

0211171 60" x 72" LH White/White, Mill Frame

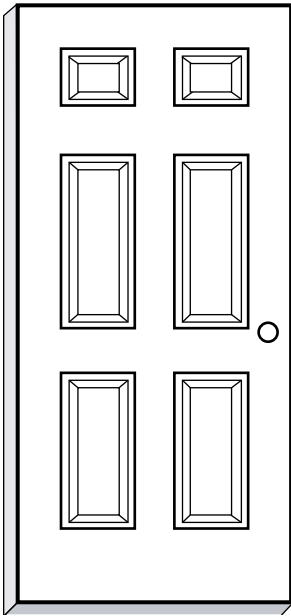

Series 300 6-Panel

Same quality features as the 400 Series with six raised panels. White door and frame only.

- 0211126** 32" x 72" LH, knocker, viewer
- 0211127** 32" x 76" RH, knocker, viewer
- 0211128** 32" x 76" LH, knocker, viewer
- 0210758** 34" x 76" LH, knocker, viewer, deadbolt bore
- 0211129** 34" x 76" RH, knocker, viewer
- 0211130** 34" x 76" LH, knocker, viewer
- 0210787** 34" x 76" LH, deadbolt bore
- 0210788** 34" x 76" RH, deadbolt bore
- 0211107** 36" x 80" RH



Specially designed for manufactured home doors, tested residential grade. Locks are sold without bolts and strike plate, which are included in our stocked doors.

- 0295040** Entrance Lock, Stainless Steel
- 0295030** Entrance Lock, Stainless Steel, Keyed to #0122544
- 0295041** Entrance Lock & Deadbolt Set, Master Keyed, Stainless Steel.



Reinforced Commercial Grade

Commercial Grade with 2 x 4 Construction

BLANK DOORS

- 0211175** 36" x 80" LH Blank White/White
- 0211176** 36" x 80" RH Blank White/White (*shown on the right*)

HEAVY DUTY LOCK

- 0295005** Round Knob, Stainless Steel
- 0295006** Lever Style, Stainless Steel

THRESHOLD FOR HANDICAP ENTRANCE

- 0265491** Interior For 36" Door
- 0265492** Exterior For 36" Door

Series 100, Double Doors

Same quality features as Series 200, but with double doors. See following pages for features of 200 series doors.

Blank Double Door

Mill Finish Frame

- 0211172** 61" x 72", RH, White/Dark
- 0211212** 61" x 72", LH, White/White
- 0211155** 61" x 80", LH, White/White
- 0211170** 72" x 72", RH, White/White
- 0211168** 72" x 72", RH, White/Dark
- 0211169** 72" x 72", LH, Cream/Cream
- 0211279** 72" x 72", RH, Buck/Buck
- 0211173** 72" x 80", LH, White/White

Cottage Double Door

White/White Mill Finish Frame

- 0211213** 72" x 76," LH

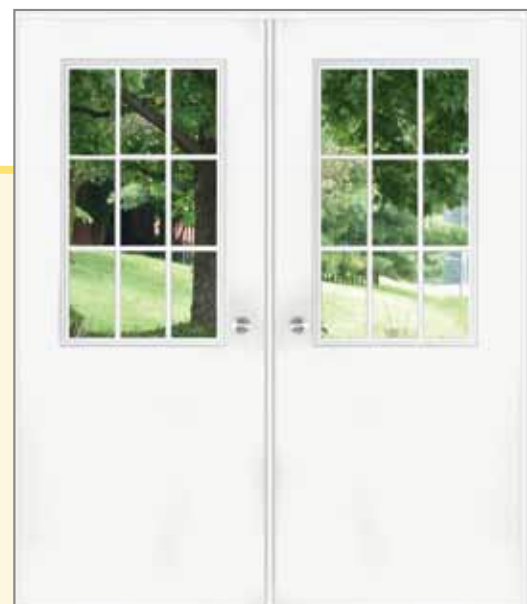

Series 200 Manufactured Home Exterior Door



Door Features:

Painted Galvanized Steel

- Long Lasting

Double Seal

- Folded Steel Edge w/Weather Stripping
- Protects Against Air, Light and Water

Factory Installed Swivel Latch Bolt

Polyurethane Foam Core

- Highly Energy Efficient R-Values

Adjustable Striker Plates

Door Color Options:

Exterior: White or Cream

Interior: White, Cream or Dark

Frame Color Options:

White, Cream or Bronze

Quick Reference For Door Hardware

Hardware is sold as an option on these doors for economy, so you can buy only what you need.

- 0295040** Lock, Stainless Steel*
- 0295041** Deadbolt Combo SS, Master-Keyed*
- 0212022** Knocker/Viewer, Brass
- 0212010** Knocker/Viewer, Chrome
- 0265506** Threshold f/32" or less
- 0265507** Threshold f/34" door
- 0265508** Threshold f/36" door
- 0265509** Threshold f/48" door
- 0265510** Threshold f/72" door
- 0219001** Weather Stripping 30'
- 0212011** Drip Cap f/32" or smaller door
- 0212012** Drip Cap f/34" door
- 0212013** Drip Cap f/36" door
- 0212014** Drip Cap f/48" door
- 0212018** Drip Cap f/53" door
- 0212009** Drip Cap f/72" door
- 0210601** Safety Chain Kit
- 0210602** S Hooks
- 0210455** Replacement Door Shipping Clip

* These items come without a bolt or strike, which are already installed on these doors

Specially designed for manufactured home doors, tested residential grade. Locks are sold without bolts and strike plate, which are included in our stocked doors.

- 0295040** Entrance Lock, Stainless Steel
- 0295030** Entrance Lock, Stainless Steel, Keyed to #0122544
- 0295041** Entrance Lock & Deadbolt Set, Master Keyed, Stainless Steel.



ELIXIR
INDUSTRIES
SINCE 1948

Series 200 Exterior Doors

		10" x 10" Diamond Window			18" x 20" Slider Window			Cottage Window		Fan Window
OUTSIDE:		White	White	White	White	White	White	White	White	White
INSIDE:		Dark	White	White	Dark	White	White	White	White	White
		MF Frame	WH Frame	MF Frame	MF Frame	WH Frame	MF Frame	WH Frame	MF Frame	WH Frame
30 x 72	LH	0211035	0210866		0210800					
	RH		0210867		0210799					
32 x 72	LH	0210916	0210850		0210801	0211400	0211846	0210885		
	RH	0210920	0210849	0211800	0210802	0211401		0210884		
32 x 74	LH	0211033	0212102		0210810	0211402		0211410		
	RH	0210935	0212103		0210812	0211403		0211411		
32 x 76	LH	0210919	0210854 0211803*	0211802 0211804*	0210806	0211404	0211850	0210887	0211878	0210847
	RH	0210797	0210855	0211805	0210798	0211405	0211851	0210896	0211879	0210848
32 x 78	LH	0210897	0210912	0211806	0210901	0211406		0211412		0210894
	RH	0210936	0210913	0211807	0210902	0211407		0211413		0210895
32 x 80	LH		0210926	0211808	0210908	0211408		0210946	0211882	
	RH		0210927			0211409	0211855	0210947	0211883	
34 x 72	LH									
	RH			0210821**						
34 x 76	LH	0210918	0210858 0211028*	0211812	0211029	0210840	0211858	0210889	0211886	0210856 0211027*
	RH	0210904	0210859	0211813	0210905	0210841	0211859	0210890*	0211887	0210857
34 x 78	LH	0210898	0210862	0211814	0210899	0210842	0211860	0210891	0211888	0210938
	RH		0210863			0210843		0210892	0211889	0210939
34 x 80	LH	0210903	0210864	0211816	0210909	0210844	0211862			
	RH		0210865	0211817		0210845	0211863			
36 x 72	LH							0210893		
	RH									
36 x 76	LH		0210868	0211820					0210861	
	RH		0210869	0211821		0210837			0210853	
36 x 80	LH	0210814	0210816	0210796	0210906	0210838		0210851		
	RH	0210833	0210817	0211822 0210822**	0210907	0210839	0211871	0210852		

*With Deadbolt Drill

**Square 10" x 10" Window

Diamond Replacement Window 10" x 10"



0210745 10" x 10" Diamond Window,
Brown

0210747 10" x 10" Diamond Window,
White



ELIXIR
INDUSTRIES
SINCE 1948

Series 200 Exterior Doors

Blank

OUTSIDE:	White	White	White	Cream	White	Buck
INSIDE:	Dark	White	White	Dark/Buck	Buck	Buck
	MF Frame	WH Frame	MF Frame	MF Frame	MF Frame	MF Frame
30 x 72	0210804	0211179	0211900			
32 x 72	0210805	0210790	0211187			
32 x 74	0210786	0211178	0211901			
32 x 76	0210811	0210791 0211826*	0211827	0210823		
32 x 78	0210780	0210781	0211828			
32 x 80		0210835	0211829			
34 x 76	0210809	0210807 0211833* 0211832**	0211835	0210824		
34 x 78	0210779	0210792	0211836			
34 x 80		0210793	0211837			
36 x 60			0211190			
36 x 61			0211196			
36 x 63			0211193 0211272 H			
36 x 70			0211192			
36 x 72	0210775		0211189 0211273 H			
36 x 74			0211194			
36 x 76	0210776	0210774	0211840			
36 x 80	0210789	0210794	0211841 0211270 H	0210828		
48 x 63			0210785			
48 x 72	0210778		0210782	0210777 B		0210761
48 x 76	0210768		0210783			
48 x 80			0210784	0210766	0210767	

* Left Hand, With Deadbolt Drill

** Left Hand, Knocker Viewer with Deadbolt Drill

H - Heavy Duty Frame

B - Buck Color

Quick Reference For Door Hardware

Hardware is sold as an option on these doors for economy, so you can buy only what you need.

0295040	Lock, Stainless Steel*	0219001	Weather Stripping 30'
0295041	Deadbolt Combo SS, Master-Keyed*	0212011	Drip Cap f/32" or smaller door
0212022	Knocker/Viewer, Brass	0212012	Drip Cap f/34" door
0212010	Knocker/Viewer, Chrome	0212013	Drip Cap f/36" door
0265506	Threshold f/32" or less	0212014	Drip Cap f/48" door
0265507	Threshold f/34" door	0212018	Drip Cap f/53" door
0265508	Threshold f/36" door	0212009	Drip Cap f/72" door
0265509	Threshold f/48" door	0210601	Safety Chain Kit
0265510	Threshold f/72" door	0210602	S Hooks
		0210455	Replacement Door Shipping Clip

* These items come without a bolt or strike, which are already installed on these doors

Replacement Windows for Doors

Diamond Window 10" x 10"



0210745 Brown
0210747 White

Long Rectangular Window



4" x 24" Window,
Colorless Obscure Glass
w/White Frame

0210746

Fan Window



0210750 White Fan Window

Cottage Window



0210744 20" x 36"
0210740 22" x 36"

Exterior Door Hinges

Door Hinges



0210608 Mill Ext.
0210609 White

Slider Window



18" x 20" w/Screen
0210803 Mill Finish
0210795 White

Exterior Door Hinges for 7000 Series Doors

Designed with Radius
Corners For The 7000
Series Doors.



0210605 Zinc

Six Finger Hinges

Six screw flanges.

0210993 Satin Nickel

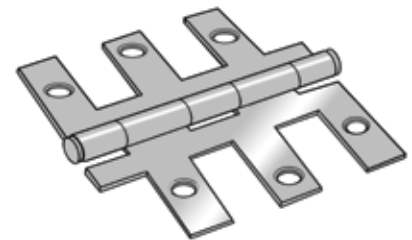

Combo Door Hinges

Designed for 6000, 8,000
and 9,000 Series Doors.

0210995 Brass
0210996 Zinc



Outdoor Improvements
Anchors & Set-Up Material
Doors & Windows
Coatings & Cleaners
Appliances
Tools & Hardware
Carpet & Flooring
Electrical
Plumbing
Towing & Safety
Heating & Cooling

		 <h1>Storm Doors</h1>				
Rough Opening		Mill	White	Bronze	White	White
		Standard	Standard	Standard	Full View	All Glass
32 x 72	LH	0210808	0212104			
	RH	0210815	0212105			
32 x 76	LH	0211006	0211007	0211059		
	RH	0210818	0211008	0211060		
34 x 76	LH	0211020	0211053	0211055	0211133	0211023
	RH	0211013	0211054	0211061	0211134	0211024
34 x 78	LH	0211012	0211062		0211135	
	RH	0211015	0211058			
34 x 80	LH	0211010	0211064			0211021
	RH	0211014	0211063			0211022
36 x 76	LH		0211043			
	RH		0211044			
36 x 80	LH		0211050			
	RH		0211041			
38 x 76	LH		0211045			
	RH		0211046			
38 x 80	LH		0211017			
	RH		0211016			
38 x 82	LH		0211048			
	RH		0211049			



All storm doors pictured are right-hand doors.

Heavy-gauge, hollow, aluminum door frame, reinforced with 14-gauge corner gussets. Fiberglass screen resists impact without permanent deformation.

Sliding window tested in 2,500 uses without failure (equivalent to more than 20 years of normal use). 1/8" tempered safety glass installed in all standard size doors.

Other sizes and styles available by special order. Note: Hardware is Not included.

Replacement Screen Window

for Standard Storm Door
27" x 29"



- 0210945** Screen f/Std. Door - Mill Finish
- 0210948** Screen f/Std. Door - White

Hardware Kits

Handle & Closure Kit

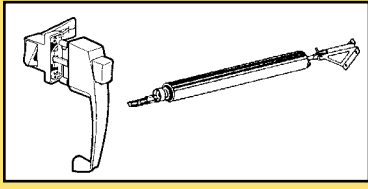

- 0212036** Black
- 0212038** White

Storm Door Parts

- 0210450** Top Glides for Bottom Glass
- 0210452** Clips & Springs for Bottom Glass
- 0210470** Clip for Full View Storm, White
- 0295085** Hinge - Mill
- 0295086** Hinge - White
- 0295087** Hinge - Brass

Pushbutton Latch Handle

- Anti-lockout feature
- 1-3/4" mounting hold spacing
- Installs in three 1/4" holes
- Carded

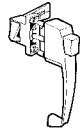

For all outswinging doors 7/8" to 1-1/4". Converts to key locking set with key plug.

- 0291300** White; 5/Ctn.
- 0291301** Aluminum; 10/Ctn.
- 0291302** Black; 10/Ctn.

Storm Door Closer

Smooth, silent regulated closing for storm and screen doors. Permanently sealed tube. Positive-latching mechanism. Shock absorber action.



- 0210700** White
- 0210701** Aluminum
- 0210702** Black

Pushbutton Key Plug

for Storm Door Locks

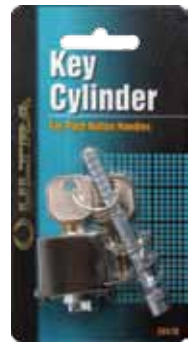
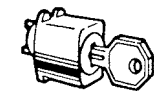

Fits most rectangular pushbutton storm doors. Furnished with calibrated metal spindle and spring.

- 0291305** Black; 10/Ctn.

Sliding Glass Patio Doors by



Vinyl 72" x 76"

- Attractive low profile multi-chambered frame increases viewing area and improves thermal and sound insulating value.
- Standard Frame for use with lap siding. Lap Frame with integral siding pocket that eliminates the need for additional siding trim pieces.
- Heat fusion welded frame and moving panel provides superior structural strength and prevents potential leakage at the corners.
- Staggered internal weep system allows minimum dust infiltration. Snap-in weep covers are standard.
- 3/4 inch sealed insulating glass (tempered) with "intercept" spacer and optional Low-E provides optimum thermal performance.
- Color coordinated attractive mortise type keyed lock mounted on steel reinforced lock jamb for strength and sturdiness that provides added security. Lock keeper is adjustable.
- Easy to reverse the door from XO to OX or OX to XO. Reversing must be done prior to installation.



Meets or exceeds the performance requirement of - AAMA 1701.2 Standard, Grade Wind Zone III AAMA/NWDA 101 / 1.5.2 Standard, Grade SGD-R15

0212029 "OX", 72" x 76"

0212028 "XO", 72" x 76"

0212030 White, Screen for vinyl door

0290403 Replacement Lock

XO: From outside looking in, left panel slides, right panel is stationary.
OX: From outside looking in, right panel slides, left panel is stationary.

Aluminum 72" x 76"

- Standard Frame for use with flush mount application.
- 5/8 inch sealed insulating glass (tempered) with optional Low-E provides optimum thermal performance.
- Heavy duty fin seal weatherstrip to reduce air, water, dust and noise infiltration.
- Fully adjustable factory lubricated steel tandem rollers mounted with ball bearing insures trouble free operation.
- Full length lip on lock jamb acts as lock strike, not requiring adjustments after the door is properly installed.
- Slide direction easily reversed from XO to OX or OX to XO.
- Lap siding application, by special order only.



For Flush Mount Applications, 72" W x 76" H

(Lap siding application, by special order only.)

0212044 "XO" with 15/15 grids, 72" x 76"

0212045 "OX" with 15/15 grids, 72" x 76"

0212026 "OX", 72" x 76"

0212025 "XO", 72" x 76"

0212034 White, Screen for aluminum door

0212035 Mill, Screen for aluminum door

0290402 Replacement Lock

XO: From outside looking in, left panel slides, right panel is stationary.
OX: From outside looking in, right panel slides, left panel is stationary.

Outswinging Double French Doors

Add value and beauty to the home with Double French Doors.

These are part of the Series 400 Exterior Doors featured on page C-8. Please refer to that page for construction details and features.



0212040 72" x 76" RH

0212041 72" x 76" LH

Sliding Patio Door Lock

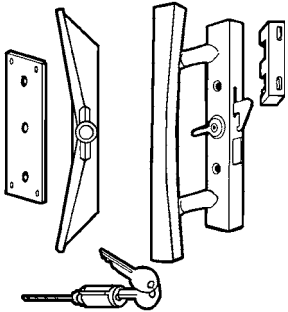

Universal sliding glass door lock features extended guide to prevent lift and opening. Also guarantees lock alignment. Fits most doors.

0290405 Patio Door Lock (Old Style)

0290406 Patio Door Lock (New Style) for Vinyl Doors

0290407 Lock Cylinder Only

Sliding Patio Door Lock Kit

Universal, recessed sliding door lock kit, with key, comes with easy to follow instructions. (Found on 1999 and older homes.)

0290408

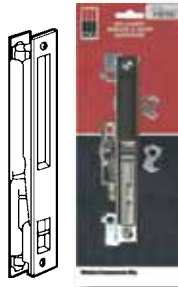

Replacement Patio Screen Door

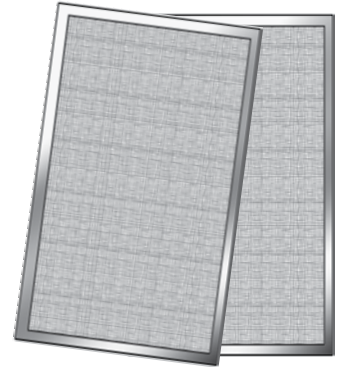

For Phillips Style M/1000 Screen Door, 36" x 75-7/16"

0212007 Mill Finish

0212008 White

For Kinro:

0212030 Vinyl Patio Door

0212034 Aluminum Patio Door

Nite Lock Pin

For Sliding Patio Door

Protects against burglary. Easy installation. Out of children's reach.



0469000

Patio Screen Roller #197C



0461702 12/Ctn.

Tacky Tape®

Tacky Tape® is designed to seal and prevent the entry of dust, air and moisture and assure a weather tight seal. Weatherability: QUV, 340A lamp (1000 Hrs, Excellent, no cracking, chalking, wash-off or flow (sag). 3/4" x 1/8" x 30'.

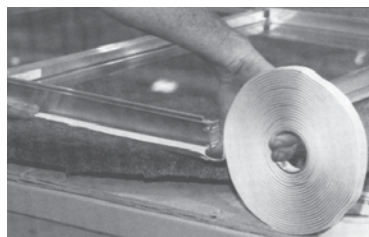

0360800 24/Ctn.

C-16

Patio Door Roller

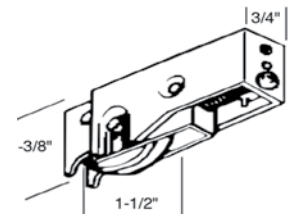

0461703

1-3/8" Interior Doors

Six-Panel Masonite Molded Doors:

The Masonite Molded Panel Series is the industry benchmark for all composite wood doors. This series utilizes a composite wood construction that results in a more durable door that resists warping, shrinking, and cracking better than a solid wood door. In harvest oak or classic white. Uses non-mortise hinges.



Standard Doors:

The Masonite® Veneer Flush interior door offers the visual beauty and refinement of natural wood doors at a value price. These doors are available as hollow core or solid core for the weight and feel of solid wood. Veneer Flush doors are both stainable or paintable.



Interior Doors

	Standard		Six Panel Molded	
	Valley Oak	Flushed White	Harvest Oak	White
24" x 78"	0210710	0210715	0210687	0210705
24" x 80"	0210729	0210725	0210680	0210735
26" x 78"	0210711	0210716	0210688	0210706
26" x 80"	0210730	0210726	0210681	0210736
28" x 78"	0210712	0210717	0210689	0210707
28" x 80"	0210731	0210727	0210682	0210737
30" x 78"	0210713	0210718	0210690	0210708
30" x 80"	0210732	0210728	0210683	0210738
32" x 78"	0210721	0210720	0210691	
32" x 80"	0210743	0210742	0210684	0210734
36" x 78"	0210714			
36" x 80"	0210741	0210739		

All Colors May Not Be Available At All Locations • Other colors available by special order.

Interior Passage & Privacy Lock



Conical knob, contemporary design. 2-3/8" round drive-in latch.

- 0290105** Passage, Polished Brass
- 0290106** Privacy, Polished Brass
- 0290103** Passage, Brushed Nickel
- 0290104** Privacy, Brushed Nickel

Other interior locks are sold on page 20

Privacy

Interior Door Hinges

Non-mortise, 3 leaf folding door hinges, 1-3/16" x 3-7/16".



Polybagged in pairs with 8 screws.

- 0210990** Brass
- 0210991** Brushed Nickel

Non-mortise, extended, 3 leaf folding door hinges. 1-3/16 x 3-7/16 (extended leaf 1-1/2")

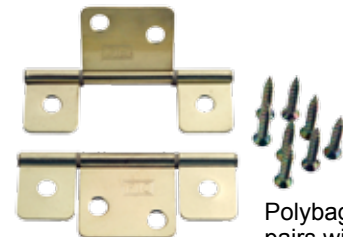

Polybagged in pairs with 8 screws.

- 0210989** Brass
- 0210992** Brushed Nickel

Non-Mortise Hinge

2/Box

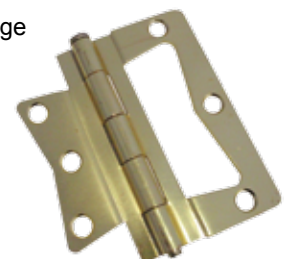

- 0210998** Brass

Outdoor Improvements
 Anchors & Set-Up Material
 Doors & Windows
 Coatings & Cleaners
 Appliances
 Tools & Hardware
 Carpet & Flooring
 Electrical
 Plumbing
 Towing & Safety
 Heating & Cooling

LOCWARE

by



ELIXIR INDUSTRIES
 SINCE 1948

Entrance Lock Only

- Seamless one-piece knob
- Auto-release and panic-proof
- Patented revolving collar adj. drive-in latch bolt for easy installation



0295046 Master-keyed, Adj. Stainless Steel

0295077 Master-keyed, Adj., Brass

0295068 Mortise Plate

0295059 Replacement Key for Master-Keyed Locks

Deadbolt Lock Only



- Solid brass cylinder housing
- Patented revolving collar drive-in latch bolt for easy installation
- Solid brass latchbolt with anti-sawing roller insert
- 2-3/8 Backset

0295054 Single, Stain. Steel

0295078 Single Deadbolt, Brass

0295079 Double Deadbolt, Brass

LOCWARE

Combo Lock Sets



Keyed-alike entrance and deadbolt lock set. Great security, specially designed for manufactured home doors, tested residential grade. Adjustable bolts, single deadbolt.

0295125 Brass

0295126 Stainless Steel

Elixir Deadbolt Drive-In Latch Bolt

2-3/8" drive-in w/swivel bolt.
 5/8" Throw



0295032 12/Ctn.

0295061 Patented revolving collar adj. drive-in latch bolt for easy installation

Elixir Entrance Drive-In Latch Bolt



Adjustable swivel latch bolt only. Slides from 2-3/8" backset to 2-3/4".

0295050 24/Ctn.



ELIXIR INDUSTRIES
 SINCE 1948

Striker Plates

0295065 For Elixir Entrance Lock (Doors produced prior to Aug. 1992)

0295066 For Elixir Dead Bolt Lock (Doors produced prior to Aug. 1992)

0295070 For Elixir Regular Doors

0295071 For House-type (Combo) Doors



Elixir Key



0295060 Blank

0295059 Master Key



Exterior Door Lock & Deadbolt



0290811 Shown

Drive-In Entrance Lock

2-1/8" diameter face hole, 1" diameter latch hole. Comes with adjustable round, drive-in latch bolt. 20/Ctn.

0290827 Stainless Steel

0290828 Master-keyed Stainless Steel, #69777

0290812 Bright Brass

0290813 Master-keyed Bright Brass, #69777

Combo Set

Single deadbolt and entry knob keyed alike in a single box. Adjustable drive-in latch.

0290810 Bright Brass

0290825 Stainless Steel

Square Latch Bolt Entrance Lock

2-1/8" diameter face hole, 1" diameter latch hole. Comes with adjustable square latch bolt. 20/Ctn.

0290826 Stainless Steel

0290811 Bright Brass

Drive-In Bolt

Drive-in dead latch adjustable back set replacement bolt.



0290819 Stainless Steel

Master Key

Fits EZSET entrance lock with drive-in latch bolt. Master-keyed. #69777.



0290818

Strike Plate



Interior Door



Standard latch for 1/2" projection dead bolt. 24/Ctn.

0290817 Bright Brass

0290820 Stainless Steel

QUALITY

- All metal construction
- All exposed components are brass or stainless steel
- Nickel plated brass key

SECURITY

- 5 Pin tumbler cylinder
- Solid brass cylinder core
- Adjustable 2-3/8" to 2-3/4" backset dead latch on entrance function

CONVENIENCE

- Cylinder removable for rekeying
- Reversible for RH/LH door
- Adjustable for 1-3/8" to 1-3/4" door thickness
- 2-3/8" to 2-3/4" adjustable backset
- Easy installation
- Can be keyed alike with any E-Z Set lockset



E-Z Set Deadbolt Lock

1-1/2" to 2-1/8" diameter door face hole. 1" diameter latch hole. 1" projection. 20/Ctn.

0290816 Double Bright Brass

0290831 Double Stainless Steel

0290815 Single Bright Brass

0290830 Single Stainless Steel

Economy Entrance Lock & Deadbolt

Adjustable backset bolt.

0295055 Combo Set, Stainless Steel

0295076 Entrance Lock, Brass

0295019 Entrance Lock, Stainless Steel

0295020 Deadbolt, Stainless Steel

0295021 Deadbolt, Brass



Outdoor Improvements
 Anchors & Set-Up Material
 Doors & Windows
 Coatings & Cleaners
 Appliances
 Tools & Hardware
 Carpet & Flooring
 Electrical
 Plumbing
 Towing & Safety
 Heating & Cooling

Outdoor Improvements
 Anchors & Set-Up Material
 Doors & Windows
 Coatings & Cleaners
 Appliances
 Tools & Hardware
 Carpet & Flooring
 Electrical
 Plumbing
 Towing & Safety
 Heating & Cooling

Exterior Door Locks, Supplies and Tools



0290805 Knob/Knob

Valterra Entrance Locks

Adjusts to fit 2-3/8" or 2-3/4" backset and standard or drive-in style latches. Eliminates the guesswork in determining which lock is needed for replacement. Stainless steel finish. Panic-proof knob always free to open. Rekeyable.



0295039 Knob/Lever

- 0290805 Knob/Knob
- 0295039 Knob/Lever



Theft Stopper

Allows you to easily repair damage from break-ins without replacing entire door, and protects against a recurrence.

Just three easy steps: remove screws from doorknob, place Theft Stopper on outside of door, then replace the knob.

0212024

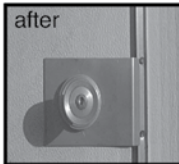
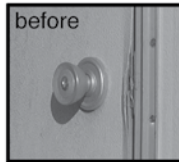

Powerbolt Keyless Lockset

Electronic touchpad single-cylinder deadbolt for residential entries.



0290611 Satin Nickel

Door Viewer

One-way viewer, zinc die-cast with 180° angle plastic lens. 9/16" diameter viewer adjusts for door thicknesses 1-1/2" to 2-1/2". Installation hole is 9/16". Display boxed.



0212017 Chrome

Lock Installation Tool Kit



Hole Saw

For fast and easy installation of most locksets and deadbolts; fits most popular electric and cordless drills. Blade-mandrel and bit are high quality heat treated and hardened. Contains one 2-1/8" diameter high carbon steel high speed holesaw and mandrel, and one 1" high speed wood power bit. Will saw through metal or wood. Carded.

0390500 12/Ctn.

Knocker Viewer



- 0212010 Stainless Steel
- 0212012 Brass

Interior Door Locks and Supplies

Conical Passage & Privacy Lock



Passage



Privacy

Conical knob, contemporary design. 2-3/8" round drive-in latch.

- 0290105** Passage, Polished Brass; 30/Ctn.
- 0290106** Privacy, Polished Brass; 30/Ctn.
- 0290107** Replacement Bolt, Polished Brass
- 0290103** Passage, Brushed Nickel; 30/Ctn.
- 0290104** Privacy, Brushed Nickel; 30/Ctn.

Lever Passage & Privacy Lock



Passage



Privacy

- 0290110** Passage, Polished Brass
- 0290111** Privacy, Polished Brass
- 0290112** Passage, Brushed Nickel
- 0290113** Privacy, Brushed Nickel

Interior Decorator Plastic Lock

For doors 1" to 1-1/2" thick. Will not rust, tarnish or corrode. 2-3/8" backset, 7/8" diameter. Standard full lip strike.

Smooth-turning. Shrink packaged. 50/Ctn.

- 0291901** Privacy, Coffee
- 0291900** Privacy, Almond
- 0291700** Passage, Almond
- 0291701** Passage, Coffee



Self-Adhesive Door Stop



- 0211002** White; 100/Ctn.

Spring-Eze Stop



Flexible brass-plated steel spring with white plastic tip. 3" long.

- 0211004** 200/Ctn.

Knob/Wall Protector

High impact material can be painted or papered. Foam on back absorbs shock. 1/4" total thickness. Washable. White.

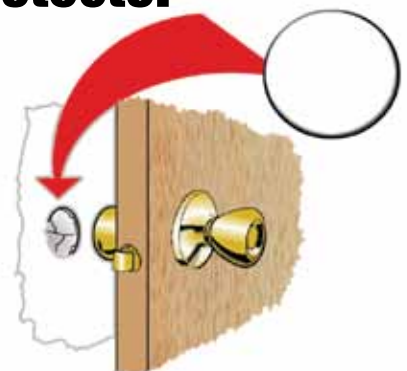

- 0211003** 3" Dia.
- 0211005** 5" Dia.

"S" Hook

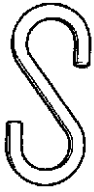

Approximately 1-1/2" Long. Ideal for chain door connections and many other uses.

0210602

Door Clip



Keeps doors closed and secure during transport or whenever you need to restrict access.

0210455

Weather Stripping



0219001 30' Weather Stripping

Adjustable Vinyl Door Bottom

Fills gap between the door and door bottom to prevent air, dust and water entry. Additional seal at top stops any water seepage. Pre-punched slotted holes and self-tapping screws. 36" long. 24/Ctn.

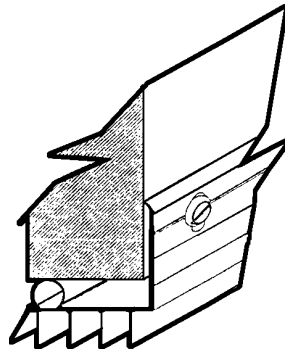

0219010 White
0219011 Brown

Roof Edge

Extra soft, heavy-gauge with standard edge. Fourteen ft. length punched with 4" centers.

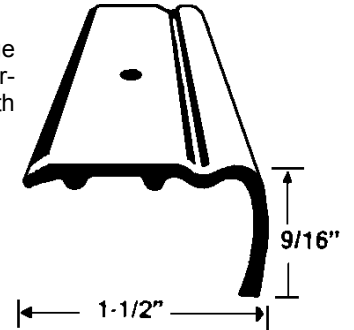

0265501 24/Ctn.

Aluminum Molding Drip Rail

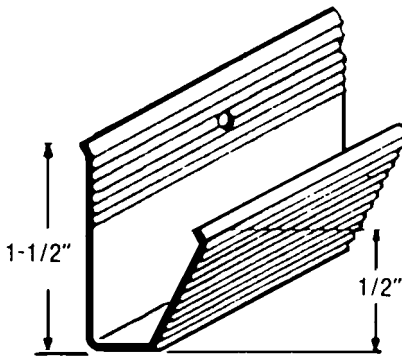

Serrated face 1-1/2" standard 1-1/2" rail 14' length w/punched 4" centers.

0265503 25/Ctn.

Elixir Drip Cap

Install over doors and windows to channel away rain and snow. Steel with white finish.



0212009 For 72" door
0212011 For 32" or less door
0212012 For 34" door
0212013 For 36" door
0212014 For 48" door
0212018 For 53" door

Drip Cap

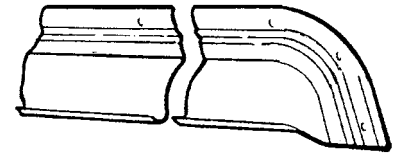

Install over doors and windows to channel away rain and snow. The confined caulking area insures neat appearance and positive seal.

0210950 31"
0210951 35"
0210953 39"
0210954 43"
0210955 49"

Door Sweep

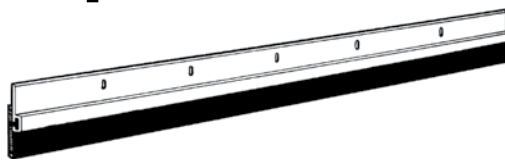

1-1/2" overall width including vinyl. 37" overall length. Satin finish. Poly-bag.

0219009 24/Ctn.

Elixir Threshold

Constructed of aluminum.

0265506 F/32" or less door
0265507 F/34" door
0265508 F/36" door
0265509 F/48" door
0265510 F/72" door

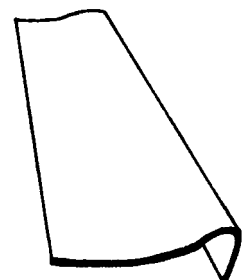

Weather Stripping



Visco Door Weather Stripping

Construction: Pine wood strip or PVC, available as 1³/₈" or 3/4" Quarter Round, Narrow.

Insert: Q-Lon soft cell foam insert. Foam has thermoplastic cover and will not deteriorate.

Finish: White foam (Brown can be special ordered). Wood is primed, PVC is white.

Lengths: 1-3' piece and 2-7' pieces.

0219015 PVC, 3/4", White, Narrow

0219016 PVC, 1³/₈", White, Quarter Round

0219017 Wood - 1³/₈", Primed, Quarter Round

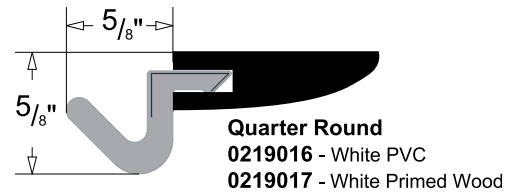
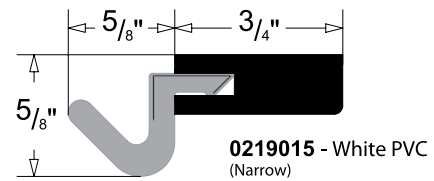

Visco Heavy Duty (Low Profile) Door Weather Stripping

Construction: Extruded aluminum. Mitered corners ensure a secure fit with slotted mounting holes for easy adjustment.

Insert: 1/4" flexible, bubble type neoprene.

Finish: Aluminum (Brown or white can be special ordered).

Set: 1-3' piece and 2-7' pieces. Custom lengths also available.

0219019 Mitered Aluminum

Approved for sound abatement program.

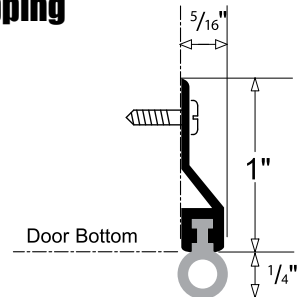

Visco Door Weather Stripping

Construction Q-Lon: Extruded aluminum. Mitered corners ensure a secure fit with slotted mounting holes for easy adjustment.

Insert: Soft cell foam insert. Foam has thermoplastic cover and will not deteriorate.

Finish: Aluminum, brown or white finish.

Custom lengths also available.

Set: 1-3' piece and 2-7' pieces. Custom lengths also available.

0219018 Mitered Aluminum

0219020 Mitered White

0219021 Mitered Brown

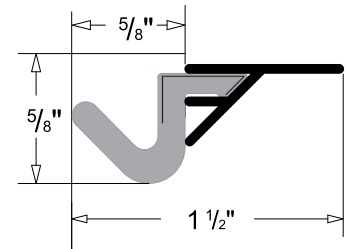

Visco Door Triple Sweep

Construction: Extruded Aluminum

Insert: 3/4" Vinyl Insert

Finish: Aluminum

Lengths: 36"

(Additional sizes and colors available by special order.)

0219025 Aluminum

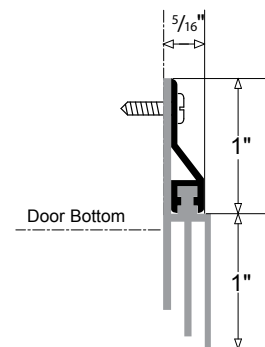

Frost King Replacement Door Seal for Kerfed Millwork Doors

Thermoset plastic door seal will replace the seal in doors with standard 1/8" x 11/32" kerfs. Superior resistance to low temperature compression and will fill gaps up to 11/16". An eliminator seal Unconditionally guaranteed never to fail.

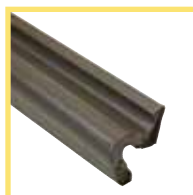

0219005 Brown; Threshold; Vinyl Covered Foam.

Frost King 1" x 7' White Vinyl Clad Foam Kerf Door Seal

White foam to match Door Jambs Foam encased in Vinyl for durability best weatherseal for Kerfed Doors Weatherproof and Water Resistant.



0219006 White; Window; Vinyl Covered Foam.