

Beginning Sound Sticks A-Z

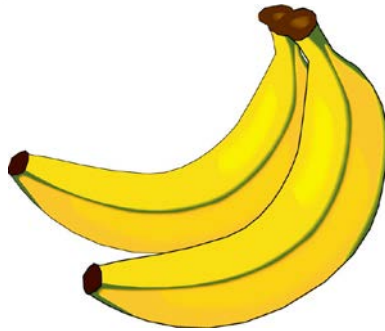
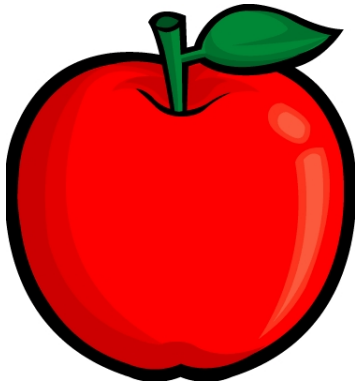

Thanks for downloading!

If you find this printable helpful please share the following link on sites like Facebook, Twitter, or Pinterest so others can benefit:

<http://www.pre-kpages.com/beginning-sound-sticks/>

Copyright

- You may use this document in your own classroom. If you wish to share it with your friends please send them the link above.
- This document may not be digitally displayed, hosted, or reproduced without permission from the author.
- You can find more literacy ideas and resources [HERE](#).
- Please read my [terms of use](#).

Contact

Vanessa Levin

- e-mail: vlevin@pre-kpages.com
- Website: www.pre-kpages.com
- Store: www.pre-kpages.com/teacher-resources/

Credits

Graphics created by Clipart.com, MyCuteGraphics and Graphics Factory

Follow

I invite you to follow me on: [Facebook](#), [Twitter](#), and [Pinterest](#). Please subscribe to [my newsletter](#) for weekly teaching tips and exclusive freebies.

Beginning Sound Sticks

Materials: one paint stirring stick per letter, cardstock, laminating film, scissors, and adhesive backed Velcro

Directions for use: Print the pages on cardstock and laminate for durability. Next, cut out each circle. Then, attach the soft side of the adhesive backed Velcro to each paint stick from top to bottom. Finally, attach one piece of hard adhesive Velcro to the back of each circle. Students will attach the objects to the stick with the correct beginning sound.

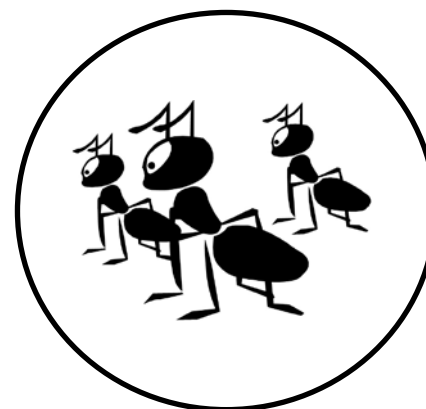
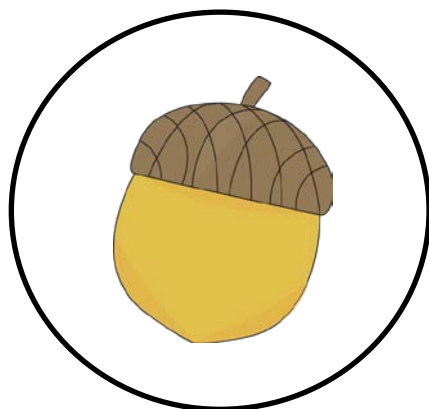
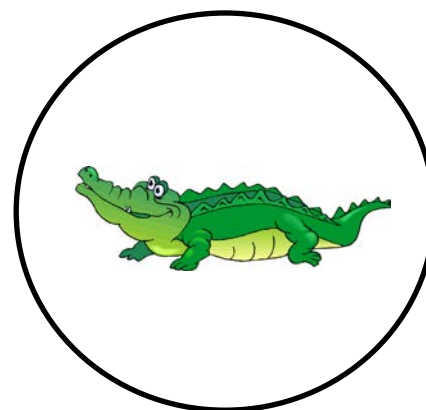
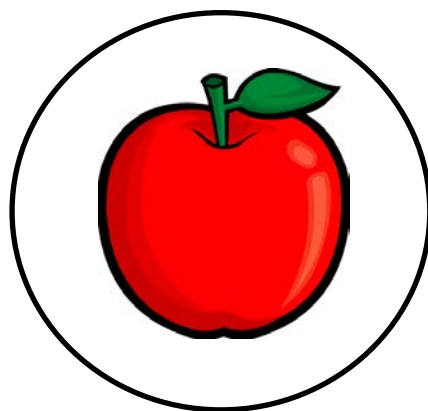
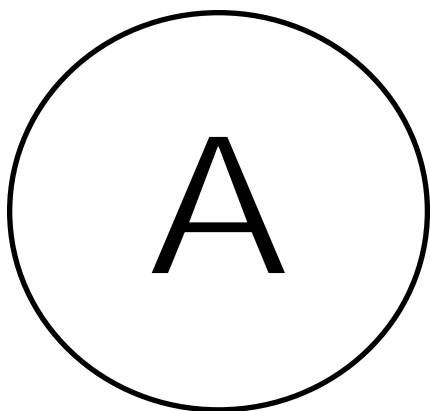

Beginning Sound Sticks

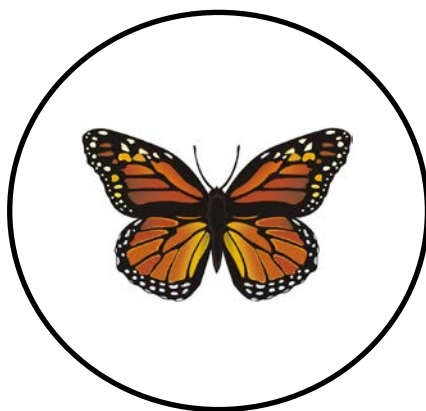
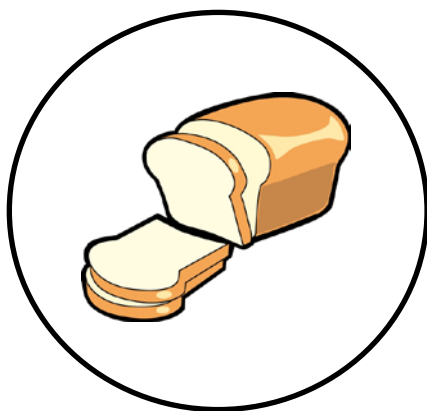
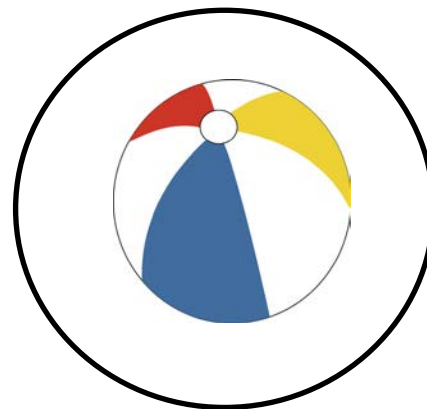
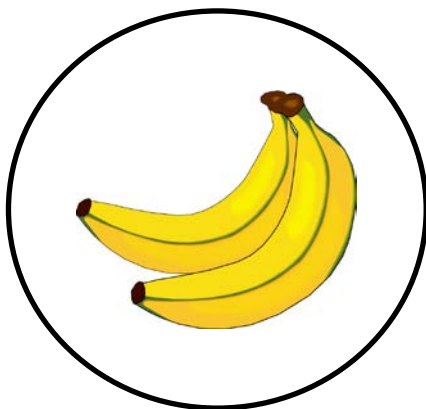
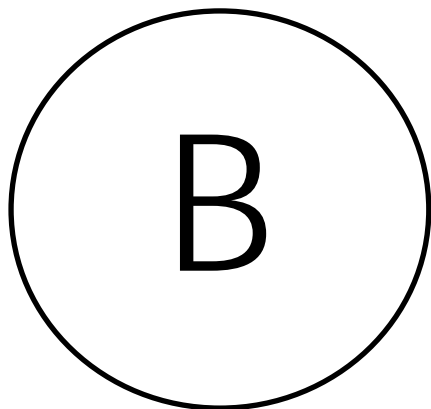

Beginning Sound Sticks

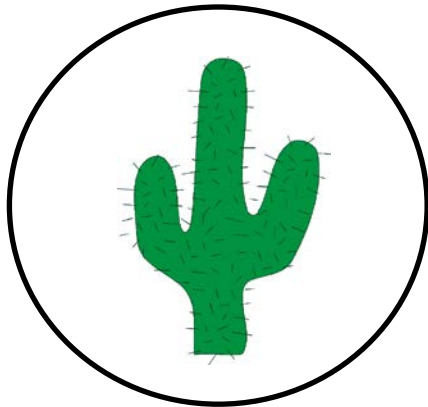
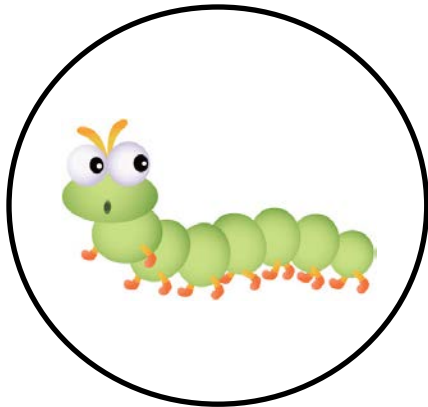
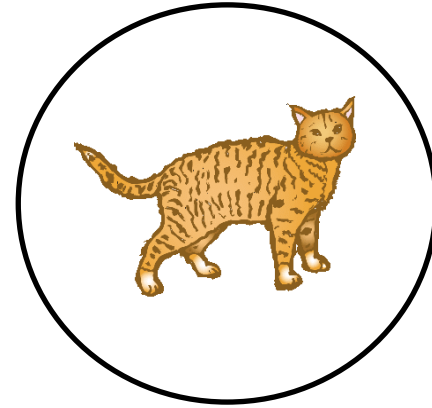
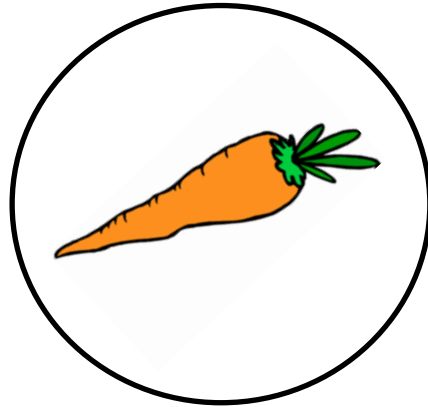
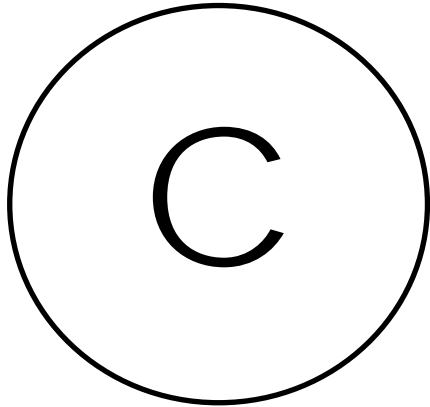

Beginning Sound Sticks

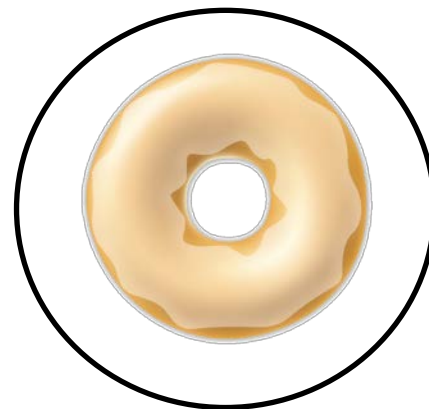
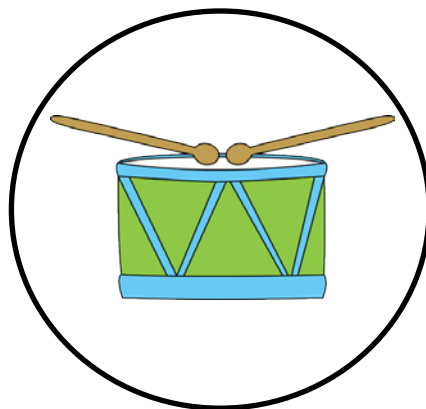
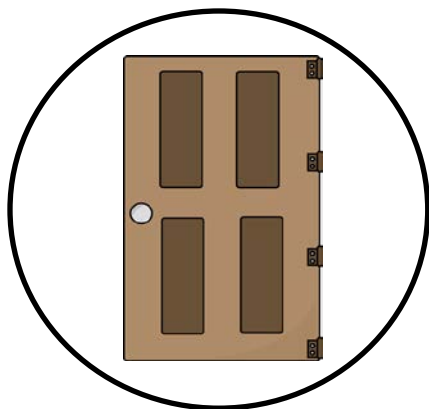
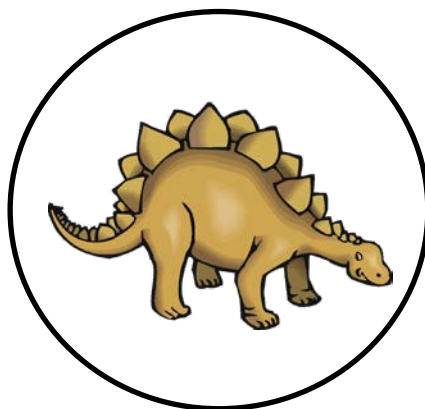
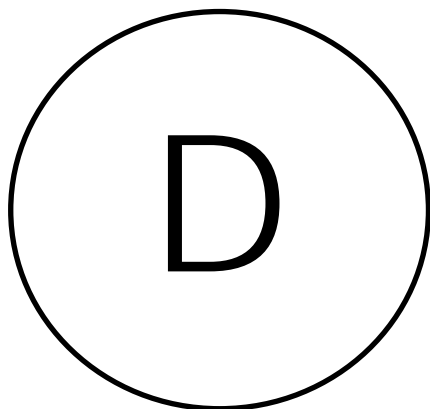

Beginning Sound Sticks

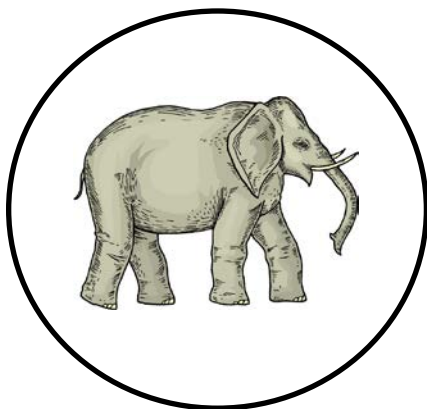
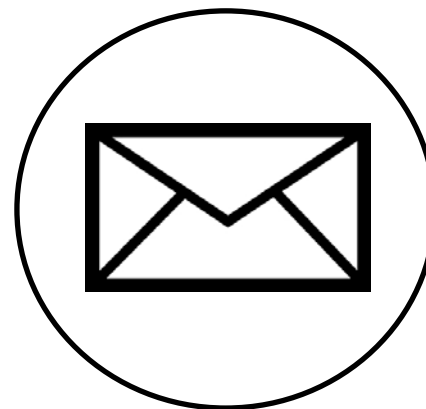
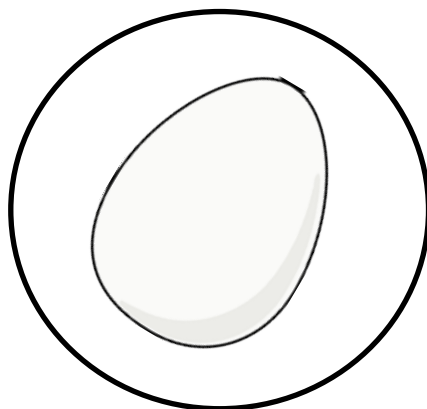
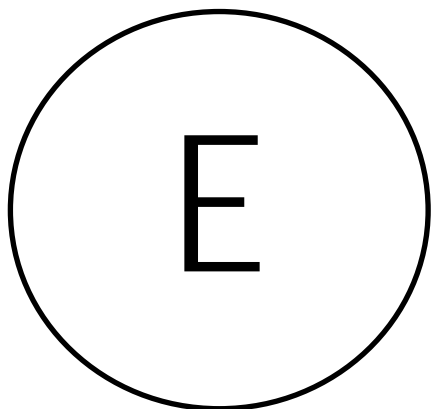

Beginning Sound Sticks

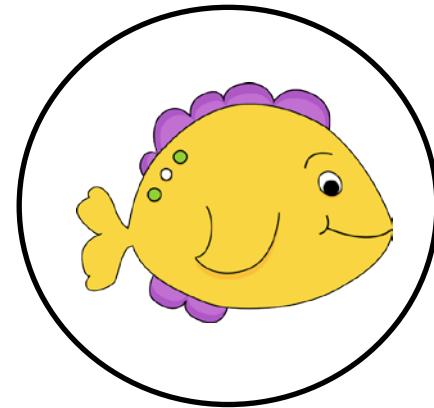
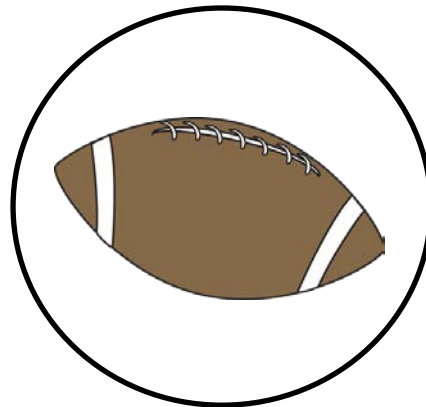
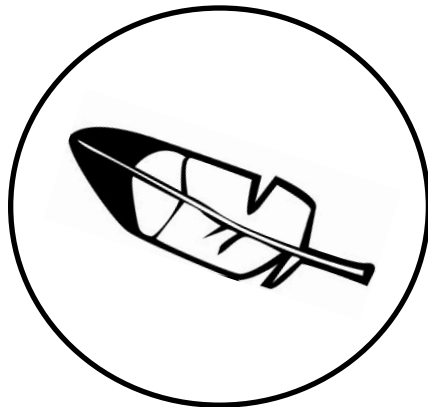
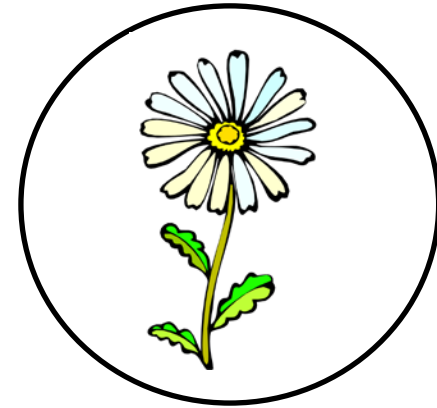
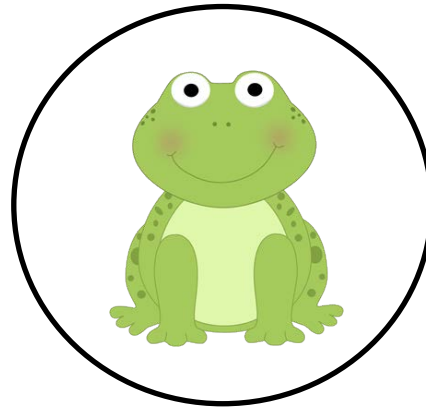
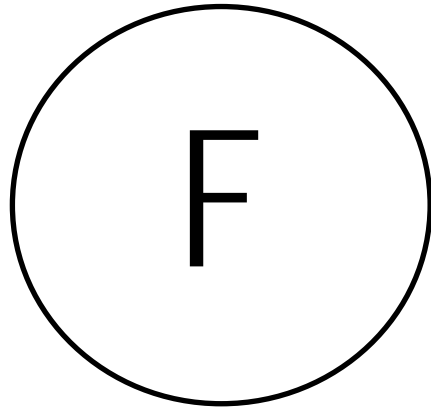

Beginning Sound Sticks

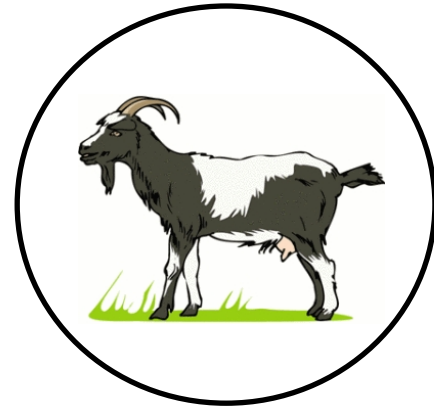
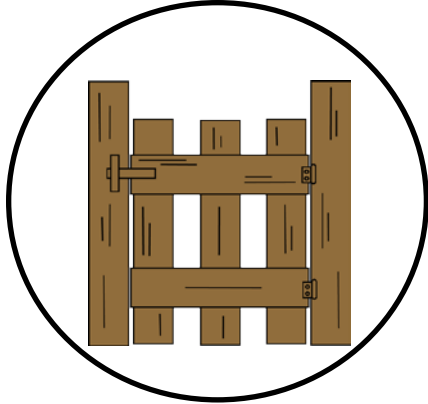
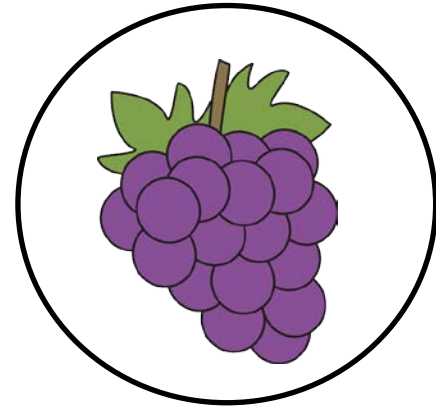
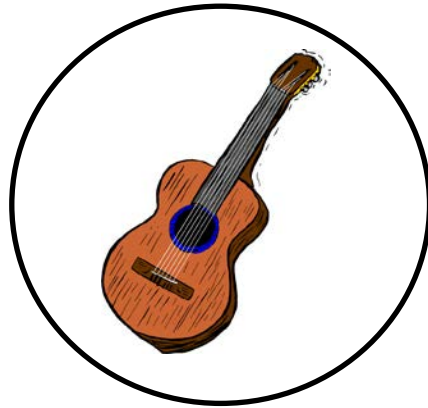
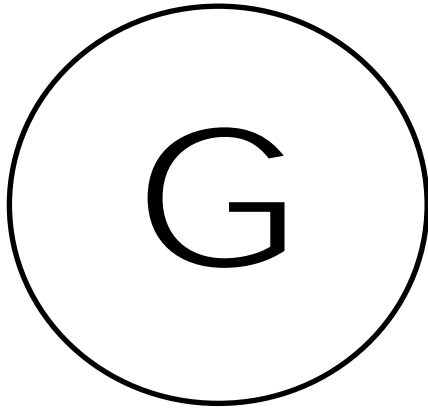

Beginning Sound Sticks

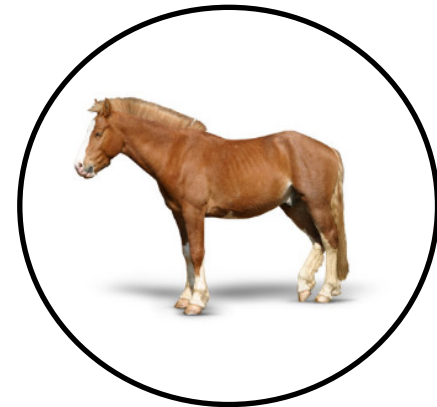
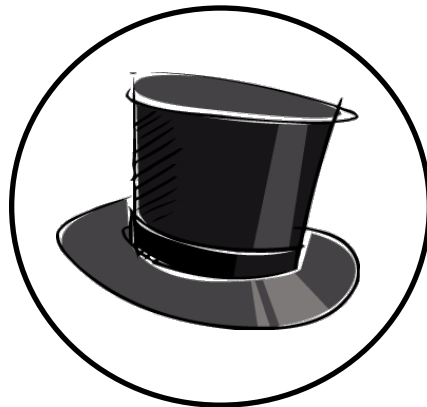
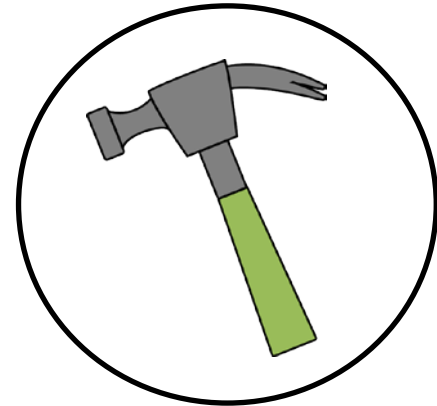
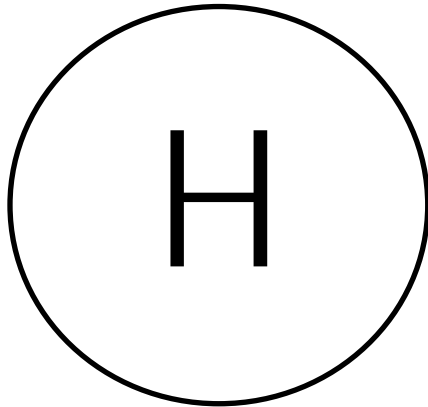

Beginning Sound Sticks

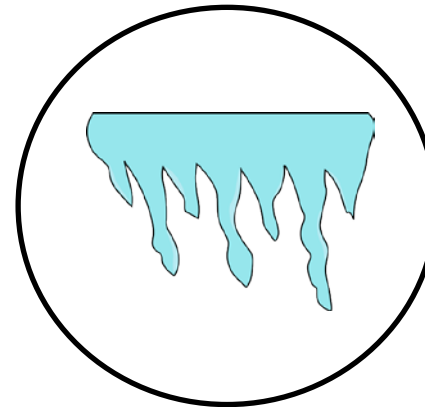
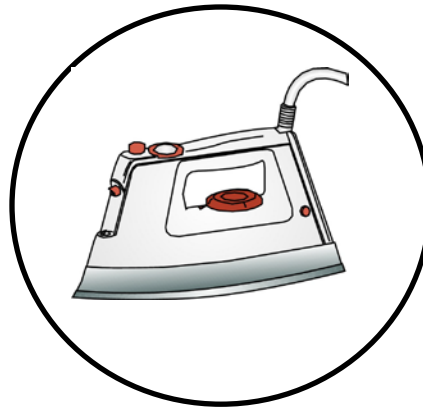
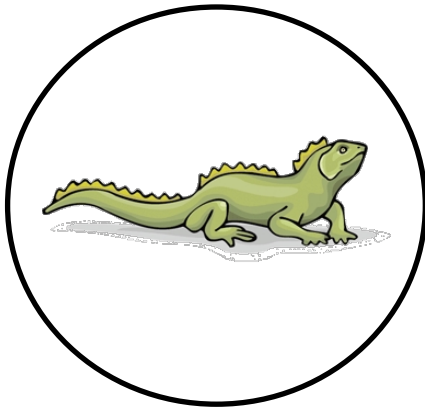
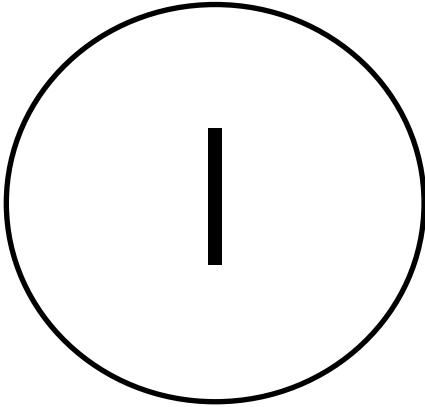

Beginning Sound Sticks

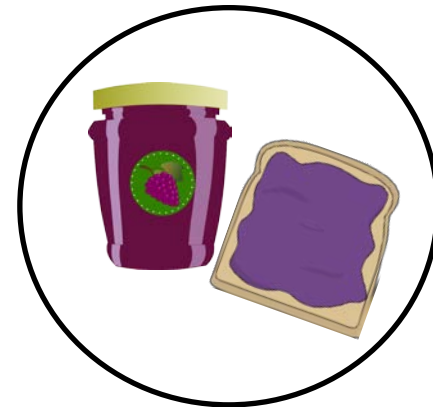
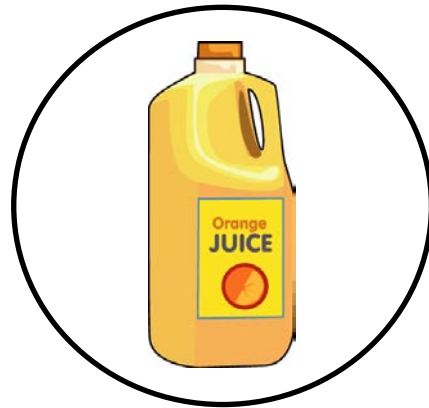
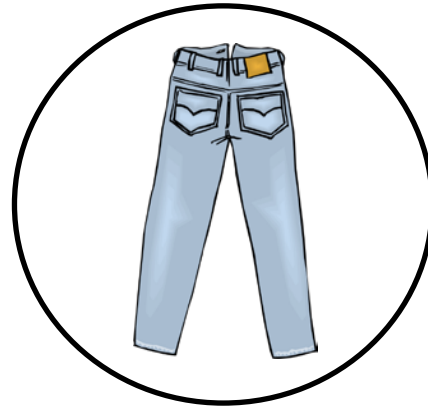
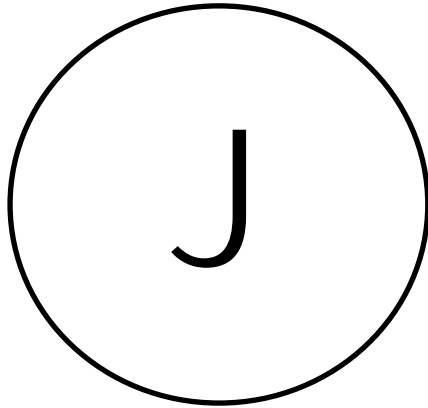

Beginning Sound Sticks

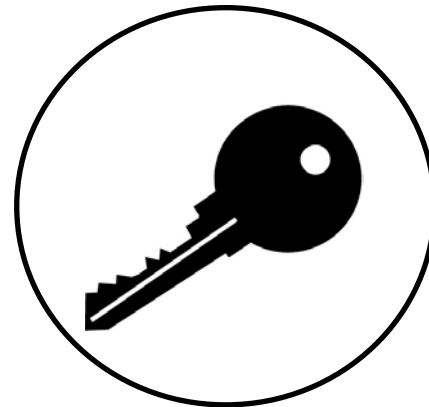
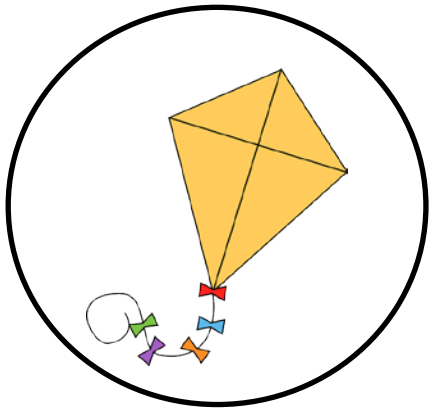
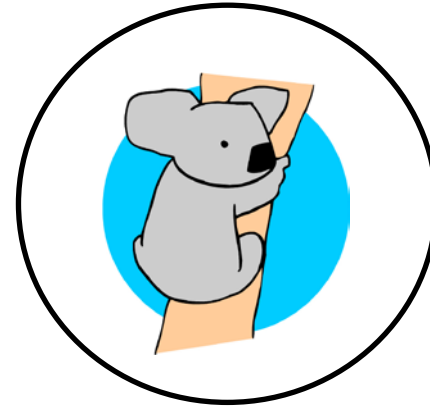
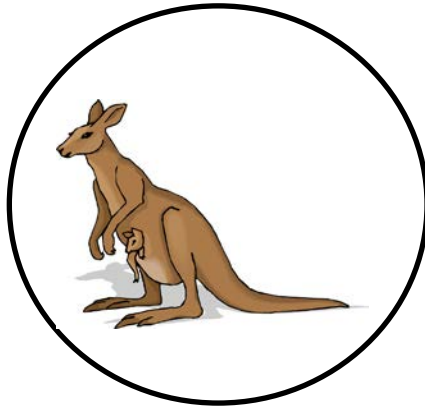
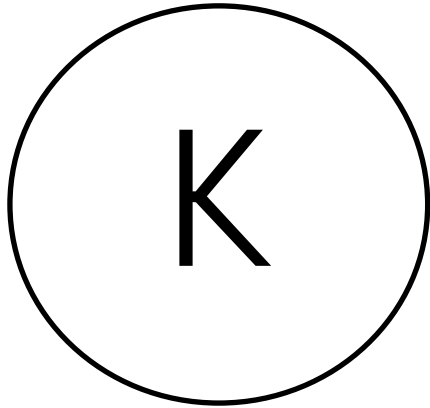

Beginning Sound Sticks

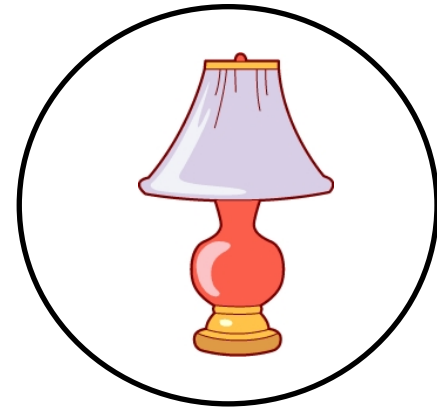
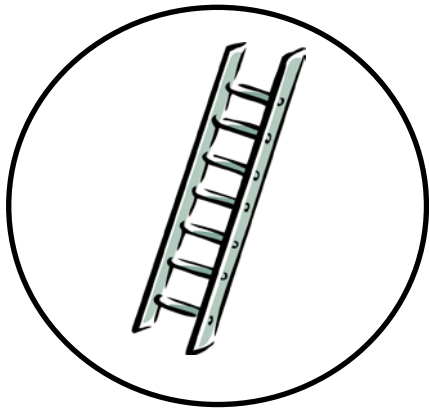
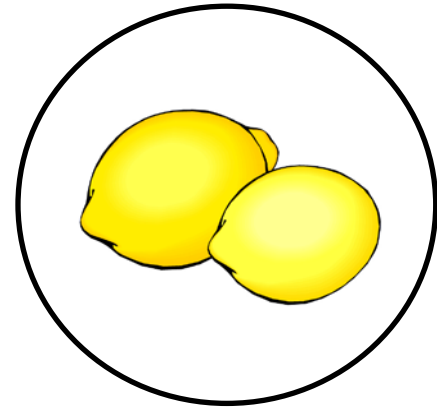
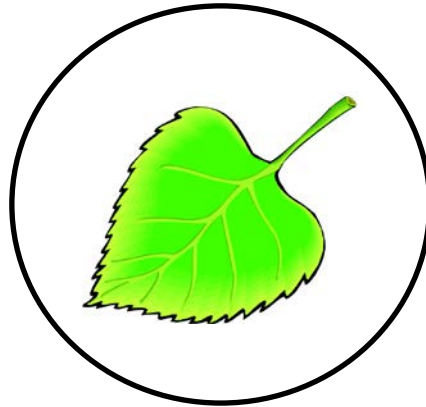
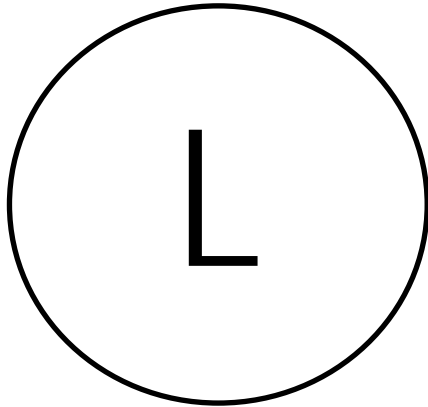

Beginning Sound Sticks

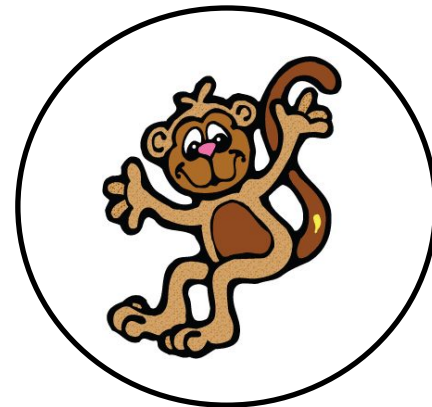
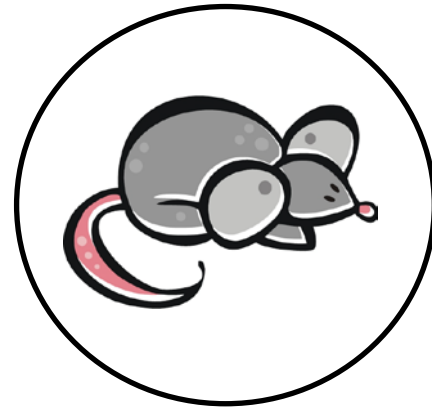
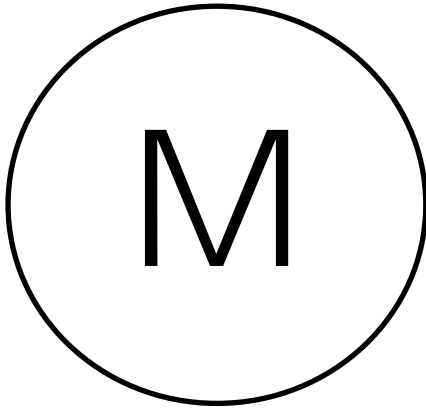

Beginning Sound Sticks

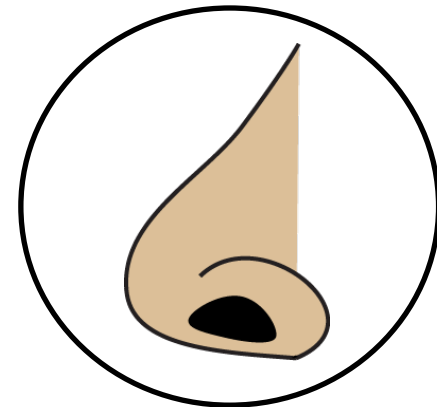
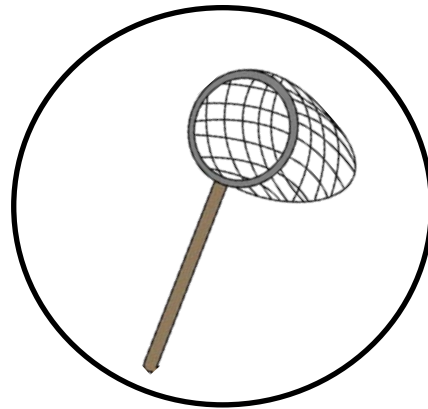
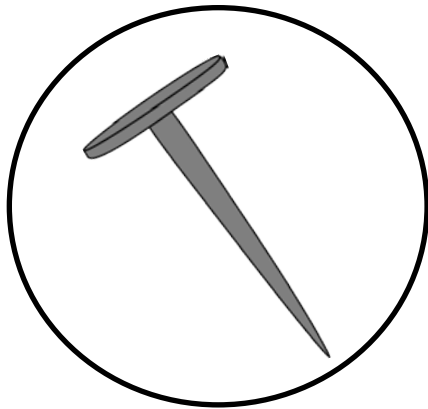
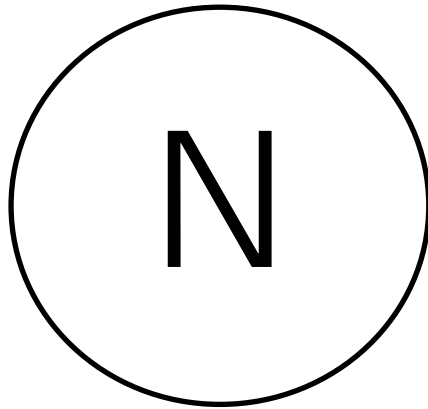

Beginning Sound Sticks

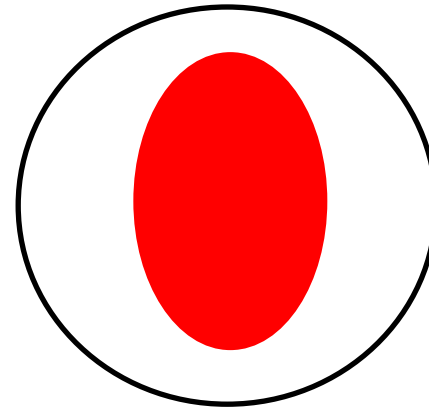
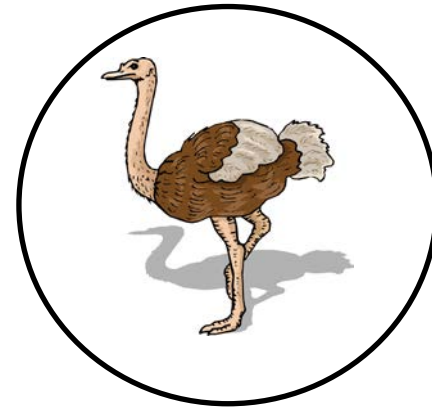
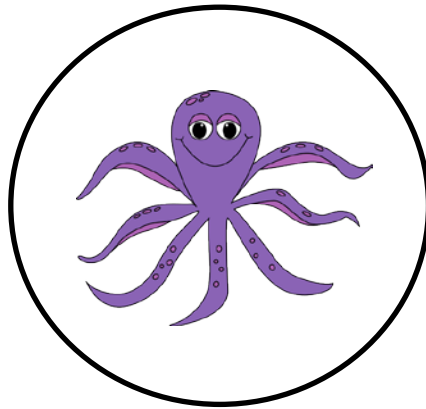
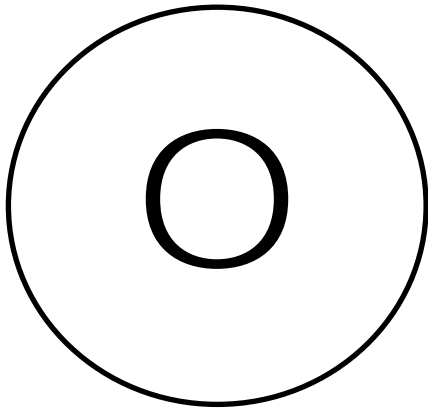

Beginning Sound Sticks

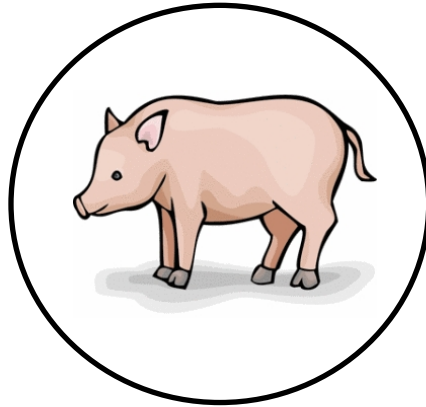
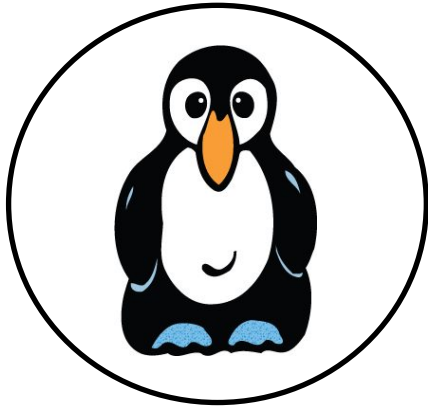
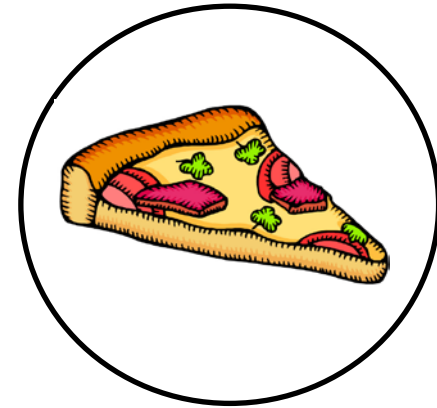
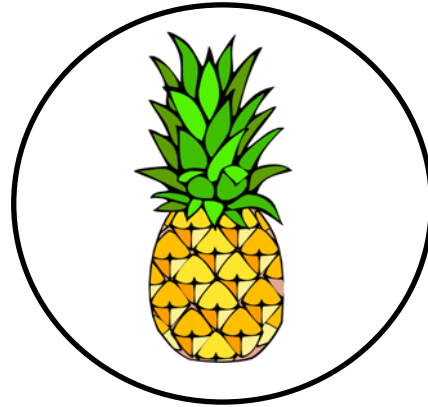
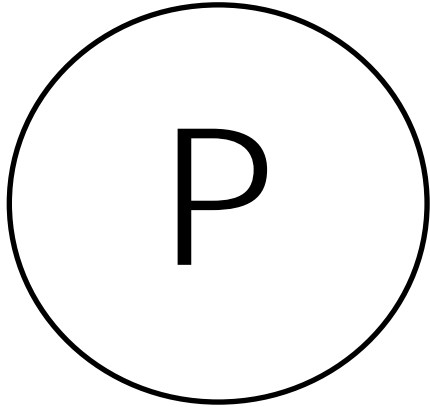

Beginning Sound Sticks

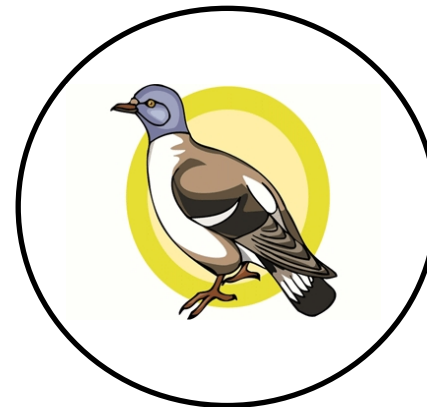
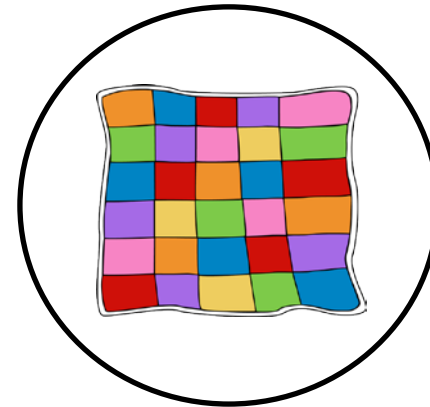
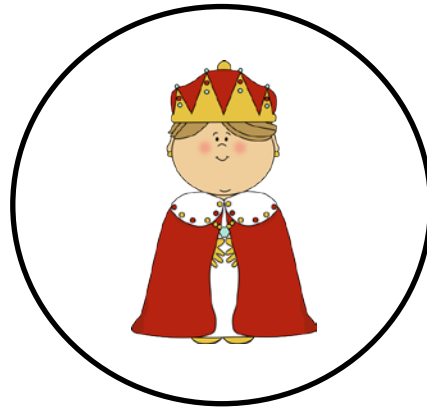
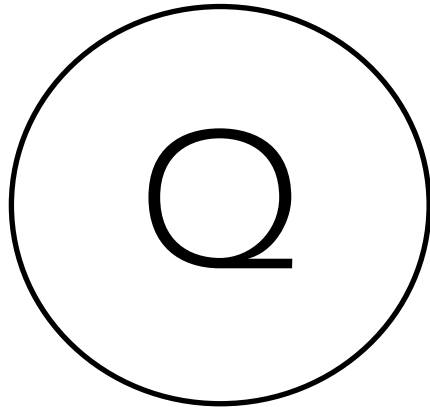

Beginning Sound Sticks

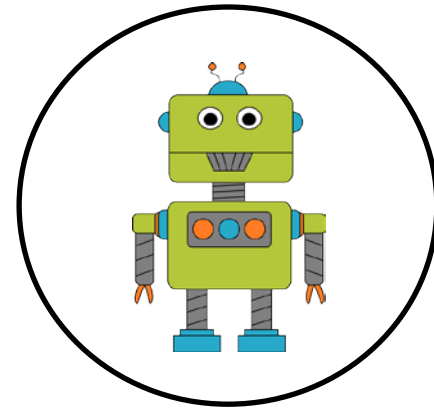
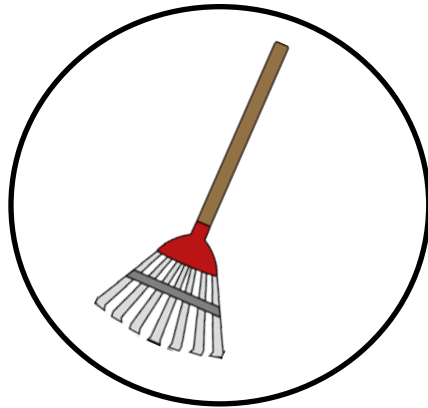
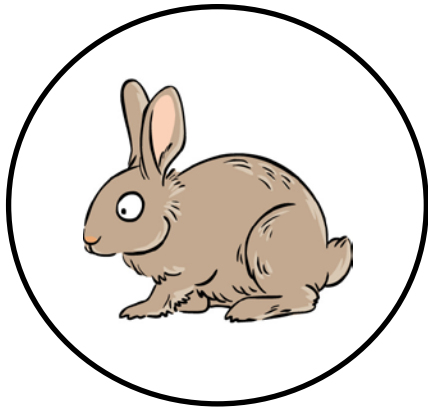
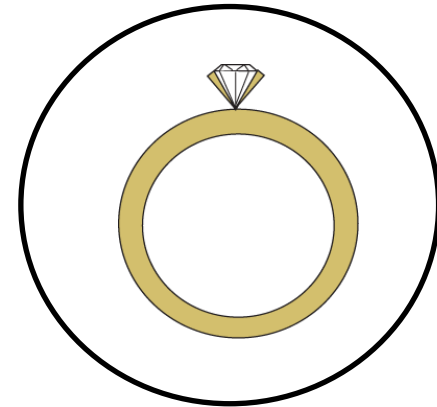
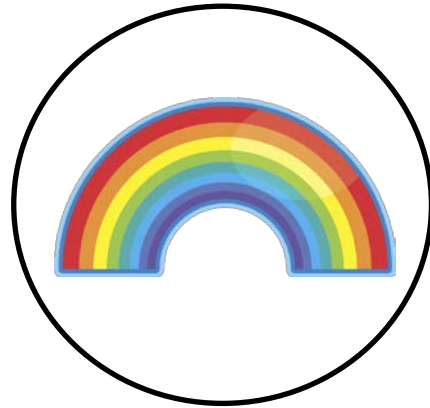
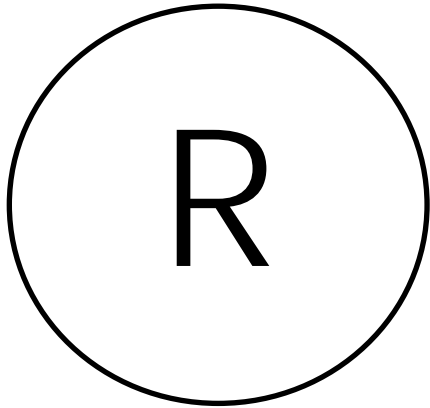

Beginning Sound Sticks

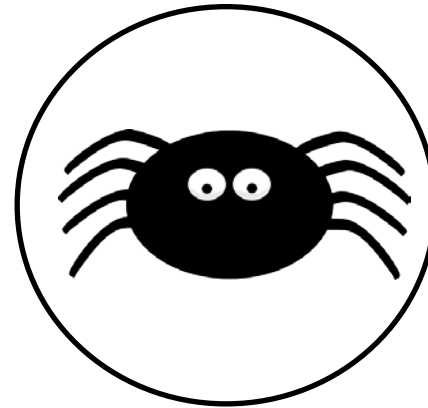
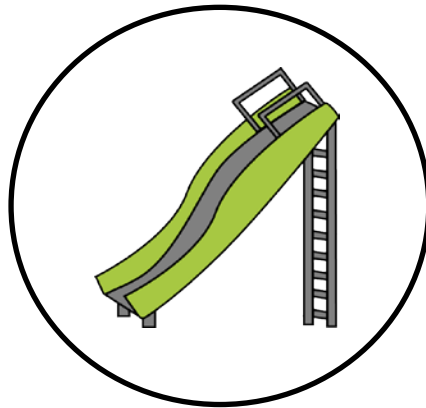
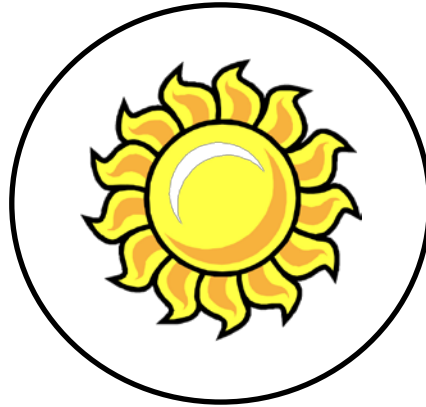
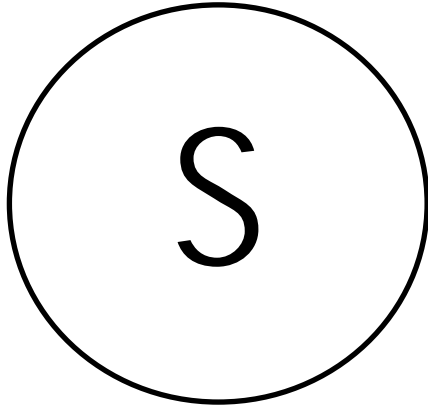

Beginning Sound Sticks

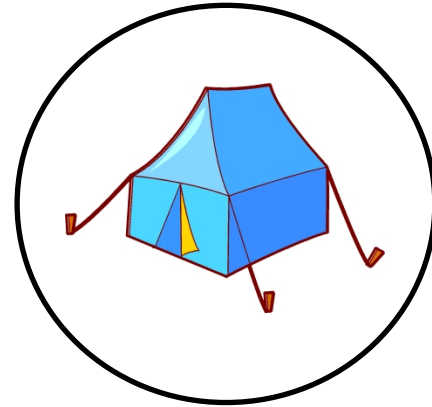
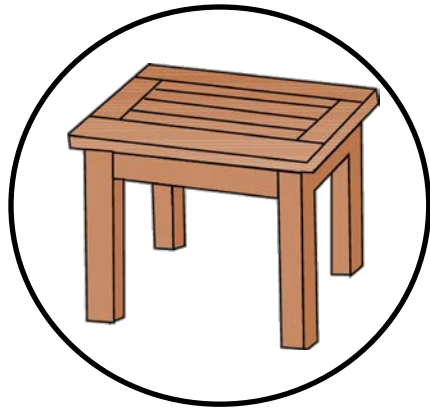
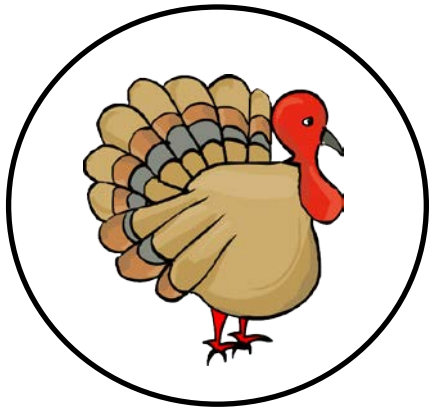
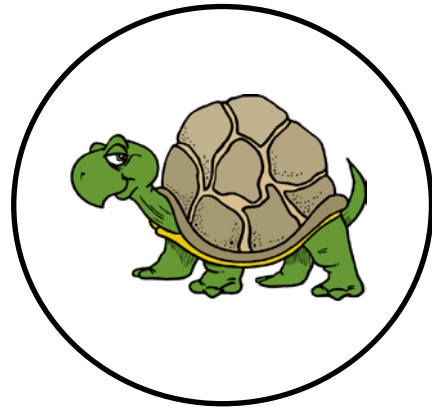
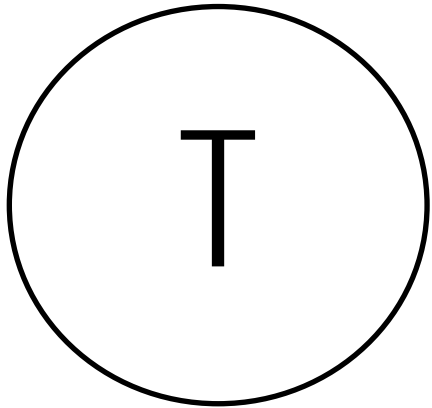

Beginning Sound Sticks

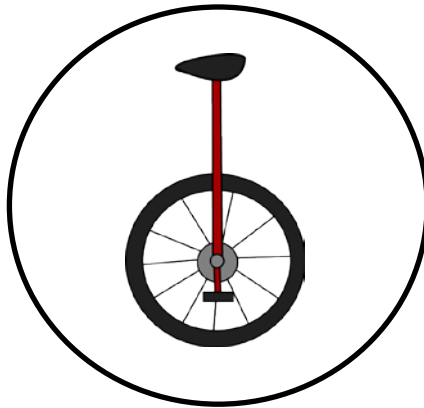
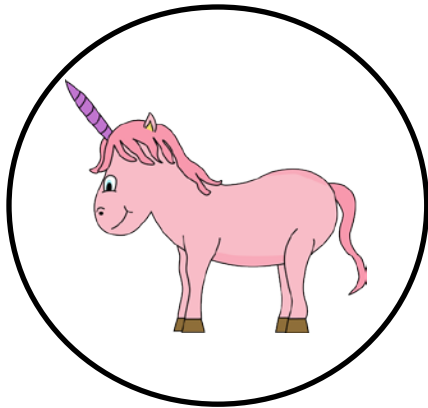
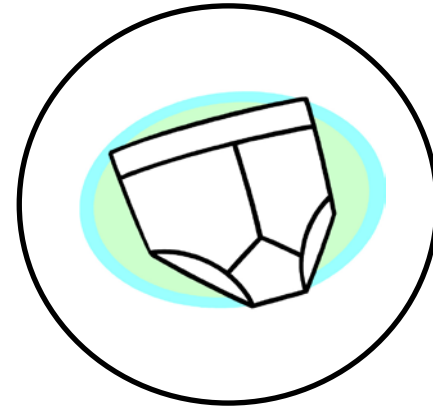
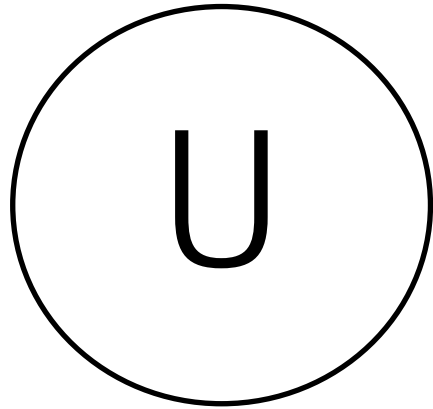

Beginning Sound Sticks

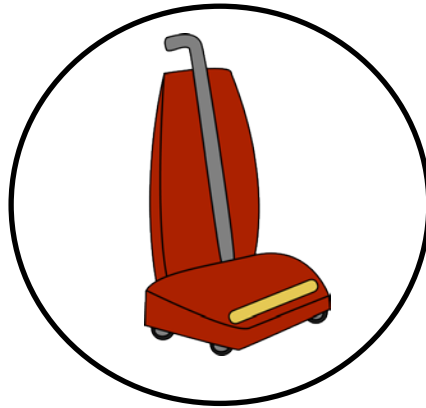
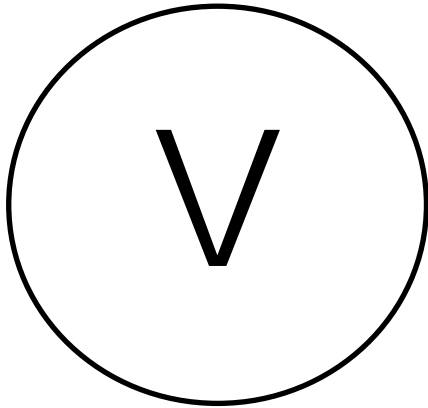

Beginning Sound Sticks

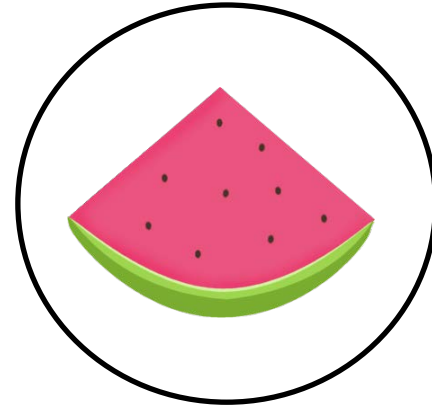
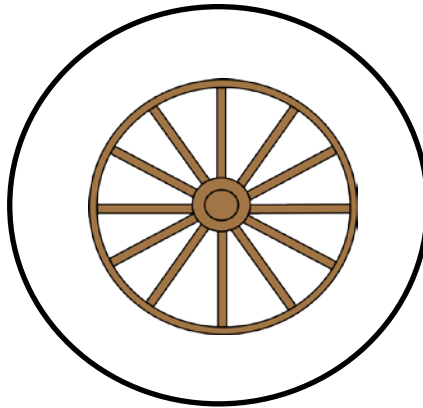
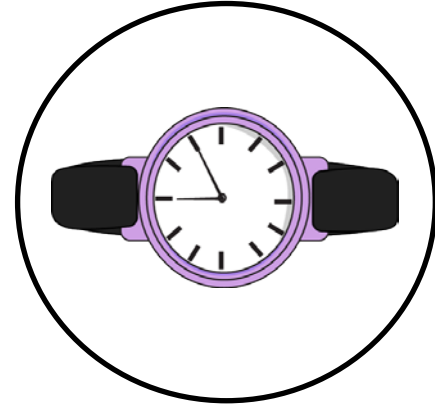
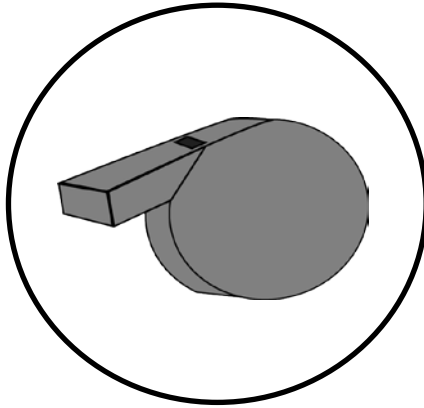
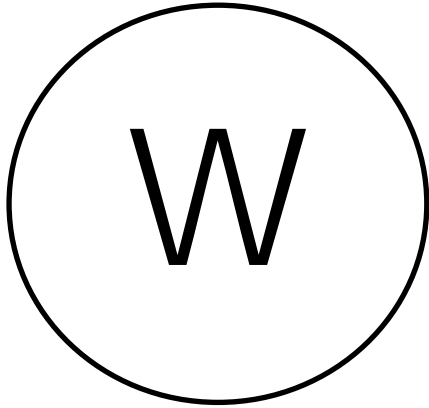

Beginning Sound Sticks

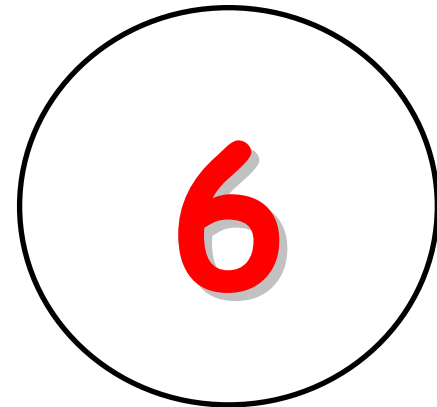
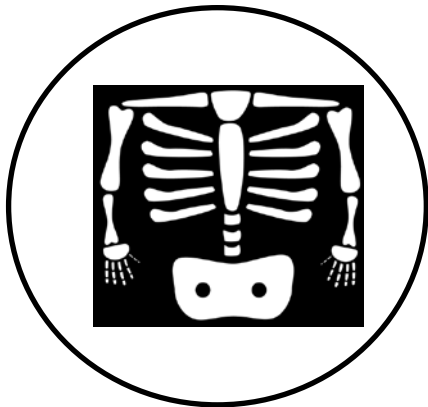
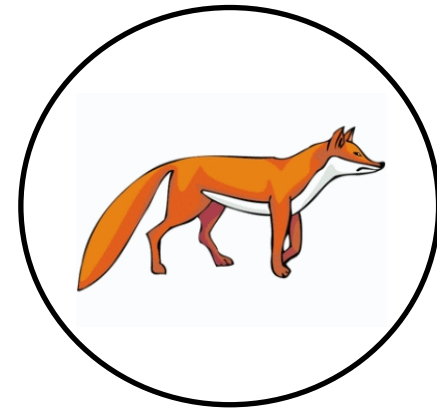
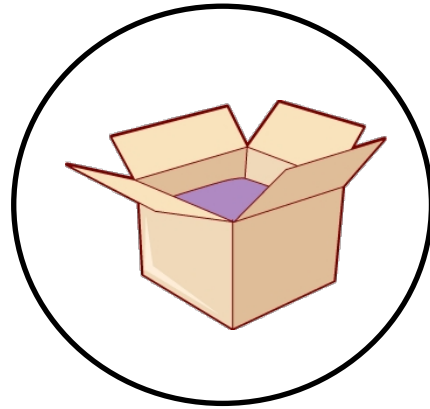
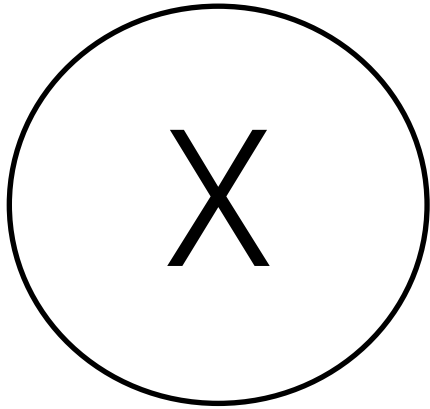

Beginning Sound Sticks

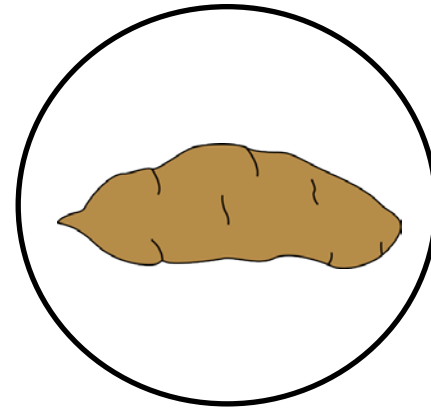
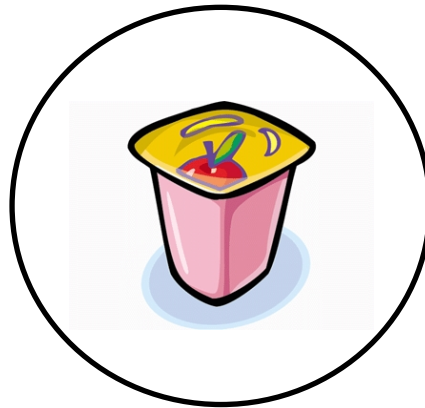
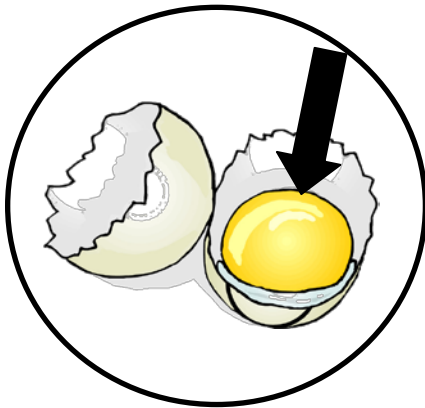
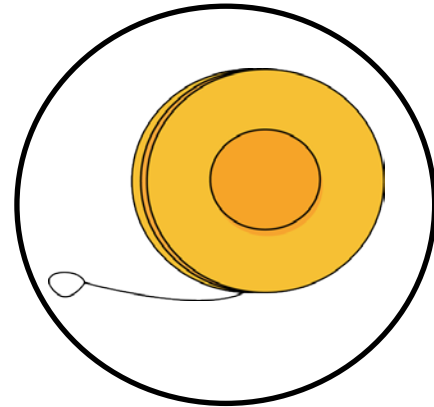
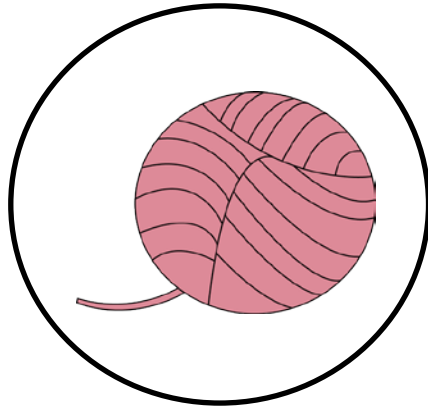
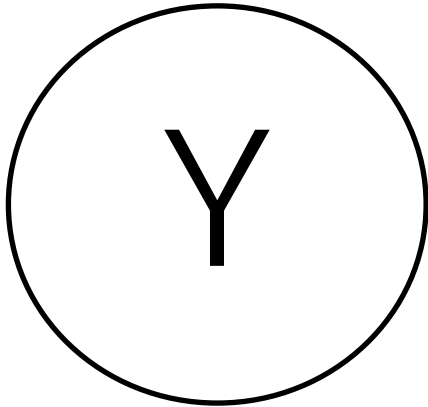

Beginning Sound Sticks

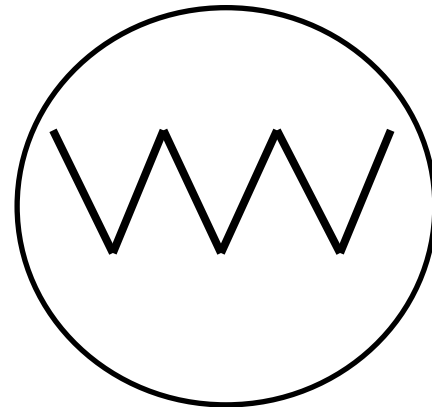
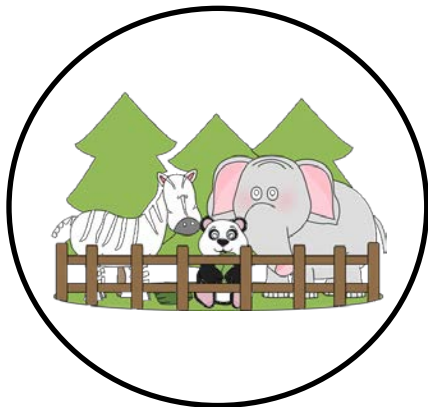
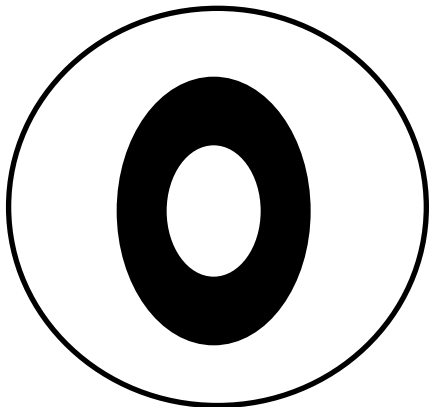
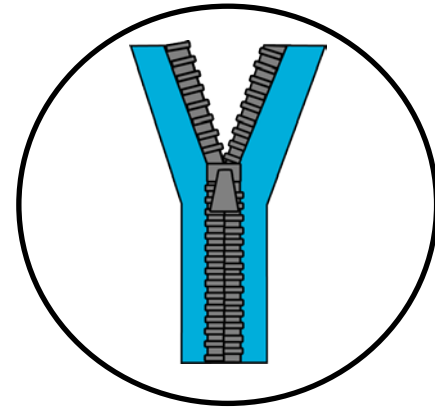
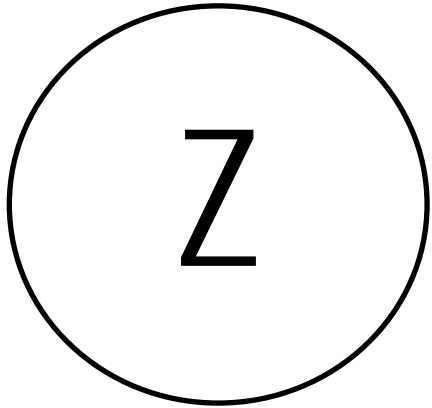

List of Pictures

A= apple, alligator, ambulance, acorns, ants

B= banana, ball, bread, butterfly, bear

C= carrot, cat, caterpillar, cactus, cupcake

D= dinosaur, dog, door, drum, doughnut

E= elephant, egg, engine, elf, envelope

F= fish, football, feather, frog, flower

G= goat, glove, grapes, gate, guitar

H= house, hammer, heart, hat, horse

I= igloo, ice cream, iguana, icicle, iron

J= jeans, jelly beans, jelly, jacket, juice

K= kite, koala, king, key, kangaroo

L= lamp, ladybug, ladder, lemons, leaf

M= mittens, milk, muffin, monkey, mouse

N= nose, necklace, net, nail, nest

O= octopus, ostrich, overalls, oval, owl

P= pineapple, pizza, penguin, pig, pumpkin

Q= queen, quarter, quail, quilt, question mark

R= rainbow, ring, robot, rabbit, rake

S= sun, snowman, scissors, slide, spider

T= table, turtle, tent, tie, turkey

U= umbrella, underwear, unicycle, unicorn, uniform

V= volcano, vase, vest, van, vacuum

W= wagon, whistle, wheel, watch, watermelon

X= (ending in X) ax, box, fox, six (starts with X) X-ray

Y= yo-yo, yarn, yogurt, yolk, yam

Z= zebra, zipper, zoo, zero, zigzag

Resources

If you enjoyed this resource here are some others that might be of interest to you:

[Pre-K Pages Literacy](#)

[Pre-K Pages Themes in Alphabetical Order](#)

[Pre-K Pages Printable Teacher Resources](#)

[Pre-K Pages Dramatic Play Printables](#)



Want to learn how to create and sell your own printables?
[Tutor for Teachers](#) can help

