



Established 1992

FOR ALL YOUR AIR BRAKE FITTINGS AND ANCILLARY ITEMS



“The Fitting People”



Section

1

Page 1/1 - 1/31



TUV MODULAR AIR BRAKE FITTINGS

Section

2

Page 2/1 - 2/8



FLEETFIT AIR BRAKE FITTINGS

Section

3

Page 3/1 - 3/8



PNEUFIT INDUSTRIAL FITTINGS

Section

4

Page 4/1 - 4/6



**PLASTIC & COMPOSITE
INDUSTRIAL FITTINGS**

Section

5

Page 5/1 - 5/9



PLASTIC INDUSTRIAL FITTINGS

Section

6

Page 6/1 - 6/17



COMPRESSION AIR BRAKE FITTINGS

Section

7

Page 7/1 - 7/5



BRASS COMPRESSION FITTINGS

Section

8

Page 8/1 - 8/3



**MALLEABLE IRON / STEEL /
SEALANTS**

Section

9

Page 9/1 - 9/3



**BRAKE PIPE FITTINGS
& BLEED SCREWS**

Section

10

Page 10/1 - 10/3



GREASE NIPPLES & ACCESSORIES

Section

11

Page 11/1 - 11/7



**PCL GARAGE / WORKSHOP
FITTINGS & ACCESSORIES**

Section

12

Page 12/1 - 12/8



**COUPLINGS / TEST EQUIP / GAUGES
PALMS / FILTERS / VALVES / LOCKS**

Section
13

Page 13/1 - 13/4



AIR BRAKE COILS & ADAPTORS

Section
14

Page 14/1 - 14/3



ELECTRICAL / ABS / EBS COILS & PLUGS / SOCKETS

Section
15

Page 15/1 - 15/9



AIR BRAKE NYLON TUBING DIN & BS / PVC / RUBBER DIN & BS / HEATER HOSE/ FUEL HOSE / CUPRO NICKEL / CONDUIT / SPIRAL WRAP & ACCESSORIES

Section
16

Page 16/1 - 16/3



AIR RESERVOIRS & ACCESSORIES

Section
17

Page 17/1 - 17/4



REAR MARKER BOARDS / CONSPICUITY TAPE / REFLECTORS

Section 1



TUV SIRIT Modular Air Brake Fittings



.....

.....

.....

.....

.....

.....

.....

.....



Scope of use

The SIRIT brass instantaneous push-in fitting has been designed to be used with (Rilsan) 11/12 polyamide or (Hytrel) elastomeric polyester tubings on the pneumatic circuits of auxiliary and braking systems on trucks and trailers.

It is a ready-to-use safety fitting that does not require additional tools or equipment for coupling with the tubing's.

The only operation required is the manual insertion of the tubing in the seat of the fitting.

This makes for a much shorter assembly time than with traditional cutting ring-type couplings.

Assembly time are estimated to be 70%+80% shorter.

The tolerance of the used tubing must comply strictly with those set forth in ISO standard 7628 and DIN standard 74324/73378.

The operating heat range for the SIRIT instantaneous fitting is : +100°C / -40°C.

The seal in these conditions is ensured by means of a specific design mix selected for the SIRIT O-Ring.

The SIRIT fittings for braking systems comply with DIN 2353 regulation. The types of fittings shown in this catalogue are based on the requests made by the main European braking systems installers.

The range which is particularly extensive, is able to satisfy the requirements of truck, trailers and semi-trailers builders as well as those of transformers and spare parts dealers. The working pressures are within the average - low pressure values and correspond to those stated for the light series (L) of DIN 2353.

The SIRIT fittings for braking systems can also be used on oil-pressure circuits as long as the pressure does not exceed 250 atm.

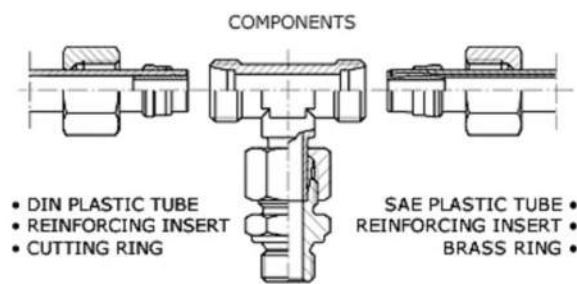
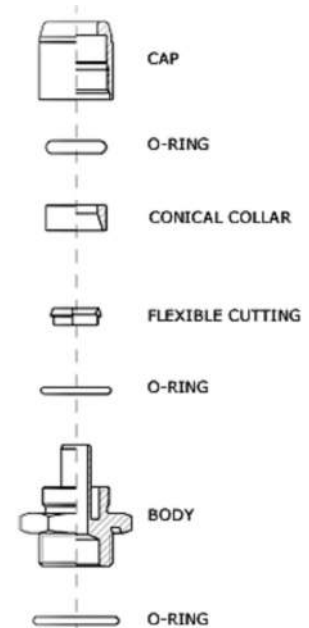



Assembly Instructions

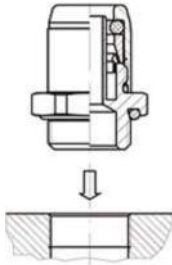

The seal of the stud coupling is specified by what is laid down in ISO standard 6149-80 and DIN standard 3482. To obtain the correct assembly on all terminal fittings it is essential to adhere to the tightening torques shown in the following table:

Thread	Tightening Torque (Nm) ± 10
M10 x 1	22
M12 x 1.5	24
M14 x 1.5	30
M16 x 1.5	35
M18 x 1.5	36
M22 x 1.5	40
M26 x 1.5	45

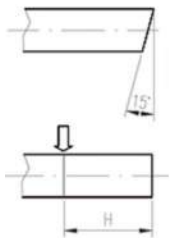

The tubing must be cut at the right angles with a maximum tolerance of 15°. Correct assembly is performed only when the tubing is inserted touches the end of the tube seat. To be absolutely certain that this is the case it is advisable to mark the depth of the tubing coupling (distance H).

Ø Pipe (mm)	Depth of Coupling (H)
6 x 4	19,8
8 x 6	20,5
10 x 7	24
10 x 7.5	24
10 x 8	24
12 x 9	25
15 x 12	27
16 x 12	27
18 x 14	27

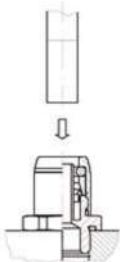

The tubing/fitting coupling does not require tools. To make the operation easier it is sufficient to slightly turn the tubing. The force required for the fitting is shown in the following table.

Ø Pipe (mm)	Fitting Force (H)
M10 x 1	22
M12 x 1.5	24
M14 x 1.5	30
M16 x 1.5	35
M18 x 1.5	36
M22 x 1.5	40
M26 x 1.5	45

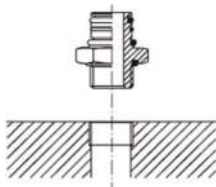

Screw the swivel Coupling into the thread ensuring the correct torque
(Over-tightening can cause damage to both the fitting and the component).

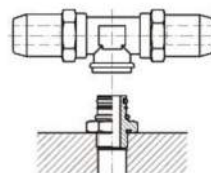

The fit the component by means of push and twist .

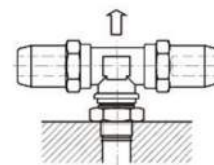

IMPORTANT:
Check the component is coupled correctly and securely.
Pull the component to ensure

The Dimensions shown in the tables in the catalogue are only shown as a guide. We reserve the right to make any due alteration when required for technical reasons.

TÜV AUTOMOTIVE

TOSI F.lli s.r.l.

I - 13019 Varallo (VC), Via Monte Rosa, 1

The enterprise gets by the certificate with the No. 00 10 9288 001 and the according to the test report 474-97-TA-GA-KB belonging to it right to mark their described as follows with the here shown test mark of the certification body of the TÜV Automotive GmbH, TÜV Süddeutschland n Group.



This product fulfills the bsical requirements for pull force, sealing, resistance and vibration resistance according to the testing requirements of TÜV Automotive GmbH, TÜV Süddeutschland Group.

Product Description:

Push-In Fittings for compressed air for vehicle braking systems

Gaimersheim, 13.03.2002

TÜV AUTOMOTIVE GmbH
TÜV Süddeutschland Group
Produktzertifizierung

IZ-Gaimersheim

Laboratory

Kölbl Martin

UNTERNEHMENSGRUPPE TÜV SÜDDEUTSCHLAND

TÜV

800 Series Male Stud Couplings



Part Ref	Thread Size	Tube Size (mm)
----------	-------------	----------------

800202	1/8"	6 x 1
800204	1/4"	6 x 1
800210	M10 x 1	6 x 1
800212	M12 x 1.5	6 x 1
800212/1	M12 x 1	6 x 1
800214	M14 x 1.5	6 x 1
800216	M16 x 1.5	6 x 1
800222	M22 x 1.5	6 x 1

800302	1/8"	8 x 1
800304	1/4"	8 x 1
800310	M10 x 1	8 x 1
800312	M12 x 1.5	8 x 1
800314	M14 x 1.5	8 x 1
800316	M16 x 1.5	8 x 1
800322	M22 x 1.5	8 x 1

800404	1/4"	10 x 1.25
800410	M10 x 1	10 x 1.25
800412	M12 x 1.5	10 x 1.25
800412/5	M12 x 1.5	10 x 1.5
800414	M14 x 1.5	10 x 1.25
800416	M16 x 1.5	10 x 1.25
800416/5	M16 x 1.5	10 x 1.5
800422	M22 x 1.5	10 x 1.25
800422/5	M22 x 1.5	10 x 1.5

Part Ref	Thread Size	Tube Size (mm)
----------	-------------	----------------

800504	1/4"	12 x 1.5
800512	M12 x 1.5	12 x 1.5
800514	M14 x 1.5	12 x 1.5
800516	M16 x 1.5	12 x 1.5
800522	M22 x 1.5	12 x 1.5

800616	M16 x 1.5	15 x 1.5
800622	M22 x 1.5	15 x 1.5

800716	M16 x 1.5	16 x 2
800722	M22 x 1.5	16 x 2

800816	M16 x 1.5	18 x 2
800822	M22 x 1.5	18 x 2
800826	M26 x 1.5	18 x 2

800912	M12 x 1.5	9 x 1.5
800916	M16 x 1.5	9 x 1.5
800922	M22 x 1.5	9 x 1.5

8001112	M12 x 1.5	11 x 1.5
8001116	M16 x 1.5	11 x 1.5
8001122	M22 x 1.5	11 x 1.5

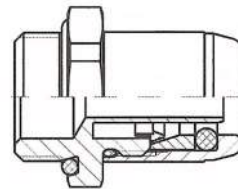

SIRIT
AIR BRAKE FITTINGS

810 Series Stud Elbows



Part Ref	Thread Size	Tube Size (mm)
810210	M10 x 1	6 x 1
810212	M12 x 1.5	6 x 1
810214	M14 x 1.5	6 x 1
810216	M16 x 1.5	6 x 1
810222	M22 x 1.5	6 x 1
810310	M10 x 1	8 x 1
810312	M12 x 1.5	8 x 1
810314	M14 x 1.5	8 x 1
810316	M16 x 1.5	8 x 1
810322	M22 x 1.5	8 x 1
810410	M10 x 1	10 x 1.25
810412	M12 x 1.5	10 x 1.25
810414	M14 x 1.5	10 x 1.25
810416	M16 x 1.5	10 x 1.25
810422	M22 x 1.5	10 x 1.25
810512	M12 x 1.5	12 x 1.5
810514	M14 x 1.5	12 x 1.5
810516	M16 x 1.5	12 x 1.5
810522	M22 x 1.5	12 x 1.5

Part Ref	Thread Size	Tube Size (mm)
810616	M16 x 1.5	15 x 1.5
810622	M22 x 1.5	15 x 1.5
810716	M16 x 1.5	16 x 2
810722	M22 x 1.5	16 x 2
810816	M16 x 1.5	18 x 2
810822	M22 x 1.5	18 x 2
810910	M10 x 1	9 x 1.5
810912	M12 x 1.5	9 x 1.5
810914	M14 x 1.5	9 x 1.5
810916	M16 x 1.5	9 x 1.5
810922	M22 x 1.5	9 x 1.5
8101112	M12 x 15	11 x 1.5
8101114	M14 x 1.5	11 x 1.5
8101116	M16 x 1.5	11 x 1.5
8101122	M22 x 1.5	11 x 1.5

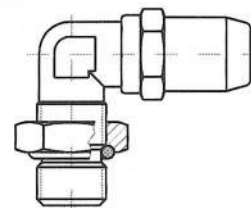

SIRIT
AIR BRAKE FITTINGS

Fixed Tees

820 Series Stud Run Tees

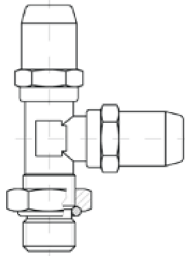

Part Ref	Thread Size	Tube Size (mm)
820210	M10 x 1	6 x 1
820212	M12 x 1.5	6 x 1
820216	M16 x 1.5	6 x 1
820222	M22 x 1.5	6 x 1
820310	M10 x 1	8 x 1
820312	M12 x 1.5	8 x 1
820316	M16 x 1.5	8 x 1
820322	M22 x 1.5	8 x 1
820410	M10 x 1	10 x 1.25
820412	M12 x 1.5	10 x 1.25
820416	M16 x 1.5	10 x 1.25
820422	M22 x 1.5	10 x 1.25
820512	M12 x 1.5	12 x 1.5
820516	M16 x 1.5	12 x 1.5
820522	M22 x 1.5	12 x 1.5
820616	M16 x 1.5	15 x 1.5
820622	M22 x 1.5	15 x 1.5
820716	M16 x 1.5	16 x 2
820722	M22 x 1.5	16 x 2
820816	M16 x 1.5	18 x 2
820822	M22 x 1.5	18 x 2

830 Series Stud Tees

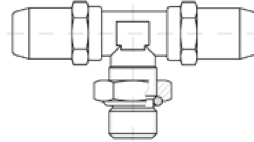

Part Ref	Thread Size	Tube Size (mm)
830210	M10 x 1	6 x 1
830212	M12 x 1.5	6 x 1
830216	M16 x 1.5	6 x 1
830222	M22 x 1.5	6 x 1
830310	M10 x 1	8 x 1
830312	M12 x 1.5	8 x 1
830316	M16 x 1.5	8 x 1
830322	M22 x 1.5	8 x 1
830410	M10 x 1	10 x 1.25
830412	M12 x 1.5	10 x 1.25
830416	M16 x 1.5	10 x 1.25
830422	M22 x 1.5	10 x 1.25
830512	M12 x 1.5	12 x 1.5
830516	M16 x 1.5	12 x 1.5
830522	M22 x 1.5	12 x 1.5
830616	M16 x 1.5	15 x 1.5
830622	M22 x 1.5	15 x 1.5
830716	M16 x 1.5	16 x 2
830722	M22 x 1.5	16 x 2
830816	M16 x 1.5	18 x 2
830822	M22 x 1.5	18 x 2

Various thread sizes available to 9mm and 11mm upon request

840 Series 45° Stud Elbow

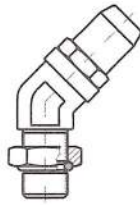

Part Ref	Thread Size	Tube Size (mm)
840216	M16 x 1.5	6 x 1
840222	M22 x 1.5	6 x 1
840316	M16 x 1.5	8 x 1
840322	M22 x 1.5	8 x 1
840416	M16 x 1.5	10 x 1.25
840422	M22 x 1.5	10 x 1.25
840516	M16 x 1.5	12 x 1.5
840522	M22 x 1.5	12 x 1.5
840616	M16 x 1.5	15 x 1.5
840622	M22 x 1.5	15 x 1.5
840716	M16 x 1.5	16 x 2
840722	M22 x 1.5	16 x 2
840816	M16 x 1.5	18 x 2
840822	M22 x 1.5	18 x 2

841 Series Fixed Stud Cross

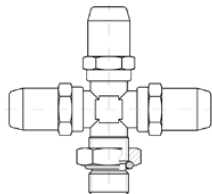

Part	Thread Size	Tube Size (mm)
841216	M16 x 1.5	6 x 1
841222	M22 x 1.5	6 x 1
841316	M16 x 1.5	8 x 1
841322	M22 x 1.5	8 x 1

Part Ref	Thread Size	Tube Size (mm)
841416	M16 x 1.5	10 x 1.25
841422	M22 x 1.5	10 x 1.25
841516	M16 x 1.5	12 x 1.5
841522	M22 x 1.5	12 x 1.5
841616	M16 x 1.5	15 x 1.5
841622	M22 x 1.5	15 x 1.5
841716	M16 x 1.5	16 x 2
841722	M22 x 1.5	16 x 2
841816	M16 x 1.5	18 x 2
841822	M22 x 1.5	18 x 2

842 Series Fixed 'Y' Stud Elbow

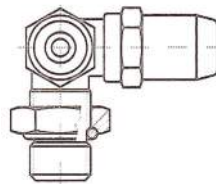

Part Ref	Thread Size	Tube Size (mm)
842216	M16 x 1.5	6 x 1
842222	M22 x 1.5	6 x 1
842316	M16 x 1.5	8 x 1
842322	M22 x 1.5	8 x 1
842416	M16 x 1.5	10 x 1.25
842422	M22 x 1.5	10 x 1.25
842516	M16 x 1.5	12 x 1.5
842522	M22 x 1.5	12 x 1.5
842616	M16 x 1.5	15 x 1.5
842622	M22 x 1.5	15 x 1.5
842716	M16 x 1.5	16 x 2
842722	M22 x 1.5	16 x 2
842816	M16 x 1.5	18 x 2
842822	M22 x 1.5	18 x 2

823 Series Stud Run Test Point Tees



831 Series Stud Tee Test Points

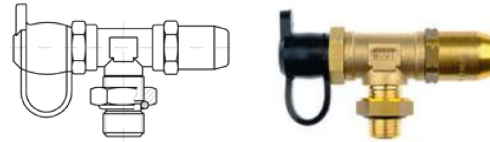

Part Ref	Thread Size	Tube Size (mm)
----------	-------------	----------------

823212	M12 x 1.5	6 x 1
823216	M16 x 1.5	6 x 1
823222	M22 x 1.5	6 x 1

823312	M12 x 1.5	8 x 1
823316	M16 x 1.5	8 x 1
823322	M22 x 1.5	8 x 1

823412	M12 x 1.5	10 x 1.25
823416	M16 x 1.5	10 x 1.25
823422	M22 x 1.5	10 x 1.25

823512	M12 x 1.5	12 x 1.5
823516	M16 x 1.5	12 x 1.5
823522	M22 x 1.5	12 x 1.5

823616	M16 x 1.5	15 x 1.5
823622	M22 x 1.5	15 x 1.5

823716	M16 x 1.5	16 x 2
823722	M22 x 1.5	16 x 2

823816	M16 x 1.5	18 x 2
823822	M22 x 1.5	18 x 2

Part Ref	Thread Size	Tube Size (mm)
----------	-------------	----------------

831212	M12 x 1.5	6 x 1
831216	M16 x 1.5	6 x 1
831222	M22 x 1.5	6 x 1

831312	M12 x 1.5	8 x 1
831316	M16 x 1.5	8 x 1
831322	M22 x 1.5	8 x 1

831412	M12 x 1.5	10 x 1.25
831416	M16 x 1.5	10 x 1.25
831422	M22 x 1.5	10 x 1.25

831512	M12 x 1.5	12 x 1.5
831516	M16 x 1.5	12 x 1.5
831522	M22 x 1.5	12 x 1.5

831616	M16 x 1.5	15 x 1.5
831622	M22 x 1.5	15 x 1.5

831716	M16 x 1.5	16 x 2
831722	M22 x 1.5	16 x 2

831816	M16 x 1.5	18 x 2
831822	M22 x 1.5	18 x 2

The above two series can be purchased without the Test Points
823 becomes 824 / 831 becomes 832

843 Series Fixed 'F' Elbows

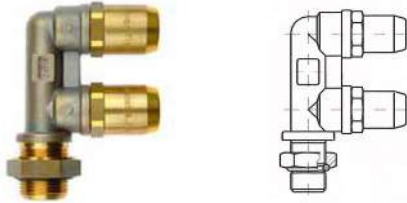

Part Ref	Thread Size	Tube Size (mm)
----------	-------------	----------------

843212	M12 x 1.5	6 x 1
843216	M16 x 1.5	6 x 1
843222	M22 x 1.5	6 x 1

843312	M12 x 1.5	8 x 1
843316	M16 x 1.5	8 x 1
843322	M22 x 1.5	8 x 1

843412	M12 x 1.5	10 x 1.25
843416	M16 x 1.5	10 x 1.25
843422	M22 x 1.5	10 x 1.25

843512	M12 x 1.5	12 x 1.5
843516	M16 x 1.5	12 x 1.5
843522	M22 x 1.5	12 x 1.5

843616	M16 x 1.5	15 x 1.5
843622	M22 x 1.5	15 x 1.5

843716	M16 x 1.5	16 x 2
843722	M22 x 1.5	16 x 2

843816	M16 x 1.5	18 x 2
843822	M22 x 1.5	18 x 2

821 Series Stud Run Test Point Tees

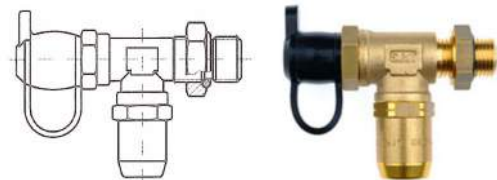

Part Ref	Thread Size	Tube Size (mm)
----------	-------------	----------------

821212	M12 x 1.5	6 x 1
821216	M16 x 1.5	6 x 1
821222	M22 x 1.5	6 x 1

821312	M12 x 1.5	8 x 1
821316	M16 x 1.5	8 x 1
821322	M22 x 1.5	8 x 1

821412	M12 x 1.5	10 x 1.25
821416	M16 x 1.5	10 x 1.25
821422	M22 x 1.5	10 x 1.25

821512	M12 x 1.5	12 x 1.5
821516	M16 x 1.5	12 x 1.5
821522	M22 x 1.5	12 x 1.5

821616	M16 x 1.5	15 x 1.5
821622	M22 x 1.5	15 x 1.5

821716	M16 x 1.5	16 x 2
821722	M22 x 1.5	16 x 2

821816	M16 x 1.5	18 x 2
821822	M22 x 1.5	18 x 2

The above 821 series can be purchased without the Test Point
821 becomes 822

TEL: 01474 535456 / FAX: 01474 537323
sales@airbrakeconnections.co.uk

803 Series Stud Bulkheads

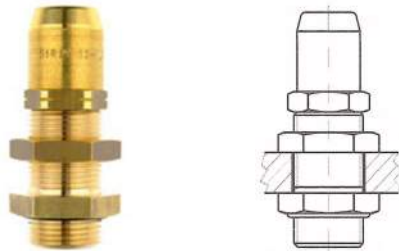

Part Ref	Thread Size	Tube Size (mm)	Body (mm)	Thread F Size (mm)
803212	M12 x 1.5	6 x 1	18 x 1.5	12 x 1.5
803216	M16 x 1.5	6 x 1	18 x 1.5	12 x 1.5
803222	M22 x 1.5	6 x 1	18 x 1.5	12 x 1.5
803312	M12 x 1.5	8 x 1	18 x 1.5	12 x 1.5
803316	M16 x 1.5	8 x 1	18 x 1.5	12 x 1.5
803322	M22 x 1.5	8 x 1	18 x 1.5	12 x 1.5
803412	M12 x 1.5	10 x 1.25	18 x 1.5	12 x 1.5
803416	M16 x 1.5	10 x 1.25	18 x 1.5	12 x 1.5
803422	M22 x 1.5	10 x 1.25	18 x 1.5	12 x 1.5
803512	M12 x 1.5	12 x 1.5	18 x 1.5	12 x 1.5
803516	M16 x 1.5	12 x 1.5	18 x 1.5	12 x 1.5
803522	M22 x 1.5	12 x 1.5	18 x 1.5	12 x 1.5
803616	M16 x 1.5	15 x 1.5	22 x 1.5	16 x 1.5
803622	M22 x 1.5	15 x 1.5	22 x 1.5	16 x 1.5
803716	M16 x 1.5	16 x 2	22 x 1.5	16 x 1.5
803722	M22 x 1.5	16 x 2	22 x 1.5	16 x 1.5
803816	M16 x 1.5	18 x 2	22 x 1.5	16 x 1.5
803822	M22 x 1.5	18 x 2	22 x 1.5	16 x 1.5

808 Series Female Studs

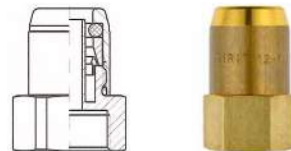

Part Ref	Thread Size (F)	Tube Size (mm)
808212	F12 x 1.5	6 x 1
808216	F16 x 1.5	6 x 1
808222	F22 x 1.5	6 x 1
808312	F12 x 1.5	8 x 1
808316	F16 x 1.5	8 x 1
808322	F22 x 1.5	8 x 1
808412	F12 x 1.5	10 x 1.25
808416	F16 x 1.5	10 x 1.25
808422	F22 x 1.5	10 x 1.25
800512	F12 x 1.5	12 x 1.5
808516	F16 x 1.5	12 x 1.5
808522	F22 x 1.5	12 x 1.5
808616	F16 x 1.5	15 x 1.5
808622	F22 x 1.5	15 x 1.5
808716	F16 x 1.5	16 x 2
808722	F22 x 1.5	16 x 2
808816	F16 x 1.5	18 x 2
808822	F22 x 1.5	18 x 2

* Please note Female Studs may be 2 piece*

Swivel Sub Components

615 Series (Swivel Elbows)

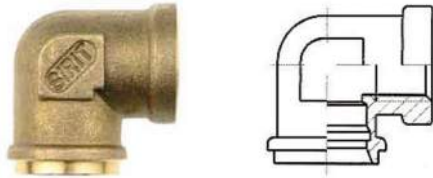

Part Ref	Thread Size (mm)	Tipo Size
615300	12 x 1.5	A
615500	16 x 1.5	B

645 Series (Swivel 45° Elbows)

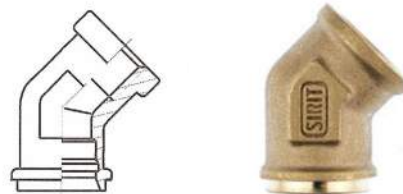

Part Ref	Thread Size (mm)	Tipo Size
645300	12 x 1.5	A
645500	16 x 1.5	B

625 Series (Stud Run Tees)

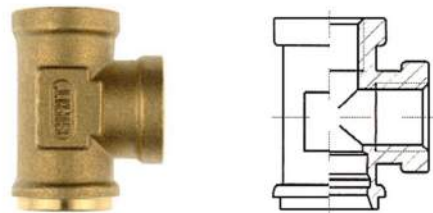

Part Ref	Thread Size (mm)	Tipo Size
625300	12 x 1.5	A
625500	16 x 1.5	B

646 Series (Swivel Cross)

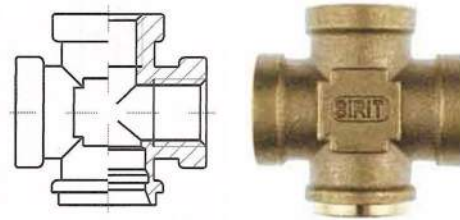

Part Ref	Thread Size (mm)	Tipo Size
646300	12 x 1.5	A
646500	16 x 1.5	B

635 Series (Stud Run Tees)

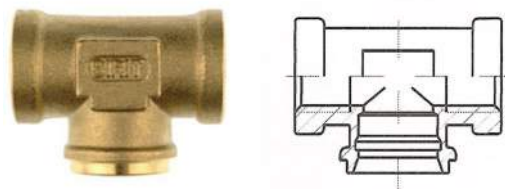

Part Ref	Thread Size (mm)	Tipo Size
635300	12 x 1.5	A
635500	16 x 1.5	B

647 Series (Y Corner Tees)

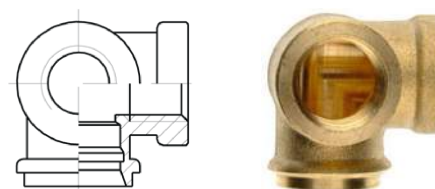

Part Ref	Thread Size (mm)	Tipo Size
647300	12 x 1.5	A
647500	16 x 1.5	B

Swivel Sub Components

648 Series (Y Corner Cross)

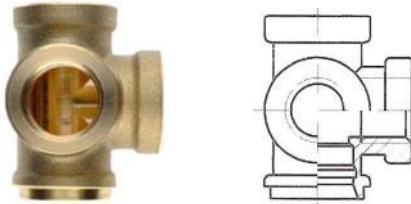

Part Ref	Thread Size (mm)	Tipo Size
648300	12 x 1.5	A
648500	16 x 1.5	B

649 Series (Corner Cross)

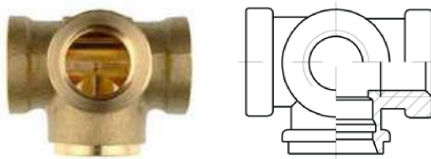

Part Ref	Thread Size (mm)	Tipo Size
649300	12 x 1.5	A
649500	16 x 1.5	B

651 Series (Swivel F Fitting)

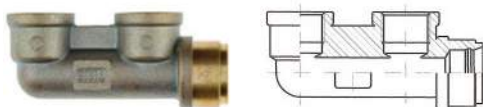

Part Ref	Thread Size (mm)	Tipo Size
651500	16 x 1.5	B

TIPO

660 Series (Swivel Studs)

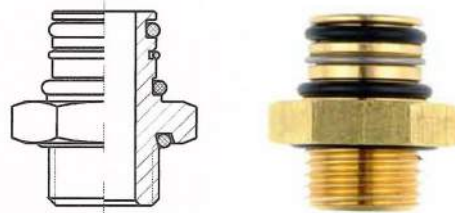

Part Ref	Thread Size	Tipo Size
660302	1/8"	A
660304	1/4"	A
660310	M10 x 1	A
660312	M12 x 1.5	A
6603125	M12 x 1.25	A
660314	M14 x 1.5	A
660316	M16 x 1.5	A
660322	M22 x 1.5	A
660502	1/8"	B
660504	1/4"	B
660512	M12 x 1.5	B
660514	M14 x 1.5	B
660516	M16 x 1.5	B
660522	M22 x 1.5	B
660526	M26 x 1.5	B

Please Note:

Swivel studs and the sub components must be paired

A + A / B + B

815 Series Swivel Elbows

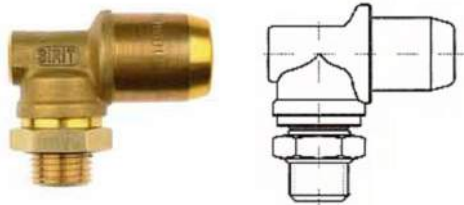

PARTS WITHOUT THE SUB TIPO

Part Ref	Tipo	Tube Size (mm)
815200	B	6 x 1
815300	B	8 x 1
815400	B	10 x 1.25
815500	B	12 x 1.5
815600	B	15 x 1.5
815700	B	16 x 2
815800	B	18 x 2

PART COMPLETE WITH THE SUB TIPO

Part Ref	Thread Size	Tube Size (mm)
815210	M10 x 1	6 x 1
815212	M12 x 1.5	6 x 1
815214	M14 x 1.5	6 x 1
815216	M16 x 1.5	6 x 1
815222	M22 x 1.5	6 x 1
815310	M10 x 1	8 x 1
815312	M12 x 1.5	8 x 1
815314	M14 x 1.5	8 x 1
815316	M16 x 1.5	8 x 1
815322	M22 x 1.5	8 x 1

Part Ref	Thread Size	Tube Size (mm)
815412	M12 x 1.5	10 x 1.25
815414	M14 x 1.5	10 x 1.25
815416	M16 x 1.5	10 x 1.25
815422	M22 x 1.5	10 x 1.25
815426	M26 x 1.5	10 x 1.25

815512	M12 x 1	12 x 1.5
815514	M14 x 1.5	12 x 1.5
815516	M16 x 1.5	12 x 1.5
815522	M22 x 1.5	12 x 1.5
815526	M26 x 1.5	12 x 1.5

815612	M12 x 1	15 x 1.5
815614	M14 x 1.5	15 x 1.5
815616	M16 x 1.5	15 x 1.5
815622	M22 x 1.5	15 x 1.5
815626	M26 x 1.5	15 x 1.5

815712	M12 x 1	16 x 2
815714	M14 x 1.5	16 x 2
815716	M16 x 1.5	16 x 2
815722	M22 x 1.5	16 x 2
815726	M26 x 1.5	16 x 2

815812	M12 x 1	18 x 2
815814	M14 x 1.5	18 x 2
815816	M16 x 1.5	18 x 2
815822	M22 x 1.5	18 x 2
815826	M26 x 1.5	18 x 2

All tube sizes are available to
1/8" thread and 1/4" thread also

825 Series Swivel Stud Run Tees



PARTS WITHOUT THE SUB TIPO

Part Ref	Tipó	Tube Size (mm)
825200	B	6 x 1
825300	B	8 x 1
825400	B	10 x 1.25
825500	B	12 x 1.5
825600	B	15 x 1.5
825700	B	16 x 2
825800	B	18 x 2

PART COMPLETE WITH THE SUB TIPO

Part Ref	Thread Size	Tube Size (mm)
825210	M10 x 1	6 x 1
825212	M12 x 1.5	6 x 1
825214	M14 x 1.5	6 x 1
825216	M16 x 1.5	6 x 1
825222	M22 x 1.5	6 x 1
825310	M10 x 1	8 x 1
825312	M12 x 1.5	8 x 1
825314	M14 x 1.5	8 x 1
825316	M16 x 1.5	8 x 1
825322	M22 x 1.5	8 x 1

Part Ref	Thread Size	Tube Size (mm)
825412	M12 x 1.5	10 x 1.25
825414	M14 x 1.5	10 x 1.25
825416	M16 x 1.5	10 x 1.25
825422	M22 x 1.5	10 x 1.25
825426	M26 x 1.5	10 x 1.25

825512	M12 x 1	12 x 1.5
825514	M14 x 1.5	12 x 1.5
825516	M16 x 1.5	12 x 1.5
825522	M22 x 1.5	12 x 1.5
825526	M26 x 1.5	12 x 1.5

825612	M12 x 1	15 x 1.5
825614	M14 x 1.5	15 x 1.5
825616	M16 x 1.5	15 x 1.5
825622	M22 x 1.5	15 x 1.5
825626	M26 x 1.5	15 x 1.5

825712	M12 x 1	16 x 2
825714	M14 x 1.5	16 x 2
825716	M16 x 1.5	16 x 2
825722	M22 x 1.5	16 x 2
825726	M26 x 1.5	16 x 2

825812	M12 x 1	18 x 2
825814	M14 x 1.5	18 x 2
825816	M16 x 1.5	18 x 2
825822	M22 x 1.5	18 x 2
825826	M26 x 1.5	18 x 2

All tube sizes are available to
1/8" thread and 1/4" thread also

835 Series Swivel Stud Tees



PARTS WITHOUT THE SUB TIPO

Part Ref	Tipo	Tube Size (mm)
835200	B	6 x 1
835300	B	8 x 1
835400	B	10 x 1.25
835500	B	12 x 1.5
835600	B	15 x 1.5
835700	B	16 x 2
835800	B	18 x 2

PART COMPLETE WITH THE SUB TIPO

Part Ref	Thread Size	Tube Size (mm)
835210	M10 x 1	6 x 1
835212	M12 x 1.5	6 x 1
835214	M14 x 1.5	6 x 1
835216	M16 x 1.5	6 x 1
835222	M22 x 1.5	6 x 1
835310	M10 x 1	8 x 1
835312	M12 x 1.5	8 x 1
835314	M14 x 1.5	8 x 1
835316	M16 x 1.5	8 x 1
835322	M22 x 1.5	8 x 1

Part Ref	Thread Size	Tube Size (mm)
835412	M12 x 1.5	10 x 1.25
835414	M14 x 1.5	10 x 1.25
835416	M16 x 1.5	10 x 1.25
835422	M22 x 1.5	10 x 1.25
835426	M26 x 1.5	10 x 1.25

835512	M12 x 1	12 x 1.5
835514	M14 x 1.5	12 x 1.5
835516	M16 x 1.5	12 x 1.5
835422	M22 x 1.5	12 x 1.5
835526	M26 x 1.5	12 x 1.5

835612	M12 x 1	15 x 1.5
835614	M14 x 1.5	15 x 1.5
835616	M16 x 1.5	15 x 1.5
835622	M22 x 1.5	15 x 1.5
835626	M26 x 1.5	15 x 1.5

835712	M12 x 1	16 x 2
835714	M14 x 1.5	16 x 2
835716	M16 x 1.5	16 x 2
835722	M22 x 1.5	16 x 2
835726	M26 x 1.5	16 x 2

835812	M12 x 1	18 x 2
835814	M14 x 1.5	18 x 2
835816	M16 x 1.5	18 x 2
835822	M22 x 1.5	18 x 2
835826	M26 x 1.5	18 x 2

All tube sizes are available to
1/8" thread and 1/4" thread also

845 Series Swivel 45° Elbows



PARTS WITHOUT THE SUB TIPO

Part Ref	Tipo	Tube Size (mm)
845200	B	6 x 1
845300	B	8 x 1
845400	B	10 x 1.25
845500	B	12 x 1.5
845600	B	15 x 1.5
845700	B	16 x 2
845800	B	18 x 2

PART COMPLETE WITH THE SUB TIPO

Part Ref	Thread Size	Tube Size (mm)
845210	M10 x 1	6 x 1
845212	M12 x 1.5	6 x 1
845214	M14 x 1.5	6 x 1
845216	M16 x 1.5	6 x 1
845222	M22 x 1.5	6 x 1
845310	M10 x 1	8 x 1
845312	M12 x 1.5	8 x 1
845314	M14 x 1.5	8 x 1
845316	M16 x 1.5	8 x 1
845322	M22 x 1.5	8 x 1

Part Ref	Thread Size	Tube Size (mm)
845412	M12 x 1.5	10 x 1.25
845414	M14 x 1.5	10 x 1.25
845416	M16 x 1.5	10 x 1.25
845422	M22 x 1.5	10 x 1.25
845426	M26 x 1.5	10 x 1.25

845512	M12 x 1	12 x 1.5
845514	M14 x 1.5	12 x 1.5
845516	M16 x 1.5	12 x 1.5
845522	M22 x 1.5	12 x 1.5
845526	M26 x 1.5	12 x 1.5

845612	M12 x 1	15 x 1.5
845614	M14 x 1.5	15 x 1.5
845616	M16 x 1.5	15 x 1.5
845622	M22 x 1.5	15 x 1.5
845626	M26 x 1.5	15 x 1.5

845712	M12 x 1	16 x 2
845714	M14 x 1.5	16 x 2
845716	M16 x 1.5	16 x 2
845722	M22 x 1.5	16 x 2
845726	M26 x 1.5	16 x 2

845812	M12 x 1	18 x 2
845814	M14 x 1.5	18 x 2
845816	M16 x 1.5	18 x 2
845822	M22 x 1.5	18 x 2
845826	M26 x 1.5	18 x 2

All tube sizes are available to
1/8" thread and 1/4" thread also

846 Series Swivel Stud Cross

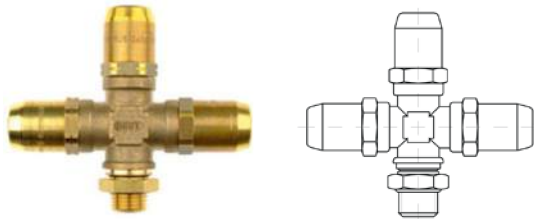

PARTS WITHOUT THE SUB TIPO

Part Ref	Tipó	Tube Size (mm)
846200	B	6 x 1
846300	B	8 x 1
846400	B	10 x 1.25
846500	B	12 x 1.5
846600	B	15 x 1.5
846700	B	16 x 2
846800	B	18 x 2

PART COMPLETE WITH THE SUB TIPO

Part Ref	Thread Size	Tube Size (mm)
846210	M10 x 1	6 x 1
846212	M12 x 1.5	6 x 1
846214	M14 x 1.5	6 x 1
846216	M16 x 1.5	6 x 1
846222	M22 x 1.5	6 x 1
846310	M10 x 1	8 x 1
846312	M12 x 1.5	8 x 1
846314	M14 x 1.5	8 x 1
846316	M16 x 1.5	8 x 1
846322	M22 x 1.5	8 x 1

Part Ref	Thread Size	Tube Size (mm)
846412	M12 x 1.5	10 x 1.25
846414	M14 x 1.5	10 x 1.25
846416	M16 x 1.5	10 x 1.25
846422	M22 x 1.5	10 x 1.25
846426	M26 x 1.5	10 x 1.25

846512	M12 x 1	12 x 1.5
846514	M14 x 1.5	12 x 1.5
846516	M16 x 1.5	12 x 1.5
846522	M22 x 1.5	12 x 1.5
846526	M26 x 1.5	12 x 1.5

846612	M12 x 1	15 x 1.5
846614	M14 x 1.5	15 x 1.5
846616	M16 x 1.5	15 x 1.5
846622	M22 x 1.5	15 x 1.5
846626	M26 x 1.5	15 x 1.5

846712	M12 x 1	16 x 2
846714	M14 x 1.5	16 x 2
846716	M16 x 1.5	16 x 2
846722	M22 x 1.5	16 x 2
846726	M26 x 1.5	16 x 2

846812	M12 x 1	18 x 2
846814	M14 x 1.5	18 x 2
846816	M16 x 1.5	18 x 2
846822	M22 x 1.5	18 x 2
846826	M26 x 1.5	18 x 2

All tube sizes are available to
1/8" thread and 1/4" thread also

847 Series Swivel Y Corner Elbow



PARTS WITHOUT THE SUB TIPO

Part Ref	Tipó	Tube Size (mm)
847200	B	6 x 1
847300	B	8 x 1
847400	B	10 x 1.25
847500	B	12 x 1.5
847600	B	15 x 1.5
847700	B	16 x 2
847800	B	18 x 2

PART COMPLETE WITH THE SUB TIPO

Part Ref	Thread Size	Tube Size (mm)
847210	M10 x 1	6 x 1
847212	M12 x 1.5	6 x 1
847214	M14 x 1.5	6 x 1
847216	M16 x 1.5	6 x 1
847222	M22 x 1.5	6 x 1
847310	M10 x 1	8 x 1
847312	M12 x 1.5	8 x 1
847314	M14 x 1.5	8 x 1
847316	M16 x 1.5	8 x 1
847322	M22 x 1.5	8 x 1

Part Ref	Thread Size	Tube Size (mm)
847412	M12 x 1.5	10 x 1.25
847414	M14 x 1.5	10 x 1.25
847416	M16 x 1.5	10 x 1.25
847422	M22 x 1.5	10 x 1.25
847426	M26 x 1.5	10 x 1.25

847512	M12 x 1	12 x 1.5
847514	M14 x 1.5	12 x 1.5
847516	M16 x 1.5	12 x 1.5
847522	M22 x 1.5	12 x 1.5
847526	M26 x 1.5	12 x 1.5

847612	M12 x 1	15 x 1.5
847614	M14 x 1.5	15 x 1.5
847616	M16 x 1.5	15 x 1.5
847622	M22 x 1.5	15 x 1.5
847626	M26 x 1.5	15 x 1.5

847712	M12 x 1	16 x 2
847714	M14 x 1.5	16 x 2
847716	M16 x 1.5	16 x 2
847722	M22 x 1.5	16 x 2
847726	M26 x 1.5	16 x 2

847812	M12 x 1	18 x 2
847814	M14 x 1.5	18 x 2
847816	M16 x 1.5	18 x 2
847822	M22 x 1.5	18 x 2
847826	M26 x 1.5	18 x 2

All tube sizes are available to
1/8" thread and 1/4" thread also

848 Series Swivel Corner Cross



PARTS WITHOUT THE SUB TIPO

Part Ref	Tipo	Tube Size (mm)
848200	B	6 x 1
848300	B	8 x 1
848400	B	10 x 1.25
848500	B	12 x 1.5
848600	B	15 x 1.5
848700	B	16 x 2
848800	B	18 x 2

PART COMPLETE WITH THE SUB TIPO

Part Ref	Thread Size	Tube Size (mm)
848210	M10 x 1	6 x 1
848212	M12 x 1.5	6 x 1
848214	M14 x 1.5	6 x 1
848216	M16 x 1.5	6 x 1
848222	M22 x 1.5	6 x 1
848310	M10 x 1	8 x 1
848312	M12 x 1.5	8 x 1
848314	M14 x 1.5	8 x 1
848316	M16 x 1.5	8 x 1
848322	M22 x 1.5	8 x 1

Part Ref	Thread Size	Tube Size (mm)
848412	M12 x 1.5	10 x 1.25
848414	M14 x 1.5	10 x 1.25
848416	M16 x 1.5	10 x 1.25
848422	M22 x 1.5	10 x 1.25
848426	M26 x 1.5	10 x 1.25

848512	M12 x 1	12 x 1.5
848314	M14 x 1.5	12 x 1.5
848316	M16 x 1.5	12 x 1.5
848322	M22 x 1.5	12 x 1.5
848526	M26 x 1.5	12 x 1.5

848612	M12 x 1	15 x 1.5
848614	M14 x 1.5	15 x 1.5
848616	M16 x 1.5	15 x 1.5
848622	M22 x 1.5	15 x 1.5
848626	M26 x 1.5	15 x 1.5

848712	M12 x 1	16 x 2
848714	M14 x 1.5	16 x 2
848716	M16 x 1.5	16 x 2
848722	M22 x 1.5	16 x 2
848726	M26 x 1.5	16 x 2

848812	M12 x 1	18 x 2
848814	M14 x 1.5	18 x 2
848816	M16 x 1.5	18 x 2
848822	M22 x 1.5	18 x 2
848826	M26 x 1.5	18 x 2

All tube sizes are available to
1/8" thread and 1/4" thread also

849 Series Swivel Side Tees

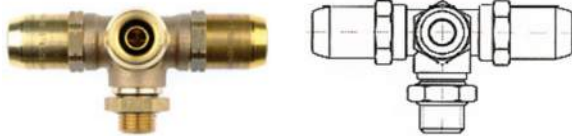

PARTS WITHOUT THE SUB TIPO

Part Ref	Tipó	Tube Size (mm)
849200	B	6 x 1
849300	B	8 x 1
849400	B	10 x 1.25
849500	B	12 x 1.5
849600	B	15 x 1.5
849700	B	16 x 2
849800	B	18 x 2

PART COMPLETE WITH THE SUB TIPO

Part Ref	Thread Size	Tube Size (mm)
849210	M10 x 1	6 x 1
849212	M12 x 1.5	6 x 1
849214	M14 x 1.5	6 x 1
849216	M16 x 1.5	6 x 1
849222	M22 x 1.5	6 x 1
849310	M10 x 1	8 x 1
849312	M12 x 1.5	8 x 1
849314	M14 x 1.5	8 x 1
849316	M16 x 1.5	8 x 1
849322	M22 x 1.5	8 x 1

Part Ref	Thread Size	Tube Size (mm)
849412	M12 x 1.5	10 x 1.25
849414	M14 x 1.5	10 x 1.25
849416	M16 x 1.5	10 x 1.25
849422	M22 x 1.5	10 x 1.25
849426	M26 x 1.5	10 x 1.25

849512	M12 x 1	12 x 1.5
849514	M14 x 1.5	12 x 1.5
849516	M16 x 1.5	12 x 1.5
849522	M22 x 1.5	12 x 1.5
849526	M26 x 1.5	12 x 1.5

849612	M12 x 1	15 x 1.5
849614	M14 x 1.5	15 x 1.5
849616	M16 x 1.5	15 x 1.5
849622	M22 x 1.5	15 x 1.5
849626	M26 x 1.5	15 x 1.5

849712	M12 x 1	16 x 2
849714	M14 x 1.5	16 x 2
849716	M16 x 1.5	16 x 2
849722	M22 x 1.5	16 x 2
849726	M26 x 1.5	16 x 2

849812	M12 x 1	18 x 2
849814	M14 x 1.5	18 x 2
849816	M16 x 1.5	18 x 2
849822	M22 x 1.5	18 x 2
849826	M26 x 1.5	18 x 2

All tube sizes are available to
1/8" thread and 1/4" thread also

851 Series Swivel Side Tees

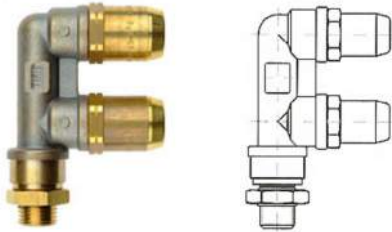

PARTS WITHOUT THE SUB TIPO

Part Ref	Tipó	Tube Size (mm)
851200	B	6 x 1
851300	B	8 x 1
851400	B	10 x 1.25
851500	B	12 x 1.5
851600	B	15 x 1.5
851700	B	16 x 2
851800	B	18 x 2

PART COMPLETE WITH THE SUB TIPO

Part Ref	Thread Size	Tube Size (mm)
851210	M10 x 1	6 x 1
851212	M12 x 1.5	6 x 1
851214	M14 x 1.5	6 x 1
851216	M16 x 1.5	6 x 1
851222	M22 x 1.5	6 x 1
851310	M10 x 1	8 x 1
851312	M12 x 1.5	8 x 1
851314	M14 x 1.5	8 x 1
851316	M16 x 1.5	8 x 1
851322	M22 x 1.5	8 x 1

Part Ref	Thread Size	Tube Size (mm)
851412	M12 x 1.5	10 x 1.25
851414	M14 x 1.5	10 x 1.25
851416	M16 x 1.5	10 x 1.25
851422	M22 x 1.5	10 x 1.25
851426	M26 x 1.5	10 x 1.25

851512	M12 x 1	12 x 1.5
851514	M14 x 1.5	12 x 1.5
851516	M16 x 1.5	12 x 1.5
851522	M22 x 1.5	12 x 1.5
851526	M26 x 1.5	12 x 1.5

851612	M12 x 1	15 x 1.5
851614	M14 x 1.5	15 x 1.5
851616	M16 x 1.5	15 x 1.5
851622	M22 x 1.5	15 x 1.5
851626	M26 x 1.5	15 x 1.5

851712	M12 x 1	16 x 2
851714	M14 x 1.5	16 x 2
851716	M16 x 1.5	16 x 2
851722	M22 x 1.5	16 x 2
851726	M26 x 1.5	16 x 2

851812	M12 x 1	18 x 2
851814	M14 x 1.5	18 x 2
851816	M16 x 1.5	18 x 2
851822	M22 x 1.5	18 x 2
851826	M26 x 1.5	18 x 2

All tube sizes are available to
1/8" thread and 1/4" thread also

Swivel Threaded Adaptors



**715 Series
Swivel Elbows**

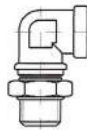

Part Ref	Male Thread	Female Thread
715302	1/8"	M12F x 1.5
715304	1/4"	M12F x 1.5
715310	M10 x 1	M12F x 1.5
715312	M12 x 1.5	M12F x 1.5
715314	M14 x 1.5	M12F x 1.5
715316	M16 x 1.5	M12F x 1.5
715322	M22 x 1.5	M12F x 1.5
715502	1/8"	M16F x 1.5
715504	1/4"	M16F x 1.5
715512	M12 x 1.5	M16F x 1.5
715514	M14 x 1.5	M16F x 1.5
715516	M16 x 1.5	M16F x 1.5
715522	M22 x 1.5	M16F x 1.5

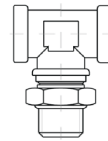

**735 Series
Swivel Stud
Tees**



Part Ref	Male Thread	Female Thread
735302	1/8"	M12F x 1.5
735304	1/4"	M12F x 1.5
735310	M10 x 1	M12F x 1.5
735312	M12 x 1.5	M12F x 1.5
735314	M14 x 1.5	M12F x 1.5
735316	M16 x 1.5	M12F x 1.5
735322	M22 x 1.5	M12F x 1.5
735502	1/8"	M16F x 1.5
735504	1/4"	M16F x 1.5
735512	M12 x 1.5	M16F x 1.5
735514	M14 x 1.5	M16F x 1.5
735516	M16 x 1.5	M16F x 1.5
735522	M22 x 1.5	M16F x 1.5



**725 Series
Swivel Stud Run
Tees**

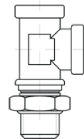

Part Ref	Male Thread	Female Thread
725302	1/8"	M12F x 1.5
725304	1/4"	M12F x 1.5
725310	M10 x 1	M12F x 1.5
725312	M12 x 1.5	M12F x 1.5
725314	M14 x 1.5	M12F x 1.5
725316	M16 x 1.5	M12F x 1.5
725322	M22 x 1.5	M12F x 1.5
725502	1/8"	M16F x 1.5
725504	1/4"	M16F x 1.5
725512	M12 x 1.5	M16F x 1.5
725514	M14 x 1.5	M16F x 1.5
725516	M16 x 1.5	M16F x 1.5
725522	M22 x 1.5	M16F x 1.5



**745 Series
45° Swivel
Elbows**



Part Ref	Male Thread	Female Thread
745302	1/8"	M12F x 1.5
745304	1/4"	M12F x 1.5
745310	M10 x 1	M12F x 1.5
745312	M12 x 1.5	M12F x 1.5
745314	M14 x 1.5	M12F x 1.5
745316	M16 x 1.5	M12F x 1.5
745322	M22 x 1.5	M12F x 1.5
745502	1/8"	M16F x 1.5
745504	1/4"	M16F x 1.5
745512	M12 x 1.5	M16F x 1.5
745514	M14 x 1.5	M16F x 1.5
745516	M16 x 1.5	M16F x 1.5
745522	M22 x 1.5	M16F x 1.5

Swivel Threaded Adaptors

Part Ref	Male Thread	Female Thread
----------	-------------	---------------

Swivel Cross

746502	1/8"	M16F x 1.5
746504	1/4"	M16F x 1.5
746512	M12 x 1.5	M16F x 1.5
746514	M14 x 1.5	M16F x 1.5
746516	M16 x 1.5	M16F x 1.5
746522	M22 x 1.5	M16F x 1.5

Swivel 'Y' Corner Tee

747502	1/8"	M16F x 1.5
747504	1/4"	M16F x 1.5
747512	M12 x 1.5	M16F x 1.5
747514	M14 x 1.5	M16F x 1.5
747516	M16 x 1.5	M16F x 1.5
747522	M22 x 1.5	M16F x 1.5

Swivel Corner Cross

748502	1/8"	M16F x 1.5
748504	1/4"	M16F x 1.5
748512	M12 x 1.5	M16F x 1.5
748514	M14 x 1.5	M16F x 1.5
748516	M16 x 1.5	M16F x 1.5
748522	M22 x 1.5	M16F x 1.5

Swivel Side Cross

749502	1/8"	M16F x 1.5
749504	1/4"	M16F x 1.5
749512	M12 x 1.5	M16F x 1.5
749514	M14 x 1.5	M16F x 1.5
749516	M16 x 1.5	M16F x 1.5
749522	M22 x 1.5	M16F x 1.5

Swivel 'F' Fitting

751502	1/8"	M16F x 1.5
751504	1/4"	M16F x 1.5
751512	M12 x 1.5	M16F x 1.5
751514	M14 x 1.5	M16F x 1.5
751516	M16 x 1.5	M16F x 1.5
751522	M22 x 1.5	M16F x 1.5

746 Series

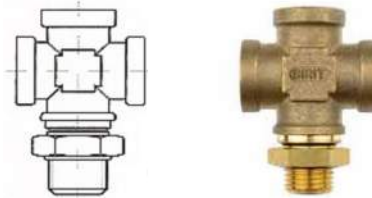

747 Series

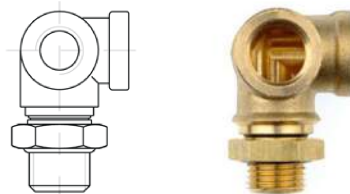

748 Series



749 Series

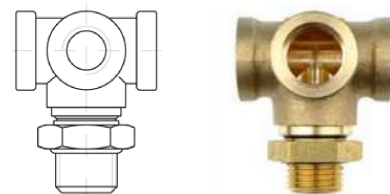

751 Series

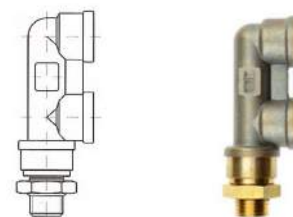

Fixed Adaptors

710 Series

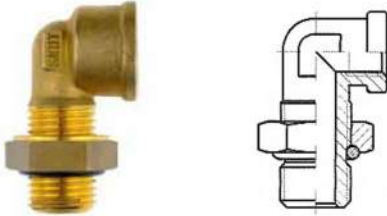

Part Ref	Male Thread	Female Thread
----------	-------------	---------------

90° Fixed Elbow

710310	M10 x 1	M12F x 1.5
710312	M12 x 1.5	M12F x 1.5
710316	M16 x 1.5	M12F x 1.5
710322	M22 x 1.5	M12F x 1.5

710512	M12 x 1.5	M16F x 1.5
710514	M14 x 1.5	M16F x 1.5
710516	M16 x 1.5	M16F x 1.5
710522	M22 x 1.5	M16F x 1.5

710716	M16 x 1.5	M22F x 1.5
710722	M22 x 1.5	M22F x 1.5

720 Series

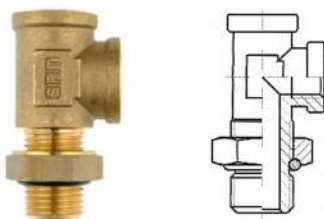

Part Ref	Male Thread	Female Thread
----------	-------------	---------------

Fixed Stud Run Tee

720310	M10 x 1	M12F x 1.5
720312	M12 x 1.5	M12F x 1.5
720316	M16 x 1.5	M12F x 1.5
720322	M22 x 1.5	M12F x 1.5

Part	Male Thread	Female Thread
------	-------------	---------------

720512	M12 x 1.5	M16F x 1.5
720516	M16 x 1.5	M16F x 1.5
720522	M22 x 1.5	M16F x 1.5

720722	M22 x 1.5	M22F x 1.5
--------	-----------	------------

730 Series

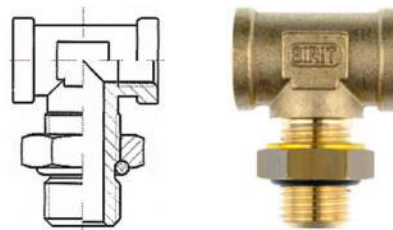

Part	Male Thread	Female Thread
------	-------------	---------------

Fixed Tee

730310	M10 x 1	M12F x 1.5
730312	M12 x 1.5	M12F x 1.5
730316	M16 x 1.5	M12F x 1.5
730322	M22 x 1.5	M12F x 1.5

730512	M12 x 1.5	M16F x 1.5
730514	M14 x 1.5	M16F x 1.5
730516	M16 x 1.5	M16F x 1.5
730522	M22 x 1.5	M16F x 1.5

730722	M22 x 1.5	M22F x 1.5
--------	-----------	------------

All fixed adaptors in any series come complete with a recessed Locknut and Sealing Ring

Fixed Adaptors

740 Series

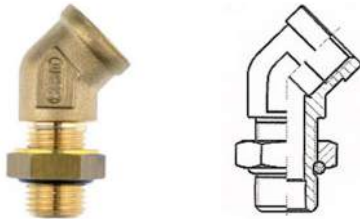

Part Ref	Male Thread	Female Thread
45° Fixed Elbow		
740516	M16 x 1.5	M16F x 1.5
740722	M22 x 1.5	M22F x 1.5

743 Series

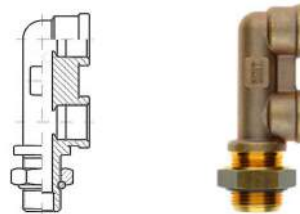

Part Ref	Male Thread	Female Thread
Fixed 'F' 90° Elbow		
743516	M16 x 1.5	M16F x 1.5
743522	M22 x 1.5	M16F x 1.5

741 Series

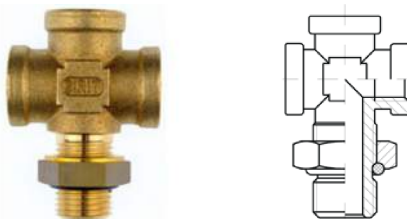

Part Ref	Male Thread	Female Thread
Fixed Stud Cross		
741516	M16 x 1.5	M16F x 1.5
741522	M22 x 1.5	M16F x 1.5

All fixed adaptors in any series come complete with a recessed Locknut and Sealing Ring

Female Adaptors

750 Series

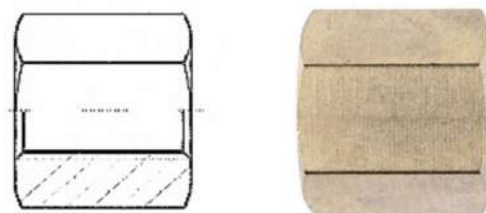

Part Ref	Female Thread	Female Thread
Straight Threaded Barrel		
750200	M10F x 1	M10F x 1
750300	M12F x 1.5	M12F x 1.5
750500	M16F x 1.5	M16F x 1.5
750700	M22F x 1.5	M22F x 1.5

742 Series

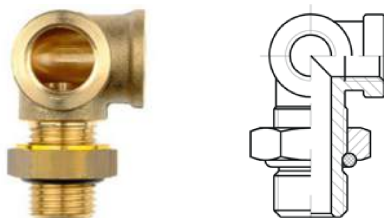

Part Ref	Male Thread	Female Thread
Fixed 'Y' Elbow		
742312	M12 x 1.5	M12F x 1.5
742516	M16 x 1.5	M16F x 1.5
742522	M22 x 1.5	M16F x 1.5

Fixed Adaptors

760 Series

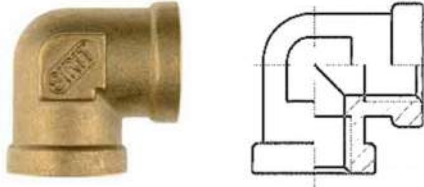

Part Ref	Female Thread	Female Thread
90° Female Elbow		
760300	M12F x 1.5	M12F x 1.5
760500	M16F x 1.5	M16F x 1.5
760700	M22F x 1.5	M22F x 1.5

753 Series

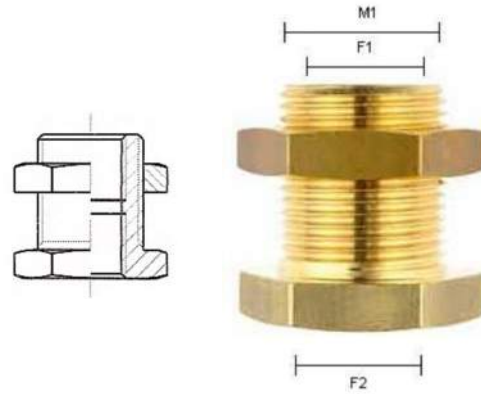

If lock nut is not required on the adaptor series 753 it then becomes an 653.

e.g; 753300 to 653300

Part Ref	M1	F1	F2
Bulkhead Adaptor			
753300	M18 x 1.5	M12F x 1.5	M12F x 1.5
753500	M22 x 1.5	M16F x 1.5	M16F x 1.5
753700	M28 x 1.5	M22F x 1.5	M22F x 1.5
753302	M18 x 1.5	M12F x 1.5	1/8"
753504	M22 x 1.5	M16F x 1.5	1/4"

770 Series

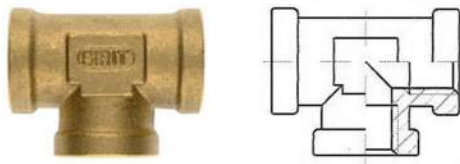

Part	Female Thread	Female Thread
Female Tee		
770300	M12F x 1.5	M12F x 1.5
770500	M16F x 1.5	M16F x 1.5
770700	M22F x 1.5	M22F x 1.5

780 Series

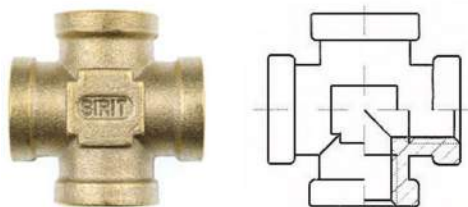

Part	Female Thread	Female Thread
Female Cross		
780300	M12F x 1.5	M12F x 1.5
780500	M16F x 1.5	M16F x 1.5

763 Series

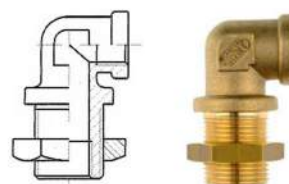

If lock nut is not required on the Adaptor series 763 it then becomes a 663

Part Ref	Male Thread	Female Thread
Male / Female 90° Bulkhead Elbow		
763300	M18 x 1.5	M12F x 1.5
763500	M22 x 1.5	M16F x 1.5

Bulkhead Adaptors

703 Series

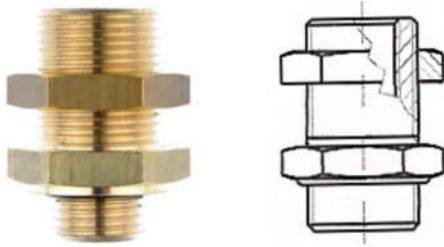

Part Ref	M1	M2	F1
Bulkhead Coupling			
703216	M16 x 1.5	M16 x 1.5	M10F x 1
703222	M22 x 1.5	M16 x 1.5	M10F x 1
703312	M12 x 1.5	M18 x 1.5	M12F x 1.5
703316	M16 x 1.5	M18 x 1.5	M12F x 1.5
703322	M22 x 1.5	M18 x 1.5	M12F x 1.5
703512	M12 x 1.5	M22 x 1.5	M16F x 1.5
703516	M16 x 1.5	M22 x 1.5	M16F x 1.5
703522	M22 x 1.5	M22 x 1.5	M16F x 1.5
703526	M26 x 1.5	M22 x 1.5	M16F x 1.5
703722	M22 x 1.5	M28 x 1.5	M22F x 1.5



If lock nut is not required on the adaptor series 703 it then becomes a 603.

e.g; 703516 to 603516

853 Series

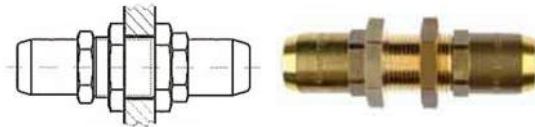

Part Ref	Tube Size (mm)	Female Thread
Equal Bulkhead Coupling		
853200	6 x 1	M12F x 1.5
853300	8 x 1	M12F x 1.5
853400	10 x 1.25	M12F x 1.5
853400/5	10 x 1.5	M12F x 1.5
853500	12 x 1.5	M16F x 1.5
853600	15 x 1.5	M16F x 1.5
853700	16 x 2	M16F x 1.5
853800	18 x 2	M16F x 1.5

863 Series



Part Ref	Tube Size (mm)	Female Thread
Equal 90° Bulkhead Elbow		
863200	6 x 1	M12F x 1.5
863300	8 x 1	M12F x 1.5
863400	10 x 1.25	M12F x 1.5
863400/5	10 x 1.5	M12F x 1.5
863500	12 x 1.5	M16F x 1.5
863600	15 x 1.5	M16F x 1.5
863700	16 x 2	M16F x 1.5
863800	18 x 2	M16F x 1.5

Equal Tube Joiners

850 Series

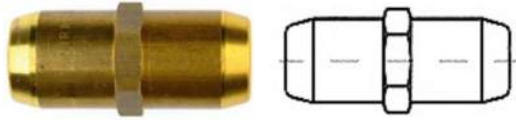

Part Ref	Tube Size (mm)	Female Thread
Straight Equal Joiner		
850200	6 x 1	M12F x 1.5
850300	8 x 1	M12F x 1.5
850900	9 x 1.5	M12F x 1.5
850400	10 x 1.25	M12F x 1.5
850110	11 x 1.5	M12F x 1.5
850500	12 x 1.5	M16F x 1.5
850600	15 x 1.5	M16F x 1.5
850700	16 x 2	M16F x 1.5
850800	18 x 2	M16F x 1.5

870 Series

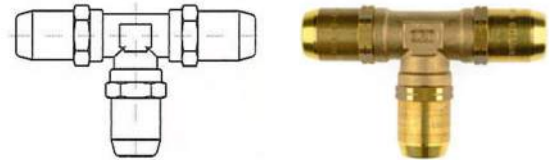

Part Ref	Tube Size (mm)	Female Thread
Tee Equal Joiner		
870200	6 x 1	M12F x 1.5
870300	8 x 1	M12F x 1.5
870900	9 x 1.5	M12F x 1.5
870400	10 x 1.25	M12F x 1.5
870110	11 x 1.5	M12F x 1.5
870500	12 x 1.5	M16F x 1.5
870600	15 x 1.5	M16F x 1.5
870700	16 x 2	M16F x 1.5
870800	18 x 2	M16F x 1.5

860 Series

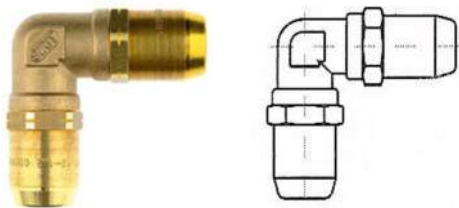

Part Ref	Tube Size (mm)	Female Thread
90° Elbow Equal Joiner		
860200	6 x 1	M12F x 1.5
860300	8 x 1	M12F x 1.5
860900	9 x 1.5	M12F x 1.5
860400	10 x 1.25	M12F x 1.5
860110	11 x 1.5	M12F x 1.5
860500	12 x 1.5	M16F x 1.5
860600	15 x 1.5	M16F x 1.5
860700	16 x 2	M16F x 1.5
860800	18 x 2	M16F x 1.5

880 Series

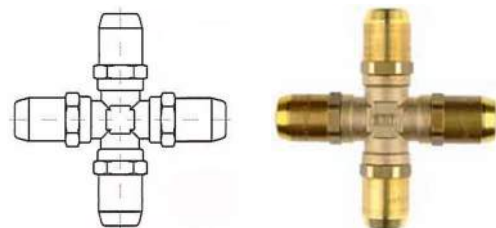

Part Ref	Tube Size (mm)	Female Thread
Cross Equal Joiner		
880200	6 x 1	M12F x 1.5
880300	8 x 1	M12F x 1.5
880900	9 x 1.5	M12F x 1.5
880400	10 x 1.25	M12F x 1.5
880110	11 x 1.5	M12F x 1.5
880500	12 x 1.5	M16F x 1.5
880600	15 x 1.5	M16F x 1.5
880700	16 x 2	M16F x 1.5
880800	18 x 2	M16F x 1.5

SIRIT
AIR BRAKE FITTINGS



Female Bracketed 'Y'

Part Ref	Thread
950500BT	M16F x 1.5



Female Bracketed Tee

Part Ref	Thread
770500BT	M16F x 1.5



90° Hose Tail Elbow

Part Ref	Size
910916	M16 x 1.5 x 13 mm ID

Other sizes available upon request



Hose Tail Bulkhead

Part Ref	Size
ABULK	12 mm Tube x 13 mm ID

Other sizes available upon request

Recessed Lock Nuts & Seals



Part Ref	Size
692010	M10 x 1
692012	M12 x 1.5
692014	M14 x 1.5
692016	M16 x 1.5
692022	M22 x 1.5

Seals

Part Ref	Size
693010	10 mm
693012	12 mm
693014	14 mm
693016	16 mm
693022	22 mm

Assorted Boxes : All boxes come clearly labelled to identify parts and sizes



Part Ref:
800AB
Male Stud Coupling Assorted Box

Part Ref	Size	Qty	Part Ref	Size	Qty
800312	M12 x 8	2	800516	M16 x 12	2
800316	M16 x 8	2	800522	M22 x 12	2
800416	M16 x 10	2	800622	M22 x 15	1
800422	M22 x 10	2	800822	M22 x 18	1



Part Ref:
810AB
Stud Elbow Assorted Box

Part Ref	Size	Qty	Part Ref	Size	Qty
810312	M12 x 8	2	810422	M22 x 10	1
810316	M16 x 8	2	810516	M16 x 12	1
810322	M22 x 8	2	810522	M22 x 12	1
810412	M12 x 10	2	810622	M22 x 15	1
810416	M16 x 10	2	810822	M22 x 18	1



Part Ref:
850AB
Straight Connectors Assorted Box

Part Ref	Size	Qty	Part Ref	Size	Qty
850200	6 mm	2	850500	12 mm	2
850300	8 mm	2	850600	15 mm	2
850400	10 mm	2	850700	16 mm	2
			850800	18 mm	1

TEL: 01474 535456 / FAX: 01474 537323
sales@airbrakeconnections.co.uk

SIRIT Workshop & Mobile Full Repair / Service Kit



SIRIT
AIR BRAKE FITTINGS

Part Ref:
SIRITAB



For the unsuspected costly times when you either do not have the correct fittings to hand or you have to await delivery, which is normally a next day service.

Air brake Connections (TUV) Fitting Case will enable you to replace either individual fittings or a valve install/replacement.

Consisting of a variety of 26 fittings and a total of 120, and also giving you the opportunity to use the sub components to make the extra fittings you require.

For a Valve replacement , pre-fit new fittings into the braking valve/valves, remove old unit/valve and either remove the tubing one by one and replace the new tubing one by one (note: the tubing must be cut cleanly and squarely), alternatively clearly label each tube. Remove and refit unit/valve and simply cut away the tube squarely, push and twist the new tubing into position (note: a pull backward on the tubing is recommend to ensure full lock has been achieved).

All fittings supplied in the Case can be used on any braking application.

A clearly labelled list of contents is applied to each Service Kit to allow easy re-ordering.

Our Service Kit is designed for repair and servicing and therefore will suit most requirements for today's braking systems.

All Fittings are TUV approved for braking applications.

Contents :

SWIVEL STUD M12 X 4	MALE STUD M16 X 6mm X 4	FEMALE ADAPTOR M16F X 8
SWIVEL STUD M16 X 6	MALE STUD M12 X 8mm X 8	BLANKING PLUG M12 X 4
SWIVEL STUD M22 X 4	MALE STUD M16 X 8mm X 6	BLANKING PLUG M16 X 4
SWIVEL ELBOW M16F X 4	MALE STUD M16 X 10mm X 6	BLANKING PLUG M22 X 4
45° SWIVEL ELBOW M16F X 4	MALE STUD M22 X 10mm X 6	TESP POINT M16 X 4
'F' FITTING M16F X 2	MALE STUD M16 X 12mm X 6	TEST POINT M22 X 4
SWIVEL SIDE TEE M16F X 4	MALE STUD M22 X 12mm X 6	BULKHEAD M16 X M22 X M16F X 3
SWIVEL BRANCH TEE M16F X 4	MALE STUD M22 X 15mm X 4	BULKHEAD M22 X 222 X M16F X 3
	MALE STUD M22 X 16mm X 4	
	MALE STUD M22 X 18mm X 4	

TEL: 01474 535456 / FAX: 01474 537323
sales@airbrakeconnections.co.uk

Section 2



FleetFit Push in Fittings



.....

.....

.....

.....

.....

.....

.....

.....

Fleetfit Push-in Tube Fittings

Metric 6 mm - 18 mm OD Tube

Imperial 1/4" - 3/4" OD Tube

-
- **Simple tube connection and disconnection with no tools required**

Corrosion Resistant

- **Easy identification with all collets marked with tube sizes**
 - **Reduced assembly time saves time/labour**
 - **Ease of tube insertion in restricted areas**
 - **TUV Approved**

Technical Data

Maximum Working Pressure:
0 to 10 bar (0 to 150 psi)

Operating Temperature: -40°C to + 100°C

Materials

Brass body, Tube support, & collet
Low Nitrile 'O' ring
Precoat 5 Thread Sealant

Warning: The swivel feature should be used for positioning purposes only and should not be used as a rotating joint.

Installation - Tube Connection / Disconnection

1. Ensure that the end of the tube is cut square and is free from burrs.

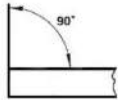

2. Push the tube through the collet into the fitting.



3. Continue pushing the tube through the 'O' ring until it bottoms on the tube stop. Then pull back on the tube to reinforce the collet teeth gripping action.



4. To disconnect - First ensure there is no air present. Push the tube into the fitting until it bottoms on the tube stop. Then hold down the collet and withdraw the tube.



Equal Connectors

Metric Joiners

Part Ref	Tube OD
97450304	6 mm
97450305	8 mm
97450313	9 mm
97450306	10 mm
97450336	11 mm
97450307	12 mm
97450392	14 mm
97450315	15 mm
97450308	16 mm



Imperial Joiners

Part Ref	Tube OD
94450303	3/16"
94450304	1/4"
94450306	3/8"
94450307	1/2"
94450308	5/8"
94450309	3/4"

Metric Equal Elbows

Part Ref	Tube OD
97451104	6 mm
97451105	8 mm
97451106	10 mm
97451107	12 mm
97451115	15 mm
97451108	16 mm



Imperial Equal Elbows

Part Ref	Tube OD
94451104	1/4"
94451106	3/8"
94451107	1/2"

Metric Equal Tees

Part Ref	Tube OD
97451404	6 mm
97451405	8 mm
97451413	9 mm
97451406	10 mm
97415436	11 mm
97415407	12 mm
97451415	15 mm
97451408	16 mm



Imperial Equal Tees

Part Ref	Tube OD
94451404	1/4"
94451406	3/8"
94451407	1/2"
94451408	5/8"

Male Stud Couplings



Reducing Metric Joiner



Part Ref	Tube OD	Tube OD
97450448	10 mm	6 mm
97450457	12 mm	8 mm

Bulkhead Connector



Part Ref	Thread	Tube OD
97450704	M15 x 1.0	6 mm
97450705	M18 x 1.5	8 mm
97450706	M20 x 1.5	10 mm
97450707	M24 x 1.5	12 mm
97450708	M30 x 1.5	16 mm

Part Ref	Thread	Tube OD
BSP Taper		
97453004	1/8"	6 mm
97453010	1/4"	6 mm
97453005	1/8"	8 mm
97453011	1/4"	8 mm
97453019	3/8"	8 mm
97453006	1/8"	10 mm
97453012	1/4"	10 mm
97453020	3/8"	10 mm
97453029	1/2"	10 mm
97453013	1/4"	12 mm
97453021	3/8"	12 mm
97453030	1/2"	12 mm
97453022	3/8"	16 mm
97453031	1/2"	16 mm

Male Stud Couplings



Part Ref	Thread	Tube OD
97466631	M10 x 1.0	6 mm
97466633	M12 x 1.5	6 mm
97466634	M14 x 1.5	6 mm
97466635	M16 x 1.5	6 mm
97466638	M22 x 1.5	6 mm
97466641	M10 x 1.0	8 mm
97466643	M12 x 1.5	8 mm
97466644	M14 x 1.5	8 mm
97466645	M16 x 1.5	8 mm
97466648	M22 x 1.5	8 mm
97466651	M10 x 1.0	10 mm
97466653	M12 x 1.5	10 mm
97466654	M14 x 1.5	10 mm
97466655	M16 x 1.5	10 mm
97466658	M22 x 1.5	10 mm
97466663	M12 x 1.5	12 mm
97466664	M14 x 1.5	12 mm
97466665	M16 x 1.5	12 mm
97466668	M22 x 1.5	12 mm
97466670	M22 x 1.5	15 mm
97466679	M16 x 1.5	16 mm
97466675	M22 x 1.5	16 mm
97466680	M22 x 1.5	18 mm

Part Ref	Thread	Tube OD
94466631	M10 x 1.0	1/4"
94466633	M12 x 1.5	1/4"
94466635	M16 x 1.5	1/4"
94466638	M22 x 1.5	1/4"
94466653	M12 x 1.5	3/8"
94466654	M14 x 1.5	3/8"
94466655	M16 x 1.5	3/8"
94466658	M22 x 1.5	3/8"
94466665	M16 x 1.5	1/2"
94466668	M22 x 1.5	1/2"
94466679	M16 x 1.5	5/8"
94466675	M22 x 1.5	5/8"



Part Ref	Thread	Tube OD
BSP Taper		
94453004	1/8"	1/4"
94453010	1/4"	1/4"
94453006	1/8"	3/8"
94453012	1/4"	3/8"
94453020	3/8"	3/8"
94453029	1/2"	3/8"
94453013	1/4"	1/2"
94453021	3/8"	1/2"
94453030	1/2"	1/2"
94453031	1/2"	5/8"

Male Stud Couplings



Part Ref	Thread	Tube OD
NPTF		
98453004	1/8"	6 mm
98453010	1/4"	6 mm
98453018	3/8"	6 mm
98453027	1/2"	6 mm
98453005	1/8"	8 mm
98453011	1/4"	8 mm
98453019	3/8"	8 mm
98453012	1/4"	10 mm
98453020	3/8"	10 mm
98453029	1/2"	10 mm
98453013	1/4"	12 mm
98453021	3/8"	12 mm
98453030	1/2"	12 mm
98453022	3/8"	16 mm
98453031	1/2"	16 mm

Part Ref	Thread	Tube OD
NPTF		
95453003	1/8"	3/16"
95453004	1/8"	1/4"
95453010	1/4"	1/4"
95453018	3/8"	1/4"
95453006	1/8"	3/8"
95453012	1/4"	3/8"
95453020	3/8"	3/8"
95453029	1/2"	3/8"
95453013	1/4"	1/2"
95453021	3/8"	1/2"
95453030	1/2"	1/2"
95453022	3/8"	5/8"
95453031	1/2"	5/8"
95453049	1/2"	3/4"

Blanking Plugs (Metric)

Part Ref	Tube OD
97050903	5 mm
97050904	6 mm
97050905	8 mm
97050906	10 mm
90750907	12 mm



Stud Elbow (Hobbs)



Part Ref	Thread	Tube OD
97413831	M10 x 1.0	6 mm
97413833	M12 x 1.5	6 mm
97413835	M16 x 1.5	6 mm
97413838	M22 x 1.5	6 mm
97413843	M12 x 1.5	8 mm
97413844	M14 x 1.5	8 mm
97413845	M16 x 1.5	8 mm
97413848	M22 x 1.5	8 mm
97413851	M10 x 1.0	10 mm
97413853	M12 x 1.5	10 mm
97413854	M14 x 1.5	10 mm
97413855	M16 x 1.5	10 mm
97413858	M22 x 1.5	10 mm
97413863	M12 x 1.5	12 mm
97413864	M14 x 1.5	12 mm
97413865	M16 x 1.5	12 mm
97413868	M22 x 1.5	12 mm
97413870	M22 x 1.5	15 mm
97413879	M16 x 1.5	16 mm
97413875	M22 x 1.5	16 mm
97413880	M22 x 1.5	18 mm

Stud Elbows



974330 Range



984331 Range

Part Ref	Thread	Tube OD
BSP Taper		
97433004	1/8"	6 mm
97433010	1/4"	6 mm
97433005	1/8"	8 mm
97433011	1/4"	8 mm
97433019	3/8"	8 mm
97433028	1/2"	8 mm
97433006	1/8"	10 mm
97433012	1/4"	10 mm
97433020	3/8"	10 mm
97433029	1/2"	10 mm
97433039	1/4"	11 mm
97433013	1/4"	12 mm
97433021	3/8"	12 mm
97433030	1/2"	12 mm

Part Ref	Thread	Tube OD
NPTF		
98433104	1/8"	6 mm
98433110	1/4"	6 mm
98433118	3/8"	6 mm
98433105	1/8"	8 mm
98433111	1/4"	8 mm
98433119	3/8"	8 mm
98433106	1/8"	10 mm
98433112	1/4"	10 mm
98433120	3/8"	10 mm
98433129	1/2"	10 mm
98433113	1/4"	12 mm
98433121	3/8"	12 mm
98433130	1/2"	12 mm
98433198	3/8"	16 mm
98433131	1/2"	16 mm

Swivel Elbow



Part Ref	Thread	Tube OD
97452133	M12 x 1.5	6 mm
97452135	M16 x 1.5	6 mm
97452144	M14 x 1.5	8 mm
97452145	M16 x 1.5	8 mm
97452153	M12 x 1.5	10 mm
97452154	M14 x 1.5	10 mm
97452155	M16 x 1.5	10 mm
97452197	M16 x 1.5	11 mm
97452165	M16 x 1.5	12 mm
97452168	M22 x 1.5	12 mm

The swivel feature should be used for positioning purposes only and
Should not be used as a rotating joint.

Stud Tee (Hobbs)



Part Ref	Thread	Tube OD
97443916	M12 x 1.5	10 mm
97443901	M16 x 1.5	10 mm
97443902	M22 x 1.5	10 mm
97443922	M24 x 1.5	10 mm
97443904	M16 x 1.5	12 mm
97443906	M22 x 1.5	12 mm
97443923	M24 x 1.5	12 mm

Side Tee (Hobbs)



Part Ref	Thread	Thread	Tube OD
	Male	Female	
97464101	M16 x 1.5	M16 x 1.5	10 mm
97464102	M22 x 1.5	M16 x 1.5	10 mm
97464106	M12 x 1.5	M12 x 1.5	10 mm
97464107	M16 x 1.5	M16 x 1.5	12 mm

Side Tee Adaptor (Hobbs)



Part Ref	Thread	Thread	Tube OD
	Male	Female	
97464605	M16 x 1.5	M16 x 1.5	10 mm
97464607	M22 x 1.5	M16 x 1.5	10 mm

Tee Adaptor (Hobbs)



Part Ref	Thread Male	Thread Female
36083201	M12 x 1.5	M12 x 1.5
36083202	M16 x 1.5	M16 x 1.5
36083203	M22 x 1.5	M22 x 1.5

Side Tee Adaptor (Hobbs)



Part Ref	Thread Male	Thread Female
36074306	M12 x 1.5	M12 x 1.5
36074301	M16 x 1.5	M16 x 1.5
36074305	M22 x 1.5	M22 x 1.5

Section 3



PneuFit Push in Fittings



.....

.....

.....

.....

.....

.....

.....

.....

PneuFit Push-in Tube Fittings

Metric 4 mm - 14 mm OD Tube

Imperial 1/4" - 3/4" OD Tube

-
- **Very compact units**
 - **Easy tube insertion for rapid assembly of pneumatic circuits**
 - **Positive tube anchorage**
 - **All tapered threads are pre-coated with non-PTFE based sealant**
 - **Straight Adaptors feature internal hexagon for Allen Key**
 - **Silicone free O-rings**
-

Technical Data

Operating Pressure: vacuum - 18 bar
(Dependant upon operating specification of tubing)

Operating Temperature: -20°C to + 80°C

Materials

Nickel plated brass for body and collet
Silicone free nitrile rubber 'O' ring
Non - PTFE thread sealant

Warning: The Push-in tube fittings in the pneuFit range must not be used in vehicle air braking systems

TEL: 01474 535456 / FAX: 01474 537323
sales@airbrakeconnections.co.uk

Metric

Part Ref	Tube OD
100200400	4 mm
100200500	5 mm
100200600	6 mm
100200800	8 mm
100201000	10 mm
100201200	12 mm
100201400	14 mm

Straight Joiners



Imperial

Part Ref	Tube OD
120200100	1/8"
120200200	5/32"
120200300	3/16"
120200400	1/4"
120200500	5/16"
120200600	3/8"
120200700	1/2"

Part Ref	Tube OD
100400400	4 mm
100400500	5 mm
100400600	6 mm
100400800	8 mm
100401000	10 mm
100401200	12 mm
100401400	14 mm

Equal Elbows



Part Ref	Tube OD
120400100	1/8"
120400200	5/32"
120400300	3/16"
120400400	1/4"
120400500	5/16"
120400600	3/8"
120400700	1/2"

Part Ref	Tube OD
100600400	4 mm
100600500	5 mm
100600600	6 mm
100600800	8 mm
100601000	10 mm
100601200	12 mm
100601400	14 mm

Equal Tees



Part Ref	Tube OD
120600100	1/8"
120600200	5/32"
120600300	3/16"
120600400	1/4"
120600500	5/16"
120600600	3/8"
120600700	1/2"

Straight Adaptors



Taper Thread

Parallel Thread

Part Ref	Thread	Tube OD
101250418	1/8"	4 mm
101250428	1/4"	4 mm
101250518	1/8"	5 mm
101250528	1/4"	5 mm
101250618	1/8"	6 mm
101250628	1/4"	6 mm
101250818	1/8"	8 mm
101250828	1/4"	8 mm
101250838	3/8"	8 mm
101250848	1/2"	8 mm
101251018	1/8"	10 mm
101251028	1/4"	10 mm
101251038	3/8"	10 mm
101251048	1/2"	10 mm
101251228	1/4"	12 mm
101251238	3/8"	12 mm
101251248	1/2"	12 mm
101251438	3/8"	14 mm
101251448	1/2"	14 mm

Part Ref	Thread	Tube OD
102250405	M5 x 0.8	4 mm
102250418	1/8"	4 mm
102250428	1/4"	4 mm
102250505	M5 x 0.8	5 mm
102250518	1/8"	5 mm
102250528	1/4"	5 mm
102250605	M5 x 0.8	6 mm
102250618	1/8"	6 mm
102250628	1/4"	6 mm
102250818	1/8"	8 mm
102250828	1/4"	8 mm
102250838	3/8"	8 mm
102250848	1/2"	8 mm
102251018	1/8"	10 mm
102251028	1/4"	10 mm
102251038	3/8"	10 mm
102251048	1/2"	10 mm
102251228	1/4"	12 mm
102251238	3/8"	12 mm
101251248	1/2"	12 mm

Straight Adaptor



Part Ref	Thread	Tube OD
BSP		
121250118	1/8"	1/8"
121250128	1/4"	1/8"
101250418	1/8"	5/32"
101250428	1/4"	5/32"
121250418	1/8"	1/4"
121250428	1/4"	1/4"
121250438	3/8"	1/4"
101250818	1/8"	5/16"
101250828	1/4"	5/16"
101250838	3/8"	5/16"
121250618	1/8"	3/8"
121250628	1/4"	3/8"
121250638	3/8"	3/8"
121250648	1/2"	3/8"
121250728	1/4"	1/2"
121250738	3/8"	1/2"
121250748	1/2"	1/2"

Bulkhead Connector

Part Ref	Tube OD
100290400	4 mm
100290500	5 mm
100290600	6 mm
100290800	8 mm
100291000	10 mm
100291200	12 mm
100291400	14 mm



Fixed Elbow



Part Ref	Thread	Tube OD
BSP		
101450418	1/8"	4 mm
101450428	1/4"	4 mm
101450518	1/8"	5 mm
101450528	1/4"	5 mm
101450618	1/8"	6 mm
101450628	1/4"	6 mm
101450818	1/8"	8 mm
101450828	1/4"	8 mm
101450838	3/8"	8 mm
101450848	1/2"	8 mm
101451018	1/8"	10 mm
101451028	1/4"	10 mm
101451038	3/8"	10 mm
101451048	1/2"	10 mm
101451228	1/4"	12 mm
101451238	3/8"	12 mm
101451248	1/2"	12 mm

Swivel Elbows



Taper Thread

Part Ref	Thread	Tube OD
	BSP	
101470418	1/8"	4 mm
101470428	1/4"	4 mm
101470518	1/8"	5 mm
101470528	1/4"	5 mm
101470618	1/8"	6 mm
101470628	1/4"	6 mm
101470638	3/8"	6 mm
101470818	1/8"	8 mm
101470828	1/4"	8 mm
101470838	3/8"	8 mm
101470848	1/2"	8 mm
101471018	1/8"	10 mm
101471028	1/4"	10 mm
101471038	3/8"	10 mm
101471048	1/2"	10 mm
101471228	1/4"	12 mm
101471238	3/8"	12 mm
101471248	1/2"	12 mm
101471438	3/8"	14 mm
101471448	1/2"	14 mm



Parallel Thread

Part Ref	Thread	Tube OD
	BSP	
102470405	M5 x 0.8	4 mm
102470418	1/8"	4 mm
102470428	1/4"	4 mm
102470505	M5 x 0.8	5 mm
102470518	1/8"	5 mm
102470528	1/4"	5 mm
102470605	M5 x 0.8	6 mm
102470618	1/8"	6 mm
102470628	1/4"	6 mm
102470818	1/8"	8 mm
102470828	1/4"	8 mm
102470838	3/8"	8 mm
102470848	1/2"	8 mm
102471018	1/8"	10 mm
102471028	1/4"	10 mm
102471038	3/8"	10 mm
102471048	1/2"	10 mm
102471228	1/4"	12 mm
102471238	3/8"	12 mm
102471248	1/2"	12 mm
102471438	3/8"	14 mm
102471448	1/2"	14 mm

 **NORGREN - PneuFit**



Swivel Elbow

Part Ref	Thread	Tube OD
BSP Taper		
121470118	1/8"	1/8"
101400418	1/8"	5/32"
121470318	1/8"	3/16"
121470418	1/8"	1/4"
101470818	1/8"	5/16"
101470428	1/4"	5/32"
121470328	1/4"	3/16"
121470428	1/4"	1/4"
101470828	1/4"	5/16"
101470628	1/4"	3/8"
121470728	1/4"	1/2"
121470638	3/8"	3/8"
121470648	1/2"	3/8"
121470738	3/8"	1/2"
121470748	1/2"	1/2"



Female Stud



Part Ref	Thread	Tube OD
102260405	M5 x 0.8	4 mm
102260418	1/8"	4 mm
102260428	1/4"	4 mm
102260518	1/8"	5 mm
102260528	1/4"	5 mm
102260618	1/8"	6 mm
102260628	1/4"	6 mm
102260818	1/8"	8 mm
102260828	1/4"	8 mm
102261028	1/4"	10 mm
102261038	3/8"	10 mm

Part Ref	Stem	Tube OD
102261238	3/8"	12 mm
102261248	1/2"	12 mm

Stem Tube Reducers



Part Ref	Stem	Tube OD
100230504	5 mm	4 mm
100230604	6 mm	4 mm
100230605	6 mm	5 mm
100230804	8 mm	4 mm
100230805	8 mm	5 mm
100230806	8 mm	6 mm
100231004	10 mm	4 mm
100231006	10 mm	6 mm
100231008	10 mm	8 mm
100231204	12 mm	4 mm
100231205	12 mm	5 mm
100231206	12 mm	6 mm
100231208	12 mm	8 mm
100231210	12 mm	10 mm
100231406	14 mm	6 mm
100231408	14 mm	8 mm
100231410	14 mm	10 mm
100231412	14 mm	12 mm

Expanders

Part Ref	Stem	Tube OD
100230406	4 mm	6 mm
100230608	6 mm	8 mm

Section 4



Plastic & Composite Push Fit Fittings



.....

.....

.....

.....

.....

.....

.....

.....

Plastic & Composite Push Fit Fittings

1

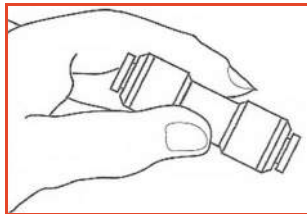

Select the part required for use from the range of Push Fit Connectors

2

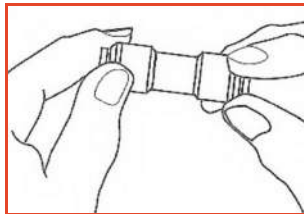

Visually inspect the part to ensure no obstruction is present

3

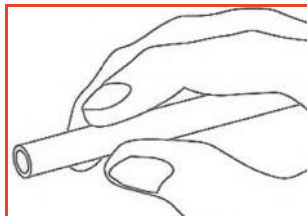

Prepare the tubing ready for insertion ensuring that the end is cut square

4

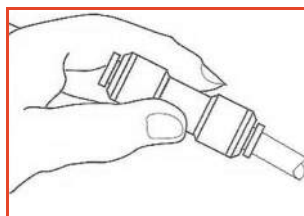

Insert tube, ensuring you have reached the stop position, now pull back



The Plastic Metal range can be used for a variety of uses including: Air, Water, Vacuum and Fuel. However under no circumstances can be used for carrying acids.

Not to be used on Braking Systems

TECHNICAL INFORMATION

Maximum Working Pressure 0 To 10 Bar

Temperature Range 0°C To +60°C

Plastic & Composite Push Fit Fittings

Equal Joiners

Part Ref	Tube OD
PFM 4NR	4 mm
PFM 5NR	5 mm
PFM 6NR	6 mm
PFM 8NR	8 mm
PFM 10NR	10 mm
PFM 12NR	12 mm
PHM 16NR	16 mm



Equal Elbows

Part Ref	Tube OD
PFM 54NR	4 mm
PFM 56NR	6 mm
PFM 58NR	8 mm
PFM 510NR	10 mm
PFM 512NR	12 mm
PFM 516NR	16 mm



Equal Tees

Part Ref	Tube OD
PFM 74NR	4 mm
PFM 75NR	5 mm
PFM 76NR	6 mm
PFM 78NR	8 mm
PFM 710NR	10 mm
PFM 712NR	12 mm
PFM 716NR	16 mm



Equal 'Y' Joiner

Part Ref	Tube OD
PFM 1004NR	4 mm
PFM 1006NR	6 mm
PFM 1008NR	8 mm
PFM 1010NR	10 mm
PFM 1012NR	12 mm



Stem Reducers / Expanders

Part Ref	Stem OD	Tube OD
PFM 154NR	5 mm	4 mm
PFM 164NR	6 mm	4 mm
PFM 184NR	8 mm	4 mm
PFM 186NR	8 mm	6 mm
PFM 1104NR	10 mm	4 mm
PFM 1106NR	10 mm	6 mm
PFM 1108NR	10 mm	8 mm



Part Ref	Stem OD	Tube OD
PFM 128NR	12 mm	8 mm
PFM 11210NR	12 mm	10 mm

Expanders

PFM 146NR	4 mm	6 mm
PFM 168NR	6 mm	8 mm

Plastic & Composite Push Fit Fittings



Threaded
Male Studs

Part Ref	Thread	Tube OD
PMS 0402NR	1/8"	4 mm
PMS 0404NR	1/4"	4 mm
PMS 0602NR	1/8"	6 mm
PMS 0604NR	1/4"	6 mm
PMS 0606NR	3/8"	6 mm
PMS 0802NR	1/8"	8 mm
PMS 0804NR	1/4"	8 mm
PMS 0806NR	3/8"	8 mm

Part Ref	Thread	Tube OD
PMS 0808NR	1/2"	8 mm
PMS 1002NR	1/8"	10 mm
PMS 1004NR	1/4"	10 mm
PMS 1006NR	3/8"	10 mm
PMS 1008NR	1/2"	10 mm
PMS 1204NR	1/4"	12 mm
PMS 1206NR	3/8"	12 mm
PMS 1208NR	1/2"	12 mm



90° Swivel
Stud Elbows

Swivel 'Y'
Adaptor



Part Ref	Thread	Tube OD
PMSE 0402NR	1/8"	4 mm
PMSE 0404NR	1/4"	4 mm
PMSE 0602NR	1/8"	6 mm
PMSE 0604NR	1/4"	6 mm
PMSE 0606NR	3/8"	6 mm
PMSE 0802NR	1/8"	8 mm
PMSE 0804NR	1/4"	8 mm
PMSE 0806NR	3/8"	8 mm
PMSE 1004NR	1/4"	10 mm
PMSE 1006NR	3/8"	10 mm

Part Ref	Thread	Tube OD
PMSY 0402NR	1/8"	4 mm
PMSY 0404NR	1/4"	4 mm
PMSY 0602NR	1/8"	6 mm
PMSY 0604NR	1/4"	6 mm
PMSY 0606NR	3/8"	6 mm
PMSY 0802NR	1/8"	8 mm
PMSY 0804NR	1/4"	8 mm
PMSY 1004NR	1/4"	10 mm
PMSY 1006NR	3/8"	10 mm
PMSY 1008NR	1/2"	10 mm

Plastic & Composite Push Fit Fittings

Part Ref	Thread	Tube OD
PMFS 0402NR	1/8"	4 mm
PMFS 0404NR	1/4"	4 mm
PMFS 0504NR	1/4"	5 mm
PMFS 0602NR	1/8"	6 mm
PMFS 0604NR	1/4"	6 mm
PMFS 0606NR	3/8"	6 mm
PMFS 0802NR	1/8"	8 mm

Threaded
Female
Studs



Part Ref	Thread	Tube OD
PMFS 0804NR	1/4"	8 mm
PMFS 0806NR	3/8"	8 mm
PMFS 1004NR	1/4"	10 mm
PMFS 1006NR	3/8"	10 mm
PMFS 1008NR	1/2"	10 mm
PMFS 1206NR	3/8"	10 mm
PMFS 1208NR	1/2"	10 mm



Swivel
Tee

Swivel Branch
Tee



Part Ref	Thread	Tube OD
PMT 0402NR	1/8"	4 mm
PMT 0404NR	1/4"	4 mm
PMT 0602NR	1/8"	6 mm
PMT 0604NR	1/4"	6 mm
PMT 0802NR	1/8"	8 mm
PMT 0804NR	1/4"	8 mm
PMT 0806NR	3/8"	8 mm
PMT 1004NR	1/4"	10 mm
PMT 1006NR	3/8"	10 mm

Part Ref	Thread	Tube OD
PMSRT 0402NR	1/8"	4 mm
PMSRT 0404NR	1/4"	4 mm
PMSRT 0602NR	1/8"	6 mm
PMSRT 0604NR	1/4"	6 mm
PMSRT 0802NR	1/8"	8 mm
PMSRT 0804NR	1/4"	8 mm
PMSRT 0806NR	3/8"	8 mm
PMSRT 1004NR	1/4"	10 mm
PMSRT 1006NR	3/8"	10 mm



90° Stem
Elbow Connector

Part Ref	Stem	Tube OD
PFM 544NR	4 mm	4 mm
PFM 566NR	6 mm	6 mm
PFM 588NR	8 mm	8 mm

Plastic Push Fit - Assorted Boxes

Equal Joiners

Part Ref	Tube OD	Qty
PFM 4NR	4 mm	5
PFM 6NR	6 mm	5
PFM 8NR	8 mm	5
PFM 10NR	10 mm	5
PFM 12NR	12 mm	5

Part Ref:
PFMASB



Equal Elbows

Part Ref	Tube OD	Qty
PFM 54NR	4 mm	5
PFM 56NR	6 mm	5
PFM 58NR	8 mm	5
PFM 510NR	10 mm	5
PFM 512NR	12 mm	5

Part Ref:
PFMAEB



Equal Tees

Part Ref	Tube OD	Qty
PFM 74NR	4 mm	4
PFM 76NR	6 mm	4
PFM 78NR	8 mm	4
PFM 710NR	10 mm	3
PFM 712NR	12 mm	3

Part Ref:
PFMATB



Part Ref

TC2/G

Cuts up
to 22 mm



Part Ref

TC1

Cuts up
to 12 mm



Section 5

 **John Guest**

Plastic Push Fit Fittings



.....

.....

.....

.....

.....

.....

.....

.....

Plastic Push Fit

1

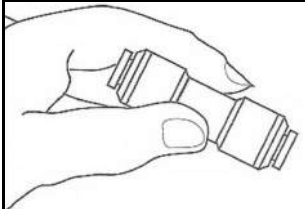

Select the part required for use from the range of Push Fit Connectors

2

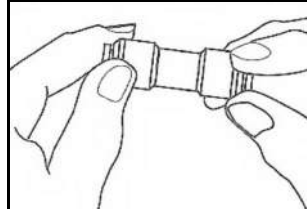

Visually inspect the part to ensure no obstruction is present

3

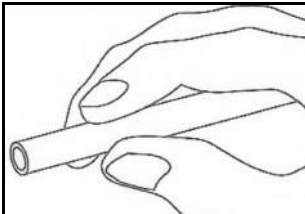

Prepare the tubing ready for insertion ensuring that the end is cut square

4

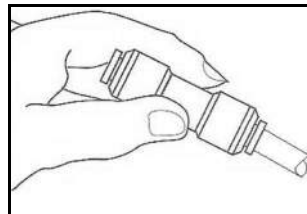

Insert tube, ensuring you have reached the stop position, now pull back

Our range of Push In Connectors will provide a secure seal without the use of any special tools.

They can be used for a wide range of materials Including: Nylon, Plastic, Calibrated Copper, Bundy Tubing.

We recommend that they only be used for carrying the following: Air, Water, Petrol Diesel and Oil.

Please Note that under any circumstances they are not to be used for carrying acids or to be used for Braking Systems.

TECHNICAL INFORMATION

Maximum Working Pressure 10 Bar

Minimum Burst Pressure 25 Bar

Temperature Range -25 To +75°C

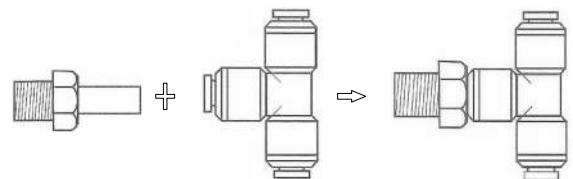
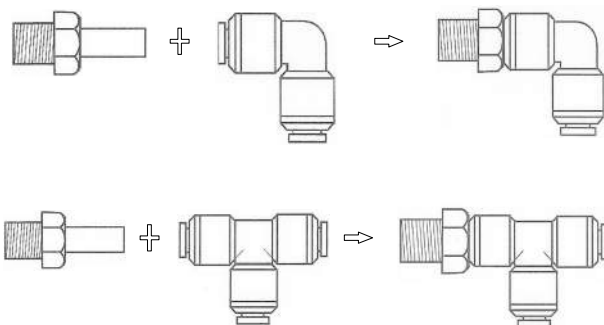

Plastic Push Fit - Imperial

JG John Guest

Equal Joiners

Part Ref	Tube OD
PFI 1	5/32"
PFI 3	3/16"
PFI 4	1/4"
PFI 5	5/16"
PFI 6	3/8"
PFI 8	1/2"



Equal Elbows

Part Ref	Tube OD
PFI 622	5/32"
PFI 633	3/16"
PFI 644	1/4"
PFI 655	5/16"
PFI 666	3/8"
PFI 688	1/2"



Equal Tees

Part Ref	Tube OD
PFI 922	5/32"
PFI 933	3/16"
PFI 944	1/4"
PFI 955	5/16"
PFI 966	3/8"
PFI 988	1/2"



Blanking Plugs

Part Ref	Tube OD
PFI 1222	5/32"
PFI 1233	3/16"
PFI 1244	1/4"
PFI 1255	5/16"
PFI 1266	3/8"
PFI 1288	1/2"



Male Studs

Part Ref	Thread BSP(T)	Tube OD	Part Ref	Thread BSP(T)	Tube OD
PFI 222	1/8"	5/32"	PFI 246	1/4"	3/8"
PFI 223	1/8"	3/16"	PFI 265	3/8"	5/16"
PFI 224	1/8"	1/4"	PFI 266	3/8"	3/8"
PFI 225	1/8"	5/16"	PFI 268	3/8"	1/2"
PFI 244	1/4"	1/4"	PFI 288	1/2"	1/2"
PFI 245	1/4"	5/16"			



Plastic Push Fit - Imperial

JG John Guest

Unequal Joiners

Part Ref	Tube OD
PFI 43	1/4" x 3/16"
PFI 53	5/16" x 3/16"
PFI 54	5/16" x 1/4"
PFI 64	3/8" x 1/4"
PFI 65	3/8" x 5/16"
PFI 86	1/2" x 3/8"



Unequal Elbows

Part Ref	Tube OD
PFI 652	5/16" x 5/32"
PFI 653	5/16" x 3/16"
PFI 654	5/16" x 1/4"
PFI 663	3/8" x 3/16"
PFI 664	3/8" x 1/4"
PFI 665	3/8" x 5/16"
PFI 686	1/2" x 3/8"



Unequal Tees

Part Ref	Tube OD
PFI 986	1/2" x 3/8"



Equal Bulkheads

Part Ref	Thread
PFI 21	5/32"
PFI 23	3/16"
PFI 24	1/4"
PFI 25	5/16"
PFI 26	3/8"
PFI 28	1/2"



Equal Dividers

Part Ref	Tube OD
PFI 1005	5/16"
PFI 1006	3/8"



Swivel Tees

Part Ref	Thread BSP(T)	Tube OD	Part Ref	Thread BSP(T)	Tube OD
PFI 522	1/8"	5/32"	PFI 545	1/4"	5/16"
PFI 523	1/8"	3/16"	PFI 546	1/4"	3/8"
PFI 524	1/8"	1/4"	PFI 565	3/8"	5/16"
PFI 525	1/8"	5/16"	PFI 566	3/8"	3/8"
PFI 542	1/4"	5/32"	PFI 568	3/8"	1/2"
PFI 544	1/4"	1/4"	PFI 588	1/2"	1/2"



Plastic Push Fit - Imperial

JG John Guest



Swivel
Elbows

Part Ref	Thread BSP(T)	Tube OD
PFI 442	1/8"	5/32"
PFI 423	1/8"	3/16"
PFI 424	1/8"	1/4"
PFI 425	1/8"	5/16"
PFI 442	1/4"	5/32"
PFI 444	1/4"	1/4"
PFI 445	1/4"	5/16"
PFI 446	1/4"	3/8"
PFI 465	3/8"	5/16"
PFI 466	3/8"	3/8"
PFI 468	3/8"	1/2"
PFI 488	1/2"	1/2"



Stud
Stems

Part Ref	Thread BSP(T)	Tube OD
PFI 322	1/8"	5/32"
PFI 323	1/8"	3/16"
PFI 324	1/8"	1/4"
PFI 325	1/8"	5/16"
PFI 342	1/4"	5/32"
PFI 344	1/4"	1/4"
PFI 345	1/4"	5/16"
PFI 346	1/4"	3/8"
PFI 365	3/8"	5/16"
PFI 366	3/8"	3/8"
PFI 368	3/8"	1/2"
PFI 388	1/2"	1/2"



Stem
Elbows

Part Ref	Stem OD	Tube OD
PFI 822	5/32"	5/32"
PFI 833	3/16"	3/16"
PFI 844	1/4"	1/4"
PFI 855	5/16"	5/16"
PFI 863	3/8"	3/16"
PFI 864	3/8"	1/4"
PFI 865	3/8"	5/16"
PFI 866	3/8"	3/8"
PFI 888	1/2"	1/2"

Part Ref	Stem OD	Tube OD
PFI 153	3/16"	5/16"
PFI 154	1/4"	5/16"
PFI 165	5/16"	3/8"
PFI 186	3/8"	1/2"

Stud
Reducers



Part Ref	Tube OD
PFI 1104	1/4"
PFI 1106	3/8"

Stop
Ends



Part Ref	Tube OD
PFI 9666	3/8"

Equal Cross



Plastic Push Fit - Metric

JG John Guest

Equal Joiners

Part Ref	Tube OD
PFM 4	4 mm
PFM 5	5 mm
PFM 6	6 mm
PFM 8	8 mm
PFM 10	10 mm
PFM 12	12 mm
PFM 15	15 mm
PFM 18	18 mm
PFM 20	20 mm



Equal Elbows

Part Ref	Tube OD
PFM 54	4 mm
PFM 55	5 mm
PFM 56	6 mm
PFM 58	8 mm
PFM 510	10 mm
PFM 512	12 mm
PFM 515	15 mm
PFM 518	18 mm



Equal Tees

Part Ref	Tube OD
PFM 74	4 mm
PFM 75	5 mm
PFM 76	6 mm
PFM 78	8 mm
PFM 710	10 mm
PFM 712	12 mm
PFM 715	15 mm
PFM 718	18 mm



Blanking Plugs

Part Ref	Tube OD
PFM 44	4 mm
PFM 45	5 mm
PFM 46	6 mm
PFM 48	8 mm
PFM 410	10 mm
PFM 412	12 mm
PFM 415	15 mm
PFM 418	18 mm



Part Ref	Thread	Tube OD	Part Ref	Thread	Tube OD
"BSPT"			"BSPT"		
PFM 214	1/8"	4 mm	PFM 248	1/4"	8 mm
PFM 244	1/4"	4 mm	PFM 268	3/8"	8 mm
PFM 215	1/8"	5 mm	PFM 2410	1/4"	10 mm
PFM 245	1/4"	5 mm	PFM 2610	3/8"	10 mm
PFM 216	1/8"	6 mm	PFM 2810	1/2"	10 mm
PFM 246	1/4"	6 mm	PFM 2612	3/8"	12 mm
PFM 218	1/8"	8 mm	PFM 2812	1/2"	12 mm

Male Studs



Plastic Push Fit - Metric

JG John Guest

Unequal Joiners

Part Ref	Tube OD "mm"
PFM 64	6 x 4
PFM 84	8 x 4
PFM 86	8 x 6
PFM 104	10 x 4
PFM 106	10 x 6
PFM 108	10 x 8
PFM 128	12 x 8
PFM 1210	12 x 10



Unequal Elbows

Part Ref	Tube OD "mm"
PFM 564	6 x 4
PFM 584	8 x 4
PFM 586	8 x 6
PFM 5104	10 x 4
PFM 5106	10 x 6
PFM 5108	10 x 8
PFM 5128	12 x 8
PFM 5120	12 x 10



Equal Dividers

Part Ref	Tube OD
PFM 1004	4 mm
PFM 1006	6 mm
PFM 1008	8 mm
PFM 1010	10 mm
PFM 1012	12 mm



Equal Bulkheads

Part Ref	Thread
PFM 24	4 mm
PFM 25	5 mm
PFM 26	6 mm
PFM 28	8 mm
PFM 210	10 mm
PFM 212	12 mm



Swivel Tees

Part Ref	Thread BSP(T)	Tube OD	Part Ref	Thread BSP(T)	Tube OD
PFM 824	1/8"	4 mm	PFM 848	1/4"	8 mm
PFM 844	1/4"	4 mm	PFM 868	3/8"	8 mm
PFM 825	1/8"	5 mm	PFM 8410	1/4"	10 mm
PFM 845	1/4"	5 mm	PFM 8610	3/8"	10 mm
PFM 826	1/8"	6 mm	PFM 8810	1/2"	10 mm
PFM 846	1/4"	6 mm	PFM 8612	3/8"	12 mm
PFM 828	1/8"	8 mm	PFM 8812	1/2"	12 mm



Plastic Push Fit - Metric

JG John Guest



Swivel
Elbows

Part Ref	Thread BSP(T)	Tube OD
PFM 624	1/8"	4 mm
PFM 644	1/4"	4 mm
PFM 625	1/8"	5 mm
PFM 645	1/4"	5 mm
PFM 626	1/8"	6 mm
PFM 646	1/4"	6 mm
PFM 628	1/8"	8 mm
PFM 648	1/4"	8 mm
PFM 668	3/8"	8 mm
PFM 6410	1/4"	10 mm
PFM 6610	3/8"	10 mm
PFM 6810	1/2"	10 mm
PFM 6612	3/8"	12 mm
PFM 6812	1/2"	12 mm



Stud
Stems

Part Ref	Thread BSP(T)	Tube OD
PFM 314	1/8"	4 mm
PFM 344	1/4"	4 mm
PFM 315	1/8"	5 mm
PFM 345	1/4"	5 mm
PFM 316	1/8"	6 mm
PFM 346	1/4"	6 mm
PFM 318	1/8"	8 mm
PFM 348	1/4"	8 mm
PFM 368	3/8"	8 mm
PFM 3410	1/4"	10 mm
PFM 3610	3/8"	10 mm
PFM 3810	1/2"	10 mm
PFM 3612	3/8"	12 mm
PFM 3812	1/2"	12 mm



Stem
Elbows

Part Ref	Stem OD	Tube OD
PFM 544	4 mm	4 mm
PFM 555	5 mm	5 mm
PFM 566	6 mm	6 mm
PFM 588	8 mm	8 mm
PFM 51010	10 mm	10 mm
PFM 51212	12 mm	12 mm

John Guest Super Thread Swivel
Tee's / Elbow's and Stem Adaptors are
available upon Request

Stud Reducers



Part Ref	Stem OD	Tube OD
PFM 154	5 mm	4 mm
PFM 164	6 mm	4 mm
PFM 165	6 mm	5 mm
PFM 184	8 mm	4 mm
PFM 185	8 mm	5 mm
PFM 186	8 mm	6 mm
PFM 1106	10 mm	6 mm
PFM 1108	10 mm	8 mm
PFM 1128	12 mm	8 mm
PFM 11210	12 mm	10 mm

TEL: 01474 535456 / FAX: 01474 537323
sales@airbrakeconnections.co.uk

Plastic Push Fit - Assorted Boxes

JG John Guest

**Part Ref:
PFMASB/GUEST**

Part Ref	Qty
PFM 4	5
PFM 6	5
PFM 8	5
PFM 10	5
PFM 12	5



**Part Ref:
PFIASB**

Part Ref	Qty
PFI 1	3
PFI 3	3
PFI 4	3
PFI 5	3
PFI 6	3
PFI 8	3



**Part Ref:
PFMAEB/GUEST**

Part Ref	Qty
PFM 54	5
PFM 56	5
PFM 58	5
PFM 510	5
PFM 512	5



Part Ref: PFI AEB

Part Ref	Qty
PFI 633	3
PFI 644	3
PFI 655	3
PFI 666	3
PFI 688	3



**Part Ref:
PFMATB/GUEST**

Part Ref	Qty
PFM 74	4
PFM 76	4
PFM 78	4
PFM 710	3
PFM 712	3



**Part Ref:
PFIATB**

Part Ref	Qty
PFI 933	3
PFI 944	3
PFI 955	3
PFI 966	2
PFI 988	2



Part Ref

TC2/G

Cuts up
to 22 mm



Part Ref

TC1

Cuts up
to 12 mm



Section 6

Compression Range



.....

.....

.....

.....

.....

.....

.....

.....

Compression Fittings

Assembly Instructions

- Firstly ensure the nylon tube is cut square.
- Push the tube insert lightly into the tubing , avoiding any damage to the internal surface.
- The tube insert must be fully pushed in, until the shoulder is firmly flat against the end of the tube.
- Remove the nut and olive from the fitting, and then slide nut, followed by olive over the tubing, ensuring the seat face has been reached.
- Push nut and olive firmly against the fitting. Screw nut on until finger tight.
- Using the correct size spanner, tighten another 1 3/4 turns.
- Now release the nut from the fitting to inspect that the olive has in fact penetrated the tube and created a visible seal.
- Re-assembly can now take place as normal.

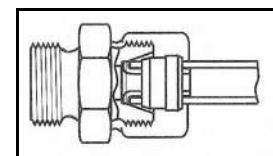
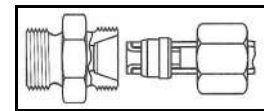
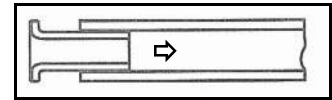

CAUTION: DO NOT OVERTIGHTEN, AS THIS CAN CAUSE SEVERE DAMAGE TO ALL COMPONENTS, ESPECIALLY THE TUBING.

Compression Fittings

Bulkhead Adaptors

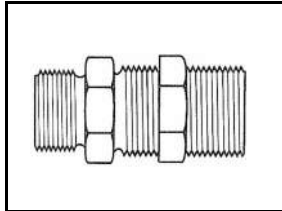

Part Ref	Thread Size	Thread Size
BA1212Z	M12 x 1.5	M12 x 1.5
BA1414Z	M14 x 1.5	M14 x 1.5
BA1422Z	M14 x 1.5	M22 x 1.5
BA1616Z	M16 x 1.5	M16 x 1.5
BA1618Z	M16 x 1.5	M18 x 1.5
BA1622Z	M16 x 1.5	M22 x 1.5
BA1818Z	M18 x 1.5	M18 x 1.5
BA2222Z	M22 x 1.5	M22 x 1.5
BA2218Z	M22 x 1.5	M18 x 1.5
BA2250Z	M22 x 1.5	1/2"

Bulkhead adaptors as above C/W olive cut out (Tube Ended)

Part Ref	Thread	Tube od	Thread	Tube od
BAT12	M12	6 mm	M12	6 mm
BAT14	M14	8 mm	M14	8 mm
BAT16	M16	10 mm	M16	10 mm
BAT18	M18	12 mm	M18	12 mm
BAT22	M22	15 mm	M22	15 mm
BAT22/16	M22	16 mm	M22	16 mm
BAT2626	M26	18 mm	M26	18 mm

Blanking Plugs (Steel)

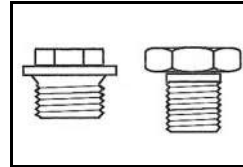

Part Ref	Thread Size
BP10	M10 x 1
BP12	M12 x 1.5
BP14	M14 x 1.5
BP16	M16 x 1.5
BP18	M18 x 1.5
BP22	M22 x 1.5
BP26	M26 x 1.5

As above
C/W Thrust & 'o' Ring



Part Ref	Thread Size
BP10T	M10 x 1
BP12T	M12 x 1.5
BP14T	M14 x 1.5
BP16T	M16 x 1.5
BP18T	M18 x 1.5
BP22T	M22 x 1.5
BP26T	M26 x 1.5

Blanking Plugs (Brass)

C/W 'O' RING



Part Ref	Thread Size
BP12B	M12 x 1.5
BP16B	M16 x 1.5
BP22B	M22 x 1.5
BP26B	M26 x 1.5

Compression Fittings

Branch Stem Tee

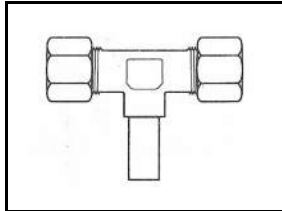

Part Ref	Tube OD	Stem OD
BST6Z	6 mm	6 mm
BST8Z	8 mm	8 mm
BST10Z	10 mm	10 mm
BST12Z	12 mm	12 mm
BST15Z	15 mm	15 mm
BST18Z	18 mm	18 mm

Bulkhead Test Point Tee

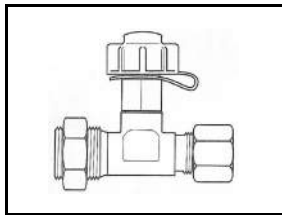

Part Ref	Thread Size	Tube OD
BTP812Z	M12 x 1.5	8 mm
BTP1012Z	M12 x 1.5	10 mm
BTP1016Z	M16 x 1.5	10 mm
BTP1216Z	M16 x 1.5	12 mm
BTP1022Z	M22 x 1.5	10 mm
BTP1222Z	M22 x 1.5	12 mm
BTP1522Z	M22 x 1.5	15 mm

Drain Tap



Part Ref	Thread Size
DT2	1/4"

Equal Bulkhead Coupling

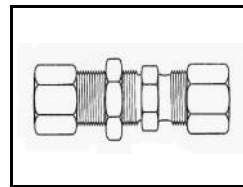

Part Ref	Tube OD
EBC6Z	6 mm
EBC8Z	8 mm
EBC10Z	10 mm
EBC12Z	12 mm
EBC15Z	15 mm
EBC16Z	16 mm
EBC18Z	18 mm

Equal Bulkhead Elbow

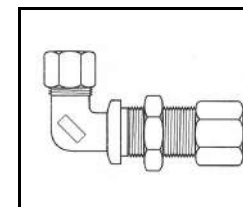

Part Ref	Tube OD
EBE6Z	6 mm
EBE8Z	8 mm
EBE10Z	10 mm
EBE12Z	12 mm
EBE15Z	15 mm
EBE16Z	16 mm
EBE18Z	18 mm

Compression Fittings

Equal Connector

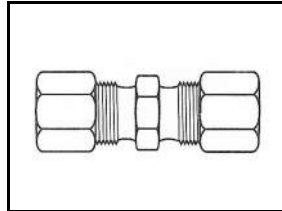

Part Ref	Tube OD	Tube OD
EC6Z	6 mm	6 mm
EC8Z	8 mm	8 mm
EC10Z	10 mm	10 mm
EC12Z	12 mm	12 mm
EC15Z	15 mm	15 mm
EC16Z	16 mm	16 mm
EC18Z	18 mm	18 mm
EC20Z	20 mm	20 mm
EC22Z	22 mm	22 mm

Equal Tee

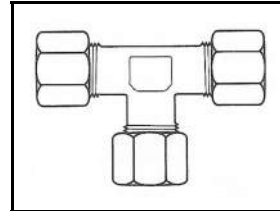

Part Ref	Tube OD	Tube OD	Tube OD
ET6Z	6 mm	6 mm	6 mm
ET8Z	8 mm	8 mm	8 mm
ET10Z	10 mm	10 mm	10 mm
ET12Z	12 mm	12 mm	12 mm
ET15Z	15 mm	15 mm	15 mm
ET16Z	16 mm	16 mm	16 mm
ET18Z	18 mm	18 mm	18 mm
ET20Z	20 mm	20 mm	20 mm
ET22Z	22 mm	22 mm	22 mm

Equal 90° Elbow

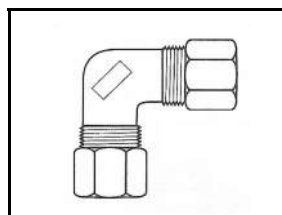

Part Ref	Tube OD	Tube OD
EE6Z	6 mm	6 mm
EE8Z	8 mm	8 mm
EE10Z	10 mm	10 mm
EE12Z	12 mm	12 mm
EE15Z	15 mm	15 mm
EE16Z	16 mm	16 mm
EE18Z	18 mm	18 mm
EE22Z	22 mm	22 mm

Female Adaptor

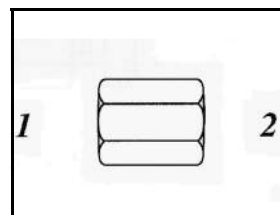

Part Ref	Tread Size 1	Thread Size 2
FFA1612Z	M16 x 1.5	M12 x 1.5
FFA16Z	M16 x 1.5	M16 x 1.5
FFA22Z	M22 x 1.5	M22 x 1.5
FFA226Z	M22 x 1.5	3/8"
FFA227Z	M22 x 1.5	1/2"
FFA2216Z	M22 x 1.5	M16 x 1.5
FFA2218Z	M22 x 1.5	M18 x 1.5

Compression Fittings

Female Stud Couplings

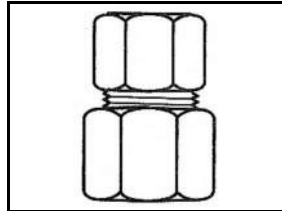

Part Ref	Female Thread	Tube OD
FSC128Z	M12 x 1.5	8 mm
FSC1410Z	M14 x 1.5	10 mm
FSC168Z	M16 x 1.5	8 mm
FSC1610Z	M16 x 1.5	10 mm
FSC1612Z	M16 x 1.5	12 mm
FSC226Z	M22 x 1.5	6 mm
FSC228Z	M22 x 1.5	8 mm
FSC2210Z	M22 x 1.5	10 mm
FSC2212Z	M22 x 1.5	12 mm
FSC2215Z	M22 x 1.5	15 mm
FSC2216Z	M22 x 1.5	16 mm
FSC2218Z	M22 x 1.5	18 mm

Hosetail Stems

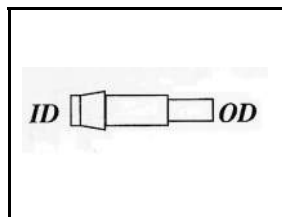

Part Ref	Tube OD	Tube ID
HS106Z	10 mm	3/8"
HS1011Z	10 mm	11 mm
HS1013Z	10 mm	13 mm
HS1211Z	12 mm	11 mm
HS1213Z	12 mm	13 mm

Fixed Hosetails (Steel)

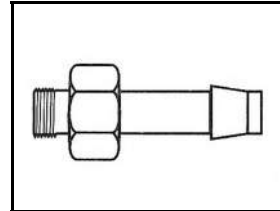

Part Ref	Thread Size	Tube ID
HTS166Z	M16 x 1.5	3/8"
HTS1611Z	M16 x 1.5	11 mm
HTS1613Z	M16 x 1.5	13 mm
HTS2211Z	M22 x 1.5	11 mm
HTS2213Z	M22 x 1.5	13 mm

Fixed Hosetails (Brass)

C/W 'O' Ring

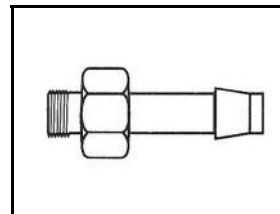

Part Ref	Tread Size	Tube ID
HTS1613B	M16 x 1.5	13 mm
HTS2213B	M22 x 1.5	13 mm

Locking Nuts

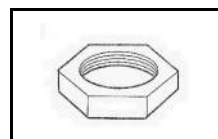

Part Ref	Tread Size
LN12Z	M12 x 1.5
LN14Z	M14 x 1.5
LN16Z	M16 x 1.5
LN18Z	M18 x 1.5
LN22Z	M22 x 1.5
LN26Z	M26 x 1.5

Compression Fittings

Male Female Adaptors (Steel)

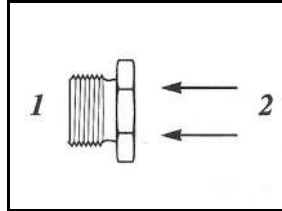

Part Ref	Thread Size 1	Thread Size 2
MFA1610	M16 x 1.5	M10 x 1
MFA1612	M16 x 1.5	M12 x 1.5
MFA222	M22 x 1.5	1/8"
MFA224	M22 x 1.5	1/4"
MFA226	M22 x 1.5	3/8"
MFA2212	M22 x 1.5	M12 x 1.5
MFA2214	M22 x 1.5	M14 x 1.5
MFA2216	M22 x 1.5	M16 x 1.5

Part Ref	Thread Size 1	Thread Size 2
MFA1216	M12 x 1.5	M16 x 1.5
MFA1222	M12 x 1.5	M22 x 1.5
MFA1416	M14 x 1.5	M16 x 1.5
MFA1422	M14 x 1.5	M22 x 1.5
MFA164	M16 x 1.5	1/4"
MFA166	M16 x 1.5	3/8"
MFA167	M16 x 1.5	1/2"
MFA1616	M16 x 1.5	M16 x 1.5
MFA1622	M16 x 1.5	M22 x 1.5
MFA227	M22 x 1.5	1/2"
MFA2218	M22 x 1.5	M18 x 1.5
MFA2622	M26 x 1.5	M22 x 1.5

Male Female Adaptor (Brass)

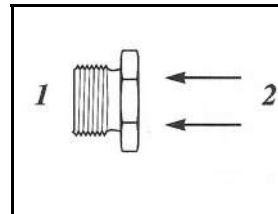
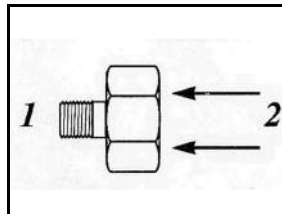

Part Ref	Thread Size 1	Thread Size 2
MFA46	1/4"	3/8"
MFA412	1/4"	M12 x 1.5
MFA416	1/4"	M16 x 1.5
MFA422	1/4"	M22 x 1.5
MFA616	3/8"	M16 x 1.5
MFA622	3/8"	M22 x 1.5
MFA716	1/2"	M16 x 1.5
MFA718	1/2"	M18 x 1.5
MFA722	1/2"	M22 x 1.5

Part Ref	Thread Size 1	Thread Size 2
MFA224B	M22 x 1.5	1/4"
MFA2212B	M22 x 1.5	M12 x 1.5
MFA2216B	M22 x 1.5	M16 x 1.5
MFA2622B	M26 x 1.5	M22 x 1.5

Brass Male Female Adaptors come complete with a built in 'O' Ring

If you require a Steel part complete with a Thrust & 'O' Ring on the male metric side please add a T to the end of the part:

eg: MFA2216 becomes MFA2216T

Compression Fittings

Male Female 90° Elbow

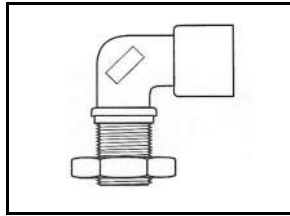

Part Ref	Male Thread	Female Thread
MFE1616Z	M16 x 1.5	M16 x 1.5
MFE2222Z	M22 x 1.5	M22 x 1.5

Male Locking Tee

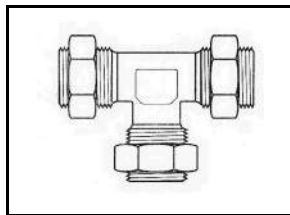

Part Ref	Thread	Thread	Thread
MLT22Z	M22x1.5	M22x1.5	M22x1.5

Male Bulkhead Tee

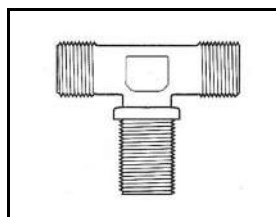

Part Ref	Thread	Thread	Thread
MBT22Z	M22x1.5	M22x1.5	M22x1.5

Male Male Adaptors

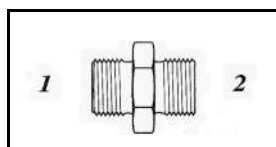

Part Ref	Thread Size 1	Thread Size 2
MMA212Z	1/8"	M12 x 1.5
MMA214Z	1/8"	M14 x 1.5
MMA216Z	1/8"	M16 x 1.5
MMA412Z	1/4"	M12 x 1.5
MMA414Z	1/4"	M14 x 1.5
MMA416Z	1/4"	M16 x 1.5
MMA616Z	3/8"	M16 x 1.5
MMA618Z	3/8"	M18 x 1.5
MMA718Z	1/2"	M18 x 1.5
MMA722Z	1/2"	M22 x 1.5
MMA1012Z	M10 x 1	M12 x 1.5
MMA1014Z	M10 x 1	M14 x 1.5
MMA1016Z	M10 x 1	M16 x 1.5
MMA1212Z	M12 x 1.5	M12 x 1.5
MMA1214Z	M12 x 1.5	M14 x 1.5
MMA1216Z	M12 x 1.5	M16 x 1.5
MMA1218Z	M12 x 1.5	M18 x 1.5
MMA1222Z	M12 x 1.5	M22 x 1.5
MMA1412Z	M14 x 1.5	M12 x 1.5
MMA1414Z	M14 x 1.5	M14 x 1.5
MMA1416Z	M14 x 1.5	M16 x 1.5
MMA1418Z	M14 x 1.5	M18 x 1.5
MMA1422Z	M14 x 1.5	M22 x 1.5
MMA1612Z	M16 x 1.5	M12 x 1.5
MMA1614Z	M16 x 1.5	M14 x 1.5
MMA1616Z	M16 x 1.5	M16 x 1.5
MMA1618Z	M16 x 1.5	M18 x 1.5
MMA1622Z	M22 x 1.5	M22 x 1.5
MMA2212Z	M22 x 1.5	M12 x 1.5
MMA2214Z	M22 x 1.5	M14 x 1.5
MMA2216Z	M22 x 1.5	M16 x 1.5
MMA2218Z	M22 x 1.5	M18 x 1.5
MMA2222Z	M22 x 1.5	M22 x 1.5
MMA2226Z	M22 x 1.5	M26 x 1.5

Compression Fittings

Male Female Adaptors (Steel)

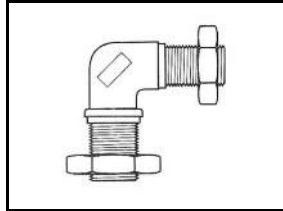

Part Ref	Thread Size 1	Thread Size 2
MME1616Z	M16 x 1.5	M16 x 1.5
MME1622Z	M16 x 1.5	M22 x 1.5
MME2222Z	M22 x 1.5	M22 x 1.5

Male Stud Couplings

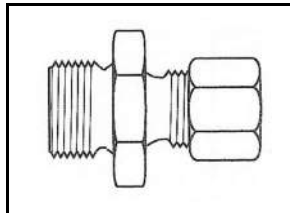

Part Ref	Thread Size	Tube OD
MSC26Z	1/8"	6 mm
MSC28Z	1/8"	8 mm
MSC210Z	1/8"	10 mm
MSC46Z	1/4"	6 mm
MSC48Z	1/4"	8 mm
MSC410Z	1/4"	10 mm
MSC412Z	1/4"	12 mm
MSC610Z	3/8"	10 mm
MSC612Z	3/8"	12 mm
MSC812Z	1/2"	12 mm
MSC815Z	1/2"	15 mm
MSC106Z	M10 x 1	6 mm
MSC108Z	M10 x 1	8 mm
MSC1010Z	M10 x 1	10 mm

Part Ref	Thread Size 1	Thread Size 2
MSC126Z	M12 x 1.5	6 mm
MSC128Z	M12 x 1.5	8 mm
MSC1210Z	M12 x 1.5	10 mm
MSC1212Z	M12 x 1.5	12 mm
MSC146Z	M14 x 1.5	6 mm
MSC148Z	M14 x 1.5	8 mm
MSC1410Z	M14 x 1.5	10 mm
MSC1412Z	M14 x 1.5	12 mm
MSC1415Z	M14 x 1.5	15 mm
MSC166Z	M16 x 1.5	6 mm
MSC168Z	M16 x 1.5	8 mm
MSC1610Z	M16 x 1.5	10 mm
MSC1612Z	M16 x 1.5	12 mm
MSC1615Z	M16 x 1.5	15 mm
MSC1616Z	M16 x 1.5	16 mm
MSC226Z	M22 x 1.5	6 mm
MSC228Z	M22 x 1.5	8 mm
MSC2210Z	M22 x 1.5	10 mm
MSC2212Z	M22 x 1.5	12 mm
MSC2215Z	M22 x 1.5	15 mm
MSC2216Z	M22 x 1.5	16 mm
MSC2218Z	M22 x 1.5	18 mm

If you require a Part Number from the MSC range complete with a Thrust & 'O' Ring, add a T to the end of the Part Number:

eg: MSC1610Z becomes MSC1610ZT

Compression Fittings

Stud Bulkhead Couplings

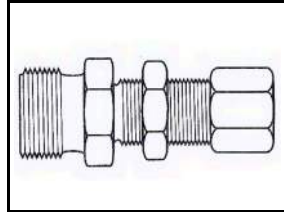

Part Ref	Thread Size	Tube OD
SE16Z	16 mm	16 mm
SE18Z	18 mm	18 mm

Part Ref	Thread Size	Tube OD
SBC126Z	M12 x 1.5	6 mm
SBC168Z	M16 x 1.5	8 mm
SBC1610Z	M16 x 1.5	10 mm
SBC1612Z	M16 x 1.5	12 mm
SBC86Z	1/2"	3/8"
SBC88Z	1/2"	1/2"
SBC228Z	M22 x 1.5	8 mm
SBC2210Z	M22 x 1.5	10 mm
SBC2212Z	M22 x 1.5	12 mm
SBC2215Z	M22 x 1.5	15 mm
SBC2216Z	M22 x 1.5	16 mm
SBC2218Z	M22 x 1.5	18 mm

Stud 90° Elbow

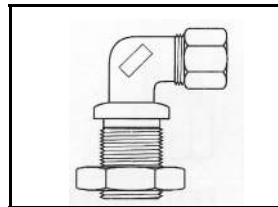

Part Ref	Thread Size	Tube OD
SE210Z	1/8"	10 mm
SE410Z	1/4"	10 mm
SE610Z	3/8"	10 mm
SE128Z	M12 x 1.5	8 mm
SE1210Z	M12 x 1.5	10 mm
SE148Z	M14 x 1.5	8 mm
SE1410Z	M14 x 1.5	10 mm
SE168Z	M16 x 1.5	8 mm
SE1610Z	M16 x 1.5	10 mm
SE1612Z	M16 x 1.5	12 mm
SE1615Z	M16 x 1.5	15 mm
SE228Z	M22 x 1.5	8 mm
SE2210Z	M22 x 1.5	10 mm
SE2212Z	M22 x 1.5	12 mm
SE2215Z	M22 x 1.5	15 mm
SE2216Z	M22 x 1.5	16 mm
SE2218Z	M22 x 1.5	18 mm

Stem 90° Elbows

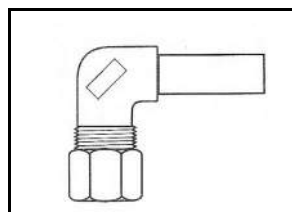

Part Ref	Tube OD	Stem OD
SE6Z	6 mm	6 mm
SE8Z	8 mm	8 mm
SE10Z	10 mm	10 mm
SE12Z	12 mm	12 mm
SE15Z	15 mm	15 mm

Compression Fittings

Shut Off Taps



Part Ref	Thread Size	Thread Size
SOT4	1/4"	1/4"
SOT6	3/8"	3/8"
SOT8	1/2"	1/2"
SOT8Y	1/2"	1/2"

SOT4/6/8 ARE RED
HANDLED
SOT8Y YELLOW HANDLED (GAS)

Stud Run Tees

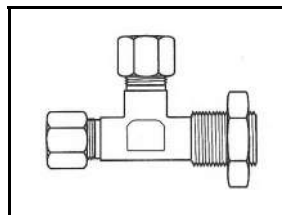

Part Ref	Thread Size	Tube OD
SRT128Z	M12 x 1.5	8 mm
SRT1210Z	M12 x 1.5	10 mm
SRT1212Z	M12 x 1.5	12 mm
SRT168Z	M16 x 1.5	8 mm
SRT1610Z	M16 x 1.5	10 mm
SRT1612Z	M16 x 1.5	12 mm
SRT228Z	M22 x 1.5	8 mm
SRT2210Z	M22 x 1.5	10 mm

Equal Tee

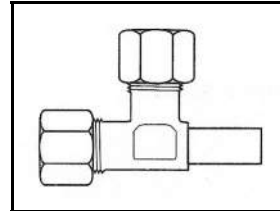

Part Ref	Tube OD	Stem OD
SST6Z	6 mm	6 mm
SST8Z	8 mm	8 mm
SST10Z	10 mm	10 mm
SST12Z	12 mm	12 mm
SST15Z	15 mm	15 mm

Side Tees

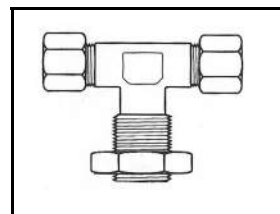

Part Ref	Tread Size	Tube OD
ST1010Z	M10 x 1.5	10 mm
ST126Z	M12 x 1.5	6 mm
ST128Z	M12 x 1.5	8 mm
ST1210Z	M12 x 1.5	10 mm
ST168Z	M16 x 1.5	8 mm
ST1610Z	M16 x 1.5	10 mm
ST1612Z	M16 x 1.5	12 mm
ST226Z	M22 x 1.5	6 mm
ST228Z	M22 x 1.5	8 mm
ST2210Z	M22 x 1.5	10 mm
ST2212Z	M22 x 1.5	12 mm
ST2215Z	M22 x 1.5	15 mm

Compression Fittings



Stem Tube Reducer

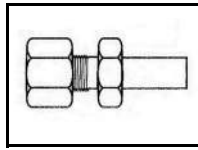

Part Ref	Tube OD	Stem OD
STR86Z	8 mm	6 mm
STR106Z	10 mm	6 mm
STR108Z	10 mm	8 mm
STR126Z	12 mm	6 mm
STR128Z	12 mm	8 mm
STR1210Z	12 mm	10 mm
STR1510Z	15 mm	10 mm

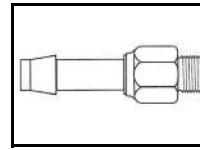

Swivel Hosetails



(Male Thread)

Part Ref	Male Thread	Tube ID
SWHT46Z	1/4"	3/8"
SWHT166Z	M16 x 1.5	3/8"
SWHT168Z	M16 x 1.5	1/2"
SWHT1613Z	M16 x 1.5	13 mm
SWHT228Z	M22 x 1.5	1/2"
SWHT2213Z	M22 x 1.5	13 mm



Stem Studs

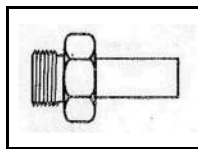

Part Ref	Male Thread	Stem OD
STS1610Z	M16 x 1.5	10 mm
STS1612Z	M16 x 1.5	12 mm
STS2210Z	M22 x 1.5	10 mm
STS2212Z	M22 x 1.5	12 mm

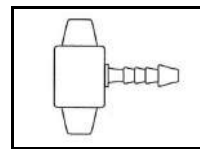

Test Point Adaptors



(TPA2 & TPA3 have a knurled barrel)

Part Ref	Thread	Tube ID
TPA1	M16 x 1.5	3/16" - 5 mm
TPA2	M16 x 1.5	1/4" - 7 mm
TPA3	M16 x 1.5	3/8" - 10 mm



Hosetails

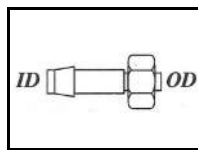

(Swivel Female Nut)

Part Ref	Thread	Tube OD	Hose ID
SWH106Z	M16 x 1.5	10 mm	3/8"
SWH109Z	M16 x 1.5	10 mm	9 mm
SWH1011Z	M16 x 1.5	10 mm	11 mm
SWH1013Z	M16 x 1.5	10 mm	13 mm
SWH1213Z	M18 x 1.5	12 mm	13 mm

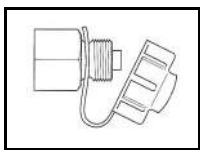

Test Point



(Female Test Points)

Part Ref	Female Thread	Male Thread
TPF12	M12 x 1.5	M16 x 1.5
TPF14	M14 x 1.5	M16 x 1.5
TPF16	M16 x 1.5	M16 x 1.5
TPF18	M18 x 1.5	M16 x 1.5
TPF22	M22 x 1.5	M16 x 1.5

Compression Fittings

Male Test Points

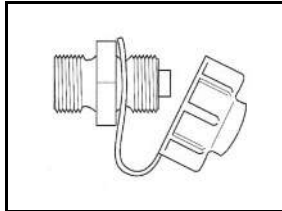

Part Ref	Thread Size	Thread Size
TPM12T	M12 x 1.5	M16 x 1.5
TPM14	M14 x 1.5	M16 x 1.5
TPM16T	M16 x 1.5	M16 x 1.5
TPM22T	M22 x 1.5	M16 x 1.5
TPM25	1/4"	M16 x 1.5

Part Number with a 'T' at the end comes complete with seal

Tilt Taps

(C/W Pull Ring)



Part Ref	Thread Size
TT3T	M22 x 1.5

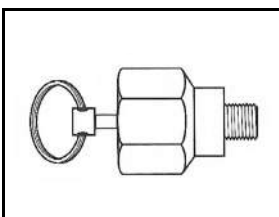

Above Part Number comes complete with seal

Tilt Taps



Part Ref	Thread Size
TT4	M22 x 1.5

Part Number without Pull Ring

Tilt Taps



Part Ref	Thread Size
TTC3	M22 x 1.5

Part Number complete with 6ft Stainless Steel Cable

Tee Test Points

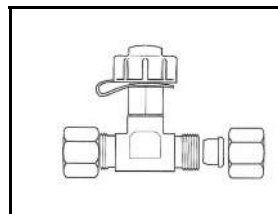

Part Ref	Tube OD	Tube OD
TTP8	8 mm	8 mm
TTP10	10 mm	10 mm
TTP12	12 mm	12 mm
TTP15	15 mm	15 mm

Compression Fittings

Aluminium Sealing Ring



Part Ref	Thread Size
AL10	M10 x 1
AL12	M12 x 1.5
AL14	M14 x 1.5
AL16	M16 x 1.5
AL22	M22 x 1.5
AL26	M26 x 1.5

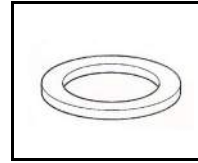
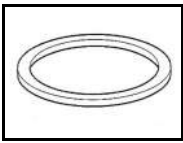

**Fibre
Seals**



Part Ref	Tube OD	ID	OD
FS1219	15 mm	12 mm	19 mm
FS1420	16 mm	14 mm	20 mm

Bonding Seals



Part Ref	Thread Size
Imperial sizes available upon request	
BS10	M10 x 1
BS12	M12 x 1.5
BS14	M14 x 1.5
BS16	M16 x 1.5
BS18	M18 x 1.5
BS22	M22 x 1.5
BS26	M26 x 1.5

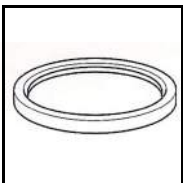

Olives (Cutting Rings)



(Brass)

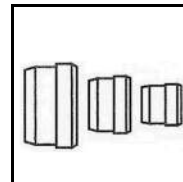

Part Ref	Tube OD
O6B	6 mm
O8B	8 mm
O9B	9 mm
O10B	10 mm
O12B	12 mm
O15B	15 mm
O16B	16 mm
O18B	18 mm
O20B	20 mm

Copper Sealing Rings



Part Ref	Thread Size
CRI1	1/8"
CR6	M6 x 1
CR8	M8 x 1
CR10	M10 x 1
CR12	M12 x 1.5
CR14	M14 x 1.5
CR16	M16 x 1.5
CR18	M18 x 1.5
CR20	M20 x 1.5
CR22	M22 x 1.5
CR26	M26 x 1.5
CR32	M32 x 1.5



'O' Rings



Part Ref	Thread Size
OR10	M10 x 1
OR12	M12 x 1.5
OR14	M14 x 1.5
OR16	M16 x 1.5
OR18	M18 x 1.5
OR22	M22 x 1.5
OR26	M26 x 1.5

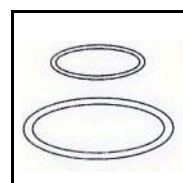

Used with 'TR' Range on following page

Compression Fittings

Tube Inserts (Metric)



Part Ref	Tube ID
TI4	4 mm
TI6	6 mm
TI7	7 mm
TI7.5	7.5 mm
TI8	8 mm
TI9	9 mm
TI10	10 mm
TI11	11 mm
TI12	12 mm
TI14	14 mm

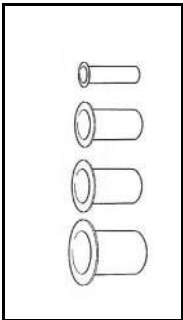

Tube Nuts

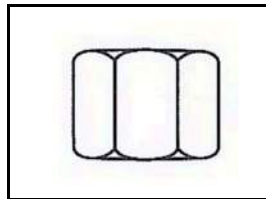

Part Ref	Thread Size	Tube OD
TN4Z	M10 x 1	4 mm
TN6Z	M12 x 1.5	6 mm
TN8Z	M14 x 1.5	8 mm
TN9Z	M14 x 1.5	9 mm
TN10Z	M16 x 1.5	10 mm
TN12Z	M18 x 1.5	12 mm
TN15Z	M22 x 1.5	15 mm
TN16Z	M22 x 1.5	16 mm
TN18Z	M26 x 1.5	18 mm
TN20Z	M30 x 2	20 mm
TN22Z	M30 x 2	22 mm

Tube Inserts (Imperial)

Part Ref	Tube OD	Tube ID
TII4	1/4"	.170
TII5	5/16"	.212
TII6	3/8"	.265
TII8	1/2"	.375

Thrust Rings

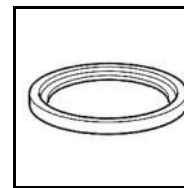

Part Ref	Thread Size
TR10	M10 x 1
TR12	M12 x 1.5
TR14	M14 x 1.5
TR16	M16 x 1.5
TR18	M18 x 1.5
TR22	M22 x 1.5
TR26	M26 x 1.5

Thrust Rings and 'O' Rings are used in conjunction with each other, resulting in a sealed connection



'O' Ring must sit in recess

Thrust & 'O' Ring

Thrust and 'O' rings are also supplied in mixed packs of ten using a combined Part Number.

For example a packet with both ten TR16 and ten OR16, the Part Number would be: TROR16

ASSORTED DISPLAY BOXES

Part Ref: ABCS1



Compression Equal Connectors

Contents Includes:

EC6Z x 3 (6 mm)	EC12X x 2 (12 mm)	EC18Z x 1 (18 MM)
EC8Z x 3 (8 mm)	EC15Z x 1 (15 mm)	
EC10Z x 3 (10 mm)	EC16Z x 1 (16 mm)	

Part Ref: TRA1



Thrust & 'O' Rings

Contents Includes:

TR10 x 25 (10 mm)	TR14 x 25 (14 mm)	TR22 x 25 (22 mm)
OR10 x 25 (10 mm)	OR14 x 25 (14 mm)	OR22 x 25 (22 mm)
TR12 x 25 (12 mm)	TR16 x 25 (16 mm)	
OR12 x 25 (12 mm)	OR16 x 25 (16 mm)	

Part Ref: OLA1



Olives (Cutting Rings)

Contents Includes:

O6B x 20 (6 mm)	O12B x 20 (12 mm)	O18B x 10 (18 mm)
O8B x 20 (8 mm)	O15B x 10 (15 mm)	
O10B x 20 (10 mm)	O16B x 10 (16 mm)	

Part Ref: TIA1



Tube Inserts

Contents Includes:

TI4 x 25 (4 mm)	TI8 x 25 (8 mm)	TI12 x 10 (12 mm)
TI6 x 25 (6 mm)	TI9 x 25 (9 mm)	TI14 x 10 (14 mm)
TI7 x 25 (7 mm)	TI10 x 10 (10 mm)	
TI7.5 x 25 (7.5 mm)	TI11 x 10 (11 mm)	

Palms & Valves

Palm Coupling (Universal)

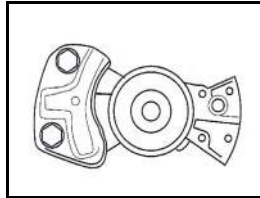

Part Ref	Thread Size
PALM7	1/2" BSP
PALM16	M16 x 1.5
PALM22	M22 x 1.5

Palm Coupling (Operating)

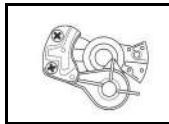

Part Ref	Thread Size
PALM7R	1/2" BSP
PALM7Y	1/2" BSP
PALM16R	M16 x 1.5
PALM16Y	M16 x 1.5
PALM22R	M22 x 1.5
PALM22Y	M22 x 1.5

Palm Coupling (Auto Self Seal)

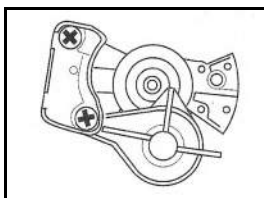

Part Ref	Thread Size
PALM16RA	M16 x 1.5
PALM16YA	M16 x 1.5
PALM22RA	M22 x 1.5
PALM22YA	M22 x 1.5

In Line Filters



Part Ref	Thread Size
ILF22	M22 x 1.5

Park Valve



Part Ref	Thread Size
PV16	M16 x 1.5

Shunt Valve



Part Ref	Thread Size
SV16	M16 x 1.5

Double Check Valve



Part Ref	Thread Size
DCV	M16 x 1.5

Section 7

Brass Compression



.....

.....

.....

.....

.....

.....

.....

.....

Brass Compression

Universal Stepped Olive



Part Ref	Tube OD
----------	---------

Metric

1021	4 mm
1045	5 mm
1022	6 mm
1023	8 mm
1049	9 mm
1024	10 mm
1041	11 mm
1025	12 mm
1026	13 mm
1027	14 mm
1028	15 mm
1029	16 mm

Part Ref	Tube OD
----------	---------

Imperial

1001	1/8"
1002	5/32"
1003	3/16"
1004	1/4"
1005	5/16"
1006	3/8"
1007	1/2"
1008	5/8"
1009	3/4"

Universal Olive



Part Ref	Tube OD
----------	---------

Imperial

1086	1/8"
1087	3/16"
1088	1/4"
1089	5/16"
1090	3/8"
1091	1/2"
1092	3/4"

Part Ref	Tube OD
----------	---------

Metric

1112	4 mm
1113	5 mm
1114	6 mm
1115	8 mm
1116	10 mm
1117	12 mm

Barrel Olive



Part Ref	Tube OD
----------	---------

Imperial

1011	1/8"
1012	5/32"
1013	3/16"
1014	1/4"
1015	5/16"
1016	3/8"
1017	1/2"
1018	5/8"
1019	3/4"

Part Ref	Tube OD
----------	---------

Metric

1031	4 mm
1032	6 mm
1033	8 mm
1034	10 mm
1035	12 mm
1036	13 mm
1037	14 mm
1038	15 mm
1039	16 mm

Straight Joiners



Part Ref	Tube OD
----------	---------

Metric

1311	4 mm
1325	5 mm
1322	6 mm
1333	8 mm
1329	9 mm
1344	10 mm
1301	11 mm
1355	12 mm
1366	13 mm
1377	14 mm
1388	15 mm
1399	16 mm

Part Ref	Tube OD
----------	---------

Imperial

1211	1/8"
1222	5/32"
1233	3/16"
1244	1/4"
1255	5/16"
1266	3/8"
1277	1/2"
1288	5/8"
1299	3/4"

Brass Compression

Unequal Joiners



Part Ref	Tube OD	Part Ref	Tube OD
Imperial		Metric	
1231	3/16" x 1/8"	1365	6 x 5 mm
1241	1/4" x 1/8"	1385	8 x 5 mm
1243	1/4" x 3/16"	1386	8 x 6 mm
1253	5/16" x 3/16"	1345	10 x 5 mm
1254	5/16" x 1/4"	1346	10 x 6 mm
1264	3/8" x 1/4"	1348	10 x 8 mm
1265	3/8" x 5/16"	1356	12 x 6 mm
1274	1/2" x 1/4"	1358	12 x 8 mm
1275	1/2" x 5/16"	1354	12 x 10 mm
1276	1/2" x 3/8"		

Equal Tees



Part Ref	Tube OD	Part Ref	Tube OD
Imperial		Metric	
1411	1/8"	1501	4 mm
1422	5/32"	1505	5 mm
1433	3/16"	1506	6 mm
1444	1/4"	1508	8 mm
1455	5/16"	1509	9 mm
1456	3/8"	1510	10 mm
1477	1/2"	1511	11 mm
1488	5/8"	1512	12 mm
1499	3/4"	1513	13 mm
		1514	14 mm
		1515	15 mm
		1516	16 mm

Equal Elbows



Part Ref	Tube OD	Part Ref	Tube OD
Imperial		Metric	
1611	1/8"	1701	4 mm
1622	5/32"	1705	5 mm
1633	3/16"	1706	6 mm
1644	1/4"	1708	8 mm
1655	5/16"	1709	9 mm
1666	3/8"	1710	10 mm
1677	1/2"	1711	11 mm
1688	5/8"	1712	12 mm
1699	3/4"	1713	13 mm
		1714	14 mm
		1715	15 mm
		1716	16 mm

Male / Female Adaptors



Part Ref	Male Thread	Female Thread
Taper		
1442	1/4"	1/8"
1464	3/8"	1/4"
1474	1/2"	1/4"
1476	1/2"	3/8"
1497	3/4"	1/2"
1519	1"	3/4"

Brass Compression

Male Stud Couplings



Part Ref	Thread	Tube OD
Taper		
1811	1/8"	1/8"
1812	1/8"	5/32"
1813	1/8"	3/16"
1814	1/8"	1/4"
1815	1/8"	5/16"
1816	1/8"	3/8"
1841	1/4"	1/8"
1843	1/4"	3/16"
1844	1/4"	1/4"
1845	1/4"	5/16"
1846	1/4"	3/8"
1847	1/4"	1/2"
1864	3/8"	1/4"
1865	3/8"	5/16"
1866	3/8"	3/8"
1867	3/8"	1/2"
1874	1/2"	1/4"
1875	1/2"	5/16"
1876	1/2"	3/8"
1877	1/2"	1/2"
1879	1/2"	3/4"
1897	3/4"	1/2"
1899	3/4"	3/4"

Part Ref	Thread	Tube OD
Taper		
1911	1/8"	4 mm
1915	1/8"	5 mm
1916	1/8"	6 mm
1918	1/8"	8 mm
1910	1/8"	10 mm
1941	1/4"	4 mm
1945	1/4"	5 mm
1946	1/4"	6 mm
1948	1/4"	8 mm
1940	1/4"	10 mm
1942	1/4"	12 mm
1966	3/8"	6 mm
1968	3/8"	8 mm
1960	3/8"	10 mm
1962	3/8"	12 mm
1976	1/2"	6 mm
1978	1/2"	8 mm
1970	1/2"	10 mm
1972	1/2"	12 mm
1975	1/2"	15 mm
1979	1/2"	16 mm
1992	3/4"	12 mm

Brass Compression

Stud Elbows



Part Ref	Thread	Tube OD
Taper		
1722	1/8"	5/32"
1723	1/8"	3/16"
1724	1/8"	1/4"
1725	1/8"	5/16"
1743	1/4"	3/16"
1744	1/4"	1/4"
1745	1/4"	5/16"
1746	1/4"	3/8"
1747	1/4"	1/2"
1765	3/8"	5/16"
1766	3/8"	3/8"
1767	3/8"	1/2"
1776	1/2"	3/8"
1777	1/2"	1/2"
1779	1/2"	3/4"
1799	3/4"	3/4"

Part Ref	Thread	Tube OD
Taper		
1924	1/8"	4 mm
1925	1/8"	5 mm
1926	1/8"	6 mm
1928	1/8"	8 mm
1920	1/8"	10 mm
1929	1/4"	4 mm
1930	1/4"	5 mm
1931	1/4"	6 mm
1932	1/4"	8 mm
1933	1/4"	10 mm
1934	1/4"	12 mm
1935	3/8"	6 mm
1936	3/8"	8 mm
1937	3/8"	10 mm
1938	3/8"	12 mm
1951	1/2"	10 mm
1952	1/2"	12 mm
1953	1/2"	15 mm
1954	1/2"	16 mm

Blanking Plugs

Part Ref	Thread
Taper	
1402	1/8"
1404	1/4"
1406	3/8"
1407	1/2"
1409	3/4"
1410	1"



Female Sockets

Part Ref	Thread
1200	1/8"
1202	1/4"
1205	3/8"
1208	1/2"



Section 8

Malleable Range

Malleable Iron / Steel Fittings - Sealants



.....

.....

.....

.....

.....

.....

.....

.....

Malleable Iron / Steel Fittings

Part Ref	Thread
MIBP802	1/8"
MIBP804	1/4"
MIBP806	3/8"
MIBP808	1/2"
MIBP812	3/4"
MIBP816	1"

Blanking Plugs



Part Ref	Thread
MIFE622	1/8"
MIFE644	1/4"
MIFE666	3/8"
MIFE688	1/2"
MIFE612	3/4"
MIFE616	1"

Female Equal Elbows



Part Ref	Thread
MIFR442	1/4" x 1/8"
MIFR464	3/8" x 1/4"
MIFR484	1/2" x 1/4"
MIFR486	1/2" x 3/8"
MIFR124	3/4" x 1/4"
MIFR128	3/4" x 1/2"

Reducing Female Sockets



Part Ref	Thread
MIFS422	1/8"
MIFS444	1/4"
MIFS466	3/8"
MIFS488	1/2"
MIFS412	3/4"
MIFS416	1"

Female Sockets



Part Ref	Thread
MIMF722	1/8"
MMF744	1/4"
MIMF766	3/8"
MIMF788	1/2"
MIMF712	3/4"
MIMF716	1"

Male / Female Elbows



All Malleable Iron products are suitable for all industrial uses such as, air, gas, water, diesel, petrol

Can also be used in airbrake applications

Malleable Iron / Steel Fittings

Part Ref	Thread
MIHN522	1/8"
MIHN544	1/4"
MIHN566	3/8"
MIHN588	1/2"
MIHN512	3/4"
MIHN516	1"

Hexagon Nipples



Part Ref	Thread
MIHN542	1/4" x 1/8"
MIHN546	1/4" x 3/8"
MIHN548	1/4" x 1/2"
MIHN568	3/8" x 1/2"
MIHN812	1/2" x 3/4"
MIHN1216	3/4" x 1"

Hexagon Reducing Nipples



Part Ref	Thread
MIRB342	1/4" x 1/8"
MIRB362	3/8" x 1/8"
MIRB364	3/8" x 1/4"
MIRB382	1/2" x 1/8"
MIRB384	1/2" x 1/4"
MIRB386	1/2" x 3/8"
MIRB3124	3/4" x 1/4"
MIRB3126	3/4" x 3/8"
MIRB3128	3/4" x 1/2"
MIRB1612	1" x 3/4"

Reducing Bushes



Part Ref	Thread
MIT322	1/8"
MIT344	1/4"
MIT366	3/8"
MIT388	1/2"
MIT312	3/4"

Female Tees



Suitable for all industrial uses such as, air, gas, water, diesel, petrol

Can also be used in airbrake applications

BRAKE PIPE SEALANT / P.T.F.E TAPE



Part Ref: BPS100

(100 ml / 65g)

Brake & Pipe Sealant is PTFE modified and aerobic adhesive for sealing pipe fittings and threaded joints.

It replaces PTFE and Yarn, etc.

Produces an instant seal against moderate pressures and retains a flexible cured film.



Part Ref: PTFE1

(12 mm / 12 mtr)

PTFE sealing tape ensures air tight sealing on all type of thread seals.

PTFE aids prevention of corrosive or electrolytic reaction between metal threaded components.

TEL: 01474 535456 / FAX: 01474 537323
sales@airbrakeconnections.co.uk

Section 9

Brake Pipe Fittings - Bleed Screws



-
-
-
-
-
-
-
-

Brake Pipe Fittings

Male Pipe Nuts

Part Ref	Thread	Length
----------	--------	--------

3/16" 4.75 mm Tube Size

8001	3/8" x 24 TPI	21 mm
8002	3/8" x 20 TPI	23 mm
8020	3/8" x 24 TPI (TTE Short)	16 mm
8022	3/8" x 24 TPI (TTE Long)	21 mm
8015	7/16" x 24 TPI	20 mm
8019	7/16" x 20 TPI	22 mm
8003	10 x 1.25 mm (Long)	20 mm
8004	10 x 1.25 mm (Short)	17 mm
8023	10 x 1.25 mm TTE	21 mm
8005	10 x 1 mm Long	23 mm
8006	10 x 1 mm Long TTE	22 mm
8007	10 x 1 mm Short	16 mm
8008	10 x 1 mm TTE	16 mm
8009	12 x 1 mm	21 mm

1/4" 6 mm Tube Size

8010	7/16" x 20 TPI	24 mm
8016	1/2" x 20 TPI	27 mm
8021	1/2" x 20 TPI (Short)	18 mm

Female Nuts

Part Ref	Thread	Length
----------	--------	--------

3/16" 4.75 mm Tube Size

8101	3/8" x 24 TPI	17 mm
8102	10 x 1 mm	18 mm
8107	12 x 1 mm	20 mm

1/4" 6 mm Tube Size

8103	7/16" x 20 TPI	24 mm
8108	12 x 1 mm	19 mm

5/16" 8 mm Tube Size

8104	1/2" x 20 TPI	22 mm
------	---------------	-------



Part Ref	Thread	Length
----------	--------	--------

8018	12 x 1 mm	21 mm
8025	12 x 1 mm	39 mm
8028	14 x 1.5 mm	25 mm

5/16" 8 mm Tube Size

8011	1/2" x 20 TPI	28 mm
8012	1/2" x 20 TPI (Short)	23 mm
8024	1/2" x 20 TPI	18 mm
8026	14 x 1.5 mm	26 mm

3/8" 10 mm Tube Size

8013	5/8" x 18 TPI	20 mm
------	---------------	-------

10 mm Tube Size

8027	M16 x 1.5 mm	27 mm
------	--------------	-------

1/2" 12.7 mm Tube Size

8014	3/4" x 16 TPI	27 mm
------	---------------	-------



Part Ref	Thread	Length
----------	--------	--------

3/8" 10 mm Tube Size

8105	5/8" x 18 TPI	25 mm
------	---------------	-------

1/2" 12.7 mm Tube Size

8106	3/4" x 16 TPI	
------	---------------	--

Brake Pipe Fittings - Bleed Screws

3 Way Connector

Part Ref	Thread
8303	3/8" x 24 TPI
8305	10 x 1 mm



Male Connectors

Part Ref	Thread
8200	10 x 1 mm
8201	3/8" x 24 TPI



Female Connectors

Part Ref	Thread
8301	3/8" x 24 TPI
8302	10 x 1 mm
8307	12 x 1 mm



Flaring Tool and Accessories Kit available
upon request in Metric & Imperial

Part Ref	Thread	Length
8406	1/4" x 28 TPI	28 mm
8401	3/8" x 24 TPI	32 mm
8408	3/8" x 24 TPI	37 mm
8407	7/16" x 20 TPI	37 mm
8402	10 x 1 mm	30 mm
8403	10 x 1 mm	37 mm
8411	10 x 1 mm	27 mm
8405	8 x 1.25 mm	28 mm
8404	7 x 1 mm	28 mm
8410	6 x 1 mm	37 mm
8409	6 x 1 mm	28 mm

Bleed Screws Metric / Imperial



Section 10

Grease Nipples - Accessories

Grease Nipples - Diaphragms - Silencers - Pressure Switches



.....

.....

.....

.....

.....

.....

.....

.....

Grease Nipples

Straights



Part Ref	Thread
GN2	1/8" BSP
GN4	1/4" BSP
GN4UNF	1/4" UNF
GN5BSF	5/16" BSP
GN6	6 x 1 mm
GN8	8 x 1 mm
GN8125	8 x 1.25 mm
GN101	10 x 1 mm
GN10125	10 x 1.25 mm
GN1015	10 x 1.5 mm

90 Degree



Part Ref	Thread
GN902	1/8" BSP
GN904	1/4" UNF
GN9061	6 x 1 mm
GN9081	8 x 1 mm
GN90101	10 x 1 mm
GN901015	10 x 1.5 mm

Hook On



Part Ref	Thread
GNHO1	1/8" BSP

45 Degree



Part Ref	Thread
GN452	1/8" BSP
GN454	1/4" BSP
GN545BSF	5/16" BSP
GN4561	6 x 1 mm
GN4581	8 x 1 mm
GN45101	10 x 1 mm
GN4510125	10 x 1.25 mm
GN451015	10 x 1.5 mm

Assorted box of Grease Nipples:
Part Ref: GNAB

Extension



Part Ref	Thread
GNEXT	1/8" BSP



Grease Gun
Part Ref: GGU

11" Grease Gun Hose / Part: GGH11R

20" Grease Gun Hose / Part: GGH20R

12" Grease Gun Flexi Hose / Part: GFH12

Diaphragms - Silencers - Switches

SERVICE

Part Ref	Type
DS9	9
DS12	12
DS16	16
DS20	20
DS24	24
DS30	30
DS36	36



LONG STROKE

Part Ref	Type
DLS9	9
DLS12	12
DLS16	16
DLS20	20
DLS24	24
DLS30	30
DLS36	36

SILENCERS



Sintered Bronze

Part Ref	Thread
MS1	1/8"
MS2	1/4"
MS3	3/8"
MS4	1/2"

Flat and Coned Silencers are also available

PRESSURE SWITCHES & BOOTS



Hexagon

Part Ref	Thread
PS1	1/8"



Knurled

Part Ref	Thread
PS2	1/8"



Part Ref	To Suit
PS1B	PS1



Part Ref	To Suit
PS2B	PS2

Section 11



PCL Air Coupling and Garage / Workshop Accessories



.....

.....

.....

.....

.....

.....

.....

.....

Hose Connector / Repairer

Part Ref	Hose ID
903	1/4"
904	5/16"
905	3/8"
906	1/2"



Slim-line Coupling

Male Thread

Part Ref	Thread
921	1/4"



Female Thread

Part Ref	Thread
920	1/4"



Standard Airflow Coupling (Quick Release)

Male Thread

Part Ref	Thread
915	1/4"
916	3/8"
917	1/2"



Female Thread

Part Ref	Thread
918	1/4"
919	3/8"
914	1/2"



Standard Bayonet Fittings

Male Thread

Part Ref	Thread
925	1/4"
926	3/8"



Female Thread

Part Ref	Thread
928	1/4"



Standard Safety Bayonet Male Thread

Part Ref	Thread
924	1/4"



Hose Tailpiece

Part Ref	Hose ID
915HT	1/4"
916HT	3/8"
917HT	1/2"

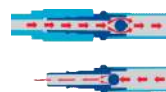

Allows to vent
Safely

Hose / Bayonet Connector

Part Ref	Hose ID
927	3/16"
929	1/4"
930	5/16"
931	3/8"



Twin 'Y' Connector

Part Ref	Type
950	Standard
951	Slim-line



Safe-flow Safety Coupling



Part Ref	Thread Type	Thread
915 / SC	Male	1/4"
916 / SC	Male	3/8"
917 / SC	Male	1/2"
918 / SC	Female	1/4"
919 / SC	Female	3/8"
914 / SC	Female	1/2"

Safe-flow offers a two stage self-venting release, totally eliminating the dangers of hose whip.

60 Series

60 Series Coupling

Male Thread

Part Ref	Thread
915 / 60	1/4"
916 / 60	3/8"
917 / 60	1/2"



Female Thread

Part Ref	Thread
918 / 60	1/4"
919 / 60	3/8"
935 / 60	1/2"



60 Series Bayonet Fitting

Male Thread

Part Ref	Thread
925 / 60	1/4"
926 / 60	3/8"



Female Thread

Part Ref	Thread
928 / 60	1/4"



60 Series Hose / Bayonet Connector

Part Ref	Hose ID
930 / 60	5/16"
931 / 60	3/8"
940 / 60	1/2"



100 Series Coupling

Male Thread

Part Ref	Thread
932	3/8"
933	1/2"



Female Thread

Part Ref	Thread
934	3/8"
935	1/2"



100 Series Bayonet Fittings

Male Thread

Part Ref	Thread
936	3/8"
937	1/2"



Female Thread

Part Ref	Thread
938	3/8"



100 Series Hose / Bayonet Connector

Part Ref	Hose ID
939	3/8"
940	1/2"



Hose Tails



Part Ref	Thread	Hose ID	
		Imperial	Metric
943	1/4"	3/16"	4.75 mm
944	1/4"	1/4"	6.35 mm
945	1/4"	5/16"	7.9 mm
946	1/4"	3/8"	9.5 mm
947	1/4"	1/2"	12.7 mm
964	3/8"	1/4"	6.35 mm
965	3/8"	5/16"	7.9 mm
966	3/8"	3/8"	9.5 mm
967	3/8"	1/2"	12.7 mm
976	1/2"	3/8"	9.5 mm
977	1/2"	1/2"	12.7 mm

'Y' Adaptor

Part Ref	Thread
922	1/4"
923	3/8"





Nylon Coil

**Forecourt,
Garage, Workshop**

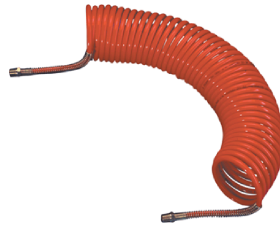

Part Ref: 910

25ft Coil Complete with
Swivel 1/4" Bsp Male Ends

Palm Blowgun

**Robust and compact
design and easy to fit
with additional nozzle
range**



Part Ref: 954 (Conical)

Part Ref: 955 (Safety)

Pistol Blowgun

**Robust and compact
design and easy to fit
with additional nozzle
range**



Part Ref: 956

Supplied with Conical and
Safety Nozzle

Blowgun Nozzles

Part Ref: 960

Extension (9")



Part Ref: 961

Conical



Part Ref: 962

Safety



Plastic Blowgun

Part Ref: 970

Conical Nozzle



**Plastic Blowgun
(Extended)**

Part Ref: 971

Conical Nozzle



Tyre Valve Connections

Twin Connectors (HOLD ON)

Open End
Part Ref: 988

Closed End
Part Ref: 989



Twin Connectors (CLIP ON)

Open End
Part Ref: 990

Closed End
Part Ref: 991



Clip-On Connectors (1/4" Hose ID)

Open End
Part Ref: 992

Closed End
Part Ref: 993

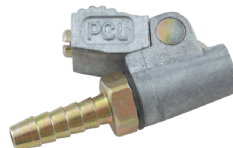

Clip-On Connectors (3/16" Hose ID)

Open End
Part Ref: 994

Closed End
Part Ref: 995

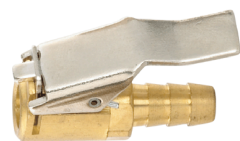

Euro Style Connector (3/16" Hose ID)

Open End
Part Ref: 998

Tyre Pressure Gauges



Part Ref: 981

A Pocket Gauge, Service type with twin head

10-120 lbf/in²



Part Ref: 982

A Pocket Gauge, Low pressure type with angled head

2-20 lbf/in²



Part Ref: 983

A Pocket Gauge, with In-line head

6-50 lbf/in²



Part Ref: 984

A Pocket Gauge, Service type with angled head

10-120 lbf/in²



Part Ref: 985

Universal Service Gauge with twin head

10-160 lbf/in²



Part Ref: 986

A Heavy Duty Gauge, Universal Service type with twin head & rubber handled

10-160 lbf/in²



Part Ref: 969

Tyre Depth Gauge: Measures tread of 1-26mm in 1mm increments (1.6mm mark)

Section 12

Couplings

**Couplings - Testers - Gauges - Palms - Filters -
Valves - Locks - Accessories**



.....

.....

.....

.....

.....

.....

.....

.....

Couplings

(TRACTOR)



(TRAILER)



EMERGENCY

Part Ref

SSVCA7IR

SSVCA22IR

Part Ref

FC7IR

FC22IR

Part Ref

MC7IR

MC22IR

Thread Size

1/2" BSP

M22 x 1.5



AUXILIARY

Part Ref

SSVCA7IR

SSVCA22IR

Part Ref

FCA7IR

FCA22IR

Part Ref

MCA7IR

MCA22IR

Part Ref

1/2" BSP

M22 x 1.5



SERVICE

Part Ref

SSV7IR

SSV22IR

Part Ref

MC7IR

MC22IR

Part Ref

FCOV7IR

FCOV22IR

Part Ref

1/2" BSP

M22 x 1.5

OR



SERVICE

Part Ref

SSV7IR

SSV22IR

Part Ref

MC7IR

MC22IR

Part Ref

FC7IR

FC22IR

Part Ref

OV7IR

OV22IR

Part Ref

1/2" BSP

M22 x 1.5

TEL: 01474 535456 / FAX: 01474 537323

sales@airbrakeconnections.co.uk

Couplings

BRITISH STANDARD BSAU138b:2000

(TRACTOR)



(TRAILER)



EMERGENCY

Part Ref
SSVCA16FH
SSVCA22FH

Part Ref
MC16FH
MC22FH

Thread
M16 x 1.5
M22 x 1.5



SERVICE

Part Ref
SSV16FH
SSV22FH

Part Ref
FCOV16FH
FCOV22FH

Thread
M16 x 1.5
M22 x 1.5

The British Standard BSAU138a:1980 for 'C' type couplings assemblies has been superseded by BSAU138b:2000, which addresses the concerns of U.K haulage industry, with regard to quality and compatibility of couplings currently in use.

The new standard requires one piece couplings that cannot be readily de-assembled, and meets improved valve lift dimensions ensuring adequate airflow (See one piece BSAU138b:2000 above).

Complete Coil Coupling Kit

**FITTED WITH NEW BSAU138b:2000
STANDARD COUPLINGS**

Part Ref: ABCA1

Emergency Line



Service Line



Provides vehicle safety, lower operational costs & 'Peace of Mind'.
Specify coupling kits from Air Brake Connections meet the new standard and are
manufactured and tested by the principal supplier and designers.

ABCA1 Kit consists of the following:

1 x Din Red 22 Turn x M22 x 1.5 Air Coil	1 x Din Red 22 Turn x M22 x 1.5 Air Coil
1 x self Seal Valve M22 x 1.5 (SSVCA22FH)	1 x self Seal Valve M22 x 1.5 (SSVCA22FH)
1 x Male 'c' M22 x 1.5 (MC22FH)	1 x Male 'c' M22 x 1.5 (MC22FH)



Benefits:

- Reduces fitting time.
- No tools required.
- Couplings supplied tested.
- Din spec euro coils c/w spring guard.
- Colour coded standards attached to couplings.
- Eliminates leakage.
- Reduce chance of tampering.



TEL: 01474 535456 / FAX: 01474 537323
sales@airbrakeconnections.co.uk

Palms & Valves

Palm Coupling (Universal)

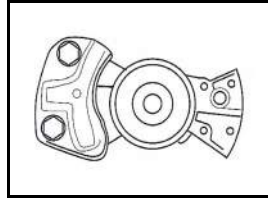

Part Ref	Thread Size
PALM7	1/2" BSP
PALM16	M16 x 1.5
PALM22	M22 x 1.5

Palm Coupling (Operating)

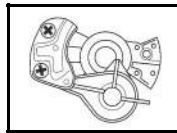

Part Ref	Thread Size
PALM7R	1/2" BSP
PALM7Y	1/2" BSP
PALM16R	M16 x 1.5
PALM16Y	M16 x 1.5
PALM22R	M22 x 1.5
PALM22Y	M22 x 1.5

Palm Coupling (Auto Self Seal)

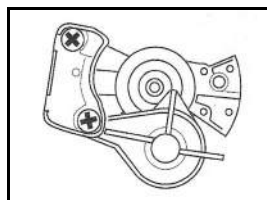

Part Ref	Thread Size
PALM16RA	M16 x 1.5
PALM16YA	M16 x 1.5
PALM22RA	M22 x 1.5
PALM22YA	M22 x 1.5

In Line Filters



Part Ref	Thread Size
ILF22	M22 x 1.5

Park Valve



Part Ref	Thread Size
PV16	M16 x 1.5

Shunt Valve



Part Ref	Thread Size
SV16	M16 x 1.5

Double Check Valve



Part Ref	Thread Size
DCV	M16 x 1.5

Coupling Accessories



Airline Coupling Lock

Part Ref: ABCCL2



- The Coupling lock locks over the male coupling, preventing the male coupling from being unscrewed from the trailer or the trailer from being coupled up.
- Each lock is supplied with two keys, which are safely tucked inside the plastic cap for transit.
 - Compact, rugged and simple to operate.
 - To fit, remove key and push lock onto male coupling.
 - Over 10'000 key combinations.
- Sets of locks can be supplied individually keyed or keyed alike (a number of locks operating from the same key).
 - High visibility reflective sleeves are available for the locks.



Test Tool and Gauge

Part Ref: FCTG / IR



- Securely boxed complete with gauge.
- This tool allows you to check the levels of lift the female couplings will cause when coupled to the male self sealing valve.
 - The gauge checks the correct operation of the test tool.
 - Double band in indicator section.
 - Start of yellow band indicates minimum requirement of 3 mm lift.
 - Start of green band indicates preferred level of lift for correct operation - 4 mm.
- Used to verify correct manufacture and installation of female service line coupling.
 - As supplied to VOSA and OEM.



Dummy Couplings - Part Ref: FCMCDUM

- Secure Storage locations for couplings.
 - Reduce damage to air coils.
 - Compact size.
- Chain and split rings available.

Test Gauge Kits

- Enable you to identify the air pressure from any given test point
- Enable you to determine the air pressure from Truck to Trailer
 - Pre MOT Testing
 - Faulty valve indication
 - Calibration
 - Load sensing valve testing
 - Balancing air pressure



Part Ref
ABC009



ABC009 Contains:

- 1 Gauge 0—11 Bar (Max 160 PSI)
- 2 Coupling Testers
- Hard Carry Case
- 2 Mtr's of High Visibility PVC c/w Test Point Adaptors



Part Ref: **ETB001V**

ETB001V Contains:



1 Gauge 0—11 Bar

1 Gauge 0—16 Bar

2 x 2 Mtr's of High Visibility PVC c/w Test Point Adaptors

Test Coupling Tee Piece

Service Line Coupling Tester

TEL: 01474 535456 / FAX: 01474 537323
sales@airbrakeconnections.co.uk

Test Gauges & Accessories



0 - 11 Bar Test Gauge

Part Ref: **TG1B**
(M16 x 1.5 Thread)



0 - 11 Bar Test Gauge
Part Ref: **TG1**

Or

0 - 16 Bar Test Gauge
Part Ref: **TG2**



Both TG1 and TG2 have M16 x 1.5 Thread and are Rubber cased heavy duty Gauges



Test
Gauge
Adaptors

Part Ref	Thread	Tube ID
TPA1	M16 x 1.5	3/16" - 5 mm
TPA2	M16 x 1.5	1/4" - 7 mm
TPA3	M16 x 1.5	3/8" - 10 mm

(TPA2 & TPA3 have a knurled barrel)

Test Gauge Boxes



Part Ref: **TGB2**

Holds up to two
Gauges
complete
with hoses

Part Ref: **TGB3**

Holds up to three
Gauges
complete
with hoses



Section 13

Air Coils & Adaptors



.....

.....

.....

.....

.....

.....

.....

.....

Air Coils

To Specifications DIN 74324 / 73378



Red Coils

Part Ref	Coils	Working Length	Mandrel	Thread Size
ABC168R	16 Turn	3.6 Metre	90 mm	1/2" BSP
ABC228R	22 Turn	4.9 Metre	90 mm	1/2" BSP
ABC328R	32 Turn	11.3 Metre	130 mm	1/2" BSP
ABC1616R	16 Turn	3.6 Metre	90 mm	M16 x 1.5
ABC2216R	22 Turn	4.9 Metre	90 mm	M16 x 1.5
ABC3216R	32 Turn	11.3 Metre	130 mm	M16 x 1.5
ABC1622R	16 Turn	3.6 Metre	90 mm	M22 x 1.5
ABC2222R	22 Turn	4.9 Metre	90 mm	M22 x 1.5
ABC3222R	32 Turn	11.3 Metre	130 mm	M22 x 1.5
ABC1618R	16 Turn	3.6 Metre	90 mm	F18 x 1.5
ABC2218R	22 Turn	4.9 Metre	90 mm	F18 x 1.5
ABC3218R	32 Turn	11.3 Metre	130 mm	F18 x 1.5

Yellow Coils

Part Ref	Coils	Working Length	Mandrel	Thread Size
ABC168Y	16 Turn	3.6 Metre	90 mm	1/2" BSP
ABC228Y	22 Turn	4.9 Metre	90 mm	1/2" BSP
ABC328Y	32 Turn	11.3 Metre	130 mm	1/2" BSP
ABC1616Y	16 Turn	3.6 Metre	90 mm	M16 x 1.5
ABC2216Y	22 Turn	4.9 Metre	90 mm	M16 x 1.5
ABC3216Y	32 Turn	11.3 Metre	130 mm	M16 x 1.5
ABC1622Y	16 Turn	3.6 Metre	90 mm	M22 x 1.5
ABC2222Y	22 Turn	4.9 Metre	90 mm	M22 x 1.5
ABC3222Y	32 Turn	11.3 Metre	130 mm	M22 x 1.5
ABC1618Y	16 Turn	3.6 Metre	90 mm	F18 x 1.5
ABC2218Y	22 Turn	4.9 Metre	90 mm	F18 x 1.5
ABC3218Y	32 Turn	11.3 Metre	130 mm	F18 x 1.5

Air Coils

UNICOILS



Black / Red Coils

Part Ref	Coils	Working Length	Mandrel	Thread Size
ABC2218BKR	20 Turn	4 Metre	90 mm	M18 x 1.5 (F)
ABC2618BKR	26 Turn	5.8 Metre	90 mm	M18 x 1.5 (F)

Black / Yellow Coils

Part Ref	Coils	Working Length	Mandrel	Thread Size
ABC2218BKY	20 Turn	4 Metre	90 mm	M18 x 1.5 (F)
ABC2618BKY	26 Turn	5.8 Metre	90 mm	M18 x 1.5 (F)

The above coils are supplied with M18 female ends enabling you to order the correct fittings required for, example: DAF / VOLVO / SCANIA, ETC

Unicoils to Truck Brand Complete With Fittings

Part Ref	Colour	Truck Brand	Thread A	Thread B
ABC22DAFR	Red	DAF	M18 x 1.5 (F)	M16 x 1.5 (M)
ABC22DAFY	Yellow	DAF	M18 x 1.5 (F)	M16 x 1.5 (M)
ABC22IVER	Red	IVECO	M16 x 1.5 (M)	M18 x 1.5 Bulkhead
ABC22IVEY	Yellow	IVECO	M16 x 1.5 (M)	M18 x 1.5 Bulkhead
ABC22MANR	Red	MAN	M16 x 1.5 Bulkhead	M16 x 1.5 Bulkhead
ABC22MANY	Yellow	MAN	M16 x 1.5 Bulkhead	M16 x 1.5 Bulkhead
ABC22MERC R	Red	MERCEDES	M18 x 1.5 (F)	M16 x 1.5 (M)
ABC22MERC Y	Yellow	MERCEDES	M18 x 1.5 (F)	M16 x 1.5 (M)
ABC22REN R	Red	RENAULT	M16 x 1.5 (M)	M16 x 1.5 (M)
ABC22REN Y	Yellow	RENAULT	M16 x 1.5 (M)	M16 x 1.5 (M)
ABC22SCAN R	Red	SCANIA	M16 x 1.5 (M)	M18 x 1.5 Bulkhead
ABC22SCAN Y	Yellow	SCANIA	M16 x 1.5 (M)	M18 x 1.5 Bulkhead
ABC22VOL R	Red	VOLVO	M16 x 1.5 (M)	M16 x 1.5 (M)
ABC22VOL Y	Yellow	VOLVO	M16 x 1.5 (M)	M16 x 1.5 (M)

TEL: 01474 535456 / FAX: 01474 537323
sales@airbrakeconnections.co.uk

Air Coils & Adaptors

Fittings for Unicoil / Air Coil

Male / Male Adaptors

Part Ref	Thread
MMA718Z	1/2" BSP x M18
MMA1618Z	M18 x M16
MMA2218Z	M18 x M22



Bulkhead Adaptors

Part Ref	Thread
BA1618Z	M18 x M16
BA1818Z	M18 x M18

Fittings to Truck Brand

Brand	Fitting Required	Qty	Brand	Fitting Required	Qty
DAF	MMA1618Z	1	RENAULT	MMA1618Z	2
IVECO	MMA1618Z	1	SCANIA	MMA1618Z	1
	BA1818Z	1		BA1818Z	1
MAN	MMA1618Z	1	VOLVO	MMA1618Z	2
	BA1618Z	1			
MERCEDES	MMA1618Z	1			

Unicoil / Air Coil Fitting Assorted Box Part Ref: ABCADAP1

Part Ref	Thread	Qty in Box
MMA718Z	1/2" BSP x M18	4
MMA1618Z	M18 x M16	4
MMA2218Z	M18 x M22	4
BA1618Z	M18 x M16	2
BA1818Z	M18 x M18	2



Anti - Kink Coils



Part Ref	Coils	Mandrel	Colour	Thread Size
ABC2218AKR	20 Turn	50 mm	Red	M18 x 1.5 (F)
ABC2218AKY	20 Turn	50 mm	Yellow	M18 x 1.5 (F)

Section 14

Electrical Coils

ABS / EBS Coils - Electrical Coils - Sockets - Plugs



.....

.....

.....

.....

.....

.....

.....

.....

Electrical Coils, Plugs, Sockets

All Electrical coils come complete with two 7 pin plugs

Coils



EC2NP22



EC2SP22

Part Ref	Description	Turns	Type	Plug Type
EC2NA16	Electrical Coil	16	Normal	Aluminium
EC2SA16	Electrical Coil	16	Supplementary	Aluminium
EC2NP16	Electrical Coil	16	Normal	Plastic
EC2SP16	Electrical Coil	16	Supplementary	Plastic
EC2NA22	Electrical Coil	22	Normal	Aluminium
EC2SA22	Electrical Coil	22	Supplementary	Aluminium
EC2NP22	Electrical Coil	22	Normal	Plastic
EC2SP22	Electrical Coil	22	Supplementary	Plastic
EC2NP30	Electrical Coil	30	Normal	Plastic
EC2SP30	Electrical Coil	30	Supplementary	Plastic
EC44T	Electrical Coil (Trombone)	44	Normal	Plastic

Plugs



EPA24N



EPP24N

Part Ref	Description
EP3P	Electrical Plug 3 Pin Plastic
EPA24N	Aluminium Electrical Plug 7 Pin 24V Screw Terminal
EPP24N	Plastic Electrical Plug 7 Pin 24V Screw Terminal
EPA24S	Aluminium Electrical Plug 7 Pin 24S Screw Terminal
EPP24S	Plastic Electrical Plug 7 Pin 24S Screw Terminal

Sockets



ESA24S



ESP24N

Part Ref	Description
ES3P	Electrical Socket 3 Pin Plastic
ES7P	Electrical Socket 7 Pin (Caravan)
ESA24N	Aluminium Electrical Socket 7 Pin Screw Terminal (normal)
ESA24S	Aluminium Electrical Socket 7 Pin Screw Terminal (supplementary)
ESP24N	Plastic Electrical Socket 7 Pin Screw Terminal
ESP24NADR	Plastic Electrical Socket 7 Pin Spade Terminal (ADR Regulation)
ESP24S	Plastic Electrical Socket 7 Pin Screw Terminal
ESP24SADR	Plastic Electrical Socket 7 Pin Spade Terminal (ADR Regulation)
ESPPS	Electrical Parking Socket Plastic to suit 24V

ABS / EBS

ABS

Part Ref	Description
ABSEC	ABS Electrical Coil 4 Mtr c/w 2 x 5 Pin Plugs
ABSEC / 12V	ABS Electrical Coil 4 Mtr (12 Volt) c/w 2 x 5 Pin Plugs
ABOVE COILS NOT TO BE USED FOR EBS	
ABSP	ABS 5 Pin Plug (Crimped Terminals)
ABSPS	ABS Parking Socket (Dummy)
ABSPST	ABS 5 Pin Plug (Screw Terminals)
ABSS	ABS 5 Pin Socket (Crimped Terminals)
ABSSS	ABS 5 Pin Socket (Screw Terminals)



ABSEC



ABSPST



ABSS



ABSSS

EBS

Part Ref	Description
EBS / TAC	EBS Twin Adaptor Electrical Coil 3.5 Mtr (7 Pin N & 7 Pin S into EBS 15 Pin)
EBSEC	EBS Electrical Coil c/w 2 x 7 Pin Plugs (may be used on ABS)
EBSP	EBS 7 Pin Plug (Screw Terminals)
EBSS	EBS 7 Pin Socket (Crimped Terminals)
EBSSS	EBS 7 Pin Socket (Screw Terminals)



EBSEC



EBSP



EBSS



EBSSS

Section 15

Tubing - Hose & Accessories

**Nylon - PVC - Air, Brake, Heater, Fuel Hose -
Cupro Nickel & Accessories**



.....

.....

.....

.....

.....

.....

.....

.....

Nylon Metric Tubing



ALL NYLON SIZES AVAILABLE IN 15 & 30 MTRS COILS PLUS OTHER LENGHTS SHOWING

For example if 6mm Black is required in a 15 mtr coil the part number would be: N61BK/15

Tube OD	Tube ID	Black	Red	Yellow	Natural	Blue	Burst Bar	Work Bar	Lengths (mtrs)
4mm	2 mm	N41BK	N41R	N41Y	N41N	N41B	136	45	100 / 1000
5 mm	3.3 mm	N51BK	-	-	N51N	-	68	22	100 / 1000
6mm	4 mm	N61BK	N61R	N61Y	N61N	N61B	82	27	100 / 1000
8 mm	6 mm	N81BK	N81R	N81Y	N81N	N81B	57	19	100 / 500
9 mm	6 mm	N915BK	-	-	N915N	-	82	27	100
10 mm	7 mm	N1015BK	N1015R	N1015Y	N1015N	N1015B	68	22	100
10 mm	7.5 mm	N10125BK	N10125R	N10125Y	N10125N	N10125B	57	19	100 / 500
10 mm	8 mm	N101BK	N101R	N101Y	N101N	N101B	45	15	100
11 mm	8 mm	N1115BK	-	-	N1115N	-	63	21	100
12 mm	9 mm	N1215BK	N1215R	N1215Y	N1215N	N1215B	57	19	100 / 300
12 mm	8 mm	N122BK	-	-	N122N	-	82	27	100
13 mm	10 mm	N1315BK	-	-	N1315N	-	63	21	-
13 mm	9 mm	N132BK	-	-	N132N	-	77	26	-
14 mm	10 mm	N142BK	-	-	N142N	-	63	21	-
15 mm	12 mm	N1515BK	-	-	-	-	45	15	200
15 mm	11 mm	N152BK	-	-	-	-	78	25	-
16 mm	12 mm	N162BK	-	-	N162N	-	57	19	200
18 mm	14 mm	N182BK	N182R	-	-	-	65	21	200

OTHER COLOURS AVAILABLE FOR EXAMPLE, ORANGE, PURPLE, GREEN, GREY, ETC (POA)

- Our Flexible Nylon Tubing is manufactured and printed to DIN 73378 and 74324 standards from light and heat stabilised Nylon 11 & 12 and is suitable for use with air, water, diesel, petrol and a variety of other fluids and chemicals.
- The working and burst pressure above are applicable at plus 20° C
- We recommend that tube supports are fitted from 6 mm Nylon and above where they are not complete with the fitting.
- Please ensure all Nylon is cut Square

TEL: 01474 535456 / FAX: 01474 537323
sales@airbrakeconnections.co.uk

Nylon Imperial Tubing

- Our Flexible Nylon Tubing is manufactured from light and heat stabilised Nylon 11 & 12 and is suitable for use with air, water, diesel, petrol and a variety of other fluids and chemicals.
 - The Nylon is manufactured to BS5409
 - The working and burst pressures shown below are applicable at plus 20° C.
 - We recommend tube supports are fitted with all size 1/4 " and above.
 - Please ensure Nylon is cut square

Tube OD"	Tube ID"	Black	Natural	Yellow	Red	Blue	Green	Burst Bar	Work Bar
1/8"	.95	N1BK	N1N	-	-	-	-	54	13
5/32"	.106	N2BK	N2N	-	-	-	-	88	22
3/16"	.117	N3BK	N3N	N3Y	N3R	N3B	N3G	109	27
1/4"	.150	N4BKH	N4NH	-	-	-	-	136	34
1/4"	.170	N4BK	N4N	N4Y	N4R	N4B	N4G	102	25
5/16"	.182	N5BKH	N5NH	-	-	-	-	136	34
5/16"	.212	N5BK	N5N	N5Y	N5R	N5B	N5G	102	25
3/8"	.250	N6BKH	N5NH	-	-	-	-	-	-
3/8"	.265	N6BK	N6N	N6Y	N6R	N6B	N6G	88	22
1/2"	.375	N8BK	N8N	N8Y	N8R	N8B	N8G	75	19
5/8"	.500	N10BK	N10N	-	-	-	-	58	14
3/4"	.595	N12BK	N12N	-	-	-	-	45	16

OTHER COLOURS MAY BE AVAILABLE FOR EXAMPLE, ORANGE, PURPLE, GREY, ETC UPON REQUEST

All coils Nylon above are available in 15 and 30 mtr coils.

Please use a backslash and the length when ordering.

For example if you require 3/8" black in a 15 mtr coil the part number would be: N6BK / 15

100 mtr Coils available in various sizes (POA)

TEL: 01474 535456 / FAX: 01474 537323
sales@airbrakeconnections.co.uk

PVC Tubing

BRAIDED

Our braided PVC tubing is reinforced with polyester fibre braiding and has exceptional physical properties.

It is flexible and lightweight as well as being resistant to most alkalis and acid.

It has a Variety of uses and can be used most fluids.



Tube ID (Imperial)	Tube ID (Metric)	Tube OD	Part Ref	Max Working Pressure (Bar)
1/8"	3 mm	8 mm	PVC1N	32
3/16"	5 mm	10 mm	PVC3N	21
1/4"	6 mm	11.5 mm	PVC4N	18
5/16"	8 mm	13.5 mm	PVC5N	17
3/8"	10 mm	16 mm	PVC6N	17
1/2"	12 mm	18.5 mm	PVC8N	14
5/8"	16 mm	23 mm	PVC10N	11
3/4"	19 mm	25 mm	PVC12N	9
1"	25 mm	33 mm	PVC16N	7
1 1/4"	32 mm	44 mm	PVC20N	6
1 1/2"	38 mm	49 mm	PVC24N	5
2"	50 mm	64 mm	PVC30N	4

ALL COILS AVAILABLE IN 30 MTR LENGTHS

CLEAR

Our clear PVC tubing is exceptionally clear for high visibility

It has varied range of uses for low pressure applications and is resistant to oils, grease, and solvents and many other fluids.



Tube ID (Imperial)	Tube ID (Metric)	Tube OD	Part Ref
1/8"	3 mm	6 mm	PVC1
	4 mm	6 mm	PVCW1
5/32"	4 mm	10 mm	PVC2
3/16"	5 mm	8 mm	PVC3
1/4"	6 mm	9 mm	PVC4
1/4"	6 mm	12 mm	PVC4H
5/16"	8 mm	11 mm	PVC5
5/16"	8 mm	14 mm	PVC5H
3/8"	9 mm	12 mm	PVC6
3/8"	10 mm	16 mm	PVC6H
1/2"	12 mm	15 mm	PVC8
	8 mm	10 mm	PVC101
5/8"	-	-	PVC10
3/4"	19 mm	25 mm	PVC12
1"	25 mm	31 mm	PVC16
1 1/4"	32 mm	41 mm	PVC20
1 1/2"	38 mm	47 mm	PVC24

Air Brake Hose

Our Braided Rubber Air Brake Hose is manufactured to Air Brake Standard BSAU/110 and has a burst pressure of 65 BAR and a working pressure of 15.5 BAR



DIN 74310



IMPERIAL

Part Ref	Hose ID	Length
ABH6/10	3/8"	10 mtr
ABH7/10	1/2"	10 mtr
ABH6/60	3/8"	60 ft (18.3 mtr)
ABH7/60	1/2"	60 ft (18.3 mtr)
ABH6/100	3/8"	100 mtr
ABH7/100	1/2"	100 mtr

METRIC

Part Ref	Hose ID	Hose OD	Length
ABH13/10	13 mm	25 mm	10 mtr
ABH13/15	13 mm	25 mm	15 mtr
ABH13/50	13 mm	25 mm	50 mtr

AIR BRAKE HOSE ASSEMBLIES



These hoses are assembled using 3/8" ID BSAU110-5 rubber and 13 mm ID DIN 74310 rubber with one fixed end and one swivel end.

Hose assemblies can be ordered to any length and also in 1/2" with in variety of hoesetail ends , enabling you to mix imperial hoesetail's with metric.

All hoses leave crimped and checked and thrust and 'o' rings can be added to the ends upon request.

Hose ID	M16 x 1.5 Ends	1/4" Ends	Hose Length
3/8"	BHA216	BHA24	2 ft
3/8"	BHA2616	BHA264	2.5 ft
3/8"	BHA316	BHA34	3 ft
3/8"	BHA3616	BHA364	3.5 ft
3/8"	BHA416	BHA44	4 ft
3/8"	BHA4616	BHA464	4.5 ft
3/8"	BHA516	BHA54	5 ft
3/8"	BHA5616	BHA564	5.5 ft
3/8"	BHA616	BHA64	6 ft
13 mm	BHA133	-	3 ft
13 mm	BHA134	-	4 ft
13 mm	BHA135	-	5 ft
13 mm	BHA136	-	6 ft

Hose

Part Ref	Hose ID
HH6	3/8"
HH8	1/2"
HH10	5/8"
HH12	3/4"
HH16	1"

HEATER



Reinforced rubber hose has a maximum working pressure of 8 bar, 120 psi.

Suitable for use on all vehicle water systems within the psi limit.

Available in 10 mtr / 20 mtr lengths for example: HH6/10

Part Ref	Hose ID
FLH3/10	3/16"
FLH4/10	1/4"
FLH5/10	5/16"
FLH6/10	3/8"
FLH8/10	1/2"
FLH10/10	5/8"
FLH12/10	3/4"
FLH14/10	7/8"

RUBBER FUEL LINE



Manufactured to BSAU 108/2/L4/C4 R/177.

Hose is specifically designed to carry fuels such as petrol and diesel.

Available in 10 mtr lengths.

Part Ref	Hose ID
ALH3	3/16"
ALH4	1/4"
ALH5	5/16"
ALH6	3/8"
ALH8	1/2"
ALH10	5/8"
ALH12	3/4"

AIR LINE



BS 5118 Type 1

200 PSI WP 600 PSI B/P

Available in 10 / 15 / 100 mtr lengths.

For Example 1/4" in a 15 mtr length: ALH4/15

Air Line Hose is available in other colours upon request.

Conduit - Spiral Wrap - Cutters

Part Ref	Hose ID
CON10	10 mm
CON20	20 mm
CON25	25 mm
CON40	40 mm

CONDUIT

Other sizes maybe available upon request



(Self Extinguishing)

Part Ref	ID	Length
ARM6	6 mm	100 mtr
ARM10	10 mm	50 mtr
ARM16	16 mm	50 mtr
ARM20	20 mm	50 mtr
ARM22	22 mm	25 mtr
ARM26	26 mm	25 mtr
ARM30	30 mm	25 mtr

SPIRAL WRAP



TUBE CUTTERS / SPARE BLADES

Smooth handled heavy duty cutters c/w Stainless Steel blade suitable for nylon and a variety of hose.



Part Ref

TC2

Black plastic cutter c/w Stainless Steel blade suitable for nylon tubing up to 18 mm OD.



Part Ref

TC1



Part Ref

TCB2



Part Ref

TCB1

TEL: 01474 535456 / FAX: 01474 537323
sales@airbrakeconnections.co.uk

Clips

Part Ref	Hose OD
OC3	3/16" OD
OC4	1/4" OD
OC5	5/16" OD
OC6	3/8" OD
OC7	7/16" OD
OC8	1/2" OD
OC9	9/16" OD
OC10	5/8" OD
OC12	3/4" OD
OC14	7/8" OD
OC16	1" OD

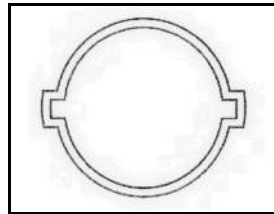

'O' CLIPS

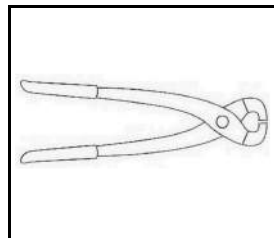

'O' CLIP PINCERS

PART: OCP2
(Side Closing)



Assorted Box of 'O' Clips is available with the Part Ref being: OCAB comprising of popular sizes

Part Ref	Standard Ref	Adjustment (mm)
WD67	OOO	9.5 - 12 mm
WD810	MOO	11 - 16 mm
WD812	OO	13 - 20 mm
WD1014	O	16 - 22 mm
WD1216	OX	18 - 25 mm
WD1418	1A	22 - 30 mm
WD1622	1	25 - 35 mm
WD1826	1X	30 - 40 mm
WD2032	2A	35 - 50 mm
WD2434	2	40 - 55 mm
WD2836	2X	45 - 60 mm
WD3444	3	55 - 70 mm
WD3850	3X	60 - 80 mm
WD4456	4	70 - 90 mm
WD5064	4X	85 - 100 mm
WD5676	5	90 - 120 mm

WORMDRIVE CLIPS

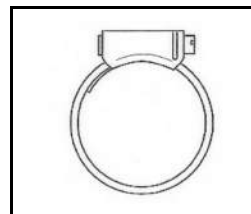

WORMDRIVE CLIPS (BOLT)

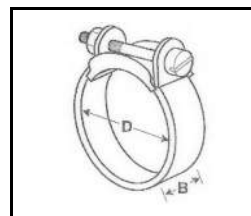

Part Ref	Hose ID
WD25	13 mm

Clips & Ferrules

TUBE CLAMPS



Part Ref	Tube OD
TC6	6 mm
TC8	8 mm
TC10	10 mm
TC12	12 mm
TC16	16 mm
TC18	18 mm
TC25	25 mm

FERRULES



Part Ref	Hose ID
F6	3/8"
F7	1/2"
F13	13 mm

Ferrules are for use with our air brake hose:

ABH6 / ABH7 / ABH13

Cupro - Nickel 90 / 10 Brake Tubing

Part Ref	Tube OD	Coil Length
CN5	5 mm	25'
CN6	6 mm	25'
CN8	8 mm	25'
CN10	10 mm	25'
CN12	12 mm	25'
CN90103	3/16"	25'
CN90104	1/4"	25'
CN90105	5/16"	25'
CN90106	3/8"	25'
CN90108	1/2"	25'



Produced to international standards and conforms to: BS2871 pt 2, SMMT C5B, ASTM A254, SAE J2527.

Produced from 90% copper and 10% nickel alloy our tubing is seamless, carries a guarantee for the vehicle life and is easily flared.

Its flexibility allows easy manipulation even in situ.

Section 16

Air Reservoirs & Accessories



.....

.....

.....

.....

.....

.....

.....

.....

Air Reservoirs

Strap Mounted



Part Ref	Volume (Litre)	Length (mm)	Diameter (mm)
All Ports are M22 x 1.5 mm			
AR 5	5	215	206
AR 10	10	370	206
AR 15	15	530	206
AR 20	20	690	206
AR 20SP	20	500	246
AR 30	30	720	246
AR 40	40	620	310
AR 40L246	40	940	246
AR 40L276	40	760	276
AR 50	50	748	310
AR 60	60	895	310
AR 60L246	60	1352	246
AR 60L276	60	1110	276
AR 60L310	60	895	310
AR 60396	60	580	396
AR 80	80	750	396
AR 100	100	915	396
AR 120	120	1067	396

Straps

Strap & Saddles

'U' Bolt & Saddle

Part Ref	To Suit (mm)
----------	--------------

AR 310US	310
----------	-----



Nuts not included



Part Ref	To Suit (mm)
----------	--------------

AR 206SS	206
AR 246SS	246
AR 276SS	276
AR 310SS	310
AR 396SS	396

Air Reservoirs

End Mounted

Part Ref	Volume (Litre)	Length (mm)	Diameter (mm)
----------	----------------	-------------	---------------

All Ports are M22 x 1.5 mm

AR 20EM	20	685	206
AR 38EM	38	815	246
AR 45EM	45	700	300
AR 50EM	50	733	300
AR 60EM	60	888	300



Side Mounted

Part Ref	Volume (Litre)	Length (mm)	Diameter (mm)
----------	----------------	-------------	---------------

All Ports are M22 x 1.5 mm

AR 20SM	20	685	206
AR 38SM	38	815	246
AR 50SM	50	733	300
AR 60SM	60	888	300



Aluminium Air Reservoirs are available upon request and all dimensional drawings to suit the desired Part for all tanks listed

Various Tank Fittings



Part Ref: **AD22**
M22 x 1.5 Auto Drain



Part Ref: **TPM22T**
M22 x 1.5 Test Point



Part Ref: **BP22B**
M22 x 1.5 Blanking Plug



Part Ref: **TTC3**
M22 x 1.5 Drain Tap
with 6ft Cable



Part Ref: **TT3T**
M22 x 1.5 Drain Tap
with Pull Ring

Section 17

Marker Boards

Marker Boards - Conspicuity Tape - Reflectors



.....

.....

.....

.....

.....

.....

.....

.....

Marker Boards

ECE 70 REGULATION REAR ALUMINIUM MARKER BOARDS

Part Ref: RMB1



130mm x 1130mm
(Supplied Individually)
Self Adhesive Part Ref: RMB1SA

Part Ref: RMB5



195mm x 1130mm
(Supplied Individually)
Self Adhesive Part Ref: RMB5SA

Part Ref: RMB23



130mm x 565mm
(Supplied In Pairs)
Self Adhesive Part Ref: RMB23SA

Part Ref: RMB67



195mm x 565mm
(Supplied In Pairs)
Self Adhesive Part Ref: RMB67SA

Part Ref: RMB4



130mm x 282mm
(Supplied In Fours)
Self Adhesive Part Ref: RMB4SA

Part Ref: RMB8



195mm x 282mm
(Supplied In Fours)
Self Adhesive Part Ref: RMB8SA

Marker Boards

LONG VEHICLE



WIDE LOAD



HIGHWAY MAINTENANCE

Part Ref	Description	Qty	Dimensions
HMM	Highway Maintenance	1	225mm x 1265mm
LVM	Long Vehicle	1	225mm x 1265mm
LVM2	Long Vehicle	2	250mm x 525mm
MMM	Motorway Maintenance	1	225mm x 1265mm
MMM2	Motorway Maintenance	2	250mm x 525mm
RMBRS	Rear Steering	1	225mm x 1265mm
SMM	Slow Moving	1	225mm x 1265mm
SMM2	Slow Moving	2	250mm x 525mm
SVM	Slow Vehicle	1	225mm x 1265mm
SVM2	Slow Vehicle	2	250mm x 525mm
WLM	Wide Load	1	225mm x 1265mm
WLM2	Wide Load	2	250mm x 525mm
WVM	Wide Vehicle	1	225mm x 1265mm
WVM2	Wide Vehicle	2	250mm x 525mm

For Self Adhesive Boards please put an "SA" on the end of the part number, eg: WLMSA

Part Ref: FRPM



Front / Rear Load Protection Markers
610mm x 610mm
Flexible Part Ref: FRPMV

Part Ref: RMBAL



Abnormal Load Sign
500mm x 500mm

Hazardous Plates (Hazchem)

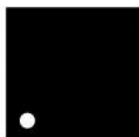

Various Hazchem plates and holders available upon request, both vertical and horizontal

TEL: 01474 535456 / FAX: 01474 537323
sales@airbrakeconnections.co.uk

Tape & Reflectors

Conspicuity Tape (50mm)



Part Ref	Colour	App	Length
CT/A12550	Amber	Side	12.5 Mtr
CT/A5050	Amber	Side	50 Mtr
CT/R12550	Red	Rear	12.5 Mtr
CT/R5050	Red	Rear	50 Mtr
CT/W12550	White	Front	12.5 Mtr
CT/W5050	White	Front	50 Mtr

Contour & Curtain Grade Tape also available upon request

Reflectors

Part Ref	Colour	Description	Shape	Size
REF 1	Red	Screw - Bolt	Triangle	150mm
REF 2	Red	Screw - Bolt	Triangle	150mm
REF 3	Red	Screw - Bolt	Rectangle	95 x 60mm
REF 4	Amber	Screw - Bolt	Rectangle	95 x 60mm
REF 5	White	Screw - Bolt	Rectangle	95 x 60mm
REF 6	Red	Screw - Bolt	Round	60mm
REF 6SA	Red	Self Adhesive	Round	60mm
REF 7	Amber	Screw - Bolt	Round	60mm
REF 7SA	Amber	Self Adhesive	Round	60mm
REF 8	White	Screw - Bolt	Round	60mm
REF 8SA	White	Self Adhesive	Round	60mm
REF 9	Red	Screw - Bolt	Rectangle	90 x 40mm
REF9 SA	Red	Self Adhesive	Rectangle	90 x 40mm
REF 10	Amber	Screw - Bolt	Rectangle	90 x 40mm
REF 10SA	Amber	Self Adhesive	Rectangle	90 x 40mm
REF 11	White	Screw - Bolt	Rectangle	90 x 40mm
REF 11SA	White	Self Adhesive	Rectangle	90 x 40mm
REF 12SA	Red	Self Adhesive	Rectangle	95 x 60mm
REF 13SA	Amber	Self Adhesive	Rectangle	95 x 60mm
REF 14SA	White	Self Adhesive	Rectangle	95 x 60mm

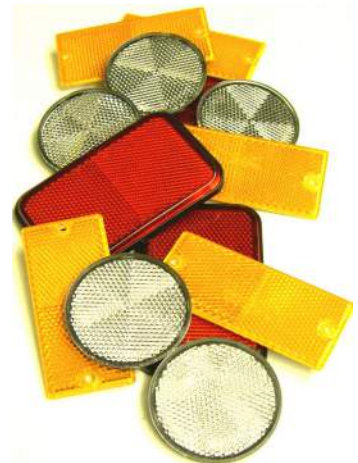

Display Packets & Racking



Air Brake Connections Display Packets are of a slide design enabling them to be fully re-usable. They have a heavy card backing and a slide on case, which securely holds all parts inside. Each packet is clearly labelled at the bottom with part numbers and description.

The Display Packs are a simple way to stock parts which are visible to a customer at the point of sale in customer counter areas.

The Racking System comprises of one Air Brake Connections Limited header board and a wall mountable two row section enabling space for 16 slide in euro hooks (8 per row). Each further section comprising of two rows is then simply hooked on.

We also issue reorder cards that are placed behind the packs making easy for restocking replacements and keep the packets in order.

Bespoke systems and products are also available upon request.



Order in Display Packs is also simple, by just added a 'DIS' to the part you require, for example: 800416 = DIS 800416. A list of these can be found on the following pages or please refer to your current price list.

Display Pack Reference

PART REF	QTY PER PACK
----------	--------------

P.C.L Range	
DIS 903	2
DIS 904	2
DIS 905	2
DIS 906	1
DIS 914	1
DIS 915	1
DIS 916	1
DIS 917	1
DIS 918	1
DIS 919	1
DIS 920	1
DIS 921	1
DIS 922	1
DIS 924	2
DIS 925	2
DIS 926	2
DIS 927	2
DIS 928	2
DIS 929	2
DIS 930	2
DIS 931	2
DIS 932	1
DIS 933	1
DIS 934	1
DIS 935	1
DIS 936	1
DIS 937	1
DIS 938	1
DIS 939	1
DIS 940	1
DIS 941	1
DIS 943	2
DIS 944	2
DIS 945	2
DIS 946	2
DIS 947	2
DIS 964	2
DIS 965	2
DIS 966	2
DIS 967	2
DIS 976	2
DIS 977	2

On all Brass Compression the first Digit '1' becomes a '3'

PART REF	QTY PER PACK
----------	--------------

BRASS COMPRESSION	
DIS 3001	25
DIS 3002	25
DIS 3003	25
DIS 3004	25
DIS 3005	15
DIS 3006	12
DIS 3007	8
DIS 3008	5
DIS 3009	6

PART REF	QTY PER PACK
----------	--------------

DIS 3011	25
DIS 3012	25
DIS 3013	25
DIS 3014	20
DIS 3015	15
DIS 3016	12
DIS 3017	8
DIS 3018	6
DIS 3019	5
DIS 3021	25
DIS 3022	20
DIS 3023	15
DIS 3024	12
DIS 3025	6
DIS 3026	7
DIS 3027	6
DIS 3028	6
DIS 3029	5
DIS 3041	10
DIS 3045	20
DIS 3049	12
DIS 3031	25
DIS 3032	20
DIS 3033	15
DIS 3034	12
DIS 3035	8
DIS 3036	8
DIS 3037	6
DIS 3038	6
DIS 3039	5
DIS 3211	3
DIS 3222	3
DIS 3231	2
DIS 3233	3
DIS 3241	1
DIS 3243	2
DIS 3244	3
DIS 3253	2
DIS 3254	2
DIS 3255	3
DIS 3264	2
DIS 3265	2
DIS 3266	2
DIS 3274	1
DIS 3275	1
DIS 3276	1
DIS 3277	1
DIS 3288	1
DIS 3299	1
DIS 3301	1
DIS 3311	1
DIS 3322	3
DIS 3325	3
DIS 3329	3
DIS 3333	2
DIS 3344	3
DIS 3345	2
DIS 3346	1
DIS 3348	1
DIS 3354	1

PART REF	QTY PER PACK
----------	--------------

DIS 3355	1
DIS 3356	1
DIS 3358	1
DIS 3365	1
DIS 3366	1
DIS 3377	1
DIS 3385	1
DIS 3386	1
DIS 3388	1
DIS 3399	1
DIS 3402	5
DIS 3404	4
DIS 3406	4
DIS 3407	3
DIS 3409	1
DIS 3410	1
DIS 3411	1
DIS 3422	1
DIS 3433	2
DIS 3444	1
DIS 3455	1
DIS 3466	1
DIS 3477	1
DIS 3488	1
DIS 3499	1
DIS 3442	4
DIS 3464	4
DIS 3474	3
DIS 3497	2
DIS 3519	1
DIS 3501	1
DIS 3505	1
DIS 3506	1
DIS 3508	1
DIS 3509	1
DIS 3510	1
DIS 3511	1
DIS 3512	1
DIS 3513	1
DIS 3514	1
DIS 3515	1
DIS 3516	1
DIS 3611	1
DIS 3622	2
DIS 3633	1
DIS 3644	1
DIS 3655	1
DIS 3666	1
DIS 3677	1
DIS 3688	1
DIS 3701	2
DIS 3705	1
DIS 3706	1
DIS 3708	1
DIS 3709	1
DIS 3710	1
DIS 3711	1
DIS 3712	1
DIS 3713	1
DIS 3714	1

Display Pack Reference

PART REF	QTY PER PACK
----------	--------------

DIS 3715	1
DIS 3716	1
DIS 3721	1
DIS 3722	2
DIS 3723	2
DIS 3724	1
DIS 3725	1
DIS 3743	1
DIS 3744	2
DIS 3745	2
DIS 3746	1
DIS 3747	1
DIS 3765	1
DIS 3766	1
DIS 3767	1
DIS 3776	1
DIS 3777	1
DIS 3779	1
DIS 3799	1
DIS 3811	3
DIS 3812	3
DIS 3813	4
DIS 3814	3
DIS 3815	3
DIS 3816	2
DIS 3841	1
DIS 3843	2
DIS 3844	3
DIS 3845	3
DIS 3846	2
DIS 3847	1
DIS 3864	2
DIS 3865	2
DIS 3866	2
DIS 3867	1
DIS 3874	1
DIS 3875	1
DIS 3876	1
DIS 3877	1
DIS 3878	1
DIS 3879	1
DIS 3897	1
DIS 3899	1
DIS 3910	1
DIS 3911	3
DIS 3915	2
DIS 3946	3
DIS 3918	3
DIS 3940	2
DIS 3941	2
DIS 3942	1
DIS 3945	2
DIS 3946	3
DIS 3948	3
DIS 3960	2
DIS 3962	1
DIS 3966	1
DIS 3968	1
DIS 3970	1
DIS 3972	1

PART REF	QTY PER PACK
----------	--------------

DIS 3975	1
DIS 3976	1
DIS 3978	1
DIS 3979	1
DIS 3992	1
DIS 3920	1
DIS 3924	2
DIS 3925	1
DIS 3926	2
DIS 3928	1
DIS 3929	1
DIS 3930	1
DIS 3931	2
DIS 3932	2
DIS 3933	1
DIS 3934	1
DIS 3935	1
DIS 3936	1
DIS 3937	1
DIS 3938	1
DIS 3951	1
DIS 3952	1
DIS 3953	1
DIS 3954	1

PART REF	QTY PER PACK
----------	--------------

BRAKE PIPE FITTINGS	
DIS 8001	10
DIS 8002	10
DIS 8003	10
DIS 8004	10
DIS 8005	10
DIS 8006	10
DIS 8007	10
DIS 8008	10
DIS 8009	5
DIS 8010	10
DIS 8011	5
DIS 8012	5
DIS 8013	5
DIS 8014	4
DIS 8015	10
DIS 8016	5
DIS 8017	5
DIS 8018	5
DIS 8019	10
DIS 8020	10
DIS 8021	5
DIS 8022	10
DIS 8023	10
DIS 8024	5
DIS 8025	3
DIS 8026	3
DIS 8027	3
DIS 8101	10
DIS 8102	10
DIS 8103	6

PART REF	QTY PER PACK
----------	--------------

DIS 8104	4
DIS 8105	4
DIS 8106	2
DIS 8107	3
DIS 8108	3
DIS 8200	5
DIS 8201	5
DIS 8301	5
DIS 8302	5
DIS 8303	1
DIS 8304	1
DIS 8305	1
DIS 8306	1
DIS 8307	2

PART REF	QTY PER PACK
----------	--------------

BLEED SCREWS	
DIS 8401	10
DIS 8402	10
DIS 8403	10
DIS 8404	10
DIS 8405	10
DIS 8406	10
DIS 8407	5
DIS 8408	5
DIS 8409	10
DIS 8410	4
DIS 8411	10

PART REF	QTY PER PACK
----------	--------------

SIRIT PUSH IN RANGE	
DIS 615300	1
DIS 615500	1
DIS 625300	1
DIS 625500	1
DIS 635300	1
DIS 635500	1
DIS 645300	1
DIS 645500	1
DIS 646300	1
DIS 646500	1
DIS 647300	1
DIS 647500	1
DIS 648300	1
DIS 648500	1
DIS 649300	1
DIS 649500	1
DIS 651500	1
DIS 660302	1
DIS 660304	1
DIS 660310	1
DIS 660312	1
DIS 6603125	1
DIS 660314	1

Display Pack Reference

PART REF	QTY PER PACK
----------	--------------

DIS 660316	1
DIS 660322	1
DIS 660502	1
DIS 660504	1
DIS 660512	1
DIS 660514	1
DIS 660516	1
DIS 660522	1
DIS 660526	1
DIS 692010	4
DIS 692012	4
DIS 692014	4
DIS 692016	4
DIS 692022	4
DIS 693010	4
DIS 693012	4
DIS 693014	4
DIS 693016	4
DIS 693022	4
DIS 703216	1
DIS 703222	1
DIS 703312	1
DIS 703316	1
DIS 703322	1
DIS 703512	1
DIS 703516	1
DIS 703522	1
DIS 703526	1
DIS 703722	1
DIS 710310	1
DIS 710312	1
DIS 710316	1
DIS 710322	1
DIS 710512	1
DIS 710516	1
DIS 710522	1
DIS 710716	1
DIS 710722	1
DIS 715302	1
DIS 715304	1
DIS 715310	1
DIS 715312	1
DIS 715316	1
DIS 715322	1
DIS 715502	1
DIS 715504	1
DIS 715512	1
DIS 715514	1
DIS 715516	1
DIS 715522	1
DIS 715526	1
DIS 720310	1
DIS 720312	1
DIS 720316	1
DIS 720322	1
DIS 720512	1
DIS 720516	1
DIS 720522	1
DIS 725302	1
DIS 725304	1

PART REF	QTY PER PACK
----------	--------------

DIS 725310	1
DIS 725312	1
DIS 725316	1
DIS 725322	1
DIS 725502	1
DIS 725504	1
DIS 725512	1
DIS 725514	1
DIS 725516	1
DIS 725522	1
DIS 725526	1
DIS 730310	1
DIS 730312	1
DIS 730316	1
DIS 730322	1
DIS 730512	1
DIS 730516	1
DIS 730522	1
DIS 735302	1
DIS 735304	1
DIS 735310	1
DIS 735312	1
DIS 735316	1
DIS 735322	1
DIS 735502	1
DIS 735504	1
DIS 735512	1
DIS 735514	1
DIS 735516	1
DIS 735522	1
DIS 735526	1
DIS 740516	1
DIS 740722	1
DIS 742312	1
DIS 742516	1
DIS 742522	1
DIS 743516	1
DIS 743522	1
DIS 745302	1
DIS 745304	1
DIS 745310	1
DIS 745312	1
DIS 745316	1
DIS 745322	1
DIS 745502	1
DIS 745504	1
DIS 745512	1
DIS 745514	1
DIS 745516	1
DIS 745522	1
DIS 745526	1
DIS 746502	1
DIS 746504	1
DIS 746512	1
DIS 746514	1
DIS 746516	1
DIS 746522	1
DIS 746526	1
DIS 747502	1
DIS 747504	1

PART REF	QTY PER PACK
----------	--------------

DIS 747512	1
DIS 747514	1
DIS 747516	1
DIS 747522	1
DIS 747526	1
DIS 748502	1
DIS 748504	1
DIS 748512	1
DIS 748514	1
DIS 748516	1
DIS 748522	1
DIS 748526	1
DIS 749502	1
DIS 749504	1
DIS 749512	1
DIS 749514	1
DIS 749516	1
DIS 749522	1
DIS 749526	1
DIS 750200	1
DIS 750300	1
DIS 750500	1
DIS 750700	1
DIS 753300	1
DIS 753500	1
DIS 753700	1
DIS 753302	1
DIS 753504	1
DIS 760300	1
DIS 760500	1
DIS 760700	1
DIS 763300	1
DIS 763500	1
DIS 770300	1
DIS 770500	1
DIS 770500BT	1
DIS 770700	1
DIS 780300	1
DIS 780500	1
DIS 800202	1
DIS 800204	1
DIS 800210	1
DIS 800212	1
DIS 800212/1	1
DIS 800214	1
DIS 800216	1
DIS 800222	1
DIS 800302	1
DIS 800304	1
DIS 800310	1
DIS 800312	1
DIS 800314	1
DIS 800316	1
DIS 800322	1
DIS 800404	1
DIS 800410	1
DIS 800412	1
DIS 800412/5	1
DIS 800414	1
DIS 800416	1

Display Pack Reference

PART REF	QTY PER PACK
----------	--------------

DIS 800416/5	1
DIS 800422	1
DIS 800422/5	1
DIS 800504	1
DIS 800512	1
DIS 800514	1
DIS 800516	1
DIS 800522	1
DIS 800616	1
DIS 800622	1
DIS 800716	1
DIS 800722	1
DIS 800816	1
DIS 800822	1
DIS 800912	1
DIS 800916	1
DIS 800922	1
DIS 8001112	1
DIS 8001116	1
DIS 8001122	1
DIS 803212	1
DIS 803216	1
DIS 803222	1
DIS 803312	1
DIS 803316	1
DIS 803322	1
DIS 803412	1
DIS 803416	1
DIS 803422	1
DIS 803512	1
DIS 803516	1
DIS 803522	1
DIS 808212	1
DIS 808216	1
DIS 808222	1
DIS 808312	1
DIS 808316	1
DIS 808322	1
DIS 808412	1
DIS 808416	1
DIS 808422	1
DIS 808512	1
DIS 808516	1
DIS 808522	1
DIS 810210	1
DIS 810212	1
DIS 810214	1
DIS 810216	1
DIS 810222	1
DIS 810310	1
DIS 810312	1
DIS 810314	1
DIS 810316	1
DIS 810322	1
DIS 810410	1
DIS 810412	1
DIS 810414	1
DIS 810416	1
DIS 810422	1
DIS 810512	1

PART REF	QTY PER PACK
----------	--------------

DIS 810514	1
DIS 810516	1
DIS 810522	1
DIS 810616	1
DIS 810622	1
DIS 810716	1
DIS 810722	1
DIS 810816	1
DIS 810822	1
DIS 810912	1
DIS 810914	1
DIS 810916	1
DIS 810922	1
DIS 8101112	1
DIS 8101114	1
DIS 8101116	1
DIS 8101122	1
DIS 815200	1
DIS 815300	1
DIS 815400	1
DIS 815500	1
DIS 815600	1
DIS 815700	1
DIS 815800	1
DIS 815202	1
DIS 815204	1
DIS 815210	1
DIS 815212	1
DIS 815314	1
DIS 815216	1
DIS 815222	1
DIS 815302	1
DIS 815304	1
DIS 815310	1
DIS 815312	1
DIS 815314	1
DIS 815316	1
DIS 815322	1
DIS 815402	1
DIS 815404	1
DIS 815412	1
DIS 815414	1
DIS 815416	1
DIS 815422	1
DIS 815502	1
DIS 815504	1
DIS 815512	1
DIS 815514	1
DIS 815516	1
DIS 815522	1
DIS 815616	1
DIS 815622	1
DIS 815716	1
DIS 815722	1
DIS 815816	1
DIS 815822	1
DIS 845200	1
DIS 845300	1
DIS 845400	1
DIS 845500	1

PART REF	QTY PER PACK
----------	--------------

DIS 845202	1
DIS 845204	1
DIS 845210	1
DIS 845212	1
DIS 845214	1
DIS 845216	1
DIS 845222	1
DIS 845302	1
DIS 845304	1
DIS 845310	1
DIS 845312	1
DIS 845314	1
DIS 845316	1
DIS 845322	1
DIS 845402	1
DIS 845404	1
DIS 845412	1
DIS 845414	1
DIS 845416	1
DIS 845422	1
DIS 845502	1
DIS 845504	1
DIS 845512	1
DIS 845514	1
DIS 845516	1
DIS 845522	1
DIS 850200	1
DIS 850300	1
DIS 850400	1
DIS 850500	1
DIS 850600	1
DIS 850700	1
DIS 850800	1
DIS 850900	1
DIS 850110	1

PART REF	QTY PER PACK
----------	--------------

Norgren Fittings	
DIS 94450303	2
DIS 94450304	2
DIS 94450306	1
DIS 94450307	1
DIS 94450308	1
DIS 94451104	1
DIS 94451106	1
DIS 94451107	1
DIS 94451404	1
DIS 94451406	1
DIS 94453004	2
DIS 94453006	2
DIS 94453010	1
DIS 94453012	1
DIS 94453013	1
DIS 94453020	1
DIS 94453021	1
DIS 94453029	1
DIS 94453030	1

Display Pack Reference

PART REF	QTY PER PACK
----------	--------------

DIS 94466631	1
DIS 94466633	1
DIS 94466635	1
DIS 94466653	1
DIS 94466655	1
DIS 94466658	1
DIS 94466665	1
DIS 94466668	1
DIS 94466675	1
DIS 95411404	1
DIS 95411406	1
DIS 95411410	1
DIS 95411412	1
DIS 95411413	1
DIS 95411418	1
DIS 95411420	1
DIS 95411430	1
DIS 95433104	1
DIS 95433105	1
DIS 95433106	1
DIS 95433110	1
DIS 95433112	1
DIS 95433113	1
DIS 95433118	1
DIS 95433120	1
DIS 95433121	1
DIS 95433127	1
DIS 95433129	1
DIS 95433130	1
DIS 95433131	1
DIS 95453003	1
DIS 95453004	1
DIS 95453006	1
DIS 95453009	1
DIS 95453010	1
DIS 95453012	1
DIS 95453013	1
DIS 95453018	1
DIS 95453020	1
DIS 95453021	1
DIS 95453022	1
DIS 95453029	1
DIS 95453030	1
DIS 95453031	1
DIS 97413833	1
DIS 97413835	1
DIS 97413838	1
DIS 97413843	1
DIS 97413844	1
DIS 97413845	1
DIS 97413848	1
DIS 97413851	1
DIS 97413853	1
DIS 97413854	1
DIS 97413855	1
DIS 97413858	1
DIS 97413864	1
DIS 97413865	1
DIS 97413868	1
DIS 97413875	1

PART REF	QTY PER PACK
----------	--------------

DIS 97413879	1
DIS 97413880	1
DIS 97433004	1
DIS 97433005	1
DIS 97433006	1
DIS 97433010	1
DIS 97433011	1
DIS 97433012	1
DIS 97433013	1
DIS 97433019	1
DIS 97433020	1
DIS 97433021	1
DIS 97433028	1
DIS 97433029	1
DIS 97433030	1
DIS 97450304	2
DIS 97450305	1
DIS 97450306	1
DIS 97450307	1
DIS 97450308	1
DIS 97450313	1
DIS 97450315	1
DIS 97450336	1
DIS 97450392	1
DIS 97451104	1
DIS 97451105	1
DIS 97451106	1
DIS 97451107	1
DIS 97451404	1
DIS 97451405	1
DIS 97451406	1
DIS 97451407	1
DIS 97452133	1
DIS 97452135	1
DIS 97452143	1
DIS 97452144	1
DIS 97452145	1
DIS 97452154	1
DIS 97452155	1
DIS 97452158	1
DIS 97452165	1
DIS 97452168	1
DIS 97453004	1
DIS 97453005	1
DIS 97453006	1
DIS 97453010	1
DIS 97453011	1
DIS 97453012	1
DIS 97453013	1
DIS 97453019	1
DIS 97453020	1
DIS 97453021	1
DIS 97453022	1
DIS 97453029	1
DIS 97453030	1
DIS 97453031	1
DIS 97466631	1
DIS 97466633	1
DIS 97466634	1
DIS 97466635	1

PART REF	QTY PER PACK
----------	--------------

DIS 97466638	1
DIS 97466641	1
DIS 97466643	1
DIS 97466644	1
DIS 97466645	1
DIS 97466648	1
DIS 97466651	1
DIS 97466653	1
DIS 97466654	1
DIS 97466655	1
DIS 97466658	1
DIS 97466663	1
DIS 97466665	1
DIS 97466668	1
DIS 97466670	1
DIS 97466675	1
DIS 97466679	1
DIS 97466680	1
DIS 98433104	1
DIS 98433110	1
DIS 98433111	1
DIS 98433112	1
DIS 98433113	1
DIS 98433118	1
DIS 98433119	1
DIS 98433120	1
DIS 98433121	1
DIS 98433129	1
DIS 98433130	1
DIS 98453004	1
DIS 98453005	1
DIS 98453006	1
DIS 98453010	1
DIS 98453011	1
DIS 98453012	1
DIS 98453013	1
DIS 98453018	1
DIS 98453019	1
DIS 98453020	1
DIS 98453021	1
DIS 98453029	1
DIS 98453030	1
DIS 98453031	1
DIS 100200400	2
DIS 100200500	2
DIS 100200600	2
DIS 100200800	2
DIS 100201000	1
DIS 100201200	1
DIS 100201400	1
DIS 100230406	1
DIS 100230504	1
DIS 100230604	1
DIS 100230605	1
DIS 100230608	1
DIS 100230804	1
DIS 100230806	1
DIS 100231004	1
DIS 100231006	1
DIS 100231008	1

TEL: 01474 535456 / FAX: 01474 537323
sales@airbrakeconnections.co.uk

Display Pack Reference

PART REF	QTY PER PACK
----------	--------------

DIS 100231208	1
DIS 100231210	1
DIS 100600400	1
DIS 100600600	2
DIS 100600800	1
DIS 100601000	1
DIS 100601200	1
DIS 100601400	1
DIS 101250418	2
DIS 101250428	2
DIS 101250518	1
DIS 101250528	1
DIS 101250618	2
DIS 101250628	2
DIS 101250818	2
DIS 101250828	2
DIS 101250838	1
DIS 101250848	1
DIS 101251018	1
DIS 101251028	1
DIS 101251038	1
DIS 101251228	1
DIS 101251238	1
DIS 101251248	1
DIS 101251438	1
DIS 101251448	1
DIS 101450418	1
DIS 101450428	1
DIS 101450518	1
DIS 101450528	1
DIS 101450618	1
DIS 101450628	1
DIS 101450818	1
DIS 101450828	1
DIS 101450838	1
DIS 101450848	1
DIS 101451018	1
DIS 101541028	1
DIS 101451038	1
DIS 101451048	1
DIS 101451228	1
DIS 101451238	1
DIS 101451248	1
DIS 101470418	1
DIS 101470428	1
DIS 101470518	1
DIS 101470528	1
DIS 101470618	1
DIS 101470628	1
DIS 101470638	1
DIS 101470818	1
DIS 101470828	1
DIS 101470838	1
DIS 101470848	1
DIS 101471018	1
DIS 101471028	1
DIS 101471038	1
DIS 101471048	1
DIS 101471228	1
DIS 101471238	1

PART REF	QTY PER PACK
----------	--------------

DIS 97413879	1
DIS 97413880	1
DIS 97433004	1
DIS 97433005	1
DIS 97433006	1
DIS 97433010	1
DIS 97433011	1
DIS 97433012	1
DIS 97433013	1
DIS 97433019	1
DIS 97433020	1
DIS 97433021	1
DIS 97433028	1
DIS 97433029	1
DIS 97433030	1
DIS 97450304	2
DIS 97450305	1
DIS 97450306	1
DIS 97450307	1
DIS 97450308	1
DIS 97450313	1
DIS 97450315	1
DIS 97450336	1
DIS 97450392	1
DIS 97451104	1
DIS 97451105	1
DIS 97451106	1
DIS 97451107	1
DIS 97451404	1
DIS 97451405	1
DIS 97451406	1
DIS 97451407	1
DIS 97452133	1
DIS 97452135	1
DIS 97452143	1
DIS 97452144	1
DIS 97452145	1
DIS 97452154	1
DIS 97452155	1
DIS 97452158	1
DIS 97452165	1
DIS 97452168	1
DIS 97453004	1
DIS 97453005	1
DIS 97453006	1
DIS 97453010	1
DIS 97453011	1
DIS 97453012	1
DIS 97453013	1
DIS 97453019	1
DIS 97453020	1
DIS 97453021	1
DIS 97453022	1
DIS 97453029	1
DIS 97453030	1
DIS 97453031	1
DIS 97466631	1
DIS 97466633	1
DIS 97466634	1
DIS 97466635	1

PART REF	QTY PER PACK
----------	--------------

DIS 101471248	1
DIS 101471438	1
DIS 101471448	1
DIS 101670418	1
DIS 101670428	1
DIS 101670518	1
DIS 101670528	1
DIS 101670618	1
DIS 101670628	1
DIS 101670818	1
DIS 101670828	1
DIS 101670838	1
DIS 101671028	1
DIS 101671038	1
DIS 101671048	1
DIS 101671228	1
DIS 101671238	1
DIS 120200100	2
DIS 120200200	2
DIS 120200300	2
DIS 120200400	1
DIS 120200500	1
DIS 120200600	1
DIS 120200700	1
DIS 120400100	1
DIS 120400200	1
DIS 120400300	1
DIS 120400400	1
DIS 120400500	1
DIS 120400600	1
DIS 120400700	1
DIS 120600100	1
DIS 120600200	1
DIS 120600300	1
DIS 120600400	1
DIS 120600600	1
DIS 120600700	1
DIS 121250118	2
DIS 121250318	2
DIS 121250328	1
DIS 121250418	2
DIS 121250428	2
DIS 121250618	1
DIS 121250628	1
DIS 121250728	1
DIS 121250738	1
DIS 101250748	1
DIS 121470118	1
DIS 121470318	1
DIS 121470328	1
DIS 121470418	1
DIS 121470428	1
DIS 121470628	1
DIS 121470638	1
DIS 121470648	1
DIS 121470738	1
DIS 121470748	1

Display Pack Reference

PART REF	QTY PER PACK
----------	--------------

Aluminium Seals	
DIS AL10	20
DIS AL12	20
DIS AL14	10
DIS AL16	10
DIS AL18	10
DIS AL22	10
DIS AL26	10
DIS AL32	10

Bulkheads	
DIS BA1212	1
DIS BA1414	1
DIS BA1422	1
DIS BA1616	1
DIS BA1618	1
DIS BA1622	1
DIS BA1818	1
DIS BA2218	1
DIS BA2222	1
DIS BA2250	1

Blanking Plugs	
DIS BP10	2
DIS BP12	2
DIS BP14	2
DIS BP16	2
DIS BP18	2
DIS BP22	2
DIS BP26	1
DIS BP12B	2
DIS BP16B	2
DIS BP22B	2
DIS BP26B	1

Bonding Seals	
DIS BS10	10
DIS BS12	10
DIS BS14	6
DIS BS16	10
DIS BS18	8
DIS BS22	8
DIS BS26	8
DIS BS32	8
DIS BSI4	4
DIS BSI6	4
DIS BSI8	4
DIS BSI12	4
DIS BSI16	4

Tee's	
DIS BST6	1
DIS BST8	1
DIS BST10	1
DIS BST12	1

Copper Rings	
DIS CR10	10
DIS CR12	10
DIS CR14	10
DIS CR16	10
DIS CR18	10
DIS CR22	10
DIS CR26	10

PART REF	QTY PER PACK
----------	--------------

Drain Tap	
DIS DT2	1
Equal Bulkhead	
DIS EBC6	1
DIS EBC8	1
DIS EBC10	1
DIS EBC12	1
DIS EBE6	1
DIS EBE8	1
DIS EBE10	1
DIS EBE12	1

Equal Connectors	
DIS EC6	2
DIS EC8	2
DIS EC10	2
DIS EC12	2
DIS EC15	1
DIS EC16	1
DIS EC18	1
DIS EE6	1
DIS EE8	1
DIS EE10	1
DIS EE12	1
DIS EE15	1
DIS ET6	1
DIS ET8	1
DIS ET10	1
DIS ET12	1

Female Adaptors	
DIS FFA16	1
DIS FFA1612	1
DIS FFA226	1
DIS FFA227	1
DIS FFA2216	1
DIS FFA2218	1
DIS FFA22	1

Female Tee	
DIS FT12	1
DIS FT16	1
DIS FT22	1

Grease Nipples	
DIS GN2	6
DIS GN4	6
DIS GN6	6
DIS GN8	6
DIS GN8125	6
DIS GN101	10
DIS GN10125	10
DIS GN1015	6
DIS GN452	4
DIS GN454	2
DIS GN4561	4
DIS GN4581	4
DIS GN458125	5
DIS GN45101	4
DIS GN4510125	4
DIS GN451015	4
DIS GN902	4
DIS GN904	4
DIS GN9061	4

PART REF	QTY PER PACK
----------	--------------

DIS GN9081	4
DIS GN908125	4
DIS GN90101	4
DIS GN901015	4

Hosetail Fittings	
DIS HS106Z	2
DIS HS1011Z	2
DIS HS1013Z	2
DIS HS1211Z	2
DIS HS1213Z	2
DIS HTS44	2
DIS HTS46	2
DIS HTS48	2
DIS HTS66	2
DIS HTS68	2
DIS HTS86	2
DIS HTS88	2
DIS HTS166	2
DIS HTS1611	2
DIS HTS1613B	2
DIS HTS1613	2
DIS HTS2211	2
DIS HTS2213B	2
DIS HTS2213	2

Lock Nuts	
DIS LN12Z	10
DIS LN14Z	8
DIS LN16Z	6
DIS LN18Z	6
DIS LN22Z	6
DIS LN26Z	4

Male Female Adaptors	
DIS MFA46	2
DIS MFA48	2
DIS MFA64	2
DIS MFA68	2
DIS MFA84	2
DIS MFA86	2
DIS MFA164	2
DIS MFA166	2
DIS MFA167	1
DIS MFA224	2
DIS MFA224B	2
DIS MFA226	2
DIS MFA227	2
DIS MFA412	2
DIS MFA416	2
DIS MFA422	1
DIS MFA616	2
DIS MFA622	1
DIS MFA716	2
DIS MFA718	2
DIS MFA722	2
DIS MFA1216	1
DIS MFA1222	1
DIS MFA1422	1
DIS MFA1610	1
DIS MFA1612	1
DIS MFA1616	1
DIS MFA1622	1

Display Pack Reference

PART REF	QTY PER PACK
----------	--------------

DIS MFA2212	2
DIS MFA2212B	2
DIS MFA2216	2
DIS MFA2216B	2
DIS MFA2622	1
Male Female Elbow	
DIS MFE1616	1
DIS MFE2222	1
Malleable Iron Fittings	
DIS MIBP802	3
DIS MIBP804	5
DIS MIBP806	4
DIS MIBP808	3
DIS MIBP812	2
DIS MIBP816	1
DIS MIFE622	2
DIS MIFE644	3
DIS MIFE666	2
DIS MIFE688	2
DIS MIFR442	2
DIS MIFR464	2
DIS MIFR484	1
DIS MIFR486	1
DIS MIFS422	3
DIS MIFS444	3
DIS MIFS466	3
DIS MIFS488	3
DIS MIHN522	3
DIS MIHN544	3
DIS MIHN566	2
DIS MIHN588	3
DIS MIHN542	2
DIS MIHN546	2
DIS MIHN548	2
DIS MIHN568	2
DIS MIMF722	2
DIS MIMF744	3
DIS MIMF766	2
DIS MIMF788	2
DIS MIRB342	3
DIS MIRB362	2
DIS MIRB364	3
DIS MIRB382	2
DIS MIRB384	3
DIS MIRB386	3
DIS MIT322	2
DIS MIT344	2
DIS MIT366	2
DIS MIT388	1
Male Male Adaptors	
DIS MMA212	2
DIS MMA214	2
DIS MMA216	2
DIS MMA412	2
DIS MMA414	2
DIS MMA416	2
DIS MMA616	2
DIS MMA618	2
DIS MMA718	2
DIS MMA722	2

PART REF	QTY PER PACK
----------	--------------

DIS MMA1012	2
DIS MMA1014	2
DIS MMA1016	2
DIS MMA1212	2
DIS MMA1214	2
DIS MMA1216	2
DIS MMA1218	2
DIS MMA1222	2
DIS MMA1412	2
DIS MMA1414	2
DIS MMA1416	2
DIS MMA1418	2
DIS MMA1422	2
DIS MMA1612	2
DIS MMA1614	2
DIS MMA1616	2
DIS MMA1618	2
DIS MMA1622	2
DIS MMA2212	2
DIS MMA2214	2
DIS MMA2216	2
DIS MMA2218	2
DIS MMA2222	2
DIS MMA2226	2
Male Male Elbows	
DIS MME1616	1
Male Studs	
DIS MSC26Z	2
DIS MSC28Z	2
DIS MSC210Z	2
DIS MSC46Z	2
DIS MSC48Z	2
DIS MSC410Z	2
DIS MSC412Z	1
DIS MSC610Z	1
DIS MSC612Z	1
DIS MSC812Z	1
DIS MSC815Z	1
DIS MSC106Z	2
DIS MSC108Z	2
DIS MSC1010Z	2
DIS MSC126Z	2
DIS MSC128Z	2
DIS MSC1210Z	2
DIS MSC1212Z	2
DIS MSC146Z	2
DIS MSC148Z	2
DIS MSC1410Z	2
DIS MSC1412Z	2
DIS MSC1415Z	1
DIS MSC166Z	2
DIS MSC168Z	2
DIS MSC1610Z	2
DIS MSC1612Z	2
DIS MSC1615Z	1
DIS MSC1616Z	1
DIS MSC226Z	2
DIS MSC228Z	2
DIS MSC2210Z	2
DIS MSC2212Z	2

PART REF	QTY PER PACK
----------	--------------

DIS MSC2215Z	1
DIS MSC2216Z	1
DIS MSC2218Z	1
Olives	
DIS O6B	7
DIS O8B	7
DIS O9B	10
DIS O10B	10
DIS O12B	10
DIS O15B	10
DIS O16B	6
DIS O18B	5
'O' Clips	
DIS OC3	10
DIS OC4	10
DIS OC5	10
DIS OC6	10
DIS OC7	10
DIS OC8	10
DIS OC9	10
DIS OC10	10
DIS OC12	10
DIS OC14	10
DIS OC16	10
Thrust and 'O' Rings	
DIS ORTR10	10 each
DIS ORTR12	10 each
DIS ORTR14	10 each
DIS ORTR16	10 each
DIS ORTR18	10 each
DIS ORTR22	10 each
DIS ORTR26	10 each
John Guest Plastic (Imperial)	
DIS PFI1	3
DIS PFI3	3
DIS PFI4	2
DIS PFI5	2
DIS PFI6	2
DIS PFI8	1
DIS PFI43	2
DIS PFI53	2
DIS PFI54	2
DIS PFI64	2
DIS PFI65	2
DIS PFI86	1
DIS PFI153	3
DIS PFI154	2
DIS PFI165	2
DIS PFI186	1
DIS PFI222	3
DIS PFI223	3
DIS PFI224	3
DIS PFI225	3
DIS PFI244	3
DIS PFI245	3
DIS PFI246	2
DIS PFI265	2
DIS PFI266	2
DIS PFI268	1
DIS PFI288	1

Display Pack Reference

PART REF	QTY PER PACK
DIS PFI622	2
DIS PFI633	2
DIS PFI644	2
DIS PFI655	2
DIS PFI666	1
DIS PFI688	1
DIS PFI922	2
DIS PFI933	2
DIS PFI944	2
DIS PFI955	2
DIS PFI966	1
DIS PFI988	1
John Guest Plastic (Metric)	
DIS PFM4	3
DIS PFM5	3
DIS PFM6	3
DIS PFM8	2
DIS PFM10	2
DIS PFM12	2
DIS PFM15	1
DIS PFM54	2
DIS PFM55	2
DIS PFM56	2
DIS PFM58	2
DIS PFM510	2
DIS PFM512	1
DIS PFM515	1
DIS PFM64	2
DIS PFM84	2
DIS PFM86	2
DIS PFM104	2
DIS PFM106	2
DIS PFM108	2
DIS PFM128	2
DIS PFM1210	2
DIS PFM74	2
DIS PFM75	2
DIS PFM76	2
DIS PFM78	2
DIS PFM710	1
DIS PFM712	1
DIS PFM715	1
DIS PFM154	2
DIS PFM164	3
DIS PFM165	2
DIS PFM184	3
DIS PFM185	3
DIS PFM186	3
DIS PFM1106	2
DIS PFM1108	2
DIS PFM1128	2
DIS PFM11210	1
DIS PFM214	3
DIS PFM215	3
DIS PFM216	2
DIS PFM244	3
DIS PFM245	3
DIS PFM246	3
DIS PFM248	2
DIS PFM2410	2

PART REF	QTY PER PACK
DIS PFM268	2
DIS PFM2610	2
DIS PFM2612	1
DIS PFM2810	1
DIS PFM2812	1
Norgren Plastic (Metric)	
DIS PFM4NR	3
DIS PFM6NR	3
DIS PFM8NR	2
DIS PFM10NR	2
DIS PFM12NR	2
DIS PFM16NR	1
DIS PFM54NR	2
DIS PFM56NR	2
DIS PFM58NR	2
DIS PFM510NR	2
DIS PFM512NR	1
DIS PFM516NR	1
DIS PFM74NR	2
DIS PFM76NR	2
DIS PFM78NR	2
DIS PFM710NR	1
DIS PFM712NR	1
Stud Bulkhead Couplings	
DIS SBC126	1
DIS SBC168	1
DIS SBC1610	1
DIS SBC1612	1
DIS SBC86	1
DIS SBC88	1
DIS SBC228	1
DIS SBC2210	1
DIS SBC2212	1
Stem / Stud Elbows	
DIS SE6	1
DIS SE8	1
DIS SE10	1
DIS SE12	1
DIS SE15	1
DIS SE210	1
DIS SE410	1
DIS SE128	1
DIS SE1210	1
DIS SE148	1
DIS SE1410	1
DIS SE168	1
DIS SE1610	1
DIS SE1612	1
DIS SE1615	1
DIS SE228	1
DIS SE2210	1
DIS SE2212	1
DIS SE2215	1
DIS SE2216	1
DIS SE2218	1
Side Stem Tees	
DIS SST6	1
DIS SST8	1
DIS SST10	1
DIS SST12	1

PART REF	QTY PER PACK
DIS SST15	1
Stem Studs	
DIS STS1610	1
DIS STS1612	1
DIS STS2210	1
DIS STS2212	1
Hosetails	
DIS SWH106	2
DIS SWH109	2
DIS SWH1011	2
DIS SWH1013	2
DIS SWH1213	2
DIS SWHT46	2
DIS SWHT166	2
DIS SWHT168	2
DIS SWHT1613	2
DIS SWHT228	2
DIS SWHT2213	2
Tube Clamps	
DIS TC6	5
DIS TC8	5
DIS TC10	5
DIS TC12	5
DIS TC16	5
DIS TC18	5
DIS TC25	5
Tube Inserts	
DIS TI4	10
DIS TI6	10
DIS TI7	10
DIS TI7.5	10
DIS TI8	10
DIS TI9	10
DIS TI10	10
DIS TI11	10
DIS TI12	10
DIS TI14	10
DIS TI14	10
DIS TI15	10
DIS TI16	10
DIS TI18	10
Tube Nuts	
DIS TN6	10
DIS TN8	10
DIS TN10	8
DIS TN12	8
DIS TN15	2
DIS TN16	2
DIS TN18	2
Test Point Adaptors	
DIS TPA1	1
DIS TPA2	1
DIS TPA3	1
Test Points	
DIS TPF12	1
DIS TPF14	1
DIS TPF16	1
DIS TPF18	1
DIS TPF22	1
DIS TPM12	1

TEL: 01474 535456 / FAX: 01474 537323
sales@airbrakeconnections.co.uk

Display Pack Reference

PART REF	QTY PER PACK
DIS TPM14	1
DIS TPM16	1
DIS TPM22	1
DIS TPM25	1
Tilt Taps	
DIS TT3	1
DIS TT4	1
DIS TT8	1
DIS TTC3	1
Test point Tee	
DIS TTP8	1
DIS TTP10	1
DIS TTP12	1
Worm Drive Clips	
DIS WD18	4
DIS WD25	4
DIS WD67	4
DIS WD810	4
DIS WD812	4
DIS WD1014	4
DIS WD1216	4
DIS WD1418	4
DIS WD1622	4



.....

.....

.....

.....

.....

.....

.....

.....

.....

CONDITIONS OF SALE

1: IN GENERAL - These conditions of sale shall be applied as conditions in any order or contract accepted by us. No agent, stockist, third party or an employee other than director of the company selling our products is authorised to transact any business, which gives any warranty, or any representation, or incurs any liability on our behalf. We reserve the right to change our products, their design or construction details without prior notice. If these conditions or any other conditions to which another party may seek to incorporate into the contract conflict, these conditions shall prevail. Any notice required to be served pursuant to these conditions should be served as follows:

1/1: *The Seller.* Air Brake Connections International Ltd address as registered office.

1/2: *The Buyer.* To the address as notified to the seller or in case of default or notification to the address from which the products and or services were ordered. Or to the registered offices of the buyer. An addressed notice sent via first class post to those destinations within the UK or the Republic of Ireland shall be expected as having been received three days after the day of despatch. An addressed notice of any other destination via Air mail shall be expected as having been received seven days after the date of despatch.

2: DISTRIBUTION - The method of distribution shall be decided by ABC Ltd and all goods went be sent carriage free except in the case of:

2/1: Any mainland UK order below a nett value of £150.00.

2/2: Any Non mainland UK (Scotland, N. Ireland) order below a nett value of £200.00.

2/3: Any Eire order below a nett value of €250.00.

2/4: Any special orders placed upon ABC for which any carriage charges incurred by ABC shall be charged to our customer in full.

2/5: Orders despatched on customers instructions by any means more expensive than our normal chosen method.

3: DESCRIPTIONS - While every effort has been made to ensure that the products are accurately described and we believe to be fit for the purpose as described in our catalogues leaflets, wall charts, etc. We give no warranty or representation to this effect. We also take no responsibility in the event of any error or misdescription of any such unfitness, or any damage relating there from. Photographs, illustrations, etc and technical information generally represent the goods or products offered for sale but are not binding in detail. ABC reserve the absolute right to make detailed alterations to the materials and specifications, weights, dimensions, etc.

4: DELIEVRY VIA SCHEDULE - Delivery of orders via schedules made at scheduled rate to which on the following conditions:

4/1: No delay of delivery can be taken unless the customer has agreed or ABC prior and or has written agreement.

4/2: Delay of any schedule or delivery months from the originally agreed not be accepted.

4/3: ABC require and reserve the right to insist that fourteen days notice must be given to delay firm orders or schedules.

4/4: Each delivery constitutes a separate transaction. Quantities delivered in each time scale within the schedules will be subject to a tolerance agreed to prior between ABC and their customers.

5: DELIVERY QUOTATIONS - Delivery dates quoted for despatch is subject to stock remaining old sold. Should we be delayed or prevented from delivering the whole or part of our customers orders due to circumstances beyond our control our customers shall not be entitled to refuse or to except those goods or products previously ordered unless prior agreement has been sought and agreed.

6: DISCLAIMER NOTICE - Where our part reference and or other supplier manufactures references are quoted side by side, this has been done purely for reference only and does not necessarily indicate the manufacturer of said goods or products nor does it have any reflection upon our competitors.

7: GUARANTEES - In lieu of such warranty implied or covered by law, we expressly guarantee to replace or make good any products supplied by ABC, which may be defective through faulty materials or workmanship, provided always, that such parts are promptly returned free to our premises within seven working days of the defect having become apparent and not later than six months after the date of delivery having been made by ABC or it chosen carriers.

7/1: ABC will not be liable for any loss incurred through stoppage, nor for any consequential loss or damaged caused.

7/2: ABC guarantee is in respect of material and workmanship only we shall not apply this if injury, or expenditure, However the goods or products are altered or tampered with or if a defect shall be due to or brought about by fair wear and tear., carelessness on the part of the user, misuse or accident, or other cause outside the control of ABC, and providing the customer is not in default of payment of any sums due to ABC. The customer is responsible for ensuring the goods ordered upon us are suitable for the purpose for which they are intended or required for. Te liability under this guarantee is limited to repair and or replacement, in no circumstances whatsoever shall we incur or be liable for any further liability under this guarantee, save where you have dealt with us on a customer basis.

7/3: Any express or implied condition of warranty or term statutory, or otherwise as to the quality fitness, compliance with description, or sample of the whole or part of the goods or products, or any replacement thereof, or as to the quality of any work or repair or replacement is hereby excluded.

8: INTERPRETATION BY LAW - These conditions and contracts are governed in all respect by ENGLISH LAW and the customer submits to the jurisdiction of the English Courts.

9: MINIMUM INVOICING DETAILS - Due to the ever increasing high costs of processing small value orders our minimum invoice charge will be £40.00 nett excluding the carriage charges. This condition shall not apply to back orders or part orders.

10: PACKAGING - ABC reserve the right to charge for export packaging with the prior agreement of export customers.

11: PRICING - All prices are subject to alteration without prior notice . If during the currency of any contract or schedule there be an increase in the cost of labour and or materials required in connection with or for the purpose of any such contract or schedule over the cost of such labour and or materials prevailing at the date of acceptance such nett increases of costs may or shall be added to those contracts or schedules prices and shall be payable by our customer. All prices are subject to the addition of VAT when appropriate. Special orders placed with ABC may be subject to a variance from the normal list price. Quotations of price will be given at the time of placing and order and will be deemed to be binding solely for that special order.

12: RETURN OF GOODS - All goods or products correctly supplied in accordance with the customers order but which are subsequently refused or returned will only be credited provided that:

- Our written agreement has been obtained. We do reserve the right to accept returned goods or products.
- Those goods to be credited are contained within our current price list, are of current design, and in condition for resale.
- Those goods returned must be accompanied by a packing or returns document stating the reason for return. To include the original invoice or despatch note document reference.

We reserve the right to charge a 20% handling charge and also the original cost of carriage if incurred. Special orders placed upon ABC will not be accepted as a return unless we have written agreement prior.

13: RISK, DAMGE, LOSS, NON DELIVERY - Risk in the goods or products will pass to customer upon, delivery of the goods to the customers premises or to a third party address as instructed by the customer in respect of a sale to a UK based customer: and delivery F.O.B. UK port in respect of any sale to an overseas based customer unless otherwise agreed between the parties in writing:

14: TERMS OF PAYMENT - UK payment by the last working day of the month following the date of invoice, pending ABC opening a credit account all goods must be paid for in advance, and prior to the confirmation of satisfactory trade and or bank references a credit limit of £1000.00 shall be applied.

Exports/Overseas: The method of payment shall be determined prior to or at the time of confirmation of the order. Any bank charges on export bills are payable by the customer.

ABC reserve the right to charge interest at the rate of 5% per month on extended terms of payment and overdue accounts. All costs incurred during the recovery period of an outstanding debt shall be met by the customer. While any account of one of our customers is overdue the company may withhold or suspend and supply or any contractual obligation to such customers.

15: TITLE RETENTION - Property in the goods and or products, services, shall remain with ABC until you have paid to ABC the price of all goods, products, services supplied under the contract for the supply of goods, products, services and all sums owing at any time by you to ABC. On any ground whatsoever (including without prejudice to the generality of the foregoing, all sums owing by you to ABC at any time in respect of any supply of goods, products, or services under any contract) you undertake that in the event that you buy from a party other than ABC supplies of goods that are or were manufactured by or sold by ABC or are similar to such goods if the intention of retaining such goods, products, or services as stock you will clearly mark each of those goods, products, or services in the said supply in order to distinguish each of those goods, products, or services from goods, products, or services sold to you by ABC.

15/1: You irrevocably grant to ABC a licence to enter (by ABC itself or its servants or agents and with or without vehicle) without notice upon lands and or premises owned, used, or occupied by you for the purpose of ABC taking possession on goods, products, services, the property of ABC: and that you agree to render without charge all assistance as ABC may request to ABC and to ABC servants or agents for the purpose of ABC's identifying and taking possession of goods, products, services the property of ABC.

15/2: Subject to always to and without prejudice to above, you are entitled to sell the goods, products, services to a purchaser or purchasers by way of bona fide sale in the ordinary course of business at any time that (and insofar as) ABC shall permit and provided always that your entitlement shall cease immediately and without notice on the occurrence of any one or more of the following events:

- A receiver or administrative receiver is appointed in respect of you or over all or part of your assets or undertaking.
- You announce that you have ceased or intend to cease to trade.
- You suspend payment of your debts or unable to pay or admit to state your inability to pay your debts as they fall due.
- You dispose or threaten to dispose of all or a material part of your assets whether by one or a series of transactions (other than the sole purpose of and followed by your reconstruction or amalgamation, approved by ABC).
- You Convene, call or hold a meeting of your creditors or make any arrangement, voluntary arrangement or composition with your creditors.
- Your directors make or state an intention to make or give notice of a proposal in relation to you for a voluntary arrangement under part of the insolvency Act 1986.
- A petition is presented for your winding up or administration.
- A resolution (other than for the sole purpose of and followed by your reconstruction or amalgamation, approved by ABC) is passed for your voluntary winding up.
- You are dissolved.
- You suffer the levy or enforcement of any execution, distress, sequestration, detention or the process on any property or premises.
- In the event that you sell goods to a particular purchaser or purchasers in accordance with 15/2, prior you shall sell as principal in relation to the purchaser or purchasers and have no right to commit ABC to any contractual relationship with or liability to the purchaser or purchasers or any other third party.
- You undertake that in the event that you sell any goods supplied by ABC you will sell those goods (of the type required for the particular sale) as have at the material time been longest in your possession.

16: CUSTOMER CONDITIONS OF PURCHASE - In all instances ABC's Conditions of Sale stated herein over ride any separate Terms and Conditions of Purchase stated by ABC's customers.

17: CONSTRUCTION - If any provisions of this agreement are held to be invalid for any reason then this Agreement shall be read if the invalid provisions had to that extent been deleted and the validity of the remaining provisions of this Agreement shall not be affected hereby.

18: VARIANCES TO THESE STANDARD CONDITIONS OF SALE - ABC reserve the right to vary ABC's standard Conditions of Sale as stated herein. Any variation will be notified in writing to individual customers effected by these variances and will only apply in respect of products purchased following such changes and notifications.

Tel: 01474 535456

Fax: 01474537323

Web: www.airbrakeconnections.co.uk

E-mail: sales@airbrakeconnections.co.uk



**SOLE
DISTRIBUTORS**



**Unit 5 May Avenue Industrial Estate,
Northfleet, Kent, DA11 8RU**