

KEURIG®

K·Café™

Use & Care Guide

Get the most from your
new Keurig® brewer

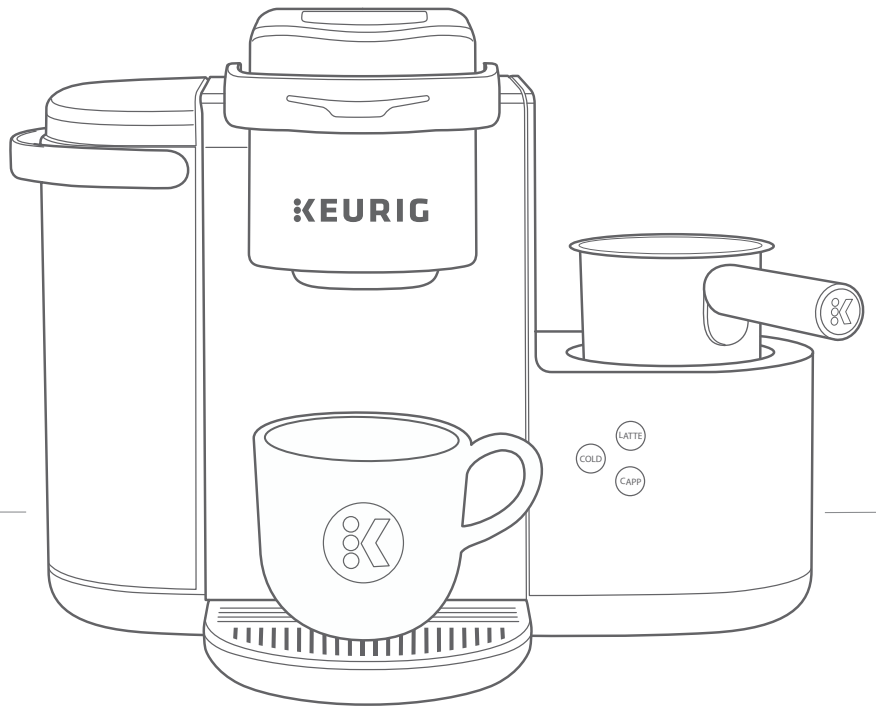

Before You Brew

1 Plug & Place

Remove packing tape from brewer and remove frother from plastic bag. Plug into a grounded outlet.

Place a large mug (12oz minimum) on the drip tray.

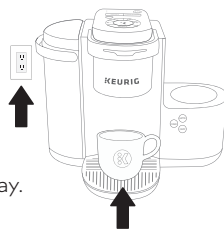

2 Rinse & Fill

Remove the water reservoir lid, then lift the reservoir straight up to remove it.

Rinse reservoir with fresh water and fill to the **MAX** fill line.

Replace water reservoir, making sure the lock tab engages with the brewer. Replace lid.

NOTE: Do not use distilled water.

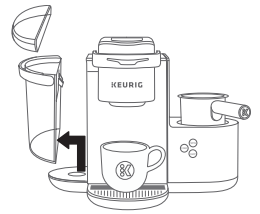

3 Clean the Frother

Remove the lid and whisk from inside the frother. Wash the interior of the frother, lid, and whisk with warm, soapy water. Dry all parts thoroughly using a soft, non-abrasive cloth, and then reassemble.

NOTE: Frother and frother lid are top rack dishwasher safe. Whisk should be placed in the utensil basket. If washing by hand, only use non-abrasive cleaning materials to prevent damage to the inner surface of the frother.

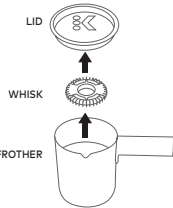

4 Power On

Press power button — the power light and AUTO OFF light will illuminate.

The brewer will automatically begin heating the water. This will take about 3 minutes. Once the heating sound stops, the brewer is ready.



5 Cleansing Brew

Lift and lower the handle. **Do not insert a K-Cup® pod.** The COFFEE and LATTE & CAPP buttons will blink. Press the **6oz** button, then press the blinking **brew button** to start a cleansing brew (the COFFEE button will illuminate). Pour the hot water into the sink.

The one-time setup process is now complete and you are ready to brew!

NOTE: Between brew cycles, the brewer may take about a minute to reheat.

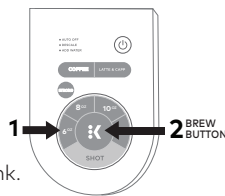

Make Your First Latte or Cappuccino

1 Fill Frother

To make a Hot Latte or Hot Cappuccino:

Remove lid and add chilled milk to the LATTE or CAPP line marked in the frother. Replace the lid and place frother on the frother base. Press the LATTE or CAPP button on the frother base. The frother will beep once and the button will illuminate while heating – approximately 3 minutes.

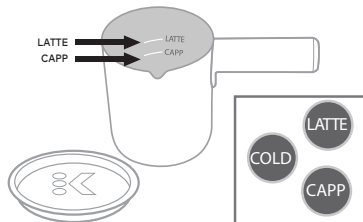

Frothing is complete when the frother beeps twice and the light on the LATTE or CAPP button is no longer illuminated.

TIP: Having trouble frothing? We're here to help. Give us a call at 1-866-901-BREW (2739).

NOTE: Do not under or overfill frother. Do not operate before adding milk. CAPP line = minimum fill LATTE line = maximum fill

CAUTION: Frother is not microwave safe.

To make an Iced Latte or Iced Cappuccino:

Remove lid and add chilled milk to the LATTE or CAPP line marked in the frother. Replace the lid and place frother on the frother base. Press the **COLD** button followed by the LATTE or CAPP button. The frother will beep once and both buttons will illuminate while the milk is frothing – approximately 3 minutes.

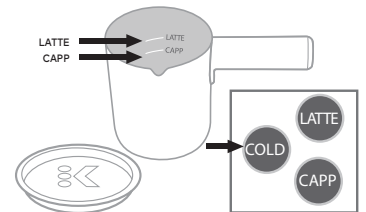

Frothing is complete when the frother beeps twice and the light on the COLD and LATTE or CAPP buttons are no longer illuminated.

NOTE: Do not under or overfill frother. Do not operate before adding milk. CAPP line = minimum fill LATTE line = maximum fill

CAUTION: Frother is not microwave safe.

2 Place Mug & Pod

Place a mug on the drip tray plate. Lift the handle and place any K-Cup® pod in the K-Cup® pod holder. Lower the handle completely to close the lid.

Do not remove the foil lid on the K-Cup® pod.

To make an iced latte or iced cappuccino, fill a 16oz plastic cup half way with ice, then follow instructions above.

NOTE: For iced beverages, only use a plastic cup, do not use glass.

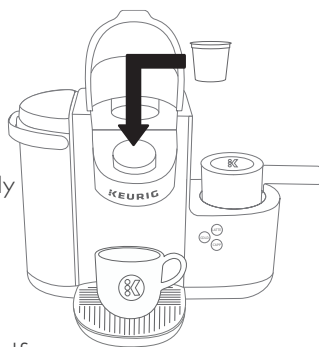

3 Brew a Shot

The COFFEE and LATTE & CAPP buttons will blink. Press the **LATTE & CAPP** button - the SHOT button and STRONG button will illuminate. Press the blinking **brew button**. The LATTE & CAPP, SHOT, STRONG, and brew button will all remain illuminated while brewing – about 1 minute. Brewing is complete when the buttons are no longer illuminated. Lift the handle and dispose of the used K-Cup® pod. The brewer will be ready to brew another cup in about a minute.

NOTE: After 60 seconds, the brew button will be disabled. To re-activate, lift and lower the handle completely.

CAUTION: While brewing, there is extremely hot water in the K-Cup® pod holder. To avoid injury, do not lift the handle during the brewing process.

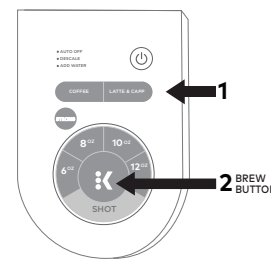

4 Create Your Coffeehouse Beverage

Remove the frother from the base. Remove the lid and pour the frothed milk over your shot of coffee.

NOTE: Clean frother immediately after use. For cleaning instructions, see Caring for your Brewer section in this guide.



Brew Your First Coffee

1 Place Mug & Pod

Place a mug on the drip tray. If using a travel mug, remove the drip tray and place the mug on the drip tray base. Lift the handle and place a K-Cup® pod in the pod holder. Lower the handle completely to close the lid.

Do not remove the foil lid on the K-Cup® pod.

High Altitude Brewing: While holding the brewer handle up, push down slowly on the K-Cup® pod in the pod holder until the bottom of the K-Cup® pod is punctured by the exit needle.

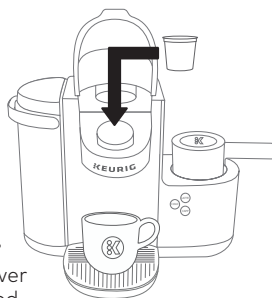

2 Brew & Enjoy!

The COFFEE and LATTE & CAPP buttons will blink. Press the **COFFEE** button. The 4 cup sizes will blink. Select your cup size – for bolder coffee, press the **STRONG** button before selecting your cup size. Press the blinking **brew button**. The COFFEE, STRONG (if selected), cup size, and brew button will all remain illuminated while brewing – about 1 minute. Brewing is complete when the buttons are no longer illuminated. Lift the handle and dispose of the used K-Cup® pod. The brewer will be ready to brew another cup in about a minute.

NOTE: After 60 seconds, the brew buttons will be disabled. To re-activate, lift and lower the handle completely.

CAUTION: While brewing, there is extremely hot water in the K-Cup® pod holder. To avoid injury, do not lift the handle during the brewing process.

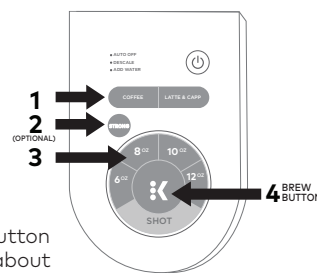

Brewer Features

Frother froths milk to create your favorite latte or cappuccino.

SHOT button brews a shot of coffee to make full-flavored, delicious lattes and cappuccinos.

COLD button for cold frothed milk to create iced lattes and iced cappuccinos.

Strong Brew increases your coffee strength and intensity. For bolder coffee, press the **STRONG** button.

Smart Start heats then brews in one simple process. No need to wait for the brewer to heat before selecting cup size. Power on your brewer, place mug, insert a K-Cup® pod, and lower the handle. Then, select your cup size and press the brew button. The brewer will heat, then automatically begin brewing.

Auto Off automatically turns your brewer off 2 hours after the last brew for energy savings.

To disable the Auto Off feature:

1. Power the brewer off while it is plugged in.

2. Press and hold the **STRONG** and the **10oz** buttons for 3 seconds – the Auto Off light will turn off.

3. Power the brewer on – the Auto Off light will no longer be illuminated.

To enable the Auto Off feature, repeat steps 1-3. The Auto Off light will illuminate.

High Altitude Brewing: To ensure your brewer works properly at higher altitudes (5,000 feet) please follow these brewing instructions and enable the High Altitude Brewing Mode on your brewer.

Brewing Instructions - While holding the brewer handle up, push down slowly on the K-Cup® pod in the pod holder until the bottom of the K-Cup® pod is punctured by the exit needle.

To enable High Altitude Brewing Mode:

1. Power the brewer off while it is plugged in.

2. Press and hold the **STRONG** and **8oz** buttons for 3 seconds- both lights will blink 3 times to confirm that the High Altitude Brewing Mode has been enabled.

To disable High Altitude Brewing Mode:

1. Power the brewer off while it is plugged in.

2. Press and hold the **STRONG** and **8oz** buttons until the lights are no longer illuminated.

Caring For Your Brewer

Regular cleaning keeps your brewer running smoothly. Always be sure to turn off and unplug your brewer before cleaning.

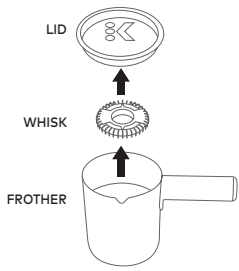

Frother

Clean immediately after each use and before first use.

To clean - **frother and frother lid are top rack dishwasher safe.** After use, wait until the frother has cooled then rinse before placing in the top rack of the dishwasher, or cool and hand wash immediately. Whisk should be placed in the utensil basket of your dishwasher. If washing by hand, only use non-abrasive cleaning materials to prevent damage to the inner surface of the frother. To hand wash the whisk, soak in warm, soapy water for 15 minutes then scrub with a soft bristled brush. Dry thoroughly, and then reassemble for next use.

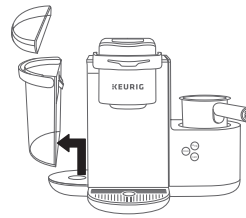

Water Reservoir & Reservoir Lid

The water reservoir lid and water reservoir should be cleaned periodically. Clean in a dishwasher (top rack only) or hand wash. To hand wash, use a damp, soapy, non-abrasive cloth. Rinse the reservoir thoroughly after cleaning. This will ensure that no cleaning solutions remain in the area as they may contaminate the water supply. After rinsing, fill the reservoir with clean water and return it to the brewer. Do not dry the inside of the water reservoir with a cloth as lint may remain. If needed, repeat above procedures.

NOTE: If you are using a water filter inside the water reservoir, remove it before cleaning.

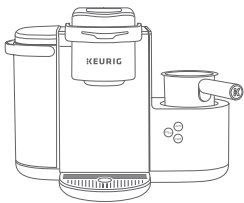

Brewer Exterior

Keep your Keurig® brewer looking its best by cleaning the exterior from time to time. Just clean with a damp, soapy, lint-free, non-abrasive cloth. Never immerse the brewer in water or other liquids.



Drip Tray

The drip tray can hold up to 8 ounces of overflow and should be emptied and cleaned occasionally. To remove, slide it toward you, keeping it level to avoid spilling. Clean in dishwasher (top rack only) or rinse and clean with a damp, soapy, lint-free, non-abrasive cloth.

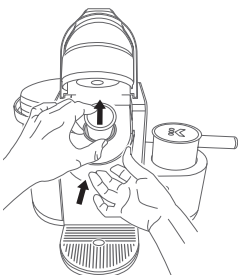

K-Cup® Pod Holder

To remove the K-Cup® pod holder from the brewer, lift the handle and grasp the top of the K-Cup® pod holder with one hand while pushing up on the bottom of the K-Cup® pod holder from underneath with the other until it releases. After cleaning, align the K-Cup® pod holder with the opening using the two front ribs as a guide and snap into place from the top.

CAUTION: There are sharp needles that puncture the K-Cup® pod above the K-Cup® pod holder and in the bottom of the K-Cup® pod holder. To avoid risk of injury, do not put your fingers in the K-Cup® pod holder.

NOTE: Always remove and dispose of the used K-Cup® pod after brewing.

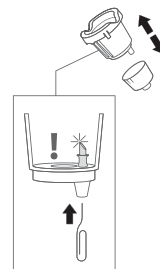

Exit Needle

Remove the pod holder assembly and detach the funnel. Locate the exit needle on the inside bottom of the K-Cup® pod holder. Insert a straightened paper clip into the exit needle to loosen any coffee grounds.

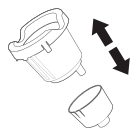

Funnel

Washing the funnel ensures a fresh beverage experience. The funnel should be washed regularly and can be removed from the K-Cup® pod holder by pulling on it until it pops off. To replace it, orient the snaps to the indent and just snap it back onto the K-Cup® pod holder.

Entrance Needle

Lift the brewer handle and locate the entrance needle on the underside of the lid. To clean both holes in the needle, hold the brewer handle in the upward position and with your other hand, carefully insert a straightened paper clip into both holes. Gently move it around to loosen any coffee grounds. Lower the handle completely and run two water-only brew cycles. Do not insert a K-Cup® pod.

TIP: Refer to support.keurig.com for video instructions on cleaning the entrance/exit needles.

Descaling Your Brewer

You should descale your brewer every 3-6 months. Properly follow the descaling procedure.

Depending on the mineral content of your water, calcium deposits or scale may build up in your brewer. Scale is non-toxic but if left unattended can hinder brewer performance. Regularly descaling your brewer every 3-6 months helps maintain the heating element, and other internal parts that come in contact with water. Calcium deposits may build up faster, making it necessary to descale more often.

Descaling Procedure

Before you begin, you will need a large ceramic mug, fresh water, Keurig® Descaling Solution, and access to a sink. Do not use a paper cup. Ensure that there is no beverage pod in the K-Cup® pod holder. Please allow approximately 45 minutes for the descaling procedure.

Empty the water from the water reservoir. If using a Keurig® Water Filter, remove and set aside.

STEP 1: Cleansing Rinse

Press the power button to power the brewer off.

Pour the entire bottle of Keurig® Descaling Solution into an emptied water reservoir. Then fill the empty bottle with water and pour into the water reservoir. Press the power button to turn the brewer back on.

Place a large mug on the drip tray and run a rinsing brew by lifting and lowering the handle, select the largest brew size, then press the brew button.

STEP 2: Internal Tank Soak

Repeat the rinsing brew process until the add water light is illuminated. Do not use a K-Cup® pod. Let brewer stand for at least 30 minutes while still on.

After 30 minutes, discard any residual solution from the water reservoir and rinse thoroughly.

STEP 3: Fresh Water Rinse

Fill the water reservoir with fresh water to and not beyond the MAX fill line.

Place a large mug on the drip tray plate and run a rinsing brew using the largest brew size. Do not use a K-Cup® pod. Pour the contents of the mug into the sink.

Repeat brew process until you have completed at least 12 rinsing brews using the largest brew size. You may need to refill the water reservoir at least one time during this process.

NOTE: The cleaning action of Keurig® Descaling Solution may result in a "foam" dispensed from the brewer. This is natural, as the solution is reacting with the scale inside. For a brewer that is heavily scaled, the brewer may not fill properly after the descaler is added. If this occurs, you may see only a small or no output dispensed, followed by the sound of air blowing out. If this occurs:

- Turn off and unplug the brewer.
- If there is Keurig® Descaling Solution in the water reservoir, discard the contents, rinse the water reservoir thoroughly and refill with water.
- Plug the brewer back in, power on, and repeat the Step 3 Fresh Water Rinse cycle. The brewer should begin to function normally as the solution is rinsed out and the scale is removed. If problem persists, allow brewer to sit unplugged for at least 30 minutes before continuing with the rinse.

Troubleshooting

Frother

- If the milk you are using isn't frothing, please call Customer Service.
- If the light on the frother base is pulsing in and out - it may be because you are trying to froth while brewing coffee. Once the brew cycle is complete, the frother will automatically start frothing.
- If all lights on the frother base are flashing, check to make sure there is milk in the frother, the whisk is correctly placed in the frother, and the frother is properly seated on the base.

Grounds in Your Coffee

Grounds may have gathered in the exit or entrance needles and can be cleaned using a straightened paper clip or similar tool.

- Clean the exit needle of the K-Cup® pod holder. Refer to the Exit Needle care instructions.
- Clean the brewer entrance needle. Refer to the Entrance Needle care instructions.

Brewer Will Not Brew

- After placing the K-Cup® pod in the K-Cup® pod holder, make sure that the handle is pushed down securely and the brew buttons are flashing.
- If the add water light is illuminated, add water to water reservoir. Fill to and not beyond the MAX fill line. Make sure the water reservoir is seated properly in its base. If the add

water light continues to be illuminated even after refilling, contact Customer Service.

- If frother is in use, you may not be able to brew coffee at the same time. If this happens, wait 30 seconds after the frother has finished frothing then try brewing again. If you still cannot brew, contact Customer Service.

Brewing a Partial Cup

- The exit needle may be clogged. Refer to the Exit Needle care instructions.
- The water reservoir may have been removed during brewing. Replace the water reservoir and perform a rinsing brew without a K-Cup® pod.
- The brewer may need to be descaled. If you have repeated the descale procedure on your brewer two times and it is still only brewing a partial cup, contact Customer Service.

Brewer Does Not Have Power or Shuts Off

- Make sure that the power button has been turned on.
- Plug brewer into its own grounded outlet. If the electric circuit is overloaded with other appliances, your brewer may not function properly. The brewer should be operated on its own circuit, separate from other appliances.
- Auto Off sets the brewer to turn off 2 hours after the last brew for energy savings. Refer to Brewer Features for instructions on enabling and disabling this feature.
- If the brewer still doesn't have power, contact Customer Service.

Helpful Hints

Water quality varies greatly. If you notice an undesirable taste in your beverage (such as chlorine or mineral tastes), we recommend using bottled or filtered water. Do not use distilled water. You can also install a Keurig® Water Filter to help remove water impurities and improve beverage taste.

Service

Beyond these recommended cleaning and maintenance procedures, this brewer is not user serviceable. For service, please refer to the Warranty section of this guide.

Storage

Empty the water reservoir before storing or transporting and take care to ensure that you store your brewer in a safe and frost free environment. Please be sure to store your brewer in its upright position to avoid water leakage from the inner tank. If you store the brewer in a cold environment, you run the risk of water freezing inside the brewer and causing damage. When you prepare to use it after storage, we recommend cleaning the water reservoir with soap and fresh water and descaling the brewer as detailed in the section above.

If you plan to move your brewer to a different location, turn the brewer off, unplug it, and empty the water reservoir. If your brewer has been in an environment below freezing, please be sure to let it warm to room temperature for at least 2 hours before using.

Click or Call!

Have Questions?

We're here to help. Visit support.keurig.com for step-by-step videos on cleaning, descaling, and more.



Still Need Help?

Give us a call at
1-866-901-BREW (2739)

Warranty

LIMITED ONE YEAR WARRANTY

Keurig Green Mountain, Inc. (Keurig) warrants that your brewer will be free of defects in materials or workmanship under normal home use for one year from the date of purchase. It is recommended that you register your brewer on keurig.com/new so that your purchase information will be stored in our system. Keurig will, at its option, repair or replace a defective brewer without charge upon its receipt of proof of the date of purchase. If a replacement brewer is necessary to service this warranty, the replacement brewer may be new or reconditioned. If a replacement brewer is sent, a new limited one year warranty will be applied to the replacement brewer.

This warranty only applies to brewers operated in the United States and Canada. This warranty gives you specific legal rights, and you may also have other rights that vary from state to state and, in the case of Canada, from province to province.

Only the use of Keurig® K-Cup® brand pods and accessories will guarantee the proper functioning and lifetime of your Keurig® brewer. Any damage to or malfunction of your brewer resulting from the use of non-Keurig® pods and accessories may not be covered by this warranty or may result in a service fee if the damage or malfunction is determined to be caused by such use.

WHAT IS NOT COVERED BY THE LIMITED WARRANTY?

THIS WARRANTY DOES NOT COVER CONSEQUENTIAL OR INCIDENTAL DAMAGES SUCH AS PROPERTY DAMAGE AND DOES NOT COVER INCIDENTAL COSTS AND EXPENSES RESULTING FROM ANY BREACH OF THIS WARRANTY, EVEN IF FORESEEABLE. Some states or provinces do not allow the exclusion or limitations of incidental or consequential damages, so the above limitation or exclusion may not apply to you depending on the state or province of purchase.

Nor does this warranty cover damages caused by use of non-Keurig® pods or accessories, services performed by anyone other than Keurig or its authorized service providers, use of parts other than genuine Keurig® parts, or external causes such as abuse, misuse, inappropriate power supply, or acts of God.

OTHER LIMITATIONS

THIS WARRANTY IS EXCLUSIVE AND IS IN LIEU OF ANY OTHER EXPRESS WARRANTY, WHETHER WRITTEN OR ORAL. IN ADDITION, KEURIG HEREBY SPECIFICALLY DISCLAIMS ALL OTHER WARRANTIES WITH RESPECT TO YOUR KEURIG® BREWER, INCLUDING ANY IMPLIED WARRANTY OF MERCHANTABILITY OR FITNESS FOR ANY PARTICULAR PURPOSE. Some states or provinces do not allow disclaimers of such implied warranties or limitations on how long an implied warranty lasts, so the above limitation may not apply to you depending on the state or the province of purchase.

HOW DO YOU OBTAIN WARRANTY SERVICE?

Keurig® brewers are high-quality appliances and, with proper care, are intended to provide years of satisfying performance. However, should the need arise for warranty servicing, simply call Keurig Customer Service at our toll free phone number 1.866.901.BREW (2739). Please do not return your brewer for servicing without first speaking to Keurig Customer Service to obtain a Return Materials Authorization (RMA) number. Keurig® brewers returned without a RMA number will be returned to the sender without servicing.

K·Café™

SINGLE SERVE COFFEE, LATTE
& CAPPUCCINO MAKER

- A. Water Reservoir Lid
- B. MAX Fill Line
- C. Water Reservoir Lock Tab Slot
- D. Water Reservoir
- E. Power Cord
- F. Drip Tray Plate
- G. Drip Tray
- H. Drip Tray Base
- I. Handle
- J. K-Cup® Pod Holder (J and K are the K-Cup® Pod Holder Assembly)
- K. Funnel
- L. K-Cup® Pod Assembly Housing
- M. Frother Lid
- N. Frother Whisk
- O. Frother

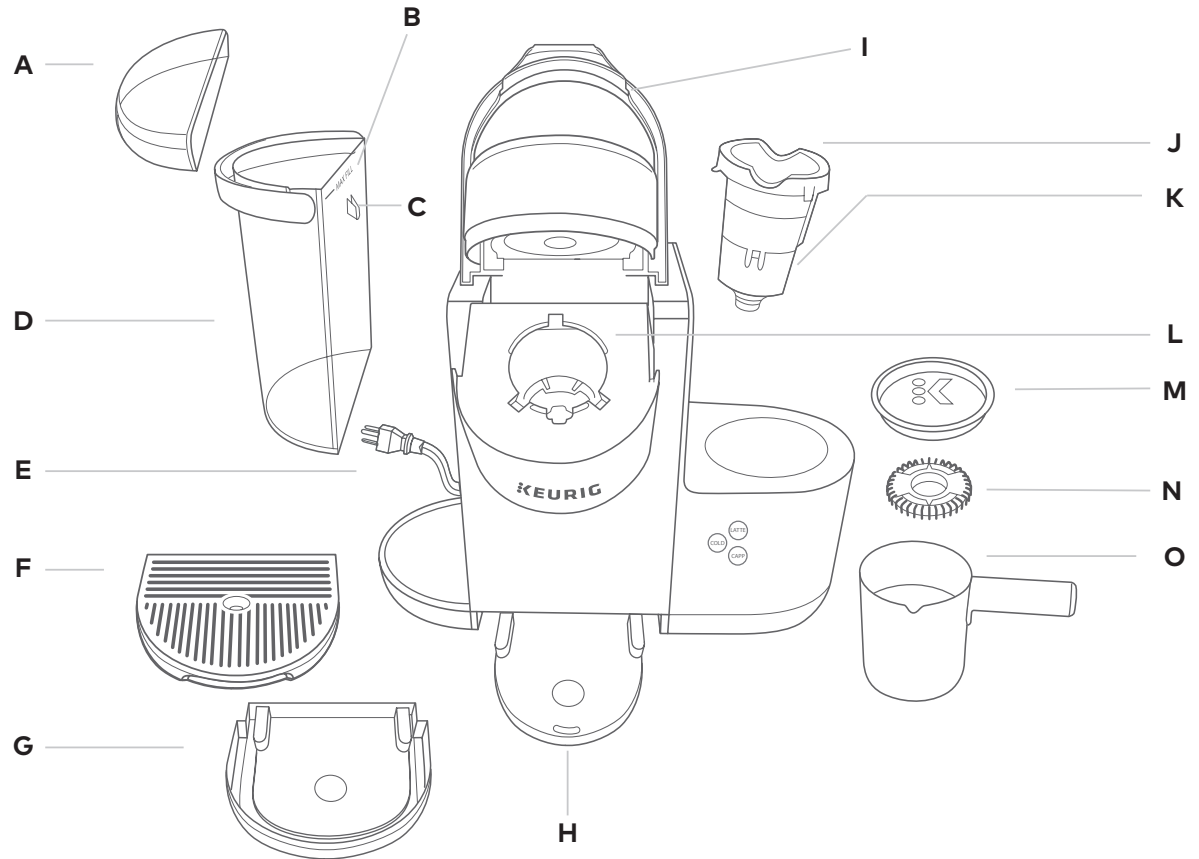

For replacement parts, please visit www.Keurig.com

Coffeehouse taste in your own home.

FIND YOUR PERFECT POD

With over 70 brands and hundreds
of varieties, find your match at

Keurig.com/new