



CERTIFICATE

By Authority Of
THE UNITED STATES OF AMERICA
Legally Binding Document

By the Authority Vested By Part 5 of the United States Code § 552(a) and Part 1 of the Code of Regulations § 51 the attached document has been duly INCORPORATED BY REFERENCE and shall be considered legally binding upon all citizens and residents of the United States of America. *HEED THIS NOTICE:* Criminal penalties may apply for noncompliance.



Document Name: Purging Principles and Practices

CFR Section(s): 49 CFR 193.2615

Standards Body: American Gas Association



Official Incorporator:

THE EXECUTIVE DIRECTOR
OFFICE OF THE FEDERAL REGISTER
WASHINGTON, D.C.

PURGING PRINCIPLES AND PRACTICE

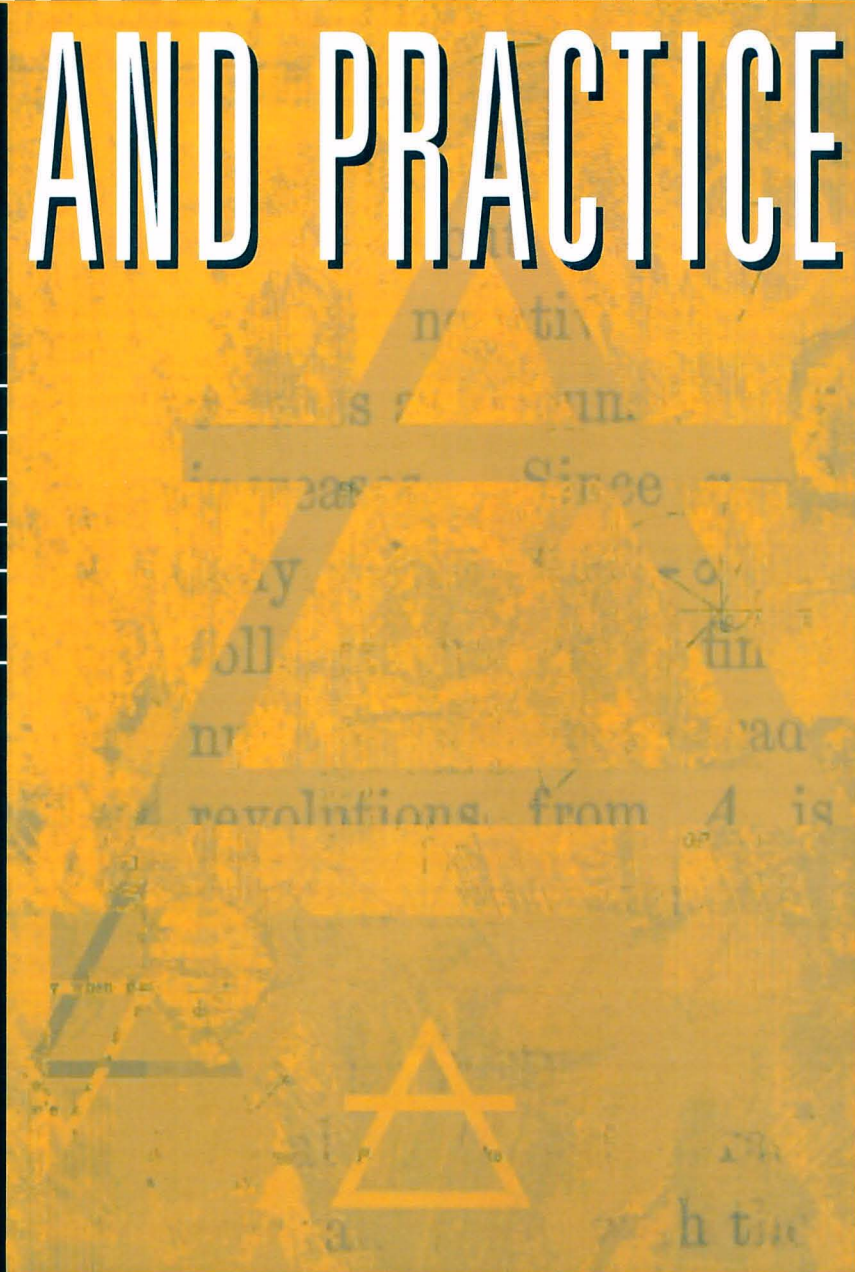

American Gas Association

Third Edition 2001

PURGING PRINCIPLES AND PRACTICE

THIRD EDITION

June 2001

**American Gas Association
400 N. Capitol Street N.W.
Washington, DC 20001**

Catalog No. XK0101

Third Edition

Copyright © 2001

Registered by American Gas Association

Printed in the United States of America

PURGING PRINCIPLES AND PRACTICE PREFACE TO THIRD EDITION

This manual helps provide principles and practices for pipeline purging and describes equipment encountered in the natural gas industry. The information provided is based on sound engineering principles and good operating practices. The intent is to provide the operator with guide material to help safely and successfully plan and implement a purging operation. The operator should use this information with caution and recognize that the information may not be adequate for all conditions encountered.

The material included provides guidelines for maintaining safe atmospheres inside pipes, holders, and other facilities that are to be purged into service or taken out of service. Good operating practice as well as federal and state laws require that precautions be taken to minimize or control mixtures of combustible gas in the air during purging, welding and cutting operations.

New information presented includes information for purging pipelines developed by the Gas Research Institute (GRI), now known as the Gas Technology Institute (GTI). In addition, there have been significant improvements made in instruments that measure combustible gas mixtures.

This publication is not an operating code, but is instead guide material consisting of background information and descriptions of various methods and procedures found by experienced operators to be effective in minimizing or controlling combustible mixtures. Applicable federal, state and local regulations must be observed. The methods and procedures described within cannot be considered to have universal application because of various job conditions. The operator is cautioned that the material presented may not be adequate under all conditions encountered.

We also wish to acknowledge the following for assistance in preparation of this manual.

Safety & Compliance Evaluation (SCE)

Ron Bursek

The American Gas Association (AGA)

Mario Carbone, KeySpan Energy
Glyn Hazelden, Hazelden Group
Harlan Rogers, Cinergy Corp.

The American Iron & Steel Institute (AISI)

Frederick L. Maddalena, US Steel Div., USX Corp
William Obenchain, AISI
The Technical Subcommittee on Coke Oven By-Products

Stannard & Company

James H. Stannard, Jr. P.E.

Larry T. Ingels, P.E.
Engineering Services Director
American Gas Association

TABLE OF CONTENTS

	PAGE #
CHAPTER 1 - GENERAL INFORMATION	1
SECTION	
1.1 Introduction	2
1.2 Glossary of Terms	2
1.3 Factors Affecting Purging	4
1.4 Supervision, Personnel, and Planning	6
1.5 Isolation	9
1.6 Sources of Ignition	13
1.7 Vent Pipes for Purging	15
Table 1-1 Pressure Loss through 10 Ft. vent Pipes	16
CHAPTER 2 – CONTROL OF PURGING	18
2.1 Introduction	19
2.2 Cautionary Note	19
2.3 Limits of Flammability of Gas Mixtures	19
2.4 End-Points for Purging	24
2.5 Purging Facilities Into Service	27
2.6 Purging Facilities Out of Service	30
2.7 Holding Purge	31
2.8 Purging Progress Charts	32
TABLES	
2-1 Limits of Flammability of Gases & Vapors	20
2-2 The Calculation of Flammable Limits	22
2-3 Inert Gas End Points for Purging into Service	30
2-4 Oxygen End Points for Purging into Service	30
2-5 Inert Gas End points for Purging our of Service	31
2-6 Combustible Gas End Points for Purging our of Service	31
FIGURES	
2-1 Flammable Limits for hydrogen, Carbon Monoxide, Methane	23
2-2 Flammability End Point Diagram- Air-Methane-Nitrogen	25
2-3 Flammability End Point Diagram- Air-Hydrogen-Nitrogen	26
2-4 Comparative Flammability End Point Diagram- Air-Methane-Carbon Dioxide	28

2-5	Comparative Flammability End Point Diagram-Air-Hydrogen-Carbon Dioxide	29
2-6	Purging Progress Chart	32
2-7	Purging Progress Chart- Combustible Gas is Replaced by Inert Gas	33
2-8	Purging Progress Chart- Air is Replaced by Combustible Gas	34

CHAPTER 3 - GAS ANALYSIS AND INSTRUMENTATION 35

3.1	Introduction	36
3.2	Sampling	36
3.3	Gas Detection and Monitoring Instruments	38
3.4	Specific Gravity Determination	42
3.5	Use of Instruments for Verifying Purging and End-Points	42
3.6	Moisture Measurement	43
3.7	Flow Meters	43
3.8	Testing of Gases Hazardous to Health	43
3.9	Detection and Measurement of Hazardous Gases	46

FIGURES

3-1	Mobile Gas Analysis Equipment- Photo	37
3-2	Multi-Gas Monitor- Photo	38
3-3	Gas-Trac Gas Detector- Photo	39
3-4	Flame Ionization Gas Leak Detector- Photo	40
3-5	Gas Instrument Docking Station- Photo	41
3-6	Gas-Sentry Oxygen Monitor- Photo	42
3-7	Physiological Effects of CO ₂	45
3-8	Typical Range of Monitor Set Points and Alarms	46

CHAPTER 4 - INERT PURGE MEDIA 47

4.1	Introduction	48
4.2	General	48
4.3	Commercial Nitrogen and Carbon Dioxide	49
4.4	Inert Gas Generators	56
4.5	Diesel Exhaust Engines	57
4.6	Steam	58
4.7	Water	60

FIGURES

4-1	CO ₂ Cylinder with Syphon Tube attachment	52
4-2	Standard CO ₂ Cylinder in Horizontal Position	52

CHAPTER 5 - NATURAL GAS TRANSMISSION AND DISTRIBUTION PIPE	63
5.1 Introduction	64
5.2 Safety Precautions	64
5.3 Typical Purging Procedures Direct Displacement of Combustible Gas or Air	65
5.4 Inert Purge by Complete Filling with Inert Gas	75
5.5 Inert Purge Using Slug to Separate Media Being Interchanged	77
FIGURES	
5-1 Minimum Purge Velocity to Limit Stratification...	65
5-2 Distribution Main System for New Subdivision	66
5-3 Geometry and Operating Conditions Used to Calculate the Purge Pressure in Table 5-1	70
5-4 Pressure Drop Calculation Methods for Table 5-1	70
5-5 Air Mover Diagram	71
5-6 Typical Air Mover Installation	74
5-7 Arrangement for Displacing Air to Gas from Pipe	75
5-8 Graphical Presentation of Nitrogen Slug Shortening	78
5-9 Shortening of Nitrogen Slug During Inert Purging Operations	78
5-10 Explosive Limits of Natural Gas Nitrogen Mixture with Air	79
5-11 Typical Procedure for Replacement of Air with Natural Gas	80
5-12 Typical Procedure for Replacement of Natural Gas with Air Utilizing Slug Purge	81
TABLES	
5-1 Purging Data for Inlet Control Procedure	69
5-2 Capacity of Various Air Movers	72
5-3 Measuring Injection Rates Through Hoses or Orifices	76
5-4 Nitrogen Required for Inert Slug	81
 CHAPTER 6 - LIQUEFIED NATURAL GAS FACILITIES	 83
6.1 Introduction	84
6.2 LNG Metal Tanks	84
6.3 LNG Pre-stressed Concrete Tanks Purging into Service	90
6.4 LNG Plant Piping and Process Equipment	93
6.5 Shop Fabricated LNG Pressure Tanks	96
6.6 LNG Transports	100
FIGURES	
6-1 Open Top Inner LNG Tank	85
6-2 Gas Tight Inner LNG Tank	87
6-3 Double Wall Sphere	88
6-4 LNG Tank- Cross Section	91

6-5	Expander- Compressor Schematic	94
6-6	CO ₂ Absorber Schematic	96
6-7	Liquefied Natural Gas Transport	98
6-8	Schematic for LNG Transport	99

CHAPTER 7 - LIQUEFIED PETROLEUM GAS FACILITIES 103

7.1	Introduction	104
7.2	Inerting Media	104
7.3	Description of LPG Facilities Requiring Purging	105
7.4	Vents, Piping, and Valves	105
7.5	Physical Properties of LP-Gases	107
7.6	Disposition of LPG Liquids and Vapor	107
7.7	Purging Piping and Equipment Out of Service	108
7.8	Purging Pressurized Storage Containers Out of Service	109
7.9	Purging Refrigerated Storage Containers Out of Service	109
7.10	Purging LP Gas Piping and Equipment Into Service	110
7.11	Purging Pressurized Storage Containers Into Service	111
7.12	Purging Refrigerated or Semi-Refrigerated Containers	111

FIGURE		
7-1	Buried and Exposed Vessels Connected	106

APPENDIX A
(Taken from 1975 Edition of "Purging Principles and Practice") 113

Figure 2-1, Flammable Limit Chart (H ₂ , CO, CH ₄)	A1
Figure 2-3, Flammable Limit Chart (Parafin Hydrocarbons)	A2
Figure 2-5, Flammable Limit Chart (CH ₄ , C ₂ H ₄ , C ₆ H ₆)	A3
Figure 2-9, Purging End-Point Chart	A3
Chapter 5, Gas Plant Facilities and Piping	A5
Chapter 6, Gas Holders	A6

CHAPTER 1
GENERAL INFORMATION

SECTION	PAGE #
1.1 Introduction	2
1.2 Glossary of Terms	2
1.3 Factors Affecting Purging	4
1.4 Supervision, Personnel and Planning	6
1.5 Isolation	9
1.6 Sources of Ignition	13
1.7 Vent Pipes for Purging	15
Table 1-1 Pressure Loss through 10 Ft. vent Pipes	16

CHAPTER 1 GENERAL INFORMATION

1.1 INTRODUCTION

When the combustible gas content of a pipe, tank, or other enclosure is directly replaced by air, a mixture of gas and air within the flammable limits forms and remains during part of the operation. A similar mixture within flammable limits occurs when air is directly replaced by gas.

Carefully controlled purging of air from pipelines by direct displacement with natural gas has been safely practiced for many years with the recognition that some flammable mixture is present. Purging of natural gas from pipelines by direct displacement with air also has been similarly practiced.

There are many situations in which formation of flammable mixtures during purging should be prevented. As an example, flammable mixtures in large pipelines, tanks and other large volume containers cannot be safely controlled or tolerated even though there may be no apparent source of ignition present. Whenever flammable mixtures cannot be tolerated, their formation should be prevented by means of an inert purge,

which involves using an inert substance to keep separate the two media being interchanged.

The basic requirement for a successful and safe purging operation is knowledge of the principles concerning the formation, analysis and control of gas mixtures. Additional requirements include a thorough preliminary study of the application of these principles for each situation; a well prepared procedure detailing the sequence of events, a predetermined rate of introduction of the purge medium and verification of end-points. Finally, the steps of the procedure must be followed and carried out by capable, well-informed people.

Chapters 1, 2, 3 and 4 cover general principles of purging. Subsequent chapters discuss application of the principles to particular situations and provide some examples of typical procedures. The appendices include information on purging facilities that were common in the natural gas industry but for the most part, are no longer in use. This information is included for historical reference.

1.2 GLOSSARY OF TERMS

Words and expressions commonly used in purging procedures are defined below:

Aeration: Provision of a constant supply of air by mechanical means.

Blanking: Insertion of a solid metal plate across a pipe at fitting flanges.

Channeling: The occurrence of lighter gases or fluids flowing over heavier gases or fluids during a pipeline purging process.

Clear: See *Purge*

Combustible: Capable of being ignited and rapidly oxidized when mixed with proper proportions of air.

Combustible mixture: A gas and air mixture that can be ignited at ordinary temperature and pressure. (See *Flammable limits*)

Concentration: Percent by volume unless otherwise noted.

Dilution: A form of purging in which replacement of one substance by another is accomplished with appreciable mixing.

Disking: See *Blanking*

Displacement: A form of purging in which replacement of one substance by another is accomplished without appreciable mixing.

End-point: Attainment of concentration (percent by volume) of inert substance in the closed system being purged that subsequent admission of air, if purging out of service, or admission of gas or vapor if purging into service, will not result in formation of a flammable mixture.

Exhaust gas: The products of combustion gas (primarily carbon dioxide and nitrogen) from an inert gas generator that is used as an inert gas for purging.

Explosive limits: See *Flammable limits*

Explosive mixtures: Gas and air mixtures that can be ignited at ordinary temperatures and pressure. (Synonymous: *Flammable mixtures*)

Flammable limits: The lowest (lower limit) and highest (upper limit) concentrations of a specific gas or vapor in mixture with air that can be ignited at ordinary temperature and pressure. (Synonymous: explosive limits, limits of flammability and limits of flame propagation)

Holding purge: The procedure of maintaining in a closed system during maintenance or repair an inert gas or liquid which has been introduced to replace the normal combustible content.

Hot cutting: Cutting by oxy-acetylene torch or other means into any pipeline or vessel containing only combustible gas at slightly above atmospheric pressure.

Hot tap: Cutting into a pipeline containing a combustible gas or liquid by use of a special machine. The machine is attached to suitable fittings, which have been previously welded or otherwise secured to the loaded pipeline. The tapping machine and fittings are so constructed that the required size opening may be cut in the loaded pipeline and the machine may be safely removed without appreciable loss of combustibles or taking the pipeline out of service.

Inert gas: A gas, noncombustible and incapable of supporting combustion, which contains less than two percent oxygen and combustible constituents of less than 50 percent of the lower explosive limit of the combustible being purged.

Inert purge: The act of changing the contents of a pipe or container by using an inert substance to displace the original content or to separate the two media being interchanged. Flammable mixtures are thus avoided.

Isolation: Disconnection from all other equipment or piping of a chamber or space to be purged.

Liquefied natural gas (LNG): (From NFPA, 59, 1998) A fluid in the liquid state which is stored at cryogenic temperatures of -200°F to -260°F and is composed predominantly of methane possibly containing minor quantities of ethane, propane, nitrogen or other components normally found in natural gas.

Liquefied petroleum gas (LPG): Any liquid or liquefiable hydrocarbon, or mixtures of hydrocarbons, which are completely gaseous at 60°F and 14.74 psig. and whose vapor pressure at 105°F does not exceed 225 psig. ("American Society of Testing Materials" designation) Liquid petroleum gases usually consist of propane, propylene, butanes and butylenes, or mixtures thereof.

Mixed gas: A term generally applied to mixtures of natural and manufactured gases normally having a range of 600 to 1000 Btu per cu. ft. In local instances, the term may refer to mixtures of different heating value manufactured gases. For purging purposes, it should be treated as a manufactured gas, unless containing more than 75 to 80 percent of natural gas.

Natural gas: A mixture of gases produced by nature in the oil and natural gas fields and consisting primarily of methane and ethane and low percentages of carbon dioxide, oxygen and nitrogen, normally having a heating value of 800 to 1300 Btu per cu. ft. and a specific gravity range of 0.59 to 0.75. Varying low percentages of propane, butane and gasoline may be present. It is not toxic but sufficient concentration in the atmosphere will produce oxygen deficiency. Ignition temperature is approximately 1600°F. Flammable limits are approximately 4 percent to 14 percent gas in air.

Operator: From DOT Pipeline Safety Regulations Part 192, a person who engages in the transportation of gas.

Pig: A cylindrical, spherical, or barrel-shaped device that is moved through the pipe by gas or air or liquid introduced behind it. When used for purging, the pig separates media being interchanged. It must be non-abrasive and non-sparking when flammable mixtures could be encountered.

Pipe: See *Pipeline*

Pipeline: Long cylindrical conduit or tubing used for transporting a gas or liquid.

Purge: The act of removing the content of a pipe or container and replacing it with another gas or liquid. See *Inert purge, Displacement, Dilution*. (Synonym: Clear)

Purge gas: Gas used to displace the contents of a container. To avoid flammable mixtures, the purge gas is usually inert except in certain instances where the relatively small area of contact allows the amount of flammable mixture to be minimized and controlled satisfactorily.

Purge into service: The act of replacing the air or inert gas in a closed system by a combustible gas, vapor, or liquid.

Purge out of service: The act of replacing the normal combustible content of a closed system by inert gas, air, or water.

Pyrophoric: A substance or mixture that can ignite spontaneously.

Slug: A quantity of inert gas interposed between combustible gas and air during purging. The slug does not fill the complete length of the

pipe but moves through the pipe as a separate mass to prevent mixing of the gas and air.

Slug shortening: Process that takes place as a slug of gas is mixed with the upstream and downstream gases as the slug travels the length of the pipeline.

Supplemental Natural Gas (SNG): Also known as Substitute Natural Gas or Synthetic Gas (SG). A fuel gas produced from coal, oil, oil

shale, naphtha, LPG or waste, by processes that yield a gas that is generally interchangeable with natural gas.

Stratification: Process of different gases settling into layers.

Ventilation: The procedure in which doors, manholes, valves, etc. are opened to permit the ingress of air by natural circulation to replace gas contents.

1.3 FACTORS AFFECTING PURGING

1.3(a) DISPLACEMENT VS. DILUTION OR MIXING

The replacement of one gas by another in an enclosed space or chamber takes place by means of two distinct actions: (1) displacement and (2) dilution or mixing. In a purge that is effected entirely by displacement, the gas or the air that is originally present is pushed out of the escape vents by the entering purge gas with little or no mixing of the purge gas and the original contents. Thus, the quantity of purge gas required for purging by displacement approximates the quantity of gas or air being replaced.

Frequently certain conditions, such as the size or shape of the chamber or the nature of the gases, cause the purge gas to mix with the original contents so that the purge tends to proceed by dilution. Purging by dilution can be accomplished in some situations by alternately pressurizing and depressurizing the facility. To accomplish a satisfactory purge by dilution or mixing requires a volume of inert purge gas that may be four or five times the free space of the chamber being purged. This occurs because as the purging proceeds, increasing amounts of purge gas are lost from the escape vents in mixture with original contents.

Almost all purging operations are combinations of displacement and dilution actions. In actual practice it is impossible to avoid some mixing of the purge gas with the gas or air that is being replaced but, in general, the less the mixing or dilution, the more efficient the purge. Purging which proceeds with mixing or dilution such as occurs in tanks and holders should be accomplished with an inert purge medium to avoid flammable mixtures. Purging without the use of an inert medium should be limited to pipelines where the amount of mixing

can be controlled satisfactory by methods such as described in Chapter 5.

1.3(b) CAUSES OF DILUTION OR MIXING

The factors affecting the relative proportions of displacement and mixing action in a purge should be understood thoroughly so that careful attention can be given to avoiding or minimizing those factors or conditions which promote mixing. Some of the more important causes of mixing during a purging are:

- (1) A large area of contact, promoting natural diffusion;
- (2) A long period of contact, permitting natural diffusion;
- (3) Agitation resulting from a high input velocity;
- (4) Gravitational effects resulting from introduction of a heavy gas over a light gas or a light gas under a heavy gas;
- (5) Temperature changes and differentials causing convection currents.

Failure to recognize the importance of such apparently insignificant things as the location of the purge gas input connection, the rate of input of the purge gas, or temperature differentials, can result in a purging operation being 80 to 85 percent dilution and only 15 to 20 percent displacement.

1.3(c) AREA OF CONTACT

There is always some diffusion of the purge gas into the original gas and of the latter into the purge gas at the surface of contact. The amount of mixing which results from this diffusion is dependent upon contact. The area of contact between the purge gas and the original contents

is dependent on the size, shape and internal construction of the chamber being purged. Ordinarily little can be done to limit the mixing resulting from this factor. Nevertheless, contact area has a very great effect on the efficiency of a purge.

When purging a tall, narrow tower, the area of contact between the gases is small compared to their volumes. Mixing is limited and the quantity of inert purge gas used may not be much greater than the volume of gas or air to be cleared out.

The crown of a storage holder, in contrast, is a flat, shallow dome, having a height significantly less than the diameter. It is impossible to avoid having a very large area of contact in a chamber of this shape. Consequently, it is usually necessary to use at least 1.5 to 2.5 volumes of inert gas per volume of free space in purging.

When purging a pipeline, the area of contact may be so small that little mixing will occur. Advantage can be taken of this condition to conduct an inert purge by use of a quantity of inert gas that is only a fraction of the volume of combustible gas or air to be replaced. It is possible to introduce just enough inert gas to form a "slug" or piston between the original gas (or air) content and the entering air (or gas). This slug and the original gas or air ahead of it, is pushed along the pipe to the end of the section being purged by air or gas introduced after it. Recent research has greatly expanded the understanding of the slugging process, particularly for larger diameter pipelines. See Chapter 5 for more information.

1.3(d) TIME OF CONTACT

The duration of contact of the surfaces of the purge gas and the original gas or air should be as short as possible. Excessive mixing by natural diffusion will result if the purge gas input rate is too low. Interruptions and variations of the purge gas input rate should be avoided.

1.3(e) INPUT VELOCITIES

The velocity of the entrance of the purge gas has an important effect on the nature of the purge. As a rule, the size of the purge gas inlet to containers other than pipe should be as large as practical, so that the input velocity will not exceed 2 or 3 feet per second. This keeps

agitation or stirring of the chamber contents at a minimum. If the purge gas input connection is small relative to the rate of input, the velocity of the purge gas may carry it to the center or across the chamber, resulting in thorough mixing. When the only available input connection is relatively small, it may be better to use a low rate of input to attain purging by displacement in over a longer period of time rather than purging by dilution, which may take significantly longer. If the input velocity is high and the outlet vent is large, the purge gas may stream or arc across from the inlet to the outlet, limiting both displacement and dilution.

1.3(f) DENSITIES OF GASES

The relative densities of the purge gas and of the gas (or air) being purged have important effects on the mechanics of the purging action. Carbon dioxide has a specific gravity of approximately 1.5. This specific gravity is large enough compared to that of natural gas (approximately 0.6) to create a tendency for the inert gases to stratify and remain in a layer on the bottom of a chamber filled with natural gas. Therefore, when purging a light gas out of a chamber, an effort should be made to push the lighter gas out through vents in the top of the chamber by admitting the heavier gas at the base. Conversely, in putting equipment back into service, when heavy inert gas is to be replaced by a light gas, the latter should be introduced at the top of the chamber and the heavier gas vented from the bottom.

When purging facilities out of service that have contained gases with a higher specific gravity, the vapors can be most effectively replaced with a minimum of mixing by introducing the inert gas at the top of the chamber and displacing the vapors downward and out of bottom vents.

When purging facilities into service that are to receive such substances and after replacement of the air by an inert purge gas, the heavy vapors or liquids should be admitted at the base of the vessel and the purge gas displaced upward and out of the top vents.

The introduction of a fourth atmosphere will, in some cases, facilitate the purging of a tank containing vapors appreciably heavier than the inert gas available. Heavier gases such as butane, propane or benzyl vapors can first be displaced downward and out of bottom connections or vents by natural gas; the natural

gas then displaced upward and out of top vents by an inert gas and the inert gas replaced by air.

The importance of differences in densities in facilitating or hampering a purging operation is exemplified by the fact that it usually requires 50 percent more time and inert gas to replace the air in a large chamber than it does to effect the same degree of replacement of natural gas under equivalent conditions. A purge gas such as nitrogen has a specific gravity of approximately 0.97 which is almost identical to that of air so that mixing is not as greatly restrained by stratification as when natural gas is being replaced.

1.3(g) TEMPERATURE EFFECTS

It is desirable to keep the temperature of the purge gas entering a large chamber as low as practicable in order to minimize the possibility of setting up any "thermal currents."

The contraction in the volume of gases caused by decrease in temperature is another temperature effect that should be considered. A positive, though slight, pressure must be maintained within a chamber being purged. Thus, when a sudden drop in atmospheric temperature occurs during the purging of a vessel, it may be necessary to reduce the rate of release of the purged gas (or air). In order to offset the contraction of the contents of the chamber or system. However, it may be necessary to forego any attempts to control temperatures or avoid thermal currents when the chamber being purged contains deposited solids or liquids. Special precautions should be taken if the holder, tank, pipe or other facility contains naphthalene or tar deposits, oils, solvents or other materials that will volatilize and give off combustible vapors as a result of relatively small increases in temperature above ambient. Either before or during the purge, these deposits should be heated to such a degree that there could be no further volatilization of combustible vapors when air is admitted to the chamber. This

topping distillation of deposits may be accomplished by:

- (1) Steaming of the chamber or system prior to gas purging;
- (2) Using steam as the purging gas; or
- (3) Admitting the purge gas at an elevated temperature, 150 to 180°F, saturated with water vapor. See Chapter 3.

For pipelines, the purging media, likelihood of "freeze-offs" and the possible need for line drying should be considered.

1.3(h) SUMMARY

A perfect purge is one in which the replacement of gas or air by a purge gas is effected entirely by displacement and only one volume of purge gas is needed. Dilution or mixing of the purge gas with the original content of a chamber will result in the quantity of inert purge gas ordinarily required to be larger. Experience has shown that the quantity will be approximately 1.5 or 2.5 times greater compared with complete displacement.

The mechanical efficiency of a purge may be calculated from the ratio of the volume of the free space of the chamber purged to the volume of purge gas required to attain the desired end-point:

$$\% \text{ Mech. Eff.} = \frac{100 \times \text{Volume of Space}}{\text{Volume of Purge Gas Used}}$$

To attain as high a mechanical efficiency as possible it is necessary to keep mixing and dilution at a minimum by:

- (1) Avoiding interruptions or variations in purge gas input;
- (2) Using large input connections;
- (3) Controlling the input velocity;
- (4) Introducing purge gas at proper location with respect to gas densities;
- (5) Avoiding differences and sharp changes in temperature;
- (6) Using vents large enough to permit ready escape of displaced gas.

1.4 SUPERVISION, PERSONNEL AND PLANNING

1.4(a) SUPERVISION

The person assigned the responsibility of directing a purging operation should have had

previous experience, be technically competent and possess requisite authority. It is suggested that operators that do not have trained personnel should arrange to have several of their capable

employees gain such experience by participating in purging operations performed in other companies and under competent directors. Other options include seminars and training that concentrates on purging practices. Contractors that have the demonstrated background, skills and experience should also be considered.

1.4(b) PERSONNEL

The purging of pipelines and other pipeline facilities are generally covered tasks as defined by the Department of Transportation Part 192 Pipeline Safety Regulations Operator Qualification Rule. Only persons who are properly qualified should participate in a purging operation unless they are under direct supervision of a qualified person.

The number of persons required to control a purging operation will vary depending on complexity and magnitude of the purge. In case the purging requires an extended period, provisions should be made for relief personnel.

The duties of those assigned to the purging operation may include:

- (1) Arranging for adequate supply of the purging gas to be used;
- (2) Controlling of the flow of the purge media;
- (3) Controlling of the venting of the purged gas;
- (4) Testing of the quality of the purge gas, analysis of the purged gas, and evaluation of the purging operation;
- (5) Establishing reliable communications;
- (6) Notifying the public where necessary.

1.4(c) PERSONAL SAFETY

Personal safety is paramount during any purging operation. The Occupation Safety and Health Administration (OSHA) rules have had a dramatic impact on many aspects of the purging operation. While a detailed discussion of the impact of these rules is beyond the scope of this manual, the operator should always read, understand and follow the appropriate rules that govern personal safety and good operating practices.

Appropriate personal protection equipment should always be provided as necessary. Confined space entry presents a number of potential safety issues including oxygen deficiency, toxic gases, flammable gases,

entrapment, engulfment, extreme noise and others which the operator must identify and provide for appropriate protection. A plan administrator should be identified to ensure compliance with all safety rules developed by the operator. All necessary permits must be obtained. "Lock-out-Tag-out" procedures should be developed and followed when appropriate.

Hazardous materials should be identified. Material Safety Data Sheets (MSDS) must be provided. Suitable personal protective equipment should be used and mitigation plans must be developed and implemented.

Site-specific evaluations may be necessary by the plan administrator.

Some atmospheric substances may pose long-term adverse health hazards if the permissible exposure limit for a toxic substance is exceeded. These substances should be identified and appropriate action taken. The safety of the personnel conducting the purging procedure must always be predominant in the planning, implementation and follow-through of this operation.

1.4(d) PLANNING

The following is an outline of the planning or preliminary preparations for a purging operation, which is intended to be descriptive rather than definitive in nature. More specific and detailed instructions are discussed in sections of the text devoted to purging of various types of facilities.

Written plans should be developed for all purging procedures. Service lines and small diameter pipelines can be purged using the general procedures outlined in the operator's Operation and Maintenance Manual. More complex purging operations may require specific detailed written plans.

1.4(e) FACILITIES INVOLVED

The pipeline or facilities that are involved should be clearly defined. Records should be checked and verified if necessary. Field verification may be necessary.

It is then important to decide what facilities should be included in the purging operation. Sometimes the reason for performing the purge, as in the case of repairing a holder, makes it obvious what is to be purged. In other cases, it may be necessary to determine at what points

disconnections can best be made to isolate the section to be purged. The goal is to prevent any leakage during or after the purge. The next decision involves determining how to isolate the facilities for purging. A number of methods of isolation are described in Section 1.5.

The points at which the purge gas is to be introduced and vented may affect how the facility is to be isolated. As is pointed out in the discussion of the basic factors affecting the mechanics of a purge (Section 1.3(f)), the purge gas should be introduced near the bottom of the space to be purged in some cases and at the top in other cases.

Thus, the above factors are so closely related that in planning a purge they can almost be considered simultaneously:

- (1) What facilities are to be purged?
- (2) How will the facilities be isolated?
- (3) Where to introduce inert gas and how to vent the purge gas?

1.4(f) GASES INVOLVED

The nature of the combustible gas or vapor which is to be purged or which is to occupy the space after the air is purged should be identified. The chemical composition, the specific gravity and the limits of flammability of this gas or vapor should be known. A method by which the limits of flammability of a gas mixture may be calculated is described in Section 2.3.

Consideration should also be given to the possible presence in the facility of any deposits or condensates, which may be vaporized during the purging operation. These materials may appear (even small amounts) in the gas mixture being vented.

The choice of the gas to be used in purging frequently will depend on the nature of the combustible gas or vapor involved. Availability and economics are generally the deciding factors. (See Chapter 4 for inert purge media information.)

The end-point of the purge should be specifically and accurately defined as a part of the preliminary planning. The manner of expressing the end-point (i.e., in terms of the percent of CO₂, N₂, O₂, etc.) will be dependent on the manner of testing to be employed. This in turn may be dependent on the nature of the purge gas and of the combustible gas involved in the purge. (See Section 2.4 for end-point data.)

The foregoing discussion would indicate that there is a second group of factors that should be considered simultaneously in planning a purge. They are:

- (1) The nature of the combustible gas and/or vapor involved;
- (2) The choice of the purge gas to be used;
- (3) The manner of testing;
- (4) The end-point of the purging.

1.4(g) SCHEDULE OF OPERATIONS

Scheduling and timing are the next factors to be considered in planning a purge.

Selection of the time of day for performing the purging operation may be affected by many factors not directly related to the purge itself (i.e., demands and loads, availability of personnel, etc.)

The length of time that will be required to complete the purge may be estimated from the size of the space to be purged and the anticipated rate of introduction of purge gas.

The purging operation should be broken down into successive steps, the sequence of these steps decided upon and the timing carefully estimated and scheduled. This is particularly important if the facility being purged extends over such an appreciable area that the director is not in constant contact with all persons involved. As an example, when all or part of a large plant is to be purged, or when several branches of a gas distribution system are to be purged. Each successive part of such a large-scale operation will be considered a separate purge.

1.4(h) AGREEMENT ON PLAN

A written plan of action should be established that will include all of the decisions made thus far concerning:

- (1) The facility to be purged;
- (2) The gases involved;
- (3) The purging operation time and schedule.

This plan of action might well include additional details such as:

- (1) Installation of adequate input and vent connections;
- (2) Listing of the valves to be operated;
- (3) Deactivation of remote or automatic valve controllers;

- (4) Listing of test equipment and accessories;
- (5) Instruction and assignment of personnel;
- (6) Provision for communication system;
- (7) Notification of public agencies, general public and affected customers;
- (8) Supply, control and measurement of purge medium, including volume, rate, pressures and temperatures;
- (9) Control of venting;
- (10) Position and height of vent stack;
- (11) Elimination of sources of ignition;
- (12) Safety precautions and equipment, including fire extinguishers;
- (13) Requirement for prior approval of all deviations from the approved plan by all involved departments.

1.4(i) SUMMARY OF PLANNING

The purging operation should be under the direction of an experienced supervisor.

In planning a purge, definite decisions should be made concerning:

- (1) What is to be purged and how it is to be isolated;
- (2) What purge medium is to be used and how it is to be introduced and vented;
- (3) The method of testing and the end-point
- (4) The time and probable duration of the operation.

All of these decisions should be composed into a written plan of action. All parties affected should be informed and all approvals should be obtained. The plan should cover the procedure for obtaining approval for any deviation from the approved plan.

1.5 ISOLATION

1.5(a) GENERAL

Whenever any facility is to be purged, it is essential to isolate it from the rest of the system either by mechanical means or by severing all of the connections. Two distinct but related objectives are thus accomplished:

- (1) Preventing any vapors (or air) or any inert gases from leaking out during the purging;
- (2) Preventing any vapors from leaking in after the purging, when the facility is out of service for inspection, repair or demolition.

If possible, the measures adopted for isolating the space for purging out of service should also provide the desired post-purging isolation. If bags, liquid seals, or similar means of isolation must be used while purging out of service, they should be replaced by permanent means of isolation such as blanks or gaps before the purging inert gases are replaced by air.

1.5(b) METHODS OF ISOLATION

There are a number of methods by which a space may be isolated from adjoining facilities or piping:

- (1) Actual detachment, by removal of fittings or sections of pipe and capping, blanking or plugging of the open ends;
- (2) Insertion of blanks, which block flow;
- (3) Valve closures;
- (4) Use of mechanical stop-off equipment;
- (5) Water sealing or flooding of depressed sections;
- (6) Insertion of bags or stoppers in the pipe.

Selection of a particular isolation method usually is dependent on the operator's system and its structural and operating conditions. It may be advisable to use different methods at different locations on the same purging job, or even to use combinations of two methods at a single location.

When a high degree of reliability is required (for example, when workers will be inside a structure for a long period of time), removal of sections of pipe, valves or fittings and capping, blanking or plugging of open ends is recommended. This will provide complete detachment from supply sources.

1.5(c) VALVING-GENERAL

The use of valves already located in the system is the simplest and easiest method of isolating the section or space to be purged. It

may not be recommended when complete shut-off is required unless two valves can be closed and the piping between them either removed or vented. An alternative to double valving may be considered when valves designed with the block and bleed feature, which permits venting the volume between valve seals to atmospheric pressure, are available. This will provide the sealing effectiveness.

There are great differences in the dependability of various types of valves. Frequently the valve may be in such a condition or position that it cannot be made gas tight merely by closing it. Any valve to be used in connection with a purging operation should be examined carefully as a part of the preparations for purging and, if possible, cleaned and conditioned. The time to determine whether a particular valve can be used is prior to the start of the purging operation. Valves should not be depended upon to maintain post-purging isolation or to prevent leakage of gas into the space that is out of service. Locking and tagging of valves will minimize the possibility of unintended operations of valves during purging operations.

1.5(d) PLUG VALVES, BALL VALVES

Lubricated plug valves and ball valves may be utilized to provide isolation for purging when the operation does not require complete detachment. Particular attention should be paid to their proper conditioning before starting the purging operation.

1.5(e) GATE VALVES

For some purging operations, gate valves, particularly those designed for improved shut-off, will provide satisfactory isolation. Because of deposits or erosion, the discs of ordinary gate valves may not seat well enough to make them gas-tight. When used for low pressure purging isolation, gate valves (both single and double plate forms) can be sealed with a liquid. For liquid sealing, two connections to the valve body are necessary: one for admission of the liquid and one to permit overflow of the liquid after the proper depth seal is obtained.

If a valve cannot be closed tight enough to be sealed effectively with a liquid, or if the valve construction or other circumstances prevent liquid sealing, some additional method of

isolation must be used. This is important. A leaking valve may not only prevent attainment of a satisfactory purge, but will also be useless in post purging isolation and will have to be removed at the end of the purge before the inert gases are replaced by air or gas. Under such circumstances use one of the following procedures:

- (1) Blank off the valve by inserting a metal disc at the downstream flange. (See Section 1.5(h), Blanks);
- (2) When the pressure does not exceed the recommended maximum operating pressure rating of the bag or stopper, insert bags and stoppers upstream from the valve. If the pressure is in excess of the maximum recommended value, insert the bags and stoppers downstream from the valve. In either case, provide a vent to atmosphere from the piping between valve and bag or stopper. (See Section 1.5(i), Bags and Stoppers);
- (3) With a local holding purge near the valve, remove it and cap the free ends of the main;
- (4) Install one or more aspirators about two pipe diameters downstream from the valve to pick up and discharge the leakage through the valve. (See Chapter 5)

1.5(f) FLOW VALVES

Ordinarily check valves, regulators, pressure controllers and similar types of flow control equipment by themselves cannot provide the degree of shut-off required for isolation during a purge. However, they may be used in combination with other methods.

1.5(g) WATER SEALING OF PIPE OR FACILITIES

Occasionally depressed sections of pipe or the bottoms of some facilities can be flooded with water to obtain isolation. Several precautions should be observed in water-sealing:

- (1) The weight of the water that must be introduced to attain an effective seal should not be so great as to cause undue strain on the container or its supports;
- (2) The effective depth of the seal, or the pressure provided by the height of the water, should be approximately twice as great as either the normal pressure upstream from the

point of sealing or the purging pressure, whichever is greater;

(3) The depth of the seal either should be readily apparent or easy to determine and should be frequently checked;

(4) There should be an ample supply of water right at the seal to maintain it;

(5) Means should be provided for the ready and rapid removal of the water in the event of an emergency or as may be required as part of the purging procedure;

(6) The use of water seals in locations exposed to freezing temperatures should be avoided;

(7) Care should be taken, or provisions made, to avoid entraining air in the water supplied to a seal that is replenished constantly.

(8) Care must be taken to properly dispose of the water after the purging operation.

1.5(h) BLANKS

A blank or inserted metal plate in a pipe or connection generally is considered an effective method of isolation, however, only blanks designed for the working pressure of the line should be used. When reliability is required, the use of blanks with flat face flanges and full face flange gaskets is not recommended because of the possibility of leakage through the bolt holes. The use of blanks fitting inside the bolt circle with ring gaskets provides a more reliable method of isolation.

Blanks can be inserted only at flanges and then only when it is possible to force the flanges apart far enough for insertion. It is seldom possible to spread a flanged joint without damaging the gasket it usually contains; even then, it is extremely difficult to insert and later remove the blank without damaging the gasket. If the gasket is damaged either during the spreading of the flange or by the insertion of the blank, it is difficult to make the insertion gas tight. The use of blanks for isolation purposes generally is restricted to locations that can be subsequently regasketed without difficulty or made gas tight without gaskets and to locations where valving or flooding cannot be used.

1.5(i) BAGS AND STOPPERS

1.5(i)(1) Mechanical Line Stoppers

In many instances, mechanical line stoppers may be utilized for isolating medium and high-pressure facilities for purging when line valves are not conveniently located. Mechanical line stoppers are available for stopping off lines $\frac{3}{4}$ " in diameter through 30" and approved for very high operating pressure, depending on size and manufacturer. Mechanical line stoppers require the installation of special fittings on the pipe to facilitate their use.

Mechanical line stoppers should not be used to maintain post-purging isolation. The completeness of shut-off can vary depending on field conditions and must be checked prior to purge operations.

Mechanical line stoppers used in conjunction with bag or diaphragm stoppers downstream and a vent between will provide acceptable short-term isolation for purging of facilities.

1.5(i)(2) Cylindrical Bag Stoppers

Cylindrical bag stoppers inflatable to as high as 15 psig, in small sizes may be utilized for isolating intermediate pressure facilities for purging. These cylindrical bags utilize a heavy-duty canvas covering and can be used to hold against line pressures equal to 60 percent of the pressure in the bag according to the manufacturer's recommendations.

The stoppers are available in sizes up to 36". As is the case with all stoppers, cylindrical bags should not be relied upon to maintain post-purge isolation.

1.5(i)(3) Bags and Diaphragm Stoppers

Bags and diaphragm stoppers should not be used alone as a means of effecting isolation for purging, except in the case of low-pressure pipe, because they cannot withstand appreciable pressure differentials and surges. In addition, they should not be used for post-purging isolation.

Bags and diaphragm stoppers are frequently used to prevent the gas which may leak past a valve from entering the space being purged. The gas between the valve and the bag or stopper is vented to the atmosphere. If the pressure at the upstream face of a leaking valve is not over the rated operating pressure of the bag or stopper, it is advisable to locate the bag and stopper ahead of the valve-thereby eliminating the venting of

gas which would have leaked through the valve had the stoppers been installed downstream of the valve.

The "setting" or installation of bags and/or stoppers in connection with purging isolation should be entrusted only to persons who have had proper training or experience in this work. When two stoppers or bags, or combination thereof, are to be utilized for isolation, the downstream unit can be set first if it is desired to check for proper sealing under pressure prior to setting the second unit. The second unit can be checked at a vent between the two units.

Holding pressures of bags and diaphragm stoppers vary with pipe diameter. Manufacturer's recommendations should be followed.

1.5(k) SQUEEZING OF PLASTIC PIPE

Squeezing of plastic pipe may be an acceptable means of isolation. Only approved squeeze machines should be used and the manufacturer's instructions must be followed. All machines used must achieve a gastight seal. Care should be taken to avoid static electrical discharge before, during and after purge operations.

1.5(l) PHYSICAL DISCONNECTION

The most dependable method of isolation is the actual disconnection or breaking of the physical continuity of a connection or pipe by removal of a fitting or spool. This makes infiltration of gas impossible. Although the method is almost universally used for post-purging isolation, caution should be exercised when removing fittings or sections from pipe containing combustible gas. To avoid possible hazard, the combustible gas can first be purged from the pipe by displacement with inert gas after temporarily isolating by some means such as flooding or closing valves. While the pipe contains inert gas, the fittings or sections can be removed for post-purging isolation before air is admitted.

If it is necessary to remove a fitting or spacer-piece from a pipe or connection containing combustible gas in order to obtain isolation, proper electrical bonding should be provided across the section to be removed prior to removal.

Isolation may be accomplished by one of the following methods:

(1) The section containing the fitting or spacer-piece is first valved off and depressurized. Then bags and/or stoppers are inserted ahead of and behind the fitting and the space between them given a local purge. When the fitting has been removed, the open ends of the pipe should be capped;

(2) In another method, after the depressurizing, the bolts of the flanges of the fitting or coupling are loosened and all of those on one half of the flange removed. Then temporary blanks of sheet metal cut to fit within the bolt circles and having three long tabs that can be bent back and down over the edges of the flanges. They are inserted at each flange to minimize the escape of gas or infiltration of air as the fitting is removed. When the fitting is removed, these temporary blanks are retained in place by bent tabs, but they are immediately covered with a standard blank or cap bolted into place. When removing a fitting or spool from a pipe or connection that contains inert gas, as at the end of a purge and for post-purging isolation, the precautions of bagging and stopping or using preliminary tabbed blanks usually are omitted.

1.5(m) TESTING OF PURGING ISOLATION

A thorough physical check should be made to ensure that all accessory piping and small connections have been disconnected. This is important in the case of plant piping and facilities where instrument or sample lines may permit back-leakage from manifolds or bypasses. Visual inspection should be made, as drawings are not always reliable.

The standard method of testing to ensure that isolation for a purging out of service is complete is to reduce the pressure in the chamber or system to just above atmospheric (or at least appreciably below that in previously connected facilities). Then, note any rise in pressure by the use of water manometers, over a period of time related to the size of the space. In making this test, all connections and vents should first be closed and examined for tightness. Then, the depressurizing should be done slowly through one purge gas vent. Care should be taken not to reduce the pressure below 2" or 3" water column as observed on a water manometer. A rise in

pressure within the isolated space of 4" water column indicates an infiltration equivalent to 1.0 percent of the volume of the space in the interval of observation.

Such an isolation test should be made immediately before the start of the purging.

1.5(n) POST-PURGING ISOLATION TESTS

Satisfactory post-purging isolation will be provided if isolation for the purging has been effected by detachment. The atmosphere of the chamber or space should be examined periodically to detect contamination from other sources although tests to detect infiltration may not be necessary. Space contamination tests should be directed toward the detection and measurement of substances in the atmosphere of the confined space that may be harmful or distressing to anyone working therein. A multi-gas instrument should be used to test substances, such as carbon monoxide or dioxide, hydrogen sulfide, cyanide, oil vapors, etc. Flammability tests should be included. Contamination tests and oxygen deficiency tests should be made immediately before confined space is entered and at intervals frequent enough to ensure a safe atmosphere during the time any person is in the structure. It should be noted that the absence of oxygen could render some instruments unreliable. All confined space rules must be followed.

If the purged space has not been completely disconnected from any possible source of gas infiltration by detachment, tests of its contents should be made to:

- (1) Ensure completeness of replacement of inert gases by air at the end of the purge;
- (2) Detect any infiltration of combustible gas through connections;
- (3) Detect undue contamination of the air by gases or vapors released from water or deposits.

1.5(o) SUMMARY

Isolation of equipment or chambers to be purged should take into account the necessity of preventing infiltration of gas while the space is out of service after the purging, as well as infiltration during the purge. Isolation for the purging action may be accomplished by use of valves, flooding of depressed sections, insertion of blanks, approved stoppers or actual detachment. In isolating for the post-purging period entrance and repairs, actual detachment is preferable.

The degree of isolation should be determined by test. These may include: purging isolation by observation of pressure increases within the space with all vents closed, use of gas monitoring instruments, post-purging isolation by chemical analysis and flammability tests of samples of the atmosphere within the space or chamber.

1.6 SOURCES OF IGNITION

1.6(a) GENERAL

During purging operations, it is of utmost importance that all possible sources of ignition be eliminated or controlled. The various sources may be represented by the classification given below:

(1) Flames

- Open lights
- Pilot lights
- Blow torches
- Matches
- Cigarette lighters
- Lanterns
- Fire in boilers
- Water heaters

- Burning material

- Incinerators

(2) Sparks and arc

- Non-approved flashlights
- Torch igniters
- Sparks from engines, stacks, etc.

- Static electricity

- Electrical shorts

- Lightning

- Sparks from tools (i.e., cutting or welding equipment)

- Solids traveling at high velocity in pipe

(3) Heated materials

- Glowing metals, cinders and filaments
- Electrical lights

(4) Pyrophoric materials (Materials that can ignite spontaneously in the presence of a gas- air mixture

In purging from combustible gas to air, especially when old piping is being purged, it should be remembered that purging removes only gaseous or volatile materials. Undetected liquid combustibles can be ignited by sparks carried back into a purged line when the line is cut. It is possible that solid combustible material remains in the lines after purging is completed and that pyrophoric or auto-ignition can take place as soon as an adequate air supply is available. Deposits of iron sulfide and other materials can easily be oxidized providing centers for auto-ignition. Therefore, special care should be exercised after purging and before such piping is entered or disassembled. Iron sulfide deposits should be kept wet to avoid auto-ignition.

Values of ignition temperature reported in the literature are variable, can be used only in a relative sense and even may be misleading unless complete details of the procedure by which the results were obtained are given. The results obtained are affected by a number of variables. The most important are the percentage of combustible in the mixture; the oxygen concentration, the "lag" or time required at a given temperature to cause ignition, the size, composition and dimensions of equipment. When the tests are made, the pressure at which the mixture is confined at the time of ignition and the presence of catalysts and impurities in the mixtures are critical.

1.6(b) STATIC ELECTRICITY

Static electricity is one of the most difficult ignition hazards to control. There are few operations in which it may not be present and it is more serious when the relative humidity is low. Static electricity is generated in several ways: by friction, by making and breaking of physical contact between two objects and by the passage of solids, liquids, or gases at high velocity through small openings.

Static electricity on materials, which are conductors of electricity, may be eliminated by grounding all machinery, pipes and other equipment when charges may accumulate. Before severing or disconnecting a pipe, a bond wire should be attached to the metallic pipe at two points to provide a connection across the proposed severance or disconnection. Further

information may be found in NFPA 77, Static Electricity, 1993 Edition.

1.6(c) STATIC ELECTRICITY ON PLASTIC PIPE

Static electricity on plastic pipe presents a different problem because the pipe is a nonconductor (dielectric) and the charge cannot be drained by a ground connection. Polyethylene pipe, for example, can gain an unbalanced static charge on its surface. The lack of conductivity in a dielectric means that each small section, will acquire its own local charge and potential.

Charges on plastic pipe are produced by normal handling. Contact between hands or clothing and the pipe can produce voltages of about 9kv. The charges on the human body or clothing can be produced by normal walking or sliding down the sides of a ditch; these charges can then be transferred to the pipe. Removal of dirt and dust prior to joining can produce voltages of 14kv. The steady flow of clean gas at 30 psig, free of particles, does not produce voltages of significance (400 to 500 volts). Up to 5,000 volts can be produced by pulsing gas from no flow to full flow quickly. The voltages are increased to that level by a cascading effect. The presence of particles in the gas stream, such as rust, sand, or dirt produce charges as high as 24kv. The voltage is especially high in areas of turbulence, such as elbows. The inside of the pipe will have a charge if the outside is charged and vice versa. The size of the charge on the secondary surface tends to follow the charge on the original surface. In summary, tests show that charges can be developed on plastic pipe in two ways:

- (1) By contact with clothing or the hands in normal handling;
- (2) By the flow of gas which contains particles of rust or dirt.

Charges may decay in time. The process may quicken if the relative humidity is high.

The application of a wet cloth instantly reduces the voltage to a value below 500v. Removal of the wet cloth results in a doubling of this voltage, however, this rebound effect can be eliminated if the wet cloth is reapplied over a large area.

Application of a wet cloth over the outside of the pipe causes an instantaneous reduction in the charge on both inside and outside surfaces. In purging or leak repair operations, a gas-air

mixture may be present in the area. Air will diffuse back into the pipe once the gas flow is stopped. In these cases, workers should avoid contact with the end of the pipe until the pipe surface is wet on the inside as well as the outside. The simple act of putting a metal insert stiffener into the pipe for a mechanical coupling may cause an ignition, if a gas-air mixture is present. Merely waving a hand in front of the pipe end to test for gas flow while a co-worker slowly opens a valve or releases a squeeze-off tool may result in fire.

1.6(d) SAFETY RECOMMENDATIONS FOR PLASTIC PIPE

(1) All pipes in the work area should be kept wet by wiping it with a wet cloth before taking any action that might result in the release of gas;

(2) The cloth should be made wet by submerging it in water;

(3) The use of liquid dishwashing detergent in the water will help spread the water over the pipe (certain early plastics are susceptible to cracking after being subjected to detergent. Detergent should not be used unless the environmental stress crack resistance (ESCR) of the plastic used is sufficiently high);

(4) Soft absorbent material such as cotton terry cloth or towel material is recommended;

(5) All pipe which may be touched by workers should be kept wet throughout work which might cause the release of gas. Leaving wet cloths on the pipe will accomplish this if the cloth is kept wet.

1.7 VENT PIPES FOR PURGING

1.7(a) GENERAL

The purpose of a vent pipe is to carry the purged gas from the facility being purged to a point from which the purged gas can diffuse into the air without hazard to the workers, the public and all property. In general, this requires a pipe long enough to carry the gases above the heads of the workers. Pipes 6 to 10 feet long usually suffice for most purging jobs performed on equipment located out of doors.

Equipment located inside building may require longer pipes or lines to carry the venting gases to the outside atmosphere. The location of gas lines in congested areas may also require longer pipes to carry the gases above nearby buildings, or to some other point. Gases heavier than air, such as LPG, require special precautions to ensure that vented gas is conducted away from the work area and disposed of or disbursed safely.

It may be necessary to install a number of vent pipes to completely purge a piece of equipment. Whether there is one vent pipe or many vent pipes, they must be placed so that they will permit the space to be purged completely. No traps should be permitted. The following chapters, covering the actual purging procedures for various types of facilities indicate

the points at which vent pipes should be placed. Chapter 5 on the purging of transmission and distribution pipe provides greater details of particular requirements for this application.

1.7(b) SIZE OF VENT PIPES

In general, the total cross-sectional area of all the vent pipes in operation at one time should be sized to ensure the retention of a positive pressure in the chamber being purged, prevent the infiltration of air (if flammable gas is in the equipment) and ensure a gas velocity at the outlet of the vent pipe greater than the rate of travel of the flame in the event the emerging gas mixture should be ignited.

The rate of flame travel in tube 1" to 2" in diameter for natural gas, propane and butane and is approximately 2 to 4 feet per second. For most commercial gases the rate with air ranges from about 3 feet per second for producer gas, to 6 to 7 feet per second for coke oven gas. Thus, an exit velocity that will minimize hazards at vent points should be selected.

Table 1-1 lists the pressure drop in inches of water, for hourly flows of 2,000 to 50,000 cu. ft. per hour of gas (specific gravity - 1.00) through pipes 1" to 4" in diameter and 10 feet long.

This table may be used as a guide in selecting pipe sizes, applying, if necessary, the following corrections for different specific gravities of the gas, or for different lengths of pipe:

(1) The pressure loss varies directly as the square of the quantity of gas flowing. For example: the pressure loss with 4,500 cu. ft. of gas per hour through 1 1/4" pipe is 13.5". The pressure drop with 4,800 cu. ft. will be:

$$13.5 \times \frac{(4800)^2}{(4500)^2} = 13.5 \times 1.14 = 15.4 \text{ inches w.c.}$$

The pressure loss varies directly as the specific gravity of the gas. For example: the pressure loss with 4,500 cu. ft. of 0.60 specific gravity gas flowing through a 1 1/4" pipe will be:

$$13.5 \times \frac{0.60}{1.00} = 8.10 \text{ inches w.c.}$$

(2) To obtain the flow velocities (V) in feet per second, from the cubic feet per hour (Q), for the various pipe sizes with area (a), apply the following formula:

$$V = \frac{Q}{60 \times 60} \times \frac{144}{a} = Q \times \frac{0.04}{a} = QF$$

in which

F is the factor $\frac{0.04}{a}$ for various pipe :

F for 1" pipe (d = 1.049") = 0.0463

F for 1 1/4" pipe (d = 1.380") = 0.0267

F for 1 1/2" pipe (d = 1.610") = 0.0196

F for 2" pipe (d = 2.067") = 0.0119

F for 2 1/2" pipe (d = 2.469") = 0.0084

F for 3" pipe (d = 3.068") = 0.0054

F for 4" pipe (d = 4.026") = 0.0031

TABLE 1-1

Pressure Loss in Inches of Water, for Gas
Flows Through Vent Pipes 10 Feet Long, with
Nominal 1" - 4" Inside Diameter
Specific Gravity = 1.000

NOMINAL INSIDE PIPE DIAMETER, INCHES

Gas Flow Cu. Feet per Hour	NOMINAL INSIDE PIPE DIAMETER, INCHES						
	1"	1-1/4"	1-1/2"	2"	2-1/2"	3"	4"
2,000	10.5	2.7	1.0	0.2	0.1	-	-
2,500	16.4	4.2	1.6	0.4	0.2	-	-
3,000	23.6	6.0	2.3	0.6	0.2	0.1	-
3,500	32.1	8.2	3.1	0.8	0.3	0.1	-
4,000	42.0	10.7	4.1	1.0	0.4	0.1	-
4,500	53.1	13.5	5.2	1.2	0.5	0.1	-
5,000	65.6	16.7	6.4	1.5	0.6	0.2	-
6,000	94.5	24.0	9.2	2.2	0.9	0.3	-
7,000	128.6	32.6	12.5	3.0	1.2	0.4	0.1
8,000	-	42.6	16.3	3.9	1.6	0.5	0.1
9,000	-	53.9	20.6	5.0	2.0	0.6	0.1
10,000	-	66.6	25.5	6.1	2.5	0.7	0.2
15,000	-	149.9	57.3	13.8	5.7	1.6	0.4
20,000	-	-	101.9	24.5	10.1	2.9	0.7
25,000	-	-	-	38.3	15.8	4.5	1.1
30,000	-	-	-	55.2	22.7	6.5	1.6
35,000	-	-	-	75.2	30.9	8.9	2.1
40,000	-	-	-	98.2	40.4	11.6	2.8
50,000	-	-	-	-	63.1	18.1	4.3

Note(1) - Based upon the Gas Flow Formula: -

$$Q = C \sqrt{\frac{d^5 (p_1 - p_2)}{S \times L}} \quad \text{in which}$$

Q - gas flow in cubic feet per hour
d - internal diameter of pipe, inches
p₁ - p₂ - pressure drop thru pipe, inches of water
S - specific gravity of gas
L - length of pipe, in yards

C - gas flow constant: -
Diameter - 1" - 1-1/4" 1-1/2" 2" - 2-1/2" 3" 4"
Constant - 1,000 1,100 1,200 1,300 1,350

The data are based upon S = 1.00, and L = 3.333 yards
(equivalent of 10 feet)

1.7(c) FIRE SCREENS ON VENT PIPES

The practice among natural gas companies with respect to the use of fire screens on the outlet of the purge vent pipes varies greatly.

If the velocity of flow is greater than the speed of the flame travel, fire screens should not be necessary, however, some companies use screens as a secondary precaution. They can protect against:

- (1) Unpredictable conditions;
- (2) Unforeseen interruptions in the supply of inert gas while purging from gas to air;
- (3) Carelessness that may develop when purging into service rather than when purging out of service.

Fire screens, in addition, tend to prevent flashback should an explosive mixture become ignited.

In addition, fire screens are generally 50 to 60 mesh wire screen between pipe at least 4 times the area of the vent pipe. For example: 4" flanges on 2" pipe.

The disadvantages accompanying the use of fire screens include:

- (1) There is no assurance that the flame will not strike back through the screen. If the gas discharging from the pipe should become ignited, the center of the screen could become hot enough to ignite the gas-air mixture approaching the screen

(2) The mesh may become clogged with condensates and dust. The condensates may be volatile oils or water. This can be quite troublesome and constant attention should be given to the screen. If condensates collect, it may be possible to dislodge them by tapping the screen lightly, or it may be necessary to remove the screen for cleaning or replacement.

(3) The trapping of the volatile oils on the screen in the test connection may affect the reading of the combustible gas indicator when it is used for testing the progress of the purging. Instances have occurred in which combustible mixtures were indicated long after the time schedule and other test apparatus showed the purging to be completed. Investigation proved that trapped oils in the screen had volatilized and indicated an explosive mixture still present.

(4) Plugged screens will decrease the flow of the purged mixture and may stop it entirely, unless constant attention is given to keeping them clean and open.

In summary, careful attention should be given to whether fire screens should be used. The disadvantages may out-weigh the advantages of use. In general, their use should be given careful consideration when explosive or combustible mixtures are present. They should not be depended upon to correct or offset any faults in the purging conditions or procedures.

REFERENCES

Natural Fire Protection Association, NFA59, "Standard for the Storage and Handling of Liquefied Petroleum Gases at Utility Gas Plants", 1998 Edition.

Natural Fire Protection Association, NFPA77, "Static Electricity", 1993 Edition.

CHAPTER 2
CONTROL OF PURGING

SECTION	PAGE #
2.1 Introduction	19
2.2 Cautionary Note	19
2.3 Limits of Flammability of Gas Mixtures	19
2.4 End-Points for Purging	24
2.5 Purging Facilities Into Service	27
2.6 Purging Facilities Out of Service	30
2.7 Holding Purge	31
2.8 Purging Progress Charts	32
TABLES	
2-1 Limits of Flammability of Gases & Vapors	20
2-2 The Calculation of Flammable Limits	22
2-3 Inert Gas End Points for Purging into Service	30
2-4 Oxygen End Points for Purging into Service	30
2-5 Inert Gas End points for Purging our of Service	31
2-6 Combustible Gas End Points for Purging our of Service	31
FIGURES	
2-1 Flammable Limits for hydrogen, Carbon Monoxide, Methane	23
2-2 Flammability End Point Diagram- Air-Methane-Nitrogen	25
2-3 Flammability End Point Diagram- Air-Hydrogen-Nitrogen	26
2-4 Comparative Flammability End Point Diagram- Air-Methane-Carbon Dioxide	28
2-5 Comparative Flammability End Point Diagram-Air-Hydrogen-Carbon Dioxide	29
2-6 Purging Progress Chart	32
2-7 Purging Progress Chart- Combustible Gas is Replaced by Inert Gas	33
2-8 Purging Progress Chart- Air is Replaced by Combustible Gas	34

CHAPTER 2 CONTROL OF PURGING

2.1 INTRODUCTION

The control of the purging operation requires a basic understanding of the fundamentals and theory of purging. An understanding of the physical properties and interrelationships of oxygen, inert gases and combustible gases is essential.

The necessary factors in a successful purging operation may be calculated or estimated using theoretically or experimentally determined data. Although the discussion in this chapter is directed primarily toward the purging of natural gas, other combustible mixtures will be referenced to better illustrate the practices and principles of purging.

Knowledge of the flammability limits of combustible gas mixtures, the impact of pressure and temperature variations on the flammability

limits and the changes in these limits as combustible gas concentrations vary is important. This knowledge is invaluable in estimating the purging end-points for the combinations of different blends of combustible and inert gas and air or oxygen.

Defining end-points for purging and testing methods for the control of purging will be presented. The flammability end point diagram is a useful tool the understanding the impact of complex combustible gas mixtures. The flammability zone for these complex mixtures will become readily apparent.

The operation for purging a facility into service, out of service or holding a purge is best illustrated by the development of purging progress charts.

2.2 CAUTIONARY NOTE

Throughout this chapter, the discussion will be concerned primarily with theoretical or calculated conditions in which it is assumed that the necessary factors are known or can be estimated from predetermined relationships. From a practical point of view, however, there is always the possibility that actual conditions may not correspond precisely with those which have been derived, even though the best-known data and the most justifiable methods are employed. In conducting any purging operation, a good rule to follow is to purge too much rather than too little.

Furthermore, after a purging operation is properly conducted according to a safe procedure and brought to a satisfactory end-point, the purged atmosphere must be rechecked. The operator must ensure that condensates, residues, leaks, or some other such condition will not subsequently create a dangerous condition with the container. Due consideration should be given in this regard to the possible presence of substances within the container, which, due to chemical reactions, may result in the production of combustible elements or cause spontaneous combustion.

2.3 LIMITS OF FLAMMABILITY OF GAS MIXTURES

A basic requirement in approaching a purging operation is the knowledge of the flammable limits of the combustible gas in air. When small increments of a combustible gas are progressively mixed with air, a concentration is finally attained in which a flame will propagate if a source of ignition is present.

This is referred to as the Lower Flammable Limit of the gas in air. For practical purposes, this can be considered the same as the Lower Explosive Limit (LEL). As further increments of the gas are added, a higher concentration of

flammable gas in air will finally be attained in which a flame will fail to propagate. The concentration of gas and air, just as this point is reached, is referred to as the Upper Flammable Limit of the gas in air. For practical purposes, the Upper Flammable Limit can also be considered the same as the Upper Explosive Limit (UEL).

Safety requires that only the most reliable experimentally determined flammable limit data be considered in purging calculations. Sample information is included in Table 2-1.

TABLE 2-1
LIMITS OF FLAMMABILITY OF GASES
AND VAPORS, PERCENT IN AIR:

GAS OR VAPOR	LOWER	UPPER
Hydrogen	4.00	75.0
Carbon monoxide	12.50	74.0
Ammonia	15.50	26.60
Hydrogen sulfide	4.30	45.50
Carbon disulfide	1.25	44.0
Methane	5.30	14.0
Ethane	3.00	12.5
Propane	2.20	9.5
Butane	1.90	8.5
Iso-butane	1.80	8.4
Pentane	1.50	7.80
Iso-pentane	1.40	7.6
Hexane	1.20	7.5
Heptane	1.20	6.7
Octane	1.00	3.20
Nonane	0.83	2.90
Decane	0.67	2.60
Dodecane	0.60
Tetradecane	0.50
Ethylene	3.1	32.0
Propylene	2.4	10.3
Butadiene	2.00	11.50
Butylene	1.98	9.65
Amylene	1.65	7.70
Acetylene	2.50	81.00
Allylene	1.74
Benzene	1.4	7.1
Toluene	1.27	6.75
Styrene	1.10	6.10
o-Xylene	1.00	6.00
Naphthalene	0.90
Anthracene	0.63
Cyclo-propane	2.40	10.4
Cyclo-hexene	1.22	4.81
Cyclo-hexane	1.30	8.0
Methyl cyclo-hexane	1.20
Gasoline-regular	1.40	7.50
Gasoline-73 octane	1.50	7.40
Gasoline-92 octane	1.50	7.60
Gasoline-100 octane	1.45	7.50
Naphtha	1.10	6.00

NOTE: More complete tables of data are included in Appendix of "GASEOUS FUELS" published by A.G.A., 1954 (10)

2.3(a) PRESSURE EFFECTS ON COMBUSTIBLE LIMITS

Pressures below atmospheric pressure do not affect the limits of flammability of natural gas-air mixtures and most other gas-air mixtures.

From atmospheric pressure up to 300 psig. the lower limit of flammability is not affected, but the upper limit rises as the pressure on the mixture is increased. This widens the range of flammability as the pressure increases, as shown below:

APPROXIMATE EFFECTS OF PRESSURE INCREASE ON THE UPPER FLAMMABILITY LIMIT (UFL) OF NATURAL GAS					
PSIG	0	100	200	300	350
UFL	15	18	24	32	40

Few combustible gases are composed of pure gases or vapors, but in most cases are mixtures of many different gases. In approaching a purging operation it is therefore necessary to obtain the limits of flammability of the particular gas mixture in question. If the equipment and time are available, the fuel gas-air mixtures may be prepared and its flammability may be determined by ignition. It is much easier to determine the flammability limits of complex gas mixtures by calculation. Experience has shown that the results obtained generally are sufficiently dependable.

2.3(b) CALCULATION OF FLAMMABILITY LIMITS

Flammability limits of complex gas mixtures are calculated using the mixture rule first applied in such estimations by Le Chatelier in 1891. Stated simply, the mixture rule is that if two limit mixtures of different gases are added together, the resulting mixture also will be a limit mixture (e.g. if both gas mixtures were at the respective UFL's, the resulting mixture will be at its UFL). The equation expressing this law is written as follows:

$$L = \frac{100}{\frac{P_1}{N_1} + \frac{P_2}{N_2} + \frac{P_3}{N_3} + \frac{P_4}{N_4} + \text{etc.}}$$

Where P_1, P_2, P_3, P_4 etc., are the proportions, of each combustible gas present in the original mixture, free from air and inert gas so that $P_1 + P_2 + P_3 + P_4 = \text{etc.} = 100$ and N_1, N_2, N_3, N_4 etc., are the limits of flammability of the mixture (upper or lower as the case may be) in air. L is the corresponding limit of flammability of the mixture.

An example of the application of this law is indicated by a natural gas of the following composition:

GAS	% BY VOLUME	LFL % GAS IN AIR
Methane	80.0	5.30
Ethane	15.0	3.00
Propane	4.0	2.20
Butane	1.0	1.90

$$\text{Lower Limit} = \frac{100}{\frac{80.0}{5.30} + \frac{15.0}{3.00} + \frac{4.0}{2.20} + \frac{1.0}{1.90}}$$

= 4.46% Gas in Air

Any oxygen contained in a mixture may be considered as though it were a part of the air required of the combustion. The analysis of the flammable mixture should be converted to an air-free basis before the flammable limits are calculated.

Simple combustible inert mixtures may be extrapolated directly from Figure 2-1. As an example take a mixture that is 90 percent hydrogen and 10 percent nitrogen; the inert combustion ratio is nine. From Figure 2-1, the lower and upper flammability limits are approximately 44 and 76 percent respectively.

When mixtures are more complex and contain appreciable quantities of the inert gases, such as nitrogen and carbon dioxide, calculation of the flammability limits becomes somewhat more complicated and requires the use of an extension of the mixture rule. In this modification the inert gases are considered by assuming that the original mixture is composed of a number of sub-mixtures of inert gas and

combustible gas for which the flammability limits have been experimentally determined. The flammability limits of mixtures of hydrogen, carbon monoxide and methane with CO₂, N₂ and H₂O are shown in Figure 2-1 with the different combustibles in any of several ways, two of which are represented by calculations A and B in Table 2-2.

In these examples, the inert gases CO₂ and N₂ are combined with the combustible H₂ and CO and the small amount of CH₄ is taken alone. Next, the ratio of inert to combustible gas is obtained for each group as shown and the flammable limits for each such mixture are obtained from Figure 2-1. The mixture rule formula is now applied, using the data as shown in Table 2-2.

The summary at the bottom of Table 2-2 indicates the relative agreement between the calculated data and that experimentally determined for this particular gas mixture. The difference between calculated and determined data in this case may have been due more to inaccuracies in the analysis of the gas mixture (particularly for methane) than to the fault of the mixture rule formula. This points up the fact that reliable gas analyses also are a necessary part of the calculated flammability limit data.

TABLE 2-2

THE CALCULATION OF FLAMMABLE LIMITS

Gas Analysis		Combinations Chosen	Total	Ratio Inert/Combustible	Flammable Limits	
Gas Composition					Lower	Upper
H ₂	12.4%	12.4H ₂ + 6.2 CO ₂	18.6%	0.50	6.0	71.5
CO	27.3	27.3 CO + 53.4 N ₂	80.7%	1.96	39.8	73.0
CH ₄	0.7	0.7 CH ₄	0.7%	0.00	5.0	15.0
CO ₂	6.2					
O ₂	0.0					
N ₂	53.4					

CALCULATION A

$$\text{Lower Limit} = \frac{100}{\frac{18.6}{6.0} + \frac{80.7}{39.8} + \frac{0.7}{5.0}} = 19.0$$

$$\text{Upper Limit} = \frac{100}{\frac{18.6}{71.5} + \frac{80.7}{73.0} + \frac{0.7}{15.0}} = 70.8$$

Gas Analysis	12.4 H ₂ + 53.4 N ₂	- 65.8	4.31	22.0	76.0
	27.3 CO + 6.2 CO ₂	- 33.5	0.23	15.0	71.0
same	0.7 CH ₄	- 0.7	0.7	5.0	15.0

CALCULATION B

$$\text{Lower Limit} = \frac{100}{\frac{65.8}{22.0} + \frac{33.5}{15.0} + \frac{0.7}{5.0}} = 18.7$$

$$\text{Upper Limit} = \frac{100}{\frac{65.8}{76.0} + \frac{33.5}{71.0} + \frac{0.7}{15.0}} = 71.9$$

		Lower Limit	Upper Limit
Summary	Determined	20.7	73.7
	Calculation A	19.0	70.8
	Calculation B	18.7	71.9

Figure 2-1

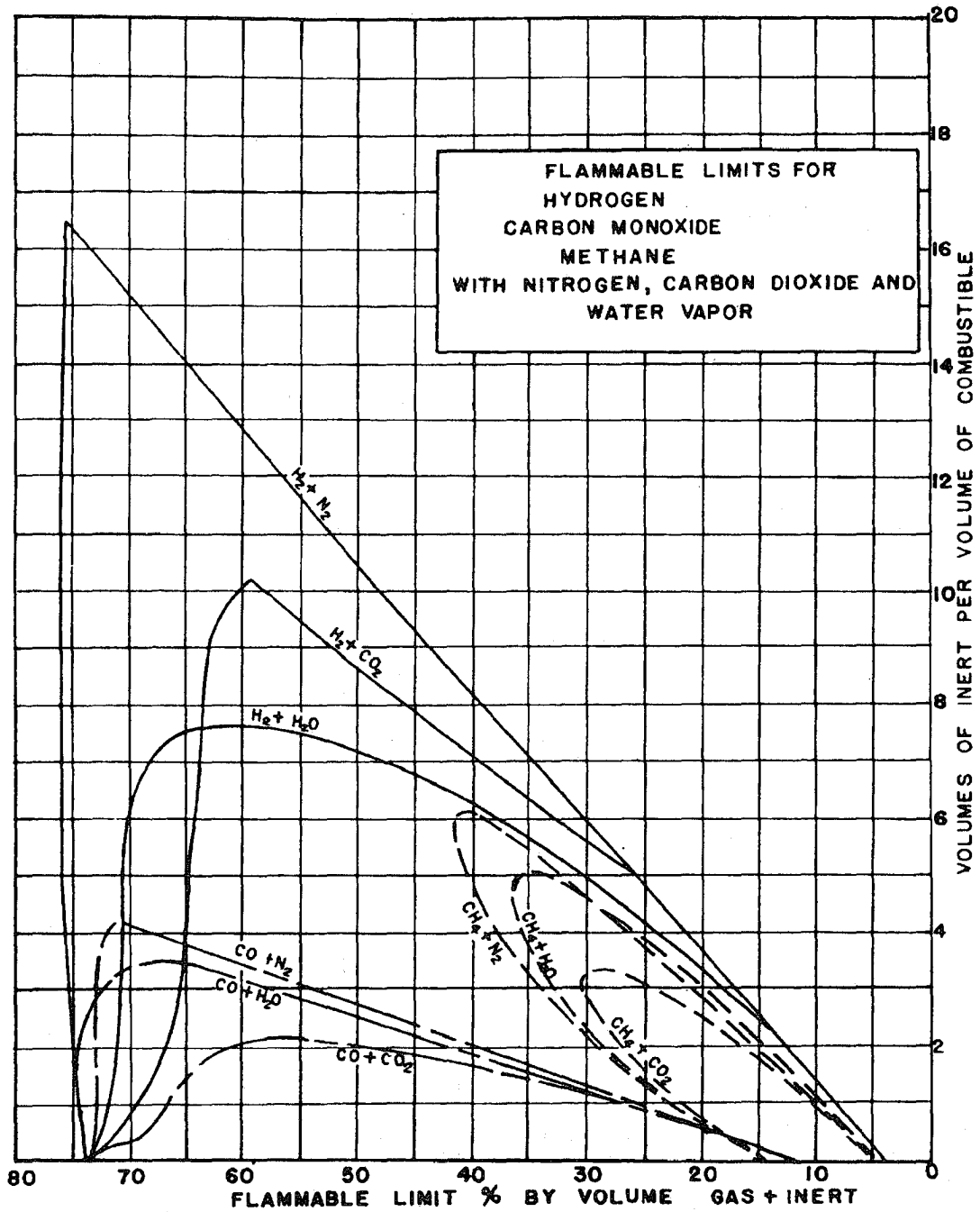

Figure 2-1 - Flammable limits for hydrogen, carbon monoxide, methane, with nitrogen, carbon dioxide and water vapor

2.4 END-POINTS FOR PURGING

Inert gases, such as carbon dioxide, nitrogen and steam change the explosive limit range of certain combustible gases as show in Figure 2-1. When these inert gases are mixed in suitable proportions with the combustible gases, the formation of flammable mixtures can be prevented.

There is no additional safety involved in unnecessarily prolonging a purging operation. So the question at this point is "How long should the introduction of inert gas be continued in order to ensure that the subsequent admission of air or of combustible gas, as the case may be, into the container will not form a possible flammable mixture?" The end-points of purging must be determined to answer this question.

The discussion in the remaining parts of this section refers primarily to inert purge gases composed of CO_2 and N_2 or of gas containing various proportions of CO_2 and N_2 . Purging with steam will be covered separately in a subsequent part of the present chapter.

The proper end-point of a purge may be deduced from a graph or diagram of the flammability limits in air of mixtures containing various proportions of the combustible gas and the inert gas being employed. It is possible to derive such a graph by experimental work involving the preparation and testing of numerous mixtures of the combustible gas and the inert gas with air. A simpler procedure employs calculation using Le Chatelier's formula and the data from Figure 2-1. The calculation is similar to that illustrated in Table 2-2.

The mixtures for which the flammable limits are to be derived are estimated from various combinations of the combustible and inert gas mixtures to be used in the purging operation (i.e., 90 percent combustible gas + 10 percent inert gas; 80 percent combustible gas + 20 percent inert gas; 70 percent combustible gas + 30 percent inert gas; etc.).

Some deviation may occur when the combustible gases involved are of larger molecular structure or approach vapors in nature such as benzene or gasoline. The calculation still may be used for all practical purposes for the estimation of end-points of purging. For mixtures composed chiefly of the simpler gases, the calculated data may be taken to be as dependable as the basic data relating to the individual gases shown in Table 2-1 and Figure 2-1.

The relationships among constituents of the three-component system (flammable gas, atmospheric air and inert gases) may be represented on triangular or rectangular coordinates. A triangular plot for air, methane and nitrogen is shown in Figure 2-2. This is called a flammability end-point diagram.

Figure 2-2 could also be derived directly from Figure 2-1. By estimating the percentage amounts of combustible, inert and air-mixtures at various points on the curves in Figure 2-1, a flammability end-point diagram is obtained by plotting these same points on a triangular graph for these mixtures.

Figure 2-3 shows the flammability zone for a mixture of hydrogen, nitrogen and air. This graph was derived directly by estimating the percentages of the gas mixture at points 1, 2, 3 and 4 as shown on Figure 2-1 and plotted on Figure 2-3.

In this example, hydrogen was chosen to demonstrate this process, but also to visually indicate the vast range of flammability limits of different combustible gases. Natural gas has a relatively narrow flammability range while hydrogen has one of the widest ranges for gases that are normally encountered in a purging operation.

The development of a flammability end-point graph will greatly aid in the understanding of the relationships of the gases involved. Consider Figure 2-2. The horizontal axis XH represents combustible gas concentration, the vertical axis XV indicates the concentration of atmospheric air respectively and the diagonal axis VH illustrates concentration of the inert gas nitrogen. Point V denotes 100 percent air or 21 percent oxygen, zero percent natural gas and zero percent inert gases. Point O represents 100 percent nitrogen, zero percent air (or oxygen) and zero percent methane. Point H denotes 100 percent methane, zero percent air or oxygen and zero percent nitrogen. Therefore, line VH represents all possible concentrations of air and methane and no nitrogen; all possible mixtures of methane, air and nitrogen are included within the area XVH. Points A and B on VH represent the lower and upper flammable limits of the combustible gas in air respectively.

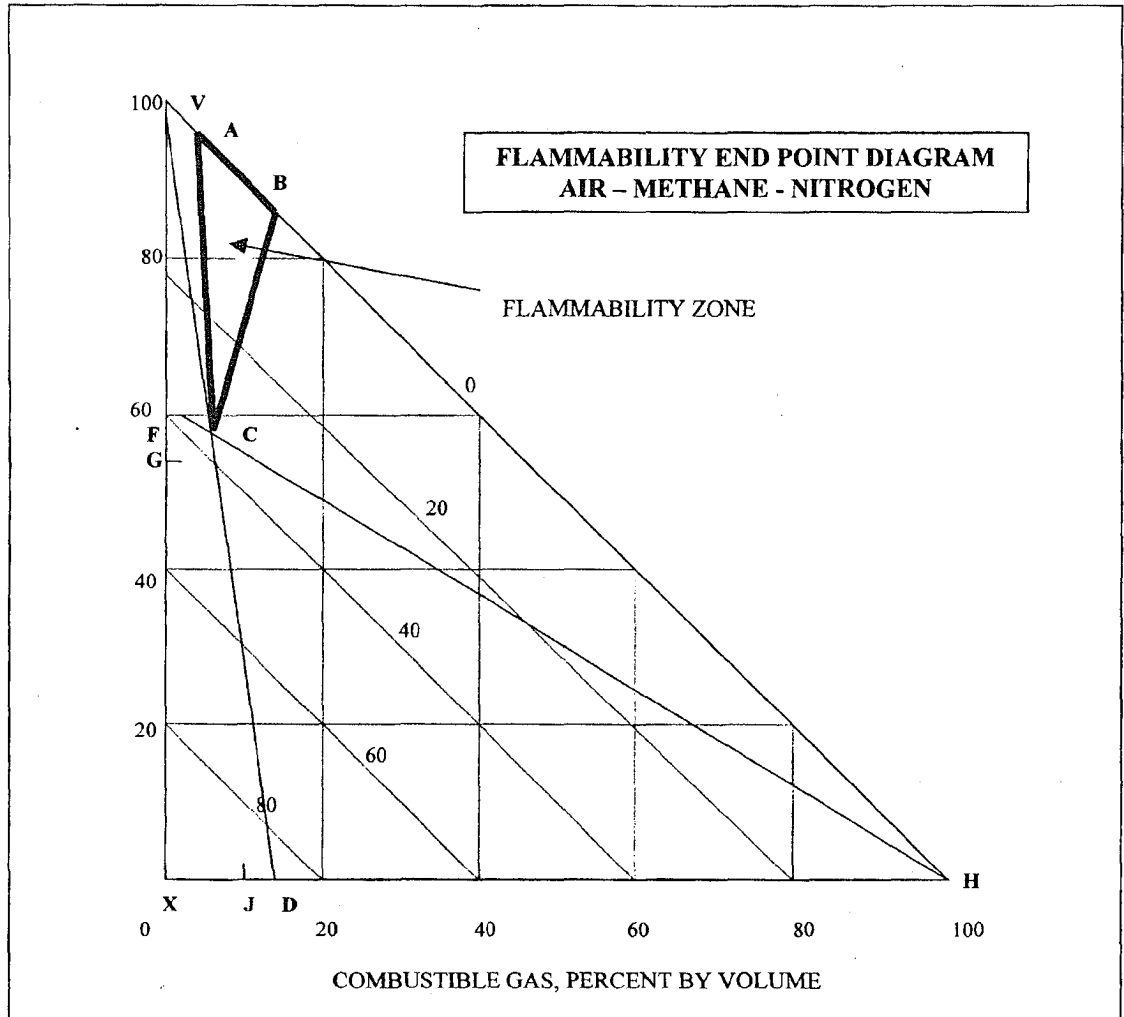

Flammability end point diagram for the purging of methane with nitrogen at 70° F. The A and B coordinates are 5 and 14 percent methane, and 0-percent nitrogen, respectively. The C coordinate is a mixture of approximately 6 percent methane, 36 percent nitrogen and 58 percent air. The triangle formed by the coordinates of A, B and C represent the flammability zone at 70 degrees F. Note: the flammability zone area will increase as the temperature increases.

FIGURE 2-2

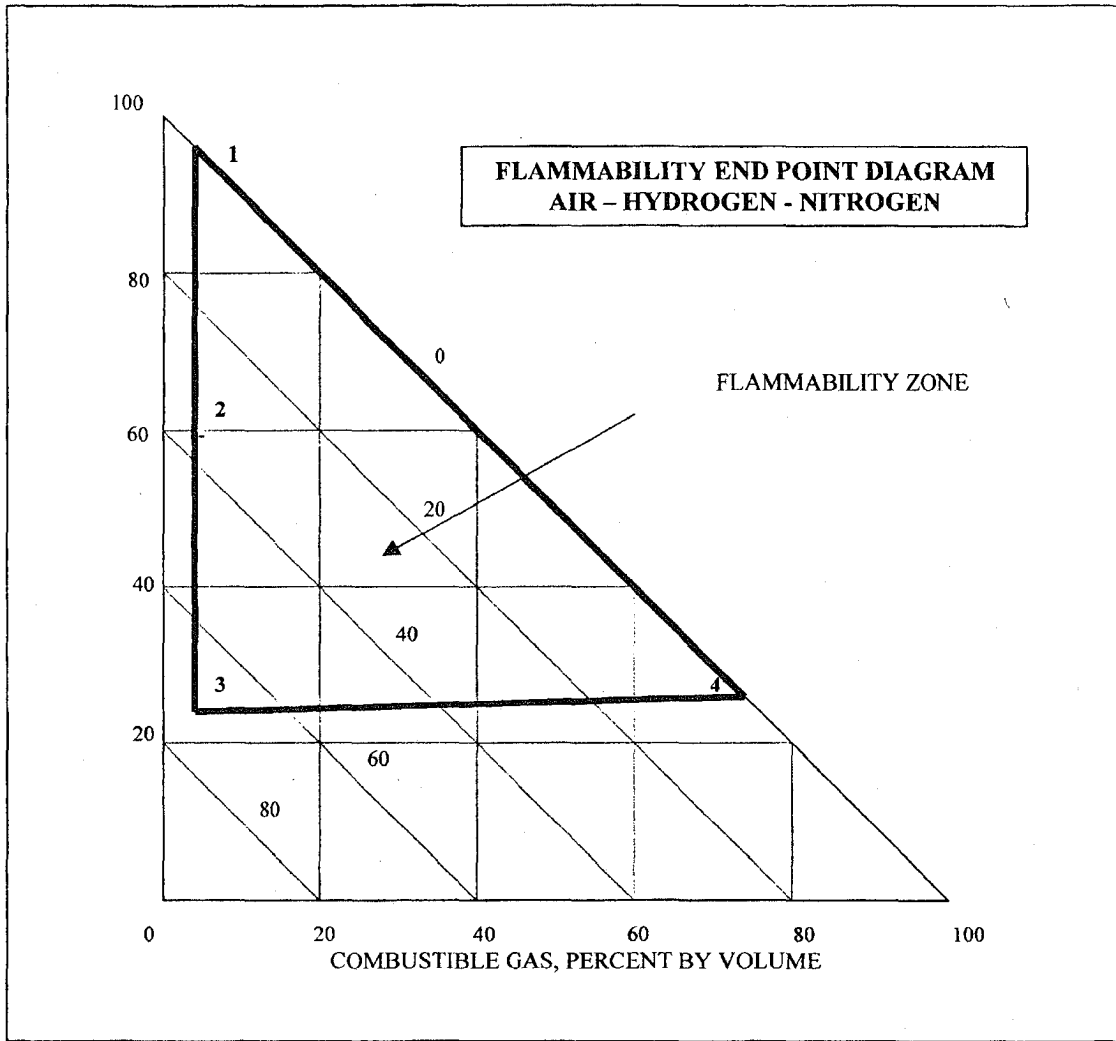

Flammability end point diagram for the purging of hydrogen with nitrogen can be approximated from Figure 2-1. The approximate concentrations of hydrogen, nitrogen and air have been estimated at points 1, 2, 3 and 4 in Figure 2-1. Those same concentrations points are represented as points 1, 2, 3 and 4 above. Note: this method approximates the flammability zone since the interior lines forming the triangle may not be precisely linear.

FIGURE 2-3

As inert gas is mixed with methane and air in the flammable range, other mixtures are formed which have different lower and upper flammable limits. These new limiting mixtures are represented by the lines AC and BC. As more nitrogen is added, AC and BC converge at point C. No mixture of combustible gas which contains less than the amount of air represented at point C is flammable within itself. All mixtures within ABC are within the flammable limits and must be avoided for safe purging practice.

Mixtures within the area DCBH are above the flammable limits, but will become flammable when air is added. Thus, in Figure 2-2, a mixture containing 40 percent air, 40 percent natural gas and 20 percent nitrogen (point E) is not flammable. If air is added to this mixture, its composition will vary along the line EV and as it enters the area ABC, the mixture becomes flammable.

Similarly, all mixtures within the area VACF are below flammability limits but will become flammable if combustible gas is added, since the mixtures may enter the area ABC.

Mixtures indicated by points in the area XDCF are not only nonflammable, but *cannot* be made flammable by adding either combustible gas or air.

The development of graphs such as Figure 2-2 illustrates the relationship of the flammable limits of methane, oxygen and nitrogen mixtures. A similar graph for mixtures of methane, oxygen and carbon dioxide and is shown in Figure 2-4.

As stated earlier, the primary purpose of this manual is to deal with the purging of natural gas, however, it is instructive to consider other flammable gases with respect to the flammable limits. Natural gas has a relatively narrow flammable range (approximately 5-14%) while hydrogen has a broad flammable range (approximately 4-75%). A similar technique may be used to develop a flammability zone graph for hydrogen, oxygen and combinations of nitrogen and carbon dioxide as shown in Figure 2-5. It is apparent that safe purging of hydrogen is significantly more difficult because of the large flammable zone. Greater care must be practiced for combustible gases as the flammable zone increases.

Figures 2-2 through 2-5 represent the extremes that may normally be encountered during a purging operation. The discussion in the next three sections regarding purging facilities into service, out of service and holding a purge may be extended to any combustible gas or gas mixture using a flammability zone graph.

2.5 PURGING FACILITIES INTO SERVICE

A safe purging operation of air from a container subsequently to be filled with natural gas may be indicated in Figure 2-2. As an inert gas is added, the air concentration drops along ordinate VX to any point G below F. Subsequent addition of natural gas causes the mixture composition to change along line GH (not shown), which crosses no part of the flammable zone ABC. In the example shown in Figure 2-2, inert gas should be added until the purged atmosphere contains at least 42 percent inert gas, thereby reducing the air content in the purged atmosphere to 58 percent, or an oxygen concentration of about 12 percent.

To render a given combustible-air mixture nonflammable it is desirable to know what percentage of inert gases is required. Table 2-3 gives the values for a number of combustibles investigated by the U.S. Bureau of Mines. To ensure safety, purging should be continued to a point at least 20 percent beyond the flammable

limit. These purging end-points are given on the right side of Table 2-3.

Sometimes it is more convenient to control the purging by determining the oxygen content of the purged gases. In purging into service, inert gas is added to the container until the oxygen concentration of the mixture is decreased to the point where no mixture of this with the combustible gas would be flammable. This data, also presented by the U.S. Bureau of Mines, is given in Table 2-4. Suggested purging end-point data with a 20 percent safety factor are given on the right half of Table 2-4 in terms of percent of oxygen for the purging of containers in preparation to receive the various combustibles shown. Note: NFPA 69 requires that oxygen end-points be calculated at 60% of the limiting oxidant concentration. The reader is urged to review both sources for the applicable standard to their operation.

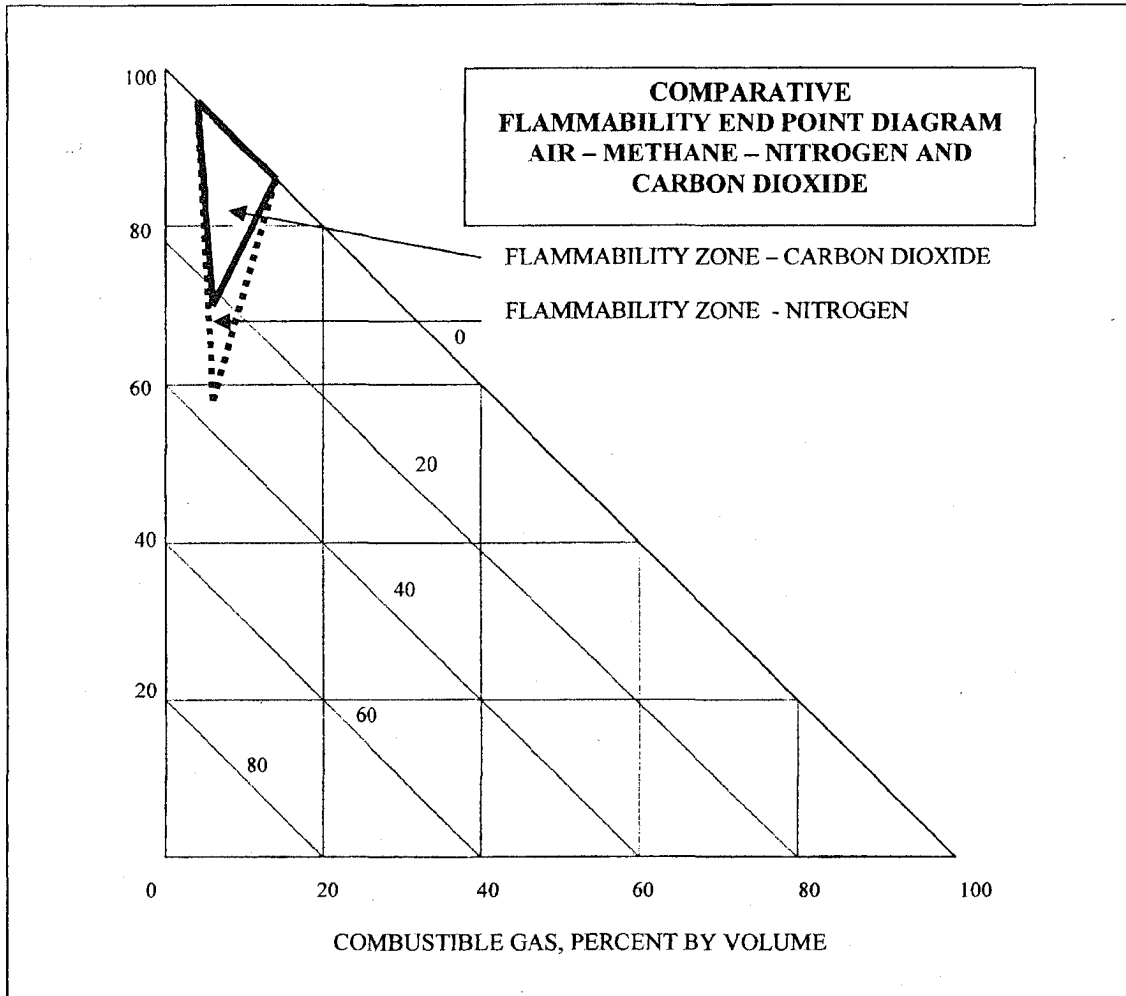

The comparative flammability end point diagram for the purging of methane with carbon dioxide and nitrogen.

FIGURE 2-4

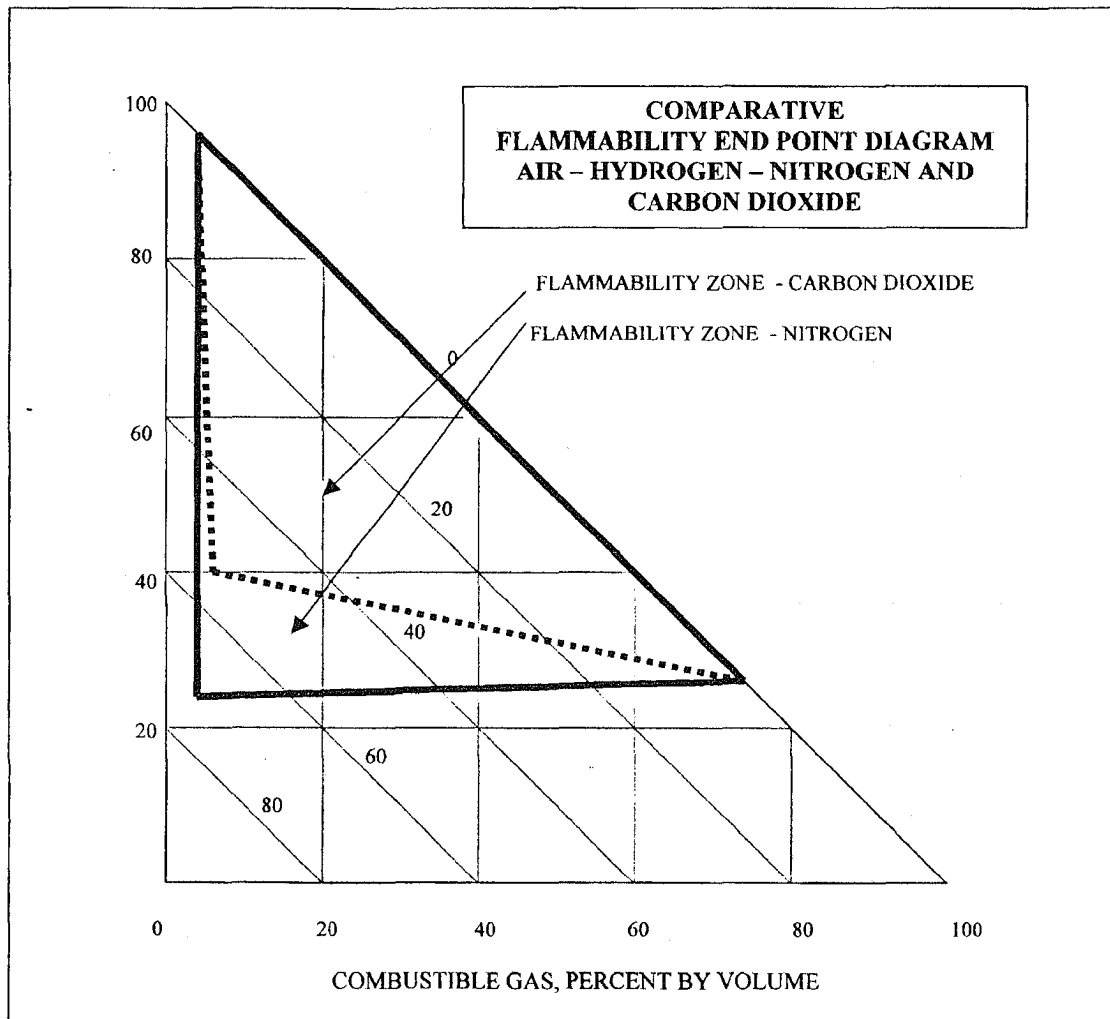

The comparative flammability end point diagram for the purging of hydrogen with carbon dioxide and nitrogen.

FIGURE 2-5

TABLE 2-3

INERT GAS END POINTS
FOR PURGING INTO SERVICE

Purge Medium	CO ₂ N ₂ *		CO ₂ N ₂ *	
	Percent required to render mixtures non-flammable		Purging End Points with 20% Safety Factor	
Hydrogen	57	71	66	77
Carbon Monoxide	41	58	53	66
Methane	23	36	38	49
Ethane	32	44	46	55
Propane	29	42	43	54
Butane	28	40	42	52
Iso-butane	26	40	41	52
Pentane	28	42	42	54
Hexane	28	41	42	53
Gasoline	29	43	43	55
Ethylene	40	49	52	59
Propylene	29	42	43	54
Cyclopropane	30	41	44	53
Butadiene	35	48	48	49
Benzene	31	44	44	55

* Nitrogen percentages do not include nitrogen of the air in mixtures.

TABLE 2-4

OXYGEN END POINTS
FOR PURGING INTO SERVICE

Purge Medium	CO ₂ N ₂		CO ₂ N ₂	
	Percent of Oxygen below which no mixture is flammable		Purging End Points with 20% Safety Factor	
Hydrogen	5.9	5.0	4.7	4.0
Carbon Monoxide	5.9	5.6	4.7	4.5
Methane	14.6	12.1	11.7	9.7
Ethane	13.4	11.0	10.7	8.8
Propane	14.3	11.4	11.4	9.1
Butane	14.5	12.1	11.6	9.7
Isobutane	14.8	12.0	11.8	9.6
Pentane	14.4	12.1	11.5	9.7
Hexane	14.5	11.9	11.6	9.5
Gasoline	14.4	11.6	11.5	9.3
Ethylene	11.7	10.0	9.4	8.0
Propylene	14.1	11.5	11.3	9.2
Cyclopropane	13.9	11.7	11.1	9.4
Butadiene	13.1	10.4	10.5	8.3
Benzene	13.9	11.2	11.1	9.0

2.6 PURGING FACILITIES OUT OF SERVICE

The operation of purging natural gas from a container to be filled subsequently with air may also be illustrated using Figure 2-2. As inert gas is added, the natural gas concentration decreases from point H (at the right) along abscissa HX to a point J beyond D. Subsequent addition of air results in a change in the mixture composition along line JV (not shown), which crosses no part of flammable zone ABC. In the example shown in Figure 2-2, at least 88 percent of the natural gas should be replaced by inert gas when the container is purged out of service.

To render a given combustible nonflammable should air be added to it in any amount, it is desirable to know what percentages of inert gases are required. Table 2-5 gives the data for a number of combustibles investigated by the U.S. Bureau of Mines. To ensure safety, purging should be continued to a point at least 20 percent beyond the flammable limit. These purging end-points are given on the right side of

Table 2-5. Again the requirements NFPA 69 implies that U.S. Bureau of Mines oxygen end-points listed in these tables do not meet the safety margins of a 60% limiting oxidant concentration. The reader is urged to research the appropriate standard that applies to their operation.

It is sometimes more convenient to control the purging by determining the combustible content of the purged gases. In purging out of service, inert gas is added to the container until the combustible gas concentration of the mixture is decreased to the point where no mixture of this with any amount of air would be flammable. These data are given on Table 2-6. Suggested purging end-point data with a 20 percent safety factor are given on the right side of Table 2-6 in terms of the percent of combustible in a mixture which will remain nonflammable regardless of any amount of air which may be added to it.

2.7 HOLDING PURGE

A holding purge is similar to the purging of a facility out of service except that in a holding purge an inert atmosphere is maintained and is not replaced at once by air. Alterations or repairs can sometimes be made safely on closed systems under such conditions, after which combustible gas is readmitted and the equipment is returned to service.

Figure 2-2 also may be applied to a holding purge for natural gas. Natural gas concentration decreases during purging from point H (at the right) along abscissa HX to a point J beyond D. Natural gas may then be readmitted at any time, the composition of the mixture changing from J along XH until H is reached and the facility is returned to service.

TABLE 2-5

INERT GAS END POINTS FOR PURGING OUT OF SERVICE				
Purge Medium	CO ²	N ²	CO ²	N ²
Combustible	Percent required to render mixtures non-flammable when air is added in any amount		Purging End Points with 20% Safety Factor	
Hydrogen	91	95	93	96
Carbon Monoxide	68	81	74	85
Methane	77	86	82	89
Ethane	88	93	91	95
Propane	89	94	91	95
Butane	91	95	93	96
Iso-butane	91	95	93	96
Pentane	96	97	97	98
Hexane	96	97	97	98
Gasoline	93	96	95	97
Ethylene	90	94	92	95
Propylene	94	96	95	97
Benzene	93	96	95	97

TABLE 2-6

COMBUSTIBLE GAS END POINTS FOR PURGING OUT OF SERVICE				
Purge Medium	CO ²	N ²	CO ²	N ²
Combustible	Percent of Combustible below which no mixture is flammable when air is added in any amount		Purging End Points with 20% Safety Factor	
Hydrogen	9	5	7	4
Carbon Monoxide	32	19	26	15
Methane	23	14	18	11
Ethane	12	7	9	5
Propane	11	6	9	5
Butane	9	5	7	4
Iso-butane	9	5	7	4
Pentane	4	3	3	2
Hexane	4	3	3	2
Gasoline	7	4	5	3
Ethylene	10	6	8	5
Propylene	6	4	5	3
Benzene	7	4	5	3

2.8 PURGING PROGRESS CHARTS

A good method to link the results of tests with control of operations is to compare the actual results with the desired results throughout the progress of the operation. This may be accomplished by means of a purging progress chart which is a graph or diagram of the theoretical compositions of the mixtures or purge gases which will be forced from the vents during the purging either by displacement or by dilution. By plotting the compositions of the vented gases as actually determined through tests on this diagram, it is possible to judge to what extent mixing is occurring and how the replacement is proceeding. The operator can identify the causes and the corrections of undesirable conditions may be obtained from such a comparison of the actual changes in composition of the vented mixture, with changes that could be expected on the basis of theory or past experience. Figure 2-6 represents a generic chart of this type for a facility that is being purged out of service.

The accumulated volumes of inert gas introduced into the facility at a particular time is represented by the ordinate of the purging progress chart (Figure 2-6). The ordinate units may be either cubic unit of inert gas per cubic unit to be purged, or cubic unit of inert gas per total units of the space to be purged. The abscissa represents the compositions of the mixture escaping from the vent at the same time. The abscissa units may be the percentage of the inert purge gas in the vented mixture, or more practically they may be the characteristics of composition; i.e., the percent by volume of carbon dioxide or of oxygen in the vented mixture.

The abscissa point C is the inert gas content of the original contents of the container to be purged. Point A represents 100% inert gas in the container. In theoretically perfect purging, effected entirely by displacement, the carbon dioxide content of the vented gases would follow a course C to B to A, suddenly jumping from a minimum to a maximum concentration when the chamber became filled with purge gas. In the absence of any mixing, until the purge gas content had become large enough to completely fill the space, only the original contents of the space would be vented. After that only the inert purge gas would appear. The line CA represents the change in the average percentage of inert gas in the total contents of the container

when purging is effected entirely by displacement.

When purging is entirely by mixing or dilution, the change in the average inert gas content of the mix inside the container follows the line CDF. The location of this line is determined from the theoretical compositions of mixtures of the original contents of the chamber with the proportions of purge gas indicated on the ordinate. When complete dilution is occurring, there could be theoretically little, if any, difference between the mixture of gases within the chamber and the mixture leaving it. The line CDF represents the change in the inert gas content of the gases leaving the vents during a purging proceeding entirely by admixture or dilution.

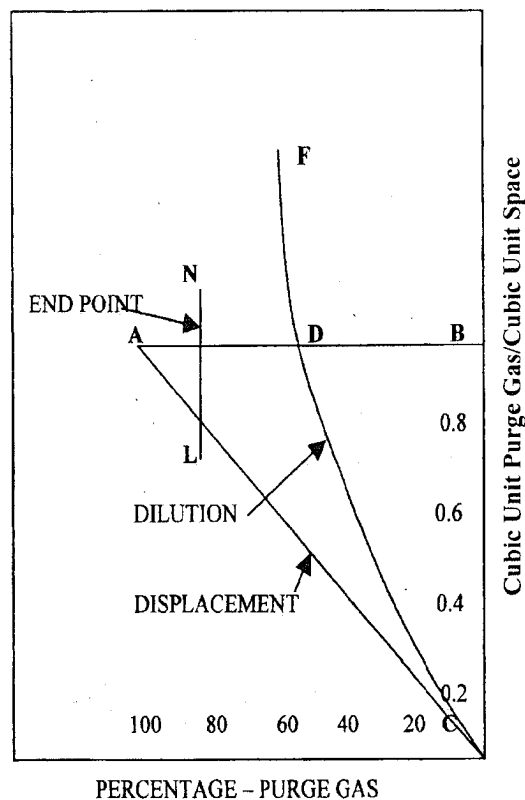

Purging Progress Chart

FIGURE 2-6

The line LN is the end-point of the purging as estimated from a graph similar to Figure 2-2, prepared from the flammable limit data for mixtures that cannot be made flammable by either adding air or natural gas. The construction and interpretation process has previously been explained in this chapter. The line LN is the concentration of inert gas in the vented purge gas indicating that the concentration of combustible gas remaining in the container is too low for subsequent admission of air to produce a flammable mixture.

It is impossible to attain 100 percent displacement in a purging operation in which an inert gas is employed. Instead of a series of points along C to B to A for displacement or along C to D to F for dilution, actual test results of purging operations yield a series of points, as shown in Figure 2-7.

Actual results have shown that the inert gas vented during the purges were generally located between the lines WX and YZ in Figure 2-7. It can be postulated that, in purging combustible gas from a large vessel or chamber, the optimum operation will be indicated by the inert gas content of the vented gas approaching the lower part of the YZ curve and the upper part of the WX curve.

If the concentration of inert gas in the vented mixtures fall to the left of or below the line CA, it is an indication that the purge gas is passing through the chamber directly from the inlet to the outlet vent. In such a case, purging action by displacement or by dilution is minimal. This might be corrected by using a vent in a different location or by decreasing the velocity of the inert gas at the inlet by lowering the input rate or increasing the area of the inlet opening.

If the inert gas concentration lies in the area between AC and WX, the purge gas is mixing with the original contents of the container instead of tending to stratify at the bottom of the chamber. This may be due to one or more of a number of causes:

- (1) Too long a time of contact which fosters diffusion caused by too low an input rate;
- (2) Too high a temperature for the inert gas (over 150°F), which may result in setting up convection currents within the chamber being purged;
- (3) Too high a velocity of the entering inert gas as compared to the velocity of the escaping purge gas, thereby resulting in a mechanical stirring action;
- (4) Irregular or pulsating flow of gases at the inlet causing eddy currents and churning.

If the inert gas concentration falls to the right of BDF, it indicates that:

- (1) Live gas or air is leaking into the chamber;
- (2) Appreciable amounts of inert gas were lost in the early parts of the operation by arcing across the vessel or by leaking from inlet connections;
- (3) A serious contraction of the contents of the container has occurred, possibly due to cooling.

A purging progress chart for a purging operation in which air is to be replaced by inert gas is shown by Figure 2-8. It is similar to that used for the gas to inert purging as given by Figure 2-7 except for one slight difference. The purging of air from a vessel is measured by the decrease in oxygen content from 21.0 percent downward. It is therefore more desirable and instructive to use the oxygen content of the vented gases for the abscissa values in air purging program charts rather than the inert gas as in the case of Figure 2-7.

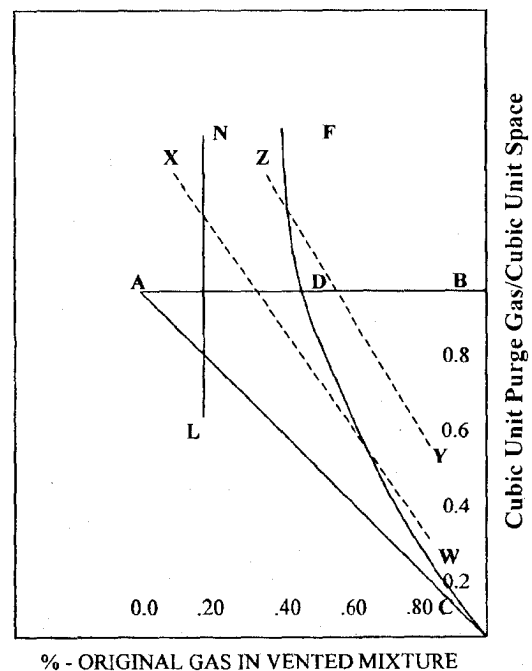

Purging Progress Chart
Combustible Gas Is Replaced By Inert Gas

FIGURE 2-7

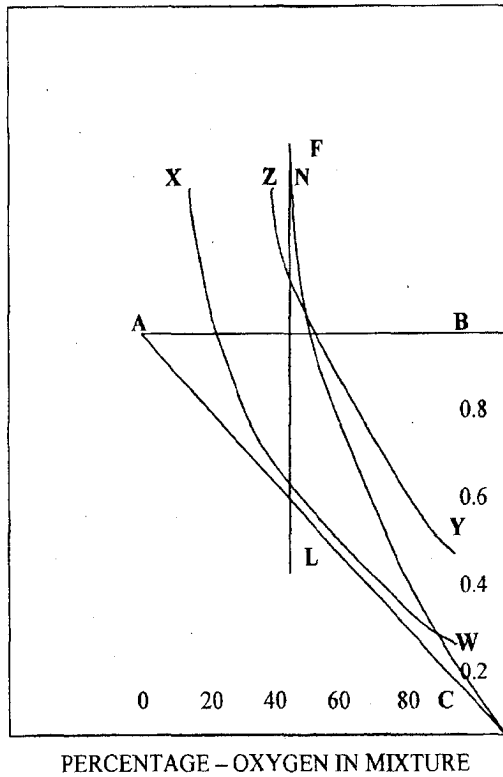

Purging Progress Chart
Air Is Replaced By Combustible Gas

FIGURE 2-8

Stratification is not very pronounced in air purging. There is generally little difference in the densities of the inert gases as compared to air, so that larger proportion of an air purging consists of dilution. This is indicated by a relatively rapid drop in the oxygen content of the vented gases right at the start of the purge, with the change in oxygen content subsequently tending to run parallel to the dilution effect line CDF. The lines WX and YZ in Figure 2-8 indicate the normal variation in the change of oxygen content of the vented gases during representative purging samples of air from the vessel.

The various diagnoses for the relationships between oxygen content and inert input volume which yielded points outside WX and YZ on the air purging chart are comparable to those offered for the gas purging chart. An ideal purge would be one in which the change in oxygen content of the vented gas followed the course C to B to A. Points above the line AC indicate arcing across and points below DF may indicate leakage in of air or leakage out of inert purge gas.

It is of interest to note that the end-point line LN in Figure 2-8 for the air purging tends to be closer to the center of the chart than in the case of the end-point line LN in Figure 2-7 for the combustible gas purging. However, the volumes of inert gases required to purge the container in the two cases were relatively close. The reason for this is generally a function of the densities of the various gases involved.

REFERENCES

Natural Fire Protection Association,
NFPA69, "Standard on Explosion Prevention
Systems", 1997 Edition.

CHAPTER 3

GAS DETECTION AND INSTRUMENTATION

SECTION	PAGE #
3.1 Introduction	36
3.2 Sampling	36
3.3 Gas Detection and Monitoring Instruments	38
3.4 Specific Gravity Determination	42
3.5 Use of Instruments for Verifying Purging and End-Points	42
3.6 Moisture Measurement	43
3.7 Flow Meters	43
3.8 Testing of Gases Hazardous to Health	43
3.9 Detection and Measurement of Hazardous Gases	46
FIGURES	
3-1 Mobile Gas Analysis Equipment- Photo	37
3-2 Multi-Gas Monitor- Photo	38
3-3 Gas-Trac Gas Detector- Photo	39
3-4 Flame Ionization Gas Leak Detector- Photo	40
3-5 Gas Instrument Docking Station- Photo	41
3-6 Gas-Sentry Oxygen Monitor- Photo	42
3-7 Physiological Effects of CO ₂	45
3-8 Typical Range of Monitor Set Points and Alarms	46

CHAPTER 3 GAS DETECTION AND INSTRUMENTATION

3.1 INTRODUCTION

The usefulness of gas detection instruments has been well established in the gas industry. They are ordinarily used to perform two types of service. The first is to perform routine tests for locating leaks and test atmospheres in manholes, valve pits and similar locations for combustible mixtures. The second is testing of mixtures that are incidental in the proper control of purging operations. It is with particular reference to the latter use that this chapter is written.

Quantitative and qualitative testing is necessary to maintain and ensure control during purging operation and determine the completeness of the purge.

In the natural gas industry, there are generally three types of gases involved in the purging operation:

- (1) Natural gas – either to be purged into or out of service;
- (2) Inert gas – used for the purge, either totally or as a slug;
- (3) Air – which in combination with natural gas may produce a mixture within the flammable limits.

The emphasis of this manual is on purging natural gas. However, when the combustible gas

is other than natural gas, detecting and monitoring products or instruments may be used to sample, monitor and detect many of the gases involved in the purging operation.

For the purpose of this manual, gas detecting or monitoring instruments will be defined as the following:

- (1) Gas detector – an instrument or device which detects the presence of the gas and indicates or quantifies the amount of gas in the mixture;
- (2) Gas indicator – an instrument or device which detects the presence of the gas but does not indicate or quantify the amount of gas in the mixture;
- (3) Gas monitor – an instrument or device that continuously detects and quantifies the amount of gas in the mixture.

Equipment for the measurement of the physical properties (specific gravity, dew point) of the gases may be desirable or necessary to provide additional information, to identify certain gases or rapidly indicate changes in the gas composition.

3.2 SAMPLING

Sampling is one of the procedures for obtaining a representative portion of the gases to be analyzed. The size of the sample and the frequency of collection are determined by the purging operation needs and subsequent sample analytical procedures.

Analytical test results, which may be useful as an operating guide during the purging procedures, must be made available to the operating personnel in a timely fashion. The sampling and testing procedure that should be used is one which will permit the utilization of the test results in the shortest practical time.

The purpose and scope of the sampling should be specific. Most methods for the testing and analysis of gas samples have been developed to a high degree of accuracy. The results obtained, however, are no better than the sample taken. Analytical results may be misleading if

the tests are made on poor samples. Sampling points should therefore be chosen with care.

Samples taken must be representative of the mixture being tested to be fully satisfactory. Precautions should be observed to ensure that the samples are neither contaminated nor altered in any way that might affect the integrity of the sample. Such factors as sample tubes, pumps, lubricants, internal leakage, dead spaces, etc. should be considered.

Sample containers should be of such types as will protect the sample from deterioration and contamination. Consideration should be given to adequately marking and recording of samples with provisions for noting all of the necessary information which should be furnished with the sample. This includes information such as date, time, name of sample, sampling point, gas sampled, reference number, etc. Portable

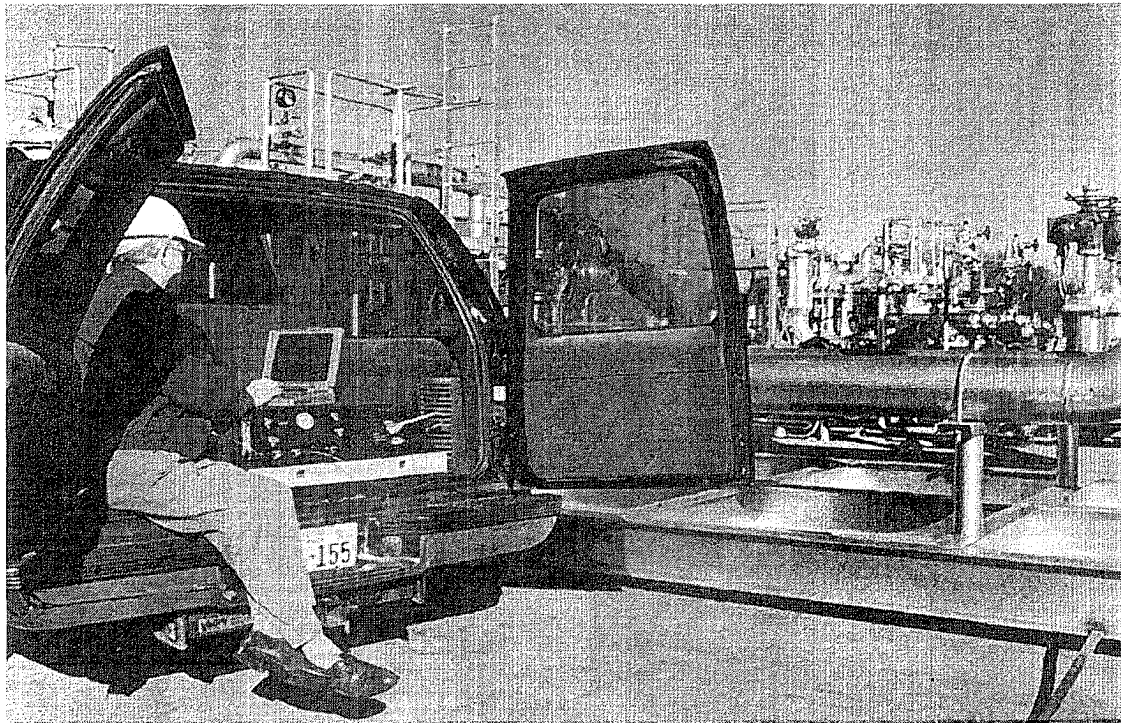

FIGURE 3-1
DANIELS INDUSTRIES
MOBILE GAS ANALYSIS EQUIPMENT – MODEL 575 TRANSPORTABLE/LAB GC

electronic gas monitoring instruments allows the operator to have accurate and timely information at the job site. See Figure 3-1.

However, if samples are to be transported any distance, special precautions may be necessary to ensure that the sample will arrive intact and uncontaminated.

A few general guidelines should be considered for the sampling procedure required during purging operation. A sufficient number of sampling points should be established to furnish the necessary information with respect to a purging control. No additional safety or efficiency may be necessarily achieved by requiring an excessive number of sampling points. It may be apparent during the purging operation that additional points may be required, or that the information secured at one or more of the original points is not meaningful. Proper advance planning should reduce the likelihood of having to change sampling locations during the purge and thereby reduce the possibility of erroneous or unnecessary information. Sample connections should be of the correct size. They

should be constructed of materials that will not allow adulteration or contamination of the sample. In general, the connections should be as short as practicable. Sampling connections must be tight to prevent contamination of the sample.

An adequate sample may be obtained from simple sample connections in places where the gas is well mixed, as in purge vents or small pipelines. Sampling connections that extend only to the inside of the wall or shell of large containers or gas mains are not generally satisfactory. The connection in large containers such as tanks and holders should extend inside far enough to prevent possible surface condensate from entering the sample tube. In large pipelines, the sampling tube should extend into the pipe a distance equal to $\frac{1}{2}$ the diameter of the pipe.

Sampling probes composed of the softer non-sparking metals such as copper or aluminum are recommended. Due consideration should be given to ensure that such metal sampling probes will not come into contact with electrical connections of any sort. Glass or plastic sampling probes also may be employed.

3.3 GAS DETECTION AND MONITORING INSTRUMENTS

3.3(a) GENERAL

Site-specific detailed gas analysis of natural gas is generally not required for purging since the constituents of natural gas are usually known prior to the purging operation. In cases where more complex mixtures are encountered, the use of gas detection and monitoring instruments may provide the necessary information.

Where gas detection, monitoring, or measurement is required, excellent gas instruments are available. Recent technological and electronic advances in these instruments have significantly improved the ease of operation, portability and dependability of these units. Instruments and monitors are available that are capable of detecting and monitoring oxygen, combustible gases and many toxic gases. These instruments are designed to detect, qualify and quantify accurately many of the gases that may be encountered.

Improvements have also been made in reliability, sensitivity, ease of calibration, functionality, calibration and storage of information in many purging operations. These instruments may be equipped with internal

sampling pumps that can draw samples from remote locations up to 100 feet. In many purging operations, a properly chosen multi-tester may be an inexpensive and reasonable alternative to instruments with more limited applications. See Figure 3-2.

Probably the first necessity for gas detection instruments arose as a result of the mining of coal. As early as 1700, coal mine atmospheres were tested by lowering a dog down the shaft in a basket. Small animals and birds have continued to be used until relatively recently, chiefly for detecting leaks, dangerous atmospheres containing toxic gases, or an oxygen deficiency.

Candles and open flame lamps originally used to provide underground lighting served also as the first crude and unsafe devices for the detection of combustible gas and/or oxygen deficient atmospheres. The first safety lamp was invented about 1813. Since that date, there have been significant improvements made in not only the detection of combustible gas, but also virtually all gases that are routinely encountered during the purging operation.



FIGURE 3-2
INDUSTRIAL SCIENTIFIC CORPORATION
MULTI-GAS MONITOR – MODEL AXD 620

3.3(b) TECHNOLOGICAL IMPROVEMENTS

Recent technological improvements are now available that provide the operator with a wide range of products and instruments that, when used in the proper application, enhance the safety and effectiveness of the purging operation. Each of these technologies has their own advantages and limitations and it is incumbent on the operator to ensure the correct instrument is being applied.

The most common technologies for detecting combustible gases during the purging operation are:

- (1) Thermal conductivity;
- (2) Catalytic bead;
- (3) Infrared;
- (4) Flame ionization.

These technologies may be found in single gas combustible gas indicators or multi-gas, oxygen and combustible gas instruments.

Some of the features, advantages and limitations of each of these technologies is summarized below. The operator is advised to work with the supplier or manufacturer's representative to ensure that the proper instrument is being used at the purging operation.

Thermal conductive sensors:

- Traditional "hot wire" gas sensor;
- Response based on difference of thermal conductivity of target gas in air;
- Capable of detecting gas to 100% of volume;

- Will respond to any gas with conductivity different than air;
- Not accurate in reduced oxygen concentrations.

Catalytic bead sensors:

- Most common technology used for detecting combustible gases in portable instruments;
- Responds to any vapor which can be burned;
- Detects combustible from 0-100% Lower Explosive Limit (LEL)
- Damaged by gas concentrations in excess of 100% LEL;
- Not capable of detecting gas in oxygen-free environment.

Infrared gas sensors:

- Emerging technology for detecting combustible gases;
- Will detect combustible from 1% LEL to 100% of volume;
- Can be very gas specific;
- Will detect gas accurately in inert atmospheres;
- Cannot detect hydrogen.

Flame ionization:

- Capable of detecting combustible hydrocarbons in parts-per-million (PPM) range;
- Available for use on vehicles for mobile detection;
- Detects all combustible hydrocarbons and does not distinguish natural gas
- Equipped with flame suppressors.

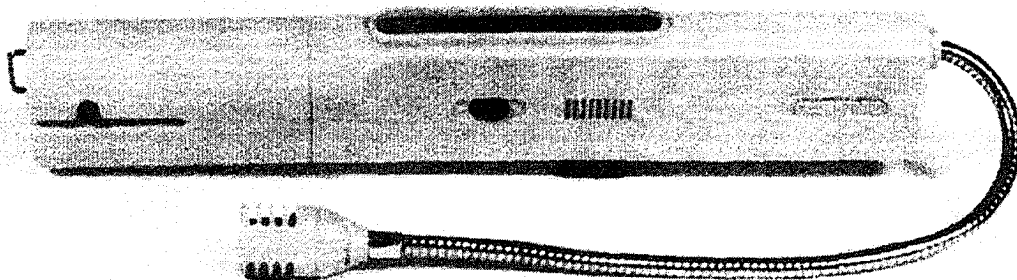

FIGURE 3-3
J AND N ENTERPRISES, INCORPORATED
GAS-TRAC GAS DETECTOR

3.3(c) COMBUSTIBLE GAS DETECTORS

The combustible gas indicator was probably the most widely used instrument for purging to detect and measure gas concentrations up to the lower explosive limit (LEL). As described above, there have been a significant number of technological improvements made in combustible gas indicators (Figures 3-3 and 3-4). These instruments are generally 100% solid state, require little maintenance and tend to be very durable. The detection of the combustible gas may use several different types of technology including electrical resistance, flame ionization, infrared and catalytic diffusion. Many are microprocessor control, have digital displays and

are easy to calibrate. Self-diagnostic features and automatic zeroing are generally included. Many of these instruments use internal sampling pumps and therefore are intrinsically safe. Hydrocarbon detection in the parts-per-million (PPM) range is commonplace.

Automatic docking stations (Figure 3-5) can provide automatic calibration, instrument diagnostics and automatic battery charging. In addition, docking stations can be an automated instrument management system that downloads and stores information and maintains database information for up to five instruments. Summaries of individual instrument data trends are viewable in easy-to-read graphs and data-logging history.

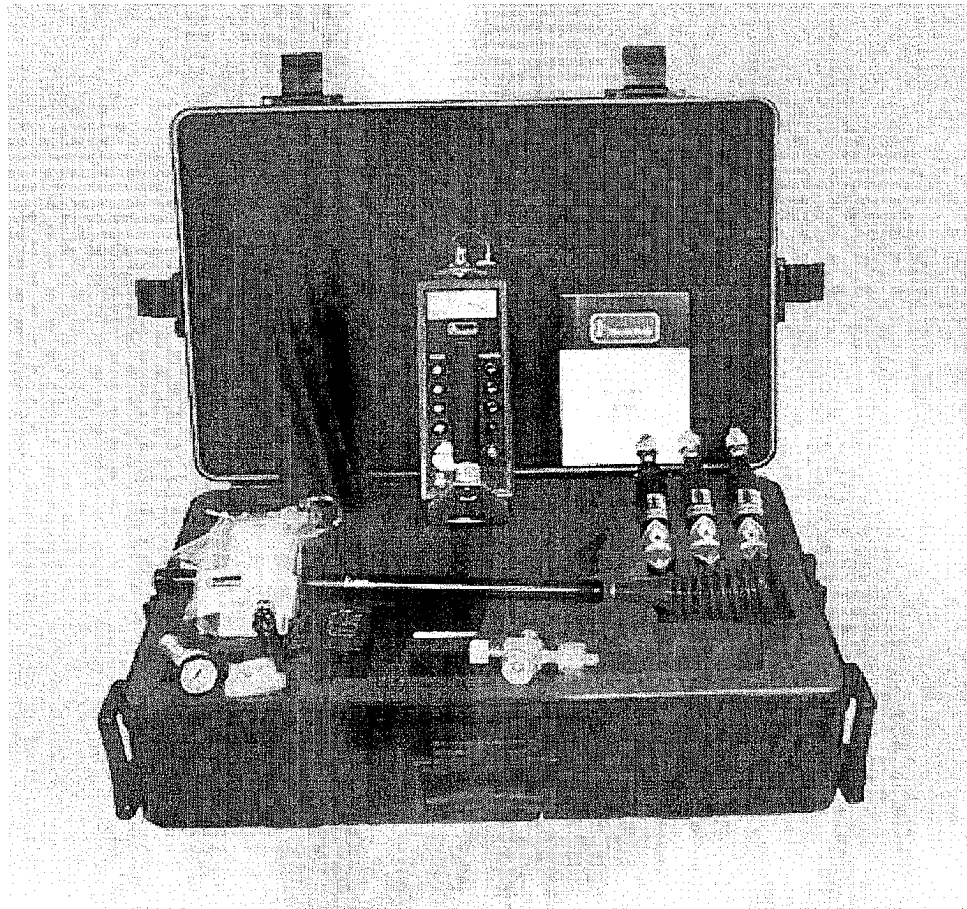

FIGURE 3-4
HEATH CONSULTANTS INC.
FLAME IONIZATION GAS
LEAK DETECTOR

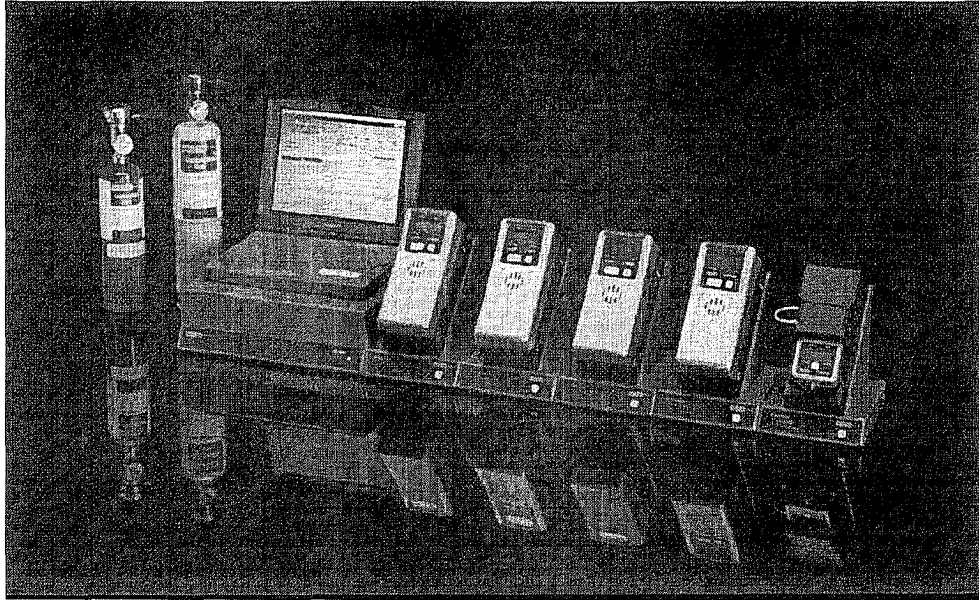

FIGURE 3-5
INDUSTRIAL SCIENTIFIC CORPORATION
GAS INSTRUMENT DOCKETING STATION

3.3(d) OXYGEN MONITORS

Oxygen is one of the three constituents most significant in purging control, the other two being inert and combustible gas. Gas mixtures, which contain limiting fractions of oxygen, become nonflammable and safe with respect to explosion hazards as long as no increase in the oxygen is allowed. The determination of the oxygen content of inert gases and purge gases is, therefore, a very important part of purging control.

Electronic monitors are available that will detect oxygen in concentrations from zero to 30% of volume in 0.1% increments. The oxygen monitor uses an electrochemical sensor. Many of the oxygen monitors are also multi-gas monitors and detectors. These devices have many of the advantages listed in the previous section regarding combustible indicators. See Figure 3-6.

3.3(e) COMBINATION MONITORS

Multiple gas monitors and detectors are

available that are designed to be a complete monitoring instrument for multiple applications. See Figure 3-2. These instruments include infrared sensors, an oxygen sensor, a catalytic PPM hydrocarbon sensor and electrochemical toxic gas sensors. These devices have many of the advantages listed in the previous section regarding combustible gas indicators.

The gases that may be detected or monitored with a multiple gas monitor include the following gases:

- Ammonia
- Carbon dioxide
- Carbon monoxide
- Chlorine
- Chlorine dioxide
- Hydrogen chloride
- Hydrogen cyanide
- Hydrogen sulfide
- Methane
- Nitric oxide
- Oxygen
- Sulfur dioxide

FIGURE 3-6
BASCOM-TURNER
GAS-SENTRY OXYGEN MONITOR

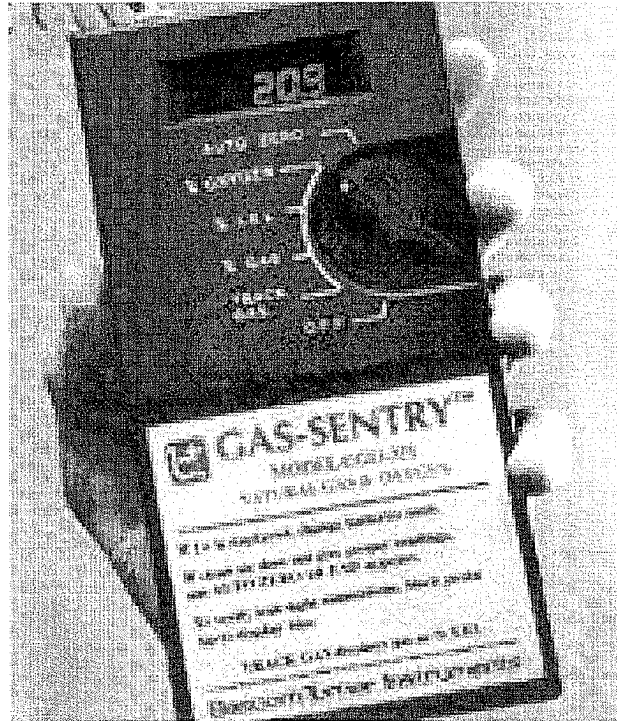

3.4 SPECIFIC GRAVITY DETERMINATION

The specific gravity or density of natural gas tends to be relatively constant. For other combustible gas mixtures and purging mediums, there may be a significant difference. The property may then be utilized as part of the purging control. There have recently been a significant number of technological

improvements made in instruments that measure specific gravity. These instruments are easy to use, portable, require little maintenance and tend to be very durable. Many are microprocessor controlled, have digital displays and are easy to calibrate.

3.5 USE OF INSTRUMENTS FOR VERIFYING PURGING AND END-POINTS

In Chapter 2, an extensive discussion on calculating or estimating purging end-points was presented. In actual field conditions, it is important to have the ability to accurately measure the gas mixtures at predetermined locations during the purging operation.

The advance in technology for instruments that monitor or detect has greatly enhanced the

ability to verify purging end-points. As pointed out earlier in this section, instruments that are inexpensive, durable and reliable are available for most gas mixtures that may be encountered in the field. These easy to use, multi-function instruments can provide valuable information to ensure a safe and successful purging operation.

3.6 MOISTURE MEASUREMENT

The measurement and monitoring of moisture in gases is a necessary part of purging LNG tanks or other vessels into and out of service, where moisture cannot be tolerated.

The water content of a gaseous system may be described in several ways, although each is easily converted to the other. Dew point, relative humidity, pounds of water per million cubic feet of gas, all expressed at specific temperatures and pressures, are the common terms to describe water content.

Water dew point temperature of a gas is the temperature at which the gas is saturated with water vapor at the existing pressure.

Relative humidity is the amount of water vapor in a unit volume of gas compared to the total amount that could be contained in the same volume under the same conditions of pressure and temperature.

There are a number of reliable state-of-the-art instruments available to measure the water content of various gases. These instruments are reliable, inexpensive, durable and easy to use.

3.7 FLOW METERS

There are several types of flow meters available depending on the operator's requirements. For air or gas flows normally not exceeding 0-2000 SCFH and 100 psig. maximum operating pressure, the variable area flow meter was commonly used. This is basically a vertical, transparent, internally tapered tube with the larger taper diameter at the top. The tube is calibrated with a certain unit scale and contains a float that is slightly smaller in diameter than the small end of the tube. As a gas is introduced through the bottom of the tube, the float will move upward to be supported at a point where the annular space between it and the tube is just large enough to pass the medium flowing through the system.

Depending on the scale calibration, weight of the float and the medium being measured, a direct reading of flow can be obtained. The scale units can be related to a prepared calibration curve to determine actual flow. For high capacity flows upwards of 2000 SCFH and

operating pressures which may exceed 1000 psig., a turbine type meter will better meet the requirements.

One type of turbine meter operates on an electronic impulse provided by a vaned rotor mounted in the gas stream. As the rotor revolves, the pulses can be relayed to a gas meter compensator that provides visual reading of flow rate and totalized flow. This instrument can compensate for static line pressure, temperature, density and specific gravity to convert the measurements to engineering units at standard conditions. It is obvious that this type of flow measurement system is far more sophisticated than the variable area flow meter.

Positive displacement rotary meters also are available in a wide range of capacities but unless they are used with other instrumentation, only a total volumetric flow can be obtained. These meters are designed for operating pressures of $\frac{1}{4}$ psig. to a maximum of 125 psig.

3.8 TESTING OF GASES HAZARDOUS TO HEALTH

3.8(a) GENERAL

Natural gas is neither toxic nor poisonous. However, purging other gases that may be either toxic or poisonous into or out of service may present physiological hazard. Severe injury or death may result from a toxic reaction, poisoning

or oxygen starvation. Precautions must be taken to prevent such mishaps. Since one of the objects of purging is the removal of equipment from service for repair work, reliable tests must be available for the examination of the contents of the purged container. Care must be taken to ensure that the atmospheres are safe and will

remain safe for entry by the workers charged with the task of completing proposed repair work.

3.8(b) INERT PURGE GASES

Inert gases commonly available for purging are composed primarily of carbon dioxide or nitrogen. Since neither of these gases will support life, inhalation of abnormal concentrations should be avoided, as the oxygen may thereby be reduced sufficiently to cause oxygen starvation or smothering. For the same reason, personnel should not enter trenches, valve pits, manholes and the like into which inert gas is being vented.

This is also one reason for the specification of adequate vents in purging operations, particularly for those that must be carried out inside buildings or other enclosed areas. It is necessary in such cases to install vent lines that carry well outside of the buildings and away from windows and doors. Combustion products that are intended as an inert purge gas may contain carbon monoxide in sufficient quantities to have toxic effects.

3.8(c) MAXIMUM ALLOWABLE CONCENTRATION OF TOXIC GASES AND VAPORS FOR PROLONGED EXPOSURES

It is beyond the scope of this manual to include the physiological reactions and different methods of detection of all of the various gases and vapors which might be encountered in connection with a purging operation.

This discussion will be confined to some of those gases most commonly found in the purging of containers or pipelines in the natural gas industry. If the proposed purging should involve other types of gases or vapors, due consideration should be given to the possible physiological hazards and special methods detailed for the detection of the harmful constituents.

Appropriate health and safety regulations should be referenced to determine the maximum allowable concentrations of toxic gases to determine safe exposure levels.

3.8(d) OXYGEN DEFICIENT ATMOSPHERES

Exposure to oxygen deficient atmospheres is an ever-present hazard in purging operations. It

may be encountered in numerous situations such as in tanks, vaults, pits, tunnels, large diameter pipes, or in any poorly ventilated area where the air may be diluted or displaced by gases or vapors of volatile materials. In addition, care must be taken where oxygen may be consumed by chemical or biological reaction processes.

Normally, air contains about 21 percent oxygen at sea level. The first physiologic signs of a deficiency of oxygen (anoxemia) are increased rate and depth of breathing. Oxygen concentrations of less than 16 percent by volume cause dizziness, rapid heartbeat and headache.

Workers should not enter or remain in areas where tests have indicated less than 19 ½ percent oxygen unless wearing some form of supplied-air or self-contained respiratory equipment.

Oxygen deficient atmospheres may cause inability to move and semiconscious lack of concern about the imminence of death. In cases of sudden entry into areas containing little or no oxygen, the individual usually has no warning symptoms but immediately loses consciousness and has no recollection of the incident if they are rescued and revived.

The fire hazard of oxygen deficient atmospheres is below normal. When the oxygen content of the atmosphere is below 16 percent; many common materials will not burn.

Portable instruments (see Figure 3-6) are available for measurement of oxygen deficient atmospheres for worker safety and for measuring the state of completion when gas pipes or containers are being purged of air. Many of these instruments continuously monitor the air for oxygen with both visual and audible alarms.

The Occupational Safety and Health Administration (OSHA) has specific provisions and regulations when an oxygen deficient atmosphere may be encountered. It is beyond the scope of this manual to describe the OSHA requirements. The operator must review the OSHA requirements and ensure complete compliance with all provisions of OSHA and all other applicable rules and regulations.

3.8(e) CARBON DIOXIDE

Carbon dioxide is an odorless gas and is non-toxic in small quantities. Normally, pure air contains approximately 0.05 percent carbon dioxide. CO₂ vitiation of the air due to human occupancy is generally of no physiological concern because the changes are too small to produce appreciable effects.

The specific effect of carbon dioxide on human beings is to increase lung ventilation, but exposures to less than 3.0 percent are not considered serious.

Appreciable quantities of CO₂ which might result in physiological hazard to human life, may be determined with the instrumentation that use infrared continuous auto-ranging detection described earlier in this chapter. The physiological effects of CO₂ are shown in Figure 3-7.

The unexplained presence of appreciable quantities of CO₂ should be considered as a warning of a hazardous atmosphere, not only because of the CO₂, but because CO₂ may be associated with other and usually more significant amounts of undesirable gases.

PPM	EFFECTS
30,000	Weakly narcotic, decreasing activity of hearing and increasing blood pressure
50,000	30-minute exposure may be intoxicating
70,000-100,000	May produce unconsciousness in a few minutes

FIGURE 3-7
PHYSIOLOGICAL EFFECTS OF CO₂

3.8(f) CARBON MONOXIDE

Carbon monoxide is a colorless, odorless gas which should not be inhaled by human beings in concentration above 50 parts-per-million (PPM) or 0.005 percent. Poisoning is entirely by inhalation of the gas and an individual who is comparatively quiet may display few symptoms.

The most common symptoms of complete asphyxia are pounding of the heart, dull headache, flashes before the eyes, dizziness, ringing in the ears, nausea and sometimes (but not often) convulsions.

As described earlier in this chapter, portable, electronic, continuous monitoring, CO monitors are available for extended sampling periods. This instrument continuously monitors for CO using electrochemical sensors.

3.8(g) HYDROGEN SULFIDE

Hydrogen sulfide is a colorless, highly toxic gas, rapidly causing death when inhaled in relatively low concentrations. The notoriously bad "rotten egg" odor of hydrogen sulfide cannot be taken as a warning sign because sensitivity to this odor disappears rapidly with the breathing of a small quantity of the gas.

The threshold limit value for prolonged exposure is 10 PPM. As little as 100 PPM may cause coughing, irritation of eyes, loss of sense of smell, sleepiness, throat irritation, etc., within minutes and the very real possibility of death in a few hours with a concentration of 250 PPM. Death may occur in a very few minutes with a concentration as low as 600 PPM.

Because of the toxicity of hydrogen sulfide, it is most important to be able to detect small concentrations quickly. Portable, electronic, continuous monitoring, hydrogen sulfide indicators are available for extended sampling periods. Instruments use electrochemical sensors to continuously monitor for hydrogen sulfide.

3.8(h) AMMONIA GAS

Ammonia gas is a strong irritant and can produce sudden death from bronchial spasm. Concentrations small enough not to be severely irritating are rapidly absorbed through the respiratory tract and metabolized so that they cease to act as ammonia.

The threshold limit value for ammonia is 50 PPM for an 8-hour workday. Gas masks are useful for concentrations up to about 3 percent above which severe skin irritation will prevent a prolonged stay in the area.

Ammonia can also be monitored with portable, electronic, continuous monitoring, ammonia detectors for extended sampling periods. This instrument continuously monitors for ammonia using electrochemical sensors.

3.8(i) METHANOL

Methanol (methyl alcohol) is a colorless liquid with a rather pleasant odor. The threshold limit value for prolonged exposure is 200 PPM. The alcohols are noted for their effect on the central nervous system and the liver but vary widely in their range of toxicity.

Methanol poisoning usually is produced by inhaling high concentrations of vapor in an enclosed place such as a tank. The signs of poisoning include headache, nausea, vomiting,

violent abdominal pains, aimless and erratic movements, dilated pupils, sometime delirium and such eye symptoms as pain, and tenderness on pressure. Peculiarities of methanol poisoning include its exceptionally severe action on the optic nerve.

3.8(j) NATURAL GAS, LNG, SNG, LPG

Natural gas, LNG, SNG and LPG gases, which are free of toxic substances such as

hydrogen sulfide and carbon monoxide, are not toxic to human beings. High concentrations of natural gas may cause asphyxiation because of the displacement of oxygen. See Section 3.8(d).

Combustible gas detectors and monitors are usually used for the detection of hydrocarbon gases. See Section 3.3 for a detailed discussion of combustible gas indicators.

3.9 DETECTION AND MEASUREMENT OF HAZARDOUS GASES

Single or multi-gas instruments are available for the detection and measurement of toxic gases which may be found in tanks, vessels, mains, or vaults to be purged. These devices are state of the art instruments that use electrochemical

sensors to continuously monitor all of the gases listed above. See Figure 3-8 for the typical range of monitor set points and alarms for some of the gases discussed in the previous section.

SINGLE GAS MONITORS						
	CL266	CO262	HS267	NO268	OX231	SO261
Gas Monitored	Chlorine	Carbon Monoxide	Hydrogen Sulfide	Nitrogen Dioxide	Oxygen	Sulfur Dioxide
Range of Monitor	0 to 199.9 ppm	0 to 1999 ppm	0 to 1999 ppm	0 to 1999 ppm	0 to 30.0% of volume	0 to 1999 ppm
Readout Increments	0.1 ppm	1 ppm	1 ppm	0.1 ppm	0.1%	0.1 ppm
Alarm Set Point (Factory)	0.5 ppm	35 ppm	10 ppm	3 ppm	19.5% of volume	2 ppm
Alarm Set Point Range	0.1 to 25 ppm	1 to 300 ppm	1 to 25 ppm	0.1 to 25 ppm	17.0%-19.5% of volume	0.1 to 15 ppm

FIGURE 3-8
COURTESY - INDUSTRIAL SCIENTIFIC CORPORATION
TYPICAL RANGE OF MONITOR SET POINTS AND ALARMS

REFERENCES

- Daniel Industries, Inc., Houston, TX
- Industrial Scientific Corporation, Oakdale, PA
- J and N Enterprises, Wheeler, IN
- Heath Consultants Ins., Houston, TX
- Bascom-Turner Instrument, Inc., Norwood, MA

CHAPTER 4
INERT PURGE MEDIA

SECTION	PAGE #
4.1 Introduction	48
4.2 General	48
4.3 Commercial Nitrogen and Carbon Dioxide	49
4.4 Inert Gas Generators	56
4.5 Diesel Exhaust Engines	57
4.6 Steam	58
4.7 Water	60
FIGURES	
4-1 CO ₂ Cylinder with Syphon Tube attachment	52
4-2 Standard CO ₂ Cylinder in Horizontal Position	52

CHAPTER 4 INERT PURGE MEDIA

4.1 INTRODUCTION

Inert purging is the process of replacing the atmosphere within a container by an inert substance in a manner as to prevent the formation of an explosive mixture. The success of an inert purging operation depends upon the inert gas or liquid selected; therefore, the inert substance must meet specific requirements. Generally, the inert substance should be non-combustible, unable to support combustion, contain less than 2 percent oxygen and contain combustible constituents that are less than 50

percent of the lower explosive limit of the gas to be purged.

Although most natural gas distribution operators prefer nitrogen this chapter will discuss various inert substances that are commonly available for purging in the natural gas industry. The inert gases and water that will be discussed have proven to be satisfactory when used for the appropriate circumstances considering their respective properties and characteristics.

4.2 GENERAL

4.2(a) TYPES OF INERT PURGING MEDIA

Although commercially prepared nitrogen is the most common inert gas used in the natural gas industry the following types of inert purging media are also used:

- (1) Commercially prepared carbon dioxide;
- (2) Products of combustion from inert gas generators;
- (3) Exhaust gas from internal combustion engines;
- (4) Steam;
- (5) Water, as purging medium should be considered in specialized situations.

The selection of the proper, or best, inert medium to use in a particular circumstance depends upon many factors, including its availability, comparative advantages, disadvantages and economics. The operator should evaluate the relative merits of the various purge media when making a decision.

4.2(b) CALCULATING VOLUMES OF CONTAINERS

The volume to be purged should be calculated in order that the correct quantity of inert gas or water can be estimated. This will ensure that sufficient quantity of the inert gas is available for the purging operation.

Gas plants, holders, or other equipment may include squares, rectangles, cylinders, spheres or

combinations of each. The volumes can be determined by applying the appropriate formulas for these shapes. The formulas for these vessels or other unusual or unique containers may be located in appropriate reference manuals or engineering handbooks.

4.2(c) CHANGE IN GAS VOLUME DUE TO A CHANGE IN TEMPERATURE

When a gas at one temperature is changed to another temperature by any means, it changes volume if the pressure remains constant. This change in volume is directly proportional to the change in its absolute temperature which is 460°F (or 273°C) greater than that indicated by the thermometer. That is, if V_1 = the original volume at temperature t_1 and V_2 = the new volume at temperature t_2 , the relationship is expressed by the following:

(a) for Fahrenheit temperatures (6)

$$\frac{V_2}{V_1} = \frac{(t_2 + 460^\circ)}{(t_1 + 460^\circ)}$$

Or

$$V_2 = \frac{V_1 (t_2 + 460^\circ)}{(t_1 + 460^\circ)} \quad (7)$$

(b) for Celsius temperatures (8)

$$\frac{V_2}{V_1} = \frac{(t_2 + 273^\circ)}{(t_1 + 273^\circ)}$$

Or

$$V_2 = \frac{V_1 (t_2 + 273^\circ)}{(t_1 + 273^\circ)} \quad (9)$$

That is, then, as the temperature rises, the volume increases; or, as the temperature decreases, the volume decreases.

4.2(d) CHANGE IN GAS VOLUME DUE TO A CHANGE IN PRESSURE

When a gas at one pressure is changed to another pressure, the volume changes in value opposite to the change in pressure. In other words, as the pressure increases, the volume decreases and vice-versa.

This change is proportional to the change in the absolute pressure that may be measured in a number of different units, however, the common units are pounds per square inch or inches of mercury. The absolute pressure is equal to the barometric pressure plus the gage pressure, both in the dimensionally correct units, at the time of the reading.

Therefore, if a gas at Volume V_1 and at gage pressure of p_1 is changed to Volume V_2 at gage

pressure p_2 , with a barometer reading of B , the relationship is expressed by the following:

$$\frac{V_2}{V_1} = \frac{(P_1 + B_1)}{(P_2 + B_2)} \quad (10)$$

Or

$$V_2 = \frac{V_1 (P_1 + B_1)}{(P_2 + B_2)} \quad (11)$$

4.2(e) CHANGE IN GAS VOLUME DUE TO A CHANGE IN BOTH TEMPERATURE AND PRESSURE

In practice, problems arise where both temperature and pressure vary. In this case, the separate formulas for temperature and pressure are combined as follows:

(a) for Fahrenheit units: (12)

$$\frac{V_2}{V_1} = \frac{P_1 + B_1}{P_2 + B_2} \times \frac{t_2 + 460^\circ}{t_1 + 460^\circ}$$

(b) for Celsius units: (13)

$$\frac{V_2}{V_1} = \frac{P_1 + B_1}{P_2 + B_2} \times \frac{t_2 + 273^\circ}{t_1 + 273^\circ}$$

4.3 COMMERCIAL NITROGEN AND CARBON DIOXIDE

4.3(a) ADAPTABILITY

Commercially prepared nitrogen (N_2) and carbon dioxide (CO_2) are satisfactory for purging facilities of practically all descriptions and sizes.

4.3(b) KINDS AVAILABLE

Commercially, nitrogen is supplied as a liquid or gas and carbon dioxide is supplied in the liquid or solid state.

In the liquid state, N_2 and CO_2 are available in tank trucks and in railroad tank cars. CO_2 is furnished in portable cylinders holding about 50

pounds (about 425 cu. ft.) under a pressure of about 850 psig.

In the gaseous state, N_2 is furnished in portable cylinders under high pressure. Generally, the most common size cylinder holds about 16-17 pounds (about 220 cu. ft.), at about 2,200 psig. This varies in many areas of the country and higher-pressure cylinders with greater volume are common.

Since N_2 and CO_2 cylinders may be similar in appearance and size and both are available, it may be advisable to verify the contents of the cylinders using an instrument designed to detect CO_2 . It is not always certain that the color-coding of cylinders can be relied on.

In the solid state, only CO_2 is available, in the form commonly known as "dry-ice".

4.3(c) INSTRUMENTS FOR MEASURING PROGRESS OF PURGE

4.3(c)(1) Pressure Indicating Devices

Installation of a pressure meter, monitor, or chart on the facility to be purged, as close as possible to the CO₂ or N₂ entry point, is necessary to show that the maximum allowable pressure is not being exceeded. The device must be within the view of the person controlling the flow of the inert gas so the operator can shut off the flow instantly if necessary.

4.3(c)(2) Gas Analysis Instruments

A multi-gas monitoring or detecting instrument, calibrated for the gases involved, should be available for analysis of the gases escaping from the purge vent. In addition, the multi-gas instrument will be necessary following the purging operations as a combustible gas indicator, an oxygen indicator and other needs as the purge requires. Various instruments are discussed in detail in Chapter 3.

4.3(d) CHARACTERISTICS OF NITROGEN AND CARBON DIOXIDE

Nitrogen is a gas at atmospheric temperature and pressures having a specific gravity of 0.97 and a specific volume of about 13.50 cu. ft. per pound. Unlike CO₂, N₂ is chemically inert and it will not solidify on rapid expansion.

Nitrogen is maintained as a liquid during delivery in low pressure, well-insulated containers (trucks or tank cars). In transit, the container is vented to the atmosphere. During the purging operation, only a few pounds per square inch are maintained in the N₂ container.

Carbon dioxide is a gas at atmospheric temperatures and pressures, having a specific gravity of 1.53 and a specific volume of 8.54 cu. ft. per pound. The gas is very soluble in water, tends to solidify on too rapid expansion and is chemically active forming carbonates as solid dust particles

Carbon dioxide generally is maintained as a liquid in bulk storage at a temperature of approximately 0°F and a corresponding vapor pressure of approximately 300 psig.

4.3(e) COMPARATIVE ADVANTAGES OF COMMERCIAL N₂ AND CO₂ AS PURGING MEDIA

The general advantages of using commercial N₂ and CO₂ as purging media include:

(1) The quality of the gas is constant, both N₂ and CO₂, being better than 99.7 percent pure. No time is required for adjustment of the quality either prior to or during the purging operations as is required with other sources, such as automotive exhaust, inert producers, etc.

(2) The inert gas is available as soon as connections are complete, by opening the valve on the container. Other sources require quality adjustment such as temperature, control, etc.

(3) Carbon dioxide is readily analyzed by a CO₂ monitor making it simple matter to follow the progress of purging in the field. Nitrogen, however, is one of the most difficult gases to identify and is usually estimated only by indirect methods.

(4) Both commercial CO₂ (specific gravity 1.53) and N₂ (specific gravity 0.97) are nearly pure and their specific gravities remain relatively constant; making them readily detectable by gravimeters in most instances.

(5) CO₂ is ideal for purging low points or low elevations where it can be added slowly in order to displace a lighter gas. The higher specific gravity of this gas may result in stratification, which in most instances of purging would be an advantage.

Its lower specific gravity causes N₂ to tend to diffuse more readily than CO₂ in air or lighter gases. This, generally, will cause more N₂ than CO₂ to be required. Conversely, the lower specific gravity of nitrogen makes it useful for purging LPG where it can be added slowly to displace the heavier LPG downward.

(6) The explosive range of combustible gas mixtures is depressed to a greater extent by CO₂ than by N₂ or any other gas generally available for purging purposes. See Figures 2-4 and 2-5.

(7) The greater solubility of CO₂ in water, with the consequent increase in its acidity and corrosiveness and the formation of carbonates, may be an important factor in some instances.

In piping or vessels containing water there may be a small amount of contraction due to the CO₂ and N₂ being soluble in water. Generally, complete saturation of the water is rarely experienced in a purging operation. Generally the facility would not be idle for a sufficient period for saturation to occur, however, if it were to be idle for a longer period, air would probably be admitted to replace the CO₂ or N₂. It is doubtful, therefore, that solubility will cause any dangerous decrease in the pressure in the facility, provided there was a sufficient positive pressure in the facility when purging operations are ended.

4.3(f) VENTS AND CONNECTIONS

Purge vents are recommended for the escape of the purge gases. As a rule, the vents should be located at the high points of the facility, or any "pockets" being purged. Both N₂ and CO₂ are heavier than any of the usual supplemental and natural gases (liquid petroleum gas excepted), so stratification will tend to take place in large facilities. The heavy inert gases settle to the bottom and the lighter gases rise to the top until the lighter gases have been completely expelled.

When air is purged with N₂, there may be a large amount of mixing because both gases have very nearly the same specific gravity.

4.3(g) NITROGEN AND CARBON DIOXIDE IN CYLINDERS

4.3(g)(1) Relative Merit of Cylinders

Cylinders are ideal for relatively small jobs requiring up to about 5,000 cu. ft. of inert gas, although there is no limit to the size of job for which they can be used. Typical data for full cylinders that can be used for planning jobs follows: (As stated earlier, higher pressure cylinders with greater capacity are available. Exact weights vary with suppliers.)

Item	Carbon Dioxide	Nitrogen
Weight when full-pounds	193	149
Weight of gas-pounds	60	16
Pressure when full-psig	830	2,200
Volume at Atmospheric		
Pressure-70°(cu. ft.)	528	226
Standard cu. ft. per pound	8.76	13.8

Although cylinder gas is convenient, it is usually more expensive. Costs will vary depending on the size and location of the job. Cost comparisons should include the cost of introducing the gas into the facility as well as its purchase.

The cost of manifolding many cylinders or of extending the time of the job if they are used a few at a time should be considered. The weight of material handled when using cylinders is largely dead weight that must be returned after the job is completed-70 percent for carbon dioxide and 85 percent for nitrogen.

4.3(g)(2) Handling Cylinders

Cylinders should be handled carefully. They should not be dropped, struck by other objects or used for supports or rollers.

Never lift cylinders by slings, caps or electric magnets. A platform, cage, or suitable stand should be used on cylinders that are to be handled by a crane or derrick.

Before moving a cylinder, close the valve and install a protective cap and keep the cap in place over the valve when the cylinder is not in use.

If a cylinder is frozen to the ground, the use of warm (not boiling) water is recommended to loosen the cylinder. Do not pry under valves or protection caps.

A cylinder may be raised from a horizontal to a vertical position by the protective cap after making certain that is properly hand-tightened. Do not use valve protection caps for lifting cylinders from one vertical position to another.

Store cylinders in well-protected, well-ventilated, dry locations, away from sources of heat and combustible material; avoid storage in subsurface locations. Cylinders should be stored away from elevators, stairs and gangways where they might be knocked over or damaged by passing or falling objects.

Secure cylinders in the upright position and in assigned storage areas prominently posted with names of the gases. Segregate cylinders with the nonflammable CO₂ and N₂ stored apart from oxygen and fuel-gas cylinders.

Cylinders should be stored in the open, but in all cases should be protected against extremes in temperature (screened against direct rays of the sun and sheltered from accumulations of ice and snow).

It is required that a cylinder be condemned when it leaks or when corrosion, denting,

bulging or evidence of rough usage exists to the extent that the cylinder is likely to be weakened appreciably. Remove the leaking cylinder out of doors to a well ventilated located.

Notify the gas supplier and follow his instructions as to the return of the cylinder. Return doubtful cylinders to the supplier for re-inspection.

Use cylinders in the order received from the supplier. Empty cylinders should be marked "empty", segregated from full cylinders and promptly returned to the supplier. Keep valves closed and protection caps in place on empty cylinders.

4.3(g)(3) Using Carbon Dioxide Cylinders

Securely fasten cylinders to a permanent object or bundle together when in use. As many cylinders as practical should be manifolded together to avoid delays when exchanging

cylinders during the purge. The manifold piping must be sufficiently flexible to be able to avoid stress from distortion during usage and should have adequate strength to contain the gas pressure up to the point of expansion into the piping being purged.

Limit the rate of withdrawing gas from the cylinders to avoid excessive temperature drops. The magnitude of temperature drop may cause carbon dioxide to solidify and temporarily stop flow. This can be alleviated by securing carbon dioxide in cylinders with siphon tube (Figure 4-1) or using them in a position with the withdrawal valve in a bottom position. This causes the carbon dioxide to leave the cylinder in its natural liquid state and vaporize at some point in the piping where the formation of solid carbon dioxide is less likely to stop the piping. See Figures 4-1 and 4-2.

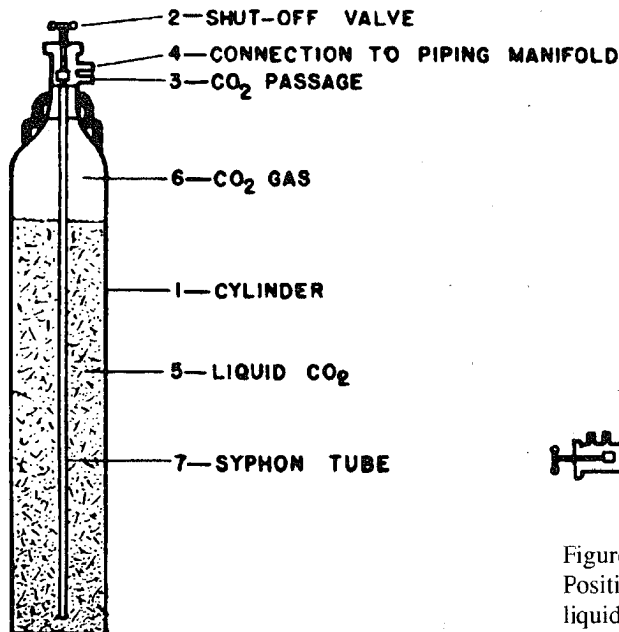

Figure 4-1 - CO₂ Cylinder with Syphon Tube Attachment. This becomes a Standard CO₂ Cylinder without the Syphon Tube.

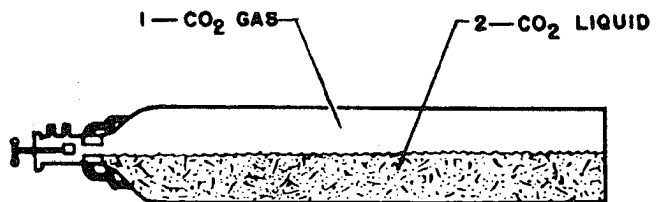

Figure 4-2 - Standard CO₂ Cylinder in Horizontal Position, about 1/2 full, showing relative positions of CO₂ liquid and gas.

4.3(g)(4) Connections Between the CO₂ Cylinder and Equipment to be Purged

Connections between the CO₂ cylinder and the facility to be purged can be constructed of either commercially manufactured high-pressure flexible metallic hose connections or a manifold assembled on the job. Either is satisfactory if connected and used in the proper manner.

High-pressure flexible metallic hose, available commercially, is furnished in several capacities. The cylinders may connect in parallel to a metallic hose of the proper diameter and length. The manifold should be provided with valves permitting the discharge of each cylinder independently and permitting the removal and replacement of empty cylinders while another or others are discharging.

A single connection, or a manifold, can be assembled from pipefittings if CO₂ is to be at a low pressure in the piping. It is recommended that the pipe size be at least 1" and preferably 1 1/4" or 1 1/2". The latter sizes will help to eliminate largely the freezing or solidifying of the CO₂ in the manifold. Vaporization of liquid CO₂ takes place in the piping immediately after the cylinder outlet valve by which the flow is controlled so the piping should be large enough, as mentioned above, to carry gas instead of liquid.

If the cylinders are solidly connected to the equipment to be purged the manifold should be of extra heavy material. It is recommended, however, that for ease of installation a flexible connection should be installed as close as possible to each cylinder.

4.3(g)(5) Electrical Bond Connection

In use, the cylinder should be directly connected to the equipment being purged with the metallic tubing or pipe. If such a direct connection is not made, electrically bond the cylinder, tube, etc. to dissipate any static charge.

For bonds and ground connections from cylinders and/or a stand, it is suggested that a single wire be used, not smaller in size than #14 AWG. Bare stranded wire is preferred because bare wire shows any and all breaks in the wire

which otherwise would be hidden by insulation. Stranded wire is more flexible than solid wire and is less likely to be broken off at the test clip terminals.

4.3(g)(6) General Rules for Using N₂ from Cylinders

Unlike CO₂, compressed N₂ is not a liquid in the cylinder; therefore, the cylinder may be held in any convenient position during use.

Connections between the cylinder and facility can be assembled satisfactory from pipefittings. However, due to the exceedingly high pressures in the N₂ cylinders, special high pressure fittings are required. For flows of N₂ less than 50 cu. ft. per minute, the manifold requires the use of a regulator to reduce the pressure from the cylinder pressure to the low pressure required for the purging.

For flows of N₂ greater than 50 cu. ft. per minute, the capacity of the regulators used may be considered or the manifold may be used without regulators.

To determine the rate of withdrawal of nitrogen from a cylinder, a pressure gauge may be installed on the outlet control valve of each cylinder.

This arrangement gives a more satisfactory method of controlling high rates of flow of N₂. Injection is through a high pressure 1/2" pipe manifold with a single 1/2" needle valve for regulating the flow. All fittings in the manifold, up to and including the 1/2" needle valve, must be rated for the appropriate high pressures. Several cylinders can be connected in parallel and the single valve used for regulating the flow. Flows as great as 700 cu. ft. per minute have been obtained through this type of manifold. However, it is recommended that additional manifolds with throttle valves be used for rates over 500 cu. ft. per minute.

Freezing may occur between the throttle valve and the cylinder, at temperatures below 32°F. This freezing tends to occur first at the cylinder control valve orifice and begins when the withdrawal rate is about 50 cu. ft. per minute.

4.3(h) LIQUID BULK CARBON DIOXIDE

Low-pressure carbon dioxide is carbon dioxide which is stored and handled in its liquid form at a controlled cryogenic temperature.

The reduced temperature serves to suppress the vapor pressure so that the liquid carbon dioxide can be stored and transported in large size containers designed for relatively low working pressures. In this way, it is possible to handle liquid carbon dioxide in bulk quantities as with petroleum products and other low pressure liquefied gases.

4.3(h)(1) Storage Units

Stationary storage units are constructed in capacities ranging from 750 pounds to 125 tons. The pressure vessels are designed for working pressures from 300 to 325 pounds per square inch. Four to six inches of thermal insulation is applied to the pressure vessel to assist in maintaining the necessary low temperature. An air-cooled mechanical type refrigerator provides the refrigeration required for prolonged storage.

The containers are equipped with pressure relief valves in accordance with code requirements. The purpose of these valves is to prohibit the pressure within the container from rising above a specified maximum as protection for the container.

4.3(h)(2) Transport Units

Low-pressure liquid carbon dioxide transport units are available in several sizes including 3-5 ton truck transports, 8-10 ton semi-trailers and 24-ton railroad car units.

These transport units are well insulated but are not provided with mechanical refrigeration. Under ordinary conditions, the liquid carbon dioxide is loaded at a somewhat reduced temperature and pressure so that the delivery usually can be made before the carbon dioxide warms up sufficiently to activate the pressure relief valve.

The capacities of the transport units mentioned above, in equivalent cubic feet of CO₂ gas at 8.5 cu. ft. per pound are:

Capacity-tons	3	5	8	10	24
Capacity-1000 cu. ft.	51	85	136	170	408

4.3(h)(3) Equipment Required for Purging

The equipment that is required for purging with liquid (bulk) CO₂ is comparatively simple. It consists primarily of a transport unit or other container with the required amount of carbon dioxide, a means for vaporizing the carbon dioxide and a means for regulating the flow of vaporous carbon dioxide into the space to be purged.

4.3(h)(4) Advantages of Liquid Bulk CO₂

Up to 400,000 cu. ft. of CO₂ gas is obtainable in a single transport unit.

It is delivered to the point of use. This frees the operator of the trouble and expense of transporting other sources of inert gas, (such as cylinders of CO₂ or N₂ or inert gas producers, etc.) to the purging site.

The set-up time is negligible with proper equipment and CO₂ vapor can be applied at rates higher than 6,000 lbs (51,000 cu. ft.) per hour. Actually, the rate is determined by the size of the vaporizer and there appear to be no reasons why a vaporizer cannot be constructed for any rate that may be required.

It can be stored in specially designed tanks (4.3(h)(1)) at any desirable location so that it can be instantly available when required.

It is a comparatively economical means of purging relatively large volumes, when all cost factors are considered, including cost of material, trucking, connection material and equipment, vaporization, labor, etc.

4.3(h)(5) Disadvantages of Liquid Bulk CO₂

It may not be economically available at every point where purging is to be done. Liquid (bulk) CO₂ requires special transport facilities that may not be within reasonable, practicable, economical trucking distance from the source of supply. This may not be a significant disadvantage as the transport facilities are constructed to go long distances and to hold the CO₂ at low temperatures for some time.

The costs vary from place to place depending upon the distance the CO₂ must be transported. Limitation, then, is really a matter of economy rather than physical availability.

The purging site might be inaccessible to the truck. Long lengths of tubing or pipe might be required.

4.3(h)(6) Properties of Low Pressure (Liquid) CO₂

Low-pressure liquid carbon dioxide is generally maintained at a temperature of approximately 0°F and a corresponding vapor pressure of approximately 300 pounds per square inch. If liquid at this temperature is released to atmospheric pressure, about 47 percent by weight will be converted instantly to dry ice. The remainder will flash to vapor at minus 110°F. In order to convert all of the liquid to vapor, heat must be added at a rate of about 150 Btu per pound.

The pressure vessels (trucks, tank cars and storage tanks) are equipped with pressure relief valves. At first thought, it may appear that in case of a failure of the refrigerating system, the pressure will rise to the relief valve setting and the carbon dioxide will be lost quickly by bleeding to atmosphere. This, however, is not the case because a considerable amount of heat must be absorbed by the liquid before it can vaporize. In other words, the removal of some of the vapor through the pressure relief valve produces a self-refrigerating effect. For instance, bleeding off carbon dioxide vapor at the rate of approximately 10 pounds per hour will serve to maintain a 4-ton capacity storage unit at the desired temperature and pressure. This is generally true even when the ambient temperature is as high as 100°F

4.3(h)(7) Handling of Liquid (Bulk) CO₂

To transfer the liquid CO₂ from one container to another a rotary type liquid pump is used. The transfer operation usually is handled by the supplier. The supplier usually furnishes a vaporizer of sufficient size for the rate of CO₂ required and can furnish all other necessary information upon request.

4.3(i) LOW PRESSURE (LIQUID BULK) NITROGEN

Low-pressure liquid nitrogen is nitrogen that is stored and handled at cryogenic temperatures and at pressures only slightly above atmospheric.

4.3(i)(1) Transport Units

Liquid nitrogen is available with mobile and skid mounted pumpers. Typical capacities range up to 2,000 gallons of liquid N₂ at 2640 psig and 70°F, with gaseous equivalent up to 190,000 SCF. Larger capacity tanker trucks are available.

Pumps and vaporizers on both truck and skid mounted units can generate N₂ gas at rates between 10,000 and 500,000 SCF per hour and at pressures up to 10,000 psig.

The N₂ gas can be delivered at temperatures between 40 and 800°F, controlled within 5 percent. This eliminates problems of overheating, freezing and thermal shock.

4.3(i)(2) Storage Units

Stationary storage units may be installed for any desired capacity.

Low-pressure liquid bulk nitrogen can be stored in specially designed and constructed cryogenic storage vessels. High-pressure nitrogen is stored as a gas at about 2,200 psig. at atmospheric temperature. Typically, cylinders 5 to 40 feet in length are manifolded together.

4.3(i)(3) Advantages of Liquid Bulk Nitrogen

Arrangements can be made for additional trucks to supply as much N₂ as may be required for any operation.

Liquid nitrogen can be delivered to the point of use. This frees the user of the trouble and expense of transporting other sources of inert gas (such as cylinders of CO₂, N₂, or inert gas producers, etc.) to the purging site.

The set-up time is negligible. There is less piping required than with any other source of inert gas. A vaporizer is required, but usually the delivery truck is equipped with one, so a separate one is not required. Also, the truck is equipped with flexible delivery hose and can connect to a suitable fitting on the equipment to be purged. When all cost factors are considered including the cost of material, trucking, connection material and equipment, vaporization, labor, etc., liquid nitrogen provides a comparatively economical means of purging relatively large volumes.

4.3(i)(4) Disadvantages of Liquid Bulk Nitrogen

It may not be economically available at every point where purging is to be done. The

special transport facilities may not be within reasonable, practicable, economical trucking distance from the source of supply. This may not be too much of a disadvantage as the material can be kept in the truck (and therefore, can be in transit) for about one day.

The purging site might be inaccessible to the truck. Long lengths of tubing or pipe might be required.

4.3(i)(5) Connections for and Handling Low Pressure (Liquid) Nitrogen

Gaseous nitrogen for purging can be delivered directly from the truck to the facility to be purged, as discussed previously.

The driver of the delivery truck can operate the pumping and temperature controlling equipment on the truck to supply any required rate of flow within the capacities of the equipment.

The operator provides the labor for making preliminary purging preparations. This will be required regardless of the type of inert media. The required fittings on the facility to be purged need to accommodate the filling hose from the truck. The purging supervisor will need to instruct the truck operator in regard to pumping rates desired and completion of the purging operation.

4.4 INERT GAS GENERATORS

4.4(a) GENERAL

An acceptable purging medium is products of combustion produced by carefully controlled combustion of various fuels. These combustion products can be prepared in inert gas generators. Since nitrogen constitutes approximately 79% of air, the product of an inert gas generator is predominantly nitrogen also.

The inert gas generators can be designed to produce practically perfect combustion of fuel gases or oil. The products of combustion can be cooled to 130°-150°F, depending primarily upon the temperature of the cooling water. Most of these units will yield mixtures of carbon dioxide and nitrogen containing less than 0.5 percent of either oxygen or carbon monoxide. Production capacities range up to 100 MCF/hour.

The inert gas generator can be powered by a gas or diesel fueled engine, thus avoiding the need for electric power.

4.4(b) PIPING FOR FUEL AND FOR INERT GAS GENERATORS

When the required pressures and rates of flow of the fuel and inert gas are known, the sizes of the piping can be determined by using either a gas flow computer, or by calculation using one of the common formulas for the flow of gas through pipes.

In the installation of the inert gas piping, care should be taken that no traps are permitted. If low points are necessary, drains or drips should be provided. Drains should be checked frequently.

4.4(c) COOLING WATER

Sufficient water must be provided to cool the products of combustion from the inert gas generator to a usable temperature; not higher than 150° for normal usage.

The quantity of water required varies with its own temperature and the temperature to which the products of combustion should be cooled.

Clean water is essential. Dirty water will tend to plug the sprays and, over time, build up deposits in the cooling chamber. When the water supply is taken from river, creeks or lakes it should be cleaned before it is used. In the absence of water cleaning facilities it is suggested that city water or well water be used when available.

In addition, provision must be made to dispose of the cooling water. A permit may be required to dispose of the water.

4.4(d) PURGING CATALYTIC UNITS

Manufacturers' recommendations should be followed when purging any catalytic unit. Purge gas containing carbon monoxide should not be used for purging equipment containing metallic nickel, as in catalytic reforming units, for example. At temperatures below 400°F, carbon monoxide reacts with metallic nickel to form nickel carbonyl. This compound is about five times as toxic as carbon monoxide. The maximum allowable concentration of nickel carbonyl that may be tolerated is an 8 hr time weighted average (TWA) of 0.001 parts per million.

Nickel carbonyl is a volatile liquid, boiling at 109.4°F. It may be absorbed through the skin as a liquid, or into the respiratory system as a vapor. Density of nickel carbonyl vapor is about six times that of air.

It is recommended that carbon dioxide or nitrogen be used for purging equipment containing nickel. Caution also should be observed in entering equipment containing nickel which was pressurized with gas containing carbon monoxide before purging with CO₂ or N₂. Nickel carbonyl present in the liquid phase may not have been completely vaporized and removed during the purging operation.

4.5 DIESEL EXHAUST ENGINES

4.5(a) INTRODUCTION

The products of combustion from diesel engines have been used as inert purge gas in instances where the composition of the products meets the requirements of the situation and the oxygen can be safely handled.

Studies have shown that purging with diesel exhaust is both safe and economical. Like inert gas generators, the principle product of combustion of a diesel engine is nitrogen. The products of combustion also include water, carbon dioxide and oxygen. Small amounts of other gases are also present.

The studies cited above indicate that gas mains could be safely purged using diesel exhaust provided that the oxygen concentrations is less than 11%. Care must be taken to ensure the products of combustion do not contain oxygen above the 11% threshold plus an appropriate factor of safety. To produce the maximum volume of exhaust gas with minimum variation in composition, engines should operate under a full, steady load.

Care must be taken if the main to be purged would be damaged by high temperatures (above 140°F). It will be necessary to cool the exhaust gas prior to introducing it into the main. A heat exchanger similar to that described for the inert gas generator would be appropriate.

4.5(b) ADVANTAGES OF DIESEL EXHAUST

The advantages for diesel gas exhaust purging include:

- (1) It can be a faster and more convenient purging technique than regular nitrogen purging. The scheduling and operation of the diesel purging engine can be easier than that of commercial nitrogen equipment.
- (2) The actual cost of the diesel exhaust can be significantly less than that of commercial nitrogen.
- (3) Diesel exhaust has a distinct odor that may be an additional safety factor in determining unwanted purge gas within a breathable atmosphere.

4.5(c) DISADVANTAGES OF DIESEL EXHAUST

The disadvantages for a diesel gas exhaust purging include:

- (1) The exhaust products generally must be cooled prior to introducing into the main. Arrangements should be made for equipment, such as a self contained unit in which the cooling agent can be re-circulated.
- (2) Testing and verification of the level of oxygen in the exhaust products is necessary.
- (3) Cylinders of nitrogen may be more convenient for small purging operations.

4.6 STEAM

4.6(a) GENERAL

Steam can be successfully used for purging when it is available and when the higher temperatures and moisture incident to steam purging are not objectionable.

Steam is useful as the medium for distilling volatile oils when their removal is necessary. The removal of oil from a light oil scrubber, for example, packed with oil-soaked parts and elements, is hardly possible by inert purging alone. The problem then becomes one of reducing the vapor pressure of the oil to a point where it will not vaporize a sufficient quantity to become a hazard. The steam does this "topping" as it is called. It is useful because the rate of volatilization of the oils is largely a function of temperature and the steam acts as a carrier of the oil vapors produced at this temperature.

4.6(b) ADVANTAGES OF STEAM AS A PURGING AGENT

Steam is an inexpensive, effective purge medium for situations where high temperature and moisture are acceptable.

(1) Provides direct displacement. At pressures at or near atmospheric, one pound of steam occupies a volume of about 26.5 cu. ft. When steam is introduced quickly, in relatively large volumes, into a space containing flammable gas or air, it expands rapidly into a large, relatively solid "slug" of steam. This tends to push ahead of it whatever gas or air was in the facility. This is particularly effective in containers of comparatively small diameters such as are listed in "Facilities Suitable of Steam Purging" in Section 4.6(d).

(2) High temperatures. The comparatively high temperatures of the steam atmosphere cause the volatilization of any light oils, benzol, naphthalene, tar or other combustible material that will volatilize under small increases in temperature above atmospheric. Inert gases at ordinary temperature will not accomplish this.

(3) Steam distillation. Steam is an ideal carrier for the volatilized vapors mentioned above. The comparatively high

temperatures keep the vapors volatile and the steam carries these vapors along with it as it passes through the facility until both steam and vapors pass out through the exit vent.

(4) Cleaning effect. The heating effect of the steam softens and melts the tarry deposits in the facility and causes them to run off. This effect may be beneficial to the future operation of the facility in addition to the desired elimination of the volatile portion of those deposits. Sometimes such tar substances will cool and solidify in the drains and plug them, therefore drains must be examined frequently to be sure they are open. If for no other reason, stoppages must be cleared at once to prevent the rapid development of possibly excessive pressures in the facility.

(5) Quantity of steam condenses. An appreciable quantity of steam condenses in the facility before actually replacing an equivalent volume of the original gas or air contents. As the condensed steam runs down over the contents and inside of the facility, it tends to carry with it any loosened solid particle of tar, coke breeze, carbon, etc. that otherwise would not be removed. This is an additional benefit not obtained by other inert purging media except water.

As mentioned in the previous section, drains must be examined frequently and opened at once if stoppages occur.

(6) In conjunction with inert gases. Steam may be used in conjunction with inert gases, such as CO₂, N₂ and combustion products. It is the most practical source of higher temperatures.

4.6(c) DISADVANTAGES OF STEAM AS A PURGING AGENT

As was noted in the previous section, steam is not recommended for indiscriminate use in all kinds of facilities.

(1) Interruptions. Interruptions of purging while using steam generally require special instructions. The consequences of interruptions not planned for may result in the rapid development of a serious condition

due to the cooling and condensation of the steam and the resultant sudden drop in pressure within the container.

(2) Quantity in question. An appreciable quantity of the steam condenses in the facility during the progress of a steam purging. It is difficult, therefore, to estimate the actual amount of steam required for a given purge job.

4.6(d) FACILITIES SUITABLE FOR STEAM PURGING

The construction of the following types of facilities makes them generally adaptable to the use of steam as a purging medium, because the variation in temperature will not cause any structural or mechanical damage. In actual application, each facility must be considered on the merits of its own construction.

Generally, such facilities include:

- (1) Steel scrubber towers of various sorts and sizes;
- (2) Water gas machines and attached equipment;
- (3) Producer gas machines and attached equipment;
- (4) Tubular and direct contact condensers
- (5) Relatively short lengths of pipe, particularly if located above ground. Steam is not recommended for purging cast iron pipe because of the danger of cracking the pipe or causing leaking joints;
- (6) Liquid petroleum gas storage tanks, piping, vaporizers and other associated equipment, particularly when purging out of service or for cleaning purposes. (See also limitations on steam for LPG equipment in Chapter 7.)

4.6(e) FACILITIES NOT SUITABLE FOR STEAM PURGING

The construction of and the material in certain types of facilities make them generally unsuitable for the use of steam as the only purging medium. The high temperatures necessary to use steam may produce excessive strains, flange leaks, cracking of castings, etc. Temperatures significantly above ambient may damage some pipe coatings and plastic materials. In addition, excessive condensation may damage finished or bearing surfaces.

Generally, steam is not recommended for use in the following facilities:

- (1) Cast iron facilities, such as piping facilities, in which excessive expansion may set up strains that may cause the pipe to break and joints to leak.
- (2) Facilities with close clearances, such as boosters, exhausters, compressors, station meter, engines, etc. in which excessive temperature may cause permanent warping or maladjustment.
- (3) Facilities with large and effective condensing surfaces, such as holders (except when tars or oils are present), wet meter, purifiers, etc.
- (4) Tanks which are used for the storage of combustible substances, such as oils or gasoline and which are open to the atmosphere. The use of steam in such cases may result in explosions due to temperature effects or to the discharge of static electricity. The same facilities could be purged with an inert gas first, after which steam may be used.
- (5) LNG facilities such as storage tanks, process plants and transports, which should not be subjected to moisture contamination.
- (6) High strength pipe; due to sudden temperature change, where the introduction of steam may cause damage.

4.6(f) PRECAUTIONS TO BE OBSERVED

Generally, a large proportion of the steam admitted to the container will be condensed upon coming in contact with the colder sides or parts for the facility. This condensation becomes less rapid as the facility rises in temperature but, of course, is never eliminated.

The condensed water runs down to the bottom of the facility from which it must be drained continuously because:

- (1) Water is heavy and its accumulation upon or in a facility that has not been designed for heavy loads may cause damage to the shells, casings, foundations, etc.
- (2) The water may contain dissolved salts and varying concentrations of oil and sludge that have been washed from the interior of the facility. The undesirable "contaminations" should be withdrawn as quickly as possible. This washing effect by the condensed steam is desirable and materially aids the purging operation.

If it becomes necessary to shut off the steam and discontinue purging operations, arrangements must be made to neutralize the contraction that will take place within the facility caused by the cooling of the contents. The condensation may be sufficient to produce a vacuum capable of causing damage to the facility and possible collapse.

To guard against possible damage, the following recommendations are made:

- (1) An operator should be in constant attendance at the controls for admitting steam and/or inert gas, so that remedies can be applied immediately when undesirable conditions develop within the facility.
- (2) The pressure gauges, or manometers, provided for should remain in place to indicate the pressure within the facility during the shutdown period. A careful

watch should be kept on these gauges to ensure that a stable condition is maintained.

(3) Excess pressure must be avoided at all times. Before the pressure is increased, careful consideration must be given to the relative advantages and disadvantages of such an increase.

If the maximum allowable pressure is known for the facility this must not be exceeded. If the maximum allowable pressure is not known the recommended rule is to operate at as low a pressure within the container as will accomplish the desired result. Such a pressure should not exceed five pounds per square inch.

The pressure within the facility must be maintained above that of the atmosphere. This should be accomplished by admitting whatever kind of gas will prohibit an explosive mixture within the facility.

4.7 WATER

4.7(a) GENERAL

Water can be useful as a displacing medium in those cases where residual water, if it is objectionable, can be removed sufficiently before the facility is put into service. The facility and its foundations must have been designed and constructed to withstand the weight of water required to fill it and freezing temperatures will not be encountered. The water used should be clean. Care must be taken to ensure proper disposal of the water.

skimmed off, or run off through the overflow of the purge pipe. Water heated to over 160° tends to "top" the light oils so that when the purging is completed, the volatile fractions of the oil have been removed. Proper disposal of this water-oil mixture must be exercised.

(3) Inspiring action. Water can be used to draw in the final contents of the facility, whether it is air or flammable gas, as the water is drained or pumped from the purged facility.

4.7(b) THE ADVANTAGES OF WATER

The advantages of water as purge medium include:

- (1) Availability. Water usually is available in sufficient quantities and is positive in its displacement action. It tends to fill every space in the vessel or piece of equipment so long as proper venting is provided to prevent pickets of the gaseous contents from being trapped within the unit.
- (2) Washing action. As water enters equipment that contains light oils, it tends to wash the oil from anything it contacts. The oil floats on the water and can be either

4.7(c) THE DISADVANTAGES OF WATER

The disadvantages of using water as a purging agent include:

- (1) Weight. The weight of water is one of its greater disadvantages. Therefore, when considering water as a purge medium, the structural specifications must be studied carefully to detect weakness that may make purging with water impracticable.

Note: if any riser or pipe extends above the top of a tank and allowed to fill with water, the pressure at the bottom of the tank is equivalent to the hydrostatic head from the bottom of the tank to the water level in the riser pipe.

(2) Disposal of water. The disposal of the used water presents a problem. Water used for purging may contain tars, oils, or other undesirable materials. State and local laws prohibit these materials from being put into streams, rivers, or sewers, therefore contaminated water must undergo some purifying process. A permit may be required before disposal.

(3) Not adaptable to all equipment. Water should not be used in certain types of equipment such as LNG facilities, compressors, pressure regulators or orifice meter plates.

(4) May not completely remove oils and tars. Water may not completely remove oil or tar residues from a facility.

(5) Hydrates in natural gas. Hydrates may be formed at high pressures and low temperatures in the combination of water with natural gas. Under the proper conditions, a cup of water may form sufficient hydrates to fill solidly 6 to 8 feet of 8" pipe. Likewise, under certain conditions of temperature or pressure reduction, the freezing of water at regulators or in small orifices may cause stoppages in gas piping.

4.7(d) USE OF WATER

4.7(d)(1) Inlet Supply Connection

Connections must be made between the source of the water and the equipment to be purged. A shut-off valve should be installed in the connection near the equipment so the operator can see the equipment and be in a position to shut off the supply instantly in case of trouble.

Consideration should be given to the installation of a suitable check valve in the inlet supply line. This prevents accidental backflow of undesirable material into the water supply line in case excess pressure should develop in the facility being purged.

4.7(d)(2) Vents

A vent pipe should be installed at the highest point of the facility to be purged, specifically where pockets of gas might be trapped.

A side outlet connection attached to a container or tank of appropriate size to handle

the overflow of light oils and some water should be provided near the bottom end of the vent pipe. If this connection is not provided, the oils and water will have to either remain in the facility, or overflow the end of the vent pipe and run over the exterior of the equipment. The overflow is dangerous and messy. A shut-off valve should be installed in the vent pipe immediately above the side outlet draw-off pipe and closed when water has filled the facility and begins to run off to the drain through the side outlet.

If the equipment contains pockets where gas might be trapped, arrangements should be made before the start of the purging work to vent them, wherever possible. This usually is applicable to piping, where there may be numerous vertical bonds where the gaseous contents may be trapped.

4.7(d)(3) Piping

If water is used to purge a section of pipe, an appropriate pig should be considered as a means of separating the water from the material being purged. This will also prevent trapping of the material being purged.

4.7(d)(4) Drains

Suitable drains should be provided to dispose of the water.

4.7(d)(5) Pressure Gauge

Pressure gauges should be installed on the facility at points where they will indicate the true pressure within the equipment and be in constant view of the operator of the water control valve. It is suggested that a gauge to indicate the maximum pressure be installed as close as possible to the lowest point of the facility to be purged.

Water fed into the system too rapidly for the number of vents provided may cause pressure to be built up in excess of the weight of water. In certain facilities, this may have serious consequences, therefore each facility must be studied and treated as an individual problem in a manner commensurate with its construction and limitations.

4.7(e) PRECAUTIONS

As oils are volatilized, they will diffuse into the space above the rising water level. It must be remembered that no inert gases are being used to

dilute the original contents of the facilities, therefore, care must be taken to prevent air from mixing with those contents.

REFERENCES

Carbone, M., Loo, O., Rush, W., "Purging Gas Mains with Diesel Exhaust is Fast, Economical, Convenient and Safe," Brooklyn Gas Company, Institute of Gas Technology, 2000.

CHAPTER 5

NATURAL GAS TRANSMISSION AND DISTRIBUTION PIPE

SECTION	PAGE #
5.1 Introduction	64
5.2 Safety Precautions	64
5.3 Typical Purging Procedure Direct Displacement of Combustible Gas or Air	65
5.4 Inert Purge by Complete Filling with Inert Gas	75
5.5 Inert Purge Using Slug to Separate Media Being Interchanged	77
FIGURES	
5-1 Minimum Purge Velocity to Limit Stratification...	65
5-2 Distribution Main System for New Subdivision	66
5-3 Geometry and Operating Conditions Used to Calculate the Purge Pressures in Table 5-1	70
5-4 Pressure Drop Calculation Methods for Table 5-1	70
5-5 Air Mover Diagram	71
5-6 Typical Air Mover Installation	74
5-7 Arrangement for Displacing Air to Gas from Pipe	75
5-8 Graphical Presentation of Nitrogen Slug Shortening	78
5-9 Shortening of Nitrogen Slug During Inert Purging Operations	78
5-10 Explosive Limits of Natural Gas Nitrogen Mixture with Air	79
5-11 Typical Procedure for Replacement of Air with Natural Gas	80
5-12 Typical Procedure for Replacement of Natural Gas with Air Utilizing Slug Purge	81
TABLES	
5-1 Purging Data for Inlet Control Procedure	69
5-2 Capacity of Various Air Movers	72
5-3 Measuring Injection Rates Through Hoses or Orifices	76
5-4 Nitrogen Required for Inert Slug	81

CHAPTER 5 NATURAL GAS TRANSMISSION AND DISTRIBUTION PIPE

5.1 INTRODUCTION

Typical purging procedures applying the principles outlined in Chapter 1, 2 and 3 to segments of transmission and distribution pipe will be discussed in this chapter. These purging procedures have been developed in the gas industry over many years in the installation of thousands of miles of pipe. Research published by the Gas Research Institute has provided additional and technically supportable guidelines for safe, reliable and accurate purging practices.

TYPICAL PURGING PROCEDURES

(1) Direct displacement of air with combustible gas or vice versa. (See Section 5.3)

(2) Inert purging by completely filling with inert gas. (See Section 5.4)

(3) Inert purging utilizing a slug to separate the media being interchanged. (See Section 5.5)

The choice of one of these procedures or modifications of them depends upon the physical configuration and combination of sizes of pipe and upon certain local conditions. No one procedure set forth in this chapter will satisfy all conditions that may be encountered.

5.2 SAFETY PRECAUTIONS

In addition to the safety precautions described in Chapter 1, following are additional precautions that should be considered when preparing for a purging operation.

5.2(a) VOLATILE LIQUIDS

Special precautions should be taken in cases where liquids such as drip oil, crude oil, gasoline, liquid condensates, or oil from scrubber may have entered a pipeline that is to be taken out of service for repair or replacement. The precautions may vary depending upon the situation.

Usually the first step before blowing down a pipeline is to remove liquid from the pipeline to be purged. If only a small volume of liquid is suspected, purging may proceed.

5.2(b) VENTING OF GAS

Disposal of large volumes of combustible gas into the atmosphere should be minimized

where practical by transferring as much as possible of the combustible gas content of the pipeline to be purged to other parts of the system.

When it may be necessary to discharge large volumes of combustible gas into the atmosphere, it is essential that the combustible gas be diffused into the air without hazard to the workers, the public, or property. Vertical vent stacks of sufficient height and capacity with valving to provide safe control should be used. The location of these vent pipes should be selected with due consideration of buildings, overhead power lines, aircraft landing patterns and other potential sources of ignition.

Consideration must be given to public relations with regard to objectionable noise and odor as well as to any applicable federal, state and local noise and pollution abatement requirements. Such considerations may include the use of noise suppressors, reduction of line pressure, deodorizing filters, etc.

5.2(c) SULFUR

When gas with high concentrations of sulfur has been present in a pipeline, or small concentrations of sulfur gas have been present for long period, it is necessary to follow special

precautions. These include testing for iron sulfide in the pipeline, followed by an appropriate purge procedure to prevent spontaneous combustion.

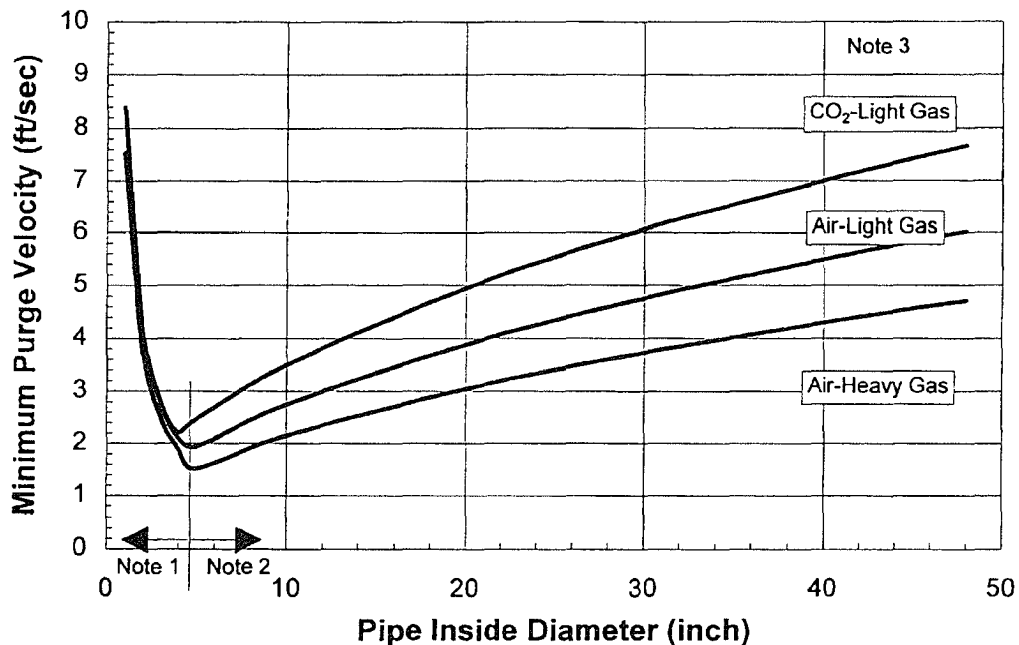

FIGURE 5-1 MINIMUM PURGE VELOCITY TO LIMIT STRATIFICATION AND ENSURE TURBULENT FLOW

Note 1: Minimum velocity for turbulent flow, Reynolds # = 4000.

Note 2: Minimum velocity to limit stratification.

Note 3: The minimum purge velocity depends upon the pipe diameter and the density difference between the purge gases. Gases with larger density differences require higher purge velocities. Light Gas Specific Gravity = 0.55. Heavy Gas Specific Gravity = 0.70.

5.3 TYPICAL PURGING PROCEDURES DIRECT DISPLACEMENT OF COMBUSTIBLE GAS OR AIR

5.3(a) GENERAL

During purging, combustible gas introduced directly and rapidly into a pipeline containing air, or air similarly introduced into a pipeline containing combustible gas, forms a region of mixed gas within the flammable range. To

minimize mixing, the purge velocity in the pipeline should be high enough to limit stratification of the gases and create turbulent flow at the interface of the gas and air.

The minimum allowable purge velocity to limit stratification and provide turbulent flow is shown in Figure 5-1. A slow purge of less than

shown in Figure 5-1 may permit excessive mixing and stratification of air and combustible gas and should be avoided due to the potential for ignition from solid particles inside the pipe scale. The greater the velocity, the greater the turbulence and, therefore, less chance of creating a long section of air-combustible gas mixture.

Example procedure for Figure 5-2:

- (1) Close off 2" lines at C and D, isolating by pinch, fitting, valve or other means.
- (2) Open vent at 1.
- (3) Open valve A. Leave valve B closed.
- (4) Close vent at 1 when natural gas end-point is reached.

- (5) Open vent at 2 and close when natural gas end-point is reached.
- (6) Open vent at 3 and close when natural gas end-point is reached.
- (7) Open vent at 4 and close when natural gas end-point is reached.
- (8) Open vent at 5 and close when natural gas end-point is reached.
- (9) Purge all service lines installed.
- (10) Open isolation points C and D.
- (11) Open valve B.
- (12) Partial (stub) service lines may be purged when extended later.

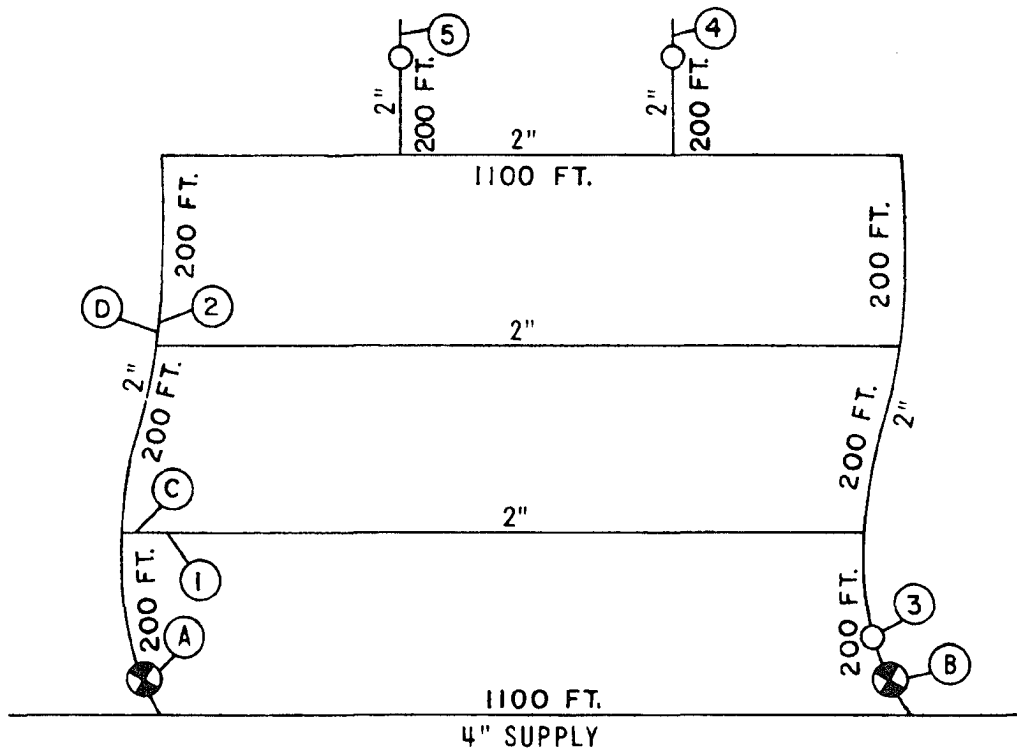

Figure 5-2 DISTRIBUTION MAIN SYSTEM FOR NEW SUBDIVISION

5.3(b) SMALL DIAMETER PIPE – 4" AND SMALLER

Lines of 4" diameter and smaller can be purged by direct displacement of air with combustible gas or combustible gas with air provided that the purge velocity is above the

minimum velocity in Figure 5-1. All parts of the piping system must be purged completely and combustible gas vented to the atmosphere must be discharged safely. Purging should progress without interruption. The configuration of the piping system determines the number and locations of points where combustible gas should

be vented. Possible ignition sources should be eliminated where combustible gas is vented to the atmosphere. See Figure 5-2.

5.3(c) PURGING SERVICE LINES

When purging normal sized service lines containing air or an air-gas mixture, the combustible gas itself is satisfactory for the purging medium. Purge out of doors wherever practicable. Proper precautions must always be taken to avoid venting of sufficient gas to form an explosive mixture or create objectionable odors or an oxygen deficient condition within a room or space.

After the service line has been tested for tightness with the meter service shut-off closed, combustible gas is admitted into the service line. If the meter is located outdoors, allow the air from the service line to vent near the meter until an odor of gas appears. If the meter is inside, the air-combustible gas mixture should be discharged through a flexible hose or other means to the outside of the building. New lines inactive for a long time may absorb the odorant and the gas may not be detectable. This may result in the gas being vented before odor is detected.

5.3(d) PURGING RESIDENTIAL FUEL LINES

When residential fuel lines containing air or a combustible gas mixture are purged with combustible gas, it is necessary that precautions be taken to avoid an explosive mixture within the appliance or interior space. Care should be taken to avoid an objectionable odor or oxygen deficiency in the space.

The following methods are recommended for purging new and existing fuel lines before putting them into use.

- (1) Make certain that the line is gas tight and that all openings are properly plugged, capped, or severed before turning meter on and allowing gas to enter system.
- (2) Valve off all appliances with spark ignition.
- (3) Do not purge by breaking a union and letting gas blow; use a valve to control the flow of gas.
- (4) All appliances with pilot lights should be relit. Wait until the flame burns steadily,

without popping out, to be sure all the air is out of the line.

(5) Appliances with spark ignition should be put back in service by purging the line at the drip leg using the appliance valve.

(6) To purge a fuel line to an appliance which has a combustion chamber and a pilot light, turn appliance and pilot valve off, make sure combustion chamber is free of combustible gas, then use one of the following methods:

- (a) If there are no open flames in the space where the appliance is located, disconnect the pilot tubing and use the pilot valve to control the flow, holding a flame at the open end. Purge the line until the flame burns steadily.
- (b) Purge through the pilot, controlling flow with the pilot valve and maintain a constant flame at the pilot until the pilot light is stable.

Relatively long fuel lines or lines 2" or larger in diameter should be purged to the outside of the building through a hose. If there is a reason to suspect that the line contains either propane, welding gas, etc., it is advisable to purge with inert gas. Make sure there is a valve to control the flow into the hose and direct the discharge away from any opening in a building. Purge until all of the air or air-gas mixture is expelled.

5.3(e) LARGE DIAMETER PIPE – GREATER THAN 4"

As pipe diameter increases the volume of flammable mixture increases and it becomes a more important consideration during purging operations.

The length of the flammable region is dependent upon the contact time of the gases purged, therefore, longer pipe lengths or lower purge velocity will increase the length of the flammable region.

The following procedures incorporate these principles.

5.3(f) PROCEDURE FOR DISPLACEMENT OF AIR WITH COMBUSTIBLE GAS

The following procedure, often called the Inlet Control Procedure, should be used for purging dry pipe.

- (1) Determine the blow-off size (using the smallest cross sectional area of any component), pipeline size and the length of section to be purged.
- (2) Obtain the inlet control pressure from Table 5-1.
- (3) To observe the inlet pressure, connect a pressure gauge to a tap located as close as possible to the line to be purged. The gauge should be accurate and readable to within 1 psig. (Note: The gauge should be connected through several feet of flexible tubing to eliminate excessive vibration.)
- (4) Open the blow-off valve at the downstream end of the section to be purged. Downstream blow-off valves should always be in the fully open position.

(5) Start purging by bringing the inlet control pressure quickly to the pressure determined in step 2. Maintain the pressure for a period of time equal to two minutes for each mile of pipe in the section being purged.

- (6) Verify completeness of the purge at the end of the determined time (two minutes per mile). A combustible gas indicator or other sampling device can be used for analyzing the gas-air mixture throughout the purging operation and for confirming the gas to be free of air.
- (7) Purge an additional percentage volume of gas to obtain additional safety margin to ensure that the pipe is void of flammable mixture. (Typical additional purge times range from 50% to 200% of the initial purge duration.)
- (8) Close the blow-off valve and return the pipeline to service.

Basis for the Purge Pressure Calculated in Table 5-1

To estimate the purge pressure required to obtain a purge time of 2 minutes per mile of pipeline, the flow rate and pressure drop through the piping must be determined. This is accomplished by computing pressure drops in particular segments of the pipeline (See Figure 5-4) for given inlet pressures. The inlet piping and blow-off piping are modeled as adiabatic (no heat transfer) pipes with friction. The main pipeline segment is modeled as an isothermal pipe with friction.

A time-dependent model is required to correctly model the pipeline purging operation.

The calculated pressure, since the blow-off valve should be opened method assumes the pipeline is initially at atmospheric prior to starting the flow of gas at the inlet. Once gas starts to flow into the pipeline, the pressure in the pipeline starts to rise. The gas already in the pipeline is compressed and the amount of gas stored in the pipeline increases. A steady flow model would not correctly account for these factors.

Figure 5-3 summarizes the pipeline geometry and operating conditions that were assumed for calculating the purge pressure shown in Table 5-1.

TABLE 5-1

Purging Data for Inlet Control Procedure
 Minimum Inlet Pressures- PSIG
 (By line size)

PIPELINE LENGTH (MILE)	2" B/OFF VALVE Inlet Pressure (psig)		4" BLOWOFF VALVE Inlet Pressure (psig)				6" BLOWOFF VALVE Inlet Pressure (psig)					
	4" Pipe	6" Pipe	6" Pipe	8" Pipe	10" Pipe	12" Pipe	12" Pipe	16" Pipe	18" Pipe	20" Pipe	22" Pipe	24" Pipe
1	6	9	3	3	3	5	2	3	4	5	8	12
2	12	13	7	5	5	7	3	4	5	6	8	12
3	18	17	10	7	7	8	5	5	5	7	9	13
4	24	21	13	10	9	10	6	6	6	8	10	14
5	32	25	16	12	11	11	7	7	7	8	11	15
6	40	30	20	14	12	13	9	8	8	9	12	15
7	49	35	24	17	14	14	10	9	9	10	12	16
8	59	41	28	20	16	16	11	10	10	11	13	17
9	71	46	33	22	18	18	13	11	11	12	14	18
10	83	52	38	25	20	19	14	12	12	13	15	19
11	97	59	43	28	22	21	16	13	13	14	16	20
12		66	48	31	25	23	17	14	14	15	17	20
13		73	54	35	27	25	19	15	15	15	17	21
14		81	60	38	29	27	21	16	16	16	18	22
15		90	67	42	32	29	22	18	17	17	19	23
20				63	45	40	31	24	22	22	24	28
25				90	62	52	42	31	28	28	29	33
30					81	66	54	39	35	33	34	38
35						82	68	47	42	40	40	44
40							84	57	50	46	46	50
45								67	58	54	53	56
50								79	67	61	60	63

PIPELINE LENGTH (MILE)	8" BLOWOFF VALVE Inlet Pressure (psig)			10" BLOWOFF VALVE Inlet Pressure (psig)			12" BLOWOFF VALVE Inlet Pressure (psig)			
	20" Pipe	22" Pipe	24" Pipe	24" Pipe	26" Pipe	30" Pipe	34" Pipe	36" Pipe	42" Pipe	48" Pipe
1	2	3	3	2	2	3	2	3	6	10
2	3	3	4	2	3	3	3	3	6	11
3	3	4	5	3	3	4	3	4	6	11
4	4	5	5	3	4	5	4	4	6	11
5	5	5	6	4	4	5	4	4	7	12
6	6	6	6	5	5	5	4	5	7	12
7	7	7	7	5	5	6	5	5	7	12
8	7	7	8	6	6	6	5	6	8	12
9	8	8	8	6	6	7	6	6	8	13
10	9	9	9	7	7	7	6	6	8	13
11	10	9	10	8	7	8	6	7	9	13
12	10	10	10	8	8	8	7	7	9	14
13	11	11	11	9	9	9	7	7	9	14
14	12	12	12	9	9	9	8	8	10	14
15	13	12	12	10	10	10	8	8	10	15
20	17	16	16	13	13	12	10	10	12	16
25	22	20	19	17	16	15	12	12	14	18
30	27	24	23	20	19	17	14	14	15	20
35	32	29	27	24	22	20	17	16	17	22
40	38	34	32	28	26	23	19	18	19	24
45	44	39	36	32	29	26	21	21	21	25
50	51	45	41	37	33	29	24	23	23	27

Notes:

- (1) Purge pressures that exceed 100 psig are not shown in the table. Possible detonation of flammable gases could create unsafe pipeline pressures. Longer purge times (greater than 2 min/mile) and lower purge pressures should be used. See Figure 5-3 for geometry and operating conditions used to calculate the purge pressures in Table 5-1.
- (2) Add 5 psig to the pressures shown in Table 5-1, if purging is done through a crossover arrangement and the pressure is measured at the crossover valve. Example: A 30" pipe, 13 miles long, is to be placed into service. A 10" blowdown is to be used for venting. A fifty percent safety factor is selected. Table 5-1 shows that 30" pipe, 13 miles long, requires a natural gas inlet pressure of 9 psig. The length of time is 13 miles times 2 minutes per mile or 26 minutes. After 26 minutes have elapsed, the venting continues for an additional 13 minutes more. Then the blowoff valve is closed.

Pipeline Temperature (F)	60	Gas Initially in Pipeline	Air
Inlet Gas Temperature (F)	60	Gas Injected into Pipeline	Nat Gas
Inlet Pipe Length (ft)	8	Gas Specific Gravity	0.60
Blowoff Pipe Length (ft)	8	Average Purge Velocity (ft/sec)	44
Blowoff Valve ID to Pipe ID	1:1	Pipe Absolute Roughness (ft)	0.0008
Blowoff Valve Effective Length	18	Pipe Wall Thickness (for ID's)	STD

Figure 5-3
Geometry and Operating conditions Used to Calculate the Purge Pressures in Table 5-1

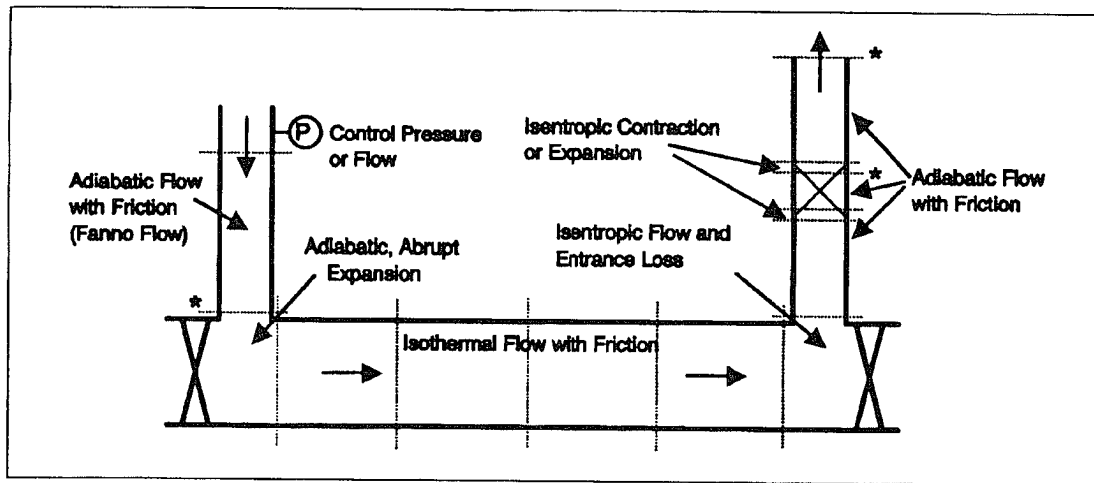

The pipeline is divided into a number of segments to aid in calculating the pressure drop and flow rate through the piping system. The calculation method for each segment of pipe is shown above.

Figure 5-4
Pressure Drop Calculation Methods for Table 5-1

5.3(g) DISPLACEMENT OF COMBUSTIBLE GAS WITH AIR

Air movers are essentially portable ventilating devices that have no moving part, employed as either blowers or exhausters. They are most commonly used to evacuate toxic or explosive atmospheres from confined places, such as boilers, chemical vats, scrubbers and the like with compressed air being used to operate the air mover. The focus of this section is the use of air movers to evacuate gas from pipeline with the pressure from the pipeline gas or compressed air being used to power the air mover. (See Figure 5-5)

Like many other tools used on natural gas pipeline, they must be used with care, discretion and advance planning. When air movers are properly utilized cuts or repairs of all descriptions on the gas pipelines at atmospheric pressure can be made without the danger of gas venting or flowing through openings and into a work area.

In the absence of compressed air to operate the air movers, natural gas may be used. If air is used, the time required to evacuate the gas from the pipeline will be longer because the amount of energy available from air compressors is usually less than that normally available from high pressure gas in the pipeline.

If compressed air is to be used to operate the air movers, radio communication between the control and work areas should be established, or an alternate source of air supply made available for use in case the primary source fails.

In practice, air movers are installed on blow-offs (Figure 5-6) on each end of a blowdown section to draw air into the pipe at the work site and move combustible gas through the pipe toward the air mover. A 0-100 psig. gauge allows the operator to make any adjustment in supply necessary to produce the desired control of draft at the point of severance in the blowdown section. The seal between the air mover and the blow-off valve face is accomplished by a gasket cut from 1/4" thick soft sheet rubber. The air mover is attached to the blow-off with three 6" sharp pointed "c" clamps, spaced evenly around the bell. The sharp points provide the metal-to-metal contact across the soft rubber gasket necessary to drain off effectively any possible buildup of static electricity during the operation of the air mover.

If a single air mover is utilized to purge a continuous section of pipeline, the opening at the inlet to the line being purged must be at least equal in area to the outlet of the air mover being used. The capacity of the air mover must provide sufficient flow such that the pipeline velocity is above the stratification velocity identified in Figure 5-1.

A continuous supply of gas or air must be maintained in the air mover to provide a constant and unfailing flow rate at each blow-off. An alcohol bottle should therefore be set up so that the supply control valve can be quickly freed of any icing where moisture-laden gas or air is used for supply.

The air mover device converts the pressure of a compressed air or gas into a large induced volume of moving atmosphere (Figure 5-5).

In the air mover, the supply air or gas is expanded at a high velocity through an annular orifice. The design of the device produces a powerful venturi effect. This causes the atmosphere being moved to be drawn through the bell of the air mover and delivered with the expended air or gas supply through the outlet horn.

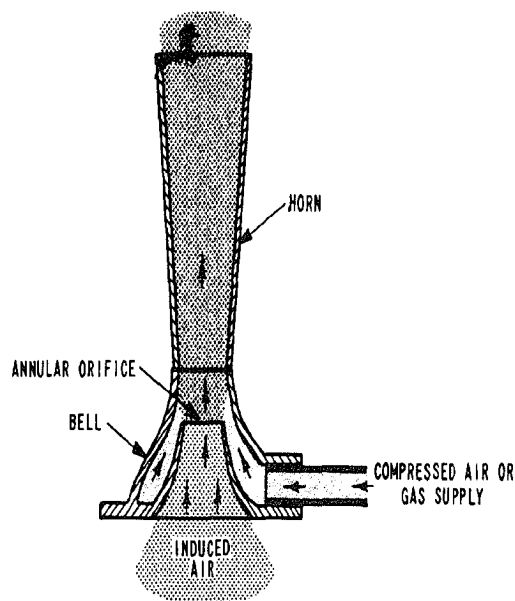

Figure 5-5 Air Mover Diagram

When selecting model size and air or gas pressure requirements, select the conditions that will produce a velocity above the limits shown in Figure 5-1 to minimize the length of the combustible mixture.

$$\text{Velocity of Air} = \frac{\text{Induced Air Flow Rate}}{\text{Inside Area}}$$

$$= \frac{520.0 \text{ Scfm}}{4.71 \text{ sq. ft.}} = 110 \text{ ft. per min.}$$

Note:

(1) Select pressure and model size to obtain the desired average velocity of air within the pipeline for various conditions as shown by the flow rates given in Table 5-2 below for full size access hole plug valve with air and plug valve with gas supply.

(2) When an air mover is mounted on a plug valve, the air mover capacity is 40 percent of the listed induced air value and when gas is used as the supply, the corrected volume of induced air is further reduced by 60 percent.

Examples of Use:

Determine velocity of air within a 30" pipeline using table 5-2:

(1) A 3" air mover at 50 psig. through a full-size access hole with air supply but not through a plug valve.

(2) A 6" air mover at 30 psig. through a full-size access hole with air supply and through a plug valve.

$$\text{Velocity of Air} = \frac{\text{Induced Air Flow Rate} \times 40\%}{\text{Inside Area}}$$

$$= \frac{1259 \times .40}{4.71} = 107 \text{ ft. per min.}$$

(3) A 6" air mover at 50 psig. through a full-size access hole with gas supply and through a plug valve.



$$\text{Velocity of Air} = \frac{\text{Induced Air} \times 40\% \times 60\%}{\text{Inside Area}}$$

$$= \frac{2058 \times .40 \times .60}{4.71} = 105 \text{ ft. per min.}$$

The supervisor at the worksite should be responsible for maintaining a sequence of events that will accomplish the work in a safe and successful manner.

Table 5-2. Capacity of Various Air Movers

AIR MOVER MODEL	Gage PRESSURE	COMPRESSED AIR	DISCHARGED AIR	INDUCED AIR	NOM PIPELINE SIZE												
					8"	10"	12"	16"	20"	24"	30"	36"					
					INSIDE AREA - SQ. FT.												
					.360	.573	.819	1.31	2.07	3.01	4.71	6.76					
3"	20 PSIG	19.0 SCFM	274 SCFM	255.0 SCFM													
	30				26.4	397	370.6										
	40				33.4	496	462.6										
	50				40.8	561	520.2										
	60				49.8	614	561.2										
	70				60.0	681	621.0										
6"	60	72.4	736	663.6													
	20	48.0	900	852.0													
	30	91.0	1350	1259.0													
	40	141.0	1800	1658.0													
	50	192.0	2250	2058.0													
	60	242.0	2700	2458.0													
10"	70	293.0	3150	2857.0													
	30	149.0	2900	2751.0													
	42	214.0	3700	3486.0													
	55	261.0	4240	3879.0													
	70	342.0	5050	4708.0													
	81	398.0	5560	5162.0													

-  FULL SIZE ACCESS MOLE WITH AIR SUPPLY
-  PLUG VALVE WITH AIR SUPPLY
-  PLUG VALVE WITH GAS SUPPLY

Prior to reducing the pressure in the isolated section to just above atmospheric, the following items should be accomplished:

- (1) Instruct all persons assigned to the project.
- (2) Check material and equipment required to complete the scheduled work.
- (3) Verify operability of all valves involved and lubricate if necessary.
- (4) Isolate other sources where gas may enter the section to be isolated.
- (5) Deactivate remote control or automatic valve operators.
- (6) Shut-off rectifiers within a prescribed distance from the work sites.
- (7) Establish a reliable communication system.

Caution should be employed if liquid hydrocarbons are suspected of being in the isolated section of pipe. If liquid hydrocarbons are present, removal of the liquids is necessary and may be accomplished by the following:

- (1) Install a siphon drip;
- (2) Drill holes in the pipe;
- (3) Sever the pipe with mechanical cutters;
- (4) Internally clean the pipe.

The procedure for displacement of gas with air is described below in a sequence that should be followed after the isolated section has been reduced to just above atmospheric. (Note: No air should be allowed to enter the blow-off prior to cutting out the access coupon or "hot cutting" the pipe.)

- (1) Install air movers on blow-offs as shown on Figure 5-6 at each end of the isolated section.
- (2) Install shunt wire and ground at the work site as shown in Figure 5-6. The shunt wire should remain attached to the pipe until the stringer weld has been completed.
- (3) A handle may be welded at the access coupon for ease of handling when removing the access coupon from the pipe.
- (4) Drill or cut a small hole near the access coupon area. This hole is used to check the gas pressure and also enables the person in charge to control the fire using the blowdowns while noting the flame height. (Note: Sufficient fire extinguishers of the proper type must be located at each work site. Electric drills are not to be used.)
- (5) Proceed to "hot cut" the elliptical shaped access coupon with a diameter approximately 70 percent of the pipe diameter at the approximate center of the

segment of pipe to be removed. Inspect inside of pipe or coupon for the presence of liquids and iron sulfide. (See Section 1.6)

In "hot cutting" the pipe, leave one inch or more of metal on the topside of pipe if it shows evidence of being twisted or contracted. This should be carefully watched for by the cutting torch operator during the progress of the cut. Before completing the cut, the pipe should be restrained by clamps, side-boom or blocking.

As the cut is being made, seal and extinguish fire with fireproof "mud" and extinguish all fires in the work area when completing the cut. Inspect the inside of pipe and coupon for liquids and iron sulfides to determine if air movers may be used.

Size of Cut

Size of Pipe	Size of Access Coupon
26" to 36"	24" elliptical hole
12" to 24"	16" elliptical hole
10" and under	Sever and separate pipe

(Note: The access coupon width should be approximately 70 percent of the pipe diameter.)

(6) Complete the installation of air movers at blow-off locations as shown in Figure 5-6 and

(a) Attach streamers to center of air mover outlets so operation of the air movers can be visually observed and monitored at all times.

(b) Fully open blow-off valves only after receiving authorization from the supervisor at the work location.

(c) Attach streamers to the upstream and downstream edges of access hole or end of pipe and observe angle of streamers to determine that air is flowing into the pipe toward both air movers.

(d) When authorized, slowly open control valve to air movers for five minutes until the desired set pressure is achieved at the work location (do not exceed 80 psig.). (Operate air mover for five minutes at reduced pressure so air will not bypass the gas.)

(e) The air mover at the higher elevation will require less control pressure than the air mover located at the lower elevation.

(f) When equalizing the movement of air in both directions as indicated by the streamers, the evacuation of the pipeline should

continue for fifteen minutes; then test with a combustible gas indicator for the presence of gas in and around the access opening or in the ends of the pipe. If no gas is indicated, the pipeline is available for the cutting "cold" operation. (Note: The movement of air into the access hole or open ends of the pipe must be maintained throughout the cutting and welding operation.)

(g) Prior to cutting out the cylindrical piece of pipe, reduce the air mover rate to minimize spark travel in the pipe. Before severing, the pipe should be restrained by clamps, side-boom or blocking. (Note: Fire extinguishers of the proper type or available inert gas should be located at the work site for use in the event of a fire within the pipe.)

(h) When the cutting has been complete, the air mover may be adjusted to a rate required for the next operation.

(7) The air mover rate should be adjusted to a rate that will minimize welding problems on the replacement pipe. The low air mover flow should be retained until the work is completed and inspected.

(8) Upon completion and acceptance of the welds, remove air mover equipment and return pipeline into service by a method such as displacement of air with combustible gas (Section 5.3); displacement of air with inert gas (Section 5.4); or slug purging (Section 5.5).

Note: All safety precautions should be strictly observed at all times.

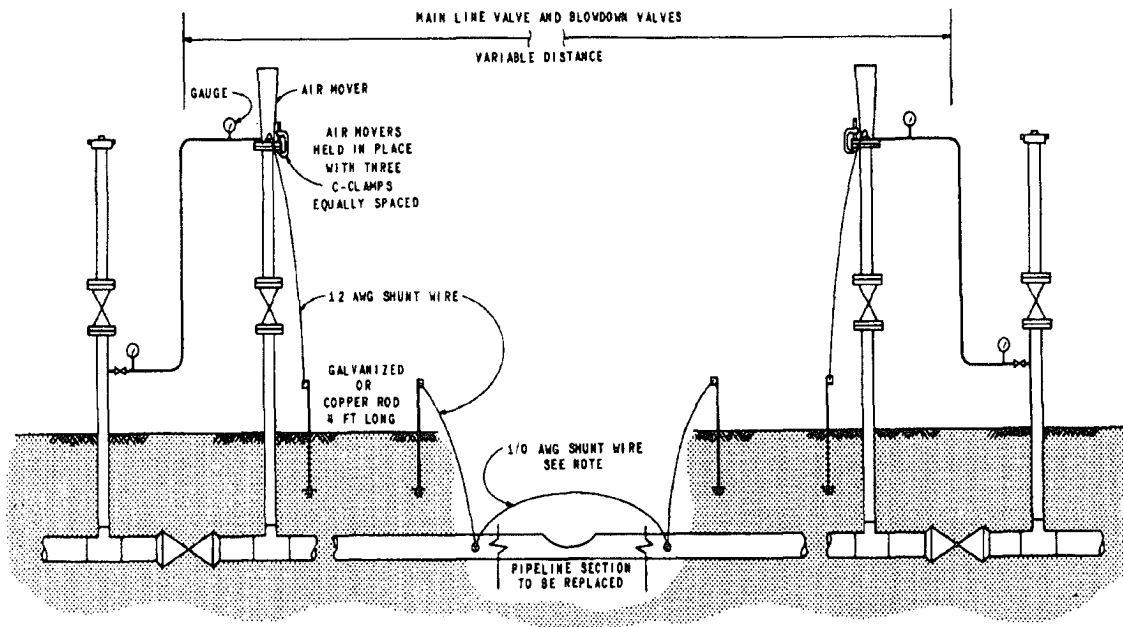

NOTE: INSTALL A SECOND SHUNT WIRE ACROSS THE PIPELINE SECTION TO BE REPLACED WHEN THE PIPELINE IS LOCATED IN CLOSE PROXIMITY TO ELECTRICAL TRANSMISSION LINES.

TYPICAL AIR MOVER INSTALLATION

FIGURE 5-6

5.4 INERT PURGE BY COMPLETE FILLING WITH INERT GAS

5.4(a) GENERAL

The three most commonly used inerts are carbon dioxide, nitrogen and inert gas generator products. The general advantages of using carbon dioxide and nitrogen are:

- (1) Constant quality;
- (2) Availability immediately upon completion of connections without waiting for a gas generator to be put into operation;
- (3) Ease of transportation and connection.

Carbon dioxide (CO₂) is ideal for purging low points because it is heavier than natural gas and causes diffusion less readily than nitrogen (N₂); thus less CO₂ than N₂ is generally required. However, since CO₂ is more soluble in water than N₂, problems can be created where prolonged contact between the CO₂ and any water that may be present in the pipeline.

An inert purge of a pipeline may be accomplished by filling the entire line with inert gas. The volumetric capacity of various sized pipes can be calculated. A volume of 10 percent to 50 percent more inert gases than the total volume of the line, added rapidly, will ensure complete filling. However, vent gases should be analyzed with suitable analytical equipment to make sure that the line has been filled with the inert gas and the specified end-point reached.

5.4(b) TYPICAL PROCEDURE, PURGE BY COMPLETE FILLING WITH NITROGEN

- (1) Determine volume of air or gas to be displaced from 110 foot long isolated section of 30" pipe (internal diameter = 29")

$$\text{Flow Area} = \frac{\pi (29^2)}{2^2} = 661 \text{ in}^2 = 4.59 \text{ ft}^2$$

$$\text{Volume} = 110 \times 4.59 = 504.6 \text{ cu. ft.}$$

Provide 50 percent additional nitrogen for purge gas: (504.6)(1.5)=756.9 std. cu. ft.

- (2) Install connection to inject nitrogen (See Figure 5-7).
- (3) Install vent stack.
- (4) Isolate section of line, blow down to atmospheric pressure and leave stack open.
- (5) Inject nitrogen, venting at stack. Table 5-3 indicates that a manifold pressure of 45 psig. will provide an injection rate of 1350 cu. ft. per minute through 50 feet of 2" I.D. hose. The purge velocity would exceed the velocity for Figure 5-1 (4.5 ft./sec).
- (6) Verify completion of purge end-point by instrument as indicated in Table 2-6.

FIGURE 5-7 ARRANGEMENT FOR DISPLACING AIR TO GAS FROM PIPE

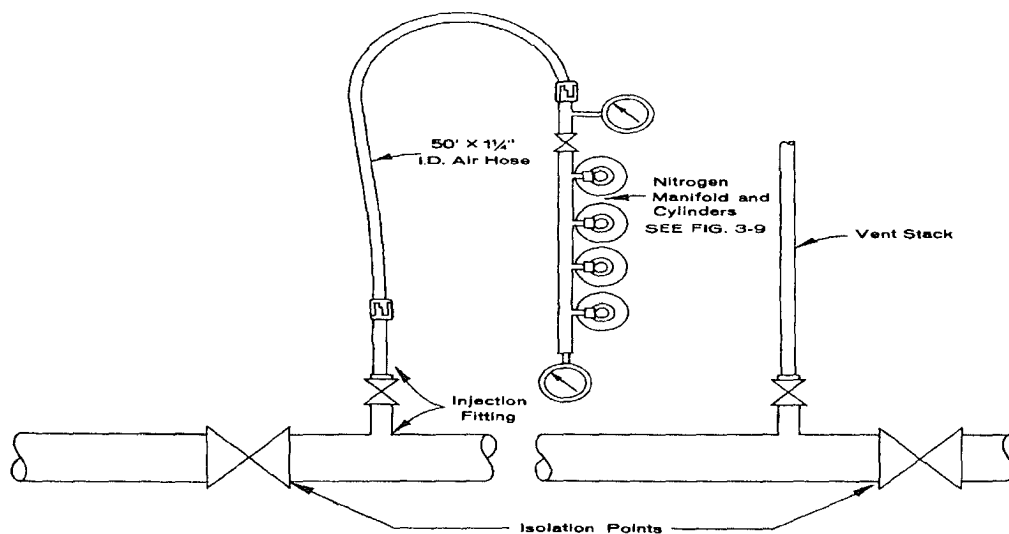

TABLE 5-3
Measuring Injection Rates Through Hoses or Orifices

Determination of pressure required to inject various flow rates of natural gas, nitrogen or air through various size hoses and orifices, which can be used as flow meters.

Desired Inject Rate CFM	Required Pressure Up Stream of Hose or Orifice, Psig																		
	Each 3/4" I.D.		Each 1-1/4" I.D.		EACH 2" I.D.		ORIFICES												
	50' Hose		50' Hose		50' Hose		3/8"		1/2"		5/8"		7/8"		1-1/8"		1-3/8"		
	Gas	N ₂ -Air	Gas	N ₂ -Air	Gas	N ₂ -Air	Gas	N ₂ -Air	Gas	N ₂ -Air	Gas	N ₂ -Air	Gas	N ₂ -Air	Gas	N ₂ -Air	Gas	N ₂ -Air	
10	3	3																	
20	4	5																	
40	9	11																	
60	15	18						20	25										
80	21	26						31	39										
100	28	35	4	6			42	52	18	23									
120	35	44	5	8			52	65	24	30									
130	39	49	6	9			58	72	27	34									
140	43	54	7	10			63	78	30	38									
160	51	64	8	12			74	92	37	46	19	24							
200	68	87	11	17			86	118	48	60	26	33							
230	82	103	14	21			113	—	58	73	33	41							
270	100	—	19	26	3	4	—	—	69	86	39	49							
320	—	NOTE: —	23	33	4	5	—	—	85	105	49	61	19	24					
370	—	—	28	40	5	7	—	—	100	—	58	73	24	30					
420	—	MULTIPLE	34	46	6	8	—	—	—	—	69	86	29	36					
430	—	—	35	47	7	9	—	—	—	—	71	88	30	38					
530	—	—	44	60	8	12	—	—	—	—	91	112	40	50	20	25			
620	—	HOSES —	55	75	11	16	—	—	—	—	109	—	49	61	26	32			
700	—	—	62	87	13	19	—	—	—	—	—	—	57	71	30	38	16	20	
720	—	MAYBE —	65	89	14	20	—	—	—	—	—	—	58	73	31	39	17	21	
830	—	—	78	105	17	26	—	—	—	—	—	—	70	87	38	43	22	27	
900	—	USED —	85	—	18	30	—	—	—	—	—	—	77	95	42	53	24	30	
950	—	—	90	—	20	31	—	—	—	—	—	—	82	101	45	56	26	33	
1000	—	TO —	95	—	21	32	—	—	—	—	—	—	87	—	48	60	28	35	
1050	—	—	—	—	23	33	—	—	—	—	—	—	92	—	51	64	30	38	
1070	—	—	—	—	24	34	—	—	—	—	—	—	94	—	52	65	31	39	
1170	—	INCREASE	—	—	27	38	—	—	—	—	—	—	104	—	58	74	35	44	
1200	—	—	—	—	28	39	—	—	—	—	—	—	—	—	60	75	36	45	
1350	—	THE —	—	—	33	45	—	—	—	—	—	—	—	—	69	86	42	53	
1520	—	—	—	—	38	52	—	—	—	—	—	—	—	—	80	99	49	61	
	—	VOLUME	—	—															
	—	—																	
	—	—																	

5.5 INERT PURGE USING SLUG TO SEPARATE MEDIA BEING INTERCHANGED

Formation of flammable mixtures during purging can be prevented with inert gas without filling the entire length of the isolated section of pipe with the inert gas. This is accomplished by maintaining a quantity of inert gas known as a slug between the air and combustible gas while the two are being interchanged. The slug of inert gas travels through the pipe as a separate mass preventing the mixing of the air and combustible gas. The slug must be long enough to allow for shortening by reason of mixing with air on one end of the slug and combustible gas at the other end. If a purge cannot immediately follow the insertion of the inert gas slug because of unforeseen delay, additional inert gas must be inserted and an entirely new slug established. Precaution should be taken to avoid damage to high strength pipe by sudden temperature change caused by rapid introduction of a purge gas.

It is necessary to know what happens to a slug of inert gas during purging, particularly how much the slug shortens or deteriorates under various conditions in order to determine the amount of inert gas needed and the velocity to be maintained during purging. Early experimental studies conducted a number of years ago involving limited lengths of pipeline (3.3 miles or less) were used to develop empirical correlation of slug shortening as a function of purging velocity and pipe length. Earlier versions of this practice used these results. More recent studies based on more advanced modeling and additional experimental results form the basis for the purging operations outlined in the following sections.

Figure 5-8 provides a graphical presentation of the slug shortening process and definition of the relevant terminology.

The initial length of the slug required for purging a given size pipe is dependent primarily upon two factors: the length of the pipe and the velocity of the slug within the pipe. Figure 5-9 indicates the amount of shortening of a nitrogen slug for various sizes and lengths of pipe at

various purge velocities which just exceed the stratification velocity in pipelines being purged at atmospheric pressure. Further increases in velocity (as shown in Figure 5-7) have minimal effect on further slug shortening.

Purge velocities can be controlled by maintaining a predetermined pressure differential across a restriction in the line used to insert the inert gas, air or natural gas into the pipe being purged. Standard orifices or even standard hoses may be used as the restriction. Table 5-3 shows injection rates measured through hoses and orifices. The pressure drops indicated in Table 5-3 are greater than those used to produce critical velocity so that the amount of downstream pressure is of little relative importance. The amount of nitrogen required for inert slug purging of various size pipelines is the volume necessary to form a slug that will reduce to zero length by the time the slug reached the pipeline vent. In other words, there will be no pure inert buffer gas between the natural gas and air just at the instant the purge is completed. However, extra inert gas should be introduced when the slug is formed so that a finite length of slug will exist at the end of the purge. A suggested additional volume is that which would fill 100 feet of the pipe being purged. Therefore, the required nitrogen values for inert slug purging of various size pipelines in Table 5-4 reflect this additional volume.

Although the data presented here is based upon a slug of 100 percent nitrogen remaining in the pipeline at the end of the purge, a factor of safety results from the fact that a mixture of 85 percent or more of nitrogen with natural gas cannot be made to burn regardless of the amount of air present as shown in Figure 5-10. Accordingly, the effective and safe length of non-combustible slug is the length of any pure nitrogen plus the length of mixture including more than 85 percent of nitrogen. (See Figure 5-8)

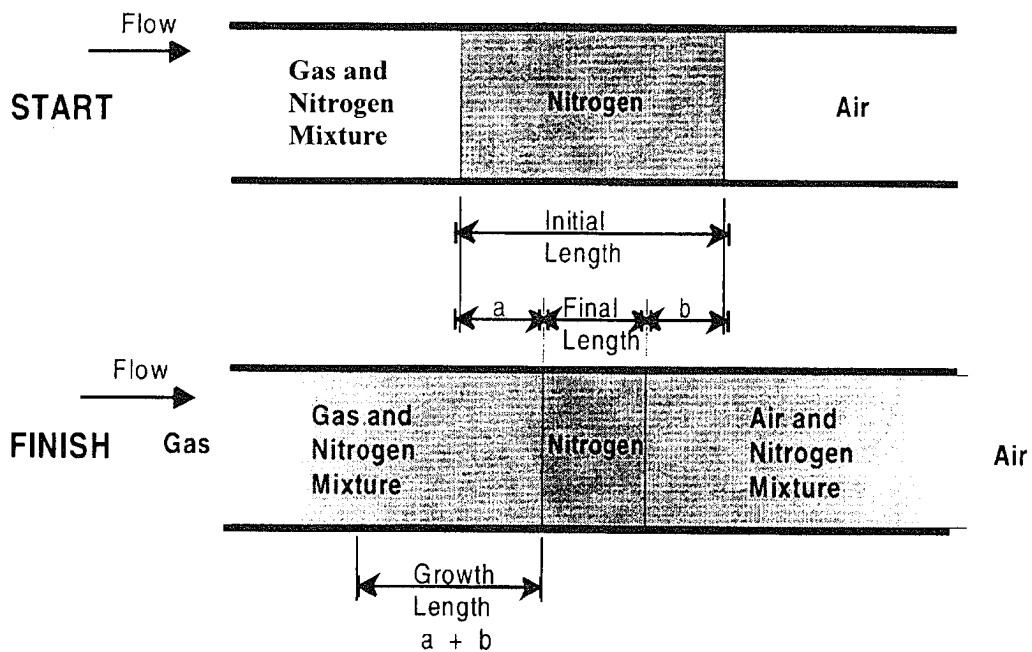

FIGURE 5-8 GRAPHICAL PRESENTATION OF NITROGEN SLUG SHORTENING

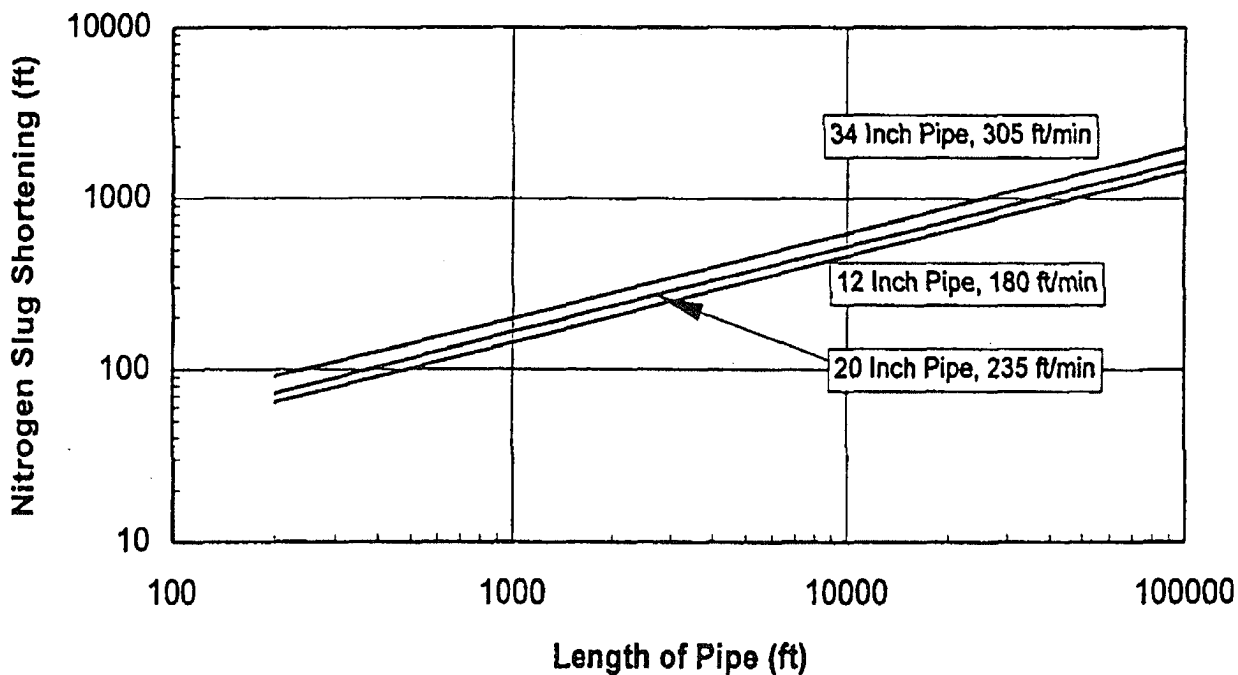

FIGURE 5-9 SHORTENING OF NITROGEN SLUG DURING INERT PURGING OPERATIONS

EXPLOSIVE LIMITS OF NATURAL GAS NITROGEN MIXTURE WITH AIR

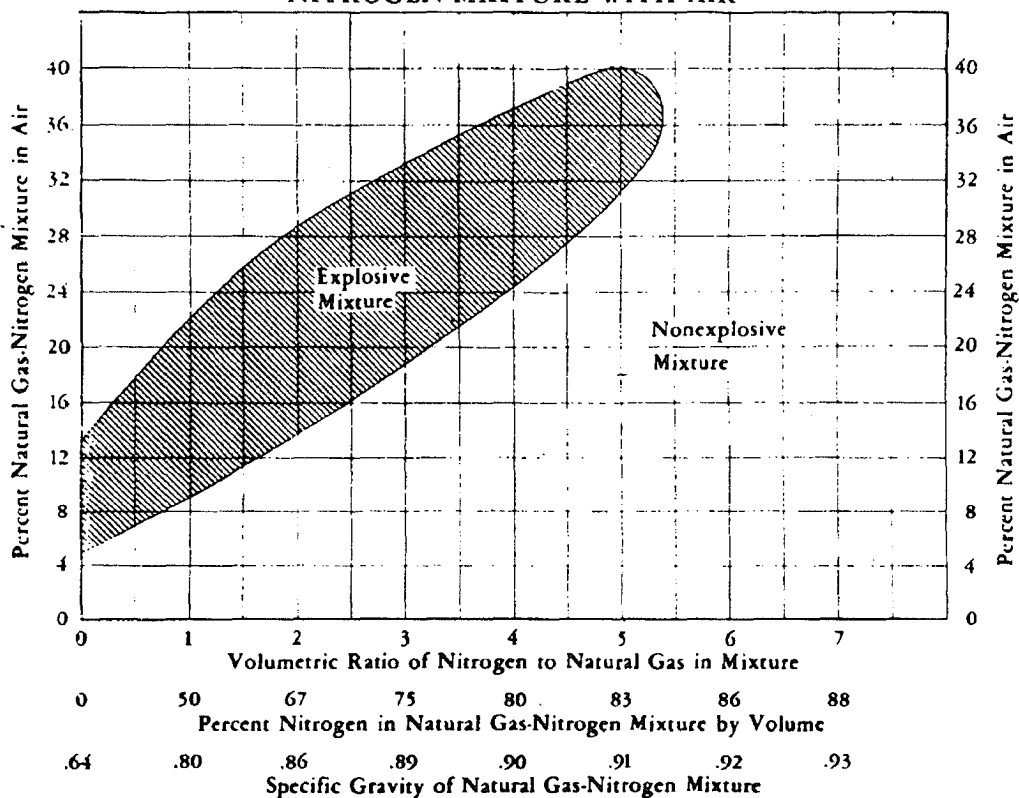

Figure 5-10 EXPLOSIVE LIMITS OF NATURAL GAS NITROGEN MIXTURE WITH AIR

Example:

If a mixture contains 83 percent nitrogen and 17 percent natural gas, the lower flammable limit of the mixture in air would be 31 percent; the upper flammable limit 40 percent.

Pigs are used in some cases to avoid mixing of gas and air. They may be placed directly between the combustible gas and air or at each end of a slug of inert gas. In the latter case, the pigs minimize the dilution of the slug of inert gas. A velocity of 50 feet per minute has been used successfully for moving a foam plastic purging pig through pipe 16" in diameter and larger.

Following are additional facts regarding inert slug purging which have been determined experimentally.

(1) Purge velocity is extremely important. Avoid a slow purge. Velocities less than those shown in Figure 5-1 allow stratification between heavier and lighter gases.

(2) The amount of nitrogen necessary to purge short lengths (500 feet or less) of large-diameter pipe satisfactory at practical purge velocities exceeds the volume of the line.

(3) Changes in horizontal or vertical direction because of ells or return bends do not tend to destroy the nitrogen slug.

(4) A temperature variation in the order of 20°F between tests has no effect on mixing of the nitrogen slug with combustible gas or air.

(5) The same amount of inert gas, as a slug, may be used if either combustible gas or air is being purged from a line.

(6) Turbulence, even if it causes mixing, is much less the cause of deterioration of the slug than is stratification.

(7) A delay of approximately three minutes between the addition of the inert gas and the purge with air or combustible gas will destroy the slug. (Delays of any nature should be avoided.)

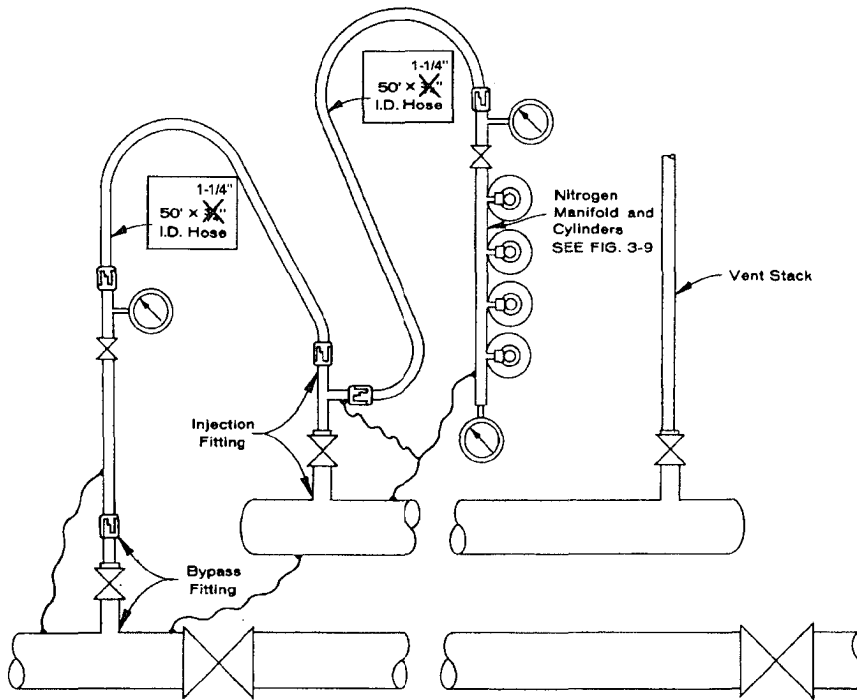

Figure 5-11 TYPICAL PROCEDURE FOR REPLACEMENT OF AIR WITH NATURAL GAS UTILIZING SLUG PURGE

Example:

Replace air with natural gas in a newly installed segment of 5,000 feet of 16" pipe utilizing an inert gas slug purge to prevent formation of a flammable mixture. The tie-in is to be made after purging by cutting and welding while both the old and new pipe segments contain natural gas.

- (1) Install vent stack.
- (2) Install temporary connection to inject nitrogen and natural gas. Table 5-4 shows that 605 cu. ft. (just slightly over three cylinders) of nitrogen will be needed. (Table 5-4 shows that 273 cu. ft. per minute must be injected to maintain a slug velocity of 210 feet per minute to avoid stratification.)
- (3) Blow down line to atmospheric pressure and leave vent stack open.
- (4) Inject nitrogen while maintaining a pressure of 26.4 (interpolate) psig, or higher at the nitrogen manifold using a 1 1/4" hose. (Table 5-3 shows that a pressure of 26.4 psig. at the nitrogen manifold will provide an injection rate of 273 cu. ft. per minute through the 50 feet of 1 1/4" I.D. hose.)
- (5) Inject natural gas immediately following the nitrogen, maintaining at least 19.2 psig. on the gauge at the bypass fitting,

closing nitrogen manifold valve as gas bypass valve is opened. Progress of the purge may be followed by observing. Stop injection of gas when combustible gas indicator at vent indicates essentially 100 percent gas.

- (6) Close vent.
- (7) During tie-in, the following precautions should be observed to keep air from entering line.
 - (a) A very slight positive internal pressure should be maintained while cutting and welding. Before cutting the line, drill or torch cut a small test hole at the work site to verify that internal pressure can be controlled. Verify control by observing flame height at test hole while adjusting slight input of gas through a small bypass. If there is leakage of gas at isolation points, the pressure can be controlled by adjusting vent stack valves while observing flame height at the test hole. If infiltration is excessive, a venturi type exhaustor can be used on the vent stack.

- (b) All cuts in the pipe should be progressively mudded during torch cutting leaving no more than a few inches of cut open at a time.
- (c) When a pipe is opened to the atmosphere, the open ends should be immediately covered by some appropriate closure.

- (d) All joints should be taped as soon as the pipe is in place.
- (e) The air which gets into the pipe in spite of the foregoing precautions should be purged from the bottom of a joint before welding is done. The completeness of the purge, essentially 100 percent gas, should be checked by an instrument.

Table 5-4. NITROGEN REQUIRED FOR INERT SLUG

Pipe Size (inch)	Pipe * Volume per Foot (CF/ft)	Minimum Slug Velocity (ft/min)	Injection Rate (CFM)	Cubic Feet of Nitrogen for an Inert Slug Pipe Length in Feet						
				500	1000	2000	5000	10000	20000	50000
4	0.09	125	11	19	23	29	40	53	71	107
6	0.22	130	29	46	56	70	98	129	173	261
8	0.37	150	56	77	94	117	164	217	291	439
10	0.58	165	96	121	147	184	257	340	457	688
12	0.83	180	149	173	211	263	368	486	653	985
16	1.3	210	273	280	342	430	605	802	1,080	1,632
18	1.67	220	367	360	440	553	777	1,030	1,387	2,097
20	2.08	235	489	448	548	689	968	1,283	1,728	2,611
22	2.51	245	615	541	661	831	1,168	1,548	2,085	3,151
26	3.51	265	930	757	925	1,162	1,633	2,165	2,916	4,406
30	4.67	285	1,331	1,007	1,230	1,546	2,173	2,880	3,880	5,863
34	5.97	305	1,821	1,400	1,733	2,204	3,137	4,189	5,677	8,630
36	6.72	315	2,117	1,576	1,951	2,480	3,531	4,716	6,391	9,714

*100 ft of additional pipe line volume is included.

FIGURE 5-12 TYPICAL PROCEDURE FOR REPLACEMENT OF NATURAL GAS WITH AIR UTILIZING SLUG PURGE

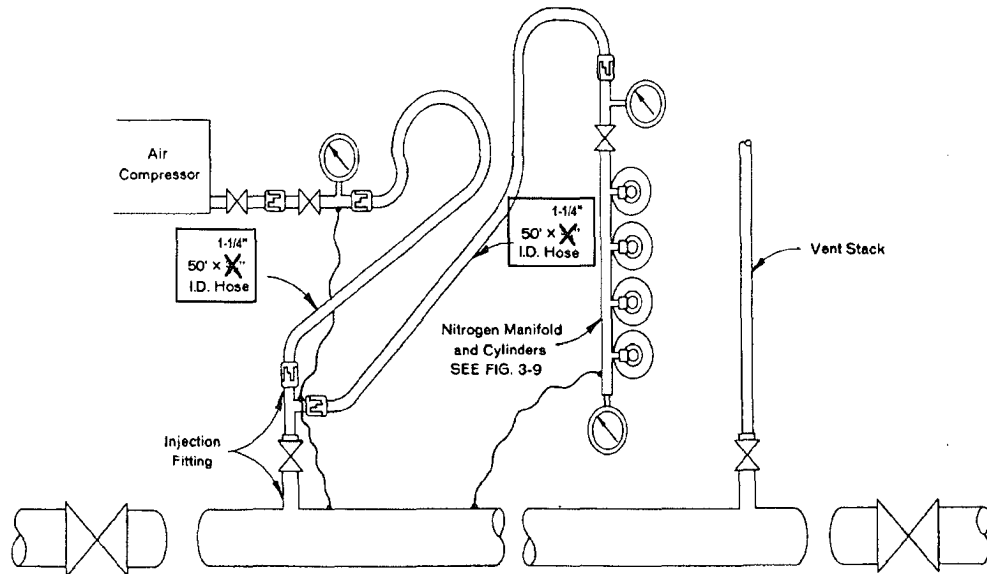

Example:

Replace the natural gas with air in a section of 16" pipe 5,000 feet long utilizing an inert gas slug purge to limit formation of a flammable mixture.

(1) Install vent stack.

(2) Install connection to inject nitrogen and air. Table 5-4 shows that 605 cu. ft. of nitrogen (just slightly over three cylinders) will be needed. To maintain a minimum purge velocity of 210 feet per minute (see Table 5-4) the corresponding injection rate for either the air or nitrogen is 273 cu. ft. per minute. For air injection, three 105 cfm air compressors are required. Table 5-3 shows that a pressure of 26.4 (interpolated) psig at the nitrogen manifold will provide an injection rate of 273 cu. ft. per minute through the 50 feet of 1 1/4" I.D. hose. Only three cylinders of nitrogen will be needed to

provide the 590 cu. ft. required for the higher purge velocity.

(3) Isolate pipe segment to be purge; blow down to atmospheric pressure and leave vent stack open.

(4) Inject cylinders of nitrogen, maintaining a pressure of 26.4 psig. at the nitrogen manifold.

(5) Inject air immediately following the nitrogen, maintaining at least 26.4 psig. on the gauge at the inlet to the air hose, closing the nitrogen manifold as the air valve is opened. Progress of the purge may be monitored with a multi-gas monitoring instrument at the vent stack.

(6) Stop injection of air when oxygen indicator at vent indicates 20.8 percent oxygen or higher.

(7) Close vent.

REFERENCES

GRI-97/0104 Johnson, J.E., Svedeman, S.J. and Kuhl, C.A., "Pipeline, Purging Principles and Practices Research," Southwest Research Institute, January 1997.

CHAPTER 6
LIQUIFIED NATURAL GAS FACILITIES

SECTION	PAGE #
6.1 Introduction	84
6.2 LNG Metal Tanks	84
6.3 LNG Pre-Stressed Concrete Tanks	90
6.4 LNG Plant Piping and Process Equipment	93
6.5 Shop Fabricated LNG Pressure Tanks	96
6.6 LNG Transport	100
FIGURES	
6-1 Open Top Inner LNG Tank	85
6-2 Gas Tight Inner LNG Tank	87
6-3 Double Wall Sphere	88
6-4 LNG Tank- Cross-Section	91
6-5 Expander- Compressor Schematic	94
6-6 CO ₂ Absorber Schematic	96
6-7 Liquefied Natural Gas Transport	98
6-8 Schematic for LNG Transport	99

CHAPTER 6 LIQUIFIED NATURAL GAS FACILITIES

6.1 INTRODUCTION

The purging of liquefied natural gas (LNG) metal tanks, pre-stressed concrete tanks, plant piping, process equipment and transports is done to prevent the presence of a combustible gas-oxygen mixture in the tank proper and in the insulated spaces. Safe purging operations require a basic knowledge of the principles regarding the formation, analysis and control of

the gas mixtures. A well-prepared written procedure detailing the sequence of events, the control of the purge medium and a well-defined end-point are important elements of a successful purging operation. The following sections will present guide material for the purging of metal and concrete tanks, piping and process equipment and transport facilities.

6.2 LNG METAL TANKS

6.2(a) GENERAL CONSIDERATIONS

A detailed and specific written purging procedure, including the tank designer's recommendations, should be prepared for each individual tank. Everyone in the crew should be familiar with the hazards of oxygen deficiency. Care must be taken to ensure that oxygen deficient pockets do not build up in the work area, especially where exhaust nozzles are at ground level. If weather conditions are such that the air is still, forced ventilation of the work area should be considered.

The purging gas selected should be inert and dry and available in sufficient quantities. Liquid nitrogen is a preferred source of inert gas because when vaporized it satisfies the above requirements and is compatible with LNG storage temperatures. Where the inert gas is not temperature compatible with LNG storage temperatures, it must be displaced with natural gas prior to cool down.

There should be a physical isolation between the tank and any possible source of flammable gas or liquid until the tank is purged. A physical isolation exists when the piping is blanked or physically separated and sealed such that an air gap exists.

Immediately prior to introducing a flammable product, the atmosphere in the tank should be sampled and the inert purge verified.

6.2(b) PURGING INTO SERVICE METAL OPEN TOP INNER TANKS

An open top inner tank is shown in Figure 6-1. The LNG is contained in the inner tank that is surrounded by an annular space containing insulation. An insulated deck or roof is located above the inner tank. In some designs, the roof is suspended from the outer tank roof. The annular space and the volume above the insulated roof will contain natural gas when the tank is in service since this space is in communication with the inner tank through open vents, which are placed in the insulated deck.

The tank can be broken down into six different spaces or areas that require purging when removing the tank from service or when putting the tank into service. The six areas are:

- (1) Liquid container;
- (2) Vapor space in the dome roof;
- (3) Perlite in the side wall;
- (4) Resilient blanket in the side wall;
- (5) Load-bearing insulation;
- (6) Insulated deck.

The liquid container is generally purged by a combination of two mechanisms; namely, first displacement (sometimes called pistoning) and second, dilution. The vapor space in the roof is purged in the same manner.

The side wall insulation space, which contains the perlite, is somewhat more complicated because the perlite is a granular and finely divided material with vapor in the void spaces and methane absorbed onto the surface of the perlite particle. In order to purge the space, the gas in the void spaces and the gas that is absorbed on the perlite particles must be removed. The purge mechanisms used are displacement, dilution and diffusion. In addition, the methane which is absorbed onto the

perlite surfaces is a function of the temperature of the perlite. To remove methane, the temperature of the bed of perlite must be warmed up to near ambient.

The resilient blanket, which makes up part of the material in the sidewall, also has void spaces. However, these spaces are quite open and flowing gas through the fibrous structure is relatively easy. Actually, one of the problems encountered in purging the sidewall is the fact that gas will preferentially flow through the fiberglass blanket.

The insulating foundation is a tight structure with very few void spaces and consequently there are few places to purge. The sand layer directly underneath the liquid tank bottom, which is porous, can be readily purged.

The deck insulation, whether it be perlite or mineral wool, is supported on the deck structure at the top of the liquid container. There is no way built into the structure to force gas by differential pressure to pass through the insulation material on the deck. Consequently, the principle mechanism for purging the

suspended deck insulation is diffusion and perhaps some displacement.

The procedure includes the following steps:

(1) Arrangements should be made to procure a supply of inert purging medium. If the supply is in liquid form, a vaporization system should include a pressure indicator and a temperature indicator downstream of the vaporizer and a throttling valve to control the flow into the tank being purged. If the inert purging medium contains water vapor, a drying system is required. If nitrogen is being used as the medium and if 9.7 percent by volume oxygen is the required end-point, then theoretically, enough nitrogen is required to displace 54 percent of the air in the tank. In practice, however, the required volume of nitrogen gas ranges between 100 percent to 150 percent of the volume to be purged. The additional volume is required because of mixing and diffusion between the nitrogen purge gas and the air being purged from the tank.

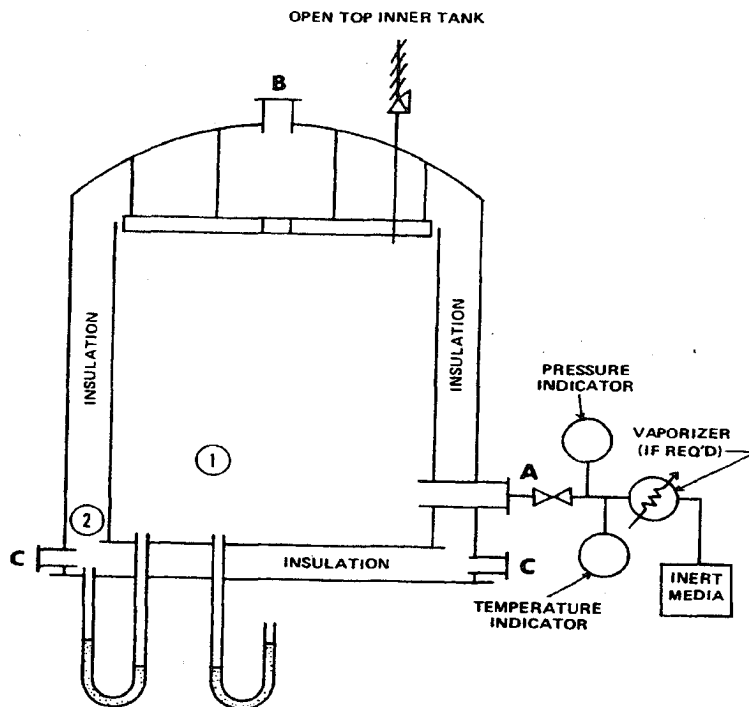

FIGURE 6-1

A set of data should be taken prior to start of the purging operation. During purging operation, periodic readings should be taken of tank pressure; pressure difference between the inner tank and the annular space; approximate flow rates; vent gas composition at point "B" (refer to Figure 6-1); the total quantity of purging medium being used; and water dew point readings.

As shown in Figure 6-1, purging begins with the introduction of the medium into nozzle "A" at or near the bottom of the inner tank. If no bottom penetrations are available, the purge gas should be introduced through a nozzle, which has an extension inside the tank that terminates at or near the bottom of the inner tank. This may be a product pump discharge outlet, for example. The displaced air is purged through nozzle "B" at top of the tank. It is recommended that the inner tank should be purged first; and, thus, nozzle "C" on the annular space should be closed during the purging of the inner tank. Manometers should be connected to read the inner tank pressure and the pressure difference between the inner tank and the annular space, as shown in Figure 6-1. Care must be taken not to exceed the design pressure of the tank during purging operations. Tank safety valves should be in operation during the purging operations.

(2) When the inner tank is to be purged, the inert purging gas should be admitted at ambient temperature and at approximately 10 to 20 percent of the full rate to the bottom of the tank. If the inert purge gas has a specific gravity equal to or less than air, such as nitrogen, it is suggested that a "buffer" zone of purge gas at ambient temperature be established. From the dew point, the minimum temperature at which the nitrogen should initially enter the tank can be determined. The "buffer" zone will aid in preventing the condensation of water vapor from the air by the cold nitrogen. After several hours, the purging rate may be increased to the full rate and the purge gas may be introduced at a colder than ambient temperature. The cold nitrogen also will facilitate the piston effect of the purge gas due to its higher density.

(3) Continue purging in this manner until the desired end-point is obtained at nozzle "B".

(4) Upon obtaining the desired end-point condition in the inner tank, nozzle "B" is closed and nozzle "C" in the annular space opened to commence purging of the annular space downward. Purging in this manner maintains a positive pressure difference between point 1 and 2 across the bottom of the inner tank. It is important to maintain the inner tank at a higher pressure than the annular space to avoid lifting the inner tank bottom. If it becomes necessary to purge upward through the annular space, the annular space pressure at point 2 must not exceed the inner tank pressure by more than a very few inches of water column. The storage tank designer should be consulted to establish this maximum allowable pressure differential.

Purging should be continue downward through nozzle "C" until the desired end-point is obtained at all the nozzles "C". There should be enough purging nozzles "C" provided to ensure there is not channeling of flow within the annular space insulation, taking into consideration the height and diameter of the tank and the proposed purging flow rate. A method to check for channeling is to stop the annular space purge for a period of hours and then start again. If the oxygen concentration has increased when the purge is resumed, channeling is taking place and purging should continue. Channeling will give a low oxygen reading and it would not be apparent in a continuous purge.

After the desired end-point is obtained, the purging supply may be disconnected and the nozzles closed. It is suggested that after a period of time, the atmosphere in the tank again be sampled.

If the tank is to remain in an inerted state for a length of time before natural gas is to be admitted or it is to be cooled down with LNG, a positive pressure must be maintained within the tank.

Purge all lines connected to the tank up to the physical disconnections. At this time, the tie-ins to the tank may be made.

If natural gas is to be admitted to the tank prior to cool down, care must be taken to use dry natural gas. If the air was purged from the tank with nitrogen, it will only be necessary to displace the nitrogen in the inner tank with natural gas. This may be accomplished by admitting natural gas

through nozzle "B" at the top of the tank and venting the inert gas through nozzle "A" at the bottom of the tank. The nitrogen may be allowed to remain in the annular space to eventually diffuse and be replaced by natural gas vapor. If the annular space was previously purged with CO₂, it will be necessary to displace the CO₂ with natural gas or nitrogen prior to tank cool down. This is because the carbon dioxide may solidify and possibly impair the insulation adjacent to the inner tank when the tank is cooled down to LNG storage temperature.

As an alternative to displacing the nitrogen from the inner tank with natural gas, the inerted LNG tank also may be cooled down directly with LNG following the manufacturer's specifications.

6.2(c) PURGING INTO SERVICE METAL DOUBLE WALL GAS TIGHT INNER TANKS

The double wall gas tight inner tank, shown in Figure 6-2, consists of an inner tank for storage of LNG and an outer tank to contain insulation completely around the inner tank. The

same general precautions as outlined in Section 6.1 also should be applied to purging the double wall tank.

The procedure includes the following steps:

(1) The inner tank is purged first, employing a procedure similar to that recommended for the open top inner tank (Section 6.1). Upon completion, a positive pressure should be maintained in the inner tank.

(2) After the inner tank is purged and closed off, the out tank is ready to be purged. Begin admitting the purging gas to the purge nozzles at point "C". Enough nozzles must be provided to assure a good flow distribution up the annular space and out the nozzle at point "D" near the center of the outer roof. This distribution also may be accomplished by use of a purge ring around the bottom of the annulus. A positive differential pressure should be maintained between points 1 and 2, as observed on a manometer connected to these points (refer to Figure 6-2). It is necessary for the inner tank to be at higher pressure than the outer tank so that an uplift is not created on the

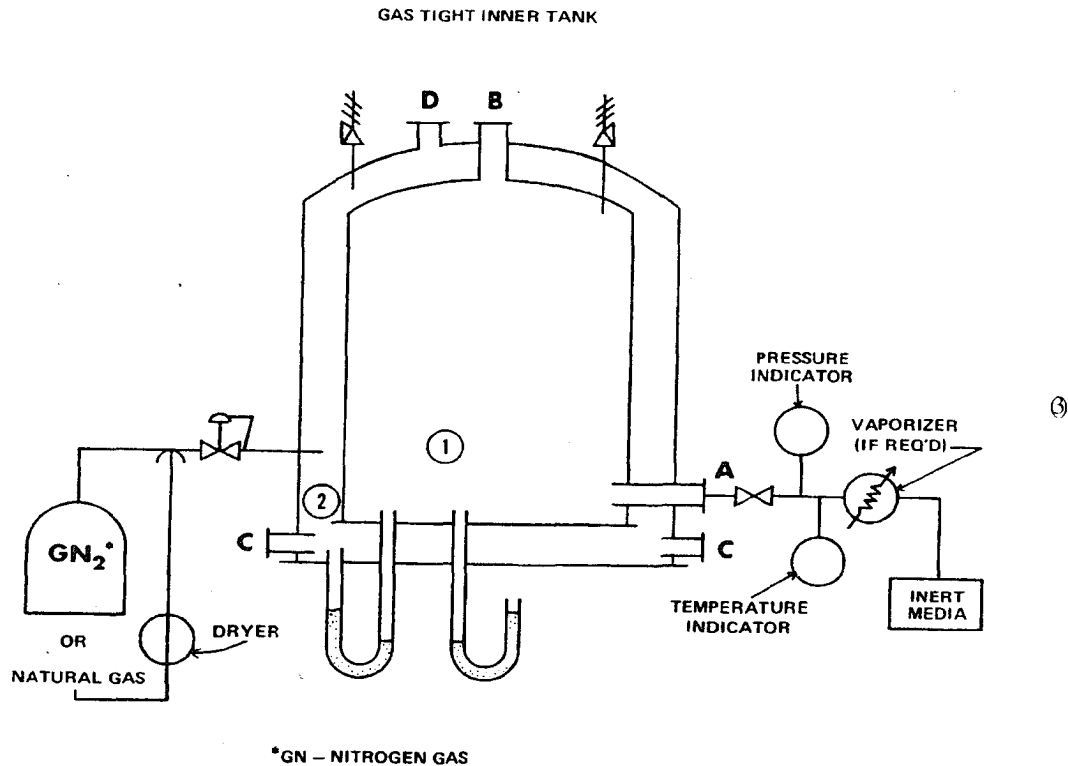

FIGURE 6-2

tank bottom. Purging of the outer tank should continue until the required end-point has been reached at nozzle "D". A sufficient number of sample points may be installed around the periphery of the top of the tank to ensure that flow channeling is not taking place. A method to check for channeling is to stop the annular space purge for a period of hours and then start again. If the oxygen concentration has increased when the purge is resumed, channeling is taking place and purging should continue. Channeling will give a low oxygen reading and it would not be apparent in a continuous purge. The direction of purging flow in the annular space of a double wall gas tight inner tank is opposite to that of an open top inner tank. If there is only one sensing penetration on the top of the tank, there is no way of checking for flow channeling.

Consequently, in this or similar situations, it may be desirable to introduce the purging gas at the top of the tank. At this point, the system for maintaining pressure in the annular space should be connected to the out tank. The inner tank is then ready to receive dry natural gas or be cooled down with LNG following the manufacturer's specifications.

6.2(d) PURGING INTO SERVICE DOUBLE WALLED SPHERES

The double wall sphere is essentially a sphere within a sphere, where the inner sphere shown in Figure 6-3, is the only one subjected to the cryogenic temperatures and pressures of the LNG in storage.

The outer sphere serves as a vapor-tight container minimum by utilizing a loose fill perlite and high vacuum insulation system in the annular space. The same general precautions as outlined in Section 6.1 should be applied.

The procedure includes the following steps:

During the purging operation, periodic readings should be taken of instrumentation monitoring the purge. This should include purge gas pressure, approximate flow rate, the tank pressure, the vent gas composition and the total quantity of purge gas used up to that time.

Although the density of the purge gas may be slightly less than air, there are certain advantages in introducing it at the bottom of the inner sphere. Because an oxygen deficient atmosphere is dangerous, the vented gases must be safely exhausted. Venting high in the air best accomplishes this.

Install a thermometer and a pressure gauge as shown in Figure 6-3. Begin admitting about 10-20 percent of full purge rate at ambient temperature to the inner tank at nozzle "A" and vented at "B". Be certain that the maximum allowable tank pressure is not exceeded during purge. The purge gas can be admitted at a colder temperature after allowing several hours to build up a "buffer" zone that prevents cold purge gas from condensing water vapor in the air.

If nitrogen is used and 9.7 percent oxygen is the desired end-point, then 100 to 150 percent of the tank volume will be required.

If cool down is to follow within a day or two, the safety valve can be left open and a very slow nitrogen bleed continued to keep air from entering the tank. If the final product purge is

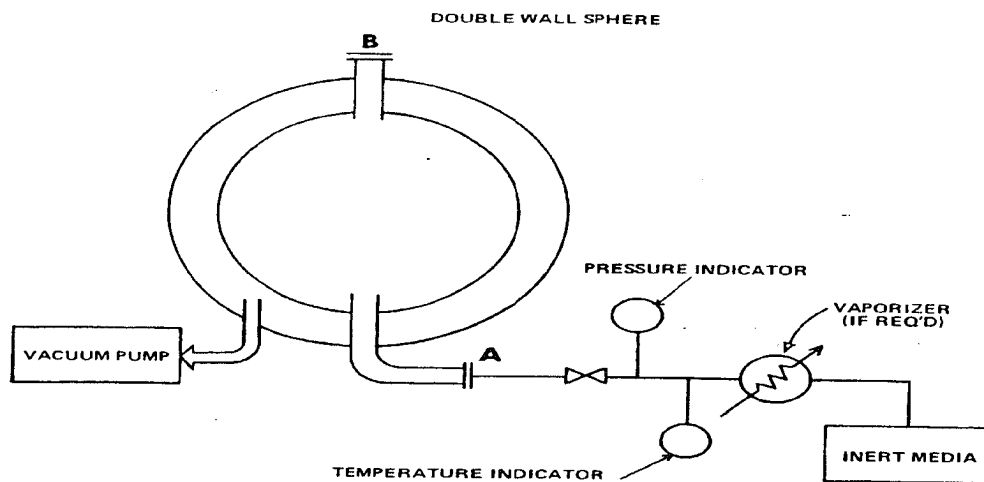

FIGURE 6-3

not to occur for some time, it is advisable to close the safety valve to conserve nitrogen and maintain a positive pressure in the inner sphere.

6.2(e) PURGING OUT OF SERVICE METAL OPEN TOP INNER TANKS, DOUBLE WALL GAS TIGHT INNER TANKS AND DOUBLE WALL SPHERES

(Also applies to Purging Pre-Stressed Concrete LNG Storage Tanks Out of Service-See Section 6.3(e))

In the event that it is necessary to take a LNG tank out of service, a detailed and specific written purging tank procedure, including the tank designer's recommendations, should be prepared for each individual tank.

The procedure includes the following steps:

Remove as much LNG as possible by pumping to another storage tank, a vaporization system or a truck terminal. If it is not possible to empty completely the contents of a tank by pumping, the remaining LNG may be disposed of by introducing warm dry natural gas or nitrogen to vaporize the LNG in the tank.

If it is necessary to warm the tank, introduce either warm dry natural gas or nitrogen to the bottom of the inner tank and discharge the effluent from the top of the tank through the vapor withdrawal line or other lines terminating below the insulated roof. Caution should be exercised in introducing the warm gas at a rate that will avoid exceeding tank design pressure and creating excessive temperature differences in the tank bottom. The designer should be consulted to establish these allowable differences. Continue introducing warm gas until the bottom of the tank has warmed to the point where liquid residuals such as propane, butane or heavier hydrocarbons are no longer sustained. A positive pressure should be maintained in the tank with natural gas until the inert purge gas system has been connected and is ready to operate.

Before introducing the inert purge gas into the tank bottom, the tank should be physically disconnected from any source of natural gas or LNG. Introduce the purge gas at the tank bottom and continue venting until the desired end-point is obtained at nozzle "B". It should be remembered that LNG is a mixture of hydrocarbons including methane, ethane, butane, propane and heavier elements. The combustible gas end-points for the individual constituents

should be obtained from Chapter 2. It is suggested that the lowest end-point be obtained at the sample point to signify completion of the inner tank purge.

6.2(f) PURGING OUT OF SERVICE OPEN TOP INNER TANK INSULATION SPACE

When the inner tank has been inerted, the annulus should be inert gas purged by opening the nozzles at "C" (see Figure 6-1) and allowing the purging gas to remove the natural gas in the annular space. This is done to ensure that no uplift of the tank floor occurs. It is recommended that enough nozzles be provided to ensure a good flow distribution rate and that gas samples be taken at enough points to assure a uniform purge to the desired end-point. If repair work is to be done on the inner tank bottom of a double wall metal tank, appropriate end-point measurements will be needed for the bottom insulation space. The tank designer should be consulted for the proper procedure.

6.2(g) PURGING OUT OF SERVICE DOUBLE WALL GAS TIGHT INNER TANK INSULATION SPACE

The insulation space should be purged from the bottom through nozzle "C" and vented at the top of the tank through nozzle "D" (see Figure 6-2). See paragraph 6.2(f) for purging of bottom insulation.

6.2(h) PURGING OUT OF SERVICE DOUBLE WALL SPHERE INSULATION SPACE

(1) If it is a vacuum jacketed insulation space, the vacuum should be broken by slowly admitting a suitable inert purge gas to the insulation space until atmospheric pressure is reached.

(2) Sample the insulation atmosphere. If the desired end-point has not been attained, re-evacuate the insulation space and repeat step 1.

6.2(i) INERT GAS TO AIR – INNER TANKS

In some cases, it may not be practical to repair the tank when it is under an inert gas atmosphere. It is then necessary to purge the

inert gas with air. Referring to Figure 6-1, open vent "B" and introduce clean air into the bottom of the tank at nozzle "A" at the highest practical rate. Care should be taken not to exceed the maximum tank design pressure or pressure differential. Continue this operation until the sample taken at nozzle "B" indicates an oxygen content of approximately 21 percent by volume. The inner tank atmosphere should be continuously monitored during the entire repair operation. Continuous ventilation of the inner tank also is advisable.

6.2(j) INERT GAS TO AIR – INSULATION SPACE OPEN TOP INNER TANK

When the inner tank has an air atmosphere, the annular space may be purged to air by opening the nozzles at "C" (Figure 6-1). Fresh air should be continuously admitted to the inner tank through nozzle "A". It may be necessary to utilize a system of blowers or gas jet compressors to "pull" the air from the inner tank, down the annular space and out nozzles "C". The exhaust from nozzle "C" should be stacked to prevent an oxygen deficient atmosphere from developing in a working area. This operation should be continued until the samples indicate a uniform "air" atmosphere (21 percent oxygen by volume) within the annular space. If it is practicable, the ventilation of the annulus should continue for the entire repair operations. The annulus should be continuously monitored during the entire repair procedure. Care should be taken not to exceed maximum allowable pressures or pressure differentials during the operations.

6.3 LNG PRE-STRESSED CONCRETE TANKS PURGING INTO SERVICE

6.3(a) GENERAL

The purging of LNG pre-stressed concrete tanks is done to prevent, at any time, the presence of a combustible gas-oxygen mixture in the tank proper and in the insulated spaces.

The procedure for purging into service pre-stressed concrete LNG storage tanks differs from the procedure for metal tanks because during the inert gas purging operation, consideration must

6.2(k) INERT GAS TO AIR – INSULATION SPACE DOUBLE WALL GAS TIGHT INNER TANK

Referring to Figure 6-2, air can be introduced at nozzles "C" and exhausted at nozzles "D" on top of the tank. Enough nozzles should be provided to assure a good flow distribution. Care should be taken to assure that maximum allowable pressures and pressure differentials are not exceeded. A system employing aspirators or air blowers can be used to provide the airflow. Sufficient sampling should be made to assure a uniform 21 percent by volume oxygen content in the annular space. The annular space should be continuously monitored during the repair operation. It is advisable also to maintain the ventilation operation during this period of repair.

6.2(l) INERT GAS TO AIR – INSULATION SPACE DOUBLE WALL VACUUM JACKETED SPHERE

The inerted insulation space should be evacuated and the vacuum broken by slowly admitting air to the insulation space. Samples should then be taken until oxygen content is 21 percent by volume and the procedure repeated if necessary.

Continuous monitoring should be employed for the repair period. Care should be taken to assure that allowable pressures and pressure differentials are not exceeded.

be given to the control of moisture retained in the tank walls.

A detailed and specific written purging procedure, including the tank designer's recommendations, should be prepared for each individual tank.

The start of the purging operation constitutes the end of construction and the beginning of placing tank into service. No further entry into the tank is possible. The purging operation includes the reduction of the oxygen content

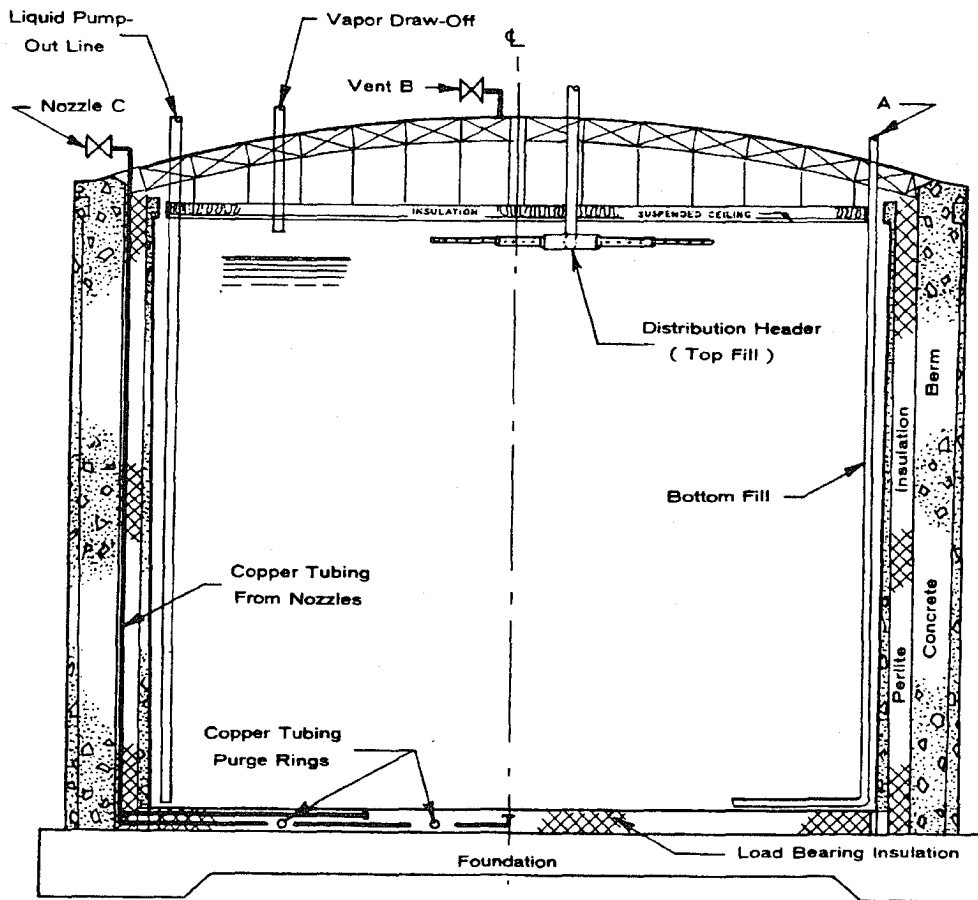

FIGURE 6-4

within the tank to the desired end-point as defined in Chapter 2, the removal of moisture (reduction of dew point temperature) and optionally, the replacement of inert purge gas with natural gas.

There should be a physical disconnection between any possible source of flammable gas and/or liquid in the tank until the tank is purged. A physical disconnection exists when the piping is separated and sealed so that an air gap exists.

Inert purge gas should be manifolded to the inner tank through lines that terminate near bottom of the tank. (See Figure 6-4)

Ambient dry natural gas may be introduced into the inner tank after the air has been replaced with inert gas and the desired end-point has been reached. The purged condition should be maintained until the start of the cool down operation. Just prior to introducing the flammable product, the tank atmosphere should be sampled and the inert purge verified. Provide all necessary operating personnel for manual operation and monitoring of all equipment,

valves and instrumentation during the purging operation.

Provide all temporary supply connections, vaporizers and appurtenances necessary for adequate supply of purge gas during the purging operation.

6.3(b) INERT PURGE GAS, INSTRUMENTS and EQUIPMENT

A volume of inert gas, approximately 100 percent to 150 percent of the volume to be purged, is required. If the inert purging medium contains water vapor, a drying system is needed. After attaining the desired end-point, additional quantities may be required to lower the moisture content of the inner tank atmosphere. Furnish, calibrate and install the following instruments:

- (1) Gas flow meter for continuously indicating, recording and totalizing of purge gas supply;
- (2) Pressure gauge(s) for monitoring internal tank pressure during purging;

- (3) A manometer, if necessary, to monitor differential pressure between inner tank and annular space;
- (4) Portable oxygen analyzer and sample bulb to take sample in the tank and monitor the oxygen content of the purge outlet gas;
- (5) Portable dew point instrument for periodic indication of internal tank dew point temperature.

6.3(c) PREPARATION OF TANK AND PERSONNEL

Supervisory and operating personnel should be adequately instructed on the purging procedure specified and the operation of equipment used for purging. Inspect the inner tank to ensure that all free water, condensate, dirt, debris and other foreign material have been removed to the fullest extent.

Install temporary purge piping as necessary to ensure adequate inert purge gas supply.

All block valves for pressure relief devices should be fully open and relief devices fully operational.

6.3(d) PROCEDURE

- (1) It is recommended that tank purging be an uninterrupted operation with a positive pressure maintained within the tank until the start of cool down.
- (2) A set of data should be taken prior to start of the purging operation. During purging operation, periodic readings should be taken of tank pressure; pressure difference between the inner tank and the annular space; approximate flow rates; vent gas compositions at purge outlets and at other locations within the tank as specified; total quantity of purging medium being used; inner tank dew point.
- (3) Care should be taken not to introduce purge gas at a temperature below the dew point.
- (4) Purge gas flow rate through the vent valve should be such that a constant positive internal tank pressure is maintained. Monitor tank pressures every thirty minutes via remote and local pressure instruments,

watching differential pressure manometer, total flow and tank pressure.

(5) Inspect periodically to ensure integrity of temporary piping and instrumentation and to ensure that no abnormal conditions exist.

(6) As the purging proceeds, temperature of the purge gas may be reduced to a point equaling the average dew point temperature of the least set of samples.

(7) If the inert purge gas supply temperature is decreased, monitor the inner tank thermocouples. Do not permit a temperature reduction that would cause the differential temperatures across the concrete wall and between the wall and floor to exceed the tank designer's specifications.

(8) When the inner tank end-point is reached at nozzle "B" (Figure 6-4), open the insulation space purge nozzles "C" and close vent "B". Continue purging until samples taken at each purging nozzle indicate the desired end-point. Then interrupt the flow of inert purge gas and seal the tank. Following a designated period of time, take a complete set of samples. If all samples indicate the desired end-point, tank purging shall be considered complete. Care should be taken to maintain a positive pressure within the tank after completion of purge.

(9) If it ever becomes necessary to purge upward through the annular space, the tank designer should be consulted to establish the maximum allowable pressure differential between the annular space and the inner tank.

(10) Purge all lines connected to the tank up to the physical disconnects.

(11) After all lines from the natural gas supply to the physical disconnects have been purged, the tie-ins to the tank may be made.

6.3(e) LNG PRE-STRESSED CONCRETE TANKS PURGING OUT OF SERVICE

As this procedure is essentially the same as that recommended for purging out of service open top inner tank metal LNG tanks, the procedure given in Section 6.2(e) should be followed.

6.4 LNG PLANT PIPING AND PROCESS EQUIPMENT

6.4(a) GENERAL

This section discusses general consideration and gives some specific examples that can be used in purging LNG plant piping and equipment.

Since every LNG plant is unique in its design and layout, there can be no universal purge procedure. However, there are some general precautions that should be noted regardless of the type of facility or the magnitude of the purge project. For example, precautions should be taken to eliminate all traces of residual hydrostatic test water prior to or during purge to avoid later problems of freezing and ice damage to facilities.

Although nitrogen is generally the best of the inert purge gases for LNG applications, it is not a cure-all. Small quantities of nitrogen left in cascade or mixed refrigerant streams can reduce the system efficiency. Carbon dioxide and dry purge gas from an inert gas generator can be used if these gases can be completely replaced by clean, dry natural gas and if contaminated, pretreatment systems can be regenerated to dispel absorbed CO₂.

A detailed purge procedure should be prepared for each purge project. All personnel involved in the project should be familiar with the procedure and the hazards of oxygen deficiency, fire and explosion.

6.4(b) INITIAL LNG PLANT PURGE

(1) Prior to inert gas purging of a new plant, a detailed procedure should be written. The plant should be checked to see if it is physically disconnected from all sources of flammable gases and liquids. All bolts on flanges and valve packing should be checked for tightness. Drain valves and bleeds should be checked for obstructions such as dirt or ice. All valve stems should be lubricated and all valves closed.

(2) Since most LNG plant systems contain check valves, it is generally easier to purge the plant and/or subsystems in the direction of normal flow.

(3) Because of the complexity of plant piping systems, the inert gas purge is best

controlled by starting at the plant inlet and inert gas purging the first section of pipe or vessel completely before opening the next valve. Although this method of purging requires more testing and effort than a straight-through purge of the whole plant, it provides the safest overall approach. New plant design and construction can be planned to provide installation of enough drains and bleeds to handle future purges in this manner.

(4) After the inert gas purge of the plant is completed, the piping should be connected to the natural gas piping, the inert gas in the gas treatment systems should be displaced with natural gas and the natural gas treatment systems started. This provides clean, dry natural gas for completing the purge on the remaining systems and the tanks.

6.4(c) VESSELS CONTAINING PERLITE, MOLECULAR SIEVES AND ACTIVATED CHARCOAL

There are two major problems in purging these types of vessels. First, they require more time and purge gas than do empty vessels. Second, it is almost impossible to eliminate all the natural gas or air previously contained in the vessels and absorbed by the solid matter. This means that if a vessel of this type is purged out of service, disconnected and opened, it is necessary to blow inert gas or air through the unit and monitor the vented gases carefully to ensure that an explosive mixture does not develop in the vessel during the maintenance operation. It may be necessary to remove carefully the solid matter containing absorbed natural gas in order to purge successfully such vessels to a safe level.

6.4(d) PURGING AN EXPANDER – SAMPLE PROCEDURE

6.4(d)(1) General

There are a few unique aspects in purging expander-compressors and centrifugal compressor units that must be considered.

In general, these units have auxiliary piping such as seal gas and lube oil systems that cannot be ignored when purging.

Care must be taken to keep the inert gas pressure and flow rate through the unit to a level which will prevent the rotation of the shaft while the lube system is out of service.

Since the volume of these units is relatively small, they can be flushed out with clean, dry natural gas very easily after purging. This permits the use of any purge medium that will not leave a residue in the unit or contaminate the lube oil system.

6.4(d)(2) Purging Out of Service – Gas to Air

PRELIMINARY PREPARATION

- (1) De-energize all electrical circuits to the unit.
- (2) Inspect inert gas hoses, piping and apparatus. Blow inert gas through them to prevent moisture, dirt and other contaminants from entering the unit.
- (3) Install inert connections on vent valve 1 and 5. (Figure 6-5)

- (4) Reduce gas pressure in and around the unit to the lowest positive pressure possible before venting the contents to atmosphere.

PURGING

- (5) Close the expander and compressor inlet and out valves A, B, C and D.
- (6) Open vent 2 and 6 and reduce the pressure in both sides of the unit to approximately 0.5 psig. Close the vents and check for pressure buildup due to leakage.
- (7) If there is no leakage, reopen vents 2 and 6.
- (8) Slowly introduce inert purge gas through valves 1 and 5 while venting through valves 2 and 6. **Warning:** Excessive inert flow could spin the rotating element and cause bearing damage.
- (9) As the desired end-point is approached, break a union or open a vent valve in the seal gas and the lube oil vent lines.
- (10) When the desired end-point has been reached at all vent points, stop the flow of inert gas and open the unit to atmosphere.
- (11) Physically disconnect the unit if it is to be out of service for an extended period.

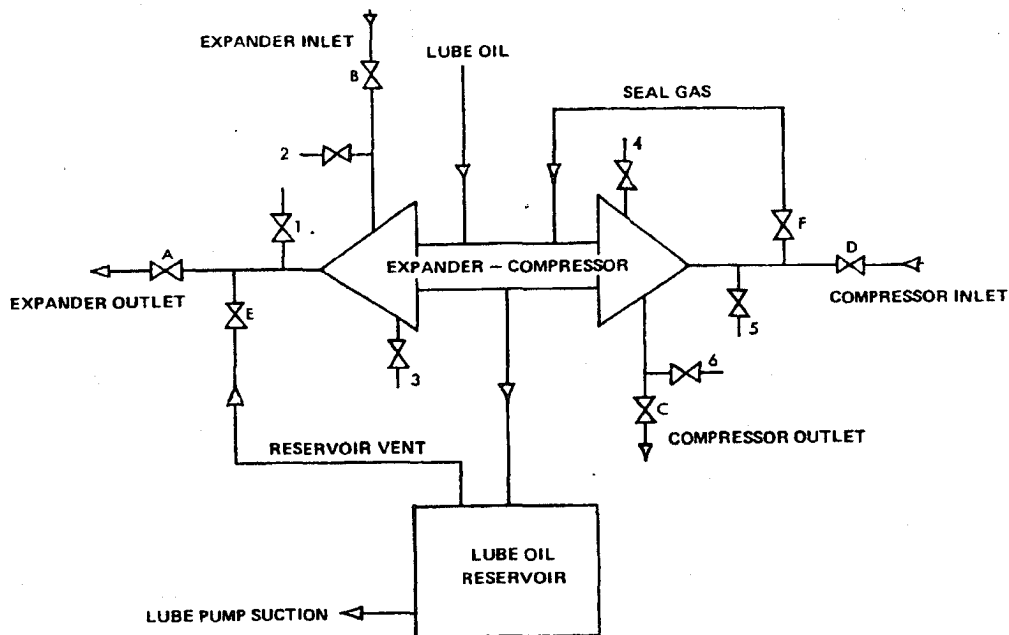

EXPANDER - COMPRESSOR SCHEMATIC

NOTE: Arrows indicate normal process flow.

FIGURE 6-5

6.4(d)(3) Purging Into Service – Air to Gas

PRELIMINARY PREPARATION

- (1) Reduce the gas pressure in the adjacent piping to the lowest positive pressure possible before venting the contents to atmosphere.
- (2) Install vents, gauges and inert connections if they were removed.

PURGING

- (3) With the unit still physically disconnected, slowly introduce the inert gas through valves 1 and 5, taking care not to spin the rotating element.
- (4) Test the purged gases at vent 2 and 6 and at the bleeds in the seal gas and lube oil vent lines. When the desired end-points have been reached, reconnect the piping.
- (5) Stop the inert gas flow to the unit.
- (6) Slowly open valves A and D and displace the inert purge gas with clean natural gas.
- (7) Close vents 2 and 6.
- (8) Remove all vents and inert hoses and piping. Plug all bleed valves used.
- (9) Energize all electric circuits to the unit.
- (10) The unit is now ready for operation.

6.4(e) PURGING A CO₂ ABSORBING TOWER SAMPLE PROCEDURE

6.4(e)(1) General

Purging much of the LNG plant equipment presents a problem not only in the displacement of air or natural gas, but also in the elimination of flammable and/or toxic vapors from process liquids normally contained in the units. These liquids could be pretreatment solutions such as methanol or condensates such as odorant, heavy hydrocarbons or LNG itself.

6.4(e)(2) Purging Out of Service – Gas to Air

PRELIMINARY PREPARATION

- (1) Bring the temperature of the tower to ambient temperature.
- (2) Drain all methanol from the vessel.
- (3) Pass warm natural gas through the tower to evaporate and carry off as much methanol vapor as possible. Care must be taken not to contaminate other parts of the plant with the methanol-laden natural gas. This gas may have to be vented and flared, or the methanol could be evaporated and vented with the inert gas later on in the purge.
- (4) Install an inert purge gas connection on valve 2 and a vent connection on valve 1. (Figure 6-6)
- (5) Reduce the gas pressure in the vessel and adjacent piping to the lowest positive pressure possible without venting to atmosphere.

PURGING

- (6) Close methanol inlet and outlet valves A and B and gas inlet and outlet valves C and D.
- (7) Open vent 1 and reduce the pressure to approximately 0.5 psig. Close the vent and check for pressure buildup due to gas leakage or evaporating liquids.
- (8) If there is no pressure buildup, open vent 1 and introduce inert purge gas at valve 2.
- (9) When the desired end-point has been reached at vent 1, close inert inlet valve 2 and open the unit to atmosphere. **Warning:** Refer to Chapter 3 for the effect of methanol vapor on combustible gas indicators and methanol vapor as a toxic gas.
- (10) Physically disconnect the unit if it is to be out of service for an extended period. Aerate if it is to be opened to the atmosphere, otherwise it should be kept under positive pressure with inert gas.
- (11) It may be necessary to ventilate the unit while it is open.

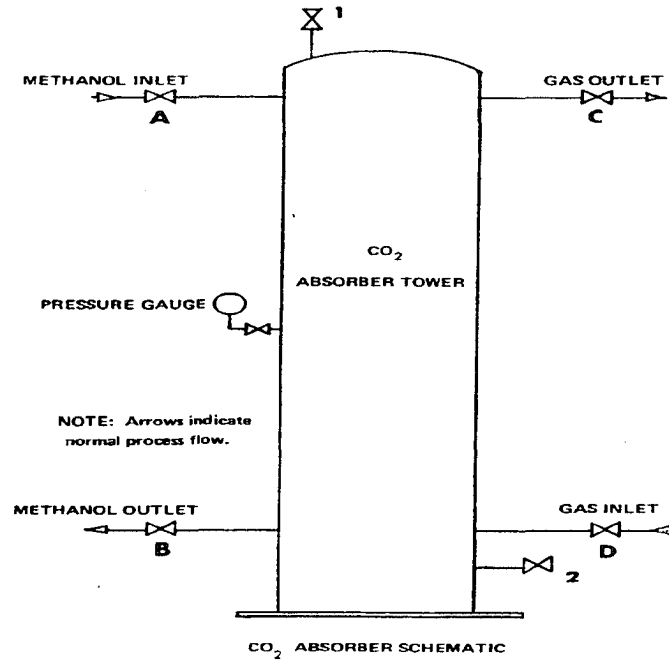

FIGURE 6-6

6.4(e)(3) Purging Into Service – Air to Gas

PRELIMINARY PREPARATION

- (1) Reduce the gas pressure in adjacent piping to the lowest positive pressure possible without venting to atmosphere.
- (2) Install vents, gauges and inert connections if they were removed.

PURGING

- (3) Introduce inert purge gas through valve 2 and vent at valve 1.

- (4) When the desired end-point is reached at vent valve 1, reconnect the unit and stop the inert gas flow.

- (5) Open gas inlet valve D and gas out the vessel. Close vent valve 1. Open valve C.
- (6) Open methanol valve A and B and fill the vessel to the proper level.
- (7) Remove all temporary piping and plug all bleed valves used.

6.5 SHOP FABRICATED LNG PRESSURE TANKS

6.5(a) GENERAL

This section discusses precautions to be observed and, in general terms, procedures to be followed in purging shop-fabricated LNG tanks into and out of service. The larger field-erected spherical pressure vessels are covered in Sections 6.2(d), 6.2(e) and 6.2(g).

6.5(b) DESCRIPTION OF TANKS

Shop-fabricated vessels are generally vacuum-jacketed with long, small diameter piping passing through the insulation. They can be vertical or horizontal.

Vertical tanks have piping at top and bottom. They can be made and shipped up to approximately 12,000 gallons capacity. Maximum allowable working pressures usually are from 50 to 250 psig.

Horizontal tanks commonly have all their piping at one end. They can be made and shipped up to approximately 60,000 gallons capacity. Maximum allowable working pressures usually are from 50 to 150 psig.

6.5(c) GENERAL PRECAUTIONS

- (1) A detailed procedure should be prepared for each purging situation and should include the tank manufacturer's recommendations.
- (2) Tie-ins to a natural gas system should not be made until the LNG tank and system have been purged.
- (3) Inner vessels are designed for internal pressure, as indicated on the code plate, but may not be able to withstand internal vacuum. Vacuum jackets are designed for internal vacuum, but can take only limited internal pressure. All pressure and vacuum safety relief devices should be operational.
- (4) At least two people should work on a purge operation. All should be familiar with the procedure to be followed and with the equipment involved.
- (5) In most cases, the only instruments required are the pressure gauge on the tank and an analyzer to determine that the end-point has been obtained.
- (6) The usual purging medium is nitrogen since both carbon dioxide and water are solid at LNG temperature. From dew point readings, the minimum temperature at which nitrogen can enter the tank can be determined to avoid water vapor condensation.

Carbon dioxide or dried combustion products can be used, but must be replaced with dry natural gas before cool down.

Nitrogen can be supplied as cylinder gas or as liquid. Liquid nitrogen can be vaporized for use as gas, or can be used directly. If N_2 is used directly, tank pressure should be carefully monitored and kept positive. (Original contents could condense, producing negative pressure.)

Most LNG vessels have a design minimum working temperature of $-320^{\circ}F$ and can contain some liquid nitrogen, but do

not have supports suitable for the weight of a full load of liquid nitrogen or water.

6.5(d)(1) Purging Into Service

(1) Both vertical and horizontal shop-fabricated vessels are sometimes shop-tested with liquid nitrogen and shipped with a positive pressure of nitrogen. However, it must be assumed that a newly installed system will have nitrogen-air mixtures in the tank, connecting piping, vaporizers, etc. Unless it can be shown by a positive sampling technique that the vessel is purged to the desired end-point, the following procedures should be applied.

(2) Horizontal vessels, because of their shape and piping arrangement, are practically impossible to purge by displacement and difficult to purge by ordinary dilution techniques: several container volumes of nitrogen could be passed through the piping and one end of the vessel without much effect on oxygen concentration at the other end of the vessel.

The basic recommended technique is dilution by pressurizing with nitrogen so that the desired end-point is obtained after venting. This can be done either by a single pressurization or by multiple pressurizations.

For purging into service from air, this technique requires approximately 1.2 volumes of nitrogen. With a starting oxygen concentration of less than 21 percent, less nitrogen is required.

With the pressurization technique, time is required for mixing. The vessel contents should be analyzed during blow down. If concentration of oxygen in the vented gas is lower than expected, more mixing time should be allowed. A high-than-expected concentration of oxygen in the vented gas indicates a helpful displacement and blow down should proceed.

Mixing in the long slender pipes is very slow, but these pipes are readily purged by venting when vessel contents have reached the proper concentration. Blow down should be done through all lines in succession. Pressure buildup and liquid level gauge circuits, which connect from top of vessel to bottom of vessel, should be disconnected at some point and blow down for both ends.

(3) Vertical vessels, by their configuration and by the fact that there are piping connections at both top and bottom, might lend themselves to displacement purging. However, their rather large diameter to height ratio and the small diameter of the piping make considerable mixing likely. Vertical vessels also can be purged by pressure-dilution or by a combination technique. For example, starting with air in a tank at room temperature and seeking an end-point of 9.7 percent O_2 , admit N_2 at a temperature high enough to avoid condensation of water vapor in the tank through the bottom fill line until tank

pressure is 18 to 20 psig. Then, let gas out

(4) through one line at a time until vented gas composition is satisfactory. If complete mixing occurs, all gas vented after the line is cleared and gas remaining in tank will be 9.7 percent oxygen. If mixing is incomplete, gas vented from top lines will at first be higher than 9.7 percent oxygen and gas remaining in tank will be less than 9.7 percent O_2 .

6.5(d)(2) Cool Down

Cool down procedure should follow manufacturer's recommendations.

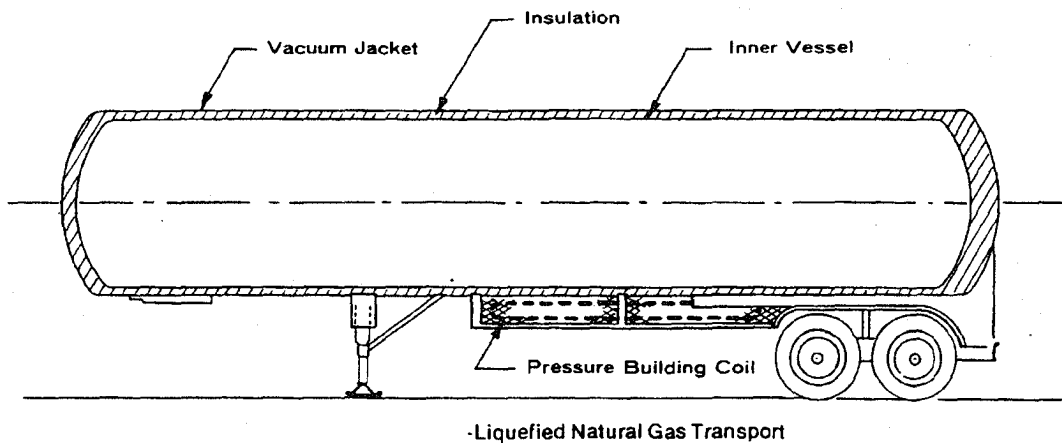

FIGURE 6-7

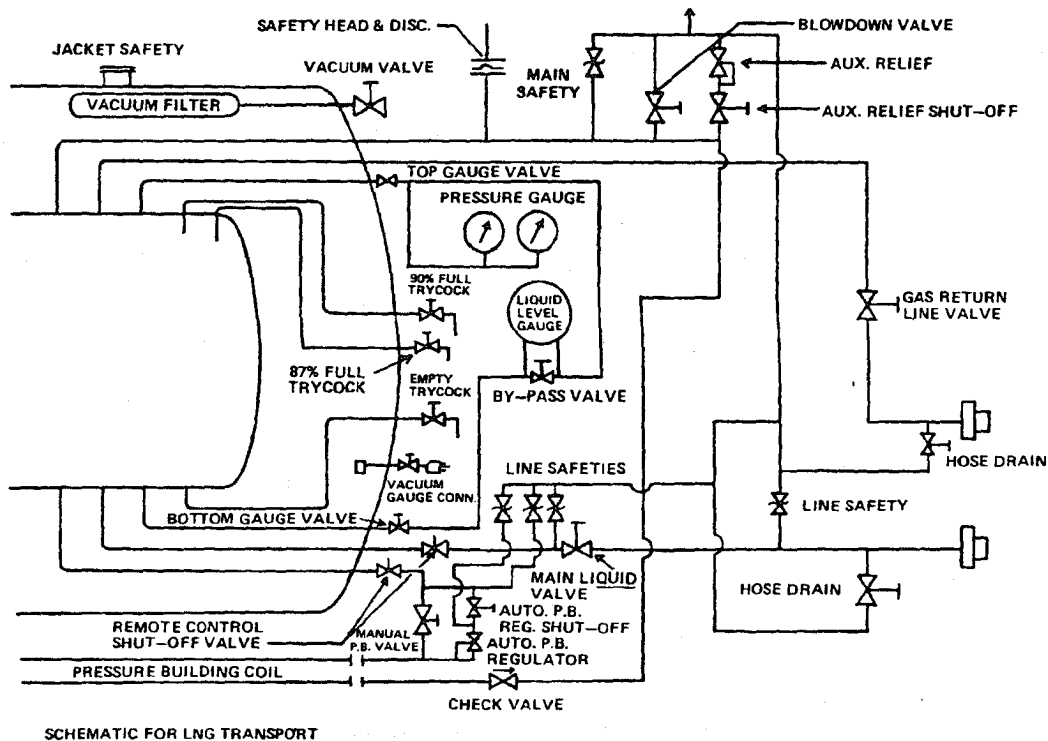

FIGURE 6-8

6.5(e) PURGING OUT OF SERVICE

- (1) Remove liquid and/or allow it to boil off until tank is empty. Bringing the insulation space to atmospheric pressure with N₂ will accelerate boil-off. Allow 24 hours or more after last detectable liquid is out to evaporate puddles at far end of tank. Vent tank to atmospheric pressure.
- (2) Inerting from LNG service is similar to inerting from air except that much larger volumes of nitrogen are required. A reduction from 100 percent natural gas to 10 percent natural gas can be done in one pressurization to 10 atmospheres absolute, two pressurizations to 3 ½ atmospheres absolute, or four pressurizations to 2 atmospheres absolute.

(3) If any welding is to be done, the insulation space also should be inerted. Admit nitrogen slowly through a vacuum valve until insulation space is at atmospheric pressure. Check gas composition at a safety head at the end opposite to that being used to admit N₂. Use the thermal conductivity scale of a combustible gas detector that has been calibrated for the heaviest hydrocarbon expected in nitrogen. If concentration is satisfactory-2 percent or less by volume hydrocarbon in nitrogen-replace safety head, wait 12 hours or more and check gas composition again. If concentration is not satisfactory, re-evacuate the insulation space and again break vacuum with nitrogen. (In this unlikely case, the tank should be tested for an inner vessel leak.)

6.6 LNG TRANSPORTS

6.6(a) GENERAL

This section discusses precautions to be observed and, in general terms, procedures to be followed in purging LNG transports into service and out of service.

6.6(b) DESCRIPTION OF TRANSPORTS

LNG transports are well-insulated pressure vessels of materials suitable for service at least down to the normal boiling point of methane (-260°F). Most, like liquid nitrogen transports, are vacuum-jacketed. Some, like transports for liquid ethylene and other low-temperature liquefied gases, are foam insulated.

The piping connections of LNG transports usually are all concentrated in one area, most commonly at the rear. Piping through the insulation contains expansion loops and liquid traps and usually is quite long and small in diameter.

A vacuum-jacketed transport is shown in Figure 6-8. Hauling of liquid nitrogen, liquid ethylene, liquid ethane and refrigerated propane has been done, or proposed, in LNG transports. Thus, there may be other purging situations in addition to air-to-LNG and LNG-to-air.

6.6(c) GENERAL PRECAUTIONS

- (1) Do not take a transport containing LNG, LNG vapors, or any other combustible into a garage for maintenance-either work out-of-doors or purge the transport. A transport containing combustibles may vent. This becomes a hazard in a building where ignition sources are present.
- (2) Do not do any welding on a transport until both inner vessel and insulation space atmospheres are known to be safe.
- (3) Inner vessels are designed for internal pressure but may not be able to take internal vacuum. Vacuum jackets will take only slight internal pressure and usually are equipped with safety devices that open at a fraction of a psig.
- (4) Maximum allowable pressure and vacuum should be known and all related safety relief devices should be operational.

(5) Detailed written instructions should be given for each purging operation. Since purging of transport is much more frequent than purging of large storage tanks, it may be desirable to have several standard procedures pre-written and for each purge to tell the technician in charge which procedure to use.

(6) Two people should work on a purge operation. Both should be familiar with the procedure to be followed and with the equipment involved.

(7) In most cases, the only instruments required are the pressure gauge on the transport and an analyzer to determine that the end-point has been obtained.

(8) Purging medium for LNG transports usually is nitrogen since both carbon dioxide and water are solid at LNG temperatures. From dew point readings, the minimum temperature at which nitrogen can enter the tank can be determined to avoid water vapor condensation.

Carbon dioxide or dried combustion products can be used, but must be replaced with dry, natural gas before cool down.

Nitrogen can be supplied as cylinder gas or as liquid. Liquid nitrogen can be vaporized for use as gas or can be used directly. Many LNG transports have a design minimum working temperature of -320°F and can be partially filled with liquid nitrogen, but those specifically designed for LNG (approximately 3.5 to 4.0 pounds/gallon) should not be completely filled with liquid nitrogen at 6.75 pounds/gallon. (No LNG transport is designed for the weight of a complete fill of water).

(9) Tank pressure should be carefully monitored and kept positive if LN₂ or any other substance that flashes to a lower temperature than the equilibrium temperature of the tank contents, is used directly. (Original contents could condense, producing negative pressure.)

6.6(d) GENERAL PROCEDURE

- (1) The configuration of transports-short, horizontal cylinders of relatively large

diameter-make purging by displacement practically impossible. The common piping arrangement make purging by dilution somewhat difficult-it is possible to pass several container volumes of inert gas through the piping and the rear of the vessel without vaporizing a pocket of liquid that might be at the front of the vessel. Even vapors at the front might not be effectively diluted.

(2) The basic technique recommended is pressure-dilution-pressurizing the liquid vessel with nitrogen to such a level or such a number of times that the final mixture will have the desired end-point described in Chapter 2. While this is a relatively inefficient procedure in terms of nitrogen consumption, the vessel volumes are small enough that the cost is not very great.

(3) Since piping is long and small in diameter, mixing will be very slow in the pipes and each line should be vented to atmosphere during vessel blow down. For some lines, particularly at the pressure buildup coil and contents gauge, it may be necessary to break a connection and vent to atmosphere from both sides.

(4) Gas composition should be monitored during blow down(s) to ascertain that mixing has occurred and that the expected end-point has been obtained.

6.6(e) PURGING INTO LNG SERVICE

(1) New transports are often factory-tested with liquid nitrogen and shipped with a positive pressure of nitrogen. When positive nitrogen pressure is still present at the time the transport is to be put into service, only a check on nitrogen purity is required to be sure that it is safe to admit natural gas.

(2) To inert a transport that is full of air, pressurize with nitrogen at a temperature high enough to avoid condensation of water vapor in the tank through whatever line terminates furthest forward inside the inner vessel, to a pressure that will assure the desired end-point.

For example, an 11,650 gallon gross transport contains 1,560 standard cu. ft. of oxygen. To bring this to 9.7 percent oxygen requires adding 1,820 standard cu. ft. of pure nitrogen, which will give a pressure of 2.2 atmospheres absolute or about 18 psig. Standard nitrogen gas cylinders contain

from 220 to 300 SCF, so 7 to 9 cylinders are required.

After pressurizing, allow as much time as possible for mixing. Then blow down to atmospheric pressure. Vent slowly through one line at a time and measure oxygen concentration. Since mixing in the lines will be slight, the initial flow from each line is likely to be air (21 percent O₂). This should gradually drop toward the desired end-point.

Since it is important to purge each line by venting, all the pressure must not be lost through the first line or two. A connection in the pressure build circuit and one in the liquid level gauge circuit, should be broken and the lines purged from both sides.

(3) There may be occasion to put into LNG service a transport that has been carrying liquid nitrogen, liquid ethylene, liquid ethane, or liquid propane. Since none of these is an oxidizer, the problem of forming explosive mixtures does exist; the desired concentrations of these substances in the tank depends on other considerations. In most cases, it is desirable to remove all liquid to avoid possible freezing.

A transport vessel freshly emptied of liquid nitrogen may freeze a portion of the incoming LNG, resulting in a possible pipe blockage. Allowing the vessel a day to warm up after being emptied of liquid nitrogen will prevent any blockage. Transports containing ethylene or ethane vapors are warm enough to boil off considerable quantities of LNG. With LPG vapor there is a possibility of the formation of solids by rapid introduction of LNG, so some dilution with vapor natural gas may be desirable. (A very slow input of LNG will largely evaporate in the inlet piping and provide gas for pressurization.) Refer to Section 6-5(c) for pressure considerations.

(4) When a transport has been inerted with nitrogen (or has been transporting nitrogen), consideration should be given to disposal of the nitrogen vapor when filling with LNG. If boil-off vapor is to be delivered into a distribution system where a high concentration of nitrogen would create problems, vapor should be vented to atmosphere initially and analyzed until nitrogen concentration is acceptable.

6.6(f) COOL DOWN

Cool down procedure should follow manufacturer's recommendations.

6.6(g) PURGING OUT OF LNG SERVICE

(1) Inerting a vessel containing a natural gas can be done in the same way as inerting a vessel containing air, except that more pressure and/or repeated pressurization will be required

For example, if the desired end-point is 10 percent natural gas, a single pressurization must go to 10 atmospheres absolute or 132 psig. Since most transports have a 70 psig. maximum allowable working pressure, at least two pressurizations usually are required. Pressurizing to 3.5 atmospheres absolute or 37 psig., give 28.6 percent natural gas and a second pressurization reduces natural gas concentration to 8.2 percent. Four pressurizations to 2 atmosphere absolute will give a final natural gas concentration of 6.3 percent.

Nitrogen required for these three cases, with a transport gross volume of 11,650 gallons would be 14,000 SCF, 7,800 SCF and 6,300 SCF. This sort of quantity could be supplied as cylinder gas, bulk liquid, or by liquid cylinders.

As in inerting from air, lines should be purged by venting to atmosphere one by one and vent gas composition should be monitored. A reading appreciably higher in nitrogen than the expected end-point generally indicates a lack of mixing and venting should be stopped for a while.

(2) In purging out of service, the insulation space should be considered. If extensive repair work is to be performed, this space should be filled with inert gas. With safety heads in working condition, admit a slow flow of nitrogen through a vacuum valve to bring the insulation to atmospheric pressure. Let the tank stay this way overnight if the inner vessel was initially warm, longer if it was initially cold. Remove a safety head cover, admit a very slow flow of N₂ from the opposite end and check combustible concentrations at the open safety head. If concentrations are not satisfactory, evacuate, again admit N₂ and again evacuate.

6.6(h) LNG TO OTHER COMMODITIES

Any transition from LNG to one of the other commodities mentioned previously should involve both gas people and the shipper of the other commodity. The extent of removal of natural gas necessary will not be governed by explosive mixture considerations, but by purity required in the other commodity. The shipper should know the requirements for their product, but their plant (particularly a nitrogen plant) may not be a suitable place for venting natural gas.

6.6(i) CONNECTIONS

Transports and the loading and unloading facilities for them, necessarily involve some piping and hoses which are frequently connected and disconnected. These lines may fill with air between uses. Prior to connecting, such lines usually are cleared by admitting natural gas and allowing it to flow to the atmosphere through both sides of the joint.

CHAPTER 7
LIQUEFIED PETROLEUM GAS FACILITIES

SECTION	PAGE #
7.1 Introduction	104
7.2 Inerting Media	104
7.3 Description of LPG Facilities Requiring Purging	105
7.4 Vents, Piping and Valves	105
7.5 Physical Properties of LP-Gases	107
7.6 Disposition of LPG Liquids and Vapor	107
7.7 Purging Piping and Equipment Out of Service	108
7.8 Purging Pressurized Storage Containers Out of Service	109
7.9 Purging Refrigerated Storage Containers Out of Service	109
7.10 Purging LP Gas Piping and Equipment Into Service	110
7.11 Purging Pressurized Storage Containers Into Service	111
7.12 Purging Refrigerated or Semi-Refrigerated Containers	111
FIGURE	
7-1 Buried and Exposed Vessels Connected	106

CHAPTER 7 LIQUEFIED PETROLEUM GAS FACILITIES

7.1 INTRODUCTION

Previous chapters have discussed in detail the principles of purging such as segregation and isolation, theory of purging and end-points, instruments for testing and available inerting media. The discussions which follow add to or emphasize the basic principles as they apply to purging of liquefied petroleum gas (LPG) equipment that may be utilized in gas utility operations.

Liquefied petroleum gases, most generally propane, have been used for peak shaving in the form of propane-air (and occasionally butane-air) or for propane blending with natural gas. In addition, both propane vapor and propane-air have been utilized as base load sources for some isolated distribution systems. Such operations are subject to the Federal Pipeline Safety regulations, as found in the Code of Federal Regulations, 49 CFR Part 192 as well as the provisions of the National Fire Protection Association's (NFPA) Standards 58 and 59, "*Standard for the Storage and Handling of Liquefied Petroleum Gases*" and "*Standards for the Storage and Handling of Liquefied*

Petroleum Gases at Utility Gas Plants" respectively. Both of those standards have been incorporated in 49CFR192 by reference.

In addition to such conventional utility pipeline uses, LP Gas has been utilized as a fuel for some isolated facilities such as remote engine-generator sets for communications or other standby power systems. As with any other system handling, storing or utilizing flammable liquids or gases there is an occasional need to take such facilities into or out of service. Such operations should be carefully planned and executed in order to assure safety.

Liquefied petroleum can exist as either a liquid or a vapor at room temperature. LPG is stored as a liquid at its boiling point. In addition, the flammable limits of LPG are somewhat different from those of natural gas. Likewise, there is a significant difference in the specific gravity, or density, of LPG and natural gas. Because of those differences, some variations in the purging procedures, as previously outlined, should be considered and implemented when purging LPG equipment into or out of service.

7.2 INERTING MEDIA

In general, a system containing, or designed to contain, LPG may be safely purged with most of the commonly used purging media such as carbon dioxide, nitrogen, water, or inert gas generator products of combustion. However, because of the solubility of some of those products in propane or the potential for later problems, such as hydrate formation or the accumulation of non-condensables in the vapor space, considerable care should be exercised in the choice of a purge medium. Moreover, it should also be remembered that natural gas is considerable less dense than any of the usual purge gases while LPG is as heavy, or heavier, than most of the purge gases. That difference alone should usually rule out the displacement method of purging LPG facilities. Furthermore, the availability, cost and convenience associated with the several mediums may also have some influence on the ultimate selection of the purge medium.

Both nitrogen and carbon dioxide are readily available from industrial gas marketers in pressurized cylinders, which should prove adequate and easily handled for relatively small purging operations. When selecting a purge medium for larger projects, such as purging storage containers into or out over service, consideration should be given to the use of transport delivered liquefied nitrogen or carbon dioxide. Such products are generally available throughout the country and often the supplier can also provide the pumps and vaporizers necessary to supply the purge medium in the gaseous state at high pressures.

When utilizing carbon dioxide as a purge medium, it should be remembered that CO₂ will "flash" to solid dry ice when released from its storage pressure. Therefore, proper planning and equipment should be provided to preheat the fluid before its release.

7.3 DESCRIPTION OF LPG FACILITIES REQUIRING PURGING

Utility facilities involving the use of LPG may consist of LPG liquid storage containers(s), loading/unloading facilities serving the storage container(s), liquid pumps, vapor compressors, gas and liquid meters, vaporizers, gas-air mixers and, in some cases, air compressors, dryers and associated equipment. In addition, a refrigerated facility will include refrigeration and boil-off handling equipment as well as product vaporizers or heaters.

Large volume storage facilities may include underground storage, such as mined caverns or dissolved salt dome caverns, or refrigerated storage containers and multiple or single pressurized ambient temperature storage containers. *It should be noted that the following discussions would not include advice or recommendations regarding the purging of underground storage caverns.*

There are several variations in the design of refrigerated LPG storage containers. Those variations might include single wall, externally insulated containers; double wall, insulated containers with either open or closed inner containers; and semi-refrigerated LPG containers. Likewise, the pressurized ambient temperature containers may consist of a single container or multiple containers that are manifolded together. Also the pressurized containers may be above ground, partially below ground, mounded or buried. Each of these container configurations, both refrigerated and pressurized, will present their own unique problems with respect to the best and safest purging technique. Therefore, it is important that a purging procedure involving LPG storage containers be carefully considered before it is implemented.

7.4 VENTS, PIPING AND VALVES

In general, the proper design of LPG transfer piping will minimize the number and size of drips, drains and vents, particularly in the liquid piping. Therefore, the access to that piping may be limited and careful planning may be required to assure the adequacy of the purge in such piping. While most utility LPG plants have been designed and constructed in accordance with NFPA 59, the pressurized containers have customarily been fitted with both the vapor and liquid connections required by NFPA 58. In either case, the container connections for both liquid and vapor service, with the exception of relief valves, restricted gauge connections and plugged openings, should be fitted with either back-flow check valves, excess flow valves or emergency shut-off valves. Some of those valves are mounted internally within the container, which may make their existence not readily apparent. The presence of those product control valves makes it even more essential that proper preplanning of any purge procedure be carefully drafted so that those valves do not obstruct the procedure.

As mentioned earlier, LPG is generally stored at its boiling temperature. In the case of pressurized storage, this means that liquid is likely to condense and collect within piping runs

and equipment if those appendages should become cooler than the temperature of the liquid within the main storage container. It is for this reason that well designed vapor lines will be sloping back toward the container to allow such condensation to return to the storage container. Because of this phenomenon, as well as the possibility that back check or differential valves in the piping system may trap liquid, it would be prudent to consider that all of the idle piping in an LPG facility is full of liquid which must be disposed of before any attempt is made to purge the system.

To better illustrate this phenomenon, Figure 7-1 represents a mounded, or buried, propane container that is interconnected with another above ground vessel that is exposed to the atmospheric temperature changes. Assume that the mounded container is maintained at a near constant temperature of about 60°F and that the container is essentially full and the exposed vessel starts out at the same temperature as the mounded container and contains only propane vapor. With those assumptions, it can be stated that the system is basically in equilibrium. Then, assuming that the atmospheric temperature falls significantly, possibly the result of a cold rain or sleet, the vapor within the exposed container will

begin to condense and the vapor pressure of the exposed portion of the system will also fall. The result will be that the pressure of the vapor above the liquid in the mounded container will fall below the vapor pressure of the liquid below it. That liquid will begin to boil in order to produce the vapor required to achieve equilibrium.

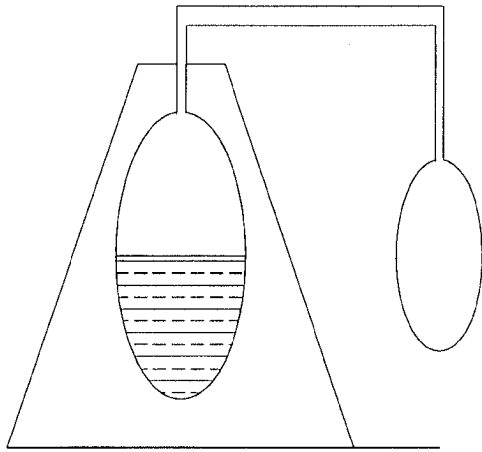

Figure 7-1 BURIED AND EXPOSED VESSELS CONNECTED

Because of the difference in temperature between the mounded vessel and the exposed vessel, equilibrium will not be achieved and condensation will continue in the exposed vessel until it is full. This phenomenon is often referred to as "cry-pumping" because it is a fairly common occurrence in cryogenic systems. Conversely, movement of product from the exposed vessel into the lower temperature mounded container may be expected if the exposed container starts out containing liquid and the ambient temperature rises above the temperature of the mounded container.

Refrigerated LPG containers, which are quite similar to the LNG containers that have been previously described, are usually constructed in accordance with the American Petroleum Institutes Standard, API 620, "Design and Construction of Large, Welded, Low Pressure Storage Tanks" and, in recent year, with some supplementary requirements of either NFPA 58 or 59. Such containers are equipped with one, or more, liquid withdrawal lines which

may be either a submerged gravity connection through the sidewall or floor of the container, or one or more "over-the-top" submerged pumps that are installed in a pump well that penetrates the roof of the container. *(It would be most unusual for a container fitted with over-the-top" pumps to have even a small submerged gravity connection or drain, with the possible exception of a very small, or restricted gauge connection.)*

In addition to the liquid withdrawal connections, a refrigerated LPG container will usually be fitted with two, or more, liquid fill connections which are often manifolded together outside of the container. One of those fill connections is usually provided as a spray head in the top of the container and its purpose is to provide a means of initial cool down of the container when it first is placed into service. In some cases, both a bottom fill and a top fill connection are provided so that the incoming fluid may be selectively placed in the container in order to prevent stratification when liquids of differing densities are introduced. Finally, a refrigerated container is equipped with one, or more, vapor connections. One of those connections is for boil-off recovery and the other connection, if not combined with the boil-off line, is used for vapor return during transfer operations.

Some refrigerated containers are also equipped with a discretionary vent valve that may be manually controlled in order to handle unexpected venting requirements. Those discretionary vents are in addition to the relief valves and vacuum breakers required by the applicable design codes. In the case of the double walled containers, there is also purge piping installed in the insulation spaces to facilitate the purging of the insulation, both into and out of service.

It should also be noted that a refrigerated LPG container is usually incapable of withstanding even a slight vacuum condition without collapsing and destroying the container. Therefore, a prime consideration of any purge procedure involving a refrigerated container should be the avoidance of a vacuum condition. A vacuum may occur if liquid or vapor is withdrawn too rapidly or if cold liquid is admitted to a warm vapor space to rapidly.

7.5 PHYSICAL PROPERTIES OF LP-GASES

While commercial LP-Gases are usually referred to as propane, butane, or propane-butane mix, they are in reality, a mixture of a number of hydrocarbon compounds including methane, ethane, propane, propylene, *iso*-butane, *n*-butane, butylenes and pentanes plus. For example, commercial propane may contain all of those constituents, but will be predominately propane and propylene so the total composition will approximate *most* of the physical properties of pure propane. Likewise, commercial butane will usually consist of a mixture that is predominately *iso*-butane, *n*-butane and butylenes along with some of the other above-mentioned constituents so as to produce a *mimic* of pure butane. It should be evident that a Butane-Propane mix, identified as a percentage of one or the other, may differ considerably from a simple mix of the two pure compounds.

Another issue that may further obscure the composition of a LP-Gas that may be the concern of a purge procedure, has to do with history of the stored liquid. In the case of a system that utilizes vapor withdrawal, as opposed to liquid withdrawal, of the stored product there will be a gradual *weathering* (i.e., the preferential vaporization of the light, or low boiling, ends) which will result in a gradual buildup of the heavier constituents and in turn

raise the boiling point and lower the vapor pressure of the remaining liquid.

Toward the other direction of composition change, it should be noted that many LP-Gas peak shaving facilities (such as propane-air plants) utilize high pressure natural gas as a "*pad*" over the stored liquid instead of pumps to move the liquid out of storage at a pressure that exceeds the normal vapor pressure of the stored LP-Gas. Propane is capable of absorbing a large percentage of methane in the liquid phase which will significantly raise the vapor pressure of the stored liquid if the natural gas pad has been in place for an extended period of time.

Either phenomena, weathering or methane absorption, will markedly alter the composition of the vapor over the stored liquid. Therefore, any purging procedure should anticipate that the combustion behavior of any LPG vapor may be somewhat different from the published value for the pure product.

Considering the wide possible variations in the actual composition of the LPG in the system, it is recommended that when using "end-points" as a measure of purging for LP-Gases it would be prudent to use the purging end-point with 20% safety factor of propane when purging into service and butane when purging out of service.

7.6 DISPOSITION OF LPG LIQUIDS AND VAPOR

When taking a LPG facility out of service there may be a question as to the ultimate disposal of any stored liquids or of the remaining vapors. Obviously, the most desirable way to dispose of any stored liquid is to save it by transferring it to another container. In the case of a facility that has multiple containers, such an option merely requires that sufficient space is available in the other on-site containers and that there is the equipment to facilitate such a transfer. If on-site storage is not available, it is suggested that contact be made with a local LPG marketer who may be able to provide both transports and transfer equipment to facilitate the product removal and possible interim storage or sale.

For both environmental and safety reasons, the goal of any procedure should be to minimize,

if not eliminate, any release of LPG liquid or vapors to the atmosphere. Generally, the transfer of the liquid to another container will satisfy that objective. However, the removal of the remaining vapor may require some release of product to the atmosphere. Not only should that release be minimized from an environmental standpoint, it should also be done in a manner that does not create an additional hazard.

Liquid withdrawal from pressurized LPG containers should be through the liquid withdrawal connections of the container. When all of the liquid has been removed, the vapor should then be either withdrawn or vented. In the case of the larger pressurized containers, the most desirable and safest method of vapor withdrawal and disposal is through the use of a LP-Gas vapor compressor. The vapor

compressor takes its suction from the vapor space of the container that is being emptied and it compresses that vapor for delivery into the liquid of another LPG container. The compressed vapor is condensed by the liquid in the second container. The reduction of pressure in the tank being emptied not only removes the vapor but it also causes any "heel" of remaining liquid to evaporate, thereby hastening the ultimate clearing of product from the container. This procedure is commonly used by the propane industry in the transfer of liquid from railcars and transports into fixed storage. If a permanently installed vapor compressor is not available, some propane marketers have engine driven portable compressors that they use for remote transfer operations. It is often possible to draw the pressure down in the vapor space to as low as five psia.

If it is not possible or practical to utilize a vapor compressor to evacuate the vapor space of a container, it is also possible to flare the remaining vapor. Some utility LP-Gas facilities are already equipped with a flare stack that is used during the startup of a peak shaving operation. However, it should be pointed out that such a flare was most likely designed for a

propane-air mix, which has different combustion characteristics than propane and the flaring operation should be closely and continuously monitored and controlled.

Another possibility for the disposal of LPG vapors at a utility operation is to slowly bleed the vapors into a lower pressure gas distribution pipeline. However, such an approach must be undertaken with considerable caution. If propane vapors are to be blended into an operating natural gas distribution system, there should be sufficient flow-by to adequately dilute the propane before it reaches any customers.

Finally, there is the choice of venting the propane vapors directly to the atmosphere. When this is necessary, the preferred approach should be to dilute the remaining vapors with sufficient inert purging gas to make the vapors nonflammable. However, it should also be pointed out that undiluted vapor may be safely vented if it is directed vertically in an unimpeded jet at high velocity, which will assure the mixing of the jet with air to less than the lower flammable limit. LP liquids or vapors should always be released out-of-doors with adequate air movement.

7.7 PURGING PIPING AND EQUIPMENT OUT OF SERVICE

As was mentioned earlier, it would be prudent to assume that all piping and associated equipment of an LPG facility are filled with liquid. Therefore, it would be unwise to simply open up a flange, on even a short piece of piping, with the assumption that only a small amount of gas will be vented. The proper approach should be to first isolate the portion of the system that is to be purged and then to vent the vapors from that isolated system to a lower pressure system if such a system is available. That venting should be preferably done from a high point of the system. When the pressure in the piping or equipment has been lowered to essentially atmospheric pressure, the safest procedure would be to introduce an inert purge gas in sufficient quantities to assure that the remaining entrapped vapors are nonflammable (i.e., that the end-point has been achieved). For example, it has been shown earlier that the safe end-point for butane, with a 20% margin of safety is 96% nitrogen and 4% butane or 93% carbon dioxide and 7%

butane. If the system pressure has been reduced to atmospheric pressure (14.69 psia), it can be shown that raising the pressure within that system with the addition of nitrogen to an absolute pressure of 26 atmospheres, which is approximately 367 psig., would achieve that dilution. Since many piping systems have not been designed and tested for such a pressure, the alternative is to pressurize the system with carbon dioxide to an absolute pressure of about 15 ½ atmospheres or about 213 psig., which is within the design pressure of most LPG piping systems. If it is more economical or practical to use nitrogen, the pressure may be raised to the design pressure and then the mixture can be vented at high velocity, as described above, to achieve atmospheric mixing below the lower flammable limit and then the pressurizing and venting cycle can be repeated a second time. (It might be noted that it requires less than a 5psi differential to achieve the minimum vent velocity.)

7.8 PURGING PRESSURIZED STORAGE CONTAINERS OUT OF SERVICE

As indicated earlier, the liquid in the container should be removed through the liquid withdrawal connections of the container. The remaining vapor should be either recovered or vented and the residual vapor pressure reduced to near atmospheric pressure. Then either nitrogen or carbon dioxide should be introduced as was described above to achieve the desired end-point before the vessel is vented to the atmosphere. It is recommended that, prior to the pressurization, the nameplate of the container be consulted to determine the safe pressure level that can be

achieved during the purging operation. If the container is to be returned to service at a later date, it is recommended that a pressure of about 10 psig be allowed to remain in the vessel in order to protect it from corrosion. On the other hand, if the container is to be entered for inspection or repair, for the safety of personnel it should be further purged with air until the oxygen level in the container has been verified to be in excess of 19.5% before the vessel is entered.

7.9 PURGING REFRIGERATED STORAGE CONTAINERS OUT OF SERVICE

As was mentioned earlier, the fact that propane and butane vapors are as heavy as or heavier than the readily available purge mediums means that the procedures outlined earlier for the purging of liquefied natural gas (LNG) containers may not be appropriate for a refrigerated LP-Gas container. Furthermore, the displacement techniques that were discussed in relation to natural gas purging practices probably will not work when purging an LP-Gas facility.

When purging a refrigerated LP-Gas container out of service, the first step is to remove as much of the liquid product as possible through the normal liquid withdrawal connections and equipment, being careful to avoid approaching a zero gauge pressure or vacuum condition in the container. When that has been accomplished, it should be assumed that a liquid "heel" remains in the container and that "heel" will not disappear until the container is fully warmed up. The variable composition of LP-Gases was addressed earlier and it should be assumed that butanes plus will be the last liquids to evaporate – even if the refrigerated product was propane.

More, if not all, refrigerated LP-Gas containers have either product heaters or vaporizers associated with the facility. It may prove possible, either through valving of the existing piping or the installation of temporary bypasses, to circulate and heat the LP-Gas vapors through the container to facilitate the container warm-up. The warm-up of the container and its contents will result in the need to dispose of excess vapor. Depending upon the capabilities of the reliquefaction system

associated with the container, it may be possible to liquefy those excess vapors for disposal to other containers. Otherwise, it will probably be necessary to either vent or flare the excess vapors. If it is necessary to vent the vapor, considerable caution should be exercised as there will not be enough pressure available to assure adequate mixing of the vapors at the vent exit. Therefore, the venting operation should be continuously monitored and consideration should be given to stopping the operation under certain conditions of low winds.

During the container warm-up, the container floor and wall temperatures should be frequently monitored to assure that the entire container is brought up to a temperature that at least exceeds the boiling point of butane-approximately 30°F. Likewise, during the warm-up operations, the container pressure should be continuously monitored, so as to prevent a vacuum condition that could destroy the container. When the warm-up has been completed, it may be necessary to shut-in the container while the necessary purging equipment is arranged. During that time, the container pressure should still be monitored continuously to guard against a vacuum condition. It should be noted that either a cooling of the container, possibly as a result of the delayed warming of the insulating material, or of a high pressure barometric condition can create an unexpected loss of pressure in the container. It is suggested that an automatic vapor make up system utilizing either LP-Gas or an inert gas be provided to further protect the container.

When the container has been completely warmed to the desired temperature, the inerting medium can then be introduced. If the container is to be returned to service at a later date, it is recommended that either dry nitrogen or dry carbon dioxide be used as the purge medium, so as to preclude the introduction of water or water vapor into the system. (Note: If a hydrostatic retesting of the container is contemplated, the need to use a dry purge medium becomes unnecessary.) It is suggested, however, it is not mandatory, that the purge gas be introduced through or at the bottom of the container so that the excess vapor may be withdrawn through the normal vapor handling piping at the top of the container.

Initially, the vapors leaving the container during the purge operation will be nearly pure LP-Gas, with little of the purge gas mixed in. Again, depending upon its design and its ability to dispose of the resultant liquid, the reliquefaction equipment may be utilized during the early stages of the purge operation so as to avoid venting or flaring of the product. As more of the purge gas becomes mixed into the stream, the capability of the reliquefier to vent non-combustibles will be overwhelmed and it will then be necessary to either vent or flare the vapors. As the vapors become richer in the inert purge gas, the flammability of the mixture will become more questionable. Therefore, it is recommended that the flare, if it is used, also be continuously monitored to assure that it remains ignited. After it is no longer possible to flare or

reliquefy the vapors, it is recommended that the vapors be released at the top of the container so as to promote adequate atmospheric mixing away from possible sources of ignition. Furthermore, during such direct venting to the atmosphere, the surrounding areas should be frequently monitored for combustible gas and the purging operations should be stopped during periods of low winds or inversions.

The determination of the end-point of the purge will require the use of very accurate instrumentation. With an end-point of only 5% fuel, the use of either a gravitometer or a combustible gas detector would give clearly questionable results. The difference in density of pure nitrogen and a mixture containing 5% propane would be less than 2%. If a dilution type combustible gas detector is used, which has been calibrated in air, the error may be significant because the purge gas would cause an apparent oxygen deficient atmosphere at the detector. It is therefore recommended that considerable care be exercised in the selection of the instrumentation to be used to verify the adequacy of the purge.

After the end-point has been achieved, the container may then be safely purged to air. Again, if entry is to be made into the container, it is essential that an oxygen level in excess of 19.5% be achieved before anyone is allowed to enter the container. Furthermore, as with the pressurized containers, it is advisable to maintain a dry nitrogen atmosphere within the container if it will be eventually returned to service.

7.10 PURGING LP GAS PIPING AND EQUIPMENT INTO SERVICE

Generally the piping and equipment associated with most LP-Gas facilities have relatively small volumes and the piping runs are usually quite short. Based upon those relatively small volumes and short piping lengths, an adequate and safe purge prior to placing small volume sections of a system into service can often be achieved by merely sweeping the lines and equipment clear with a "good blow" of an inert gas, such as nitrogen. The safer procedure, however, would be to pressurize the piping and

equipment with either nitrogen or carbon dioxide to a pressure that will assure achievement of the end-point and then allow the system to stand for a while to assure mixing before blowing the system down. With an end-point of 54% for nitrogen, this would mean that the pressure should be raised to 18 psig with the nitrogen. In the case of carbon dioxide, it would only be necessary to raise the system pressure to 11 psig to achieve the safe end-point.

7.11 PURGING PRESSURIZED STORAGE CONTAINERS INTO SERVICE

Pressurized LP-Gas storage containers may be safely purged with either nitrogen or carbon dioxide to achieve the end-points as outlined above for piping and equipment. However, there are some additional steps in the purging process that should be accomplished in placing a storage container into service. If the container is filled with liquid immediately after the inerting purge, the mixture of air and the inerting gas will remain in the container as a non-condensable gas. Because of the behavior of the mixture of gases, according to Dalton's law, the pressure of the non-condensables will become additive to the vapor pressure of the LP-Gas. Thus the pressure in the vapor space of the container may be considerably above the pressure that would be anticipated under normal operating conditions. That phenomenon could result in the premature operation of the relief valves serving the container. Furthermore, if the product withdrawal from the container is vapor, the product will be a mixture of LP-Gas and the non-condensable which could produce an unsafe condition at the appliance.

The normal mode of transfer into the larger LP-Gas containers provides for a vapor return to the supply vessel, usually a railcar or transport. The use of the vapor return system would move the non-condensables into the supply container. However, it is recommended that this approach not be considered unless the LP-Gas supplier is in full agreement with such an operation. *Moving the non-condensables into the supply container merely moves the problem to another transfer operation and the supplier may not be prepared to handle a returning container full of non-condensables.*

Depending upon the availability of vaporized LP-Gas, the most practical approach is to charge the container to a high pressure with the LP-Gas and vent the non-condensables to the atmosphere. That procedure should be repeated

three or four times – depending upon the pressure available to charge the container. For example, if the container is charged with LP-Gas to a pressure of 60 psig. and then vented three times, the resulting concentration of non-condensables remaining in the container will be less than 1% by volume. However, if the container can be charged to 135 psig., it will require only two cycles to achieve the 1% concentration. In the case of the larger LP-Gas containers, the pressurized container should be allowed several hours between the time of charging and the venting of the container in order to promote adequate mixing by diffusion within the container. Also, the venting should be carefully supervised and be at high velocity in a vertical unimpeded jet.

After the vapor space has been purged of the non-condensables, the use of a vapor return transfer practice should be acceptable. If high-pressure vapor is not available, it may prove necessary to introduce a small quantity of liquid LP-Gas into the container and then vent the vapor space until it can be confirmed by instrumentation that the non-condensables have been eliminated.

If the container that is being placed into service either is new, recently hydrostatically tested or has been open to the atmosphere for an extended period of time it may be necessary to add some additional odorant to the first fill of the container. It has been observed that the iron oxide on the inner surfaces of such a container may deplete the odorant in the liquid. Usually, the over-odorization of the first charge of liquid will adequately condition the container so as to prevent future odorant depletion. It is recommended that the container supplier, in the case of a new or rebuilt container, or the LP-Gas supplier be contacted for additional advice regarding the initial filling of the container

7.12 PURGING REFRIGERATED OR SEMI-REFRIGERATED CONTAINERS

The design pressure of most refrigerated or semi-refrigerated LP-Gas storage containers is usually less than a few pounds per square inch. Therefore, the pressurizing and venting procedure for purging is impractical. However,

there may be an opportunity to utilize the displacement method that has been described previously for LNG container purging. Carbon dioxide can be utilized to achieve the initial inerting purge, but then the purge of the non-

combustibles will, of necessity, be by mixing. On the other hand, if the initial inerting purge utilizes nitrogen, the non-condensables may be purged utilizing the displacement technique. Furthermore, there may be an opportunity to achieve a modest displacement effect during the inert purge if nitrogen is the inerting medium.

In either case, with CO₂ or N₂ it is suggested that the inerting gas be injected into the bottom of the container at a low velocity. In the meantime, the container should be vented to the atmosphere from the top of the container. If the temperature of the nitrogen can be maintained substantially below the temperature of the air in the container, the piston or displacement effect should be enhanced. The progress of the purge operation may be monitored with any oxygen sensor in the vent stream. If the displacement effects are working, the oxygen level should remain nearly constant and very close to the normal 21% until the interface reaches the sensor.

Assuming that there has been no significant change in the oxygen level during the purge and enough inerting medium has been admitted to the container to achieve the desired end-point, it may be worthwhile to stop the operations and seal in the container for several days to permit further mixing by diffusion. Then the container should be checked at several levels, if possible, to verify the adequacy of the purge. If the oxygen content is below 12%, the end-point has been achieved and it will then be safe to admit LP-Gas into the container.

As in the case with the pressurized containers, the presence of the mixture of air and inerting gas within the container should be removed before substantial quantities of liquid are introduced into the container. If the inerting purge was with nitrogen, the most effective method to clear the container of the air-inerting mixture is by the introduction of LP-Gas vapors at the bottom of the container at low velocity to achieve a piston or displacement effect to move the non-condensable to the top of the container for venting. The extent of the removal of the air-inerting gas will depend upon the ability of the reliever to handle and vent the non-condensable. When the vapor space has been cleared of the air-inerting mixture, cool down of the container can commence and it should be in accordance with the instructions of the tank constructor.

APPENDIX A

The information contained in this appendix is taken directly from the 1975 edition of the AGA "Purging Principles and Practice" Manual. Although the information is dated and generally no longer used in the natural gas industry, it is presented for historical reference.

Figures 2-1, 2-3, 2-5, and 2-9 are direct reproductions taken from that manual. Chapter 5, "Gas Plant Facilities and Piping", is presented as it was in the 1975 edition. Chapter 6, "Gas

Holders", is also presented as it was in the 1975 edition.

For additional historical information, the reader is encouraged to reference the 1975 edition of the AGA "Purging Principles and Practices Manual". The reader should use this information within the context of its origin and recognize that this information may not meet all conditions. The operator should use sound judgment and good engineering and operating practices.

- A1 Figure 2-1, Flammable Limit Chart (H_2 , CO, CH_4)
- A2 Figure 2-3, Flammable Limit Chart (Paraffin Hydrocarbons)
- A3 Figure 2-5, Flammable Limit Chart (CH_4 , C_2H_4 , C_6H_6)
- A4 Figure 2-9, Purging End-Point Chart
- A5 1975 Edition, Chapter 5, Gas Plant Facilities and Piping
- A6 1975 Edition, Chapter 6, Gas Holders

A1 FIGURE 2-1, FLAMMABLE LIMIT CHART FOR H₂, CO, CH₄

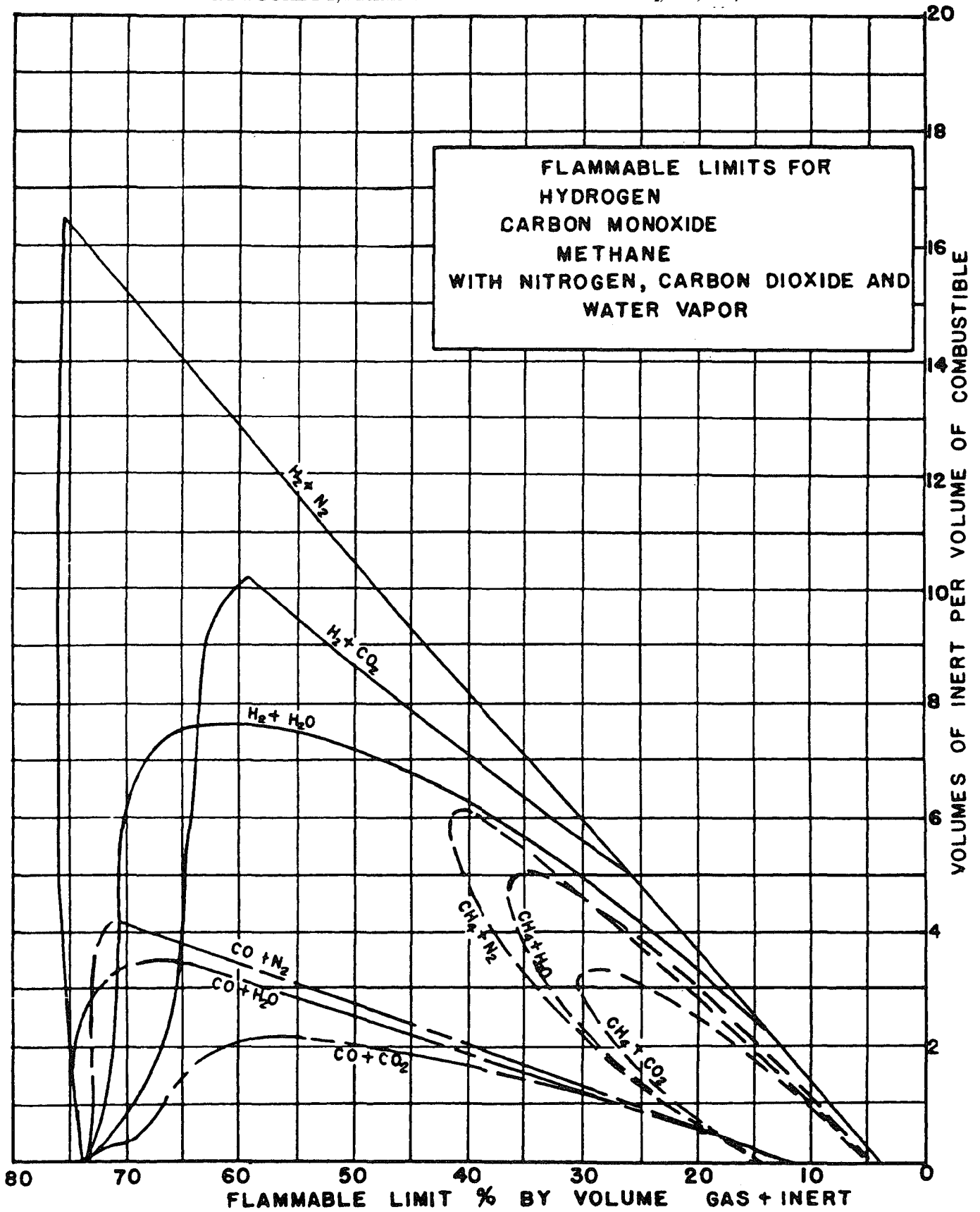

Figure 2-1 - Flammable limits for hydrogen, carbon monoxide, methane, with nitrogen, carbon dioxide and water vapor

A2 FIGURE 2-3, FLAMMABLE LIMIT CHART FOR PARAFFIN HYDROCARBONS

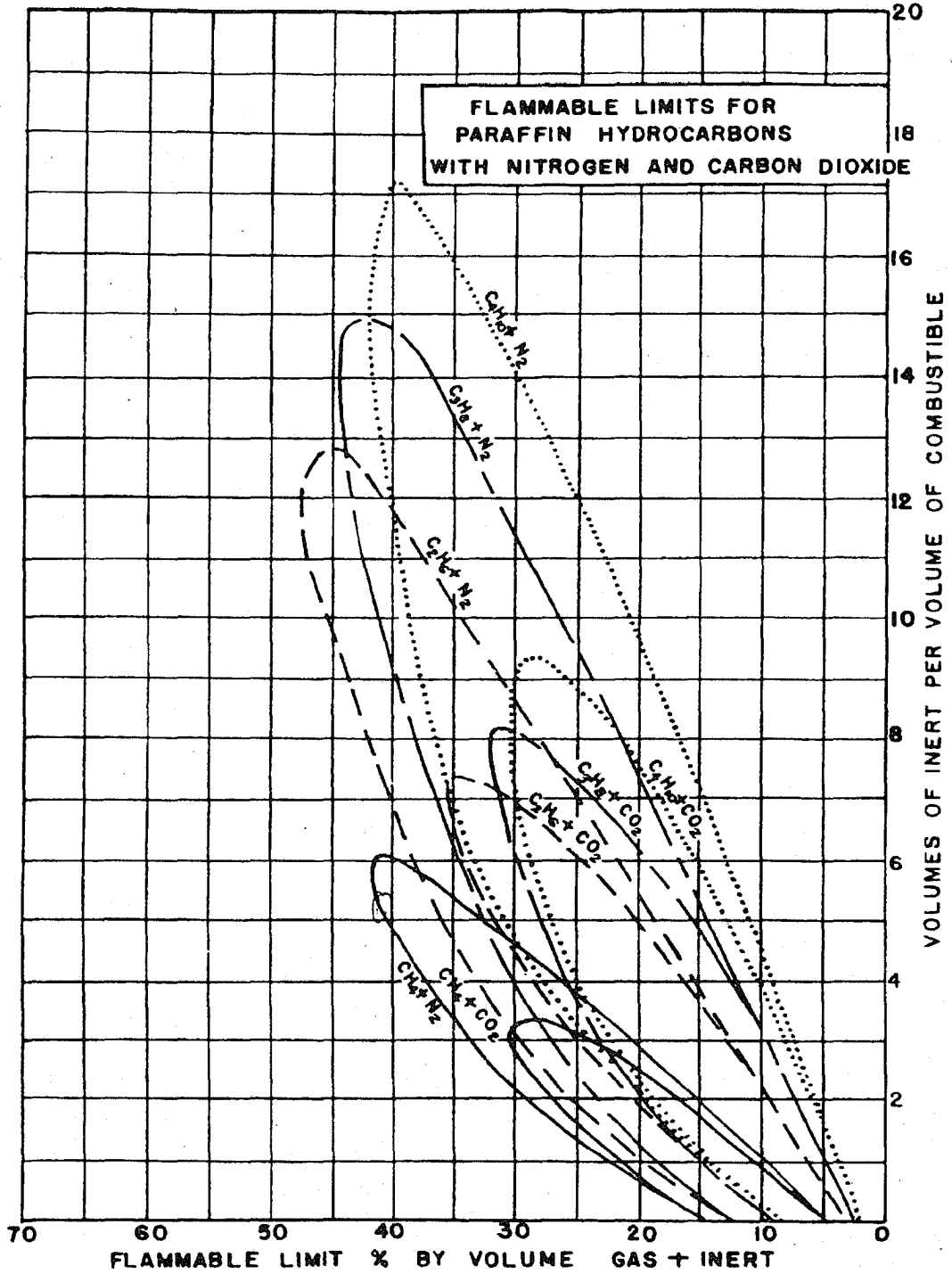

Figure 2-3 - Flammable limits for paraffin hydrocarbons with nitrogen and carbon dioxide

A3 FIGURE 2-5, FLAMMABLE LIMIT CHART FOR CH₄, C₂H₄, C₆H₆

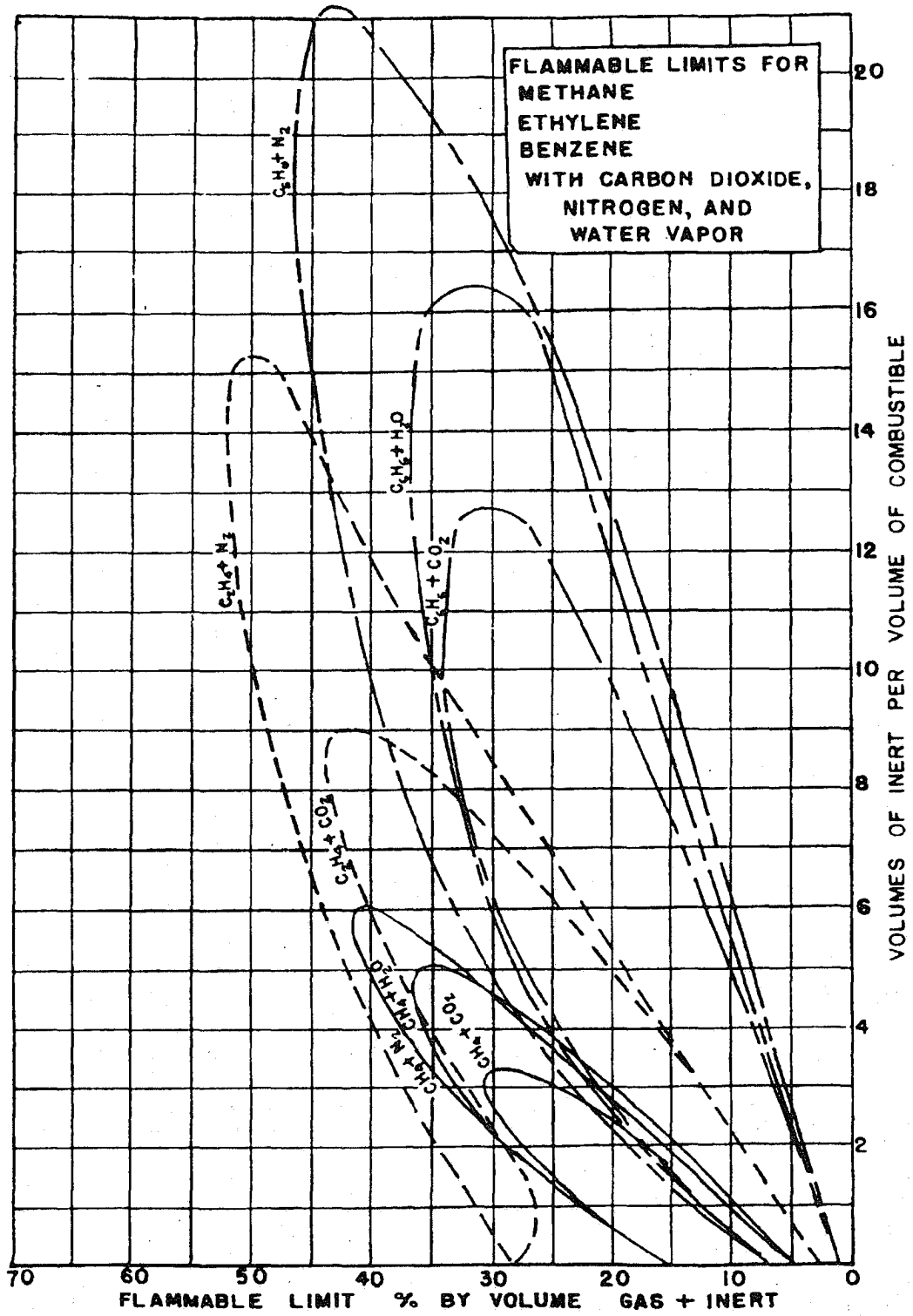

Figure 2-5 - Flammable limits for methane, ethylene, benzene, with nitrogen carbon dioxide and water vapor

A4 FIGURE 2-9, PURGING END POINT CHART

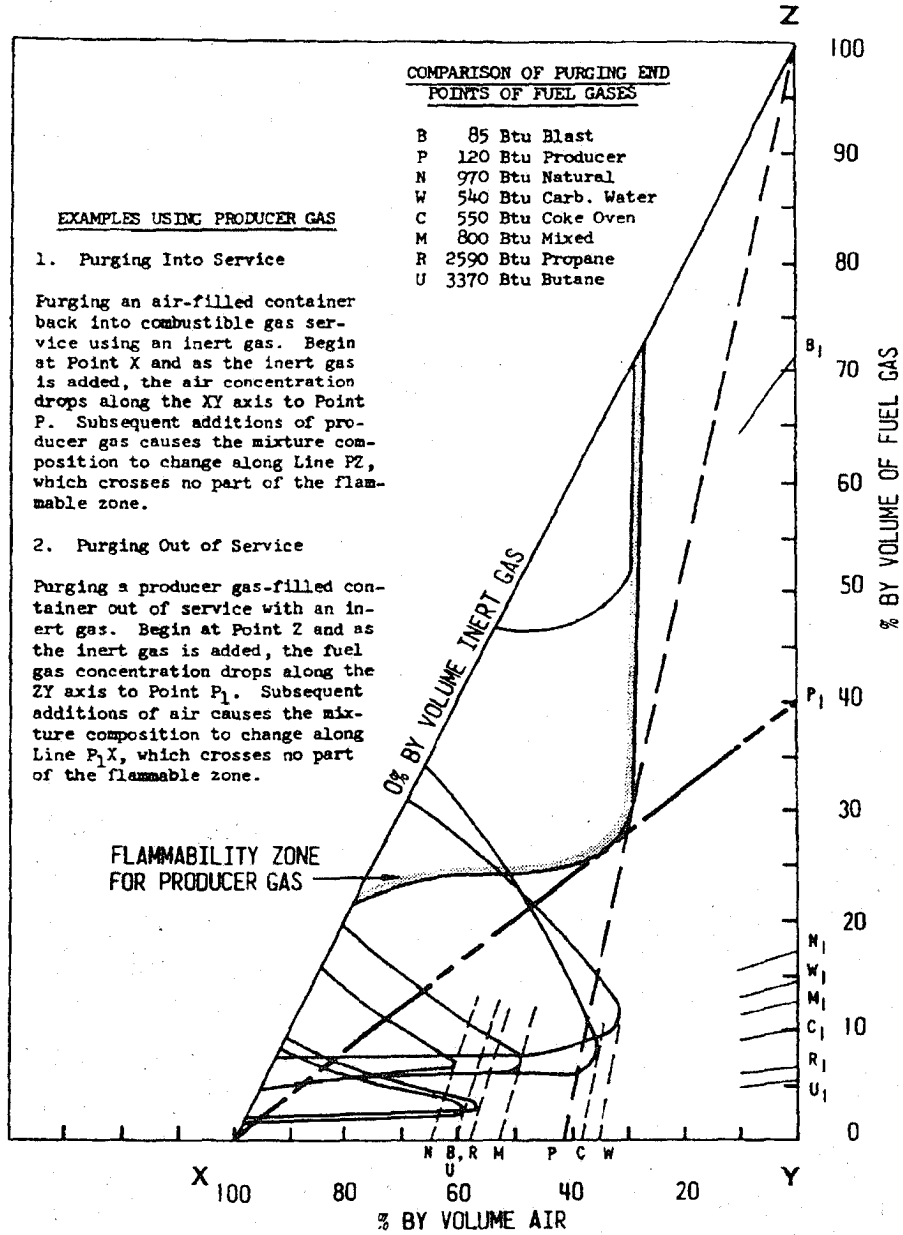

Figure 2-9 - Purging end points of fuel gases

GAS PLANT FACILITIES AND PIPING

5.11 GENERAL

The material in this chapter describes application of principles outlined in Chapters 1, 2 and 3 to some facilities encountered in gas plants and compressor stations. It is not practical in a publication of this kind to include detailed sample procedures for purging SNG plants or LNG liquifaction plants. Because of the complexities and many variables, each purging procedure must be tailored individually to the particular plant involved. Purging facilities must be kept in mind in the design of each plant and must be reviewed at each stage for adequacy in meeting process and safety

requirements. (See section 3.31, Purging Catalytic Units.) LNG facilities other than liquifaction plants are discussed in Chapter 4.

Plant facilities to be purged may differ widely in appearance, size, construction and function, but basically each is a closed system having inlet and outlet connections. The volumetric capacity of different units to be purged will vary considerably and must be determined by computation or some other reliable method.

5.13 PREPARATION FOR DOING THE WORK

In addition to the general requirements for preparation of the purging procedure (Chapter 1), the following are recommended:

- (1) Prepare for forced ventilation to be used after the purge is completed if necessary.
- (2) Inert gas supply: An adequate and reliable supply of inert purge gas should be available. This supply may be estimated as 1.5 to 2.5 volumes for each volume of the facility being purged, provided there are no volatile oils, oil emulsions, etc. The composition of the purge gas should be known or tested to determine if it is suitable. Oil scrubbers, which contain wood grids saturated with oil, may be purged with sufficient steam to remove the oil, washed with warm oil from which light ends have been removed, or washed with hot water. Inert gas may be used to complete the purge. In coal gas plants many facilities collect considerable crystallized naphthalene. Steam may be used to vaporize the naphthalene and purging completed with inerts.
- (3) Vents and test connections: Necessary vent pipes with test connections should be prepared in advance. Place the vent pipes near the outlet valve which is usually located at or near the top: at the apex of the facility, or, if the outlet pipe is a return bend coming off the top, at the highest point of the bend.

In other words, if the outlet valve is not at the highest point of the space to be inerted there

should be a vent at the highest point in addition to the one at the outlet valve. The vent or vents should be sufficiently large to permit passage of the purged gas without an appreciable buildup of pressure within the facility.

Some types of facilities are so constructed internally that they have more than one apex or pocket that will not be purged readily unless each is individually vented.

Plant piping systems frequently have several branches to duplicate facilities and a bypass. Vents should be provided at the end of each branch. Plant piping is seldom adaptable for slug purging.

A pressure gauge should be provided on the inert gas equipment or at the inlet to the facility. Another gauge may be provided near the outlet.

The inert gas connection should be made on the inlet gas connection just inside the inlet valve, if possible. If the valve is directly against the facility itself or if the inlet connection does not direct the inerts to the bottom, the inert gas connection should be made at the base of the facility itself. If plant piping is being purged with inert gas, it is preferable to make the inert connection at the lowest point of the pipe, although this may not always be possible. The size of the connection should be decided from the volume of the facility and the source of inert selected.

5.15 PURGING OPERATION FOR REMOVING FROM SERVICE FACILITIES CONTAINING FLAMMABLE GAS

5.15a. GENERAL

At this point all preliminary preparations should be completed and everything ready to complete the purging operation.

The valves should be closed and sealed, isolating the facility from all sources of flammable gas. This also applies to any means other than valves that may be used to isolate the facility. Whenever practical, an actual physical break or separation is the preferred

method. (See Section 1.19, Isolation).

Open one vent and reduce the pressure in the unit to approximately 1" w.c. pressure, close the vent and watch the gauge at least five minutes for an increase of pressure. An increase indicates leakage into the facility which must be located and stopped.

If the pressure remains constant, the vents should be opened and the purge gas introduced immediately. Continue purging until gas taken from the test connection at each vent proves to be in the safe range on the particular instrument used to determine the end point.

The interior surfaces of some facilities become coated with light oils or tars and the facilities may contain liquids at low points which tend to vaporize during the purge. It is, therefore, not at all unusual to find that even after satisfactory purge gas end points have been reached, light oil vapors are present. These oil vapors may be swept out by continued purging. (Raising the temperature of the inert gases to 130°-160°F. will speed this up.)

When purification facilities (dry or liquid) are being purged using CO₂ it is often found that due to absorption, the CO₂ in the purged gas remains below that in the inert gas. Therefore, the CO₂ content of the purged gas does not always indicate the degree of purging. A gas chromatograph can be used to determine whether the desired end point has been reached.

5.15b. WASH BOXES

Wash boxes and other facilities which have been designed, built and installed to hold a full weight of water may have their flammable gas or vapor contents displaced by filling the facilities with water, the gas or vapor escaping through a vent or vents provided for the purpose. After the flammable contents have been displaced, air may be admitted as the water is drained from the facility. When the top and bottom manhole plates are removed, or other openings are made, natural ventilation takes place.

5.15c. TANKS

Most oil and tar tanks are vented to the atmosphere and probably do not require purging before being opened. A combustible indicator test will confirm this. When such a tank has been emptied and the top and bottom openings have been made, ventilation will remove residual vapors. Air movers, which are venturi air aspirators (see Section 8.55b.), or fan blowers will hasten aeration.

Inerting is recommended if the tank contained a volatile oil, or if gas under pressure was maintained in the top of the tank over the oil. There may be local ordinances concerning the handling of tanks containing volatile oil which must be followed.

The tank may be filled with water, as in the case of wash boxes. If the tank has a conical or dome crown, it can be filled with water only to the base of the crown. An inert gas connection should be installed just above the water level and the crown purged with inert gas.

The water should be left in the tank at least 24 hours to float the oil that may have been clinging to the shell.

The residual oil floating on the water should be skimmed off before the water is drawn out. If there are not sufficient manholes to accomplish this, it may be necessary to make additional openings in the crown.

When skimming has been completed the water is drawn off. Bottom manhole plates are then removed and natural ventilation will take place.

It may be desirable to purge the entire contents with inert gas. In this case, the inert gas connection should be installed above the maximum level of the material in the tank, and the inert gas admitted while the liquid is drained or pumped out.

There may be residuals in a tank which will volatilize after inerting has been completed, creating hazards in the presence of air at normal temperatures. The temperature of the purge gas should be raised to eliminate these residuals either by the operation of an inert gas generator at higher temperatures or by the introduction of steam with the inerts. Extra precautionary measures should be taken when using higher temperature purge gas or steam so as to avoid a pressure buildup within the facility.

Steam alone may be used to purge small tanks up to approximately 30,000 gallons if the tanks are shaped so the steam can form a slug and displace the vapors ahead of it, or if steam can be furnished in sufficient quantity to completely fill the tank almost immediately.

Steam alone is not recommended for the purging of large tanks used for the storage of volatile oils.

5.15d. POST PURGING CARE

When purging is completed, the facility should be opened immediately and allowed to ventilate.

Complete any physical disconnection from the gas lines and make the temporary isolation permanent if the facility is to remain out of service.

If the facility cannot be opened immediately, provision should be made to maintain a positive pressure of purge gas.

A facility which has been opened should be tested with the combustible indicator to detect vaporization of oils coating the interior. If the facility ventilates readily, there should be no indication of vaporization; but if it does not ventilate, these vapors may build up to the danger point and must be blown out. The frequency of testing depends upon whether or not such vapors are present.

If work, such as cutting and welding, is to be done in or on a facility which has been permanently isolated, purged and opened to the atmosphere, care should be taken to remove all combustible material from the interior. Careful tests should be made to insure the purity of the atmosphere inside.

The facility should be well ventilated and tested for oxygen deficiency and for vapors and gases harmful to health before workers are allowed to enter it.

If there is any danger of spontaneous combustion while the facility is open (such as boxes containing

fouled oxide), a fire hose or other suitable fire extinguishers should be arranged readied for instant use.

In some cases, particularly if cutting or welding is to be done on the outside of the facility, it is advisable to

maintain a holding purge during the progress of the work. A slow flow of inert gas through the facility should be maintained to be sure inerts in the facility are not replaced by air during the progress of the work.

5.17 INSTRUCTIONS FOR PLACING FACILITIES CONTAINING AIR INTO FLAMMABLE GAS SERVICE

5.17a. GENERAL

All preparations and precautions that were made for removing the facility from service and maintaining its safety while open should still exist.

- (1) If a new facility is being put into service, all preparations should be made exactly as though it had been in service. In this case it is usually necessary also to purge sections of pipe in order to tie the facility to the system. A written procedure should be made up in advance of the purge to carry the work through safely.
- (2) Pipe connections, removed for permanent isolation, are reconnected, but temporary isolation, such as sealed valves, is maintained.
- (3) The final opening should remain open until it is time to start purging.
- (4) When all preparations have been completed, close the final opening and introduce the purge gas. Continue purging until samples taken at each test connection show that a satisfactory end point has been attained. Shut off the inert gas supply.
- (5) Admit flammable gas and allow the purge gas to escape through the vents until tests at the vents show that proper end points have been attained. Close all vents. Connect all necessary auxiliary piping, if any, and return to service.

5.17b. WASH BOXES

Wash boxes and some other facilities may use water for displacing the air; then flammable gas may be drawn in as the water is drained or pumped out.

5.17c. TANKS

If purging is considered necessary to return tanks to service, it is recommended that inert gas be used. If flammable gas pressure is to be maintained over the oil in the tank, the connection may be made after the inerting is completed.

5.17d. POST PURGING CARE

If the facility is not immediately returned to service and it is not desirable to admit flammable gas, a positive pressure should be maintained with purge gas.

If the facility not immediately returned to service contains flammable gas, a positive pressure should be maintained with flammable gas.

If any valves were sealed which are normally closed, they must be opened sufficiently to release the sealing material or drained in some other manner. Neglect of this step may cause serious complications if the valve was sealed with water and is located where exposure to freezing temperatures is possible.

5.21 SAMPLE PROCEDURE FOR CLEANING AND PURGING DRIP TRUCK TANKS

5.21a. GENERAL

A drip truck tank may contain solids, principally pipe dust, which have been pumped or blown from the main. It also may contain tars and volatile oils which should be "topped" before the tank can be considered safe to be opened for repairs. A suggested procedure to do this follows.

5.21b. FROM FLAMMABLE CONTENTS TO AIR

- (1) Fill the truck about $\frac{1}{2}$ to $\frac{3}{4}$ full of a hot water solution containing 3% caustic soda and 2% sodium metasilicate. Handle the chemicals and solution with care to avoid burns or serious injury to the eyes. Chemical safety goggles or face shield, gloves and protective clothing are recommended.
- (2) Drive around for a period to cause the solution to

splash around and thoroughly wash all parts of the tank interior.

- (3) Empty tank.
- (4) Attach a pressure gauge and steam hose at point "A". (Figure 5-1)
- (5) Crack drain valve "b" so condensate may run out.
- (6) Turn steam into tank at point "A", keeping the pressure on the gauge within a safe limit for the tank, and then continue to steam until tests show that the desired end points have been reached and the tank is "safe".
- (7) Open tank cover (in this case under vent "a", Figure 5-1) and allow it to air out.

NOTE: If it is considered advisable to work with a holding purge, the steam may be kept on at point "A" or a cylinder of CO₂ may be attached in place of the steam and the tank may be filled with CO₂ during the work.

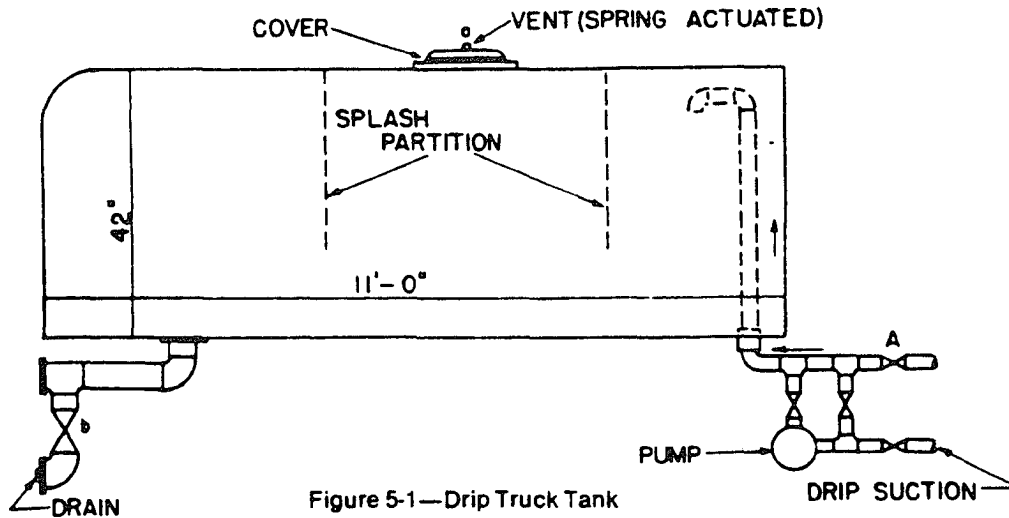

Figure 5-1—Drip Truck Tank

5.21c. FROM AIR TO FLAMMABLE CONTENTS

- (1) Connect a pressure gauge and a cylinder of CO₂ at point "A"
- (2) Fill tank with CO₂ until the Orsat test shows less than 5 percent oxygen.
- (3) Drip oil may now be put in the tank.

5.23 SAMPLE PROCEDURE FOR PURGING A COMPRESSOR

5.23a. REMOVING A COMPRESSOR FROM SERVICE

To remove a compressor from service for inspection and/or maintenance, isolate the equipment by closing all suction and discharge valves and evacuate all pressure from the isolated piping and equipment by blowing the gas to atmosphere. In the event that this procedure is not sufficient to block all gas from entering the working area, blind flanges should be installed, or the lines and equipment should be vented to a safe area.

Suitable gas detection equipment should be used to check for leakage prior to disassembling the equipment.

Compressors, sections of piping, and related station equipment should be purged by means of an inert gas, preferably nitrogen, or by use of air movers. This should be completed before any maintenance or alteration work such as welding, cutting or grinding, which would create a fire hazard, is performed on or in the immediate area of the isolated equipment.

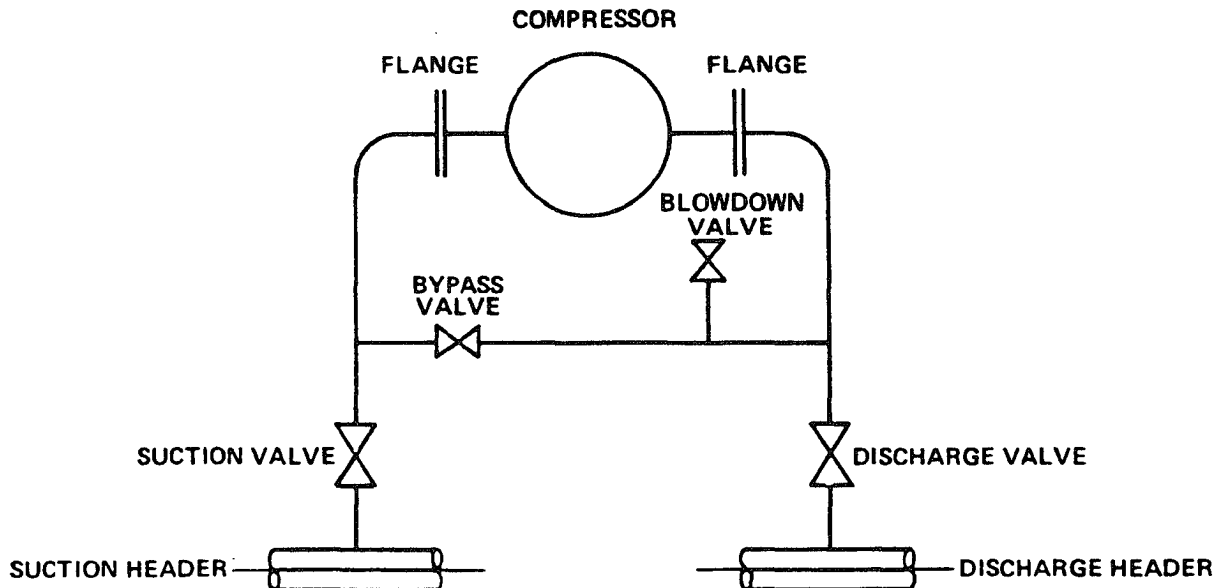

Figure 5-3

In the event purging is deemed necessary, care should be taken to assure that the purge rate is sufficient to create complete mixing of the purging medium and the natural gas in the equipment, and to achieve positive displacement of the natural gas from all chambers and pockets of the system being purged. The volume of inert gas or air required depends on the configuration of the system, but should be at least twice the volume of the system to be purged.

Valve operators which control the suction, discharge, bypass and blowdown valves should be disarmed to guard against inadvertent operation while that part of the system is out of service.

Valve cap clearance pockets, end unloaders, etc. should be in an open position for purging.

Precautions should be taken to ensure the compressor or compressors and related piping to be purged are completely isolated from the rest of the system.

Sample procedure to be used when removing a compressor from service follows: (Refer to Figure 5-3)

- (1) Close and lock suction and discharge valves.
- (2) Open and lock bypass valve.
- (3) Open and lock blowdown valve.
- (4) Check bleed-off valves and/or gauges for possible leakage.
- (5) Loosen head, valve cap, flanges, etc., and use suitable gas detection equipment to ensure isolating valves are holding.
- (6) If no abnormal amount of gas is present, compressor can be opened for inspection and/or repair.
- (7) If leakage cannot be prevented at the isolating valves, blind flanges, vents or other suitable

means should be employed to prevent gas from entering the isolated system.

- (8) If it becomes necessary to enter a compressor cylinder, or if welding or cutting operations must be performed, the isolated compressor and piping should be purged, and suitable precautions should be taken to prevent the accumulation of combustible gas in the compressor building.

5.23b. RESTORING A COMPRESSOR TO SERVICE

Compressors, sections of piping, and related equipment that have been opened or vented, should be purged with gas before they are returned to service.

Purging should be of a sufficient duration to assure a complete purge. Special attention should be given to the volume and configuration of the system. Where appropriate, assurance of a complete purge can be determined by sampling the contents in the compressor and related piping.

A sample procedure to be used when restoring a compressor to service follows: (Refer to Figure 5-3)

- (1) Secure all valve caps, flanges, heads, etc.
- (2) Close bypass valve.
- (3) Admit sufficient gas to purge system.
- (4) Close blowdown and suction valves.
- (5) Use combustible gas indicator to check for leakage and read gauges to verify sustained pressure.
- (6) Open suction and discharge valves to load compressor. (This step may be modified or deleted where automatic sequence starting systems are employed.)

5.25 SAMPLE PROCEDURE FOR PURGING AN OIL TANK

5.25a. PRELIMINARY

- (1) Appoint a supervisor or engineer to be in charge of the purging operation.
- (2) Determine the type of product and the amount of sludge contained within the tank.
- (3) Make an external inspection of the tank and survey the immediate area to determine if it is safe for the purging operation.
- (4) Train and indoctrinate all personnel to be used in the purging operation.
- (5) Inspect all equipment to be used to assure it is in good operating condition.

5.25b. CONTROL OF SOURCES OF IGNITION

- (1) Eliminate all sources of ignition from the area where flammable vapors may be released or may travel.
- (2) Barricade the area and post warning signs to keep out vehicles and other sources of ignition.

- (3) No artificial lights, other than safety, dry cell flashlights, should be used inside the tank until after the purging is completed. Portable lights and other electrical equipment used outside the tank in the path of possible vapor travel should be explosion proof and approved for hazardous locations.
- (4) Care should be taken to avoid spontaneous combustion, such might occur as with sludge removed from the tank and with crude oil, both of which contain significant quantities of hydrogen sulfide (sour stock). These materials may contain finely divided iron polysulfide deposits, which are pyrophoric on exposure to air.

5.25c. EMPTYING AND BLANKING OFF THE TANK

The tank illustrated in this procedure is a vertical cylindrical tank with a conical dome, either with or without flammable gas or inert gas in the space above the stored gas.

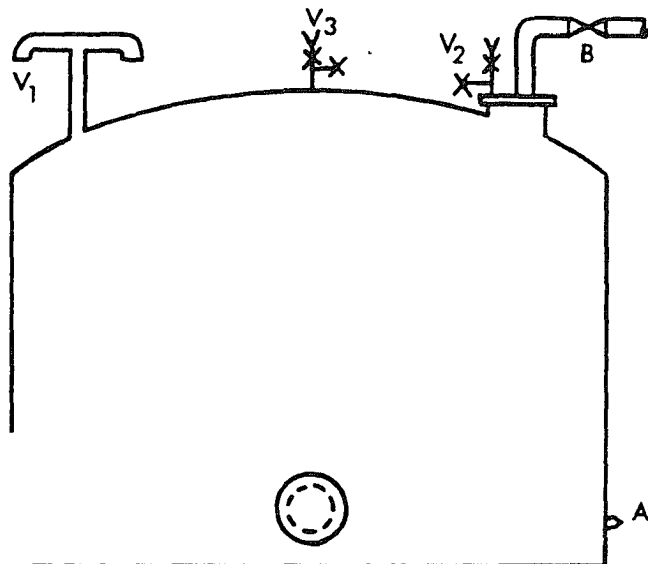

Figure 5-5

- (1) Before the tank is opened, pump or drain off all residual product to the lowest possible level. This pumping or draining may be augmented by the addition of water through existing piping connections—not through a roof opening—to float any remaining product.
- (2) Blank off all piping connected to the tank, at a point as close to the tank as possible and on the tank side of the tank valves.
- (3) Drain and flush all lines which enter the tank.

5.25d. PURGING OUT OF SERVICE

- (1) Existing tank vent "V₁" may be suitable as a purge point for inerting. If not, install a suitable vent connection. Install additional vents "V₂" and "V₃" at the apex and on the manhole. Also install pressure gauges.
- (2) Install gas connections for inert purge gas at oil line "A". (Water may be used to purge the tank and, if so, connect the water line to line "A", and the purge gas to Point "B" omitting the vent "V₂".)

- (3) Open vents "V₁", "V₂" and "V₃" if they are valved.
- (4) Admit inerts at Point "A". (If water is used, fill the tank to the edge of the dome, then start purge gas at Point "B" and purge the dome through vent "V₃".)
- (5) Test the purge gases at vent "V₁" and "V₃". When the desired end points have been attained, shut off the flow of purge gases and/or water.
- (6) Open top manhole to atmosphere.
- (7) If water was used, drain water from the tank through bottom connection Point "A".
- (8) Open bottom manhole and install a suitable blower or air mover to aerate the tank if necessary.

Oil tanks also may be freed of flammable vapors by displacing the hydrocarbon vapors with air. However, special precautions are required when vapors are displaced by mechanical ventilation, steam ventilation or natural ventilation.

5.25e. PURGING INTO SERVICE

- (1) Connect inerting machine or purge gas to Point "A".
- (2) Open vents and valves at "V₁", "V₂" and "V₃". Install pressure gauges.
- (3) Install manhole covers.
- (4) Introduce purge gas at Point "A".
- (5) Test purge gases at vents "V₁", "V₂" and "V₃" until desired end point has been reached.
- (6) Shut off purge gas and disconnect from Point "A".
- (7) Remove all blanks previously installed in the pipes connecting to the tank, and reconnect lines.
- (8) If gas pressure is to be maintained in tank, displace inert gas with gas from Point "B" and remove or close all vents.
- (9) Tank may be filled.

Additional information on the cleaning and repairing of tanks may be obtained from the American Petroleum Institute. Bulletin API RP 2015 *Recommended Practice for Cleaning Petroleum Storage Tanks*, and API PSD 2207 *Preparing Tank Bottoms for Hot Work*.

GAS HOLDERS

6.11 INTRODUCTION

The recommended purging procedure discussed in this chapter for all cases and types of holders, applies to the following situations:

Removing a holder containing flammable gas from service.

Placing a holder containing air into flammable gas service.

NOTE: The term "holder" includes all types of gas storage containers, except LNG and liquefied petroleum gas storage tanks.

6.13 PREPARATION

The preliminary preparations required prior to purging a holder include the following items essential to the safe conduct of the operation:

6.13a. SUPERVISION

Competent and experienced supervision should be provided, a written purge schedule prepared, and the procedure discussed with all personnel involved. The purge schedule should include approved drawings marked to indicate the location of the purge vents, inert connections, seal bonnets (Livezey seals), bypass valves, inlet and outlet connections, valves adjacent to holder, stopper and bag locations, drips (with reference to seal depth), etc.

6.13b. GAS ANALYST AND EQUIPMENT

A competent gas analyst, equipped with gas analysis apparatus and combustible gas indicator should be available throughout the operation. All chemical apparatus, solutions and instruments should be in a serviceable condition prior to purging and in inclement weather a working enclosure should be provided, heated if necessary.

6.13c. SHUTDOWN ARRANGEMENTS

Definite arrangements should be made with those in authority to shut down and completely bypass the holder from the distribution system, for the required period.

The following procedures should be observed:

(1) **WATER-SEAL HOLDER:**

After the oil and emulsion have been removed but prior to severing the flammable gas lines, the holder should be deflated to a point where all sections are landed except the inner section, which should remain inflated about three feet.

(2) **WATERLESS HOLDER:**

The holder should be deflated to a height such that the piston deck is brought below the lowest manhole on the shell, prior to severing the flammable gas lines or to starting any preparatory work on the holder proper.

(3) **PRESSURE HOLDER:**

The holder content should be reduced to about 6" pressure after draining out the oil, if any, but prior to severing the flammable gas lines.

6.13d. HOLDER CONTENTS

If the contents of the holder is not known, it should be tested by gas analysis to determine definitely the makeup.

6.13e. PURGING PERIOD

If possible, arrangements should be made for the entire purging operation to be performed and completed during the day. Night operations require lighting facilities which, if not sufficiently extensive, can result in unsafe working conditions. Night operations should therefore be avoided unless necessary because of special circumstances.

If a long purge is necessary and interruptions cannot be tolerated, and since the critical periods in a purge are the beginning and the end, then it is advisable to start in the middle of the day, using the night hours for the time-consuming but relatively simple job of admitting the required amount of purge gas, and completing the final work in daylight.

Although a purging operation should not be conducted in haste, nor safety sacrificed to time, convenience or expense, there is no additional safety provided by unnecessarily prolonging the operation.

6.13f. INERT GAS SUPPLY

There should be available an adequate and reliable supply of inert gas, at least twice the volume of the holder to be purged, provided there are no volatile oils, oil emulsions, etc.

The inert gas should be tested to determine that it is of a suitable composition.

6.13g. REMOVAL OF OIL AND EMULSION

Holders which have been in flammable gas service may contain deposits of volatile oils, oil emulsion, etc., depending upon the holder type. These oils and emulsions will develop flammable vapors which when mixed with air are susceptible to explosion, and should be removed before purging the holder.

(1) In the water-seal holder flammable gas is dissolved in the tank water, and the interior surface of the tank water may be covered with drip oil, drip oil emulsion, or both. The water also may contain an emulsion of volatile oils in suspen-

sion below the surface. As much of the oil and emulsion as possible should be removed by skimming prior to initially deflating the holder. If the holder is equipped with a permanent skimmer, the major portion of the oil and emulsion may be readily removed.

If the holder is not so equipped the oil and emulsion may be removed with a portable skimmer, illustrated in Figure 6-1, which should be placed successively at several points around the circumference of the holder. In the later stages of skimming more water than oil will be drawn off, but the process should be continued until the oil and emulsion have been removed, even though the tank water level will be lowered several inches.

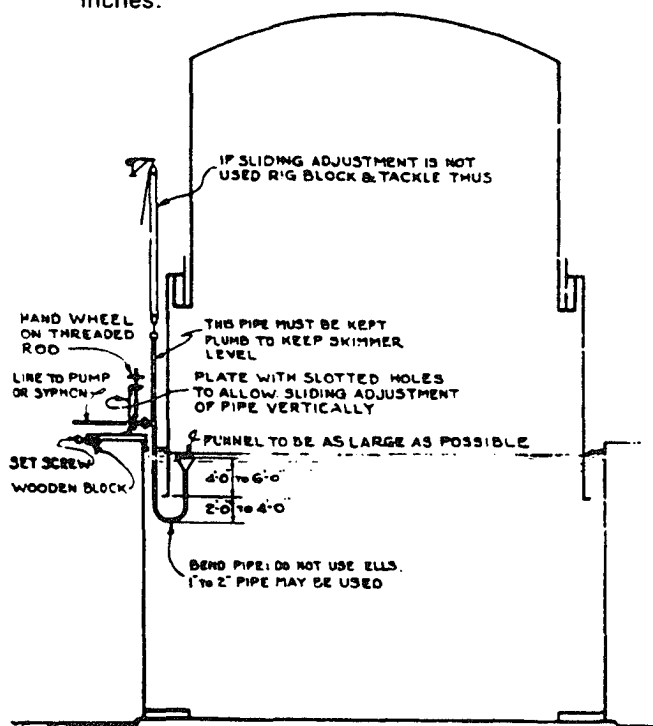

Figure 6-1—Portable Skimmer

(2) The waterless holder may accumulate oils on the bottom plating. If it is determined that these oils are volatile, they should be removed after the piston has been lowered so that the piston deck is below the shell manhole.

(a) M.A.N. type—Water should be introduced, through a line provided on the top of the piston, onto the bottom of the holder until it overflows into the lowest holder connection. The water will float off the oil through the connection and permit its removal by the drip pump. The complete removal of the oil can be ascertained by observation of the water effluent from the drip pump discharge. Some holders have a line that extends to the inner area of the holder. The line could be used to remove the volatile oils; however, if the oil is not volatile, leave the oil in the holder until

after purge of holder.

(b) Kloenne type — Water should be introduced, through a line provided on the top of the piston, onto the bottom of the holder until the water level is above a closed and sealed drain connection provided in the side of the shell near the bottom. The drain connection should then be opened and the oil and water drained from the holder. This procedure should be repeated until clear water, free of oil, runs from the drain.

(c) Wiggins (Dry Seal)—Water should be introduced through a connection in manhole at the bottom of the shell to determine presence of oil and to remove oil by floating it off through condensate drain.

(3) Pressure holders should be drained of any oil accumulation prior to reducing the holder pressure.

6.13h. VENTS, INERT GAS CONNECTIONS, TEST COCKS, GAUGE CONNECTIONS, SEAL BONNET (LIVEZEY SEAL) BYPASSES, VALVES

Necessary vents, piping and accessories should be provided for in advance. If the connections for these items are to be installed on a holder that is to be taken out of service, the workmen doing the drilling, tapping and installation should be provided with proper safety and respiratory equipment. Also, hand or air power tools and equipment should be used to reduce the fire hazard.

In selecting the locations of the various vents and the inert gas connection it is important to reduce to a minimum the possible existence of "dead" pockets, which will handicap complete purging.

Appropriate vents (Figure 1-9) should be provided on the holder "B" (Figures 6-3, 6-11) as follows:

(1) Water-seal holder: On the crown, at or near the center, auxiliary vents should be provided at four points near the outer circumference, spaced about 90° apart, to assist in equalizing distribution of inert gas and to expedite the operation.

(2) Waterless holder: A vent opening should be provided in the piston of an M.A.N. holder diametrically opposite the point where the inert gas is to be admitted, and in the piston of a Kloenne holder at or near the center of the crown. This opening should be connected by a flexible line carried to the outside of the holder through a manhole in the shell. The end of the flexible line may have a vent pipe attached to it, and should be elevated to a point at least six feet above ground level. The flexible line should permit inflating the piston three feet without damaging the holder or vent connections.

(3) Pressure holder: On spherical or vertical cylindrical tanks, a vent should be on top of holder, at or near the center.

Horizontal cylindrical tanks, if the inert gas connection is midway between the ends, two standard vents should be provided on the top

of the holder, one near each end. If the inert gas connection is at one end of the tank, a standard vent should be provided on top at the opposite end, or two vents provided, one at the middle of the top and one at the opposite end.

These vents, with the valve fully opened, should be of sufficient size to discharge the purge gas without building up more than 1" of water pressure within the holder.

Vents also should be provided on all holder connections except that one utilized for the inert gas supply (Figures 6-3, 6-7).

INERT GAS SUPPLY

The inert gas supply should be piped and connected to one of the holder connections indicated in Figures 6-3, 6-7, after which the holder drip on that connection is pumped, if water sealed.

TEST COCKS

Test cocks are provided on the vents, and in addition should be provided as follows:

- (1) Water-seal holder: On the crown, at the auxiliary vents.
- (2) Waterless holder: On the piston at four points near the outer circumference, spaced about 90° apart and provided with nipples extending through and about 6" below the piston deck.
- (3) Pressure holder: On horizontal cylindrical tanks, if the inert gas connection is midway between the ends, a test cock should be provided on top of the holder midway between the vents. If the inert

gas connection is at one end of the tank, a test cock should be provided on top of the holder about one-third the length of the holder from the inert gas inlet. Where permanent test cocks cannot be installed, provide temporary test lines during the purging operation to sample across the cross-section of the holder between the inert connection and the vent.

WATER GAUGE

A water gauge should be connected to the holder to show the pressure therein.

SEAL BONNETS

Seal bonnets (Livezey Seals) in water-seal holders, should be provided with full size bypasses (Figure 6-3). This arrangement insures complete purging of the bonnets and permits utilization of a holder connection for the inert gas inlet under all circumstances. If, for any reason, it is not convenient to install seal bonnet bypasses and it has been ascertained that the seal bonnets give a greater depth of seal than can be overcome by the available inert gas pressure, then it will be necessary to provide an inert gas inlet connection to the crown of the holder with a length of steam hose as indicated at "E", Figure 6-3. Also, under such a circumstance, a vent opening should be provided in each of the seal bonnet (Livezey Seal) covers and an inert gas supply connection instead of a vent should be provided at each holder connection to permit purging out of the standpipes and seal bonnets.

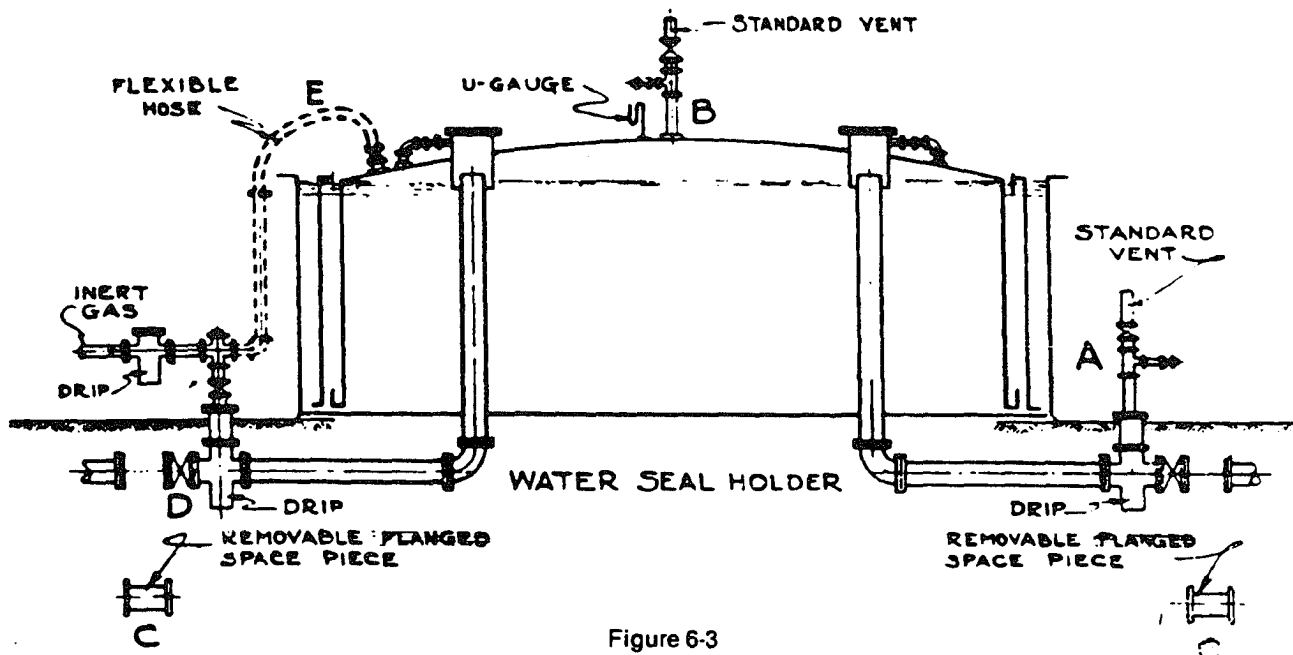

Figure 6-3

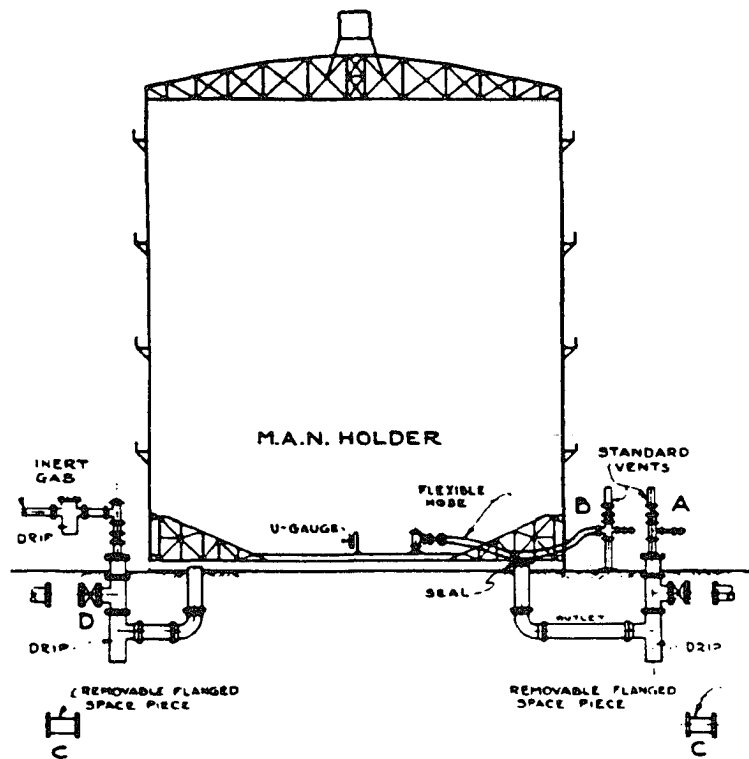

Figure 6-5

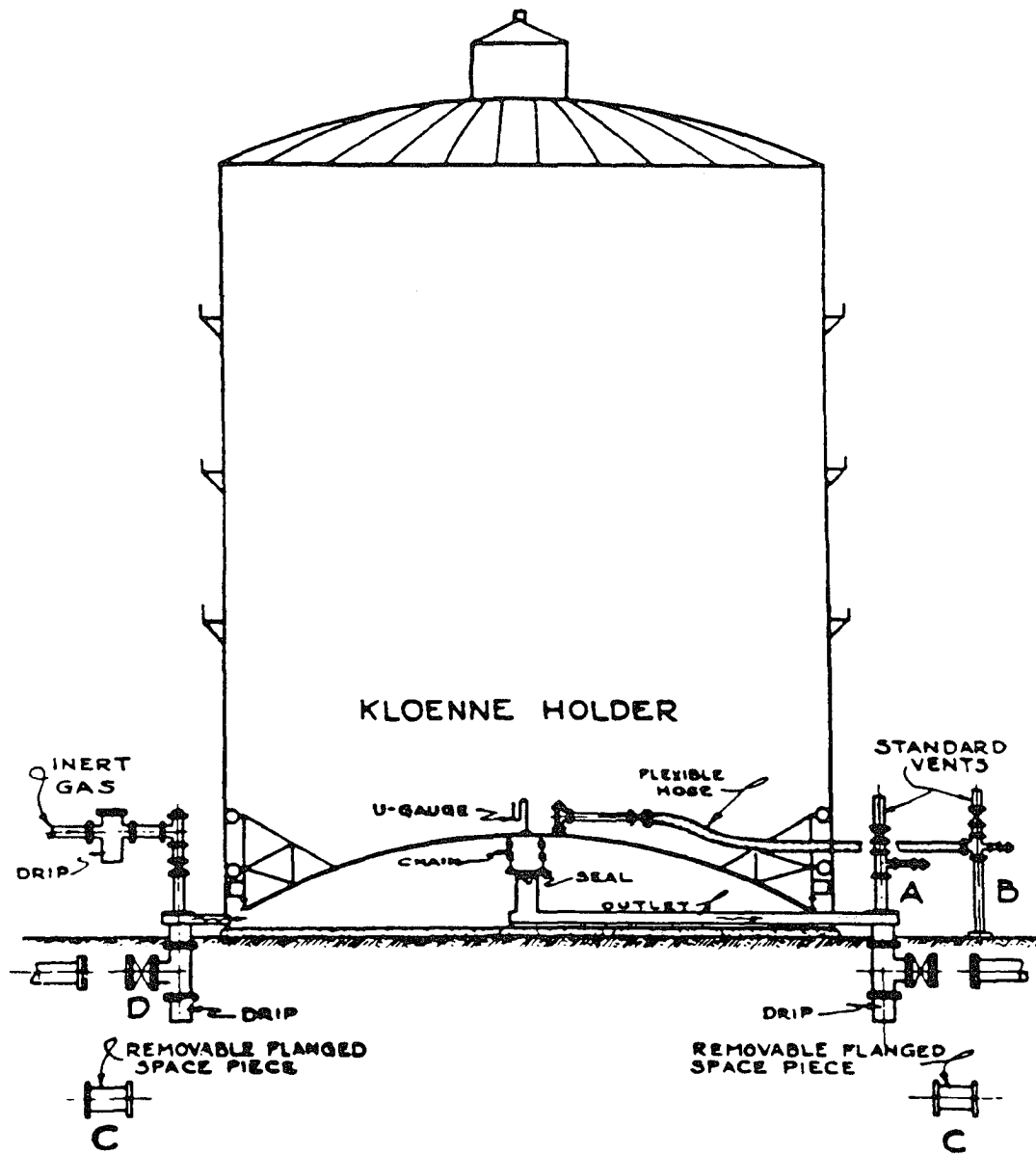

Figure 6-7

VALVES

Valves should be provided in the holder inlet and outlet flammable gas lines, adjacent to the holder and so located as to be readily accessible.

6.13i. ISOLATION OF A HOLDER BEING REMOVED FROM SERVICE

Positive isolation of the holder from the initial admission of air or flammable gas until the purging operation has been completed is necessary to prevent the possible formation of explosive mixtures.

The holder should be completely severed from all flammable gas connections, and remain disconnected throughout the entire period it is out of service. The physical separations should be made in the flammable gas lines, by removing valves, pipe sections or fittings, or by rotating a fitting from the normal flow direction, as determined by convenience and availability.

The actual performance of this operation requires water sealing of the holder drips, and installing of stoppers and vents in the flammable gas lines, to isolate that section of the line where the physical separation is to be made. The isolated sections are then purged with inert gas, the severances made, and every open end closed with a blank flange cap, or plug, after which air is removed from the pipe sections at the severances by again purging.

Before severing the last flammable gas connection of a water-seal or waterless holder, the holder should

be deflated to a height of about 6" above the landing beams.

A greater volume, perhaps keeping the holder several feet above landing, should be left when a possibility of a temperature volume change (overnight) will occur before the inerting of the holder to prevent the collapsing of the holder crown.

Materials should be arranged to permit convenient reconnection when the holder is to be returned to service.

6.13j. VENTILATING FACILITIES

A ventilating blower, or an air compressor should be installed to provide air to displace the inert gas and ventilate the holder after purge has been completed.

6.13k. PRECAUTIONARY MEASURES

- (1) Workers should be cautioned that both inert and purge gases are suffocating and may be toxic, and, therefore, should not be inhaled.
- (2) Because of the properties of flammable and purge gases, the holder's vents should be extended off to one side or upward away from or above windows and doors of adjacent buildings.
- (3) Precautions should be taken against all sources of ignition (open flames, welding and burning, smoking, electrical equipment, etc.) in the immediate vicinity of the holder. Purging should not be undertaken during an electrical storm.

6.15 PURGING OPERATIONS

The following purging procedures apply after the preliminary preparations heretofore described have been completed. Purging operations should not be started when electrical storms are threatening and consideration should be given to stopping venting if storms develop during purging.

6.15a. INSTRUCTIONS APPLICABLE TO ALL CLASSES AND TYPES OF HOLDERS

The inert gas, of a specified quality, is admitted to the holder with all vents "A" closed and vent "B" open (Figures 6-3, 6-11): auxiliary vents and the seal bonnet bypasses on water-seal holders also should be open. A minimum pressure of 1" of water, and preferably a slightly greater pressure, should be maintained in the holder throughout the purging operation. If trouble should develop with the inert supply, this practice will assure a positive pressure within the holder while the condition is being remedied, assuming, of course, that the vents are closed during the emergency.

Frequent samples of the inert gas delivered into the holder should be tested at once to insure maintenance of the required quality.

As the purging continues, samples of the purge gas taken at frequent intervals from the test cocks should

be tested immediately to determine the progress of the displacement.

When the purge gas analysis shows that the contents of the holder have been displaced with inert gas to a point of safety, vent "B" and auxiliary vents are closed, all vents "A" are opened and the holder drips pumped, if water sealed. If the seal bonnets (Livezey Seals) of a water-seal holder are not provided with bypasses, then inert gas is admitted at each of the holder drips consecutively, the vent in the seal bonnet cover opened and the holder drip pumped, if water sealed. Purging of the holder connections, standpipes and seal bonnets through vents "A" or through the vents in the seal bonnet covers, as the case may be, is continued until the purge gas at these vents is shown by test to be of a safe composition.

During the purging period there may be a tendency for the inert gas to bypass directly from the inlet connection to vent "B". This may be detected by a comparison of purge gas analysis of samples from the various holder test cocks as described hereafter. Bypassing should be broken up as follows:

- (1) Water-seal holder: Close holder vents and inflate holder about 6" with inert gas; then continue purging by opening vents and deflating holder to 1" pressure.
- (2) Waterless holder: Close vent "B" and inflate

holder about one foot with inert gas; then continue purging by opening vent "B" and deflating holder to 1" pressure.

- (3) Pressure holder: Partially close vent or vents "B" and increase pressure in holder; then continue purging by opening the vent or vents "B".

Sufficient inert gas should be put into the holder after purging has been completed, to provide for shrinkage in the volume of the holder contents on cooling. Raise the holder sufficiently to provide for shrinkage. This will prevent a negative pressure from developing within the holder. This condition may occur during the period of the actual displacement of the inert gas by flammable gas or air, and without the proper precautions could result in damage to the holder crown, piston, or shell.

6.15b. SPECIFIC INSTRUCTIONS FOR WITHDRAWING HOLDERS CONTAINING FLAMMABLE GAS FROM SERVICE

GENERAL

During the process of purging, the concurrent admission into a holder of steam with the inert gas serves to maintain a higher temperature within the holder and promote the removal of volatile oils which were not drained off. In the case of a Wiggins holder, however, steam should not be used because of the possibility of damaging the diaphragms. The flow of steam into the holder should be stopped when all purge gas samples from the holder, as tested by a combustible gas indicator, show 85 percent or less of the lower explosive limit concentration. In all cases, the supply of inert gas to the holder should be continued for a time after the admission of steam has been stopped in order to compensate for the subsequent rapid and appreciable shrinkage of the contents.

Bypassing of the inert gas within the holder is indicated when samples of the purge gas from the test cocks other than at vent "B" show a higher combustible gas content and a lower carbon dioxide content than the purge gas from vent "B" test cock.

If the purging operation on a water-seal or waterless holder is to be suspended to avoid night work, or for other reasons, all vents ("A", "B", and auxiliary) must be closed and remain closed until purging is resumed. If steam is being admitted to the holder, it must be shut off first, and the admission of inert gas continued until the holder has been inflated not less than two feet. In this position it may safely remain for an indefinite period.

When Orsat analyses and tests by a combustible gas indicator of purge gas samples from all test cocks show 85 percent or less of the lower explosive limit concentration, the flammable gas and vapors in the holder and holder connections will have been displaced by the inert gas to a point of safety. All vents "A", "B", and auxiliary, should then be closed and the holder (water-seal or waterless) should be inflated about two feet with inert gas.

WATER-SEAL HOLDER

Several hours may be saved by closing up the tank overflows and raising the level of the water to the top of the tank after the oil and emulsion have been removed and the holder deflated, thus reducing the volume of gas to be purged out.

After the supply of inert gas is connected and ready, and the holder has been completely severed from the flammable gas lines, the holder should be deflated the remaining few inches by allowing the gas to escape through vent "B" (Figure 6-3). The admission of inert gas should begin before the holder is landed and while there is still some gas pressure under the crown.

In the event the permanent supportive frame has deteriorated to the extent it fails to provide adequate support for the crown, special precautions should be taken to prevent collapsing the crown when landing the holder.

The steam for removing the last portions of volatile oils which may be in the holder, should be admitted through $\frac{3}{4}$ " pipe jets projecting through the crown at four points 90° apart, and about one eighth of the diameter from the outer edge of the crown. The pipes should be flattened at the outlet end, and these nozzles should be inclined, giving the steam an angular projection against the surface of the tank water, and imparting a circular motion thereto.

The grips of the holder sections should be purged by providing two holes which can be readily closed or plugged in each of the grips, at locations diametrically opposite each other, to allow displacement of the flammable gas by the application of an inert gas through one of the openings.

After complete purging of the holder and holder connections has been initially indicated, and the admission of inert gas has been suspended, repeated observations should be made with the combustible gas indicator to ascertain whether or not the liberation of flammable gas and/or oil vapors from the tank water continues. A reliable determination requires approximately two hours. If the observations do indicate a continued liberation of flammable gas and/or oil vapors, purging with inert gas and the admission of steam must be resumed, and possibly repeated, until further observations show that this condition has been overcome.

There may be some difficulties connected with the purging of old holders which are not met with in the case of new holders. Particularly with holders having masonry tanks, rubbish and solid matter of considerable stability may have accumulated beneath the inner section to a height of several feet above the bottom, in which case the cup of the inner section may be badly damaged upon deflating the holder. Because of their frequent landings the outer sections of a holder usually prevent the formation of such obstructions. The actual conditions should be ascertained by sounding with a long rod. In most cases, the obstructions may be dislodged either with a long-handled rake or with a water jet, though on rare occasions dredging may be necessary. If the purpose of purging

is to dismantle the holder, the obstructions in the bottom of the tank, if any, require no attention.

WATERLESS HOLDER

No purging should be done into the space above the piston. With the M.A.N. type holder, the skimmer weirs should be lowered as far as practicable to reduce the quantity of sealant in the dam.

After the supply of inert gas is connected and ready and the holder has been completely severed from the flammable gas lines, the piston should be deflated the remaining few inches by allowing the gas to escape through vent "B" (Figures 6-5, 6-7). The admission of inert gas should begin before the piston is landed and while there is still some gas pressure on the piston.

The steam, to remove the volatile oil which may still be in the holder, should be introduced into the holder through the inert gas line, concurrently with the inert gas.

If the sealing arrangement of the holder outlet connections is not equipped with lifting rods, the purging of these connections requires lifting the piston with inert gas about one or two feet above the landing position.

After the holder and holder connections of the M.A.N. type have been purged, the sealant seal tanks and sealant risers should be purged by admitting inert gas from the holder through the equalizer line and purging through the test cock plug on top of the seal tank. The outer annular which chamber receives the sealant on the bottom of a waterless holder also should be purged at this time by rotating the peripheral sealant samplers to bring their ends above the sealant in the dam, opening the samplers to air, and throttling the piston vent to force inerts over the sealant dam wall to displace gas and sealant vapors through the samplers.

PRESSURE HOLDER

After the oil, if any, has been drained from the holder, and the gas pressure reduced to about 6" the valves on all flammable gas lines to the holder should

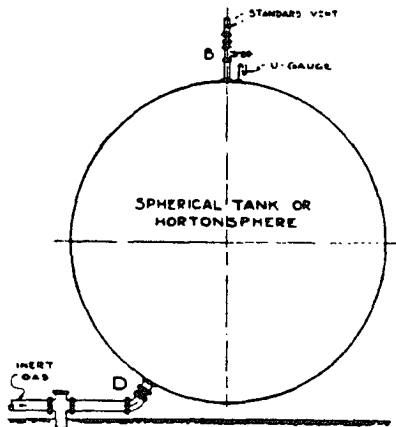

Figure 6-9

be closed and the lines severed outside of the valves.

The remaining gas pressure on the holder should be dissipated through the vent or vents "B" (Figures 6-9, 6-11), and inert gas and steam admitted concurrently through the inert gas line while there is still some pressure on the holder.

When the holder has been purged, and the steam shut off, the flow of inert gas is continued until the temperature of the purge gas has been reduced to normal.

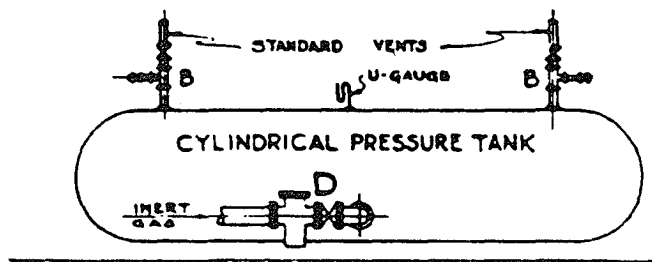

Figure 6-11

6.15c. SPECIFIC INSTRUCTIONS FOR PLACING A HOLDER, CONTAINING AIR, INTO FLAMMABLE GAS SERVICE

GENERAL

One manhole on the holder crown or piston should remain open until the purging operation begins. All other manholes should be closed.

By-passing of the inert gas within the holder is indicated when samples of the purge gas from the test cocks other than at vent "B" show a higher oxygen content than the purge gas from vent "B". (Figures 6-3, 6-11).

Should it be necessary to suspend the purging operation, all "A" and auxiliary vents should be closed, and vent "B" should remain half open to prevent the development of a vacuum within the holder caused by shrinkage of the contents on cooling.

When analyses of the purge gas samples from all vents and test cocks show an oxygen content of less than 5 percent by volume the air in the holder and holder connections will have been displaced by inert gas to a point of safety.

After the holder and holder connections have been completely purged of air, and the holder (water-seal or waterless) inflated with inert gas to a height of about two feet with all vents closed, preparations should be made to connect the flammable gas line to the holder. The inert gas must be retained in the holder during this operation either by water sealing the holder drips, or by keeping the holder valves "D" closed if the physical separation is similar to that shown in Figures 6-3, 6-11. Stoppers and vents should then be installed in the flammable gas lines, in order to isolate the severed sections and permit necessary purging and the installation of the flammable gas line connections.

After the connections have been completed, air is purged from these sections, and the holder drips pumped, if water sealed.

The inert gas should be displaced from the holder and connections by admitting flammable gas through one holder valve "D" (Figures 6-3, 6-11), and allowing it to purge through vents "A" of a water-seal or waterless holder (Figures 6-3, 6-7), or vents "B" of a pressure holder (Figures 6-9, 6-11), until the purge gas samples give satisfactory analyses.

WATER-SEAL HOLDER

All sections of the holder should be landed before commencing purging.

Several hours may be saved by closing up the tank overflows and raising the level of the water to the top of the tank, thus reducing the volume of the air to be purged out.

The holder and connections should then be purged with inert gas to a satisfactory end point, leaving the holder partially inflated.

After the flammable gas lines have been connected to the holder, the inner section should be partly deflated, and before it lands and while there is still some pressure on the crown, flammable gas should be admitted to purge out the balance of the inert gas in the holder and connections.

The seal bonnet bypasses should be closed after the inert gas has been displaced with flammable gas.

WATERLESS HOLDER

The piston should be landed before beginning the purging operation. No purging should be done into the space above the piston. If the sealing arrangement of the holder outlet connections is not equipped with lifting rods, the purging of these connections will require lifting the piston with the inert gas, about one or two feet above the landing position.

After the holder and connections of the M.A.N. type have been purged with inert gas, and before the inert gas has been displaced with flammable gas, the sealant circulating system should be placed in operation, and the proper sealant depth established in the piston cup. The sealant tanks should be purged by admitting inert gas from the holder through the equalizer line and purging through the test cock plugs on top of the seal tanks.

The outer annular chamber for receiving the sealant on the bottom of a waterless holder should also be purged at this time by rotating the peripheral sealant samplers to bring their ends above the sealant dam, opening the samplers to air, and throttling the piston vent to force inerts over the sealant dam wall to displace gas and sealant vapors through the samplers.

After the flammable gas lines have been connected to the holder, the piston should be partly deflated, and before it lands and while there is still some pressure on the piston, flammable gas should be admitted to purge out the balance of the inert gas in the holders and connections.

PRESSURE HOLDER

After the holder and connections have been purged with inert gas, a positive pressure should be maintained in the holder while the connections to the flammable gas lines are being made.

After the flammable gas lines have been connected to the holder, the inert gas should be substantially displaced with the flammable gas without building up more than one pound per square inch pressure, purging through the vents. The final operating pressure on the holder should be built up gradually after purging out of the inert gas has been completed.

6.17 POST PURGING CARE

The following procedure should be carefully followed when a holder has been withdrawn from service for repairs or an inspection.

blower or blowers, located outside and conveniently connected.

6.17a. GENERAL

- (1) After a holder and connections have been completely purged of flammable gas, the inert gas should be displaced with air, as subsequently described.
- (2) Workers should not enter the holder until analyses of samples of the contained atmosphere, withdrawn from several points in the holder, indicate that it has been thoroughly ventilated. Applicable federal, state and local codes and regulations should be followed.
- (3) While the holder contains air, frequent tests should be made to check the work area and other critical points for combustible gas or an inadequate oxygen supply. This practice is particularly important when the work to be done within the holder involves welding or burning, in which case the holder must be kept ventilated by means of a

6.17b. WATER-SEAL HOLDER

- (1) Admission of the inert gas may be suspended upon completion of the purging of the holder and holder connections as indicated by reaching a satisfactory end point. At that point ventilation openings should be made immediately in the holder crown. This includes opening all man-holes in the crown and removing the seal bonnet cover.
- (2) In addition, several openings, 15 to 35 square feet in area, diametrically opposite, should be made by removing the thinning crown plates near the outer curb. An additional opening should be made at the center. These openings can be made carefully by mechanical means, preferably with a powered ripping chisel. Prior to any personnel entering the holder, the inert gas should then be completely displaced by a ventilating blower located outside of, and connected to the holder

by a sheet metal or canvas pipe.

- (3) If the tank water is to be removed, it should be done so without delay at this time. Otherwise, an ample supply of air must be maintained in the space under the crown by a ventilating blower.
- (4) While it is possible to make the intended inspection of, or repairs to a holder after it has been purged but with the water remaining in the tank, it may be necessary or desirable to remove the water. Even though great care is exercised in the purging operation, the water in many holder tanks has been found to contain an emulsion of volatile oils in suspension in the water below its surface which cannot be completely removed. This emulsion may rise to the surface of the water after purging has been completed and liberate flammable gases or vapors or objectionable odors, a condition which may be aggravated at high atmospheric temperatures.
- (5) Depth samples of the water in the tank should be taken from the interior before proceeding with inspection or repairs, and if the presence of an emulsion is disclosed, the tank water should be removed.

6.19 SAMPLE PROCEDURE—WATER SEAL HOLDER (FIGURE 6-13)

6.19a. DESCRIPTION OF PROJECT

The following schedules cover the purging, severing and reconnecting operations for the 5,000,000 cu. ft., five section holder No. 1 at the East 63rd St. Holder Station, New York City, in connection with the general overhauling of the holder. The inert gas was obtained from a Harrison purging machine (inert gas producer). The locations of the various vents, gauges, valves, connections, etc. referred to in the projected schedules are indicated in Figure 6-13.

6.19b. REMOVAL FROM FLAMMABLE GAS SERVICE

PREPARATION

- (1) Contact the System Operation Department to verify the outage date on the holder.
- (2) Utilize portable skimmers to determine the presence of, and to remove the oil on the surface of the tank water.
- (3) Install vents on valves A, B, C and D, and connections for sealing these valves with water if found necessary.
- (4) Install $\frac{3}{4}$ " CO₂ gas connections at V-1, V-3, V-5, and V-7, 2" vents at V-2, V-4, V-6, and V-8, and gauges at G-1, G-2, G-3, and G-4.
- (5) Prepare syphon for sealing holder drips D-1, D-2, D-3, and D-4, to a depth of 10 feet with water from holder tank.
- (6) In joints at bulls (side outlets) of T-1, T-2, T-3, and T-4, and at FF-1, FF-2, FF-3, and FF-4, replace old bolts with new bolts consecutively to

After the water has been removed from the holder tank there may be found a large accumulation of sludge, composed of rubbish and dirt together with tar and oil. This must be removed, during which process air must be supplied to the men working in the bottom of the tank from a ventilating blower located outside the holder.

6.17c. WATERLESS HOLDER

Upon completion of purging for either the M.A.N., Kloenne type, or Wiggins dry-seal type, the piston should be landed and the inert gas displaced through the vents, and ventilation of the holder maintained by air supplied by a large capacity ventilating blower located outside of, and conveniently connected to the holder.

6.17d. PRESSURE HOLDER

After the purging operation has been completed, the inert gas should be displaced through the vents with air supplied by a ventilating blower of sufficient capacity.

facilitate subsequent removal of these bolts with rotating fittings T-1, T-2, T-3, and T-4.

- (7) Install rigging in preparation for handling and rotating fittings T-1, T-2, T-3, and T-4, 90° on drips D-1, D-2, D-3, and D-4 respectively.
- (8) Prepare blank flanges BF-1, BF-2, BF-3, and BF-4 with a 2" plugged hole in each for purging purposes, blank flanges for bulls of T-1, T-2, and T-3 with a $\frac{3}{4}$ " plugged hole in each for CO₂ connections, and a blank flange for bull of T-4 with a 6" inert gas connection.
- (9) Install a 2½" valved connection at M-1 for the inert gas machine fuel supply.
- (10) Install a 6" holder vent at HV-9, and 2" auxiliary holder vents at HV-10, HV-11, HV-12, and HV-13, also a U-gauge at G-5.

SEVERING HOLDER CONNECTIONS

GENERAL

- (1) Bring holder down to approximately 6 feet above landing.
- (2) Close and lock valves A, B, C, and D and seal holder drips D-1, D-2, D-3, and D-4 with water to a depth of 10 feet.

HOLDER CONNECTIONS BETWEEN VALVE A AND DRIP D-1

- (1) Open V-2 to relieve pressure, then close V-2 and check G-1 to determine whether or not valve A is tight. With no indicated buildup of pressure,

open V-2 and admit CO₂ at V-1, purging D-1 of flammable gas through V-2. When a satisfactory purge gas sample analysis is obtained, shut off CO₂, close V-2 and replace plug at V-1.

- (2) Rotate fitting T-1 90° and install blank flange BF-1 and blank flange on bull of T-1.
- (3) Open V-2 and admit CO₂ at ¾" connection in blank flange on T-1, purging drip D-1 of air through V-2. When air is satisfactorily purged out shut off CO₂, plug ¾" opening, and close V-2.
- (4) Unlock and crack open valve A and remove plug in BF-1. When valve has been satisfactorily purged with flammable gas, replace plug in BF-1.

HOLDER CONNECTION BETWEEN VALVE B AND DRIP D-2

- (1) Open V-4 to relieve pressure, then close V-4 and check G-2 to determine whether valve B is tight.

With no indicated buildup of pressure, open V-4 and admit CO₂ at V-3, purging main and D-2 of flammable gas through V-4. When a satisfactory purge gas sample analysis is obtained shut off CO₂, close V-4, and replace plug at V-3.

- (2) Rotate fitting T-2 90° and install blank flange BF-2 and blank flange on bull of T-2.
- (3) Open V-4 and admit CO₂ at ¾" connection in blank flange on T-2, purging drip D-2 of air through V-4. When air is satisfactorily purged out shut off CO₂, plug ¾" opening, and close V-4.
- (4) Remove 2" plug in BF-2, admit CO₂ at V-3 and purge main of air from V-3 to BF-2. When air has been satisfactorily purged out, shut off CO₂, and replace plugs in BF-2 and V-3.
- (5) Unlock and crack open valve B, remove plug in BF-2, and displace inerts in main with flammable gas. When main has been satisfactorily purged of inerts, replace plug in BF-2.

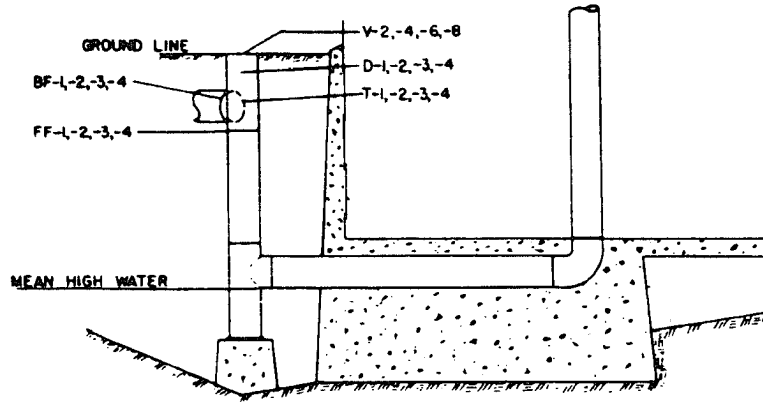

ELEVATION OF DRIPS

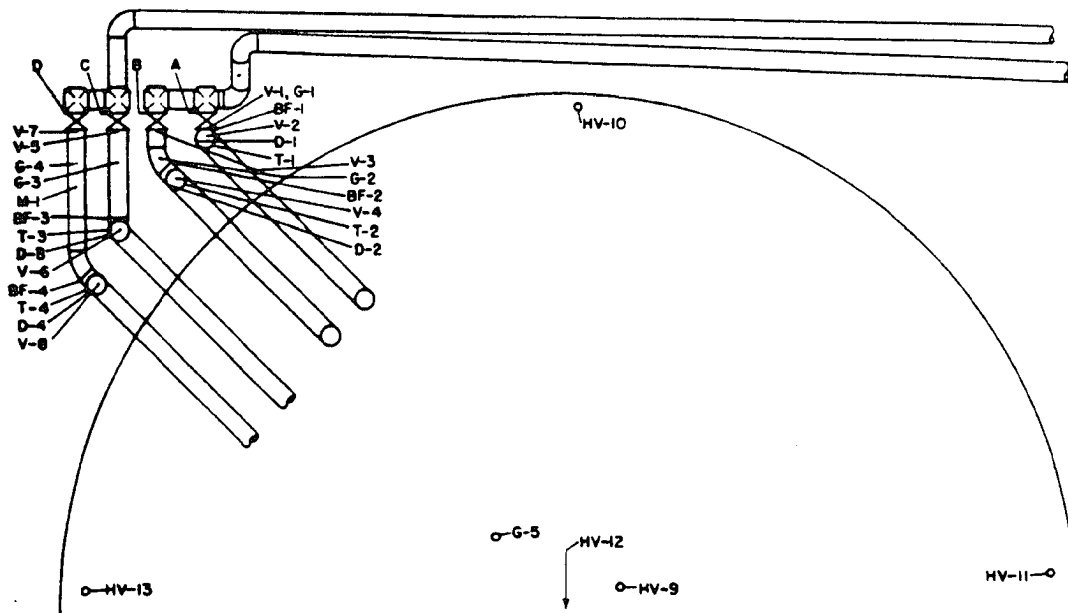

Figure 6-13—Water Seal Holder

HOLDER CONNECTION BETWEEN VALVE C AND DRIP D-3

- (1) Open V-6 to relieve pressure, then close V-6 and check G-3 to determine whether or not valve C is tight. With no indicated buildup of pressure, open V-6 and admit CO₂ at V-5, purging main and D-3 of flammable gas through V-6. When a satisfactory purge gas sample analysis is obtained, shut off CO₂, close V-6, and replace plug at V-5.
- (2) Rotate fitting T-3 90° and install blank flange BF-3 and blank flange on bull of T-3.
- (3) Open V-6 and admit CO₂ at ¾" connection in blank flange on T-3, purging drip D-3 of air through V-6. When air is satisfactorily purged out, shut off CO₂, plug ¾" opening, and close V-6.
- (4) Remove 2" plug in BF-3, admit CO₂ at V-5 and purge main of air from V-5 to BF-3. When air has been satisfactorily purged out, shut off CO₂, and replace plugs in BF-3 and V-5.
- (5) Unlock and crack open valve C, remove plug in BF-3, and displace inerts in main with flammable gas. When main has been satisfactorily purged of inerts, replace plug in BF-3.

HOLDER CONNECTION BETWEEN VALVE D AND DRIP D-4

- (1) Open V-8 to relieve pressure, then close V-8 and check G-4 to determine whether valve D is tight. With no indicated buildup of pressure, open V-8 and admit CO₂ at V-7, purging main and D-4 of flammable gas through V-8. When a satisfactory purge gas sample analysis is obtained shut off CO₂, close V-8, and replace plug at V-7.
- (2) Rotate fitting T-4 90° and install blank flange BF-4 and blank flange on bull of T-4.
- (3) Open V-8 and admit CO₂ through reducer installed in 6" inert gas connection in blank flange on T-4, purging drip D-4 of air through V-8. When air is satisfactorily purged out shut off CO₂, close 6" inert gas connection; remove reducer and close V-8.
- (4) Remove 2" plug in BF-4, admit CO₂ at V-7 and purge main of air from V-7 to BF-4. When air has been satisfactorily purged out, shut off CO₂, and replace plugs in BF-4 and V-7.
- (5) Unlock and crack open valve D, remove plug in BF-4, and displace inerts in main with flammable gas. When main has been satisfactorily purged of inerts, replace plug in BF-4.

NOTIFICATION OF COMPLETED HOLDER SEVERANCE

Notify the system operation department that the holder is now physically disconnected from the gas distribution system.

PURGING HOLDER, STANDPIPES, AND DRIPS

- (1) Connect the inert gas machine to the fuel supply at M-1.

- (2) Make up the necessary 6" gas connection between fitting T-4 and the outlet side of the inert gas machine.
- (3) Open all bypass valves at seal bonnets.
- (4) Open crown vent HV-9, bleed holder down to purging position of 6" above landing, then close HV-9.
- (5) Start up inert gas machine and when analysis indicates a satisfactory quality, pump out drip D-4 and admit inert gas to the holder through T-4.
- (6) Open crown vents HV-9, HV-10, HV-11, HV-12, and HV-13, and by regulating HV-9 maintain a positive pressure at G-5 with the inner section not less than 6" above landing. When analyses of the purge gas samples from the crown vents indicate the holder contents are satisfactorily purged, close HV-9, HV-10, HV-11, HV-12, and HV-13.
- (7) When the inner section is inflated approximately 2 feet above landing, shut off inert gas machine, close and lock valve at M-1.
- (8) Pump out drip D-3. Remove plug in blank flange on T-3, open V-6, and purge out standpipe and drip through these openings using inerts from holder. When satisfactory purge gas sample analyses are obtained, replace plug at T-3 and close V-6.
- (9) Pump out drip D-2. Remove plug in blank flange on T-2, open V-4, and purge out standpipe and drip through these openings using inerts from holder. When satisfactory purge gas analyses are obtained, replace plug at T-2 and close V-4.
- (10) Pump out drip D-1. Remove plug in blank flange on T-1, open V-2, and purge out standpipe and drip through these openings using inerts from holder. When satisfactory purge gas analyses are obtained, replace plug at T-1 and close V-2.
- (11) Open HV-9, HV-10, HV-11, HV-12, and HV-13, and land the inner section by regulating HV-9.
- (12) Open crown manhole and check for light oil.
- (13) Remove seal bonnet covers, and several crown sheets at three equi-distant points on the crown.
- (14) Remove two diametrically opposite plugs on the outer section and purge out the grip by admitting CO₂ through one opening and purging both ways around the grip to the opposite opening. When a satisfactory purge gas sample is obtained, shut off the CO₂. Repeat the procedure for the three remaining grips.
- (15) Install connections from sufficient air blowers to provide necessary ventilation within the holder.

REMOVAL OF PURGING ACCESSORIES, ETC.

Remove all gauges, vents, connections, etc., and plug all openings used in conjunction with the purging of the holder and holder connections.

SUMMARY OF GAS SAMPLE ANALYSES

Chemist's Report "A" summarizes the various gas sample analyses made during the actual removal of the holder from flammable gas service.

CHEMIST'S REPORT "A"

Water-Seal Holder No. 1, East 63rd St. Station
Removal From Flammable Gas Service

Inert Gas Analyses (Average)-Harrison Inert Gas Generator

Orsat Analysis % By Volume		
CO ₂	O ₂	CO
14.6	1.2	0.0
14.8	1.0	0.0

Date	Time
3-29-44	11:05 A.M.-6:00 P.M.
3-30-44	8:05 A.M.-2:00 P.M.

Purge Gas Analyses:

A. AT CONNECTIONS, USING CO₂ IN CYLINDERS

Date	Time	Location	Combustible Gas Indicator Reading*	CO ₂ % By Volume
3-27-44	9:25 AM	Valve B to Drip D-2	3.3	-
	2:10 PM	Drip D-2	-	85 +
	3:00	Valve B to BF-2	-	85 +
3-28-44	8:50 AM	Valve A to Drip D-1	3.5	-
	10:50	Valve C to Drip D-3	2.0	-
	11:20	Drip D-1	-	85 +
	1:05 PM	Valve D to Drip D-4	4.0	-
	1:15	Drip D-3	-	85 +
	1:40	Valve C to BF-3	-	85 +
	2:20	Drip D-4	-	85 +
3:00	Valve D to BF-4	-	85 +	

B. HOLDER VENTS, USING HARRISON INERT GAS GENERATOR

3-29-44	6:00 PM	Crown Vent	15 +	
3-30-44	11:05 AM	Crown Vent	10.4	
	12:45 PM	Crown Vent	7.0	
	1:50	Crown Vent	4.9	
	2:00	Crown Vent	4.4	
	2:05	All Crown Vents	4.0 - 4.5	Holder Purging Complete
	2:20	Standpipe & Drip D-3	4.3	
	2:35	Standpipe & Drip D-2	4.4	
	2:50	Standpipe & Drip D-1	4.2	
	3:00	Several Crown Sheets Removed		
	3:30	No. 1 Grip	4.5	
	No. 2 Grip	4.3		
	No. 3 Grip	4.4		
	No. 4 Grip	4.2		
3-31-44	8:45 AM	All Vents	0.0	

NOTE: * - Tests made on samples containing 50% purge gas and 50% air.

6.19c. RETURNING HOLDER TO FLAMMABLE GAS SERVICE

PREPARATION

- | | |
|---|--|
| <ol style="list-style-type: none"> (1) Notify the System Operation Department of the approximate time and date that flammable gas will be required for the holder. (2) Install and leave in open position the holder vents HV-9, HV-10, HV-11, HV-12 and HV-13, also install U-gauge G-5. (3) Check that the seal bonnet bypass valves are open. (4) Replace all crown sheets previously removed, and all seal bonnet covers. (5) Install vents on valves A, B, C, and D, and connections for sealing these valves with water, if found necessary. | <ol style="list-style-type: none"> (6) Install ¾" CO₂ gas connections at V-1, V-3, V-5, and V-7, 2" vents at V-2, V-4, V-6, and V-8, and U-gauges at G-1, G-2, G-3, and G-4. (7) Prepare syphon for sealing holder drips D-1, D-2, D-3, and D-4 with water from the holder tank. (8) Prepare rigging, etc., to remove blank flanges BF-1, BF-2, BF-3, and BF-4, and blank flanges from bulls of T-1, T-2, T-3, and T-4, also to rotate fittings T-1, T-2, T-3, and T-4 back to original position. (9) Connect inert gas machine to M-1, and unlock and open valve admitting flammable gas to control valve on Harrison machine. Make up the necessary 6" inert gas connection between fitting T-4 and the outlet side of the inert gas machine. (10) Remove air blower connections to holders. |
|---|--|

CHEMISTS'S REPORT "B"
EXAMPLE NO. 1

Water-Seal Holder No. 1, East 63rd St. Station
Returning to Flammable Gas Service

Inert Gas Analyses (Average) - Harrison Inert Gas Generator

<u>Date</u>	<u>Time</u>	<u>Location</u>	<u>Orsat Analysis</u>		<u>Combustible Gas Indicator Reading (%)</u>
			<u>O₂</u>	<u>CO₂ (2)</u>	
	<u>Date</u> 8-10-44				
			<u>Time</u> 8:20 A.M. - 3:00 P.M.		
					<u>% By Volume</u> CO ₂ O ₂ CO 15.0 0.3 0.0
8-10-44	11:40 A.M.	Crown Vent	0.6		
	1:00 P.M.	Crown Vent	8.7		
	1:30	Crown Vent	7.0		
	2:10	No. 1 Grip		85 +	
	2:40	No. 2 Grip		85 +	
	3:30	No. 3 Grip		85 +	
	3:45	No. 4 Grip		85 +	
	3:50	Crown Vent	4.6 - Holder Purging Complete.		
	3:55	Valve D to BF-4			4.0
	4:15	Standpipe & Drip D-3	4.7		
	4:30	Standpipe & Drip D-2	4.5		
	4:50	Standpipe & Drip D-1	4.6		3.8
8-11-44	9:30 A.M.	Valve C to BF-3			
	10:50	Valve D to Drip D-4		85 +	
	11:55	Valve C to Drip D-3		85 +	
	12:15 P.M.	Valve B to BF-2			3.5
	1:30	Valve A to BF-1			4.0
	3:20	Valve B to Drip D-2		85 +	
	6:15	Valve A to Drip D-1		85 +	

NOTE: (1) Tests made on samples containing 50% purge gas and 50% air.
(2) CO₂ in cylinders used as inert medium for these points.

PURGING HOLDER, STANDPIPES, AND DRIPS OF AIR

- (1) Start up the inert gas machine, venting to atmosphere and checking sample analyses until a satisfactory quality is indicated.
- (2) Replace manhole cover on holder crown and close vents HV-9, HV-10, HV-11, HV-12, and HV-13.
- (3) Admit inert gas to holder through T-4 and inflate inner section. Open HV-10, HV-11, HV-12, and HV-13, and regulate HV-9 to maintain the inner section 6" above landing with a positive pressure at G-5.
- (4) When the analyses of samples from the crown vents indicate the holder contents as satisfac-

- torily purged of air, close vents HV-9, HV-10, HV-11, HV-12 and HV-13. Allow inner section to inflate to 6 feet above landing, then shut down inert gas machine, close and lock valve at M-1, and seal drip D-4 with water to a depth of 10 feet.
- (5) Open V-6, remove plug in blank flange on T-3, and purge out air from standpipe and drip D-3 through these openings, using inerts from holder. When satisfactory purge gas analyses are obtained, close V-6, replace plug in T-3, and seal D-3 with water to a depth of 10 feet.
- (6) Open V-4, remove plug in blank flange on T-2, and purge out air from standpipe and drip D-2 through these openings, using inerts from holder. When satisfactory purge gas analyses are obtained, close V-4, replace plug in T-2, and seal D-2 with water to a depth of 10 feet.

- (7) Open V-2, remove plug in blank flange on T-1, and purge out air from standpipe and D-1 through these openings, using inerts from holder. When satisfactory purge gas analyses are obtained, close V-2, replace plug in T-1, and seal D-1 with water to a depth of 10 feet.
- (8) Remove two diametrically opposite plugs in the outer section and purge out the grip by admitting CO₂ through one plug opening and purging both ways around the grip to the opposite opening. When a satisfactory purge gas sample is obtained, shut off the CO₂. Repeat this procedure for the three remaining grips.

RECONNECTING HOLDER CONNECTIONS

HOLDER CONNECTION BETWEEN VALVE D AND DRIP D-4

- (1) Close and lock Valve D.
- (2) Remove plug in BF-4 to relieve pressure, replace this plug and check G-4 to determine whether or not valve D is tight. With no indicated build up of pressure, remove plug in BF-4 and admit CO₂ at V-7 purging main of flammable gas through BF-4. When a satisfactory purge gas sample analysis is obtained, shut off CO₂ and remove BF-4.
- (3) Remove blank flange on bull T-4, rotate fitting T-4 90°, and make up flanged joint between main and T-4.
- (4) Open V-8 and admit CO₂ at V-7, purging main and drip D-4 of air through V-8. When a satisfactory purge gas sample analysis is obtained, shut off CO₂, plug V-3 and close V-8.

HOLDER CONNECTION BETWEEN VALVE C AND DRIP D-3

- (1) Close and lock valve C.
- (2) Remove plug in BF-3 to relieve pressure, replace this plug and check G-3 to determine whether valve C is tight. With no indicated buildup of pressure, remove plug in BF-3 and admit CO₂ at V-5, purging main of flammable gas through BF-3. When a satisfactory purge gas analysis is obtained, shut off CO₂ and remove BF-3.
- (3) Remove blank flange on bull of T-3, rotate fitting T-3 90°, and make up flanged joint between main and T-3.
- (4) Open V-6 and admit CO₂ at V-5, purging main and drip D-3 of air through V-6. When a satisfactory purge gas sample analysis is obtained, shut off CO₂, plug V-5, and close V-6.

HOLDER CONNECTION BETWEEN VALVE B AND DRIP D-2

- (1) Close and lock valve B.
- (2) Remove plug in BF-2 to relieve pressure, replace this plug and check G-2 to determine whether

valve B is tight. With no indicated buildup of pressure, remove plug in BF-2 and admit CO₂ at V-3, purging main of flammable gas through BF-2. When a satisfactory purge gas analysis is obtained, shut off CO₂ and remove BF-2.

- (3) Remove blank flange on bull of T-2, rotate fitting T-2 90°, and make up flanged joint between main and T-2.
- (4) Open V-4 and admit CO₂ at V-3, purging main and drip D-2 of air through V-4. When a satisfactory purge gas sample analysis is obtained, shut off CO₂, plug V-3, and close V-4.

HOLDER CONNECTION BETWEEN VALVE A AND DRIP D-1

- (1) Close and lock valve A.
- (2) Remove plug in BF-1 to relieve pressure, replace this plug, and check G-1 to determine whether valve A is tight. With no indicated buildup of pressure, remove plug in BF-1 and admit CO₂ at V-1, purging holder side of valve of flammable gas through BF-1. When a satisfactory purge gas analysis is obtained, shut off CO₂ and remove BF-1.
- (3) Remove blank flange on bull of T-1, rotate fitting T-1 90°, and make up flanged joint between valve A and T-1.
- (4) Open V-2 and admit CO₂ at V-1, purging valve and drip D-1 of air through V-2. When a satisfactory purge gas sample analysis is obtained, shut off CO₂, plug V-1, and close V-2.

DISPLACEMENT OF INERT GAS IN HOLDER AND HOLDER CONNECTIONS WITH FLAMMABLE GAS

- (1) Unlock and crack open valve D, and pump out drip D-4.
- (2) Open HV-10, HV-11, HV-12, and HV-13, and regulate HV-9 to maintain the purging position of the inner section at 6" above landing.
- (3) Unlock and crack open valve C, and pump out drip D-3.
- (4) Unlock and crack open valve B, and pump out drip D-2.
- (5) Unlock and crack open valve A, and pump out drip D-1.
- (6) When the analyses of the purge gas samples from the crown vents indicate that the holder and holder connections have been satisfactorily purged, close HV-9, HV-10, HV-11, HV-12, and HV-13.
- (7) Close all bypass valves at the seal bonnets.
- (8) Notify the system operation department that the holder is physically connected to the gas distribution system and is ready for service.

REMOVAL OF PURGING ACCESSORIES, ETC.

Remove all gauges, vents, connections, etc., and

plug all openings used in conjunction with the purging of the holder and holder connections.

SUMMARY OF GAS SAMPLE ANALYSES

Chemist's Report "B" summarizes the various gas sample analyses made during the return of the holder to flammable gas service.

6.21 SAMPLE PROCEDURE—WATERLESS HOLDER FIGURE 6-15

6.21a. DESCRIPTION OF PROJECT

The following schedules cover the purging, severing and reconnecting operations for the 7,000,000 cu. ft. waterless holder No. 5 at the 45th Street Holder Station, New York City, in connection with general repairs made on the holder. The locations of the various vents, gauges, valves, connections, etc., referred to in the projected schedules are indicated on Figure 6-15.

6.21b. REMOVAL FROM FLAMMABLE GAS SERVICE

PREPARATION

- (1) Contact the System Operation Department to verify the outage date on the holder.
- (2) Deflate holder to a point where piston deck is below lowest manhole on the shell.
- (3) Close valves A, B, and C.
- (4) Install vents on valves E and F, and connections for sealing these valves with water if found necessary.
- (5) Provide 3/4" plugged holes at V-1 and V-4 for CO₂ gas connections, 2" vents at V-2, V-3, V-5, and V-6, and gauges at G-1 and G-2.
- (6) In joints at valves A, B, and C replace old bolts with new bolts consecutively to facilitate subsequent removal of these valves.
- (7) Provide water supply to seal holder drips D-1, D-2, and D-3 with water.

- (8) Prepare rigging for removal and handling of valves A, B, and C, also for installation of blank flanges BF-1, BF-2, BF-3, BF-4, BF-5, and BF-6.
- (9) Provide 2" plugged holes for purging purposes in BF-2, BF-4, and BF-6, a 6" inert gas connection in BF-1, and a 3/4" plugged hole in each of BF-3 and BF-5 for CO₂ connections.
- (10) Install a 2 1/2" valved connection at M-1 for the inert gas machine fuel supply.
- (11) Draw up, by lifting rods, the seal caps suspended below the piston and over the holder connections.
- (12) Install a 6" holder vent connection in piston at HV-1, and bring connection through lowest manhole on shell to vent located outside of holder. Also install a U-gauge, with connection in piston, at G-3, and four test cocks on piston near the outer circumference spaced about 90° apart.
- (13) Install water connection through piston and allow water to enter on bottom of holder to determine presence of, and to remove oil by floating off through lowest holder connection into drips. Remove oil, if any, and water from drip by means of drip pump.

SEVERING HOLDER CONNECTIONS

HOLDER CONNECTIONS BETWEEN VALVE E AND DRIPS D-1 AND D-2

- (1) Close and lock valve E, and seal holder drips D-1

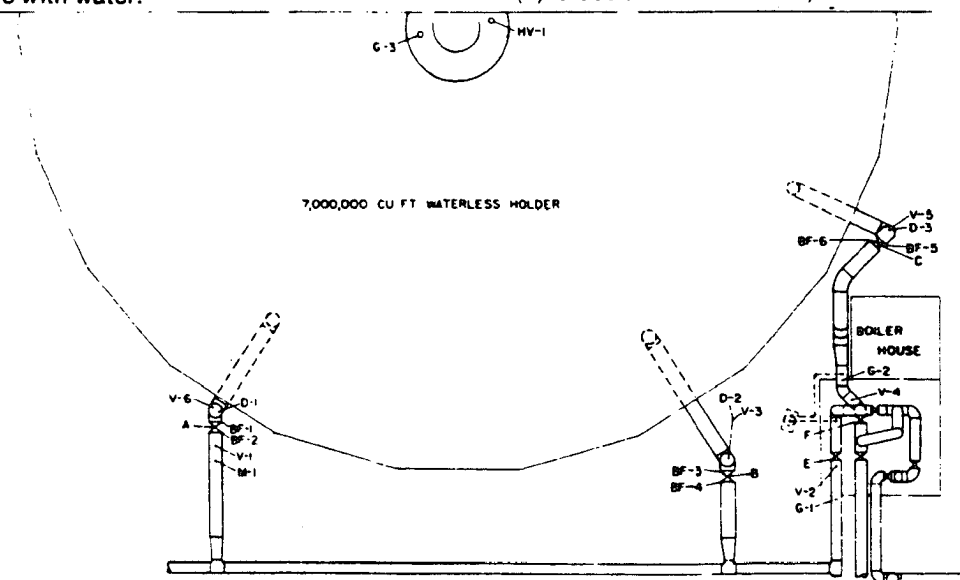

Figure 6-15—Waterless Holder

and D-2 with water to a depth of 10 feet.

- (2) Open vent on valve E to relieve pressure, then close vent and check G-1 to determine whether valve E is tight. With no indicated buildup of pressure, open V-2, V-3, and V-6, also valves A and B, and admit CO₂ at V-1, purging mains and drips D-1 and D-2 of flammable gas through vents V-2, V-3 and V-6. When satisfactory purge gas sample analyses are obtained shut off CO₂, close V-2, V-3, and V-6, and replace plug at V-1.
- (3) Remove valves A and B and install blank flanges BF-1, BF-2, BF-3, and BF-4.
- (4) Open V-3 and admit CO₂ at ¾" connection in BF-3, purging drip D-2 of air through V-3. When air is satisfactorily purged out, shut off CO₂, plug ¾" opening, and close V-3.
- (5) Open V-6 and admit CO₂ through reducer installed in 6" inert gas connection in BF-1, purging drip D-1 of air through V-6. When air is satisfactorily purged out, shut off CO₂, close 6" inert gas connection, remove reducer, and close V-6.
- (6) Remove 2" plugs in BF-2 and BF-4, open V-2, admit CO₂ at V-1 and purge main of air through BF-2, BF-4, and V-2. When air has been satisfactorily purged out, shut off CO₂, close V-2, and replace plugs in BF-2, BF-4 and V-1.
- (7) Unlock and crack open valve E, remove plugs in BF-2 and BF-4, and displace inerts in main with flammable gas. When main has been satisfactorily purged of inerts, replace plugs in BF-2 and BF-4.

HOLDER CONNECTION BETWEEN VALVE F AND DRIP D-3

- (1) Close and lock valve F, and seal holder drip D-3 with water to a depth of 10 feet.
- (2) Open vent on valve F to relieve pressure, then close vent and check G-2 to determine whether valve F is tight. With no indicated buildup of pressure, open V-5 and valve C, and admit CO₂ at V-4, purging main and drip D-3 of flammable gas through V-5. When a satisfactory purge gas sample analysis has been obtained, shut off CO₂, close V-5, and replace plug at V-4.
- (3) Remove valve C and install blank flanges BF-5 and BF-6.
- (4) Open V-5 and admit CO₂ at ¾" connection in BF-5, purging drip D-3 of air through V-5. When air is satisfactorily purged out, shut off CO₂, plug ¾" opening, and close V-5.
- (5) Remove 2" plug in BF-6, admit CO₂ at V-4, and purge main of air through BF-6. When air has been satisfactorily purged out, shut off CO₂ and replace plugs in BF-6 and V-4.
- (6) Unlock and crack open valve F, remove plug in BF-6, and displace inerts in main with flammable gas. When main has been satisfactorily purged of inerts, replace plug in BF-6.

NOTIFICATION OF COMPLETED HOLDER SEVERANCE

Notify the System Operation Department that the holder is now physically disconnected from the gas distribution system.

PURGING HOLDER, CONNECTIONS, DRIPS, AND TAR TANKS

- (1) Connect the inert gas machine (Harrison) to the fuel supply at M-1.
- (2) Make up the necessary 6" gas connection between BF-1 and the outlet side of the inert gas machine.
- (3) Open holder vent HV-1, bleed piston down to purging position of 6" above landing, then close HV-1.
- (4) Start up inert gas machine and, when analysis indicates a satisfactory quality, pump out holder inlet drip D-1 and admit inert gas under piston through BF-1.
- (5) Open holder vent HV-1, and by regulating this vent maintain a positive pressure at G-5 with the piston not less than 6" above landing. When analyses of the purge gas samples from the various test cocks and vent HV-1 indicate the holder contents as satisfactorily purged, close HV-1.
- (6) When the piston is inflated to about 2 feet above landing, shut off the inert gas machine, close and lock valve at M-1.
- (7) Pump out drip D-2. Remove plug in BF-3, open vent V-3, and purge out connection and drip through these openings, using inerts from holder. When satisfactory purge gas sample analyses are obtained, replace plug in BF-3 and close V-3.
- (8) Pump out drip D-3. Remove plug in BF-5, open vent V-5, and purge out connection and drip through these openings, using inerts from holder. When satisfactory purge gas sample analyses are obtained, replace plug in BF-5 and close V-5.
- (9) Close 6" tar line between holder and pump box No. 1. With gas equalizer line open, remove 3" plug in top of tar tank, and purge out flammable gas from tank through this 3" opening with inerts from holder. Replace plug and open 6" tar line when purging has been completed. Repeat this operation at each of pump boxes Nos. 2, 3, 4, 5, and 6 consecutively.
- (10) Open HV-1, and land piston by regulating HV-1.
- (11) Provide connections from sufficient air blowers (heat killers) to displace the inerts and to maintain necessary ventilation within the holder.

REMOVAL OF PURGING ACCESSORIES, ETC.

Remove all gauges, vents, connections, etc., and plug all openings, used in conjunction with the purging of the holder, holder connections, and mains.

SUMMARY OF GAS SAMPLE ANALYSES

Chemist's Report "C" summarizes the various gas sample analyses made during the actual removal of the holder from flammable gas service.

6.21c. RETURNING HOLDER TO FLAMMABLE GAS SERVICE

PREPARATION

- (1) Notify the System Operation Department of the approximate time and date that flammable gas will be required for the holder.
- (2) Install and leave in open position holder vent HV-1, also install U-gauge at G-5, and four test cocks on piston near the outer circumference spaced about 90° apart.
- (3) Install vents on valves E and F, and connections for sealing these valves with water, if found necessary.
- (4) Install 2" vents at V-2, V-3, V-5, and V-6, and gauges at G-1 and G-2.

- (5) Provide water supply to seal holder drips D-1, D-2, and D-3 with water.
- (6) Prepare rigging for reinstallation of valves A, B, and C, also for removal of blank flanges BF-1, BF-2, BF-3, BF-4, BF-5, and BF-6.
- (7) Connect inert gas machine to M-1, and unlock and open valve admitting flammable gas to control valve on Harrison machine. Make up the 6" inert gas connection between BF-1 and the outlet side of the inert gas machine.
- (8) Remove air blower connections to holder.

PURGING HOLDER, CONNECTIONS, DRIPS, AND TAR TANKS OF AIR

- (1) Start up the inert gas machine, venting to atmosphere and checking sample analyses until a satisfactory quality is indicated.
- (2) Close holder vent HV-1, and admit inert gas under piston through BF-1. Open and regulate HV-1 to maintain a positive pressure at G-3 and the piston at a purging position of 6" above landing. When the analyses of the purge gas samples

**CHEMIST'S REPORT "C"
EXAMPLE NO. II**

Waterless Holder No. 5, West 45th St. Station
Removal From Flammable Gas Service

Inert Gas Analyses (Average) - Harrison Inert Gas Generator

Date	Time	Orsat Analysis % By Volume		
		CO ₂	O ₂	CO
2-29-44	11:45 A.M.-6:00 P.M.	14.3	1.0	0.0
3-1-44	8:05 A.M.-4:00 P.M.	14.6	0.8	0.0

Purge Gas Analyses:

Date	Time	Location	Combustible Gas Indicator Reading ⁽¹⁾	CO ₂ % By Volume ⁽²⁾
2-28-44	10:45 AM	Valve E to Drip D-1 and Drip D-2	3.1	
	1:30 PM	Drip D-1		85 +
	2:15	Drip D-2		85 +
	3:50	Valve E to BF-2 and BF-4		85 +
2-29-44	10:00 AM	Valve F to Drip D-3	3.5	
	11:55	Drip D-3		85 +
	1:50 PM	Valve E to BF-6		85 +
	4:00	Piston Vent		
3-1-44	9:30 AM	Piston Vent	15 +	
	11:35	Piston Vent	11.1	
	2:25 PM	Piston Vent	7.5	
	3:30	Piston Vent and all Test Cocks	4.5	
	4:15	Connection and Drip D-1	4.1 to 4.3	Holder Purging Complete
	4:55	Connection and Drip D-2	4.2	
	5:35	Connection and Drip D-3	4.3	
	4.2			
3-2-44	8:40 AM	Piston Vent and all Test Cocks	4.2	
	10:45	Tar Tanks, Nos. 1-6	4.3	

NOTE: (1) Test made on samples containing 50% purge gas and 50% air.
(2) CO₂ in cylinders used as inert medium for these points.

from the various test cocks and HV-1 indicate the holder contents as satisfactorily purged of air, close HV-1.

- (3) Allow the piston to inflate to about 2 feet above landing, then shut down the inert gas machine, close and lock valve at M-1, and seal drip D-1 with water to a depth of 10 feet.
- (4) Open V-3, remove plug in BF-3, and purge out air from connection and drip D-2 through these openings, using inerts from holder. When satisfactory purge gas sample analyses are obtained, close V-3, replace plug in BF-3 and seal D-2 with water to a depth of 10 feet.
- (5) Open V-5, remove plug in BF-5, and purge out air from connection and drip D-3 through these openings using inerts from holder. When satisfactory purge gas sample analyses are obtained, close V-5, replace plug in BF-5 and seal D-3 with water to a depth of 10 feet.
- (6) Close 6" tar line between holder and pump box No. 1. With gas equalizer line open, remove 3" plug in top of tar tank and purge air out of tank through this 3" opening with inerts from holder. Replace plug and open 6" tar line when purging has been completed. Repeat this operation at each pump box Nos. 2, 3, 4, 5, and 6, consecutively.

RECONNECTING HOLDER CONNECTIONS

HOLDER CONNECTION BETWEEN VALVE F AND DRIP D-3

- (1) Close and lock valve F.
- (2) Open vent on valve F to relieve pressure, then close vent and check G-2 to determine whether valve F is tight. With no indicated buildup of pressure, remove 2" plug in BF-6, admit CO₂ at V-4, and purge main of flammable gas through BF-6. When purging operation has been satisfactorily completed, shut off CO₂ and remove BF-6.
- (3) Remove BF-5, install valve K in position between main and drip D-3, and made up flanged joints.
- (4) Check that valve C is open, open V-5, and admit CO₂ at V-4 purging main and drip D-3 of air through V-5. When a satisfactory purge gas sample analysis is obtained, shut off CO₂, plug V-4, and close V-5.

HOLDER CONNECTIONS BETWEEN VALVE E AND DRIPS D-1 AND D-2

- (1) Close and lock valve E.
- (2) Open vent on valve E to relieve pressure, then close vent and check G-1 to determine whether valve E is tight. With no indicated buildup of pressure, remove 2" plugs in BF-2 and BF-4, open V-2, admit CO₂ at V-1 and purge main of flammable gas through BF-2, BF-4, and V-2. When purging operation has been satisfactorily

completed, shut off CO₂, close V-2, and remove BF-2 and BF-4.

- (3) Remove BF-1 and BF-3, install valves A and B in position between main and drips D-1 and D-2 respectively, and make up flanged joints.
- (4) Check that valves A and B are open, open V-2, V-3 and V-6, and admit CO₂ at V-1, purging main and drips D-1 and D-2 of air through V-2, V-3, and V-6. When satisfactory purge gas sample analyses have been obtained, shut off CO₂, plug V-1, and close V-2, V-3, and V-6.

DISPLACEMENT OF INERT GAS IN HOLDER AND HOLDER CONNECTIONS WITH FLAMMABLE GAS

HOLDER CONNECTION BETWEEN VALVE F AND DRIP D-3

- (1) Unlock and crack open valve F.
- (2) Open V-5, purging main and drip D-3 of inerts through V-5 with flammable gas. When satisfactorily purged, close V-5 and valve F, also close and lock valve C.

HOLDER CONNECTIONS BETWEEN VALVE E AND DRIPS D-1 AND D-2

- (1) Unlock and crack open valve E.
- (2) Open V-3 and V-6, purging main and drips D-2 and D-1 of inerts through V-3 and V-6 with flammable gas. When satisfactorily purged, close V-3, V-6, and valve E, also close and lock valves A and B.

HOLDER AND CONNECTIONS TO DRIPS D-1, D-2, AND D-3

- (1) Open valve E, unlock and crack open valve A, and pump out drip D-1.
- (2) Open holder vent HV-1, and regulate this vent to maintain the purging position of the piston at 6" above landing.
- (3) Unlock and crack open valve B, and pump out drip D-2.
- (4) Open valve F, unlock and crack open valve C, and pump out drip D-3.
- (5) When the analyses of the purge gas samples from the various test cocks and vent HV-1 indicate that the inerts in the holder and connections have been satisfactorily displaced by flammable gas, close HV-1.
- (6) Inflate piston to about 2 feet above landing, then close valves A, B, and C.
- (7) Lower to normal position, by means of the lifting rods, the seal caps suspended below the piston and over the holder connections.
- (8) Close 6" tar line between holder and pump box No. 1. With gas equalizer line open, remove 3" plug in top of tar tank, and purge out tank through this 3" opening with flammable gas from holder. Replace plug and open 6" tar line when purging has been completed. Repeat this opera-

tion at each of pump boxes Nos. 2, 3, 4, 5, and 6 consecutively.
 (9) Remove HV-1 connection, gauge G-3, and test cocks in piston, and plug all openings. Also close manhole in side of holder shell.

(10) Notify the System Operation Department that the holder is physically connected to the gas distribution system and is ready for service.

CHEMIST'S REPORT "D"

EXAMPLE NO. II

Waterless Holder No. 5, West 45th St. Station
 Returning To Flammable Gas Service

Inert Gas Analyses (Average) - Harrison Inert Gas Generator

Date	Time	% By Volume		
		CO ₂	O ₂	CO
6-19-44	9:30 A.M. - 4:00 P.M.	13.8	0.6	0.0
6-20-44	8:15 A.M. - 4:00 P.M.	14.6	0.4	0.0

Purge Gas Analyses:

Date	Time	Location	Orsat Analysis % By Volume		Combustible Gas Indicator Reading ⁽¹⁾
			O ₂	CO ₂	
6-19-44	1:30 P.M.	Piston Vent	11.6		
6-20-44	8:30 A.M.	Piston Vent	8.4		
	10:10	Piston Vent	7.6		
	12:20 P.M.	Piston Vent	5.5		
	2:30	Piston Vent and all Test Cocks	3.2 - Holder Purging Comp.		
6-21-44	3:45	Drip D-2	3.2		
	9:45 A.M.	Drip D-3	3.4		
	10:00 A.M. to				
	11:15 A.M.	Tar Tanks, Nos. 1-6	3.2		
	12:50 P.M.	Valve E to BF-2 and BF-4			3.5
6-22-44	1:05	Valve F to BF-6			3.8
	4:10	Valve E to Drip D-1 and Drip D-2		85 +	
	10:15 A.M.	Valve F to Drip D-3		85 +	
	3:00 P.M.	Holder deflated, flammable gas admitted, piston floating on line.			

NOTE:

- (1) Tests made on samples containing 50% purge gas and 50% air.
- (2) CO₂ in cylinders used as inert medium for these points.

REMOVAL OF PURGING ACCESSORIES, ETC.

Remove all gauges, vents, connections, etc., and plug all openings used in conjunction with the purging of the holder and holder connections.

SUMMARY OF GAS SAMPLE ANALYSES

Chemist's Report "D" summarizes the various gas sample analyses made during the returning of the holder to flammable gas service.

**6.23 SAMPLE PROCEDURE—HORTONSPHERE
 (PRESSURE HOLDER) FIGURE 6-17**

6.23a. DESCRIPTION OF PROJECT

The following schedules cover the purging, severing, and reconnecting operations for the 113,000 cu. ft. actual physical volume (549,000 cu. ft. usable gas at 72

pounds per sq. in.) Hortonsphere, in connection with repair work on the holder. The locations of the various vents, gauges, valves, connections, etc., referred to in the projected schedules are indicated on Figure 6-17.

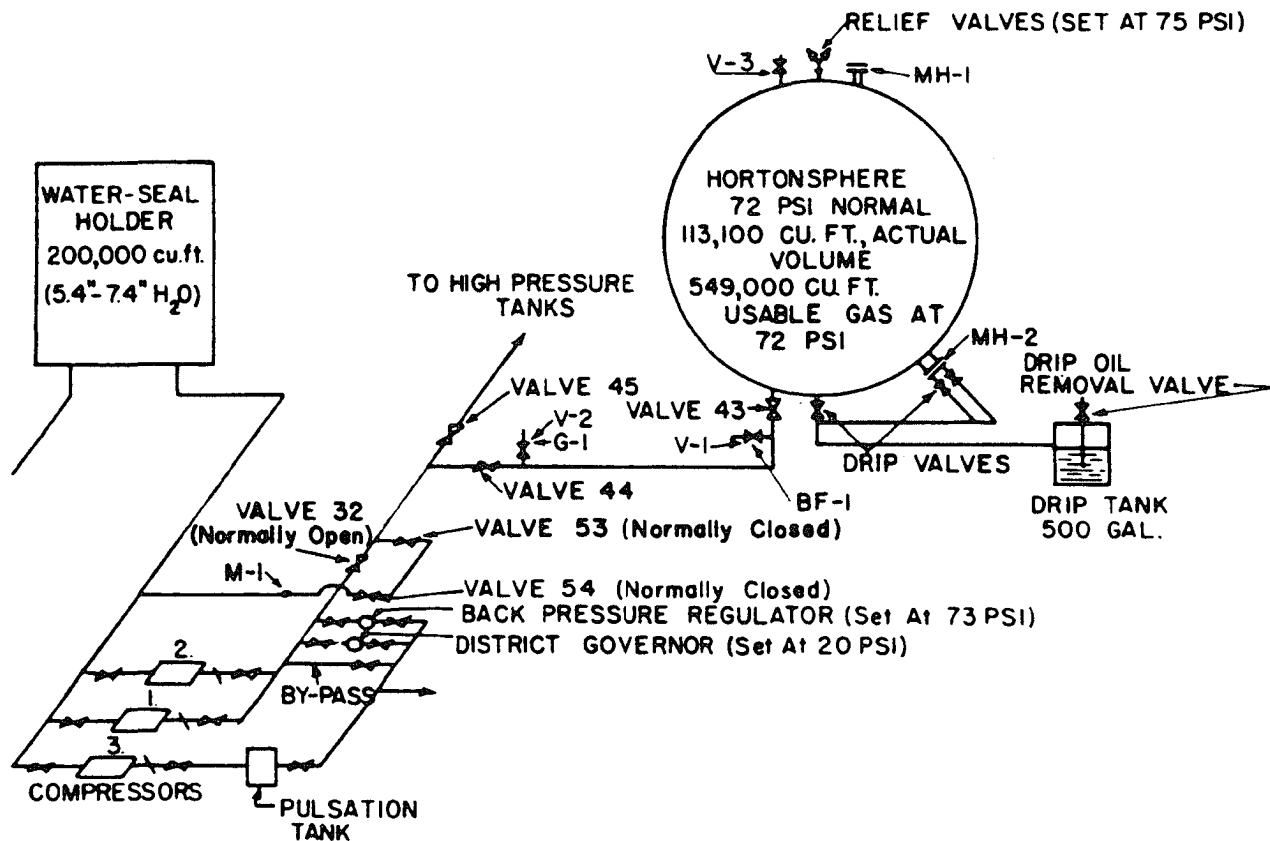

Figure 6-17—Hortonsphere

6.23b. REMOVAL FROM FLAMMABLE GAS SERVICE

PREPARATION

- (1) Contact the System Operation Department to verify the outage date on the holder.
- (2) Install 2" inert gas connection at V-1, 1½" vent at V-2 and gauge at G-1.
- (3) In both joints of valve 43, replace old bolts with new bolts consecutively to facilitate subsequent removal of these bolts when removing valve 43.
- (4) Install rigging, etc., in preparation for removal of valve 43.
- (5) Prepare blank flange BF-1 for open end of 8" line after removal of valve 43.
- (6) Install 4" holder vent V-3 on top of Hortonsphere.
- (7) Prepare to disconnect drip lines from bottom of holder.
- (8) Prepare to remove manhole covers MH-1 and MH-2 at top and bottom of holder, respectively.
- (9) Provide air blower and connection for ventilation of holder after flammable gas has been purged out.
- (10) Provide a 2" valved connection at M-1 for the inert gas machine fuel supply.

PROCEDURE

- (1) Connect the inert gas machine to the fuel supply at M-1.

- (2) Make up connection between V-1 and the outlet side of the inert gas machine.
- (3) Close and lock valves 32 and 45.
- (4) Check that valves 43 and 44, also drip valves at bottom of holder, are open.
- (5) Open valve 54, then crack open valve 53 to bleed down high pressure gas in Hortonsphere to water seal holder and low pressure system.
- (6) When G-1 indicates that gas pressure in Hortonsphere is equivalent to water seal holder pressure (5.4" to 7.4" water) close and lock 8" valve 44.
- (7) Open vent V-2 and relieve pressure in Hortonsphere and holder connection. When G-1 indicates zero pressure, close vent V-2 and check for buildup.
- (8) When no buildup of pressure is indicated, open vents V-2 and V-3, also close drip valves at bottom of Hortonsphere.
- (9) Start up inert gas machine and when analysis indicates a satisfactory quality, admit inert gas at V-1, purging Hortonsphere and holder connection of flammable gas from V-1 to vents V-2 and V-3. When a satisfactory purge gas sample is obtained, close V-1 and shut down inert gas machine. Also close valve 43.
- (10) Disconnect drip lines at bottom of holder, remove MH-1 and MH-2, and connect air blower discharge to bottom manhole opening.
- (11) Start air blower and purge out inert gas in holder with air through V-3 and top manhole opening.

- (12) When holder has been satisfactorily ventilated, remove valve 43, install BF-1 on open end of 8" line and make up joint tight.
- (13) Start up inert gas machine and when analysis indicates a satisfactory quality admit inert gas at V-1, purging section of 8" line between BF-1 and valve 44 of air from V-1 to vent V-2. When satisfactory purge gas analyses are obtained, close V-1 and shut down inert gas machine, also close and lock valve at M-1.
- (14) Remove inert gas connection and install vent at V-1, also close vent V-2.
- (15) Remove lock and crack open valve 44, admitting flammable gas and purging line of inert gas from valve 44 to vent V-1. When a satisfactory gas sample is obtained, close vent V-1.
- (16) Remove locks at valves 32 and 45.
- (17) Close valves 53 and 54, and operate valves 32 and 45 as directed by Gas Holder Operation Bureau.
- (18) Notify the System Operation Department that the holder is physically disconnected from the gas distribution system.

REMOVAL OF PURGING ACCESSORIES, ETC.

Remove gauge and vents, and plug all openings used in connection with the purging of the holder and holder connection.

6.23c. RETURNING HOLDER TO FLAMMABLE GAS SERVICE

PREPARATION

- (1) Notify the System Operation Department of the approximate time and date that flammable gas will be required for the holder.
- (2) Install 2" inert gas connection at V-1, 1½" vent at V-2, and gauge at G-1.
- (3) Install rigging, etc., in preparation for reinstallation of valve 43.
- (4) Prepare to remove blank flange BF-1.
- (5) Install and leave in open position 4" holder vent V-3 on top of Hortonsphere.
- (6) Remove air blower connection to holder.
- (7) Reinstall manhole covers MH-1 and MH-2 at top and bottom of holder, respectively, and make up joints tight.
- (8) Reconnect drip lines and check that drip valves are closed at bottom of holder.

6.25 SAMPLE PROCEDURE—WIGGINS HOLDER (FIGURE 6-19)

6.25a. DESCRIPTION OF PROJECT

The following schedules cover the purging, severing and reconnecting operations for a typical Wiggins

PROCEDURE

- (1) Connect the inert gas machine to fuel supply at M-1.
- (2) Make up connection between V-1 and the outlet side of the inert gas machine.
- (3) Close and lock valves 32 and 45.
- (4) Check that valve 44 is open.
- (5) Open valve 54, then crack open valve 53 to bleed down high pressure gas in 8" line to water seal holder and low pressure system.
- (6) When G-1 indicates that gas pressure in line is equivalent to water seal holder pressure (5.4" to 7.4"), close and lock valve 44.
- (7) Open vent V-2 and relieve pressure in line. When G-1 indicates zero pressure, close vent V-2 and check for buildup.
- (8) When no buildup of pressure is indicated, open vent V-2.
- (9) Start up inert gas machine and, when analysis indicates a satisfactory quality, admit inert gas at V-1, purging line of flammable gas from V-1 to vent V-2. When satisfactory purge gas sample is obtained at vent V-2, close V-1 and shut down inert gas machine.
- (10) Remove BF-1, reinstall and open valve 43, and make up joints tight.
- (11) Start up inert gas machine and when analysis indicates a satisfactory quality admit inert gas at V-1, purging Hortonsphere and connecting line of air from V-1 to vents V-2 and V-3. When satisfactory purge gas analyses are obtained, close V-1 and shut down inert gas machine. Also close and lock valve at M-1.
- (12) Close vent V-2.
- (13) Open drip valves at bottom of holder, and check that drip oil removal valve at drip tank is closed.
- (14) Remove lock and crack open valve 44 admitting flammable gas and purging connecting line and Hortonsphere of inert gas from valve 44 to vent V-3. When a satisfactory purge gas sample is obtained, close vent V-3.
- (15) Remove locks at valves 32 and 45.
- (16) Close valves 53 and 54, and operate valves 32 and 45 as directed by gas holder operations bureau.
- (17) Notify the System Operation Department that the holder is physically connected to the gas distribution system and is ready for service.

REMOVAL OF PURGING ACCESSORIES, ETC.

Remove gauge, vents, inert gas connection, etc., and plug all openings used in connection with the purging of the holder and holder connections.

holder in connection with repair work on the holder. The locations of the various vents, gauges, valves, connections, etc., referred to in the projected schedules are indicated on Figure 6-19.

Caution: Steam should not be used for any phase of purging in connection with a Wiggins holder because of the possibility of damaging the diaphragms.

6.25b. REMOVAL FROM FLAMMABLE GAS SERVICE

PREPARATION

- (1) Contact the System Operation Department to verify the outage date on the holder.
- (2) Install vents on valves A and B, and connections for sealing these valves with water if found necessary.
- (3) Provide 3/4" plugged holes at V-1 and V-3 for CO₂ gas connections, 2" vents at V-2 and V-4, and gauges at G-1, G-2, and G-3.
- (4) In joints at spool pieces SP-1 and SP-2, located between valves A and B, and holder drips D-1 and D-2 respectively, replace old bolts with new bolts consecutively to facilitate subsequent removal of these spool pieces.
- (5) Provide water supply to seal holder drips D-1 and D-2 with water.

- (6) Prepare rigging for removal and handling of spool pieces SP-1 and SP-2, also for installation of blank flanges BF-1, BF-2, BF-3, and BF-4.
- (7) Provide a 3/4" plugged hole in each of BF-2 and BF-4 for CO₂ connections.
- (8) Prepare to block open volume control valve at V-5 to serve as a vent. Also check that permanent vent connection V-6 is clear.
- (9) Install water connection W-1 through manhole at bottom of shell and allow water to enter on bottom of holder to determine presence of, and to remove oil by floating off through condensate drain C.
- (10) After water has been removed from holder through condensate drain, close and lock valve C in line from drain box, and provide an inert gas connection to this valve.
- (11) Provide for a continuous supply of satisfactory quality inert gas to valve C from Harrison Inert Gas Generator or other available source. If Harrison generator is used, install a 2" valved connection at M-1 for fuel supply.
- (12) Deflate holder to a point where piston is approximately 1 foot above landing.

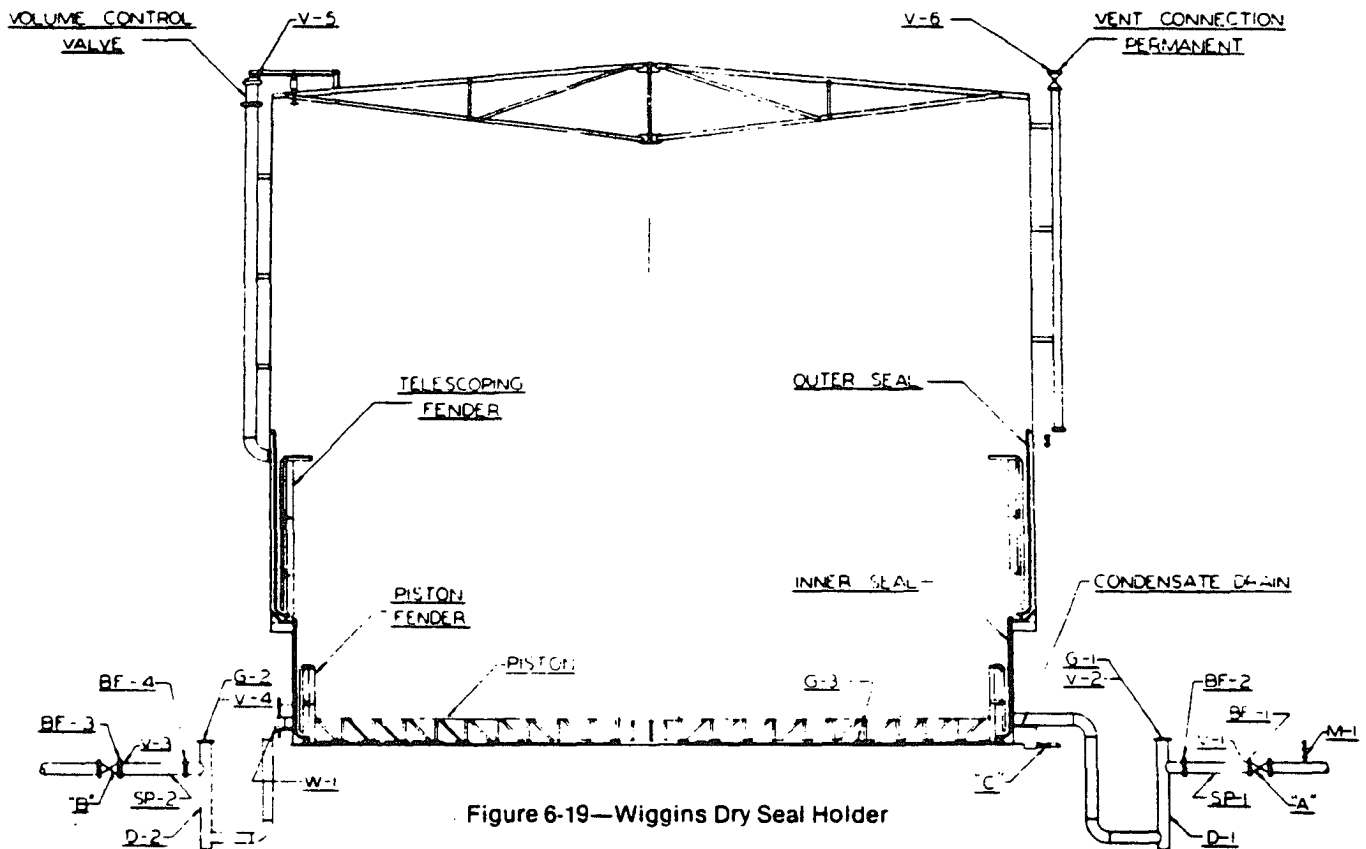

Figure 6-19—Wiggins Dry Seal Holder

SEVERING HOLDER CONNECTIONS

HOLDER CONNECTION BETWEEN VALVE A AND DRIP D-1

- (1) Close and lock valve A, and seal holder drip D-1 with water.
- (2) Open V-2 to relieve pressure, then close V-2 and

check G-1 to determine whether or not valve A is tight. With no indicated buildup of pressure, open V-2 and admit CO₂ at V-1, purging spool piece SP-1 and drip D-1 of flammable gas through V-2. When a satisfactory purge gas sample analysis is obtained, shut off and disconnect CO₂ supply at V-1.

- (3) Remove SP-1, also install blank flange BF-1 on valve A and BF-2 on D-1.
- (4) Admit CO₂ at ¾" connection in BF-2, purging D-1 of air through V-2. When air is satisfactorily purged out, shut off CO₂, plug ¾" opening and close V-2.
- (5) Unlock and crack open valve A. Also open valve vent. When valve has been satisfactorily purged with flammable gas close valve vent.

HOLDER CONNECTION BETWEEN VALVE B AND DRIP D-2

- (1) Close and lock valve B, and seal holder drip D-2 with water.
- (2) Open V-4 to relieve pressure, then close V-4 and check G-2 to determine whether or not valve B is tight. With no indicated buildup of pressure, open V-4 and admit CO₂ at V-3, purging spool piece SP-2 and drip D-2 of flammable gas through V-4. When a satisfactory purge gas sample analysis is obtained, shut off and disconnect CO₂ at V-3.
- (3) Remove SP-2, also install blank flange BF-3 on valve B and BF-4 on D-2.
- (4) Admit CO₂ at ¾" connection in BF-4, purging D-2 of air through V-4. When air is satisfactorily purged out, shut off CO₂, plug ¾" openings, and close V-4.
- (5) Unlock and crack open valve B, also open valve vent. When valve has been satisfactorily purged with flammable gas, close valve vent.

NOTIFICATION OF COMPLETED HOLDER SEVERANCES

Notify the System Operation Department that the holder is now physically disconnected from the gas distribution system.

PURGING HOLDER, CONNECTIONS, AND DRIPS

- (1) If the Harrison Inert Gas Generator is used, connect machine to fuel supply at M-1.
- (2) Make up the necessary connection between valve C and source of inert gas, and provide inert gas up to this valve.
- (3) Open vent V-6, bleed out flammable gas until G-3 indicates substantially zero pressure in holder, then close V-6.
- (4) Unlock and open valve C, and admit satisfactory quality inert gas from Harrison machine or other available source into holder.
- (5) When holder seals are inflated and piston is raised approximately 1 foot, shut off inerts, open vents V-5 and V-6 until G-3 indicates zero pressure. Regulate vents V-5 and V-6 to again raise piston, and repeat process until analyses of the purge gas samples from the vents indicate the holder contents as satisfactorily purged.
- (6) Close vents V-5 and V-6, and, when piston is inflated to about 2 feet above landing, close valve

C and shut down source of inert gas supply. If Harrison machine is used, close and lock fuel supply valve at M-1.

- (7) Pump out drip D-1, open vent V-2 and purge out connection and drip through V-2, using inerts from holder. When satisfactory purge gas sample analysis is obtained, close V-2.
- (8) Pump out drip D-2, open vent V-4, and purge out connection and drip through V-4, using inerts from holder. When satisfactory purge gas sample analysis is obtained, open vents V-2, V-5, and V-6 and land piston.
- (9) Provide connections from sufficient air blowers to displace the inerts and to maintain necessary ventilation within the holder.

REMOVAL OF PURGING ACCESSORIES, ETC.

Remove all gauges, vents, etc., and plug all openings used in connection with the purging of the holder and holder connections.

6.25c. RETURNING HOLDER TO FLAMMABLE GAS SERVICE

PREPARATION

- (1) Notify the System Operation Department of the approximate time and date that flammable gas will be required for the holder.
- (2) Install vents on valves A and B, and connections for sealing these valves with water, if found necessary.
- (3) Install 2" vents at V-2 and V-4, and gauges at G-1, G-2, and G-3.
- (4) Provide water supply to seal holder drips D-1 and D-2 with water.
- (5) Provide rigging for removal of blank flanges BF-1, BF-2, BF-3, and BF-4, also for reinstallation of spool pieces SP-1 and SP-2.
- (6) Prepare to block open volume control valve at V-5 to serve as a vent.
- (7) Provide for a continuous supply of satisfactory quality inert gas to valve C from Harrison generator or other available source. If Harrison generator is used, install a 2" valved connection to M-1 for fuel supply.
- (8) Remove air blower connections to holder and close up manhole openings in piston and shell.

PURGING HOLDER, CONNECTIONS AND DRIPS OF AIR

- (1) If the Harrison machine is used, connect machine to fuel supply at M-1.
- (2) Make up the necessary connection between valve C and source of inert gas, and provide inert gas up to this valve.
- (3) Close vents V-2, V-4, V-5, and V-6.
- (4) Unlock and open valve C, and admit satisfactory quality inert gas from Harrison machine or other available source into holder.

- (5) When holder seals are inflated and piston is raised approximately 1 foot, open vents V-5 and V-6 until G-3 indicates zero pressure. Regulate vents V-5 and V-6 to again raise piston, and repeat process until analysis of the purge gas samples from the vents indicate the holder contents as satisfactorily purged of air.
- (6) Close vents V-5 and V-6, and when piston is inflated to about 2 feet above landing close and lock valve C and shut down source of inert gas supply. Also, remove inert gas connection and restore drain connection to valve C. If Harrison generator is used, close and lock fuel supply valve at M-1.
- (7) Open vent V-2 and purge out connection and drip D-1, using inerts from holder. When satisfactory purge gas sample analysis is obtained close V-2 and seal drip D-1 with water.
- (8) Open vent V-4 and purge out connection and drip D-2, using inerts from holder. When satisfactory purge gas sample analysis is obtained close V-4, and seal drip D-2 with water.

RECONNECTING HOLDER CONNECTIONS

HOLDER CONNECTION BETWEEN VALVE A AND DRIP D-1

- (1) Close and lock valve A.
- (2) Open valve vent to relieve pressure in valve A, then close vent, check with gauge to determine whether or not valve is tight. With no indicated buildup of pressure, remove BF-1.
- (3) Remove BF-2, install spool piece SP-1 between valve A and D-1, and make up flanged joints.
- (4) Open vent V-2 and admit CO₂ at V-1, purging SP-1 and D-1 of air through V-2. When a satisfactory purge gas sample analysis is obtained close V-2, also shut off and disconnect CO₂ supply at V-1.

HOLDER CONNECTION BETWEEN VALVE B AND DRIP D-2

- (1) Close and lock valve B.
- (2) Open valve vent to relieve pressure in valve B, then close vent and check with gauge to determine whether or not valve is tight. With no indicated build up of pressure, remove BF-3.
- (3) Remove BF-4, install spool piece SP-2 between valve B and D-2, and make up flanged joints.

- (4) Open vent V-4 and admit CO₂ at V-3, purging SP-2 and D-2 of air through V-4. When a satisfactory purge gas sample analysis is obtained, close V-4, also shut off and disconnect CO₂ supply at V-3.

DISPLACEMENT OF INERT GAS IN HOLDER AND HOLDER CONNECTIONS WITH FLAMMABLE GAS

HOLDER CONNECTION BETWEEN VALVE A AND DRIP D-1

- (1) Unlock and crack open valve A.
- (2) Open V-2, purging SP-1 and D-1 of inerts through V-2, with flammable gas. When satisfactorily purged, close V-2, also close and lock valve A.

HOLDER CONNECTION BETWEEN VALVE B AND DRIP D-2

- (1) Unlock and crack open valve B.
- (2) Open V-4, purging SP-2 and D-2 of inerts through V-4 with flammable gas. When satisfactorily purged, close V-4, also close and lock valve B.

HOLDER CONNECTIONS TO DRIPS D-1 and D-2

- (1) Unlock and crack open valve A, and pump out D-1.
- (2) Open vents V-5 and V-6, and regulate these vents to maintain the purging position of the piston at 6" above landing.
- (3) Unlock and crack open valve B, and pump out D-2.
- (4) When analyses of the purge gas samples from V-5 and V-6 indicate that the inerts in the holder and connections have been satisfactorily displaced by flammable gas, close V-5 and V-6.
- (5) Inflate piston to about 2 feet above landing, then close valves A and B.
- (6) Remove lock at valve C, also remove G-3 and water connection in manhole at bottom of shell, and plug all openings.
- (7) Notify the System Operation Department that the holder is physically connected to the gas distribution system, and is ready for service.

REMOVAL OF PURGING ACCESSORIES, ETC.

Remove all gauges, vents, connectons, etc., and plug all openings used in conjunction with the purging of the holder and holder connections.