

— THE —  
**LIGHTER SIDE**  
— OF TEFL —

**WORD SEARCHES**

**READING & WRITING**

**WORD PUZZLES & SCRAMBLES**

**CROSSWORD PUZZLES**

**GAMES WITH LETTERS**

**LOGIC PUZZLES**





# “The Lighter Side” of TEFL

A Teacher’s Resource Book of Fun Activities  
for Students of English as a Foreign Language



© 2019 by **The Bureau of Educational and Cultural Affairs, Office of English Language Programs.**  
This work is licensed under the Public Domain. To view a copy of this license, visit  
<https://creativecommons.org/share-your-work/public-domain/pdm/>

## The Lighter Side of TEFL

© 2019 by **The Bureau of Educational and Cultural Affairs,  
Office of English Language Programs.**

This work is licensed under the Public Domain. To view a copy of this license,  
visit <https://creativecommons.org/share-your-work/public-domain/pdm/>

This publication is available free of charge online at: [www.americanenglish.state.gov](http://www.americanenglish.state.gov)

Office of English Language Programs  
Bureau of Educational and Cultural Affairs  
United States Department of State  
Washington, D.C.  
[americanenglish.state.gov](http://americanenglish.state.gov)

Third Edition 2019

Second Edition 2010

Reprinted in 2005

First published by the United States Information Agency in 1994

First and Second Editions Compiled by Elizabeth Ball

Third Edition Compiled by Amy Hanna

**Editor of First Edition:** Thomas Kral

**Original Layout and Design:** Cynthia Malecki

**Third Edition Cover Art:** Fathom Creative, Inc.

Dedicated to  
*Anne Covell Newton*

“A little of this and little of that  
(A balanced mixture of lean and fat)  
Adds Spice to the pudding; it cannot hurt,  
And it brings to the reader his just dessert.”\*



# introduction

This third edition of *The Lighter Side of TEFL* contains activities mainly taken from *English Teaching Forum* from 2004 to the present. A few puzzles that were published prior to 2004 are included. The puzzles are grouped into categories by type. The categories also progress from letter- and word-based activities to more complex exercises involving reading and writing skills.

The purpose of *The Lighter Side of TEFL* has always been to make learning English fun. These puzzles help students develop vocabulary and practice thinking critically. Listening, speaking, reading, and writing may be used to solve the puzzles, but the goal of each activity is to inspire students to see that communicating in English can be an enjoyable, and even lighthearted, experience.

Each of the puzzles in this book would be an excellent warm-up activity at the beginning of class, or a great wrap-up activity at the end. The puzzles are short and do not require any additional materials. These activities are best completed in pairs or small groups so that different perspectives can be utilized—and enjoyment can be shared! After completing the puzzles, discuss the answers as a class using the solutions found in the back of the book.

*The Lighter Side of TEFL* is a resource for teachers, who may reproduce individual pages for use in their classrooms. The puzzles in this edition are intended to be used as supplemental material—warm-up games, group work, wrap-up activities—not as a textbook for students to complete during a course.

# table of contents

---

**1**

*section 1*  
games with  
letters

**12**

*section 2*  
word searches

**23**

*section 3*  
scrambles

**34**

*section 4*  
crossword  
puzzles



**42** *section 5*  
word games

**52** *section 6*  
reading + writing

**67** *section 7*  
logic puzzles

**77** answer key

**94** puzzle credits



# games with letters

---

The puzzles in this portion of the book must be completed by filling in letters that are missing from words. These activities help students practice parts of speech, spelling, sound/symbol correspondence, and vocabulary. For beginner students, an activity that provides practice with letter identification and the order of the English alphabet is included.

TEACHING TECHNIQUES. To motivate students, these activities can be completed in small groups or teams to see who can finish first or which team can get the most correct answers. Use the puzzles about dog tricks, animal sounds, motorcycles, and gardens to introduce or review vocabulary related to those topics. Give students one of the puzzles prior to teaching about the topic to assess background knowledge, and then have learners complete it again after teaching. The puzzles Fishy Fun and Silent Letters can be used to teach specific pronunciation skills and spelling patterns. What's Missing? is excellent for reviewing vowel sounds and spelling patterns. The activity can be scaffolded by reading the words aloud and asking students to listen for the missing vowels.

# Chicago Word Train

**F**ill in the spaces with the letters of the 24 words defined by the clues below. The words are linked like cars in a train; the last letter of one word is the first letter of the next word. —

1. *noun.* A structure or artistic object that sprays water      f o u n t a i n
2. *noun.* A daily publication of news      n \_ \_ \_ \_ \_
3. *noun.* Part of the track that a train runs on      \_ \_ \_ \_ \_
4. *noun.* A body of water surrounded by land      \_ \_ \_ \_ \_
5. *verb.* To consume food      \_ \_ \_ \_ \_
6. *noun.* A tall building or structure      \_ \_ \_ \_ \_
7. *noun.* A long, flowing body of water      \_ \_ \_ \_ \_
8. *noun.* A cement or dirt path for vehicles      \_ \_ \_ \_ \_
9. *adjective.* Moist      \_ \_ \_ \_ \_
10. *noun.* Baked dough topped with tomato sauce and cheese      \_ \_ \_ \_ \_
11. *noun.* Tank that holds water; home for fish      \_ \_ \_ \_ \_
12. *noun.* Institution that displays art to the public      \_ \_ \_ \_ \_
13. *noun.* Sounds made by voices or instruments      \_ \_ \_ \_ \_
14. *verb.* To trim or cut      \_ \_ \_ \_ \_
15. *noun.* Wooden structure where ships dock      \_ \_ \_ \_ \_
16. *noun.* Top covering of a house or building      \_ \_ \_ \_ \_
17. *noun.* Nourishment consumed daily      \_ \_ \_ \_ \_
18. *verb.* To move in rhythm with music      \_ \_ \_ \_ \_
19. *noun.* Opposite direction of west      \_ \_ \_ \_ \_
20. *noun.* A narrow path      \_ \_ \_ \_ \_
21. *noun.* Circular route      \_ \_ \_ \_ \_
22. *noun.* Authority or control      \_ \_ \_ \_ \_
23. *noun.* Objects arranged in an orderly line      \_ \_ \_ w
24. *adjective.* Blustery or breezy      w i n d y

# ALPHABET CONNECT

I am the largest of the land mammals. I live in the forests and savannas of Africa, India, and Southeast Asia. *Who am I?*

To answer the question connect the letters of the alphabet in order (A, B, C...), first the capital letters, then the small letters.

•w •x •y •z •E •F •G  
•v •u •D •H  
•t •q •C •A  
•r •B •U •T •S •I  
•s •P •l •h •g •V •R •J  
•m •k •f •a •N •O •Q •K  
•o •e •b •Z •P •L  
•n •j •i •d •c •Y •X •W •M

# W H \_ T ' S M \_ S S \_ N G ?

**B**elow is a list of activities that might be part of an English Club meeting. However, the vowels are missing from the activities. Your job is to fill in the missing letters to complete the list.

For example, you would complete “S K \_ T S” by filling in the blank with an *I* to spell *skits*.

Now see if you can fill in the letters below.

1. S \_ N G \_ N G S \_ N G S
2. M \_ V \_ \_ \_ N \_ G H T
3. B \_ \_ K C L \_ B
4. D \_ B \_ T \_
5. R \_ L \_ P L \_ Y S
6. D \_ S C \_ S S \_ N G C \_ R R \_ N T \_ V \_ N T S
7. P H \_ T \_ C \_ N T \_ S T
8. G \_ M \_ S
9. C \_ N V \_ R S \_ T \_ \_ N P R \_ C T \_ C \_
10. C \_ F F \_ \_ B R \_ \_ K
11. T R \_ N S L \_ T \_ \_ N
12. W \_ T C H \_ N G T V S H \_ W S
13. L \_ S T \_ N \_ N G T \_ P \_ D C \_ S T S
14. \_ L \_ C T \_ N G C L \_ B \_ F F \_ C \_ R S

# Dog Tricks

People often teach their dogs to do a “trick” in response to a command. Fill in the spaces below with commands that someone might give to a dog (this one is named Fido). Use the letters in Fido’s food dish to spell the tricks; cross off the letters as you use them. The first command has been done for you.



1. Tell your dog to bark.  
"Fido, S P E A K."
2. Tell your dog to take a seat.  
"Fido, \_\_\_\_\_."
3. Tell your dog to put its paw in your hand; then move it up and down.  
"Fido, \_\_\_\_\_."
4. Tell your dog to move to a sleeping position on the floor.  
"Fido, \_\_\_\_\_."
5. Tell your dog to move from its stomach to its back while lying down.  
"Fido, \_\_\_\_\_."
6. Tell your dog to run after a ball, pick it up, and bring it back to you.  
"Fido, \_\_\_\_\_."
7. Tell your dog to lie down and pretend it is no longer living.  
"Fido, \_\_\_\_\_."
8. Give your dog a reward!  
"Fido, good job! Here's a \_\_\_\_\_!"



# Animal Sounds

**F**ind the letters indicated by the clues. Next, write those letters in the numbered blanks in the Matching section to spell animal sounds. Then match the sounds with the animals that make them.

## CLUES

- 1 A = First letter of the word for living creatures ( A N I M A L S )
- 2 \_\_\_ = Last letter of a place where crops are grown and animals are raised ( \_\_\_\_\_ )
- 3 \_\_\_ = First letter of an animal that swims, such as salmon or cod ( \_\_\_\_\_ )
- 4 \_\_\_ = First letter of the things that hens lay ( \_\_\_\_\_ )
- 5 \_\_\_ = First letter of an animal whose young are called "kids" ( \_\_\_\_\_ )
- 6 \_\_\_ = Second letter of a farm animal that is pink ( \_\_\_\_\_ )
- 7 \_\_\_ = First letter of the word for "baby cat" ( \_\_\_\_\_ )
- 8 \_\_\_ = First letter of an animal that rhymes with *mama* ( \_\_\_\_\_ )
- 9 \_\_\_ = Last letter of a building that animals live in on a farm ( \_\_\_\_\_ )
- 10 \_\_\_ = Second letter of an animal that is known for providing milk ( \_\_\_\_\_ )
- 11 \_\_\_ = First letter of the head of a bee colony ( \_\_\_\_\_ )
- 12 \_\_\_ = Second letter of the word for "baby dog" ( \_\_\_\_\_ )
- 13 \_\_\_ = First letter of a liquid that animals drink ( \_\_\_\_\_ )
- 14 \_\_\_ = First letter of the word for a young rabbit ( \_\_\_\_\_ )
- 15 \_\_\_ = First letter of an animal that can live in a house or barn and eats mice ( \_\_\_\_\_ )
- 16 \_\_\_ = First letter of an animal that can pull carts and race ( \_\_\_\_\_ )

## MATCHING

<u>Animal Sounds</u>	<u>Animals</u>										
<table border="0" style="margin-left: auto; margin-right: auto;"> <tr><td style="border-top: 1px solid black; width: 20px;"></td><td style="border-top: 1px solid black; width: 20px;"></td><td style="border-top: 1px solid black; width: 20px;"></td><td style="border-top: 1px solid black; width: 20px;"></td></tr> <tr><td style="text-align: center;">10</td><td style="text-align: center;">6</td><td style="text-align: center;">9</td><td style="text-align: center;">7</td></tr> </table>					10	6	9	7	PIG		
10	6	9	7								
<table border="0" style="margin-left: auto; margin-right: auto;"> <tr><td style="border-top: 1px solid black; width: 20px;"></td><td style="border-top: 1px solid black; width: 20px;"></td><td style="border-top: 1px solid black; width: 20px;"></td></tr> <tr><td style="text-align: center;">2</td><td style="text-align: center;">10</td><td style="text-align: center;">10</td></tr> </table>				2	10	10	DUCK				
2	10	10									
<table border="0" style="margin-left: auto; margin-right: auto;"> <tr><td style="border-top: 1px solid black; width: 20px;"></td><td style="border-top: 1px solid black; width: 20px;"></td><td style="border-top: 1px solid black; width: 20px;"></td><td style="border-top: 1px solid black; width: 20px;"></td><td style="border-top: 1px solid black; width: 20px;"></td></tr> <tr><td style="text-align: center;">15</td><td style="text-align: center;">8</td><td style="text-align: center;">12</td><td style="text-align: center;">15</td><td style="text-align: center;">7</td></tr> </table>						15	8	12	15	7	CHICKEN
15	8	12	15	7							
<table border="0" style="margin-left: auto; margin-right: auto;"> <tr><td style="border-top: 1px solid black; width: 20px;"></td><td style="border-top: 1px solid black; width: 20px;"></td><td style="border-top: 1px solid black; width: 20px; text-align: center;"><u>A</u></td><td style="border-top: 1px solid black; width: 20px;"></td><td style="border-top: 1px solid black; width: 20px;"></td></tr> <tr><td style="text-align: center;">11</td><td style="text-align: center;">12</td><td style="text-align: center;">1</td><td style="text-align: center;">15</td><td style="text-align: center;">7</td></tr> </table>			<u>A</u>			11	12	1	15	7	HORSE
		<u>A</u>									
11	12	1	15	7							
<table border="0" style="margin-left: auto; margin-right: auto;"> <tr><td style="border-top: 1px solid black; width: 20px;"></td><td style="border-top: 1px solid black; width: 20px;"></td><td style="border-top: 1px solid black; width: 20px;"></td><td style="border-top: 1px solid black; width: 20px;"></td></tr> <tr><td style="text-align: center;">2</td><td style="text-align: center;">4</td><td style="text-align: center;">10</td><td style="text-align: center;">13</td></tr> </table>					2	4	10	13	CAT		
2	4	10	13								
<table border="0" style="margin-left: auto; margin-right: auto;"> <tr><td style="border-top: 1px solid black; width: 20px;"></td><td style="border-top: 1px solid black; width: 20px; text-align: center;"><u>A</u></td><td style="border-top: 1px solid black; width: 20px; text-align: center;"><u>A</u></td></tr> <tr><td style="text-align: center;">14</td><td style="text-align: center;">1</td><td style="text-align: center;">1</td></tr> </table>		<u>A</u>	<u>A</u>	14	1	1	DOG				
	<u>A</u>	<u>A</u>									
14	1	1									
<table border="0" style="margin-left: auto; margin-right: auto;"> <tr><td style="border-top: 1px solid black; width: 20px;"></td><td style="border-top: 1px solid black; width: 20px;"></td><td style="border-top: 1px solid black; width: 20px;"></td><td style="border-top: 1px solid black; width: 20px;"></td></tr> <tr><td style="text-align: center;">13</td><td style="text-align: center;">10</td><td style="text-align: center;">10</td><td style="text-align: center;">3</td></tr> </table>					13	10	10	3	SHEEP		
13	10	10	3								
<table border="0" style="margin-left: auto; margin-right: auto;"> <tr><td style="border-top: 1px solid black; width: 20px;"></td><td style="border-top: 1px solid black; width: 20px;"></td><td style="border-top: 1px solid black; width: 20px;"></td><td style="border-top: 1px solid black; width: 20px;"></td><td style="border-top: 1px solid black; width: 20px;"></td></tr> <tr><td style="text-align: center;">9</td><td style="text-align: center;">4</td><td style="text-align: center;">6</td><td style="text-align: center;">5</td><td style="text-align: center;">16</td></tr> </table>						9	4	6	5	16	COW
9	4	6	5	16							



# Shop Talk

*Shop talk* is a phrase used to describe conversation related to someone's work.  
*Shop* is also a short term for a mechanic's shop, a place to get your car or motorcycle fixed.

**R**ead the questions below. Each answer is a motorcycle part, and each answer fits into one set of blanks on the right. Fill in the letters to complete each answer and draw a line from each question to the matching answer. (The first one has been done for you.) If you need help, at the bottom you will find a picture of each part.

1. What part of the motorcycle shows you how fast you are going?
2. What do you use to shift gears?
3. What do you wear to protect your head?
4. What holds the motorcycle up when you are not riding it?
5. What do you look in to see behind you?
6. What do you put fuel in?
7. What stops the motorcycle?
8. What do you hold onto to steer the motorcycle?
9. What gives the bike power?
10. What do you use to turn on the motorcycle?

\_\_\_\_\_ M \_\_\_\_\_  
 \_\_\_\_\_ O \_\_\_\_\_  
 \_\_\_\_\_ T \_\_\_\_\_  
S P E E D O M E T E R  
 \_\_\_\_\_ R \_\_\_\_\_  
 \_\_\_\_\_ C \_\_\_\_\_  
 \_\_\_\_\_ Y \_\_\_\_\_  
 \_\_\_\_\_ C \_\_\_\_\_  
 \_\_\_\_\_ L \_\_\_\_\_  
 \_\_\_\_\_ E \_\_\_\_\_

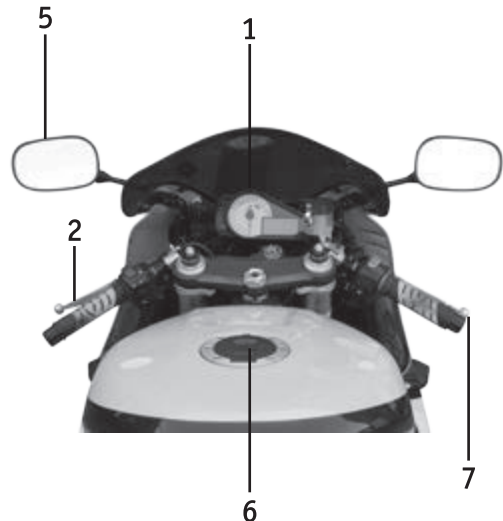
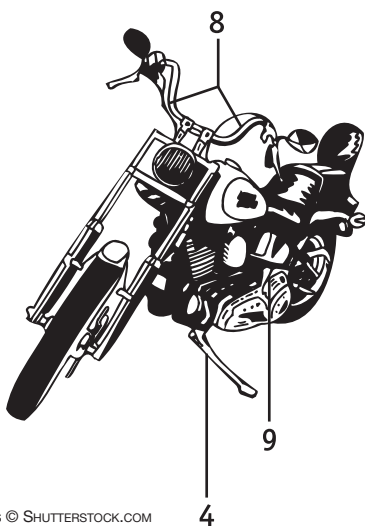

# Tenpins

**T**en is a significant number in bowling: The goal is to knock down all ten pins, and a game of bowling has ten frames. In each of the ten bowling pins is a word that contains the letters *t-e-n* (as in *brighten* and *intense*). Use the clues to complete the t-e-n words.

- |                                  |  |
|----------------------------------|--|
| 1. go to (a class or a meeting)  | 7. frequently                                      |
| 2. Table of _____                | 8. make believe                                    |
| 3. past participle of <i>eat</i> | 9. bad (describing food you can no longer eat)     |
| 4. scare                         | 10. "Please give your answer in a complete _____." |
| 5. a baby cat                    |  |
| 6. pay attention to a sound      |  |

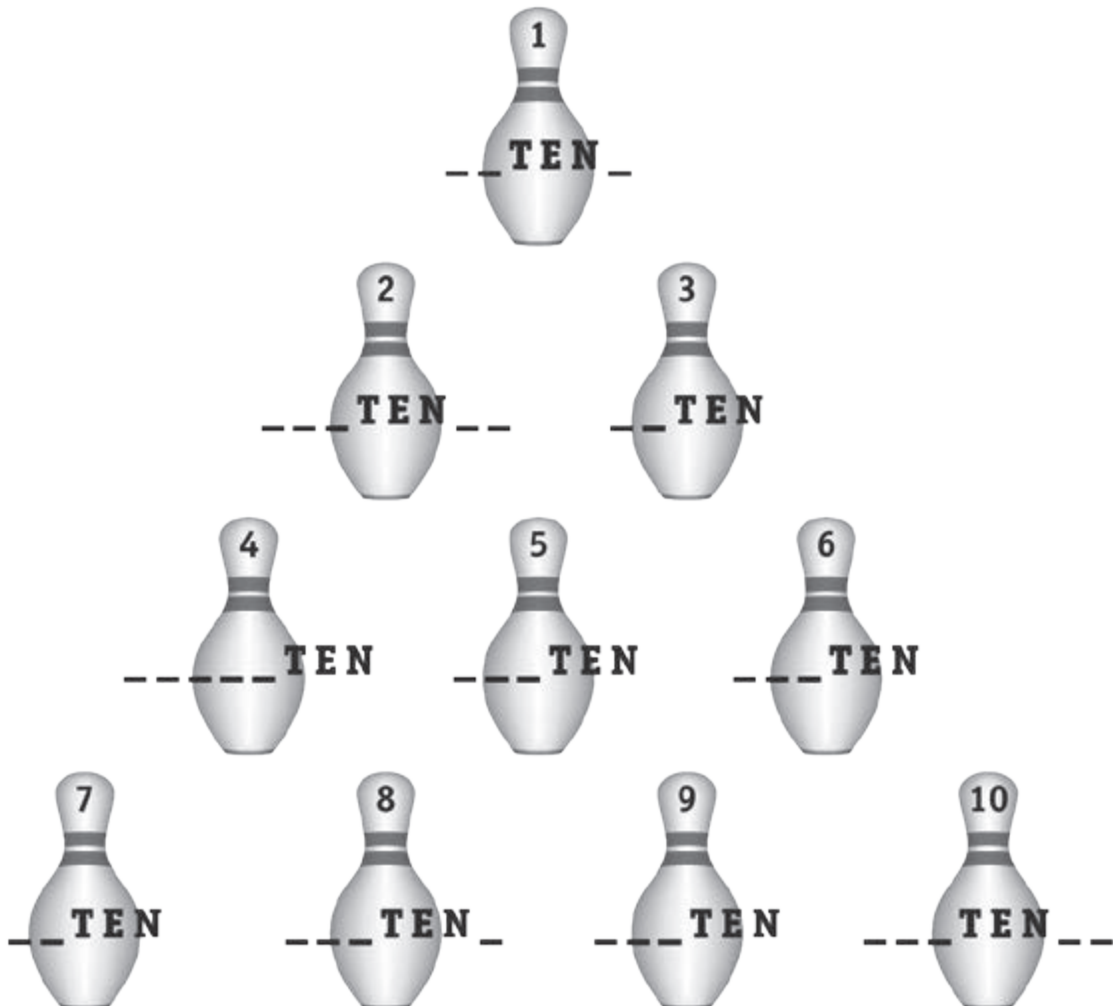

# Jumble Garden

**U**se the letters provided to make words based on the definitions. If a letter appears only once, you cannot use it more than once in your answer. In each set, one answer will use all the letters.

## Example

**A T L P N**

**ant** a small black insect

**pan** something you cook fresh vegetables in

**plant** something green that grows out of the earth

**D N R E A G R E**

1. \_ \_ \_ the color of a ripe tomato
2. \_ \_ \_ \_ the color associated with nature
3. \_ \_ \_ \_ \_ a place with dirt, flowers, vegetables, and other plants
4. \_ \_ \_ \_ \_ \_ a person who plants flowers, vegetables, and other plants

**N W R E I F G O L**

5. \_ \_ \_ a line of plants in a garden
6. \_ \_ \_ \_ the past tense of *grow*
7. \_ \_ \_ \_ \_ the blossom of a plant
8. \_ \_ \_ \_ \_ \_ \_ \_ the blossoming of a plant

**V L O H E S D E**

9. \_ \_ \_ a tool used to break up dirt
10. \_ \_ \_ \_ what you dig in the ground to put a plant in
11. \_ \_ \_ \_ a tube used to spray water
12. \_ \_ \_ \_ a small thing you put in the ground that will become a plant
13. \_ \_ \_ \_ \_ a tool used to dig
14. \_ \_ \_ \_ \_ \_ \_ \_ used a tool to dig

# Fishy Fun

Say these five times fast!

Below are five incomplete tongue twisters. In each one, you can complete all the words by adding the same letter. Add the missing letters, then practice saying the tongue twisters as fast as you can.

1. \_he \_aw \_even \_wimming \_hrimp.
2. \_ive \_at \_lat \_ish \_lapped.
3. \_liver \_rdered \_ily \_range \_ysters.
4. \_rincess \_atty's \_retty \_ond is \_erfect.
5. \_hris \_aught \_old, \_rusty \_lams.

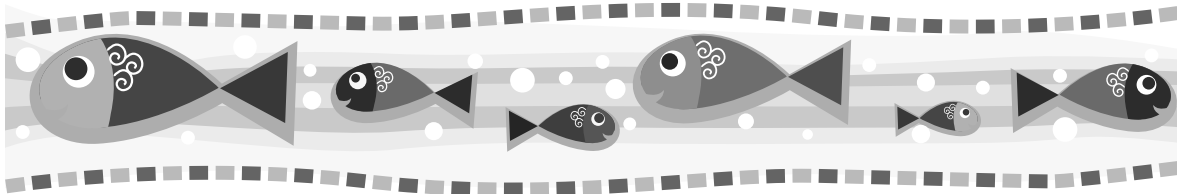

## Matching

In the column on the left, the first letter and last letter of each word are missing. Fill in the blanks to complete each word. Then match the word with its definition in the right-hand column.

- |            |  |
|------------|--|
| 1. _ano_   | a. to get a fish out of the water                              |
| 2. _o_     | b. a group of fish swimming together                           |
| 3. _atc_   | c. a large body of saltwater                                   |
| 4. _ai_    | d. a large fish with sharp teeth                               |
| 5. _choo_  | e. a long, slender boat  |
| 6. _cea_   | f. it prevents the boat from floating away                     |
| 7. _ak_    | g. food (or other items) used to attract fish                  |
| 8. _oo_    | h. a large body of freshwater                                  |
| 9. _har_   | i. a long, thin pole used for fishing                          |
| 10. _ncho_ | j. a small, curved piece of metal at the end of a fishing line |

# Silent Letters

**T**he letter *k* in the word *knitting* is silent; that is, it is not pronounced. Silent letters appear in the spelling of many English words. In the conversation below between two *English Teaching Forum* readers, there are blanks for some words that contain silent letters. Can you fill in the blanks with letters to spell the appropriate words? In each missing word, the silent letter is given to you. (For example, in “Don’t forget to \_\_\_ **B** your hair,” the missing word would be *comb*—the *b* is silent.) Numbers in brackets, such as [1] and [2], at the end of a sentence correspond with the answers you will find in the Answer Key.

*Forum* Reader A: **\_H\_ \_** are you doing? [1]

*Forum* Reader B: I’m knitting a sweater.

A: That looks like fun.

B: So, do you like to knit?

A: I’m not sure. To tell you the truth, I don’t **K\_ \_ \_** how. [2]

B: I can teach you. All you have to do is watch me and \_\_\_ **T\_ \_** to my directions. I’ll tell you what to do. [3]

A: Thanks! I’d like to learn. I don’t have much time now, \_\_\_ **U G H**. Maybe some other time. [4]

B: Why don’t you come to my knitting circle? It’s a club I’m in. We get together to knit and chat for a few **H\_ \_ \_**. It’s fun! [5]

A: But I’m not a member of your knitting circle.

B: No problem! You can come as my **\_ U \_ \_**. Everyone will welcome you. [6]

A: It sounds interesting. When do you meet?

B: We meet **\_W\_** times a week, on Mondays and **\_ \_ D \_ \_ \_ \_ \_**. [7], [8]

A: That sounds great! Thank you! Oh, by the way, **W\_ \_** is the sweater for? [9]

B: It’s for a close **\_ \_ I \_ \_ \_** of mine. She lives in a **\_ \_ \_ \_ \_ G \_** country, halfway around the world, so I’ll have to send it to her. In fact, she lives on an **\_ S \_ \_ \_ \_**, surrounded by water. [10], [11], [12]

A: Is the weather cold there?

B: Not in the summer. But it’s cool in the **\_ \_ \_ \_ \_ N** and winter. [13]

A: Well, I hope she likes the sweater.

B: So do I. And I hope it fits her, too. I’m a little bit afraid it’s going to be the **W\_ \_ \_ \_** size! [14]

# word searches

---

**W**ord searches may seem simple, but these puzzles can actually be used for more than just finding words. The word searches included here can be used to introduce or review vocabulary, practice synonyms and antonyms, and familiarize students with terms related to poetry.

**TEACHING TECHNIQUES.** The puzzles related to specific topics can be assigned before beginning a unit as a way to introduce new vocabulary to students. Have learners work in pairs to locate all of the words. Once all of the words are found, have students write down what they think each word means or describes. After teaching the unit/lessons related to the topic, revisit the word search and have students write down the meaning of each word based on what they have learned. Compare the ideas to see what students remember from the lessons. As an extension, have students write sentences or a story with blanks where the words from the puzzle would go. Have partners exchange sentences/stories and fill in the blanks with the words from the puzzle.

# Winter Sports Word Search

Figure out the answer to each numbered clue below. Then search for and circle those answers in the grid. Words may be printed vertically, horizontally, diagonally, or even backwards. All answers are related to winter sports, and the number of letters in each answer is indicated.

S	G	N	I	T	A	K	S	N	O	S	G
L	E	L	F	O	R	U	M	L	W	N	A
S	U	V	R	I	C	E	Y	S	I	O	N
M	T	T	O	W	V	M	A	D	N	W	A
O	F	E	Z	L	P	E	R	E	D	B	D
U	I	A	M	I	G	A	G	L	E	X	A
N	C	C	C	L	O	N	O	S	W	W	N
T	Y	S	I	B	E	G	I	I	H	O	A
A	F	T	W	C	L	H	N	I	O	A	C
I	A	O	M	E	L	T	T	D	K	Q	O
N	N	O	U	T	E	E	L	S	I	S	L
S	S	B	R	R	H	O	C	K	E	Y	D

- This is the color of snow. \_\_\_\_\_
- Many winter athletes wear these to keep their hands warm. \_\_\_\_\_
- In this team sport, players on skates try to score goals with a puck. \_\_\_\_\_
- One of the most popular winter sports is figure \_\_\_\_\_. \_\_\_\_\_
- There are many variations of this sport, in which athletes race down snow-covered mountains. \_\_\_\_\_
- This country was the host of the 2010 Winter Olympic Games. \_\_\_\_\_
- In this sport, athletes ride boards, like wide skis, on the snow. \_\_\_\_\_
- The \_\_\_\_\_ Olympic Games were held in the same year as the Summer Olympic Games until 1994. \_\_\_\_\_
- Skaters compete on this surface. \_\_\_\_
- Children love to sit on these and ride down snow-covered hills. \_\_\_\_\_
- The Winter Olympic Games are held every \_\_\_\_\_ years. \_\_\_\_\_
- To keep their feet warm and dry, many athletes wear these in the snow. \_\_\_\_\_
- These are higher than hills, and skiers love to glide down their sides. \_\_\_\_\_
- Snowboarders (and bobsledders) wear these to protect their heads. \_\_\_\_\_
- Skiers compete on this surface. \_\_\_\_\_

# New York City Word Search

Figure out the answer to each of the clues below. Then search for and circle those answers in the grid. Words may be printed vertically, horizontally, diagonally, or even backwards.

```

E F N T C D I U R B S E V T U G S E Z M G T
D M A F G E U W R P Q L W X U B N R K V R B
V J P Y T C N O A A S M D G B P O I G T E Q
R R X I G A A T O Z E X G A H E I E M U E S
B R F W R D Q E R C E E A B J Q T C A H N H
I V P R W E P Y Q A N N H M M V A A E O W C
R X A A I N S U E H L H C W F S N N P A I F
B E Y B Z X Z T E G M P G A K K D A E E C D
S E Y A W L C I A X D L A E T T E L Q Q H N
B A W Z M S M I I T R I R R X I T O I G V R
Q G H E O M M X R D E P R B K Y I M M Z I L
V H B R U T O J U L L B Y B O W N L K Z L J
H U D S O N R I V E R T U E N O U F Z A L S
V F E V R M U O P T A A U I R Y G Q H F A A
T U A Y H N G W Y R H D A Y L O L E S R G C
M T H N E F E N O B W V L A J D I K L O E F
Y T R E B I L F O E U T A T S G I J O B D I
M E L R A H U Q A A U R G O E P B N S O R D
C A T H U U E Y G E Z B Q N I V U Z G R R Y
K P U S T P C I P L M K R V I F M D C E E B
S Y I V J D L P Y A A A I V K J E R U J B U
L V S C F R R X Z B C U U X W V M L J I L H

```

## Clues

- \_\_\_\_\_ is another name for the Theatre District in midtown Manhattan.
- In 1609, an English explorer sailed up this body of water now named after him. (2 words)
- \_\_\_\_\_ is a neighborhood in New York City known as a place of avant-garde art and progressive politics.
- With the opening of the \_\_\_\_\_ in 1825, New York became the premier American port on the Atlantic coast.
- The headquarters of the \_\_\_\_\_ is international territory owned by all member countries.
- The \_\_\_\_\_ was a gift from France to the United States, representing the friendship formed between these two countries during the American Revolution.
- This building is shaped like a spiral, wider at the top than the bottom. (2 words)
- Each year millions of people visit this location to enjoy the lakes, play sports, visit the zoo, or see free plays and concerts. (2 words)
- It is said that if you have performed at \_\_\_\_\_, you have reached the top of your musical career.
- Until 1954, this was the tallest building in the world. Today it is one of the most famous tourist attractions in New York City. (3 words)
- Opened in 1883, the \_\_\_\_\_ joined Manhattan to Brooklyn and was considered one of the greatest engineering feats of its time.
- During the 1920s and 1930s, this neighborhood was home to many famous African-American writers and musicians, such as Langston Hughes and Duke Ellington. (1 word)



# Weather Word Search

**F**ind the weather words listed below. When you find a word in the puzzle, circle it. Words can appear vertically, horizontally, diagonally, or even backwards.



Boots

Cloud

Cloudy

Cold

Fog

Foggy

Forecast

Hot

Rain

Raincoat

Rainy

Sandals

Scarf

Snow

Snowy

Sunglasses

Sunny

Temperature

Umbrella

Warm

Weather

Wind

Windy

# Poetry Word Search

**B**elow is a list of several poetry terms. See if you can find them in the word search. The terms may be printed vertically, horizontally, or diagonally.



Alliteration

Assonance

Ballad

Couplet

Haiku

Imagery

Kenning

Limerick

Metaphor

Onomatopoeia

Personification

Rhyme

Simile

Story

Verse

# HOME ON THE RANGE

AN EXCERPT FROM *IF YOU FEEL LIKE SINGING* BY ALICE H. OSMAN AND JEAN McCONOCHIE

Sentimentally Traditional

G7 C F C

D7 G7 C

F C G7 C

Chorus: G G7 C

D7 G7 C

F C G7 C

Singing Tip: Some singers can harmonize by singing the small notes in the chorus.

G7 C F D7

The origin of this song, as of many other folksongs, is uncertain. We know that it was sung in Texas as early as 1867. We also know that a set of words was published in 1873 by a pioneer doctor, Brewster M. Higley, who had moved from Ohio to Kansas (some said he moved to escape his bad-tempered wife). The music has been attributed to Daniel E. Kelley, a musician and entertainer who had moved to Kansas from Rhode Island. Honoring these two men, Kansas adopted *Home on the Range* as its state song in 1947.

The Homestead Law of 1862 encouraged the westward movement that brought Higley and Kelley to Kansas. Under this law, a settler could become the owner of 160 acres of land after paying an \$18 fee and farming the land for five years. This distribution of government land soon brought an end to the open range; by 1885, railroad tracks and barbed wire fences had divided the land.

By the turn of the century, most of the buffalo, deer, and antelope had been killed. Buffalo can now be found only in zoos and on small private ranches. The deer and antelope herds have grown in recent years; they present a wildlife conservation problem because there isn't enough open land to support them. The range celebrated in this song—thousands of miles of unfenced grassland between the Mississippi River and the Rocky Mountains—now exists only in memory.

A	C	R	A	N	G	E	E
L	N	G	D	E	E	R	C
L	I	T	S	R	K	M	O
S	K	I	E	S	O	Q	U
P	S	H	L	L	W	T	R
L	W	O	D	A	O	U	A
A	J	M	O	N	R	P	G
Y	O	E	M	F	D	E	E

## A WORD SEARCH PUZZLE

Find the following words in the word search puzzle. When you find a word, circle it. Words can appear vertically, horizontally, diagonally, or even backwards.

- |                                     |        |
|-------------------------------------|--------|
| all                                 | on     |
| antelope                            | play   |
| are                                 | range  |
| courage (from <i>discouraging</i> ) | skies  |
| deer                                | seldom |
| home                                | where  |
| not                                 | word   |

# URBAN RENEWAL

## A WORD SEARCH PUZZLE

Z O R T X Q S P N T L U A S G N I D L I U B R E U H W I W D  
 W R B J F T S Y J R H Q E H U K Y A O A T A C S M U B P O S  
 M M B O N E Y G L Q K H A U J Q K H K O N Q A N V X B F C X  
 F L S A T A B A U I R M J Y F E F M L B H D R S T X E E H H  
 M A O Y L M N U D A B I S K Y S C R A P E R T M S A W P W Z  
 R T B E W K X W R Z G G F C L X E G W V O H O Z P T C Z E C  
 S K M G T H L G B T G X P S H N S G E A B X G B G J H L S K  
 K P C J P S L O W C U W U P O O A L D M P A R C H I T E C T  
 O E U I O V G O X Y C W G X U O O S I I S P A M P G L R V O  
 C S I K S J F R G J Y L I F S P X L S K R A P L Y T I C Z N  
 W Y I X Q F M E B E H A S T E E R T S W I B H C C P Y E O M  
 I M W K T L Y U N P D H J R S I S Z R A S B Y G A W A I N E  
 Z E U L H S X V U H B M S Y Z P D X A R B V V H W W B V I C  
 J P D M N K G X M I Q C B Y U O I B M I H N Z Z R Y D F N M  
 X S M Z Q D K T J S T Q H K G R T A W I J J W E B D Y X G M  
 O P V R D N R M O C I D H K Q M H X M L X W N X J S E Z Q A  
 O T D A D Y S W E Q U P M I D V N L T A B Q N Z N F N P R T  
 R T F Z W X Y X G D M A B S H V B P W N U V L P Z O Z A X Y  
 X Y G D Z H F U D J X X N W R D R M O U X C U U Y F T Z S P  
 M A A J Y U P R A O Z W V V I W V D J L Y Y J H R R E C J P

**F**ind the following words in the word search puzzle. When you find a word, circle it. Words can appear vertically, horizontally, diagonally, or even backwards.

architect

bridges

buildings

cartography

city

developer

houses

lake

land

maps

neighborhood

parks

roads

schools

sidewalk

skyscraper

streets

zoning

# POSTCARDS WORD SEARCH

T S L G W S R A B H O R S I M A G E M E T B P J F L C O P Q  
 X E S F F F I Q I I T E E L L K U H E V G K S I A O E T M K  
 K J G E R U T J S S N N X C I H R H M G G A H S M W V O A I  
 X N Z J R Y D Q U T K T I P I R X D E T K M S M C L D H T P  
 M L F N J D O W I O D J E O B P Q X N K D T U S V E Z P S I  
 O L T M M U D M Q R C Q C C E T I Q T R X N L P E X N G B O  
 Y S T N L V E A J I G N I T I R W E O N I S K W S M O E D R  
 W A M H F N R Z W C U Z R T R H L V N C U U V O S P V A L R  
 O F G Q T L D Z I J F B L L N J B T A T J R G X Y O P L H M  
 L U M X H R W I H G T O M J W O Q T Z P R B G V Y C W I T W  
 H B J J Y N Q K R C M T A D Y S I Y P G C V K T E D D A Z V  
 U R C R G M B H V P P Q E Q X O L T Y I K X L M O W Z M D W  
 K Q F W N Z Z O K K O W I I N I Z E A T C D F N P I M B Z B  
 Z S V P P J P M U J D M K U Z M E G M C D T O I S L I J Q O  
 I T B W Z I D R I N E V U O S N H V J Q A I U P L P T V I A  
 H J K P O S T A G E T F H B R J J J E N T V T R K F K N Q W  
 G F H N M L G L P T J S Y P H X Z Z S P T M H I E W U G M X  
 O W D L K F G P X Y X S J H L U U R A K R L F E B F A X R B  
 R H H M I E S E Y V M H P Q B H S C V W V D H I Z V G V M D  
 L L M F M Y P G B Z T V Y G U L I Z A N B G I P R P B H N L

Find the following words in the word search puzzle. When you find a word, circle it. Words can appear vertically, horizontally, diagonally or even backwards.

**address**

**caption**

**communication**

**historic**

**image**

**mail**

**memento**

**message**

**photo**

**picture**

**postage**

**recipient**

**scene**

**sentiment**

**souvenir**

**stamp**

**vacation**

**writing**

# Antonym Word Search

**B**elow are eight common pairs of antonyms. However, only the first letter of each word is given. First, think of the antonyms and write the words in the blanks—one letter per blank. Then find all 16 words in the Word Search. Circle the words as you find them. The words can be found written horizontally, vertically, diagonally, forward, or backward. The first word has been filled in and circled for you.

Antonym	Antonym
Y <u>E</u> <u>S</u>	N _
S _ _ _	G _
U _	D _ _ _
G _ _ _	B _ _
T _ _ _	F _ _ _ _
N _ _ _ _	D _ _
R _ _ _ _	L _ _ _
H _ _ _	L _ _

## WORD SEARCH

L	Y	M	P	N	P	O	T	S	G
L	E	H	G	I	H	A	L	L	O
O	S	F	N	G	S	E	A	L	O
W	R	U	T	H	Z	F	B	A	D
N	O	I	I	T	D	O	Q	U	I
H	A	S	H	S	O	R	W	D	A
E	R	I	G	H	T	U	G	O	S
U	M	E	D	N	T	M	H	W	I
R	I	F	A	L	S	E	R	N	U
T	B	O	Y	M	A	D	I	S	P

# Synonym and Antonym Word Search 1

**T**hink of a synonym and antonym for each of the feelings on the left. Write the words in the blanks—one letter per blank. The first letter of each word is shown. Then find the feelings, synonyms, and antonyms in the Word Search. Circle the words as you find them. The words can be found written forward, backward, horizontally, vertically, or diagonally. The first synonym has been filled in and circled for you.

Feeling	Synonym	Antonym
tired	S <u>L</u> E <u>E</u> P <u>E</u> <u>Y</u>	A _ _ _ _
happy	J _ _ _ _ _	S _ _
excited	E _ _ _ _	B _ _ _ _
angry	F _ _ _ _ _ _	C _ _ _
shy	T _ _ _ _	O _ _ _ _ _ _ _
scared	A _ _ _ _ _	B _ _ _ _
energized	M _ _ _ _ _ _ _	L _ _ _

## WORD SEARCH

A	L	E	R	T	I	R	H	D	Y	F	S
F	T	H	E	O	C	U	O	J	Z	M	L
R	I	D	N	U	W	A	B	R	A	V	E
A	R	E	E	T	A	N	L	A	L	J	E
I	E	T	R	G	S	F	Q	M	O	G	P
D	D	A	G	O	K	O	N	Y	E	R	Y
I	E	V	I	I	B	R	F	A	S	I	P
M	T	I	Z	N	H	U	N	H	A	O	P
I	I	T	E	G	L	M	Y	R	G	N	A
T	C	O	D	S	U	O	I	R	U	F	H
E	X	M	M	A	N	A	B	O	R	E	D
D	E	R	A	C	S	T	E	A	G	E	R

# Synonym and Antonym Word Search 2

**T**hink of a synonym and antonym for each of the adjectives on the left. Write the words in the blanks—one letter per blank. The first letter of each word is shown. Then find the adjectives, synonyms, and antonyms in the Word Search. Circle the words as you find them. The words can be found written horizontally, vertically, diagonally, forward, or backward. The first synonym has been filled in and circled for you.

Adjective	Synonym	Antonym
sick	I <u>L</u> L	H _____
easy	S _____	H _____
rich	W _____	P _____
right	C _____	W _____
fast	Q _____	S _____
kind	N _____	M _____
big	L _____	L _____

## WORD SEARCH

S	I	M	P	L	E	R	T	S	A	F	S
L	L	H	E	A	T	U	N	A	T	M	I
O	L	Q	N	R	W	E	A	L	T	H	Y
W	R	U	B	G	O	F	N	I	S	A	K
N	O	I	I	E	S	O	Q	U	I	C	K
H	A	N	G	N	O	R	W	Y	E	T	I
E	E	V	I	H	B	U	R	I	C	H	N
A	M	E	A	N	T	M	N	E	I	O	D
L	I	T	T	L	E	M	R	R	N	N	H
T	N	O	K	M	A	R	I	R	U	B	A
H	C	T	E	P	O	A	B	P	O	O	R
Y	S	A	E	C	S	I	C	K	U	T	D



# scrambles

---

**S**cramble activities can be used to practice vocabulary and spelling. The scrambles in this section require students to rearrange letters to correctly spell words related to various topics including animals, maps, classroom objects, and more. In some cases, there are clues to help students figure out the scrambled word, but in others they must think about the topic of the puzzle to guess the word.

**TEACHING TECHNIQUES.** Students can be divided into small groups or teams and compete to be the first to finish a scramble activity. The puzzles can also be split up to use as a warm-up at the beginning of class. One or two of the clues/scrambled words from a puzzle can be copied onto the board for students to complete when they come into class. A brief discussion of answers can follow to get students ready to learn. As an extension, learners can use the format of these puzzles to create their own clues with scrambled words as a way to review concepts and vocabulary studied in class.

# Coin Toss

Unscramble the set of letters next to each clue to find the answer.

Example: These facilities are set up to test the purity of precious metals. SSYAA FCSFIOE

Answer: assay offices

1. The U.S. coin worth 25 cents is called a \_\_\_\_\_. EARRQTU
2. The U.S. \_\_\_\_ was the first federal building constructed under the U.S. Constitution. IMTN
3. Pennies are this color. PRCOPE
4. As a symbol of the United States, this bird appears on all coins in use. EGEAL
5. This president was the first to be pictured on a U.S. coin. NLCNIOL
6. Only \_\_\_\_ can authorize changing a coin's design more than once every 25 years. RGSNCOES
7. This is the fourth step in creating coins. NITKSGRI
8. Hoping to make a profit, some people collect coins as an \_\_\_\_\_. MTNSETIVEN
9. Both the dollar coin and the \_\_\_\_ \_\_\_\_ coin are rarely used. FHAL LADORL
10. Children use coins in tabletop games such as \_\_\_\_ \_\_\_\_\_. NNYEP KHYOCE
11. This mint was established in 1937 to store silver bullion. STWE INTOP
12. This law in 1792 created the first U.S. monetary system. ANOIECG CTA
13. \_\_\_\_ \_\_\_\_ Banks maintain monetary reserves and issue bank notes. ELERDFA REREVES
14. Special coins designed to honor a person, place, or event are called \_\_\_\_\_. AMOOMERMVITCE
15. \_\_\_\_ is the study or collecting of coins. MINMITUCSSA

# Animal Crazy Quilt

**Step 1.** Unscramble the names of the animals. Then place each of the letters, in order, in the "quilt" box below. Place one letter in each box working across from left to right. To get you started, the first animal name has been completed.

1. ERED D E E R
2. ATR \_\_\_ T
3. ELAS \_\_\_ A \_\_\_
4. GDO \_\_\_ O \_\_\_
5. ABRE B \_\_\_ \_\_\_
6. GPI \_\_\_ G
7. TAN A \_\_\_
8. ELE \_\_\_ E \_\_\_
9. ATC \_\_\_ T
10. OILN \_\_\_ I \_\_\_
11. OWC \_\_\_ O \_\_\_
12. FLWO W \_\_\_ \_\_\_

D	E	E	R			T				A	
	O			B						G	
A					E					T	
	I					O			W		

**Step 2.** Place the circled letters, in order, into the spaces below to learn the name of the fastest animal in the world. The first letter from the word *deer* has been placed for you.

**Which animal is the fastest in the world?**

This bird can fly at over 200 miles per hour, making it the fastest animal in the world:

P E \_\_\_ F \_\_\_ N

## Fair Finds

**B**elow is a scrambled list of animals and foods commonly found at state and county fairs. Unscramble each word, placing one letter in each blank. To help you, some letters have been placed in the correct positions.

- |                  |                       |
|------------------|-----------------------|
| 1. ipg           | ---                   |
| 2. wco           | ---                   |
| 3. cukd          | -----                 |
| 4. atog          | -----                 |
| 5. keac          | _ a _                 |
| 6. nocr          | c _ _ _               |
| 7. srohe         | -----                 |
| 8. tapoot        | _ _ t _ _ _           |
| 9. teutlec       | _____ u _ _           |
| 10. arcpito      | _____ i _ _ _         |
| 11. umppikn      | _ _ m _ _ _ _         |
| 12. uahqss       | _ q _ _ _ _           |
| 13. plaep ipe    | _ p _ _ _ _ i _       |
| 14. recyrh ipe   | _ _ _ r _ _ _ _ e     |
| 15. conott dncay | _ _ t _ _ _ c _ _ _ _ |
| 16. mewatlrone   | w _ _ _ _ _ _ _ n     |

## What's the Connection?

**U**nscramble the letters in the Scrambled Words to form words that fit the Clues, then write the words in the blanks in the Answers column. Look at the words you are writing and see if you can figure out what they have in common. If you can, you will be able to answer the Question at the bottom of the page. (Tip: After you find some of the answers, try to discover what they have in common. That might help you find the rest of the answers.)

### Scrambled Words

gel	ofto	thomu	alin	reath
ram	lamp	facI	ahed	dhan

### Clues

1. A unit of measurement
2. A kind of tree
3. A young cow
4. It gets hammered
5. The end of a river
6. The leader of a group or department
7. Part of a watch or clock
8. Part of a journey
9. Give weapons to
10. The main part of something

### Answers

_____
_____
_____
_____
_____
_____
_____
_____
_____
_____

### Question

What do the words you wrote have in common?

They are \_\_\_\_\_ of the \_\_\_\_\_.

# Mountain Climbing

In this puzzle, you work from the bottom to the top—as if you are climbing a mountain. Climbing a mountain is not easy. Some people reach the top, but others see how hard the climb is and go back down to the bottom. These people may need encouragement to continue climbing. Your job is to unscramble the words to fill in the blanks in the Words of Encouragement sentences at the bottom of the page. Write those words in the spaces beside the mountain. Then take the letters in circles and squares, unscramble them, and form the Final Message.

Final Message:  !  !

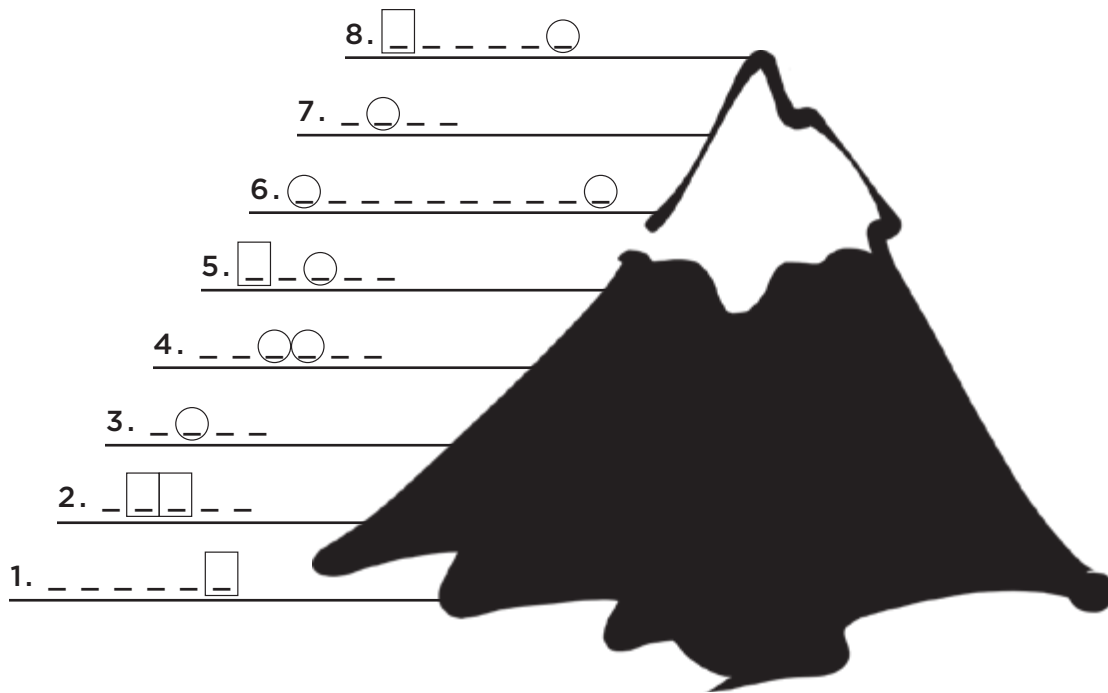

### Words of Encouragement

1. Keep climbing! You are \_\_\_\_\_.
2. Be \_\_\_\_\_. Don't be afraid to go higher.
3. Don't \_\_\_\_\_ up!
4. That's it! Keep \_\_\_\_\_!
5. A word that means *difficult* and *strong* is \_\_\_\_\_.
6. You're getting closer! Stay \_\_\_\_\_.
7. You've almost reached your \_\_\_\_\_.
8. You've made it to the top! Fantastic \_\_\_\_\_!

- T O S G N R
- V E A R B
- V E I G
- G R T Y N I
- O G U T H
- D D E E T N M R I
- L G A O
- T R E O F F

# A Maps Mind Map

**B**elow is a mind map about maps. Your job is to fill in the blanks to complete the mind map. (A mind map is a graphic organizer that shows how ideas can be connected and grouped together.)

Unscramble the Map Words in the column on the left to spell words that are related to maps: there are four *directions*, four *natural features* (such as mountains), and five *features made by humans* (such as streets). Then use those words to fill in the blanks in the Mind Map.

For example, “TESTERS” can be unscrambled to spell “STREETS.” And STREETS can then be written in the box marked “Features Made by Humans.”

Now see if you can unscramble the other words and place each in the proper box in the Mind Map.

MAP WORDS	MIND MAP
(Hint: When the words are unscrambled, they will be in alphabetical order.)	
REDROBS → _____	<div style="display: flex; justify-content: space-between;"> <div data-bbox="657 1036 874 1328" style="border: 1px solid black; padding: 5px;"> <p style="text-align: center;"><b>DIRECTIONS</b></p> <p>-----</p> <p>-----</p> <p>-----</p> <p>-----</p> </div> <div data-bbox="895 1081 1350 1265" style="border: 1px solid black; padding: 5px;"> <p style="text-align: center;"><b>NATURAL FEATURES</b></p> <p>-----</p> <p>-----</p> </div> </div>
ICITES → _____	<div style="border: 1px solid black; padding: 5px; width: fit-content; margin: 0 auto;"> <p style="text-align: center;"><b>MAPS</b></p> </div>
RECUSTION → _____	
SEAT → _____	
SLANDIS → _____	
SLEAK → _____	
THORN → _____	
CEANOS → _____	
VERRIS → _____	
DORAS → _____	
SHOUT → _____	
TESTERS → <u>STREETS</u>	<div style="border: 1px solid black; padding: 5px;"> <p style="text-align: center;"><b>FEATURES MADE BY HUMANS</b></p> <p>-----</p> <p>-----</p> <p style="text-align: center;"><b>S T R E E T S</b></p> </div>
STEW → _____	

# Classroom Clues



First, unscramble these words to spell things you can see in the photo.

- dustnets    ➡    11    21    9
- richas        ➡    23              7
- skeds         ➡    2    24    26
- okclc         ➡    4                        22
- blockharad   ➡              13                                  19

Next, unscramble these words to spell verbs and verb phrases related to the scene in the photo.

- alner         ➡              14    5
- kinth         ➡    6              10
- swaner       ➡                        25    16
- dear kobos   ➡              1                        8    15
- ryt royu steb ➡    12                        17    3                        20    18

Last, use the numbered letters from the words above to fill in the blanks and discover a message.

1 2 3 4 5 6 7 8 9    10 11    12 13 14    15 16 17  
18 19    20 21 22 23 24 25 26



# Stage Directions

**S**tage directions describe characters' emotions or actions; they help actors interpret scripts. The short script below has several stage directions, but some words have been left out. Fill in the blanks by scrambling the letters in one of the words the character speaks in that line. For example,

JOHN (*looking very* \_\_\_ \_\_\_ \_\_\_ \_\_\_): I tried, but I couldn't do it.

Scramble the letters in one of the words John says until you spell a word that makes sense in the stage direction. In this case, you can scramble the word *tried* to form *tired*; the stage direction should read *looking very tired*:

JOHN (*looking very tired*): I tried, but I couldn't do it.

For each missing word below, complete the stage direction by scrambling one word in the character's line.

## THE LOST RING

FRANCINE is sitting at a table, reading. FRANK enters.

FRANK (*loudly, with a big* \_\_\_ \_\_\_ \_\_\_ \_\_\_): Look! I found your ring!

FRANCINE (*with a wide* \_\_\_ \_\_\_ \_\_\_ \_\_\_): Wonderful! I've walked for miles looking for it.

FRANK: Here you are. (*He gives the ring to FRANCINE.*)

FRANCINE: Thank you! Where was it?

FRANK (*in a* \_\_\_ \_\_\_ \_\_\_ \_\_\_ \_\_\_ *voice than before*): In the forest.

FRANCINE (*putting her hand to her* \_\_\_ \_\_\_ \_\_\_): Why are you whispering?

FRANK (*still speaking softly*): Because we're in the library.

FRANCINE: You're right. We should go celebrate!

FRANK (*looking excited and* \_\_\_ \_\_\_ \_\_\_ \_\_\_ \_\_\_): I agree. Let's go!

*They exit.*



# Rock the Boat

Unscramble the letters to form words (all of which are types of boats) and write them in the boxes. Then unscramble the circled letters to answer the riddle at the bottom. The first one has been done for you.

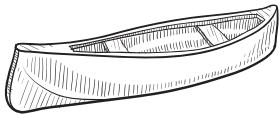

1. OCNAE

C	A	N	O	E
---	---	---	---	---

2. OOTBWAR

O							
---	--	--	--	--	--	--	--

3. SUIERCPHIS

O									
---	--	--	--	--	--	--	--	--	--

4. ITBASALO

--	--	--	--	--	--	--	--

5. EYRFR

--	--	--	--	--

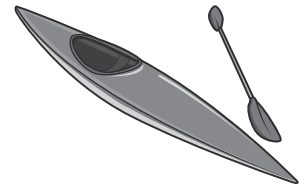

6. YKCAA

--	--	--	--	--

7. MTAATBSOE

--	--	--	--	--	--	--	--



8. PDTBSOEAE

--	--	--	--	--	--	--	--

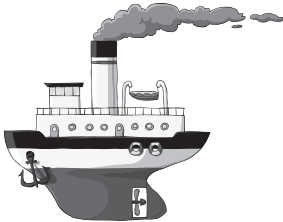

9. HACTY

O				
---	--	--	--	--



10. FATR

O			
---	--	--	--



11. GAUOTTB

--	--	--	--	--	--	--



**Riddle:** Before the windstorm, what did the ocean say to the boat?  
 "ARE YOU \_\_\_ A \_\_\_ \_\_\_ \_\_\_ \_\_\_ \_\_\_?"

## Dare to Read

**W**e've scrambled the spelling of 20 things people read. For example, *volen* would be *novel*, and *stil* would be *list*. Can you unscramble each? If you get stuck, at the bottom of the page we give you the first letter of each answer.

- |                 |                                  |
|-----------------|----------------------------------|
| 1. koob _____   | 11. bella _____                  |
| 2. mope _____   | 12. unme _____                   |
| 3. yorts _____  | 13. peerpawns _____              |
| 4. rettle _____ | 14. gainmaze _____               |
| 5. gins _____   | 15. glob _____                   |
| 6. pam _____    | 16. leami _____                  |
| 7. emom _____   | 17. kokoboco _____               |
| 8. prerot _____ | 18. crustinsinto _____           |
| 9. yases _____  | 19. hipragboy _____              |
| 10. tone _____  | 20. shingle nightace murfo _____ |

Hints (the first letter of each answer):

- |      |       |       |         |
|------|-------|-------|---------|
| 1. B | 6. M  | 11. L | 16. E   |
| 2. P | 7. M  | 12. M | 17. C   |
| 3. S | 8. R  | 13. N | 18. I   |
| 4. L | 9. E  | 14. M | 19. B   |
| 5. S | 10. N | 15. B | 20. ETF |

# crossword puzzles

---

**C**rossword puzzles are an excellent vehicle for cooperative learning. The crossword puzzles in this section cover a wide variety of topics that students will find interesting.

**TEACHING TECHNIQUES.** Working with a classmate, students can share their knowledge of English in solving the various vocabulary or grammatical questions posed in the puzzle. After students have completed the puzzle (in class or as homework assigned to be done with a classmate), the teacher should discuss the solutions with the class as a whole. Give students examples of sentences in which some of the new words are used, and ask them to write sentences of their own.

# ALASKA!

A CROSSWORD PUZZLE

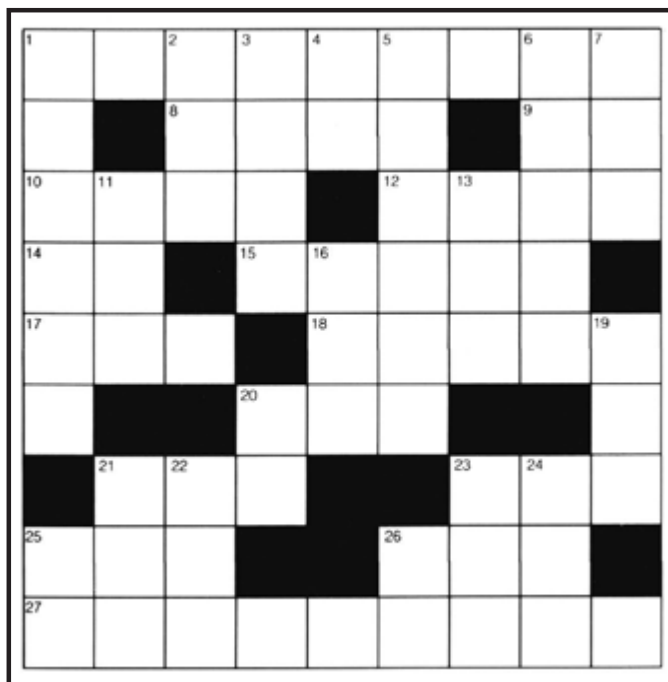

## ACROSS

- 1 A country that is also a continent
- 8 To fly or glide high in the air
- 9 A U.S. soldier in World War II
- 10 Westernmost island of Alaska
- 12 Not warm
- 14 Thus; therefore
- 15 Fraction; the relationship of two amounts
- 17 Object used to open a lock
- 18 One who guides an airplane or a boat
- 20 And so forth (abbr.)
- 21 A metal or a container for food
- 23 Light brown
- 25 To possess; have
- 26 An animal that pulls sleds in Alaska
- 27 Animals native to Australia

## DOWN

- 1 Largest state of the U.S.
- 2 Supersonic transport (abbr.)
- 3 An organized sightseeing trip
- 4 Ancient Egyptian god
- 5 Geographic area that includes the North Pole
- 6 An Eskimo house
- 7 Help; assist
- 11 Forward part of the foot
- 13 Petroleum; a substance used for lubricating
- 16 Suitable, appropriate, quick to learn, or abbr. for apartment
- 19 Unit of weight equal to 2,000 pounds avoirdupois (U.S.) or 907.18 kilograms
- 20 Past participle suffix
- 21 Name of an airline
- 22 Place for a traveler to spend the night
- 23 Also
- 24 In the past
- 25 All right
- 26 Doctor (abbr.)

# Lacrosse Word Puzzle

Use the clues below to fill in the spaces of the crossword puzzle. The answer to each clue starts in the box with the same number as the clue. If the clue is under Across, write the letters from left to right; if the clue is under Down, write the letters down the column. Place one letter in each box. Every answer is related to lacrosse, but don't worry—you don't need to be a lacrosse expert (or even a lacrosse player) to complete the puzzle.

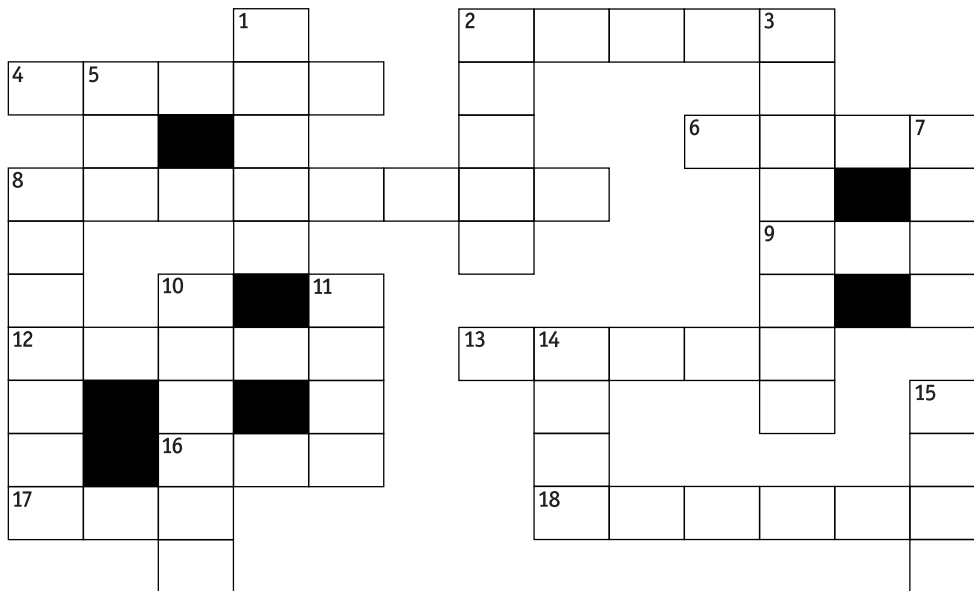

## Across

2. Lacrosse is an exciting \_\_\_\_\_.
4. Move the ball through the air
6. It moves from player to player.
8. "\_\_\_\_\_ makes perfect."
9. Each team tries to do this: \_\_\_ the game.
12. Put the ball into the goal
13. Fans do this for their team.
16. Part of a lacrosse stick
17. It's time to play, so \_\_\_ ready!
18. Who is your favorite lacrosse \_\_\_\_\_?

## Down

1. This person teaches a team to play better.
2. Each lacrosse player carries one.
3. Players playing well together develop this: good \_\_\_\_\_.
5. She's wearing \_\_\_ new uniform.
7. How \_\_\_ does the game last?
8. Sending the ball to a teammate
10. The team with the most \_\_\_\_\_ wins.
11. Sit or lie down after a hard practice
14. Playing lacrosse often can \_\_\_ you stay fit.
15. The players \_\_\_ happy when they won the game.

# Seattle Crossword Puzzle

Using the clues below, fill in the spaces of the crossword puzzle. The answer to each clue starts in the box with the same number as the clue. If the clue is under Across, write the letters from left to right. If the clue is under Down, write the letters down the column. Place one letter in each box. The first response is given.

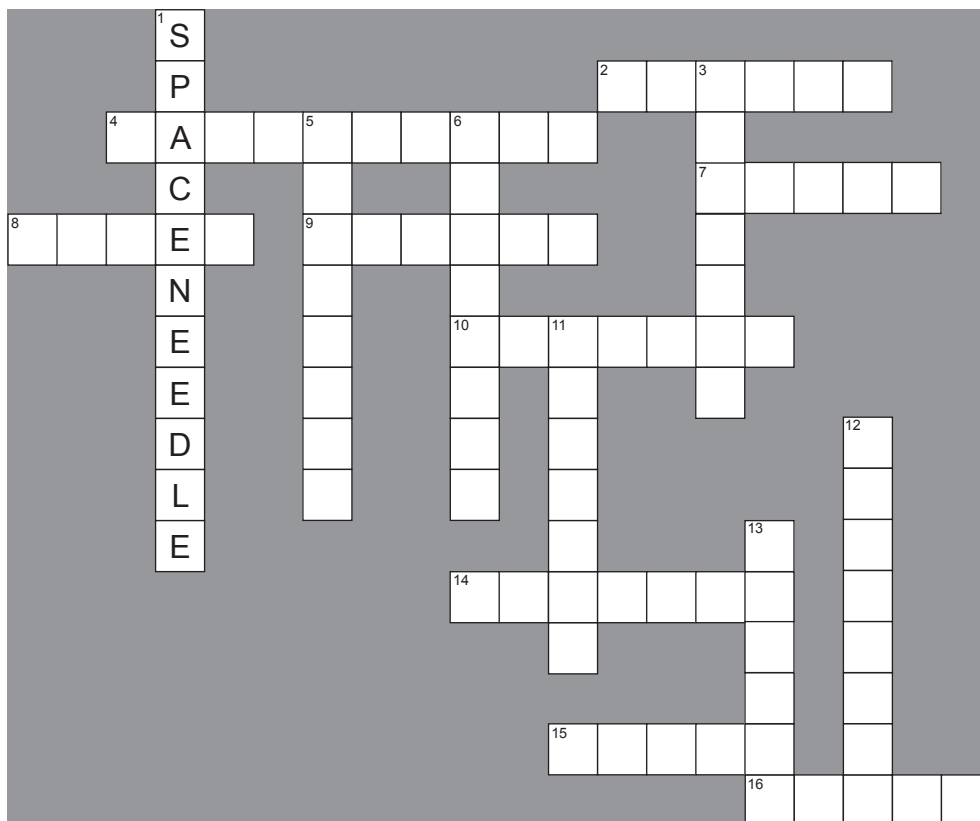

## Across

2. A hot, caffeinated beverage that people often drink in the morning
4. The ground shakes and pictures fall off of walls when this event occurs.
7. Adjective describing damp, wet weather
8. In Seattle, you can take a ferry boat along the many \_\_\_\_\_ ways of the city.
9. Baseball, basketball, and soccer are types of \_\_\_\_.
10. A place where books are available for loan to the public
14. A cone-shaped mountain that spews lava, debris, and steam when it erupts
15. Floating homes on lakes and rivers are known as house \_\_\_\_\_.
16. A connected line of railroad cars

## Down

1. Most recognized landmark in Seattle
3. Type of market that sells locally grown fruits and vegetables
5. The oldest area of most cities is known as the \_\_\_\_ district.
6. When you fly from one place to another, you travel in an \_\_\_\_\_.
11. A self-powered vehicle with two wheels, handlebars, and a set of pedals
12. A collapsible device you use to stay dry when it rains
13. A dense growth of trees and underbrush is known as a wood or a \_\_\_\_\_.

# Journalism Crossword

Using the clues below, fill in the spaces of the crossword puzzle. The answer to each clue starts in the box with the same number as the clue. If the clue is under Across, write the letters from left to right. If the clue is under Down, write the letters down the column. Place one letter in each box. For two-word answers, write both words without a space between them.

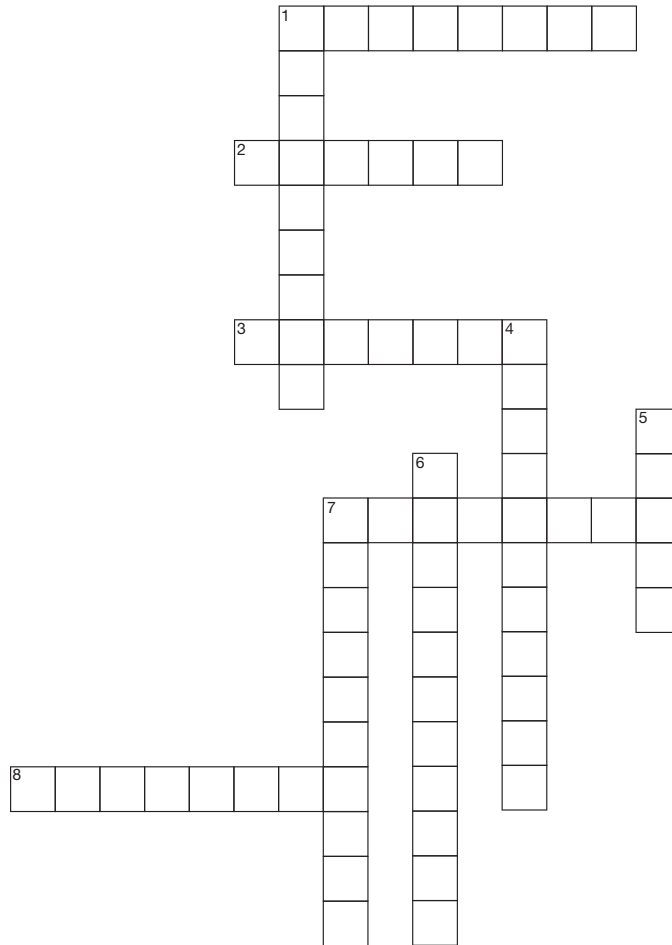

## Across

- \_\_\_\_\_ pyramid is a style of writing in which the most important information is in the first paragraphs.
- \_\_\_\_\_ journalism is a style of writing that uses large headlines, many illustrations, and simple words to sell more newspapers.
- The \_\_\_\_\_ to the Editor section of newspapers features the opinions of readers.
- Joseph \_\_\_\_\_ began a movement to raise the professionalism of journalism.
- A \_\_\_\_\_ writes the news.

## Down

- To gather news by asking people questions
- An old law that allowed jailing anyone who criticized the U.S. government in print (2 words)
- The \_\_\_\_\_ Amendment guarantees freedom of the press in the U.S. Constitution.
- \_\_\_\_\_ weeklies focus on local news, opinion pieces, and entertainment.
- The term for low-cost newspapers sold in New York in the 1800s (2 words)



# J-WORDS CROSSWORD PUZZLE

With the following clues, fill in the crossword puzzle with words that begin with the letter "J."

## Across

2. Baby kangaroo
3. Fast airplane
4. Sharp rough edge
6. To eject
7. To pull quickly
8. Largest planet in the solar system
10. You must go to work to keep your \_\_\_\_.
12. Cleans and maintains a building
13. Horse
14. Peanut butter and \_\_\_\_

## Down

1. Milk is kept in a \_\_\_\_.
2. They make sure you receive a fair trial.
3. Under the age of 18
5. Unite with a group
6. Capital of Indonesia
7. Holds your car up while you change a tire
8. First month of the year
9. If you break the law, you will go to \_\_\_\_.
10. A member of a sports team wears this
11. If it is cold, you wear a \_\_\_\_.
13. Island country
14. Independence Day in the United States falls in this month.

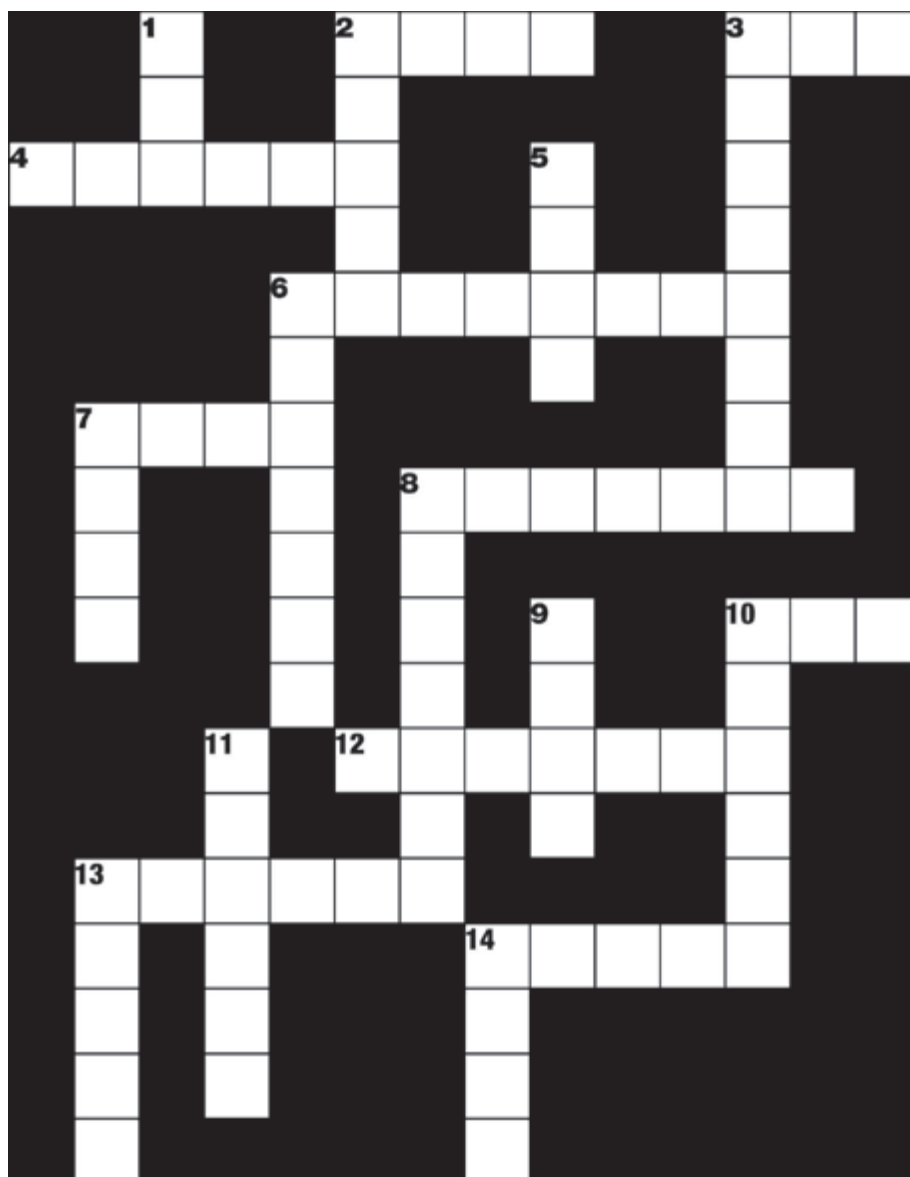



# The Write Stuff

**U**se the clues below about things related to writing to fill in the spaces of the crossword puzzle. The answer to each clue starts in the box with the same number as the clue. If the clue is under Across, write the letters from left to right; if the clue is under Down, write the letters down the column. Place one letter in each box.

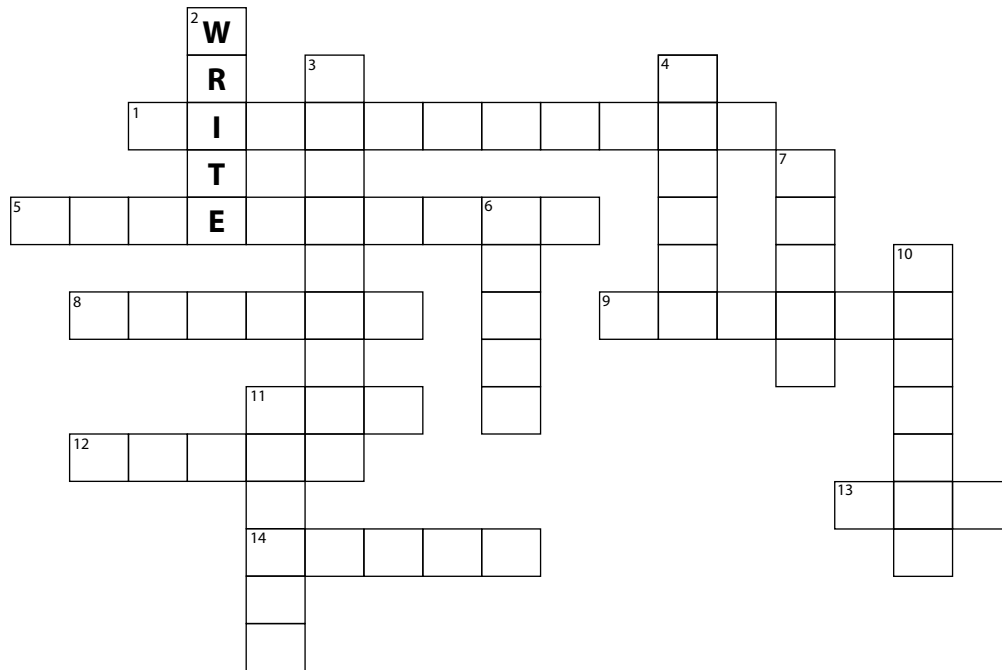

## Across

1. Bright and colorful, this instrument gets your attention.
5. "Writes" when letter keys are pressed
8. Similar to the answer for number 1, but often for children
9. Something to rub out mistakes
11. Ballpoint, roller-ball, or felt-tip
12. News\_\_\_\_, wall\_\_\_\_, poster\_\_\_\_
13. What is inside 11 across
14. Teachers write on boards with this.

## Down

2. To inscribe, to mark on a surface using an instrument
3. A pencil \_\_\_\_\_ can be manual or electric.
4. A written element of the alphabet; or a piece of correspondence
6. Electronic message
7. Used for your hair, or, in Asia, with ink
10. Some boxes of these have 150 colors.
11. This is usually made of wood and graphite.

# word games

---

**T**hese activities introduce or reinforce vocabulary using a variety of game formats. Focus may be placed upon word building, spelling, meaning, sound/symbol correspondences, and words inferred from clues or sentence context.

**TEACHING TECHNIQUES.** The full communicative potential of these games can be realized through good spirited team competition. Working in pairs or in small groups, students try to be the first to correctly complete a task. These games can be used at the end of a lesson or before introducing new material as a “change of pace” activity. Teachers should allow sufficient time for review and class discussion after the game has been completed.

# Football Transformers

## PART I

**F**or each set of clues, begin with the given word and then follow the clues to form new words. Write the new words in the blanks at the right (one letter per blank). You will use the last word you form in each set to complete one of the sentences in Part II.

A. Begin with the word BITE.

B I T E

- Make it past tense.
- Change one letter to spell the past tense of *light*.
- Change one letter to form a word that means "to strike."
- Change one letter to spell a verb that means "have a seat."
- Change one letter to spell a number.

— — —  
— — —  
— — —  
— — —  
— — —

B. Begin with the word HEAT.

H E A T

- Change one letter to spell a place to sit.
- Drop two letters to form a preposition.
- Add a vowel to form a verb meaning "finished a meal."
- Scramble the letters to spell a beverage.
- Add a consonant to the end to create a noun indicating a special group.

— — — —  
— — — —  
— — — —  
— — — —  
— — — —

C. Begin with the word AND.

A N D

- Add a consonant to spell a gritty material found on a beach.
- Change one letter to spell a part of the body.
- Change one letter to form the antonym of *soft*.
- Change one consonant to spell a unit of measure.
- Make that word plural.

— — — —  
— — — —  
— — — —  
— — — —  
— — — —

D. Begin with the word HOLE.

H O L E

- Change one letter to spell the place where you live.
- Change a letter to form a word for: "\_\_\_ in. The door's open!"
- Change one letter to form the past tense of that word.
- Change another letter to spell a noun that means "concern."
- Add first and last letters to form a verb meaning "frightens."
- Change one letter to spell a word meaning "adds points."

— — — —  
— — — —  
— — — —  
— — — —  
— — — —  
— — — —

## PART II

**N**ow use each of the words you have formed in Part I to complete one of these sentences.

1. Eleven players make up a football \_\_\_\_\_.
2. American football fields are 100 \_\_\_\_\_ long.
3. The winning team \_\_\_\_\_ more points than the other team.
4. In American football, a touchdown is worth \_\_\_\_\_ points.

# Miami Word Cruise

**M**iami is the largest cruise ship port in the world. You can make many different words from the letters in *cruise ship*. On a separate sheet of paper, list words made with these letters that fit the clues below.

## 2-letter words

1. *pronoun*: male person
2. *interjection*: greeting; hello
3. *adverb*: above, higher than; raised

## 3-letter words

4. *noun*: a small bowl-shaped container with a handle
5. *noun*: frozen water
6. *noun*: a baked food with a meat, fruit, or pudding filling and pastry crust
7. *pronoun*: female person
8. *noun*: formal title for a male person

## 4-letter words

9. *verb*: to heal
10. *noun*: a long narrative poem about heroic events
11. *noun*: an individual who receives the possessions of another individual
12. *verb*: to employ
13. *noun*: wooden structure where ships and boats dock
14. *adjective*: untouched
15. *verb*: to hurry

## 5-letter words

16. *noun*: a game for two players using black and white game pieces on a board with black and white squares
17. *verb*: to flatten by force
18. *noun*: a topic for debate or discussion
19. *noun*: the cost of an item for sale
20. *noun*: a bag, pouch, or case used for carrying various items
21. *adjective*: great, excellent
22. *noun*: an individual who shows people to their seats

## 6-letter words

23. *noun*: emergency
24. *verb*: to die
25. *noun*: seasonings that add flavor to food

# Words Within Words

How many words can you make from the letters in the phrases below?

Do not use letters more often than they appear in the phrases. Each word you find must be at least two letters long. See if you can find at least 20 words for each of the phrases.

## I. Classroom teacher

Example: heart

_____	_____	_____	_____	_____
_____	_____	_____	_____	_____
_____	_____	_____	_____	_____
_____	_____	_____	_____	_____

## II. English students

Example: slide

_____	_____	_____	_____	_____
_____	_____	_____	_____	_____
_____	_____	_____	_____	_____
_____	_____	_____	_____	_____

## III. Language homework

Example: moon

_____	_____	_____	_____	_____
_____	_____	_____	_____	_____
_____	_____	_____	_____	_____
_____	_____	_____	_____	_____

# SPELLING BEE

**Fill in the blanks in each sentence with two or three words that have the same sound but different spellings and different meanings. The number of blanks equals the number of letters in the missing word.**

1. Our team \_\_\_\_ \_\_\_\_ game and lost three games.
2. They agreed \_\_ play \_\_\_\_ more games next week, \_\_\_\_.
3. The \_\_\_\_\_ golfers watched \_\_\_\_ the ball when they heard someone shout “\_\_\_\_\_!”
4. The four of us were so hungry that we \_\_\_\_\_ hamburgers.
5. Each player \_\_\_\_\_ the ball \_\_\_\_\_ the hoop at least once.
6. As we approached the coast, we could \_\_\_\_ the \_\_\_\_.
7. Anna had \_\_ many things to \_\_\_\_ on her new machine that she had no time to \_\_\_\_ any seeds in the garden.
8. At the airport, the guide said, “Come this \_\_\_\_ so they can \_\_\_\_\_ your luggage.”
9. We had to \_\_\_\_\_ in line until they determined the \_\_\_\_\_ of our bags.
10. We \_\_\_\_\_ the boat to the dock so it wouldn’t go out when the \_\_\_\_\_ came in.
11. Unfortunately, we did \_\_\_\_ put a very good \_\_\_\_\_ in the rope, and it came unfastened.
12. The people on the safari \_\_\_\_\_ that a \_\_\_\_\_ of elephants was headed their way.
13. If you sit \_\_\_\_\_ very quietly, you can \_\_\_\_\_ the wind blowing through the trees.
14. The man in the \_\_\_\_ coat \_\_\_\_\_ the notice to me.
15. We \_\_\_\_\_ on horseback through the tall grass until we came to the \_\_\_\_\_ that led to the town.
16. Everything looked so familiar; it was as if we had \_\_\_\_\_ that \_\_\_\_\_ before.
17. We went to where they were selling boats, and \_\_\_\_\_ boats had a sign on them that said “\_\_\_\_\_.”
18. The students \_\_\_\_\_ in their notebooks the sentences that they had learned by \_\_\_\_\_.
19. The wind \_\_\_\_\_ the rain clouds away, leaving a clear \_\_\_\_\_ sky.
20. The father said, “I will sit in the shade out of the hot \_\_\_\_\_’ \_\_\_\_\_ while my \_\_\_\_\_ the roof on the house.”



# SIGHTS IN THE CITY

## A WORD PUZZLE

**T**he United States is home to some spectacular man-made edifices that have come to symbolize ingenuity and creativity. Millions of sightseers from around the world visit these places each year. Some are historic landmarks and have appeared in Hollywood films. Below are clues to some of the sights people go to see, and photograph, in U.S. cities. Read the clues, and then see if you can fill in the blanks to name the sight.

1. Built in 1937 by Joseph B. Strauss, this landmark is named after a strait that serves as the entrance to the San Francisco Bay from the Pacific Ocean. During its construction, a safety net skirting the bridge saved the lives of 19 men, who later became known as the “Halfway-to-Hell Club.”

\_\_\_\_\_

2. This building was once the tallest skyscraper in the United States and stands at the intersection of Wacker Drive and Jackson Boulevard in downtown Chicago.

The \_\_\_\_\_

3. George Washington, together with city planner Pierre L’Enfant, chose this site for the U.S. President’s private residence, which is located at 1600 Pennsylvania Avenue in Washington, D.C.

The \_\_\_\_\_

4. This monument is known as the symbol of Seattle, Washington. In 1962, it appeared on the official World’s Fair poster, which featured this building’s grand spiral entryway leading to the elevators that would take guests up 605 feet to the monument’s flying saucer top.

The \_\_\_\_\_

5. This sign, erected in 1923, is 450 feet long; its mammoth letters are 45 feet high, and it is visible from all parts of the world’s movie capital, Los Angeles, California.

The \_\_\_\_\_

6. This symbol of American ingenuity and Art Deco architecture is an awe-inspiring landmark. It was built in 1930 during the Depression and offers a spectacular view of New York City.

The \_\_\_\_\_

## Word Sudoku

In Sudoku, the goal is to place the numbers 1 through 9 in each row, column, and 3x3 box. Each number appears once in each row, once in each column, and once in each 3x3 box. In Word Sudoku, the goal is to place all the letters of a nine-letter "target word" in each row, column, and 3x3 box. No letter is repeated in any row, column, or 3x3 box. In the row that is shaded gray, the word will be spelled correctly. Can you find the target word in each puzzle below and then fill in all the squares? In each puzzle, every letter of the target word will appear exactly nine times.

Puzzle 1

			T	C		D		O
C	A			D			I	
O	I				U	N		
A	T		O				U	
		U	C		T	I		
	N				E		T	A
		I	E				D	U
	U			N			E	C
D		E		O	A			

Target Word: \_\_\_\_\_

Puzzle 2

		R	T		D		Y	
H	T			A		B		R
A	Y	S			R		T	
S				D			R	T
		B	R	I	T			
		T				D	H	B
R					I	Y		A
	D		S	Y		R		
	S	A		R	H			I

Target Word: \_\_\_\_\_

Puzzle 3

S			E	D	R		V	
	E	I				R		
Y		R		I			E	C
	S				D		Y	
R			O	C	S			E
	C		Y				S	
E	Y			S		D		V
		V				O	I	
	I		C	O	V			Y

Target Word: \_\_\_\_\_

# Moving Around

**M**any expressions in English include the word *move*—for example, *move in*, *make the first move*, *move mountains*. Each of the boxes below contains letters spelling an expression or sentence with the word *move*. Your job is to find the answers in each puzzle by connecting the letters to form an expression or sentence that uses all the letters provided. You can connect the letters by moving up, down, across, or diagonally, but you can move only one space at a time. For example, the letters in Box A can be connected to spell *move ahead*, as shown in Box B, beginning in the lower right-hand corner:

Box A

E	A	H
V	O	E
D	A	M

Box B

E	A	H
V	O	E
D	A	M

(Diagram showing arrows: E→A→H, V←O, D←A, and a path starting from M: M→O→A→D)

Read each of the clues below and find the answer in the box below the clue. Then write the answer in the spaces provided. Remember, you can move only one box (in any direction) to get to the next letter—and the word *move* is in every answer!

<p>1. A prepositional phrase meaning “active”</p> <table border="1" style="margin-left: auto; margin-right: auto; text-align: center;"> <tr><td>E</td><td>T</td><td>H</td></tr> <tr><td>V</td><td>N</td><td>E</td></tr> <tr><td>O</td><td>M</td><td>O</td></tr> </table> <p style="text-align: center;">-----</p>	E	T	H	V	N	E	O	M	O	<p>2. A command telling someone to be active</p> <table border="1" style="margin-left: auto; margin-right: auto; text-align: center;"> <tr><td>N</td><td>D</td><td>M</td><td>O</td></tr> <tr><td>A</td><td>P</td><td>T</td><td>V</td></tr> <tr><td>G</td><td>E</td><td>U</td><td>E</td></tr> </table> <p style="text-align: center;">-----!</p>	N	D	M	O	A	P	T	V	G	E	U	E										
E	T	H																														
V	N	E																														
O	M	O																														
N	D	M	O																													
A	P	T	V																													
G	E	U	E																													
<p>3. A command telling someone to stay still</p> <table border="1" style="margin-left: auto; margin-right: auto; text-align: center;"> <tr><td>M</td><td>U</td><td>S</td><td>C</td><td>L</td></tr> <tr><td>A</td><td>V</td><td>M</td><td>N</td><td>E</td></tr> <tr><td>E</td><td>O</td><td>T</td><td>O</td><td>D</td></tr> </table> <p style="text-align: center;">-----!</p>	M	U	S	C	L	A	V	M	N	E	E	O	T	O	D	<p>4. An expression meaning “go this way ... then that way ... ”</p> <table border="1" style="margin-left: auto; margin-right: auto; text-align: center;"> <tr><td>D</td><td>F</td><td>H</td><td>T</td></tr> <tr><td>N</td><td>A</td><td>O</td><td>R</td></tr> <tr><td>C</td><td>K</td><td>E</td><td>O</td></tr> <tr><td>A</td><td>B</td><td>V</td><td>M</td></tr> </table> <p style="text-align: center;">-----</p>	D	F	H	T	N	A	O	R	C	K	E	O	A	B	V	M
M	U	S	C	L																												
A	V	M	N	E																												
E	O	T	O	D																												
D	F	H	T																													
N	A	O	R																													
C	K	E	O																													
A	B	V	M																													

## Listen Up!

In each set of words below, two words rhyme and one does not. Say the three words out loud and listen for the one that does not rhyme. Write it in the "Answer" column. Then use the directions to select one of the letters in the answer, and write that letter in the "Letter" column. When you're done, take all the letters you've written and unscramble them to form an idiom. Here's an example:

Which word doesn't rhyme?	Answer	Find the ... letter of your answer	Letter
know/go/now	<i>now</i>	first	<i>n</i>

The word *now* does not rhyme with *go* and *know*, so it is the "answer." The directions say to find the first letter of the answer, which is *n*, so *n* is written in the "Letter" column.

Ready? Try these:

Which word doesn't rhyme?	Answer	Find the ... letter of your answer	Letter
1. bead / breed / bread		third	
2. soul / towel / foul		fourth	
3. beard / word / heard		third	
4. war / far / snore		second	
5. goose / choose / lose		fourth	
6. bed / said / laid		first	
7. mow / how / cow		first	
8. weight / height / eight		third	
9. meat / beat / great		second	

Write the letters here: \_\_\_\_\_

Unscramble the letters to form an idiom that means "I'm ready to listen":

\_\_\_\_\_, \_\_\_\_\_.

# Speak and Spell

**H**omophones are words that are spelled differently but pronounced the same (such as *no* and *know*). Each clue below leads to an answer that is a pair of homophones. Here is an example:

unmoving personalized paper

stationary

stationery

Can you think of homophones that match each of these clues?

1. reasonable ticket price

\_\_\_\_\_

\_\_\_\_\_

2. an ordinary aircraft

\_\_\_\_\_

\_\_\_\_\_

3. notice the ocean

\_\_\_\_\_

the

\_\_\_\_\_

4. naked large mammal

\_\_\_\_\_

\_\_\_\_\_

5. hit a red vegetable

\_\_\_\_\_

a

\_\_\_\_\_

6. damage the car's stopping device

\_\_\_\_\_

the

\_\_\_\_\_

7. two pieces of green/yellow fruit

a \_\_\_\_\_

of

\_\_\_\_\_s

8. express on paper correctly

\_\_\_\_\_

\_\_\_\_\_

9. pink lines of chairs

\_\_\_\_\_

\_\_\_\_\_

10. look at the long dock

\_\_\_\_\_

at the

\_\_\_\_\_

11. beloved doe or buck

\_\_\_\_\_

\_\_\_\_\_

12. corn labyrinth

\_\_\_\_\_

\_\_\_\_\_

# reading + writing

---

**R**eading and writing skills are required to complete the puzzles in this portion of the book. There is something for students of every level here—from early literacy skills like matching symbols with meanings to more advanced skills such as reading for information. Sentence formation, word order, and word choice are also addressed.

**TEACHING TECHNIQUES.** Many of these activities can be divided up and assigned to small groups so that peer evaluation and discussion can be incorporated. Have each group answer one or two questions and then share their reasoning and the answers with the rest of the class. Students can provide each other with feedback and corrections. The activities can also be completed in pairs for classwork or homework to review specific skills.

## SCRAMBLED ENERGY WORDS

Eight terms related to energy are written below, but the order of the letters has been scrambled. Unscramble the letters and write the answer on the line below.

1. Plant matter or methane

S O B S A M I

-----

2. Heat from the earth

G A M E R E L O T H

-----

3. Supplied as a public utility for lighting, heating, etc.

Y L C C R T E T I I E

-----

4. "Non-renewable" fuels

L U S S I F L E F O S (2 words)

-----

5. Wood or sunlight

W E N A L E B R E

-----

6. Source of paraffin, kerosene, fuel oil, gasoline, etc.

R U M E L P O T E

-----

7. Electricity from sunlight

O C I H P A T L O V O T

-----

8. Energy from the sun's rays

P O R O W L R E S A (2 words)

-----

## Energy Jokes and Puns

(by George Sholin of the California Energy Commission)

- Why is wind energy so popular?  
*Because it has a lot of fans.*
- Did you hear about the foolish gardener?  
*He planted a light bulb and thought he would get a power plant.*
- What would a barefooted man get if he steps on an electric wire?  
*A pair of shocks.*
- What do you call a silly old man?  
*A fossil fool.*
- What do cars driven late at night burn for fuel?  
*Midnight oil.*

## Energy Idioms

**All steamed up:** to be angry or worried

*Don't get all steamed up and start an argument. Try to stay calm.*

**Burn the candle at both ends:** to work too hard without enough rest

*People who burn the candle at both ends often have accidents because they are tired.*

**Burn the midnight oil:** to work late into the night

*Because she had a term paper due the next morning, Paulette was burning the midnight oil to finish it on time.*

**Burn out:** to lose one's interest or desire, often due to overuse

*After the 1994 season, Michael Jordan was burned out on basketball. He wanted to play baseball instead.*

**Get wind of:** to discover or find out

*Once the workers got wind of the free drinks, there was a line at the restaurant.*

**Hot air:** meaningless or unimportant talk

*The presenter promised his workshop would be very informative and exciting, but I left early because I thought he was full of hot air.*

# “Where in the World Is ... ?”

## A CAPITAL CITY PUZZLE

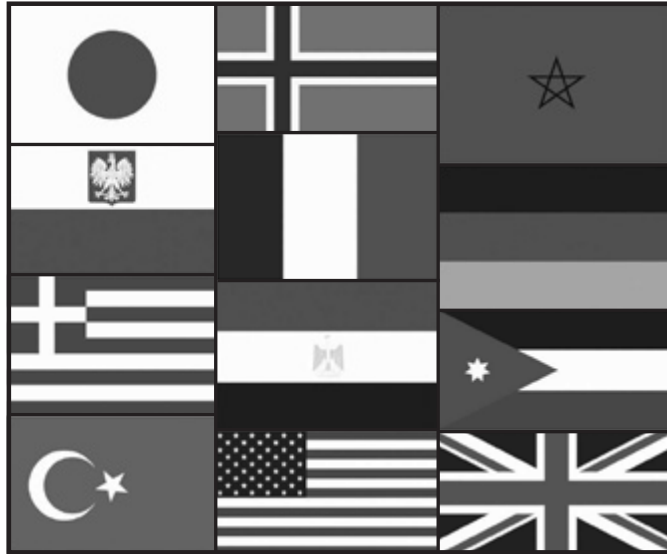

**P**aulette would like to visit the capital of each of the countries whose flags are shown above. The flags are arranged in columns from the top left in the same order as the sentences below. Each sentence below contains the name of a capital city. Can you identify each city and country?

**Example:** Well, I'm afraid I can't do it. P E R U

1. Here is the draft of your letter. If you mark it “ok” your secretary will type it. \_\_\_\_\_
2. Those who were against the war saw to it that their voices were heard. \_\_\_\_\_
3. To make underground water potable, scientists first used ammonia, then sand later on. \_\_\_\_\_
4. Can karate movies on television really make children more aggressive? \_\_\_\_\_
5. No slot machine is needed here. \_\_\_\_\_
6. The idiom “on a par” is used to mean “equal.” \_\_\_\_\_
7. While visiting Africa, I rode on buses and trains instead of driving a car there. \_\_\_\_\_
8. Housekeepers usually prefer washing to not doing anything at all. \_\_\_\_\_
9. A cobra battle against a mongoose often ends with the defeat of the former. \_\_\_\_\_
10. If you use this kind of herb on noodles, the result will be fantastic. \_\_\_\_\_
11. Tram manufacturing is declining, as nobody needs this kind of slow transportation. \_\_\_\_\_
12. If you have an infection in your colon, don't eat fats or any other rich food. \_\_\_\_\_



# Baseball Terms with Everyday Meanings

**B**elow are 12 common words that also have specific meanings related to baseball. Can you match each word with its everyday definition *and* with its baseball-related definition? An example, with the word *run*, has been done for you.

Term	Everyday definition	Baseball definition
run	H	j
1. ball		
2. base		
3. bat		
4. deck		
5. diamond		
6. double		
7. home		
8. out		
9. pitcher		
10. safe		
11. single		
12. strike		

## Everyday Definition















- A. Multiply by two
- B. A container that holds liquids
- C. A flying animal
- D. Not married
- E. Opposite of *in*
- F. The bottom of something
- G. A secure place that holds money and valuables
- H. Move quickly from one place to another
- I. A valuable gem
- J. The place where you live
- K. A round object; or a formal dance
- L. A wooden porch at the back of a house
- M. To hit; or to refuse to work as a form of protest

## Baseball Definition

- a. Players hit the ball with this.
- b. A pitch that is not a strike
- c. "Three strikes and you're \_\_\_\_."
- d. A swing and miss by the batter
- e. A one-base hit
- f. The next player to bat is "on \_\_\_\_."
- g. Batters try to reach at least first \_\_\_\_ safely.
- h. A two-base hit
- i. Opposite of *out*
- j. What a player tries to score: a \_\_\_\_
- k. The player who throws the ball to the batter
- l. The shape of a baseball infield
- m. Runners score by reaching it safely; it's also called the "plate."

# National Park Symbols

**W**rite the letter of each park symbol next to its meaning.  
Each letter is only used once.

A		___ 1. Swimming	H	
B		___ 2. Picnic areas	I	
C		___ 3. Fishing	J	
D		___ 4. Pets	K	
E		___ 5. Climbing	L	
F		___ 6. Hunting	M	
G		___ 7. Backpacking	N	
		___ 8. Boat ramps		
		___ 9. Cycling		
		___ 10. Skiing		
		___ 11. Handicapped		
		___ 12. Scenic drives		
		___ 13. Horseback riding		
		___ 14. Boating		

# HAVE YOU EVER HAD ROAD RASH?

## Take This Quiz and Find Out!

**NASCAR** drivers use special vocabulary, such as *pit stop* and *jack man*, to describe key elements of their sport. They're not alone, of course; race car drivers, truck drivers, mechanics, and even motorcycle riders use special vocabulary to talk about the ups and downs of their sport or profession with their colleagues.

Can you join in on these conversations? The quiz below will test how "road-savvy" you are! Read each sentence carefully and pick the best answer. Good luck and safe driving!

1. I got tired of *sitting in the rocking chair* all the time.
  - a. Waiting for the traffic light to change
  - b. Driving between several large trucks
  - c. Parking a vehicle in a very tight space
2. If he were smarter, he wouldn't have all that *road rash*.
  - a. Cuts and bruises from falling onto the road
  - b. Damage to the fenders and sides of a car
  - c. Sunburn from sticking an arm out the window
3. She hates to drive in the *granny lane*.
  - a. Parking lot outside a retirement home
  - b. Shopping district where people walk
  - c. Section of road with strict speed limits
4. One more *invitation* and I'll take the keys away from you!
  - a. Broken headlight
  - b. Speeding ticket
  - c. Empty gas tank
5. I think I need to get me some new *wets*.
  - a. All-weather tires
  - b. Windshield wipers
  - c. Leather car seats
6. Look out for that *alligator!*
  - a. Police car
  - b. Rough road
  - c. Piece of tire
7. She's never *t-boned* her Harley, as far as I know.
  - a. Crashed it into a vehicle
  - b. Broken it down for parts
  - c. Used it to carry groceries
8. There are too many *cash registers* on that road for me.
  - a. Toll booths
  - b. Places to gamble
  - c. Fast-food places
9. Did he finally *get the green?*
  - a. Win a prize at the races
  - b. Buy a lime-colored car
  - c. See the green flag wave
10. That *full tuck and roll job* really ruined the look of the car.
  - a. Removal of the car doors
  - b. Upholstery made for the car
  - c. Raising the car's chassis

Reference—Jackson, M. 2003. *Say what? An automotive slang guide*. <http://www.motor-cross.ca/saywhat.html>

## Place Out of Words

**B**elow are questions that people might ask someone from another country about the culture and lifestyles in that country. However, some of the words have been placed in the wrong question. In each set, move the underlined words around so that all the questions in the set make sense. Here is an example:

1. Do most families have evenings?
  2. Do students usually take extra classes in the cars?
- (ANSWERS: 1. Change evenings to cars; 2. Change cars to evenings)

### SET A (NOUNS)

1. How do people in your country celebrate breakfast?
2. Where you live, what kind of clothes do students wear to the kitchen?
3. Do you wear everybody inside your house?
4. What do people in your country usually eat for shoes?
5. In houses in your country, where is school usually located?
6. What relatives are the most popular to play?
7. Do you know New Year's who lives in your neighborhood?
8. Which sports live in your house?

#### ANSWERS:

1. Change breakfast to \_\_\_\_\_; 2. Change the kitchen to \_\_\_\_\_;
3. Change everybody to \_\_\_\_\_; 4. Change shoes to \_\_\_\_\_; 5. Change school to \_\_\_\_\_;
6. Change relatives to \_\_\_\_\_; 7. Change New Year's to \_\_\_\_\_; 8. Change sports to \_\_\_\_\_

### SET B (VERBS)

1. Does your dog speak inside your house?
2. In your country, how do people sing friends when they meet?
3. At what age do people in your country usually sleep?
4. Do people often retire at parties?
5. How often do you greet a library?
6. How many languages do people in your neighborhood visit?

#### ANSWERS:

1. Change speak to \_\_\_\_\_; 2. Change sing to \_\_\_\_\_; 3. Change sleep to \_\_\_\_\_;
4. Change retire to \_\_\_\_\_; 5. Change greet to \_\_\_\_\_; 6. Change visit to \_\_\_\_\_

## A Script by the Numbers

**C**omplete the script by filling in each blank with a number (zero, one, two, three, etc.). *Some numbers will be used more than one time.* You may have to use information from other sentences to fill in some of the blanks. When you're done, answer the Bonus Question below the script.

*Early one afternoon, A meets B on campus.*

A: Wow, that's a lot of books! How many do you have there?

B: \_\_\_\_\_. One for each day of the week. And they're heavy!

A: Where are you taking them?

B: Back to the library. \_\_\_\_\_ of them are overdue. The other \_\_\_\_\_ is due today!

A: Will you have to pay a fine?

B: I'm afraid so. The library charges \_\_\_\_\_ dollar for every day a book is late.

A: Sorry to hear that. What are the books about?

B: This \_\_\_\_\_ is about the moon. And I have \_\_\_\_\_ biographies—one on Cleopatra and one on Henry VIII.

A: What about the other \_\_\_\_\_ books?

B: These \_\_\_\_\_ are guides for healthy eating, and these \_\_\_\_\_ are about the environment.

A: They all sound interesting! Say—how will you get to the library?

B: I have \_\_\_\_\_ choices: walk, ride my bike, or take the bus.

A: Actually, you have \_\_\_\_\_ choices. I could take you there on my motorcycle.

B: Great idea! And maybe you could help me pay the library fine, too!

A: Sorry, there's \_\_\_\_\_ chance of that. I don't have any money!

*They get on A's motorcycle and ride away to the library.*

Bonus Question: Add all the numbers that you wrote. What is the total of those numbers? \_\_\_\_\_

## Debate Dialogue

**B**elow are statements that could be made during a debate about mobile technology. In each statement, one word is missing. First, fill in the missing words (some letters are provided). Then, match each statement in the “For” column with its counterargument (that is, an argument that could be made against that statement) in the “Against” column.

In this debate, the position is: **Mobile technology is more helpful than harmful.** Statements in the “For” column could be made by people who agree; statements in the “Against” column could be made by people who disagree and believe that mobile technology is more harmful than helpful.

For (Mobile technology is helpful.)	Against (Mobile technology is harmful.)
1. Mobile devices help people get <b>i _ f _ _ m _ t _ _ n</b> quickly.	A. Using mobile devices while driving increases the risk of car <b>a _ c _ d _ _ _ s</b> .
2. Mobile devices have made it easy to <b>c _ _ t _ _ t</b> friends and family.	B. People who use mobile devices a lot spend less time <b>i n _ _ _ a _ t _ _ g</b> with family and friends face-to-face.
3. Drivers can access maps and driving <b>d _ r _ _ t _ _ _ s</b> instantly on mobile devices.	C. The lack of human interaction in daily activities has been harmful to creating a sense of <b>c _ _ m _ n _ _ y</b> .
4. Apps make daily activities like paying bills and ordering food more <b>c _ _ v _ n _ _ _ t</b> .	D. Mobile devices distract young people in conversations at home, and that frustrates many <b>p _ r _ n _ s</b> .
5. Mobile technology has increased our interactions with people from <b>c _ u _ t _ _ _ s</b> around the world.	E. Mobile devices have caused some people to become <b>i _ p _ t _ _ _ t</b> and demand information immediately.
6. Teachers can use mobile devices in class to make learning more <b>i _ _ _ _ r _ s t _ _ g</b> and fun for students.	F. Constant access to audiences in various countries can lead to misunderstandings that might <b>d _ v _ d _ _</b> us from other people.
7. Mobile technology can increase time spent learning outside the <b>c _ _ s _ r _ _ m</b> .	G. Students are often <b>d _ s _ r _ c t _ d</b> by mobile devices at school.

### Matching

In each blank, write the letter of the statement in the “Against” column that is the best counterargument to the statement in the “For” column.

1. \_\_\_\_      2. \_\_\_\_      3. \_\_\_\_      4. \_\_\_\_      5. \_\_\_\_      6. \_\_\_\_      7. \_\_\_\_

## English Club Email

**S**ara attended an English Club meeting and wrote about it the next day to her friend Lisa, who could not attend the meeting. But Sara did not mention the events at the meeting in the order they happened. Can you read her email and figure out the order in which things happened?

*Hi, Lisa,*

*Sorry you weren't able to attend the English Club meeting yesterday.*

*It was a good meeting. The highlight was making plans for the picnic next month. The discussion took so long that we almost didn't have time for the Language Focus at the end of the meeting. I'll tell you more about the plans when I see you.*

*Oh, in Small-Group Discussion, we talked about the expression "Don't give up!" and related it to our lives and our communities. But I wonder if we should do those discussions right before the break instead of right after? We went straight from Small-Group Discussion to planning the picnic, and I think people would have enjoyed continuing to talk about "Don't give up!" during the break instead of having to cut off the conversation.*

*I was late for the meeting, so I missed the first part of the short-story discussion. But it was interesting! I thought about the story later when we were voting on a movie to watch next week. Should we watch movies that are based on the stories we read, or is that not important? Maybe I should have asked this question when we were choosing the movie, but before I could, it was time for the break.*

*Actually, we didn't have much time to choose the movie because we had a lot of new members at the meeting. Their introductions, right after the story discussion, took a long time. But it's great to have new people in the club!*

*Many people asked about you after the meeting, and I said you will definitely be at the next one. Talk to you soon!*

*Sara*

Now write numbers in the blanks to show the order in which the following things happened. Write "1" for the thing that happened first, "2" for the thing that happened second, and so on.

- |                            |                              |
|----------------------------|------------------------------|
| ___ Small-Group Discussion | ___ people asked about Lisa  |
| ___ Language Focus         | ___ picnic planning          |
| ___ movie selection        | ___ break                    |
| ___ short-story discussion | ___ new-member introductions |

# Three Pragmatics Puzzles

**E**ach group of words below can be arranged to form two utterances. One utterance is more formal than the other. Fill in each blank with one of the words in the group. Use each word only once.

Here is an example of a request that is more formal, followed by one that is less formal:

More formal: I'm sorry to trouble you, but would you be able to give me a ride into town?

Less formal: Could you give me a lift?

Now see if you can complete the following greetings (saying hello), apologies (saying sorry), and partings (saying good-bye).

## Greetings



More formal: \_\_\_\_\_, Ms. Smith. \_\_\_\_\_ \_\_\_\_\_ \_\_\_\_\_?

Less formal: \_\_\_\_\_, Sam. \_\_\_\_\_ \_\_\_\_\_?

## Apologies

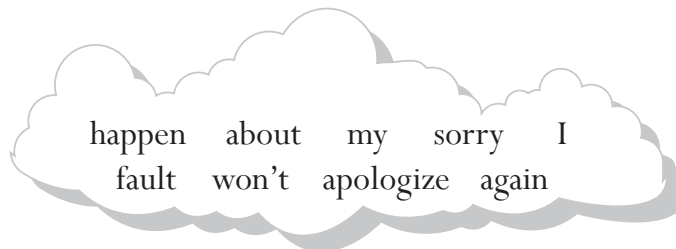

More formal: \_\_\_\_\_ . It \_\_\_\_\_ .

Less formal: \_\_\_\_\_ that. \_\_\_\_\_ .

## Partings

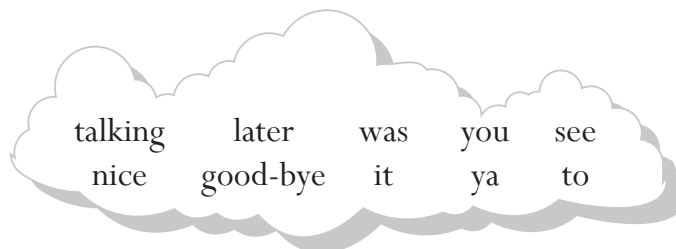

More formal: \_\_\_\_\_, Mr. Jones. \_\_\_\_\_ .

Less formal: \_\_\_\_\_, Charlie!



# Small Talk

**S**mall talk” refers to short, friendly conversations about topics that are not serious. Below are nine “opener” questions that can start small-talk conversations. In each question, a word is missing. Complete each question by choosing the most appropriate word from the List of Words. Then, choose the most appropriate small-talk topic for each question from the List of Small-Talk Topics.

OPENER	SMALL-TALK TOPIC
1. It looks like _____, doesn't it?	_____
2. Did you watch the _____ yesterday?	_____
3. How's _____ going?	_____
4. How's your _____?	_____
5. Have you seen any good _____ lately?	_____
6. Do you have any _____ for the weekend?	_____
7. The _____ sure is crowded today, isn't it?	_____
8. Are you _____ anything interesting these days?	_____
9. Wow, you got a new _____! How do you like it?	_____

## List of Words

game	movies	reading
bus	school	plans
phone	rain	sister

## List of Small-Talk Topics

family	weather	sports
studying	books	free time
technology	surroundings	entertainment

# You're Not Listening!

**B**elow are five quotations on the art of listening. But if you're listening when you read them, you will notice that something sounds wrong. The word in **bold** in each sentence doesn't belong. Replace each word in **bold** with one from a different sentence to correct the quotes. Then you'll have five sayings on listening to think about and discuss.

1. We talked for four **people**. Well, I talked for four, and she listened for two.  
Change **people** to \_\_\_\_\_.
2. The word *listen* contains the same letters as the word **intent**.  
Change **intent** to \_\_\_\_\_.
3. We have two **hours** and one tongue so that we would listen more and talk less.  
Change **hours** to \_\_\_\_\_.
4. Most of the successful **silent** I've known are the ones who do more listening than talking.  
Change **silent** to \_\_\_\_\_.
5. Most people do not listen with the **ears** to understand; they listen with the intent to reply.  
Change **ears** to \_\_\_\_\_.

#### Sources of the quotations:

1. Jarod Kintz (American writer, born 1982)
2. Alfred Brendel (Austrian pianist and author, born 1931)
3. Diogenes (philosopher of ancient Greece)
4. Bernard M. Baruch (American financier and philanthropist, died 1965)
5. Stephen R. Covey (American educator and author, died 2012)



# Traffic Jam

The cars below are stuck in a traffic jam. Rearrange them to form (1) a fact about cars and (2) a follow-up question that can be used in class for discussion. Here is an example:

**Fact: Black cars are in more accidents than orange ones.**

**Question: Why is that?**

There are fact-and-question pairs about the past, present, and future of cars. Some of the facts and questions have been started for you.

## Past



Fact: \_\_\_\_\_, started \_\_\_\_\_.

Question: \_\_\_\_\_ more \_\_\_\_\_?

## Present

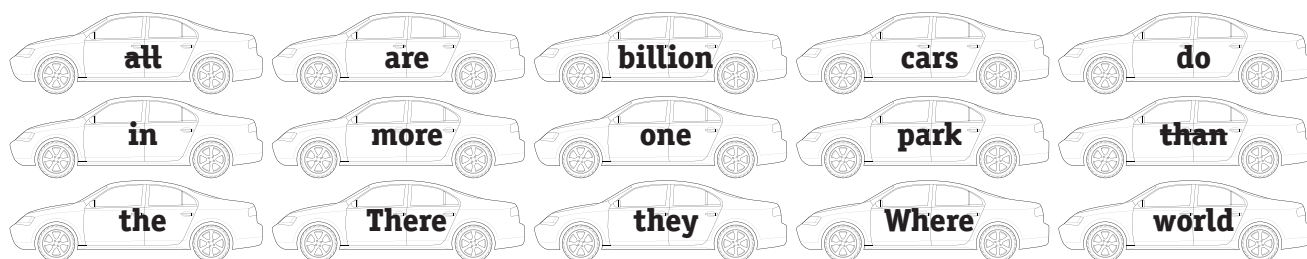

Fact: \_\_\_\_\_ than \_\_\_\_\_.

Question: \_\_\_\_\_ all \_\_\_\_\_?

## Future

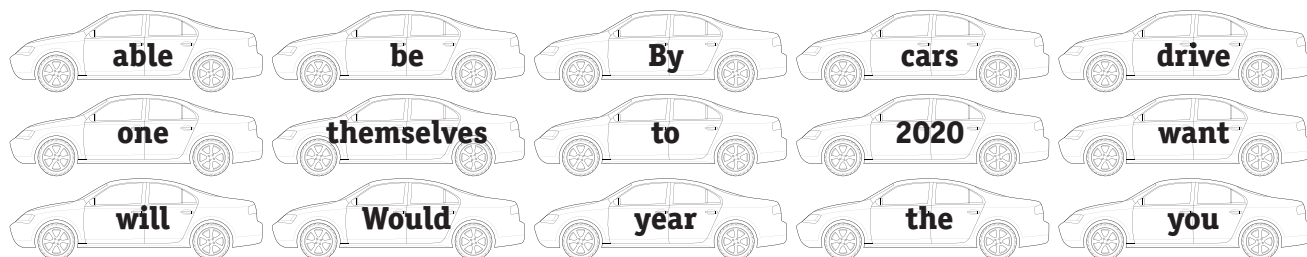

Fact: \_\_\_\_\_, \_\_\_\_\_.

Question: \_\_\_\_\_?

# Train of Thought

**P**hrasal verbs consist of a verb and a preposition. Each verb and preposition has its own meaning, but when the words are connected (like train cars), their combined meaning is different.

**Directions:** For each verb, select the preposition (or prepositions) that creates a phrasal verb with the same meaning as a word/phrase in capital letters in the sentences below. Write the word or phrase from the sentence in the first box. Below that, rewrite the sentence using the phrasal verb. The first one has been done for you.

Select from these prepositions: **off** | **up** | **in** | **out** | **down** | **off** | **away** | **forward to** | **along with** | **out of**

The train will **LEAVE** the station at noon. \* Trains **REDUCE SPEED** when passing through towns.  
 Let's **LEAVE TOWN** for the weekend. \* You need to **REGISTER WHEN ARRIVING** at the station.  
 Some people **WEAR NICE CLOTHES** when traveling. \* ~~I hope they don't **CANCEL** the trip.~~  
 Some people like to **LOITER** in train stations. \* I always **GET EXCITED ABOUT** traveling by train.  
 I often **FALL ASLEEP** on trains. \* Do you want to **JOIN** me on my trip?

1.

**CANCEL**

*I hope they don't call off the trip.*

2.

3.

4.

5.

6.

7.

8.

9.

10.

# logic puzzles

---

**T**his section contains puzzles and stories that require students to think about what they are listening to or reading. For the logic puzzles, students have to use clues and deductive reasoning skills to complete the activities. Puzzle stories can be used for listening comprehension and/or speaking practice and also require reasoning skills.

**TEACHING TECHNIQUES.** Logic puzzles are a great activity for small groups of students to collaborate to try and solve together. Have students draw pictures, create grids/tables, or make lists in their notebooks to collect information and reason to find the answers. If your class is competitive, see which group can complete the puzzles the fastest.

## WHAT WAS YOUR ORDER?

A LOGIC PUZZLE



**T**here are eleven related facts listed below for this logic puzzle. After reading them, help the waitress who is serving the table to figure out the answer to this question: *Who ordered the cola, cheeseburger with pickles, and French fries?*

1. Six friends went to a hamburger drive-in and decided to eat inside the restaurant.
2. The friends sat in a booth, three people on each side of the table.
3. They ordered six different meals.
4. Jack sat next to Jill.
5. Jill sat opposite the boy who sat next to Betty.
6. Archie ordered cola, a plain hamburger, and French fries and sat across from Jane.
7. The boy who had the vanilla milk shake and two hot dogs sat across from Betty.
8. The girl who ordered the diet cola, fish sandwich, and onion rings sat between Archie and Reggie.
9. Reggie didn't order a diet cola, grilled chicken sandwich, and French fries or a cola and taco salad.
10. The girl who ordered the diet cola, grilled chicken sandwich, and French fries sat across from Archie.
11. The girl who sat next to Jack had a cola and taco salad.

***Who had the cola, cheeseburger with pickles, and French fries?***

# Fish Tanks

**PUZZLE 1.** Place the fish—orange, blue, red, and green—in the tanks according to the clues.

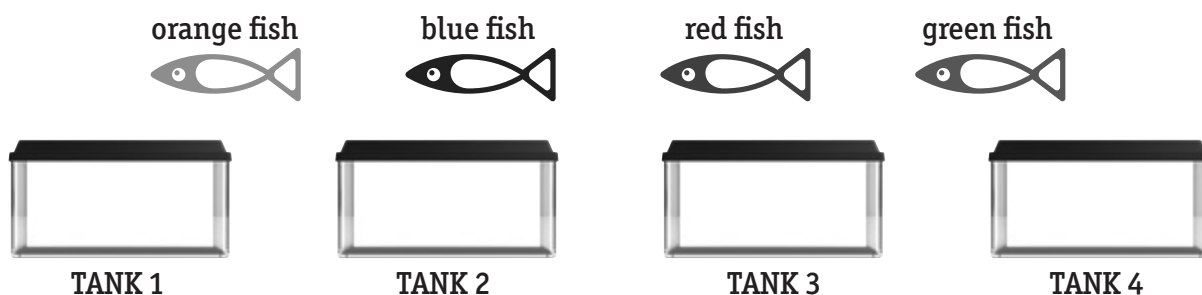

## Clues

1. The orange fish is between the blue fish and the red fish.
2. The blue fish is next to the green fish.
3. The red fish is not in Tank 1.

**PUZZLE 2.** Each tank below holds a different kind of fish. There are three rows (across) and three columns (up and down). Read the clues and figure out which tank holds each kind of fish. The goldfish are in the middle tank; here are the fish in the other tanks:

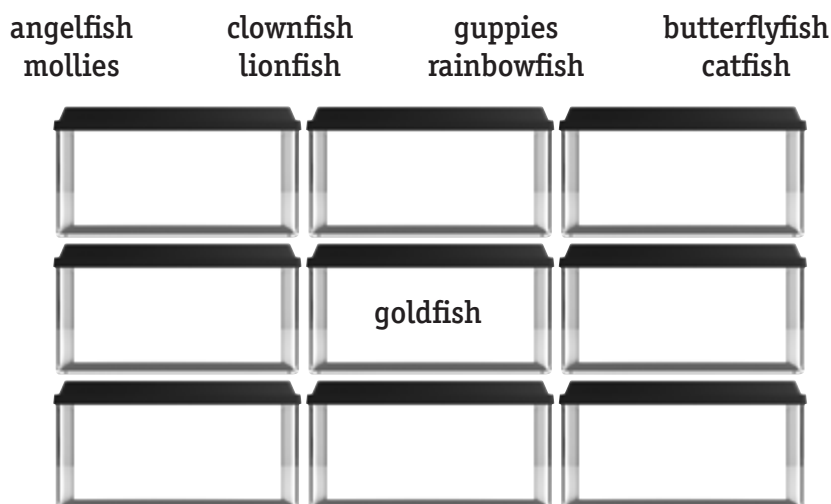

## Clues

1. The angelfish are in a corner tank, to the left of the clownfish.
2. The mollies are between the lionfish and the butterflyfish, in the same row.
3. The catfish are below the butterflyfish, but they are not in the bottom row.
4. Neither the guppies nor the clownfish are in the top row.
5. The lionfish are in the same column as the angelfish and the guppies.
6. The rainbowfish are in the bottom row, but the mollies are not.
7. The guppies and the catfish are in the same row.
8. The catfish, the clownfish, and the lionfish are not in the same row or in the same column.
9. The guppies are in the tank above the angelfish.

# Bird Logic

Below are the names and pictures of ten birds from around the world. We have assigned each of these birds a secret number. We can tell you that the peacock is number 7; your job is to figure out the rest of the secret numbers.

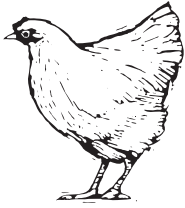

**chicken**



**eagle**

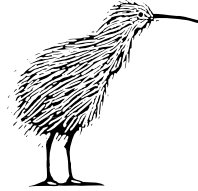

**kiwi**



**ostrich**



**owl**



**parrot**



**peacock**



**penguin**



**seagull**



**toucan**

The "Bird Facts" column gives information about these birds—by their secret numbers, not by their names. Compare the Bird Facts to determine which number goes with which bird. Then write the name of the bird next to its number.

## Bird Facts

- Birds 1, 3, and 8 can't fly.
- The names of birds 1, 4, and 9 have fewer than six letters.
- The names of birds 4 and 8 begin with the same letter.
- Birds 3, 5, and 9 will eat fish.
- The names of birds 2, 3, and 7 begin with "p."
- The names of birds 2 and 10 have the same number of letters.
- Birds 2, 7, and 10 are colorful.
- The names of birds 3, 6, and 10 end with "n."
- The names of birds 3, 5, and 9 contain a "g."
- Birds 1 and 4 are mostly nocturnal.
- The first letter in the name of bird 10 is the same as the last letter in the name of bird 2.
- The name of bird 9 begins and ends with the same letter.

	Name of Bird
1	
2	
3	
4	
5	
6	
7	peacock
8	
9	
10	



## Puzzle Stories

Teachers should direct their students to ask a series of yes/no questions as a means of discovering the solution to the Puzzle Stories. Puzzle Stories can be read by students, read aloud by the teacher or a student, or listened to using an audio file (found on the American English site: <http://bit.ly/PuzzleAudio>). After students listen to the story, explain any new vocabulary items. Have students listen to or read the story once more before getting them to ask their yes/no questions. If desired, have students work together in groups. Have groups take turns to ask a single yes/no question until a solution is found.

### 1 MR. JONES

In the middle of the night, while Mr. Jones was asleep in his hotel room, the telephone beside his bed rang. Mr. Jones woke up, picked up the phone, and said “Hello.” Then he put the phone down and went back to sleep. Can you guess who had telephoned him?

### 2 MAN IN THE BAR

A man ran down the street, walked into a bar, and asked for a glass of water. The bartender gave him the water and pointed a gun at him. The man said “Thank you” and walked out of the bar. Why did he do that?

### 3 LIARS AND TRUTH-TELLERS

The people in a far-off land consist of two tribes: Liars and Truth-tellers. Both tribes speak the same language, but the Truth-tellers always tell the truth, and the Liars never tell the truth.

An explorer going through that country came to a rushing river and saw three natives of that land on the other side. He knew their language, so he shouted across the river to the first man: “Are you a Liar or a Truth-teller?” The man replied, but his answer was lost in the noise of the rushing water.

The second man had heard the question, and seeing that the explorer did not hear the first man’s answer, he cried out: “This man said he is a Truth-teller. He is a Truth-teller. So am I a Truth-teller.”

When the third man heard that, he pointed at the last speaker and said mockingly, “Do not believe him! He’s a Liar; but I am a Truth-teller!”

PROBLEM: Which of the men are Truth-tellers, and which are Liars?

### 4 THE DOLLAR BILLS

A man phoned his daughter to ask her to buy a few things he needed for a trip. He told her she would find enough dollar bills for the purchases in an envelope on his desk. She found the envelope with “98” written on it. In a shop she bought \$90 worth of things, but when it was time to pay, she didn’t have \$8 left over, as she thought she would. In fact, she didn’t have enough money to pay for all the purchases. By how much was she short, and why?

### 5 THE CROSSING

A farmer must transport his dog, a duck, and a bag of corn across a river. The boat he has to use is very small—so small that he can take only one of the three in the boat with him at a time. If he leaves the dog alone with the duck, the dog will kill and eat the duck. If he leaves the duck alone with the corn, the duck will eat up the corn.

What is the least number of trips the farmer must make to transport all three across the river safely?

### 6 THE CAT IN THE WELL

One day a cat fell down a well. The well was eighteen feet deep. When the cat tried to climb out, it found that the sides of the well were very damp and slippery. However, with patient determination it finally managed to climb out.

It took the cat one minute of climbing to gain three feet. However, after climbing for a minute, the cat had to rest for a minute before it could go on. During each minute of rest, the cat slid back two feet.

How long did it take for the cat to get out of the well?

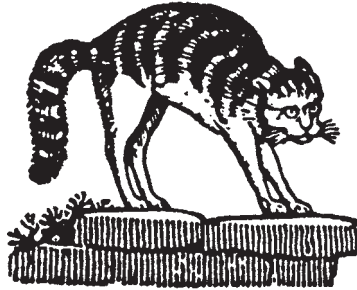

### 7 THE CAPTURED TRAVELER

A traveler had the misfortune of being caught by an enemy tribe and condemned to death. The only question that remained was how he was to be done away with.

According to tribal custom, the chief of the tribe was to make this decision on the following basis:

The victim was told to make an affirmative statement. If the chief considered the statement true, the victim would be shot with a poisoned arrow. If the statement was judged to be false, the victim would be tied to a stake and die by fire. In any case, his death was apparently inescapable—or so it seemed to everyone except the traveler.

He made a short statement which so perplexed the chief that it was found impossible to carry out the execution.

What were the words that the clever traveler must have uttered?

## CROSSING THE BRIDGE

Tom came to a bridge marked “Total weight 100 kilos.” Now, Tom weighed 95 kilos, but he had three pineapples, each weighing 2 kilos. He couldn’t throw them across the river, because the pineapples would be smashed to pieces. How did Tom cross the bridge?

## THE TWO STUDENTS

Two girls appeared at the registrar’s office of a college. The receptionist handed each of them a questionnaire to fill out. Each girl wrote the following facts on the questionnaire.

Each had the last name Smith. Each was born on February 29, 1960. Each was born at 376 East 53rd Street, New York City. Each had a father named John Smith and a mother named Gertrude Smith.

When the girls had completed the questionnaires they handed them to the registrar. The registrar read them and asked, “Are you two girls sisters?”

They replied, “Yes, we are.” Looking up from his papers, the registrar saw the two girls and noticed that they looked exactly alike. He said, “You’re twins, aren’t you?”

They both promptly answered, “No.”

Assuming that all the answers they gave were true, and that they had the same mother and father, how do you account for the fact that they were not twins?

## HOW CAN IT BE?

Albert Amblefoot walked outside in a heavy rainstorm for half an hour without getting a single hair of his head wet. He didn’t wear a hat, carry an umbrella, or hold anything over his head. His clothes got soaking wet. How could this happen?

## A BOY AND GIRL

As you are traveling in the kingdom of Jerafa, you come upon a boy and a girl who are dressed exactly alike.

“I’m a boy,” says the one with red hair.

“I’m a girl,” says the one with black hair.

If at least one of them is not telling the truth, which is which?

### 12 A SPRING WALK

A man lived at the southern tip of a small forest which was exactly circular in shape. His house was at the very edge of the forest. One fine day in the spring he decided to take a walk around the forest. He set out from his house, heading in a westerly direction, that is going in a clockwise direction, all around the forest and returning to his house. He found that it took him eighty minutes to do this, walking at a steady rate and making no stops along the way.

Another day a few months later, he again took a walk around the forest, but this time he went in a counterclockwise direction. Walking at the same rate as before and making no stops, he found that the trip took him one hour and twenty minutes. Can you explain why?

### 13 MARRIAGE OR DEATH

Ruling over the kingdom of Komosay was a very powerful king who had a beautiful daughter named Yamah. When Yamah fell in love with a poor peasant boy, the king was shocked and distressed. To show how fair he was, however, he promised to give the boy a 50-50 chance to marry his daughter by letting him choose one of two slips of paper. On one piece of paper would be written the word MARRIAGE; on the other, the word DEATH. Because of his great love for Yamah, the boy agreed to take this risk.

As he came near to the castle on the fateful day, he happened to overhear a conversation between the king and one of his attendants:

“Your Majesty,” said the attendant, “how can you do this thing, and let that unworthy boy have a chance of marrying your daughter?”

The deceitful king laughed and said, “The way I will do it, he will have no chance. I will write the word DEATH on both pieces of paper. But of course, he will not know that; he will think he has chosen the wrong piece of paper.”

When the boy heard that he was stunned and didn't know what to do. But then he thought of a clever solution to the problem. When the time came to choose, he put his plan into action. The next day he and the princess were married.

What was his solution?

## ✦ ✦ BOTTLE OF WATER

Two travelers in a desert land have been given an eight-liter bottle of water. Since they will be going in different directions, they want to divide the water equally, so they will each have four liters. However, all they have with them for the purpose of measuring are two containers, one of which holds five liters, and the other three liters.

At first it seems impossible to make an even division of four liters each by using the three containers on hand, but they finally manage to do it. How do they do this?

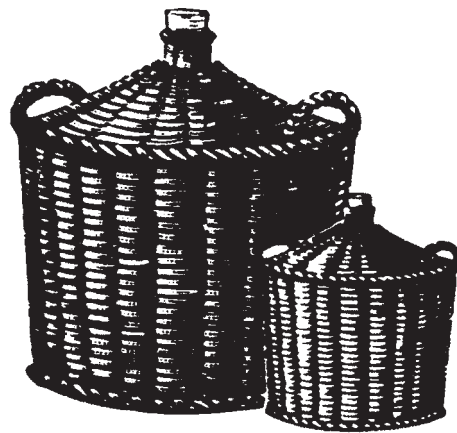

# BICYCLE MATH

 Bill rode his bicycle 300 kilometers. Three tires were used equally in accumulating this distance. How many kilometers of wear did each tire sustain?

 A railway track runs parallel to a road until a bend brings the road to a level crossing. A cyclist rides along to work along the same road every day at a constant speed of 12 miles per hour.

He normally meets a train that travels in the same direction at the crossing.

One day he was late by 25 minutes and met the train 6 miles ahead of the level crossing. Can you figure out the speed of the train?



## section 1: games with letters

**Chicago Word Train:** 1. fountain; 2. newspaper; 3. rail; 4. lake; 5. eat; 6. tower; 7. river; 8. road; 9. damp; 10. pizza; 11. aquarium; 12. museum; 13. music; 14. clip; 15. pier; 16. roof; 17. food; 18. dance; 19. east; 20. trail; 21. loop; 22. power; 23. row; 24. windy

**Alphabet Connect:**

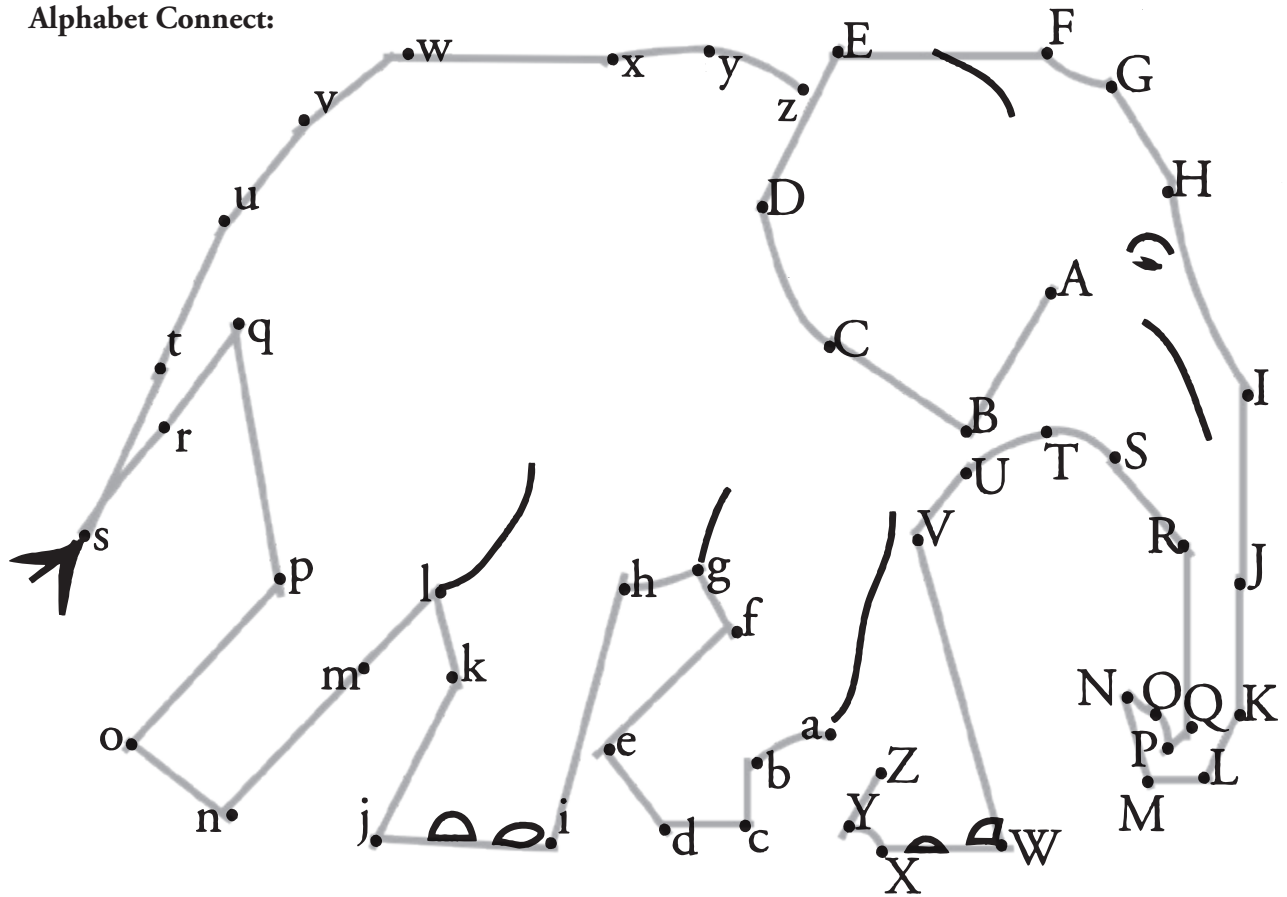

**What's Missing?**

1. singing songs; 2. movie night; 3. book club; 4. debate; 5. role plays; 6. discussing current events; 7. photo contest; 8. games; 9. conversation practice; 10. coffee break; 11. translation; 12. watching TV shows; 13. listening to podcasts; 14. electing club officers

**Dog Tricks:**

1. speak; 2. sit; 3. shake; 4. lie down; 5. roll over; 6. fetch; 7. play dead; 8. treat

**Animal Sounds:**

CLUES

1. A (animals); 2. M (farm); 3. F (fish); 4. E (eggs); 5. G (goat); 6. I (pig); 7. K (kitten); 8. L (llama); 9. N (barn); 10. O (cow); 11. Q (queen bee); 12. U (puppy); 13. W (water); 14. B (bunny); 15. C (cat); 16. H (horse)

MATCHING

OINK (pig); MOO (cow); CLUCK (chicken); QUACK (duck); MEOW (cat); BAA (sheep); WOOF (dog); NEIGH (horse)

**Shop Talk:**

1. speedometer; 2. clutch; 3. helmet; 4. kickstand; 5. mirror; 6. gas tank; 7. brakes; 8. handlebars; 9. engine; 10. key

**Tenpins:**

1. attend; 2. Contents; 3. eaten; 4. frighten; 5. kitten; 6. listen; 7. often; 8. pretend; 9. rotten; 10. sentence

**Jumble Garden:**

1. red; 2. green; 3. garden; 4. gardener; 5. row; 6. grew; 7. flower; 8. flowering; 9. hoe; 10. hole; 11. hose; 12. seed; 13. shovel; 14. shoveled

**Fishy Fun:**

SAY THESE FIVE TIMES FAST!

1. **S**: She saw seven swimming shrimp.; 2. **F**: Five fat flat fish flapped.; 3. **O**: Oliver ordered oily orange oysters.; 4. **P**: Princess Patty's pretty pond is perfect.; 5. **C**: Chris caught cold, crusty clams.

MATCHING

1. canoe; e; 2. rod; i; 3. catch; a; 4. bait; g; 5. school; b; 6. ocean; c; 7. lake; h; 8. hook; j; 9. shark; d; 10. anchor; f

**Silent Letters:**

1. What; 2. know; 3. listen; 4. though; 5. hours; 6. guest; 7. two; 8. Wednesdays; 9. who; 10. friend; 11. foreign; 12. island; 13. autumn; 14. wrong



# section 2: word searches

## Winter Sports Word Search:

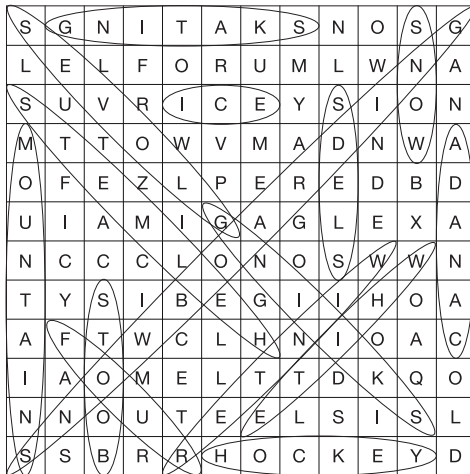

1. white; 2. gloves; 3. hockey;
4. skating; 5. skiing; 6. Canada;
7. snowboarding; 8. Winter; 9. ice;
10. sleds; 11. four; 12. boots;
13. mountains; 14. helmets; 15. snow

## New York City Word Search:

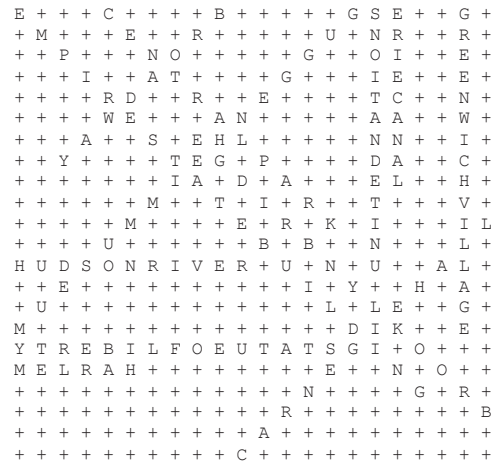

1. Broadway; 2. Hudson River;
3. Greenwich Village; 4. Erie Canal;
5. United Nations; 6. Statue of Liberty;
7. Guggenheim Museum;
8. Central Park; 9. Carnegie Hall;
10. Empire State Building;
11. Brooklyn Bridge; 12. Harlem

## Weather Word Search:



## Poetry Word Search:



Home on the Range:  
A Word Search Puzzle:



Urban Renewal: A Word Search Puzzle:

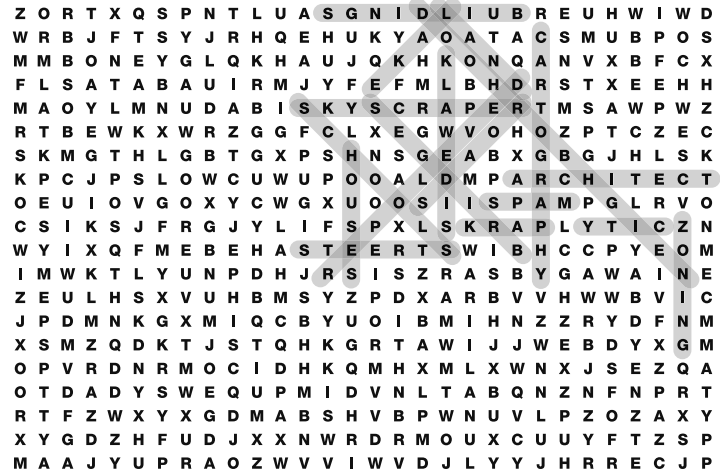

Postcards Word Search:

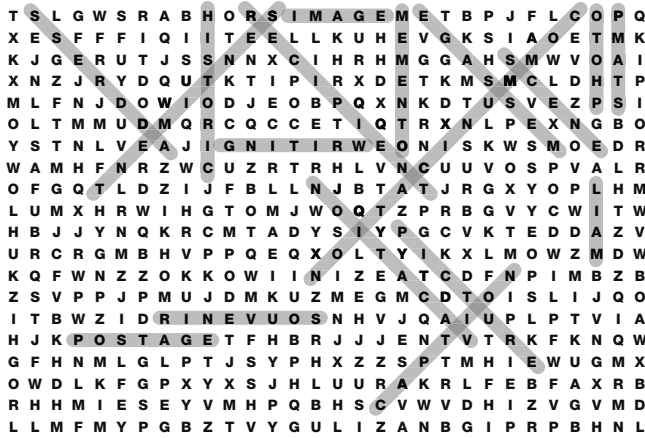

Antonym Word Search:

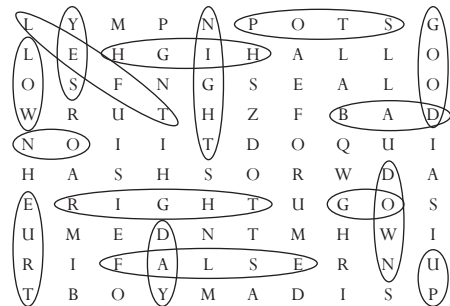

Antonym

- yes
- stop
- up
- good
- true
- night
- right
- high

Antonym

- no
- go
- down
- bad
- false
- day
- left
- low

**Synonym and Antonym Word Search 1:**

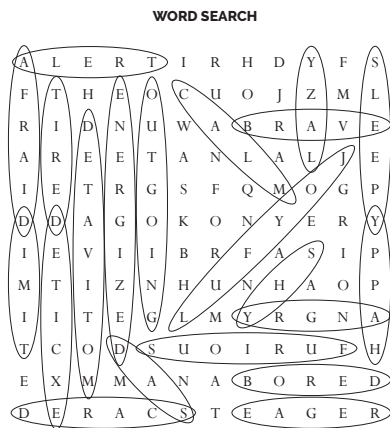

Feeling	Synonym	Antonym
tired	SLEEPY	alert
happy	joyful	sad
excited	eager	bored
angry	furious	calm
shy	timid	outgoing
scared	afraid	brave
energized	motivated	lazy

**Synonym and Antonym Word Search 2:**

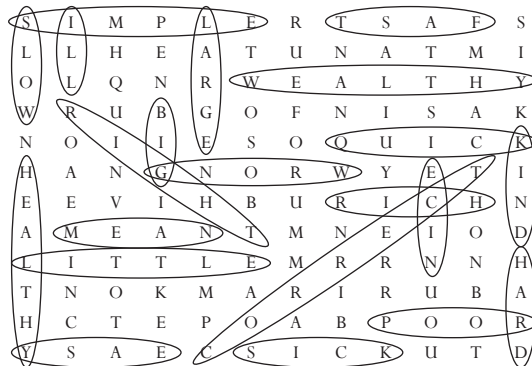

Adjective	Synonym	Antonym
sick	ill	healthy
easy	simple	hard
rich	wealthy	poor
right	correct	wrong
fast	quick	slow
kind	nice	mean
big	large	little

# section 3: scrambles

**Coin Toss:**

- quarter; 2. mint; 3. copper; 4. eagle; 5. Lincoln; 6. Congress; 7. striking; 8. investment;
9. half dollar; 10. Penny Hockey; 11. West Point; 12. Coinage Act; 13. Federal Reserve;
14. Commemorative; 15. Numismatics

**Animal Crazy Quilt:**

1. DEER
2. RAT
3. SEAL
4. DOG
5. BEAR
6. PIG
7. ANT
8. EEL
9. CAT
10. LION
11. COW
12. WOLF

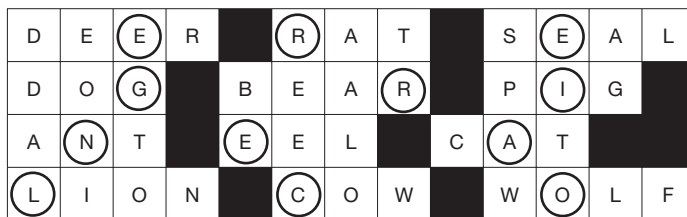

Which animal is the fastest in the world? Peregrine Falcon

**Fair Finds:**

1. pig; 2. cow; 3. duck; 4. goat; 5. cake; 6. corn; 7. horse; 8. potato; 9. lettuce; 10. apricot; 11. pumpkin; 12. squash; 13. apple pie; 14. cherry pie; 15. cotton candy; 16. watermelon

**What's the Connection?**

1. foot; 2. palm; 3. calf; 4. nail; 5. mouth; 6. head; 7. hand; 8. leg; 9. arm; 10. heart

Question: They are parts of the body. (Each word refers to part of the human body but has another meaning as well. Can you think of other words that fit this theme—parts of the body? Can you and your students think of other themes—groups of words that are related in some way but also have other, unrelated meanings?)

**Mountain Climbing:**

1. strong; 2. brave; 3. give; 4. trying; 5. tough; 6. determined; 7. goal; 8. effort

Final Message: Great! You did it!

**A Maps Mind Map:****MAP WORDS**

REDROBS → BORDERS

ICITES → CITIES

RECUSTION → COUNTRIES

SEAT → EAST

SLANDIS → ISLANDS

SLEAK → LAKES

THORN → NORTH

CEANOS → OCEANS

VERRIS → RIVERS

DORAS → ROADS

SHOUT → SOUTH

TESTERS → STREETS

STEW → WEST

**DIRECTIONS**

EAST, NORTH, SOUTH, WEST

**NATURAL FEATURES**

ISLANDS, LAKES, OCEANS, RIVERS

**FEATURES MADE BY HUMANS**

BORDERS, CITIES, COUNTRIES, ROADS

**Classroom Clues:**

dustnets → students

richas → chairs

skeds → desks

okclc → clock

blockharad → chalkboard

alner → learn

kinth → think

swaner → answer

dear kobos → read books

ryt royu steb → try your best

Message: Education is the key to success.

**Stage Directions:**

(loudly, with a big grin) ring → grin

(with a wide smile) miles → smile

(in a softer voice than before) forest → softer

(putting her hand to her ear) are → ear

(looking excited and eager) agree → eager

**Rock the Boat:**

1. CANOE; 2. ROWBOAT; 3. CRUISE SHIP; 4. SAILBOAT; 5. FERRY; 6. KAYAK;
7. STEAMBOAT; 8. SPEEDBOAT; 9. YACHT; 10. RAFT; 11. TUGBOAT

**RIDDLE:**

Before the windstorm, what did the ocean say to the boat?

“ARE YOU READY TO ROCK?”

**Dare to Read:**

1. book; 2. poem; 3. story; 4. letter; 5. sign; 6. map; 7. memo; 8. report; 9. essay; 10. note; 11. label;
12. menu; 13. newspaper; 14. magazine; 15. blog; 16. email; 17. cookbook; 18. instructions;
19. biography; 20. *English Teaching Forum*

## section 4: crossword puzzles

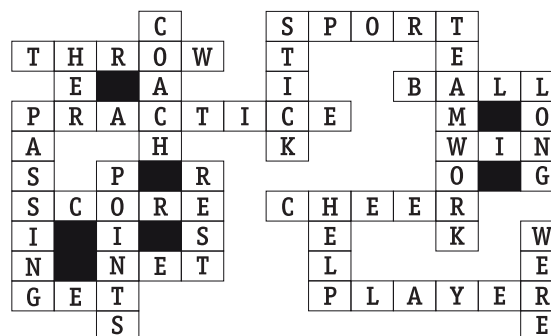
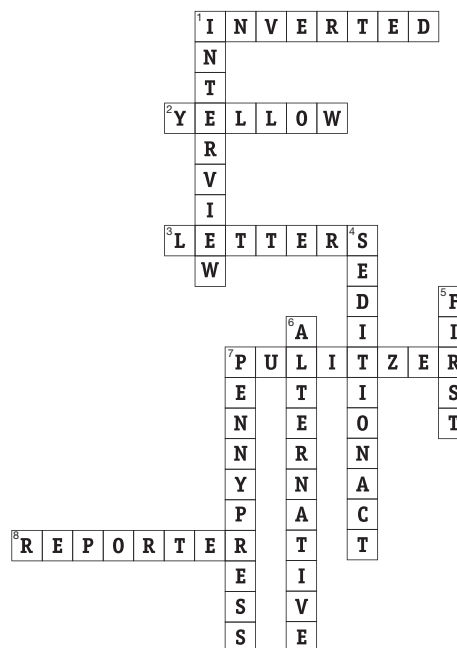
**Alaska! A Crossword Puzzle:****Lacrosse Word Puzzle:****Journalism Crossword:****Seattle Crossword Puzzle:****Across**

2. coffee
4. earthquake
7. rainy
8. water
9. sports
10. library
14. volcano
15. boats
16. train

**Down**

1. Space Needle
3. farmers
5. historic
6. airplane
11. bicycle
12. umbrella
13. forest

## J-Words Crossword Puzzle:



## The Write Stuff:

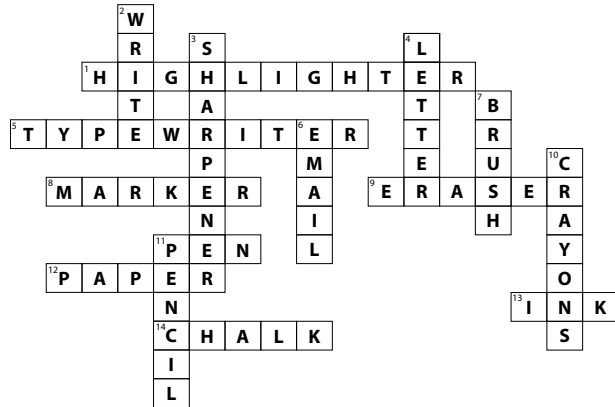

## Debate Vocabulary:

### Synonyms for *agree*

- accept
- affirm
- concur

### Synonyms for *disagree*

- contest
- dispute
- contradict

### Synonyms for *debate*

- discuss
- deliberate
- argue

### Down

1. accept
2. concur
3. discuss
4. affirm
6. to
7. argue

### Across

3. deliberate
5. contest
8. contradict
9. dispute

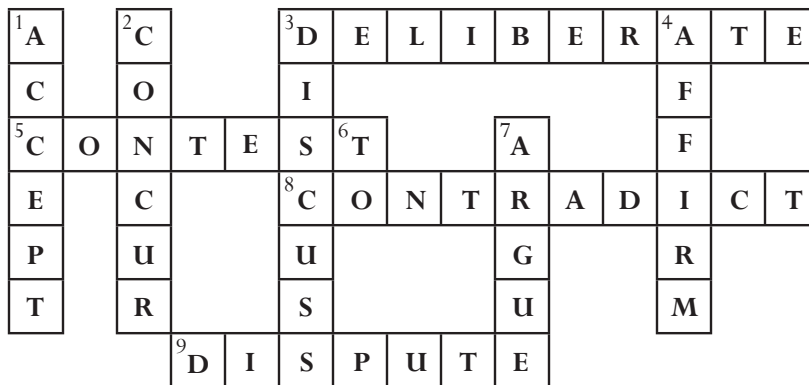

## section 5: word games

### Football Transformers:

#### Part I

- A. BITE • BIT • LIT • HIT • SIT • SIX
- B. HEAT • SEAT • AT • ATE • TEA • TEAM
- C. AND • SAND • HAND • HARD • YARD • YARDS
- D. HOLE • HOME • COME • CAME • CARE • SCARES • SCORES

#### Part II

1. team; 2. yards; 3. scores; 4. six

### Miami Word Cruise:

1. he; 2. hi; 3. up; 4. cup; 5. ice; 6. pie; 7. she; 8. sir; 9. cure; 10. epic; 11. heir; 12. hire; 13. pier;  
14. pure; 15. rush; 16. chess; 17. crush; 18. issue; 19. price; 20. purse; 21. super; 22. usher; 23. crisis;  
24. perish; 25. spices

### Words Within Words:

#### I. Classroom teacher

class, room, mass, more, each, loss, coal, cool,  
arm, ram, ham, slam, reach, ache, ore, moat,  
tea, eat, ate, hate, mate, rate, care, here, hear,  
clear, tear, race, case, heart

#### II. English students

end, send, tend, dent, set, glue, tent, less,  
lend, stud, hen, den, glen, dish, dishes, get,  
due, is, sing, sting, sling, ding, slide, glide,  
tides, in, it, sit, lit, let

#### III. Language homework

age, huge, home, name, men, work, war,  
ware, hear, here, weak, hum, hour, hang,  
heal, gang, ark, area, are, nag, wheel, ran,  
run, more, moon, hook, knee, kneel, row, how

### Spelling Bee:

1. won, one; 2. to, two, too; 3. four, for, fore; 4. ate, eight; 5. threw, through; 6. see, sea;  
7. so, sew, sow; 8. way, weigh; 9. wait, weight; 10. tied, tide; 11. not, knot; 12. heard, herd;  
13. here, hear; 14. red, read; 15. rode, road; 16. seen, scene; 17. four sail, for sale; 18. wrote,  
rote; 19. blew, blue; 20. sun's rays, sons raise

## Sights in the City: A Word Puzzle:

1. G O L D E N G A T E B R I D G E
2. The S E A R S T O W E R
3. The W H I T E H O S E
4. The S P A C E N E E D L E
5. The H O L L Y W O O D S I G N
6. The E M P I R E S T A T E B U I L D I N G

## Word Sudoku:

Puzzle 1

U	E	N	T	C	I	D	A	O
C	A	T	N	D	O	U	I	E
O	I	D	A	E	U	N	C	T
A	T	C	O	I	N	E	U	D
E	D	U	C	A	T	I	O	N
I	N	O	D	U	E	C	T	A
N	O	I	E	T	C	A	D	U
T	U	A	I	N	D	O	E	C
D	C	E	U	O	A	T	N	I

Target Word: EDUCATION

Puzzle 2

B	I	R	T	H	D	A	Y	S
H	T	D	Y	A	S	B	I	R
A	Y	S	I	B	R	H	T	D
S	A	Y	H	D	B	I	R	T
D	H	B	R	I	T	S	A	Y
I	R	T	A	S	Y	D	H	B
R	B	H	D	T	I	Y	S	A
T	D	I	S	Y	A	R	B	H
Y	S	A	B	R	H	T	D	I

Target Word: BIRTHDAYS

Puzzle 3

S	O	C	E	D	R	Y	V	I
V	E	I	S	Y	C	R	O	D
Y	D	R	V	I	O	S	E	C
O	S	E	I	V	D	C	Y	R
R	V	Y	O	C	S	I	D	E
I	C	D	Y	R	E	V	S	O
E	Y	O	R	S	I	D	C	V
C	R	V	D	E	Y	O	I	S
D	I	S	C	O	V	E	R	Y

Target Word: DISCOVERY

## Moving Around:

1. on the move

E	T	H
↑	↑	↓
V	N	E
↑	↘	↙
O	M	⊙

2. Get up and move!

N	→	D	→	M	→	O
↑						↓
A	←	P		T		V
			↘	↙		
⊙	→	E		U		E

3. Don't move a muscle!

M	→	U	→	S	→	C	→	L
↑								↓
A		V		M		N		E
↑	↘	↑	↘	↑	↘	↑	↘	↓
E	O	T	O	⊙				

4. move back and forth

D	→	F		H	←	T
↑						↑
N	←	A		O	→	R
C	→	K		E		O
↑						↑
A	←	B		V		⊙

## Listen Up!

1. bread (e); 2. soul (l); 3. beard (a); 4. far (a); 5. goose (s); 6. laid (l); 7. mow (m); 8. height (i); 9. great (r).

Unscrambled idiom: "I'm all ears."

## Speak and Spell:

1. fair fare; 2. plain plane; 3. see the sea; 4. bare bear; 5. beat a beet; 6. break the brake; 7. a pair of pears; 8. write right; 9. rose rows; 10. peer at the pier; 11. dear deer; 12. maize maze



## section 6: reading + writing

### Scrambled Energy Words:

1. Plant matter or methane  
SOBSAMI/BIOMASS
2. Heat from the earth  
GAMERELOTH/GEOTHERMAL
3. Supplied as a public utility for lighting, heating, etc.  
YLCCRTETIIE/ELECTRICITY
4. "Non-renewable" fuels  
LUSSIFLEFOS (2 words) / FOSSIL FUELS
5. Wood or sunlight  
WENALEBRE/RENEWABLE
6. Source of paraffin, kerosene, fuel oil, gasoline, etc.  
RUMELPOTE/PETROLEUM
7. Electricity from sunlight  
OCIH PATLOVOT/PHOTOVOLTAIC
8. Energy from the sun's rays  
POROWLRESA (2 words) / SOLAR POWER

### Where in the World Is ... ?

1. Tokyo, Japan; 2. Warsaw, Poland; 3. Athens, Greece; 4. Ankara, Turkey; 5. Oslo, Norway;
6. Paris, France; 7. Cairo, Egypt; 8. Washington, U.S.A.; 9. Rabat, Morocco; 10. Bonn, Germany;
11. Amman, Jordan; 12. London, England

### Baseball Terms with Everyday Meanings:

1. K, b; 2. F, g; 3. C, a; 4. L, f; 5. I, l; 6. A, h; 7. J, m; 8. E, c; 9. B, k; 10. G, i; 11. D, e; 12. M, d

### National Park Symbols:

1. l; 2. i; 3. f; 4. n; 5. d; 6. h; 7. a; 8. c; 9. e; 10. k; 11. m; 12. j; 13. g; 14. b

### Have You Ever Had Road Rash?

1. b (truck driver slang); 2. a (motorcycle rider slang); 3. c (truck driver slang); 4. b (truck driver slang); 5. a (drag racer slang); 6. c (truck driver slang); 7. a (motorcycle rider slang); 8. a (truck driver slang); 9. c (NASCAR driver slang); 10. b (custom car driver slang)

### Place Out of Words:

Set A (Nouns)

1. Change breakfast to New Year's; 2. Change the kitchen to school; 3. Change everybody to shoes;
4. Change shoes to breakfast; 5. Change school to the kitchen; 6. Change relatives to sports;
7. Change New Year's to everybody; 8. Change sports to relatives

Set B (Verbs)

1. Change speak to sleep; 2. Change sing to greet; 3. Change sleep to retire; 4. Change retire to sing;
5. Change greet to visit; 6. Change visit to speak

**A Script by the Numbers:**

*Early one afternoon, A meets B on campus.*

A: Wow, that's a lot of books! How many do you have there?

B: Seven. One for each day of the week. And they're heavy!

A: Where are you taking them?

B: Back to the library. Six of them are overdue. The other one is due today!

A: Will you have to pay a fine?

B: I'm afraid so. The library charges one dollar for every day a book is late.

A: Sorry to hear that. What are the books about?

B: This one is about the moon. And I have two biographies—one on Cleopatra and one on Henry VIII.

A: What about the other four books?

B: These two are guides for healthy eating, and these two are about the environment.

A: They all sound interesting! Say—how will you get to the library?

B: I have three choices: walk, ride my bike, or take the bus.

A: Actually, you have four choices. I could take you there on my motorcycle.

B: Great idea! And maybe you could help me pay the library fine, too!

A: Sorry, there's zero chance of that. I don't have any money!

*They get on A's motorcycle and ride away to the library.*

Answer to the Bonus Question: 33

**Debate Dialogue:****For**

1. information
2. contact
3. directions
4. convenient
5. countries
6. interesting
7. classroom

**Against**

- A. accidents
- B. interacting
- C. community
- D. parents
- E. impatient
- F. divide
- G. distracted

**Matching**

1. E (instant access to information)
2. B (interacting through devices instead of face-to-face)
3. A (benefit and risk for drivers)
4. C (convenience but without human interaction)
5. F (fast flow of information across countries and cultures)
6. G (benefit and downside of devices in the classroom)
7. D (devices outside the classroom and at home)

**English Club Email:**

- |                                 |                                   |
|---------------------------------|-----------------------------------|
| <u>5</u> Small-Group Discussion | <u>8</u> people asked about Lisa  |
| <u>7</u> Language Focus         | <u>6</u> picnic planning          |
| <u>3</u> movie selection        | <u>4</u> break                    |
| <u>1</u> short-story discussion | <u>2</u> new-member introductions |

**Three Pragmatics Puzzles:****Greetings**

More formal: Hello, Ms. Smith. How are you today?

Less formal: Hi, Sam. What's up?

**Apologies**

More formal: I apologize. It won't happen again.

Less formal: Sorry about that. My fault.

**Partings**

More formal: Good-bye, Mr. Jones. It was nice talking to you.

Less formal: See ya later, Charlie!

**Small Talk:**

1. rain (topic: weather); 2. game (topic: sports); 3. school (topic: studying); 4. sister (topic: family);  
5. movies (topic: entertainment); 6. plans (topic: free time); 7. bus (topic: surroundings); 8. reading  
(topic: books); 9. phone (topic: technology)

**You're Not Listening!**

1. Change *people* to *hours*.; 2. Change *intent* to *silent*.; 3. Change *hours* to *ears*.; 4. Change *silent* to *people*.; 5. Change *ears* to *intent*.

**Traffic Jam:****Past**

Fact: In the early 1900s, cars started to replace horses on roads.

Question: Which were more dangerous?

**Present**

Fact: There are more than one billion cars in the world.

Question: Where do they all park?

**Future**

Fact: By the year 2020, cars will be able to drive themselves.

Question: Would you want one?

**Train of Thought:**

1. call **off** = cancel; I hope they don't call off the trip.
2. check **in** = register when arriving; You need to check in at the station.
3. get **away** = leave town; Let's get away for the weekend.
4. dress **up** = wear nice clothes; Some people dress up when traveling.
5. pull **out of** = leave; The train will pull out of the station at noon.
6. slow **down** = reduce speed; Trains slow down when passing through towns.
7. come **along with** = join; Do you want to come along with me on my trip?
8. doze **off** = fall asleep; I often doze off on trains.
9. hang **out** = loiter; Some people like to hang out in train stations.
10. look **forward to** = get excited about; I always look forward to traveling by train.

## section 7: logic puzzles

**What Was Your Order? A Logic Puzzle:**

Reggie had the cola, cheeseburger with pickles, and French fries. The numbers in parentheses beside each person's name indicate which facts apply for figuring out who ordered what.

**Jane (6 & 10)**

Diet cola, grilled chicken sandwich, and French fries

**Jack (4, 7 & 11)**

Vanilla milkshake and two hot dogs

**Jill (4, 5 & 11)**

Cola and taco salad

**Archie (6, 7 & 8)**

Cola, plain hamburger, and French fries

**Betty (5, 7 & 8)**

Diet cola, fish sandwich, and onion rings

**Reggie (5, 7, 8 & 9)**

**Fish Tanks:**

PUZZLE 1

Tank 1: green fish; Tank 2: blue fish;

Tank 3: orange fish; Tank 4: red fish

PUZZLE 2

Top row (left to right): lionfish, mollies, butterflyfish

Middle row (left to right): guppies, goldfish, catfish

Bottom row (left to right): angelfish, clownfish, rainbowfish

**Bird Logic:**

1. kiwi; 2. parrot; 3. penguin; 4. owl; 5. seagull; 6. chicken; 7. peacock; 8. ostrich; 9. eagle;  
10. toucan

**Puzzle Stories:****1. Mr. Jones:**

The person who called him was the man in the room next door, and the reason the man telephoned him was that Mr. Jones had been snoring and so disturbing the man. As soon as Mr. Jones said "Hello," the man next door realized that he was awake and that was all that he wanted.

**2. Man in the Bar:**

The man had hiccups.

**3. Liars and Truth-tellers:**

The first man must have been a Truth-teller, because if he really was a Truth-teller, he would have told the truth and admitted it, and if he was a Liar, he would have told a lie and said that he was a Truth-teller.

The second man, then, must have told the truth when he said that the first man said he was a Truth-teller. Therefore he himself was a Truth-teller. His entire statement was therefore true, so the first man must have been in fact a Truth-teller.

The third man, who said that the second man was a Liar, is obviously not telling the truth. Therefore he is a Liar.

**4. The Dollar Bills:**

She was short by \$4.00. She had read the number upside down. The number was 86.

**5. The Crossing:**

Four trips. First he takes the duck across the river, leaving the dog alone with the corn. Then after returning, he takes the dog over and brings back the duck. Then he takes the corn across and leaves it with the dog, coming back for the duck which he takes over last of all.

**6. The Cat in the Well:**

It took the cat thirty-one minutes. In the first two minutes the cat climbed one foot. Continuing this way for thirty minutes, the cat had climbed fifteen feet. In the next minute the cat climbed up the remaining three feet and so was out of the well.

**7. The Captured Traveler:**

The traveler said: "I will die by fire." If the chief decided that this statement was a true one, the traveler would be executed by shooting. But that would make the statement false, and then the traveler would be doomed to die by fire. But such an execution would make the statement true, and then he would have to be shot instead. The only way out of this dilemma was to let the clever traveler go free.

**8. Crossing the Bridge:**

Tom was a juggler. He juggled the pineapples while he crossed the bridge.

**9. The Two Students:**

They were two of a set of triplets.

**10. How Can It Be?**

He was bald.

**11. A Boy and Girl:**

The boy has black hair and the girl has red hair. The statement “At least one of them is not telling the truth” means that one or more is not telling the truth. That is either the first one or the second one is not telling the truth—or both are not. If the first one is not telling the truth, then the first speaker is in truth a girl. Since the opening sentence says there is a boy and a girl, if the first speaker is in truth a girl, then the second speaker must be a boy. We arrive at the same result if we begin with the assumption that the second speaker is not telling truth. The fact is that, in accordance with the given information, if either one of them is not telling the truth, the other isn't either.

**12. Spring Walk:**

It took the man the same length of time to go in a clockwise direction or in a counter-clockwise direction. One hour and twenty minutes is the same as eighty minutes.

**13. Marriage or Death:**

The boy chose one of the pieces of paper and immediately swallowed it. Then he said that the remaining piece of paper (the one he didn't choose) should be read. Since (as he knew) it would contain the word DEATH, the piece he had chosen must (according to the king's stated rules) have said MARRIAGE. The king could not deny this without exposing his dark and devious plot.

**14. Bottle of Water:**

You begin with eight liters of water in the bottle; the two smaller containers are empty. Step 1: Pour water into the five-liter container until it is full; this will leave three liters in the eight-liter bottle. Step 2: Pour water from the five-liter container into the three-liter container until the latter is full; this will leave two liters in the five-liter container. You now have three liters in the biggest container, two liters in the middle container, and three liters in the smallest container. Step 3: Pour the three liters out of the smallest container into the biggest container. You now have six liters in the biggest container, two liters in the middle container, and nothing in the smallest container. Step 4: Pour the two liters from the middle container into the smallest container. You now have six liters in the largest container, nothing in the middle container, and two liters in the smallest container. Step 5: Pour water from the largest container into the middle container until the latter is full. This will leave one liter in the largest container, five liters in the middle container, and two liters in the smallest container. Step 6: Pour water from the middle container into the smallest container. (Since the latter already contains two liters, it will take only one liter to fill it.) This leaves four liters in the middle container, three liters in the smallest container, and one liter in the largest container. Step 7: Pour the three liters from the smallest container into the largest container, which will then contain four liters. You now have four liters in the large (eight-liter) bottle and four liters in the five-liter container.

**Bicycle Math:**

200 miles. For every kilometer traveled, two tires sustained one kilometer of usage each. Therefore, in a total of 300 kilometers traveled, there would be a total of 600 kilometers of wear. And 600 divided by three is 200.

Let's assume that the man and the train normally meet at the crossing at 8 a.m. Then the usual time of the cyclist at the bend is 8 a.m., and he is 6 miles behind at 7:30 a.m., but when the cyclist is later, he arrives at the bend at 8:25 a.m. and therefore he is 6 miles behind at 7:55 a.m. Since the train takes 5 minutes to travel the 6-mile run, the speed of the train is 72 mph (approximately 115 km/h).

**Games with Letters**

Chicago Word Train: Kate Torre

Alphabet Connect: From *“The Lighter Side” of TEFL: A Teacher’s Resource Book of Fun Activities for Students of English as a Foreign Language*, edited by Thomas Kral. Printed in 1994 by the United States Department of State.

What’s Missing?: Tom Glass

Dog Tricks: Jennifer Hodgson

Animal Sounds: Jennifer Hodgson

Shop Talk: Jennifer Hodgson

Tenpins: Jennifer Hodgson

Jumble Garden: Jennifer Hodgson

Fishy Fun: Jennifer Hodgson

Silent Letters: Tom Glass

**Word Searches**

Winter Sports Word Search: Tom Glass

New York City Word Search: Marsha Ford

Weather Word Search: Marsha Ford

Poetry Word Search: Marsha Ford

Home on the Range: A Word Search Puzzle: The FORUM Team

Urban Renewal: A Word Search Puzzle: The FORUM Team

Postcards Word Search: The FORUM Team

Antonym Word Search: Tom Glass

Synonym and Antonym Word Search 1: Amy Hanna

Synonym and Antonym Word Search 2: Tom Glass

**Scrambles**

Coin Toss: Marsha Ford

Animal Crazy Quilt: Marsha Ford

Fair Finds: Marsha Ford

What’s the Connection?: Tom Glass

Mountain Climbing: Heidi Howland

A Maps Mind Map: Tom Glass

Classroom Clues: Amy Hanna

Stage Directions: Tom Glass

Rock the Boat: Jennifer Hodgson

Dare to Read: Tom Glass

**Crossword Puzzles**

Alaska! A Crossword Puzzle: The FORUM Team

Lacrosse Word Puzzle: Tom Glass



Seattle Crossword Puzzle: Kate Torre  
 Journalism Crossword: Marsha Ford  
 J-Words Crossword Puzzle: The FORUM Team  
 Debate Vocabulary: Amy Hanna  
 The Write Stuff: Chelsea Champlin

### **Word Games**

Football Transformers: Lisa Pollard  
 Miami Word Cruise: Kate Torre  
 Words Within Words: Marsha Ford  
 Spelling Bee: From *“The Lighter Side” of TEFL: A Teacher’s Resource Book of Fun Activities for Students of English as a Foreign Language*, edited by Thomas Kral. Printed in 1994 by the United States Department of State.  
 Sights in the City: A Word Puzzle: The FORUM Team  
 Word Sudoku: Tom Glass  
 Moving Around: Tom Glass  
 Listen Up!: Jennifer Hodgson  
 Speak and Spell: Jennifer Hodgson

### **Reading + Writing**

Three Energy Puzzles: The FORUM Team  
 Where in the World Is ...?: M.A. El-Moneeb  
 Baseball Terms with Everyday Meanings: Lisa Pollard  
 National Park Symbols: From *“The Lighter Side” of TEFL: A Teacher’s Resource Book of Fun Activities for Students of English as a Foreign Language*, edited by Thomas Kral. Printed in 2005 by the United States Department of State.  
 Have You Ever Had Road Rash?: Lisa Harshbarger  
 Place Out of Words: Tom Glass  
 A Script by the Numbers: Tom Glass  
 Debate Dialogue: Amy Hanna  
 English Club Email: Tom Glass  
 Three Pragmatics Puzzles: Tom Glass  
 Small Talk: Tom Glass  
 You’re Not Listening!: Kevin McCaughey  
 Traffic Jam: Kevin McCaughey  
 Train of Thought: Jennifer Hodgson

### **Logic Puzzles**

What Was Your Order? A Logic Puzzle: The FORUM Team  
 Fish Tanks: Tom Glass  
 Bird Logic: Kevin McCaughey  
 Puzzle Stories: The FORUM Team







OFFICE OF  
ENGLISH  
LANGUAGE  
PROGRAMS

UNITED STATES DEPARTMENT OF STATE  
Office of English Language Programs  
[americanenglish.state.gov](http://americanenglish.state.gov)