

Woodmaster
TOOLS, INC.
Molder/Planer

**BUSINESS
PLAN**

HOW TO SET UP AND RUN A PROFITABLE CUSTOM MOLDING BUSINESS

*Or...How to have
the time of your life
doing what you love
& getting PAID for it!*



CONGRATULATIONS, WELCOME, & RELAX!

CONGRATULATIONS on deciding to go into the custom molding business with your Woodmaster Molder/Planer.

WELCOME to the Woodmaster family of professional woodworkers — the thousands who've turned their love of woodworking into generous part-time or handsome full-time incomes!

...and RELAX because what you're about to undertake is NOT rocket science. Sure, it takes dedication and hard work, but this special Business Plan shows you exactly what to do.

Dear Friend,

Whether you're just thinking about going into the custom molding business, have decided to, or even if you've already started, here are some key points I want you to know:

- The SUCCESS & SATISFACTION rates for Woodmaster owners who start part time or full time businesses are very, very high.
- Your STARTUP COST & FINANCIAL RISK are very low: the 4-machines-in-1 Woodmaster is the most important tool in your shop; it comes with a 30-day RISK FREE In-Shop Trial Offer; financing allows you to get it before you've paid so you can make it pay its own way; and there's ALWAYS a market for molding.
- Any model Woodmaster is 100% capable of producing huge quantities of commercial quality molding.
- You can turn a \$5 board into \$75 worth of molding — that's a profit margin of 1,500%, which is extraordinarily high.
- Custom molding is a very saleable commodity. Your molding and picture frame customers can include contractors, carpenters, remodelers, artists, lumberyards, and more.
- You don't have to go "all or nothing." Many Woodmaster business owners started by making trim for their own houses, then made it for friends, then got serious about business once they had a track record of success.
- This is NOT a "get-rich-quick" or "easy money" plan. Starting a custom molding business takes hard work, self-discipline, and staying power. But if you're willing to put your back into it, we at Woodmaster are behind you all the way.

1,500%
Profit!

Please read this special Business Plan thoroughly. Be sure to read the stories from Woodmaster owners who've been where you are now and have gone on to create success stories including "6-figure incomes."

If you have any questions about starting your own custom molding business... about your Woodmaster's operation...about ordering pattern knives... about anything in this special Business Plan or any other Woodmaster-related topic, please do give us a call.

Wishing you Tremendous Business Success!



Will Johnson, President

P. S. One of the greatest things about America is that it's possible to do just about anything you set your mind to. If you've got the personal drive to start and operate a successful molding business — and a Woodmaster — you can do it.

“YOU COULD MAKE \$5,000 A WEEK STANDING ON YOUR HEAD.”

“It’s surprising how much I can get for red oak molding I make with my Woodmaster: \$3.50 a foot for molding and baseboard; \$3 a foot for window casing. If you just cut a tree and have it milled into roughcut lumber, you haven’t invested much, so it’s pure profit — it’s not like buying dressed red oak lumber. The guy who saws for me gives me ‘clear and better.’ It’s all great, no knots or anything.

I buy all the Cypress I want for \$700 for 1,000 board feet. I can run cypress three times as fast as oak and sell it as paint grade molding for \$1.75 a foot and almost feel bad charging that. But people love my molding and my prices. If you order molding from True Value, they charge a huge setup fee. You end up paying \$5 or \$6 a foot.

\$700 investment = \$5,000 income

1,000 board feet will make 3,000 feet of crown molding — I’m making \$5,000 with a \$700 investment. You can make a lot of money in molding. How much depends on how much you pay for wood and how much you charge for your product. I can make \$2,000 a day if people bring me the raw wood and pick up the finished molding. It’s a 12-hour day but I’ve done it. You could make \$5,000 a week standing on your head. The Woodmaster is a well-made machine — it really pumps out the molding.

“I’d never run a molder before.”

It’s not like I’m a mechanical genius. I never ran a molder before I got my Woodmaster. Between the video and manuals that come with it, plus a few phone calls to Woodmaster, I got it running well. It’s the best investment I ever made.

Cabinetmakers come by and want anywhere from 16’ to 70’ of molding. I just keep about 500’ made up and in racks. The money is great, there’s a lot of money to be made.

I’m more than happy with the Woodmaster. You don’t see a lot of products made this well any more. I’ve cut over 40,000 feet and more and it just keeps going. Craftsman® and other companies say they stand behind their products — but I wouldn’t give you two bits for everything in the Sears warehouse. People will say anything, but Woodmaster has backed up what they say every step of the way.”

— Jeff Scott, Hamburg, AR

TABLE OF CONTENTS

Why Start a Custom Molding Business?	4
Molding is Your Bread & Butter Line	5
Safety First.....	6
The Business Side of Your Business	8
Marketing: Selling What You Make	12
Setting up Your Professional Shop	16
Production Tips ‘n Tricks.....	18
Success Boosters	22

WHY START A CUSTOM MOLDING BUSINESS?

“I DON’T KNOW WHAT THE OWNER WOULD HAVE DONE.”

“I make custom moldings for 5 or 6 contractors with my Woodmaster. One was working on a home that needed some siding duplicated and pieced in. I took a siding sample and had Woodmaster make the profile knife. I ran 260’ of siding and the house sold in a week. Without the Woodmaster, I don’t know what the owner would have done.”

— Don Graham, Classic Moldings, Ballwin, MS



Owning and operating your own successful business is perhaps the ultimate “American Dream” that millions strive for.

Here’s why a lot of people make the big jump:

Owning your own business means...

- You call the shots
- You make the decisions
- You decide on the hours
- You could make more money than working for others
- You rise or fall on your own skills
- You have more freedom as boss than as an employee
- You can deduct business expenses from your income tax
- You build a business that has real value and can be sold or passed down later
- You gain a sense of personal achievement

THE BEAUTY OF A CUSTOM MOLDING BUSINESS

Entrepreneurs start all kinds of businesses from electronic repair shops to locksmithing. If you’re reading this special Business Plan, there’s an excellent chance you’re already interested in WOODWORKING and thinking about how to make money doing what you love. So, you’re already off to a strong start.

From making cabinetry to building furniture, there are many money-making opportunities in woodworking, but several factors make starting a CUSTOM MOLDING business an excellent start-up choice.

1. Wood moldings are ALWAYS in high demand... EVERYWHERE.

Wherever homes are being built or remodeled; cabinetry and furniture is being manufactured; artists, sign makers, and do-it-yourself homeowners are at work, molding is in high demand.

2. Investment is low... earnings are phenomenal.

When you own a 4-machines-in-1 Woodmaster, you’ve already got the biggest part of your molding operation. Using its ripping, planing, molding, and sanding features you can turn a \$5 board into \$75 worth of molding in less than 1 minute – an incredible 1,500% return on investment!

3. Making wood molding is NOT DIFFICULT.

If you have at least intermediate woodworking skills, you can make top-quality wood molding. You don’t have to be an experienced woodworker — though experience will help you get started quicker.

4. The Woodmaster does the work.

With Woodmaster’s 4-in-1 capability, adjustable power feed, precision features, and heavy-duty professional construction, rough wood blanks go in — and out comes completely finished molding, smooth as glass in a single pass.

5. A track record of success.

The wood molding business is very solid, mainstream, and stable. Hundreds and hundreds of Woodmaster owners have taken the leap and are reaping the financial and lifestyle rewards of making their Woodmasters support them and their families.

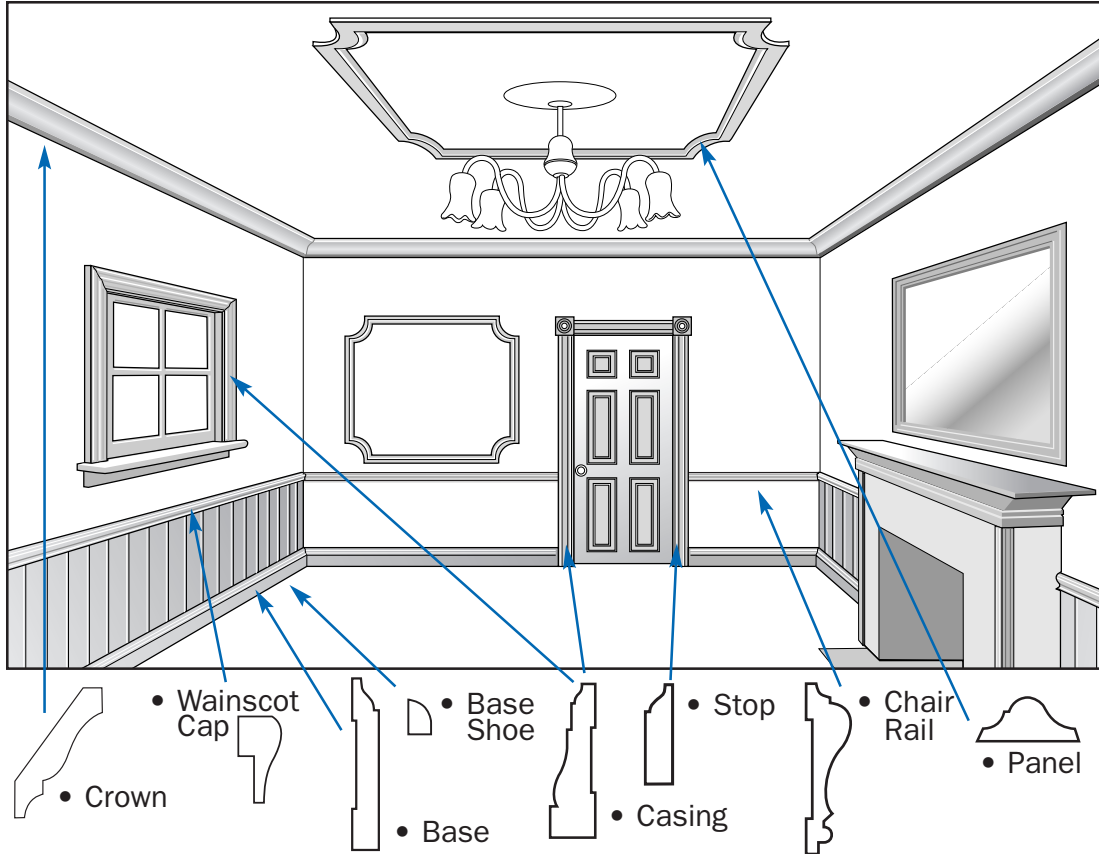

Bread & Butter

Think of molding as your “bread and butter” line. With over 500 molding patterns to try, you’ll never run out of new molding challenges.

But when you’re ready to expand into other lines with your Woodmaster, try some of these — many Woodmaster businessmen have found success with other products, too.

- Cabinetry
- Storage Units
- Signs
- Fireplace Mantles
- Reproduction Antiques
- Antique Repair
- Computer Tables
- Home Office Furniture
- Gun Cabinetry
- Planters
- Musical Instruments
- Picture Framing
- Children’s Toys
- Dog Houses
- Bird Houses
- Baby Cradles
- Quilting Frames
- Furniture
- Sculpture & Artwork
- Boats
- Flooring

SMALL is beautiful.

We are often asked, “How can a one-man shop compete with big molding mills?” Our answer? Running a small shop is a huge advantage. Small shops are more nimble than big factories: you can change pattern knives in a few minutes while the “big boys” can’t afford to re-tool for small orders — change overs might take them days.

Small means small overhead. If your garage or basement becomes your “molding factory,” you don’t have to buy or rent a facility, and chances are you get a tax deduction, too.

Then there’s startup cost. A big industrial mill costs over \$100,000. Your Woodmaster is a true bargain — especially when you consider it turns out a product equal to or better than what the big mills make. Many Woodmaster owners have developed advantageous relationships with big mills: they take on the smaller jobs the big mills can’t handle and everybody wins.

Small also means **PERSONAL SERVICE** which, in today’s too-fast, impersonal world, is a huge asset. **YOU** meet your customers, **YOU** help them solve problems, **YOU** deliver a superior product. And because **YOU** are the company, **YOU** make the profit.

SAFETY FIRST...LAST...ALWAYS

Remember...when you're the boss and the operator, you're the ONLY one who can keep you safe.

21 TRIED & TRUE SAFETY RULES

1. Know When to Wear Gloves

ALWAYS Wear Gloves when handling lumber and changing the Planer or Molder Heads: ALWAYS unplug both the motors when changing heads.

NEVER Wear Gloves when you're operating the Woodmaster.

2. Anything LOOSE is Forbidden

Don't wear anything loose or bulky — that goes for rings or other jewelry, long hair, and beards. Keep shirttails and apron strings tucked in. Wear short sleeves or roll your shirtsleeves up above your elbows.

3. NO Mind-Altering Substances

Don't run equipment under the influence of alcohol or other drugs. And don't forget PRESCRIPTION drugs — though legal, they can make you drowsy and less attentive.

4. Keep Debris Picked Up

Woodworking produces mountains of sawdust, chips, and debris. Keep working areas clean and clear to ensure good, solid footing.

5. Stop Before you get Tired

Getting tired? Stressed? Take a break. Working with machinery when you're out-of-sorts is guaranteed trouble.

6. Stand Off to the Side

When running equipment, don't stand in "the line of fire." Should the machine kick back, you'll want to be alongside...not in front or behind.

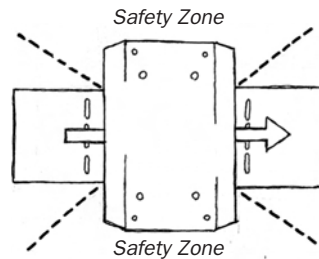

7. Protect your Eyes

ALWAYS wear safety glasses, goggles, or a face shield. It doesn't take a very big wood chip give you a whole lot of trouble.

8. Protect your Lungs, Too

You'll need a Dust Collection system to keep your equipment from getting caked with dust inside and out. Besides that, dust collection systems are the best way to eliminate airborne dust. Face masks are second best. Inexpensive paper masks come in a distant third...but they're better than nothing.

9. Keep all Machine Guards in Place

Let's be honest: it's tempting to remove guards. But don't do it. You'd have to tell your friends you got hurt because you removed a guard.

10. Use Good Lighting

Would you run equipment with your eyes half-closed? Then why would you work under too few lights or lights that aren't bright enough?

11. Keep the Temperature Cool... but not too Cool

Molding production works up a sweat so you can keep the shop thermostat down and still be quite comfortable. But don't overdo it — you can't afford stiff fingers.

12. Sorry, No Kids Allowed

The best rule is "No Kids Allowed." Kids are great, but kids and sharp things don't mix.

13. No Customers Allowed, Either

Perhaps you'll show off your shop to a customer when you're not working wood. But never while you're working: it's too distracting and dangerous for both of you.

14. Limit Your Liability

If banning kids and customers from your shop seems harsh, consider the legal nightmares you'll face if someone gets hurt. "Employees Only" is best.

15. Use Push Blocks & Push Sticks

Why do you suppose they invented Push Blocks & Push Sticks? Do you really want to find out by pushing wood without them?

16. Guard your Hearing

High-RPM motors in a closed space can be deafening...literally. Use ear plugs or "muffs." Hearing loss is cumulative and permanent.

17. Keep a First Aid Kit in Easy Reach

Buy a good kit and mount it where you can easily grab it. Refresh the contents periodically.

18. Install Fire Extinguishers

These are the cheapest insurance you can get. Get more than one, bigger than you need, rated for all types of fires. And mount them where you can get them AND get out of the shop.

19. Always put Safety First

Don't take safety for granted. Always ask, "Am I SAFE doing this?"

20. Read the Owners Manuals

Take a few minutes to read the operator's manual for any machine that's new to you. And review the manuals periodically, just to stay on the safe side.

21. Pass it On

Your personal safety is not your only responsibility as a pro. Show others, by your words and actions, how they can work safely, too.



“Our two families make a good living”

**Business runs on
5 Woodmaster
Molder/Planers**

“My partner and I own 5 Woodmaster Planers. One's set up for planing, one for curved molding, and the others for straight molding. We do a lot of custom woodworking and millwork manufacturing.

They don't break.

Our 718 paid for itself in 3 months. We've run over a million lineal feet through it and we've replaced just 4 bearings, 4 springs, and 2 washers. That's it — they don't break. If you have just the Woodmaster and a table saw, you could make a living making molding. Our two families are making a good living.”

— James Tolley,
Black Hawk SD



THE NUTS & BOLTS OF SETTING UP YOUR BUSINESS

Manufacturing miles of glass-smooth, cabinet-grade molding is just one part of business success. Running your business successfully is the bigger challenge — and setting it up right is the place to start. Heed these tips from Woodmaster owners who run molding businesses. They learned the hard way so that you won't have to.

Pro Tip: **Business Set-Up IS NOT Complicated!**

Don't be put off by our suggestion to tap into lawyers, CPAs, and licensing while setting up your businesses. Thousands of Woodmaster owners just like you have done it and you can, too. (We'll bet you \$5: Once you get your business structure set up, you'll say to yourself, "Hey, that wasn't so bad!")

Stay Small

Sometimes "bigger is better" but not in the operator-owned molding business — at least not at first. Staying small keeps overhead low, minimizes your risk, avoids employee hassles, and gives you tax advantages. It won't take much work to keep your small shop busy and you don't need big volumes to make big profit margins. Especially if you strictly avoid extra overhead like rent and employee salaries and benefits.

Building a business is going to take some time so don't quit your day job until your business is solidly up and running. The smartest approach is to think of your new molding business as a weekend-and-evening sideline and develop it over time. After all, your current job gives you stability, a regular income, and benefits. Buying your own medical insurance is EXPENSIVE these days and you're going to need a steady workflow to pay for it and all your other expenses.

Give yourself time to learn to use your Woodmaster Molder/Planer, learn to get and keep customers, learn to price your molding, and so on.

No Partners & No Employees

The simplest business is a sole proprietorship — just you, no partners. If you have no employees, you'll never have to worry about hiring, firing, salaries, benefits, withholdings, sick days, or social security.

But what if you get more work than you can handle?

Subcontract it to other woodworkers who'll work in their shops and bill you. That way, they're not your employees so there's no withholding etc. and every penny you pay them is deductible from your taxes.

Under the Table? No.

Some small businesses think they can work "under the table" — cash only — and avoid taxes without getting caught. We strongly encourage you to be "above board." You'll find there's enough money to be made in molding that you can be 100% "legit" and still enjoy a higher income. And you'll sleep better at night.

Lawyer & CPA

Check out your business setup with a lawyer. Have a CPA do your taxes. Business law and taxes are different than homeowners are used to.

Licensing

Depending on local laws, you may need a business license. Ask your lawyer and/or look in your phone book under "Business Licenses." You'll also need a Sales Tax License through your state so you can buy at wholesale prices...and because you're obliged to collect sales tax on goods sold.

Be sure to learn when and how you have to turn in taxes you've collected. Check out the details: in some states, if you make and install moldings, your customers pay taxes on your molding's wholesale price. But if someone else installs it, they pay taxes on your molding's retail value.

Make your Business Name Simple & Memorable

If people can't remember your company's name, they can't pass it along to their friends. Worse, if they can't pronounce your name, they won't even try. Name your business something that's simple, memorable, and related to what you do. What's wrong with "Dave's Custom Molding"?

Establish a Reputation for Excellence

To be a pro, you've got to be professional and that's more than just making high-quality molding. When you quote a price or promise a delivery date, stick to it, even if you lose a little money or have to work overtime. In time, you'll develop a reputation of dependability and fairness — and an A+ reputation is the straightest path to success.

Bookkeeping 101

Many a business has come to an unhappy end because the owner thought about woodworking and not about bookkeeping. It is CRITICAL to keep business records. Set up business banking accounts separate from your personal accounts. Always pay by check. Always get receipts. Keep all records. Total up expenses and income at least monthly so you know how your business is doing.

You can set up your own paper-and-pencil bookkeeping system, get a bookkeeping system at a bookstore, or buy software like Quickbooks® or Quicken®. Many small businesses hire a bookkeeper an hour or two a month. If you keep good records, your bookkeeper can sort it all out and give you regular reports on your financial status.

Business Cards & Work Forms

Spend a few hours and a couple of bucks at a local printer. Have him make business cards — these are among the best forms of advertising and certainly the least expensive.

Print carbon Work Order forms with room to write the details of each order including the agreed upon price. Put in spaces for you and your customers to sign. Give them the copy and keep the original. Print Invoices, too, so when it's time to bill, you've got something to send. See p. 12 & 23 for a lot more information on marketing including sample forms your printer can work from.

Deposits

You don't want to make a custom order then have the customer refuse it. Charge a 30% to 50% non-refundable deposit before you start a custom order. If they cancel, they lose the deposit. This is standard practice and gives you money up front to buy materials so you don't pay out-of-pocket. It also makes the customer much less likely to cancel.

Quantity: 280

Price: \$600

Deposit: \$200

COD: \$400

Signatures:

X William Smith

Customer:

X Joe Jones
Joe's Custom Wood Molding

Put it in Writing

Use your Work Orders to put all the detail of each order in writing. Both you and your customer get a copy so there can be no confusion later.

COD

It's great to be a nice guy, but you've got to make a living. Our best advice: specify COD — cash on delivery — on every Work Order. Don't give molding to anyone who promises to pay you "later." Because customers don't want to lose their deposit, they will come up with the balance. And if they don't, you've got the molding and the deposit.

Further, have your customers come to you to pick up their orders: it saves you time, travel, and gas money.

7-Point SUCCESS POLICY:

1. Be honest
2. Work hard
3. Do excellent quality work
4. Deliver on promises
5. Require a deposit on every job
6. Require a signed Work Order on every job
7. No exceptions to the above

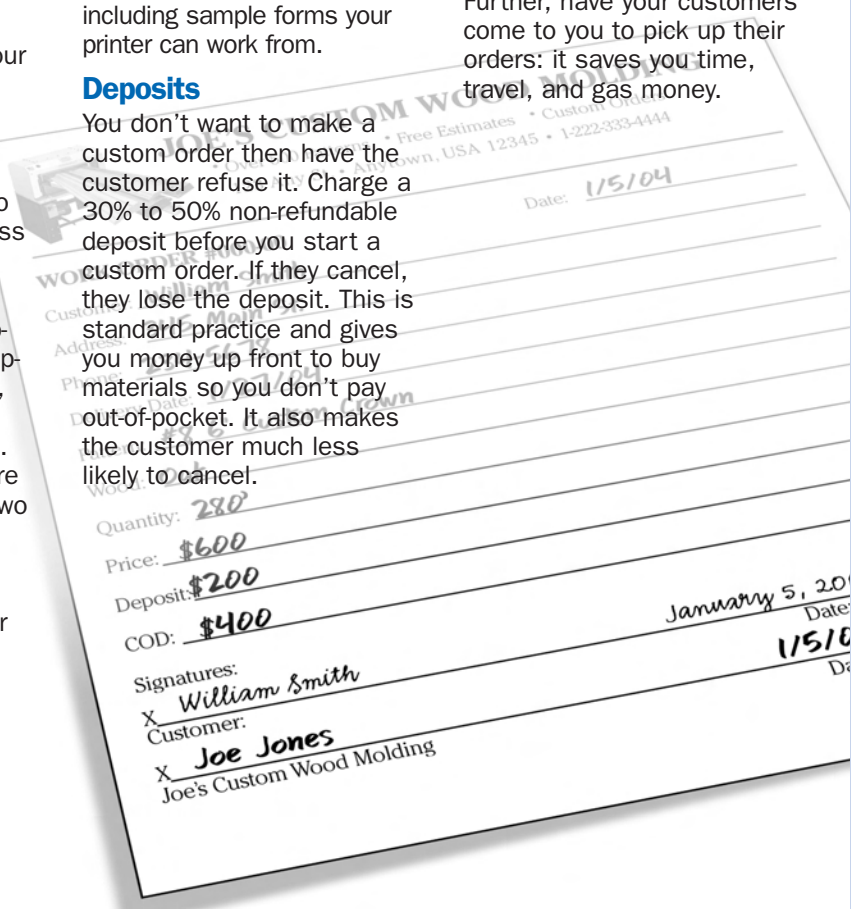

"I'M MAKING A PRETTY PENNY IN THE MOLDING BUSINESS"

Ray's MOLDING BUSINESS SUCCESS TIPS:

- Don't charge a setup fee
- Make molding samples in various woods
- Print up price sheets
- Charge less than others
- Market yourself in the beginning
- Don't charge for delivery
- Charge the customer 1/2 the cost of a custom knife and keep the knife

Selling molding to Ace® Hardware and more

"We were in the wood cabinet business for about 13 years but it's very competitive and I wanted to find a different niche. There are a lot of molding businesses, too, but if you know how to market molding, you'll do well. When I started, I wasn't sure I could make a living but now I have no trouble. I'm about 20 - 25 cents cheaper than everybody else but I'm making a pretty penny.

No Competition

When it comes to the final product, I have no competition: I'm picky and the Woodmaster is wonderful. I like our Woodmaster 718 Planer/Molder. I wanted 18" so I could run one molding pattern on one side, another pattern on the other. I have their Mop Sander, too; I think it's the best attachment they've ever made. I sanded 10' of pine in just 45 seconds!

Low Investment

The machine has paid for itself and does more than I'd expect. It's perfect for the things we need to do. We've done well with it and I intend to get three or four. Why Woodmaster? Affordability and reputation. It's awesome to work with. I haven't had a bit of trouble and every time I call Woodmaster I get a real person, not a machine. It's a good investment when I can make a living with an inexpensive machine like this.

In the molding business, I'm a small fish in a big pond and I like it! I'm a one-man shop selling against Georgia Pacific®. Sometimes my wife helps me plane and I have a part-timer but I like challenges. We recently did the custom moldings for our county courthouse. Woodmaster got my custom knife out to me fast. We're discussing making curved molding. I supply four Ace® locations with casings, baseboards, and shelf edges and they want me to expand what I do for them. I charge \$1.70/foot for molding others charge \$2.85 - \$4.50 for.

Ecstasy is Earning a Living at Home

Even when times are tough, there will always be building so molding will always be needed. You can eventually make pretty good money in molding. My business supports itself: by mid-month the bills are paid. I'm ecstatic. I started this business so I can be a husband and father and pick up my daughter if she gets sick. I can be at home and make a living.

- Ray Z., FL

He's partially disabled and says,

"MY WOODMASTER HELPED ME MAKE MONEY I COULDN'T HAVE MADE OTHERWISE."

"I've worked with wood all my life. I do specialty work: repairing antiques, building oak stairways, things like that. I'm partially disabled and my Woodmaster has helped me make a lot of money I couldn't have made otherwise. It surely has helped me make a living. It's a fine machine, I have no complaints. It's everything Woodmaster says it is.

Variable feed rate makes the difference

The variable feed rate was a big selling point for me. Here's what sold me: they're sturdy, strong, and just work well. Raising and lowering the sanding height is so precise it doesn't have any play at all.

When imports started coming over, everyone was raving you couldn't afford to buy American anymore now that these were so cheap. Well, that's what they are: cheap. Put a wrench on a nut and it'd strip. I learned early to buy American whenever I could. The closer to home the better - the quality control is better here. My advice? Woodmaster is easy and simple to use and good quality. Good for the beginner and old timer."

- John Carlson, Vergas MN



"When imports started coming over, everyone was raving you couldn't afford to buy American anymore now that these were so cheap. Well, that's what they are: cheap."

“OPENED UP A NEW LEVEL OF WORKMANSHIP.”

"I've been a woodworker for 35 years and have owned a Woodmaster Planer for about 5. It's a very good piece of equipment, very well made. I have no complaints at all, and it has opened up an entirely new avenue for me.

I used to depend entirely on buying planed, finished, surfaced hardwood. That locked me into buying either 4/4 or 8/4 - whatever the lumberyard had. With my Woodmaster, I can machine down a piece of wood to the thickness I need.

I have the 18" planer so I can plane wood up to 18" wide. Plus, I have the capability to make my own moldings. It has actually opened up a level of workmanship that was totally unachievable before.

Variable feed rate

There are always people who'll say 'I got a Grizzly®' or 'I got a Jet® for \$800' - well, it's not the same tool. I can take whatever depth cut I need to take, then I can massage the exact feed speed with the independent feed motor. That's really important when you get burled walnuts or highly figured woods. That variable feed rate is amazing. If you want a true test of Grizzly®, Delta®, or Jet® vs. a Woodmaster, just put a piece of highly figured wood through each and see what happens.

Custom knives

I do like being able to order custom planer knives through Woodmaster. That's useful for home restoration: custom baseboards, cove molding - the machine is perfect for that. Other than one faulty roll pin, absolutely nothing has gone wrong. It does everything I want it to do.”

- John Wilker, Huntington Beach, CA



MARKETING: SELLING WHAT YOU MAKE

MARKETING what you make is what makes the cash register ring. Marketing is essential, but it's not all that difficult. Follow these guidelines and you'll do just fine.

Pro Tip:

ASK FOR THE ORDER!

Don't be shy. A salesman has to ask for the order 5 times, on average, to close the sale.

Pro Tip:

Be a "1-Stop Shop"

Set yourself up with matched sets of knives for colonial, modern, and streamline molding styles so your customers can get everything they need from you. What's a matched set? Same-style knives for base, casing, crown, and chair rail.

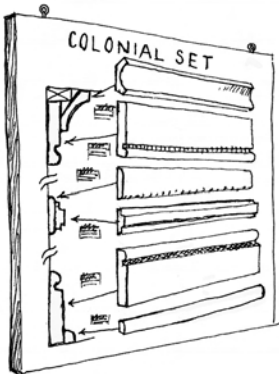

Know What You're Selling

If you think you're selling molding, you're only partially right. When you're the owner/operator/salesman, you're selling YOURSELF. Your customers will say "yes" or "no" depending, at least in part, on the impression YOU make. So, be professional in your actions, attitudes, policies, and appearance.

Develop Sales Leads

A good salesman knows his customer. Who's your customer? More people and businesses use molding than you may think. Check these listings in your local phone book and make a list of businesses, addresses, and phone numbers. Check your local Chamber of Commerce listings, too.

- Artists Materials — Frames
- Bathroom Remodeling
- Building Materials — Retail, Wholesale
- Cabinets
- Cabinetmakers
- Contractors — General, Remodeling, Repairing
- Carpenters
- Craftsmen
- Doors — Retail, Wholesale, Manufacturers
- Floors — Laying, Refinishing, Resurfacing
- Floor Materials — Retail, Wholesale, Manufacturers
- Hardwoods
- Home — Builders, Remodelers, Improvements
- Household Equipment
- Interior Decorators & Designers
- Kitchen Cabinets
- Lumber — Retail, Wholesale, Manufacturers
- Millwork
- Molding
- Photographers
- Picture Frames — Retail, Wholesale, Manufacturers
- Railings
- Stair Builders
- Store Fixtures
- Wood — Doors, Windows, etc.
- Woodworkers
- Woodworking

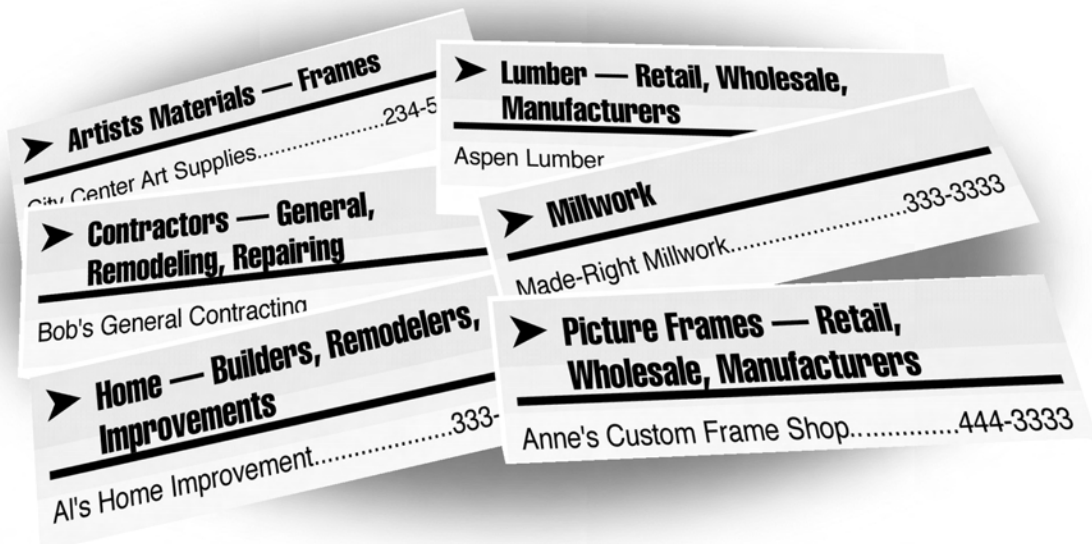

Start Prospecting

To get business, you have to start contacting your list of leads. We suggest writing potential customers...then calling to set up an appointment...then visiting them. Don't give up too soon: it may take you several calls before you end up sitting in "Mr. Big's" office.

Develop Long-Term Customers

Once you get an order, bend over backwards to give your customer excellent service. Do what you need to do, within reason, to win repeat business. The ideal is to have a few steady customers you can count on.

But even when you've got long-term, loyal customers, don't stop prospecting for new business: even the best customers don't last forever.

Pricing & Discounting

Visit every lumberyard and lumber dealer in driving distance to get an idea of the going rate. Knock off a few cents — you can afford to, since your overhead is low — and you've got your retail price.

You can sell at retail or discount to get customers. The bigger the customers' order, the bigger the discount — perhaps up to 5% or 8% off your retail prices.

Saving Customers Money is Good for YOU

It's always a good idea to look for ways to help your customers save money. Here are two ways: Customers can save if they supply you with materials. They can save even more money if they supply it cut into blanks, S4S (surfaced four sides). Charge them half-price for moldings when they supply S4S blanks; they'll save about 25% off your regular price. They pay less for finished products, and you make more per hour by not having to do the prep work on raw materials. And you earn their trust, too.

Customer Samples

Make 3" long samples of your molding patterns and encourage your customers to take them home. Don't forget to stamp your business name and number on them!

Be a Subcontractor, Too

You'll probably use subcontractors, but somewhere along the line, you'll be asked to mold, plane, sand, or saw material for someone else. That'll make YOU a subcontractor. Charge at least what your subcontractors charge — probably around \$30 per hour. Clock your time in quarter-hour increments and establish a minimum charge of at least \$10.

Good Money: Match Old Patterns

When somebody needs to match a molding, siding, or frame pattern that hasn't been made in 100 years, they're out of luck...until YOU come to the rescue. Cut a section of the pattern and have custom knives made. Woodmaster makes excellent custom pattern knives with quick turnaround using quarter-inch thick M2 steel. We use computer controlled EDM Wire & Water Jet Technology then hand-sharpen each knife for top performance.

Matching old patterns is good work because you can charge a premium price. Build the cost of the knife into the deal and keep the knife afterward. Over time, you'll have an "antique pattern collection" that keeps on earning for you.

Pro Tip:

See p. 23 of this special business report for sample ads you can use to show your printer, newspaper, or sign painter.

Pro Tip:

Make Shop Samples

Make 8" long samples of all your molding patterns. Mount them on wooden backboards, clearly mark each pattern with its name and price, and tack or mount them on the wall.

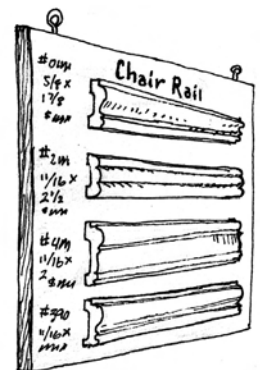

Pro Tip:
“WHERE DID YOU HEAR ABOUT MY BUSINESS?”

Don't forget to ask. It's an easy and simple way for you track where your business is coming from.

NAME YOUR OWN PRICE

When You Make Molding That's SIMPLY UNAVAILABLE at ANY Price!

HIGH-PROFIT: Specialty Woods & Custom Patterns

Lumberyard molding is limited to a few patterns in pine, oak, and not much more. YOU can easily make over 500 patterns with Woodmaster's standard patterns. Or we'll make custom knives that duplicate virtually any antique pattern.

You can make molding in virtually any wood including specialty woods that are simply unavailable at local lumberyards AT ANY PRICE. Work any wood you get locally or online: walnut, ash, cherry, mahogany, mesquite, salvaged old-growth oak, douglas fir, heart pine – you can literally name your own price on these types of molding and/or flooring. You can often quadruple what you paid for the lumber in the first place!

Top Dollar: Make CURVED Molding

Round windows...round-top doors, windows & trim...arch-ways... anything round made of wood is a pricey piece of work. Call for our DVD, “How to Make Curved Molding” by famed woodworker and Fine Woodworking author, Gary Striegler. He shows you in detail how to make all kinds of curved molding with your Woodmaster.

Interior Decorators are Great Business Associates

Cultivate business relationships with local Interior Decorators. They're in the business of redoing homes floor to ceiling — and there's a lot of trim between floor and ceiling. In return for a 10% discount from you, they can give you a lot of business.

If you install your own trim, let the Interior Decorator know. They'll hire you, mark up your fee, and bill the homeowner.

Advertise Wisely

Word-of-mouth is going to be your best advertising. But to get your name out there, you're going to have to advertise. Business cards are dirt cheap when you consider how hard they work to get your name out.

Try placing a small ad in your local “pennysaver” or weekly paper. You'll know pretty soon if the ad is working: when people call, ask them, “Where did you hear about my business?”

When you're a little more established, place a small ad in your local Yellow Pages under “Moldings.” This can be an excellent form of advertising because it makes you look bigger than you are.

Put your business name and phone number on the side of your pickup truck or business vehicle. You can have it painted on or have vinyl letters applied. See “Signs” in your Yellow Pages.



HIS HOBBY BECAME A “6-FIGURE MILLWORK BUSINESS.”

Woodmaster Owner, Gary Striegler, makes the big time.

Gary Striegler of Arkansas bought a Woodmaster Molder/Planer. Shortly thereafter, he told us, “Thanks to my Woodmaster, what started as a hobby skyrocketed into a millwork business worth six figures a year!”

Gary’s gaining national fame as the “Guru of Curved Molding” that he makes with his Woodmaster. Read his article in the Jan. 04 issue of Fine Homebuilding Magazine where he reveals his secrets.

“When I saw my first piece of curved stain-grade casing, my carpenter’s heart did backflips. Many years of trial and error (OK, lots of error) have led me to the method I still use today. I use a Woodmaster [Molder/Planer] that retails for \$1,500.”

Reprinted by permission of Fine Homebuilding.



SETTING UP A PROFESSIONAL SHOP

Before you hang your shingle, let's take a look at the shop space and setup you're going to need to bring home the bacon.

Pro Tip: LOCK IT

Lock your shop. Lock up your small tools and knives. They "walk" easily and are expensive and time-consuming to replace. Think about theft insurance, too.

Work at Home

Hands down, the best shop location is a garage or similar-size building you already rent or own. Why? You don't have to buy or rent extra space...you don't have to travel so you save time and money...you get a tax deduction...you can work when you want, day or night...and you can go home for lunch or to take a nap!

What about your basement? Works for some, but many a basement-woodworker has a wife who has fits about sawdust and noise. If home is a no-go, next best is an industrial building nearby or even a friend's garage.

NECESSARY SHOP FACILITIES

Your shop doesn't have to be a palace, but it does have to have certain things:

Minimum Requirements:

- Must meet zoning requirements
- Lots of electrical outlets
- 110V and 220V electrical service
- Lots of lighting
- Good ventilation
- Solid, level floor
- Open space at least 18' w x 34' l x 10' h
- Dust collection system
- Security — locks (and window grates & security lights if needed)
- Heating & cooling (at least a window fan)
- Bathroom facilities
- Meets zoning requirements

- Driveway access
- Parking for you and your customers
- Telephone with extra-loud ringer or flashing light
- First aid kit & emergency numbers posted

Darn nice to have:

- Sink
- Lots of windows
- Answering machine

Luxuries:

- "Clean room" office with desk
- Internet connection
- Refrigerator

EFFICIENT SHOP LAYOUT

Put your table saw dead-center with the shop's longest wall parallel to the line-of-feed: you want maximum room fore and aft — enough to handle a 16' board on either end. You can "cheat" with a garage door: open it to run long boards through.

Set up your jointer to the left of the table saw and your Woodmaster molder to the right. Place sawhorses between each machine so you can set down molding strips between operations. Voila! You're all set up to joint, saw, and mold with minimum walking and maximum efficiency.

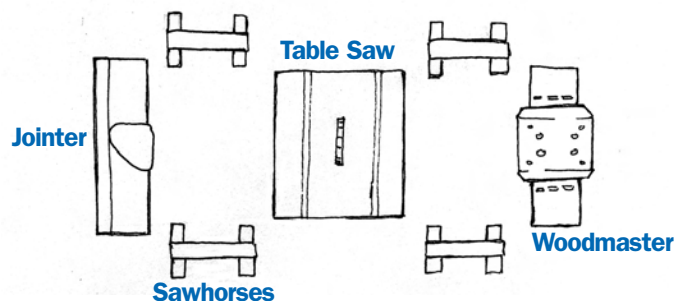

NECESSARY TOOLS & EQUIPMENT

If you're going to be a pro, get good quality, pro-grade equipment. Here are the basics you'll need, right from day 1.

- **Molder** Woodmaster 12", 18", or 25". Also functions as a planer, drum sander, and gang rip saw.
- **Table Saw** 8", 10", or 12". Minimum 1HP, 1-1/2HP is a better choice.
- **Jointer** 4" capacity minimum, 6" is more appropriate. Get one with a l-o-n-g bed — the longest you can find.
- **Dust Collection System** Once you own one of these, you'll ask yourself, "Why did I ever wait so long?"
- **Adjustable Rollers, at least 2** "Extra hands" support materials as you do jointing, sawing, molding, planing. Available from Woodmaster.
- **Chop Saw** A great tool for precise crosscuts and miter cuts.
- **Belt Sander** To smooth flat surfaces on molding. (Unnecessary if you equip your Woodmaster Molder/Planer with its Drum Sander.)
- **Saw Horses, minimum 2** Buy or build saw horses at waist height so you work with minimum bending over.
- **Safety Glasses/Goggles** You only get two eyes, so guard them well.
- **Shop Vacuum** Even if you're not the neatest guy in town, you're going to want to straighten up once in awhile.

DARN NICE TO HAVE

- **Air Compressor** Run all kinds of hand tools, use to blow dust into the next county.
- **Orbital Sander** Nice to tidy up those little areas.

Dust Collection is CRITICAL

Dust collection isn't just to keep sawdust out of your lungs or off your finishes. It's a critical part of professional woodworking.

A powerful Dust Collection System will keep dust and chips from building up in and on your Woodmaster so it'll deliver top performance. Debris-free Feed Rollers keep their grip, reducing danger of kickback. Knives cut better, too, when they aren't fighting mountains of sawdust packed inside your machine.

HE REPRODUCES MOLDING PATTERNS

"I bought my Woodmaster to use as a molder. An antique dealer who sells prints said that if I could make molding for the picture frames, he'd give me a ton of work. Sometimes his old prints are in a cracked or split frame. Often the customer really likes the frame but that pattern hasn't been made in 150 years. I take a section of it and send it to Woodmaster. They make me a knife and I make the picture frame.

I'm a 100% Woodmaster fan, I own a Woodmaster Drum Sander, too. If you're considering a Woodmaster, here's my advice: don't even think about it. Just go buy one."

— Bruce Bell,
San Francisco CA



PRODUCTION EFFICIENCY

Now that your business and shop are set up, you're ready to start producing molding. And since you're now a PRO, you'll want to do it like the pros do.

Here's how!

Pro Tip: SMALL SHOP TIMESAVER

Until you get some history, you can't anticipate what molding patterns to make and in what quantities. That puts you in the time-consuming spot of having to start each job from scratch. Here's a solution: Every molding run starts with a board that has one edge jointed. So, joint a bunch of edges ahead of time and you'll get a faster start on your orders.

Pro Tip: CHECK TIGHTNESS

Always tighten the Molding Head after final adjustment...and during production runs.

1. **Joint** one edge of a board straight. Kiln-dried lumber is always best.
2. **Plane** the board to within $1/32$ " of the thickest portion of the finished molding. Patterns which involve a cut on both sides (crown, bed, and picture moldings, etc.) should be planed to within $1/16$ " of the finished molding thickness. This will allow $1/32$ " for each pass.
3. **Measure** the width of the finished molding. If the knife involves parting legs, add $1/16$ to this width ($1/32$ " for each side).
4. **Rip** as many blanks as you need. To speed the process, you can set up your Woodmaster as a Gang Rip Saw with 2, 3, or even 4 blades.

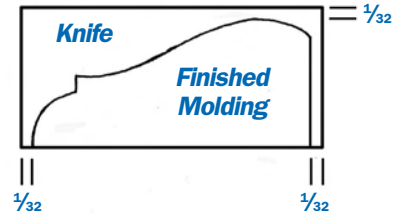

Now that you've made perfect blanks...

Stack your blanks on sawhorses placed conveniently between your saw and your Woodmaster. Install your Pattern Knife in the Woodmaster's Molding Head. Run a few scrap pieces through, adjusting bed height and Feed Rate as necessary, until you get the perfect profile.

Set up one Adjustable Roller stand at the infeed and one at the outfeed. Check everything, double check, and lock everything down tight.

Run blanks through one at a time, supported at both ends by Adjustable Roller stands. Stack finished molding on sawhorses. When you've run all your strips, vacuum or blow dust off the finished molding.

Why PRECISE WIDTH & THICKNESS are CRITICAL:

Try it yourself: try installing two pieces of molding that vary slightly in thickness. What a hassle! Your Woodmaster can give you 100% precise width and thickness. Careful adjustment is up to you.

W-I-D-E-R Moldings: Avoid Cupping With Back Relief

Wider moldings like baseboards, casings, and chair rails should have "back relief" (or "back-out") to keep them from cupping before or after installation. Cut back relief with the grain to avoid tear-outs. Use a Back Relief knife from Woodmaster (or grind your own from an old planer knife) BEFORE molding the face.

What's "with the grain?" Sight down your board and you can see the grain. It meanders through the wood, up and out at some point. You want your board to travel in the same direction the grain flows.



FLAT-FACE MOLDINGS: Sand Flat Surfaces for Stain Quality Finishes

Flat profiles may not be molded...but they should be sanded so they'll take stain evenly.

Base boards and many other patterns include flat spots. Often, your knife profile cuts only the "shaped" parts. Even though your Woodmaster can produce a smooth, flat surface with a minimum of mill marks, the flat surface should be sanded. That'll remove any lingering mill marks and make the entire surface - flat and shaped - take stain the same way.

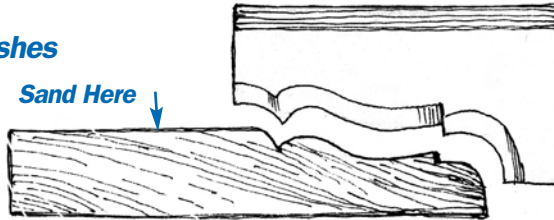

What's Your Line — Solid or Finger-Jointed Molding?

Multi-piece, finger-jointed molding is typically made of pine and is meant to be painted.

Higher quality, more expensive solid, one-piece molding is generally made of hardwood and is meant to be stained. You'll find, however, some customers want to paint solid molding because hardwood doesn't dent and scratch as pine does.

Finger-jointed molding is lower quality. Though it effectively utilizes small pieces of wood that may otherwise be wasted, jointing equipment is pricey, takes up shop space, and takes manpower to run. So costs to manufacture finger-jointed molding are high and returns are low.

Our suggestion: don't bother with finger-jointing unless you've got tons of time and money. Most molding manufacturers favor solid oak molding, though many use poplar, willow, or other native woods that are harder than pine. Grade your molding as "Paint Grade" or higher-profit "Stain Grade."

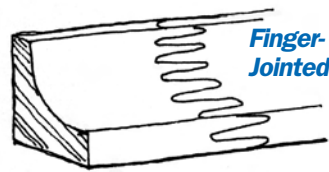

A Note About BED BOARDS

Your Woodmaster's Bed is cast iron and runs up and down on four acme-threaded screws. The BED BOARD is a piece of wood, particle board, or synthetic material secured to the Bed. This is your insurance against having knives contact cast iron. Mount Guide Strips to your Bed Board.

Woodmaster's "SuperSlick Bed Board" features a smooth, low-friction surface and easily adjustable Guide Boards.

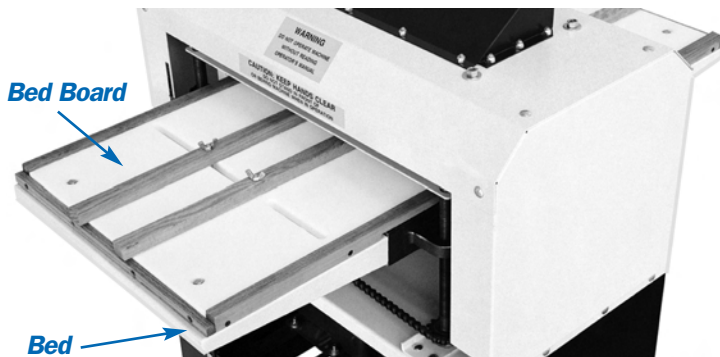

Pro Tip: QUICK SWITCH

If you're running single Pattern Knives and Balance Weights in the 3-slot Planer Head, you can switch between surfacing and molding quickly: replace the Pattern Knife with a Planer Knife or vice versa. (Don't forget to adjust Balance Weights if necessary!)

Pro Tip: KEEP TRACK

Save a sample of every run. Mark it with the customer's name and what you charged per foot. Use these samples when he orders again: you'll know exactly what he ordered, what he paid, and you can use the piece to set the molder to the EXACT thickness as the first order.

OVER 500 STOCK PATTERNS TO CHOOSE

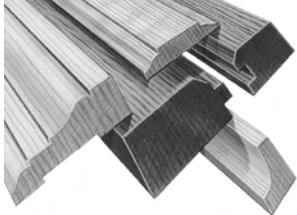

Woodmaster stocks over 500 standard patterns. Call for your FREE Pattern Book.

CUSTOM Patterns, too!

Match virtually any molding ever made. Send Woodmaster a molding sample to match and we'll make you the knife at reasonable cost.

Using & Maintaining Pattern Knives

Most Pattern Knives come as a single blade with a Gib to mount in Woodmaster's Wide Knife Holder. Other patterns, like Log Cabin Siding, take off a lot of wood and knives come in sets of three. Mount them in the 3-slot Planer Head.

You can save money on single knives by running them in the 3-slot Planer Head. Place Knife and Gib in one slot and put balance weights in the two empty knife slots.

You'll eventually own an excellent collection of pattern knives. Keep them locked up because they're quite valuable. Clean them after every use and store them safely in a box or cabinet, separated from one another in individual compartments or etc. NEVER let your knives come in contact with metal.

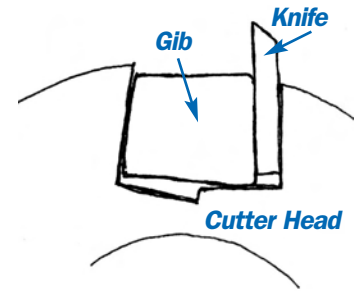

Roller Care

One of the Woodmaster's great strengths is its variable speed Feed Rollers. If grain is "wild" or otherwise difficult, run the wood through slowly: you'll get a better finish.

Feed Rollers may sometimes get coated with dust or pine pitch. Blast them clean with an air compressor or use a stiff brush.

Take a Swipe at Snipe

"Snipe" is an overcut or thinning of the stock at the end of the board, created when long boards are improperly supported. Always use Rollers to keep the workpiece at the same level as the Woodmaster's bed.

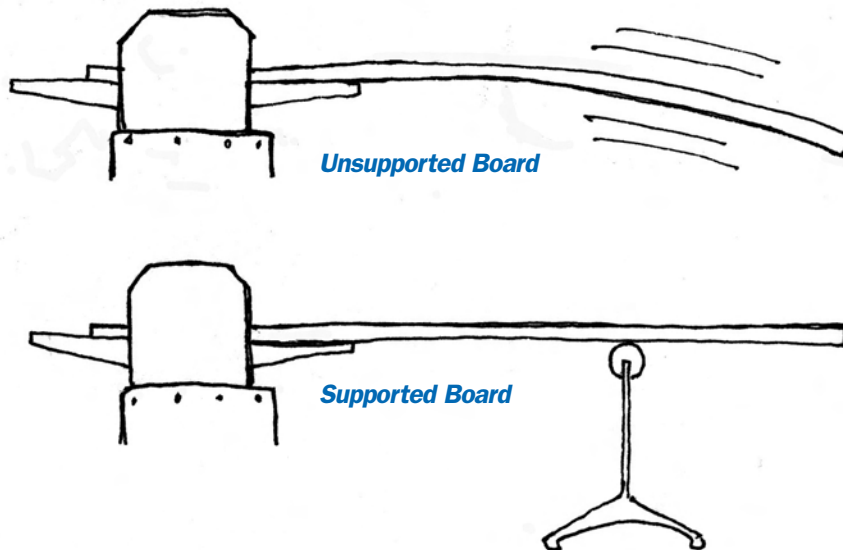

Storing Lumber & Molding

• Lumber

Store lumber flat and horizontal...but off the floor since dry wood will draw moisture and can warp. Keep lumber off the floor with a piece of 2 x 4 every three or four feet.

• Finished Molding

Stand molding upright, on end, to store it. You can make a simple rack to keep styles or lengths separate. This is an attractive, space-conserving way to display your wares.

To safeguard the quality of your work, tie or tape pieces face-to-face to prevent surface marring.

He knows first hand...

“A LOG CABIN CALLS FOR A LOT OF CUSTOM MOLDING.”

"I don't know what I would have done without my Woodmaster. I enjoyed making my own moldings for our log home we built ourselves. As you can imagine, trimming a log home calls for a lot of custom trim . We've received more compliments on our trim than most anything else in the home. Now I'm doing favors for friends - picture frames, mouldings - and making molding for my brother-in-law. I might add that your knives are fantastic!"

- Herman Johnson - a satisfied customer



SUCCESS BOOSTERS

Here are a few shortcuts to getting yourself set up with the cards, forms, and ads you'll need. Simply take these to a local printer or quick-print shop and ask them to try a few designs along these lines.



Sample Business Card



Sample Work Order





JOE'S CUSTOM WOOD MOLDING

• Over 500 Patterns • Free Estimates • Custom Orders
123 Any St. • Anytown, USA 12345 • 1-222-333-4444

WORK ORDER #000-00 Date: _____

Customer: _____

Address: _____

Phone: _____

Delivery Date: _____

Pattern: _____

Wood: _____

Quantity: _____

Price: _____

Deposit: _____

COD: _____

Signatures:

X _____ Date: _____

Customer:

X _____ Date: _____

Joe's Custom Wood Molding

Sample Newspaper Ads

Classified Ad:

Joe's Custom Wood Moldings -
Top quality, custom-made wood moldings
FAST! Will match ANY pattern. Free
Estimates, Insured. References on request.
1-222-333-4444

Small Display Ad:

JOE'S CUSTOM WOOD MOLDING

- Over 500 Patterns
- Free Estimates • Custom Orders



123 Any St. • Anytown, USA 12345

1-222-333-4444

"Clip Art"

Your print shop can use this artwork
on your cards, forms, ads, etc.

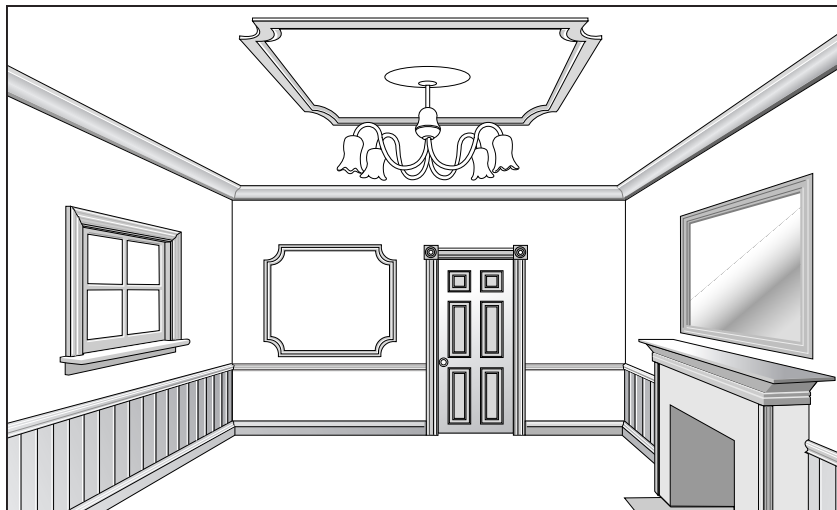
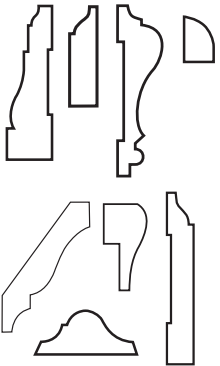
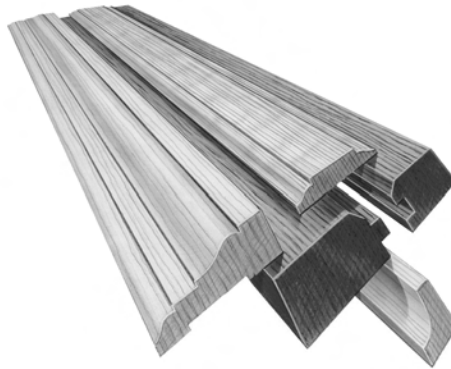
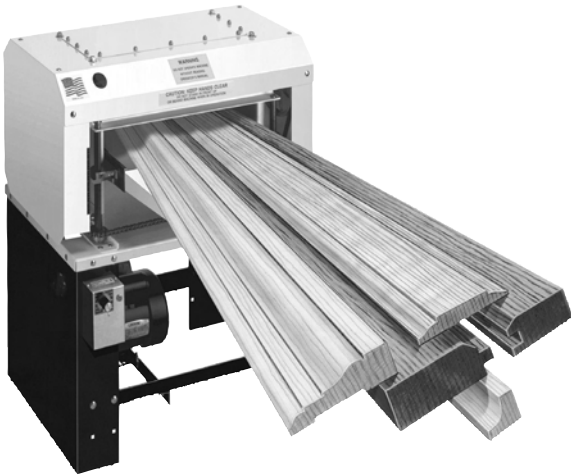

Woodmaster
TOOLS, INC.

We asked Woodmaster Molder/Planer Owners, “WHY DID YOU START YOUR OWN CUSTOM MOLDING BUSINESS?”

...and here are their 10 most common answers:

1. “I earn a good living doing what I love — woodworking.”
2. “I work the hours I want – when I want, as long or short as I want.”
3. “Getting into business with a Woodmaster was easy and affordable.”
4. “I get tax breaks on wood, tools, supplies, and the Woodmaster itself.”
5. “Molding practically sells itself. Mostly what I have to do is make it.”
6. “You never get rich working for someone else. I increased my income right from day one.”
7. “I can turn down projects if I don’t want them. I’m the boss.”
8. “Owning a woodworking business is challenging and rewarding.”
9. “It’s different every day.”
10. “My business rises or falls on my skills and abilities – nobody else’s. I’m the bottom line.”

Bruce Bell reports,
“He said if I could make moldings, he’d give me a ton of work.”

See p. 17



Gary Striegler confides,
“Woodmaster skyrocketed my millwork business to six figures a year!”

See p. 15



Herman Johnson knows,
“A log cabin needs a lot of custom molding.”

See p. 21



James Tolley says,
“Our two families are making a good living,”

See p. 7