

TOPIC 1

GENERAL PHYSICS

UNITS OF MEASUREMENT:

Measurement means comparing any physical quantity with a standard to determine its relationship to standard. This standard is called unit. All measurable quantity expressed in

- a) some number or magnitude and b) some unit

For example if the distance is 200km, 200 is the number or magnitude and km (kilometer) is the unit.

Systems of Units:

There are three major systems of units.

1. M.K.S. system: **m**eters – **k**ilogram – **s**econd system used internationally. This system is also called SI (system international) units.
2. F.P.S. system: **f**oot – **p**ound – **s**econd system use by British.
3. C.G.S. system: **c**entimetre – **g**ram – **s**econd system use by French.



Measurement of physical quantities – base units:

Length or distance (s):

The base unit of length or distance is meter (m). It is define as:

The meter is the length of the path travelled by light in vacuum during a time interval of 1/299 792 458 of a second.

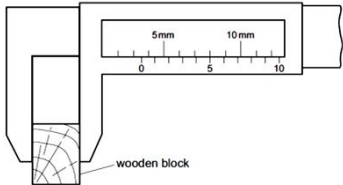
The measurement of length is used to calculate the:

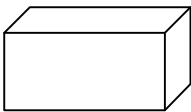
<p>i. thickness of a thin wire using vernier calliper. (The precision of length measurements can be increased by using the devices that use sliding vernier scale.)</p>	
<p>ii. area of square or rectangle = length and breadth</p>	
<p>iii. area of triangle = 1/2 base x height</p>	
<p>iv. volume of cube = length x breadth x height</p>	

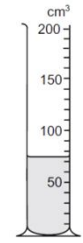
v. volume of liquid = height in calibrated measuring cylinder	
---	---

Mass (m):

It is the measure of the quantity of matter in an object and its unit is kilogram (kg) in SI units. It depends on the number of molecules in the matter and their masses and does not depend on gravity. Therefore an object would have same mass on Earth and on the Moon but different weight because of the change of gravity. Gravity on the moon is $1/6^{\text{th}}$ of the gravity on earth. Mass of an object can be measured by using spring balance (newton-meter), top pan balance or lever balance. The international definition of mass is

It is equal to the mass of the international prototype of the kilogram made up of platinum-iridium alloy kept at international bureau of weights and measurements in Paris.

Time (t):

It is the ordering or duration of events. The unit of time is second (s) which is defined as:

the particular frequency of electromagnetic spectrum given out by the common type of caesium atom.

The common devices to measure the time or duration of an event are clock and stopwatch. In stopwatch, each second is calibrated into one hundred part of a second called centisecond. The precision of time duration of an event can be improved by measuring the time for number of events and dividing time by total number of events. For example to measure the time period of a pendulum the time for ten swings should be recorded and dividing the total time by ten to get the time for one swing.

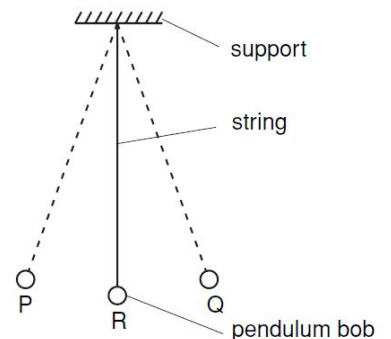
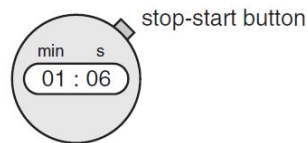

SPEED, VELOCITY AND ACCELERATION:

Speed:

Average speed is defined as the distance covered by an object in unit time.

$$\text{average speed} = \frac{\text{total distance covered by an object}}{\text{total time taken}}$$

$$v = \frac{d}{t}$$

The SI unit of speed is meters/second (m/s) and it has no definite direction.

Velocity:

Velocity is defined as the distance travelled by an object in specific direction in unit time.

$$\text{velocity} = \frac{\text{distance travelled in specific direction}}{\text{time taken}}$$

Distance moved in specific direction is called displacement therefore the above equation can be written as

$$\text{velocity} = \frac{\text{displacement}}{\text{time}}$$

$$\vec{v} = \frac{\vec{s}}{t}$$

s = the displacement in meters (m)

t = total time in seconds (s)

v = velocity, the SI unit of velocity is meters/second (m/s)

The object is said to be in linear motion if it moves in straight line.

Acceleration:

Acceleration is the change of velocity of a body in unit time.

$$\text{Acceleration} = \frac{\text{change in velocity}}{\text{time taken for the change}} \quad \text{or} \quad a = \frac{v-u}{t}$$

Where u is the initial velocity and v is the final velocity. The SI unit of acceleration is meters per second square (m/s^2). Acceleration is positive if the velocity is increasing and negative if the velocity is decreasing and this is called retardation or deceleration.

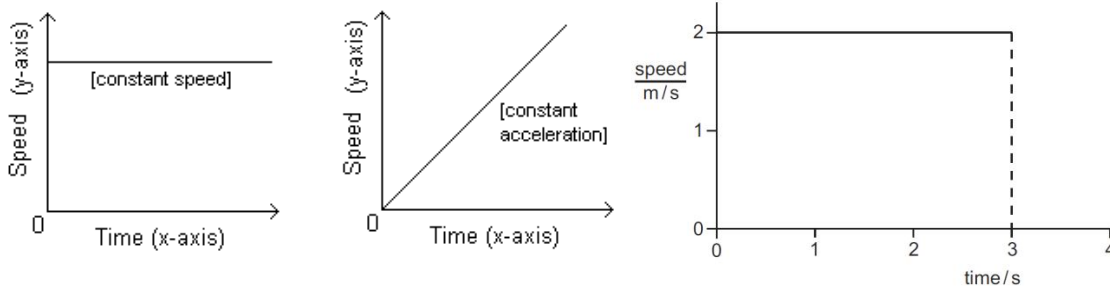
Graphical representation of velocity, acceleration and distance:Velocity – time graphs:

- The curve line in speed time graph means that the object is moving with non-uniform acceleration. The acceleration at any point is the gradient to the tangent at that point.
- In velocity-time or speed-time graph the area under the graph is total distance covered by the object.
- In velocity-time or speed-time graph the gradient of the line is acceleration.

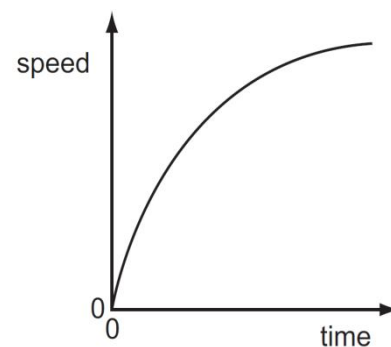

Distance – time graph:

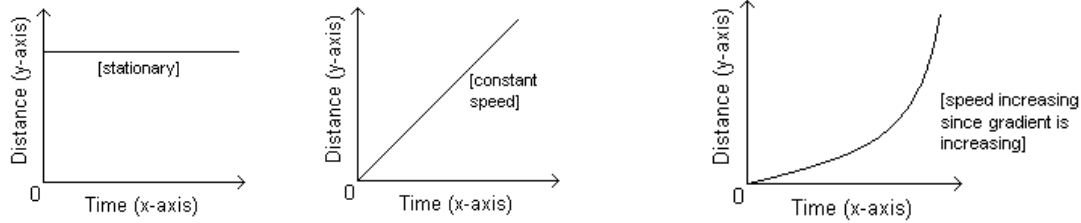

Terminal Velocity:

The terminal velocity of an object falling towards the earth, is the speed at which the downward gravitational force 'w' (i.e weight) is equal and opposite to the air resistance which is pushing it upwards which means that there is no net force and therefore no acceleration. At this speed, the object does not accelerate and falls at constant speed. The terminal velocity whose value depends upon the size, shape, volume and weight of the object.

For example, the terminal velocity of a skydiver in a normal free-fall position is at a certain point when his weight is equal to air resistance.

The reason an object reaches a terminal velocity is that the air resistance is directly proportional to the square of its speed. At low speeds the air resistance is much less than the gravitational force and so the object accelerates. As it speeds up the air resistance increases, until eventually it equals the weight. The diagrams below explain the situation

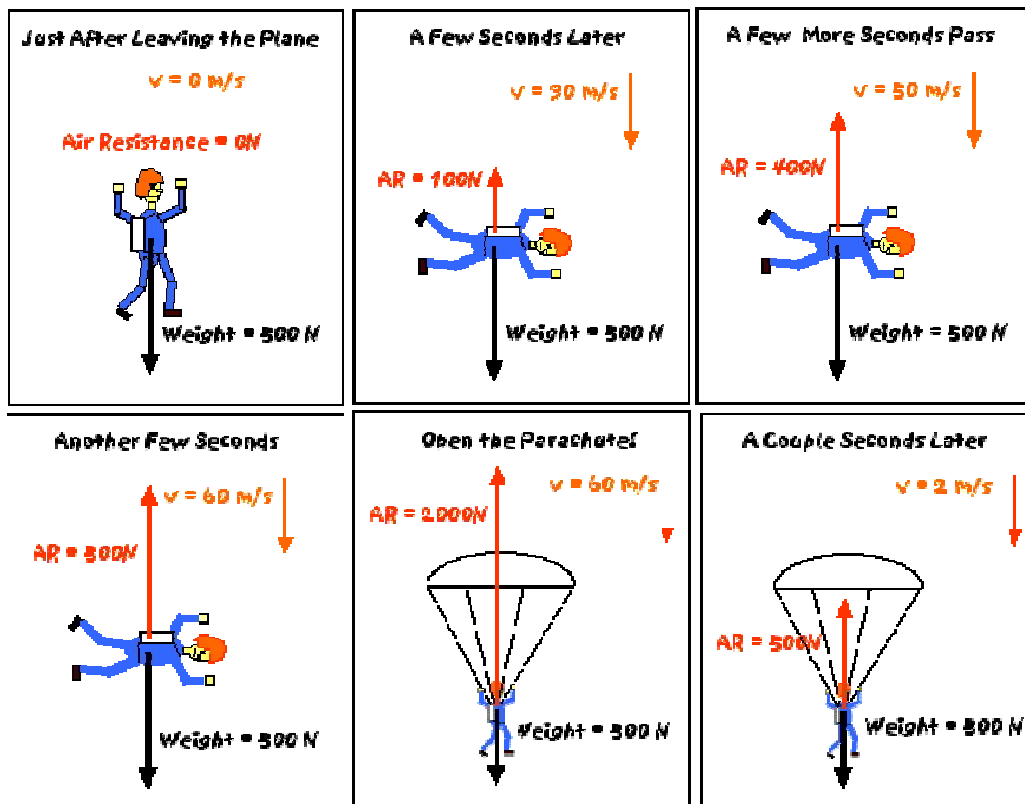
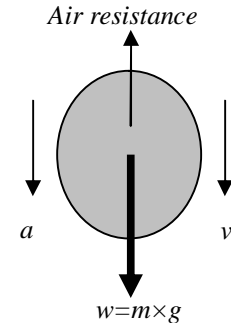

MASS, WEIGHT AND DENSITY:

Mass:

Mass of an object is the measure of the amount of matter in it. The base unit of mass is the kilogram (kg). $1\text{ kg} = 1000\text{ g}$

1 kilogram is the mass of a piece of platinum-iridium alloy at the office of weights and measurements in Paris.

Weight:

The weight of an object is the force due to earth's gravity. The nearer an object is to the centre of the earth the more the earth attracts it. Since the earth is not a perfect sphere but flatter at the poles, the weight of a body varies over the Earth's surface. It is greater at the poles than at the equator. The weight of an object of mass 'm' can be found by

$$w = m \times g$$

Where 'w' is the weight in newtons, m is the mass in kilogram and g is the acceleration due to gravity whose value is 9.81 m/s^2 or 10 m/s^2 for IGCSE course.

Density:

It is defined as the mass per unit volume of a substance. The unit of density is kg/m^3 or g/cm^3 . It is denoted by Greek symbol ρ (rho) and is calculated from the formula:

$$\text{density} = \frac{\text{mass}}{\text{volume}}$$

$$\rho = \frac{m}{V}$$

Density of regularly shaped solid: The mass can be determined by top-pan balance and the volume by multiplying length, width and height.

Density of irregularly shaped solid for e.g. rock:

The mass of the solid is determined by top-pan balance. The volume of solid is obtained by subtracting the value before and after immersing the rock in a measuring cylinder containing water. This method is called displacement method.

Density of liquid: The mass of an empty beaker is found on a balance. A known volume of the liquid is transferred from burette or measuring cylinder into the beaker. The mass of beaker plus liquid is found and the mass of liquid is obtained by subtraction.

Density of air: The mass of a 500 cm^3 round-bottomed flask full of air is found and then after removing the air with a vacuum pump; the difference gives the mass of air in the flask. The volume of air is found by filling the flask with water and pouring it into a measuring cylinder.

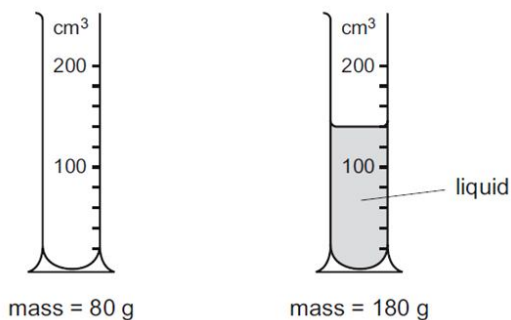
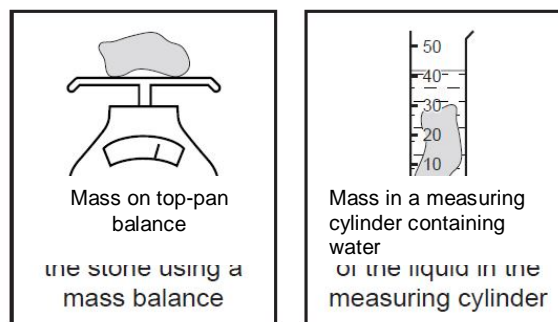

EFFECTS OF FORCE: EXTENSION / LOAD (FORCE) INVESTIGATION

Force is a push and pull of an object. Force can change the direction of the movement and the shape of an object. Force can extend the length of an object.

Hooke's Law:

Robert Hooke was the first to investigate the extension of the spring nearly 350 years ago. He stated the law of extension of the spring/string when stretching force is applied to it.

“The extension of a spring is directly proportional to the force applied on it, provided the elastic limit of the spring is not exceeded.”

Stretching force F is directly proportional (\propto) to the extension x

$$F \propto x$$

$$F = kx$$

k is the spring constant. It is the force needed to cause the extension of 1 meter.

$$k = \frac{F}{x}$$

Hooke's law holds when a force applied to a spring, a straight metal wire, elastic band or cotton thread. If too much load is applied to the spring it deforms and does not return to its original length after removing the load. The spring is said to have undergone plastic deformation; the load applied has exceeded the **elastic limit (E) or limit of proportionality**,

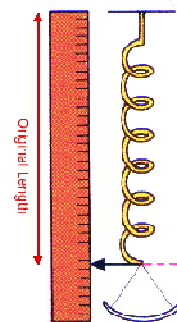
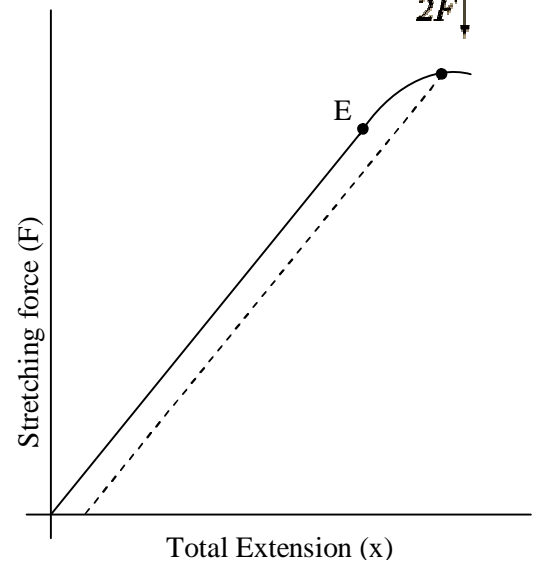
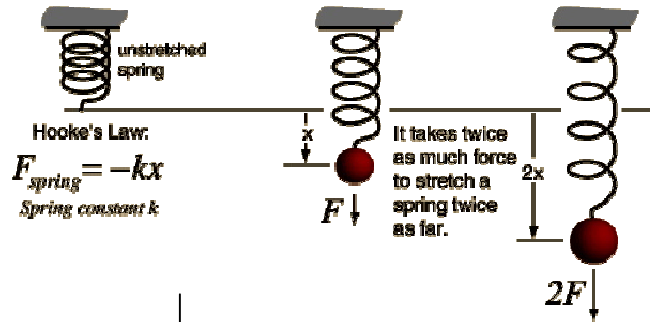

FORCE, MASS AND ACCELERATION:

Effect of forces:

Force is a push or a pull of an object and it is measured in newtons, N. Force is a vector quantity which means it needs magnitude and direction to be fully expressed. It can be used for pushing pulling, bending, stretching, squeezing and tearing. When force applied it can do following actions on an object, it can:

- change the speed or velocity,
- change the direction of movement,
- change the shape.

Isaac Newton in his second law of motion described the relation between force applied on an object, the mass of an object and its acceleration. The two parts of the law says that:

- a) *The net force applied on an object is directly proportional to the acceleration of an object:*

$$\text{net force} \propto \text{acceleration}$$

$$F \propto a$$

- b) *The mass of an object is inversely proportional to the acceleration of an object:*

$$\text{acceleration} \propto \frac{1}{\text{mass}}$$

$$a \propto \frac{1}{m}$$

Combining the above relationships we get

$$F = ma$$

Where 'F' is the net force applied in newtons, N, 'm' is the mass of an object in kilogram and 'a' is the acceleration in m/s^2 .

One newton force is defined as the force applied on an object of mass one kilogram which accelerates it with one meters per second square.

Circular motion of an object:

Any motion in a curved path represents accelerated motion, and requires a force directed toward the center of curved path. This force is called the centripetal force which means "center seeking" force. Swinging a mass on a string requires string tension T, and the mass will travel off in a tangential straight line if the string breaks.

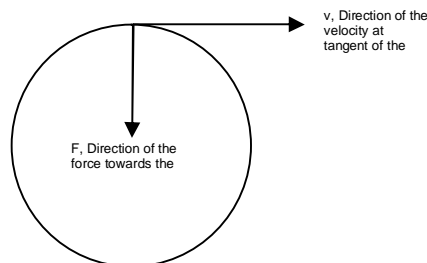

Turning effect of force - moment:

The turning effect of force is called moment of force or torque or simply moment (τ). The moment of force depends on two things:

1. the size of the force and;
2. perpendicular distance from the force applied to the pivot.

The unit is the newton-meter (N.m)

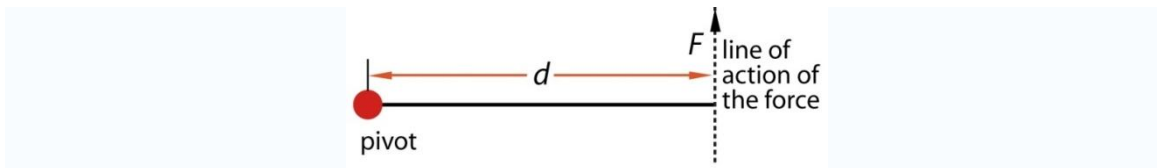

Moment of force = force \times perpendicular distance of the force from pivot or fulcrum

$$\tau = F \times d$$

Law of moments

When an object is in equilibrium the total clockwise moments about the pivot is equal to the total anticlockwise moments about the same pivot.

Total Clockwise moment of force = Total Anticlockwise moment of force

Principle of moments (1)

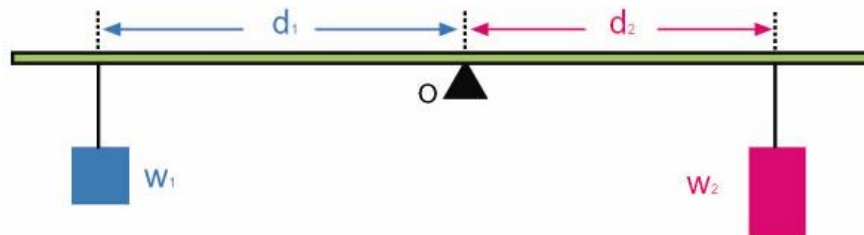

To maintain equilibration, the sum of:
anticlockwise moments = clockwise moments
about O about O
 $W_1 \times d_1 = W_2 \times d_2$

Equilibrium:

A body is said to be in equilibrium if the resultant force or net force acting on it is zero it means it has no acceleration. The equilibrium is static if the body's velocity is zero and dynamic if it is in constant motion.

Conditions of Equilibrium:

- Sum of the forces in one direction is equal to the sum of forces in the opposite direction.
 - Net horizontal Force = 0
 - Net vertical Force = 0
- The law of moment must apply: sum of clockwise moment is equal to the sum of anticlockwise
net moment = 0

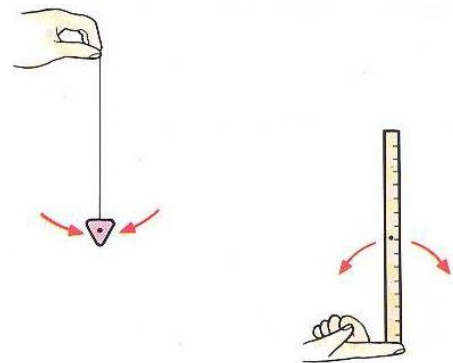

Types of Equilibrium:

Stable Equilibrium:

When the body is slightly disturbed and then released, it returns to its previous position then it is in stable equilibrium.

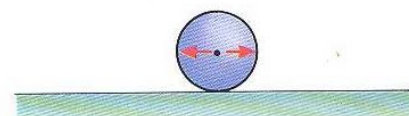

Unstable Equilibrium:

When a body is slightly disturbed and it moves further away from its previous position then it is in unstable equilibrium.

Neutral Equilibrium:

When a body is slightly displaced and it stays at its new position then it is called neutral equilibrium.

For example the plumb line is in stable equilibrium because if you push it to one side, it returns to its original position. It does this because when you push it to one side its centre of gravity rises and gravity tries to pull it back to its lowest position.

The carefully balanced ruler on your finger is in unstable equilibrium, because if it moves slightly, it's centre of gravity falls and keeps on falling down.

The ball on a perfectly level table is in neutral equilibrium, because if it is moved, its centre of gravity does not rise or fall.

Name the different kinds of equilibrium in this figure (a), (b) and (c).

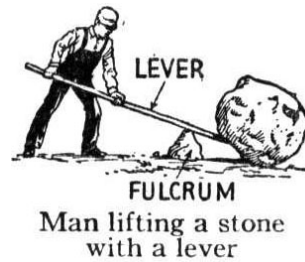
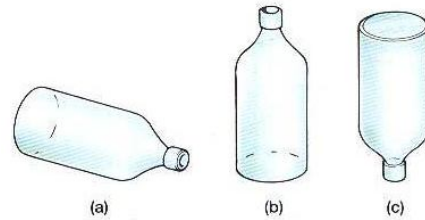

Lever

Lever is a simple machine which is used to lift heavy weight with small force. It is force multiplier.

CENTRE OF MASS OR CENTRE OF GRAVITY:

The centre of gravity or centre of mass of an object is the point through which the whole weight of an object seems to act. The centre mass of a uniform ruler is at its centre.

The centre of a circular cardboard is its centre of mass.

The centre of mass of a regularly shaped body of the same density throughout is at its centre. In other cases it can be found by following experiment.

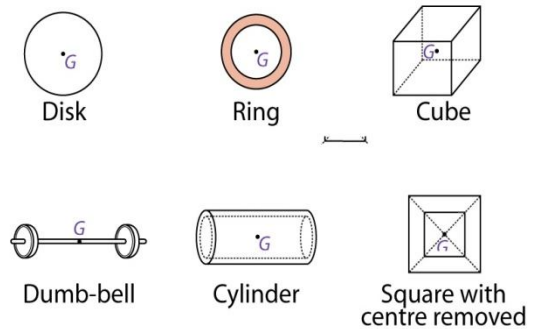

Centre of mass of a piece of flat card (lamina) using plumb line:

Let a piece of card hang freely from a pin attached with a stand. Hang the plumb line from the pin. Mark the position of the plumb line by two crosses on the card. Join the crosses with a ruler. Just as the plumb line hangs with its centre of gravity vertically below the pivot, so also will the card. This means that centre of gravity of the card is somewhere on line. Rearrange the card with pin through another hole and again mark the vertical line. The only point that is on both lines is where they cross, so this point must be the centre of gravity.

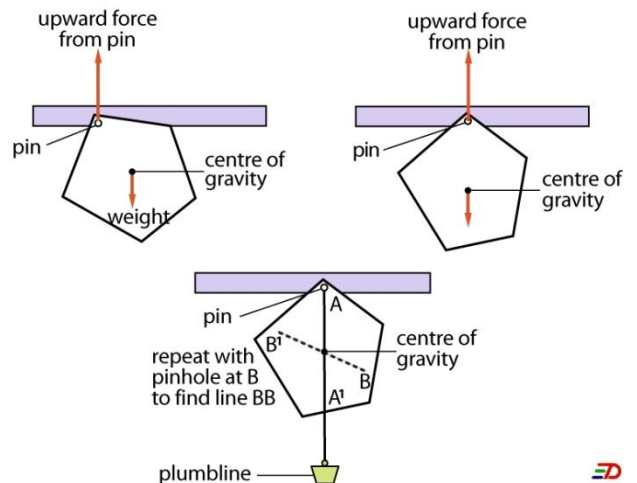

Toppling or stability:

Stability is the extent to which an object resists **toppling over**. Stable objects do not topple over easily. When designing vehicles, engineers try to design so that the centre of mass is as low as possible. This makes vehicles less likely to turn over when going round corners. The stability of an object can be increase by:

- a) Lowering its centre of mass
- b) Increasing the area of its base

Examples:

- Double Decker bus has heavy metal panels at its bottom to make it more stable
- Racing car has wider base and low centre of gravity.

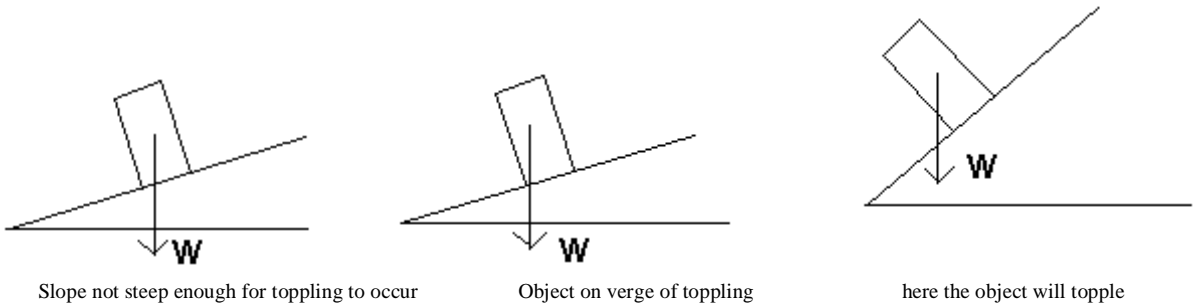

Which of these trucks will topple over?

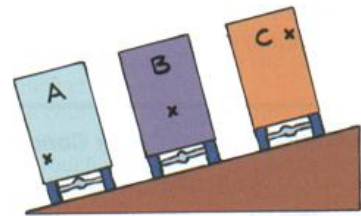

In the opposite diagram what is the moment of force.

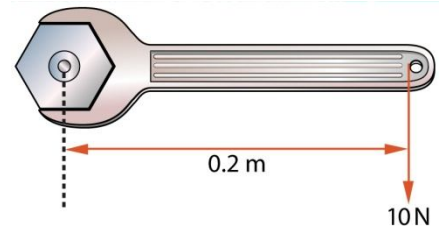

SCALARS AND VECTORS:

Scalars:

Scalars are those quantities that have magnitude (size) only. For example mass, length, distance, energy, temperature and speed. Scalar may be added together by simple arithmetic.

Vectors:

Vectors are those quantities that have both the magnitude and direction. Examples are force, velocity, acceleration, displacement. When two vectors are added the direction of the vector must also be considered. The vector may be represented by a line, the length of the line being the magnitude of the vector and direction of the line is the direction of the vector.

Addition of two vectors (eg forces):

The addition of vectors is called the resultant of those vectors. The resultant of two vectors in the same direction in straight line is found simply by addition of their magnitude and the direction is same as the

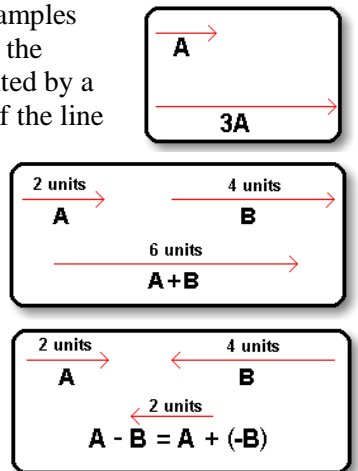

direction of the two vectors.

The addition of vectors in opposite direction in straight line is the addition of a vector and a negative vector. The direction of the resultant vector will be direction of the vector with greater magnitude.

Parallelogram method of vector addition:

When two vectors are not in the same plain then we use parallelogram method of vector addition. In this method of vector addition, the vectors are joined from a common origin and the parallelogram is constructed by drawing resultant **R** the diagonal of the parallelogram drawn from the common origin.

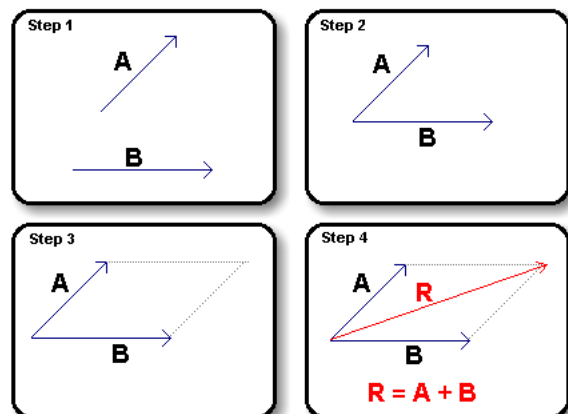

WORK, ENERGY, POWER

Work:

Work is done when a force moves an object in the direction of the force applied. The work is define as

Work done = force \times distance moved in the direction of force

$$\text{Work} = F \times s$$

Where F is the force in newton (N) and s is the distance moved in the direction of force in meters (m). Work is a scalar quantity.

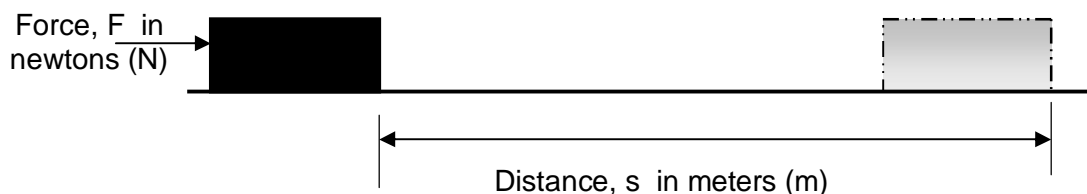

In terms of energy transfer, work done is a measure of the amount of energy transferred from one form to another. When you move an object to a certain height, the chemical energy transferred from your muscles to potential energy of an object.

The unit of work or energy is **joule (J)** and one joule is defined as *the work done when a force of 1 newton (N) moves an object through the distance of 1 meter (m).*

Some examples of work done:

- A woman pushes a trolley along for 3 meters with a force 50 N,
- A man pushes his car for 10 meters with a force 300 N,
- A boy lifts a brick weighing 50 N.

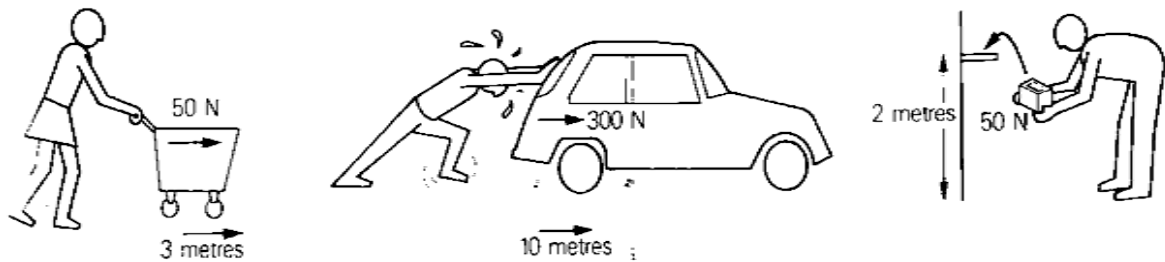

Energy:

The ability of an object to do work is called its energy. When the work is done the energy is transferred from one form to another. There are different forms of energy that we use in our daily life. For example we get:

- heat energy or also called thermal energy and light energy from sun;
- chemical energy from petrol, oil, wood, coal etc;
- sound energy from the bang of two objects;
- nuclear energy from nuclear reaction of atoms and nucleus;
- electrical energy from running turbine by burning coal, petrol etc at the power stations;
- kinetic energy is the energy because of the motion of an object;
- gravitational potential energy is the stored energy in an object due to its position from the ground.
- Elastic potential energy or strain energy in springs, coils or elastic objects is the stored energy due to their change of shapes or positions.

The two main forms of energies are kinetic energy and potential energy. The unit of energy is joules (J).

Some examples of energy conversion:

- A light bulb converts electrical energy to light energy;
- A moving car converts chemical energy from petrol to kinetic and heat energy;
- A drill machine converts electrical energy to kinetic energy.
- A mountain climber changes chemical energy from his muscles to potential energy.

Kinetic Energy E_k :

The kinetic energy is the energy of an object, because of its motion. i.e. the object possess kinetic energy if it is in motion or if an object is moving then it has kinetic energy. The kinetic energy can be expressed by equation;

$$E_k = \frac{1}{2} \times m \times v^2$$

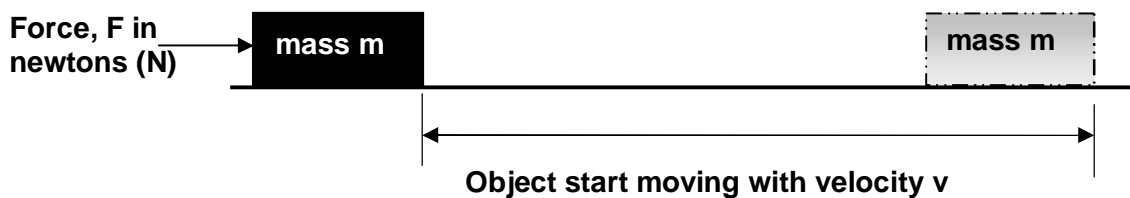

Where E_k is the kinetic energy in joules (J) of a moving object, m is the mass in kilogram (kg) and v is the speed in meters per second (m/s).

Since E_k is depends on v^2 , a high-speed object has much higher E_k than the object that is moving at low-speed.

Potential Energy E_p :

The potential energy of a body is the energy because of its position from the ground or due change in its physical shape. When an object of mass ‘ m ’ is moved to height ‘ h ’ above the Earth’s surface it is considered to have some gravitational potential energy. It is equal to the work done in moving the object at that height. The gravitational potential energy can be expressed by equation:

$$E_p = m \times g \times h$$

Where E_p is the gravitational potential energy in joules (J), m is the mass of an object in kilogram (kg), h is the height in meters (m) and g is the acceleration due to gravity equal to 10 m/s^2 .

The other potential energies are elastic potential energy in spring, electrical potential energy due to electric charge etc.

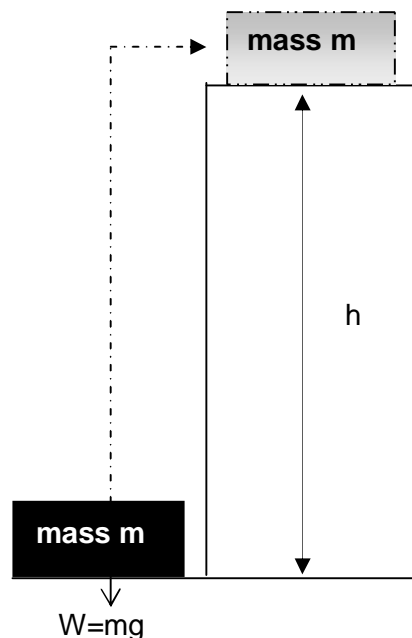

The law of conservation of energy:

The Law of conservation of energy states that:

The energy may neither be created nor can it be destroyed. The sum of all the energies in a system or in an experiment must remain constant.

We can also say that the total amount of energy in the universe is constant, although energy can be transformed from one form to another.

The most commonly used example is the **pendulum**. In the figure the two end positions have maximum potential energy (E_p) and position in the middle has maximum kinetic energy (E_k).

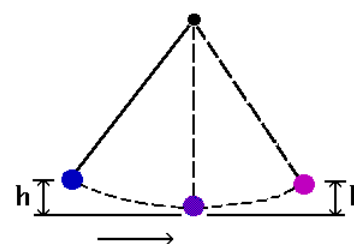

Mathematically it can be written as

$$\text{Change in } E_k = \text{change in } E_p$$

or

$$\text{Gain of } E_k = \text{Loss of } E_p$$

or

$$\text{Loss of } E_k = \text{Gain of } E_p$$

POWER:

Energy transfer or work done in one second by an object is called its power.

$$\text{Power} = \frac{\text{work done or energy transfer}}{\text{time taken}}$$

$$P = \frac{E}{t}$$

The unit of power is watt (W) and it is defined as a rate of doing work or energy transfer per second. The larger units of power are

1 kilowatt = 1 kW = 1000 W = 10^3 W and 1 megawatt = 1 MW = 1000000 W = 10^6 W

ENERGY SOURCES:

Renewable energy source:

Renewable energy source is the one that is generated from natural resources—such as sunlight, wind, waves, tides and geothermal heat—which means it can be received from nature forever. In future when we will have short of coal and natural gas to produce electricity we will be mostly relying on renewable energy sources. At current levels of use, oil and gas supplies will last for about another 40 years, and coal supplies for another 300 years. The development of renewable sources of energy is therefore becoming increasingly important.

Non-renewable energy source:

Non-renewable energy sources are those energy sources that are used up and cannot be replaced. One day they are going to be finished. These are fossil fuels like coal, oil and natural gas and nuclear fuel like uranium, polonium and thorium etc.

Energy in different forms:

Chemical Energy

The energy held in the bond between atoms in a molecule is called chemical energy. Every bond has a certain amount of energy. In a chemical reaction when it requires energy to break old bonds and create new one, in chemical language it is called endothermic reaction. Similarly in a chemical reaction when the energy releases than this process is called exothermic reaction. The burning of fossil fuel in presence of oxygen is an example of exothermic reaction.

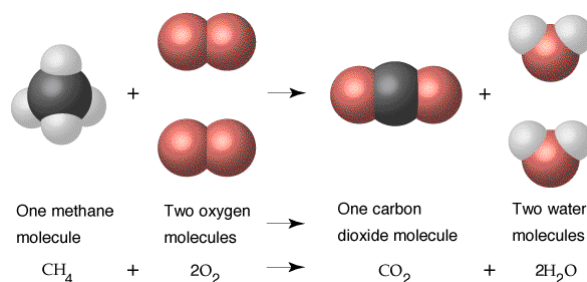

Hydroelectricity

It is the electricity obtained from hydropower. Most hydroelectric power comes from the potential energy of dammed water driving a water turbine and generator. The energy extracted from water depends not only on

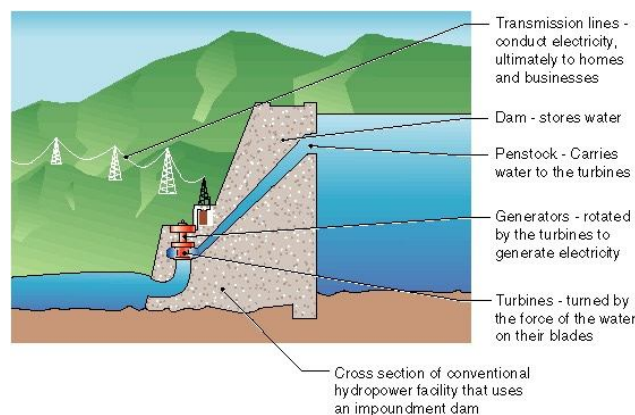

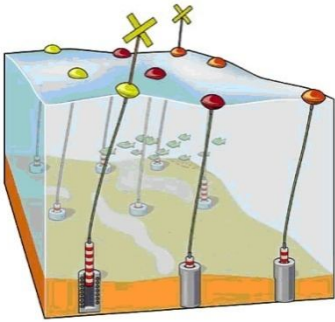

the volume but on the difference in height between the source and the water's outflow. This height difference is called the head.

Wave energy:

Movement of waves going up and down can be used make the move the fan of the generator which than generate electrical energy. It is difficult to produce on large scale by can be use for small scale power stations.

Geothermal Energy:

Hot rocks under the ground heat water to produce steam. Cold water goes down through one hole and hot steam shots out from other. The force of powerful steam rotates the turbine which drives electric generators and produce electricity.

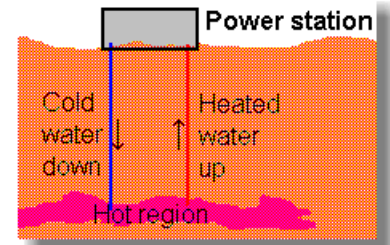

Nuclear Energy:

Another major form of energy is nuclear energy, the energy that is trapped inside each atom. One of the laws of the universe is that matter and energy can't be created nor destroyed, but can be interchanged. Nuclear energy is the energy released from the atomic nucleus. One example of nuclear reaction is fission reaction. In this reaction the neutron strikes the heavy uranium nucleus, breaks into two new nuclei and emit large amount of energy. It follows the conversion of mass to energy from the equation by Albert Einstein, $E = mc^2$. E is the energy converted or released; m is the mass, and c the speed of light which is 3×10^8 m/s.

Solar Energy:

Solar energy can be converted directly or indirectly into other forms of energy, such as heat and electricity. The major problems with the solar energy are:

- 1) that it is not consistent with how it reaches the earth.
- 2) the large area required to collect it at a useful rate.

Solar energy is used for heating water for domestic use, space heating of buildings, drying agricultural products, and generating electrical energy. The device use to convert sunlight into electricity is called solar cell. It is usually made from silicon alloys.

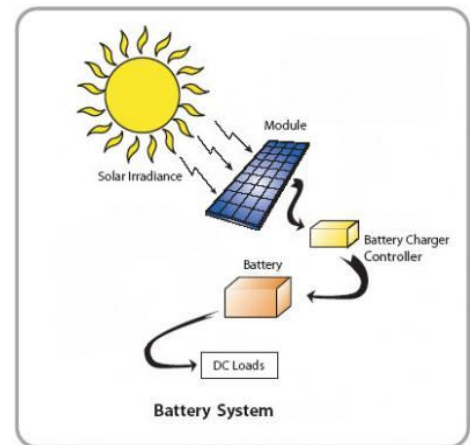

	Advantages	Disadvantages
Hydroelectric and tidal energy	No pollution, no operative cost except maintenance	Expensive to build, flooding and building dams cause environmental damage
Wind energy by using wind turbine	No pollution, no operative cost except maintenance	Large, windy areas needed, not reliable, noisy,
Solar energy by using solar panel	No pollution	Very expensive to build, useful only in very sunny areas, large area required
Geothermal from earth's rock	No pollution, reliable, cost effective	Deep drilling expensive and difficult
Nuclear energy from uranium	Very efficient and powerful,	Nuclear wastes are very dangerous, very expensive to build and maintain.
Fossil fuel from oil, coal and gas	Powerful and efficient	Limited supply, bad for environment

PRESSURE:

Pressure is defined as the force applied by an object on a unit area on its surrounding in contact with it. It means that the lower the contact area, the more the pressure is. The unit of pressure is newton per meter square (N/m^2) or more commonly used pascal (Pa).

$$\text{Pressure} = \frac{\text{Force}}{\text{Area}}$$

$$P = \frac{F}{A}$$

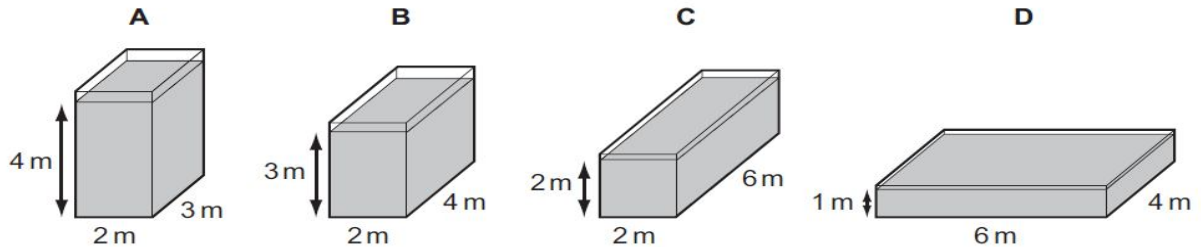

In the above figure all four glass tanks have same amount of water and therefore have same weight but each one has different area of contact with surface. Tank **A** has contact area 6 m^2 , tank **B** has 8 m^2 , tank **C** has 12 m^2 and tank **D** has 24 m^2 contact area. It means the tank A applies the highest pressure on the surface since it has the smallest contact area.

Mercury Barometer

It is a device use to measure the atmospheric pressure. It consists of a glass column of about 78 cm in height, closed at one end and open at the other. The open end is placed upside down inside a mercury-filled container. The height of the mercury in the column rises and adjusts until the weight of the mercury inside the column balances the atmospheric force due to air exerted on the mercury in the container. The height of the mercury column balances exactly at 76cm which is equivalent to the atmospheric pressure outside the column. Hence

$$1 \text{ atm.} = 76 \text{ cm Hg} = 760 \text{ mm Hg} = 101.325\text{kPa} = 101325 \text{ Pa}$$

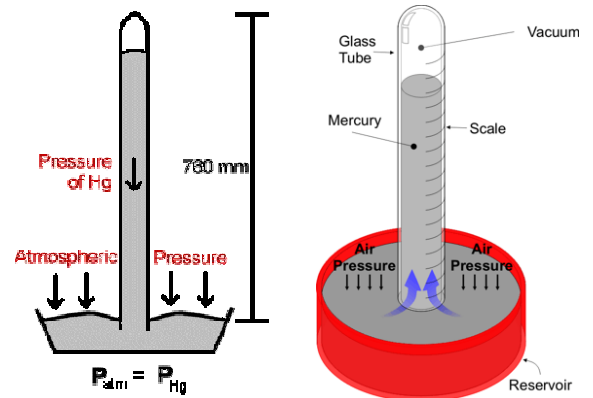

Manometer:

A manometer is a device use to measure gas pressure in a container. A simple barometer design is a U-shape glass tube. The glass tube is filled with a liquid, usually mercury as shown in figure below. One side of the tube is connected to the gas supply and other side left open. The gas exerted pressure on one side and the atmospheric pressure is on the other side difference of pressure 'h' created.

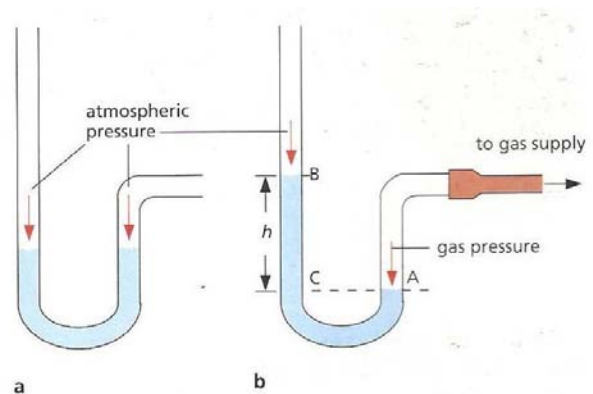

Pressure of gas inside the container in mm Hg = 760mm + difference in mercury height h

Pressure due to liquid:

A liquid held in a container exerts pressure on the inner walls of the container as well as on any object that is inside the liquid. Following are the properties applied to any object in a liquid.

1. Pressure of liquid on an object acts equally in all direction,
2. Pressure of liquid increase with the increase of depth,
3. Pressure depends upon the density of the liquid,
4. Pressure does not depend upon the shape of the container.

The pressure due to liquid of density ρ and height h can be expressed by

$$P = \rho \times g \times h$$

Pascal vases:

Liquid poured in a set Pascal vases is the demonstration that pressure depends on depth only and not on the shape of the vessel. When a set of tubes of different shapes are connected to a common source of water, the water reaches the same level in all the tubes.

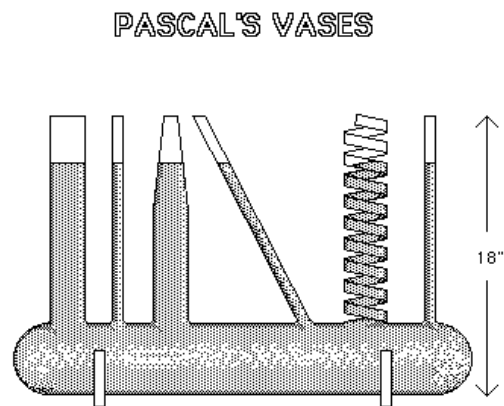

Practice questions from Book, Tom Duncun new edition:

- Measurements pg no. 57, 58
- Density pg no. 61
- Weight and mass pg no. 64
- Hooke's law pg no. 64
- Additional Questions pg no. 69, 70 (Q1 to Q6)
- Speed, velocity and acceleration pg no. 103, 107
- Force and acceleration pg no. 116
- Work, Energy and Power pg no. 87 (Q3 to Q8)
- Energy Transfer pg no. 87 (Q1 and Q2)
- Kinetic and potential energy pg no. 124
- Additional Questions pg no. 129 to 132
- Moments and Lever pg no. 75
- Centre of mass, Equilibrium pg no. 79
- Scalars and Vectors , adding vectors pg no. 82
- Pressure pg no. 92
- Additional Questions pg no. 96, 97, 98
- Energy Sources pg no. 168, 169