



Verizon 4G LTE Network Extender User Guide

Network Systems
Samsung Electronics America

Document Version 1.3
June 2016

© 2016 SAMSUNG Electronics Co. Ltd.

All Rights Reserved. No part of this document may be photocopied, reproduced, stored in a retrieval system, or transmitted, in any form or by any means whether, electronic, mechanical, or otherwise without the prior written permission of SAMSUNG Electronics Co., Ltd.

No warranty of accuracy is given concerning the contents of the information contained in this publication. To the extent permitted by law no liability (including liability to any person by reason of negligence) will be accepted by SAMSUNG Electronics Co., Ltd., its subsidiaries or employees for any direct or indirect loss or damage caused by omissions from or inaccuracies in this document.

SAMSUNG Electronics Co., Ltd. reserves the right to change details in this publication without notice.

This user guide should be read and used as a guideline for properly installing and/or operating the product.

This user guide may be changed for system improvement, standardization and other technical reasons without prior notice.

Updated user guides are available at:

<https://systems.samsungwireless.com/>

For questions on the user guides or their content, contact

[NetSys Tech Writer@sta.samsung.com](mailto:NetSys_Tech_Writer@sta.samsung.com)



WARNING! This product contains chemicals known to the State of California to cause cancer and birth defects or other reproductive harm.

Intellectual Property

All Intellectual Property, as defined below, owned by or which is otherwise the property of Samsung or its respective suppliers relating to the SAMSUNG device, including but not limited to, accessories, parts, or software relating thereto (the “4G LTE Network Extender”), is proprietary to Samsung and protected under federal laws, state laws, and international treaty provisions. Intellectual Property includes, but is not limited to, inventions (patentable or unpatentable), patents, trade secrets, copyrights, software, computer programs, and related documentation and other works of authorship. You may not infringe or otherwise violate the rights secured by the Intellectual Property. Moreover, you agree that you will not (and will not attempt to) modify, prepare derivative works of, reverse engineer, decompile, disassemble, or otherwise attempt to create source code from the software. No title to or ownership in the Intellectual Property is transferred to you. All applicable rights of the Intellectual Property shall remain with SAMSUNG and its suppliers.

Open Source Software

Some software components of this product, including but not limited to ‘PowerTOP’ and ‘e2fsprogs’, incorporate source code covered under GNU General Public License (GPL), GNU Lesser General Public License (LGPL), OpenSSL License, BSD License and other open source licenses. To obtain the source code covered under the open source licenses, please visit: <http://opensource.samsung.com>.

Disclaimer of Warranties; Exclusion of Liability

EXCEPT AS SET FORTH IN THE EXPRESS WARRANTY CONTAINED ON THE WARRANTY PAGE ENCLOSED WITH THE PRODUCT, THE PURCHASER TAKES THE PRODUCT “AS IS”, AND SAMSUNG MAKES NO EXPRESS OR IMPLIED WARRANTY OF ANY KIND WHATSOEVER WITH RESPECT TO THE PRODUCT, INCLUDING BUT NOT LIMITED TO THE MERCHANTABILITY OF THE PRODUCT OR ITS FITNESS FOR ANY PARTICULAR PURPOSE OR USE; THE DESIGN, CONDITION OR QUALITY OF THE PRODUCT; THE PERFORMANCE OF THE PRODUCT; THE WORKMANSHIP OF THE PRODUCT OR THE COMPONENTS CONTAINED THEREIN; OR COMPLIANCE OF THE PRODUCT WITH THE REQUIREMENTS OF ANY LAW, RULE, SPECIFICATION OR CONTRACT PERTAINING THERETO. NOTHING CONTAINED IN THE INSTRUCTION MANUAL SHALL BE CONSTRUED TO CREATE AN EXPRESS OR IMPLIED WARRANTY OF ANY KIND WHATSOEVER WITH RESPECT TO THE PRODUCT. IN ADDITION, SAMSUNG SHALL NOT BE LIABLE FOR ANY DAMAGES OF ANY KIND RESULTING FROM THE PURCHASE OR USE OF THE PRODUCT OR ARISING FROM THE BREACH OF THE EXPRESS WARRANTY, INCLUDING INCIDENTAL, SPECIAL OR CONSEQUENTIAL DAMAGES, OR LOSS OF ANTICIPATED PROFITS OR BENEFITS.

Modification of Software

SAMSUNG IS NOT LIABLE FOR PERFORMANCE ISSUES OR INCOMPATIBILITIES CAUSED BY YOUR EDITING OF REGISTRY SETTINGS, OR YOUR MODIFICATION OF OPERATING SYSTEM SOFTWARE.

USING CUSTOM OPERATING SYSTEM SOFTWARE MAY CAUSE YOUR DEVICE AND APPLICATIONS TO WORK IMPROPERLY. YOUR CARRIER MAY NOT PERMIT USERS TO DOWNLOAD CERTAIN SOFTWARE, SUCH AS CUSTOM OS.

Samsung Electronics America (SEA), Inc

Address:
85 Challenger Road
Ridgefield, New Jersey 07660

Phone: 1-800-SAMSUNG (726-7864)
Phone: 1-888-987-HELP (4357)

Internet Address:
www.samsung.com

©2016 Samsung Electronics America, Inc. Samsung is a registered trademark of Samsung Electronics Co., Ltd.

Do you have questions about your Samsung Mobile Device?
For 24 hour information and assistance, we offer a new FAQ/ARS System (Automated Response System) at: www.samsung.com/us/support

Contents

Preface		viii
	Relevance	viii
	Conventions in this Document	viii
	Revision History.....	viii
	Organization of This Document	ix
	Related Documentation	ix
	Personal and Product Safety	ix
Chapter 1	Getting Started	1
	Introduction	1
	Features	2
	System Requirements	3
	Network Extender Basics	4
Chapter 2	Network Extender Setup	5
Chapter 3	Network Extender Admin Website (Local)	10
	Sign In.....	11
	Connected Devices Page	13
	Settings.....	14
	About.....	17
Chapter 4	Configuring Your Device	21
	External GPS Antenna	22
Chapter 5	Troubleshooting	23
	Power/Status Indicator Light is Not Turning On	23
	Network Extender has not acquired a GPS fix even after an hour.....	23
	Unable to Place Call Using Network Extender	23
	Power/Status LED Indicator is Blinking	24
	Alarms	24
Appendix	Acronyms	28

List of Figures

Figure 1.	Verizon Wireless 4G LTE Network Extender	1
Figure 2.	Box Contents	2
Figure 3.	Optional Wall Mount Bracket (sold separately).....	2
Figure 4.	Components - Front and Rear View	4
Figure 5.	Network Extender Placement	5
Figure 6.	Connect the Ethernet Cable and Power.....	6
Figure 7.	Network Extender Home Page.....	10
Figure 8.	Network Extender Login Pop-Up Window	11
Figure 9.	Quick Reference Icons.....	12
Figure 10.	Network Extender Connected Devices Page.....	13
Figure 11.	Network Extender Network Settings Tab.....	14
Figure 12.	Network Extender Advanced Settings Tab.....	15
Figure 13.	Network Extender Change Password Tab.....	16
Figure 14.	Network Extender Status & Alerts Tab	17
Figure 15.	GPS Tab	18
Figure 16.	Performance Tab.....	19
Figure 17.	Support Tab.....	20

List of Tables

Table 1.	Destination Ports.....	21
Table 2.	Firewall Settings.....	21
Table 3.	Alarms in the Network Extender Display	24
Table 4.	Alarms in the Network Extender Admin Website (Local).....	26

Preface

This user guide describes how to install the 4G LTE Network Extender and provides cable connection specifications.

Relevance







This user guide applies to the following products/software

Model	Release
SLS-BU103	1.0.0.20

Conventions in this Document

Samsung Networks product documentation uses the following conventions.

Symbols

Symbol	Description
	Indicates a task.
	Indicates a shortcut or an alternative method.
	Provides additional information.
	Provides information or instructions that you should follow to avoid service failure or damage to equipment.
	Provides information or instructions that you should follow to avoid personal injury or fatality.
	Provides antistatic precautions that you should observe.

Revision History

The following table lists all versions of this document.

Version	Date	Description
1.0	11/10/2015	First version
1.1	6/15/2016	Second version
1.2	6/22/2016	Third version
1.3	6/24/2016	Fourth version

Organization of This Document

Section	Title	Description
Chapter 1	Getting Started	Provides an overview of the Network Extender.
Chapter 2	Device Setup	Describes the procedures needed to set up the Network Extender.
Chapter 3	Network Extender Admin Website (Local)	Describes the Network Extender Admin Website (Local).
Chapter 4	Configuring Your Device	Provides detailed information regarding firewall settings.
Chapter 5	Troubleshooting	Provides information to troubleshoot STS LED statuses.
Appendix A	Acronyms	List of terms.

Related Documentation

- Verizon 4G LTE Network Extender Quick Start Guide
- Verizon 4G LTE Network Extender Product, Safety and Warranty

Personal and Product Safety

FCC Radiation Exposure Statement

To ensure the safety of users, the FCC has established criteria for the amount of radio frequency energy various products may produce depending on their intended usage. This product has been tested and found to comply with the FCC's exposure criteria.

Place your Network Extender at least 10 feet away from products that generate electromagnetic radiation (e.g., microwave oven).



The installation of the base unit should allow at least eight inches (20 centimeters) between the base and persons to be in compliance with FCC RF exposure guidelines.

Chapter 1 Getting Started

Introduction

Congratulations on the purchase of your Verizon Wireless 4G LTE Network Extender. The 4G LTE Network Extender offers enhanced in-building 4G LTE wireless coverage of up to 7500 square feet circular coverage and capacity of up to 7 active users.

This user guide introduces you to Network Extender service and all the features of your new device.

Figure 1. Verizon Wireless 4G LTE Network Extender



Features

The Network Extender provides the following features:

- This Network Extender is a simple to install device that provides enhanced in-building wireless service without having to change your existing mobile phone.
- This Network Extender allows users to easily install and configure the system by connecting to an existing broadband network.
- This Network Extender supports an embedded web server, which allows you to customize your IP settings. For more information, see the Network Extender Admin Website (Local) chapter.

The Network Extender box contains:

- Network Extender
- GPS antenna cable
- Ethernet cable
- Power adaptor
- Quick Start Guide
- Product Safety and Warranty Manual

Figure 2. Box Contents



The following optional wall mount bracket is sold separately. Please contact your Verizon sales representative for details.

Figure 3. Optional Wall Mount Bracket (sold separately)



System Requirements

- This device only supports Verizon Wireless 4G LTE mobile handsets with Advanced Calling enabled as shown in “Making a Call on Your Network Extender” section.
- Internet Access: This Network Extender must be connected to an available LAN port on a router or modem with always-on Internet access with minimum download speed of 10 Mbps and upload speed of 5 Mbps. Speeds of 20 Mbps download and 10 Mbps upload or higher are recommended.
- GPS signal: This Network Extender requires a continuous GPS signal from the provided GPS antenna. For initial GPS fix, four strong GPS satellite signals must be available.
- Home satellite broadband access is not supported.

Network Extender Basics

This section will guide you through the basic features and functions of your Network Extender.

The included GPS antenna is required for the automated setup process and is necessary in the event the mobile phone is used to call for emergency services while in the coverage area of the Network Extender.

Figure 4. Components - Front and Rear View

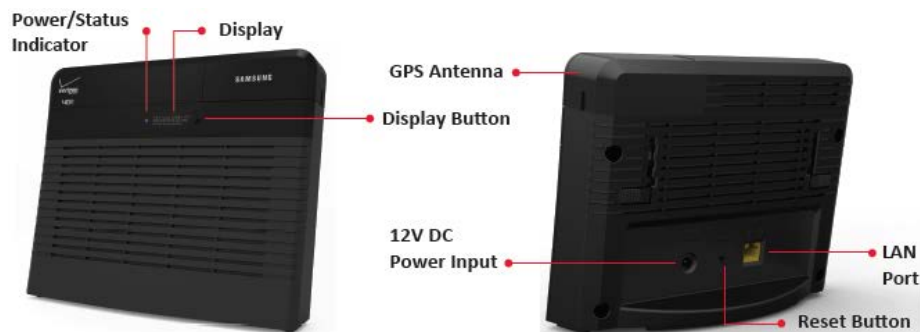

For advanced users only. Depress for 10 seconds to reset to factory default.

The Network Extender includes the following key features and connections:

- 1 Power/Status Indicator** shows the unit is on and in service.
- 2 LCD Display** shows status messages and device icons indicating the number of LTE devices connected to the Network Extender and the number of GPS satellites tracked.
- 3 Display Button** scrolls the LCD display to provide additional information about the device when in operation.
- 4 GPS Antenna** is located under the GPS antenna cover on the top right of the Network Extender. Slide the cover open to provide access to the GPS antenna so it can be relocated if needed. See the *Configuring Your Device* chapter.
- 5 LAN Port** allows you to connect an Ethernet cable to establish communication between the Network Extender and your broadband router. This connection port is then used to transmit voice and data through the Internet to the Verizon wireless network.
- 6 Reset Button** allows you to reset the device to factory default settings. Use a pen to push and hold the reset button for 10 seconds. The Power/Status Indicator will then become solid blue, indicating that the device is resetting. Any manually configured parameters will require reconfiguration.
- 7 12V DC Power Input** is used to power the Network Extender when connected to the AC power adaptor. Use only the provided power adaptor as using any other power source may damage the Network Extender.

Chapter 2 Network Extender Setup

This section outlines the procedures needed to set up the Network Extender.

- 1 Confirm your package contains all components.
- 2 Review the Product Safety and Warranty document included in the package before installing the Network Extender.
- 3 For best results, place the Network Extender in an elevated location, such as the top of a bookshelf or cabinet.

Figure 5. Network Extender Placement



- 4 Plug one end of the provided Ethernet cable into an available LAN port on your router and the other end into the LAN port on your Network Extender (1).
- 5 Plug the power supply connector into the DC 12V power port located at the rear of the Network Extender (2). Insert one end of the power cord into the power supply and then plug the other end into an available outlet (3).

Figure 6. Connect the Ethernet Cable and Power

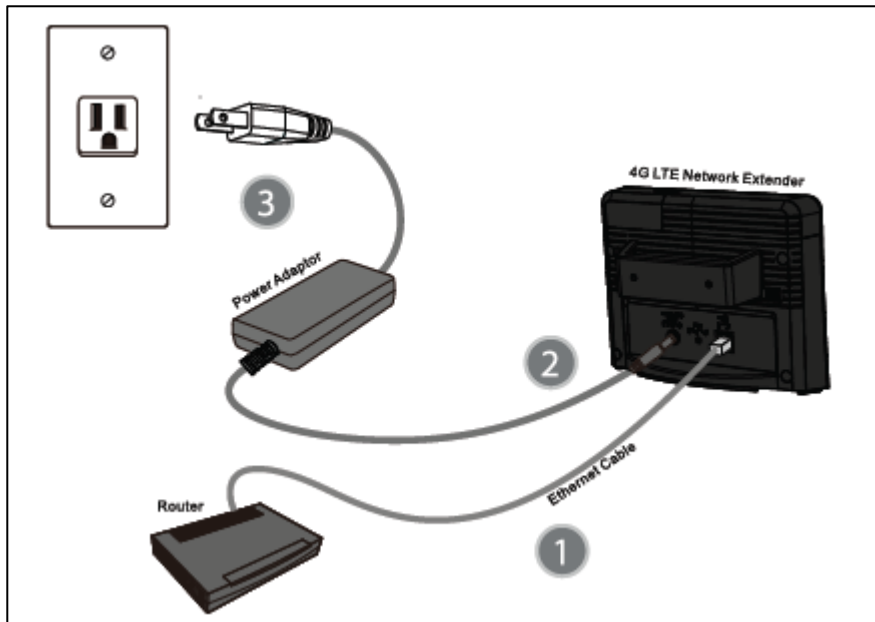

- 6 A GPS signal is required for proper operation and E911 service. If a GPS signal is not acquired after 30 to 60 minutes, please see “Configuring Your Device” section.



To see the status of the GPS acquisition, use the Admin website (Local) shown in “Network Extender Admin Website (Local)” section.

- 7 When the Network Extender is plugged in, the Power/Status LED indicator will be solid blue.

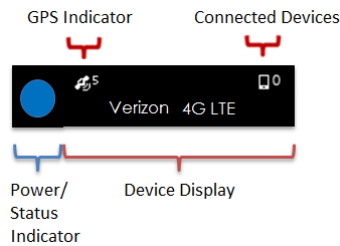

- 8 The initial startup of the Network Extender will take 30-60 minutes. During this process, the LED will blink.

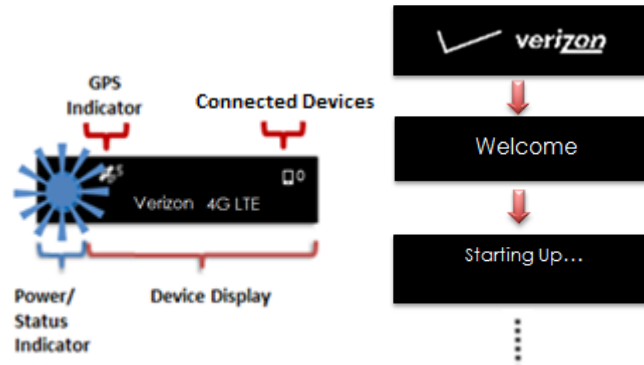

- 9 After the Network Extender successfully starts up, the LED will return to solid blue and the display will show “In Service.”

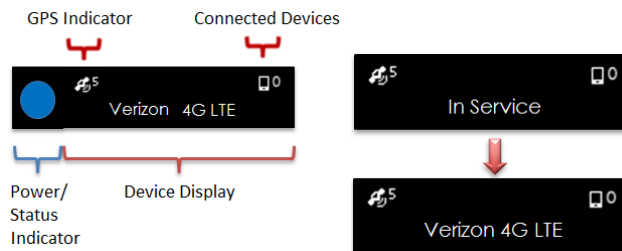

- 10 Once the Network Extender is running, check the following indicator lights:
 - o The **GPS Indicator** shows the GPS acquisition status and number of GPS satellites currently tracked.
 - o The **Connected Devices** shows the number of devices connected to the Network Extender with an active session.

Name	Icons	Description
LTE Service Status	4G LTE	Shows the device service status: 4G LTE – In service No Service Icon – Out of service
Number of Connected Devices		Shows the number of connected devices from 0 to 8.
GPS Status		Shows the GPS status with number of satellites being tracked from 1 to 9.

- 11 Press the button next to the display to show additional information about your Network Extender. The display will automatically step through the following information: Device IP address, Network Extender MAC ID, Timing Source, Device Name and CSG Mode.

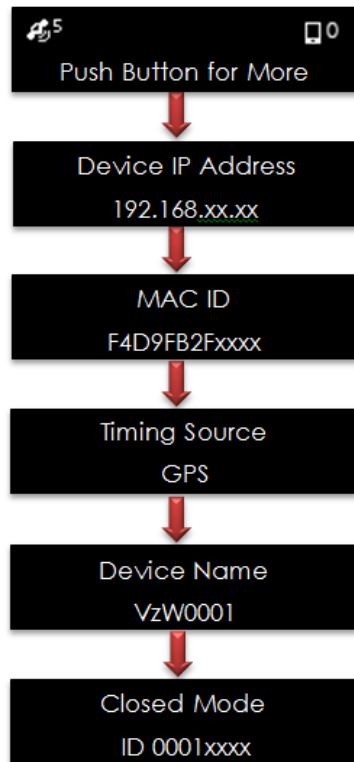

12 Making a Call on Your Network Extender

Once the Network Extender is in service, your phone must be within 50 feet of the unit.

To verify your Verizon phones are connected to the Network Extender:

- a) Make sure your Verizon Wireless 4G LTE mobile handset has the Advanced Calling feature turned on.
- b) Dial #48 from your mobile phone and listen for the following confirmation: “You are under 4G LTE Network Extender coverage ...”
- c) Some phones may show a home icon  when connected to the Network Extender.



The Network Extender’s coverage depends on environmental factors, such as physical structures and the strength of external cell towers.

To turn on Advanced Calling on your 4GLTE Verizon Wireless handset, follow the steps below for your device’s operating system:

- Android™: Go to Settings > Advanced Calling and turn ON service.



On some devices, it may be found in Wireless Calling, HD Voice or VoLTE call.

- Apple® iOS: Go to Settings > Cellular > Cellular Data Options > Enable LTE > Voice & Data. Additionally, on the “My Verizon” Mobile App, enable Advance Calling feature for your phones.
- Windows®: Go to Settings > Cellular+SIM > SIM settings and turn ON Advanced Calling.

Chapter 3 Network Extender Admin Website (Local)

This section contains detailed information regarding the Network Extender Admin Website (Local) where you can see the device status and make changes to settings.

To access settings and manage the Network Extender, sign in to the web interface by following these steps:

- 1 Use a computer connected to the same LAN as the Network Extender.
- 2 Press the button next to the display on the device to see your Network Extender's IP address.
- 3 Open a browser and enter the IP address of the Network Extender into the address bar: `http://<ip address of network extender>`. Note, the IP address of the device (once acquired) can be found in the LCD display by stepping through via the display button.

Figure 7. Network Extender Home Page

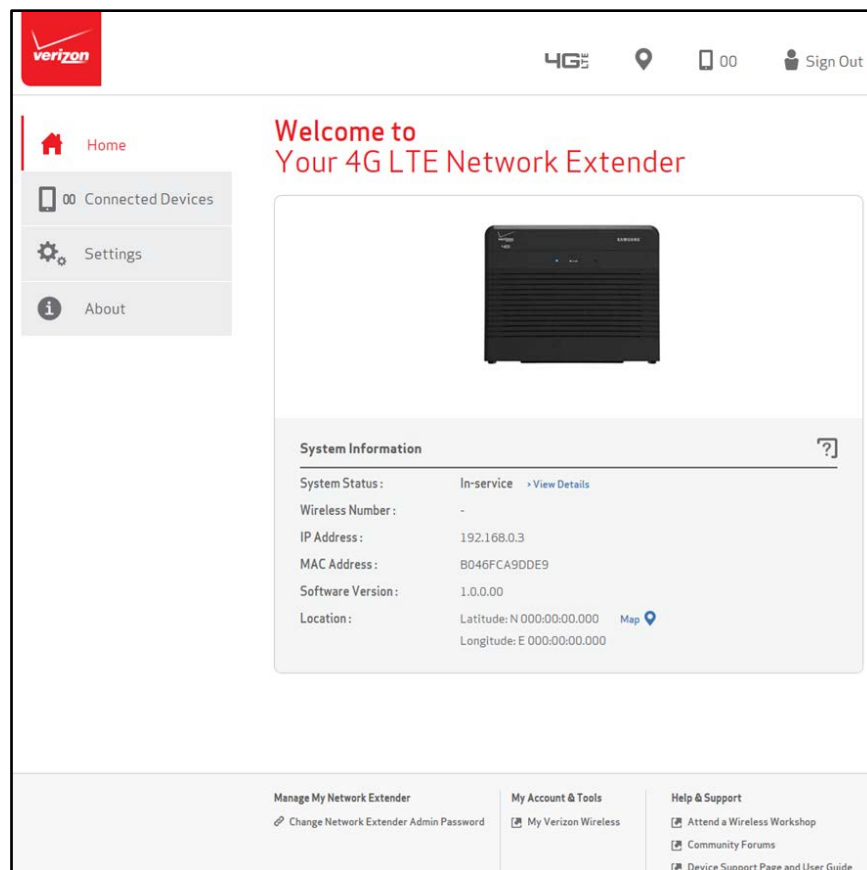

Sign In

Once you are at the Welcome Page, click **Sign In** in the top right hand corner of the screen. The default administrator password is LteFemt0. (Case sensitive. Note that the last character is a numeral zero.)



The default password and all Network Extender settings can be set back to default by pressing the reset button located on the back of the unit for more than 10 seconds.

Figure 8. Network Extender Login Pop-Up Window

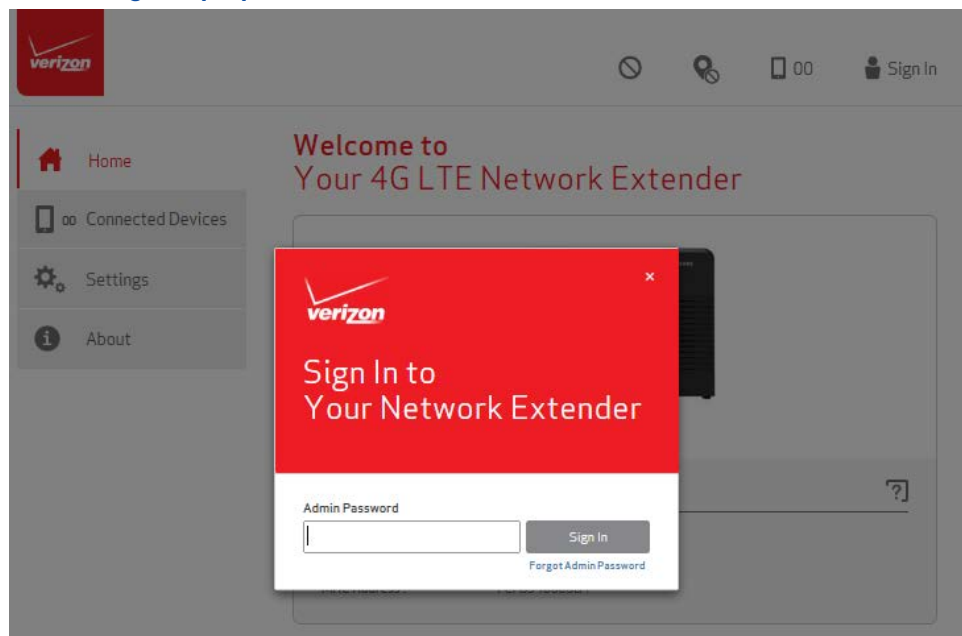

The Welcome page shows basic device information such as the Network Extender's MAC address, GPS fix location, device name and IP address.

The quick reference icons on the upper right of the Welcome page indicate device operation, GPS acquisition, number of devices connected, and login status.

Figure 9. Quick Reference Icons

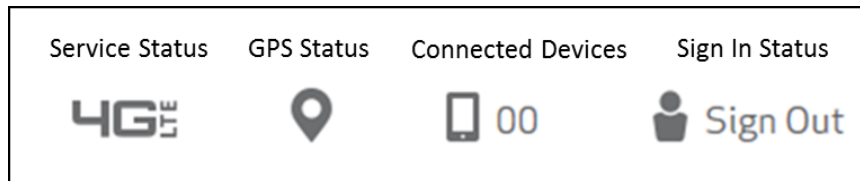

This icon will appear on your phone if the Network Extender is in service.



The map icon will show a pin point if GPS acquisition is complete. If GPS acquisition is still in progress, the icon will have a crossed out circle icon next to it.



The number next the device icon indicates the number of devices connected to the Network Extender with an active session.

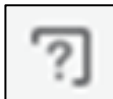

Clicking on the question mark icon will display a help screen for the related page.

Connected Devices Page

The connected devices page shows the current connected users as well as the peak Network Extender capacity utilization over the last hour and 24 hour period. The value reported is the peak for that period.

Figure 10. Network Extender Connected Devices Page

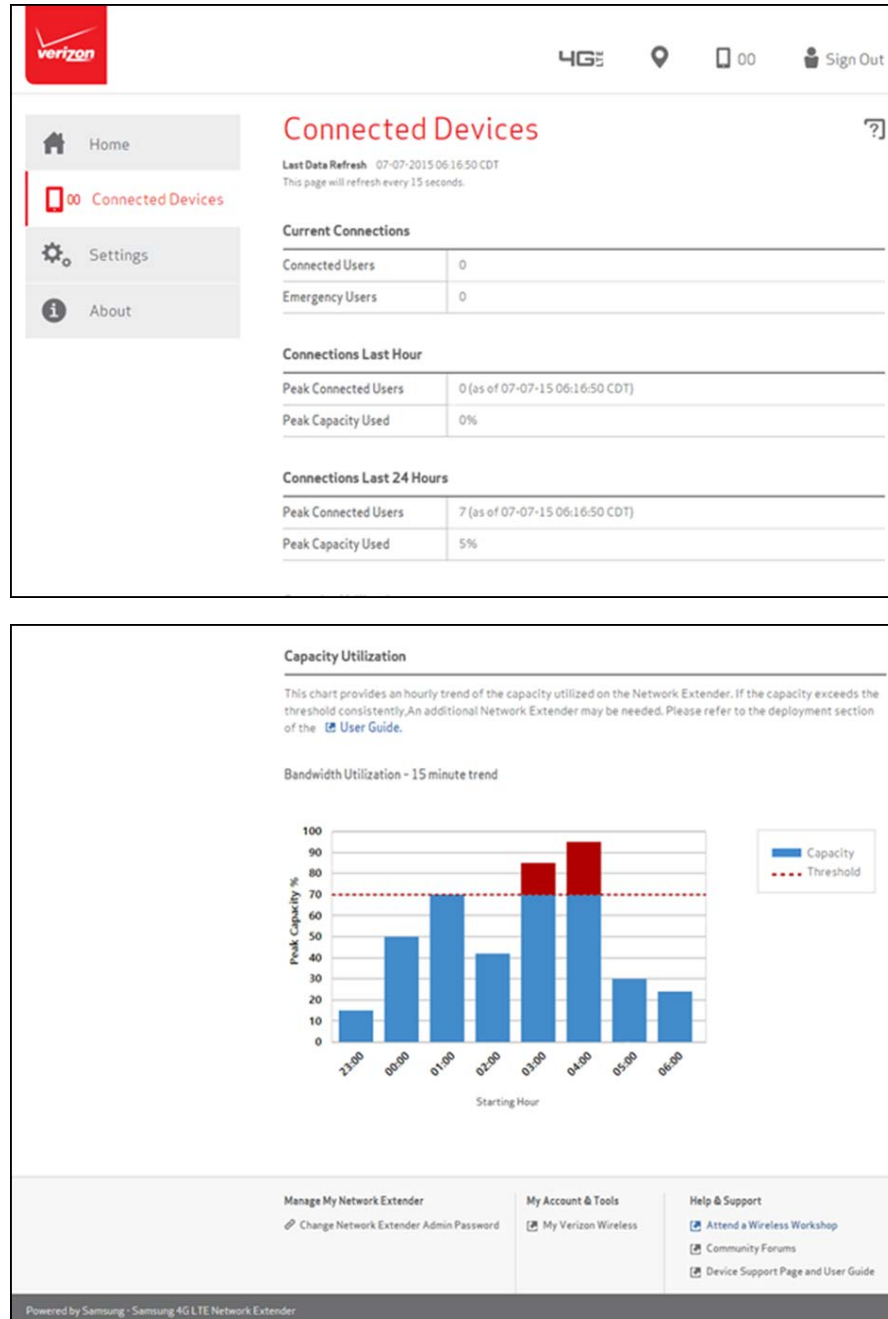

The capacity utilization chart shows the hourly trend of the device capacity in use over the last 8 hour period.

Settings

The Network Extender Network Settings tab allows you to enable/disable DHCP. If DHCP is disabled, you can also set the DNS information, default gateway, IP address and subnet mask. The backhaul limit (affects uplink speeds served by the Network Extender only) and MTU size can also be set here. Information regarding device settings is in the “Configuring Your Device” chapter.

Figure 11. Network Extender Network Settings Tab

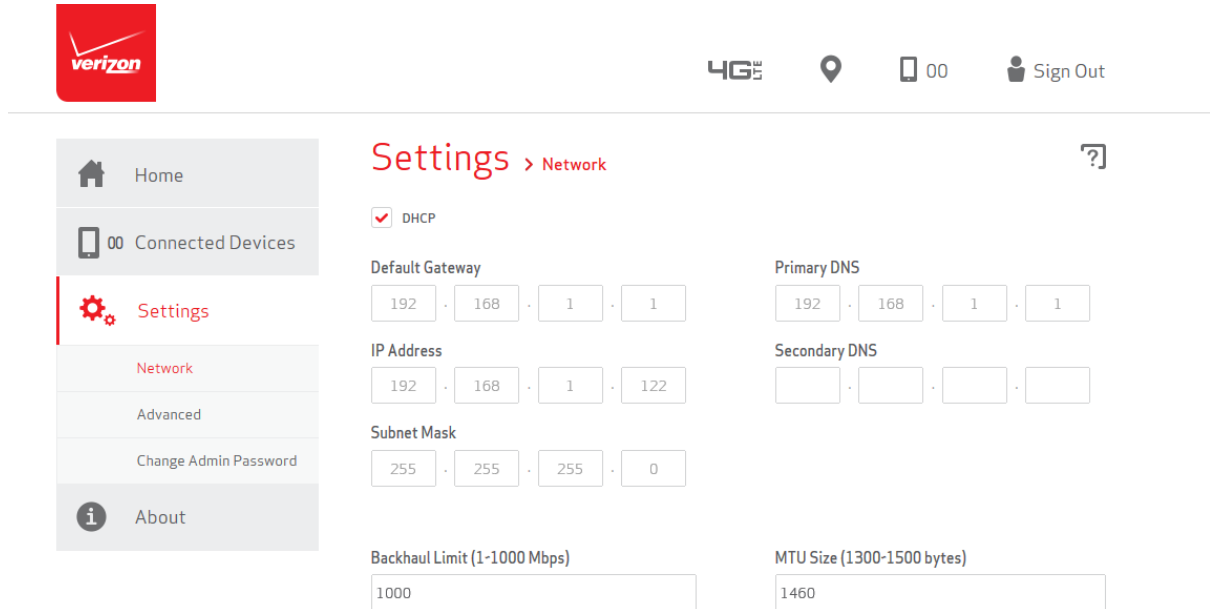

The Network Extender Advanced Settings tab allows you to set the device output power and view neighboring cell towers detected during the boot up scan. This tab provides information on how the device is positioned with other Network Extenders in the network as well as Verizon cell sites.

Figure 12. Network Extender Advanced Settings Tab

The screenshot displays the 'Settings > Advanced' page of the Verizon Network Extender admin website. The interface includes a Verizon logo, a 'Sign Out' button, and a navigation menu with options like Home, Connected Devices, Settings (selected), Network, Advanced, Change Admin Password, and About. The main content area shows 'Network Extender Information' with fields for Network ID - CELL ID and Physical CELL ID (PCI). Below this is a 'Transmit Power' slider set to 100%, with a tooltip indicating 17 dBm (50 mW). At the bottom, a 'Neighboring Cells Detected' table lists nearby cell towers with their Network ID, Cell ID, Physical Cell ID (PCI), Cell Type, and RSRP (dBm) values.

Network ID	Cell ID	Physical Cell ID (PCI)	Cell Type	RSRP (dBm)
45010	6593355	191	Macro	-113: Too Far !
45006	6593352	194	Macro	-49: Too Close !
45005	6593351	193	Macro	-93: OK ✓

The Network Extender Change Password tab allows you to change the local Admin Password for the device. In the event of a lost password, pressing the RESET button for 10 seconds will reset the device to factory default settings.

Figure 13. Network Extender Change Password Tab

verizon 4G 00 Sign Out

Home Connected Devices Settings Network Advanced Change Admin Password About

Settings > Change Admin Password

Change Admin Password

The Admin Password is used to sign in to this Network Extender Administration web page. To change the Admin Password, enter & confirm a New Password. Then create a Security Challenge used for password retrieval if you forget the Admin Password

Current Admin password

New Admin password [Password Rules](#)

Confirm Admin password

Security Challenge

Challenge Answer

Save Changes

About

The Status & Alerts tab on the About page shows the connectivity status, operational status and alerts that can be used for diagnostics and troubleshooting. If the connectivity status shows a servers as “not reachable”, confirm that the Network Extender is properly connected to the router, has acquired an IP Address. For LAN/Routers with a firewall enabled, please see “Configuration Your Device” chapter.

Figure 14. Network Extender Status & Alerts Tab

About > Status & Alerts

Last Data Refresh 09-02-2015 01:24:05 CDT
This page will refresh every 15 seconds.

Server Connectivity

Server	Status	Date & Time	IP Address & Port
DNS Server	Reachable	09-02-2015 01:24:05 CDT	IP 70.11.238.107 Port 53
IPSec Server	Reachable	09-02-2015 01:24:05 CDT	IP 70.11.238.109 Port 500
Location Assistance Server	N/A	09-01-2015 04:15:31 CDT	

Status Details

Current System Details: In Service
[System Status History](#)

Alerts

Current Alerts

Number	Date & Time	Alerts	Description	Troubleshooting
No data available in table				

The GPS tab on the About page shows the GPS satellite IDs and their signal strength. The Network Extender requires continuous GPS signal. If GPS signal is lost, the unit can operate using the Network Extender's internal clock rather than GPS timing, for approximately 24 hours, after which it shall cease being operational.

Figure 15. GPS Tab

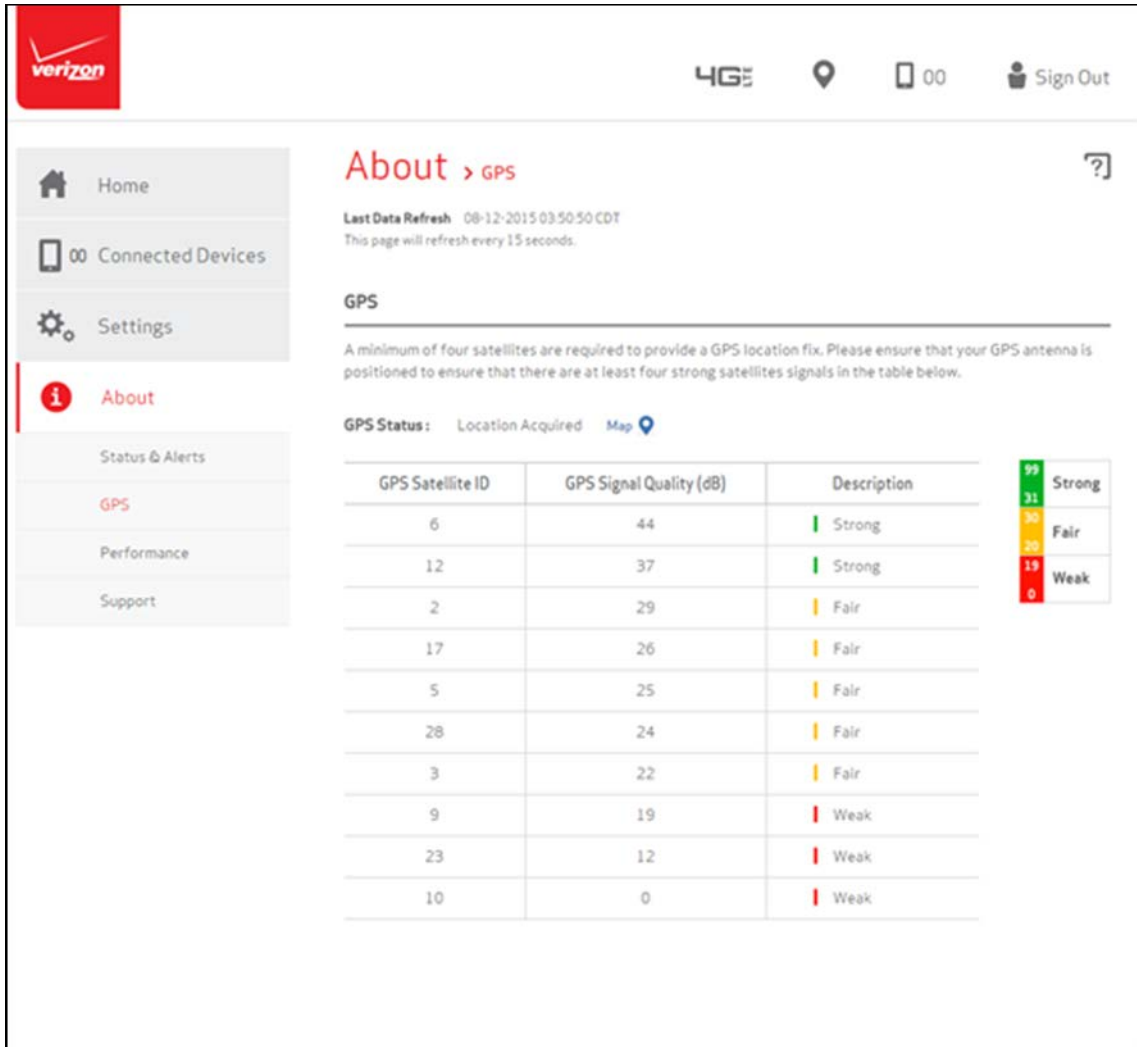

The Performance tab on the About page shows bandwidth utilization charts. There are two graphs for bandwidth utilization:

- The first graph is a 15 minute trend, updated every 30 seconds. This graph starts populating when you arrive on this screen. It will start over if you move to another screen and then come back to this one. Every data point on the graph represents the peak value for a 30 second interval.
- The second graph is an eight hour trend, updated every hour. This graph will maintain the history whether you stay on this screen or not. Every data point represents the peak value for that hour.

Figure 16. Performance Tab

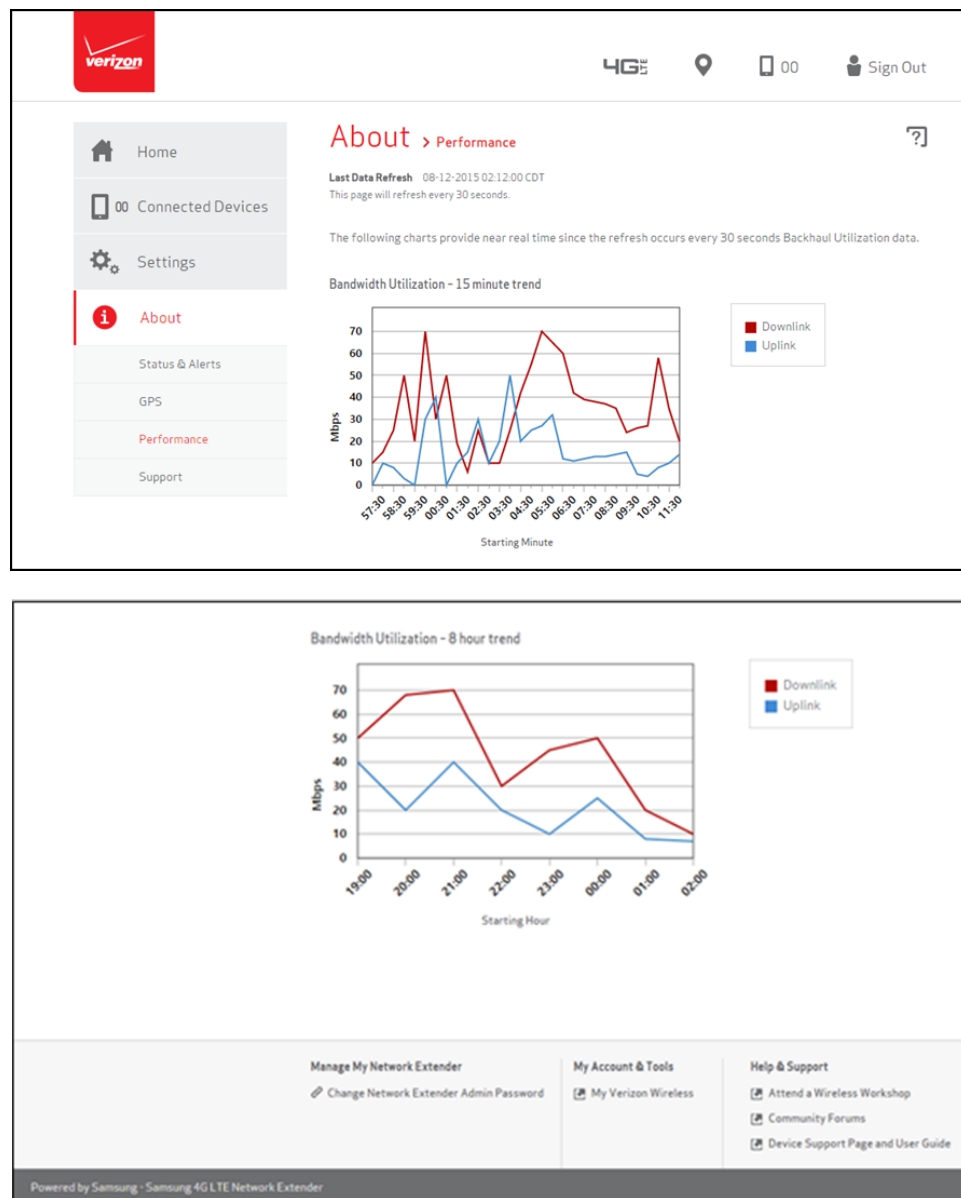

The Support tab on the About page contains the contact information for customer support.

Figure 17. Support Tab

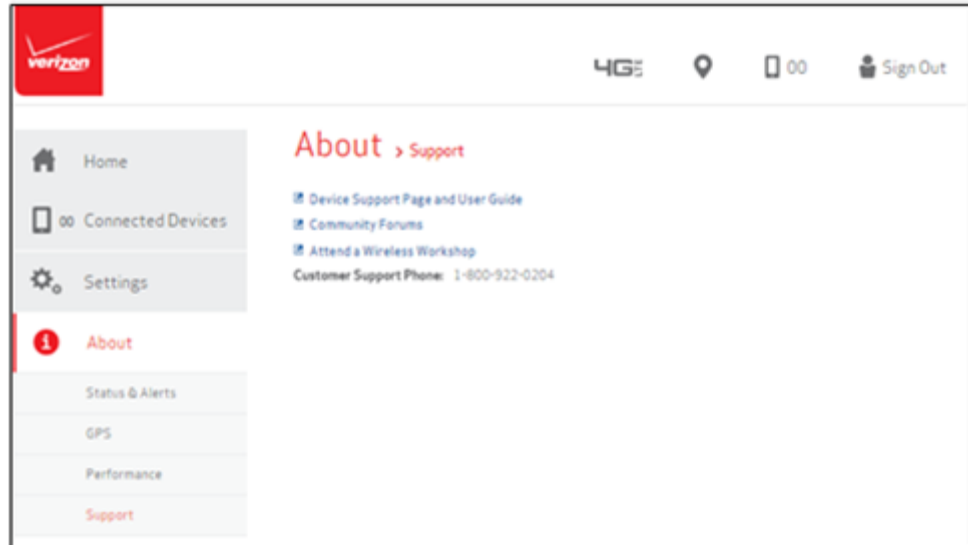

Chapter 4 Configuring Your Device

The 4G LTE Network Extender is designed to connect and automatically configure with minimal user involvement, though in some cases, depending on the firewall settings, some settings may need to be adjusted on the local LAN. This section contains detailed information regarding the firewall settings that are applicable for network administrators.

Table 1. Destination Ports

Source	Destination	Protocol	Destination Port	Notes
Network Extender	GPS Assistance Server	UDP	52428	
Network Extender	DNS Server	UDP/TCP	53	
Network Extender	VzW SeGW	UDP	500/4500	More than one port may be used for multiple device installation
Network Extender	VzW SeGW	ESP/50	NA	When NAT/PAT is not present
VzW SeGW	Network Extender	ESP/50	NA	When NAT/PAT is not present

The following table lists the IP addresses of each of the network elements that need to be included.

Table 2. Firewall Settings

Network Element	IP Address	Fully Qualified Domain Name (FQDN)
GPS Server	209.210.15.73	gps.vzwfemto.com
Security Gateway	69.78.145.119 69.78.145.122 69.78.34.151 69.78.34.154 69.78.82.87 69.78.82.90 69.78.226.55 69.78.226.58	sg.vzwfemto.com
Private DNS	108.61.73.243 192.95.20.208	0.north-america.pool.ntp.org 1.north-america.pool.ntp.org

External GPS Antenna

If your 4G LTE Network Extender cannot receive a GPS signal, it may be necessary to improve the reception by installing the extension cable and then repositioning the GPS antenna outside the unit. This section outlines the installation and relocation of the external GPS antenna.

To relocate the GPS antenna of the Network Extender, follow these steps:

- 1 Turn off the Network Extender.
- 2 Firmly press down on the open groove (top right).
- 3 Slide the protective cover to the right to expose the rectangular GPS antenna.

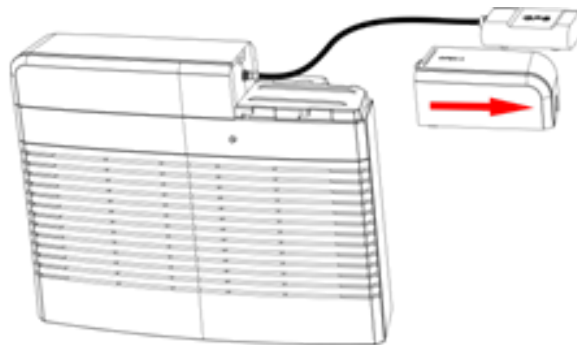

- 4 Pull the GPS antenna away from the Network Extender.
- 5 Remove the GPS antenna from its compartment.
- 6 Connect the GPS antenna to one end of the provided GPS cable.
- 7 Connect and secure the other end to the port on the Network Extender (within the GPS antenna compartment).
- 8 Place the antenna near a window where the GPS signal is stronger. You can use double-sided tape to secure the bottom of the GPS antenna to its new location. Do not cover the antenna with tape.
- 9 Replace the cover on the station and thread the cable through the opening at the base of the cover.
- 10 Turn on the Network Extender to allow the detection of available GPS satellite signals. Note, four GPS satellites (strong signals) are needed to acquire a GPS location fix and may take up to 60 minutes.
- 11 If a GPS fix still cannot be acquired, check the GPS signal in the Admin Website's GPS status page. If the device does not have 4 or more strong GPS satellite signals, place the GPS antenna in another location to receive a stronger signal. In some scenarios, an outdoor GPS antenna (not included) may be needed if adequate GPS signal is not available indoors.

Chapter 5 Troubleshooting

This section provides some troubleshooting tips for the Network Extender.

Power/Status Indicator Light is Not Turning On

- Make sure the power adapter is securely connected to a working power outlet.
- Make sure the power adapter's connector is securely inserted into the DC 12V port on the back of the Network Extender.

Network Extender has not acquired a GPS fix even after an hour

- If possible, move the Network Extender to a new location with fewer surrounding obstructions. The new location should be in an open area and closer to a window.
- Unplug the power adapter for 10 seconds and then plug it back in again. This allows the Network Extender to re-initiate its startup sequence during which it detects the Ethernet connection, GPS signal, and communication with the Verizon Wireless network.
- If the GPS signal is not detected even in the new location, install the GPS extension cable and reposition the GPS antenna, as shown in the Configuring Your Device.
- The GPS antenna must stay connected to the Network Extender at all times for operation.

Unable to Place Call Using Network Extender

- Verify the device is powered on and in service.
- Check that the router is communicating properly with your ISP. The Internet activity LED on your router and the back of the Network Extender should be blinking.
- Check that advanced calling is in use as found in the Network Extender Setup.
- Verify that your phone is connected to the Network Extender by dialing #48.

Power/Status LED Indicator is Blinking

A blue blinking LED indicates the Network Extender is not operational. It may be starting up, attempting to connect to the Verizon Wireless Network or waiting for GPS. Please check the LCD display and status page on the Admin Website to narrow the problem.

Confirm your Network Extender was activated at the time of purchase. If your Network Extender has not already been activated, call Verizon Wireless Customer Service at (800) 922-0204 or *611 from your Verizon Wireless mobile phone and select the option for technical support.

Before contacting Verizon Wireless Customer Service, confirm the following:

- Is the Internet activity LED on your router blinking?
If it is not, then there may be a communication problem between your Network Extender and the router. Check that the router is communicating properly with your ISP. For further router troubleshooting tips, please review either the router manufacturer's printed or online documentation.
- Does the GPS icon show the GPS is tracking one or more satellites?
If not, the Network Extender may not be receiving a GPS signal. Move the GPS antenna as shown in the *Configuring Your Device* chapter.

Alarms

The following alarms may appear on the display of the Network Extender. These alarms will be displayed on the Network Extender Admin website (local).

Table 3. Alarms in the Network Extender Display

Alarm	Description	Troubleshooting
Out of Service Ethernet Port Down	The Ethernet port or connection is not working.	The port connecting your device to the internet is not operational. Please check that your Ethernet cable is connected correctly and the switch, router, or internet gateway is powered on.
Out of Service MME Communication Failure	The unit has a communication failure with the Verizon network.	There is a communication failure preventing your device from functioning correctly. Please unplug your device and then plug it back in again. If the problem persists for an hour, please contact Verizon Wireless Customer Service.
GPS Failure See User Guide	The GPS unit is not working.	There is a failure in the GPS module preventing your device from functioning correctly. Please make sure that the GPS antenna is installed in a location near a window as shown in the <i>Configuring Your Device</i> chapter. If the problem persists for an hour, please contact Verizon Wireless Customer Service.
Out of Service Device Overheated	The unit has overheated.	Your device is overheating. Please move the unit to an area with an ambient temperature between 0-50 degrees Celsius (32 -122 degrees Fahrenheit) and make sure the device is in a well ventilated location.

Alarm	Description	Troubleshooting
Out of Service Transmission Over Power	The output power of the device is out of tolerance.	Please unplug your device and then plug it back in again. Wait for 10 minutes and check if the alarm is cleared. If the problem persists, please contact Verizon Wireless Customer Service.
Out of Service High Radio Interference	The unit is exposed to a high level of radio interference.	If the problem persists after 10 minutes, please relocate the unit to a different area at least 100 feet away.
Out of Service Modem Failure	The device radio unit is out of service.	Please unplug your device and then plug it back in again. Wait for 10 minutes and check if the alarm is cleared. If the problem persists, please contact Verizon Wireless Customer Service.
Out of Service For Maintenance	The unit is out of service due to maintenance mode.	The operator puts the device in maintenance mode. Wait for an hour and check if the alarm is cleared. If the problem persists, please contact Verizon Wireless Customer Service.
Setup Failure See User Guide	The device fails to download software and/or configuration.	There is a communication problem in the network preventing downloading files necessary for setting the device up. Please unplug your device and then plug it back in again. Wait for 10 minutes and check if the alarm is cleared. If the problem persists, please contact Verizon Wireless Customer Service.
Out of Service Incorrect Bandwidth	The unit is assigned incorrect bandwidth.	The unit is incorrectly configured by Verizon network. Please unplug your device and then plug it back in again. Wait for 10 minutes and check if the alarm is cleared. If the problem persists, please contact Verizon Wireless Customer Service.
Device Not Activated Call Verizon Support	The device fails to authenticate to Verizon network.	The device might not be provisioned in the Verizon network yet. Please unplug your device and then plug it back in again. Wait for 10 minutes and check if the alarm is cleared. If the problem persists, please contact Verizon Wireless Customer Service.
Out of Verizon's Service Area	The device fails to come into service due to unlicensed area.	You might be located in an area where no Verizon service is allowed. Please unplug your device and then plug it back in again. Wait for 10 minutes and check if the alarm is cleared. If the problem persists, please contact Verizon Wireless Customer Service.

The following table lists critical alarms that can halt the functioning of the Network Extender. These alarms will be displayed in the Network Extender Admin Website (Local) chapter.

Table 4. Alarms in the Network Extender Admin Website (Local)

Alarm	Description	Troubleshooting
PROCESS_DOWN	An application block is deactivated/terminated.	There is a temporary process alert but your device is still functioning correctly. No action is needed and the alert should clear itself. If the alert persists please see the troubleshooting section of the user guide.
DISK_FULL	Disk usage has exceeded a threshold.	There is a temporary disk usage alert but your device is still functioning correctly. This alert should clear itself. If the alert persists for a long time please check the number of users in the "Connected Devices" tab and see the capacity section of the user guide.
MEMORY_FULL	Memory usage has exceeded a threshold.	There is a temporary memory usage alert but your device is still functioning correctly. This alert should clear itself. If the alert persists for a long time please check the number of users in the "Connected Devices" tab and see the capacity section of the user guide.
OVERLOAD	Average CPU load has exceeded a threshold.	There is a temporary CPU load alert but your device is still functioning correctly. This alert should clear itself. If the alert persists for a long time please check the number of users in the "Connected Devices" tab and see the capacity section of the user guide.
CLOCK_FAIL	The clock is abnormal.	There is a failure preventing your device from functioning correctly. If you are using GPS, please ensure that the GPS antenna is installed in a location near the window. If you are not able to receive GPS information after repositioning the antenna, you may need to purchase and install an external outdoor antenna. You may need to check your firewall settings as defined in the user guide. If you still experience an issue after checking your GPS installation, please see the troubleshooting section of the user guide.
PORT_DOWN	Outer Ethernet port is down.	The port connecting your device to the internet is not operational. Please check that your Ethernet cable is connected correctly and the switch, router, or internet gateway is powered-on.
FUNCTION_FAIL	All RU paths are disabled.	There is a failure preventing your device from functioning correctly. Please restart your device. If the problem still persists, please contact Verizon Wireless Customer Care.
OVER_POWER	RU output power has exceeded the normal range.	There is a failure preventing your device from functioning correctly. Please contact Verizon Wireless Customer Care.
TOD_MSG_MISSED	TOD message is not received from GPSR.	There is a failure preventing your device from functioning correctly. Please verify if the GPS antenna is properly installed. Please contact Verizon Wireless Customer Care if the issue is not resolved.

Alarm	Description	Troubleshooting
LOCKING_FAIL	No GPS signal can be received.	The device is not receiving GPS information. Please ensure that the GPS antenna is installed in a location near the window. If you are not able to receive GPS information after repositioning the antenna, you may need to purchase and install an external outdoor antenna. Please see the GPS outdoor antenna section of the user guide.
FUNCTION_FAIL	GPSR module failure due to e.g. self test failure, power failure, EPC (Electronic Frequency Control) exceeding normal operation range, OCXO/TCXO failure, etc.	The device is attempting to receive GPS information. If the issue persists for more than one hour, please ensure that the GPS antenna is installed in a location near the window. If you are not able to receive GPS information after repositioning the antenna, you may need to purchase and install an outdoor GPS antenna. Please see the GPS outdoor antenna section of the user guide.
FREQUENCY_HOLDOVER_EXCEED	GPS signal has been lost for 24 hours.	The device has lost GPS signal for 24 hours and can no longer provide service. Please ensure that the GPS antenna is installed in a location near the window. If you are not able to receive GPS information after repositioning the antenna, you may need to purchase and install an external outdoor antenna. Please see the GPS outdoor antenna section of the user guide.
HOLDOVER_EXCEED	GPS signal has been lost.	The device has lost GPS signal can no longer provide service. Please ensure that the GPS antenna is installed in a location near the window. If you are not able to receive GPS information after repositioning the antenna, you may need to purchase and install an external outdoor antenna. Please see the GPS outdoor antenna section of the user guide.
TEMPERATURE_HIGH	Temperature has exceeded a threshold.	Your device is over-heating. Please locate the unit in an area with an ambient temperature between 0-50 degrees Celsius inline with the user guide.
SERVICE_OFF	Service cannot be provided due to abnormal service condition.	The Network Extender is currently not in service. Please check the System Status, System History, GPS Status or any other alerts to determine if the unit is in the process of starting up or if there is any other condition preventing it from coming into service.
MME_COMMUNICATION_FAIL	The 4G Network Extender cannot communicate with backend servers.	The Network Extender cannot communicate with Verizon's Network. Please check the LAN/Firewall settings, connectivity status and available bandwidth to see if any LAN or internet issue may be preventing the unit from communicating with backend servers. If the problem persists, please contact Verizon Wireless Customer Service.

Appendix Acronyms

AC	Alternating Current
B/H	Backhaul
CPU	Central Processing Unit
CSG	Closed Subscriber Group
DC	Direct Current
DHCP	Dynamic Host Configuration Protocol
DNS	Domain Name System
ESP	Enhanced Security Payload Protocol
FCC	Federal Communications Commission
FQDNs	Fully Qualified Domain Names
GPS	Global Positioning System
GPSR	GPS Receiver
HD	High Definition
HTTP	HyperText Transport Protocol
ID	Identifier
IP	Internet Protocol
IPSEC	Internet Protocol Security - System of Protocols
ISP	Internet Service Provider
LAN	Local Area Network
LCD	Liquid Crystal Display
LED	Light Emitting Diode
LTE	Long Term Evolution
MAC	Media Access Control
MTU	Maximum Transmission Unit
NAT	Network Address Translator
PAT	Port Address Translation
RF	Radio Frequency
RU	Radio Unit
SeGW	Security Gateway
SIM	Subscriber Identity Module
TCP	Transmission Control Protocol
TCXO	Temperature Controlled Oscillator
TOD	Time Of Day
UDP	User Datagram Protocol



**Verizon 4G LTE Network Extender
User Guide**

Document Version 1.3

©2016 Samsung Electronics Co., Ltd.
All rights reserved.