

Capresso

ULTIMA **PRO**

Programmable Pump Espresso Machine

Model #124.01

Instructions • Warranty



1450 Watts / 120 Vac / 60 Hz

Read this manual thoroughly before using and save it for future reference

IMPORTANT SAFEGUARDS

When using electrical appliances, basic safety precautions should always be followed, including:

1. Read all instructions and any other literature included in this packaging prior to using this appliance.
2. Before using check that the voltage of the wall outlet corresponds to rated voltage marked on the machine.
3. To protect against fire, electric shock or personal injury, do not immerse cord, plug or appliance in water or other liquid.
4. Unplug appliance from outlet when not in use and before cleaning. Allow appliance to cool down before putting on or taking off parts, and before cleaning the appliance.
5. Do not operate any appliance with a damaged cord or plug or after the appliance malfunctions, or has been damaged in any manner. Return appliance to the nearest authorized service facility for examination, repair or adjustment.
6. The use of accessory attachments not recommended by the appliance manufacturer may result in fire, electric shock or injury to persons.
7. Place appliance on flat surface or table, do not hang power cord over the edge of table or counter, or touch any hot surfaces.
8. Do not place the machine on or near a hot gas or electric burner, or in a heated oven.
9. To disconnect, turn any control 'OFF', then remove plug from wall outlet. Always hold the plug and never pull on the cord.
10. Do not use appliance for other than intended use.
11. Close supervision is necessary when your appliance is being used near children to ensure that they do not play with the appliance.
12. This appliance is not intended for use by persons (including children) with reduced physical, sensory or mental capabilities, or lack of experience and knowledge unless they have been given supervision or instruction concerning use of the appliances by a person responsible for their safety.
13. Use extreme CAUTION when dispensing hot steam.
14. Do not touch the hot surface of appliance. Use handle or knobs. Do not touch the warming tray as it is HOT!
15. Do not operate the espresso machine without water as it can damage the heating system.
16. Do not remove the portafilter when the appliance is brewing coffee or when steaming.
17. Do not operate or store the appliance in environments less than 35°F.
18. Do not use outdoors.

**FOR HOUSEHOLD USE ONLY
SAVE THESE INSTRUCTIONS**

SPECIAL CORD SET INSTRUCTIONS

1. A short power supply cord is provided to reduce risks resulting from becoming entangled in or tripping over a longer cord.
2. Longer detachable power-supply cords or extension cords are available and may be used if care is exercised in their use.
3. If a longer detachable power-supply cord or extension cord is used,
 - a. The marked electrical rating of the detachable power-supply cord or extension cord must be as great as the electrical rating of the appliance,
 - b. If the appliance is of the grounded type, the extension cord should be a grounding type 3-wire cord, and
 - c. The longer cord should be arranged so that it will not drape over the countertop or tabletop where it can be pulled on by children or tripped over.
4. This appliance has a polarized plug (one blade is wider than the other). To reduce the risk of electric shock, this plug will fit in a polarized outlet only one way. If the plug does not fit fully in the outlet, reverse the plug. If it still does not fit, contact a qualified electrician. Do not attempt to defeat this safety feature.

CAUTION

This appliance is for household use only. Any servicing other than cleaning and user maintenance should be performed by an authorized service agent.

1. Do not immerse in water or try to disassemble appliance.
2. To reduce the risk of fire or electric shock, do not remove the top or base. No user serviceable parts are inside. Repair should be done by authorized service personnel only.
3. Never use warm or hot water to fill the water tank. Use cold water only!
4. Keep hands and cord away from hot parts of the appliance during operation.
5. Never clean with scouring powders or hard implements.
6. Operate the appliance with the drip tray and support grid in place.
7. Never heat flammable liquids using steam.
8. Clean the steam wand only when the appliance is not under pressure and the unit is powered OFF..
9. To maintain the life of your machine, follow the instructions for "Descaling the Machine" in chapter 11.5.

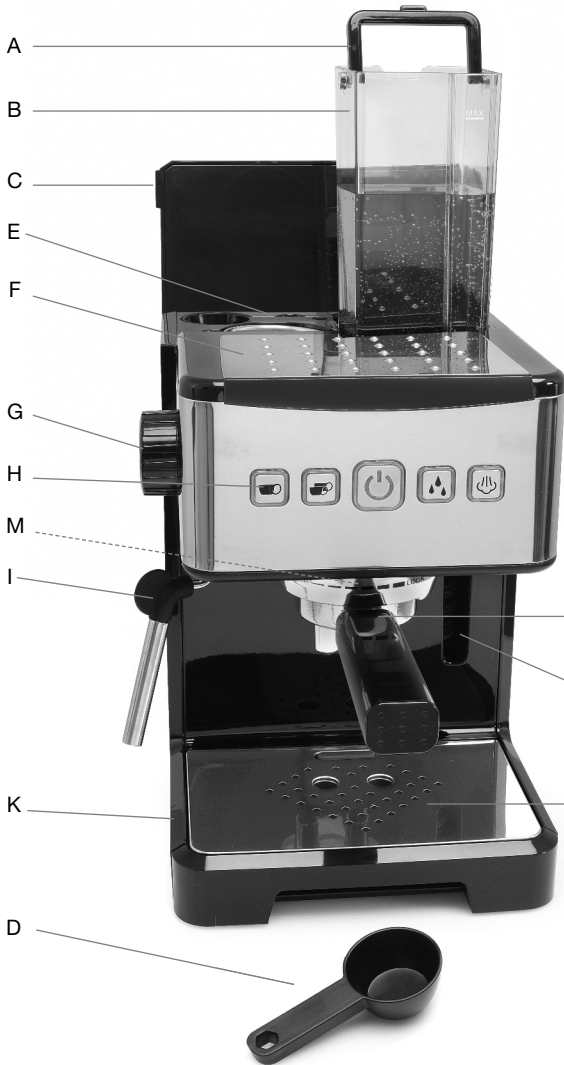

A
B
C
E
F
G
H
M
I
K
D

Fig. 1

- A. Water Tank Handle
- B. Removable Water Tank
- C. Water Tank Lid
- D. Measuring Spoon
- E. Sieve Storage
- F. Warming Tray
- G. Steam Knob
- H. Control Panel
- I. Steam Wand
- J. Portafilter
- K. Drip Tray with Overflow Indicator
- L. Drip Tray Grid
- M. Brew Head
- N. Water Level Indicator

J
N
L

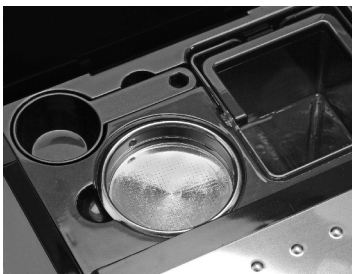

Lift Water Tank Lid to access Sieve and Measuring Spoon Storage Compartment

Fig. 2 Control Panel

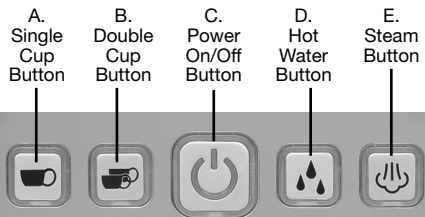

Capresso

Fig. 3

**Removable
Water Tank**

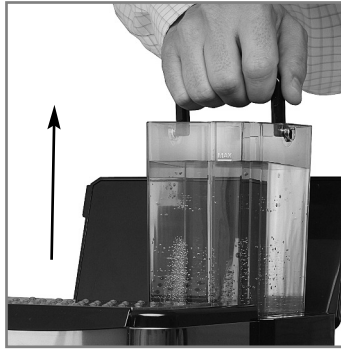

Fig. 4 Portafilter



Installing Spouts



Spouts Inserted

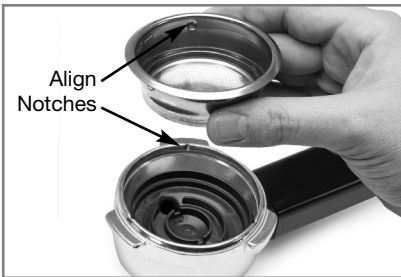

Installing Sieve

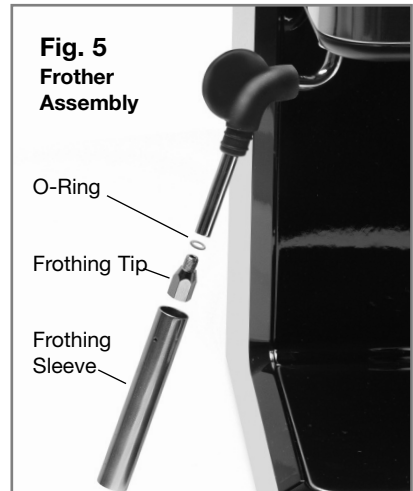

**Fig. 5
Frother
Assembly**

O-Ring

Frothing Tip

Frothing
Sleeve

**Fig. 6
Removing
Frothing Sleeve**



Pull Down

Use hexagon wrench on scoop handle to
remove frothing tip

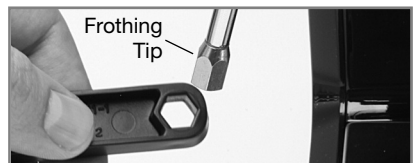

Frothing
Tip

1. Tips for Brewing the Best Espresso

- To extract the fullest flavor from your beans, we recommend using whole coffee beans that have been freshly ground each time espresso is prepared.
- In addition to the coffee used, using fresh cold water that is free of chlorine odors and other impurities will help ensure the perfect espresso.
- Store your espresso grounds in an airtight container, and in a cool, dry place to retain the flavor. Grounds should not be kept for long periods of time as the flavor will be reduced.
- Do not fill your filter holder to the brim. Using the measuring spoon included, use 1 level spoon of grounds per shot of espresso.
- If you do not use the machine for more than 5 consecutive days, rinse and drain the water tank.
- Before removing the water tank to fill or empty it, always turn the machine off.
- Always place the unit on a flat, stable, heat-resistant work surface.
- To ensure your espresso stays at optimum temperature, we recommend that you preheat your cups.
- If 5 lights are all flashing during brewing, this is a warning instruction. Please check if water is empty or steam knob is not in closed position.
- Before brewing, the filter holder must be turned to the right as tight as possible to prevent the filter holder from loosening due to high pressure.

2. Before Using for the First Time

After carefully unpacking your Ultima PRO, wash all removable parts with warm soapy water and rinse thoroughly. Familiarize yourself with the appliance and read the entire instruction manual. Plug the power cord into a grounded wall outlet according to the safety instructions. Rinse the internal components before making espresso as described below in chapter 2.1.

2.1. Priming the Machine

- a. Open the lid and remove the water tank by lifting up on the handle.
- b. Fill the tank with water following the MIN and MAX markings.
- c. Replace the water tank by pushing down firmly, to ensure the tank is properly engaged (Fig. 3), and close the lid.
- d. Press the Power button (Fig. 2, C) to turn the machine on. The Power indicator light will flash while the machine heats up.
- e. Insert the portafilter (Fig 1, J), without any coffee. Align the portafilter at the inscription "▼", push the portafilter up and turn it firmly to the right until it feels tight.

Note: In the beginning it might not be possible to turn the portafilter all the way to the "LOCK" position. Just make sure the portafilter is firmly placed. Over time the portafilter can be moved closer to the "LOCK" position.

- f. Place a container under the portafilter large enough to hold all the water in the water tank.
- g. Once the machine reaches the correct temperature, the "Power" light stops blinking and all 4 product lights illuminate (Single Cup, Double Cup, Hot Water, and Steam).

- h. Press the "Double Cup" button and let the water run out into the container. Repeat this operation 5 times or until no water is left inside the water tank.
Note: If necessary, stop the operation by pressing the "Double Cup" button to empty the container and then resume the operation.
- i. Empty the container and unlock the portafilter.
Important: Before using for the first time, after a prolonged period of inactivity or after descaling, the machine must be primed as described above.

3. Preheating the Accessories

Tip! For the best results, we recommend that you preheat the portafilter before coffee grounds are added and warm the espresso cups. When the machine is powered on, cups can be warmed on the warming tray (Fig 1, F).

- a. Press the Power button to turn the machine on. The Power indicator light will flash while the machine heats up.
- b. Insert the portafilter with sieve (without coffee grounds) in the machine and turn to the right as far as it will go. Once the required temperature has been reached the Power light will stop flashing and all 4 product lights will illuminate. Place cup(s) under the portafilter spouts.
- c. Press the "Single Cup" or "Double Cup" button. Hot water will be pumped through the filter into the cups.
- d. When the water flow stops and the cups are filled with hot water remove them from the machine and empty into the sink. Unlock the the portafilter by turning the handle to the left to release the portafilter from the machine.
Note: When the machine has been turned on for approximately 15 minutes, the warming tray will be heated up and can be used to pre-warm cups instead of using hot water from the machine.

4. Filling and Inserting the Portafilter

The Ultima PRO comes with a small (one-cup) and large (two-cup) sieve. Place one of the sieves into the portafilter and lock into the portafilter as shown in Fig. 4. Using the provided measuring spoon (Fig. 1, D), use 1 level scoop of ground coffee per cup of espresso. Be sure to brush away any loose grounds that remain on the edge of the portafilter. Grounds left on the edge of the filter will interfere with proper tamping and will affect the quality of your espresso.

Important: Do not tamp the coffee grounds down into the portafilter. The machine tamps the grounds automatically as the portafilter is inserted into the brew head (Fig. 1, M).

5. Preparing Espresso

Tip! The type of coffee you choose strongly influences the strength and flavor of your espresso. Always use coffee beans ground to a relatively fine and uniform size, suitable for espresso. Too fine a grind will result in an espresso that is over-extracted and bitter. Too coarse a grind will result in espresso that is under-extracted and weak in flavor. The perfect espresso grind will feel slightly granular, with a texture between sugar and flour. Unevenly ground beans or beans exposed to excessive heat when grinding will also affect the final result, so take care to use a Capresso Burr Grinder that consistently grinds beans to the proper size for even extraction without overheating the beans and stripping them of their natural oils.

Store your espresso grounds in an airtight container and in a cool dry place to retain the flavor. Grounds should not be kept for long periods of time as the flavor will be reduced. Do not use instant coffee, or coffee ground for drip coffee machines.

- a. Make sure there is water in the water tank, the portafilter with the sieve and ground coffee is securely in place and your cup(s) are pre-warmed as described in earlier chapters.
- b. Insert the portafilter into the machine and turn to the right as far as it will go.
- c. Put one or two cups under the portafilter as desired.

Note: For one cup of espresso use the small sieve, for two cups of espresso use the large sieve.

- d. As soon as the machine reaches the desired temperature, the Power light stops blinking and all 4 of the product lights will illuminate. Press the "Single Cup" or "Double Cup" button to start brewing. When the cups are filled to the programmed amount of espresso, the machine will stop automatically. Remove the cups from under the portafilter.

Note: After the espresso is brewed, the machine automatically creates a bit of steam and pushes the remaining water from the thermoblock into the drip tray. This ensures that there will be no rest-water in the heating system. After preparing a few cups of espresso carefully pull the tray out of the machine, empty and replace.

- e. Turn the portafilter holder to the left and remove it from the machine. Turn the portafilter upside down and tap out the used coffee grounds. Rinse the portafilter under running water and make sure the holes are free of coffee deposits. Once the portafilter has been rinsed and dried, it can be used to prepare more espresso.

Important: The machine is preprogrammed to use 1.5 oz. of water per cup of espresso. It is possible to stop the flow of espresso by pressing the "Single Cup" or "Double Cup" button again. Both the "Single Cup" and the "Double Cup" button can be reprogrammed.

Important: To avoid unnecessary wear to the seal, do not store the portafilter in the locked position when not in use.

Tip! For stronger espresso - use a heaping scoop of ground coffee.

For mild espresso - use less than a full scoop.

For extra strong shot of espresso - use two level scoops of ground coffee in the large sieve and brew into a single cup using the "Single Cup" button.

Tip! While tamping the coffee manually is not required, the flat side of the included coffee scoop can be used to level the ground coffee so that more ground coffee can be added.

6. Programming

The machine is preprogrammed to use 1.5 oz. of water per cup of espresso. Depending on your taste preference you may want to adjust this setting. Changing the preset amount to less than 1.5 oz. will result in a stronger tasting cup of espresso. Increasing the setting to more than 1.5 oz. will result in a milder tasting cup of espresso.

- a. Make sure there is water in the water tank, the portafilter with the sieve and ground coffee is securely in place and your cup(s) are pre-warmed as described in earlier chapters.

- b. Insert the portafilter into the machine and turn to the right as far as it will go.
- c. Place the desired cup(s) underneath the portafilter spouts, and push the desired "Single Cup" or "Double Cup" button for 3 seconds. The selected cup button will start flashing, indicating that the machine is in programming mode as espresso starts to flow into your cup.
- d. Once the desired volume has been reached, push and release the selected cup button and the flow of the espresso will stop. The machine will now produce the newly programmed amount each time the selected button is pushed.
Note: The maximum programmable volume for both the "Single Cup" button and the "Double Cup" button is 6 oz. To reset the machine back to its original settings, unplug the machine from the wall outlet for 2 minutes, and then plug the machine back in to the wall outlet.

7. Preparing Cappuccino

Important: During and after using the steam wand to make frothed milk or hot water, the metal parts of the steam wand can become very hot. Place fingers on the black grip when moving hot steam wand. Take care when handling the steam wand to avoid injury.

Cappuccino is the combination of one or two shots of espresso with an equal or larger amount of hot milk and milk froth (for Latte see chapter 8).

Frothing Milk

Always start with cold milk. Skim or fat-free milk will produce the most froth and provide a stronger espresso taste. 1% and 2% milk will produce less froth, and whole milk will produce less than half the amount of froth of skim milk.

- a. First prepare your espresso (see chapter 5), but use larger, preheated cappuccino cups instead of espresso cups.
- b. Press "Steam" button and the steam indicator light illuminates. During preheating, the Power light flashes and "Single Cup", "Double Cup" and "Hot Water" lights will turn off. Position the steam wand so that it points away from the machine. Pour 2 to 3 oz (1/4 – 1/3 cup) of fresh milk in a small, stainless steel frothing pitcher that is short enough to fit under the steam wand. Make sure that there is enough space left in the pitcher for the milk and milk froth to expand. Both the milk and the container should be cold for optimal results.
Tip! Although it is recommended to use a stainless steel pitcher to froth milk, porcelain or ceramic cups can also be used.
- c. As soon as the Power light stops blinking, plunge the steam wand about two thirds into the milk pitcher. Turn the steam knob (Fig. 1, G) counterclockwise to the "steam" icon. For optimal results, start frothing from the bottom of the pitcher and slowly move upward. Keep the steam wand close to the bottom of the pitcher without touching for about 25 seconds. Then gradually lower the container so that the steam wand moves up towards the surface of the milk. Do not allow the tip of the steam wand to come completely out of the milk or allow the milk level to cover the black rubber finger grip at the top of the wand.

Important: To avoid difficult cleaning of the steam wand, make sure milk froth does not cover the black rubber finger grip at the top of the steam wand.

Note: After steaming, the machine automatically creates a bit of steam and pushes the remaining water from the thermoblock into the drip tray. This ensures that there will be no rest-water in the heating system.

- d. Once milk has developed froth or reached the temperature of 160°F, turn the steam knob clockwise to the off position to stop the flow of steam from the steam wand.
- e. Pour the milk froth over the espresso and enjoy.
- f. It is important to clean the steam wand after each use to prevent milk from hardening and drying inside the wand. To clean the wand, place the steam wand in a small container filled with water and repeat the above procedure for at least 30 seconds.

Note: For thorough cleaning of the steam wand see chapter 11.2.

Caution: The steam wand will be HOT after frothing. Only reposition the steam wand using the black rubber finger grip, especially after frothing or steaming milk or preparing hot water.

8. Preparing Latte

Latte is the combination of one or two shots of espresso with an equal or larger amount of hot steamed milk with very little, or no froth.

Note: Without the frothing sleeve, the steam wand will steam, not froth the milk. Remove the frothing sleeve (Fig. 6). Then proceed with steaming the milk as described in chapter 7. Pour hot steamed milk over espresso.

Caution: The steam wand will be HOT after steaming. Only reposition the steam wand using the black rubber finger grip, especially after frothing or steaming milk or preparing hot water.

9. Hot Water

The Ultima PRO can produce hot water for tea or Americanos by using the steam wand. Always make sure the steam wand is well cleaned and free of dried milk deposits before making hot water.

- a. Press "Hot Water" button, the "Single Cup", "Double Cup" and "Steam" lights will turn off. Put a container under the steam wand to catch hot water.
- b. Turn the steam knob counterclockwise to the "steam" icon and hot water will flow from the steam wand. When the cup is filled with the desired amount of hot water, turn the steam knob clockwise to the off position and hot water stops flowing immediately.
- c. Repeat above procedure if more hot water is needed.

10. Turning OFF the Ultima PRO

We suggest turning off the machine when not in use. If you forget to turn off the machine, it will automatically shut off after 30 minutes of inactivity.

- a. After making the last coffee or frothing milk, wait approximately 15 seconds so that the thermoblock can release any steam and rest-water into the drip tray. This is perfectly normal.
- b. Now push the On/Off button to turn off the machine. The indicator lights will turn off.

Note: When not in use, remove the portafilter. This will extend the life of the seal inside the brew head.

11. Cleaning & Maintenance

11.1 Cleaning the Machine

- a. To avoid injury, always turn off and unplug the machine before cleaning and allow to cool down. Wipe the outside of the machine with a clean damp cloth. Do not immerse the appliance in water or any other liquid. Do not use harsh or abrasive cleaners or alcohol/solvent-based cleaners to clean the machine. Use only gentle dishwashing liquid and warm water. After each use, rinse out the water tank and empty before replacing back into the machine.
- b. When a thin white layer of powder starts to form in the tank, this is a sign that descaling is necessary. It's recommended that you regularly remove these deposits using Capresso Cleaning Solution or a similar descaling agent as described in chapter 11.5.

11.2 Cleaning the Steam Wand

It is important to clean the steam wand immediately after use.

- a. If the steam wand is blocked due to milk deposit build up, it is helpful to remove the blockage by cleaning the frothing wand and all parts.
- b. First, remove the stainless steel frothing sleeve from the steam wand (Fig. 6), unscrew the frothing tip by using the hexagon at the end of measuring spoon to loosen the tip from the wand. Ensure the clear o-ring on the tip frothing wand is assembled (Fig. 5).
- c. Clean all components under warm running water. Use a needle to clean the opening of the steam wand until no dried milk deposits remain. Rinse well and dry all parts completely before reassembling.
- d. Assemble all components in the sequence you removed them (follow Fig. 5). Ensure the o-ring is assembled onto the tip of the steam wand before screwing the tip back onto the steam wand (Fig. 6). Once tip is assembled, tighten the tip with the hexagon hole on the handle of the coffee scoop. Place the stainless steel frothing sleeve upward back onto steam wand pushing it tightly in place. The steam wand must be assembled correctly to ensure proper frothing of milk.

11.3 Cleaning the Drip Tray

- a. The drip tray (Fig. 1, K) must be emptied each time the machine is used. The presence of water in the drip tray is normal and is not the sign of a leak. Lift up the tray slightly and pull out to remove from the machine. If multiple espressos are prepared one after the other, the drip tray should be emptied every few espressos to prevent overflowing. The red overflow indicator in the drip tray will float up and become visible to remind you to empty the drip tray before it overflows.
- b. When emptying the drip tray, remove the drip tray grid (Fig. 1, L) and rinse both the drip tray and grid. If necessary, both the drip tray grid and drip tray can be hand washed with warm water and a gentle dishwashing liquid. Rinse well and dry completely before replacing the drip tray and grid back in the machine.

Important: Make sure when replacing the drip tray to push it all the way into the machine to avoid leaking.

11.4 Cleaning the Brew Head and Portafilter

- a. Both the brew head and portafilter should be cleaned frequently.
- b. Wipe the brew head with a clean damp cloth.

Caution: HOT! Danger of burning or scalding! Ensure the machine has completely cooled down prior to cleaning.

- c. If the inner screen inside the brew head, (Fig. 1, M) accumulates coffee oils, it can be removed for a thorough cleaning using a screwdriver. Ensure it is attached back onto the machine the same way after cleaning.
- d. Hand wash the portafilter and sieves with warm water. Do not use harsh or abrasive cleaners, or alcohol/solvent-based cleaners to clean the brew head or portafilter. When cleaning the portafilter and sieves, hold under running water. Rinse well and dry carefully. When not using the espresso machine, do not store the portafilter in the locked position. This will avoid unnecessary wear to the seal.

Important: Never wash the loose parts or accessories in the dishwasher. Hand wash only!

- e. To clean internal parts of the portafilter by hand, turn the sieve to the notch of the portafilter to release the sieve (Fig. 4). Then remove the silicone seal and the dispensing spout for cleaning. Rinse well with gentle dishwashing liquid and warm water. Dry completely before replacing the silicone seal and the dispensing spout in the filter holder. The sieve must be aligned with the notch of the portafilter so that it can be properly engaged.

11.5 Descaling the Machine

When making espresso, always use cold clean water. Using spring water or filtered water will slow down calcium build up. We recommend descaling the machine after 100-200 uses or at least every 2-3 months. Empty the water tank and fill the tank with a mixture composed of 30 oz. of water and one packet of Capresso Cleaning Solution or similar descaling agent.

NOTE: Do not use vinegar as this will considerably shorten the life of the seal inside the brew head.

Descaling the Brew Head

- a. Remove the portafilter.
- b. For best results unscrew the screen inside the brew head. Wipe off any coffee residue with a damp cloth.
- c. Fill the water tank with the descaling solution and water.
- d. Place a large container beneath the brew head.
- e. Press the "Double Cup" button and allow water to flow into the container. Repeat this process again then allow machine to sit for 15 minutes. Press the "Double Cup" button again to run more Cleaning Solution through the machine. Empty the container.

Descaling the Steam Wand

- f. Place the empty container under the steam wand.
- g. Press the Hot Water button and turn the steam knob counterclockwise to the steam icon. Let the remainder of the Cleaning Solution flow through the steam wand into the container and then turn the steam knob clockwise to the off position.

Rinsing the System

- h. Remove the water tank and rinse thoroughly, then fill with fresh cold water and place back into the machine.
- i. Repeat above steps (d through g) with fresh cold water.
- j. Replace screen in the brew head and tighten the screw securely.

12. Troubleshooting

Water leaks from the bottom of the espresso machine.

- There is too much water in the drip tray.
Clean and dry the drip tray and replace.
- The machine has possible internal defect.
Contact Capresso Customer Service.

Coffee runs down the side of the portafilter.

- Portafilter not properly inserted.
Turn the handle of the portafilter further to the right.
- Edge of sieve not free of ground coffee.
Turn OFF the appliance, remove the portafilter and clean the edges of the sieve.
- Sealing ring inside brew head is dirty.
*Turn OFF the appliance, remove the portafilter and brew head screen and clean sealing ring with a hot damp cloth. **CAUTION! HOT!***
- Sealing ring no longer has elasticity.
Sealing ring must be replaced. Please contact Capresso Customer Service.

Very little or no coffee flows through the portafilter.

- No water in water tank.
Fill water tank with fresh, cold water.
- The screen inside the brew head is blocked.
Brew water through the screen without the portafilter inserted. If no water comes through, unscrew the screen and clean and replace. See chapter 11.4, c.
- The sieve is blocked.
Clean the sieve, insert into the portafilter and pump water through without coffee. If no water comes through the sieve call Capresso Customer Service for a replacement sieve.

Espresso brews out in drops.

- Coffee grounds are too fine or packed down too firmly.
Do not tamp coffee grounds. Use a coarser grind of coffee.
- Machine blocked by calcium deposits.
Descal the appliance. See chapter 11.5..

No crema.

- Coffee old or too dry.
Use fresh coffee that is ground right before brewing.
- Water pushes through the coffee too fast. Coffee too coarse.
Use a finer grind. Use 1 scoop of ground coffee per cup.

Acid (vinegar) taste in espresso coffee.

- **Did not fully rinse the system after descaling.**
See chapter 11.5 for detailed instructions on rinsing the system after descaling.
- **The coffee is not fresh or of high quality.**
Grind fresh whole bean coffee right before brewing. After opening, store whole beans in a dark, air-tight container to maintain freshness. Use beans within 1 week.

Espresso not hot enough.

- **Pre-warm cups and system.**
Pre-warm cups with hot water or on the cup warming tray. Purge brew head and portafilter immediately before brewing. Dry portafilter and sieve before filling with ground coffee. See chapter 3.

Uneven cup filling.

- **Outlet in sieve or portafilter blocked.**
Remove sieve from portafilter. Clean with stiff brush. Clean portafilter.
- **Uneven dosing of ground coffee into sieve.**
Evenly distribute the finely ground coffee into the sieve.

Loud pump noise/no water from brew head.

- **No water in water tank.**
Fill water tank with fresh, cold water.
- **Air blockage in pump.**
Fill tank with fresh water, and run pump in intervals using the "Hot Water" function. If no liquid pumps through the machine after numerous attempts, contact Customer Service.
- **Water tank is not in the correct position.**
Push down firmly on water tank so it is fully engaged to the valve.

No steam produced from the frothing wand.

- **The steam button is not selected.**
Ensure you push the steam button prior to opening the steam knob.
- **Steam wand is blocked by milk or calcium deposits.**
Turn machine OFF. Carefully use a needle to loosen the milk residue. See chapter 11.2 for cleaning the steam wand.

Not enough froth when frothing milk.

- **Milk not fresh.**
Use the freshest milk possible. Do not use milk that has been opened for a few days as this can affect the quality of froth.
- **Milk not suitable.**
Non-dairy, organic and ultra-pasteurized milks do not froth as well as fresh, dairy milk.
- **Milk was too warm before frothing began.**
Use cold, refrigerated milk preferably at 34°F. Use a cold stainless steel frothing pitcher.

13. Limited One-Year Warranty

This warranty covers your CAPRESSO machine, model #124.01 espresso machine. The model # can be found on the bottom of the machine. This warranty is in effect for one year from the date of the first consumer purchase. This warranty covers all defects in materials or workmanship (parts and labor).

This warranty does not cover:

- Any machine not purchased from an Authorized CAPRESSO Dealer.
- Commercial use of machine.
- Damage caused by accident, abuse, negligence, misuse, improper operation or failure to follow instructions contained in this manual.
- Damaged caused to pump or thermoblock by running the machine without water.
- Any service or alteration performed by an unauthorized person, company, or association.

Other limitations and exclusions: Any implied warranties including fitness for use and merchantability are limited in duration to the period of the express warranty set forth above and no person is authorized to assume for JURA any other liability in connection with the sale of the machine. JURA expressly disclaims liability for incidental and consequential damages caused by the machine. The term "incidental damages" refers to the loss of the original purchasers' time, loss of the use of the machine or other costs relating to the care and custody of the machine. The term "consequential damages" refers to the cost of repairing or replacing other property which is damaged when this machine does not work properly. The remedies provided under this warranty are exclusive and in lieu of all others. This warranty gives you specific legal rights, and you may also have other rights which vary from state to state.

Do not attempt to repair the appliance yourself.

Contact customer service for service or repair.

14. Capresso Customer Service

Capresso Ultima PRO, Model #124.01 Product Registration

Please go to our website www.capresso.com to register your product. Your information will help us to better serve you.

Customer Service

1-800-767-3554

Mon-Thu 8AM – 9PM • Fri 8AM – 8PM • Sat 9AM – 5PM
Eastern Standard Time.

email: contact@capresso.com

JURA Inc.

20 Craig Road, Montvale, NJ 07645

201-767-3999 • Fax: 201-767-9684

Website: www.capresso.com

JURA Inc.

20 Craig Road, Montvale, NJ 07645

201-767-3999 • Fax: 201-767-9684

Website: www.capresso.com