

# HP xw8400 Service and Technical Reference Guide

---

User Guide



**Copyright Information**

© 2006 Copyright Hewlett-Packard Development Company, L.P.

**Warranty**

Hewlett-Packard Company shall not be liable for technical or editorial errors or omissions contained herein or for incidental or consequential damages in connection with the furnishing, performance, or use of this material. The information in this document is provided "as is" without warranty of any kind, including, but not limited to, the implied warranties of merchantability and fitness for a particular purpose, and is subject to change without notice. The warranties for HP products are set forth in the express limited warranty statements accompanying such products.

Nothing herein should be construed as constituting an additional warranty.

This document contains proprietary information that is protected by copyright. No part of this document may be photocopied, reproduced, or translated to another language without the prior written consent of Hewlett-Packard Company.

## **Trademark Credits**

The HP Invent logo is a trademark of Hewlett-Packard Company in the U.S. and other countries.

Microsoft and Windows are trademarks of Microsoft Corporation in the U.S. and other countries.

Red Hat is a registered trademark of Red Hat, Inc.

Linux is a registered trademark of Linus Torvalds.

Intel is a registered trademark of Intel Corporation in the U.S. and other countries and are used under license.

Acrobat and Acrobat Reader are trademarks of Adobe Systems Incorporated.

Energy Star is U.S. registered mark of the United States Environmental Protection Agency.

413615–001

Second Edition, July 2006



# Table of contents

## 1 Product overview

Product features .....	2
Exploded view .....	2
Front panel components .....	3
Rear panel components .....	4
Serial number and COA label location .....	4
Product specifications .....	6
Power supply and cooling .....	6
Power supply specifications .....	7
Power consumption and cooling .....	8
System fans and airflow .....	10
Resetting the power supply .....	10
Power cord requirements .....	10
Environmental specifications .....	11
PCI card slot power specification .....	11
Energy Star® .....	13
Energy Star compliance .....	13
Hyper-Threading Technology .....	14

## 2 Installing or restoring the operating system

Installing the operating system and software .....	16
Microsoft Windows XP Professional .....	16
Installing or upgrading device drivers .....	16
Linux-preinstalled workstations .....	16
Starting up the Linux operating system .....	16
Upgrading device drivers .....	16
Linux-enabled workstations .....	17
Verifying hardware compatibility .....	17
Installing the Linux operating system .....	17
Red Hat Activation .....	17
HP software .....	18
Restoring the operating system .....	19
Restoring the Windows operating system .....	19
The RestorePlus! process .....	19
Creating a RestorePlus! CD .....	19
Restoring from RestorePlus! CDs .....	19
Restoring from RestorePlus! on the Recovery Partition .....	19
HP Backup and Recovery Manager restore points .....	20

Restoring from the HP Backup and Recovery Manager restore point CD/DVDs .....	20
Restoring from the HP Backup and Recovery Manager restore point on the Recovery Partition .....	20
Reclaiming hard disk space from the recovery partition .....	20
Ordering backup software .....	20
Restoring the Linux operating system .....	21
Downloading the latest HP driver CD contents .....	21
Installing the operating system with the HP driver CD contents .....	21
Protecting the software .....	22

### 3 System management

Computer Setup (F10) Utility .....	24
BIOS ROM .....	25
Using Computer Setup (F10) Utility .....	25
Computer Setup (F10) Utility menu .....	26
Desktop management .....	34
Initial configuration and deployment .....	34
Remote system installation .....	34
Managing and updating software .....	35
HP Client Manager software .....	35
Altiris Client Management solutions .....	35
System Software Manager .....	36
Proactive Change Notification .....	36
Subscriber's Choice .....	36
ROM flash .....	37
Remote ROM flash .....	37
HPQFlash .....	37
FailSafe Boot Block ROM .....	37
Replicating the setup .....	38
Copying to a single workstation .....	39
Copying to multiple workstations .....	39
Dual-state power button .....	40
Worldwide web site .....	40
Building blocks and partners .....	41
Asset tracking and security .....	41
Password security .....	42
Establishing a setup password in the Computer Setup (F10) Utility .....	43
Establishing a power-on password in the Computer Setup (F10) Utility .....	43
Entering a power-on password .....	44
Entering a setup password .....	44
Changing a power-on or setup password .....	45
Deleting a power-on or setup password .....	45
National keyboard delimiter characters .....	46
Clearing passwords .....	46
Hood sensor (Smart Cover Sensor) .....	46
Setting the hood sensor protection level .....	47
Cable lock provision (optional) .....	47

Security lock (optional) .....	47
Universal chassis clamp lock (optional) .....	47
Access panel key lock .....	47
Fault notification and recovery .....	47
Drive Protection System .....	47
ECC fault prediction and pre-failure warranty .....	48
Thermal sensor .....	48

#### 4 Removal and replacement procedures

Service considerations .....	50
Read cautions, warnings, and safety precautions .....	50
Electrostatic discharge information .....	50
Generating static .....	50
Preventing electrostatic damage to equipment .....	51
Personal grounding methods and equipment .....	51
Grounding the work area .....	51
Recommended materials and equipment .....	52
Required tools and software .....	52
Screws .....	52
Special handling of components .....	52
Cables and connectors .....	53
Hard drives .....	53
Lithium coin cell battery .....	53
Customer Self Repair .....	54
Pre-disassembly procedures .....	55
System board components .....	56
System board architecture .....	57
Removing and replacing components .....	58
Disassembly order .....	58
Removing the security lock (optional) .....	59
Removing the cable lock (optional) .....	60
Access panel .....	60
Front bezel .....	61
Bezel blanks .....	62
Hood sensor (Smart Cover Sensor) .....	63
Front panel I/O device assembly .....	63
Power button assembly and system speaker .....	64
Power supply .....	65
System/memory fan assembly .....	66
Memory .....	67
Memory module features .....	67
Memory module requirements .....	67
Removing memory module .....	68
Installing memory module .....	69
Installing a DIMM .....	70
PCI slots .....	71
PCI retainer .....	71
Removing the PCI retainer .....	72
Installing the PCI retainer .....	72
PCI retention clamp .....	73

PCI Express .....	74
Removing PCI or PCI Express cards .....	74
PCI or PCI Express installation .....	75
Front fan removal (Optional) .....	76
Battery .....	78
Power connections to drives .....	78
Optical drive .....	79
Replacing the SATA optical drive data cable .....	81
Diskette drive (optional) .....	82
Hard drive .....	84
Replacing a hard drive .....	84
Removing a hard drive .....	84
Installing a hard drive .....	85
Installing a hard drive In the fifth hard drive bay .....	87
Processor heatsink .....	88
Removing the CPU heatsink .....	88
Replacing the CPU heatsink .....	90
Processor .....	91
Removing the processor .....	91
Replacing the processor .....	93
System board .....	94
Removing the system board .....	94
Replacing the System Board: .....	95

## 5 System diagnostics and troubleshooting

E-Support .....	98
Help and support center and E-Support .....	98
Troubleshooting checklist .....	99
LED color definitions .....	100
HP Insight Diagnostics Offline Edition .....	101
Key features and benefits .....	101
Theory of operation .....	101
Starting the diagnostic utility from CD .....	101
Download the ISO image .....	102
User interface .....	102
Navigation .....	102
Survey tab .....	102
Test tab .....	103
Status tab .....	104
Log tab .....	104
Help tab .....	104
Diagnostic error codes .....	106
Diagnostic light codes .....	106
Troubleshooting scenarios and solutions .....	109
Solving minor problems .....	109
Solving power supply problems .....	110
Testing power supply .....	110
Solving diskette problems .....	112
Solving hard drive problems .....	114
Solving display problems .....	115



Solving audio problems .....	116
Solving printer problems .....	118
Solving keyboard and mouse problems .....	118
Solving front panel component problems .....	119
Solving hardware installation problems .....	120
Solving network problems .....	121
Solving memory problems .....	122
Solving processor problems .....	123
Solving CD-ROM and DVD problems .....	123
Solving Internet access problems .....	124
POST error messages .....	126

#### **Appendix A Appendix A — SAS devices**

Supported SAS RAID configurations .....	134
SAS RAID 0 configuration .....	135
SAS RAID 1 configuration .....	136
SAS RAID 1E configuration .....	138

#### **Appendix B Appendix B—SATA devices**

Attaching SATA HDDs .....	142
Configuring system BIOS .....	143
Creating RAID volumes .....	144
Deleting RAID volumes .....	145

#### **Appendix C Appendix C — Ultra ATA devices**

Ultra ATA jumpers .....	148
Ultra ATA cables .....	149
Drive installation guidelines .....	150
Device classes .....	150
General attach guidelines .....	150
Attach sequence rules by class priority .....	150
Attach sequence worksheet .....	151
Example 1: Three device installation sample .....	152
Example 2: Four device installation sample .....	153
Additional drive application notes .....	153
SMART .....	154
Jumpers .....	155
CD-ROM or DVD-ROM drive .....	155

#### **Appendix D Appendix D — Connector pins**

Connector pin descriptions .....	158
----------------------------------	-----

#### **Appendix E Appendix E — System board designators**

#### **Appendix F Appendix F — Power cord set requirements**

#### **Appendix G Appendix G — Routine care**

General cleaning safety precautions .....	172
---	-----

Maximizing the airflow .....	173
Cleaning the workstation case .....	174
Cleaning the keyboard .....	175
Cleaning the monitor .....	176
Cleaning the mouse .....	177

#### **Appendix H Appendix H — Additional password security and resetting CMOS**

Resetting the password jumper .....	180
Clearing and Resetting the CMOS .....	181
Using the CMOS Button .....	181
Using Computer Setup to Reset CMOS .....	182

#### **Appendix I Appendix I — Quick troubleshooting flowcharts**

Initial troubleshooting .....	184
No power .....	185
No power, part 1 .....	185
No power, part 2 .....	186
No power, part 3 .....	186
No video .....	188
No video, part 1 .....	188
No video, part 2 .....	189
No video, part 3 .....	189
Error messages .....	191
Error messages, part 1 .....	191
Error messages, part 2 .....	192
Error messages, part 3 .....	192
No operating system loading .....	194
No operating system loading from hard drive .....	195
No operating loading from hard drive, part 1 .....	195
No operating system loading from hard drive, part 2 .....	196
No operating system loading from hard drive, part 3 .....	196
No operating system loading from diskette drive .....	198
No operating system loading from CD-ROM drive .....	199
No operating system loading from network .....	200
Non-functioning device .....	201

#### **Appendix J Appendix J—PCI bus layout**

PCI bus layout and device list .....	204
--------------------------------------	-----

# 1 Product overview

This chapter presents an overview of the hardware components of the HP Workstation.

- [Product features on page 2](#)
- [Product specifications on page 6](#)
- [Energy Star® on page 13](#)
- [Hyper-Threading Technology on page 14](#)

# Product features

## Exploded view

The following image shows a typical HP xw8400 Workstation. Drive configurations can vary.

For complete and current information on supported accessories and components, see <http://partsurfer.hp.com>.

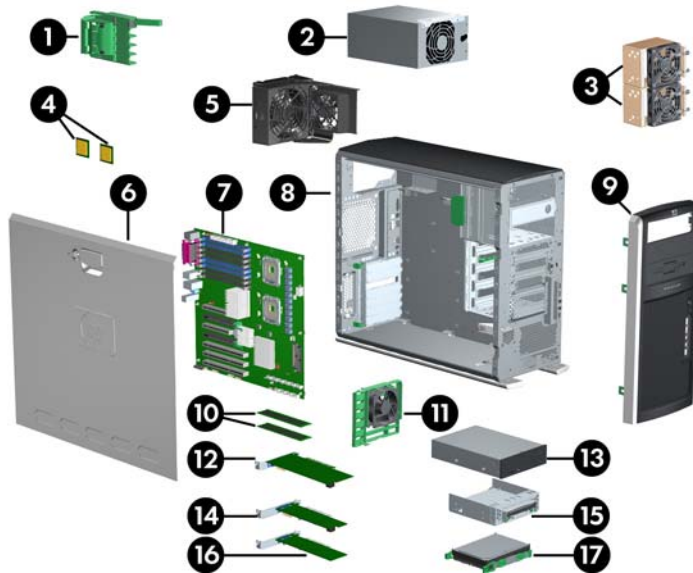

**Figure 1-1** Exploded view

**Table 1-1** Exploded view

Item	Description	Item	Description
1	PCI card support	10	Memory modules
2	Power supply	11	Card guide/Front fan (fan is optional)
3	CPU heatsinks	12	Graphics card
4	Processors	13	Optical drive*
5	System fan	14	PCI-E card
6	Access panel	15	Diskette drive
7	System board	16	PCI card
8	Chassis	17	Hard drive
9	Front bezel		

\* A CD-ROM is an example of an optical drive.





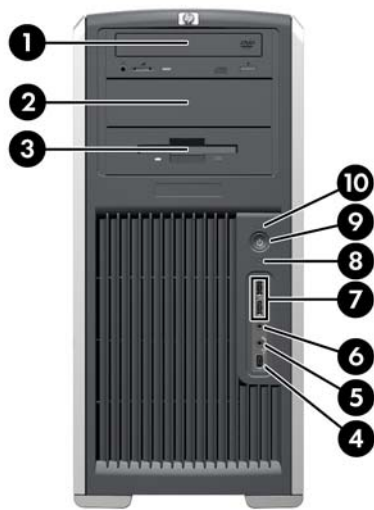

## Front panel components

The following image shows a typical HP xw8400 Workstation. Drive configurations can vary.

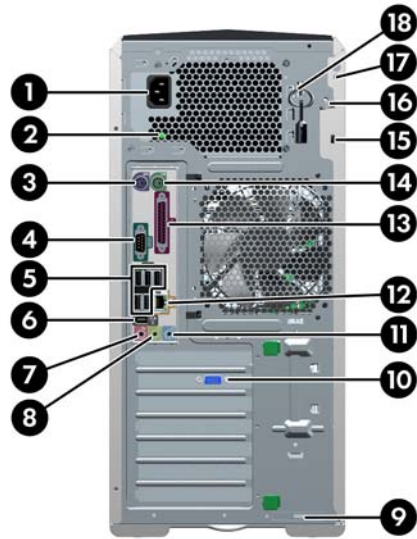

**Figure 1-2** Front panel components

**Table 1-2** Front panel components











Item	Symbol	Description	Item	Symbol	Description
1		Optical drive	6		Headphone connector
2		5.25-inch drive bay	7		USB 2.0 ports
3		Diskette drive (optional)	8		Hard drive activity light
4		IEEE-1394a connector	9		Power button
5		Microphone connector	10		Power on light

## Rear panel components



**Figure 1-3** Rear panel components

**Table 1-3** Rear panel components

Item	Symbol	Description	Item	Symbol	Description
1		Power cord connector	10		Graphics adapter
2		Built In Self Test (BIST) LED	11		Audio line-in connector
3		Keyboard connector	12		RJ-45 network connector
4		Serial connector	13		Parallel connector
5		USB 2.0 ports	14		Mouse connector
6		IEEE-1394a connector	15		Cable lock slot
7		Microphone connector	16		Padlock loop
8		Audio line-out connector	17		Universal chassis clamp opening
9		MiniSAS 4-port connector (optional)	18		Access panel key

The rear panel connectors are labeled with industry-standard icons and colors to assist you in connecting your peripheral devices.

## Serial number and COA label location

Each workstation has two unique serial number labels. Systems preinstalled with Microsoft® Windows® XP also have a certificate of authentication (COA) label (2). The serial number labels (1) are located on

the side panel of the unit and on the rear panel. Keep the serial number available when contacting customer service for assistance.



**Figure 1-4** Serial number and COA label location

# Product specifications

The following table lists the physical dimensions.

**Table 1-4** Physical characteristics

Weight (depending on configuration)	18 - 25.2 kg (39.6 - 55.6 lb.)
Tower dimensions	455 mm (17.9 in.) tall, 210 mm (8.3 in.) wide, 525 mm (20.7 in.) deep
Rack mount dimensions (top cover and foot removed)	210 mm (8.3 in.) tall, 440 mm (17.3 in.) wide, 525 mm (20.7 in.) deep

## Power supply and cooling

This section describes power supply specifications.

**Table 1-5** Voltage specification

Voltage	Minimum	Maximum	Description
3.3 V	3.17 V	3.47 V	Used with PCI, MCH, ESB2, PXH, LAN, and onboard logic
5 V	4.90 V	5.35 V	Used with storage (disk, optical, diskette), PCI, Audio, USB, input to onboard regulator, and onboard logic
12 VCPU0	11.52 V	12.6 V	Input to onboard regulator that supplies power for CPU0
12 VCPU1	11.52 V	12.6 V	Input to onboard regulator that supplies power for CPU1
12 V-M	11.52 V	12.6 V	Input to onboard regulators that supply 1.5 V and 1.8 V for memory
12 V-B	11.52 V	12.6 V	Used with PCI fans, input to onboard regulators that supply 1.5 V and 1.2 V
12 V-D	11.52 V	-12.6 V	Used with storage (disk, optical, floppy)
12 V-G	11.52 V	12.6 V	Used with PCI Express x16 auxiliary connector
V12N	-11.4 V	-12.6 V	Used by PCI
5 VSB	4.85 V	5.25 V	Used for sleep circuitry

**Table 1-6** Current specification

Current	Continuous	Description
3.3 V	22.0 A	Used with PCI, MCH, ESB2, PXH, LAN, and onboard logic
5 V	18.0 A	Used with storage (disk, optical, diskette), PCI, Audio, USB, input to onboard regulator, and onboard logic
12 VCPU0	13.7 A	Input to onboard regulator that supplies power for CPU0



**Table 1-6** Current specification (continued)

Current	Continuous	Description
12 VCPU1	13.7 A	Input to onboard regulator that supplies power for CPU1
12 V-M	14 A	Input to onboard regulators that supply 1.5 V and 1.8V for memory
12 V-B	14.5 A	Used with PCI fans, input to onboard regulators that supply 1.5 V and 1.2 V
12 V-D	10.0 A	Used with storage (disk, optical, floppy)
12 V-G	12.5 A	Used with PCI Express x16 auxiliary connector
V12N	0.3 A	Used by PCI
5 VSB	2.5 A	Used for sleep circuitry



**WARNING!** Do not exceed 135 W of a 5-V and 3.3-V power combination.

Do not exceed 64 A (768 W) of a 12-V (CPU0/CPU1/M/B/D/G) power combination.

Do not exceed 800 W of total continuous output power.

## Power supply specifications

The integrated, surge-tolerant power supply is rated to withstand a power surge of up to 2,000 V (line-to-PE or neutral-to-PE) and 1,000 V (line-to-line) without any data loss or system downtime. The following specifications describe the power supply:

**Table 1-7** Power supply specifications

Parameter	Specification
Full ranging input (No line select switch)	Yes
Active power factor correction (APFC) (Input current is nearly 1/2 non-APFC power supply)	Yes
Passive power	No
Operating voltage range	90–269 VAC
Rated voltage range	100–240 VAC/118 VAC
Rated line frequency	50–60 Hz/400 Hz
Operating line frequency range	47–66 Hz/393–407 Hz
Rated input current	13.2 A@100–120 VAC 6.6 A@200–240 VAC 11.2 A@118 VAC
Maximum rated power	800 W
Heat dissipation	Typical: 1,710 BTU/hr. (430 kg-cal/hr) Maximum: 3,793 BTU/hr. (956 kg-cal/hr)
Power supply fan	92 mm x 32 mm variable speed

**Table 1-7** Power supply specifications (continued)

Power supply size (wide x high x deep)	98 mm x 160 mm x 213 mm
Energy Star®-compliant	Yes
Blue Angel Compliant (<2 W in S5 — Power off)	N/A
Power consumption in ES mode — Suspend to RAM (S3) (Instantly Available PC)	<7 W
FEMP standby power compliant @ 115 V (<2 W in S5 - Power Off)	Yes (Wake-On-LAN (WOL) disabled)
BIST LED	Yes
Surge tolerant full ranging power supply	Withstands power surges up to 2,000 V

## Power consumption and cooling

**Example 1:** The following table shows the primary power consumption for an example configuration:

- Two 2.66-GHz Xeon 5100 series dual-core processors
- Four 1-GB, 667-MHz memory modules
- Two 160-GB SATA hard drives
- Two optical drives
- One PCI Express graphics card (nVidia FX3500)
- One diskette drive
- One monitor, powered separately

**Table 1-8** Example 1 Energy consumption \*

	115 VAC		230 VAC		100 VAC	
	LAN enabled	LAN disabled	LAN enabled	LAN disabled	LAN enabled	LAN disabled
<b>Windows Idle (S0)</b>	209 W		205 W		210 W	
<b>Windows Busy (S0)</b>	337 W		335 W		343 W	
<b>Sleep (S3)</b>	4.67 W	4.67 W	5.32 W	5.32 W	4.63 W	4.63 W

\* Energy Star low energy mode.

This product is in compliance with US executive order 13221, WOL (wake on LAN) disabled.

**Table 1-9** Example 1 Heat dissipation \*

	115 VAC		230 VAC		100 VAC	
	LAN enabled	LAN disabled	LAN enabled	LAN disabled	LAN enabled	LAN disabled
<b>Windows Idle (S0)</b>	713 BTU/hr		699 BTU/hr		718 BUT/hr	

**Table 1-9** Example 1 Heat dissipation \* (continued)

Windows Busy (S0)	1150 BTU/hr		1143 BTU/hr		1171 BTU/hr	
	16 BTU/hr	16 BTU/hr	18 BTU/hr	18 BTU/hr	16 BTU/hr	16 BTU/hr
<b>Sleep (S3)</b>	16 BTU/hr	16 BTU/hr	18 BTU/hr	18 BTU/hr	16 BTU/hr	16 BTU/hr

\* Heat dissipation calculation is based on measured watts, assuming the service level is attained for one hour.

This product is in compliance with US executive order 13221, WOL (wake on LAN) disabled.

**Example 2:** The following table shows the primary power consumption for an example configuration:

- Two 3.73-GHz Xeon 5000 series dual-core processors
- Eight 1-GB, 667-MHz memory modules
- Two 160-GB SATA hard drives
- Two optical drives
- One PCI Express graphics card (nVidia FX3500)
- One diskette drive
- One monitor, powered separately

**Table 1-10** Example 2 Energy consumption \*

	115 VAC		230 VAC		100 VAC	
	LAN enabled	LAN disabled	LAN enabled	LAN disabled	LAN enabled	LAN disabled
<b>Windows Idle (S0)</b>	293 W		286 W		292 W	
<b>Windows Busy (S0)</b>	413 W		399 W		415 W	
<b>Sleep (S3)</b>	4.1 W	3.2 W	4.8 W	3.9 W	4.1 W	3.2 W

\* Energy Star low energy mode.

This product is in compliance with US executive order 13221, WOL (wake on LAN) disabled.

**Table 1-11** Example 2 Heat dissipation \*

	115 VAC		230 VAC		100 VAC	
	LAN enabled	LAN disabled	LAN enabled	LAN disabled	LAN enabled	LAN disabled
<b>Windows Idle (S0)</b>	1000 BTU/hr		977 BTU/hr		997 BTU/hr	
<b>Windows Busy (S0)</b>	1410 BTU/hr		1362 BTU/hr		1417 BTU/hr	

**Table 1-11** Example 2 Heat dissipation \* (continued)

<b>Sleep (S3)</b>	14 BTU/hr	11 BTU/hr	17 BTU/hr	14 BTU/hr	14 BTU/hr	11 BTU/hr
-------------------	-----------	-----------	-----------	-----------	-----------	-----------

\* Heat dissipation calculation is based on measured watts, assuming the service level is attained for one hour.

This product is in compliance with US executive order 13221, WOL (wake on LAN) disabled.



**NOTE** When you power down your workstation with the power button on the front panel, the power consumption falls below 10 W. To reach zero power consumption, unplug the workstation from the power outlet or use a power strip with a switch.

For additional information on power-saving features, see your operating system documentation.

## System fans and airflow

The workstation includes one rear system fan, one memory fan, one processor (CPU) heatsink fan for each processor, and one power supply fan, plus optional front system fans.

## Resetting the power supply

If an overload triggers the power supply overload protection, all power is immediately shut off. To reset the power supply unit:

1. Disconnect the power cord.
2. Determine what caused the overload, and fix the problem.
3. Reconnect the power cord, and reboot the workstation.

When you power down the workstation through the operating system, power consumption falls below the low power consumption rate but does not reach zero. This on/off feature extends the life of the power supply.

## Power cord requirements

The power cord set (flexible cord or wall plug) received with this product meets the requirements for use in the country where you purchased the equipment.

If you must obtain a power cord for a different country, you should purchase a power cord that is approved for use in that country.

The power cord must be rated for the product and for the voltage and current marked on the product's electrical ratings label. The voltage and current rating of the cord should be greater than the voltage and current rating marked on the product. The length of the cord must be between 6 feet (1.8 m) and 12 feet (3.6 m). If you have questions about the type of power cord to use, contact the HP authorized service provider.

A power cord should be routed so that it is not likely to be walked on or pinched by items placed on it or against it. Particular attention should be paid to the plug, electrical outlet, and the point where the cord exits from the product.





**NOTE** A 15AMP-capable (minimum) power cord must be used in with a 110-V power source. A 10AMP-capable (minimum) power cord should be used with a 220-V power source.

## Environmental specifications

This section describes environmental specifications of your workstation.

**Table 1-12** Environmental Specifications

<b>Temperature (operating)</b>	40° to 95° F (5° to 35° C)
<b>Temperature (non-operating)</b>	−40° to 140° F (−40° to 60° C)
<b>Humidity (operating)</b>	8% to 85% RH, non-condensing
<b>Humidity (non-operating)</b>	8% to 90% RH, non-condensing
<b>Altitude (operating)</b>	0 to 10,000 ft. (3,048 m)
<b>Altitude (non-operating)</b>	0 to 30,000 ft. (9,144 m)
<b>Shock (operating)</b>	1/2-sine: 40 G, 2–3 ms
<b>Shock (non-operating)</b>	1/2-sine: 160 cm/s, 2–3 ms, (approximately 100 G) square: 605 cm/s, 30 G
	 <b>NOTE</b> Values represent individual shock events and are not indicative of repetitive shock events.
<b>Vibration (operating)</b>	Operating random: 0.5 G (rms), 5–300 Hz
<b>Vibration (non-operating)</b>	Random: 2.0 G (rms), 10–500 Hz
	 <b>NOTE</b> Values are not indicative of continuous vibration.

## PCI card slot power specification

**Table 1-13** PCI and PCI Express slot power specifications

Slot#	Slot Type	Slot Power (Maximum)
1	PCI (32-bit, 33 MHz)	25 W*
2	PCI Express x16 graphics	150 W**
3	PCI Express x8 (x4)	25 W*
4	PCI Express x16 (x4)	25 W*
5	PCI-X 133	25 W*
6	PCI-X 100	25 W*
7	PCI-X 100	25 W*

\* In addition to these slot power specifications, the overall power consumption of the system (including I/O cards, processor, and memory) must not exceed the maximum ratings of the system power supply. See [Power supply specifications on page 7](#) for details.

\*\* Includes 75 W maximum from the system board connector, and 75 W maximum from the auxiliary graphics power connector.



---

**NOTE** If a graphics card requiring more than 75 W is installed, HP recommends not using slot 3, which is the PCI Express slot below the graphics slot. In addition to these slot power specifications, the overall power consumption of the system (including I/O cards, processors, memory, and drives) must not exceed the maximum ratings of the system power supply.

---

For hardware specifications of other system components, such as graphics cards or optical drives, see the website of the specific manufacturer.

# Energy Star®

The Energy Star program, a government-backed initiative, promotes energy efficiency by identifying ways to reduce energy consumption. Select HP workstations participate in the Energy Star program.



---

**NOTE** Energy Star is not supported on Linux-based workstations.

---

For those workstations that support Energy Star and have it enabled, the power management features are set as follows:

- The monitor goes into power savings mode after 20 minutes of inactivity.
- The system goes into standby mode after 20 minutes of inactivity



---

**NOTE** If you have to restore the operating system, reset the Energy Star settings (if applicable) after the restore.

---

To verify the factory default power settings for your product, select **Start>Control Panel** and double-click **Power Options**.

## Energy Star compliance

HP products purchased with the Energy Star configuration are compliant with U.S. Environmental Protection Agency (EPA) Computers Program. The EPA Energy Star configuration does not imply endorsement by the EPA. As an Energy Star partner, HP offers products with the Energy Star configuration to meet the Energy Star guidelines for energy efficiency.

EPA created the Energy Star Computers Program to promote energy efficiency and reduce air pollution through more energy-efficient equipment in homes, offices, and factories. HP products achieve this result by reducing the power consumption when not being used.

Energy Star on HP workstations uses Advanced Configuration and Power Interface (ACPI) power management. The system can wake as a result of a user action (keyboard or mouse) or from the network or a modem.

The Power Management feature, when used in conjunction with an external Energy Star-compliant monitor, will support the power-down features of the monitor. The Power Management feature allows an external monitor to go into low-power mode when the Energy Save timeout occurs.



---

**NOTE** Using the Energy Star Save Monitor feature with non-Energy Star-compliant monitors might cause video distortion when the Energy Save timeout occurs.

---

# Hyper-Threading Technology

Hyper-Threading Technology, developed by Intel®, enables a single processor to execute multiple threads of instructions simultaneously. Hyper-Threading Technology enables the processor to utilize its execution resources more efficiently, delivering performance increases and improving user productivity. Not all applications or environments benefit from the Hyper-Threading Technology. Hyper-Threading is most beneficial in multi-tasking environments.



**NOTE** On the HP xw8400 Workstation, Hyper-threading is only supported on Intel Xeon(TM) 5000 Series processors.

---

To see if Hyper-Threading Technology can benefit you, test your system by enabling the feature. To do this, run Computer Setup (F10) during the boot process and select **Advanced>Power-On Option>Hyper-Threading**, and enable Hyper-Threading Technology.



**NOTE** HP recommends using Hyper-Threading Technology with Windows XP systems. This technology is detected by the system and is turned on in the operating system after it is enabled in the system BIOS.

For more information about the Hyper-Threading Technology, see Intel's website at <http://www.intel.com>.

---



## 2 Installing or restoring the operating system

This chapter describes the installation and restoration of the operating system.

- [Installing the operating system and software on page 16](#)
- [HP software on page 18](#)
- [Restoring the Windows operating system on page 19](#)
- [HP Backup and Recovery Manager restore points on page 20](#)
- [Protecting the software on page 22](#)
- [Ordering backup software on page 20](#)

If your workstation was shipped with a preinstalled operating system, it is configured automatically the first time your workstation is powered on.

Adding optional hardware devices to your workstation before the operating system successfully installs can cause errors and prevent the operating system from installing properly.



---

**CAUTION** After the automatic installation has begun, do not power off your workstation until this process completes. Powering off your workstation during the installation process might damage the software that runs the system.

---

# Installing the operating system and software

The following sections discuss operating system and HP software installation procedures.

## Microsoft Windows XP Professional

The first time you power on your workstation, you are prompted to select a language for the operating system. After selecting the language, read and follow the instructions on the screen to complete the installation of the operating system. This process takes approximately 10 minutes, depending on the system hardware configuration. During the process, do not power off your workstation unless you are directed to do so.

## Installing or upgrading device drivers

To install hardware devices, such as a printer, a display adapter, or network adapter after the operating system installation is completed, the operating system needs access to the appropriate software drivers for the devices. Device drivers are usually provided on a CD supplied with the peripheral device.

Some existing peripheral devices might not have been shipped with drivers developed for Windows XP. To locate the most current device drivers, see <http://www.hp.com/go/workstationsupport>.

## Linux-preinstalled workstations

If you have a Linux-preinstalled workstation, follow the instructions in this section to set up your operating system and software.

After the boot process completes, you can view additional HP Linux documentation by opening your Internet browser (the browser is automatically set to use the local HP documentation page as its default). You can also access Linux Web links for Red Hat (Internet access required) by using your Internet browser.

For additional information about setting up Linux-preinstalled or Linux-enabled workstations, refer to the *HP User Manual for Linux* at [http://www.hp.com/support/linux\\_user\\_manual](http://www.hp.com/support/linux_user_manual).

For more information about HP and Linux, see <http://www.hp.com/linux>.

## Starting up the Linux operating system

The first time your workstation is booted, the Red Hat First Boot utility displays. This program enables you to enter your password, network, graphics, time, and keyboard settings for your workstation.



**CAUTION** After the automatic installation has begun, do not power down your workstation until the process is complete. Powering down your workstation during the installation process might damage the software that runs your workstation or prevent its proper installation.

When you enable the YPBind feature in the Network tab of the Linux Setup Tool, you might get a blank screen for about 15–30 seconds after you have selected and saved all of your settings and exited the utility. This behavior is normal. The boot process continues its execution after the screen returns.

## Upgrading device drivers

To upgrade a Linux device driver, see <http://www.hp.com/go/workstationsupport>.

## Linux-enabled workstations

Linux-enabled workstations are not preinstalled with Linux. They require the HP Installer Kit for Linux and the purchase of a Red Hat box set. The Installer kit includes the HP CDs necessary to complete the installation of all versions of the Red Hat box set that have been verified to work on HP workstation hardware.

### Verifying hardware compatibility

To determine which Linux versions have been verified to work on HP workstation hardware:

1. Go to [http://www.hp.com/support/linux\\_hardware\\_matrix](http://www.hp.com/support/linux_hardware_matrix).
2. Select your HP workstation model.

### Installing the Linux operating system

To install the Linux operating system on your Linux-enabled system, follow the instructions for [Restoring the Linux operating system on page 21](#) in this chapter.

For more information concerning the setup of Linux-preinstalled or Linux-enabled workstations, refer to the *HP User Manual for Linux* located at [http://www.hp.com/support/linux\\_user\\_manual](http://www.hp.com/support/linux_user_manual).

For more information about HP and Linux, see <http://www.hp.com/linux>.

### Red Hat Activation

With your workstation you received an activation card called *Activate Your Subscription*. This card is necessary to activate your Linux subscription with Red Hat Network. Until activation, your Red Hat Linux is not fully enabled.

To activate Red Hat Linux, click the **Activate Your Subscription** icon on your desktop. This takes you to [www.redhat.com/activate](http://www.redhat.com/activate). Follow the instructions at this website to activate your subscription using the information on the card.

HP recommends that you activate your subscription as soon as you connect to the web.



---

**NOTE** Keep the Red Hat activation card with your workstation registration card for future reference.

---

## HP software

The following HP software may be installed on your workstation depending on the operating system and options:

- Computer Setup (F10) Utilities and diagnostic features
- HP Support Software including device drivers
- Security Management tools (optional)
- Software Support Management tools

Additional software is available for download:

- HP Client Manager Software is available at <http://www.hp.com/go/easydeploy>.
- System Software Manager is available at <http://www.hp.com/go/ssm>.



**NOTE** Additional HP software might be required in certain situations.

---

# Restoring the operating system

This section describes how to restore the Windows and Linux operating systems.

## Restoring the Windows operating system

Your workstation has a several methods to restore your Windows XP operating system to a near-factory state, or to the state of the system at a predefined snapshot in time. Your system has a recovery partition on the system hard drive that contains software and data required for the restore process as described in the following sections.



---

**NOTE** If you received restore media with your system, use the media to restore your operating system. Refer to the instructions on the media for restoring your operating system.

---

### The RestorePlus! process

The Windows operating system and device drivers (for devices shipped with the system) are reinstalled using this process. Some application software may not be restored using the RestorePlus! process. In this case you must install the application software from the appropriate application CD. The RestorePlus! process can be executed from CD or from the recovery partition contained on your system hard drive.



---

**CAUTION** Backup your data before you attempt any operating system restore. All data on the Windows partition will be deleted when you restore using the RestorePlus! process. However, the recovery partition on the system drive and other partitions should not be affected.

---

### Creating a RestorePlus! CD

You can create a set of the CDs from your system if you have a CD burner. When you first boot your system, you will be prompted to make CDs for RestorePlus!, the Windows operating system, and a supplemental HP Backup and Recovery Manager CD. (There may be additional CDs you can create depending on the options you purchased.) You also have the option to move images of the CDs to another location, such as a network share, to be burned to CD at a later time or from another system.

### Restoring from RestorePlus! CDs

The RestorePlus! process can be started by booting from the RestorePlus! CD.

### Restoring from RestorePlus! on the Recovery Partition

Follow these steps to start the RestorePlus! process from the Emergency Recovery menu:

1. Boot the workstation.
2. Press the **F11** key when prompted during the boot process to enter the Emergency Recovery menu. The F11 prompt appears briefly during the boot process.
3. Select **Recover PC's factory installed operating system, drivers, utilities, and applications** from the Emergency Recovery menu.



---

**NOTE** Some applications may not be restored using this method.

---

## HP Backup and Recovery Manager restore points

HP Backup and Recovery Manager is preinstalled on your workstation. This software allows you to backup and restore your system and data. You will be prompted to make RestorePlus! CDs at the first boot of the system. An Initial Restore Point (IRP) will be created automatically. This restore point is a complete snapshot of the system partition at the time the IRP was created. The IRP is stored in the recovery partition on the system hard drive, but you can also burn the IRP to CDs, DVDs, or copy it to another location. The restore point can be used to return the system partition back to the state the system was when captured.

### Restoring from the HP Backup and Recovery Manager restore point CD/DVDs

The HP Backup and Recovery Manager (HPBR) restore point can be burned to CD or DVDs and used to restore the system. Typically you would use the CD/DVD set if the hard drive has been replaced or all partitions have been corrupted. Boot the system from the HPBR restore point CD/DVD and follow the online instructions.

### Restoring from the HP Backup and Recovery Manager restore point on the Recovery Partition

The HP Backup and Recovery Manager (HPBR) Initial Restore Point is stored in the system recovery partition and can be restored using the Emergency Recovery menu. Boot your system and press the **F11** key when prompted to enter the Emergency Recovery menu. The F11 prompt appears briefly during the boot process. From the Emergency Recovery menu, choose **Recover PC to a specific point in time** and follow the instructions.

### Reclaiming hard disk space from the recovery partition

The recovery partition can be removed to reclaim the hard drive space. If the recovery partition is removed, the **F11** Emergency Recovery function is not available. The ability to recover the system from data on the recovery partition will be lost. Any RestorePlus! media contained in the recovery partition will be deleted. The ability to create the RestorePlus! CD set will be lost.

To free up disk space, you can remove just the recovery partition, or you can completely uninstall the HP Backup and Recovery Manager application.

- The recovery partition can be removed using **Remove HP Recovery Partition** in the HP Backup & Recovery program folder. The recovery partition is deleted, the user partition is extended to reclaim the unused hard drive space, and the F11 boot prompt is removed. The HP Backup and Recovery Manager application remains and can be used for data backup and restore.
- The HP Backup and Recovery Manager application can be uninstalled using the Windows **Control Panel**—>**Add/Remove Programs** utility. The application is uninstalled, the recovery partition is deleted, the user partition is extended to reclaim the unused space, and the F11 boot prompt is removed. Emergency recovery as well as data backup and recovery is not possible after the application is uninstalled.



---

**CAUTION** Deleting the recovery partition or uninstalling the HP Backup and Recovery Manager application reduces or eliminates the ability to recover the system.

---

### Ordering backup software

If you are unable to create system recovery CDs or DVDs, the HP Restore Plus CD set can be obtained through product support on <http://www.hp.com/support>.



---

**NOTE** Before calling HP to order the software, be sure to have the serial number of your workstation available. See [Serial number and COA label location on page 4](#) for details.

---

## Restoring the Linux operating system



---

**NOTE** To restore the Linux operating system, the HP Driver CD and Red Hat box set are required. Download the latest HP Driver CD to get any new enhancements.

---

For preloaded Linux systems, an icon called **Red Hat ISO's** is available on the desktop. Click this icon to go to the `/iso` directory. This directory contains the binary and source ISO files. This directory also contains the driver CD ISO which is the same as the CD that is shipped with the workstation. Follow the instructions in the **Readme** file in the `/iso` directory to burn the ISOs to CD.

HP recommends that you burn the ISOs to CD so you have a backup.



---

**NOTE** Linux does not support mixed drive types for a manufacturing preload. When restoring the operating system, mixed drive types can be handled with the restoring media.

---

## Downloading the latest HP driver CD contents

See <http://www.hp.com> and select **Software and Drive Downloads**. Find your workstation and operating system. Select your driver CD under **Software**, and follow the directions under **Release Notes**.

## Installing the operating system with the HP driver CD contents

1. Boot your workstation from the Red Hat box set Binary CD 1.
2. Insert the Linux operating system CDs from the Red Hat box set as prompted.
3. Continue following the prompts until the operating system is successfully installed.
4. Configure the X server to start on reboot.
5. Reboot your workstation.
6. Follow the prompts to set up your system with the Red Hat First Boot utility.
7. When prompted in First Boot to add additional CDs, insert the HP Driver CD into the CD-ROM tray of your workstation.
8. Click **Install** next to “Additional CDs.” The HP Driver CD window opens.
9. Click **Press** to begin install.

When the install is done, you will have two options— **Reboot now...** on the left side and **Press to continue, reboot later...** on the right side.

10. Click **Reboot now...**

## Protecting the software

To protect software from loss or damage, keep a backup copy of all system software, applications, and related files stored on the hard drive. See the operating system or backup utility documentation for instructions on making backup copies of data files.



# 3 System management

This section describes the various tools and utilities that allow for the system management of the workstation.

- [Computer Setup \(F10\) Utility on page 24](#)
- [Desktop management on page 34](#)

## Computer Setup (F10) Utility

The Computer Setup (F10) Utility enables you to:

- Change factory default settings and set or change the system configuration, which might be necessary when you add or remove hardware.
- Determine if all of the devices installed on the workstation are recognized by the system and functioning properly.
- Determine information about the operating environment of the workstation.
- Solve system configuration errors detected but not automatically fixed during the Power-On Self-Test (POST).
- Establish and manage passwords and other security features.
- Establish and manage energy-saving time-outs (not supported for Linux platforms).
- Modify or restore factory default settings.
- Set the system date and time.
- Set, view, change, or verify the system configuration, including settings for processor, graphics, memory, audio, storage, communications, and input devices.
- Modify the boot order of installed mass storage devices such as SATA, IDE (ATA), SAS, SCSI, diskette drives, optical drives, network drives, and LS-120 drives.
- Configure the boot priority of SATA, IDE (ATA), and SAS hard drive controllers.
- Enable or disable Network Server Mode, which enables the workstation to boot the operating system when the power-on password is enabled with or without a keyboard or mouse attached. When attached to the system, the keyboard and mouse remain locked until the power-on password is entered.
- Select POST Messages Enabled or Disabled to change the display status of POST messages. POST Messages Disabled suppresses most POST messages, such as memory count, product name, and other non-error text messages. If a POST error occurs, the error is displayed regardless of the mode selected. To manually switch to POST Messages Enabled during POST, press any key (except F1 through F12).
- Establish an Ownership Tag, the text of which is displayed each time the system is turned on or restarted.
- Enter the Asset Tag or property identification number assigned by your company to this workstation.
- Enable power-on password prompting during system restarts (warm boots) and during power-on.
- Secure the integrated I/O functionality, including the serial, USB, or parallel ports, audio, or embedded NIC, so that the I/O functionality cannot be used until they are unsecured.
- Enable or disable removable media boot ability.
- Enable or disable removable media write ability (when supported by hardware).

- Replicate your system setup by saving system configuration information on diskette and restoring it on one or more workstations.
- Execute self-tests on specified SATA and IDE (ATA) hard drives (when supported by the drive).

## BIOS ROM

The BIOS of the computer is a collection of machine language programs stored as firmware in ROM. The BIOS ROM includes such functions as POST, PCI device initialization, Plug 'n Play support, power management activities, and the Computer Setup (F10) Utility. The firmware contained in the BIOS ROM supports the following systems and specifications:

- Microsoft Windows Hardware Quality Labs (WHQL)
- Alert-on-LAN (AOL) and Wake-on-LAN (WOL)
- ACPI 1.0 and 2.0 and OnNow
- SMBIOS 2.5
- PC98/99/00 and NetPC
- HP Preboot Execution Environment (PXE) boot ROM for the integrated LAN controller
- BIOS Boot Specification 1.01
- Enhanced Disk Drive Specification 3.0
- “El Torito” Bootable CD-ROM Format Specification 1.0
- ATAPI Removable Media Device BIOS Specification 1.0
- MPS Specification 1.4 (for booting Linux SMP)
- ASF (Alert Standard Format) 1.0

The BIOS ROM is a 1-MB Intel Firmware Hub (or Firmware Hub-compatible) part. The runtime portion of the BIOS resides in a 96-KB block from E8000h to FFFFFh (approximation). ACPI code and data take about 128 KB below TOLM (top of low memory, last RAM address below 4 GB).

## Using Computer Setup (F10) Utility

You can only open the Computer Setup (F10) Utility by powering on the workstation or restarting the system. To access the Computer Setup (F10) Utility menu:

1. Power on or restart the workstation.
2. Press the **F10** key as soon as your display is active and the message **Setup** appears in the lower right corner of the screen.



**NOTE** If you do not press F10 at the appropriate time, you must try again. Restart the workstation and press **F10** again to access the utility, or press **Ctrl+Alt+Delete** prior to boot if you miss the opportunity to press F10.

3. Select your language from the list, and press the **Enter** key. In the Computer Setup (F10) Utility menu, five headings are displayed: **File**, **Storage**, **Security**, **Power**, and **Advanced**.

4. Use the left and right arrow keys to select the appropriate heading. Use the up and down arrow keys to select the option you want, and press **Enter**.
5. To apply and save changes, select **File>Save Changes and Exit**.
  - If you have made changes that you do not want applied, select **File>Ignore Changes and Exit**.
  - To reset to factory settings, select **File>Default setup>Restore Factory Settings as Default**. Press **F10** to accept the changes. Click **Apply Defaults and Exit**. This option restores the original factory system defaults.



**CAUTION** Do **not** turn the workstation power off while the ROM is saving your Computer Setup (F10) Utility changes because the CMOS could become corrupted. After you exit the F10 Setup screen, it is safe to remove all power from the workstation.

## Computer Setup (F10) Utility menu



**NOTE** The following content is subject to change with new BIOS releases, so your menu may be different than shown in Table 1–1.

**Table 3-1** Computer Setup (F10) Utility menu descriptions

Heading	Option	Description
File	System Information	Lists product name, SKU number, processor type/speed/stepping, cache size (L1/L2), memory type and size, integrated Media Access Control (MAC) for enabled or embedded Network Interface Card (NIC), if applicable, system BIOS type, chassis serial number, and asset tracking number.
	About	Displays copyright information.
	Set Time and Date	Enables you to set system time and date.
	Flash System ROM	Enables you to flash (update) system BIOS using any supported removable mass storage device (CD-ROM, USB drive, floppy).
	Replicated Setup	Save to Removable Media  Saves the current F10 Setup configuration to a text file called <b>cpqsetup.txt</b> , which can be used for Replicated Setup functions.  Restore from Removable Media  Restores previous F10 Setup configuration from a text file called cpqsetup.txt, which can be used for Replicated Setup functions.
Default Setup	Save Current Settings as Default	
		Stores the current F10 Setup configuration into the physical ROM as the default.
	Restore Factory Settings as Default	Restores the original factory settings to the F10 Setup configuration information in the physical ROM as the default.
Apply Defaults and Exit		Saves the selected default settings (previously-saved user settings or factory settings) into Non-Volatile Random Access Memory (NVRAM) and exits.
Ignore Changes and Exit		Exits the Computer Setup (F10) Utility without applying or saving any changes.

**Table 3-1** Computer Setup (F10) Utility menu descriptions (continued)

Heading	Option	Description
	Save Changes and Exit	Saves changes to system configuration and exits the Computer Setup (F10) Utility.
Storage	Device Configuration	<p>Lists all installed storage devices including hard disk, SATA 0, USB, CD-ROM, IDE Primary 0, and IDE/SATA.</p> <p>When a device is selected, detailed information and options are displayed.</p> <p><b>Hard Disk</b></p> <p>Identifies the hard disk drives on the system by model, firmware, serial number, connector color, emulation type, multi-sector transfers, and translation mode.</p> <p><b>CD-ROM</b></p> <p>Identifies the CD-ROM drives on the system.</p> <p><b>Diskette Type (for legacy diskette drives only)</b></p> <p>Identifies the highest capacity media type accepted by the diskette drive. Options are 3.5" 1.44 MB, 5.25" 1.2 MB, and Not Installed.</p> <p><b>Default Values</b></p> <p>Enables you to set the default values for IDE and SATA devices such as the following:</p> <ul style="list-style-type: none"> <li>• Multisector Transfers (IDE disks only)—Specifies how many sectors are transferred per multi-sector Programmed Input/Output (PIO) operation. Options (subject to device capabilities) are Disabled, 8, and 16.</li> <li>• Transfer Mode (IDE devices only)—Specifies the active data transfer mode. Options (subject to device capabilities) are PIO 0, Max PIO, Enhanced DMA, Ultra DMA 0, and Max UDMA.</li> <li>• Translation Mode (IDE/SATA disks only)—Enables you to select the translation mode to be used for the device, which enables the BIOS to access disks partitioned and formatted on other systems and may be necessary for users of older versions of UNIX (for example, SCO UNIX version 3.2). Options are Bit-Shift, LBA Assisted, Off, and Automatic.</li> </ul> <p> <b>NOTE</b> The Automatic option has been added to allow BIOS to automatically determine the translation mode used to configure a previously formatted IDE, SATA, or USB mass storage device. This setting prevents you from having to know how the mass storage device was previously formatted.</p> <p>Ordinarily, the translation mode selected automatically by the BIOS should not be changed. If the selected translation mode is not compatible with the translation mode that was active when the disk was partitioned and formatted, the data on the disk will be inaccessible.</p>
	Storage Options	<p><b>Removable Media Boot</b></p> <p>Enables and disables ability to boot the system from removable media.</p> <p><b>Legacy Diskette Write</b></p> <p>Enables and disables ability to write data to legacy media.</p> <p><b>BIOS DMA Data Transfers</b></p> <p>Determine the point where BIOS enables DMA transfers for both IDE and SATA devices when possible during POST to increase transfer speed.</p> <p><b>SATA Emulation</b></p>

**Table 3-1** Computer Setup (F10) Utility menu descriptions (continued)

Heading	Option	Description
		<p>Sets the SATA emulation mode with the following options:</p> <ul style="list-style-type: none"> <li>RAID + AHCI—Requires one of the two Intel SATA option ROMs to run. In this mode, the Option ROM manages the drives so they are not shown in Device Configuration. This option is the default and offers best performance.</li> <li>Separate IDE Controller—Offers standard SATA supports (four ports only).</li> <li>Combined IDE Controller—Makes the SATA controller look like an IDE controller and offers best IDE compatibility (two ports only).</li> </ul>
		<p>Primary SATA Controller</p> <p>Enables you to disable the ESB-2 SATA controller primary SATA ports from the BIOS perspective, but the controller is not hidden. The BIOS will ignore these ports and will not configure and enumerate any devices connected to it. However, the operating system can re-enable and enumerate devices upon booting.</p>
		<p>Secondary SATA Controller</p> <p>Enables you to disable the ESB-2 SATA controller secondary SATA ports from the BIOS perspective, but the controller is not hidden. The BIOS will ignore these ports and will not configure and enumerate any devices connected to it. However, the operating system can re-enable and enumerate devices upon booting.</p>
	DPS Self-Test	Selects the Drive Protection System (DPS) Self-Test (also called DST, Drive Self-Test). You are prompted for the drive on which to run the test.
	Boot Order	<p>Enables you to configure the boot, diskette drive, and hard drive orders by physically reordering the menu entries. Boot Order presents these selections:</p> <ul style="list-style-type: none"> <li>ATAPI CD-ROM Drive (Optical Drive in BIOS 1.01 and above)</li> <li>USB device</li> <li>Hard Drive</li> <li>Integrated SATA</li> <li>Integrated IDE</li> <li>Broadcom Ethernet controller</li> <li>Diskette Drive</li> </ul> <p>Boot devices can be disabled from participating in the boot order process. These order changes are reconciled with the IPL/BCV historical information and stored in the physical ROM part when the F10 Setup changes are confirmed by selecting <b>File&gt;Save Changes and Exit</b>.</p> <p> <b>NOTE</b> MS-DOS drive lettering assignments might not apply after a non-MS-DOS operating system has started.</p> <p><b>Shortcut to Temporarily Override Boot Order</b></p> <p>To boot <b>one time</b> from a device other than the default device specified in Boot Order, restart the workstation and press the <b>F9</b> key when the <b>F9=Boot Menu</b> message appears on the screen. After POST is completed, a list of bootable devices is displayed. Use the arrow keys to select the preferred bootable device and press <b>Enter</b>. The workstation then boots from the selected non-default device for this one time.</p>
Security	Setup Password	Enables you to set and enable setup (administrator) password.

**Table 3-1** Computer Setup (F10) Utility menu descriptions (continued)

Heading	Option	Description
		 <p><b>NOTE</b> If the setup password is set, you must enter Computer Setup (F10) Utility to change it, flash the ROM, and make changes to certain plug-and-play settings under Windows.</p>
	Power-On Password	Enables you to set and enable the power-on password.
	Password Options	<p>Lock Legacy Resources</p> <p>Prevents the operating system from reassigning plug-and-play resources for serial, parallel, and floppy legacy I/O devices.</p> <p>Network Server Mode</p> <p>Enable or disable Network Server Mode, which enables the workstation to boot the operating system when the power-on password is enabled with or without a keyboard or mouse attached. When attached to the system, the keyboard and mouse remain locked until the power-on password is entered.</p> <p>Password Prompt on Warm Boot</p> <p>Sets the Password Prompt on Warm Boot function. If disabled, the BIOS will only prompt for a password after power-on</p>
	Smart Cover	Enables you to disable cover removal sensor or to notify the user if the sensor has been activated. If disabled, the BIOS will only prompt for a password after power-on.
	Device Security	<p>Makes the following devices available or unavailable to the system:</p> <ul style="list-style-type: none"> <li>• Serial Port</li> <li>• Parallel Port</li> <li>• All USB Ports</li> <li>• Front USB Ports</li> <li>• System Audio</li> <li>• IDE Controller Security</li> <li>• SATA Controller Security</li> <li>• IEEE 1394 Controller</li> <li>• Network Controller</li> <li>• SAS Controller</li> </ul> <p>For each device, Device Available is the default setting and allows the operating system access to the device. Device Hidden makes the device unavailable. It is disabled by the BIOS and cannot be enabled by the OS.</p>
	Network Service Boot	Enables a Network Service Boot which boots using the NIC PXE option ROM. In this case, the actual boot image resides on a remote server. When enabled, you can set the boot order of the NIC PXE option ROM and you can force a network boot by pressing F12 during POST.
	System IDs	<p>Asset Tag</p> <p>A 16–byte string identifying the system.</p> <p>Ownership Tag</p> <p>An 80–byte string identifying ownership of the system. This tag is displayed on the screen during POST.</p>

**Table 3-1** Computer Setup (F10) Utility menu descriptions (continued)

Heading	Option	Description
		UUID (Universal Unique Identifier)  Can only be updated if the current chassis serial number is invalid. (These ID numbers are normally set in the factory and are used to uniquely identify the system.)
		Keyboard  Enables you to set the keyboard locale for System ID entry.
	OS Security	Data Execution Prevention  Sets Data Execution Prevention mode in the processors. This mode prohibits code from running in pages that were set up as data pages, and prevents attacks such as buffer overflows. Operating system support is required for this feature.
		Intel Virtualization Technology  Enables Intel Virtualization Technology in the processors. Additional virtualization software (such as VMware) is required to use virtualization. This feature requires a power cycle to be activated. Operating system support is required for this feature.
Power	OS Power Management	Runtime Power Management  Enables Enhanced Intel SpeedStep Technology (EIST) and Demand-Based Switching (DBS). This option allows the operating system to tune processor performance states depending on load.
		Idle Power Savings  When set to <b>Enhanced</b> , this option enables C1E, the high-efficiency processor halt state. When the operating system puts a processor in idle mode, its power consumption is reduced. This option reduces power consumption when the load is light. Operating system support is required for this feature.
		ACPI S3 Support  Enables the suspend-to-RAM state. This option is mostly for troubleshooting purposes; the operating system will never enter S3 if one of its drivers does not support that state. Enabled by default; disabled for troubleshooting.
		ACPI S3 Hard Disk Reset  When enabled, the BIOS sends a "drive reset" command to the IDE and SATA drives when resuming from S3, before returning to the operating system.
		ACPI S3 PS2 Mouse Wake Up  Allows the PS/2 mouse to wake from ACPI S3. PS/2 keyboards are always enabled. (Disabling this option means that nudging the mouse will not trigger a system wake.)
		USB Wake on Device Insertion  Enables the USB controllers to generate a wake event when a device is plugged in while the system is in an ACPI sleep state. The matching USB controller must be set to wake the system (from Windows, this is done from Device Manager, using the <b>Power Management</b> tab for that controller, and setting the <b>Allow this device to wake up the system</b> check box).
	Hardware Power Management	SATA Power Management  Enables you to enable or disable SATA power management. This option still works when the controller is in RAID + AHCI mode.
	Thermal	Fan Idle Mode  This setting changes the minimum fan speed. The fans are still automatically controlled.



**Table 3-1** Computer Setup (F10) Utility menu descriptions (continued)

Heading	Option	Description
Advanced **	Power-On Options	POST Messages
		Allows for selection between splash screen and text-mode startup.
		F9 Prompt (enable/disable)
		When enabled, displays <b>F9=Boot Menu</b> during POST. Displaying this feature prevents the text from being displayed, but pressing <b>F9</b> still forces the system to attempt booting from the network.
		F10 prompt (enable/disable)
		When enabled, displays <b>F10=Setup</b> during POST. Disabling this feature prevents the text from being displayed but pressing <b>F10</b> still accesses the Setup screen.
		F12 prompt (enable/disable)
		When enabled, displays <b>F12=Network Service Boot</b> during POST. Disabling this feature prevents the text from being displayed, but pressing <b>F12</b> still forces the system to attempt booting from the network.
		Option ROM* Prompt (enable/disable)
		When enabled, causes the system to display a message before loading options ROMs.
	Remote Wakeup Boot Source	
	Enables you to specify which wakeup boot source device to remove.	
	After Power Loss	
	In the event of an AC power loss, determines what the computer's behavior should be when power is restored. Options are <b>Off</b> (stay off), <b>On</b> (turn on immediately), and <b>Previous State</b> (if the computer was on when power was lost, power on immediately; if it was off, stay off).	
	POST Delay (in seconds)	
		Specifies a delay during POST. This setting may be necessary for certain add-in peripherals that respond slowly or violate specifications. For instance, disk drives are supposed to spin within 15 seconds, but some older drives might take longer. Options are None, 5, 10, 15, 20.
	Setup Browse Mode	
	Enables viewing Setup Options without entering Setup password. <b>Enable</b> allows you to view Setup in read-only mode if you do not enter the Setup password. <b>Disable</b> blocks Setup entirely if you do not enter the Setup password.	
	BIOS Power-On	Enables you to disable or specify a weekday and time for BIOS power-on.
	Processors	Hyper-Threading (enable/disable)
		Reports logical processors to ACPI-capable operating systems.
		 <b>NOTE</b> This field appears only if the installed processors support hyper-threading.
		Limit CPUID Maximum value to 3 (enable/disable)
		Instructs the processors not to report their full capabilities using the CPUID instruction. Useful for legacy systems.
	Onboard Devices	Selects the legacy devices' interrupt (IRQ), DMA channel, and I/O range. It can also disable the devices. The values are strictly valid for boot time only—a plug-and-play operating system can change them. Windows XP and Linux will not modify these values under default settings. To hide a device from the operating system, see the Security>Device Security options in this table.

**Table 3-1** Computer Setup (F10) Utility menu descriptions (continued)

Heading	Option	Description
		Serial Port Enables you to set I/O and interrupt (IRQ) for the device.
		Parallel Port Enables you to set I/O, IRQ, and DMA channel for the device.
		Diskette Controller Enables you to set I/O, IRQ, and DMA channel for the device.
PCI VGA Configuration		This menu lets you select which device to use as the primary VGA device—the one that will show graphics during POST and boot, before the OS takes over graphics. The menu is dynamically generated based on detected VGA-compatible devices.   <b>NOTE</b> This menu appears only if more than one VGA-compatible device is installed
Chipset/ Memory		PCI SERR# Generation (enable/disable) Disables PCI SERR# generation for ill-behaved PCI add-in cards (that can generate SERR# spuriously).
		PCI VGA Palette Snooping (enable/disable) Enables PCI VGA Palette Snooping. This option is kept for compatibility purposes.
		MCH Error Handling Sets which signal to use on serious MCH (North Bridge) errors. <b>SMI</b> is handled by the BIOS and causes a reboot. <b>NMI</b> and <b>Machine-Check Error</b> are handled by the operating system and cause a crash.
Device Options		Num Lock State at Power-On Sets the Num Lock state after POST. The Operating System can change this state, also.
		S5 Wake on LAN (enable/disable) Allows the network to wake the system from shutdown (ACPI S5). When set to Disable, system power consumption is reduced to match Federal Energy Management Program (FEMP) guidelines.
		Unique Sleep State Blink Rates Assigns different LED blink patterns for S1 and S3. (The LED is off for S4 and S5.)
		Monitor Tracking (enable/disable) Enabling this option allows the ROM to save the monitor asset tracking information such as the serial number and model.
		NIC PXE Option ROM Download (enable/disable) <b>Disable</b> means you cannot boot from this device, but more option ROM space is available for other devices.
		SAS Option ROM Download (enable/disable) Enables or disables downloading embedded SAS option ROM. Disable means you cannot boot from this device, but more option ROM space is available for other devices.
		SATA RAID Option ROM Download (enable/disable) <b>Disable</b> means you cannot boot from this device, but more option ROM space is available for other devices.

**Table 3-1** Computer Setup (F10) Utility menu descriptions (continued)

Heading	Option	Description
		PXH-V Secondary Latency Timer Sets the secondary latency timer on the PXH-V bridge which is connected to PCI-X slot 5.
		PCIX Secondary Latency Timer Sets the secondary latency timer on the ESB2 PCI-X bridge which is connected to PCI-X slots 6 and 7, and the SAS controller.
		SAS Latency Timer Sets the latency timer on the SAS controller.
		Peer-to-Peer Reads Enables you to allow peer-to-peer memory reads between the PCI-X buses behind the PXH-V.
		Fast Delayed Transaction Timer Enables you to set Discard Transaction Timer to "short delay." This may improve performance issues with certain PCI devices. Do not enable this setting unless instructed to do so by the PCI device supplier.
	Slot Options	Applies to these slot types: <ul style="list-style-type: none"><li>• Slot 1 — PCI</li><li>• Slot 2 — PCI Express x16</li><li>• Slot 3 — PCI Express x8 (x4)</li><li>• Slot 4 — PCI Express x16 (x4)</li><li>• Slot 5 — PCI-X 133</li><li>• Slot 6 — PCI-X 100</li><li>• Slot 7 — PCI-X 100</li></ul> For PCI Express slots, the available option is <b>Option ROM Download</b> . For PCI-X slots, the available options are <b>Speed</b> , <b>Option ROM Download</b> , and <b>Latency Timer</b> . For PCI slots, the available options are <b>Option ROM Download</b> and <b>Latency Timer</b> .

\* Available on select models.

\*\* These options should be used by advanced users only.

# Desktop management

HP Client Management Solutions (available for download from <http://www.hp.com/go/easydeploy>) provides standards-based solutions for managing and controlling workstations in a networked environment. This section summarizes the capabilities and features of desktop management key components:

- [Initial configuration and deployment on page 34](#)
- [Remote system installation on page 34](#)
- [Managing and updating software on page 35](#)
- [ROM flash on page 37](#)
- [Asset tracking and security on page 41](#)
- [Fault notification and recovery on page 47](#)



---

**NOTE** Support for specific features described in this guide might vary by model or software version.

---

## Initial configuration and deployment

The workstation comes with a preinstalled system software image. After a brief software unbundling process, the workstation is ready to use.

You might prefer to replace the preinstalled software image with a customized set of system and application software. There are several methods for deploying a customized software image, including:

- Installing additional software applications after unbundling the preinstalled software image.
- Using software deployment tools, such as Altiris® Deployment Solutions™, to replace the preinstalled software with a customized software image.
- Using a disk cloning process to copy the contents from one hard drive to another.

The best deployment method depends on your information technology environment and processes. The PC Deployment section of the HP Lifecycle Solutions website (<http://whp-sp-orig.extweb.hp.com/country/us/en/solutions.html>) provides information to help you select the best deployment method.

The Restore Plus! CD, ROM-based setup, and ACPI hardware provide further assistance with recovery of system software, configuration management and troubleshooting, and power management.

## Remote system installation

Remote System Installation enables you to start and set up your system using the software and configuration information located on a network server. This feature is usually used as a system setup and configuration tool, and can be used for the following tasks:

- Deploying a software image on one or more new PCs
- Formatting a hard drive
- Installing application software or drivers
- Updating the operating system, application software, or drivers

To initiate Remote System Installation, press **F12** when **F12=Network Service Boot** appears in the lower-right corner of the HP logo screen. Follow the on-screen instructions to continue the process. The default boot order is a BIOS configuration setting that can be changed to always attempt to PXE boot.

HP and Altiris have partnered to provide tools designed to make the task of corporate PC deployment and management easier and less time-consuming, ultimately lowering the total cost of ownership and making HP PCs the most manageable client PCs in the enterprise environment.

## Managing and updating software

HP provides several tools for managing and updating software on desktops and workstations—HP Client Manager Software, Altiris Client Management Solutions, System Software Manager, Proactive Change Notification, and Subscriber's Choice.

### HP Client Manager software

HP Client Manager Software (HP CMS) assists you in managing the hardware aspects of your client workstations with features that include:

- Detailed views of hardware inventory for asset management
- PC health check monitoring and diagnostics
- Proactive notification of changes in the hardware environment
- Web-accessible reporting of business-critical details such as machines with thermal warnings, memory alerts, and more
- Remote updating of system software such as device drivers and ROM BIOS
- Remote changing of boot order
- Configuring the system BIOS settings

For more information on the HP Client Manager, see <http://h18000.www1.hp.com/im/prodinfo.html>.

### Altiris Client Management solutions

HP and Altiris have partnered to provide comprehensive, tightly integrated systems management solutions to reduce the cost of owning HP client PCs. HP Client Manager Software is the foundation for additional Altiris Client Management Solutions that address:

- Inventory and asset management
  - Software license compliance
  - PC tracking and reporting
  - Lease contract and fixed asset tracking
- Deployment and migration
  - Microsoft® Windows® XP Professional® or Home Edition migration
  - System deployment
  - Personality migrations

- Help desk and problem resolution
  - Managing help desk tickets
  - Remote troubleshooting
  - Remote problem resolution
  - Client disaster recovery
- Software and operations management
  - Ongoing desktop management
  - HP system software deployment
  - Application self-healing

See <http://h18000.www1.hp.com/im/prodinfo.html> for more information about:

- How HP Client Manager Software works
- Which solutions are compatible with your operating system
- How to download a fully-functional, 30-day evaluation version of the Altiris solutions

## System Software Manager

System Software Manager (SSM) is a utility that enables you to update system-level software on multiple systems simultaneously. When executed on a PC client system, SSM detects both hardware and software versions and then updates the appropriate software from a central repository, also known as a file store. Driver versions that are supported by SSM are denoted with a special icon on the software, the driver download website, and the Support Software CD. To download the utility or to obtain more information on SSM, see <http://www.hp.com/go/ssm>.

## Proactive Change Notification

The Proactive Change Notification program uses the Subscriber's Choice website to proactively and automatically send you:

- Proactive Change Notification (PCN) e-mails informing you of hardware and software changes to most commercial workstations and servers, up to 60 days in advance.
- E-mails containing Customer Bulletins, customer advisories, customer notes, security bulletins, and driver alerts for most commercial workstations and servers.

You create your own profile to ensure that you only receive the information relevant to a specific IT environment. To learn more about the Proactive Change Notification program and create a custom profile, see <http://www.hp.com/go/pcn>.

## Subscriber's Choice

Subscriber's Choice is a client-based service from HP. Based on your profile, HP supplies you with personalized product tips, feature articles, and driver and support alerts and notifications. Subscriber's Choice Driver and Support Alerts/Notifications deliver e-mails notifying you that the information you subscribed to in your profile is available for review and retrieval. To learn more about Subscriber's Choice and create a custom profile, see <http://www.hp.com/go/pcn>.

## ROM flash

The workstation comes with a programmable flash ROM. By establishing a setup password in the Computer Setup (F10) Utility, you can protect the ROM from being unintentionally updated or overwritten, which is important to ensure the operating integrity of the workstation. Should you need or want to upgrade the ROM, you can:

- Order an upgraded ROMPaq diskette from HP.
- Download the latest ROMPaq images from HP driver and support page, <http://www.hp.com/support/files>.



---

**NOTE** For maximum ROM protection, be sure to establish a setup password. The setup password prevents unauthorized ROM upgrades. System Software Manager enables you to set the setup password on one or more PCs simultaneously. For more information, see <http://www.hp.com/go/ssm>.

---

## Remote ROM flash

Remote ROM Flash enables you to safely upgrade the ROM on remote HP workstations directly from the centralized network management console. Performing this task remotely on multiple workstations and personal computers results in a consistent deployment of and greater control over HP PC ROM images over the network. It also results in greater productivity and lower total cost of ownership.

The workstation must be powered on to use Remote ROM Flash.

For more information on Remote ROM Flash, see the HP Client Manager Software or System Software Manager at <http://h18000.www1.hp.com/im/prodinfo.html>.

## HPQFlash

The HPQFlash utility is used to locally update or restore the system ROM on individual PCs through a Windows operating system.

For more information on HPQFlash, see <http://www.hp.com/support/files> and enter the name of your workstation when prompted.

## FailSafe Boot Block ROM

The FailSafe Boot Block ROM allows for system recovery in the unlikely event of a ROM flash failure, for example, if a power failure occurs during a ROM upgrade. The Boot Block is a flash-protected section of the ROM that checks for a valid system ROM flash when the system is powered on.

- If the system ROM is valid, the system starts normally.
- If the system ROM fails the validation check, the FailSafe Boot Block ROM provides enough support to start the system from a ROMPaq diskette, which will program the system ROM with a valid image.



---

**NOTE** Some models also support recovery from a ROMPaq CD. ISO ROMPaq images are included with selected models in the downloadable ROM SoftPaq. Recovery from USB devices is also supported

---

When the Boot Block detects an invalid system ROM, the System Power LED blinks red eight times, once every second, followed by a two-second pause. Also, you will hear eight beeps that correspond to the blinks. A Boot Block recovery mode message is displayed on the screen (some models).

To recover the system after it enters Boot Block recovery mode:

1. If there is a diskette in the diskette drive or a CD in the CD drive, remove the diskette and CD, and power down the system.
2. Insert a ROMPaq diskette into the diskette drive, or if permitted on this workstation, insert a ROMPaq CD into the CD drive. USB media such as an HP DriveKey can also be used.
3. Power on the workstation.

If no ROMPaq diskette or ROMPaq CD is found, you will be prompted to insert one and restart the workstation.

If a setup password has been established, the Caps Lock light illuminates and you are prompted to enter the password.

4. Enter the setup password.

If the system successfully starts from the diskette and successfully reprograms the ROM, then the three keyboard lights illuminate. A rising tone series of beeps also signals successful completion.

5. Remove the diskette or CD, and restart the system.

The following table lists the various keyboard light combinations used by the Boot Block ROM (when a PS/2 keyboard is attached to the workstation) and explains the meaning and action associated with each combination.

**Table 3-2** Keyboard light combinations used by Boot Block ROM

Light	State	Description
<b>FailSafe Boot Block Mode</b>	<b>Keyboard LED Activity</b>	<b>State/Message</b>
Num Lock	On	ROMPaq diskette or ROMPaq CD not present, is bad, or drive not ready
Caps Lock	On	Enter password
Num, Caps, Scroll Lock	Blink On in sequence, one at a time—N,C, SL	Keyboard locked in network mode
Num, Caps, Scroll Lock	On	Boot Block ROM Flash successful.

D diagnostic lights do not flash on USB keyboards.

## Replicating the setup

The following procedures enable you to easily copy one setup configuration to other workstations of the same model to provide faster, more consistent configuration of multiple workstations.



**NOTE** Both procedures require a diskette drive or a USB device such as an HP DriveKey.

To collect and replicate BIOS settings on multiple computers, use System Software Manager or HP Client Manager Software. For more information, see <http://www.hp.com/go/easydeploy>.



## Copying to a single workstation



**CAUTION** A setup configuration is model-specific. File system corruption can result if the source and target workstations are not the same model. For example, do not copy the setup configuration from an HP xw6200 Workstation to an HP xw8400 Workstation.

1. Select a setup configuration to copy. Power off the workstation. In Windows, click **Start>Shut Down>Shut Down**.
2. As soon as the workstation is powered on, press and hold the **F10** key until you enter the Computer Setup (F10) Utility. Press **Enter** to bypass the title screen, if necessary.



**NOTE** If you do not press the F10 key at the appropriate time, you must restart the workstation and press and hold the **F10** key again to access the utility.

If you are using a PS/2 keyboard, disregard the keyboard error message that might appear.

3. If you are using a diskette, insert it now.
4. Click **File>Replicated Setup>Save to Removable Media**. Follow the instructions on the screen to create the configuration diskette.
5. Power off the workstation to be configured and insert the configuration diskette.
6. Power on the workstation to be configured.
7. As soon as the workstation is powered on, press and hold the **F10** key until you enter the Computer Setup (F10) Utility. Press **Enter** to bypass the title screen, if necessary.
8. Click **File>Replicated Setup>Restore from Removable Media**, and follow the instructions on the screen.
9. Restart the workstation when the configuration is complete.

## Copying to multiple workstations



**CAUTION** A setup configuration is model-specific. File system corruption can result if the source and target workstations are not the same model. For example, do not copy the setup configuration from an HP xw6200 Workstation to an HP xw8400 Workstation.

This method takes a little longer to prepare the configuration diskette, but copying the configuration to target workstations is significantly faster.



**NOTE** A bootable diskette is required for this procedure. If Windows XP is not available to create a bootable diskette, use the method for copying to a single workstation instead (see [Copying to a single workstation on page 39](#)).

1. Create a bootable diskette.
2. Select a setup configuration to copy. Power off the workstation. In Windows, click **Start>Shut Down>Shut Down**.
3. Power on the workstation.
4. As soon as the workstation is powered on, press and hold the **F10** key until you enter the Computer Setup (F10) Utility. Press **Enter** to bypass the title screen, if necessary.



---

**NOTE** If you do not press the F10 key at the appropriate time, you must restart the workstation and press and hold the **F10** key again to access the utility.

If you are using a PS/2 keyboard, disregard the keyboard error message that might appear.

---

5. If you are using a diskette, insert it now.
6. Click **File>Replicated Setup>Save to Removable Media**. Follow the instructions on the screen to create the configuration diskette.
7. Download a BIOS utility for replicating setup (repset.exe), and copy it onto the configuration diskette. To obtain this utility, go to <http://www.hp.com/support/files> and enter the model number of the workstation.
8. On the configuration diskette, create an autoexec.bat file containing the following command:  
**repset.exe cpqsetup.txt.**
9. Power off the workstation to be configured. Insert the configuration diskette and power on the workstation. The configuration utility runs automatically.
10. Restart the workstation when the configuration is complete.

## Dual-state power button

With ACPI enabled, the power button can function either as an on/off switch or as a sleep button. The feature does not completely remove the power, but instead causes the workstation to enter a low-power standby state. This feature enables you to power off without closing applications and to return to the same operational state without any data loss.

To change the power button configuration:

1. Click **Start**, and select **Control Panel>Power Options**.
2. In **Power Options Properties**, click the **Advanced** tab.
3. In the **Power Button** section, select **Hibernate**. (Hibernate must be enabled in the **Hibernate** tab.)

After configuring the power button to function as a button, press the power button to put the system in a very low power state. Press the button again to bring the system to full power status. To completely remove all power to the system, press and hold the power button for four seconds.



---

**CAUTION** Do not use the power button to power off the workstation unless the system is not responding. Powering off the power without operating system interaction can cause damage to or loss of data on the hard drive.

---

## Worldwide web site

HP engineers rigorously test and debug software developed by HP and third-party suppliers, and develop operating system specific support software, to ensure performance, compatibility, and reliability for HP workstations.

When making the transition to new or revised operating systems, it is important to implement the support software designed for that operating system. If you plan to run a version of Microsoft Windows that is different from the version included with the workstation, you must install corresponding device drivers and utilities to ensure that all features are supported and functioning properly.

HP has made the task of locating, accessing, evaluating, and installing the latest support software easier. You can download the software from <http://www.hp.com/support>. The Web site contains the latest device drivers, utilities, and flashable ROM images needed to run the latest Microsoft Windows operating system on the HP workstation.

## Building blocks and partners

HP management solutions integrate with other systems management applications, and are based on industry standards, such as:

- Web-Based Enterprise Management (WBEM)
- Windows Management Interface (WMI)
- Wake on LAN technology
- ACPI
- SMBIOS
- Pre-boot Execution Environment (PXE) support
- Alert Standard Format

## Asset tracking and security

Asset tracking features incorporated into the workstation provide key asset tracking data that can be managed using HP Systems Insight Manager, HP Client Manager Software, or other system management applications. Seamless, automatic integration between asset tracking features and these products enables you to choose the management tool that is best suited to the environment and to leverage the investment in existing tools.

HP also offers several solutions for controlling access to valuable components and information. ProtectTools Embedded Security, if installed, prevents unauthorized access to data, checks system integrity, and authenticates third-party users attempting system access. Security features such as ProtectTools and the Hood Sensor (Smart Cover Sensor) help to prevent unauthorized access to the internal components of the workstation. By disabling parallel, serial, or USB ports, or by disabling removable media boot capability, you can protect valuable data assets. Memory Change and Hood Sensor (Smart Cover Sensor) alerts can be automatically forwarded to system management applications to deliver proactive notification of tampering with a workstation's internal components.



---

**NOTE** ProtectTools, the Hood Sensor (Smart Cover Sensor), and the Hood Lock (Smart Cover Lock) are available as options on select systems.

---

Use the following utilities to manage security settings on the HP workstation:

- Computer Setup (F10) Utility (local).
- HP Client Manager Software or System Software Manager (remote). This software enables the secure, consistent deployment and control of security settings from a simple command line utility.

The following table and sections refer to managing security features of the workstation locally through the Computer Setup (F10) Utility.

**Table 3-3** Security features overview

Feature	Purpose	How It Is Established
Removable Media Boot Control	Prevents booting from the removable media drives.	From the Computer Setup (F10) Utility Menu.
Serial, Parallel, USB, or Infrared Interface Control	Prevents transfer of data through the integrated serial, parallel, USB, or infrared interface.	From the Computer Setup (F10) Utility menu.
Power-On Password	Prevents use of the workstation until the password is entered. This can apply to both initial system startup and restarts.	From the Computer Setup (F10) Utility menu.
Setup Password	Prevents reconfiguration of the workstation (use of the Setup Utilities) until the password is entered.	From the Computer Setup (F10) Utility menu.
Network Server Mode	Provides unique security features for workstations being used as servers.	From the Computer Setup (F10) Utility menu.
Ownership Tag	Displays ownership information, as defined by the system administrator, during system startup (protected by setup password).	From the Computer Setup (F10) Utility menu.
Kensington Cable Lock Provision	Prevents entire system theft only.	Install a Kensington cable lock to secure the workstation to a fixed object.
Padlock Loop	Prevents access panel from being removed. This loop can also be used to secure the unit to a fixed object.	Install a padlock.
Access Panel Key Lock (Standard)	Prevents removal of the access panel and all internal components including optical and floppy drives	Lock the access panel.
Universal Chassis Clamp Lock (Optional)	The version without a cable discourages access panel removal and prevents theft of I/O devices. The version with a cable additionally prevents entire system theft and allows multiple systems to be secured with a single cable.	Install a chassis clamp lock.
Hood Sensor	Notifies a local or remote user when the chassis access panel has been opened.	Install an intrusion sensor.

**NOTE:** For more information about the Computer Setup (F10) Utility, see [Computer Setup \(F10\) Utility menu on page 26](#).

## Password security

The power-on password prevents unauthorized use of the workstation by requiring entry of a password to access applications or data each time the workstation is turned on or restarted. The setup password specifically prevents unauthorized access to the Computer Setup (F10) Utility and can also be used as an override to the power-on password. That is, when prompted for the power-on password, entering the setup password instead will allow access to the workstation.

A network-wide setup password can be established to enable the system administrator to log in to all network systems to perform maintenance without having to know the power-on password.



---

**NOTE** System Software Manager and HP Client Manager Software allow remote management of setup passwords and other BIOS settings in a networked environment. For more information, see <http://www.hp.com/go/easydeploy>.

---

### Establishing a setup password in the Computer Setup (F10) Utility

Establishing a setup password through the Computer Setup (F10) Utility prevents reconfiguration of the workstation (through use of the Computer Setup (F10) Utility) until the password is entered.

To establish a setup password using workstation setup:

1. Power on or restart the workstation. In Windows, click **Start>Turn off>Restart**.
2. As soon as the computer is powered on, press and hold **F10** until you enter the Computer Setup (F10) Utility. Press **Enter** to bypass the title screen, if necessary.



---

**NOTE** If you do not press the F10 key at the appropriate time, you must restart the workstation and press and hold the **F10** key again to access the utility.

If you are using a PS/2 keyboard, disregard the keyboard error message that might appear.

---

3. Select **Security>Setup Password**, and follow the onscreen instructions.
4. Before exiting, select **File>Save Changes** and click **Exit**.

### Establishing a power-on password in the Computer Setup (F10) Utility

Establishing a power-on password through the Computer Setup (F10) Utility prevents access to the workstation when power is on, unless the password is entered. When a power-on password is set, the Computer Setup (F10) Utility presents Password Options under the Security menu. The password options include Network Server Mode and Password Prompt on Warm Boot.

When Network Server Mode is disabled, the password must be entered each time the workstation is powered on when the key icon appears on the monitor. When Password Prompt on Warm Boot is enabled, the password must also be entered each time the workstation is rebooted. When Network Server Mode is enabled, the password prompt is not presented during POST, but any attached PS/2 keyboard remains locked until the power-on password is entered.

To enable Network Server Mode, a power-on password must be set. The option then shows up under **Advanced>Password Options**. This feature allows the system to boot without asking for the power-on password, but the keyboard and mouse are locked until you enter it. The keyboard LEDs rotate constantly when the system is in locked mode.

To establish a power-on password through workstation setup:

1. Power on or restart the workstation. In Windows, click **Start>Shut Down>Restart**.
2. As soon as the computer is powered on, press and hold the **F10** until you enter the Computer Setup (F10) Utility. Press **Enter** to bypass the title screen, if necessary.



---

**NOTE** If you do not press the F10 key at the appropriate time, you must restart the workstation and press and hold the **F10** key again to access the utility.

If you are using a PS/2 keyboard, disregard the keyboard error message that might appear.

---

3. Select **Security>Power-On Password**, and follow the on-screen instructions.
4. Before exiting, select **File>Save Changes** and, **Exit**.

### Entering a power-on password

To enter a power-on password:

1. Power on or restart the workstation. In Windows, click **Start>Shut Down>Restart the Computer**.
2. When the key icon appears on the monitor, enter the current password, and press **Enter**.



---

**NOTE** Type carefully. For security reasons, the characters you enter do not appear on the screen.

---

If you enter the password incorrectly, a broken key icon appears. Try again. After three unsuccessful tries, you must restart the workstation, before you can continue.

### Entering a setup password

If a setup password has been established on the workstation, you will be prompted to enter it each time you run the Computer Setup (F10) Utility.

To enter a setup password:

1. Power on or restart the workstation. In Windows, click **Start>Shut Down>Restart the Computer**.
2. As soon as the workstation powers on, press and hold the **F10** key until you enter the Computer Setup (F10) Utility. Press **Enter** to bypass the title screen, if necessary.



---

**NOTE** If you do not press the F10 key at the appropriate time, you must restart the workstation and press and hold the **F10** key again to access the utility.

---

If you are using a PS/2 keyboard, disregard the keyboard error message that might appear.

---

3. When the key icon appears on the monitor, enter the setup password, and press **Enter**.



---

**NOTE** Type carefully. For security reasons, the characters you enter do not appear on the screen.

---

If you enter the password incorrectly, a broken key icon appears. Try again. After three unsuccessful tries, you must restart the workstation, before you can continue.

## Changing a power-on or setup password

To change a power-on or setup password:

1. Power on or restart the workstation. In Windows, click **Start>Shut Down>Restart**.
2. As soon as the workstation powers on, press and hold the **F10** key until you enter the Computer Setup (F10) Utility. Press **Enter** to bypass the title screen, if necessary.



---

**NOTE** If you do not press F10 at the appropriate time, you must restart the workstation and press and hold the **F10** key again to access the utility.

If you are using a PS/2 keyboard, disregard the keyboard error message that might appear.

---

3. When the key icon appears, enter the current password, a slash (/) or alternate delimiter character, your new password, another slash (/) or alternate delimiter character, and your new password again as shown: **current password/new password/new password**



---

**NOTE** Type carefully. For security reasons, the characters you enter do not appear on the screen.

---

4. Press **Enter**.

The new password takes effect the next time you power on the workstation.



---

**NOTE** See the table of [National keyboard delimiter characters on page 46](#) for information about the alternate delimiter characters. The power-on password and setup password can also be changed using the Security options in the Computer Setup (F10) Utility.

---

## Deleting a power-on or setup password

To delete a power-on or setup password:

1. Power on or restart the workstation. In Windows, click **Start>Shut Down>Restart the Computer**.
2. To delete the power-on password, go to step 3.

To delete the setup password, as soon as the workstation is powered on, press and hold the **F10** key until you enter the Computer Setup (F10) Utility. Press **Enter** to bypass the title screen, if necessary.



---

**NOTE** If you do not press the F10 key at the appropriate time, you must restart the computer and press and hold the **F10** key again to access the utility.

Use the appropriate operating system shutdown process.

---

3. When the key icon appears, enter your current password followed by a slash (/) or alternate delimiter character as shown: *current password/*.
4. Press **Enter**.



---

**NOTE** See the [National keyboard delimiter characters on page 46](#) for information about the alternate delimiter characters. The power-on password and setup password can also be changed using the Security options in the Computer Setup (F10) Utility.

---

## National keyboard delimiter characters

Each keyboard is designed to meet country-specific requirements. The syntax and keys that you use for changing or deleting your password depend on the keyboard that came with your workstation.

**Table 3-4** National keyboard delimiter characters

Arabic	/	Greek	-	Russian	/
Belgian	=	Hebrew	.	Slovakian	-
BHCSY*	-	Hungarian	-	Spanish	-
Brazilian	/	Italian	-	Swedish/Finnish	/
Chinese	/	Japanese	/	Swiss	-
Czech	-	Korean	/	Taiwanese	/
Danish	-	Latin American	-	Thai	/
French	!	Norwegian	-	Turkish	.
French Canadian	é	Polish	-	U.K. English	/
German	-	Portuguese	-	U.S. English	/

\* For Bosnia-Herzegovina, Croatia, Slovenia, and Yugoslavia.

## Clearing passwords

If you forget your password, you cannot access the workstation. See [Resetting the password jumper on page 180](#) for instructions on clearing passwords.

## Hood sensor (Smart Cover Sensor)

The optional hood sensor is a combination of hardware and software technology that can alert you when the workstation side access panel has been removed. There are three levels of protection, as described in the following table.

**Table 3-5** Hood sensor protection levels

Level	Setting	Description
Level 0	Disabled	Hood sensor is disabled (default).
Level 1	Notify User	When the workstation is restarted, the screen displays a message indicating that the workstation side access panel has been removed.
Level 2	Setup Password	When the workstation is restarted, the screen displays a message indicating that the workstation side access panel has been removed. You must enter the setup password to continue.

These settings can be changed using the Computer Setup (F10) Utility.



## Setting the hood sensor protection level

To set the hood sensor protection level:

1. Power on or restart the workstation. In Windows, click **Start>Shut Down>Restart**.
2. As soon as the workstation powers on, press and hold the **F10** key until you enter the Computer Setup (F10) Utility. Press **Enter** to bypass the title screen, if necessary.



---

**NOTE** If you do not press the F10 key at the appropriate time, you must restart the computer and press and hold the **F10** key again to access the utility.

---

If you are using a PS/2 keyboard, disregard the keyboard error message that might appear.

---

3. Select **Security>Smart Cover>Cover Removal Sensor**, then side access panel, and follow the on-screen instructions.
4. Select **File>Save Changes** and click **Exit**.

## Cable lock provision (optional)

The rear panel of the chassis can accommodate a cable lock accessory that allows the workstation to be physically secured to a work area.

## Security lock (optional)

This optional feature prevents entire system theft and discourages access panel removal.

## Universal chassis clamp lock (optional)

The version without a cable discourages access panel removal and prevents theft of I/O devices. The version with a cable also prevents entire system theft and allows multiple systems to be secured with a single cable.

## Access panel key lock

This lock prevents removal of the access panel and all internal components. The key is shipped on the rear of the workstation.

## Fault notification and recovery

Fault notification and recovery features combine innovative hardware and software technology to prevent the loss of critical data and minimize unplanned downtime.

If the workstation is connected to a network managed by HP Client Manager software, the computer sends a fault notice to the network management application. With HP Client Manager software, you can also remotely schedule diagnostics to automatically run on all managed PCs and create a summary report of failed tests.

## Drive Protection System

The Drive Protection System (DPS) is a diagnostic tool built into the hard drives installed in select HP workstations. DPS is designed to help diagnose problems that might result in unwarranted hard drive replacement.

When HP workstations are built, each installed hard drive is tested using DPS, and a permanent record of key information is written onto the drive. Each time DPS is run, test results are written to the hard

drive. The service provider can use this information to help diagnose conditions that caused you to run the DPS software.

## ECC fault prediction and pre-failure warranty

When the workstation encounters an excessive number of error checking and correcting (ECC) memory errors, the workstation displays a Local Alert message. This message contains detailed information about the errant memory module, enabling you to take action before you experience non-correctable memory errors. The pre-failure warranty for ECC memory modules enables you to replace these modules, free of charge, before the modules actually fail. ECC memory modules are optional on selected HP systems.

## Thermal sensor

There are multiple sensors on your workstation:

- One per processor
- One per memory module (DIMM)
- One for the system board
- Some hard drives

The processor thermal sensor is a hardware and software feature that tracks the internal temperature of the workstation. When combined with HP Client Manager Software, this feature notifies the network administrator when the normal range is exceeded. In this case, the processor clock automatically begins to throttle. If the temperature does not decrease, the system eventually shuts down.

# 4 Removal and replacement procedures

This chapter describes removal and replacement procedures of most internal components.

- [Service considerations on page 50](#)
- [Customer Self Repair on page 54](#)
- [Pre-disassembly procedures on page 55](#)
- [System board components on page 56](#)
- [Removing and replacing components on page 58](#)

## Service considerations

The following sections discuss service considerations that should be reviewed and practiced before removing and replacing any system components.



**WARNING!** When lifting or moving the workstation, do not use the front bezel as a handle or lifting point. Lifting the workstation from the front bezel or lifting it incorrectly can cause the unit to fall and harm the user and damage the workstation. To properly and safely lift the workstation, lift it from the bottom of the unit.

## Read cautions, warnings, and safety precautions

For your safety, you must review all safety warning and caution notices before accessing the components of the workstation. Also, review the *Safety and Regulatory Guide* that came with your workstation for more information.



**WARNING!** Some parts inside the computer will be hot. Power off and unplug the system, and then wait approximately three to five minutes for them to cool before opening the system access panels or touching internal components.

## Electrostatic discharge information

A sudden discharge of static electricity from your finger or other conductor can destroy static-sensitive devices or microcircuitry. Often the spark is neither felt nor heard, but damage occurs. An electronic device exposed to electrostatic discharge (ESD) might not appear to be affected at all and can work perfectly throughout a normal cycle. The device can function normally for a while, but it has been degraded in the internal layers, reducing its life expectancy.

Networks built into many integrated circuits provide some protection, but in many cases, the discharge contains enough power to alter device parameters or melt silicon junctions.

## Generating static

The following table shows that Different activities generate different amounts of static electricity. Static electricity increases as humidity decreases.

**Table 4-1** Static electricity

Event	Relative Humidity		
	5%	4%	1%
Walking across carpet	7,500 V	15,000 V	35,000 V
Walking across vinyl floor	3,000 V	5,000 V	12,000 V
Motions of bench worker	400 V	800 V	6,000 V
Removing bubble pack from PCB	7,000 V	20,000 V	26,500 V
Packing PCBs in foam-lined box	5,000 V	11,000 V	21,000 V



**CAUTION** 700 volts can degrade a product.

## Preventing electrostatic damage to equipment

Many electronic components are sensitive to ESD. Circuitry design and structure determine the degree of sensitivity. The following packaging and grounding precautions are necessary to prevent damage to electric components and accessories.

- Transport products in static-safe containers, such as tubes, bags, or boxes, to avoid hand contact.
- Protect all electrostatic parts and assemblies with conductive or approved containers or packaging.
- Keep electrostatic-sensitive parts in their containers until they arrive at static-free stations.
- Place items on a grounded surface before removing them from their containers.
- When handling or touching a sensitive component or assembly, ground yourself by touching the chassis.
- Avoid contact with pins, leads, or circuitry.
- Place reusable electrostatic-sensitive parts from assemblies in protective packaging or conductive foam.

## Personal grounding methods and equipment

Use the following equipment to prevent static electricity damage to equipment:

- Wrist straps are flexible straps with a maximum of one megohm  $\pm$  10% resistance in the ground cords. To provide a proper ground, wear the strap against bare skin. The ground cord must be connected and fit snugly into the banana plug connector on the grounding mat or workstation.
- Heel straps, toe straps, and boot straps can be used at standing workstations and are compatible with most types of shoes or boots. On conductive floors or dissipative floor mats, use them on both feet with a maximum of one-megohm  $\pm$  10% resistance between the operator and ground.

**Table 4-2** Static shielding protection levels

Method	Voltage
Antistatic plastic	1,500
Carbon-loaded plastic	7,500
Metallized laminate	15,000

## Grounding the work area

To prevent static damage at the work area:

- Cover the work surface with approved static-dissipative material. Provide a wrist strap connected to the work surface and properly grounded tools and equipment.
- Use static-dissipative mats, foot straps, or air ionizers to give added protection.
- Handle electrostatic sensitive components, parts, and assemblies by the case or PCB laminate. Handle them only at static-free work areas.
- Turn off power and input signals before inserting and removing connectors or test equipment
- Use fixtures made of static-safe materials when fixtures must directly contact dissipative surfaces.

- Keep work area free of nonconductive materials, such as ordinary plastic assembly aids and Styrofoam.
- Use field service tools, such as cutters, screwdrivers, and vacuums, that are conductive.

## Recommended materials and equipment

It is recommended that the following materials and equipment be used to prevent static electricity:

- Antistatic tape
- Antistatic smocks, aprons, or sleeve protectors
- Conductive bins and other assembly or soldering aids
- Conductive foam
- Conductive tabletop workstations with ground cord of one-megohm  $\pm$  10% resistance
- Static-dissipative table or floor mats with hard tie to ground
- Field service kits
- Static awareness labels
- Wrist straps and footwear straps providing one-megohm  $\pm$  10% resistance
- Material handling packages
- Conductive plastic bags and tubes
- Conductive tote boxes
- Opaque shielding bags
- Transparent metallized shielding bags
- Transparent shielding tubes

## Required tools and software

The following tools and software are required to service your workstation:

- Torx T-15 screwdriver or flathead screwdriver
- Diagnostics software

## Screws

The screws used in the workstation are not interchangeable. They might have standard or metric threads and might be of different lengths. If an incorrect screw is used during the reassembly process, it can damage the unit. HP strongly recommends that all screws removed during disassembly be kept with the removed part and then returned to their proper locations.

## Special handling of components

The following components require special handling when servicing the workstation.

## Cables and connectors

Cables must be handled with care to avoid damage. Apply only the tension required to seat or unseat the cables during insertion or removal from the connector. Handle cables by the connector or pull strap whenever possible. In all cases, avoid bending or twisting the cables, and be sure that the cables are routed in such a way that they cannot be caught or snagged by parts being removed or replaced.



---

**CAUTION** When servicing this workstation, be sure that cables are placed in their proper location during the reassembly process. Improper cable placement can damage the workstation.

---

## Hard drives

Handle hard drives as delicate, precision components, avoiding all physical shock and vibration. This guideline applies to failed drives and replacement spares. Keep the following guidelines in mind as well:

- If a drive must be mailed, place the drive in a bubble-pack mailer or other suitable protective packaging and label the package “Fragile: Handle With Care.”
- Do not remove hard drives from the shipping package for storage. Keep hard drives in their protective packaging until they are actually mounted in the workstation.
- Avoid dropping drives from any height onto any surface.
- If you are inserting or removing a hard drive, power off the workstation. Do not remove a hard drive while the workstation is on.
- Before handling a drive, be sure that you are discharged of static electricity. While handling a drive, avoid touching the connector. For more information about preventing electrostatic damage, see [Electrostatic discharge information on page 50](#).
- Do not use excessive force when inserting a drive.
- Avoid exposing a hard drive to liquids, temperature extremes, or products that have magnetic fields such as monitors or speakers.

## Lithium coin cell battery

The battery that comes with the workstation provides power to the real-time clock and has a minimum lifetime of about three years.

For instructions on battery removal and replacement, see [Battery on page 78](#).



---

**WARNING!** This workstation contains a lithium battery. A risk of fire and chemical burn exists if the battery is handled improperly. Do not disassemble, crush, puncture, short external contacts, dispose of in water or fire, or expose it to temperatures higher than 140 degrees F (60 degrees C).

---



---

**NOTE** Batteries, battery packs, and accumulators should not be disposed of with general household waste.

---

## Customer Self Repair

Customer Self Repair (CSR) enables you to obtain replacement parts and install them yourself on your workstation. The following table indicates which workstation components are customer-serviceable. See <http://www.hp.com/go/selfrepair/> for more information.



## Pre-disassembly procedures

Perform the following steps before servicing the workstation:

1. Remove or disengage any security devices that prohibit opening the workstation.
2. Close any open software applications.
3. Remove any diskettes or CDs from the workstation.
4. Exit the operating system.
5. Shut down the workstation and any peripheral devices that are connected to it.
6. Disconnect the power cord from the electrical outlet and then from the workstation.
7. Disconnect all peripheral device cables from the workstation.

# System board components

The following image shows the system board connectors and sockets on the HP xw8400 Workstation.

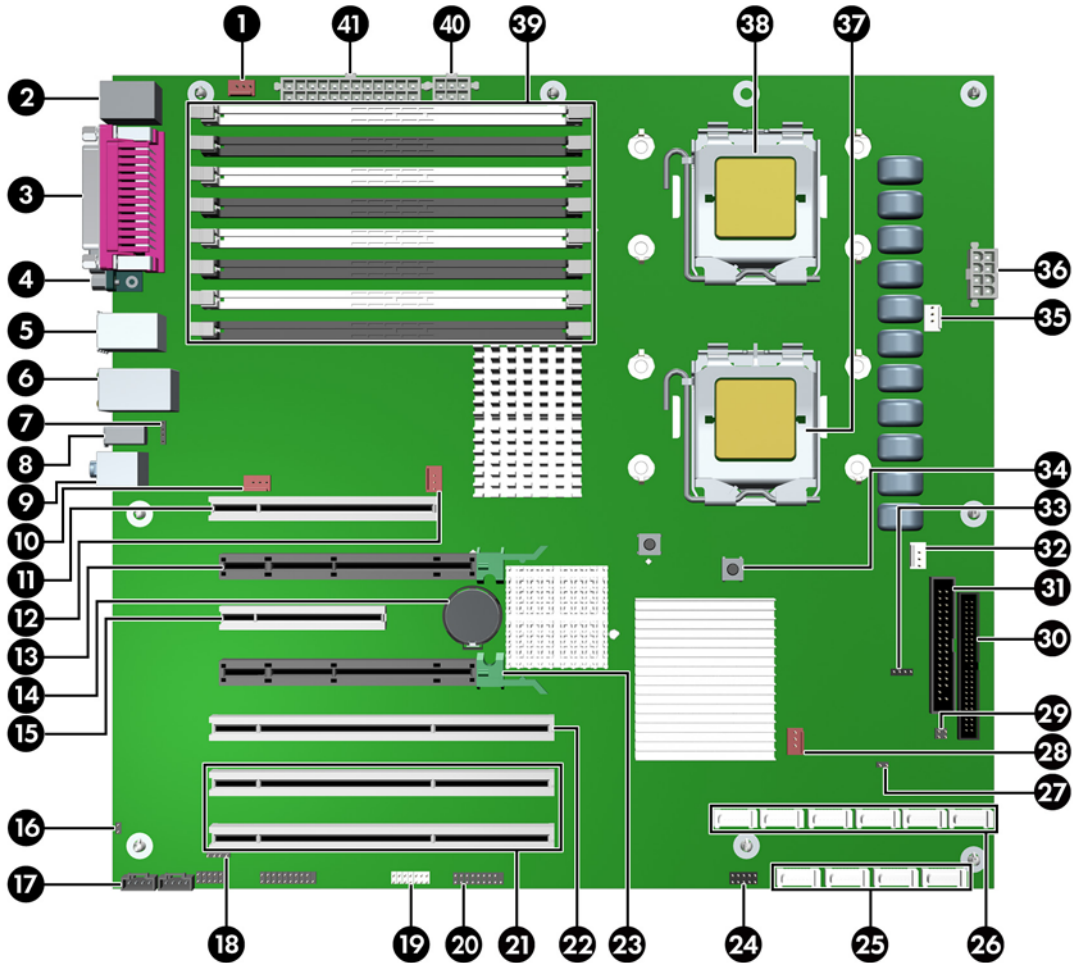

**Figure 4-1** System board identification

**Table 4-3** System board components

Item	Description	Item	Description	Item	Description	Item	Description
1	Memory Fan	12	Rear PCI Fan	23	PCI Express x16 (x4 performance)	34	Clear CMOS Button
2	PS/2 Keyboard/ Mouse	13	PCI Express x16 (graphics)	24	Front USB	35	Processor 1 Fan
3	Parallel	14	Battery	25	Serial SCSI (SAS)	36	Processor Power
4	Serial	15	PCI Express x8 (x4 performance)**	26	Serial ATA (SATA)	37	Processor 2
5	USB	16	Crisis Recovery Jumper	27	Password Jumper	38	Processor 1
6	Network/USB	17	Auxiliary Audio	28	Front Chassis Fan	39	Memory Module Pairs
7	Internal USB	18	Front audio	29	Boot Block Jumper	40	Auxiliary Power

**Table 4-3** System board components (continued)

Item	Description	Item	Description	Item	Description	Item	Description
8	IEEE 1394	19	Front IEEE 1394	30	Primary IDE*	41	Main Power
9	Audio	20	Front Control Panel	31	Diskette Drive		
10	Rear Chassis Fan	21	PCI-X 100	32	Processor 2 Fan		
11	PCI (32-bit, 33 MHz)	22	PCI-X 133	33	Hard Disk Activity LED		

\* The Primary IDE connector is generally used for hard drives.

\*\* The PCI Express x8 is a PCI Express x8 connector that has x4 bandwidth.

## System board architecture

The following image shows the HP xw8400 Workstation block diagram.

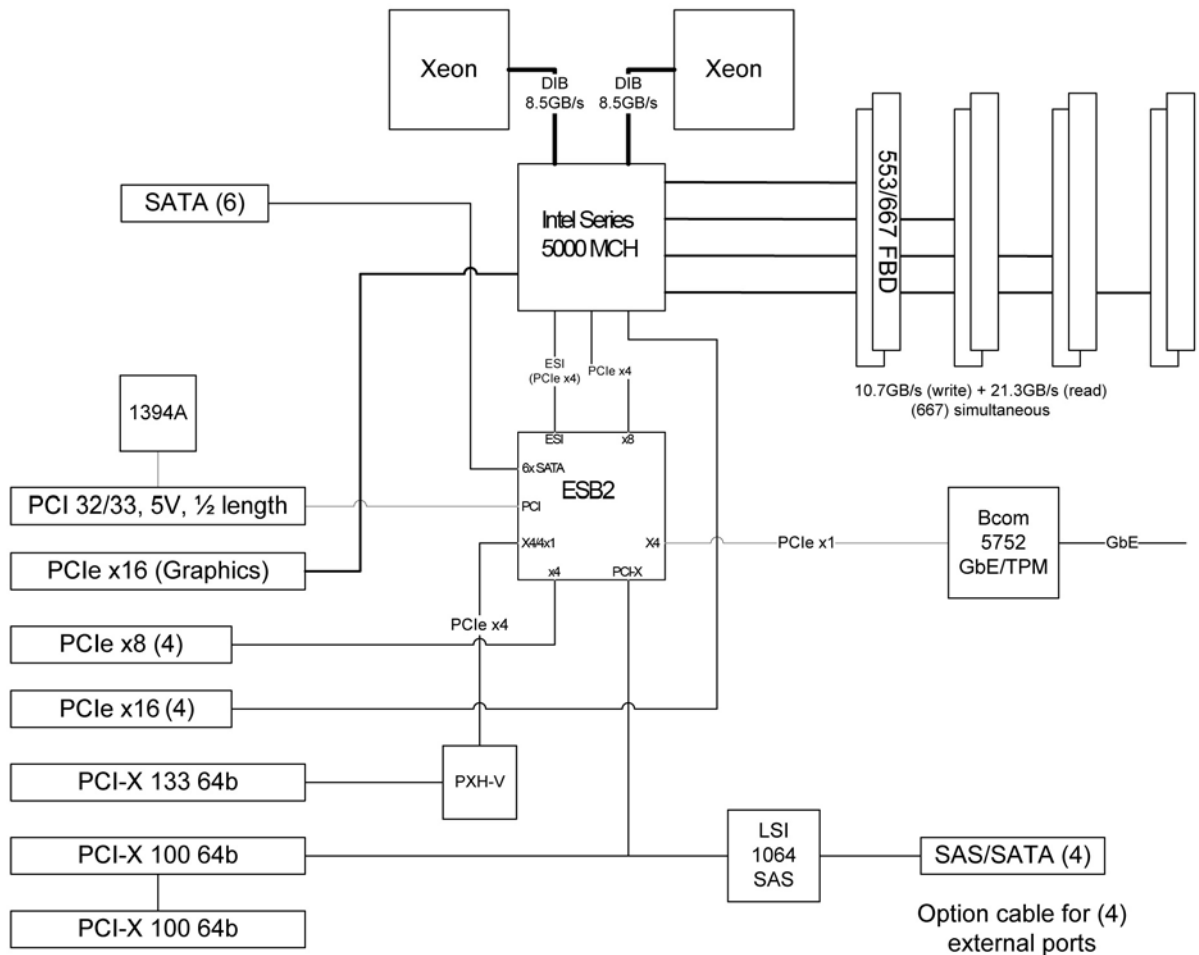

**Figure 4-2** System board block diagram

## Removing and replacing components

This section discusses the procedures necessary to remove and install various hardware components on your workstation.

Before servicing or upgrading your workstation:

1. Review the safety precautions and the [Service considerations on page 50](#), as well as the *Safety and Regulatory Information*.
2. Locate and clear a suitable work area.
3. Shut down the system and remove power from the unit.
4. Gather your tools.
5. Remove and security devices.
6. Service your unit.
7. Restore power to your unit.



**NOTE** Prior to removing and replacing a component, make sure you remove all installed components that obstruct or prevent the removal of the component.

If you are unsure how to remove a particular component, please do one of the following:

1. Refer to the appropriate section in this chapter.
2. If the content you desire is not referenced in this chapter, see [www.hp.com/support/xw8400\\_manuals](http://www.hp.com/support/xw8400_manuals) and look under “Setup and Install – General” for instructions.
3. See the manufacturer’s web site for instructions for a third party (non-HP) component.

## Disassembly order

Use the following table to determine the sequence in which to remove the major components.

Pre-cisassembly ( <a href="#">Pre-disassembly procedures on page 55</a> )
Locks ( <a href="#">Removing the security lock (optional) on page 59</a> )
Access panel ( <a href="#">Access panel on page 60</a> )
Hood sensor ( <a href="#">Hood sensor (Smart Cover Sensor) on page 63</a> )
Front bezel ( <a href="#">Front bezel on page 61</a> )
Front panel I/O device assembly ( <a href="#">Front panel I/O device assembly on page 63</a> )

Power button and front speaker ( <a href="#">Power button assembly and system speaker on page 64</a> )
Optical drive ( <a href="#">Optical drive on page 79</a> )
Diskette drive ( <a href="#">Diskette drive (optional) on page 82</a> )
Bezel blanks ( <a href="#">Bezel blanks on page 62</a> )
Power supply ( <a href="#">Power supply on page 65</a> )
System fan ( <a href="#">System/memory fan assembly on page 66</a> )
Memory ( <a href="#">Memory on page 67</a> )
Front fan removal (optional) ( <a href="#">Front fan removal (Optional) on page 76</a> )
Battery ( <a href="#">Battery on page 78</a> )
Hard drive ( <a href="#">Hard drive on page 84</a> )
CPU heatsink ( <a href="#">Removing the CPU heatsink on page 88</a> )
Processor ( <a href="#">Removing the processor on page 91</a> )
PCI retainer ( <a href="#">PCI retainer on page 71</a> )
PCI retention clamp ( <a href="#">PCI retention clamp on page 73</a> )
PCI or PCI Express card ( <a href="#">Removing PCI or PCI Express cards on page 74</a> )
CPU heatsink ( <a href="#">Removing the CPU heatsink on page 88</a> )
Processor ( <a href="#">Removing the processor on page 91</a> )
System board ( <a href="#">System board on page 94</a> )

## Removing the security lock (optional)

If a security padlock is installed, remove it before servicing the unit. To remove the padlock, unlock it and slide it out of the padlock loop as shown in the following image.



**Figure 4-3** Removing the security lock

## Removing the cable lock (optional)

If a cable lock is installed, remove it before servicing the unit. To remove the cable lock, unlock it and pull it out of the cable lock slot as shown in the following image.



**Figure 4-4** Removing the cable lock

## Access panel

Before accessing the internal components of the workstation, the access panel must be removed.

To remove the access panel:



---

**WARNING!** Before removing the workstation access panel, be sure that the workstation is powered off and that the power cord is disconnected from the electrical outlet.

---

1. Disconnect power from the system.
2. If a lock is present, unlock the access panel. The keys are on the rear panel ([Rear panel components on page 4](#)). Also, unlock any other locks that are present (Kensington, or Padlock).
3. Pull up on the handle and lift off the cover.



**Figure 4-5** Opening the access panel

To replace the access panel, align the bottom groove of the side panel with the bottom edge of the chassis. Rotate the side panel toward the chassis and press firmly until the latch engages.

## Front bezel

To remove the front bezel:

1. Lift up on the three **(1)** tabs located on the front bezel.
2. Rotate the front bezel away **(2)** from the chassis, and remove the bezel.

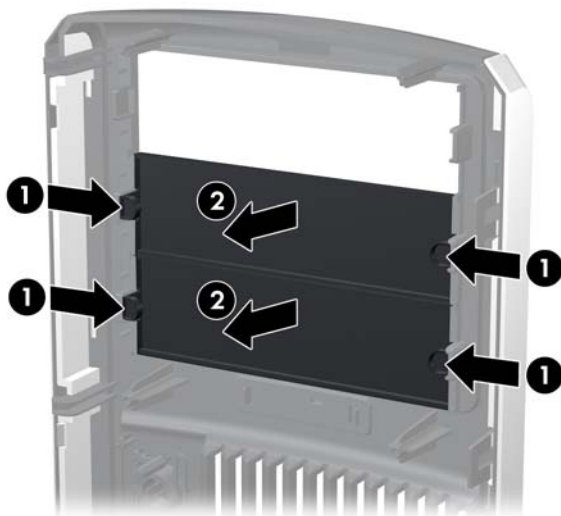

**Figure 4-6** Opening the front bezel

## Bezel blanks

To remove the bezel blanks:

1. Disconnect power from the system ( [Pre-disassembly procedures on page 55](#)) and remove the front bezel ( [Front bezel on page 61](#))
2. Remove the bezel blanks by squeezing in on the tabs (1) and pushing the bezel blanks out (2).



**Figure 4-7** Removing the bezel blanks



## Hood sensor (Smart Cover Sensor)

To remove the hood sensor:

1. Disconnect power from the system ([Pre-disassembly procedures on page 55](#)) and remove the access panel ([Access panel on page 60](#)). Lay the workstation on its side with the system board facing up.
2. Disconnect the white 1 x 3 hood sensor connector from the inline connector attached to the front panel harness.
3. Slide the hood sensor forward.
4. Push the hood sensor down and remove it from the chassis.

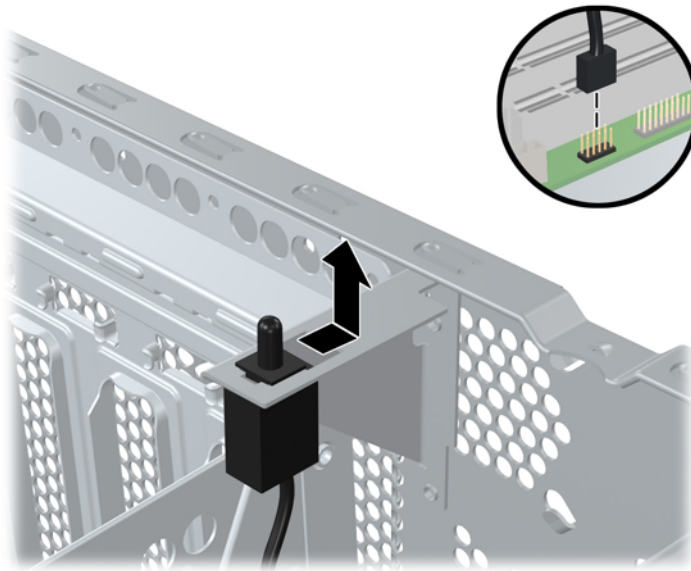

**Figure 4-8** Removing the hood sensor

To replace the hood sensor, reverse the previous steps.

## Front panel I/O device assembly

To remove the front panel I/O device assembly:

1. Disconnect power from the system ([Pre-disassembly procedures on page 55](#)). Remove the access panel ([Access panel on page 60](#)) and the front bezel ([Front bezel on page 61](#)).
2. Unlatch the plastic snap that secures the cables inside the chassis and, disconnect the front panel I/O device assembly cables from the system board.
3. Remove the screws that hold the front panel I/O device assembly and bracket to the chassis, and remove the screws that hold the front panel I/O device assembly to the bracket.
4. Pull the front panel I/O device assembly out about two inches away from the chassis.

5. Pull the bracket away from the front panel I/O device assembly.



**Figure 4-9** Removing the front panel I/O device assembly

6. Slide the front panel cables through the chassis and out the front of the unit.

To replace the front panel I/O device assembly, reverse the previous steps.

## Power button assembly and system speaker

The power button and the system speaker are part of the same assembly.

To remove the power button:

1. Disconnect power from the system ( [Pre-disassembly procedures on page 55](#)) and remove the access panel ( [Access panel on page 60](#)).
2. Remove the front bezel ( [Front bezel on page 61](#)) and the front panel I/O device assembly ( [Front panel I/O device assembly on page 63](#)).
3. Disconnect the power button assembly cable from the system board.
4. Disconnect the speaker wire and the hood sensor from the inline connectors on the power button assembly cable.
5. Remove the screw that secures the power button assembly to the chassis.
6. Pull the power button assembly away from the chassis.
7. Slide the power button assembly out from the front of the chassis.

To remove the speaker:

1. Disconnect the speaker cable from the inline front panel I/O device assembly cable, if you have not already done so.

2. Slide the speaker away from the three flanges and remove it from the chassis.

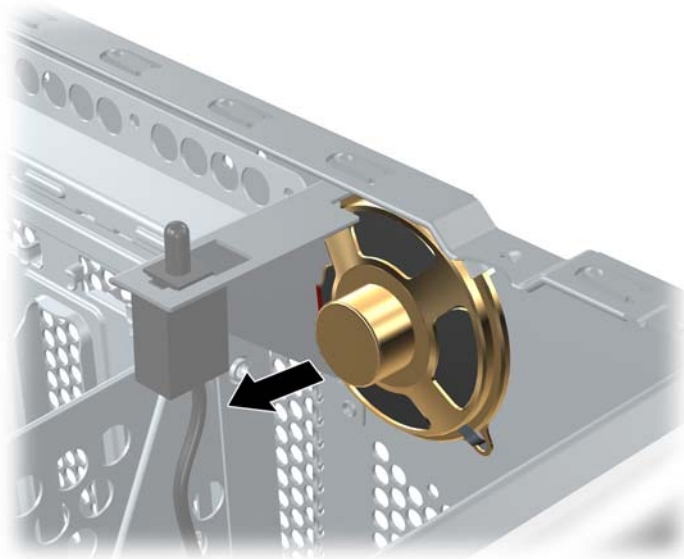

**Figure 4-10** Removing the speaker

## Power supply

1. Disconnect power from the system ([Pre-disassembly procedures on page 55](#)), and remove the access panel ([Access panel on page 60](#)). Place the workstation on its side with the system board facing up.
2. Disconnect the power supply from the system board.



**CAUTION** Be sure you can differentiate which power cable was disconnected from the PCI Express x16 graphics card and which power cable was disconnected from the system board. These two cables look similar. The PCI Express power cable has a black connector, and the power cable has a white connector. When power is present, NEVER connect the PCI Express power cable to the system board. If you do so, the system board can be damaged and your warranty voided. To see a picture of the PCI Express cable and where it must be connected, see the [PCI or PCI Express installation on page 75](#).

3. Disconnect the optical drives, diskette drive, hard drives, and graphics card (select models only) from the power supply.
4. Remove the four screws **(1)** from the back panel.
5. Slide the power supply toward the front, and lift up **(2)** to remove it from the chassis.

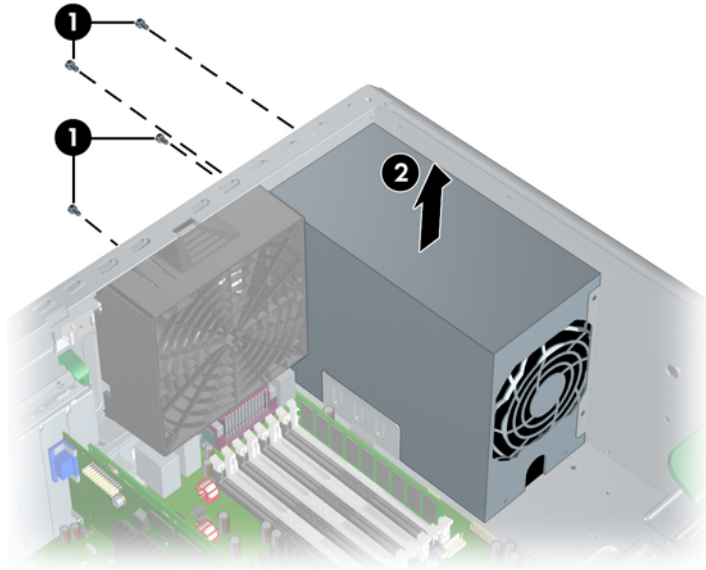

**Figure 4-11** Removing the power supply

To install the power supply, reverse the previous steps.

## System/memory fan assembly

The system fan and memory fan are connected and treated as a unit. To remove the system/memory fan assembly:

1. Disconnect power from the system ( [Pre-disassembly procedures on page 55](#)), and remove the access panel ( [Access panel on page 60](#)). Place the workstation on its side with the system board facing up.
2. Press the green tab **(2)** at the base of the memory fan, and lift it up.
3. Disconnect the system fan and memory fan power plugs from their system board connectors **(1)**.

4. Press down on the ribbed portion of the system fan housing (3), rotate the fan housing down, and lift the unit out of the chassis.

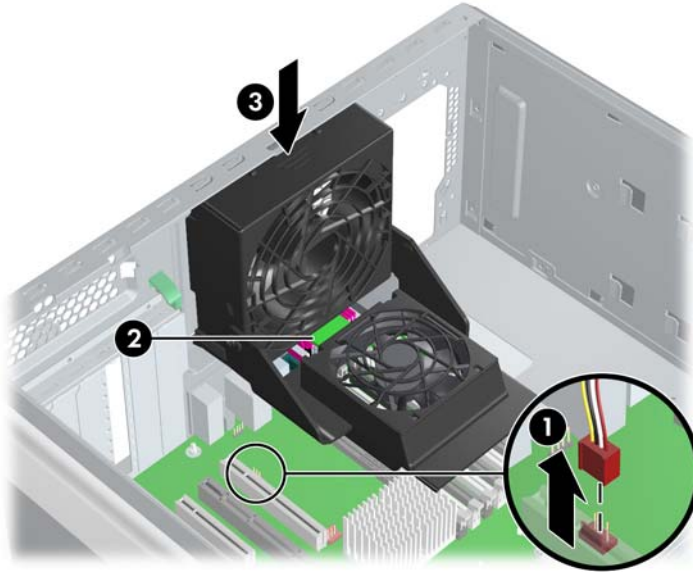

**Figure 4-12** Removing the system/memory fan assembly

To replace a system/memory fan assembly, reverse the previous steps.



**CAUTION** When installing the system/memory fan assembly, be sure that the fan is situated so that the airflow direction is going out of the chassis to avoid overheating.

## Memory

### Memory module features

- Eight memory slots for DIMMs
- 512-MB, 1-GB , 2-GB, 4-GB pairs
- 32 GB maximum configuration with 4-GB DIMMs
- Configurable for Single Channel (one DIMM), Dual Channel (two DIMMs), or Quad Channel (four to eight DIMMs)
- DDR2-667 or DDR2-533, Fully Buffered DIMMs (FBD)
- No support for mirroring
- No spare DIMM support
- Standard FBD, ECC (72-bit ECC)

### Memory module requirements

- Use only PC2-5300F, FBDs. Certified and warranted HP memory is recommended.
- Match DIMM pairs by size and type.

## Removing memory module

1. Disconnect power from the system ( [Pre-disassembly procedures on page 55](#)), and remove the access panel ( [Access panel on page 60](#)). Place the workstation on its side with the system board facing up.

 **CAUTION** To ensure that memory modules are not damaged during removal or installation, power off the workstation and unplug the power cord from the AC power outlet. Wait until the LED on the back of the power supply turns off before removing memory. If you do not unplug the power cord while installing memory, your memory modules might be damaged and the system will not recognize the memory changes.

2. Press the green tab at the base of the memory fan (1) and lift it up (2) to expose the memory modules.

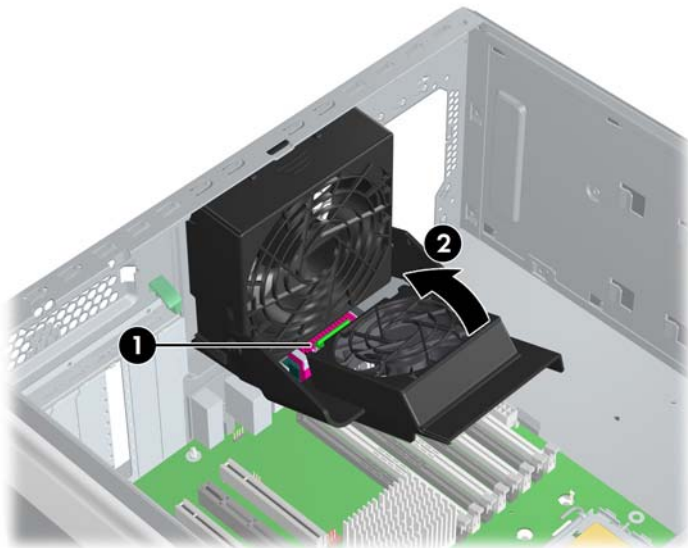

**Figure 4-13** Rotating the memory fan

3. Gently push out on the socket levers.

4. Lift the DIMM straight up, and remove it from the unit.

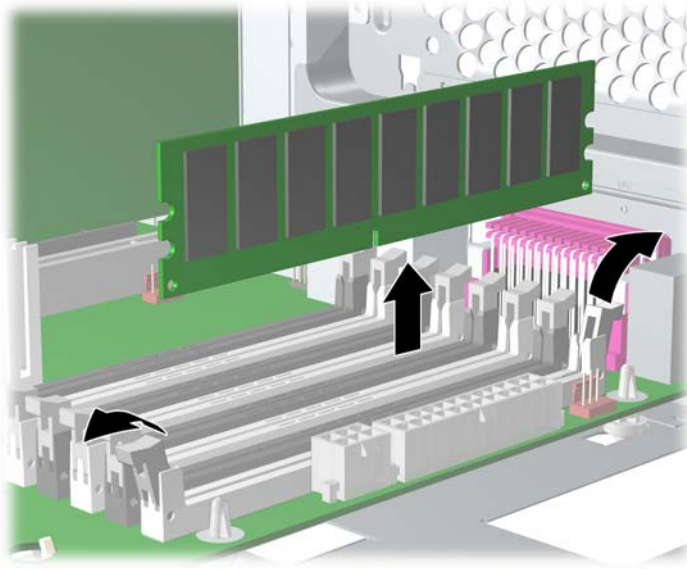

**Figure 4-14** Removing DIMM



**NOTE** DIMMs and DIMM sockets are keyed for proper installation. Be sure these guides align when installing a DIMM.

## Installing memory module



**CAUTION** HP only ships DIMMs that are electrically and thermally compatible with this product. Because third-party DIMMs might not be electrically or thermally compatible, they are not supported by HP.

You must load memory modules in valid configurations:

- If loading only one DIMM, install it in slot 1. Otherwise, DIMMs must be loaded as matched pairs.
- If loading two DIMMs, install them in slots 1 and 3.
- If loading four DIMMs, install them in slots 1, 3, 5, and 7.
- If loading six DIMMs, install them in slots 1 through 5, and 7.
- If loading eight DIMMs, install them in all slots.

- Load the memory module pairs in order of size, from smallest to largest.

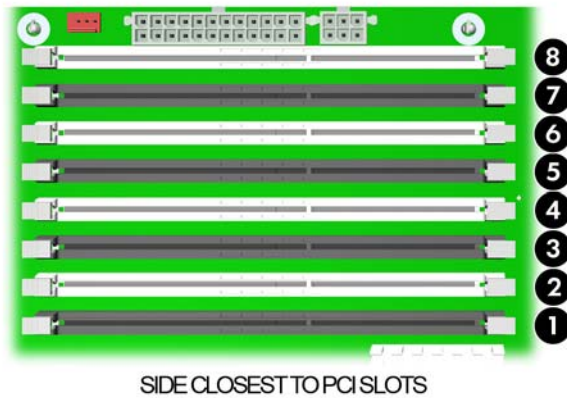

**Figure 4-15** Identifying memory slots

The BIOS generates warnings/errors on invalid memory configurations.

- If there is no way to obtain a valid memory configuration by disabling some of the plugged-in memory, the BIOS will halt with a diagnostics 2006 code for memory error (five beeps and blinks).
- If the BIOS can find a valid memory configuration by disabling some of the plugged-in memory, it will do so and report a warning during POST (“215-mismatched memory”). The system can still be booted in this condition.

## Installing a DIMM

1. Disconnect power from the system ( [Pre-disassembly procedures on page 55](#)) and remove the access panel ( [Access panel on page 60](#)). Lay the workstation on its side with the system board facing up.
2. Press the green tab at the base of the memory fan (1) and lift it up (2) to expose the memory modules.

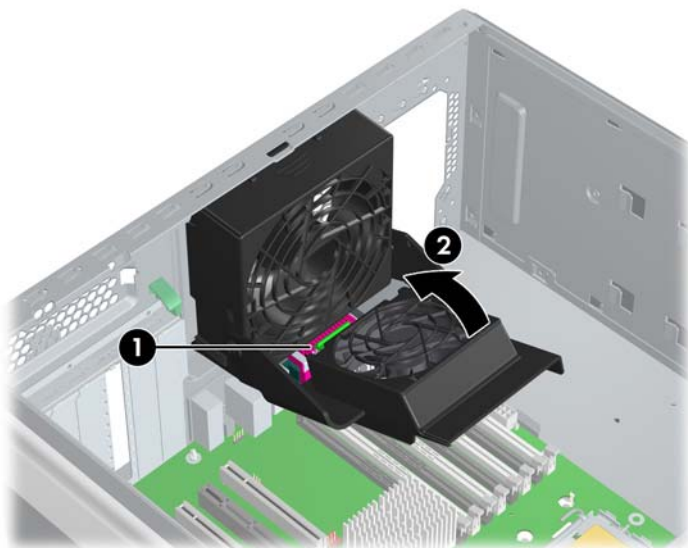

**Figure 4-16** Rotating the memory fan



3. Gently push out on the socket levers.
4. Lower the DIMM straight down, and be sure the socket levers secure the module into place.
5. Lower the memory fan until it snaps into place.



**NOTE** Ensure that all cables are clear of the fan housing when lowering the memory fan.

## PCI slots

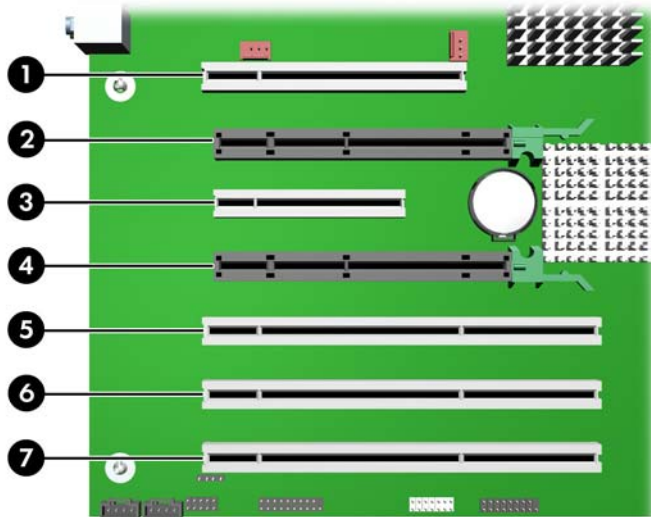

**Figure 4-17** Identifying PCI slots

**Table 4-4** PCI slots

Slot	Type	Ref
1	PCI (32-bit, 33 MHz)	J21
2	PCI Express x16 graphics	J41
3	PCI x8 (x4 performance)	J20
4	PCI Express x16 (x4 performance)	J31
5	PCI-X 133	J22
6	PCI-X 100	J23
7	PCI-X 100	J23

## PCI retainer

For added protection, some cards have PCI retainers installed to prevent movement during shipping.

## Removing the PCI retainer

1. Disconnect power from the system ( [Pre-disassembly procedures on page 55](#)), and remove the access panel ( [Access panel on page 60](#)). Place the workstation on its side with the system board facing up.
2. For short or tall cards, lift the PCI retainer arm (1) with one hand, press in on the sides (2) of the retainer, and rotate it (3) out of the chassis.

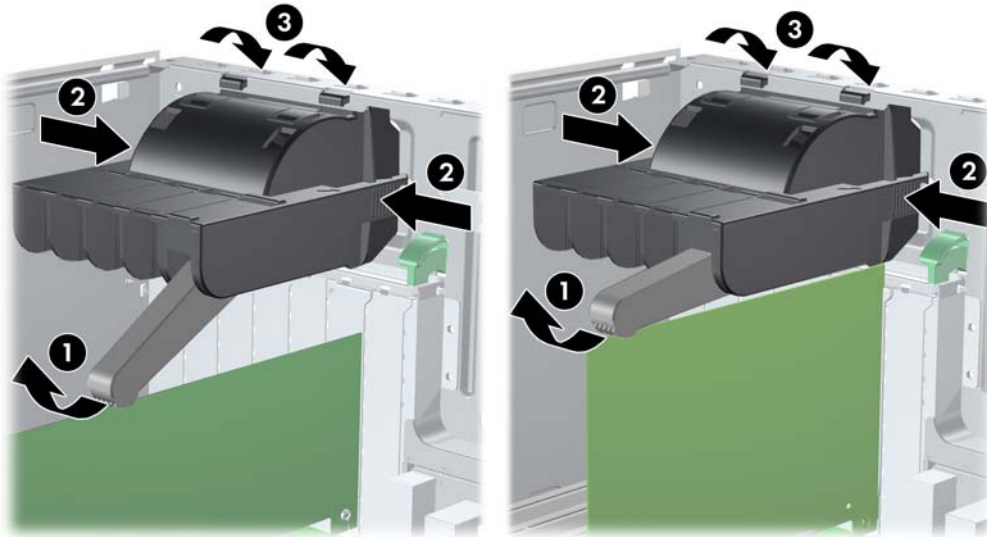
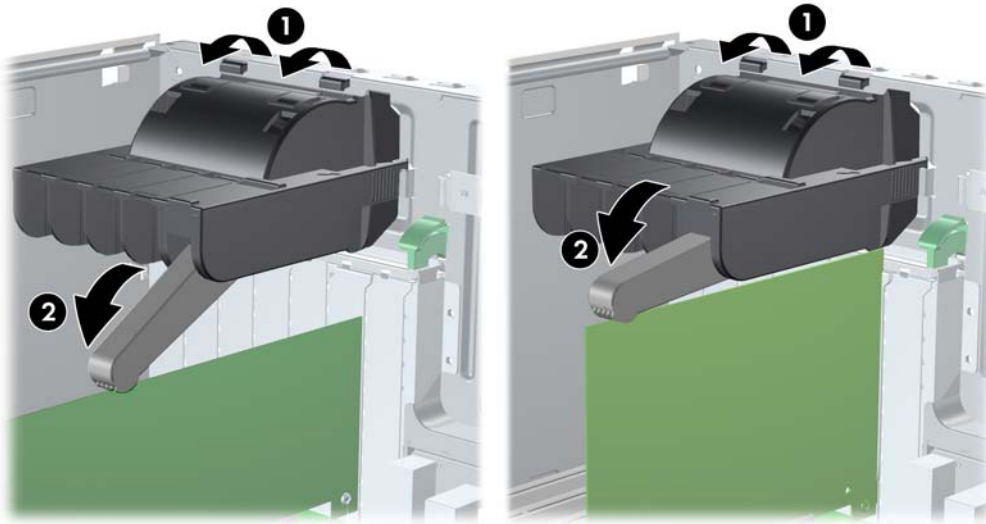

Figure 4-18 Removing the short or tall card PCI retainer

## Installing the PCI retainer

1. Disconnect power from the system ( [Pre-disassembly procedures on page 55](#)), and remove the access panel ( [Access panel on page 60](#)). Place the workstation on its side with the system board facing up.

2. For short or tall PCI cards, attach the hooks of the PCI retainer (1) under the slots on the rear of the chassis, and then rotate the retainer down until the retainer arm (2) supports the card.



**Figure 4-19** Installing the short or tall card PCI retainer

### PCI retention clamp

1. Disconnect power from the system ( [Pre-disassembly procedures on page 55](#)), and remove the access panel ( [Access panel on page 60](#)). Place the workstation on its side with the system board facing up.
2. Open the PCI retention clamp by pressing down on the two green clips at the ends of the clamp and rotating the clamp toward the back of the system.

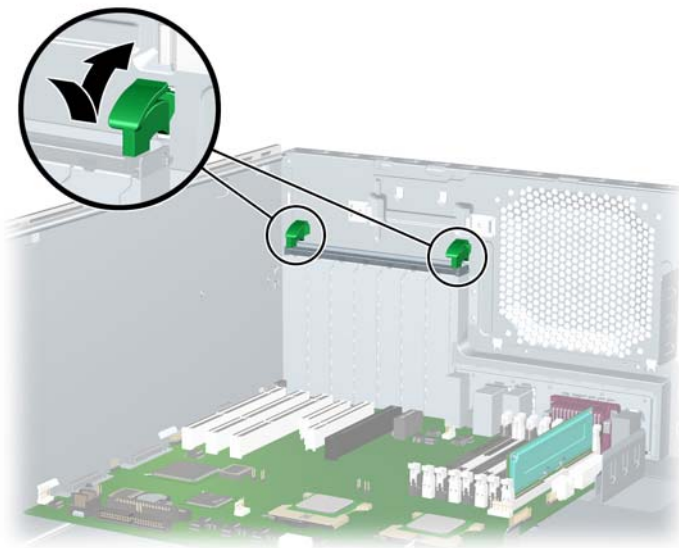

**Figure 4-20** Opening the PCI retention clamp

## PCI Express

PCI Express is a point-to-point architecture and uses a serial data transmission protocol. A single PCI Express lane consists of four wires and can transmit 250 MB/s in a single direction or 500 MB/s in both directions simultaneously. This bandwidth is not affected by what is happening on other PCI Express buses or legacy PCI/PCI-X buses (provided that total bandwidth can be handled by the CPU and the memory subsystem.) The transmission protocol is somewhat similar to that used for a LAN connection and contains error correction and detection, packet addressing, and other network features.

PCI Express improves system attributes. PCI Express enables a low-power, scalable, high-bandwidth communication path with a small number of connections (wires) compared to traditional parallel interfaces (for example, PCI).

The PCI Express I/O slots can support other PCI Express cards with lesser bus bandwidth than what is physically defined for the slot. Use the following table to determine compatibility.

For example, a PCI Express x8 card does not work in a PCI Express x1 slot, but a PCI Express x1 card works in a PCI Express x8 slot.



**NOTE** Slot 3: The HP xw8400 Workstation contains one PCI Express x8 slot that supports x4 bandwidth. If a PCI Express x8 card is plugged into the PCI Express x8 slot, the card runs at x4 bandwidth.

Slot 4: The HP xw8400 Workstation contains one PCI Express x16 slot that supports x4 bandwidth. If a PCI Express x8 or x16 card is plugged into the PCI Express x8 slot, the card runs at x4 bandwidth.

**Table 4-5** PCI Express compatibility matrix for xw8400

	Slot 2	Slot 3	Slot 4
	x16 mechanical	x8 mechanical	x16 mechanical
	x16 electrical	x4 electrical	x4 electrical
PCI Express x1 Card	Yes	Yes	Yes
PCI Express x4 Card	Yes	Yes	Yes
PCI Express x8 Card	Yes	Yes	Yes
PCI Express x16 Card	Yes	No	Yes

## Removing PCI or PCI Express cards

1. Disconnect power from the system ( [Pre-disassembly procedures on page 55](#)), and remove the access panel ( [Access panel on page 60](#)). Place the workstation on its side with the system board facing up. Remove the PCI retainer ( [PCI retainer on page 71](#)) if present.
2. Open the PCI retention clamp by pressing down on the two green clips at the ends of the clamp (1) and rotating the clamp toward the back of the system.

3. Lift the PCI card out of the chassis (2). If removing a PCI Express high-end graphics card, remove the auxiliary power supply cable (not illustrated) if required, and move the lever to release the card and lift it out of the chassis (3). Store the card in an anti-static bag.
4. Close the PCI retention clamp.

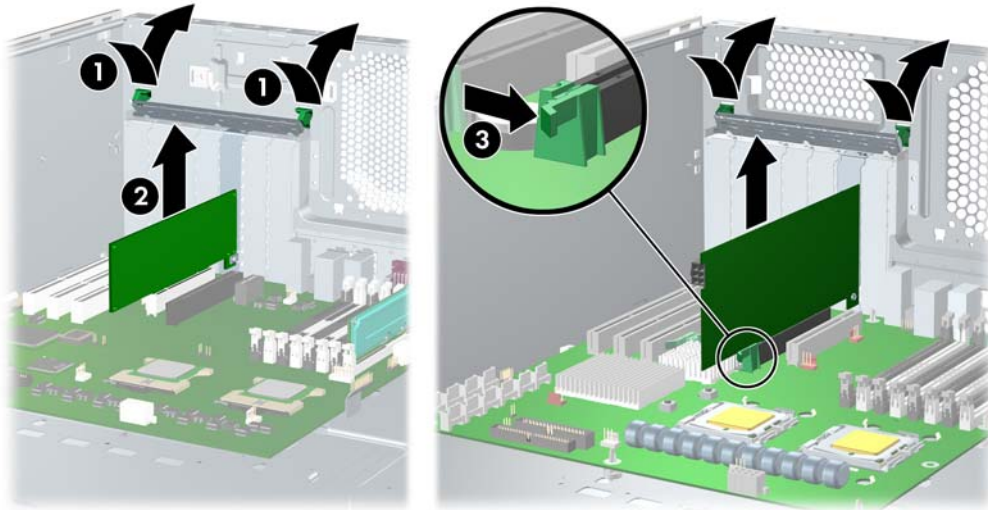

**Figure 4-21** Removing the PCI or PCI-E Card

## PCI or PCI Express installation

1. Disconnect power from the system ([Pre-disassembly procedures on page 55](#)), and remove the access panel ([Access panel on page 60](#)). Place the workstation on its side with the system board facing up, and remove the PCI retainer([PCI retention clamp on page 73](#)).
2. Open the PCI retention clamp by pressing down on the two green clips (1) at the ends of the clamp and rotating the clamp toward the back of the system.
3. Remove the PCI slot cover (2).
4. Lower the PCI (3) or PCI Express (3) card into the chassis. Verify that the keyed components of the card align with the socket.

If installing a card with an auxiliary power connector, plug in the power supply cable or adapter cable supplied with the card (4). This type of card includes, but is not limited to, a PCI Express graphics card greater than 75 W, and a 1394a I/O card.

5. Ensure that all cards are properly seated, and close the PCI retention clamp.

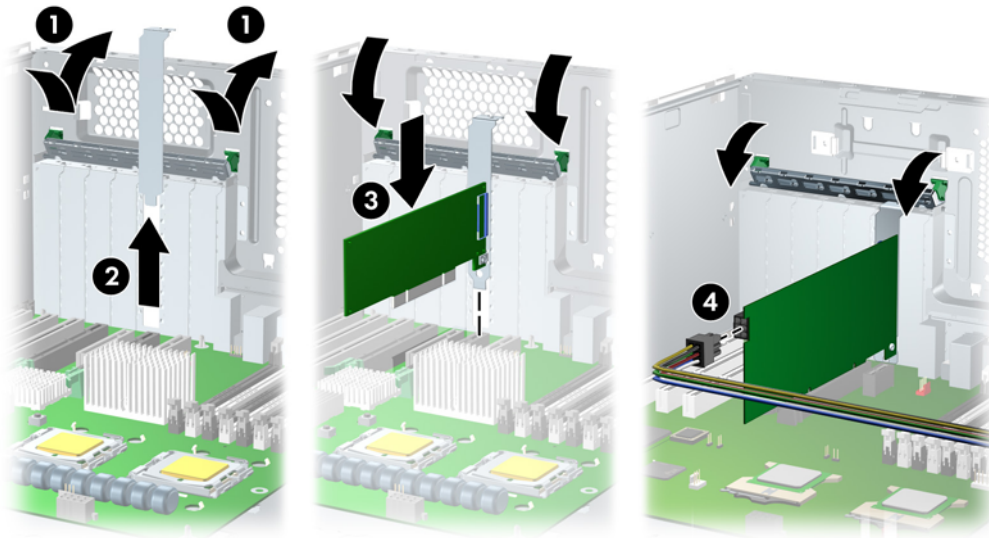
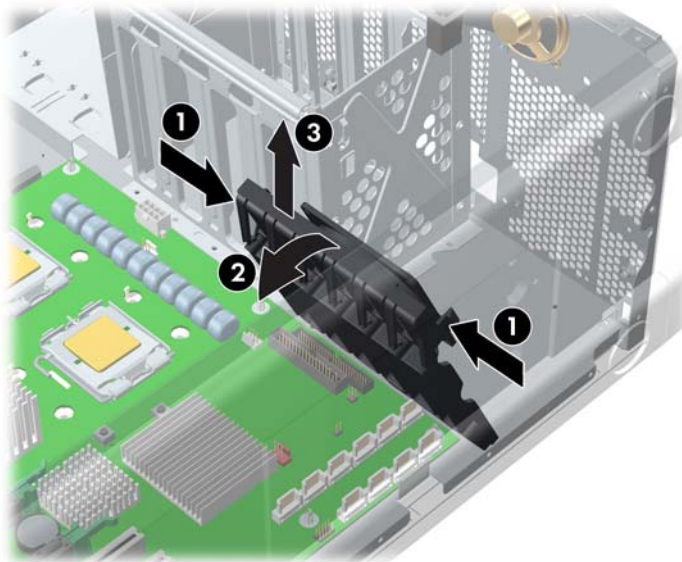

**Figure 4-22** Installing the PCI or PCI-E card

## Front fan removal (Optional)

To remove the front fan:

1. Disconnect power from the system ( [Pre-disassembly procedures on page 55](#) ), and remove the access panel ( [Access panel on page 60](#) ). Place the workstation on its side with the system board facing up.
2. Disconnect the fan wire from the connector on the system board.
3. Release the two card guide latches. Pivot the card guide toward the system board ( **1** ), and lift it out of the chassis ( **2** ).



**Figure 4-23** Removing the card guide

4. Remove the fan from the card guide by applying outward pressure on the card guide while lifting the fan away.

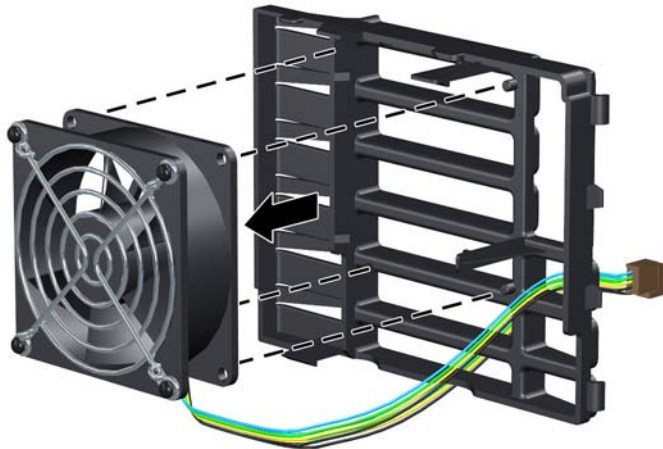

**Figure 4-24** Removing the fan from the card guide

To install the front fan:

1. Place the fan in the card guide with the fan label facing into the card guide, and the fan protector screen facing outward.



**NOTE** Ensure that the fan blows toward the rear of the chassis.

2. Place the fan wire through the slot in the card guide.
3. Snap the fan into place in the card guide.

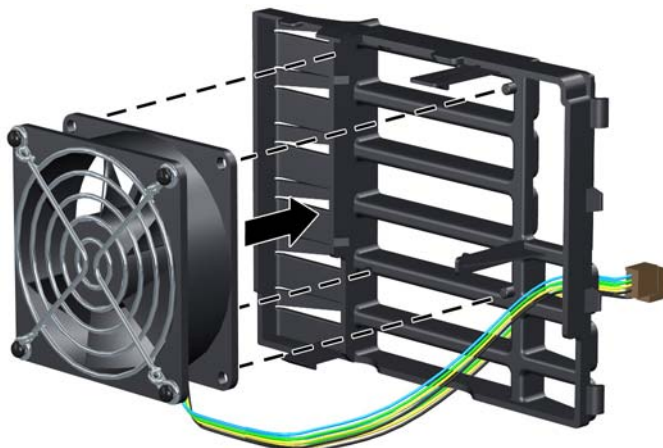

**Figure 4-25** Installing the fan in the card guide

4. Lower the card guide with installed fan into the chassis. Place the card guide tabs into the chassis slots and snap the card guide into place.
5. Plug the fan wire into its connector on the system board.

## Battery

**CAUTION** Before removing the battery, be sure your CMOS settings are backed up because all CMOS settings are lost when the battery is removed. To back up the CMOS settings, use Computer Setup and run the Save to Diskette option from the File menu.

1. Disconnect power from the system ( [Pre-disassembly procedures on page 55](#)), and remove the access panel ( [Access panel on page 60](#)). Place the workstation on its side with the system board facing up.
2. On the system board, press on the release tab of the battery holder.
3. Rotate the battery enough to get beyond the latch, and lift it straight up.

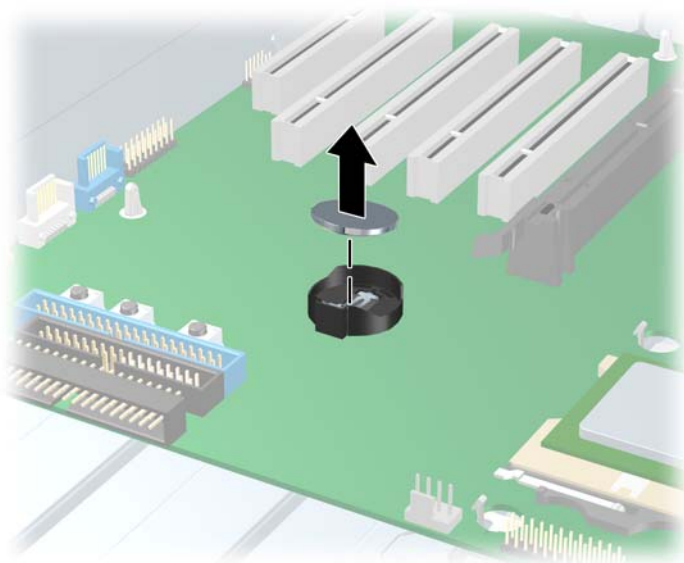

**Figure 4-26** Removing the battery

To install the battery slide the battery back in until it snaps back into place.

## Power connections to drives

For help in identifying power cables, refer to the following figure and table. Route or tie cables so that they cannot interfere with the CPU heatsink fans.

**CAUTION** Be sure you can differentiate which power cable connects to the PCI Express x16 graphics card and which power cable connects to the system board. These two cables look very similar. The PCI Express power cable has a black connector, and the power cable has a white connector. When power is present, you must **NEVER** connect the PCI Express power cable to the system board. If you do so, the system board may be damaged and your warranty voided. To see a picture of the PCI Express cable and where it must be connected, see the [PCI or PCI Express installation on page 75](#).



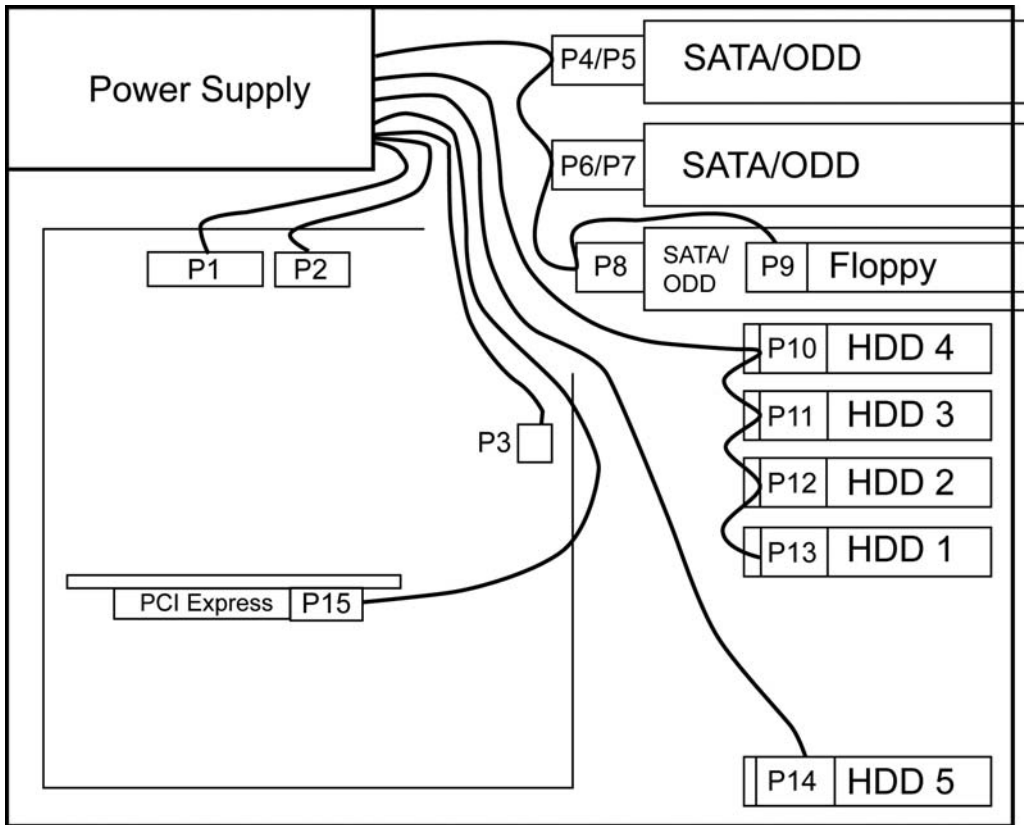

**Figure 4-27** Identifying correct power connections

**Table 4-6** Power connector descriptions

Connector	Description
P1	24-pin Power Connector
P2	4-pin Memory Connector
P3	8-pin CPU0 Connector
P4-P8	SATA and IDE ODD/ Accessory Power Connectors
P9	Diskette Connector
P10-P14	HDD Connector
P15	PCI-E Connector

## Optical drive

Your workstation might have a SATA or an IDE optical drive. To remove the optical drive.

1. Disconnect power from the system ( [Pre-disassembly procedures on page 55](#)). Remove the access panel ( [Access panel on page 60](#)) and the front bezel ( [Front bezel on page 61](#)).

2. Disconnect the audio (1), data (2), and power (3) cables from the drive. The connector colors might be different than illustrated.



**NOTE** The audio cable is only required for Linux-based systems.

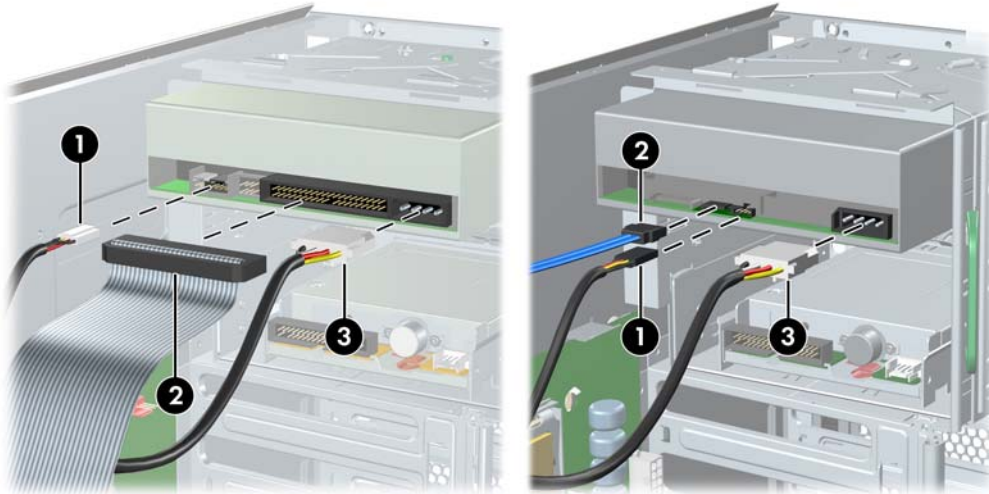

**Figure 4-28** Disconnecting the IDE (left) or SATA (right) cable from the optical drive

3. Lift the green drivelock release lever, and gently slide the drive out of the chassis.



**Figure 4-29** Removing the optical drive from the chassis

To replace an optical drive:

1. Lift the green drivelock release lever while sliding the optical drive into the bay. When the optical drive is partially inserted, release the drivelock release lever, and slide the drive completely into the bay until the drive is secured.



**CAUTION** Ensure that the optical drive is secure. Failure to do so can cause damage to the drive when moving the workstation.

2. Connect the power, data, and audio (if required) cables to the drive and workstation.



**NOTE** The audio cable is only required for Linux-based systems.

3. If you are installing more than one optical drive, route the cable as in the following image.



**NOTE** The data cable for IDE optical drives is routed under the system board.

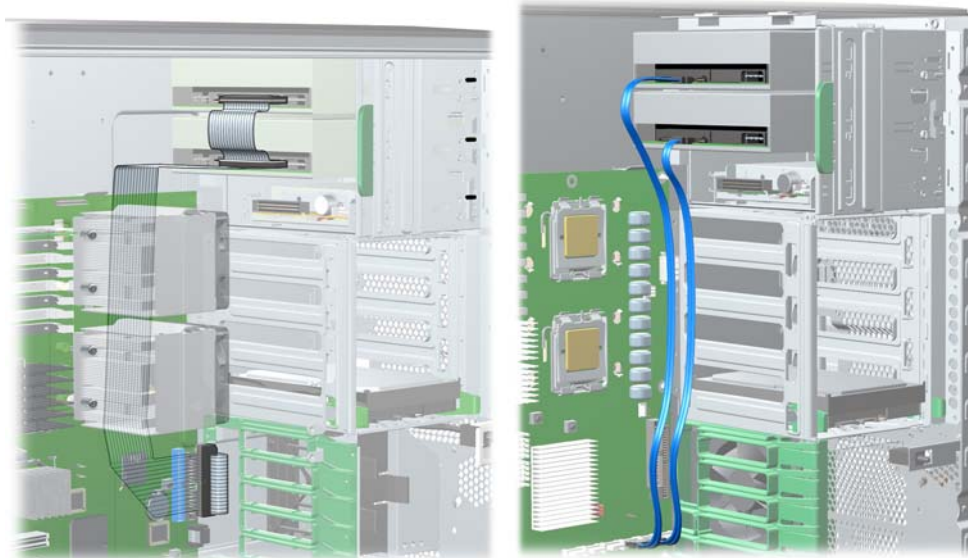
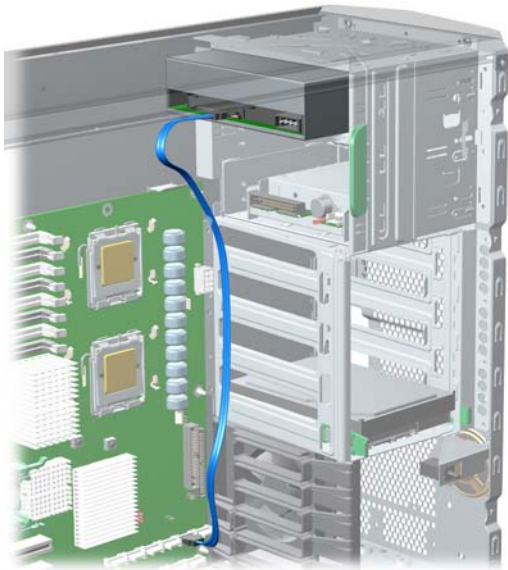

**Figure 4-30** Connecting IDE (left) or SATA (right) optical drive cable to system board

## Replacing the SATA optical drive data cable

If your workstation has a SATA optical drive, replace the cable as follows:

1. Disconnect power from the system ( [Pre-disassembly procedures on page 55](#) ), and remove the access panel ( [Access panel on page 60](#) ). Place the workstation on its side with the system board facing up.
2. Disconnect the SATA data cable from the system board and from the optical drive.
3. Replace the cable. Attach it to the optical drive and its system board connector as shown.



**Figure 4-31** Connecting the SATA optical drive cable to the system board

## Diskette drive (optional)

To remove a diskette drive:

1. Disconnect power from the system ([Pre-disassembly procedures on page 55](#)). Remove the access panel ([Access panel on page 60](#)) and the front bezel ([Front bezel on page 61](#)).
2. Disconnect the cables from the back of the diskette drive.



**Figure 4-32** Disconnecting cables from the diskette drive

3. While lifting the green drivelock release tab, slide the drive forward out of the chassis.



**Figure 4-33** Removing the diskette drive from the chassis

4. Remove the diskette drive from its bracket by removing the two M3 screws in the rear-most holes and pulling the diskette drive from the bracket.

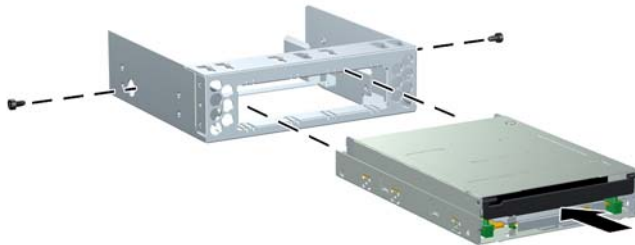

**Figure 4-34** Removing the diskette drive from the bracket

To replace a diskette drive:

1. Slide the diskette drive into the bracket, and secure it with two M3 screws.
2. While lifting the green drivelock release tab, slide the drive forward into the chassis.

3. Route the diskette drive data cable between the system board and the hard drive cage. Your cable might look different than the one shown.

 **CAUTION** The cable must stay between the system board and the hard drive cage. It might be necessary to push the cable down so that it catches on the system board. This routing method is important because it avoids interference with the CPU heatsink fans and blocking airflow.

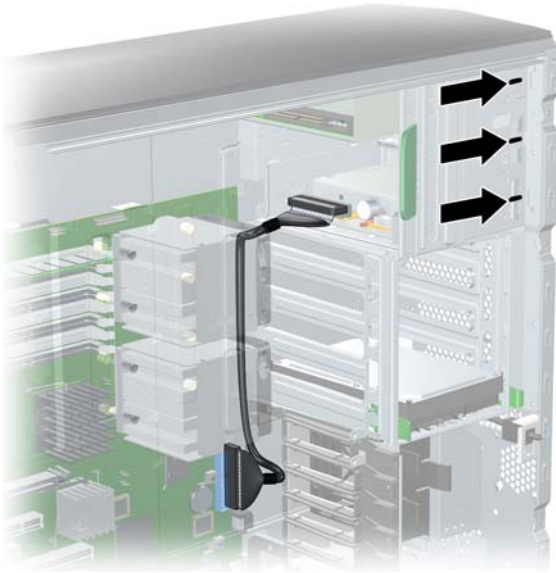

**Figure 4-35** Routing the diskette drive cable to the system board

4. Connect the cables to the back of the diskette drive.

## Hard drive

### Replacing a hard drive

For more information on SATA hard drives and the SATA RAID configuration, see [Appendix B—SATA devices on page 141](#).

### Removing a hard drive

1. Disconnect power from the system ( [Pre-disassembly procedures on page 55](#)), and remove the access panel ( [Access panel on page 60](#)).
2. Disconnect the cables from the hard drive.

3. Push in on the green drivelock release tabs, and pull the hard drive out of the chassis.

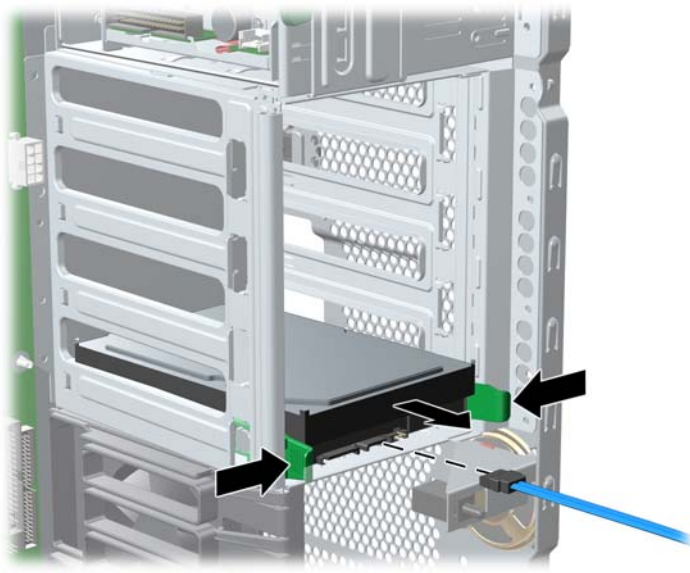

**Figure 4-36** Removing the hard drive

### Installing a hard drive

1. Select a drive bay in which to install the drive. If installing more than one hard drive, use the hard drive order shown in the following image.

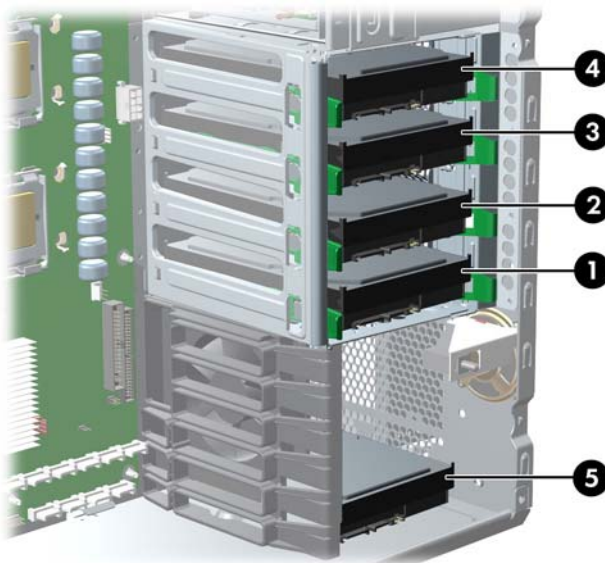

**Figure 4-37** Identifying hard drive installation order

2. Squeeze the green tabs, and slide the rails out of the empty bay.

3. Attach the rails to the hard drive. Align the pins on the rails with the hard drive holes, and snap the rails into place.

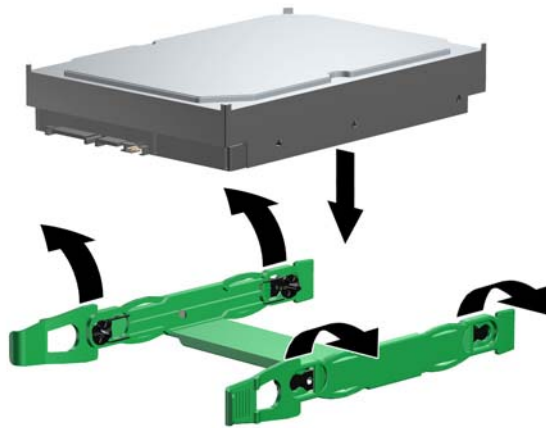

**Figure 4-38** Attaching rails to the hard drive

4. Push the drive into the selected bay until it snaps into place.
5. Attach a data cable from a SATA connector on the system board to the hard drive, and attach a power cable to the drive.

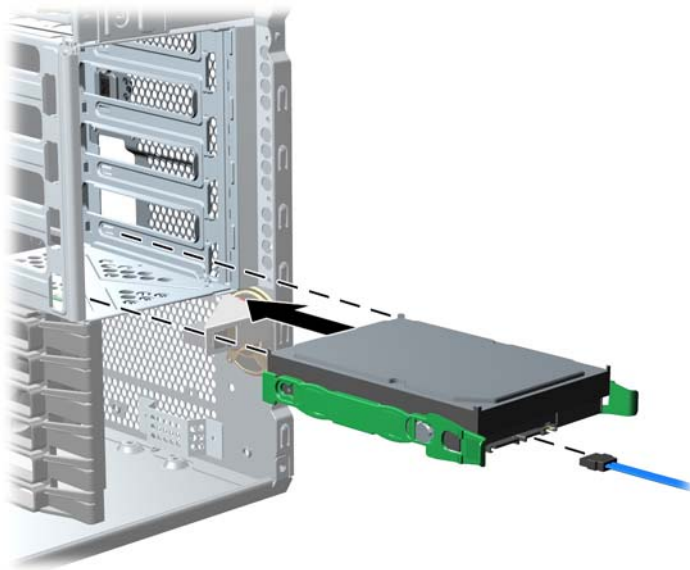

**Figure 4-39** Replacing the SATA hard drive



6. For a SAS hard drive, attach a SAS/SATA adapter to the connector on the hard drive. Attach a data cable from a SAS connector on the system board to the hard drive, and attach a power cable to the drive.

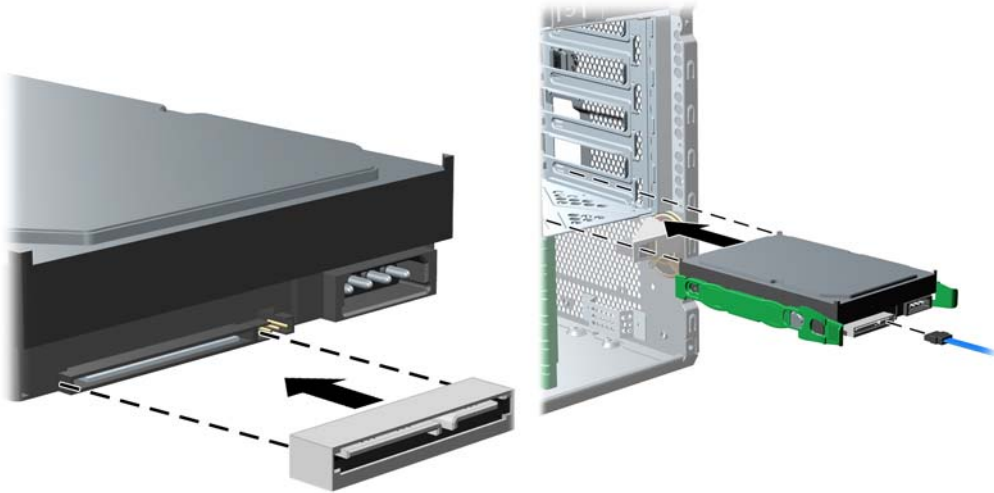
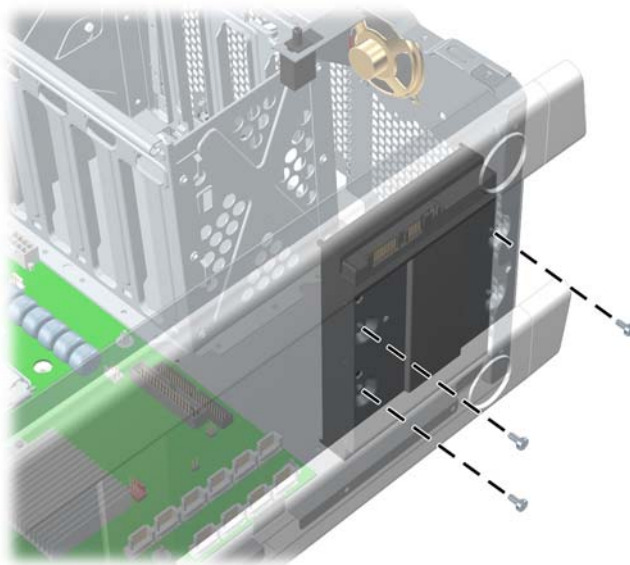

**Figure 4-40** Installing the SAS/SATA adapter (left) and cable (right)

### Installing a hard drive In the fifth hard drive bay

To install a hard drive into fifth HDD bay:

1. Place the workstation on its side, and remove the three drive screws that are located on the bottom of the chassis.



**Figure 4-41** Installing screws for the hard drive in the fifth hard drive bay

2. Insert the drive into bay 5, and align the holes in the bottom of the hard drive with the screw holes at the base of the chassis.
3. Insert the screws through the base, and tighten them to secure the hard drive to the chassis.

4. Attach a data cable from a SATA connector on the system board to the hard drive, and attach the fifth drive power cable to the drive.

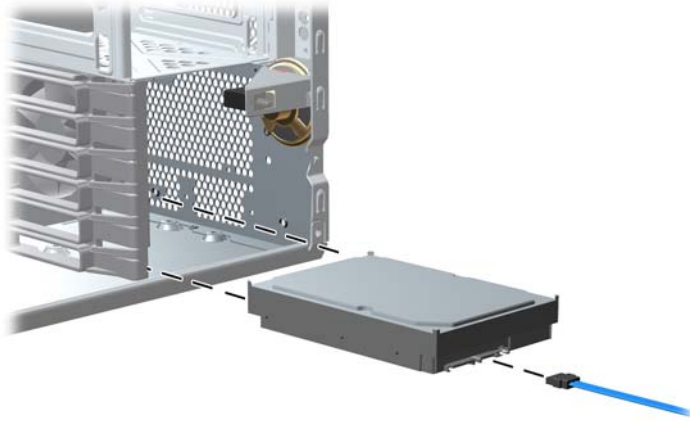

**Figure 4-42** Attaching the data cable for the SATA hard drive in the fifth hard drive bay

## Processor heatsink

### Removing the CPU heatsink



---

**NOTE** The following illustrated CPU heatsink is typical of what you might have in your workstation. Be aware that different variations of the CPU heatsinks exist, but the overall procedures listed are sufficient to assist you in removing the CPU heatsink.

---

1. Shut down the workstation, and disconnect power from the system ([Pre-disassembly procedures on page 55](#)). Remove the access panel ([Access panel on page 60](#)), and place the workstation on its side with the system board facing up.

2. Remove the four processor screws slowly, being sure to loosen all the screws evenly. Loosen one pair of diagonally opposite screws (1) until the screw shanks disengage from the system board, and then loosen the remaining pair (2). Do not fully loosen one screw, then move on to the next. Loosen all of the screws a little at a time, so that the processor remains level.

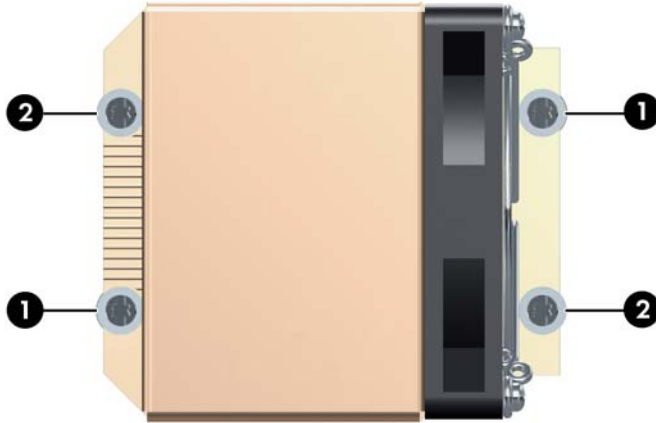

**Figure 4-43** Identifying proper screw removal order

3. Disconnect the CPU heatsink fan connector (1) from the system board.
4. Before lifting the heatsink, carefully break the adhesive compound between the CPU heatsink and processor by rotating the heatsink back and forth (2).

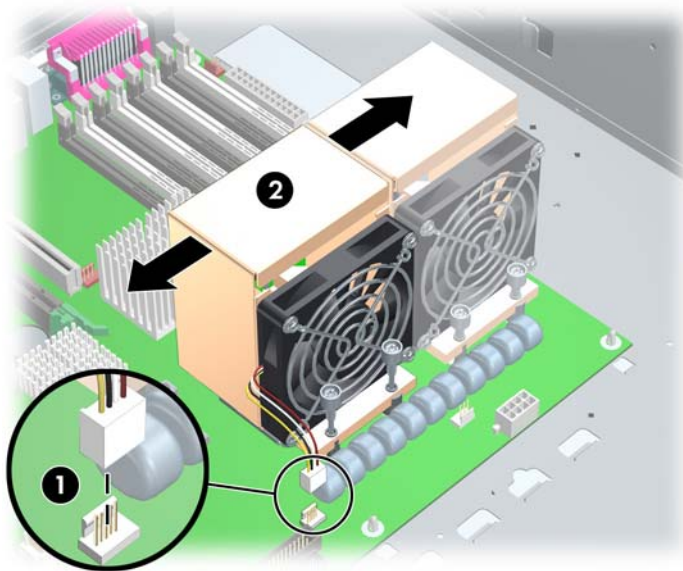

**Figure 4-44** Removing the CPU heatsink from the system board

5. Use alcohol and a soft cloth to clean all of the thermal interface material residue from the CPU heatsink and processor.



**CAUTION** Allow the alcohol on the processor and CPU heatsink to dry completely.

## Replacing the CPU heatsink

1. Disconnect power from the system ([Pre-disassembly procedures on page 55](#)). Remove the access panel ([Access panel on page 60](#)) and the CPU heatsink ([Removing the CPU heatsink on page 88](#)).
2. Use alcohol and a soft cloth to clean all of the thermal interface material residue from the CPU heatsink and processor.



**CAUTION** Allow the alcohol on the processor and CPU heatsink to dry completely.

3. Place the CPU heatsink on top of the processor, and align the four mounting screws with the holes (1) in the system board.



**NOTE** If both CPU heatsinks were removed, be sure that all system board standoffs engage with the keyholes in the chassis, and that the system board connectors engage correctly with the rear I/O panel, and push back on the system board while engaging the CPU heatsink screws with the chassis standoffs. You only need to push back when trying to engage the first screw.

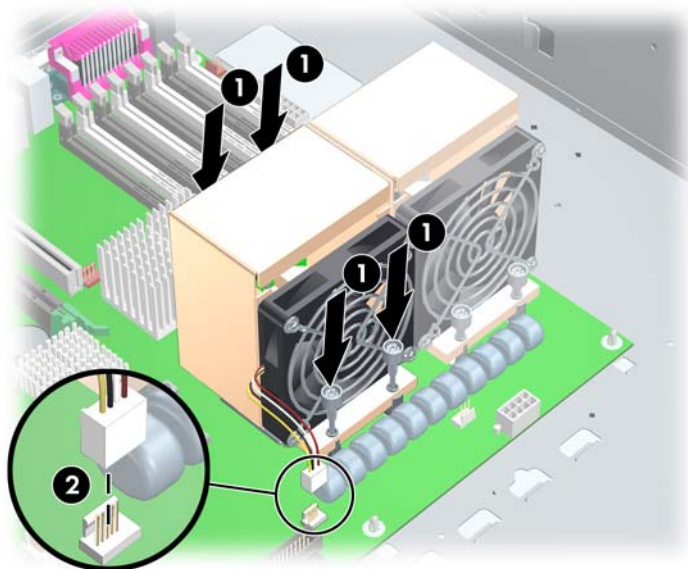

**Figure 4-45** Replacing the CPU heatsink on the system board

4. Insert and tighten the four CPU heatsink screws. First, tighten all of the screws partially so that the CPU heatsink remains level. Next, fully tighten one pair of diagonally opposite screws **(1)**, and then fully tighten the remaining pair **(2)**. Tighten firmly to a torque setting of 6 in-lb.

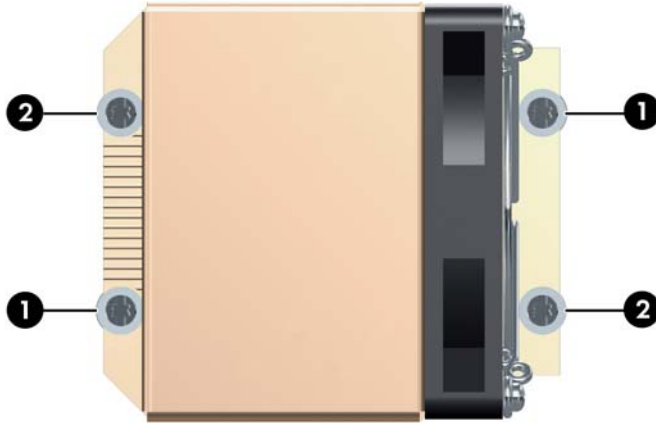

**Figure 4-46** Identifying proper screw removal order

5. Connect the CPU heatsink fan connector to the system board **(2)** as shown in Figure 1–45.

## Processor

### Removing the processor

1. Disconnect power from the system ( [Pre-disassembly procedures on page 55](#)). Remove the access panel ( [Access panel on page 60](#)) and the CPU heatsink ( [Removing the CPU heatsink on page 88](#)).

2. Raise the processor socket handle (1) fully (the full swing angle of the lever is approximately 105 degrees). Lift the processor socket cover (2).

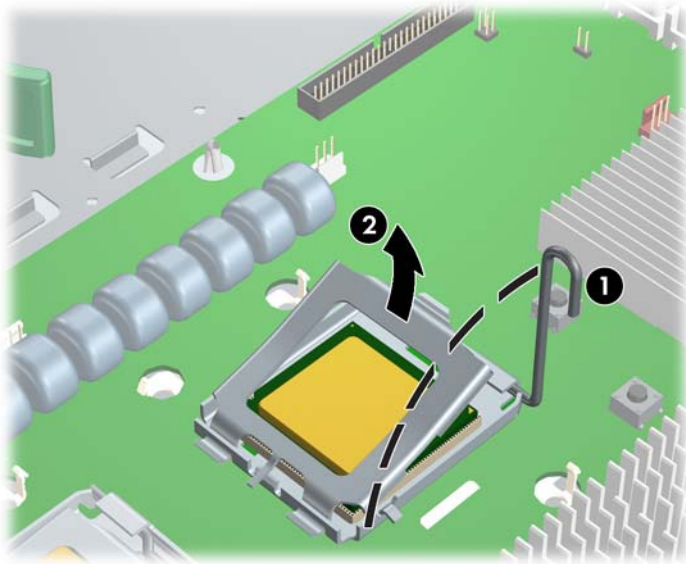

**Figure 4-47** Raising the processor socket handle

3. Lift the processor straight out of the socket.

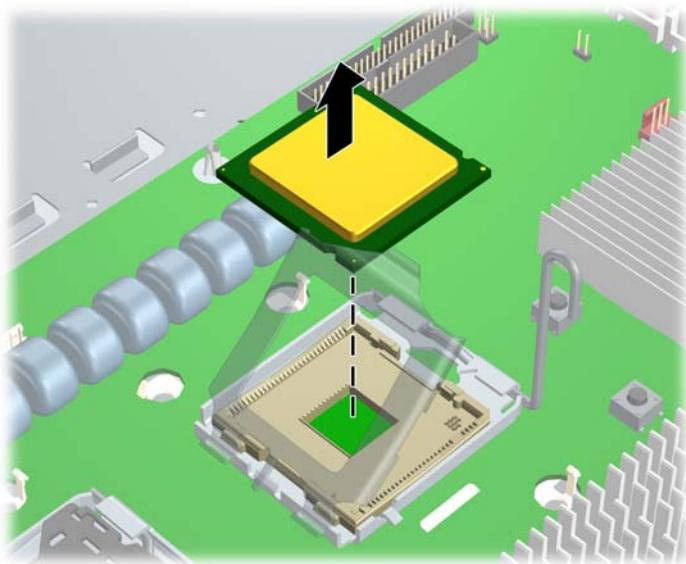

**Figure 4-48** Lifting the processor from the socket



**CAUTION** To avoid bending the socket pins, keep the processor perfectly flat when removing or installing it.



**NOTE** Store the processor in a safe place where it will not be damaged.

## Replacing the processor

1. Disconnect power from the system ( [Pre-disassembly procedures on page 55](#)). Remove the access panel ( [Access panel on page 60](#)), the CPU heatsink ( [Removing the CPU heatsink on page 88](#)), and the processor ( [Removing the processor on page 91](#)).
2. Raise the processor socket handle fully (the full swing angle of the lever is approximately 105 degrees).



**CAUTION** Socket pins are delicate and bend easily. Use extreme care when placing the processor in the socket to avoid bending pins.

3. Align the notches in the processor base with the tabs on the socket. Seat the processor into the socket. Ensure that the underside of the processor is level with the top of the processor socket. Close the processor cover plate. Lightly press down on the processor cover plate while closing the socket lever.

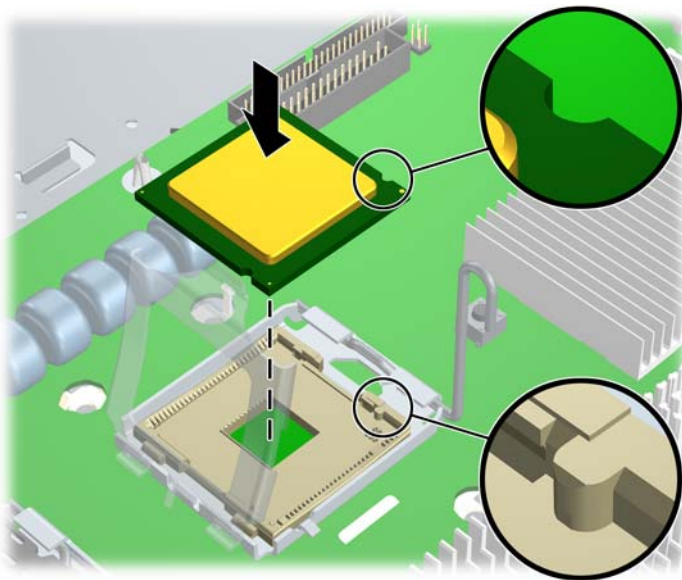



**Figure 4-49** Seating the processor

## System board

### Removing the system board

1. Disconnect power from the system ( [Pre-disassembly procedures on page 55](#)), and remove the access panel ( [Access panel on page 60](#)). Place the workstation on its side with the system board facing up. Remove all expansion boards, graphics cards ( [Removing PCI or PCI Express cards on page 74](#)), and the CPU heatsink ( [Processor heatsink on page 88](#)). If an airflow duct is installed, remove the system/memory fan assembly ( [Power supply on page 65](#)).
2. Disconnect all cables from the system board.

 **CAUTION** Be sure you can differentiate which power cable was disconnected from the PCI Express x16 graphics card and which power cable was disconnected from the system board. These two cables look similar. The PCI Express power cable has a black connector and the power cable has a white connector. When power is present, **NEVER** connect the PCI Express power cable to the system board. If you do so, the system board can be damaged and your warranty voided. To see a picture of the PCI Express cable and where it must be connected, see [PCI or PCI Express installation on page 75](#).

 **NOTE** Make note of the cable connections before disconnecting them from the system board. See [Power connections to drives on page 78](#) for more information.

3. Slide the system board forward ( **1**) to disengage the metal mounting standoffs from the chassis.

 **CAUTION** Do **not** attempt to remove the eight system board mounting screws. These screws are permanently secured and are not removable.

4. Lift the system board out ( **2**) of the chassis, being careful not to damage the cables and rear panel connectors. You can lift the board by the rear audio connector and the 2 x 4 power connector.

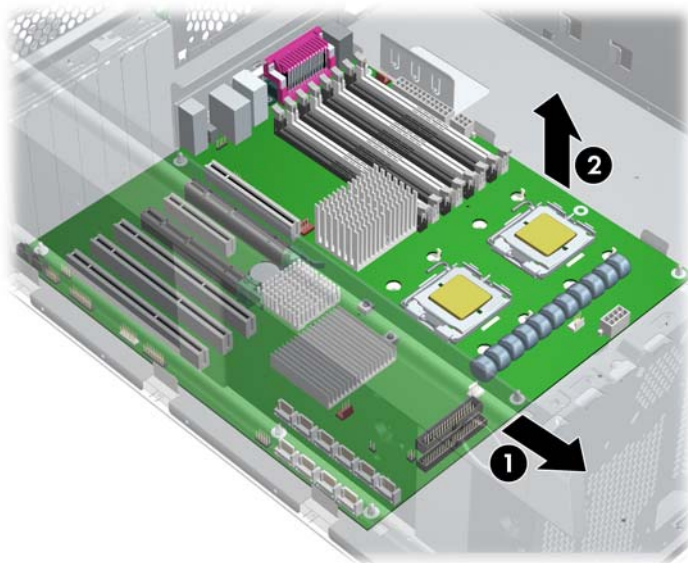

**Figure 4-50** Removing the system board



## Replacing the System Board:

1. Insert the system board straight down, and be sure that all system board standoffs engage with the keyholes in the chassis.



---

**NOTE** Be sure the system board connectors engage correctly with the rear I/O panel.

---

2. Push back on the board while maintaining downward pressure on the board, so all standoffs remain engaged.
3. Install the heatsink ([Replacing the CPU heatsink on page 90](#)).



# 5 System diagnostics and troubleshooting

This chapter discusses the tools available for diagnosing and troubleshooting system issues.

- [E-Support on page 98](#)
- [Troubleshooting checklist on page 99](#)
- [LED color definitions on page 100](#)
- [HP Insight Diagnostics Offline Edition on page 101](#)
- [Diagnostic error codes on page 106](#)
- [Troubleshooting scenarios and solutions on page 109](#)
- [POST error messages on page 126](#)

# E-Support

## Help and support center and E-Support

Help and Support Center (HSC) provides online access to technical support information, software updates and downloads, diagnostic tools, and HP support contact information.

To open HSC from your desktop, click **Start>Help and Support**.

HSC contains four sections:

- HP Product Information (requires Internet access)—Links to the HP Technical Support website for your product. You can access all related documentation, downloads and updates, tools, and more.
- HP Software and Driver Downloads (requires Internet access)—Links to HP specific software downloads and updates.
- HP Support Tools (requires Internet access)—Links to self-help tools and diagnostics offered by HP Instant Support Professional Edition.
- Contact HP for Support—Provides two different options:
  - Chat with an expert online (requires Internet access)—Provides a tool to communicate with a support specialist online through **Active Chat**.
  - Call a support agent—Provides hardware details about the workstation and HP support contact phone number worldwide.

# Troubleshooting checklist

Before running any of the diagnostic utilities, use the following checklist to find possible solutions for workstation or software problems.

- Are the workstation and monitor connected to a working electrical outlet?
- Is the workstation powered on?
- Is the green power light illuminated?
- Is the monitor powered on?
- Is the green monitor light illuminated?
- Adjust the monitor brightness and contrast controls if the monitor is dim.
- Press and hold any key. If the system beeps, then the keyboard is operating correctly.
- Examine all cables for loose or incorrect connections.
- Reconfigure the workstation after installing a non-PNP (positive-negative-positive) expansion board or other option, such as a diskette drive.
- Are all of the necessary device drivers installed?
- Have all printer drivers been installed for each application?
- Remove all diskettes and CDs from the drives before you power on the system.
- Are you running the latest BIOS version, drivers, and/or software updates?

## LED color definitions

The front panel LED indicates system status as described in Table 1.

**Table 5-1** Front panel LED color definitions

LED State	LED Color	System Status
Solid	Green	System is on.
Blinking	Green	System is in Standby mode.
Solid or blinking	Red	System has an error. See <a href="#">Diagnostic light codes on page 106</a> .
None	No light	System is in Hibernate mode, or it is off.

# HP Insight Diagnostics Offline Edition

The HP Insight Diagnostics utility enables you to perform testing and to view critical computer hardware and software configuration information from various sources. This utility enables you to:

- Run diagnostics.
- View the hardware configuration of the system.

## Key features and benefits

HP Insight Diagnostics simplifies the process of effectively identifying, diagnosing, and isolating the hardware issues.

In addition to robust management tools, service tools can be invaluable in quickly resolving system problems. To streamline the service process and resolve problems quickly, you must have the right information available at the time you place a service call. The primary information requirement, which is also the one that provides the greatest insight into potential system issues, is the configuration of the system. Insight Diagnostics helps provide higher system availability. Typical uses of the Insight Diagnostics are:

- Testing and diagnosing apparent hardware failures
- Documenting system configurations for upgrade planning, standardization, inventory tracking, disaster recovery, and maintenance
- Sending configuration information to another location for more in-depth analysis

## Theory of operation

HP Insight Diagnostics Offline Edition operates in offline mode only. Here, the operating system is not running, and software information from the system is not available to the diagnostics.

Offline Survey is available to display the current system configuration.

The Insight Diagnostics Test feature enables you to test functionality of all the major hardware components in the system. The Test feature is designed to be flexible to enable you to customize test selections by providing different modes and types of testing. It includes Quick, Complete, and Custom testing levels to give you control over testing depth and required user interaction.

## Starting the diagnostic utility from CD

HP Insight Diagnostics is available on the *Documentation & Diagnostic* CD that was shipped with your workstation.

To start the diagnostic utility on the *Documentation & Diagnostic* CD:

1. Power on your workstation, and press the **F10** key during the initial boot process to enter the Computer Setup (F10) Utility ([Using Computer Setup \(F10\) Utility on page 25](#)).
2. Select your language from the list, and press the **Enter** key. In the Computer Setup Utilities menu, four headings are displayed: **File**, **Storage**, **Security**, and **Advanced**. Other headings might be displayed, depending on the workstation.
3. Use the right arrow key to select **Storage**.
4. Use the down arrow key to select **Boot Order**, and press **Enter**.

5. Select **CD-ROM Drive**, and enable it as a bootable device by pressing the **F5** key (if not already enabled, pressing the **F5** key again disables the device). The default setting is enabled.
6. Set the CD-ROM Drive to the top of the boot order. Select **CD-ROM**, press the **Enter** key, and use the up arrow to move it to the top of the boot order.
7. To apply and save changes, press the **F10** key, and select **File>Save Changes and Exit**.
8. Insert the *Documentation & Diagnostic* CD into the workstation.
9. Restart your system, HP Insight Diagnostics launches automatically.

## Download the ISO image

1. Browse to <http://www.hp.com>.
2. Click **Software & Driver Downloads**.
3. Enter your product number (for example, xw8400) in the text box, and press the **Enter** key.
4. Select your operating system.
5. Click the **Diagnostic** link.
6. Locate HP Insight Diagnostics Offline on the display, and click **Download**.

## User interface

### Navigation

The Insight Diagnostics home page contains the following tabs: **Survey**, **Test**, **Status**, **Log**, and **Help**. These tabs separate the major functions of Insight Diagnostics.

### Survey tab

When you click the Survey tab, the Survey menu displays and enables you to view important system configuration information. The **Summary** view limits the amount of data displayed, while the **Advanced** view shows all the data in the selected category. Regardless of whether you choose **Advanced** or **Summary**, the following categories of information are available on the **Survey** menu:

**Overview**—Lists general information about the computer.

**All**—Lists all information about the computer.

**Architecture**—Shows the type of bus the computer uses, and BIOS information. In addition, if the bus is PCI, information about the PCI configuration is displayed.

**Asset Control**—Shows the serial number of the computer, and provides processor information.

**Communication**—Shows information about the computer parallel (LPT) and serial (COM) port settings, USB, and network controller information.

**Graphics**—Shows information about the graphics subsystem of the computer.

**Input Devices**—Shows information about the type of keyboard and mouse.

**Memory**—Shows information about all memory in the computer, including memory on the board and any memory modules installed.



**Miscellaneous**—Shows information obtained from the computers configuration memory (CMOS), BIOS data area, Interrupt Vector table, and diagnostics component information.

**Storage**—Shows information about storage media connected to the computer, including all fixed disks, floppy drives, and CD-ROM drives.

**System**—Shows product type, processor type and speed, and coprocessor information, and information about all ROMs in the computer.

## Test tab

The Insight Diagnostics utility enables you to test all the major pieces of hardware in the system. You can select from several types of tests:

**Quick Test**—Provides a predetermined script in which a sample of most hardware components is exercised and requires no user intervention.

**Complete Test**—Provides a predetermined script in which most hardware components are fully tested. You can select Interactive or Unattended tests, which will change the devices tested during the Complete Test. More tests are available in Interactive mode, but these require user intervention.

**Custom Test**—Provides the most flexibility in controlling the testing of a system. The Custom Test mode enables you to select which devices, tests, and test parameters are run. You can select tests that do not require any user interaction through the Interactive or Unattended test modes. More tests are available in Interactive mode, but these require user intervention.

To begin testing:

1. Click the **Test** tab.
2. Select **Type of Test** to perform, and select **Interactive** or **Unattended** as the test mode.
3. Determine how you want the test to be executed.
  - Select **Number of Loops** and enter the number of loops to perform.
  - Select **Total Test Times** and enter the amount of time in minutes that you want the diagnostic test to run.
4. When choosing to run the test over a specified number of loops, enter the number of loops to perform. If you desire to have the diagnostic test for a specified time period, enter the amount of time in minutes.
5. Click **Begin Testing** in the lower right corner of the display to start the test.

While tests are being performed, you can monitor the progress by clicking the **Status** tab. Any errors that are detected are summarized in the Error Log. Click **Save** to save the report to a floppy disk or a USB key drive if attached.

If the diagnostics utility detects an error during a test, you can mouse-over the failed text in the Status tab to display additional information for the type of error and the error code.

To view all test failure information, select **Error Log**. To view the status of all testing that has been performed, click the **Log** tab.

## Status tab

The Status tab displays the status of the selected tests. The type of test executed (for example, **Quick, Complete, Custom**) is displayed. The main progress bar displays the percent complete of the current set of tests. While testing is in progress, a Cancel Testing button is activated. Clicking **Cancel Testing** cancels the test job.

After testing has completed the **Cancel Testing** button is replaced with two buttons, **Select New Tests** and **Retest**. Clicking the **Select New Tests** button enables you to go back to the previous test selection page to select a new set of tests. Clicking the **Retest** button runs the last set of tests executed without having to go back to the test selection page.

The Status page also shows the:

- Devices being tested
- Tests that are running
- Overall test time
- Individual test times
- Condition status of each test

## Log tab

The Log tab consists of two views:

**Test Log**—Displays all tests that have been executed, the number of times the test executed, the number of times the test failed, and the time it took to complete the test. Clicking the **Clear Test Log** button clears the contents of the Test Log.

**Error Log**—Displays the tests that have failed during the diagnostic testing. Besides displaying the device and test, this section might also include error details. The description section describes the error that the diagnostic test found. Clicking the **Recommended Repair** button gives a recommended action that should be performed to resolve the failed hardware. The error count is the number of times the test has failed. Clicking the **Clear Error Log** button clears the contents of the Error Log.

## Help tab

The Help tab has three views:

- **HP Insight Diagnostics**—Provides introductory and detailed information about Insight Field Diagnostics.
- **Error Codes**—Provides error code listings. It includes device tested, message, and recommended repair information.
- **Test Components**—Reloads and refreshes all components and display component details after the refresh.

The Help tab provides information option selections:

- **Reload**—Located in the upper-right corner of the display, this selection reloads all hardware components.
- **About**—Provides revision details of Insight Diagnostics.
- **Exit**—Located in the lower-left corner of the display, this selection provides the option to exit diagnostics.

# Diagnostic error codes

This sections provides an overview of the diagnostic lights and error codes that are related to your workstation.

## Diagnostic light codes



**NOTE** The beeps are heard through the onboard piezo speaker and not the chassis speaker. The blinking LEDs and beeps repeat for five cycles. After that, only the blinking LEDs repeat.

**Table 5-2** Diagnostic LED codes

Chassis Indicator LEDs	
Power LED and Sound Activity	Diagnosis and Service Action
None	<p>System does not power on. Press power button. If HDD LED = GREEN, then:</p> <ol style="list-style-type: none"><li>1. Remove expansion cards one at a time.</li><li>2. Replace the system board.</li></ol> <p>OR</p> <p>Press power button. If HDD LED does not illuminate, then:</p> <ol style="list-style-type: none"><li>1. Verify that the unit is plugged into a working AC outlet.</li><li>2. Open access panel, and verify that the power button harness is properly connected to the inline front panel I/O device assembly connector.</li><li>3. Verify that the power supply cables are properly connected to the system board.</li><li>4. Verify the power supply functionality.<ol style="list-style-type: none"><li>a. Disconnect AC power.</li><li>b. Remove all internal power supply cables from the system board.</li><li>c. Plug in AC power.</li></ol></li><li>• If the power supply fan spins and the BIST* LED lights, then the power supply is good. Replace the system board.</li><li>• If the power supply fan does not spin or the BIST* LED does not light, replace the power supply.</li></ol>
Blinks red 2 times, once per second, then 2 second pause, 2 beeps	<p>Thermal shutdown.</p> <ol style="list-style-type: none"><li>1. Ensure that the workstation air vents are not blocked and the cooling fan is running.</li><li>2. Open the access panel, press power button, and see if the processor fan spins. If the processor fan is not spinning, make sure the fan's cable is plugged onto the system board header. Ensure the fan is fully/properly seated or installed.</li><li>3. If fan is plugged in and seated properly, but is not spinning, the problem may be in the processor fan. Contact HP for assistance</li><li>4. Verify that the fan assembly is properly attached. If problems persist, there may be a problem with the processor heatsink. Contact HP for assistance.</li></ol>

**Table 5-2** Diagnostic LED codes (continued)

Chassis Indicator LEDs	
Power LED and Sound Activity	Diagnosis and Service Action
Blinks red 3 times, once per second, then 2-second pause, 3 beeps	<p>CPU not installed.</p> <ol style="list-style-type: none"><li>1. Check to see that the processor is present.</li><li>2. Reseat the processor.</li></ol>
Blinks red 4 times, once per second, then 2 second pause, 4 beeps	<p>Power supply failure.</p> <ol style="list-style-type: none"><li>1. Open the access panel and ensure the following connections are secure on the system board:<ul style="list-style-type: none"><li>• 24-pin main power (all systems)</li><li>• 4-pin CPU (xw4000 series)</li><li>• 8-pin CPU (xw6000/xw8000/xw9000 series)</li><li>• 4-pin memory (xw8000/xw9000 series)</li></ul></li><li>2. Locate faulty device by removing all devices and then reinstalling one at a time until workstation fails. Replace the device causing the failure. Continue adding devices to ensure all are functioning properly.</li><li>3. Verify power supply functionality.<ol style="list-style-type: none"><li>a. Disconnect AC power.</li><li>b. Remove all internal power supply cables from the system board.</li><li>c. Plug in AC power.<ul style="list-style-type: none"><li>• If the power supply fan spins and the BIST* LED lights, then the power supply is good. Replace the system board.</li><li>• If the power supply fan does not spin or the BIST* LED does not light, replace the power supply.</li></ul></li></ol></li></ol>
Blinks red 5 times, once per second, then 2 second pause, 5 beeps	<p>Pre-video memory error.</p> <ol style="list-style-type: none"><li>1. Reseat DIMMs</li><li>2. Replace DIMMs one at a time to isolate faulty module</li><li>3. Replace third-party memory with HP memory.</li><li>4. Replace system board.</li></ol>
Blinks red 6 times, once per second, then 2 second pause, 6 beeps	<p>Pre-video graphics card error.</p> <p>For systems with integrated graphics, replace the system board.</p> <p>For systems with graphics cards, perform the following steps.</p> <ol style="list-style-type: none"><li>1. Reseat the graphics card.</li><li>2. Replace the graphics card.</li><li>3. Replace the system board.</li></ol>

**Table 5-2** Diagnostic LED codes (continued)

Chassis Indicator LEDs	
Power LED and Sound Activity	Diagnosis and Service Action
Blinks red 7 times, once per second, then 2 second pause, 7 beeps.	System board failure (ROM detected failure before video). <ol style="list-style-type: none"><li>1. Clear CMOS.</li><li>2. Replace system board.</li></ol>
Blinks red 8 times, once per second, then 2 second pause, 8 beeps	Invalid ROM based on bad checksum. <ol style="list-style-type: none"><li>1. Clear CMOS.</li><li>2. Upgrade the ROM using a ROMPaq diskette, CD, diskette, or USB removable device (e.g., HP Drive Key). See the <i>ROM Flash</i> section of the <i>Service and Technical Reference Guide</i> at <a href="http://www.hp.com/support/workstation_manuals">http://www.hp.com/support/workstation_manuals</a>.</li><li>3. Replace system board.</li></ol>
Blinks red 9 times, once per second, then 2 second pause, 9 beeps	System powers on but is unable to boot. <ol style="list-style-type: none"><li>1. Replace the system board.</li><li>2. Replace the processor.</li></ol>

\* Refer to the *Service and Technical Reference Guide* for your workstation for BIST information.

# Troubleshooting scenarios and solutions

This section presents an extensive overview of various troubleshooting scenarios and includes possible solutions for each.

## Solving minor problems

Table 5-3 Minor problems

Problem	Cause	Possible Solution
Workstation appears locked up and will not turn off when the power button is pressed.	Software control of the power switch is not functional.	<ol style="list-style-type: none"> <li>1. Press and hold the power button for at least four seconds until the workstation turns off.</li> <li>2. Disconnect electrical plug from outlet.</li> </ol>
Workstation seems to be locked up.	Program in use has stopped responding to commands.	<ol style="list-style-type: none"> <li>1. Attempt the normal Windows shut down procedure.</li> <li>2. Restart the workstation using the power button.</li> </ol>
Workstation date and time display is incorrect.	Real-time clock (RTC) battery might need to be replaced.	<ol style="list-style-type: none"> <li>1. Reset the date and time under Control Panel.</li> <li>2. Replace the RTC battery.</li> </ol>
Workstation appears to pause periodically.	Network driver is loaded and no network connection is established.	Establish a network connection, or use Computer Setup or Microsoft Windows Device Manager to disable the network controller.
Cursor will not move using the arrow keys on the keypad.	The <b>Num Lock</b> key might be on.	Press <b>Num Lock</b> . The Num Lock key can be disabled (or enabled) in Computer Setup.
Poor performance is experienced.	Processor is hot.	<ol style="list-style-type: none"> <li>1. Be sure airflow to the workstation is not blocked.</li> <li>2. Be sure the fans are connected and working properly (some fans only operate when needed).</li> <li>3. Be sure the CPU heatsink is installed properly.</li> </ol>
	Hard drive is full.	Transfer data from the hard drive to create more space on the hard drive.
Workstation powered off automatically and the Power LED flashes Red two times, once every second, followed by a two-second pause, and two simultaneous beeps are heard.	Processor thermal protection activated: A fan might be blocked or not turning. OR The CPU heatsink is not properly attached to the processor.	<ol style="list-style-type: none"> <li>1. Be sure workstation air vents are not blocked and the cooling fan is running.</li> <li>2. Open the hood, press the power button, and determine if the processor fan spins. If not spinning, be sure the fan's cable is plugged into the system board header. Be sure the fan is fully/properly seated or installed.</li> <li>3. Replace the processor fan.</li> <li>4. Reseat CPU heatsink and verify that the fan assembly is properly attached.</li> </ol>
System does not power on and the LEDs on the front of the workstation are not flashing.	System unable to power on.	Press and hold the power button for less than four seconds. If the hard drive LED turns green, then: <ol style="list-style-type: none"> <li>1. Remove the expansion cards.</li> <li>2. Replace the system board.</li> </ol> OR Press and hold the power button for less than four seconds. If the HDD LED does not illuminate, then:

**Table 5-3** Minor problems (continued)

Problem	Cause	Possible Solution
		<ol style="list-style-type: none"><li>1. Verify that the unit is plugged into a working AC outlet.</li><li>2. Open the access panel, and verify that the power button harness is properly connected to the inline front panel I/O device assembly connector.</li><li>3. Verify that the power supply cables are properly connected to the system board.</li><li>4. Verify power supply functionality:<ol style="list-style-type: none"><li>a. Disconnect AC power.</li><li>b. Remove all internal power supply cables from the system board.</li><li>c. Plug in AC power.<ul style="list-style-type: none"><li>• If the power supply fan spins and the BIST* LED lights, then the power supply is good. Replace the system board.</li><li>• If the power supply fan does not spin or the BIST* LED does not light, replace the power supply.</li></ul></li></ol></li></ol>

## Solving power supply problems

### Testing power supply

Before replacing the power supply, use the BIST feature to determine if the power supply still works.

To test the power supply:

1. Disconnect all internal power supply cables.
2. Plug in AC power.
  - a. If the green BIST LED on the rear of the workstation is lit **and** the fan is spinning, the power supply is functional.
  - b. If the green BIST LED is not lit **or** the fan is not spinning, replace the power supply.



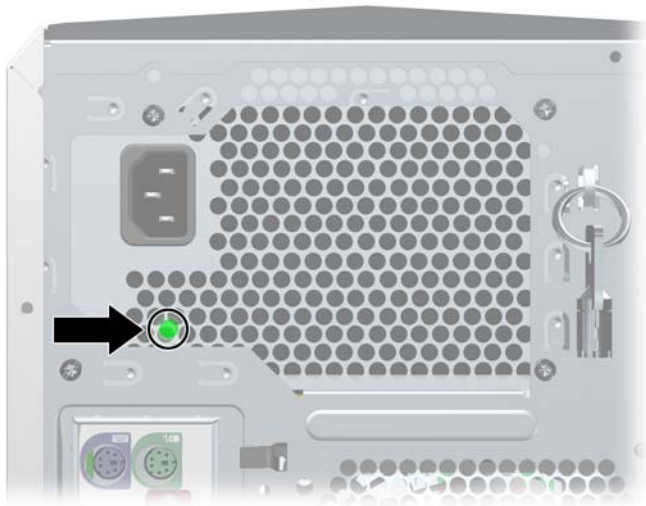

**Figure 5-1** Power supply

**Table 5-4** Power supply problems

Problem	Cause	Solution
Power supply shuts down intermittently.	Power supply fault.	Replace the power supply.

**Table 5-4** Power supply problems (continued)

Problem	Cause	Solution
Workstation powered off automatically and the Power LED flashes red two times, once every second, followed by a two-second pause.	Processor thermal protection activated.	<ol style="list-style-type: none"> <li>1. Be sure that the workstation air vents are not blocked and the cooling fan is running.</li> <li>2. Open the access panel, press the power button, and determine if the processor fan spins. If the processor fan is not spinning, be sure the fan's cable is plugged into the system board header. Be sure the fan is properly seated or installed.</li> <li>3. Replace the processor fan.</li> <li>4. Reseat the CPU heatsink, and verify that the fan assembly is properly attached.</li> </ol>
	A fan might be blocked or not turning.  OR  The CPU heatsink fan assembly is not properly attached to the processor.	
Power LED flashes red, once every two seconds.	Power failure (power supply is overloaded).	<ol style="list-style-type: none"> <li>1. Determine whether a device is causing the problem by removing all attached devices). Power on the system. If the system enters the POST, then power off and replace one device at a time and repeat this procedure until failure occurs. Replace the device causing the failure. Continue adding devices one at a time to ensure all devices are functioning properly.</li> <li>2. Verify power supply functionality.               <ol style="list-style-type: none"> <li>a. Disconnect AC power.</li> <li>b. Remove all internal power supply cables from the system board.</li> <li>c. Plug in AC power.                   <ul style="list-style-type: none"> <li>• If the power supply fan spins and the BIST LED lights, then the power supply is good. Replace the system board.</li> <li>• If the power supply fan does not spin or the BIST LED does not light, replace the power supply.</li> </ul> </li> </ol> </li> </ol>

## Solving diskette problems

**Table 5-5** Diskette problems

Problem	Cause	Solution
Diskette drive light stays on.	Diskette is damaged.	Right-click <b>Start</b> , click <b>Explore</b> , and select a drive. Select <b>File&gt;Properties&gt;Tools</b> . Under <b>Error-checking</b> , click <b>Check Now</b> .
	Diskette is incorrectly inserted.	Remove diskette and reinsert.
	Files on diskette are damaged.	Check the program diskettes.
Drive not found.	Drive cable is not properly connected.	Reconnect power cable. Be sure that all four pins are connected.
	Cable is loose.	Reseat diskette drive data and power cables.
	Removable drive is not seated properly.	Reseat the drive.

**Table 5-5** Diskette problems (continued)

<b>Problem</b>	<b>Cause</b>	<b>Solution</b>
Diskette drive cannot write to a diskette.	Diskette is not formatted.	Format the diskette.
	Diskette is write-protected.	Use another diskette or remove the write protection.
	Writing to the wrong drive.	Check the drive letter in the path statement.
	Not enough space is left on the diskette.	Use another diskette.
	Diskette write control is enabled.	Use Computer Setup to check the storage security feature disabled settings.
	Diskette is damaged.	Replace the damaged disk.
Cannot format diskette.	Invalid media reported.	When formatting a disk in MS-DOS, you might need to specify diskette capacity. For example, to format a 1.44-MB diskette, enter the following command at the MS-DOS prompt:  <b>FORMAT A: /F:1440</b>
A problem has occurred with a disk transaction.	The directory structure is bad, or there is a problem with a file.	Right-click <b>Start</b> , click <b>Explore</b> , and select a drive. Select <b>File&gt;Properties&gt;Tools</b> . Under Error-checking, click <b>Check Now</b> .
Diskette drive cannot read a diskette.	Diskette is not formatted.	Format the diskette.
	You are using the wrong diskette type for the drive type.	Be sure you use the correct diskette type for the type of drive you are using.
	You are reading the wrong drive.	Check the drive letter in the path statement.
	Diskette is damaged.	Replace the diskette with a new one.
"Invalid system disk" message is displayed.	A diskette that does not contain the system files needed to start the workstation has been inserted in the drive.	When drive activity stops, remove the diskette and press the <b>spacebar</b> . The workstation should start up.
	Diskette error has occurred.	Restart the workstation by pressing the power button.
Cannot Boot to Diskette.	Diskette is not bootable.	Replace with a bootable diskette.
	Diskette boot has been disabled in Computer Setup.	Run Computer Setup and enable diskette boot in <b>Storage&gt;Boot Order</b> .
	Removable media boot has been disabled in Computer Setup.	Run Computer Setup and enable <b>Removable Media Boot</b> in <b>Storage&gt;Storage Options</b> .
	Diskette Master Boot Record (MBR) validation is enabled.	Run Computer Setup, and disable <b>diskette MBR validation</b> in <b>Storage&gt;Storage Options</b> .

## Solving hard drive problems

Table 5-6 Hard drive problems

Problem	Cause	Solution
Hard drive error occurs.	Hard disk has bad sectors or has failed.	Use a utility to locate and block usage of bad sectors. If necessary, reformat the hard disk.
Disk transaction problem.	Either the directory structure is bad or there is a problem with a file.	Right-click <b>Start</b> , select <b>Explore</b> , and select a drive. Select <b>File&gt;Properties&gt;Tools</b> . Under <b>Error-checking</b> , click <b>Check Now</b> .
Drive not found (identified).	Loose cable.  The system might not have automatically recognized a newly installed device.	Check cable connections.  <ol style="list-style-type: none"> <li>1. Run Computer Setup.</li> <li>2. If the system still does not recognize the new device, determine if the device is listed within Computer Setup. If it is listed, the probable cause is a driver problem. If it is not listed, the probable cause is a hardware problem.</li> <li>3. If this is a newly installed drive, enter <b>Setup</b> and try adding a POST delay under <b>Advanced&gt;Power-On</b>.</li> </ol>
	Drive responds slowly immediately after power on.	Run Computer Setup, and increase the POST Delay in <b>Advanced&gt;Power-On Options</b> .
Non-system disk/NTLDR missing message.	System is trying to start from a non-bootable diskette.	Remove the diskette from the diskette drive.
Non-system disk/NTLDR missing message.	System is trying to start from a damaged hard drive.	<ol style="list-style-type: none"> <li>1. Insert a bootable diskette into the diskette drive and restart the workstation.</li> <li>2. If the hard drive is still inaccessible and <b>MBR Security</b> is enabled, try restoring the previously saved MBR image by entering <b>Setup</b> and selecting <b>Security&gt;Restore Master Boot Record</b>.</li> </ol>
	System files missing or not properly installed.	<ol style="list-style-type: none"> <li>1. Insert a bootable system diskette and restart.</li> <li>2. Verify that the hard drive is partitioned and formatted.</li> <li>3. Install system files for the appropriate operating system if necessary.</li> </ol>
	Hard drive boot disabled in Computer Setup.	Run Computer Setup, and enable the hard drive entry in the <b>Storage—&gt;Boot Order</b> list.
	Both slow and fast UATA devices are on the same data cable.	Connect slower UATA devices to a separate data cable connected to the secondary IDE (ATA) controller.
Workstation will not start.	Hard drive is damaged.	Observe the beeps and LED lights on the front of the workstation. See <a href="#">POST error messages on page 126</a> .

## Solving display problems

Table 5-7 Display problems

Problem	Cause	Solution
Blank screen (no video).	The cable connections are not correct.	Check the cable connections from the monitor to the workstation and to a working electrical outlet.
	The monitor is off.	Switch the monitor to on (LED is on). You might need to refer to the monitor manual for an explanation of the LED signals.
	Screen blanking utility installed or energy saver features enabled.	Press any key or click the mouse button and, if set, enter your password.
	System ROM is bad; system is running in FailSafe Boot Block mode (indicated by eight beeps).	Reflash the ROM using a ROMPaq diskette.
	Fixed-sync monitor will not sync at the resolution chosen.	Be sure that the monitor can accept the same horizontal scan rate as the resolution chosen.
Computer is in mode.	Press the power button to resume from mode.	
The display works properly during the POST but goes blank when the OS starts.	Monitor settings in the workstation are not compatible with the monitor.	1. Restart the workstation and press <b>F8</b> during startup when you see <b>Press F8</b> in the bottom-right corner of the screen.
		2. Using the keyboard arrow keys, select <b>Enable VGA Mode</b> and press <b>Enter</b> .
		3. In Windows Control Panel, double-click the <b>Display</b> icon and click the <b>Settings</b> tab.
		4. Use the sliding control to reset the resolution.
The display works properly during the POST but goes blank when the OS starts.	The display settings in the operating system are incompatible with your graphics card and monitor.	1. Restart your workstation in VGA mode.
		2. After the operating system starts, change the display settings to match those supported by your graphics card and monitor.
		3. Refer to your operating system and graphics card documentation for information on changing display settings.
Power LED flashes Red six times, once every second, followed by a two second pause, and the workstation beeps six times.	Pre-video graphics error.	For systems with a graphics card: <ol style="list-style-type: none"> <li>1. Reseat the graphics card.</li> <li>2. Replace the graphics card.</li> <li>3. Replace the system board.</li> </ol>
Monitor does not function properly when used with energy saver features.	Monitor without energy saver capabilities is being used with energy saver features enabled.	Disable monitor energy saver feature.
Dim character s.	The brightness and contrast controls are not set properly.	Adjust the monitor brightness and contrast controls.
	Cables are not properly connected.	Verify that the graphics cable is securely connected to the graphics card and the monitor.

**Table 5-7** Display problems (continued)

Problem	Cause	Solution
Blurry video or requested resolution cannot be set.	If the graphics controller was upgraded, the correct video drivers might not be loaded.	Install the video drivers included in the upgrade kit.
	Monitor is not capable of displaying requested resolution.	Change requested resolution.
The picture is broken up, rolls, jitters, or flashes.	The monitor connections might be incomplete or the monitor might be incorrectly adjusted.	1. Be sure the monitor cable is securely connected to the workstation.
		2. In a two-monitor system or if another monitor is in close proximity, be sure the monitors are not interfering with each other's electromagnetic field by moving them apart.
		3. Be sure that fluorescent lights or fans are not too close to the monitor.
	Monitor needs to be degaussed.	Degauss the monitor.
Vibrating or rattling noise coming from inside a CRT monitor when powered on.	Monitor degaussing coil has been activated.	None. It is normal for the degaussing coil to be activated when the monitor is powered on.
Clicking noise coming from inside a CRT monitor.	Electronic relays have been activated inside the monitor.	None. It is normal for some monitors to make a clicking noise when turned on and off, when going in and out of Standby mode, and when changing resolutions.
High pitched noise coming from inside a flat panel monitor.	Brightness and contrast settings are too high.	Lower brightness and contrast settings.
Fuzzy focus; streaking, ghosting, or shadowing effects; horizontal scrolling lines; faint vertical bars; or unable to center the picture on the screen. (Flat panel monitors using an analog VGA input connection only.)	Flat panel monitor's internal digital conversion circuits might be unable to correctly interpret the output synchronization of the graphics card.	<ol style="list-style-type: none"> <li>1. Select the monitor's Auto-Adjustment option in the monitor's on-screen display menu.</li> <li>2. Manually synchronize the Clock and Clock Phase on-screen display functions. Download SoftPaq SP20930 or SP22333, depending on the monitor, to assist with the synchronization.</li> </ol>
Certain typed symbols do not appear correct.	The font you are using does not support that particular symbol.	Use the Character Map to locate the and select the appropriate symbol. Click <b>Start&gt;All Programs&gt;Accessories&gt;System Tools&gt;Character Map</b> . You can copy the symbol from the Character Map into a document.

## Solving audio problems

**Table 5-8** Audio problems

Problem	Cause	Solution
Sound does not come out of the speaker or headphones.	Software volume control is turned down.	Double-click the <b>Speaker</b> icon on the taskbar and use the volume slider to adjust the volume.
	The external speakers are not turned on.	Turn on the external speakers.
	External speakers are plugged into the wrong audio jack.	See the sound card documentation for proper speaker connection.

**Table 5-8** Audio problems (continued)

Problem	Cause	Solution
	Audio cable not connected.	Connect audio cable between CD or DVD-ROM drive and the system board.
	Digital CD audio is not enabled.	Enable digital CD audio: <ol style="list-style-type: none"> <li>1. From the Control Panel, select <b>System</b>.</li> <li>2. On the Hardware tab, click <b>Device Manager</b>.</li> <li>3. Right-click the <b>CD/DVD</b> device and select <b>Properties</b>.</li> <li>4. On the Properties tab, be sure <b>Enable digital CD audio for this CD-ROM device</b> is selected.</li> </ol>
	Headphones or devices connected to the line-out connector mute the internal speaker.	Turn on and use headphones or external speakers, if connected, or disconnect headphones or external speakers.
	Volume is muted.	<ol style="list-style-type: none"> <li>1. From the Control Panel program, click <b>Sound, Speech and Audio Devices</b>, and then click <b>Sounds and Audio Devices</b>.</li> <li>2. Clear the Mute check box.</li> </ol>
	Computer is in mode.	Press the power button to resume from mode.
Noise or no sound comes out of the speakers or headphones.		<ol style="list-style-type: none"> <li>1. If using digital speakers that have a stereo jack and want the system to auto-switch to digital, use a stereo-to-mono adapter to properly engage the auto-sense feature or use the multimedia device properties to manually switch the audio signal from analog to digital.</li> <li>2. If the headphones have a mono jack, use the multimedia device properties to switch the system to analog out.</li> </ol>
 <p><b>NOTE</b> If you set digital as the <b>Output Mode</b>, the internal speaker and external analog speakers will no longer output audio until you switch back to an auto-sense or analog mode.</p> <p>If you set analog as the <b>Output Mode</b>, external digital speakers will not function until you change the output mode back to an auto-sense or digital mode.</p>		
Sound cuts in and out.	Processor resources are being used by other open applications.	Shut down all open processor-intensive applications.
Workstation appears to be locked up while recording audio.	The hard disk might be full.	<ol style="list-style-type: none"> <li>1. Before recording, be sure there is enough free space on the hard disk.</li> <li>2. Try recording the audio file in a compressed format.</li> </ol>

## Solving printer problems

Table 5-9 Printer problems

Problem	Cause	Solution
Printer does not print.	Printer is not turned on and online.	Turn the printer on and be sure it is online.
	The correct printer driver for the application are not installed.	<ol style="list-style-type: none"> <li>1. Install the correct printer driver for the application.</li> <li>2. Try printing using the MS-DOS command: <b>DIR C:\&gt; [printer port]</b> where <b>[printer port]</b> is the address of the printer being used. If the printer works, reload the printer driver.</li> </ol>
	If you are on a network, you might not have made the connection to the printer.	Make the proper network connections to the printer.
Printer does not turn on.	Printer might have failed.	Run printer self-test.
	The cables might not be connected properly.	Reconnect all cables.
Printer prints garbled information.	The correct printer driver is not installed.	Install the correct printer driver for the application.
	The cables might not be connected properly.	Reconnect all cables.
	Printer memory might be overloaded.	Reset the printer by turning it off for one minute, then turn it back on.
Printer is offline.	The printer might be out of paper.	<ol style="list-style-type: none"> <li>1. Check the paper tray and refill it if it is empty.</li> <li>2. Select online.</li> </ol>

## Solving keyboard and mouse problems

Table 5-10 Keyboard and mouse problems

Problem	Cause	Solution
Keyboard commands and typing are not recognized by the workstation.	Keyboard connector is not properly connected.	<ol style="list-style-type: none"> <li>1. Power off the workstation.</li> <li>2. Reconnect the keyboard to the back of the workstation and restart the workstation.</li> </ol>
	Program in use has stopped responding to commands.	Shut down the workstation using the mouse and then restart the workstation.
	Keyboard needs repairs.	Replace the keyboard.
	Keyboard key is stuck down.	Remove any debris from the keyboard.
	Workstation is in mode.	Press the power button to resume from mode.
Cursor will not move using the arrow keys on the keypad.	The <b>Num Lock</b> key might be on.	Press the <b>Num Lock</b> key. The Num Lock light should not be on if you want to use the arrow keys. The <b>Num Lock</b> key can be disabled (or enabled) in Computer Setup.



**Table 5-10** Keyboard and mouse problems (continued)

Problem	Cause	Solution
Mouse does not respond to movement or is too slow.	Mouse connector is not properly plugged into the back of the workstation.	<ol style="list-style-type: none"> <li>1. Shut down the workstation using the keyboard.</li> <li>2. Plug the mouse connector into the PS/2 mouse connector slot in the workstation and restart the workstation.</li> </ol>
	Program in use has stopped responding to commands.	Shut down the workstation using the keyboard and then restart the workstation.
	Mouse needs repairs.	Replace the mouse.
	Workstation is Stand By mode.	Press the power button to resume from Stand By mode.
Mouse will only move vertically or horizontally, or movement is jerky.	Mouse roller ball is dirty.	Remove roller ball cover from the bottom of the mouse and clean it.

## Solving front panel component problems

If you are experiencing problems with one of the front panel ports, you might be able to try your device in the corresponding port on the back side of the computer. If this does not fix the problem, or you must use the front panel ports, continue troubleshooting.

Some problems in this section are also discussed in other troubleshooting suggestions in this chapter.

**Table 5-11** Front panel component problems

Problem	Cause	Solution
If a USB device, headphone, or microphone is not recognized by the workstation.	It is not properly connected.	<ol style="list-style-type: none"> <li>1. Power off the workstation.</li> <li>2. Reconnect the device to the front of the workstation and restart the workstation.</li> </ol>
	The device does not have power.	If the USB device requires AC power, be sure one end is connected to the device and one end is connected to a live outlet.
	The correct device driver is not installed.	<ol style="list-style-type: none"> <li>1. Install the correct driver for the device.</li> <li>2. You might need to reboot the workstation.</li> </ol>
	The cable from the device to the computer does not work.	<ol style="list-style-type: none"> <li>1. If possible, replace the cable.</li> <li>2. Restart the workstation.</li> </ol>
	The device is not working.	<ol style="list-style-type: none"> <li>1. Replace the device.</li> <li>2. Restart the workstation.</li> </ol>
If a USB, audio, and IEEE-1394 devices are not working.	The internal cables might not be connected to the system board or the PCI card.	<ol style="list-style-type: none"> <li>1. Power off the workstation.</li> <li>2. Connect the cables correctly.</li> </ol>
A device in the IEEE-1394a port is not responsive.	Cables of new external device are loose or power cables are unplugged.	Be sure that all cables are properly and securely connected.

**Table 5-11** Front panel component problems (continued)

Problem	Cause	Solution
	The power switch on the device is not turned on.	Power off the workstation, and power on the external device, then turn on the workstation to integrate the device with the workstation system.
The IEEE-1394 port is not active.	The port is not there because it was not purchased with the system.	You can buy an IEEE 1394 PCI adapter card. Contact an HP seller.

## Solving hardware installation problems

You might need to reconfigure the workstation when you add or remove hardware, such as an additional diskette drive. If you install a PNP (positive-negative-positive) device, Windows XP automatically recognize the device and configure the workstation. If you install a non-PNP device, you must reconfigure the workstation after completing installation of the new hardware.

**Table 5-12** Hardware installation problems

Problem	Cause	Solution
A new device is not recognized as part of the system.	Device is not seated or connected properly.	Be sure that the device is properly and securely connected and that pins in the connector are not bent.
	Cables of new external device are loose or power cables are unplugged.	Be sure that all cables are properly and securely connected and that pins in the cable or connector are not bent.
	Power switch of new external device is not turned on.	Power off the workstation, power on the external device, and power on the workstation to integrate the device with the workstation system.
	When the system advised you of changes to the configuration, you did not accept them.	Reboot the workstation, and follow the instructions for accepting the changes.
	A PNP board might not automatically configure when added if the default configuration conflicts with other devices.	Use the Device Manager to clear the automatic settings for the board and select a basic configuration that does not cause a resource conflict. You can also use Computer Setup to reconfigure or disable devices to resolve the resource conflict.
	Device hardware is not properly jumpered or otherwise configured.	Read the device-specific configuration information and check for incorrect settings or conflicts with other devices already installed in the system.
Workstation will not start.	Wrong memory modules were used in the upgrade or memory modules were installed in the wrong location.	<ol style="list-style-type: none"> <li>1. Review the documentation that came with the system to determine if you are using the correct memory modules and to verify the proper installation.</li> <li>2. Observe the beeps and LED lights on the front of the workstation. Refer to <a href="#">POST error messages on page 126</a> to determine possible causes.</li> </ol>
	PCI Express power cable might be plugged into the wrong connector on the system board.	Connect the auxiliary PCI Express power cable to the PCI Express card.

**Table 5-12** Hardware installation problems (continued)

Problem	Cause	Solution
Power LED flashes Red five times, once every second, followed by a two second pause, and the workstation beeps five times.	Memory is installed incorrectly or is bad.	<ol style="list-style-type: none"> <li>1. Reseat DIMMs.</li> <li>2. Replace DIMMs one at a time to isolate the faulty module.</li> <li>3. Replace third-party memory with HP memory.</li> <li>4. Replace the system board.</li> </ol>
Power LED flashes Red six times, once every second, followed by a two second pause, and the workstation beeps six times.	Video card is not seated properly or is bad, or system board is bad.	<p>For systems with a graphics card:</p> <ol style="list-style-type: none"> <li>1. Reseat the graphics card.</li> <li>2. Replace the graphics card.</li> <li>3. Replace the system board.</li> </ol>

## Solving network problems

These guidelines do not discuss the process of debugging the network cabling.

**Table 5-13** Network problems

Problem	Cause	Solution
Wake-on-LAN feature is not functioning.	Wake-on-LAN is not enabled.	Use the Network control application to enable Wake-on-LAN.
Network driver does not detect network controller.	Network controller is disabled.	Run Computer Setup and enable network controller.
	Incorrect network driver.	Check the network controller documentation for the correct driver, or obtain the latest driver from the manufacturer's website.
Network status link light does not turn on or it never flashes.	No active network is detected.	Check cabling and network equipment for proper connection.
The network status light should flash when there is network activity.	Network controller is not set up properly.	Use the network control application to verify that the device is working properly.
	Network driver is not properly loaded.	Reinstall network drivers.
	System cannot auto-sense the network.	Disable auto-sensing capabilities and force the system into the correct operating mode.
Diagnostics reports a failure.	The cable is not securely connected.	Be sure that both ends of the data cable are securely connected.
	The cable is attached to the incorrect connector.	Be sure that the cable is attached to the correct connector.
	There is a problem with the cable or a device at the other end of the cable.	Be sure that the cable and device at the other end are operating correctly.
	Network controller interrupt is shared with an expansion board.	Under the Computer Setup <b>Advanced</b> menu, change the resource settings for the board.

**Table 5-13** Network problems (continued)

Problem	Cause	Solution
	The network controller is defective.	Replace the NIC.
Diagnostics passes, but the workstation does not communicate with the network.	Network drivers are not loaded, or driver parameters do not match current configuration.	<ol style="list-style-type: none"> <li>1. Be sure the network drivers are loaded and that the driver parameters match the configuration of the network controller.</li> <li>2. Be sure the correct network client and protocol is installed.</li> </ol>
	The network controller is not configured for this workstation.	Select the <b>Network</b> icon in the Control Panel and configure the network controller.
Network controller stopped working when an expansion board was added to the workstation.	Network controller interrupt is shared with an expansion board.	Under the Computer Setup <b>Advanced</b> menu, change the resource settings for the board.
	The network controller requires drivers.	Verify that the drivers were not accidentally deleted when the drivers for a new expansion board were installed.
	The expansion board installed is a Network Interface Card (NIC) and conflicts with the embedded NIC.	Under the Computer Setup <b>Advanced</b> menu, change the resource settings for the board.
Network controller stops working without apparent cause.	The files containing the network drivers are corrupted.	Reinstall the network drivers, using the <i>Restore Plus!</i> CD.
	The cable is not securely connected.	Be sure that both ends of the cable are securely attached to the correct devices.
	The network controller is defective.	Replace the NIC.
New network card will not boot.	New network card might be defective or might not meet industry-standard specifications.	Install a working, industry-standard NIC, or change the boot sequence to boot from another source.
Cannot connect to network server when attempting Remote System Installation.	The network controller is not configured properly.	Verify Network Connectivity, that a DHCP Server is present, and that the Remote System Installation Server contains the NIC drivers for your NIC.
System setup utility reports unprogrammed EEPROM.	Unprogrammed EEPROM.	Flash the ROM.

## Solving memory problems



**CAUTION** For those systems that support ECC memory, HP does not support mixing ECC and non-ECC memory. Otherwise, the system will not boot the operating system.

**Table 5-14** Memory problems

Problem	Cause	Solution
System will not boot or does not function properly after installing additional memory modules.	Memory module is not the correct type or speed, or the new memory module is not seated properly.	Replace module with the correct industry-standard device for the workstation.
		On some models, ECC and non-ECC memory modules cannot be mixed.

**Table 5-14** Memory problems (continued)

Problem	Cause	Solution
Out of memory error.	Memory configuration might not be set up correctly.	Use the Device Manager to check memory configuration.
	You have run out of memory to run the application.	Check the application documentation to determine the memory requirements.
Memory count during POST is wrong.	The memory modules might not be installed correctly.	Check that the memory modules have been installed correctly and that proper modules are used.
Insufficient memory error during operation.	Too many Terminate and Stay Resident programs (TSRs) are installed.	Delete any TSRs that you do not need.
	You have run out of memory for the application.	Check the memory requirements for the application or add more memory to the workstation.
Power LED flashes red 5 times, once every second, followed by a 2-second pause, and the workstation beeps 5 times.	Memory is installed incorrectly or is bad.	1. Reseat DIMMs.
		2. Replace DIMMs one at a time to isolate the faulty module.
		3. Replace third-party memory with HP memory.
		4. Replace the system board.

## Solving processor problems

**Table 5-15** Processor problems

Problem	Cause	Solution
Poor performance is experienced.	Processor is hot.	1. Be sure the airflow to the workstation is not blocked.
		2. Be sure the fans are connected and working properly (some fans only operate when needed).
		3. Be sure the CPU heatsink is installed properly.
Power LED is Red and stays on.	Processor is not seated properly or not installed.	1. Check to see that the processor is present.
		2. Reseat the processor.

## Solving CD-ROM and DVD problems

**Table 5-16** CD-ROM and DVD problems

Problem	Cause	Solution
System will not boot from CD-ROM or DVD drive.	The CD-ROM or DVD boot is not enabled through the Computer Setup utility.	Run the Computer Setup utility and enable booting to removable media and verify boot order settings.
	Non-bootable CD in drive.	Try a bootable CD in the drive.
CD-ROM or DVD devices are not detected or driver is not loaded.	Drive is not connected properly or not properly configured.	1. Reconnect power and data cables to the drive.
		2. Install correct device driver.

**Table 5-16** CD-ROM and DVD problems (continued)

Problem	Cause	Solution
Movie will not play in the DVD drive.	Movie might be regionalized for a different country.	See the documentation that came with the DVD drive.
	Decoder software is not installed.	Install decoder software.
Cannot eject compact disc (tray-load unit).	Disc not properly seated in the drive.	<ol style="list-style-type: none"> <li>1. Power off the workstation, and insert a thin metal rod into the emergency eject hole and push firmly.</li> <li>2. Slowly pull the tray out from the drive until the tray is fully extended, and remove the disc.</li> </ol>
CD-ROM, CD-RW, DVD-ROM, or DVD-R/RW drive cannot read a disc or takes too long to start.	CD has been inserted upside down.	Reinsert the CD with the label facing up.
	The DVD-ROM drive takes longer to start because it has to determine the type of media played, such as audio or video.	Wait at least 30 seconds to let the DVD-ROM drive determine the type of media being played. If the disc still does not start, read the other solutions listed for this topic.
	CD or DVD disc is dirty.	Clean CD or DVD with a CD cleaning kit.
	Windows does not detect the CD-ROM or DVD-ROM drive.	<ol style="list-style-type: none"> <li>1. Use Device Manager to remove or uninstall the device in question.</li> <li>2. Restart the workstation and allow Windows to detect the device.</li> </ol>
	Recording audio CDs is difficult or impossible.	Wrong or poor quality media type. <ol style="list-style-type: none"> <li>1. Try using a slower recording speed.</li> <li>2. Verify that you are using the correct media for the drive.</li> <li>3. Try a different brand of media. Quality varies widely between manufacturers.</li> </ol>

## Solving Internet access problems

**Table 5-17** Internet access problems

Problem	Cause	Solution
Unable to connect to the Internet.	Internet Service Provider (ISP) account is not set up properly.	Verify Internet settings or contact the ISP for assistance.
	Modem is not set up properly.	Reconnect the modem. Verify the connections are correct using the quick setup documentation.
	Web browser is not set up properly.	Verify that the web browser is installed and set up to work with your ISP.
	Cable/DSL modem is not plugged in.	Plug in cable/DSL modem. You should see a "power" LED light on the front of the cable/DSL modem.
	Cable/DSL service is not available or has been interrupted due to bad weather.	Try connecting to the Internet at a later time or contact your ISP. (If the cable/DSL service is connected, the "cable" LED light on the front of the cable/DSL modem will be on.)
	The CAT5 10/100/1000 cable is disconnected.	Connect the CAT5 10/100 cable between the cable modem and the workstations's RJ-45 connector. (If the connection

**Table 5-17** Internet access problems (continued)

Problem	Cause	Solution
		is good, the "PC" LED light on the front of the cable/DSL modem will be on.)
	IP address is not configured properly.	Contact the ISP for the correct IP address.
	Cookies are corrupted.	<ol style="list-style-type: none"><li>1. Select <b>Start&gt;Control Panel</b>.</li><li>2. Double-click <b>Internet Options</b>.</li><li>3. On the General tab, click <b>Delete Cookies</b>.</li></ol>
Cannot automatically launch Internet programs.	You must log on to the ISP before some programs will start.	Log on to the ISP and launch the desired program.
Internet takes too long to download websites.	Modem is not set up properly.	<p>Verify that the correct modem speed and COM port are selected.</p> <ol style="list-style-type: none"><li>1. Select <b>Start&gt;Control Panel</b>.</li><li>2. Double-click <b>System</b>. Click the <b>Hardware</b> tab.</li><li>3. In the Device Manager area, click <b>Device Manager</b>.</li><li>4. Double-click <b>Ports (COM &amp; LPT)</b>.</li><li>5. Right-click the COM port your modem uses, then click <b>Properties</b>.</li><li>6. Under Device status, verify that the modem is working properly.</li><li>7. Under Device usage, verify the modem is enabled.</li><li>8. If there are further problems, click <b>Troubleshoot</b> and follow the on-screen instructions.</li></ol>

## POST error messages

POST is a program run at startup that initializes and runs some tests on installed hardware. An audible and/or visual message occurs if the POST encounters a problem. POST checks the following items to ensure that the workstation system is functioning properly:

- Keyboard
- Memory modules
- Diskette drives
- All SATA, IDE, and SAS mass storage devices
- Processors
- Controllers



**NOTE** If the Power-On Password is set, a key icon appears on the screen while POST is running. You must enter the password before continuing.

**Table 5-18** POST error messages

Screen Message	Probable Cause	Recommended Action
101–Option ROM Error.	System ROM checksum.	<p>Verify the correct ROM:</p> <ol style="list-style-type: none"> <li>1. Flash the ROM if needed.</li> <li>2. If an expansion card was recently added, remove it and see if the problem remains.</li> <li>3. Clear CMOS. If the message disappears, there might be a problem with the expansion card.</li> <li>4. Replace the system board.</li> </ol>
102–System Board Failure.	DMA, timers.	<ol style="list-style-type: none"> <li>1. Clear CMOS.</li> <li>2. Remove expansion boards.</li> <li>3. Replace the system board.</li> </ol>
103–System Board Failure.	DMA, timers.	<ol style="list-style-type: none"> <li>1. Clear CMOS.</li> <li>2. Remove expansion boards.</li> <li>3. Replace the system board.</li> </ol>
110–Out of Memory for Option ROMs.	Option ROM for a device was unable to run due to memory constraints.	Move the suspected card to a different slot to see if the error resolves. Contact HP for assistance if necessary.
162–System Options Not Set.	Your system configuration has changed since your last boot, in which case press <b>F1</b> . Or, a loss of power to the Real Time clock has occurred.	<ol style="list-style-type: none"> <li>1. Run Computer Setup (F10 Setup).</li> <li>2. Set the date and time under Control Panel or in F10 Setup, depending on the operating system.</li> <li>3. If the problem persists, replace the RTC battery.</li> </ol>
163–Time and Date Not Set.	<p>Invalid time or date in configuration memory.</p> <p>RTC (real-time clock) battery might need to be replaced.</p>	<ol style="list-style-type: none"> <li>1. Set the date and time under Control Panel or in F10 Setup, depending on the operating system.</li> <li>2. If the problem persists, replace the RTC battery.</li> </ol>



**Table 5-18** POST error messages (continued)

Screen Message	Probable Cause	Recommended Action
	CMOS jumper might not be properly installed.	
164–Memory Size Error.	The system memory size is different or memory configuration has changed from the last startup.	<ol style="list-style-type: none"> <li>1. Pressing <b>F1</b> will record the configuration.</li> <li>2. If the problem persists, be sure memory modules (if any) are installed correctly.</li> <li>3. If third-party memory has been added, test using HP memory only.</li> <li>4. Verify proper memory module type.</li> </ol>
201–Memory Error.	The memory test performed during startup failed.	<ol style="list-style-type: none"> <li>1. Run Computer Setup (F10 Setup) or Windows utilities.</li> <li>2. Ensure that memory modules are installed correctly.</li> <li>3. Verify proper memory module type.</li> <li>4. Remove and replace memory modules one at a time to isolate faulty module.</li> <li>5. Replace the faulty memory modules.</li> <li>6. If error persists after replacing memory modules, replace the system board.</li> </ol>
202–Mixed 533 and 667 MHz memory detected.	Memory modules do not match each other.	Replace memory modules with matched sets.
207–Incompatible memory modules detected.	Incompatible memory module(s) detected.	<ol style="list-style-type: none"> <li>1. Verify proper memory module type.</li> <li>2. Try another memory socket.</li> <li>3. Replace memory module if problem persists.</li> </ol>
209–Incompatible FBD memory modules detected.	Incompatible memory modules detected.	<ol style="list-style-type: none"> <li>1. Verify proper memory module type.</li> <li>2. Try another memory socket.</li> <li>3. Replace memory module if problem persists.</li> </ol>
210–Incompatible memory modules (AMBs) detected.	Incompatible memory module(s) detected. Mismatched Advanced Memory Buffer (AMB) IC.	<ol style="list-style-type: none"> <li>1. Verify proper memory module type.</li> <li>2. Try another memory socket.</li> <li>3. Replace memory module if problem persists.</li> </ol>
211–Memory warning condition detected.	An unknown issue with one of the DIMMs has been detected.	<ol style="list-style-type: none"> <li>1. Verify proper memory module type.</li> <li>2. Try another memory socket.</li> <li>3. Replace memory module if problem persists.</li> </ol>
212–Failed Processor.	Processor has failed to initialize.	<ol style="list-style-type: none"> <li>1. Reseat the processor in its socket.</li> <li>2. If the processor does not respond, replace it.</li> </ol>
213–Incompatible ECC Memory Module in memory Socket(s).	The memory modules in the system are either not all ECC, or not all non-ECC. This could also be caused because the DIMM is missing critical SPD information.	<ol style="list-style-type: none"> <li>1. Verify that all memory modules are ECC or non-ECC.</li> <li>2. Replace memory module if problem persists.</li> </ol>

**Table 5-18** POST error messages (continued)

Screen Message	Probable Cause	Recommended Action
214–DIMM Configuration Warning.	DIMMs not installed correctly (not paired correctly).	Refer to <a href="#">Memory on page 67</a> “Memory” for the correct memory configurations and reseat the DIMMs accordingly.
301–Keyboard Error.	Keyboard failure.	<ol style="list-style-type: none"><li>1. Reconnect keyboard with workstation powered off.</li><li>2. Check the connector for bent or missing pins.</li><li>3. Be sure that none of the keys are pressed.</li><li>4. Replace keyboard.</li></ol>
303–Keyboard Controller Error.	I/O board keyboard controller.	<ol style="list-style-type: none"><li>1. Reconnect keyboard with workstation powered off.</li><li>2. Replace the system board.</li></ol>
304–Keyboard or System Unit Error.	Keyboard failure.	<ol style="list-style-type: none"><li>1. Reconnect the keyboard with workstation powered off.</li><li>2. Be sure that none of the keys are pressed.</li><li>3. Replace keyboard.</li><li>4. Replace system board.</li></ol>
401–Parallel Port 1 Address Assignment Conflict.	IRQ address conflicts with another device.	Reset the IRQ in the BIOS Setup menu.
404–Parallel Port Address Conflict Detected.	Both external and internal ports are assigned to parallel port X.	<ol style="list-style-type: none"><li>1. Remove any parallel expansion cards.</li><li>2. Clear CMOS.</li><li>3. Reconfigure card resources and run Computer Setup (F10 Setup).</li></ol>
410–Audio Interrupt Conflict.	IRQ address conflicts with another device.	Reset the IRQ in the BIOS Setup menu.
411–Network Interface Card Interrupt Conflict.	IRQ address conflicts with another device.	Reset the IRQ in the BIOS Setup menu.
501–Display Adapter Failure.	Graphics display controller.	<ol style="list-style-type: none"><li>1. Reseat the graphics card (if applicable).</li><li>2. Clear CMOS.</li><li>3. Verify that the monitor is attached and turned on.</li></ol>
510–Splash Screen image corrupted.	Splash Screen image has errors.	Install latest version of ROMPaq to restore image.
511–CPU Fan not detected.	Fan is not connected or it might have malfunctioned.	<ol style="list-style-type: none"><li>1. Reseat fan cable.</li><li>2. Reseat the fan.</li><li>3. Replace the fan.</li></ol>
512–Chassis fan not detected.	Fan is not connected or it might have malfunctioned.	<ol style="list-style-type: none"><li>1. Reseat chassis or rear chassis fan cable.</li><li>2. Reseat chassis, rear chassis, or front chassis fan.</li><li>3. Replace chassis, rear chassis, or front chassis fan.</li></ol>

**Table 5-18** POST error messages (continued)

Screen Message	Probable Cause	Recommended Action
513–Memory fan not detected.	Memory fan is not connected or it might have malfunctioned.	<ol style="list-style-type: none"> <li>1. Reseat memory fan connector.</li> <li>2. Replace memory fan.</li> </ol>
601–Diskette Controller Error.	Diskette controller circuitry or diskette drive circuitry incorrect.	<ol style="list-style-type: none"> <li>1. Run Computer Setup (F10 Setup).</li> <li>2. Check and replace cables.</li> <li>3. Clear CMOS.</li> <li>4. Replace diskette drive.</li> <li>5. Replace the system board.</li> </ol>
605–Diskette Drive Type Error.	Mismatch in drive type.	<ol style="list-style-type: none"> <li>1. Run Computer Setup (F10 Setup).</li> <li>2. Disconnect any other diskette controller devices (tape drives).</li> <li>3. Clear CMOS.</li> </ol>
610–External Storage Device Failure.	External tape drive not connected.	Reinstall tape drive, or press <b>F1</b> and allow system to reconfigure without the drive.
611–Primary Diskette Port Address Assignment Conflict.	Configuration error.	<ol style="list-style-type: none"> <li>1. Run Computer Setup (F10 Setup).</li> <li>2. Remove expansion cards.</li> <li>3. Clear CMOS.</li> </ol>
912–Computer Cover Has Been Removed Since Last System Start Up.		No action required.
914–Hood Lock Coil is not Connected.	Hood lock mechanism is missing or not connected.	<ol style="list-style-type: none"> <li>1. Reconnect or replace the hood locking mechanism.</li> <li>2. Reseat or replace the hood locking mechanism cable.</li> </ol>
915–Fan Power from Power Supply Not Connected.	The fan power cable is not connected, or the power supply is bad.	<ol style="list-style-type: none"> <li>1. Verify that all power supply cables are connected.</li> <li>2. Replace the power supply.</li> </ol>
916–Power Button Not Connected.	The power button is not connected.	Connect the power button.
917–Front Audio Not Connected.	The front audio cable is not connected.	Connect the front audio cable.
918–Front USB Not Connected.	Front USB is not connected.	Connect the front USB cable.
921–Device in PCI Express Slot Failed to Initialize.	A PCI Express card was detected in one of the slots, but failed to initialize properly.	Reseat all PCI Express cards. If this failure occurred after inserting a new card, there could be a problem with that card.
922–Fatal error on slot #	Fatal error occurred in the designated slot.	Try moving card to a different slot. If the problem persists, try replacing the card.
923–Non fatal error on slot #.	A PCI or PCIe non-fatal error condition occurred for the device in the designated slot.	Try moving card to a different slot. If the problem persists, try replacing the card.

**Table 5-18** POST error messages (continued)

Screen Message	Probable Cause	Recommended Action
931–Northbound CRC error on non-redundant retry	CRC error occurred. This could be due to a faulty system board, memory, or BIOS issue.	Try replacing or reseating DIMMs first, then system board.
932–Alert on non-redundant retry	Alert present on retry.	Try replacing or reseating DIMMs first, then system board.
945-FBD northbound CRC error		Try replacing or reseating DIMMs first, then system board.
946-Correctable patrol data ECC error	Bad DIMM or improperly installed DIMM	Try reseating the DIMMs and make sure that they are inserted correctly. If the problem persists, remove or replace the DIMMs one by one until the problem DIMM is isolated.
949-Correctable non-mirrored demand data ECC error	Bad DIMM or improperly installed DIMM	Try reseating the DIMMs and make sure that they are inserted correctly. If the problem persists, remove or replace the DIMMs one by one until the problem DIMM is isolated.
950-Redundant retry FBD northbound CRC error		Try replacing or reseating DIMMs first, then system board.
953-Non-aliased uncorrectable patrol data ECC error	Double bit ECC error due to bad DIMM or improperly installed DIMM	Try reseating the DIMMs and make sure that they are inserted correctly. If the problem persists, remove or replace the DIMMs one by one until the problem DIMM is isolated.
956-Non-aliased uncorrectable non-mirrored demand data ECC error	Bad DIMM or improperly installed DIMM	Try reseating the DIMMs and make sure that they are inserted correctly. If the problem persists, remove or replace the DIMMs one by one until the issue is resolved.
960–CPU Overtemp occurred.	The ambient temperature could exceed operating limits (maximum = 95° F), or there are obstructions to airflow, including dust build up.	<ol style="list-style-type: none"> <li>1. Be sure you are not operating the system in an environment that exceeds 95° F.</li> <li>2. Disconnect power and open the access panel.</li> <li>3. Check that cables are not blocking CPU heatsink fans or front fan, if installed.</li> <li>4. Check that there is not excessive dust on major components.</li> <li>5. If airflow is acceptable and there is not excessive dust, the thermal sensing circuitry has failed on the processors or on the system board. You must replace the processors, the system board, or both.</li> </ol>
961-Uncorrectable data ECC on replay error	Bad DIMM or improperly installed DIMM	Try reseating the DIMMs and make sure that they are inserted correctly. If the problem persists, remove or replace the DIMMs one by one until the problem DIMM is isolated.
1151–Serial Port 1 Address Conflict Detected.	Both external and internal serial ports are assigned to COM1.	<ol style="list-style-type: none"> <li>1. Remove any COM port expansion cards.</li> <li>2. Clear CMOS.</li> <li>3. Reconfigure card resources and run Computer Setup (F10 Setup).</li> <li>4. Run Computer Setup or Windows utilities.</li> </ol>

**Table 5-18** POST error messages (continued)

Screen Message	Probable Cause	Recommended Action
1155–Serial Port Address Conflict Detected.	Both external and internal serial ports are assigned to same IRQ.	<ol style="list-style-type: none"> <li>1. Remove any COM port expansion cards.</li> <li>2. Clear CMOS.</li> <li>3. Reconfigure card resources and run Computer Setup (F10 Setup).</li> <li>4. Run Computer Setup or Windows utilities.</li> </ol>
1201–System Audio Address Conflict Detected.	Device IRQ address conflicts with another device. (Usually due to an add-in audio card.)	Reset the IRQ.
1202–MIDI Port Address Conflict Detected.	Device IRQ address conflicts with another device. (Usually due to an add-in audio card.)	Reset the IRQ.
1203–Game Port Address Conflict Detected.	Device IRQ address conflicts with another device. (Usually due to an add-in audio card.)	Reset the IRQ.
1720 SMART Hard Drive Detect Imminent Failure.	Hard drive is about to fail. (Some hard drives have a firmware patch that will fix an erroneous error message.)	<ol style="list-style-type: none"> <li>1. Determine if hard drive is giving correct error message.</li> <li>2. Run the Drive Protection System test if applicable.</li> <li>3. Apply firmware patch if applicable (see <a href="http://www.hp.com/support">http://www.hp.com/support</a>).</li> <li>4. Back up contents and replace hard drive.</li> </ol>
1783–Disk 0 Failure.	The drive is not installed correctly or has failed.	<ol style="list-style-type: none"> <li>1. Be sure that power and drive cables are connected to the drive and to the system board.</li> <li>2. Verify that the cables are the correct cables for your computer model.</li> <li>3. If this message persists, you might need service for your workstation.</li> </ol>
1784–Disk 1 Failure.	The drive is not installed correctly or has failed.	<ol style="list-style-type: none"> <li>1. Be sure that power and drive cables are connected to the drive and to the system board.</li> <li>2. Verify that the cables are the correct cables for your computer model.</li> </ol> <p>If this message persists, you might need service for your workstation.</p>
1794–Inaccessible devices attached to SATA 1 and/or SATA 3.	Devices attached to the SATA 1 (blue) and SATA 3 (black) connectors are inaccessible while <b>SATA Emulation</b> is set to <b>Combined IDE Controller</b> in Setup.	<ol style="list-style-type: none"> <li>1. Run Computer Setup (F10 Setup).</li> <li>2. Select <b>Storage&gt;Storage Options</b>, and set the SATA controller to <b>Separate IDE Controller</b>.</li> </ol>
1800–Temperature Alert.	Internal temperature exceeds specification.	<ol style="list-style-type: none"> <li>1. Check that workstation air vents are not blocked and that the cooling fan is running.</li> <li>2. Verify processor speed selection.</li> <li>3. Replace the processor.</li> <li>4. Replace the system board.</li> </ol>

**Table 5-18** POST error messages (continued)

Screen Message	Probable Cause	Recommended Action
1801–Microcode Update Error.	Missing or Invalid Processor Microcode Update. Contact HP for a new Microcode Update to support the new Processor Stepping.	Upgrade BIOS to proper version.
1802–Processor Not Supported.	The system board does not support the processor.	Replace the processor with a compatible one.
Invalid Electronic Serial Number.	Electronic serial number has become corrupted.	<ol style="list-style-type: none"><li>1. Run Computer Setup. If Setup already has data in the field or will not allow the serial number to be entered, download SP5572.EXE (SNZERO.EXE) from <a href="http://www.hp.com">http://www.hp.com</a> and run it on your workstation.</li><li>2. Run Computer Setup. Try to enter the serial number under <b>Security&gt;System ID</b>, and save the changes.</li></ol>
ECC Multiple Bit Error Detected in Memory Module.	Chipset has detected more than one bad bit in a 64-bit quadword of the memory array.	Replace the memory module.
Parity Check 2.	Parity RAM failure.	Run Computer Setup and Diagnostic utilities.

# A Appendix A — SAS devices

# Supported SAS RAID configurations

The following RAID configurations are supported on the HP xw8400 Workstation.



---

**NOTE** This section does not apply to configuring RAID in the Linux environment. For RAID in the Linux environment, configure SW RAID configurations as provided by Red Hat Enterprise Linux.

---

- Up to 4 internal or external SAS hard disk drives
- External connections require optional internal-to-external cable
- SAS drives require SAS to SATA data and power converter
- LSI MyStorage Utility for Windows
- RAID 0 – Striped disk array
  - Two drives minimum
  - Improved I/O performance
  - No fault tolerance
- RAID 1 — Mirrored disk array
  - Improved read performance
  - 100% redundancy
  - Can recover from single drive failure
  - Two drives
- RAID 1E
  - Three drives minimum
  - Can be an odd number of drives
  - Can always recover from a single drive failure, and in some cases, recover from two drive failures



## SAS RAID 0 configuration

Follow the steps below to configure an Integrated Striped (IS) volume with the BIOS-based configuration utility. The configuration procedure assumes that the system already has the required disk and disk controllers.

1. On the Main menu screen of the BIOS-based configuration utility, use the arrow keys to select an adapter.
2. Press **Enter** to go to the Adapter Properties screen.
3. On the Adapter Properties screen, use the arrow keys to select **RAID Properties** on the screen.
4. Press **Enter** to go to the RAID Properties screen.
5. In the RAID Properties screen, use the arrow keys to select the first disk for the IS volume. Then use the arrow keys to move to the Array Disk column for this disk, and press the **SPACE**, **+**, or **-** key to select **Yes** as the value for this column. If partitions are defined on the selected disk, a message appears warning you that data on the disk will be lost when the striped volume is created. Press the **M** key to migrate, or the **D** key to delete the data on the drive.
6. Repeat the previous step to select up to three more disks for the striped volume.
7. Press the **C** key to create the array once all drives have been chosen, then press **Esc** and **SAVE**.

# SAS RAID 1 configuration

Follow the steps below to configure an Integrated Mirroring (IM) volume with the BIOS-based configuration utility. The configuration procedure assumes that the system already has the required disk and disk controllers.

1. On the Main menu screen of the BIOS-based configuration utility, use the arrow keys to select an adapter.
2. Press **Enter** to go to the Adapter Properties screen.
3. On the Adapter Properties screen use the arrow keys to select **RAID Properties** on the screen.
4. Press **Enter** to go to the RAID Properties screen. Continue with Step 5 to configure a two-disk mirrored volume. Go to Step 6 to configure a mirrored volume with three to six disks.
5. To configure a two-disk mirrored volume with an optional hot spare disk:
  - In the RAID Properties screen, use the arrow keys to select the primary disk for the IM volume (the disk with the data you want to mirror.)
  - Use the arrow keys to move to the Array Disk column for this disk and use the **SPACE** key to select **Yes** as the value. If partitions are defined on the selected disk, a message appears warning you that data on the disk will be lost when the striped volume is created. Press the **M** key to migrate, or the **D** key to delete the data on the drive.
  - When the **Keep Data/Erasedisk** message appears, press **F3** to keep the data that is currently on this disk. The value in the Array Disk column changes to **Primary**.
  - Use the arrow keys to select the secondary (mirrored) disk for the IM volume. Select **Yes** as the value for the Array Disk column.

If partitions are defined on this disk, a message warns you that data on the disk will be lost when the mirrored volume is created. Press **Delete** to confirm erasing data from the disk, or press any other key to deselect the disk. Continue with Step 7.
6. To configure a mirrored volume with three to six disks, or three to five disks with an optional hot spare disk:
  - In the RAID Properties screen, use the arrow keys to select the first disk for the IM volume.
  - Use the arrow keys to move to the Array Disk column for this disk, and use the **+** and **-** keys to select **Yes** as the value.
  - When the **Keep Data/Erasedisk** message appears, press **Delete** to erase the disk.
  - Use the arrow keys to select the next disk for the IM volume. Select **Yes** as the value for the Array Disk column.

If partitions are defined on this disk, a message warns you that data on the disk will be lost when the mirrored volume is created. Press **Delete** to confirm erasing data from the disk, or press any other key to deselect the disk.
  - Repeat the previous steps to select up to four more disks for the IM volume. If you want to configure a hot spare disk for the volume, you can only select up to three more disks.

7. (Optional) Use the arrow keys to select a hot spare disk for the IM volume. Select **Yes** as the value for the Hot Spare column.
8. When you have selected all disks for the IM volume, press **Esc** and select **Save changes, then exit this menu**. (If you do not want to create the IM volume, select **Discard changes, then exit this menu**.)

The IM volume exists as soon as you save the changes. The RAID Properties screen now displays the IM volume properties and status.

## SAS RAID 1E configuration

Follow the steps below to configure an Integrated Mirroring Extended (IME) volume with the BIOS-based configuration utility. The configuration procedure assumes that the system already has the required disk and disk controllers.

1. On the Main menu screen of the BIOS-based configuration utility, use the arrow keys to select an adapter.
2. Press **Enter** to go to the Adapter Properties screen.
3. On the Adapter Properties screen use the arrow keys to select **RAID Properties** on the screen.
4. Press **Enter** to go to the RAID Properties screen. Continue with Step 5 to configure a two-disk mirrored volume. Go to Step 6 to configure a mirrored volume with three to six disks.
5. To configure a two-disk mirrored volume with an optional hot spare disk:

- In the RAID Properties screen, use the arrow keys to select the primary disk for the IME volume (the disk with the data you want to mirror.)
- Use the arrow keys to move to the Array Disk column for this disk and use the **SPACE**, **+**, or **-** key to select **Yes** as the value. If partitions are defined on the selected disk, a message appears warning you that data on the disk will be lost when the striped volume is created. Press the **M** key to migrate, or the **D** key to delete the data on the drive.
- When the **Keep Data/Erase Disk** message appears, press **F3** to keep the data that is currently on this disk. The value in the Array Disk column changes to **Primary**.
- Use the arrow keys to select the secondary (mirrored) disk for the IME volume. Select **Yes** as the value for the Array Disk column.

If partitions are defined on this disk, a message warns you that data on the disk will be lost when the mirrored volume is created. Press **Delete** to confirm erasing data from the disk, or press any other key to deselect the disk. Continue with Step 7.

6. To configure a mirrored volume with three to six disks, or three to five disks with an optional hot spare disk:
  - In the RAID Properties screen, use the arrow keys to select the first disk for the IME volume.
  - Use the arrow keys to move to the Array Disk column for this disk, and use the **+** and **-** keys to select **Yes** as the value.
  - When the **Keep Data/Erase Disk** message appears, press **Delete** to erase the disk.
  - Use the arrow keys to select the next disk for the IME volume. Select **Yes** as the value for the Array Disk column.

If partitions are defined on this disk, a message warns you that data on the disk will be lost when the mirrored volume is created. Press **Delete** to confirm erasing data from the disk, or press any other key to deselect the disk.

  - Repeat the previous steps to select up to four more disks for the IME volume. If you want to configure a hot spare disk for the volume, you can only select up to three more disks.

7. (Optional) Use the arrow keys to select a hot spare disk for the IME volume. Select **Yes** as the value for the Hot Spare column.
8. When you have selected all disks for the IME volume, press **Esc** and select **Save changes, then exit this menu**. (If you do not want to create the IME volume, select **Discard changes, then exit this menu**.)

The IME volume exists as soon as you save the changes. The RAID Properties screen now displays the IME volume properties and status.



# B Appendix B—SATA devices

This appendix describes how to use the Intel® Matrix Storage Manager option ROM Configuration Utility to set up and manage SATA RAID volumes.



---

**NOTE** If only a single HDD is attached, the Intel Matrix Storage Manager option ROM will not execute, and all associated messages will not be displayed.

Intel's Serial ATA AHCI BIOS always executes when RAID/AHCI is selected for the SATA emulation mode. This BIOS is only used to support serial attached optical drives. When an HDD is attached, the AHCI BIOS properly identifies the HDD that is connected to the appropriate SATA port and displays **(Device not supported in this configuration)**. This message is expected and is not an indication of a problem.

---

## Attaching SATA HDDs

Attach the required number of SATA HDDs for the desired RAID level.

- RAID 0: two to six HDDs
- RAID 1: two HDDs
- RAID 5: three to six HDDs
- RAID 10: four to six HDDs



# Configuring system BIOS

Configure the system BIOS to enable embedded SATA RAID functionality.

1. Press **F10** to enter the system BIOS setup.
2. Use the arrow keys to highlight the desired language, then press **Enter**.
3. Press left arrow, right arrow, left arrow, and right arrow to highlight **Storage>Storage Options**, then press **Enter**.
4. Press the up or down arrow key to highlight **SATA Emulation**.
5. Press the left or right arrow key to select **RAID/AHCI**.
6. Press **F10** to accept the new setting.
7. Press left arrow, right arrow, left arrow, and right arrow to highlight **Advanced > Power-On Options**, then press **Enter**.
8. Press the up or down arrow key to highlight **POST Messages**.
9. Press the left or right arrow key to select **Enable**.
10. Press **F10** to accept the new setting.
11. Use the arrow keys to highlight **Advanced>Device Options**, and press **Enter**.
12. Press the up or down arrow key to highlight **SATA RAID Option ROM Download**, and press **Enter**.
13. Press the left or right arrow key to select **Enable**.
14. Press **F10** to accept the new setting.
15. Press left arrow, right arrow, left arrow, and right arrow to highlight **File>Save Changes and Exit**, and press **Enter**.
16. Press **F10** when prompted.

## Creating RAID volumes

Use the Intel Matrix Storage Manager option ROM Configuration Utility to create RAID volumes

1. Press **Ctrl+I** when prompted to enter the Intel Matrix Storage Manager option ROM Configuration Utility.
2. If required, refer to [Deleting RAID volumes on page 145](#) to make enough physical drives available to create the desired RAID volume.
3. Press the up or down arrow key to highlight **1. Create RAID Volume**, and press **Enter**.
4. Type the desired RAID volume name in the Name: field, and press **Tab**.
5. Press the up or down arrow key to select the desired RAID level in the RAID Level: field, then press **Tab**.
6. Press **Enter** to display the Select Disks dialog.
7. Press the up and down arrow keys and <Space> to mark individual physical disks which will be members of the volume.
8. Press **Enter** to exit the Select Disks dialog and return to the Create Volume Menu dialog.
9. If appropriate, press the up or down arrow key to select the Strip Size in the Strip Size: field, and press **Tab**.
10. Type the desired volume size in the Capacity: field, and press **Tab**.
11. Press **Enter** to initiate volume creation.
12. When prompted, press **Y** to acknowledge the warning message and create the volume.
13. Return to step 3. to create additional RAID volumes, or use **↑** or **↓** to highlight **4. Exit**, and press **Enter**.
14. Press **Y** when prompted to confirm the exit.

## Deleting RAID volumes

Use the Intel Matrix Storage Manager option ROM Configuration Utility to delete RAID volumes.

1. Press the up or down arrow key to highlight **2. Delete RAID Volume**, and press [Enter](#).
2. Press the up or down arrow key to highlight the RAID volume to be deleted, and press [Del](#).
3. When prompted, press [Y](#) to confirm the deletion of the selected RAID volume.
4. Choose one of the following steps:
  - Return to step 1. to delete additional RAID volumes.
  - Refer to [Creating RAID volumes on page 144](#) to create RAID volumes.
  - Use the up or down arrow key to highlight **4. Exit**, and press [Enter](#).
  - Use the up or down arrow key to highlight **3. Reset Disks to Non-RAID**, and press [Enter](#).
5. Press the up and down arrow keys and <Space> to mark individual physical disks to be reset.
6. Press [Enter](#) to complete the selection.
7. When prompted, press [Y](#) to confirm the reset action.
8. Choose one of the following steps:
  - Return to step 1. to delete additional RAID volumes.
  - Refer to [Creating RAID volumes on page 144](#) to create RAID volumes.
  - Use the up or down arrow key to highlight **4. Exit**, and press [Enter](#).



# C Appendix C — Ultra ATA devices

## Ultra ATA jumpers

---



**NOTE** This system supports a mixed configuration of UATA/IDE optical drives, and SAS and SATA hard drives. While HP supports the presence of SCSI and IDE hard drives, it does not ship any configurations using those drives.

---

Ultra ATA drives are configured with jumper settings. Factory-installed drives ship with the jumpers preset to the cable-select mode; therefore, no jumper setting changes are required on factory preinstalled, replacement, or option drives. With cable-select, the drive is configured as either Master (Drive/Device 0) or Slave (Drive/Device 1) by its physical attachment to the cable.

If you purchase a third-party hard drive, refer to the documentation included with the drive kit to ensure proper cable installation and configuration.



**NOTE** All drives on a controller channel must have their jumpers either in the cable-select mode or have the individual drive jumper installed on the appropriate Master (Drive/Device 0) or Slave (Drive/Device 1) position.

---

## Ultra ATA cables

When installing a second device on either the primary or secondary controller, you must use an industry standard 80-conductor Ultra ATA cable for optimal performance. These cables have a maximum length of 18 inches and a maximum distance of six inches between the two devices for a two-drive cable.

Drives operating at speeds faster than those of the Ultra ATA-33 devices require industry-standard 40-pin, 80-conductor cables to maintain the highest data transfer rates possible with the improved technology.

When using Ultra ATA-133, -100, -66, and -33 drives in the same system, each drive will operate at its appropriate data transfer rate.

## Drive installation guidelines

Most workstation system boards have two ATA (IDE) controller channels with a dedicated connector for each controller. One controller is designated as the primary and the other as the secondary controller.

Each of the two controllers can have up to two devices attached to it. Each workstation system might therefore have a maximum of four ATA/ATAPI drives. All drives are connected to these controllers using an industry-standard, 80-conductor cable.



**NOTE** The industry standard, 1.44-MB diskette drive has its own separate channel and is not included as a part of the maximum four drives.

Any drive attached to a controller must have a drive designation. If only a single drive is connected to a controller and its jumper is in the cable-select position, it is designated as the Master Drive (Drive/Device 0) by its attachment to the Drive/Device 0 cable position. If two cable-selected drives are connected to a single controller, one will be designated by its attachment to the cable as the Master (Drive/Device 0) and the other as Slave (Drive/Device 1).

For optimal performance of a workstation system, all drives must be attached to the ATA controllers in a specified sequence. This sequence is determined by the device class of the drives and by specific attach sequence rules.

## Device classes

To determine the best drive attach sequence, ATA/ATAPI drives are segregated into four different classes based on the bandwidth demands they place on an ATA controller. The most demanding devices are in Class 1 and the least demanding are in Class 4.

**Table C-1** Device classes

Class 1 Hard drives	Class 2 High Speed optical drives	Class 3 Optical storage drives	Class 4 Magnetic storage drives
ATA-100	DVD	R/W CD-ROM	LS-120
ATA-66	DVD-CD R/W	CD-ROM	Tape
ATA-33			Zip

## General attach guidelines

- The lower the device class number, the faster the device and the more bandwidth required.
- Drives installed in the Device 0 positions on both the primary and secondary controllers receive the greatest possible bandwidth.
- The bootable ATA hard drive should always be installed on the primary controller in the Device 0 position.

## Attach sequence rules by class priority

Drives should be attached in the sequence shown for optimum performance starting at position **1**.



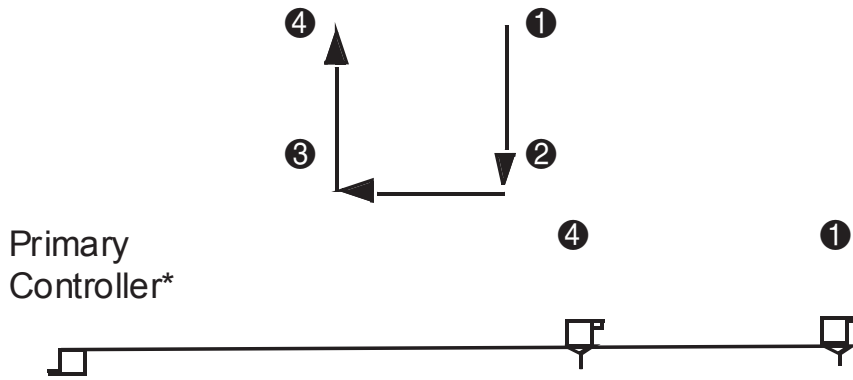

### Installing drive order

\*If there are three or more devices, two or more of which are hard drives, two hard drives should be attached to the primary controller first before following the general attach sequence rule.

The attach sequence rule can also be stated in table format:

**Table C-2** General attach sequence rule

Sequence	Description
1	The lowest class drive—Bootable hard drive recommended.
2	If only two drives, the last drive goes here; otherwise, the lowest class of the remaining drives goes here.
3	If only three drives, attach the final drive here. If a fourth drive exists, attach the lowest class drive here.
4	If there is a fourth drive, attach the final drive here—the drive with the highest class number of all devices.

If there are three or more devices, two or more of which are hard drives, two hard drives should be attached to the primary controller first before following the general attach sequence rule.

The rules allow for:

- Keep the hard drive on a separate controller channel to maximize drive performance until a fourth device is added.
- Keep the hard drives and removable media drives on separate controller channels to maximize compatibility.
- Keep the hard drive and the writable optical drive on separate controller channels to maximize optical drive reliability.

## Attach sequence worksheet

Use the worksheet below to obtain optimum system performance when setting up a workstation with multiple drives. Use the general attach sequence rule to determine the best drive installation sequence.

**Table C-3** Attach sequence worksheet

Device name	Device class	Position number	Controller name	Device number

**Table C-3** Attach sequence worksheet (continued)

Device name	Device class	Position number	Controller name	Device number

Two examples of how to use the worksheet are:

- Three device installation
- Four device installation

**Example 1: Three device installation sample**

A system has three devices: Ultra ATA-100 hard drive, CD-ROM drive, and a DVD drive. Using the Device Class Table, the devices can be identified as:

- Ultra ATA-100 hard drive = Class 1
- DVD drive = Class 2
- CD-ROM drive = Class 3

**Table C-4** Attach sequence worksheet—Three device installation (sample)

Device name	Device class	Position number	Controller name	Device number
Ultra ATA-100 hard drive	1	1	Primary	0
DVD drive	2	2	Secondary	0
CD-ROM drive	3	3	Secondary	1

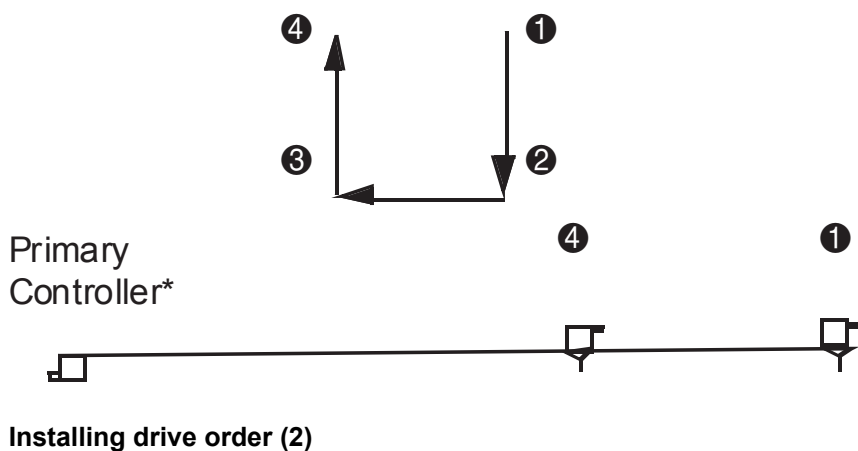

### Example 2: Four device installation sample

A system has four devices: Ultra ATA-100 hard drive, Ultra ATA-100 hard drive, DVD-CDR/W drive, and a ZIP-250 drive.

- Ultra ATA-100 hard drive = Class 1
- Ultra ATA-100 hard drive = Class 1
- DVD-CDR/W drive = Class 2
- ZIP-250 drive = Class 4

**Table C-5** Attach sequence worksheet—Four device installation (sample)

Device name	Device class	Position number	Controller name	Device number
Ultra ATA-100 hard drive	1	1	Primary	0
DVD-CDR/W drive	2	2	Secondary	0
ZIP-250 drive	4	3	Secondary	1
Ultra ATA-100 hard drive*	1	4	Primary	1

\*If there are three or more devices, two or more of which are hard drives, two hard drives should be attached to the primary controller first before following the general attach sequence rule.

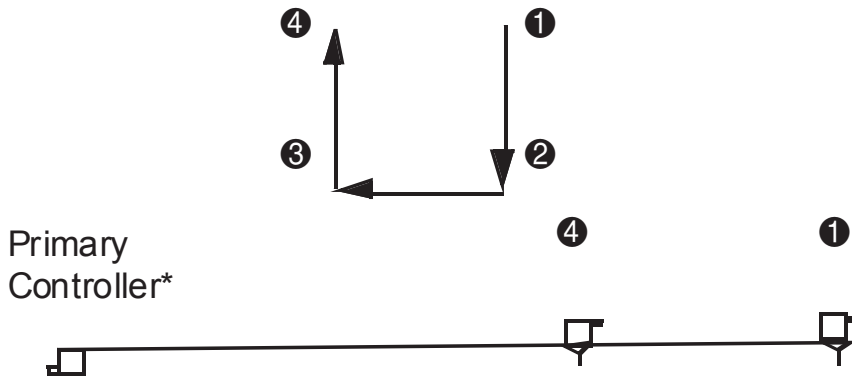

**Installing drive order (3)**

### Additional drive application notes

- When replacing a hard drive, the replacement should be of the same type (Ultra ATA-33, -66, or -100) as that being removed to retain the same level of performance.

## SMART

The Self Monitoring Analysis and Recording Technology (SMART) ATA drives for HP workstations have built-in drive failure prediction that warns the user or network administrator of an impending failure or crash of the hard drive. The SMART drive tracks fault prediction and failure indication parameters, such as reallocated sector count, spin retry count, and calibration retry count. If the drive determines that a failure is imminent, it generates a fault alert.

# Jumpers

The following specification is the standard drive configuration.

## CD-ROM or DVD-ROM drive

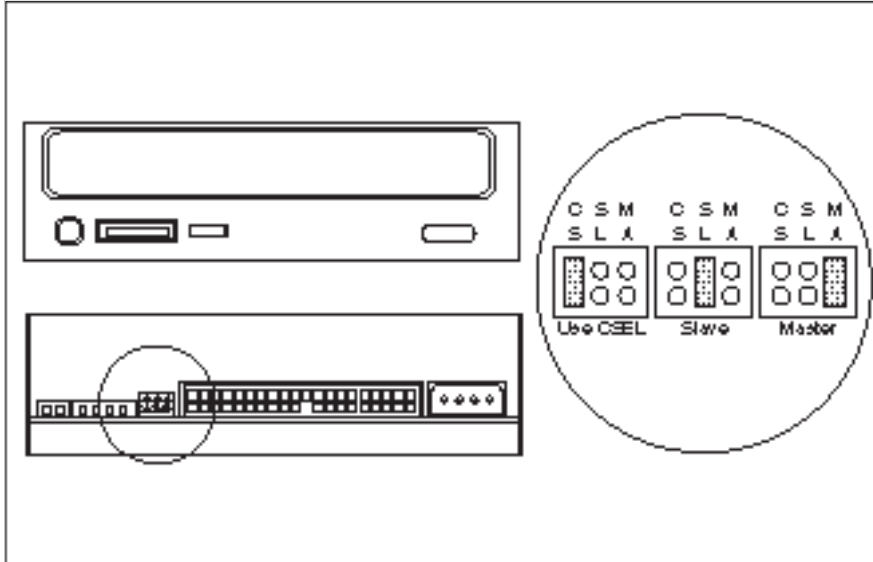

CD-ROM or DVD-ROM drive jumpers



# D Appendix D — Connector pins

# Connector pin descriptions

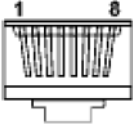

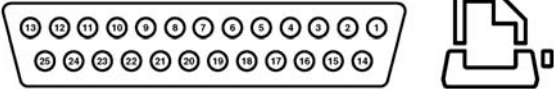
Ethernet connector	Pin	Signal
	1	(+) Transmit Data
	2	(-) Transmit Data
	3	(+) Receive Data
	4	Unused
	5	Unused
	6	(-) Receive Data
	7	Unused
	8	Unused

Parallel connector

Pin	Signal	Pin	Signal	Pin	Signal
1	Strobe	7	Data Bit 5	13	Select
2	Data Bit 0	8	Data Bit 6	14	Auto Linefeed
3	Data Bit 1	9	Data Bit 7	15	Error
4	Data Bit 2	10	Acknowledge	16	Initialize Printer
5	Data Bit 3	11	Busy	17	Select IN Signal
6	Data Bit 4	12	Paper End	18-25	Ground

Serial connector	Pin	Signal
	1	Carrier Detect
	2	Receive Data
	3	Transmit Data
	4	Data Terminal Ready Signal
	5	Ground
	6	Data Set Ready
	7	Request to Send
	8	Clear to Send
	9	Ring Indicator

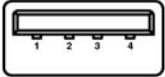

USB connector	Pin	Signal
 	1	+5 VDC
	2	- Data
	3	+ Data
	4	GND

IEEE 1394 connector	Pin	Signal
	1	power
	2	gnd
	3	tpb-
	4	tpb+
	5	tpa-
	6	tpa+

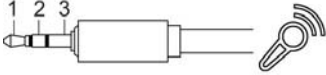
Microphone connector (1/8 inch)	Pin	Signal
	1 (Tip)	Audio
	2 (Ring)	Power
	3 (Shield)	Ground

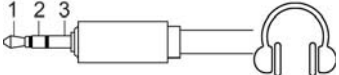
Headphone connector (1/8 inch)	Pin	Signal
	1 (Tip)	Audio_Left
	2 (Ring)	Audio_Right
	3 (Shield)	Ground

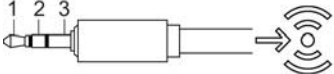
Line-in audio connector (1/8 inch)	Pin	Signal
	1 (Tip)	Audio_In_Left
	2 (Ring)	Audio_In_Right
	3 (Shield)	Ground

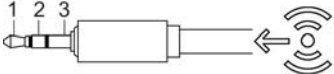
Line-out audio connector (1/8 inch)	Pin	Signal
	1 (Tip)	Audio_Out_Left
	2 (Ring)	Audio_Out_Right

Line-out audio connector (1/8 inch)	Pin	Signal
	3 (Shield)	Ground

### SATA connector

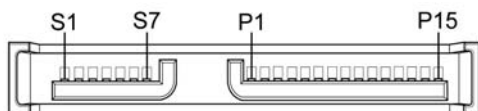

Pin	Signal	Pin	Signal	Pin	Signal
<b>Data Cable</b>		<b>Power Cable</b>		<b>Power Cable</b>	
S-1	Ground	P-1	3.3-V power	P-8	5-V power
S-2*	A+	P-2	3.3-V power	P-9	5-V power
S-3*	A-	P-3	3.3-V power	P-10	Ground
S-4	Ground	P-4	Ground	P-11	Reserved
S-5**	B-	P-5	Ground	P-12	Ground
S-6**	B+	P-6	Ground	P-13	12-V power
S-7	Ground	P-7	5-V power	P-14	12-V power
				P-15	12-V power

\* S2 and S3 differential signal pair

\*\*S5 and S6 differential signal pair

### SAS connector

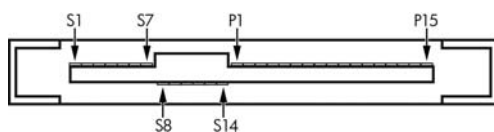

Segment	Pin	Backplane receptacle	Plug and cable receptacles
Primary signal segment	S1	SIGNAL GROUND	
	S2	TP+	RP+
	S3	TP-	RP-
	S4	SIGNAL GROUND	
	S5	RP-	TP-
	S6	RP+	TP+
	S7	SIGNAL GROUND	

## SAS connector

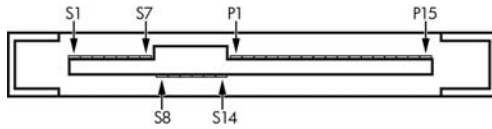

Segment	Pin	Backplane receptacle	Plug and cable receptacles
Secondary signal segment	S8	SIGNAL GROUND	
	S9	TS+	RS+
	S10	TS-	RS-
	S11	SIGNAL GROUND	
	S12	RS-	TS-
	S13	RS+	TS+
	S14	SIGNAL GROUND	
	Power segment	P1	$V_{33}^c$
P2		$V_{33}^c$	
P3		$V_{33}^c$ precharge <sup>c</sup>	
P4		GROUND	
P5		GROUND	
P6		GROUND	
P7		$V_5^c$ precharge <sup>c</sup>	
P8		$V_5^c$	
P9		$V_5^c$	
P10		GROUND	
P11		READY LED <sup>d</sup>	
P12		GROUND	
P13		$V_{12}$ precharge <sup>c</sup>	
P14		$V_{12}^c$	
P15		$V_{12}^c$	

### VGA connector

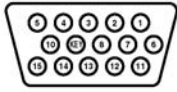

Pin	Signal	Pin	Signal	Pin	Signal
1	Red Analog	6	GND	11	Monitor ID
2	Green Analog	7	GND	12	DDC Serial Data
3	Blue Analog	8	GND	13	Horizontal Sync
4	Monitor ID	9	+5V DC	14	Vertical Sync
5	GND	10	GND	15	DDC Serial Clock

### DVI connector

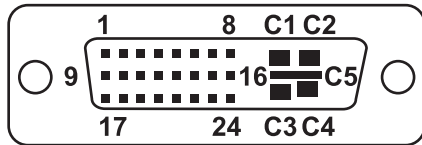

Pin	Signal	Pin	Signal
1	T.M.D.S DATA 2-	16	HOT PLUG DETECT
2	T.M.D.S DATA 2+	17	T.M.D.S DATA 0-
3	T.M.D.S DATA 2/4 SHIELD	18	T.M.D.S DATA 0+
4	T.M.D.S DATA 4-	19	T.M.D.S DATA 0/5 SHIELD
5	T.M.D.S DATA 4+ 2	0	T.M.D.S DATA 5-
6	DDC CLOCK	21	T.M.D.S DATA 5+
7	DDC DATA	22	T.M.D.S CLOCK SHIELD
8	ANALOG VERT. SYNC	23	T.M.D.S CLOCK+
9	T.M.D.S DATA 1-	24	T.M.D.S CLOCK-
10	T.M.D.S DATA 1+		
11	T.M.D.S DATA 1/3 SHIELD	C1	ANALOG RED
12	T.M.D.S DATA 3-	C2	ANALOG GREEN
13	T.M.D.S DATA 3+	C3	ANALOG BLUE
14	+5V POWER	C4	ANALOG HORZ SYNC
15	GND	C5	ANALOG GROUND

### ATA/ATAPI (IDE) standard drive cable connector

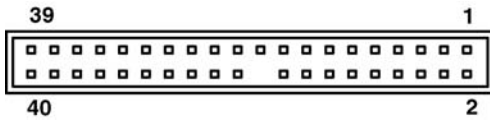

Pin	Signal	Pin	Signal	Pin	Signal
1	Reset	15	DD1	29	DMAK
2	GND	16	DD14	30	GND
3	DD7	17	DD0	31	INTRQ
4	DD8	18	DD15	32	IOCS16
5	DD6	19	GND	33	DA1
6	DD9	20	(Key)	34	PDIAG (cable detect)
7	DD5	21	DMARQ	35	DA0
8	DD10	22	GND	36	DA2
9	DD4	23	DIOW	37	CS1FX
10	DD11	24	GND	38	CS3FX
11	DD3	25	DIOR	39	DASP
12	D12	26	GND	40	GND
13	D2	27	IORDY		
14	D13	28	CSEL		

### 24-Pin Main power connector

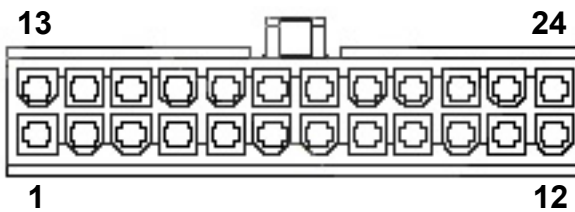

1	+3.3 V	8	POK	14	-12 V	21	+5 V
2	+3.3 V	9	+5 Vaux	15	GND	22	+5 V/+5 V-Rsense
3	GND	10	+12 V-A	16	PS_ON_L	23	+5 V
4	+5 V	11	+12 V-A	17	GND	24	GND
5	GND	12	+3.3 V	18	GND		
6	+5 V	13	+3.3 V/+3.3 V-Rsense	19	GND		
7	GND			20			



**CAUTION** Be sure you can differentiate between which power cable connects to the PCI Express x16 graphics card and which power cable connects to the system board. These two cables look very similar. The PCI Express power cable has a black connector, and the system board power cable has a white connector. When power is present, you must **never** connect the PCI Express power cable to the system board. If you do so, the system board may be damaged and your warranty voided. To see a picture of the PCI Express cable and where it must be connected, refer to [PCI or PCI Express installation on page 75](#).

6-Pin power (auxiliary system board) connector	Pin	Color	Signal
	1	BLD w/ORG stripe	+3.3V
	2	BLK w/ORG stripe	+3.3V
	3	BLD w/YEL stripe	+12V-A
	4	BLK	GND
	5	BLK	GND
	6	BLD w/YEL stripe	-12V

8-Pin power (for CPUs and memory)	Pin	Color	Signal
	1	BLK	GND
	2	BLK	GND
	3	BLK	GND
	4	BLK	GND
	5	Gray	+12 V CPU0 Rsense
	6	BLK w/WHT stripe	+12 V CPU0
	7	BLK w/light blue stripe	+12V CPU1
	8	BLK w/light blue stripe	+12V CPU1





**CAUTION** Be sure you can differentiate between which power cable connects to the PCI Express x16 graphics card and which power cable connects to the system board. These two cables look very similar. The PCI Express power cable has a black connector, and the system board power cable has a white connector. When power is present, you must **never** connect the PCI Express power cable to the system board. If you do so, the system board may be damaged and your warranty voided. To see a picture of the PCI Express cable and where it must be connected, refer to [PCI or PCI Express installation on page 75](#).

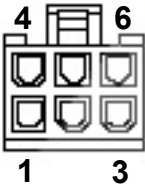

**NOTE** The 6-pin power (auxiliary PCI Express) is only required with high-powered graphics cards.

6-Pin power (auxiliary PCI Express)	Pin	Color	Signal
	1	BLK w/YEL stripe	+12V-C
	2	BLK w/YEL stripe	+12V-C
	3	BLK w/YEL stripe	+12V-C
	4	BLK	GND
	5	BLK	GND
	6	BLK	GND

Keyboard connector	Pin	Signal
	1	Data
	2	Unused
	3	Ground
	4	+5 VDC
	5	Clock
	6	Unused

Mouse connector	Pin	Signal
	1	Data
	2	Unused
	3	Ground
	4	+5 VDC
	5	Clock
	6	Unused





# E Appendix E — System board designators

This appendix lists the system board designators for this system.

Designator	Silkscreen	Component
MH02-03, MH06-09, MH14-15	N/A	Mounting holes
N/A	N/A	LED: 5V_AUX power indicator
N/A	N/A	Power LED
E14	BBLK_WP	Boot block header/jumper
E49	PSWD	Clear password header/jumper
J20	SLOT1 PCI	PCI slot
J21	SLOT5 PCI-X 133	PCI slot
J22	SLOT6 PCI-X 100	PCI slot
J23	SLOT7 PCI-X 100	PCI slot
J31	SLOT 3 PCI-E x8 (4)	PCI Express slot
J32	SLOT 4 PCI-E x16 (4)	PCI Express slot
J41	SLOT2 PCI-E x16 GRAPHICS	PCI Express x16 slot for graphics
P80-83	SAS0, SAS1, SAS2, SAS3	SAS Connectors
P60-63, P66-67	SATA0, SATA1, SATA2, SATA3, SATA4, SATA5	SATA Connectors
J53, P53	PAR/SER	Parallel port and serial port stack connector
J68	KBD MS PS2	Stacked keyboard/mouse connector
J9	RJ45/USB	Stacked RJ 45/dual USB
J10	USB	Quad stacked USB
J11	1394	IEEE 1394a connector
J83	AUD	Triple stacked audio jack
N/A	N/A	Reset header
SW50	CMOS	Clear CMOS switch/push button
P1	PWR	Power supply connector (24-pin)
P2	PWR2	Second power supply connector

Designator	Silkscreen	Component
P3	PWRCPU	Processor 12-V header
P10	FDD	Diskette driver connector
N/A	N/A	Security boot connector
N/A	N/A	CD analog audio connector
P11	AUX	Auxiliary audio connector
P20	PRIMARY IDE	Primary IDE connector
N/A	N/A	Secondary IDE connector
J12	FRNT 1394	Front panel 1394a header
J34	FRNT AUD	Front panel audio header
P24	FRNT USB	Front panel USB header
P25	INT USB	Internal USB header
N/A	N/A	Multi-Bay Header
P29	HDD LED	HDD LED connector
J33	CONTROL PANEL	Main power/HDD LED/internal speaker connector
P70	CPUFAN1	Primary CPU fan header
P71	CPU2FAN	Secondary CPU fan header
P8	CHFAN	Primary chassis fan header
P92	MEMFAN	Memory fan header
P9	PCIFAN1	PCI fan header
P93	FRNTFAN	Front chassis fan header
BAT1	BAT	Battery retainer
XMM1	DIMM1	Memory slot
XMM2	DIMM2	Memory slot
XMM3	DIMM3	Memory slot
XMM4	DIMM4	Memory slot
XMM5	DIMM5	Memory slot
XMM6	DIMM6	Memory slot
XMM7	DIMM7	Memory slot
XMM8	DIMM8	Memory slot
U1	XU1	Primary processor socket
U2	XU2	Secondary processor socket
U23	ROM	ROM socket
E15	RECOVER	Crisis recovery header/jumper

# F Appendix F — Power cord set requirements

The power cord set (flexible cord or wall plug) received with this product meets the requirements for use in the country where you purchased the equipment.

If you must obtain a power cord for a different country, purchase a power cord that is approved for use in that country.

The power cord must be rated for the product and for the voltage and current marked on the product's electrical ratings label. The voltage and current rating of the cord should be greater than the voltage and current rating marked on the product. The length of the cord must be between 1.8 m (6 feet) and 3.6 m (12 feet). If you have questions about the type of power cord to use, contact an HP authorized service provider.

Route the power cord so that it is not likely to be walked on or pinched by items placed on it or against it. Pay particular attention to the plug, electrical outlet, and the point where the cord exits from the product.



---

**NOTE** Use a 15 A-capable (minimum) power cord with a 110V power source. Use a 10 A-capable (minimum) power cord with a 220V power source.

---



# G Appendix G — Routine care

## General cleaning safety precautions

- Never use solvents or flammable solutions to clean the workstation.
- Never immerse any component in water or cleaning solutions; apply any liquids to a clean cloth and then use the cloth on the component.
- Always unplug the workstation before cleaning the keyboard, mouse, or air vents.
- Disconnect the keyboard before cleaning it.
- Wear safety glasses equipped with side shields when cleaning the keyboard.

## Maximizing the airflow

- Keep your workstation in an area where the airflow to the front and rear of the system is not obstructed.
- If possible, keep the unit off of surfaces where dust can gather.
- Keep the back of the unit at least 0.15 m (6 in.) away from a wall or other obstruction.
- Keep the front of the unit clear of any obstruction that keeps air from entering the front of the system.
- Remove any dust on the front panel (vent area) and the rear fans with a small vacuum, compressed air, or dust rag.

## Cleaning the workstation case

- Follow the safety precautions presented in [Service considerations on page 50](#) before cleaning the workstation.
- To remove light stains or dirt, use plain water with a clean, lint-free cloth or swab.
- For stronger stains, use a mild dish-washing liquid diluted with water. Rinse well by wiping it with a cloth or swab dampened with clear water.
- For stubborn stains, use isopropyl (rubbing) alcohol. No rinsing is needed because the alcohol will evaporate quickly and not leave a residue.
- After cleaning, always wipe the unit with a clean, lint-free cloth.
- Occasionally clean the air vents on the workstation. Lint and other foreign matter can block the vents and limit the airflow.



# Cleaning the keyboard



**CAUTION** Use safety glasses equipped with side shields before attempting to clean debris from under the keys.

---

- Follow the safety precautions presented in [Service considerations on page 50](#) before cleaning the keyboard.
- Visible debris underneath or between the keys can be removed by vacuuming or shaking.
- Canned, pressurized air can be used to clean debris from under the keys. Use caution because too much air pressure can dislodge lubricants applied under the wide keys.
- If you remove a key, use a specially designed key puller to prevent damage to the keys. This tool is available through many electronic supply outlets.



**CAUTION** Never remove a wide leveled key (like the space bar) from the keyboard. If these keys are improperly removed or installed, the keyboard might not function properly.

---

- Clean under a key with a swab moistened with isopropyl alcohol and squeezed out. Be careful not to wipe away lubricants necessary for proper key functions. Allow the parts to air dry before reassembly.
- Use tweezers to remove any fibers or dirt in confined areas.

## Cleaning the monitor

- Follow the safety precautions presented in [Service considerations on page 50](#) before cleaning the keyboard.
- To clean the monitor, wipe the monitor screen with a towelette designed for cleaning monitors or a clean cloth moistened with water.



---

**CAUTION** Do not use sprays or aerosols directly on the screen—the liquid might seep into the housing and damage a component.

Never use solvents or flammable liquids on the monitor because display or housing damage may result.

---

## Cleaning the mouse

1. Follow the safety precautions presented in [Service considerations on page 50](#) before cleaning the mouse.
2. Remove the mouse ball from the housing by removing the retaining plate.
3. Clean the mouse ball.
4. Pull out any debris from the ball socket, and wipe the ball with a clean, dry cloth.
5. Reassemble the mouse.



# H Appendix H — Additional password security and resetting CMOS

This workstation supports the following security password features, which can be established through the Computer Setup Utilities menu:

- Setup password
- Power-on password

When you establish a setup password, only the power-on password is required to access Computer Setup and any other information on the workstation. When you establish both passwords, only the setup password will give you access to Computer Setup.

When both passwords are set, the setup password can also be used in place of the power-on password as an override to log in to the workstation, which is a useful feature for a network administrator.

If you forget the password for the computer, two methods are available for clearing that password so you can gain access to the information on the workstation:

- Reset the password jumper
- Use the **Clear CMOS** button



---

**CAUTION** Pushing the CMOS button resets CMOS values to factory defaults and erases any customized information, including passwords, asset numbers, and special settings. It is important to back up the workstation CMOS settings before resetting them in case they are needed later. To back up the CMOS settings, use Computer Setup and run the Save to Diskette option from the File menu.

---

## Resetting the password jumper

To disable the power-on or setup password features and clear the power-on and setup passwords:

1. Shut down the operating system, and power off the workstation and any external devices. Disconnect the power cord of the workstation and any external devices from the power outlets.
2. Disconnect the keyboard, monitor, and any other external devices that are connected to the workstation.



---

**WARNING!** To reduce the risk of personal injury from electrical shock and hot surfaces, be sure to disconnect the power cord from the wall outlet and allow the internal system components to cool before touching. Remove the access panel.

---



---

**CAUTION** When the workstation is plugged in, the power supply always has voltage applied to the system board even when the unit is turned off. Failure to disconnect the power cord can result in damage to the system.

---

**CAUTION** Static electricity can damage the electronic components of the workstation or optional equipment. Before beginning these procedures, be sure that you are discharged of static electricity by briefly touching a grounded metal object.

---

3. Remove the access panel.
4. Locate the password header and jumper. The password header is E49.



---

**NOTE** The password jumper is green so that it can be easily identified. For assistance locating the password jumper and other system board components, see [System board components on page 56](#).

---

5. Remove the jumper from either pin 1 or 2. Place the jumper on pins 1 and 2 (connecting both pins together).
6. Replace the access panel.
7. Reconnect the external equipment.
8. Plug in and power on the workstation. Allow the operating system to start. This process clears the current passwords and disables the password features.
9. To establish new passwords, repeat steps 1 through 4, replace the password jumper on either pin 1 or pin 2 (but not both), and repeat steps 6 through 8. Establish the new passwords in Computer Setup.

# Clearing and Resetting the CMOS

The CMOS of the workstation stores password information and information about the workstation configuration. This section describes the steps to successfully clear and reset the CMOS.

## Using the CMOS Button

1. Shut down the operating system, and power off the workstation and any external devices. Disconnect the power cord of the workstation and any external devices from the power outlets.
2. Disconnect the keyboard, monitor, and any other external devices that are connected to the workstation.



**WARNING!** To reduce the risk of personal injury from electrical shock and hot surfaces, be sure to disconnect the power cord from the wall outlet and allow the internal system components to cool before touching.

---



**CAUTION** When the workstation is plugged in, the power supply always has voltage applied to the system board even when the unit is powered off. Failure to disconnect the power cord can result in damage to the system

Static electricity can damage the electronic components of the workstation or optional equipment. Before beginning these procedures, be sure that you are discharged of static electricity by briefly touching a grounded metal object.

---

3. Remove the access panel.



**CAUTION** Pushing the CMOS button resets CMOS values to factory defaults and erases any customized information, including passwords, asset numbers, and special settings. It is important to back up the workstation CMOS settings before resetting them in case they are needed later. To back up the CMOS settings, use Computer Setup and run the Save to Diskette option from the File menu.

---

4. Locate, press, and hold the CMOS button in for five seconds.



**NOTE** Be sure that the AC power cord is disconnected from the power outlet. The CMOS button does not clear CMOS if the power cord is connected.

For assistance locating the CMOS button and other system board components, see [System board components on page 56](#).

---

5. Replace the access panel.
6. Reconnect any external devices.
7. Plug in and power on the workstation.



**NOTE** The workstation passwords and any special configurations along with the system date and time will have to be reset.

---

## Using Computer Setup to Reset CMOS

1. To reset CMOS using Computer Setup, access the Computer Setup (F10) Utilities menu. When the Computer Setup message appears in the lower-right corner of the screen, press the **F10** key. Press **Enter** to bypass the title screen, if necessary.



**NOTE** If you do not press the F10 key while the message is displayed, the workstation must be powered off, then on again, to access the utility.

---

2. From the Computer Setup menu, select **File>Set Defaults** and **Exit**. This restores the soft settings that include boot sequence order and other factory settings. It does not, however, force hardware rediscovery.



**NOTE** The workstation passwords and any special configurations, along with the system date and time, will have to be reset.

---



# I Appendix I — Quick troubleshooting flowcharts

This appendix presents some quick troubleshooting flowcharts for the following issues:

- Initial troubleshooting
- No power
- No video
- Error messages
- No OS loading
- No OS loading from hard drive
- No OS loading from diskette drive
- No OS loading from CD-ROM drive
- No OS loading from network
- Non-functioning device



---

**NOTE** The flowcharts presented are for general troubleshooting purposes only and they might not apply to your specific workstation.

---

## Initial troubleshooting

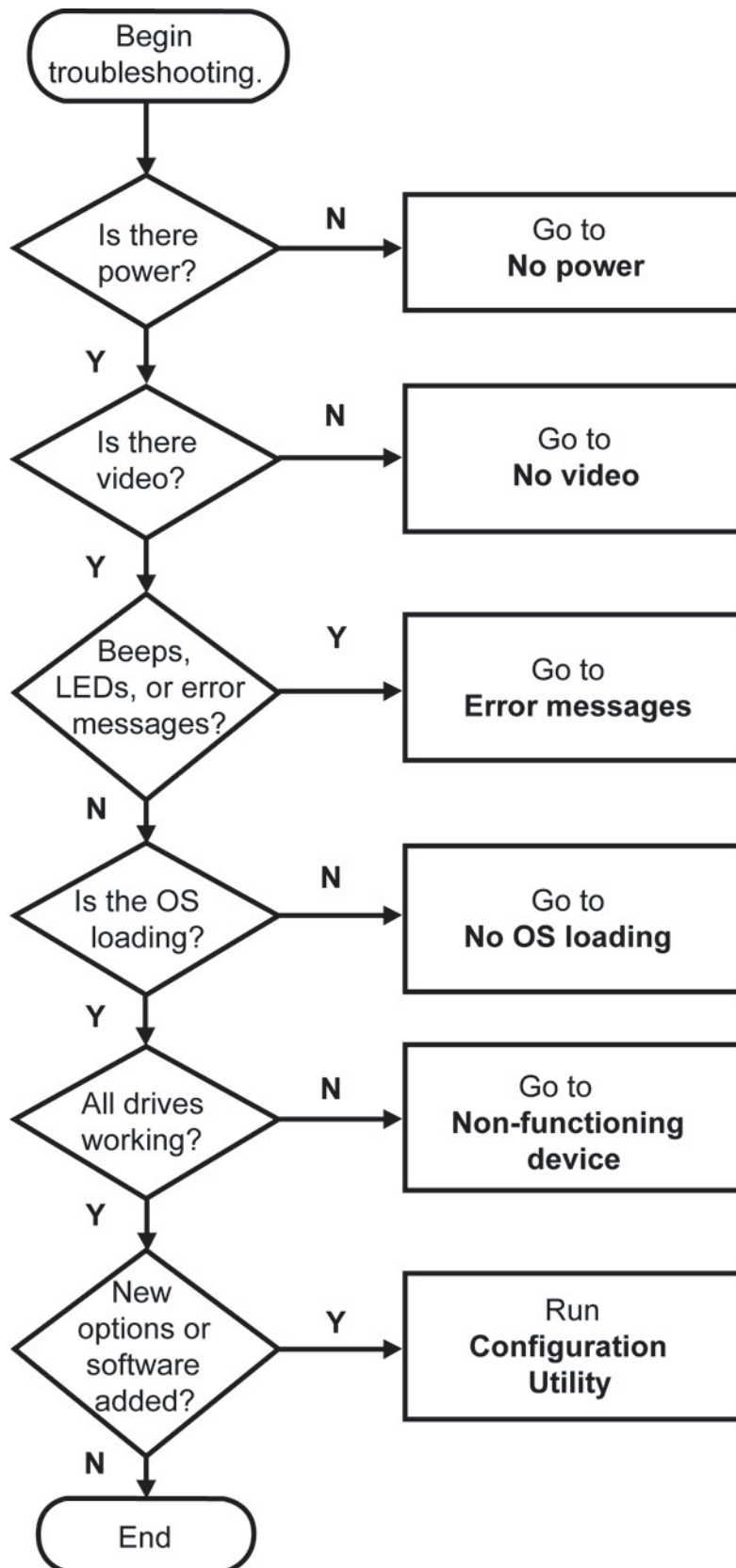

# No power

## No power, part 1

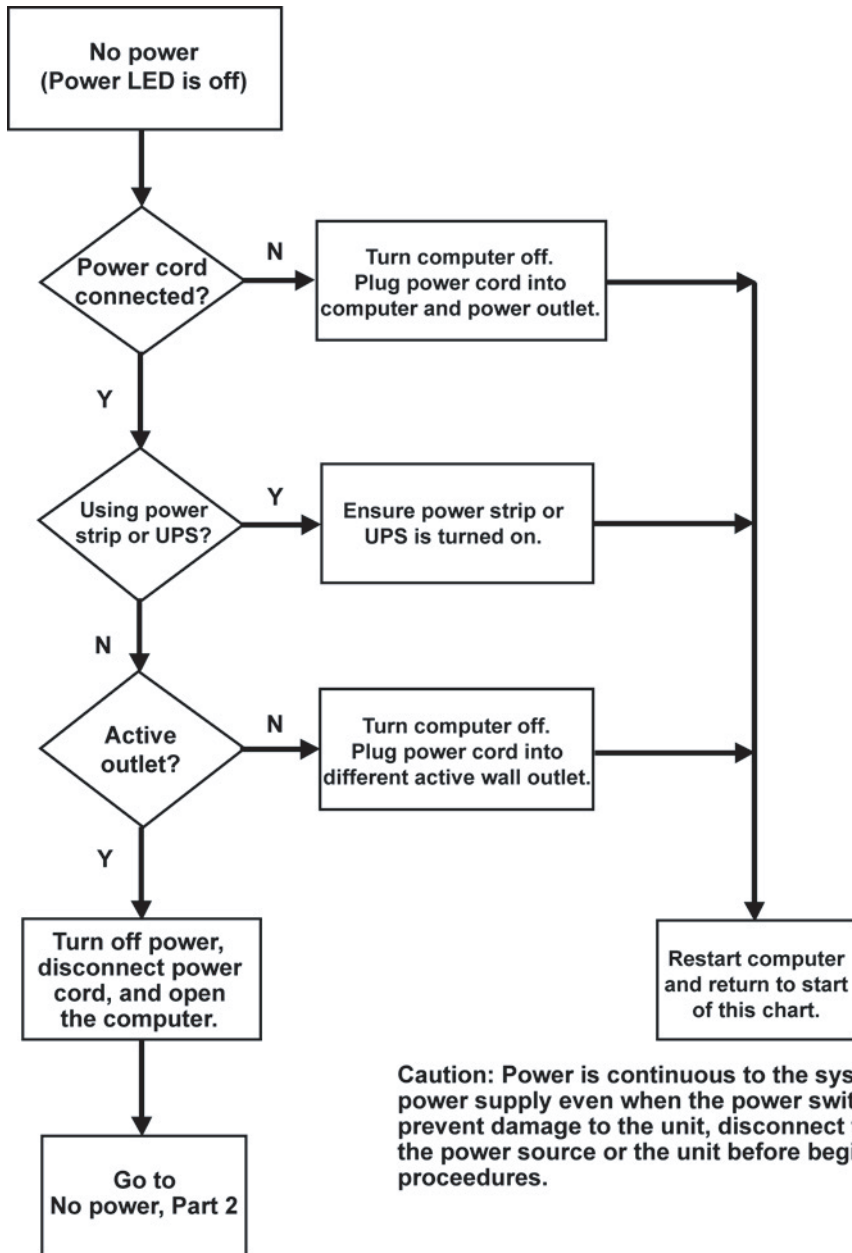

**Caution:** Power is continuous to the system board and power supply even when the power switch is off. To prevent damage to the unit, disconnect the power cord from the power source or the unit before beginning disassembly procedures.

## No power, part 2

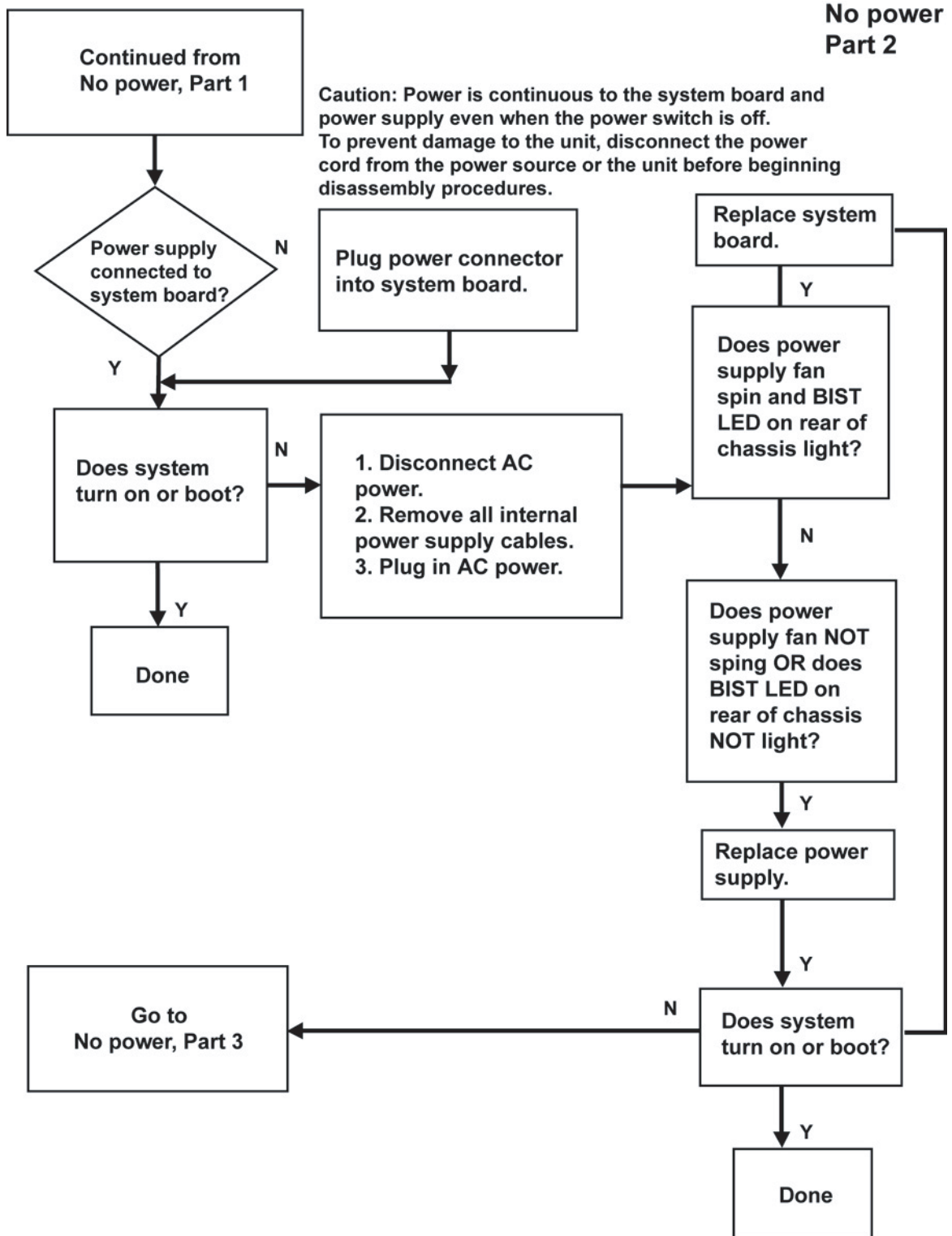

## No power, part 3

## No power Part 3

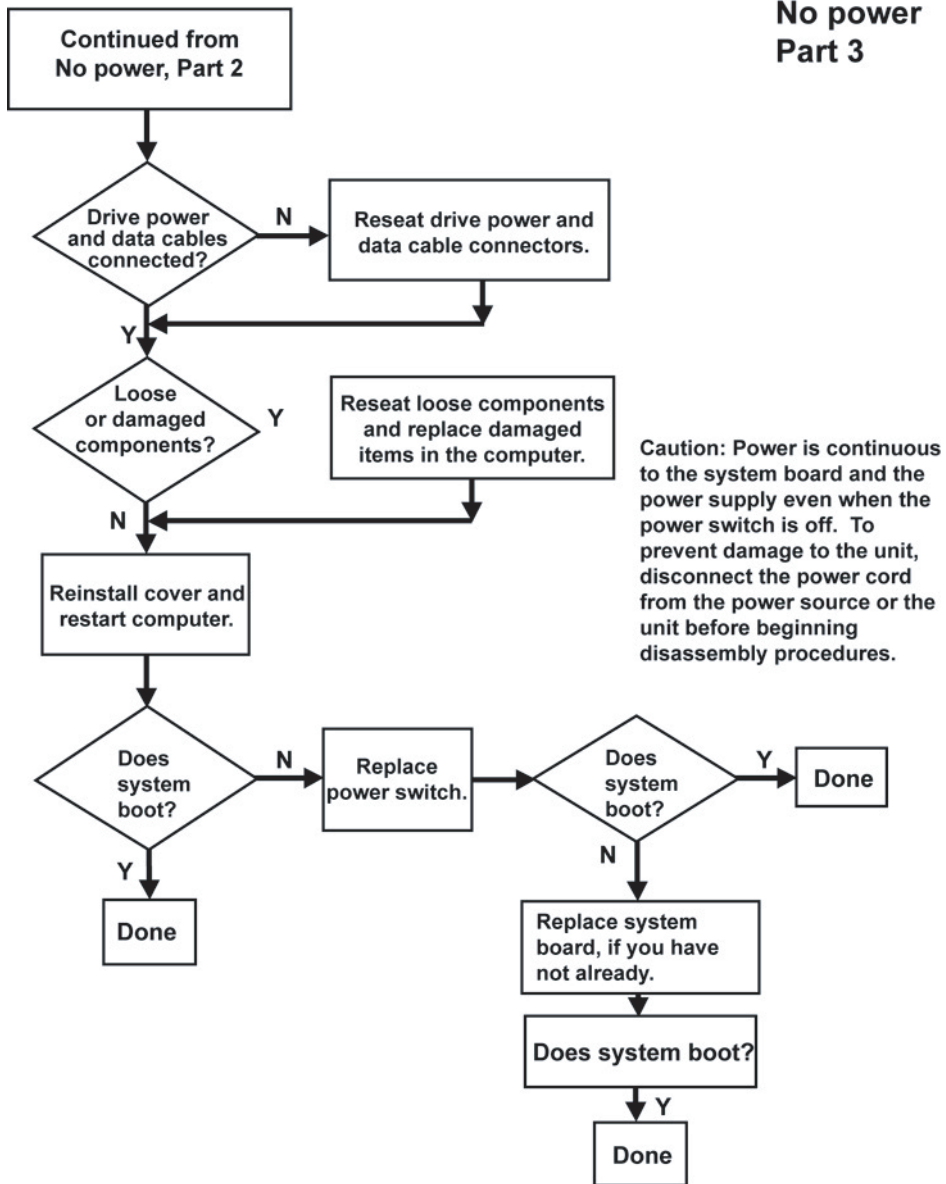

# No video

## No video, part 1

### No video Part 1

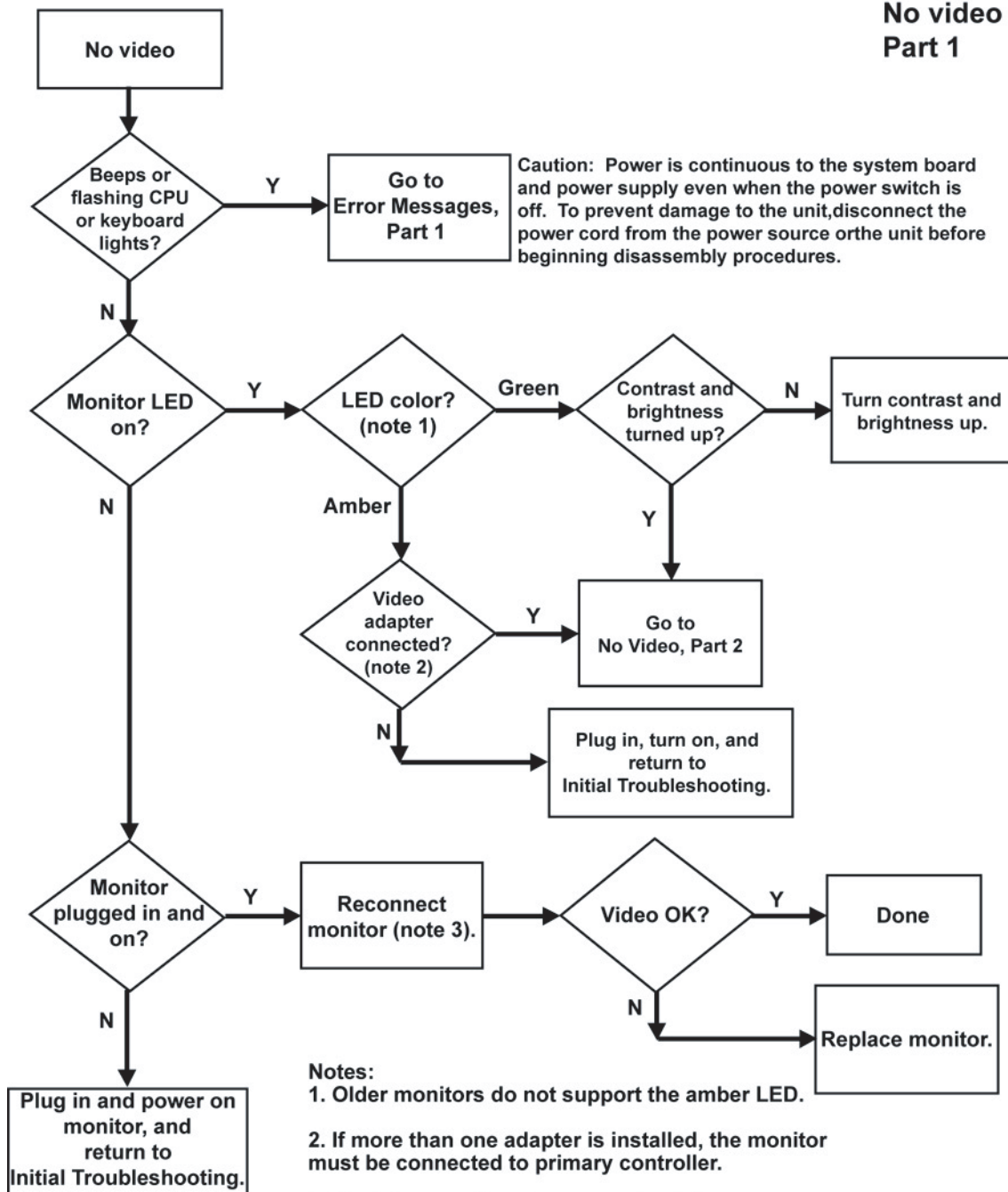

## No video, part 2

## No video Part 2

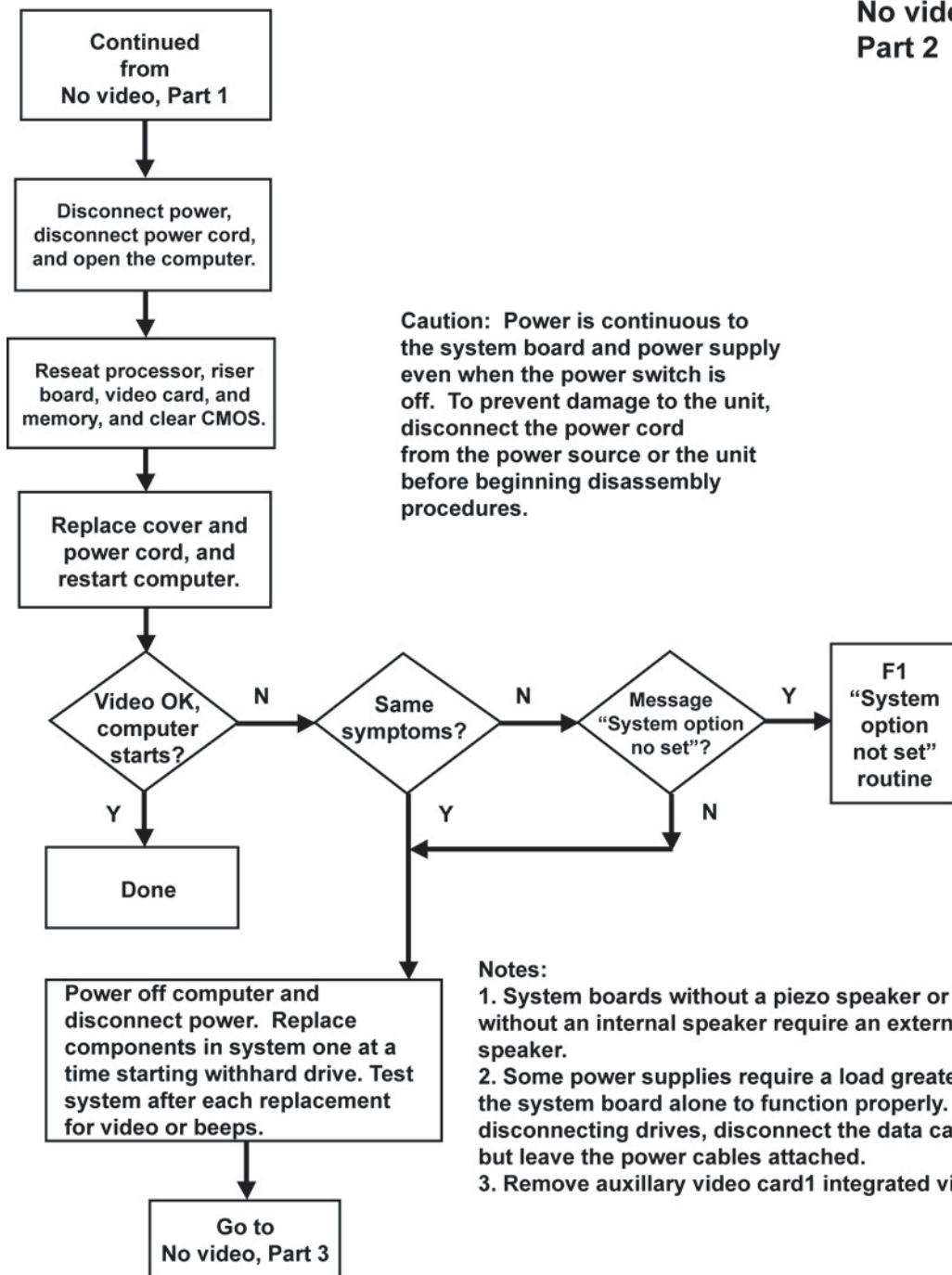

## No video, part 3

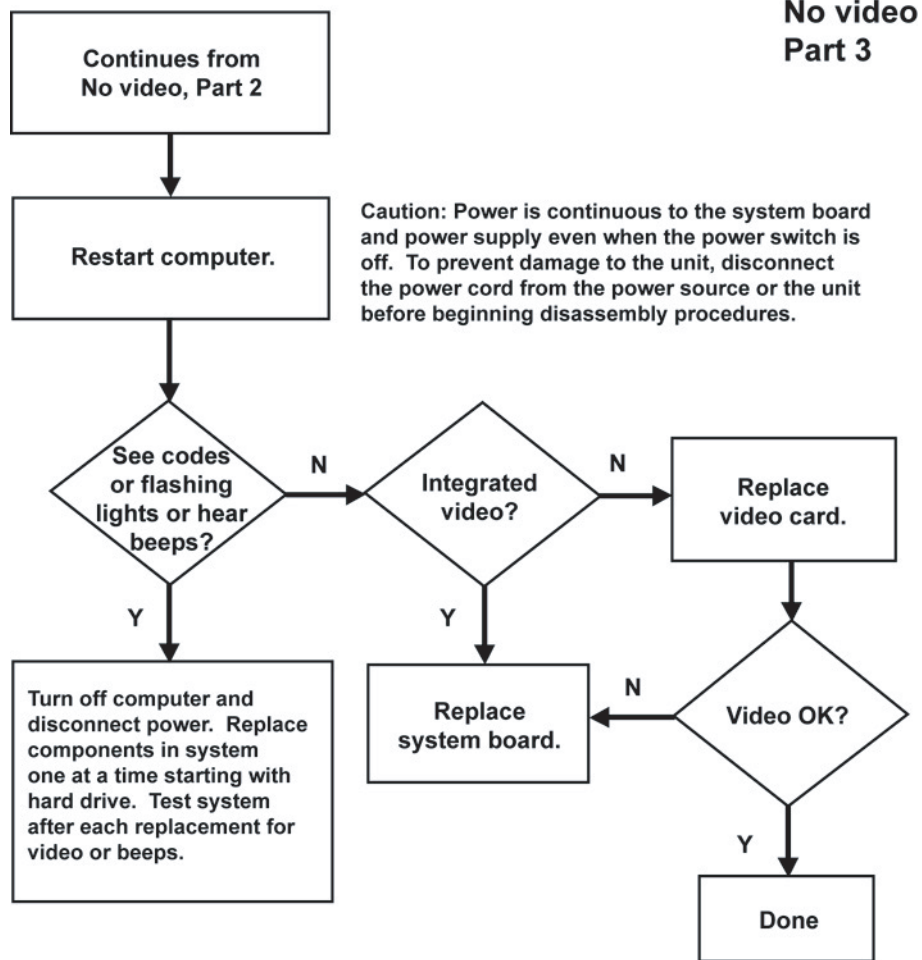



# Error messages

## Error messages, part 1

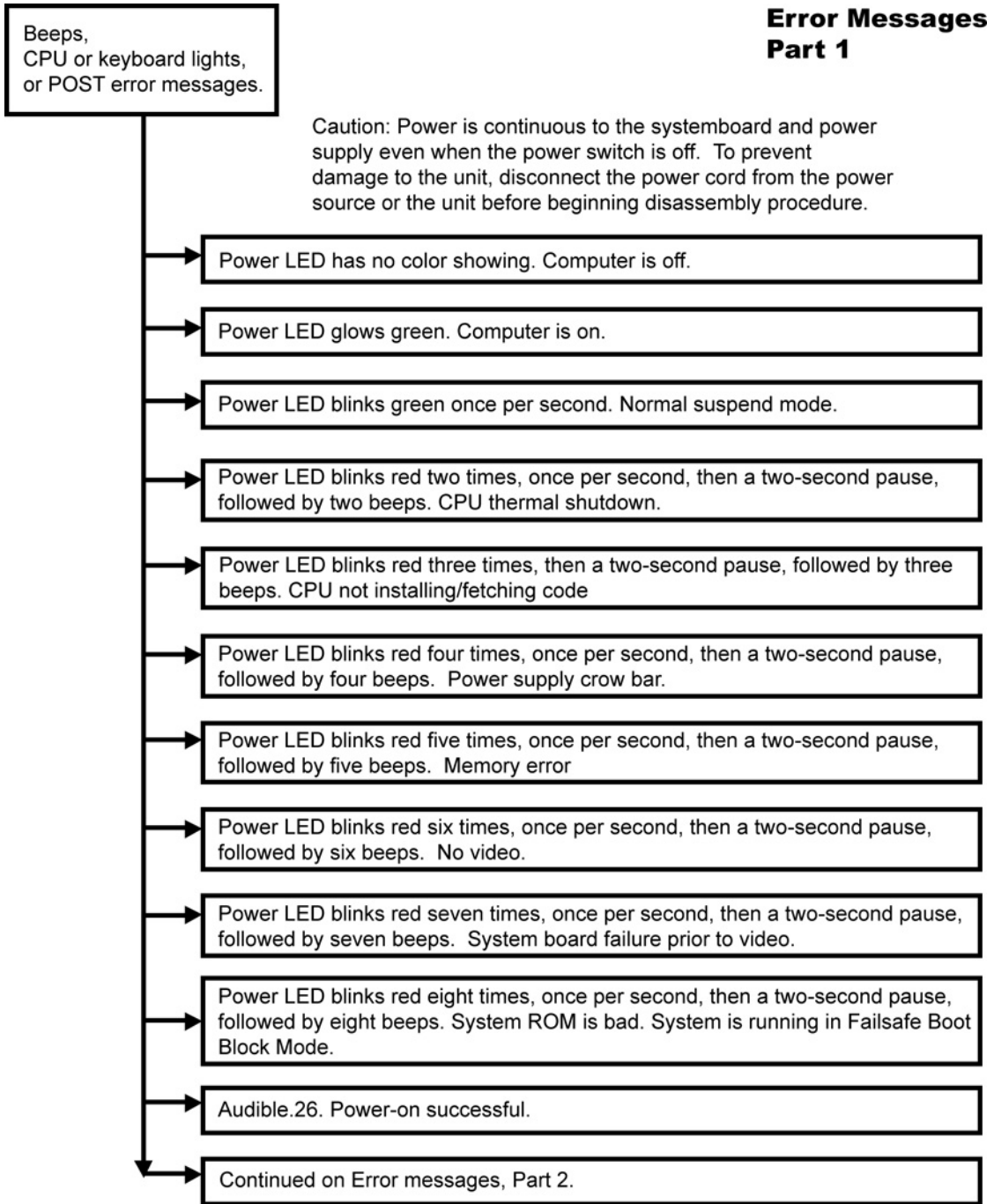

**Error Messages  
Part 2**

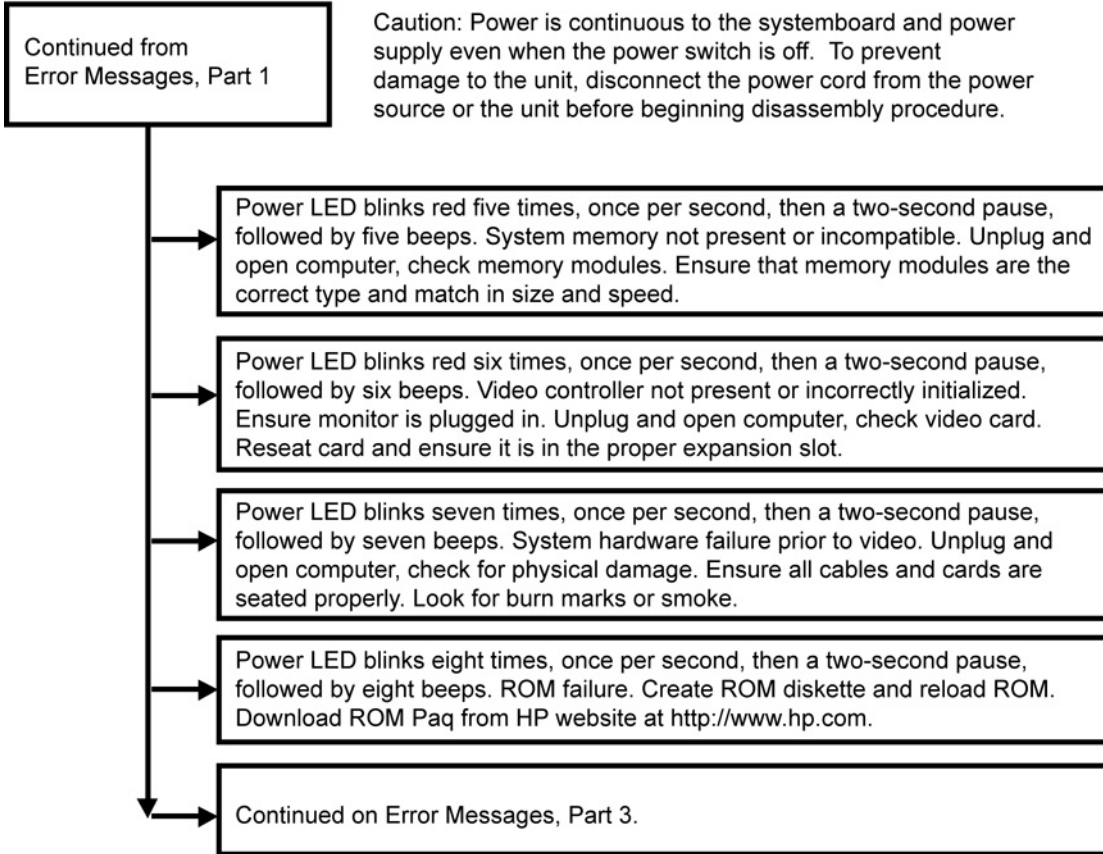

## Error messages, part 3

### Error Messages Part 3

Continued from  
Error Messages, Part 2

Caution: Power is continuous to the systemboard and power supply even when the power switch is off. To prevent damage to the unit, disconnect the power cord from the power source or the unit before beginning disassembly procedure.

Error 162. 2S Beeps System Option not set. Select F1. If error occurs after reboot, unplug and open computer and check CMOS jumper setting.

Error 163. Time & Date Not Set. Set time and date in F10 or boot OS and set time and date. If error occurs after reboot, unplug and open computer, and check CMOS setting.

Error 2xx. Memory Error. Unplug, open computer and reseal memory modules. Ensure modules are correct type and that they match in size and speed.

Error 30x. Keyboard Error. Do not type on keyboard before POST. Ensure keyboard connected to proper connector.

Error 6xx. Floppy Error. Unplug, open computer, check diskette drive, and check and reseal power and data cables.

Error 91x. Misc. Connection Error. Unplug, open computer, check hood lock coil and thermal sensor pigtail for good connection.

Error 178x. Fixed Disk Error. Unplug, open computer, check hard drive and check and reseal power and data cables.

Error 1800. Thermal Alert. System overheating. Allow computer to cool. Ensure processor has a heatsink installed and that speed setting on system board is correct. Remove obstructions to air vents.

All others POST error messages, see Chapter 5 for definitions and solutions.

Notes: Short (S) and long (L) beeps will only be heard if the system has a speaker.  
LEDs will only function on PS/2 keyboards, not USB.  
x = Numbers 1 - 9

# No operating system loading

## No OS loading

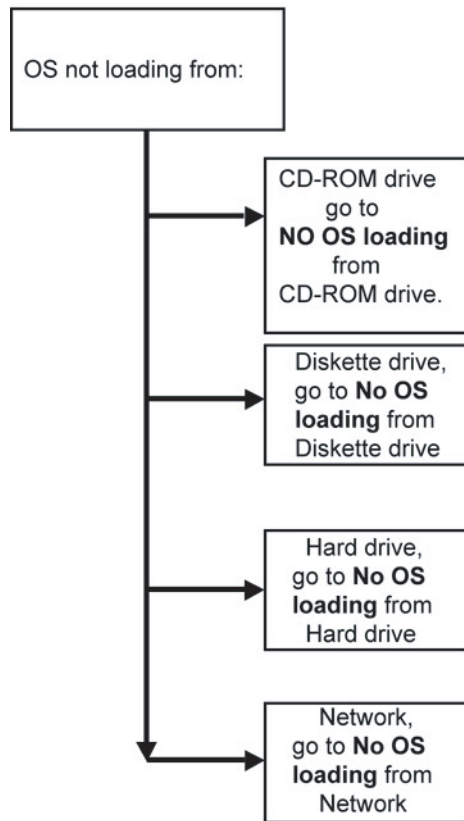

### Factory recommended booting priority

1. CD-ROM drive
2. Diskette drive
3. Hard drive
4. Network

**NOTE:** Before beginning, always check drive jumpers, cable connections, cable ends, and drives for bent or damaged pins.

# No operating system loading from hard drive

## No operating loading from hard drive, part 1

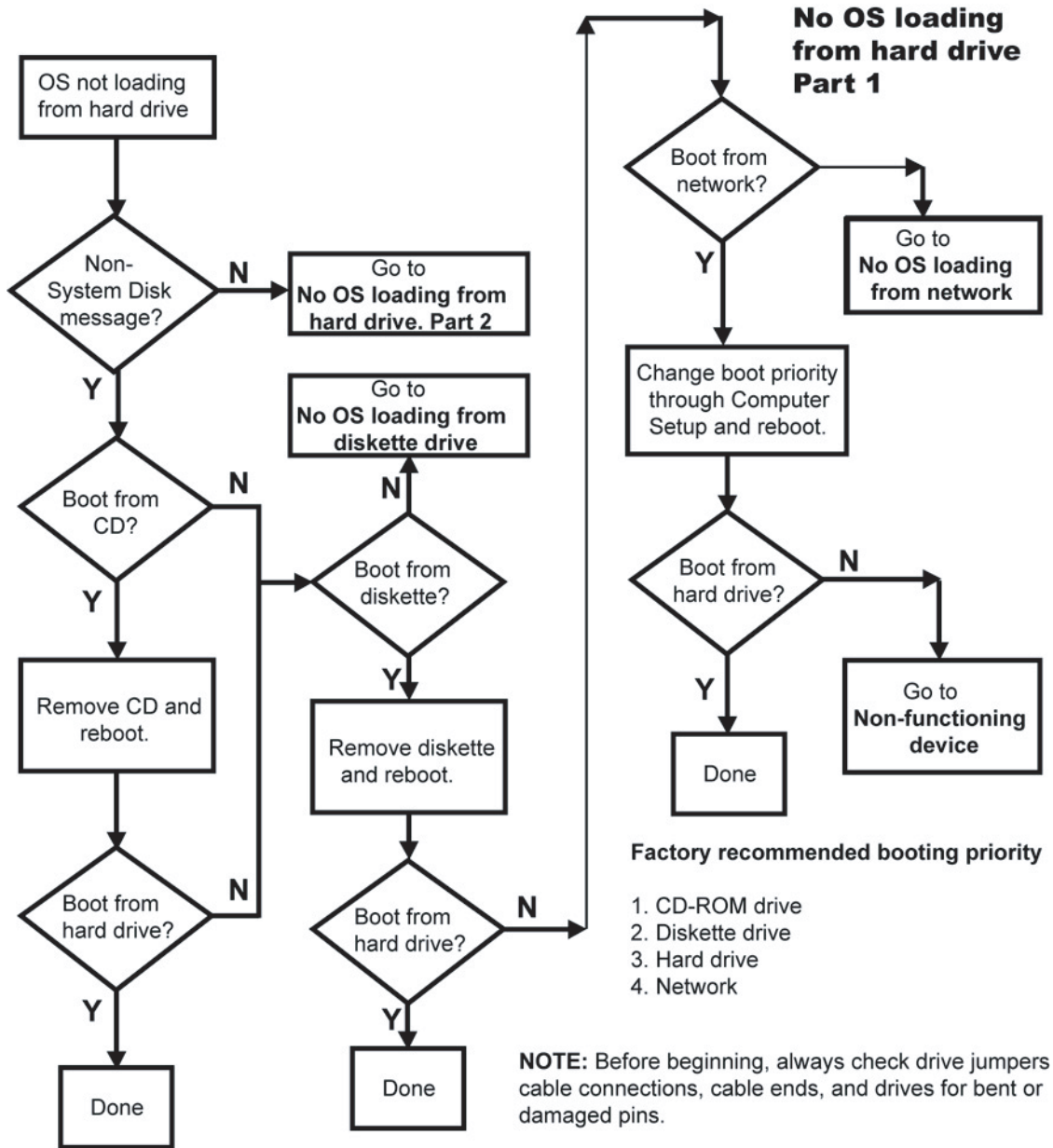

## No operating system loading from hard drive, part 2

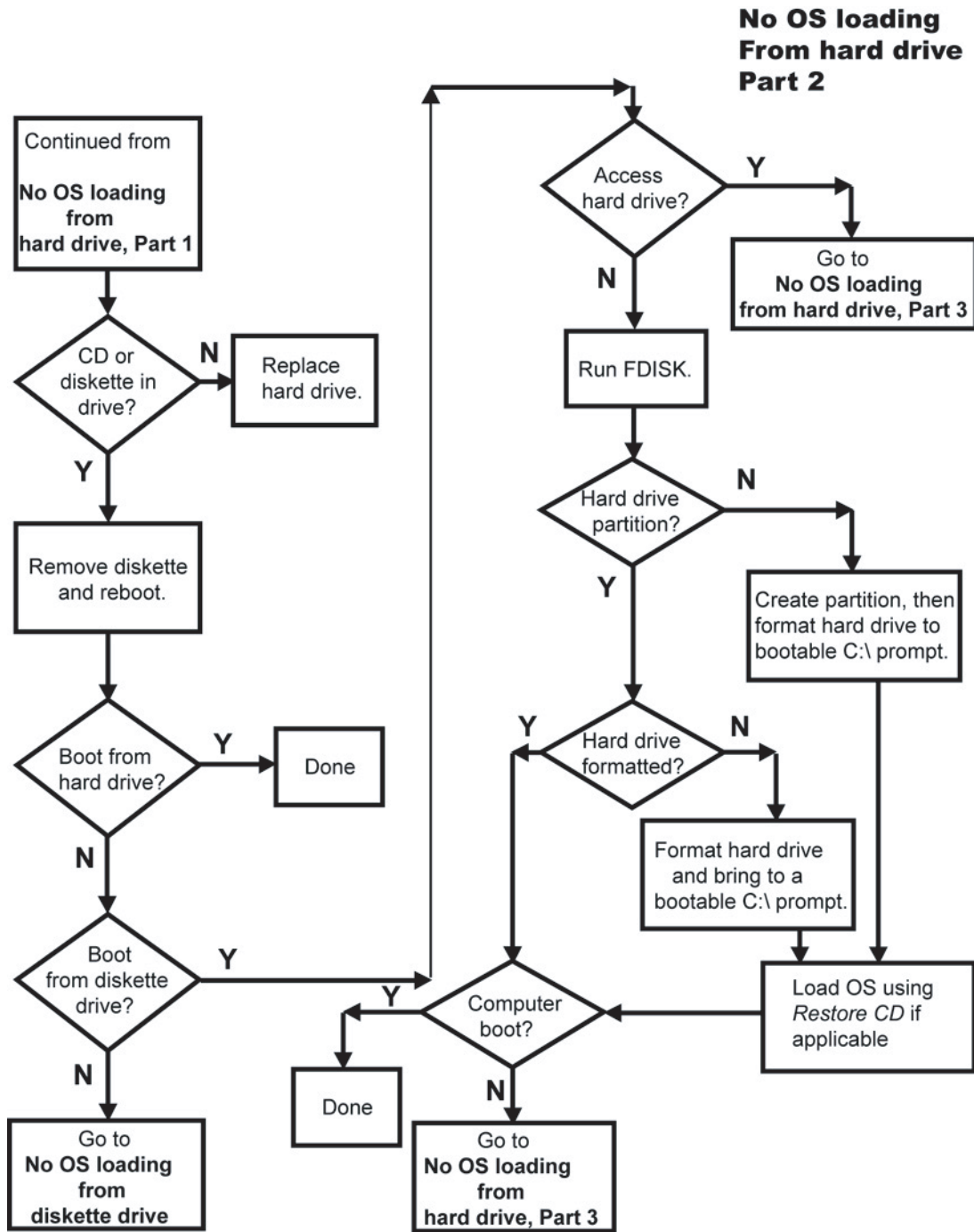

### No operating system loading from hard drive, part 3

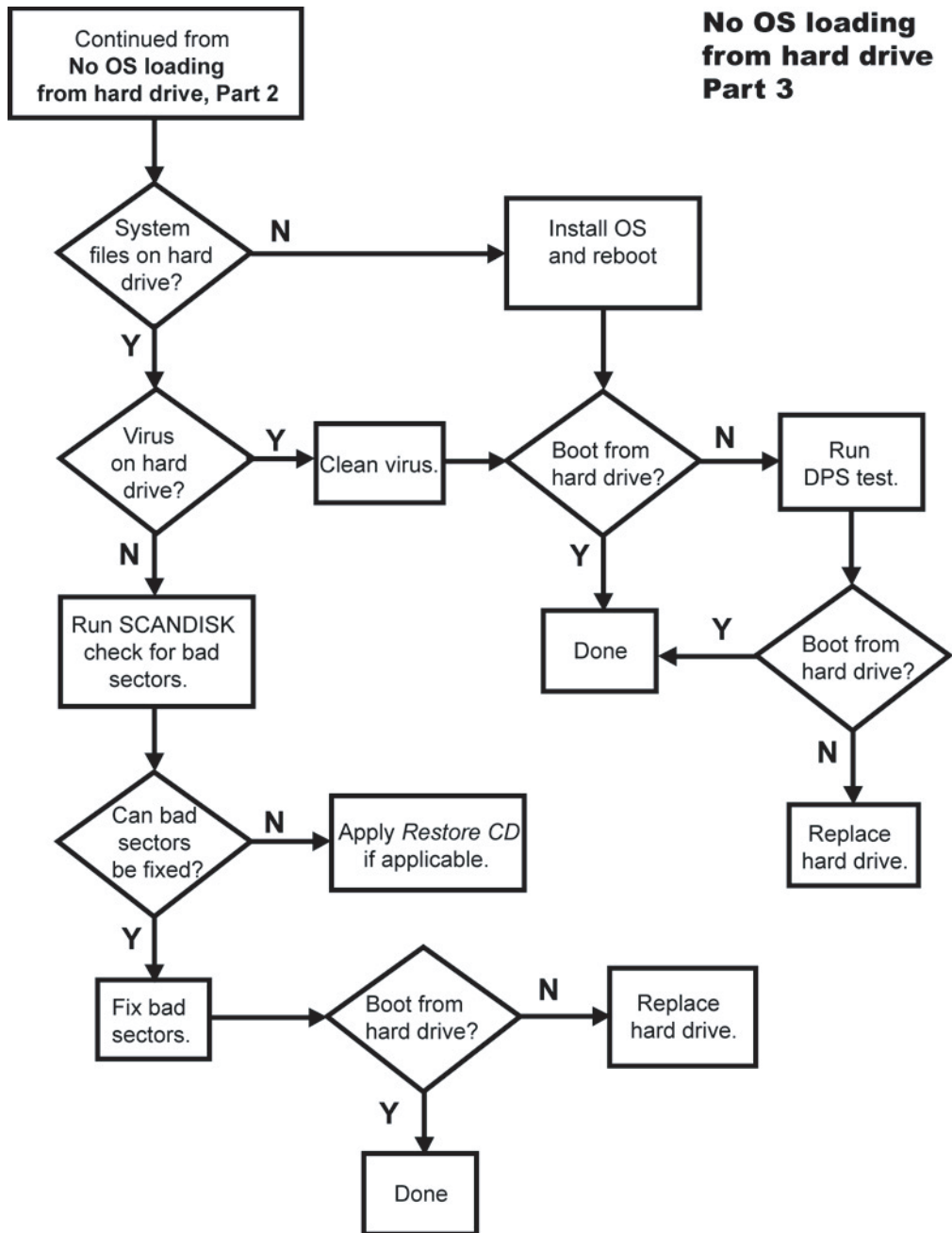

# No operating system loading from diskette drive

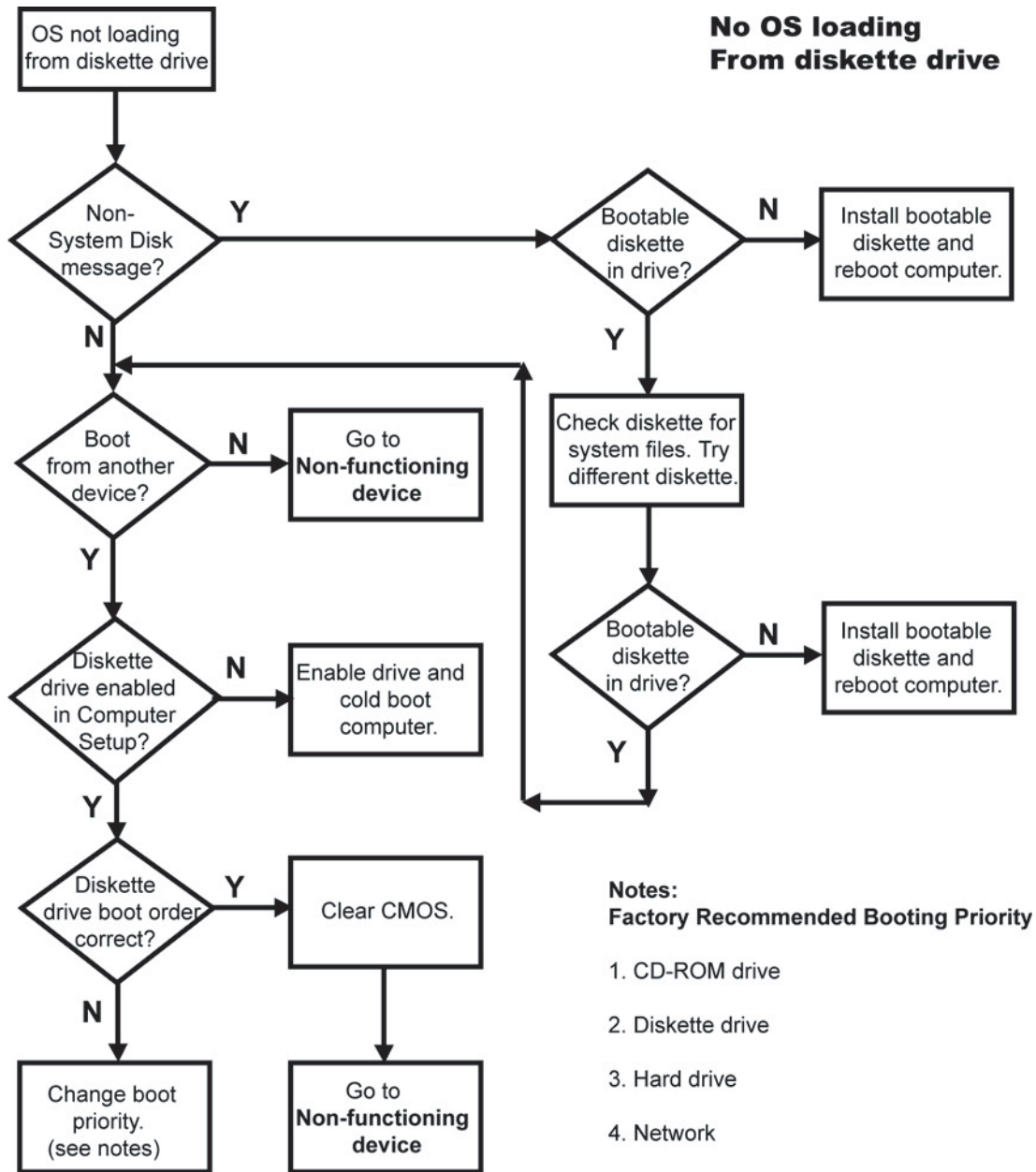



# No operating system loading from CD-ROM drive

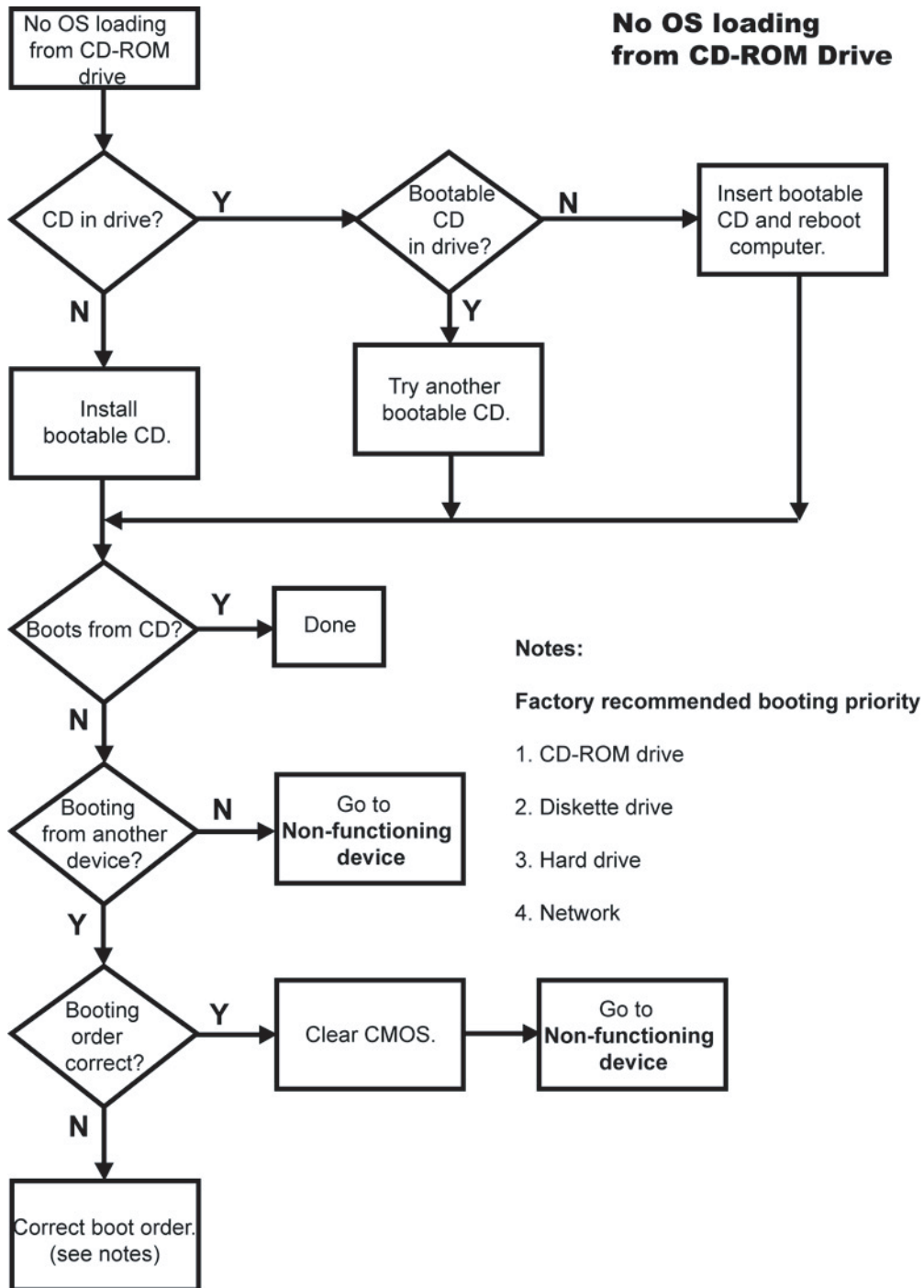

# No operating system loading from network

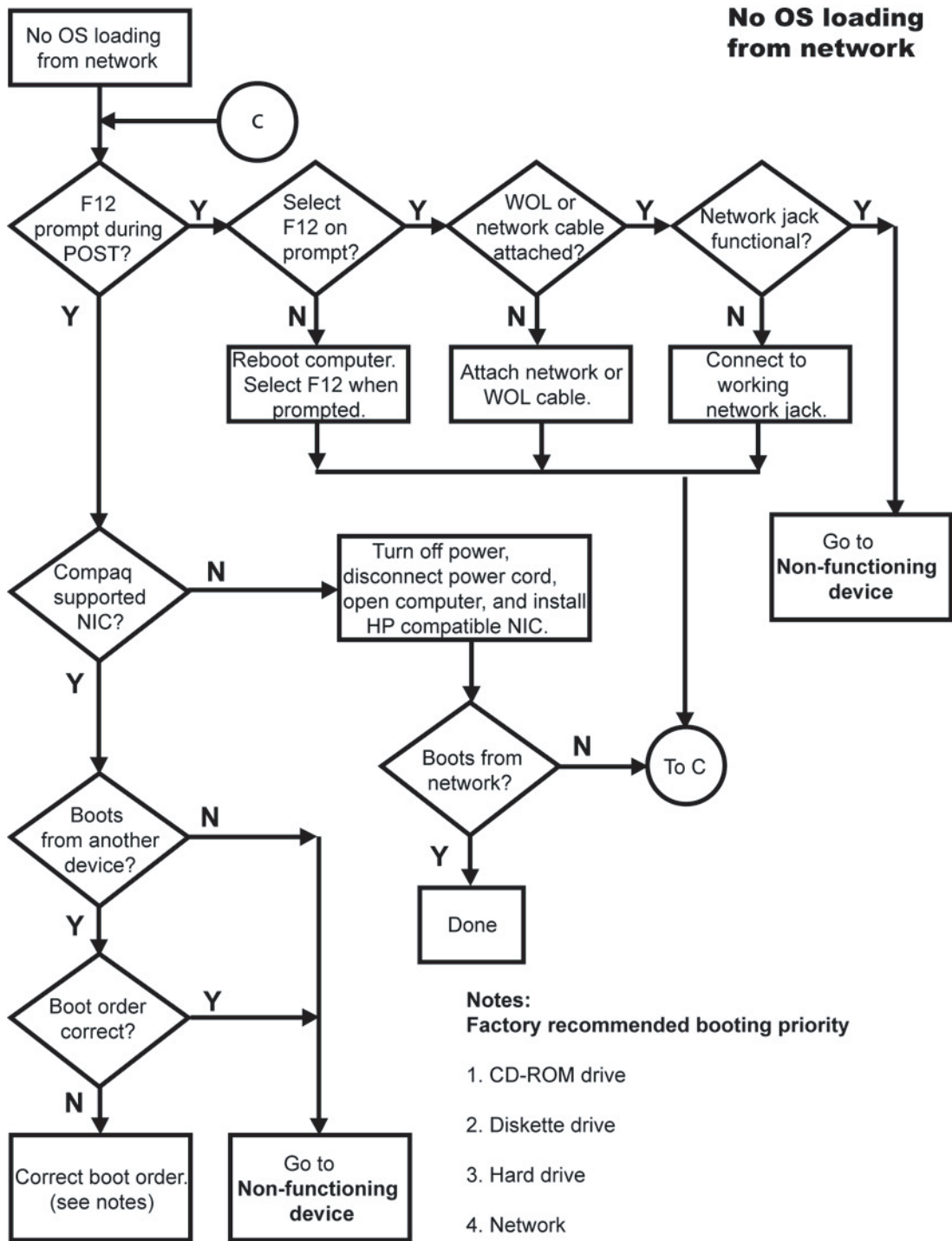

# Non-functioning device

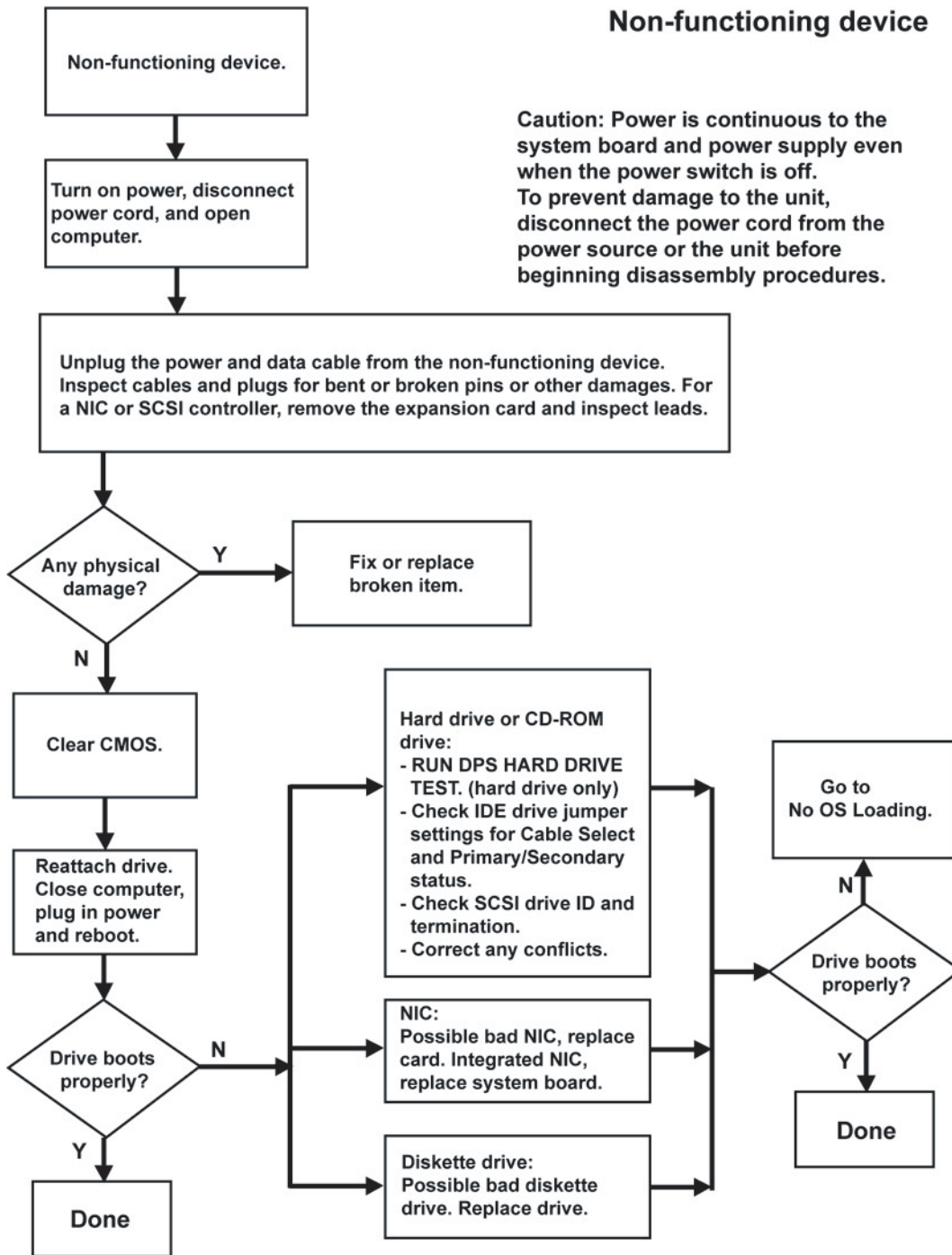



# J Appendix J—PCI bus layout

# PCI bus layout and device list

The following illustration shows the HP xw8400 Workstation PCI bus layout. It is followed by a PCI device list description.

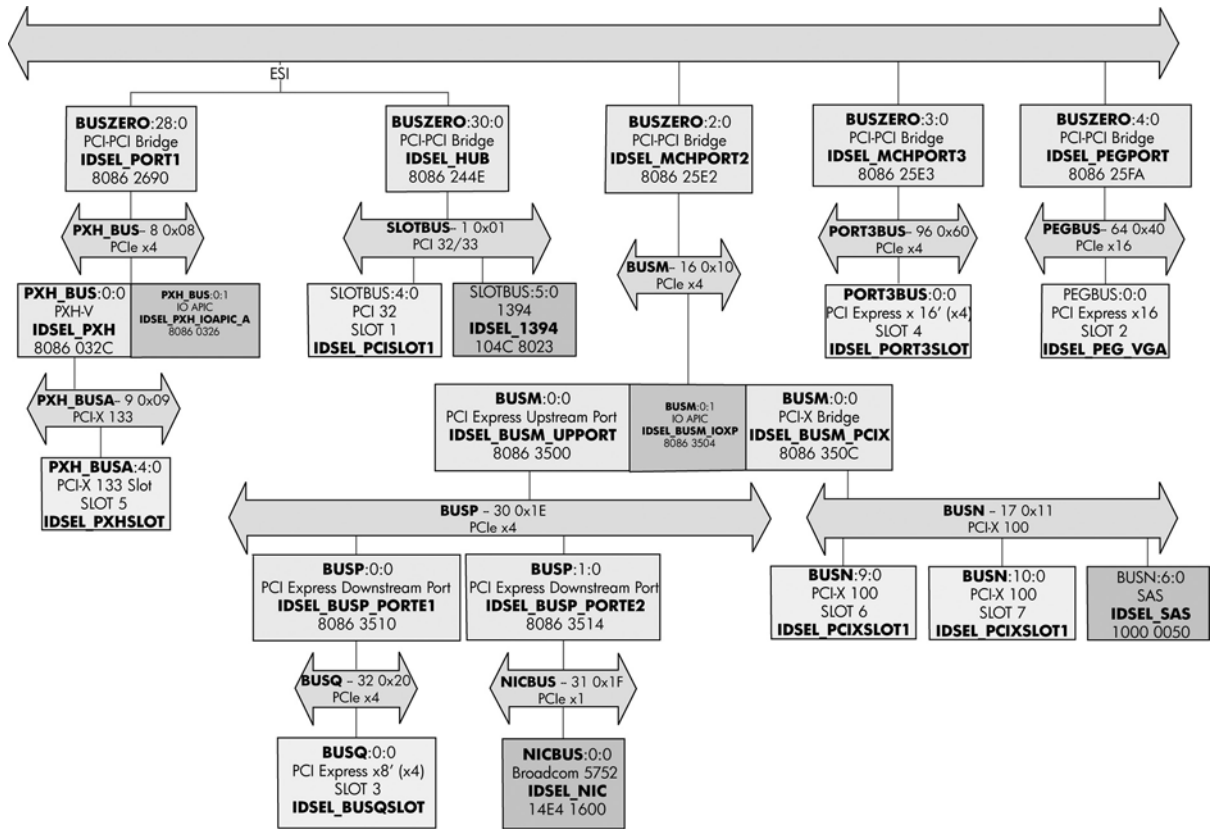

**Figure J-1** PCI bus layout

**Table J-1** PCI device list

Device	Bus#	Dev#	Fn#
Intel® 5000X Chipset Memory Controller Hub (BUS0)	0	0	0
Intel PCI Express x4 MCH Port 2 (MCH to ICH Bridge)	0	2	0
Intel PCI Express x4 MCH Port 3 (Bridge for PCI-E x16 — Slot 4)	0	3	0
Intel PCI Express x16 MCH Port 4 (Bridge for PCI-E x16 — Slot 2)	0	4	0
Port 5, Slave Port of Port 4	00	5	00
Port 6, Slave Port of Port 4	00	6	00
Port 7, Slave Port of Port 4	00	7	00
Intel 5000 Series Chipset Error Reporting Registers	00	16	00
Intel 5000 Series Chipset Error Reporting Registers	00	16	01
Intel 5000 Series Chipset Error Reporting Registers	00	16	02
Intel 5000 Series Chipset Reserved Registers	00	17	00

**Table J-1** PCI device list (continued)

Device	Bus#	Dev#	Fn#
Intel 5000 Series Chipset Reserved Registers	00	19	00
Intel 5000 Series Chipset FBD Registers	00	21	00
Intel 5000 Series Chipset FBD Registers	00	22	00
High Definition Audio Controller	00	27	00
Intel 631xESB/6321ESB PCI Express Root Port 1)	00	28	00
Intel 631xESB/6321ESB USB Universal Host Controller	00	29	00
Intel 631xESB/6321ESB USB Universal Host Controller	00	29	01
Intel 631xESB/6321ESB USB Universal Host Controller	00	29	02
Intel 631xESB/6321ESB USB Universal Host Controller	00	29	03
Intel 631xESB/6321ESB USB2 Enhanced Host Controller	00	29	07
Intel 82801 PCI Bridge (Bridge above Slot 1 and 1394)	00	30	00
Intel 631xESB/6321ESB LPC Interface Controller	00	31	00
Intel 631xESB/6321ESB Ultra ATA Storage Controller	00	31	01
Intel 631xESB/6321ESB Serial ATA Storage Controller	00	31	02
Intel ESB2 SATA AHCI Controller	00	31	02
Intel ESB2 SATA RAID Controller	00	31	02
TI IEEE 1394 Controller	01	05	00
Intel 6702PXH PCI Express-to-PCI Bridge A (Bridge for 133 MHz PCI-X Slot 5)	08	00	00
Intel 6311ESB/6321ESB PCI Express Upstream Port (Bridge for 100 Mhz PCI-X Slots 6 and 7)	16	00	00
Intel 6311ESB/6321ESB PCI Express to PCI-X Bridge	16	00	03
LSI 1064 SAS Controller - PCI-X	17	06	00
Intel 6311ESB/6321ESB PCI Express Downstream Port E1 (Bridge for PCI-E x8 — Slot 3)	30	00	00
Intel 6311ESB/6321ESB PCI Express Downstream Port E2 (Bridge for onboard NIC)	30	01	00

