

Valve Types and Features

The three basic functions of valves are: 1. to stop flow, 2. to keep a constant direction of flow, and 3. to regulate the flow rate and pressure. To select the correct valve to fulfill these functions properly, an outline of the different types of valves and their features is given below.

Butterfly valve

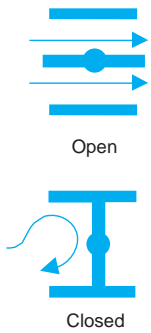

- Valve shaped like a butterfly.
- Tight shut-off and can be used as a control valve.
- Little resistance to flow (allows smooth flow).
- Optimal for automated operation with a low operating torque and 90 degrees operating angle.
- Lightweight and compact (large diameter models are also available).

Check valve

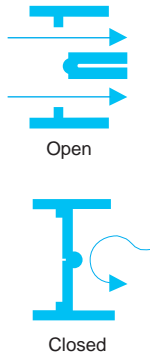

- For use when flow is only in one direction.
- Lightweight disc allows vertical installation.
- High operating speed prevents water hammer.

Gate valve

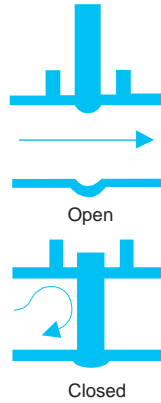

- Like its name implies, the gate is lowered to cut off the path of flow.
- For use as an on/off valve (not suitable as a control valve).
- Little resistance to flow when fully open (allows smooth flow).
- Long stroke requires time to open and close; not suitable for quick operation.

Globe valve

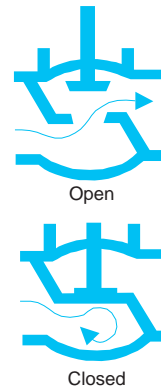

- The globe-shaped body controls the fluid into a S-shaped flow.
- Tight shut-off and can be used as a control valve.
- Large resistance to flow (does not allow smooth flow).
- Much power is required to open and close the valve (not suitable for large sizes).

Ball valve

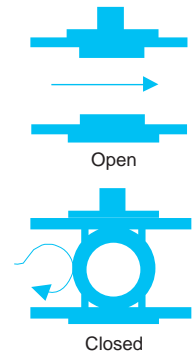

- Valve stopper is ball-shaped.
- For use as an on/off valve (not suitable as a control valve).
- Little resistance to flow when fully open (allows smooth flow).
- Optimal for automated operation with a 90 degrees operating angle.
- Advanced technology is required to manufacture ball.

Comparison of butterfly valves with other valves (using 100mm diameter TOMOE 700G model valve)

Butterfly valve and globe valve

Item	Butterfly valve	Globe valve
Pressure loss()	0.3	1.5
Flow characteristics	Equal %	Equal %
Rangeability	10:1	30:1

Butterfly valve and ball valve

Item	Butterfly valve	Ball valve
Pressure loss()	0.3	0.05
Flow characteristics	Equal %	Quick open
Rangeability	10:1	3:1

Butterfly valve and gate valve

Item	Butterfly valve	Gate valve
Pressure loss()	0.3	0.2
Flow characteristics	Equal %	Quick open

Comparison of Cv value (Butterfly valve=1)

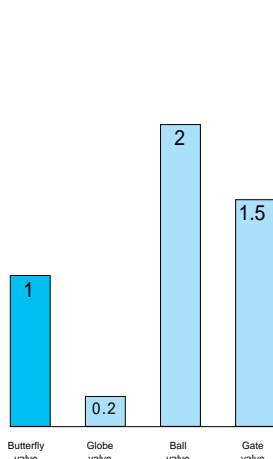

Comparison of pressure loss (Butterfly valve=1)

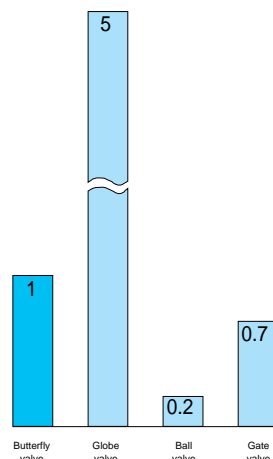

Inherent flow characteristics

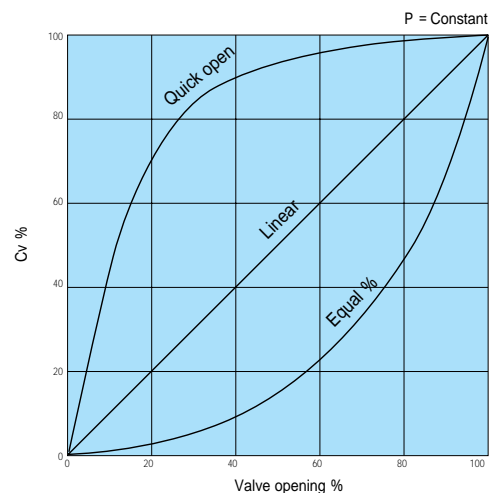

Valve Sizing Procedures

It is essential to understand the valve sizing formula and selection procedure when determining the size of a valve. The following is the proper selection procedure. The valve sizing calculation is based on ISA.

1. Judge if the flow condition is subcritical or critical based on the given flow condition.
2. Calculate the Cv value by putting the data into an appropriate formula.
3. Select the size of the valve using the Cv value chart. Consider the following points when sizing the valve.
 - ① A proper adjustment of the Cv calculation should be made based on the piping adjustment coefficient F_p if a valve is located between reducers.
 - ② If the result of the Cv calculation is over 80% compared to the full Cv value, select a valve one size larger.
Example: For fresh water with $P_1 = 0.3$ MPa, $P_2 = 0.25$ MPa, flow rate = 100 m³/h, the calculated Cv will be 164. If 80 mm, 507V is selected, the rated Cv is 176. The calculated Cv (164) is over 80% of rated the Cv (176) in this case. We recommend 100 mm, 507V.
 - ③ If no P is given, 5 to 10% of the pump outlet pressure should be used as the assumed P for valve sizing.

Cv Value Calculation

Cv value calculation

Fluid		Pressure conditions	Formula
Liquid	Volume flow rate	Sub critical $\Delta P < F_L^2 (\Delta PS)$	$C_v = 11.6q \sqrt{\frac{Gf}{\Delta P}}$
		Critical $\Delta P \geq F_L^2 (\Delta PS)$	$C_v = 11.6 \frac{q}{F_L} \sqrt{\frac{Gf}{\Delta PS}}$
	Mass flow	Sub critical $\Delta P < F_L^2 (\Delta PS)$	$C_v = \frac{11.6W}{\sqrt{Gf\Delta P}}$
		Critical $\Delta P \geq F_L^2 (\Delta PS)$	$C_v = \frac{11.6W}{F_L \sqrt{Gf\Delta PS}}$
Gas	Volume flow rate	Sub critical $\Delta P < F_L^2 \frac{P_1}{2}$	$C_v = \frac{Q}{3.01} \sqrt{\frac{GT}{\Delta P (P_1 + P_2)}}$
		Critical $\Delta P \geq F_L^2 \frac{P_1}{2}$	$C_v = \frac{Q\sqrt{GT}}{2.62 F_L \cdot P_1}$
	Mass flow	Sub critical $\Delta P < F_L^2 \frac{P_1}{2}$	$C_v = \frac{4627W}{\sqrt{\Delta P (P_1 + P_2) Gf}}$
		Critical $\Delta P \geq F_L^2 \frac{P_1}{2}$	$C_v = \frac{5343W}{F_L \cdot P_1 \sqrt{Gf}}$
Saturated vapour	Mass flow	Sub critical $\Delta P < F_L^2 \frac{P_1}{2}$	$C_v = \frac{7098W}{\sqrt{\Delta P (P_1 + P_2)}}$
		Critical $\Delta P \geq F_L^2 \frac{P_1}{2}$	$C_v = \frac{8206W}{F_L \cdot P_1}$
Super-heated vapour	Mass flow	Sub critical $\Delta P < F_L^2 \frac{P_1}{2}$	$C_v = \frac{7098W (1 + 0.00126Tsh)}{\sqrt{\Delta P (P_1 + P_2)}}$
		Critical $\Delta P \geq F_L^2 \frac{P_1}{2}$	$C_v = \frac{8206W (1 + 0.00126Tsh)}{F_L \cdot P_1}$

Symbol Legend

Symbol

Cv: Valve flow coefficient	
FL: Pressure recovery coefficient	
G: Specific gravity of gas	(Air = 1)
Gf: Specific gravity at valve-inlet temperature	(Water = 1 at 15 degrees C)
P1: Valve-inlet pressure	(kPaA)
P2: Valve-outlet pressure	(kPaA)
P: Pressure difference across valve [P ₁ — P ₂]	(kPa)
Pc: Critical pressure	(kPaA)
Pv: Saturated vapour pressure of liquid at valve-inlet temperature	(kPaA)
PS: Max. DP for sizing	
• Working conditions: Outlet pressure is higher than vapour pressure.	
PS = P ₁ — P _v	(kPa)
• Working conditions: Outlet pressure is equal to or lower than vapour pressure.	
DPS = P ₁ — $\left(0.96 - 0.28\sqrt{\frac{Pv}{PC}}\right) P_v$	(kPa)
q: Volume flow rate of liquid	(m ³ / h)
Q: Volume flow rate of gas [At 15 degrees C, 1 atm]	(m ³ / h)
= Nm ³ /h × $\frac{288}{273}$	
T: Fluid temperature [273 + degrees C]	(K)
Tsh: Degree of superheat	(degrees C)
= T — T _c	
Tc: Saturated vapour temperature at valve-inlet pressure	(K)
W: Mass flow rate (T / h) = (1,000 kg / h)	

Calculation for piping geometry factor

$$F_p = \left\{ 1 + \frac{\left\{ 0.5 \left(1 - \left(\frac{d}{D1} \right)^2 \right)^2 + 1.0 \left(1 - \left(\frac{d}{D2} \right)^2 \right)^2 \right\} \times \left(\frac{Cv}{d^2} \right)^2}{0.00214} \right\}^{-\frac{1}{2}}$$

Fp: Piping geometry factor
 Cv: Valve flow coefficient
 d: Valve size (mm)
 D1: Inlet pipe size (mm)
 D2: Outlet pipe size (mm)

Calculation for modified Cv value

$$CvR = F_p \quad Cv$$

CvR : Revised Cv value

Conversion Formula for Reference

Pressure loss coefficient $\zeta \leftrightarrow$ Cv value

$$\zeta = 21.38 \times \frac{D^4}{Cv^2}$$

$$Cv = 4.624 \times \frac{D^2}{\sqrt{\zeta}}$$

D: Inside diameter of pipe (cm)

Cv value \rightarrow Kv value

Kv value is used in Europe.

It shows the flow rate (m³/h) of drinking water at a pressure of 1 bar and temperature of 5 - 30 degrees C.

$$Kv = \frac{Cv}{1.167}$$

Pressure loss coefficient $\zeta \rightarrow$ Kv value

$$Kv = 4.0 \times \frac{D^2}{\sqrt{\zeta}}$$

D: Inside diameter of pipe (cm)

Cv value \rightarrow Av value

Av value is a SI unit.

$$Av = \frac{24}{10^6} \times Cv$$

Length of pipe

$$L = 8.5 \times \frac{D^{4.87}}{Q^{1.85}} \times \Delta P$$

D: Inside diameter of pipe (cm)

Q: Flow rate (ℓ/min)

P: Pressure difference (kPaA)

Reference: For performance appraisal of fire safety and disaster prevention equipment, the equivalent pipe length is measured based on the flow rates in the table below.

Nominal dia.	Flow rate (ℓ/min)
50mm	800
65mm	900
80mm	1350
100mm	2100
125mm	3300
150mm	4800
200mm	8500
250mm	13000
300mm	19000

Pressure difference

$$\Delta P = \frac{1}{102} \cdot \zeta \cdot \frac{V^2}{2g} \gamma$$

ζ : Pressure loss coefficient

P: Pressure difference (kPa)

g: Acceleration of gravity 9.8 m/sec²

γ : Specific gravity (water = 1000) (kg/m³)

V: Flow velocity (m/sec)

Guidance for Vacuum Use

Valve type	Nominal dia. range (mm)	Usable vacuum (kPaA)			Valve seat leak (kPa·ℓ/h)	Remark
		10 to 50 degrees C	50 to 80 degrees C	80 to 100 degrees C		
304A	80-200	0.133	0.133	1.33	1.0	Special gland structure required.
	250-300	1.33	1.33	2.66	8.0	
	350-600	2.66	3.99	5.32		
302A	80-200	1.33	1.33	2.66	8.0	
	250-300	1.33	3.99	5.32	14.0	
	350-600	2.66	3.99	5.32		
302Y	40-200	1.33	1.33	2.66	14.0	
	250-300	2.66	3.99	5.32		
337Y	50-200	1.33	1.33	2.66	14.0	
	250-300	2.66	3.99	5.32		
304Y	40-200	1.33	1.33	2.66	1.0	
	250-300	2.66	3.99	5.32	8.0	
846T	65-200	0.133	1.33	2.66	0.3	Leakage increases if heat cycle and open/close frequency is high.
847T	50-300					
731P	50-200	0.133	1.33	13.3	0.3	
732P	250-300	0.133	2.66	26.6	3.0	
731X 732X	350-600	2.66	13.3	Use not possible.	5.0	
700G	40-200	13.3	26.6	Use not possible.	3.0	
	250-300	26.6	53.2	Use not possible.	5.0	
	350-600	39.9	66.5	Use not possible.		
705G 704G	50-200	13.3	26.6	Use not possible.	3.0	
	250-300	26.6	53.2	Use not possible.	5.0	
	350-600	39.9	66.5	Use not possible.		
722F	125-300	26.6	53.2	Use not possible.	5.0	
	350-600	39.9	66.5	Use not possible.		
841T	250-300	26.6	53.2	Use not possible.	5.0	
	350-600	39.9	66.5	Use not possible.		
842T	350-600	39.9	66.5	Use not possible.		

Leak amounts are predicted values based on testing at room temperature with new valves. If you will be using in a range that exceeds the above table, please consult us.

Velocity Calculation

Velocity limitation

Velocity limitations are shown below:

Type of fluid		Velocity limitation (continuous operation)
Liquid	Replaceable rubber seat	3 m/s
	Vulcanized rubber seat	5 to 6 m/s
Gas, vapour		120 to 200 m/s
Steam	Saturated steam	50 to 80 m/s
	Superheated steam	80 to 120 m/s

* Velocity limitation varies depending on the valve models. Please consult us for further information.

Pipe line velocity calculation

For liquids

$$V = 354 \times \frac{Q}{D^2}$$

For gases and vapours

$$V = 124.5 \times \frac{Q(T+273)}{D^2 \cdot P_2}$$

For steam

$$V = 354 \times \frac{Q \cdot U}{D^2}$$

Where:

V: Flow velocity (m/sec)

Q: Flow rate

Liquid (m³/h)

Gas [At 15 degrees C, 101325 Pa] (m³/h)

$$= \text{Nm}^3/\text{h} \times \frac{288}{273}$$

Steam (kg/h)

U: Specific volume of valve-outlet (m³/kg)

D: Nominal size (mm)

P₂: Valve-outlet pressure (kPaA)

T: Temperature (degrees C)

Noise Prediction Methods and Countermeasures

Noise measuring method

The following are methods recommended by ISA.

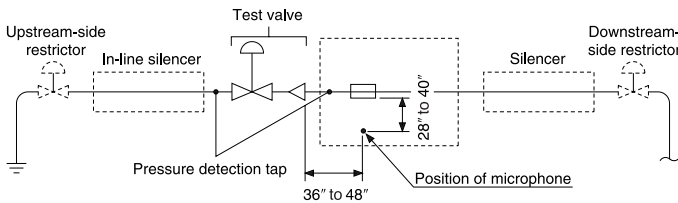

Note: Parts surrounded by dotted lines are optional.

Fig. 1 Laboratory test unit by ISA-RP59.1

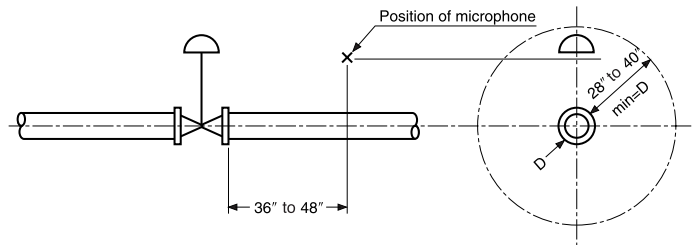

Fig. 2 Position of microphone in plant by ISA-RP59.2

Noise calculation formula for 507V and 508V Types

For gases

$$SP = -10.7 + 10 \log (C_v \cdot FL \cdot P_1 \cdot P_2) + 18.5 \log (D) - 30 \log (t/t_{40}) + 12 \log (P_1/P_2 - 1.05) - 10 \log (no) + SG$$

For liquids

$$SP = 10 \log (C_v) + 12 \log (0.0102 \times (P_{2crit} - P_2)) + 16 \log (P_2 - P_v) - 10 \log (no) + 18.5 \log (D) - 30 \log (t) + *26.5$$

Notes regarding liquids:

1. When the pressure difference across the valve $\Delta P (= P_1 - P_2)$ is smaller than 5% of P_1 , the formula above cannot be applied.
2. For $0.7P_1 - P_2 \leq 6.86$, substitute 0 dBA for $12 \log (0.0102 \times (P_{2crit} - P_2))$ in the formula above, and also 12.7 for 26.5, the coefficient with *mark.

Where:

SP: Noise value [sound pressure level at 91 cm]	(dBA)
C_v : Flow coefficient in actual conditions	
P_1 : Valve upstream pressure	(kPaA)
P_2 : Valve downstream pressure	(kPaA)
FL : Pressure recovery coefficient (507V: 0.72)	
D : Nominal pipe diameter	(mm)
t : Pipe wall thickness	(mm)
t_{40} : Pipe wall thickness of Sch #40	(mm)

no: Apparent valve orifice coefficient

50mm = 10	150mm = 18
80mm = 14	200mm to 400mm = 30
100mm = 16	

SG: Gas component modification coefficient

(Saturated vapour = -2, overheated vapour = -3)
(Natural gas = -1, air = 0)

P_{2crit} : $P_1 - 0.3 (P_1 - P_v)$	(kPaA)
P_v : Vapour pressure of liquid	(kPaA)

Noise calculation formula for valves other than 507V and 508V Types

Formulas are in accordance with those introduced by ISA.

For gases

$$SP = 10 \log (X \cdot \eta \cdot 10^9 \cdot C_v \cdot F_L \cdot 2.105 \cdot P_1 \cdot P_2) - TL + SG + 3$$

When liquid cavitation is generated

$$SP = 10 \log (C_v \cdot F_L) + 8 \log (0.1451 \times (P_{2crit} - P_2)) + 20 \log (0.1451 \times (P_2 - P_v)) + 33$$

Where:

- SP: Noise value [sound pressure level at 91cm] (dBA)
- C_v: Flow coefficient in actual conditions
- F_L: Pressure recovery coefficient
- P₁: Valve upstream pressure (kPaA)
- P₂: Valve downstream pressure (kPaA)
- m: Weight of pipe wall (kg/m²)
- n: Apparent valve orifice coefficient (butterfly valve: n = 1.4)
- TL: Transmission loss Except for valves releasing directly into the air.

$$= 17 \log_{10} \left(\frac{3.072 \times 1.4m}{\sqrt{C_v \cdot F_L}} \right) - 36 \text{ (dBA)}$$

$$*P_{2crit}: P_1 - F_L^2 (P_1 - P_v) \text{ (kPaA)}$$

P_v: Vapour pressure of liquid (kPaA)

X: Conversion fraction of mechanical output

$$= \frac{P_1 - P_2}{0.47 P_1} \quad X = 1 \text{ even if } X \text{ is bigger than } 1.$$

SG: Gas property factor

: Acoustical efficiency coefficient (Refer to page Data-11.)

Note: When the difference between K_c and F_L² exceeds 10% of K_c, substitute K_c for F_L².

Specific gravity SG

Saturated steam	-2
Superheated steam	-3
Natural gas	-1
Hydrogen	-10
Oxygen	+0.5
Ammonia	-2
Air	0
Acetylene	-1
Carbon dioxide	+1
Carbon monoxide gas	0
Helium	-6.5
Methane liquid	-1
Nitrogen	0
Propane	+1
Ethylene	-1
Ethane	-1

Refer to the graph on left for fluids other than those above.

Specific gravity SG

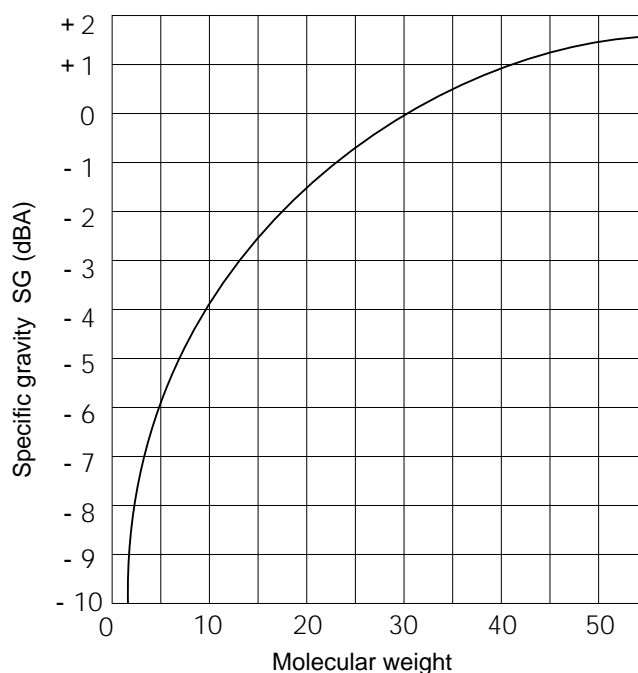

Weight of pipe (m)

$$m = A \times t$$

*A: Basic weight (kg/mm·m²)

[Steel pipe: 7.85, stainless steel pipe: 7.93]

t: Pipe thickness (mm)

(kg/m²)

Nominal dia.		m						
mm	inch	SGP	Sch20	Sch40	Sch60	Sch80	Sch10S	Sch20S
40	1 1/2	27.5	-	29.0	35.3	40.0	22.2	23.8
50	2	29.8	25.1	30.6	38.5	43.2	22.2	27.8
65	2 1/2	33.0	35.3	40.8	47.1	55.0	23.8	27.8
80	3	33.0	35.3	43.2	51.8	59.7	23.8	31.7
100	4	35.3	38.5	47.1	55.7	67.5	23.8	31.7
125	5	35.3	40.0	51.8	63.6	74.6	27.0	39.7
150	6	39.3	43.2	55.7	73.0	86.4	27.0	39.7
200	8	45.5	50.2	64.4	80.9	99.7	31.7	51.5
250	10	51.8	50.2	73.0	99.7	118.5	31.7	51.5
300	12	54.2	50.2	80.9	112.3	136.6	35.7	51.5
350	14	62.0	62.0	87.1	118.5	149.2	-	-
400	16	62.0	62.0	99.7	131.1	168.0	-	-
450	18	62.0	62.0	112.3	149.2	186.8	-	-
500	22	62.0	74.6	118.5	161.7	205.7	-	-
550	20	-	74.6	124.8	174.3	224.5	-	-
600	24	-	74.6	137.4	193.1	243.4	-	-

.....Acoustical efficiency factor

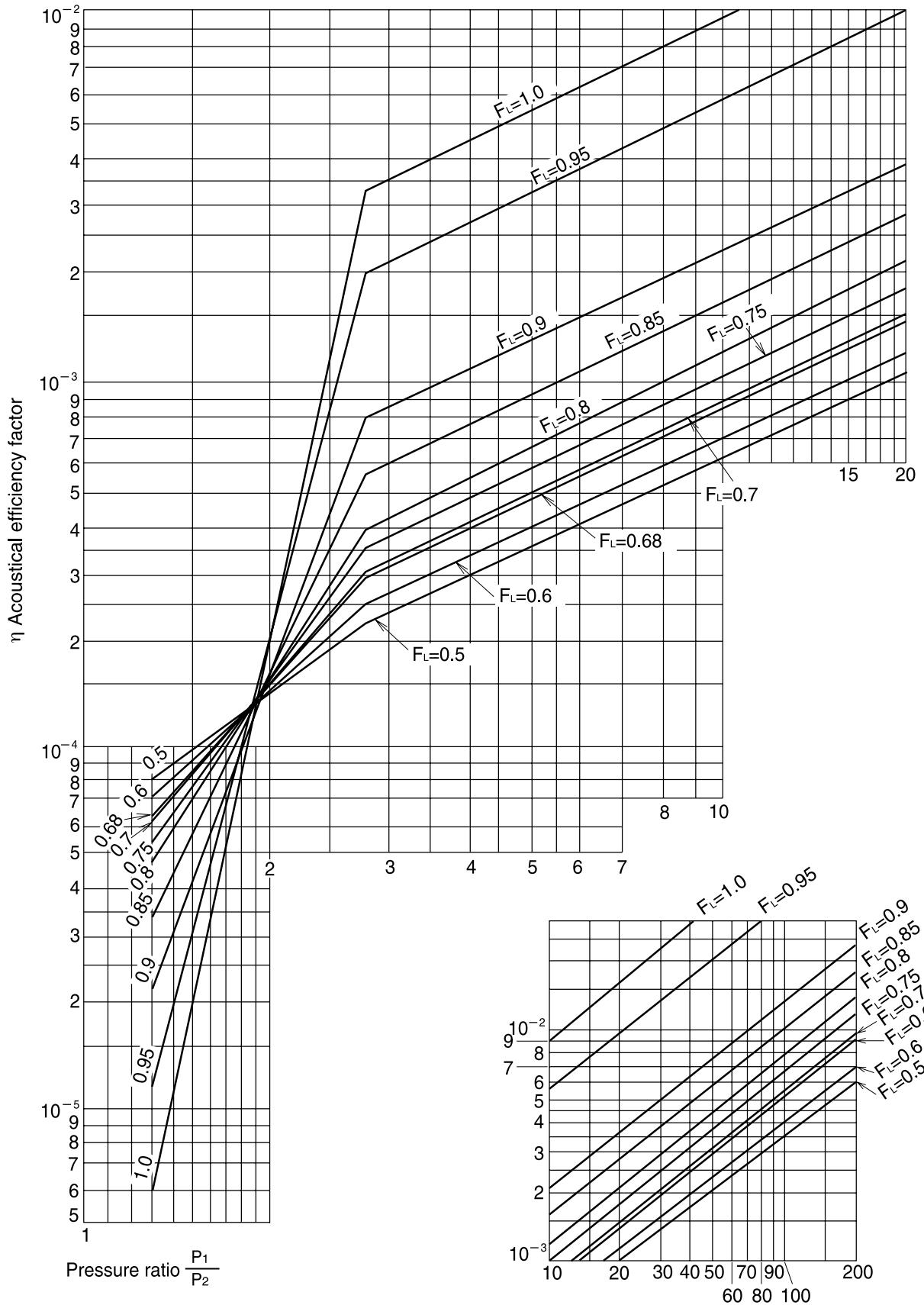

Data

Valve noise reduction countermeasures

Aerodynamic noise is discussed here.
Noise can be reduced at the following points:

- 1 Noise source
- 2 Sound insulation

When selecting a countermeasure, controllability of process, initial cost and maintenance cost should be considered along with noise evaluation and noise type.

Various factors should be discussed between the customer and manufacturer. Please refer to the section "Calculation of Estimated Cavitation" and its countermeasure to reduce and prevent cavitation noise.

Countermeasures for noise source

There are two countermeasures for noise source.

(1) Adoption of low noise valve

- ① 507V and 508V types:
- ② Globe type low noise valve:

Max. possible reduction is 10 dBA.

Max. possible reduction is 15 to .30 dBA.

(2) Countermeasure at valve downstream side

- ① Insert resistance plate:

Max. possible reduction is 15 dBA.

Example of low noise unit

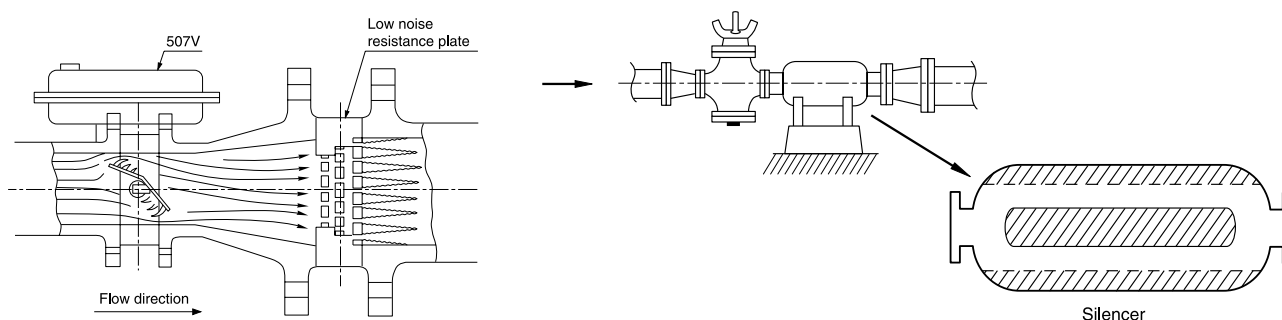

Sound insulation

This countermeasure does not reduce sound generation itself.

- ① Increase of pipe wall thickness (pipe schedule)
If it doubles, 5 dBA can be reduced.
- ② Soundproof lagging
In this countermeasure, piping is covered with layers of heat insulating materials (rock wool), lead plates, or iron plates, etc.
- ③ Prepare sound insulating box or wall
In order to reduce noise effectively, combine the various methods mentioned above.

Example: Pipe lagging materials

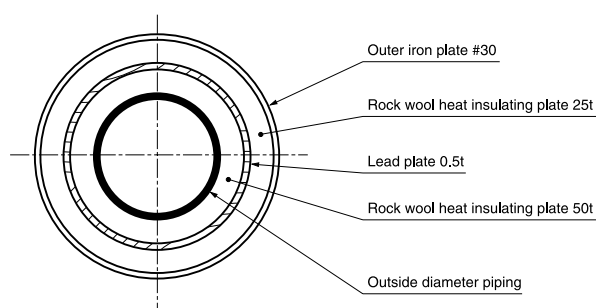

Calculation of Estimated Cavitation

Cavitation generation in butterfly valves

Cavitation is caused by low pressure areas in fluids. There are four causes of low pressure areas:

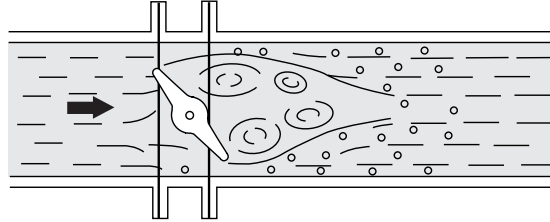

Fig. 1 Butterfly valves in nearly closed position

- (1) Fluid is compressed, contraction flow exists, and flow velocity is increased. Then, pressure reduces.
- (2) Low pressure area inside vortices at valve-outlet side.
- (3) Low pressure area is produced at the boundary between the fluid flowing at high velocity and objects such as the protruding portion of the valve-moulded surface, heads of taper pins, and hubs, etc.
- (4) When the valve body or disc is vibrating at high frequency, the flow is disturbed and air bubbles form in the fluid.

The main causes of cavitation generation in butterfly valves are (1) and (2).

Thus, when the valve is nearly closed, the flow passes over the upper and lower edges of the disc as shown in figure. 1. The low pressure area can be caused when high flow velocity is created.

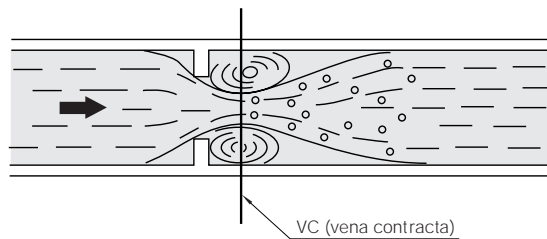

Fig. 2 Orifice flow

Figure 2 shows orifice flow corresponding to valve flow. The contracted part is called vena contracta. The relation between pressure and flow rate is shown in figure 3.

When fluids flow at high velocity and pressure drops below the saturated vapour pressure, air bubbles are produced. They are carried away toward the valve downstream side, and then, as surrounding water recovers its original pressure, air bubbles break instantaneously (approx. 1/1000 sec) and produce a strong impact force (200 to 500 atm). If air bubbles break near a substance, the impact applies great stress on both the outside and inside of the substance, and causes damage to the surface.

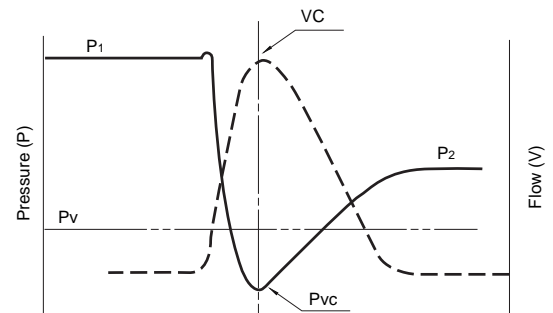
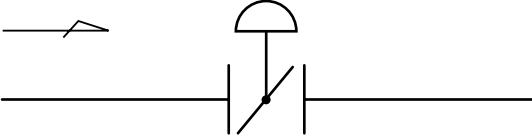
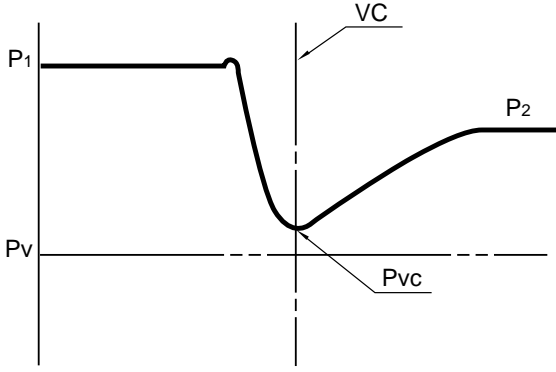
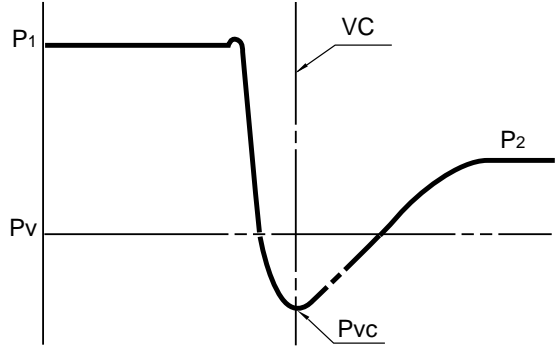
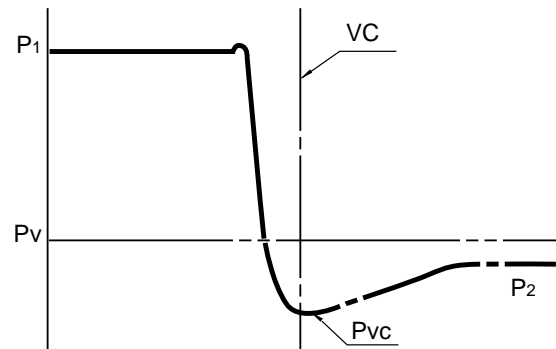

Fig. 3 Pressure and flow rate relation

Cavitation generation process in butterfly valves and formula to estimate it

There are many stages in cavitation generation, as follows.

Flow conditions	Pressure conditions	Explanation
 <p>Fig. 4 Normal flow</p> 	$P_2 > P_v$ $P_{vc} > P_v$	<ul style="list-style-type: none"> • Normal flow means turbulent flow. • In this stage, valve flow rate increases in proportion to the square root of the differential pressure.
<p>Fig. 5 Cavitation flow</p> 	$P_2 > P_v$ $P_{vc} \leq P_v$	<ul style="list-style-type: none"> • Cavitation flow has three stages corresponding to the increase in differential pressure. <ol style="list-style-type: none"> a. Incipient cavitation stage b. Critical cavitation stage c. Full cavitation stage • Noise and oscillation may cause damage to the valve and downstream-side piping.
<p>Fig. 6 Flashing flow</p> 	$P_2 \leq P_v$ $P_{vc} < P_v$	<ul style="list-style-type: none"> • This occurs when pressure on the valve downstream side drops below the vapour pressure of the liquid. The fluid changes from liquid to gas, bringing rapid velocity change and volume expansion. These two factors are the main causes of a flashing noise. Flashing noise is of lower level than cavitation noise because gas acts as a cushion. • Attention must be paid to materials of the valve body (e.g., upgrading to stainless steel or chromium molybdenum steel) or the type of downstream-side piping.

Cavitation prediction

No cavitation

$$P < K_c (P_1 - P_v)$$

Incipient cavitation

$$P = K_c (P_1 - P_v)$$

Critical cavitation

$$FL^2 (P_1 - P_v) > DP > K_c (P_1 - P_v)$$

Full cavitation

$$P > FL^2 (P_1 - P_v)$$

Flashing

$$P_2 < P_v$$

$$FL^2 (P_1 - P_v) > P$$

P: Pressure difference across valve [$P_1 - P_2$] (kPa)

K_c: Cavitation coefficient

P₁: Valve-inlet pressure (kPaA)

P₂: Valve-outlet pressure (kPaA)

P_v: Vapour pressure of liquid (kPaA)

FL: Pressure recovery coefficient

Cavitation level and availability

Type of valve Cavitation level	Rubber seated (700G, 702Z)	Double "Teflon" offset metal (302A, 304A)	507V
		731P	508V
No cavitation	○	○	○
Incipient cavitation	○	○	○
Critical cavitation	△	○	○
Full cavitation	×	×	△ (Countermeasure is necessary)
Flashing	×	×	△ (Countermeasure is necessary)

- — Suitable
- △ — Consult us regarding usage.
- × — Unsuitable

Note:
Normal operation material is stainless steel except when critical cavitation is determined.

Cavitation reduction treatment

The following are the main methods for reducing or preventing cavitation damage to control valves.

- (1) Install valves in series and control them. This method is for reducing the pressure load on each valve. In this case, space valves out at least 4D (4 times the pipe diameter). The total K_c or FL will be improved. In order to avoid full cavitation FL should satisfy the following condition:

$$FL > \sqrt{\frac{P_1 - P_2}{P_1 - P_v}}$$

In this case, however, valve control balance may be difficult.

Example:

When 507V and 508V types are nearly fully opened, FL is 0.72. When 507V and 508V types are installed in series, the combined FL is $0.72 = 0.84$ and the permissible pressure difference across the valve is increased by 36%. However, both valves should be operated under exactly the same conditions.

- (2) Use a resistance plate (perforated orifice for pressure reduction) at the same time. If the flow rate fluctuates heavily, a good result cannot be expected.
- (3) Use a valve with higher K_c or FL.
- (4) Lower the installation position of the valve; that is, lower the secondary pressure. However, this method is hard to adopt in existing piping installations.
- (5) Rectify the turbulent flow by using a rectifier grid.

Cavitation coefficient K_c and pressure recovery coefficient F_L

**Concentric type butterfly valve
700 and 800 series**

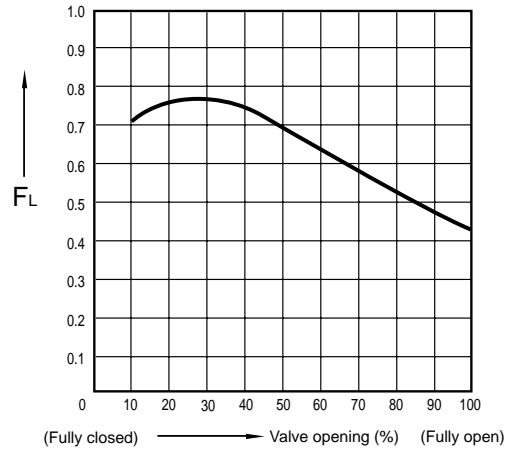
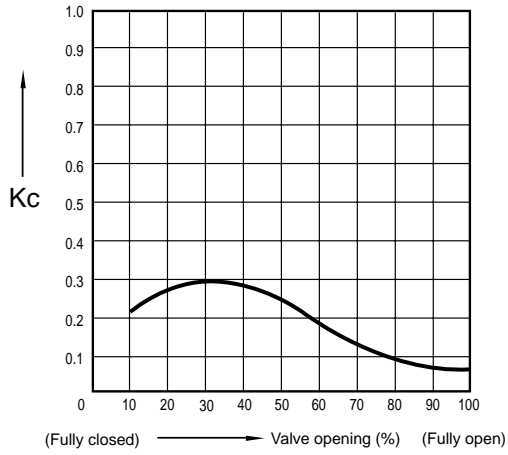

**High performance butterfly valve
300 series**

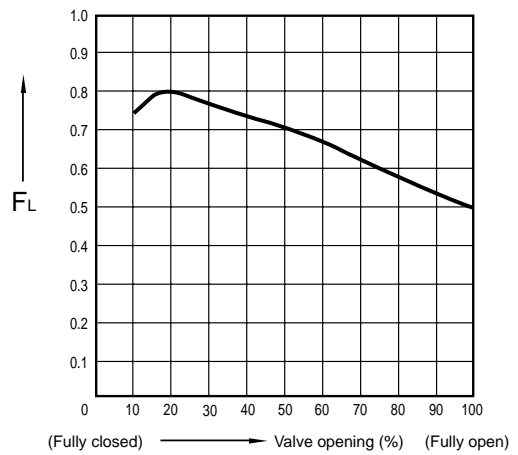
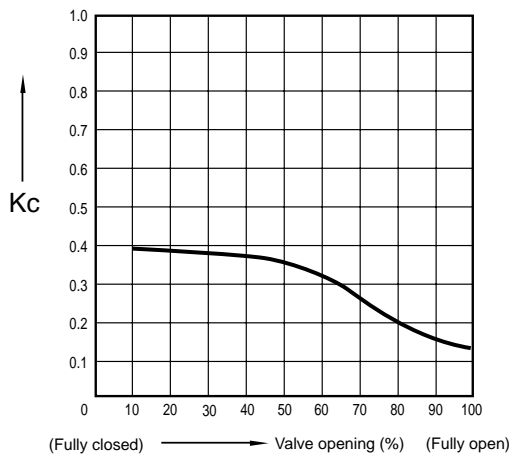

**Rotary control valve
507V and 508V types**

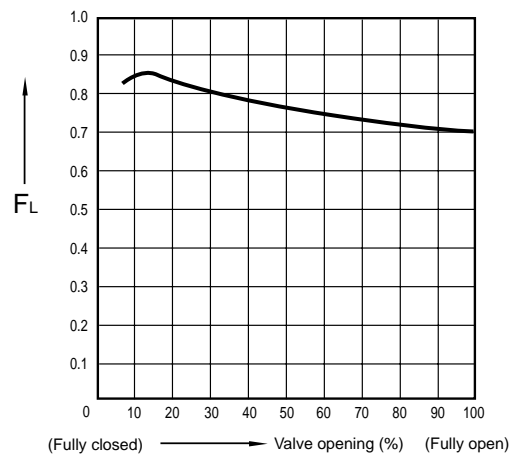
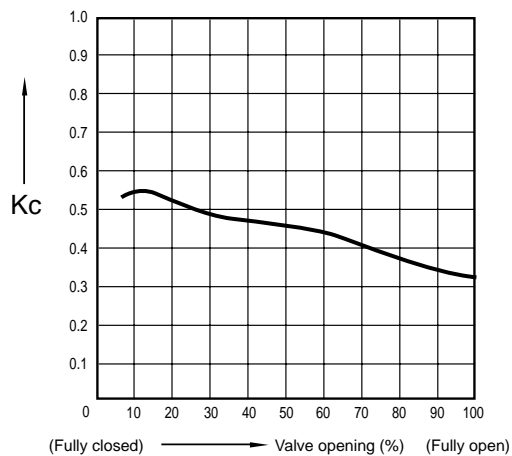

Face to Face Dimensions

Face to face dimensions

Unit: mm

Series Diameter	JIS B 2002			API594 Class125	Reference: Maker's face-to-face dimension									
	Wafer shape for standard equipment		Wafer shape for ships											
	46	47			123									
40	33	—	—	—	—	—	—	—	—	—	—	35	—	—
50	43	—	—	54	56	—	40	40	45	45	35	—	43	
65	46	—	—	60	56	—	46	—	45	45	35	—	46	
80	46	—	—	67	60	—	56	40	50	50	40	—	64	
100	52	—	—	67	66	—	56	40	50	50	40	—	64	
125	56	—	100	83	70	—	62	—	55	55	45	—	70	
150	56	—	100	95	76	—	76	52	60	60	50	90	76	
200	60	—	100	127	95	—	85	62	65	65	60	100	89	
250	68	—	110	140	108	—	96	89	90	80	—	110	114	
300	78	—	110	181	144	—	120	89	90	90	—	110	114	
350	78	92	120	—	—	184	—	89	100	100	—	120	—	
400	102	102	130	—	—	190	—	108	110	110	—	130	—	
450	114	114	150	—	—	200	—	—	120	120	—	150	—	
500	127	127	160	—	—	—	—	—	140	140	—	160	—	
600	154	154	170	—	—	—	—	—	160	160	—	200	—	
Tomoe applicable types	302A-304A (80mm to 300mm) 302Y-304Y 508V 846T-847T 713Z-718Z 700G-704G-705G 731P-732P* 732X-731X 702Z (discontinued)	302A* 304A (350mm to 600mm)	722F	906C	903C-904C	901C	337Y	507V	841T-842T	700S (discontinued) 700E	700Z (discontinued)	107H-108H (discontinued)	337Y* 338Y (discontinued)	

Remark: For detailed dimensions, please refer to the individual dimensional drawings.

Unit Conversion

Cavitation prediction

Conversion from flow rate unit for each type to K/h

	m ³ /h	Gas m ³ /h (at 15 101kPa)
Gas m ³ /h	—	× [A]
Gas m ³ /h (at 15 101kPa)	× [B]	—
kg/h	÷ SG × 0.001	× 23.83 ÷ MW
kℓ/h	—	× [A]
t/h	÷ SG	× 1000 × 23.83 ÷ MW
ℓ/h	× 0.001	÷ 0.001 × [A]
ℓ/min.	× 0.06	× 0.06 × [A]
t/min.	÷ SG × 60	× 60 × 1000 × 23.63 ÷ MW
Lb/h	× 0.4536 ÷ SG × 0.001	× 0.4536 × 23.63 ÷ MW
CFH (ft ³ /h)	× 0.02832	× 0.02832 × [A]
SCFH (Nft ³ /h)	× 0.02832 × [B]	× 0.02832
BBL/h (barrel)	× 0.159	× 0.159 × [A]
BBL/min.	× 0.159 × 60	× 0.159 × 60 × [A]
GPM (gallon/min.)	× 0.2271	× 0.2271 × [A]
CFM (ft ³ /min.)	× 1.699	× 1.699 × [A]
SCFM	× 1.699 × [B]	× 1.699
Nm ³ /h (at 0 101kPa)	× T ₁ × 0.1013 ÷ (P ₁ × 273)	× 288 ÷ 273

[A] = P₁ × 288 ÷ (T₁ × 0.1013) P₁ = Valve inlet pressure (MPaA)

[B] = T₁ × 0.1013 ÷ (P₁ × 288) T₁ = Temperature (°K)

SG = Specific gravity MW = Molecular weight

Pressure unit conversion

Conversion from pressure unit for each type to MPaA

	MPa A
kgf/cm ² G	× 9.807 × 10 ⁻² + 0.1013
Bar G	× 1 × 10 ⁻¹ + 0.1013
Bar A	× 1 × 10 ⁻¹
mmH ₂ O or mmAq	× 9.807 × 10 ⁻⁶ + 0.1013
cmH ₂ O or cmAq	× 9.807 × 10 ⁻⁵ + 0.1013
mH ₂ O or mAq	× 9.807 × 10 ⁻³ + 0.1013
mmHg or Torr	× 1.333 × 10 ⁻⁴
cmHg	× 1.333 × 10 ⁻³
atm	× 1.013 × 10 ⁻¹
atg	× 9.807 × 10 ⁻² + 0.1013
Pa G	× 1 × 10 ⁻⁶ + 0.1013
kPa G	× 1 × 10 ⁻³ + 0.1013
kPa A	× 1 × 10 ⁻³
MPa G	+ 0.1013
MPa A	-
Lb/in ² G (psi G)	× 6.895 × 10 ⁻³ + 0.1013
Lb/in ² A (psi A)	× 6.895 × 10 ⁻³
in Hg	× 3.386 × 10 ⁻³

Temp. conversion table

Temperature conversion

$$= \frac{5}{9} (F - 32)$$

$$F = \frac{9}{5} + 32$$

	F	°F
-28.9	-20	-4.5
-26.1	-15	-5.0
-23.3	-10	14.0
-20.6	-5	23.0
-17.8	0	32.0
-15.0	5	41.0
-12.2	10	50.0
-9.4	15	59.0
-6.7	20	68.0
-3.9	25	77.0
-1.1	30	86.0
1.7	35	95.0
4.4	40	104.0
7.2	45	113.0
10.0	50	122.0
12.8	55	131.0
15.6	60	140.0
18.3	65	149.0
21.1	70	158.0
23.9	75	167.0
26.7	80	176.0
29.4	85	185.0
32.2	90	194.0
35.0	95	203.0
37.8	100	212.0
43.3	110	230.0
48.9	120	248.0
54.4	130	266.0
60.0	140	284.0
65.6	150	302.0
71.1	160	320.0
76.7	170	338.0
82.2	180	356.0
87.8	190	374.0
93.3	200	392.0
98.9	210	410.0
104.4	220	428.0
110.0	230	446.0
121.1	250	482.0
148.9	300	572.0
176.7	350	662.0
204.4	400	752.0
232.2	450	842.0
260.0	500	932.0
315.6	600	1112.0
317.0	700	1292.0

Pressure conversion table

Pa	kPa	MPa	bar	kgf/cm ²	atm	mH ₂ O	mHg	Lb/in ²
1	1 × 10 ⁻³	1 × 10 ⁻⁶	1 × 10 ⁻⁵	1.02 × 10 ⁻⁵	9.87 × 10 ⁻⁶	1.02 × 10 ⁻⁴	7.5 × 10 ⁻⁶	1.45 × 10 ⁻⁴
1 × 10 ³	1	1 × 10 ⁻³	1 × 10 ⁻²	1.02 × 10 ⁻²	9.87 × 10 ⁻³	1.02 × 10 ⁻¹	7.5 × 10 ⁻³	1.45 × 10 ⁻¹
1 × 10 ⁶	1 × 10 ³	1	1 × 10	1.02 × 10	9.87	1.02 × 10 ²	7.5	1.45 × 10 ²
1 × 10 ⁵	1 × 10 ²	1 × 10 ⁻¹	1	1.02	9.87 × 10 ⁻¹	1.02 × 10	7.52 × 10 ⁻¹	1.45 × 10
9.81 × 10 ⁴	9.81 × 10	9.81 × 10 ⁻²	9.81 × 10 ⁻¹	1	9.68 × 10 ⁻¹	1 × 10	7.7 × 10 ⁻¹	1.42 × 10
1.01 × 10 ⁵	1.01 × 10 ²	1.01 × 10 ⁻¹	1.01	1.03	1	1.03 × 10	7.6 × 10 ⁻¹	1.47 × 10
9.81 × 10 ³	9.81	9.81 × 10 ⁻³	9.81 × 10 ⁻²	1 × 10 ⁻¹	9.68 × 10 ⁻²	1	7.36 × 10 ⁻²	1.42
1.33 × 10 ⁵	1.33 × 10 ²	1.33 × 10 ⁻¹	1.33	1.3	1.32	1.36 × 10	1	1.93 × 10
6.89 × 10 ³	6.89	6.89 × 10 ⁻³	6.89 × 10 ⁻²	7.03 × 10 ⁻²	6.8 × 10 ⁻²	7.03 × 10 ⁻¹	5.17 × 10 ⁻²	1

Torque conversion table

oz·in	Lb·in	Lb·ft	kg·cm	kg·m	N·cm	N·m
1	0.0625	0.005	0.072	0.0007	0.706	0.007
16	1	0.083	1.152	0.0115	11.3	0.113
192	12	1	13.83	0.138	135.6	1.356
13.89	0.868	0.072	1	0.01	9.807	0.098
1389	86.8	7.233	100	1	980.7	9.807
14.16	0.088	0.007	0.102	0.001	1	0.01
141.6	8.851	0.738	10.20	0.102	100	1

Specific gravity conversion

	Condition	Specific gravity G
kg/Nm ³	0 degrees C 1013mmbar	÷ 1.293
	15 degrees C 1013mmbar	÷ 1.225

Physical Properties

Physical properties of liquids

Fluid	Boiling point when air pressure is 1		Gravity			Molecular weight
			Temp.		Water = 1 at 4 °C	
	°C	°F	°C	°F		
Acetaldehyde	20.6	69	20	68	.782	44.05
Acetic acid	118.3	245	20	68	1.049	60.05
Acetone	56.1	133	20	68	.79	58.08
Aero motor oil (typical)	-	-	15.6	60	.895	-
	-	-	-	-	-	-
Alcohol, allyl-n	97.2	207	20	68	.855	58.05
Alcohol, butyl-n	117.2	243	20	68	.81	74.12
	117.2	243	70	158	.78	-
Alcohol, ethyl-n (grain)	77.8	172	20	68	.789	46.07
Alcohol, methy-n (wood)	66.1	151	20	68	.79	102.17
Alcohol, propyl-n	97.2	207	- 17.8	0	.804	60.09
Ammonia (liquid)	- 33.3	- 28	20	68	.662	17.31
Aniline	183.9	363	20	68	1.022	93.12
Automobile crankcase oils,						
SAE 10	-	-	15.6	60	.88 — .94	-
SAE 20	-	-	15.6	60	.88 — .94	-
SAE 30	-	-	15.6	60	.88 — .94	-
SAE 40	-	-	15.6	60	.88 — .94	-
SAE 50	-	-	15.6	60	.88 — .94	-
SAE 60	-	-	15.6	60	.88 — .94	-
SAE 70	-	-	15.6	60	.88 — .94	-
Automobile transmission lub,						
SAE 80	-	-	15.6	60	.88 — .94	-
SAE 90	-	-	15.6	60	.88 — .94	-
SAE 140	-	-	15.6	60	.88 — .94	-
SAE 250	-	-	15.6	60	.88 — .94	-
Beer	-	-	15.6	60	1.01	-
Benzol (Benzene)	80	176	20	68	.879	78.11
Brine, calcium chloride, 25%	-	-	15.6	60	1.23	-
Brine, sodium chloride, 25%	-	-	15.6	60	1.19	-
Bromine	61.1	142	20	68	2.9	159.83
Butyric acid-n	157.8	316	20	68	.959	88.10
Carbolic acid (phenol)	182.2	360	18.3	65	1.08	94.11
Carbon disulphide	46.1	115	20	68	1.263	76.14
Carbon tetrachloride	76.7	170	20	68	1.594	153.84
Castor oil	-	-	20	68	.96	-
Chloroform	61.1	142	20	68	1.489	119.39
Compounded steam cyl oil (5% tal, ow)	-	-	15.6	60	.90	-
	-	-	-	-	-	-
Decane-n	172.8	343	20	68	.73	142.28
Diethyl ether	34.7	94.4	20	68	.714	74.12
Ethyl acetate	77.2	171	20	68	.90	88.10
Ethyl biomide	38.3	101	15	59	1.45	108.98
Ethylene btomide	131.7	269	20	68	2.18	187.88
Ethylene chloride	83.9	183	20	68	1.246	98.97
Formic acid	100.6	213	20	68	1.221	46.03

Physical properties of liquids

Fluid	Boiling point when air pressure is 1		Gravity			Molecular weight
			Temp.		Water = 1 at 4 °C	
	°C	°F	°C	°F		
Freon 11	-	-	21.1	70	1.49	-
Freon 12	-	-	26.1	79	1.33	-
Freon 21	-	-	21.1	70	1.37	-
Fuel oil, No.1	-	-	15.6	60	.82 — .95	-
No.2	-	-	15.6	60	.82 — .95	-
No.3	-	-	15.6	60	.82 — .95	-
No.5	-	-	15.6	60	.82 — .95	-
No.6	-	-	15.6	60	.82 — .95	-
Gasoline, typical (a)	-	-	- 14.4	6	.74	-
(b)	-	-	- 14.4	6	.72	-
(c)	-	-	- 14.4	6	.68	-
Glycerine, 100%	290	554	20	68	1.26	92.03
Glycerine and water. 50%	-	-	20	68	1.13	-
Glycol, Ethylene	-	-	20	68	1.125	62.07
Heptane-n	98.3	209	20	68	.684	100.20
Hexane-n	68.9	156	20	68	.66	86.17
Hydrochloric acid, 31.5%	-	-	20	68	1.05	-
Kerosene	-	-	15.6	60	.78 — .82	-
Lard oil	-	-	15.6	60	.91 — .92	-
Linseed oil (raw)	28.1	538	15.6	60	.92 — .94	-
Marine engine oil (20% blown rape)	-	-	15.6	60	.94	-
Methy acetate	57.2	135	20	68	.93	58.08
Methy iodide	42.2	108	20	68	2.28	141.94
Milk	-	-	20	68	1.02 — 1.04	-
Naphthelene	217.8	424	20	68	1.145	-
Neatsfoot oil	-	-	15.6	60	.91 — .92	-
Nitric acid, 60%	-	-	20	68	1.37	-
Nitrobenzene	211.1	412	20	68	1.203	-
Nonane-n	150	302	20	68	.718	128.6
Octane-n	125.6	258	20	68	.70	-
Olive oil	(298.9)	(570)	20	68	.91	-
Pentane-n	36.1	97	20	68	.63	123.11
Petroleum ether (benzine)	-	-	15.6	60	.64	128.25
Propionic acid	141.1	286	20	68	.99	114.22
Quenching oil (typical)	-	-	15.6	60	.86 — .89	-
Rapeseed oil	-	-	20	68	.91	72.09
Soya bean oil	-	-	15.6	60	.924	-
Sperm oil	(98.3)	(209)	25	77	.88	74.08
Sugar, 20%	-	-	20	68	1.08	-
40%	-	-	20	68	1.18	-
60%	-	-	20	68	1.29	-
Sulfuric acid, 100%	337.8	640	20	68	1.83	98.08
95%	-	-	20	68	1.83	-
60%	-	-	20	68	1.50	-
Turbine oil (typical medium)	-	-	15.6	60	.91	-
Turpentine	160	320	15.6	60	.86 — .87	136.23
Water (fresh)	100	212	15.6	60	1.0	-
Water (sea)	-	-	15.6	60	1.03	-
Xyolene-o	141.7	287	20	68	.87	-

Density of fluids

Fluid	Density g /cm ³	Density	Temp. °C
Acetone	0.792	49.4	20
Alcohol, ethyl	0.791	49.4	20
Alcohol, methyl	0.810	50.5	0
Benzene	0.899	56.1	0
Carbolic acid	0.950 — 0.965	59.2 — 60.2	15
Carbon disulfide	1.293	80.7	0
Carbon tetrachloride	1.595	99.6	20
Chloroform	1.489	93.0	20
Ether	0.736	45.9	0
Gasoline	0.66 — 0.69	41.0 — 43.0	-
Glycerin	1.260	78.6	0
Kerosene	0.82	51.2	-
Mercury	13.6	849.0	-
Milk	1.028 — 1.035	64.2 — 64.6	-
Naphtha, petroleum ether	0.665	41.5	15
Wood	0.848 — 0.810	52.9 — 50.5	0
Oils:			
Castor	0.969	60.5	15
Coconut	0.925	57.7	15
Cotton seed	0.926	57.8	16
Creosote	1.040 — 1.100	64.9 — 68.6	15
Linseed, boiled	0.942	58.8	15
Olive	0.918	57.3	15
Sea water	1.025	63.99	15
Turpentine (spirits)	0.87	54.3	-
Water	1.00	62.43	4

Critical pressures and temperatures

Fluid	Critical pressure Pc		Critical temperature Tc	
	kPaA	Bars (abs.)	F	°C
Acetic acid	5798	58.0	612	322
Acetone	4764	47.6	455	235
Acetylene	6280	62.9	97	36
Air	3771	37.8	- 222	- 141
Ammonia	11297	113.0	270	132
Argon	4860	48.6	- 188	- 122
Benzene	4833	48.4	552	289
Butane	3647	36.5	307	153
Carbon dioxide	7390	74.0	88	31
Carbon monoxide	3543	35.5	- 218	- 139
Carbon tetrachloride	4557	45.6	541	283
Chlorine	7708	77.0	291	144
Ethane	4944	49.5	90	32
Ethyl alcohol	6391	64.0	469	243
Ethylene	5115	51.2	50	10
Ethyl ether	3599	36.0	383	195
Fluorine	2530	25.3	- 247	- 155
Helium	228.9	2.29	- 450	- 268
Heptane	2716	27.2	513	267
Hydrogen	1296	13.0	- 400	- 240
Hydrogen chloride	8266	82.6	124	51
Isobutane	3750	37.5	273	134
Isopropyl alcohol	5370	53.7	455	235
Methane	4640	46.4	- 117	- 83
Methyl alcohol	7970	79.6	464	240
Nitrogen	3392	34.0	- 233	- 147
Nitrous oxide	7267	72.7	99	37
Octane	2496	25.0	565	296
Oxygen	5033	50.4	- 182	- 119
Pentane	3344	33.5	387	197
Phenol	6129	61.3	786	419
Phosgene	5674	56.7	360	182
Propane	4254	42.6	207	97
Propylene	4557	45.6	198	92
Refrigerant 12	4012	40.1	234	112
Refrigerant 22	4915	49.2	207	97
Sulfur dioxide	7873	78.8	315	157
Water	22104	221.0	705	374

Data

Physical properties of gases

Fluid	Density kg·m ⁻³ (0 °C, 101325 Pa)	Gravity Air = 1	Gravity Oxygen = 1	Molecular weight
Acetylene	1.173	0.9073	0.8208	26.04
Air	1.2929	1.0000	.9047	28.97
Ammonia	.7710	.5963	.5395	17.03
Argon	1.7837	1.3796	1.2482	39.944
Arsenic fluoride	7.71*	5.96*	5.40*	169.91
Arsenic hydride	3.484*	2.695*	2.438*	76.93
Boron fluoride	2.99*	2.31*	2.09*	61.82
Butane (n)	2.5190*	2.0854*	1.8868*	58.12
Butane, iso	2.673	2.067	1.870	58.12
Carbon dioxide	1.9769	1.5290	1.3834	44.01
Carbon monoxide	1.2504	.9671	.8750	28.01
Carbon oxysulfide	2.72	2.10	1.90	60.07
Chlorine	3.214	2.486	2.249	70.91
Chlorine dioxide	3.0911	2.3911	2.1611	67.46
Chlorine monoxide	3.89	3.01	2.72	86.91
Cyanogen	2.335*	1.806	1.634*	52.04
Dimethylamine	1.96617	1.52117	1.37617	45.08
Ethane	1.3566	1.0493	.9493	30.07
Ethylene	1.2604	.9749	.8820	28.05
Fluorine	1.696	1.312	1.187	38.00
Germanium hydride (digermane)	6.7420	5.2120	4.7220	151.25
Germanium tetrahydride	3.420	2.645	2.393	76.63
Helium	.17847	.13804	.12489	4.003
Hydrogen	.08988	.06952	.06290	2.016
Hydrogen bromide	3.6445	2.8189	2.5503	80.92
Hydrogen chloride	1.6392	1.2678	1.1471	36.47
Hydrogen iodide	5.7891	4.4776	4.0510	127.93
Hydrogen selenide	3.670	2.839	2.568	80.98
Hydrogen sulfide	1.539	1.190	1.077	34.08
Hydrogen telluride	5.81	4.49	4.07	129.63
Krypton	3.708	2.868	2.595	83.70
Methane	.7168	.5544	.5016	16.04
Methylamine	1.396	1.080	.9769	31.06
Methyl chloride	2.3076	1.7848	1.6148	50.49
Methyl ether	2.1098	1.6318	1.4764	46.07
Methyl fluoride	1.5452	1.1951	1.0813	34.03
Neon	.90036	.69638	.63004	20.18
Nitric oxide	1.3402	1.0366	.9378	30.01

Physical properties of gases

Fluid	Density $\text{kg}\cdot\text{m}^{-3}$ (0 °C, 101325 Pa)	Gravity Air = 1	Gravity Oxygen = 1	Molecular weight
Nitrogen	1.25055	.96724	.87510	28.02
Nitrogen (atm.)	1.2568	.9721	.8795	-
Nitrosyl chloride	2.992	2.314	2.094	65.47
Nitrosyl fluoride	2.176*	1.683*	1.523*	49.01
Nitrous oxide	1.9778	1.5297	1.3840	44.02
Nitroxyl chloride	2.57*	1.99*	1.798*	81.47
Nitroxyl fluoride	2.90	2.24	2.03	65.01
Oxygen	1.42904	1.10527	1.0000	32.00
Ozone	2.144	1.658	1.500	48.00
Phosphine	1.5294	1.1829	1.0702	34.00
Phosphorus fluoride	3.907*	3.022*	2.734*	87.98
Phosphorus oxyfluoride	4.8	3.7	3.4	103.98
Phosphorus pentafluoride	5.81	4.494	4.066	125.98
Propane	2.0096	1.554	1.407	44.09
Radon	9.73	7.526	6.809	222.00
Silicane, chloro-	3.03	2.34	2.12	66.54
Silicane, chloromethyl	3.64	2.82	2.55	80.60
Silicane, dichloromethyl	5.3	4.1	3.7	115.02
Silicane, dimethyl	2.73	2.11	1.91	60.14
Silicane, methyl	2.08	1.61	1.46	46.12
Silicane, trifluoro-	3.86	2.99	2.70	86.07
Silicon fluoride	4.684	3.623	3.278	104.06
Silicon hexahydride	2.85	2.204	1.994	62.17
Silicon tetrahydride	1.44	1.114	1.008	32.09
Stibine (15 °C, 754A)	5.30	4.10	3.71	125.00
Sulfur dioxide	2.9269	2.2638	2.0482	64.07
Sulfur fluoride	6.50*	5.03*	4.55*	146.07
Sulfuric oxyfluoride	3.72*	2.88*	2.60*	102.07
Trimethylamine	2.580	1.996	1.085	59.11
Trimethyl boron	2.52	1.95	1.76	55.92
Tungsten fluoride	12.9	9.98	9.03	297.92
Xenon	5.851	4.525	4.094	131.30

* Density at 20 °C.

Physical properties of water

Water temperature		Vapour pressure	Gravitational weight	Gravity
°C	°F	kPaA	kgf/m ³	
0	32	0.6107	999.87	1.00
4	40	0.8385	1000.1	1.00
10	50	1.2268	999.81	1.00
16	60	1.7656	999.18	1.00
21	70	2.5020	998.13	1.00
27	80	3.4353	996.76	1.00
32	90	4.8129	995.10	1.00
38	100	6.5440	993.18	.99
43	110	8.7899	991.03	.99
49	120	11.6699	988.65	.99
54	130	15.3258	986.03	.99
60	140	19.9183	983.24	.98
66	150	25.6346	980.23	.98
71	160	32.6875	977.12	.98
77	170	41.3135	973.81	.97
82	180	51.7811	971.32	.97
88	190	64.3905	966.69	.97
93	200	79.4613	962.91	.96
99	210	97.3653	959.00	.96
100	212	101.313	958.19	.96
104	220	117.994	955.00	.96
116	240	172.136	946.48	.95
127	260	244.235	937.44	.94
138	280	339.192	927.94	.93
149	300	461.942	918.06	.92
177	350	927.974	890.49	.89
204	400	1704.59	859.44	.86
232	450	2913.07	824.50	.82
260	500	4694.25	784.15	.78
288	550	7207.3	736.22	.74
316	600	10639.2	677.66	.68
343	650	15224.8	599.04	.60
371	700	21332.4	437.46	.44

Saturated steam (Based on temperature)

Temp. °C	Pressure P		Specific volume m ³ /kg	
	kPaA	mmHg	V'	V''
0	0.61	4.6	0.00100022	206.305
2	0.71	5.3	0.00100009	179.923
4	0.81	6.1	0.00100003	157.272
6	0.93	7.0	0.00100004	137.780
8	1.07	8.0	0.00100011	120.966
10	1.23	9.2	0.00100025	106.430
12	1.40	10.5	0.00100044	93.8354
14	1.60	12.0	0.00100069	82.8998
16	1.82	13.6	0.00100099	73.3843
18	2.06	15.5	0.00100133	65.0873
20	2.34	17.5	0.00100172	57.8383
22	2.64	19.8	0.00100216	51.4923
24	2.98	22.4	0.00100263	45.9260
26	3.36	25.2	0.00100315	41.0343
28	3.78	28.3	0.00100371	36.7276
30	4.24	31.8	0.00100431	32.9288
32	4.26	35.7	0.00100493	29.5724
34	5.32	39.9	0.00100560	26.6014
36	5.94	44.6	0.00100631	23.9671
38	6.62	49.7	0.00100704	21.6274
40	7.37	55.3	0.00100781	19.5461
42	8.20	61.1	0.00100861	17.6916
44	9.10	68.3	0.00100943	16.0365
46	10.09	75.6	0.00101030	14.5572
48	11.16	83.7	0.00101119	13.2329
50	12.33	92.5	0.00101211	12.0547
55	15.74	118.1	0.00101454	9.57887
60	19.92	149.4	0.00101714	7.67854
65	25.01	187.6	0.00101991	6.20228
70	31.16	233.7	0.00102285	5.04627
75	38.55	289.1	0.00102594	4.13410
80	47.36	355.2	0.00102919	3.40909
85	57.80	433.6	0.00103259	2.82881
90	70.10	525.9	0.00103614	2.36130
95	84.52	634.0	0.00103985	1.98222
100	101.32	760.0	0.00104371	1.67300
105	120.79	906.1	0.00104771	1.41928
110	143.26	1074.6	0.00105187	1.20994
120	198.53	1489.2	0.00106063	0.891524
130	270.12	2026.2	0.00107002	0.668136
140	361.35	2710.6	0.00108006	0.508494
150	475.96		0.00109078	0.392447
160	618.02		0.00110222	0.306756
170	791.97		0.00111445	0.242553
180	1002.57		0.00112752	0.193800
190	1255.07		0.00114150	0.156316
200	1554.74		0.00115649	0.127160
210	1907.66		0.00117260	0.104239
220	2319.71		0.00118995	0.0860378
230	2797.46		0.00120872	0.0714498
240	3347.57		0.00122908	0.0596544
250	3977.31		0.00125129	0.0500374
260	4694.03		0.00127563	0.0421338
270	5505.48		0.00130250	0.0355880
280	6419.79		0.00133239	0.0301260
290	7445.60		0.00136594	0.0255351
300	8592.12		0.00140406	0.0216487
310	9869.74		0.00144797	0.0183339
320	11288.67		0.00149950	0.0154798
330	12861.55		0.00156147	0.0129894
340	14604.08		0.00163871	0.0107804
350	16533.90		0.00174112	0.0087991
360	18673.57		0.0018599	0.0069398
370	21052.50		0.0022136	0.0049727
374.15	22118.41		0.0031700	0.0031700

Saturated steam (Based on pressure)

Pressure P		Temp. °C	Specific volume m ³ /kg	
kPaA	mmHg		V'	V''
0.98	7.4	6.699	0.00100006	131.62401
1.96	14.7	17.204	0.00100119	68.2556
3.92	29.4	28.645	0.00100390	35.4496
5.88	44.1	35.83	0.00100625	24.1820
7.84	58.8	41.16	0.00100872	18.4405
9.81	73.6	45.45	0.00101006	14.9467
19.61	147.1	59.66	0.00101696	7.79127
29.42	220.7	68.68	0.00102206	5.32592
39.22	294.2	75.42	0.00102621	4.06715
49.03	367.8	80.86	0.00102976	3.30001
58.84	441.3	85.45	0.00103291	2.78214
78.45	588.4	92.99	0.00103834	2.12544
98.06	735.6	99.09	0.00104299	1.72495
101.32	760.0	100.00	0.00104371	1.67300
147.09	1103.3	110.79	0.00105253	1.18041
196.12	1471.1	119.61	0.00106028	0.901776
294.18	2206.7	132.88	0.00107284	0.616754
392.24	2942.2	142.92	0.00108312	0.470785
490.30	3677.8	151.11	0.00109202	0.381632
588.36	4413.4	158.08	0.00109997	0.321345
686.42		164.17	0.00110723	0.277768
784.48		169.61	0.00111396	0.244751
882.54		174.53	0.00112026	0.218840
980.60		179.04	0.00112622	0.197945
1176.72		187.08	0.00113732	0.166284
1372.84		194.13	0.00114757	0.143394
1568.96		200.43	0.00115717	0.126047
1765.08		206.15	0.00116525	0.112434
1961.20		211.39	0.00117493	0.101455
2157.32		216.24	0.00118327	0.0924081
2353.44		220.76	0.00119133	0.0848196
2549.56		224.9	0.00119913	0.0783601
2745.68		228.98	0.00120674	0.0727929
2941.80		232.76	0.00121417	0.0679431
3137.92		236.35	0.00122145	0.0636793
3334.04		239.77	0.00122859	0.0599001
3530.16		243.04	0.00123562	0.0565266
3726.28		246.17	0.00124255	0.0534959
3922.40		249.18	0.00124938	0.0507578
4118.52		252.07	0.00125615	0.0482713
4314.64		254.86	0.00126284	0.0460028
4510.76		257.56	0.00126947	0.0439246
4706.88		260.17	0.00127606	0.0420132
4903.0		262.69	0.00128260	0.0402491
5393.3		268.69	0.00129882	0.0363798
5883.6		274.28	0.00131489	0.0331317
6373.9		279.53	0.00133089	0.0303641
6864.2		284.47	0.00134689	0.0279761
7844.8		293.61	0.00137912	0.0240593
8825.4		301.91	0.00141194	0.0209758
9806.0		309.53	0.00144575	0.0184791
10786.6		316.58	0.00148088	0.0164099
11767.2		323.15	0.00151774	0.0146594
12747.8		329.31	0.00155677	0.0131514
13728.4		335.10	0.00159853	0.0118316
14709.0		340.57	0.00164374	0.0106617
15689.6		345.75	0.00169345	0.0096151
16670.2		350.67	0.0017491	0.0086722
17650.8		355.35	0.0018139	0.0077945
18631.4		359.81	0.0018921	0.0069743
19612.0		364.07	0.0019902	0.0061872
20592.6		368.15	0.0021242	0.0053845
21573.2		372.05	0.0023668	0.0044231
22118.41		374.15	0.0031700	0.0031700

This data is provided by the Japan Mechanical Society.

Data

Flange Standards

Nominal pressure 5K steel flange reference dimensions (JIS B2238-1996)

Nominal diameter		Flange outer diameter (mm)	Thickness (mm)	Bolt hole			Bolt nominal screw designation
mm	inch			Center diameter (mm)	Number	Diameter (mm)	
40	1 1/2	120	12	95	4	15	M12
50	2	130	14	105	4	15	M12
65	2 1/2	155	14	130	4	15	M12
80	3	180	14	145	4	19	M16
100	4	200	16	165	8	19	M16
125	5	235	16	200	8	19	M16
150	6	265	18	230	8	19	M16
200	8	320	20	280	8	23	M20
250	10	385	22	345	12	23	M20
300	12	430	22	390	12	23	M20
350	14	480	24	435	12	25	M22
400	16	540	24	495	16	25	M22
450	18	605	24	555	16	25	M22
500	20	655	24	605	20	25	M22
550	22	720	26	665	20	27	M24
600	24	770	26	715	20	27	M24
650	26	825	26	770	24	27	M24
700	28	875	26	820	24	27	M24
750	30	945	28	880	24	33	M30
800	32	995	28	930	24	33	M30
850	34	1045	28	980	24	33	M30
900	36	1095	30	1030	24	33	M30
1000	40	1195	32	1130	28	33	M30
1100	44	1305	32	1240	28	33	M30
1200	48	1420	34	1350	32	33	M30
1350	54	1575	34	1505	32	33	M30

Nominal pressure 10K steel flange reference dimensions (JIS B2238-1996)

Nominal diameter		Flange outer diameter (mm)	Thickness (mm)	Bolt hole			Bolt nominal screw designation
mm	inch			Center diameter (mm)	Number	Diameter (mm)	
40	1 1/2	140	16	105	4	19	M16
50	2	155	16	120	4	19	M16
65	2 1/2	175	18	140	4	19	M16
80	3	185	18	150	8	19	M16
100	4	210	18	175	8	19	M16
125	5	250	20	210	8	23	M20
150	6	280	22	240	8	23	M20
200	8	330	22	290	12	23	M20
250	10	400	24	355	12	25	M22
300	12	445	24	400	16	25	M22
350	14	490	26	445	16	25	M22
400	16	560	28	510	16	27	M24
450	18	620	30	565	20	27	M24
500	20	675	30	620	20	27	M24
550	22	745	32	680	20	33	M30
600	24	795	32	730	24	33	M30
650	26	845	34	780	24	33	M30
700	28	905	34	840	24	33	M30
750	30	970	36	900	24	33	M30
800	32	1020	36	950	28	33	M30
850	34	1070	36	1000	28	33	M30
900	36	1120	38	1050	28	33	M30
1000	40	1235	40	1160	28	39	M36
1100	44	1345	42	1270	28	39	M36
1200	48	1465	44	1380	32	39	M36
1350	54	1630	48	1540	36	45	M42

Nominal pressure 16K steel flange reference dimensions (JIS B2238-1996)

Nominal diameter		Flange outer diameter (mm)	Thickness (mm)	Bolt hole			Bolt nominal screw designation
mm	inch			Center diameter (mm)	Number	Diameter (mm)	
40	1 1/2	140	16	105	4	19	M16
50	2	155	16	120	8	19	M16
65	2 1/2	175	18	140	8	19	M16
80	3	200	20	160	8	23	M20
100	4	225	22	185	8	23	M20
125	5	270	22	225	8	25	M22
150	6	305	24	260	12	25	M22
200	8	350	26	305	12	25	M22
250	10	430	28	380	12	27	M24
300	12	480	30	430	16	27	M24
350	14	540	34	480	16	33	M30×3
400	16	605	38	540	16	33	M30×3
450	18	675	40	605	20	33	M30×3
500	20	730	42	660	20	33	M30×3
600	24	845	46	770	24	39	M36×3

Nominal pressure 20K steel flange reference dimensions (JIS B2238-1996)

Nominal diameter		Flange outer diameter (mm)	Thickness (mm)	Bolt hole			Bolt nominal screw designation
mm	inch			Center diameter (mm)	Number	Diameter (mm)	
40	1 1/2	140	18	105	4	19	M16
50	2	155	18	120	8	19	M16
65	2 1/2	175	20	140	8	19	M16
80	3	200	22	160	8	23	M20
100	4	225	24	185	8	23	M20
125	5	270	26	225	8	25	M22
150	6	305	28	260	12	25	M22
200	8	350	30	305	12	25	M22
250	10	430	34	380	12	27	M24
300	12	480	36	430	16	27	M24
350	14	540	40	480	16	33	M30×3
400	16	605	46	540	16	33	M30×3
450	18	675	48	605	20	33	M30×3
500	20	730	50	660	20	33	M30×3
600	24	845	54	770	24	39	M36×3

Nominal pressure 30K steel flange reference dimensions (JIS B2238-1996)

Nominal diameter		Flange outer diameter (mm)	Thickness (mm)	Bolt hole			Bolt nominal screw designation
mm	inch			Center diameter (mm)	Number	Diameter (mm)	
50	2	165	22	130	8	19	M16
65	2 1/2	200	26	160	8	23	M20
80	3	210	28	170	8	23	M20
100	4	240	32	195	8	25	M22
125	5	275	36	230	8	25	M22
150	6	325	38	275	12	27	M24
200	8	370	42	320	12	27	M24
250	10	450	48	390	12	33	M30×3
300	12	515	52	450	16	33	M30×3

ANSI class 150 steel flange reference dimensions (ANSI/ASME B16.5-1996)

Nominal diameter		Flange outer diameter (mm)	Thickness (mm)	Bolt hole			Bolt nominal screw designation
mm	inch			Center diameter (mm)	Number	Diameter (mm)	
40	1 1/2	127	17.5	98.5	4	16	U1/2-13UNC
50	2	152	19.1	120.6	4	20	U5/8-11UNC
65	2 1/2	178	22.3	139.7	4	20	U5/8-11UNC
80	3	191	23.9	152.4	4	20	U5/8-11UNC
100	4	229	23.9	190.5	8	20	U5/8-11UNC
125	5	254	23.9	215.9	8	23	U3/4-10UNC
150	6	279	25.4	241.3	8	23	U3/4-10UNC
200	8	343	28.6	298.4	8	23	U3/4-10UNC
250	10	406	30.2	361.9	12	26	U7/8- 9UNC
300	12	483	31.8	431.8	12	26	U7/8- 9UNC
350	14	533	35.0	476.2	12	29	U1 - 8UNC
400	16	597	36.6	539.7	16	29	U1 - 8UNC
450	18	635	39.7	577.8	16	32	U1 1/8-8UN
500	20	698	42.9	635.0	20	32	U1 1/8-8UN
600	24	813	47.7	749.3	20	35	U1 1/4-8UN

ANSI class 300 steel flange reference dimensions (ANSI/ASME B16.5-1996)

Nominal diameter		Flange outer diameter (mm)	Thickness (mm)	Bolt hole			Bolt nominal screw designation
mm	inch			Center diameter (mm)	Number	Diameter (mm)	
50	2	165	22.3	127.0	8	20	U5/8-11UNC
65	2 1/2	191	25.4	149.4	8	23	U3/4-10UNC
80	3	210	28.6	168.1	8	23	U3/4-10UNC
100	4	254	31.8	200.2	8	23	U3/4-10UNC
125	5	279	35.0	235.0	8	23	U3/4-10UNC
150	6	318	36.6	269.7	12	23	U3/4-10UNC
200	8	381	41.3	330.2	12	26	U7/8- 9UNC
250	10	444	47.7	387.4	16	29	U1 - 8UNC
300	12	521	50.8	450.9	16	32	U1 1/8-8UN