

# Oracle Lease Management Unleashed

Ranu Srivastava

<http://apps2fusion.com>



Oracle Lease Management Overview	2
Cross Product Interaction	2
Create & Book the Contract	3
Generate Payments Streams For Contract	6
Generate Invoices for Contract	11
Terminate Lease Contracts	12
Sell Terminated Assets	15

**Oracle Lease Management Overview**

This article presents a very simplistic view of Oracle Leasing from a technical/module point of view, although the module is a monster! to implement, being an admirer of ‘Simplicity’ here is my effort to make it look simple ie you create a lease contract, define when/how much you want to get paid, generate invoices, end of it(or when you wish) terminate the contract & the sell ypur assets of lease them again if you wish.

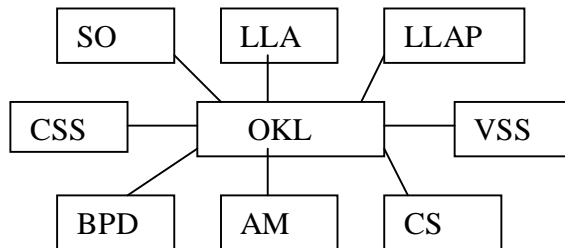

1. Sales – This is the process of negotiating with the customer, involves identifying the asset, lease term, payment plans, services and generating the lease quote.
2. Origination – This involves establishing the credit line, creating Vendor agreement, Operating agreement, Master Lease agreement and the Lease contract, validation, approval and activation of the Lease contract.
3. Accounting – Generate payment streams and make journal entries to record the transaction in sub ledger.
4. Billing, Payment and Disbursements – This covers sending invoices to customers, collecting payments from customers and sending payments to suppliers.
5. Asset Management – Handle lease termination, manage asset returns, re-purchase of assets.
6. Customer Service – Handle customer and vendor inquiries and requests relating to the lease agreement, account information, billing, payments etc
7. Customer Self-Service – Customers have access to view and update their account information, make payments, view lease contract etc.
8. Vendor Self-Service – Vendors have access to view and update their account information, view receivables etc.

**Cross Product Interaction**

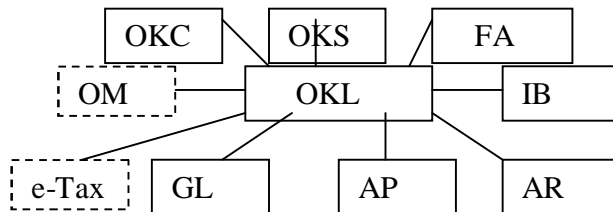

1. Contracts –Core contracts data model used to store lease header and lines.

2. Service Contracts – Interaction with service contracts is done for billing, when the lease contract has Usage or Service lines.
3. Fixed Assets - On activation of a lease contract, an addition is made to Fixed assets. Re-booking and Mass Re-booking may require adjustments to Fixed assets if there is a change in asset cost. Split contracts and split assets also cause additions or adjustments to fixed assets.
4. Install Base – The location of the leased assets is passed on to Install Base.
5. Receivables – Interaction with Receivables is done for invoicing and receiving payments from customers.
6. Payables – Interaction with Payables is done for making payments to vendors and investors.
7. General Ledger – Journal accounting data is transferred to GL

### **Create & Book the Contract**

- Establish credit line – check and approve credit limits for the customer
- Enter Contract Details –
  - Parties – Customer, Vendor, Guarantor etc
  - Rental period
  - Financial product
  - Terms and Conditions
  - Lines – Asset, Service, Fees, Usage
  - Payment Structure – establishes payment frequency, payment type etc.
- Vendor Agreements – Agreement between lessor and vendor for a specific program
- Operating Agreements – General agreement between lessor and vendor
- Master Lease Agreements – Set up terms and conditions for a lease customer having multiple lease contracts
- Insurance – Capture insurance details or create quote and sell insurance to lessee.
- Book the contract - validate the contract, generate streams, approve and activate the contract
- Revisions –
  - Re- book Contract - Changes to financial terms of the contract
  - Reverse Contract – Unbook the contract and reverse accounting entries
  - Split Contract – Moving some asset lines to a different contract
  - Split Assets – Split an asset line into multiple asset lines within the same contract
- Subsidies – Discount given to lessor by vendor or 3<sup>rd</sup> party. Set up the application period, calculation method, accounting method and termination details. Link to a lease contract
- Securitization – Create a pool of lease receivables and sell to investors. Handle payments to investors.

Oracle Lease Management Unleashed

Ranu Srivastava

<http://apps2fusion.com>

# Oracle Lease Management Unleashed

Ranu Srivastava

<http://apps2fusion.com>

Data structure –

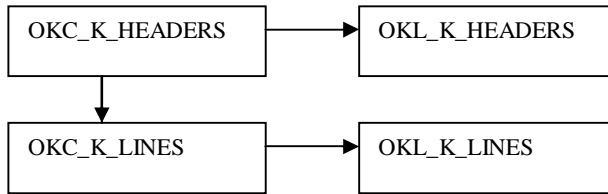

The Line items for a Lease Contract

Financial Asset :

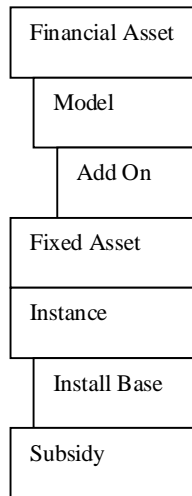

Service :

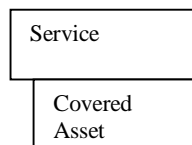

Fee :

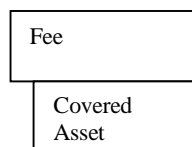

Usage :

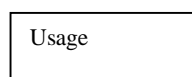

Main Authoring A

Covered  
Asset

Contract header and Line : OKL\_CONTRACT\_PVT

Copy Contract : OKL\_COPY\_CONTRACT\_PVT

Copy Asset : OKL\_COPY\_ASSET\_PVT

Create asset line : OKL\_CREATE\_KLE\_PVT

Terms & Conditions Pages : OKL\_RULE\_EXTRACT\_PVT

Payments Page : OKL\_RGRP\_PROCESS\_PVT

Lease QA Checks : OKL\_QA\_DATA\_INTEGRITY

Subsidy setup : OKL\_SUBSIDY\_PVT

Associating asset to Subsidy : OKL\_ASSET\_SUBSIDY\_PVT

Subsidy Processing/Calculations : OKL\_SUBSIDY\_PROCESS\_PVT

Booking: OKL\_CONTRACT\_BOOK\_PVT

Activation : OKL\_ACTIVATE\_CONTRACT\_PUB

Asset(FA) integration : OKL\_ACTIVATE\_ASSET\_PVT

IB integration : OKL\_ACTIVATE\_IB\_PVT

Online rebook : OKL\_CONTRACT\_REBOOK\_PVT

Mass Rebook : OKL\_MASS\_REBOOK\_PVT

Service Integration : OKL\_SERVICE\_INTEGRATION\_PVT

UBB Service integration: OKL\_UBB\_INTEGRATION\_PVT

### **Generate Payments Streams For Contract**

Streams are the breakdown of the payment plan. Stream Generation is thus the process of generating this split up of the payment plan in the Contract Booking Process.

Stream Generation in OKL is done in 2 ways.

1. External Stream Generation
2. Internal Stream Generation

External Stream Generation uses a Third Party Pricing Engine Called SuperTrump for generating the Streams. In Contrast, Internal Stream Generation Process uses an OKL API to generate Streams.

**Process Flow in External Stream Generation**

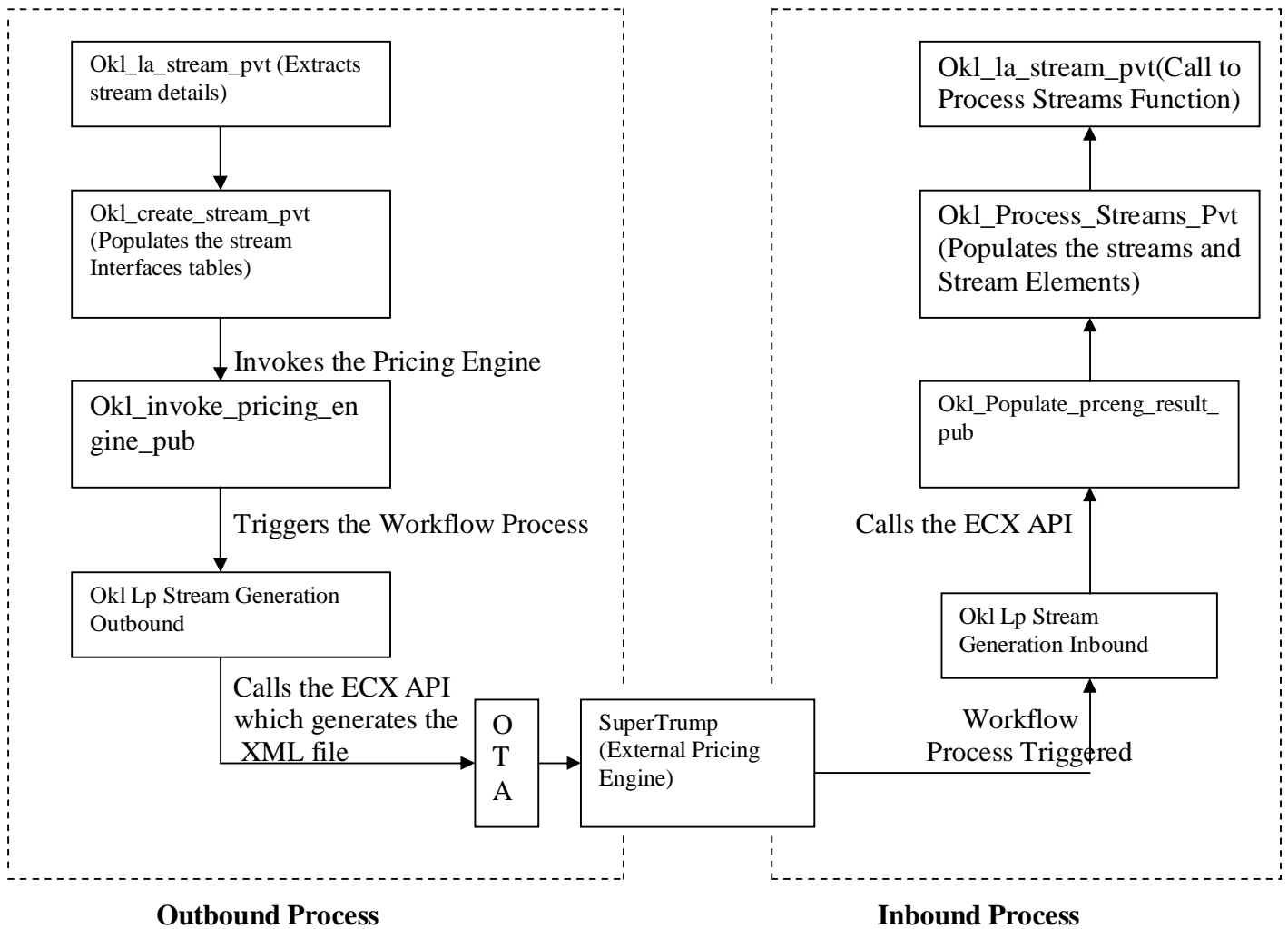

**External Stream Generation**

External Stream Generation consists of two Processes

1. Outbound Process: The process which feeds the input from the Contract to the SuperTrump.
2. Inbound Process: The process which directs the output from SuperTrump to the Contract Tables.

**Outbound Process**

The Outbound Process consists of 3 stages.

Call to the Extraction API – **Okl\_La\_Stream\_Pvt**

1. Call to the **Okl\_Create\_Stream\_Pvt** API
2. Invoke the Pricing Engine **Okl\_Invoke\_Pricing\_Engine\_Pvt** which triggers the Workflow Process

The Outbound Process is triggered on clicking the ‘Generate Streams’ Button in the Contract Booking Screen. This calls the Okl\_La\_Stream\_Pvt API with the contract details.

#### **Pricing Engine and Workflow**

The pricing engine **Okl\_Invoke\_Pricing\_Engine\_Pvt** triggers a workflow process **Okl Lp Stream Generation Outbound**

The workflow process which is triggered accepts 3 parameters

- Event Name – ‘**oracle.apps.okl.outbound.lease.send**’
- Event Key – Value of transaction\_id of the process
- Parameter List

The Parameter list is built by the Pricing Engine before the call to the Workflow Process. The following is the list of Parameters

- ECX\_TRANSACTION\_TYPE
- ECX\_TRANSACTION\_SUBTYPE
- ECX\_PARTY\_ID
- ECX\_PARTY\_SITE\_ID
- ECX\_DOCUMENT\_ID
- ECX\_PARAMETER1
- ECX\_PARAMETER2
- ECX\_PARAMETER3
- ECX\_PARAMETER4
- ECX\_PARAMETER5

This workflow process in turn calls the ECX API's .The ECX API generates an XML file that contains all the contract details needed by SuperTrump. This XML file is stored in **/sqlcom/log/<DBNAME>**. For p2 **/appslog/fin\_top/utl/fin115p2/log**

This XML file is the input that the External Pricing Engine SuperTrump accepts. The XML file is transferred through an OTA (Oracle Transfer Agent) which is a server that acts as an interface between SuperTrump and the Pricing Engine.

#### **SuperTrump**

SuperTrump is the External Pricing Engine which calculates the yields for the Stream Generation Process. For more information about the product

<http://www.ivorycc.com/products/super.html>

#### **Inbound Process**

The Inbound Process refers to the process that directs the output of the SuperTrump to the Contract Tables.



The outbound XML returned by SuperTrump is sent to the **oklLpSTProxySrvr.jsp**. The result is stored as a CLOB in **okl\_stream\_trx\_data\_v** for further references.

The Inbound Process is a three stage process

1. Call to the Inbound Workflow Process- **Okl Lp Stream Generation Inbound**
2. Call to **Okl\_Process\_Streams\_Pvt**
3. Call to **Okl\_La\_Stream\_Pvt**

#### **Okl Lp Stream Generation Inbound**

This workflow process is triggered after the SuperTrump processes its input. This process calls the ECX API's which in turn makes a call to the Pricing Engine **Okl\_Populate\_Prceng\_Result\_Pvt**. This API stores the results of the Super Trump in the respective tables – Okl\_Sif\_Ret\_Errors, Okl\_Sif\_Ret\_Levels, Okl\_Sif\_Ret\_Strms. The pricing Engine also updates the status code of the Stream Interface table Okl\_Stream\_Interfaces.

The Workflow also makes a call to the Okl\_Process\_Streams\_Pvt

#### **Okl\_La\_Stream\_Pvt**

The yields obtained from SuperTrump are passed to the API and a call is made to the function process\_streams. This function accepts the yields and updates the contract header with the yields details.

### **Setups in Stream Generation Process**

#### Profile Options

- Log into Forms and choose the System Administrator responsibility
- Choose the System Profile option
- Query on the Profile OKL%STREAM%

For External Stream Generation the following options are set

OKL: Stream Generation Pricing Engine Name : SuperTrump

OKL: Streams for Booking Path : External

For Internal Stream Generation , the following options are set

OKL: Stream Generation Pricing Engine Name : ---

OKL: Streams for Booking Path : Internal

### **Stream generation debugging process**

The Stream Generation can be fired through the Contracts Booking Screen .

The following check points in the Stream Generation Process Flow help in identifying issues when the Stream Generation Process fails.

#### **For the Outbound Process**

1. The Profile options of the Stream Generation Process are verified.

For External Stream Generation ,the following are the profile options

OKL: Stream Generation Pricing Engine Name : SuperTrump

OKL: Streams for Booking Path : External

For Internal Stream Generation , the following are the profile options

OKL: Stream Generation Pricing Engine Name : ---

OKL: Streams for Booking Path : Internal

2. The Workflow process is verified. To verify the Workflow Process,

- Log into SSWA
- Choose the Responsibility Workflow Administrator Web Applications
- Choose the 'Find Processes' Option
- Search for Item Type 'OKL – Okl Lp Stream Generation Outbound' for the Outbound Process.

The Processes triggered have a unique transaction number by which they can be identified. A check is made to see if the workflow process has gone through fine.

3. The next step is to check the log file. The log files can be viewed if the log option has been set to true. The location of the log file can be obtained from the Profile option. **OKL: Stream Generation Log Directory.** (Navigate to Forms, System -> Profile ). For Findv115 the log file is available at **/sqlcom/log/findv115** .

4. A check is made to see if the OTA is up. This can be done by running a simple script located at **\$ECX\_TOP/patch/115/sql/ecxver.sql** that checks the profile option and checks if the setups are correct and the OTA is up and running.

If no issues are discovered at this stage, then it implies that the Outbound Process has gone through fine.

#### **For the Inbound Process**

1. The output from the supertrump produces a log file. For the Inbound Process the log file can be found at `/export/home/dbadmin/db/iAS_qapache/Apache/Apache/okl_<PORT NUMBER>/log1 /jserve.log`. This log file gives us the details of whether the Stream Generation Process went through fine and the lists the errors if any.

2. The Workflow process is then verified. Log into the Workflow Responsibility and Search for the following process: 'OKL – Okl Lp Stream Generation Inbound' for the Inbound Process.

3. The ECX profile Options are then verified. The Trading Partner Setup is verified. The following is an example of the settings

Protocol Address:

[http://ap106jvm.us.oracle.com:5993/OA\\_HTML/oklLpSTProxySrvr.jsp](http://ap106jvm.us.oracle.com:5993/OA_HTML/oklLpSTProxySrvr.jsp)

User Name: apps

Password: apps

The server and port varies from one database to the other.

There are times when the username/password of the DB gets reset. This could be one of the reasons for the failure of the Stream Generation Process as the Process is unable to write into the DB as it does not have the access.

The port settings are also verified. The JVM that the SuperTrump server points to should correspond to the host name of the port.

- The final check is to see if the SuperTrump is working and processing the information. This can be done by passing the XML file generated by the ECX API to a Java Program which makes a call to the SuperTrump and viewing the Output file generated. This would help us to determine if the SuperTrump is working and processing the information.

**Stream Types generated for the different types of Contracts**

Stream Type	Book Classification			
	Lease OP	Lease DF	Loan	Lease ST
PRE-TAX INCOME	Y	Y	Y	Y
RENT	Y	Y	N	Y
TERMINATION VALUE	Y	Y	Y	Y

**Generate Invoices for Contract**

Streams are date/amt generated for contract & used by Transactions, Streams represent Schedule of payments which is signed for the contract. Modification to contract; schedule of payments normally happens during Stream Generation/Re-generation only.

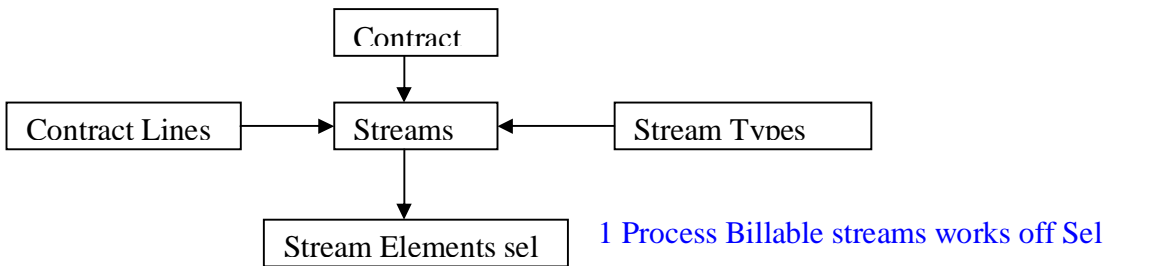

These are schedule for contract & Form Integral part of contract :okl billing tables  
okl interface tables

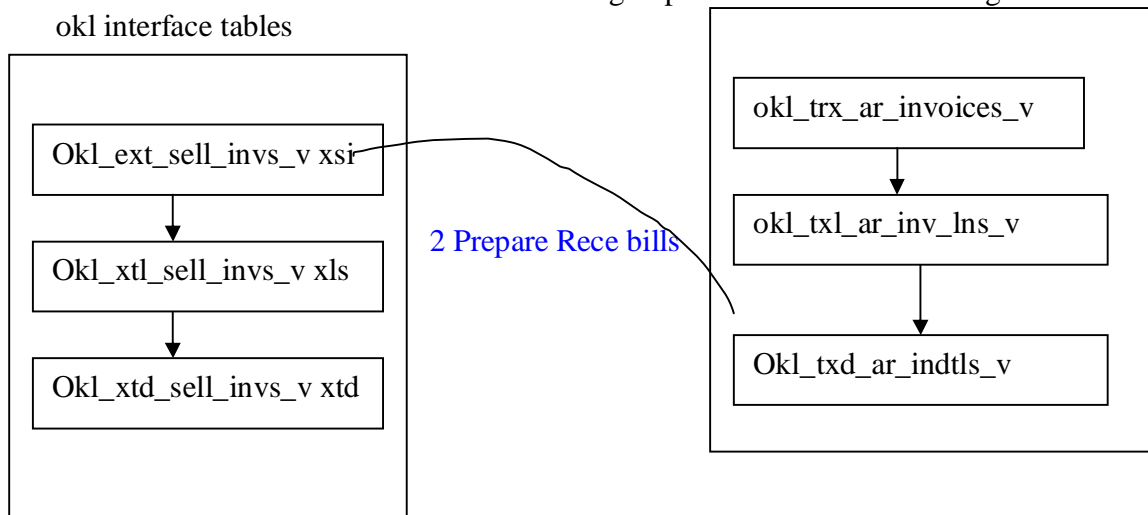

**3 Consolidation(Rece Bills Consolidation) based on consolidation hierarchy**  
(cust,bto,pymt\_methd,invoice\_fmt,bill\_date,currency/org)

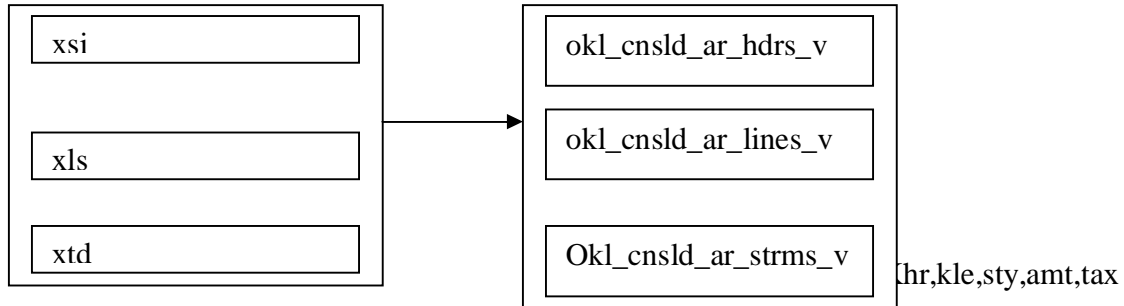

Interface\_attribute1 (cons\_inv#) (6 contract#, 7 Asset ,9 stream type, 10 lsm\_id .....)  
Can be useful to invoice Adjustment for asset, streams, contract overall)

**4 Transfer to AR : Possibly customize for re-book before data gets to AR**

Step 1 means losing contract sanity,  
Step 2 & 3 can be looked at from possible solution point of view

**5 Auto Invoice** (ra\_cust\_trx\_all,ra\_cust\_trx\_lines\_all,ar\_payment\_schedules\_all)

**6 Fetch AR invoice number#** ( Update okl consolidated invoices)

**Terminate Lease Contracts**

Termination of contract (or assets of contract) can be done via a termination quote

Termination Quote undergoes the following steps:

1. Create Termination Quote – quote calculated and created
2. Acceptance of Termination Quote – An existing approved quote for a contract can be accepted. Acceptance triggers
  - a. Creation of invoices
  - b. Creation of Termination transaction

A Termination transaction created can have status “Processed” if all the termination steps pass or can have status “Error” if one or more of the termination steps have failed.

If the Termination transaction has failed then the termination transaction details can be viewed and once the error is rectified the termination can be triggered again by recycling the transaction and running the “Terminate Expired Contracts” concurrent program.

The termination steps carried out by the termination process varies based on the deal type of the contract and based on the termination quote type.

If deal type is OP Lease/DF Lease and Termination quote is **Termination without purchase and it is a full termination** then

Validate contract

- Cancel Insurance
- Close balances
- Close Streams
- Post Accounting Entries
- Amortize Asset
- Create Asset Return
- Update Contract

If deal type is OP Lease/DF Lease/Sales type Lease and **Termination quote is Termination with purchase and it is a full termination** then

- Validate contract
- Cancel Insurance
- Close balances
- Close Streams
- Post Accounting Entries
- Dispose Assets
- Update Contract

If deal type is **loan/revolving loan and it is a full termination** then

- Validate contract
- Cancel Insurance
- Close Balances
- Close Streams
- Post Accounting Entries
- Dispose Assets
- Update Contract

If deal type is OP Lease/DF Lease and Termination quote is **Termination without purchase** and it is a partial termination then

- Validate contract
- Split Asset (needed if partial unit termination) (not shown as a step on the screen)
- Cancel Insurance
- Close Streams
- Post Accounting Entries
- Amortize Asset
- Create Asset Return
- Update Contract
- Rebook the contract (not shown as a step on the screen, part of update contract step)

If deal type is OP Lease/DF Lease and Termination quote is **Termination with purchase and it is a partial termination** then

- Validate contract
- Split Asset (needed if partial unit termination)

Cancel Insurance  
 Close Streams  
 Post Accounting Entries  
 Dispose Assets  
 Update Contract  
 Rebook the contract

If deal type is loan/revolving loan and it is a partial termination then

Validate contract  
 Split Asset (needed if partial unit termination)  
 Cancel Insurance  
 Close Streams  
 Post Accounting Entries  
 Dispose Assets  
 Update Contract  
 Rebook the contract

Termination of a contract can also be done at the end of term of contract by running the “**Terminate Expired Contracts**” concurrent program. The concurrent program creates a termination transaction and

Validate contract  
 Cancel Insurance  
 Close balances  
 Close Streams  
 Post Accounting Entries  
 Amortize Asset  
 Create Asset Return  
 Update Contract

Contract could have **evergreen** terms and conditions set in which case

Validate contract  
 Set to Evergreen

**Steps**

Validate Contract	Set To Evergreen	Cancel Insurance	Close Balances	Close Streams	Post Accounting Entries	Dispose Asset	Amortize Asset	Create Asset Return	Update Contract
✓				✓	✓	✓			✓

1. Validate Contract : Checks if billing for the contract has been performed if the request is from “Terminate Expired Contracts” concurrent program.
2. Set To Evergreen : If the contract evergreen terms and conditions are set to “true” then the contract status is set to evergreen

3. Cancel Insurance : Cancels insurances related to the contract
4. Close Balances : If the remaining balance is less than the tolerance (specified in the profile “OKL: Small Balance Write-Off Tolerance”, Lease Management creates adjustments for the balance.
5. Close Streams : Closes all the streams associated to the contract if it is a full termination. If it is a partial termination then streams associated to the quoted assets are closed.
6. Post Accounting Entries : Does accounting for all the termination accounting templates.  
Does catchup of accruals for the contract if needed.  
Does reversal of loss provisions for the contract if needed.  
Does acceleration of accruals for IDC expense for fees.  
Does processing of discounts and subsidies attached to the contract.
7. Dispose [of] Asset : Assets are retired in Oracle Fixed Assets.
8. Amortize Asset : Off-lease amortization transactions are created in Oracle Lease Management for depreciation of asset value in FA Tax and Corporate books.
9. Create Asset Return : An asset return request is created in Oracle Lease Management which will be used for repossession, remarketing etc.
10. Update Contract : If any of Steps required *errors*, then the termination transaction has an “error” status and the contract remains “Booked”.

However if it is a full termination and all the required steps have processed successfully then the contract and line statuses are updated to “Terminated”/“Expired”. If it is a partial termination and all the required steps have processed successfully then the quoted line statuses are updated to “Terminated” and the contract is rebooked.

## **Sell Terminated Assets**

### **Create an Inventory Item for Remarketing**

**Prerequisite : Price List has been created using Oracle Pricing**

- ▼ Setup the following Remarketing Options for each operating unit, under setup > Operational > Operational Options
  - Inventory Organization
  - Subinventory
  - Price List
  - Process

Item Template  
Item Invoiced

- ✓ Set the profile 'QP:Item Validation Organization' to Master Inventory Organization of the Remarketing organization at the responsibility level.
- ✓ Create an asset return using the Asset Return screen
- ✓ Update Asset Return status to "Available for Sale", enter the Item description and price. Save the screen. This will create an inventory item for remarketing.

**Sell the Inventory Item through iStore**

**Workflow Setup**

Prerequisites : OKL's Customized Order Management Order **Line** Workflow exists.

OKL's **Line** workflow needs to be merged into OM's **Line** workflow.

- ✓ Open the workflow builder.
- ✓ Open "OM Order **Line**" item type from the database. This is Order Management's default order **line** workflow.
- ✓ Open "**OKL - AM : OM Order Line**" item type from the database. This is OKL's customized Order Management **Line** Workflow.
- ✓ Drag the following function nodes from "OKL - AM : OM Order **Line**" item type and drop them over to "OM Order **Line**" item type.
  - o Create Remarket Invoice
  - o Dispose Asset
  - o Reduce Item Quantity
  - o Update Asset Return Status
- ✓ Drag the "**OKL Line Flow - Generic**" process diagram from "OKL - AM : OM Order Line" item type and drop it over "**OM Order Line**" item type.
- ✓ Validate "OM Order **Line**" item type and save it in database. "OM Order **Line**" item type now has OKL's customized Order management **Line** process flow.

**Order Management Setup**

- ✓ Set up OKL specific Transaction Types(Order Type) for Order Header and Order Line
  - o Log on to Oracle Applications as SYSADMIN/SYSADMIN.
  - o Select "Order Management Super Menu" responsibility.
  - o Select Setup/Transaction Types/Define. This will open Transaction Types window.
  - o Modify Order Line Transaction Type :
    - § Query the existing LINE Transaction Type "Standard (Line Invoicing)" Make sure the transaction Type Code is "LINE" and Order Category is "Order". Click on the shipping tab and enter the warehouse name e.g "Vision Operations" Save the changes and close the window.
  - o Create Order Header Transaction Type :
    - § Open the Transaction Types window
    - § Enter details of the Transaction Type that you want to create. sample values are provided below



## Oracle Lease Management Unleashed

Ranu Srivastava

<http://apps2fusion.com>

- Transaction Type : OKL\_Standard
- Description : OKL Standard Order Type
- Transaction Type Code : ORDER
- Order Category : Mixed
- Order Workflow : Enter name of the  
Order Management

Order Header

Workflow -  
"Order Flow - Generic"

- Agreement Type : "Standard Terms And  
Conditions"
- Default Order Line Type : "Standard (Line Invoicing)"
- Price List : Corporate
- Ordering : Booking
- Shipping : Picking

§ Click on the Shipping tab on the Transaction Type Window and Enter the Warehouse name e.g "Vision Operations"

§ Click "Assign Line Flows" button. This opens the Line Workflow Assignments window. Enter the following information

- Order Type : "OKL\_Standard"  
(Same as the Transaction Type )
- Line Type : Standard (Line Invoicing)
- Item Type : Standard Item
- Process Name : "OKL Line Flow - Generic"
- Start Date : Enter a start date
- Save and exit.

✓ Set up Document Sequencing for the Transaction Type you created for OKL

o Create Document Sequence

§ Log on to Oracle Applications as SYSADMIN/SYSADMIN.

§ Select System Administrator responsibility

§ Select Application/Document/Define. This opens "Document Sequences" window.

§ Check if the sequence is already defined

Press "F11", enter "OKL\_Standard" in the name field and

Execute the query by pressing "Ctrl F11" If the screen

does not bring back any data then the document sequence is

not defined. Proceed with the next step. If the query

brings back some data then make sure the record has the

following values.

§ Create a record with following information

- Name : OKL\_Standard

- Application : Oracle Order Management
  - From : Enter a start date
  - To : keep it null or enter a future date
  - Type : Automatic
  - Message : check the checkbox
  - Initial Value : 1
  - Save and exit
- o Assign the document sequence to Transaction Type Document  
Select Application/document/assign. This opens the Sequence Assignments window.  
Check if the document record already exists  
On the Document tab, Press "F11", enter "OKL\_Standard" in the Category field and execute the query by pressing "Ctrl F11" If the screen does not bring back any data then the document sequence is not defined.  
Proceed with the next step. If the query brings back some data then make sure the record has the following values.  
On the Document tab, enter the following info
- Application : Oracle Order Management
  - Category : OKL\_Standard
  - Set Of Books : e.g. Vision Operations(USA)
  - Method : Null
- Check if the Assignment already exists
- If the document record was already there then the assignment will also probably exist. Click on the assignment tab, if it shows the following record, then assignment exists otherwise proceed with the next step  
On the Assignment Tab. Enter the following info
- Application : Oracle Order Management
  - Category : OKL\_Standard
  - Start Date : Enter a strat date
  - End Date : Null
  - Sequence : OKL\_Standard
- ▼ Set the Default Order Type
- o Log on to Oracle Applications as SYSADMIN/SYSADMIN.
  - o Select System Administrator responsibility.
  - o Select Profile/System. This opens the Profile window
  - o Check Site, Application and Responsibility checkboxes.

## Oracle Lease Management Unleashed

Ranu Srivastava

<http://apps2fusion.com>

- o Enter "Oracle Order Capture" as the application and "IBE\_CUSTOMER" as the responsibility. Enter "ASO%" in the Profile field and click the "Find" button.
- o Set the "ASO : Default Order Type" profile to "OKL\_Standard" at the Site and Responsibility level.

### Oracle Receivables Setup

- ✓ Set up the tax method, tax codes, default tax code, sales tax rate and address validation.
- ✓ Log on to Oracle Applications with Receivables Manager responsibility.
- ✓ Select Setup/System/System Options. This opens the system options window.
- ✓ Click on the "Tax" tab
- ✓ Enter a Tax Method
- ✓ Enter a Location Flexfield Structure. This is used to determine taxes for different customer locations.
- ✓ Enter a value for Address Validation field.  
Oracle Receivables validates the shipping and Billing address that the customer enters while booking the order. Validation method can be "Error", "No Validation" or "Warning"
- ✓ Click on the "Tax Defaults and Rules" tab and set up the appropriate values.
- ✓ Save and Exit
- ✓ Set up the tax codes, tax locations and tax rates.
- ✓ Select Setup/Tax/Codes. This opens Tax Codes and Rates window.
- ✓ Enter/Maintain the tax codes and their associated tax rates.
- ✓ Select Setup/Tax/Locations. This opens up the Tax Locations and Rates window.
- ✓ There should be a valid tax rate defined for the State-county-city-zip code combination of the customer's address.

### iStore Setup

- ✓ Create an iStore Manager User Account
- ✓ Verify that the Foundation(JTF), iStore(IBE), Order Capture(ASO) and Order management(OM) profile options are setup correctly
- ✓ In addition to the profiles mentioned in these sections, set the "ASO: Validate Salesrep" profile to "No" at the responsibility level for IBE\_CUSTOMER
- ✓ Log on to Oracle CRM Applications Login page as a Store Manager user  
`http://<host>:<apache port>OA_HTML/jtflogin.jsp`  
This should open iStore 11i Merchant UI. If not, Click on the Profile Icon, Select IBE\_ADMINISTRATOR as the current responsibility and click 'Update'. This opens iStore 11i Merchant UI

- ✓ Setup a Specialty Store - it should be set already e.g. (Vision Operations) - Oracle iStore Implementation Guide section - section 4.3

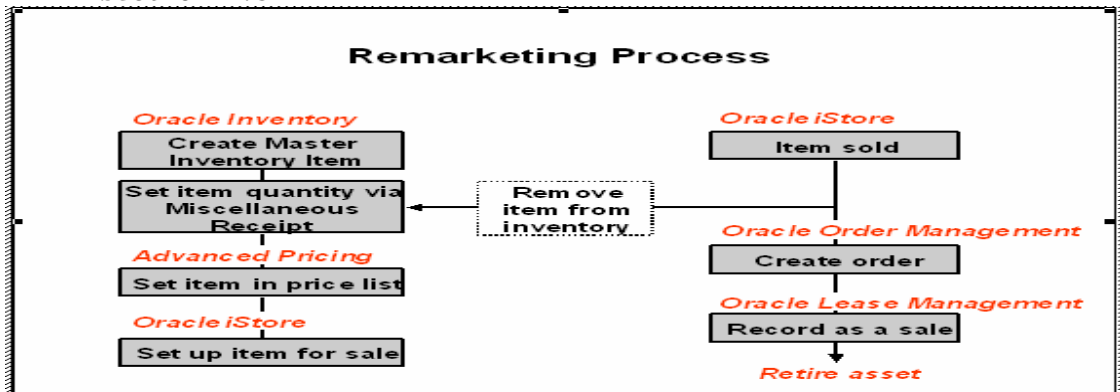

- ✓ Setup an overall hierarchy for the Store sections and products - Oracle iStore Implementation Guide section - section 4.4
- ✓ Setup Oracle iStore Guest User Account
- ✓ Log out of any Oracle Applications with which you have been working and Restart the Apache Server
- ✓ Navigate to the URL :  
`http://<host>:<apache port>OA_HTML/ibeCZzdMinisites.jsp`  
This brings up a page with the list of Specialty Stores that are accessible to the guest user.

Log on to a Specialty Store, select the products and Add them to your Cart and proceed with the Checkout mechanism