

Answers to revision questions

1 Scientific method

- The calculator gives 4653.376
The least number of significant figures of any of the items is TWO.
The answer is best represented to TWO significant figures i.e. 4700.
 - The calculator gives 21.32
The least precise item is represented to one decimal place.
The answer is best represented as 21.3.
- Random errors are those which have equal chance of causing the result to be greater or lesser than the true value. An example is a parallax error.
 - Systematic errors are those which make the result always too small or always too large by the same amount due to some inaccuracy in the system. An example is a zero error on an ammeter.
- gradient = $\frac{0 - 10.0 \text{ A}^{-1}}{4.0 - 0 \text{ V}} = -2.5 \text{ A}^{-1} \text{ V}^{-1}$
- micrometer
 - metre rule
 - vernier caliper
- $7.50 \text{ mm} + 0.47 \text{ mm} = 7.97 \text{ mm}$
 - $2.50 \text{ cm} + 0.04 \text{ cm} = 2.54 \text{ cm}$
- mass/kg, length/m, time/s, current/A, temperature/K
- pressure/Pa
 - work/J
 - force/N
 - power/W
- $555.22 = 5.5522 \times 10^2$
 - $0.000123 = 1.23 \times 10^{-4}$
- $55\,000\,000 \text{ J} = 55 \text{ MJ}$
 - $0.0333 \text{ mA} = 33.3 \mu\text{A}$
 - $400 \text{ mW} = 0.0004 \text{ kW}$
- $$\text{density} = \frac{\text{mass}}{\text{volume}}$$

$$\text{density} \times \text{volume} = \text{mass}$$

$$2 \text{ g cm}^{-3} \times 4 \text{ cm}^3 = \text{mass}$$

$$8 \text{ g} = \text{mass}$$

2 Scalars and vectors

- Vectors:** displacement, velocity, acceleration, force, momentum
Scalars: distance, speed, mass, time, energy
- This could be done by **constructing a scale diagram**.
The same scale **must** be used for both vectors.

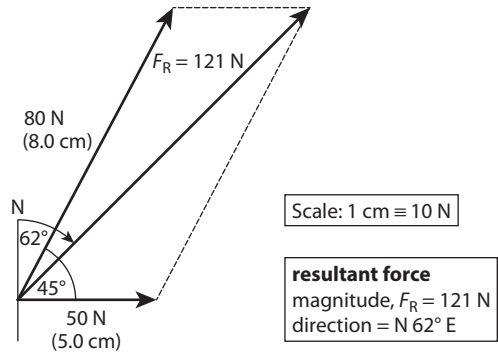

- Since the vectors are at right angles to each other, it may be easier to tackle this problem by a **sketch** and simple **calculation**.

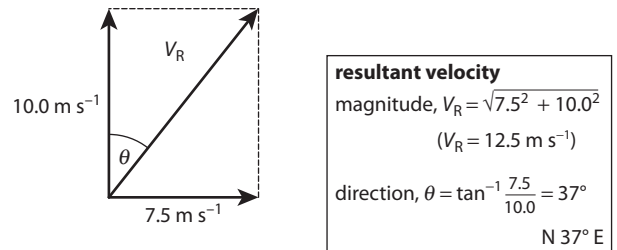

- $$\sin 30^\circ = \frac{y}{25} \quad y = 25 \sin 30^\circ$$

$$(y = 12.5 \text{ m s}^{-1})$$

$$\cos 30^\circ = \frac{x}{25} \quad x = 25 \cos 30^\circ$$

$$(x = 21.7 \text{ m s}^{-1})$$

- Taking north as + and south as - $25 \text{ N} - 40 \text{ N} = -15 \text{ N}$
Taking east as + and west as - $50 \text{ N} - 30 \text{ N} = 20 \text{ N}$

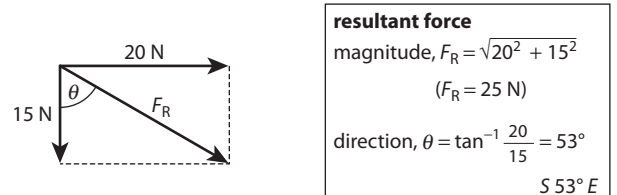

3 Forces, mass and weight

- Gravitational, electrostatic, magnetic, nuclear
- A frictional force is a mechanical force which opposes the relative motion of the surfaces of bodies in contact with each other.
- The mass of a body is the quantity of matter of the body.
 - The weight of a body is the force of gravity on the body.
- $$W = mg$$

$$0.80 = m \times 2.0$$

$$\frac{0.80}{2.0} = m$$

$$(0.40 \text{ kg} = m)$$
 - $$W = mg$$

$$W = 0.40 \times 10$$

$$(W = 4.0 \text{ N})$$

4 Moments

- A moment about a point is the product of a force and the perpendicular distance of its line of action from the point.
 - The following conditions hold for a system of coplanar forces in equilibrium:
 - The sum of the **forces** in any direction is equal to the sum of the **forces** in the opposite direction (translational equilibrium).
 - The sum of the clockwise **moments** about any point is equal to the sum of the anticlockwise **moments** about that same point (rotational equilibrium).
 - This second rule is known as the **principle of moments**.
- The centre of gravity of a body:** The point through which the resultant gravitational force on the body acts.
 - Stable equilibrium:** A body is in stable equilibrium if, when slightly displaced, its centre of gravity rises and a restoring moment is created which returns it to its base.
 - Unstable equilibrium:** A body is in unstable equilibrium if, when slightly displaced, its centre of gravity falls and a toppling moment is created which removes it from its base.
- The lamina is hung so that it swings freely from a pin placed through a small hole near its edge as shown. A plumbline is suspended from the pin and the position where it passes in front of the lamina is marked by small crosses. A line is drawn through the crosses. The procedure is repeated twice by suspending the lamina from other points near its edge. The point where the lines cross is the centre of gravity of the body.

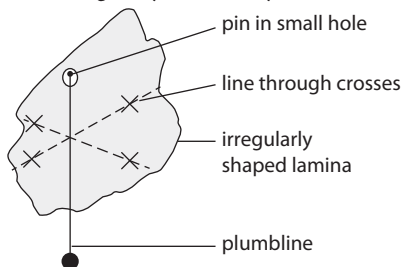

- Factors affecting the stability of an object:
 - Height of its centre of gravity
 - Width of its base
 - Its weight
- Taking moments about the fulcrum:

$$\Sigma \text{ anticlockwise moments} = \Sigma \text{ clockwise moments}$$

$$60 \times 0.20 = 1.2 W$$

$$\frac{60 \times 0.20}{1.2} = W$$

$$(10 \text{ N} = W)$$

$$\Sigma \text{ upward forces} = \Sigma \text{ downward forces}$$

$$R = 60 + 10$$

$$(R = 70 \text{ N})$$

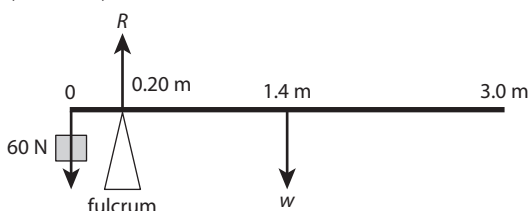

5 Deformation

- Hooke's law** states that the force applied to a spring is proportional to its extension.
 - The elastic limit (E)** is the point beyond which any further increase in the load applied to a spring will produce a permanent stretch.
 - Elastic deformation** is the change in size and shape of a material due to a load which is insufficient to produce a permanent stretch.

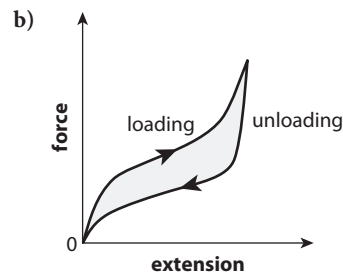
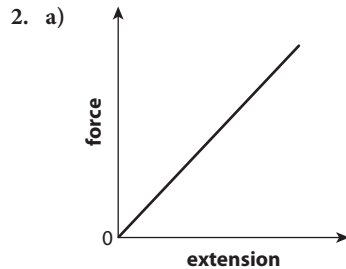

- $$F = ke$$

$$80 = k \times 0.020$$

$$\frac{80}{0.020} = k$$

$$(4000 \text{ N m}^{-1} = k)$$
 - $$F = ke$$

$$40 = 4000 e$$

$$\frac{40}{4000} = e$$

$$(0.010 \text{ m} = e)$$
- length of spring = $0.40 \text{ m} + 0.010 \text{ m} = 0.41 \text{ m}$ or 41 cm

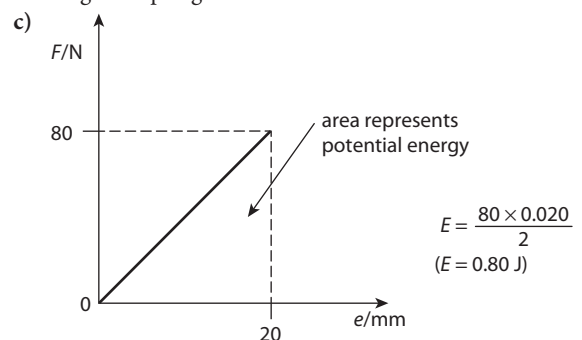

6 Kinematics

- Distance is the length between two points.
 - Displacement is distance in a specified direction.
 - Speed is the rate of change of distance.
 - Velocity is the rate of change of distance in a specified direction.
 - Acceleration is the rate of change of velocity.

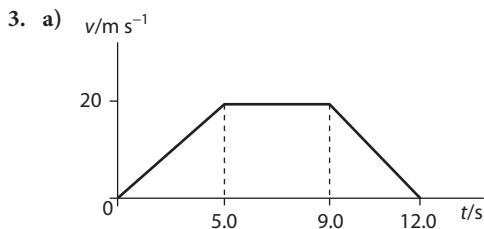
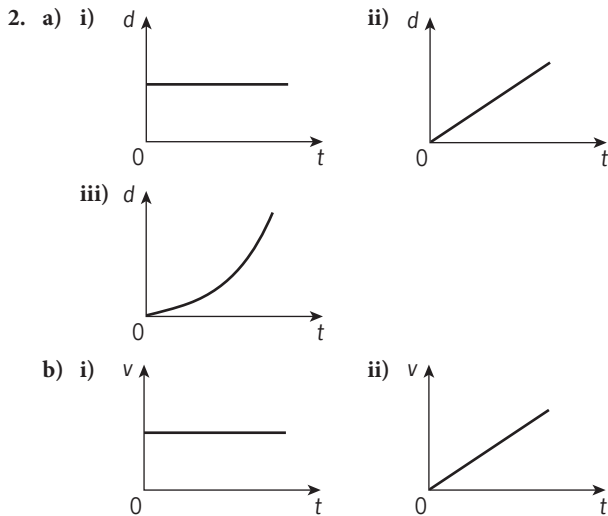

- b) i) 1st stage acc. = $\frac{20.0 - 0}{5.0 - 0}$ (acc. = 4.0 m s^{-2})
 2nd stage acc. = $\frac{20.0 - 20.0}{9.0 - 5.0}$ (acc. = 0 m s^{-2})
 3rd stage acc. = $\frac{0 - 20.0}{12.0 - 9.0}$ (acc. = -6.7 m s^{-2})
 The negative sign indicates that the acceleration and associated force are opposite in direction to that in the 1st stage.
 Since the velocity decreases, it can be said that the **deceleration** is 6.7 m s^{-2}
- ii) distance = $\frac{20.0 \times 5.0}{2} + 20.0 \times 4.0$ ($d = 130 \text{ m}$)
- iii) Since the motion is in a straight line, the magnitude of the displacement is the same as the distance. Average velocity = $\frac{\text{disp.}}{\text{time}} = \frac{130}{9.0}$
 (average velocity = 14.4 m s^{-1})

7 Newton's laws and momentum

1. a) Aristotle believed that the force applied to a body was proportional to its velocity. ($F \propto v$)
 b) **His argument**
- To pull a chariot at a greater speed required more horses, which provided a greater force.
 - A moving body comes to rest when the force on it is removed.
- c) If friction is negligible, a trolley will **accelerate** when pushed along a level surface by a constant force. There is no force which results in a unique velocity for the trolley and, therefore, Aristotle's 'law of motion' cannot be correct.
2. Law 1 A body continues in its state of rest or uniform motion in a straight line unless acted on by an external force.

Ex: A rocket, with its engines off, moves through outer space at constant velocity in a straight line. The resultant force on the rocket is zero; there is no forward force since the engines are off and there is no opposing force since there is no atmosphere to create friction with its surface.

Law 2 The rate of change of momentum of a body is proportional to the applied force and takes place in the direction of the force. $F_R = \frac{mv - mu}{t}$

Ex: As a car crashes into a wall, a force acts against its motion for a particular time, causing it to quickly decelerate to rest.

Law 3 If body A exerts a force on body B, then body B exerts an equal but oppositely directed force on body A.

Ex: As a child springs upward from a trampoline, a force acts on his/her feet. The force exerted by the child on the trampoline is equal in magnitude but opposite in direction to the force exerted by the trampoline on the child.

3. There is a resultant force if the velocity changes.
- The resultant force is zero since the velocity remains at zero (is constant).
 - The resultant force is zero since the velocity is constant.
 - There is a resultant force since the **magnitude** of the velocity is changing.
 - There is a resultant force since the **direction** of the velocity is changing.
4. a) The momentum of a body is the product of its mass and velocity.
 b) kg m s^{-1} and N s
 c) The law of conservation of linear momentum states that, in the absence of external forces, the total momentum of a system of bodies is constant.
 d) Momentum is a vector quantity.
 e) If the magnitudes of the momentums of two bodies are the same but they are moving in opposite directions, then their total momentum will cancel to zero.

5. 0 m s^{-1} 0 m s^{-1} -5.0 m s^{-1} v $+$

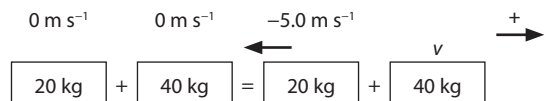

$$\boxed{20 \text{ kg}} + \boxed{40 \text{ kg}} = \boxed{20 \text{ kg}} + \boxed{40 \text{ kg}}$$

total momentum before = total momentum after

$$(20 + 40)0 = (20 \times -5.0) + 40v$$

$$0 = -100 + 40v$$

$$100 = 40v$$

$$\frac{100}{40} = v$$

$$2.5 = v$$

(magnitude of Rikita's velocity = 2.5 m s^{-1})

6. 4.0 m s^{-1} 0 m s^{-1} v v $+$

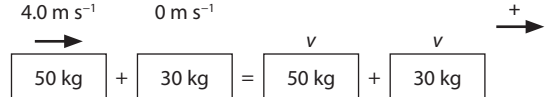

$$\boxed{50 \text{ kg}} + \boxed{30 \text{ kg}} = \boxed{50 \text{ kg}} + \boxed{30 \text{ kg}}$$

total momentum before = total momentum after

$$(50 \times 4.0) + 0 = 50v + 30v$$

$$200 = 80v$$

$$2.5 = v$$

(magnitude of vel. = 2.5 m s^{-1})

(direction of vel. = same as initial direction of Omorade)

7. a) $\longrightarrow +$
 $u = 40 \text{ m s}^{-1} \longrightarrow$
 $v = 10 \text{ m s}^{-1} \longrightarrow$
 $F_R = ?$
 $a = \frac{v-u}{t} = \frac{10-40}{0.020} = -1500 \text{ m s}^{-2}$
deceleration = 1500 m s^{-2}

b) $F_R = ma$
 $F_R = 0.500 \times (-1500)$
 $F_R = -750 \text{ N}$

The negative sign indicates that the force on the BALL is opposite to its direction of motion (using the sign convention above). From Newton's third law, the force of the hands ON THE BALL is equal but oppositely directed to the force of the ball ON THE HANDS. The magnitude of the force on Akib's hands was therefore also 750 N.

8 Energy

- a) Work is the product of a force and the distance through which its point of application moves in the direction of the force.

b) Energy is the ability to do work.

c) Power is the rate of doing work (the rate of using energy).

d) Potential energy is the energy a body has due to its position in a field of force or due to its state.

e) Kinetic energy is the energy a body has due to its motion.
- a) Energy cannot be created or destroyed, but can be transferred from one type to another.

b) i) Chemical potential energy \longrightarrow kinetic energy + thermal energy and sound energy
ii) Chemical potential energy \longrightarrow thermal energy and sound energy
iii) Gravitational potential energy \longrightarrow kinetic energy \longrightarrow gravitational potential energy \longrightarrow kinetic energy...
iv) Gravitational potential energy \longrightarrow kinetic energy \longrightarrow electrical energy
v) Chemical potential energy \longrightarrow kinetic energy \longrightarrow electrical energy
vi) Chemical potential energy \longrightarrow electrical energy \longrightarrow gravitational potential energy
- a) Chemical potential energy \longrightarrow gravitational potential energy

b) $E = Fd$
 $E = 400 \times 4.0$
 $(E = 1600 \text{ J})$

c) $P = \frac{E}{t}$
 $P = \frac{1600}{2.5}$
 $(P = 640 \text{ W})$
- a) $E_k = \frac{1}{2}mv^2$
 $E_k = \frac{1}{2}(0.020 \times 400^2)$
 $(E_k = 1600 \text{ J})$

b) The kinetic energy was transformed in boring the hole. Therefore 1600 J was used in boring the hole.

c) work done = energy transformed
work done = 1600 J

d) $W = Fd$
 $1600 = F \times 0.12$
 $\frac{1600}{0.12} = F$
 $(1.3 \times 10^4 \text{ N} = F)$

- a) **Problems associated with the use of fossil fuels**

 - **Limited reserves:** Supplies are rapidly diminishing.
 - **Pollution:** Burning of fossil fuels contaminates the environment with several pollutants, including greenhouse gas emissions.
 - **Falling oil prices:** This has highlighted the high risk of investing in crude oil companies.

b) **Four alternative sources of energy**

 - Solar
 - Hydroelectric
 - Wind
 - Biomass
- efficiency = $\frac{\text{useful power output} \times 100\%}{\text{power input}}$
 $20 = \frac{P_o}{500} \times 100$
 $\frac{20 \times 500}{100} = P_o$
 $(100 \text{ W} = P_o)$ rate of energy supplied to water = 100 W

9 Pressure and buoyancy

- $P = \frac{F}{A}$
 $P = \frac{mg}{A}$
 $P = \frac{40 \times 10}{2(0.0140)}$
 $(P = 1.4 \times 10^4 \text{ Pa})$
- pressure on base of pool = atmospheric pressure + pressure caused by water
 $P = 1.1 \times 10^5 + (h\rho g)_w$
 $P = 1.1 \times 10^5 + (2.0 \times 1000 \times 10)$
 $(P = 1.3 \times 10^5 \text{ Pa})$
- a) The principle of Archimedes states that when a body is completely or partially immersed in a fluid, it experiences an upthrust equal to the weight of the fluid displaced.

b) The following equations can be applied when an object floats:
weight of object = upthrust on object
weight of object = weight of fluid displaced
- a) upthrust on raft = weight of raft ... since it floats
upthrust on raft = 500 N

b) weight of water displaced = weight of raft ... since the raft floats
 $m_w g = 500$
 $\rho_w V_w g = 500$
 $1000 \times V_w \times 10 = 500$
 $V_w = \frac{500}{(1000 \times 10)}$
 $(V_w = 0.050 \text{ m}^3)$
- As the balloon is heated, the air in it expands and the volume of air it displaces increases. According to Archimedes' principle, the upthrust is equal to the weight of the air displaced. When the weight of the air displaced (upthrust) is greater than the weight of the balloon and its contents, the resultant upward force will cause the balloon to rise.

10 Nature of heat

1. a) The caloric theory of heat is an obsolete theory from the 18th century. Heat was believed to be an invisible fluid called 'caloric' which could combine with matter, raising its temperature.
- b) **Arguments for the caloric theory**
 - Objects expand when heated since the increased caloric they contain causes them to occupy more space.
 - Heat flows from hotter to cooler bodies since 'caloric' particles repel each other.

Arguments against the caloric theory

- When bodies are heated so that they change state (solid to liquid or liquid to gas), an increase in caloric cannot be detected.
 - When different materials are given the same amount of heat, their temperatures increase by different amounts indicating that they have received different quantities of caloric.
- c) Count Rumford realised that the thermal energy produced when a cannon was being bored was inexhaustible and depended only on the work done in boring the hole. If caloric was a material substance, there would be a time when all has left the cannon.
2. a) Kinetic theory
 - b) According to the kinetic theory, the particles of matter (atoms, molecules, etc.) are in constant motion of vibration, translation or rotation, and the kinetic energies they possess are responsible for their temperatures. There are spaces between the particles, as well as attractive forces which pull them together when they are near to each other.

3. Joule's experiment

Two bodies, each of mass, m , and attached to the ends of a string, were allowed to fall through a height h , as shown in the diagram below. As they descended, a spindle mechanism caused the strings to turn paddles in the water. On reaching the lowest point, the masses were quickly wound up to the starting position using a slip ratchet system and then were allowed to fall once more. This was repeated several times (n times).

The work done by the paddles in churning the water was equal to the gravitational potential energy of the falling masses which transformed into a rise in thermal energy of the water.

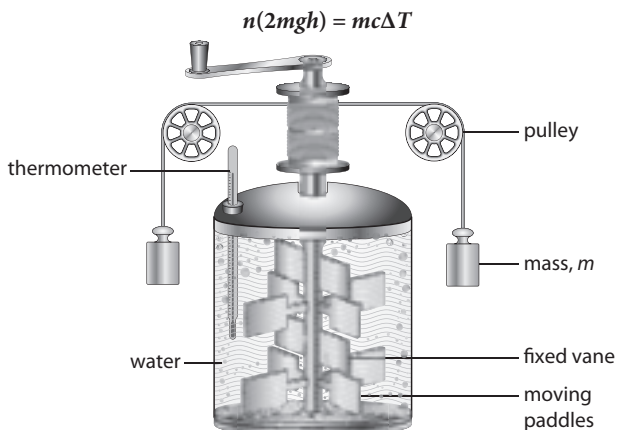

11 Temperature and thermometers

1. a) Temperature is the degree of hotness of a body.
 - b) The upper fixed point on the Celsius scale is the temperature of steam from pure boiling water at standard atmospheric pressure.
2. **Liquid-in-glass thermometer** – the volume of liquid increases as the temperature increases.
Constant-volume gas thermometer – the pressure of a fixed mass of gas at constant volume increases as the temperature increases.
3. Two advantages of a liquid-in-glass **mercury** thermometer.
 - Mercury is a metal and therefore has a high conductivity and a low specific heat capacity. Its temperature quickly adjusts to the temperature it is measuring.
 - Has a linear scale which is easy to read.
 Two disadvantages of a liquid-in-glass **mercury** thermometer.
 - Mercury is poisonous.
 - Cannot be used to measure very cold temperatures since mercury freezes at -39°C .
 4. Three ways in which a laboratory mercury thermometer differs from a clinical mercury thermometer:
 - The range of the laboratory thermometer is much larger than that of the clinical thermometer.
 - The precision of the laboratory thermometer is not generally as high as that of the clinical thermometer.
 - There is a narrow constriction in the bore of a clinical thermometer but there is no constriction in the laboratory thermometer.

5. a) Thermocouple used as a thermometer

A thermocouple is simply two wires of different metals, A and B, connected as shown in the diagram. On heating one of the junctions, an emf is produced which varies with the temperature difference between the junctions. By connecting a voltmeter between the junctions, the emf can be detected. The scale of the voltmeter can be calibrated in units of temperature. Since the thermometer depends on **temperature difference**, the reference junction must always be at the same temperature it had at calibration. The cold junction is generally the reference junction.

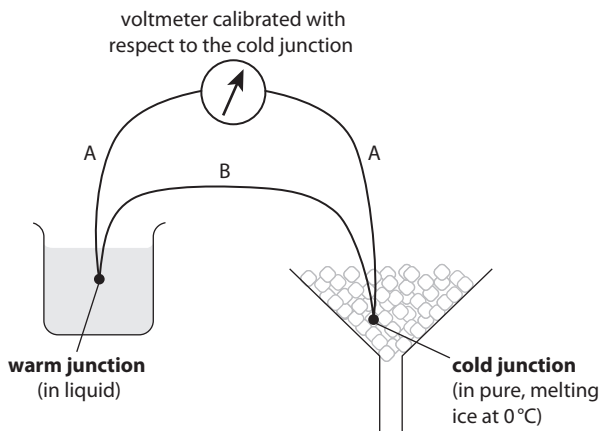

- b) Two advantages of a thermocouple
- Thermocouples can withstand very low and very high temperatures and are, therefore, useful for measuring temperatures in freezers and in furnaces.
 - Since they are electrical, they can be connected to digital displays and computer systems.

Two disadvantages of a thermocouple

- The measuring instrument used with a thermocouple must be sensitive to small changes in emf and, therefore, these thermometers can be expensive.
- The scale is non-linear and is, therefore, difficult to read.

12 States of matter

1. Solids

The attractive forces between the particles of a solid are strong, bringing them **very close** together. However, at even closer distances, these forces are repulsive. The atoms or molecules, therefore, constantly **vibrate** about some mean position and are bonded in a fixed lattice.

Liquids

The forces between the particles of a liquid are weaker than in solids. The molecules have more energy and the weaker forces are not enough to make the bonds rigid. They separate slightly more than in solids and are able to **translate** relative to each other.

Gases

Except at the time of collision, the particles of a gas are far apart and the forces between them are negligible. They therefore **translate** freely, filling the container in which they are enclosed.

2. Properties of a liquid

a) Density

Liquids have fairly high densities since their particles are packed almost as close as in solids.

b) Shape

The bonds between the particles are not rigid and therefore liquids take the shape of their container. However, the weaker forces existing between the particles still cause liquids to have a fixed volume.

c) Ability to be compressed

Liquids are not easily compressed since the particles are tightly packed and it is difficult to push them closer.

d) Ability to flow

The weak intermolecular forces existing between the particles of a liquid cannot form rigid bonds and, therefore, liquids can flow.

13 Expansion

1. When matter is heated, the energy supplied converts to kinetic energy of its particles. The molecules of a solid vibrate faster and with greater amplitude; those of a liquid or gas, translate faster, spreading out more as they do so. The extra kinetic energy, therefore, results in expansion of the material.

2. At room temperature, the hammer is just able to fit into the space. However, when it is heated, the fit is no longer possible.

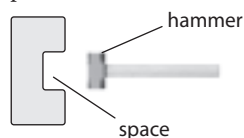

3. Dealing with problems of expansion

- Power lines must be **laid slack** in summer so that strong tensions are not produced when they contract in winter.
 - Concrete surfaces are laid in slabs, the spaces between them being **filled with pitch**. During expansion of the surface, the soft pitch is compressed, relieving the concrete of the strong forces which would otherwise produce cracks.
4. A simple fire alarm is shown in the diagram. Heat from the fire causes the bimetallic strip to bend and closes the contacts. This completes the circuit and sounds the alarm.

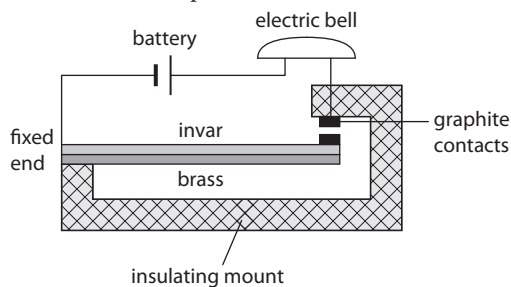

14 The ideal gas laws

1.

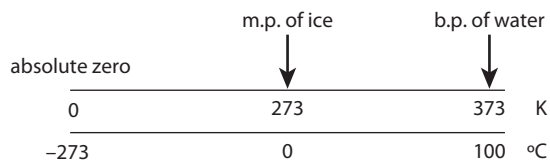

2. To verify Boyle's law

Boyle's law can be verified using the apparatus shown in the diagram below. The pressure, P , and volume, V , are measured and recorded. The pressure is increased by use of the pump and the new pressure and volume are taken. This is repeated until a total of 6 pairs of readings are obtained and tabulated.

$\frac{1}{V}$ is calculated and recorded for each V and a graph of P versus $\frac{1}{V}$ is plotted.

Precaution Increasing the pressure will also increase the temperature. Before taking readings, a short period should be allowed after increasing the pressure for the air to return to room temperature.

The straight line through the origin of the graph verifies the law.

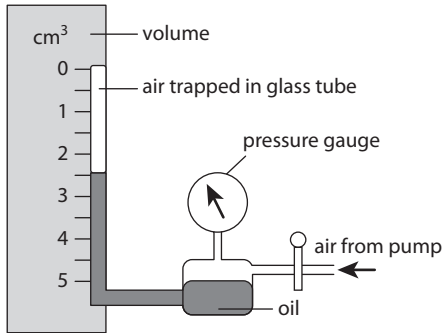

Pressure, P Pa	Volume, V cm ³	$\frac{1}{V}$ cm ⁻³

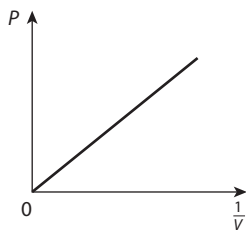

3. a) The molecules of mass, m , of a gas, bombard each other and the walls of their container. As they rebound in a short time, t , their velocity changes from u to v and they impart forces, F , in accordance with Newton's second law of motion.

$$F = \frac{m(v - u)}{t}$$

Since this force acts on the area, A , of the walls, it creates a pressure.

$$P = \frac{F}{A}$$

- b) As the temperature of the air in the tyre rises, the average speed of the molecules increases and, therefore, the force exerted by the molecules on the walls of the container becomes greater. This increased force per unit area on the inner walls of the tyre implies that the pressure increases.
4. Since the vessel is freely expanding the pressure remains constant.

$$\frac{V_1}{T_1} = \frac{V_2}{T_2}$$

$$\frac{40}{(273 + 27)} = \frac{V_2}{(273 + 227)}$$

$$\frac{40}{300} = \frac{V_2}{500}$$

$$\frac{(40 \times 500)}{300} = V_2$$

$$(67 \text{ cm}^3 = V_2)$$

15 Heat and temperature change

- Heat is a form of energy which flows from places of higher temperature to places of lower temperature.
- The specific heat capacity of a SUBSTANCE is the heat needed to change unit mass of the substance by unit temperature.
- The heat capacity of a BODY is the heat needed to change the body by unit temperature.

- Specific heat capacity $\text{J kg}^{-1} \text{K}^{-1}$
Heat capacity J kg^{-1}

$$0.250 \text{ kg} \xrightarrow{mc\Delta T} 0.250 \text{ kg}$$

15 °C 65 °C

$$E_H = mc\Delta T$$

$$E_H = 0.250 \times 2400 \times (65 - 15)$$

$$(E_H = 3.0 \times 10^4 \text{ J})$$

-

$$0.400 \text{ kg} \xrightarrow{m_w c_w \Delta T_w} 0.400 \text{ kg} \quad 0.300 \text{ kg} \xleftarrow{m_c c_c \Delta T_c} 0.300 \text{ kg}$$

20 °C 22 °C x

heat gained by water = heat lost by lead

$$0.400 \times 4200 \times (22.0 - 20.0) = 0.300 \times 130(x - 22)$$

$$3360 = 39(x - 22)$$

$$3360 = 39x - 858$$

$$4218 = 39x$$

$$\frac{4218}{39} = x$$

$$(108 \text{ °C} = x)$$

5. To determine the specific heat capacity of a metal by an electrical method

- The mass, m , of the metal block is measured and recorded.
- The apparatus is then set up as shown in the diagram and the heater is switched on.
- After a short while, the initial temperature, T_1 , of the block is measured and the stop watch is started simultaneously.
- The current is kept constant by adjusting the rheostat. Readings of the current, I , and the voltage, V , are measured and recorded.
- When the temperature has risen by about 20 °C the new temperature, T_2 , is measured and recorded and the heater is switched off.

Assuming that all the electrical energy is responsible for the increase in thermal energy of the block, the specific heat capacity, c , can be calculated from the equation below.

$$\text{electrical energy} = \text{heat transferred to block}$$

$$VI t = mc(T_2 - T_1)$$

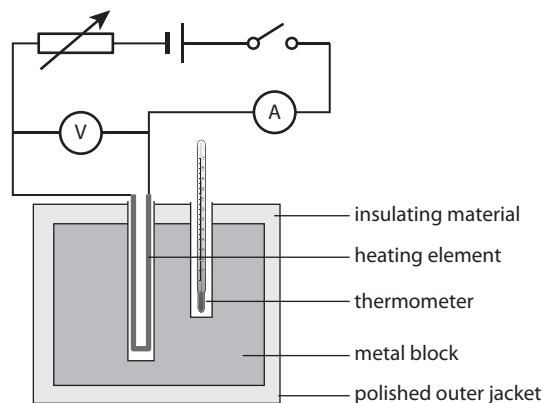

Oil, placed around the thermometer and heater, improves conduction with the block. The block is surrounded by an insulating material to reduce outward conduction. A polished silver jacket (foil paper) surrounds the insulator to reduce radiation to the air.

16 Heat and state change

- Latent heat is the heat necessary to change the state of a substance without a change of temperature.
 - The specific latent heat of fusion of a substance is the heat needed to change unit mass of the substance from solid to liquid without a change of temperature.
- A beaker of water is heated from room temperature until about one quarter of it boils away. Several readings of temperature and corresponding time are measured and recorded. It will be observed that there is no change in temperature as the water boils.

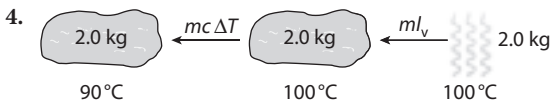
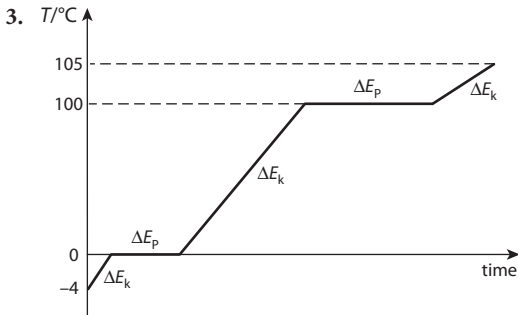

$$E_H = ml_v + mc\Delta T$$

$$E_H = (2.0 \times 2.3 \times 10^6) + (2.0 \times 4200 \times 10)$$

$$E_H = 4.6 \times 10^6 + 8.4 \times 10^4$$

$$(E_H = 4.7 \times 10^6 \text{ J})$$

5. To determine the specific latent heat of fusion of ice by an electrical method

- The mass, m_b , of the empty beaker is measured and recorded.
- The apparatus is set up as shown in the diagram and the heater is switched on.
- Ice chips are packed around the heating element so that it is completely immersed and a stop watch is simultaneously started. The melted ice is collected in the beaker.
- The readings of voltage, V , across the heater, and current, I , through it, are measured and recorded.
- Before all the ice has melted, the funnel is removed, the watch stopped and the time, t , measured and recorded.
- The mass, m_{bw} , of the beaker and water is taken and the mass of water, m_w , calculated from $m_w = m_{bw} - m_b$.

Assuming that all the electrical energy is used in melting the ice, the following equation can be used to calculate its specific latent heat of fusion.

electrical energy = heat to melt ice

$$VI t = m_w l_f$$

$$\frac{VI t}{m_w} = l_f$$

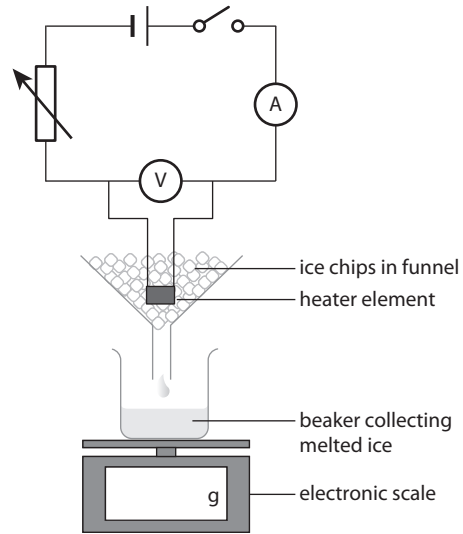

17 Evaporation and boiling

1.

Evaporation	Boiling
Occurs only at the surface of a liquid	Occurs throughout the body of a liquid
Occurs over a range of temperatures	Occurs at one temperature for a given pressure
Does not require an external heat source	Requires an external heat source

2. Factors affecting the rate of evaporation explained by kinetic theory

- Temperature:** Molecules move faster at higher temperature and therefore possess more kinetic energy. They have a better chance of overcoming the attractive forces of the neighbouring molecules so that they may escape as a gas.
- Humidity:** If the humidity is high, evaporating molecules are more likely to crash into particles above the surface and rebound to the liquid, thereby reducing the rate of evaporation.
- Wind:** This removes molecules from above the surface allowing the evaporating molecules to have a better chance of escaping completely, without colliding and rebounding to the liquid.
- Surface area:** Evaporation is a surface phenomenon and therefore the larger the surface area the greater the chance for molecules of the liquid to escape.

- A volatile liquid used as the refrigerant is pumped to an evaporator where it changes to a gas. The latent heat needed to produce the change in state is absorbed by conduction from the air in the room, which is circulated around the tubes of the evaporator by means of a fan.

The gas is then pumped to a condenser outside the building where it is compressed and condensed back to a liquid, releasing the latent heat energy that was previously absorbed. This heat conducts into an aluminium grill and then radiates to the surroundings. A fan is used to produce forced convection of the hot air away from the unit.

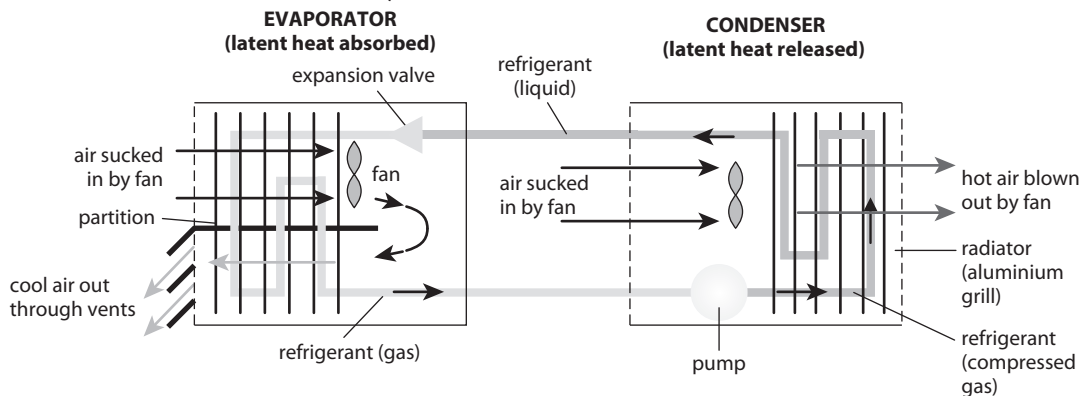

18 Thermal energy transfer

1. a) Conduction is the process of thermal energy transfer between two points in a medium by the relaying of energy between adjacent particles of the medium with no net displacement of the particles.
- b) Convection is the process of thermal energy transfer between two points in a medium by the movement of the particles of the medium due to existing regions of different density.
- c) Radiation is the process of thermal energy transfer by means of electromagnetic waves.

2. a) Conduction in metals

When one end of a metal bar is heated, the thermal energy supplied converts to kinetic energy of its cations, causing them to **vibrate** faster and with greater amplitude than before. They bombard their neighbours with greater force and frequency than before, passing on the increased vibration.

Metals also contain a 'sea' of free electrons which **translate** freely between the cations. When these electrons are warmed, the thermal energy supplied gives them more kinetic energy, causing them to translate faster. On collision with cations, they transfer the energy to them.

The temperature of a substance is proportional to the kinetic energy of its particles and, therefore, the temperature at the cooler end of the bar increases.

b) Convection in liquids

On warming a liquid or gas **from below**, the heat energy gives the molecules more kinetic energy, causing them to **translate** more vigorously and to take up more space. The region, therefore, becomes less dense and rises above the cooler, denser region, which falls in to take its place. The cooler region in turn is heated and rises, effectively creating a circulating current.

3. a) Convection currents in a liquid

A crystal of potassium permanganate is added to a beaker of water. The beaker is heated from below the crystal and the purple-coloured solution that is formed shows the path of the convection current.

b) Black surfaces are better absorbers of radiation than white surfaces

The apparatus is set up as shown in the diagram with a cork stuck by means of wax to the outer surface of each plate. The wax melts first from the plate which has its inner surface painted black, indicating that it is the better absorber.

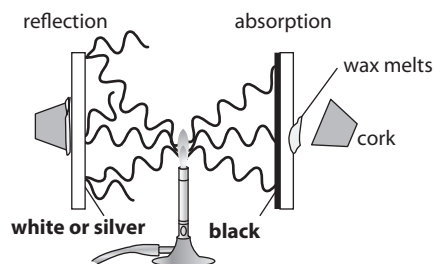

c) Thermal radiation can propagate through a vacuum.

The apparatus is set up as shown in the diagram. The jar is first evacuated by means of the pump and the heater is then switched on. The coil begins to glow, and shortly after, the walls of the jar become warm. The energy has therefore **radiated through the vacuum**, is absorbed by the glass, and is conducted through it to the outer surface.

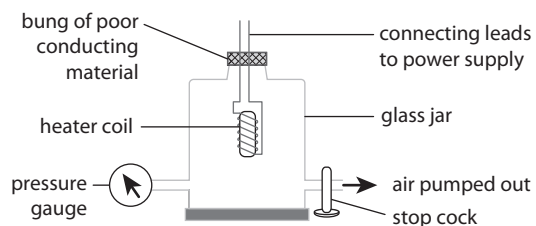

4. a) i) A vacuum surrounding the storage compartment
 ii) An insulating case
 iii) A silver outer surface
- b) i) The vacuum prevents thermal energy transfer by conduction and convection.
 ii) The insulating case prevents thermal energy transfer by conduction.
 iii) The silver outer surface prevents thermal energy transfer by radiation.

5. The greenhouse effect

The Earth's atmosphere behaves like the glass of a greenhouse. High frequency radiation is emitted from the very hot surface of the Sun. This is mainly visible light, but also consists of infrared and ultraviolet radiation (IR and UV). The high frequency waves including some of the more powerful IR waves easily penetrate the Earth's atmosphere and warm the planet.

The Earth's surface then emits its own radiation, but of longer wavelength, **mainly in the longer wavelength IR band**. These waves are absorbed by certain gases in the atmosphere, particularly carbon dioxide (CO₂), water vapour (H₂O) and methane (CH₄).

When the gases are warmed, they emit their own IR radiation, much of it returning to Earth to produce **global warming**.

6. a) i) radiation ii) conduction iii) radiation
 iv) convection v) conduction vi) radiation
- b) i) The glass traps most of the outgoing infrared radiation, which is of longer wavelength.
 ii) Copper is a good conductor and transfers the heat rapidly to the water in the tubes.
 iii) A matt black surface is a good absorber, allowing solar radiation to be readily collected.
 iv) Placing the tank above the heater panel allows hot water to rise to it by natural convection.
 v) The lagging is of a good insulating material, preventing conduction of thermal energy from the hot water in the tank to its outer surface.
 vi) Since silver is a poor emitter of radiation, the silver outer surface of the tank reduces the amount of radiant energy being lost to the atmosphere.

19 Wave motion

1. a) A longitudinal wave is one which has vibrations parallel to its direction of propagation.
 b) A transverse wave is one which has vibrations perpendicular to its direction of propagation.
 c) Progressive waves (or travelling waves) are those which transfer energy from one point to the next.
2. Transverse: electromagnetic wave, water wave
 Longitudinal: sound, slinky spring vibrated parallel to its length from one end
3. a) Wavelength: The distance between successive points in phase in a wave.
 b) Amplitude: The maximum displacement of a vibration from its mean position.
 c) Frequency: The number of vibrations per second.

- d) Period: The time for one complete vibration.
 e) Wavefront: A line perpendicular to the propagation of a wave through which all points are in phase.

4. a) Increases
 b) Decreases
 c) Decreases
 d) Increases
5. The speed of a sound wave **decreases** when moving from air to a denser gas since the particles of the denser medium have **greater mass** and, therefore, respond with a lesser average speed to the vibrations.
 The speed of a sound wave **increases** when moving from air to water since the particles of water are much **closer** and can, therefore, more readily pass on the vibrations.

$$6. \quad v = \lambda f$$

$$3.0 \times 10^8 = 4.0 \times 10^{-7} f$$

$$\frac{3.0 \times 10^8}{4.0 \times 10^{-7}} = f$$

$$(7.5 \times 10^{14} \text{ Hz} = f)$$

7. a) $f = \frac{1}{T} = \frac{1}{0.40}$
 $(f = 2.5 \text{ Hz})$
- b) $\lambda = \frac{v}{f} = \frac{40}{2.5}$
 $(\lambda = 16 \text{ m})$
- c) $\lambda = \frac{v}{f} = \frac{32}{2.5}$ (note that frequency remains constant when the medium is changed)
 $(\lambda = 12.8 \text{ m})$
- d) $\frac{\sin \theta_2}{\sin \theta_1} = \frac{v_2}{v_1}$
 $\frac{\sin \theta_2}{\sin 30} = \frac{32}{40}$
 $\sin \theta_2 = \frac{32}{40} \sin 30$
 $(\theta_2 = 24^\circ)$
8. a) period = 50 ms or 0.050 s
 b) $f = \frac{1}{T} = \frac{1}{0.050}$
 $(f = 20 \text{ Hz})$
 c) amplitude = 5.0 cm
 d) $\lambda = \frac{v}{f} = \frac{4.0}{20}$
 $(\lambda = 0.20 \text{ m})$

20 Sound waves

1. As a source vibrates within a material medium, it repeatedly compresses and then decompresses the region adjacent to it, causing the particles of the medium to vibrate with the same frequency. These oscillations are then relayed through the medium in a direction parallel to the direction of vibration of the source.

2. Note A has a lower pitch but a higher volume than note B.

3.

Infrasound	Audible range	Ultrasound
< 20 Hz	20 Hz – 20 kHz	> 20 kHz

4. Ultrasound is used in diagnostic imaging, such as pre-natal scanning.

It is also used by ships to find the depth of the ocean by measuring the time for the return of an echo from the sea bed.

5. $v = \frac{2x}{t}$... (x = depth of water)

$$1500 = \frac{2x}{0.20}$$

$$\frac{1500 \times 0.20}{2} = x$$

$$(150 \text{ m} = x)$$

6. $v = \frac{d}{t}$

$$350 = \frac{d}{3.0}$$

$$350 \times 3.0 = d$$

$$1050 \text{ m} = d$$

7. **Sounds are more audible at night.** The air in contact with the ground is cooler at night. A sound wave travelling upwards will increase in speed as it enters layers of **warmer** air. The wavefronts therefore separate more, taking up the shape shown in the diagram. Since rays are always perpendicular to wavefronts, the sound ray **refracts** along a curved path, returning to the surface of the Earth and allowing more sound energy to reach the observer.

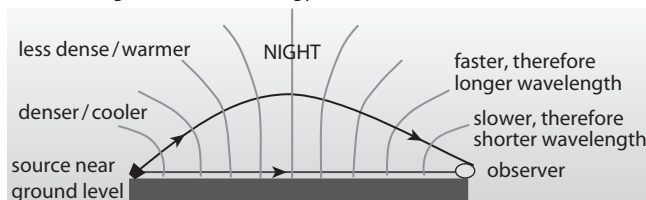

8. A signal generator, connected to speakers as shown in the diagram, emits a note of **constant frequency**. S_1 and S_2 are **coherent sources**, emitting waves in phase or with some constant phase difference.

An experimenter walking along the line AB will observe alternate points where he hears no sound and then a loud sound. Where the waves from S_1 and S_2 meet the experimenter in phase, a loud note is observed, and where they meet exactly out of phase, nothing is heard. Sound waves, therefore, exhibit the phenomenon of interference.

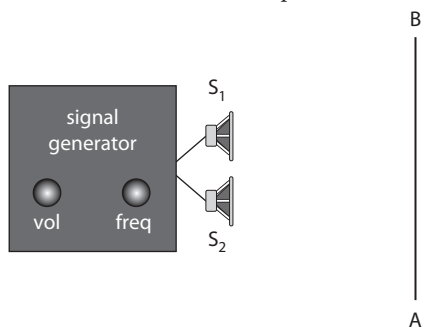

21 Electromagnetic waves

- Four properties of electromagnetic waves
 - They are all transverse waves.
 - They travel at the same speed of $3.0 \times 10^8 \text{ m s}^{-1}$ through a vacuum or through air.
 - They can propagate through a vacuum.
 - They consist of varying electric and magnetic fields.
- a) Radio and microwaves, infrared, light, ultraviolet, X-waves and gamma waves.

- Range of wavelengths of visible spectrum: $4 \times 10^{-7} \text{ m}$ to $7 \times 10^{-7} \text{ m}$.
- Violet has the shortest wavelength.
- Radio waves have the longest wavelength.
-

Group	Source	Use
Radio and microwaves	Radio transmitters – metal rods (aerials) which emit radio waves due to electric currents oscillating within them	Radio and television broadcasting
Infrared	All bodies from temperature 0 K ($-273 \text{ }^\circ\text{C}$) upward	Infrared cameras
Light	Bodies above $1100 \text{ }^\circ\text{C}$, such as the flame of a candle	Photography
Ultraviolet	Very hot bodies, electric sparks such as lightning	Fluorescent lighting
X and gamma	X – High-speed electrons bombarding metal targets Gamma – nuclei of unstable atoms	Imaging of dense materials such as bones or tumours within flesh

22 Light waves

1. Huygens' wave theory of light

Huygens suggested that light was a longitudinal wave capable of propagating through a material called the aether which he believed fills **all space**. This material medium justified why light can pass through a vacuum despite the fact that it was supposedly a longitudinal wave, as is sound. He proposed that each point along a wavefront, such as A, acts as a source of new wavelets. After a short time, t , each of these secondary wavelets advances by the same amount and a new wavefront, B, is formed from the envelope of the individual wavelets from sources on wavefront A. After a time, $2t$, the wavefront, C, is the envelope of all the wavelets produced from sources on wavefront B. The advancing wavefront is therefore always perpendicular to the direction of propagation of the wave.

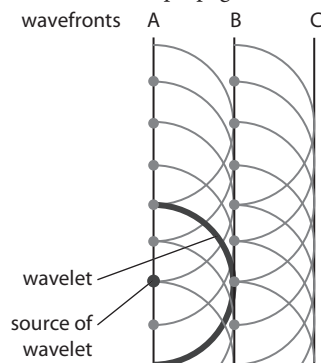

- Newton proposed a particle theory of light.

3. a) The wave theory was supported by Young's experiment.
- b) Young's experiment produces an interference pattern of bright and dark fringes from two coherent sources of light. Interference is a phenomenon of waves. The bright fringes occur where the waves meet in phase and the dark fringes occur where they meet exactly out of phase.
4. a) The wave theory was supported by Foucault's experiment.
- b) Foucault's experiment proved that light travels faster in air than in water. This is contrary to the expectations of particle theory, which suggest that it should travel faster in water.
5. a) Planck and Einstein are the scientists responsible for the quantum theory.
- b) The quantum theory suggests that light can be considered as being particle *and* wavelike in nature. Each **wave** pulse can be considered as a packet (**particle**) of energy.
6. a) Diffraction is the spreading of a wave as it passes through a gap or round a barrier.
- b) Strong diffraction occurs when the wavelength of the diffracting wave is about the same size as the width of the gap through which it diffracts.
- c) The wavelengths of light waves are extremely small – approximately 5×10^{-7} m for yellow light travelling in air. This is much smaller than most gaps commonly encountered and, therefore, the diffraction of light is not usually observed.
7. a) Interference is the phenomenon which occurs at a point where two or more waves superpose on each other to produce a combined vibration of amplitude lesser or greater than any of the individual waves.

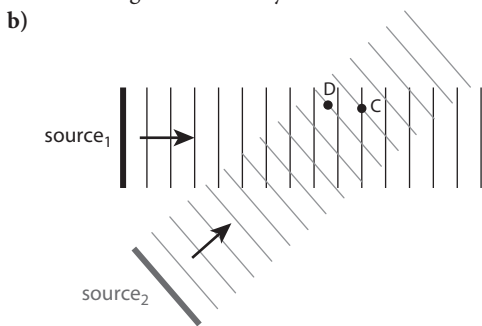

- c) Amplitude at C = 4 mm
Amplitude at D = 0 mm
8. a) Since each lamp emits waves randomly, the sources will not be coherent and a fixed pattern cannot be formed on the screen.
- b) A source of white light emits waves of several wavelengths. There would be no place on the screen where the light intensity for all the various waves cancels to zero.
- c) The optical path difference between rays producing a bright fringe is always a whole number multiple of the wavelength.

23 Light rays and rectilinear propagation

1. a) A ray of light is the direction taken by light.
- b) A beam of light is a stream of light energy.
2. Shadows are produced due to the rectilinear propagation of light.
3. a) **Shadow produced by a point source of light**

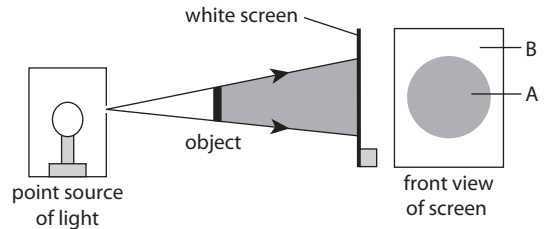

A: umbra – total shadow of **uniform obscurity** and **sharp edge**, indicating that light travels in straight lines

B: bright

b) Eclipse of the Moon

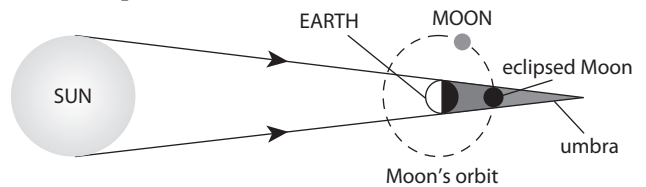

Diagram not to scale

c) Eclipse of the Sun

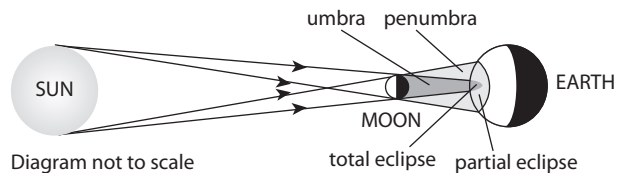

Diagram not to scale

4. a) focused, real, inverted image
- b) image brighter but blurred
- c) smaller image
- d) larger image

24 Reflection and refraction

1. Laws of reflection

- The incident ray, the reflected ray, and the normal, at the point of incidence, are on the same plane.
- The angle of incidence is equal to the angle of reflection.

2. image

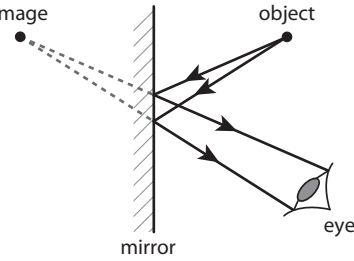

3. Four characteristics of the image formed in a plane mirror:

- same size as object
- same distance perpendicularly behind the mirror as the object is in front
- virtual
- laterally inverted.

4. Laws of refraction

- The incident ray, the refracted ray and the normal at the point of incidence are on the same plane.
- The ratio $\frac{\sin i}{\sin r}$ is a constant for a given pair of media where i is the angle of incidence and r is the angle of refraction.

$$\frac{\sin \theta_w}{\sin \theta_a} = \frac{\eta_a}{\eta_w}$$

$$\sin \theta_w = \frac{1}{1.3} \times \sin 40$$

$$(\theta_w = 30^\circ)$$

6. a) Reflection

b) Refraction

$$\frac{v_1}{v_2} = \frac{\eta_2}{\eta_1}$$

$$\frac{v_1}{3.0 \times 10^8} = \frac{1}{1.4}$$

$$v_1 = \frac{1}{1.4} \times 3.0 \times 10^8$$

$$(v_1 = 2.1 \times 10^8 \text{ m s}^{-1})$$

8.

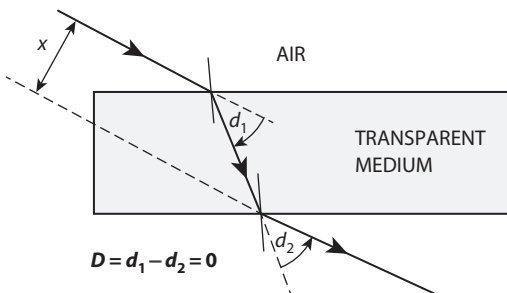

The **net deviation, D** , is zero since the clockwise deviation, d_1 , is equal in magnitude to the anti-clockwise deviation, d_2 . There is, however, a **lateral displacement, x** .

9. The mirage

During the day, the temperature of the air directly above the surface of a road increases due to conduction from the asphalt. A ray of light from low in the sky will refract away

from the normal as it enters the hotter, lesser dense air, below. This continues until it is totally internally reflected just above the hot road and is then continuously refracted towards the normal as it enters the cooler, denser, air above. An observer receiving this ray will see a virtual image of the sky above and may interpret it as a pool of water.

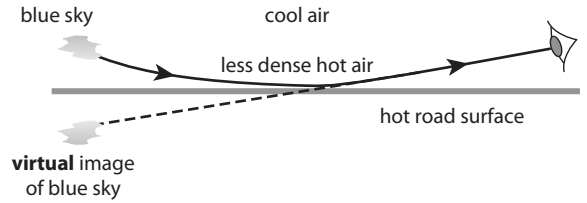

10.

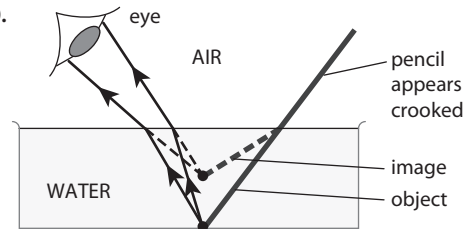

11.

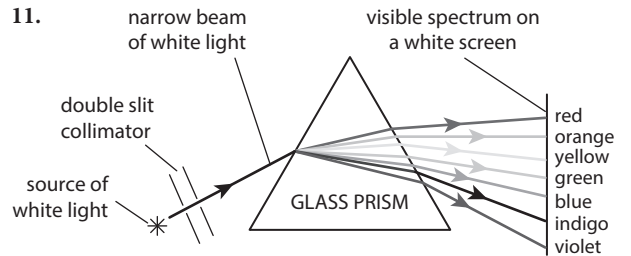

12. Rainbows are produced as light from the Sun is refracted and dispersed by water droplets in the sky.

13. Newton concluded that white light is composed of several colours.

$$14. \sin c_g = \frac{1}{\eta_g}$$

$$\sin c_g = \frac{1}{1.5}$$

$$(c_g = 42^\circ)$$

$$15. \eta_m = \frac{1}{\sin c_m}$$

$$\eta_m = \frac{1}{\sin 35}$$

$$(\eta_m = 1.7)$$

$$16. \frac{\sin \theta_a}{\sin \theta_w} = \frac{\eta_w}{\eta_a}$$

$$\frac{\sin c_a}{\sin 90} = \frac{1.3}{1.5}$$

$$\sin c_g = \frac{1.3}{1.5}$$

$$(c_g = 60^\circ)$$

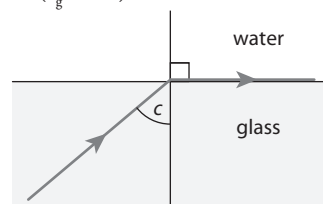

17. $\frac{\sin \theta_m}{\sin \theta_a} = \frac{v_m}{v_a}$
 $\frac{\sin c_m}{\sin 90} = \frac{1.8 \times 10^8}{3.0 \times 10^8}$
 $\sin c_m = \frac{1.8 \times 10^8}{3.0 \times 10^8}$... (the smaller speed is in the numerator)
 $(c_m = 37^\circ)$

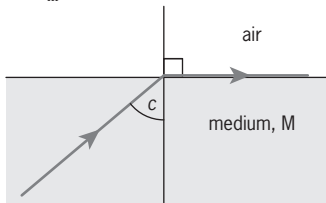

18. $\sin c_w = \frac{1}{1.3}$
 $(c_w = 50^\circ)$

$\tan 50 = \frac{r}{2.0}$

$2.0 \tan 50 = r$

$2.38 = r$

diameter = $2r = 2 \times 2.38$

(diameter = 4.8 m)

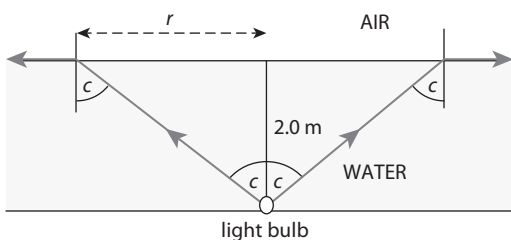

19. Uses of optical fibres

- Fibre optic bundles are used to direct light beams into and out of cavities such as the stomach and intestines. A video camera connected to the system produces the image of the region under investigation.
- The internet and telephone systems are particularly dependent on the use of fibre optic cables to transmit digital information.

20. a) turning through 90°

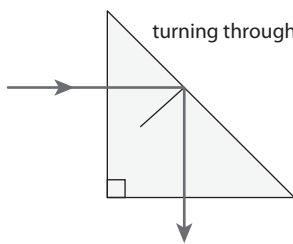

b) turning through 180°

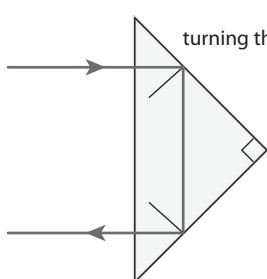

25 Lenses

- a) A convex or converging lens is one which is thicker at its centre and is capable of converging parallel rays of light to produce a real image.
 - b) A concave or diverging lens is one which is thinner at its centre and is capable of diverging parallel rays of light to produce a virtual image.
 - c) The focal length of a lens is the distance between its optical centre and its principal focus.
 - d) The principal focus, F, of a lens is the point on the principal axis through which all rays parallel and close to the axis converge, or from which they appear to diverge, after passing through the lens.
 - e) The optical centre, O, of a lens is that point at the centre of a lens through which all rays pass without deviation.

2. a)

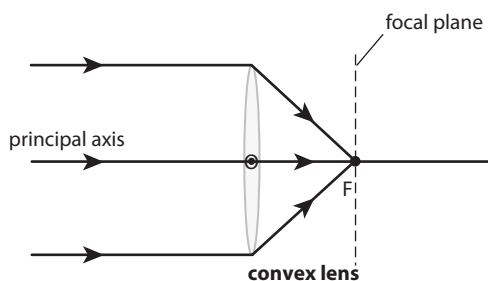

b)

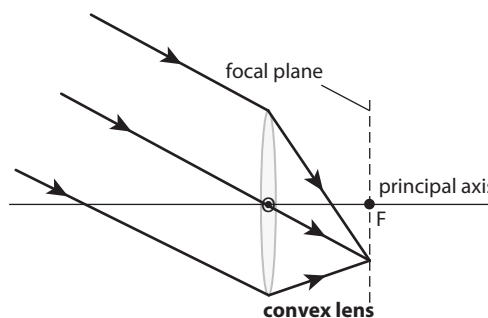

3. a) $\frac{I}{O} = \frac{v}{u}$
 $\frac{I}{5} = \frac{50}{20}$
 $I = \frac{50}{20} \times 5$
 $(I = 12.5 \text{ cm})$

b) $m = \frac{50}{20} = 2.5$

- a) **Real images** are those produced at a point at which light rays converge. Examples are the image formed on the screen at the cinema and the image formed on the retina of the eye.
 - b) **Virtual images** are those produced at a point from which light rays appear to diverge from. Examples are the image formed in a mirror and the image formed by a concave lens.
5. When the object is further from the convex lens than its focal length, the image is real and inverted. When the object is closer to the convex lens than its focal length, the image is virtual and erect.

6. Scale Vertical: 1 cm ≡ 1 cm
 Horizontal: 1 cm ≡ 10 cm

a) The image is real and is 1.3 cm tall. It is inverted and is 33.3 cm from the opposite side of the lens to the object.

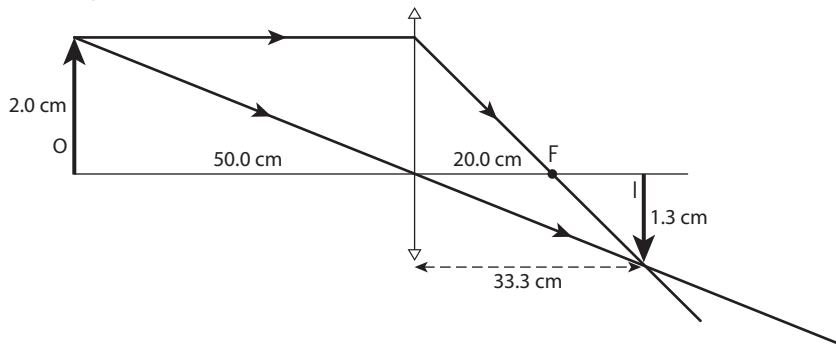

b) The image is virtual and is 4.0 cm tall. It is erect and is 20.0 cm from the same side of the lens as the object.

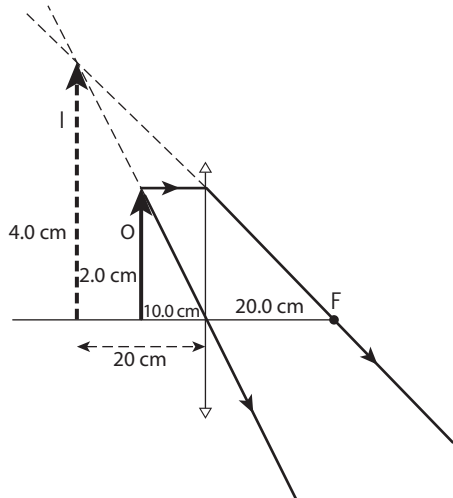

7. Scale Vertical: 1 cm ≡ 1 cm
 Horizontal: 1 cm ≡ 2 cm

The image is virtual and is 1.8 cm tall. It is erect and is 4.1 cm from the same side of the lens as the object.

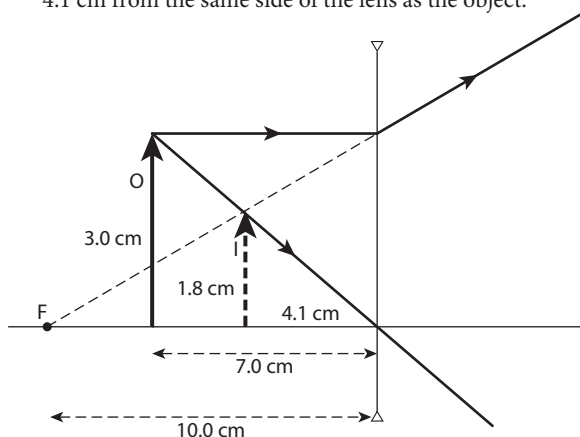

8. $\frac{1}{u} + \frac{1}{v} = \frac{1}{f}$
 $\frac{1}{5.0} + \frac{1}{v} = \frac{1}{12}$
 $\frac{1}{v} = \frac{1}{12} - \frac{1}{5.0}$
 $v = -8.6$

The image is virtual, erect and 8.6 cm from the lens, on the same side as the object.

9. $\frac{1}{u} + \frac{1}{v} = \frac{1}{f}$
 $\frac{1}{5.0} + \frac{1}{v} = \frac{1}{-12}$
 $\frac{1}{v} = -\frac{17}{60}$
 $v = -3.5$

The image is virtual, erect and 3.5 cm from the lens, on the same side as the object.

26 Static electricity

1. a) When a glass rod is rubbed with a cloth, electrons transfer from the surface of the rod onto the cloth, leaving the glass with excess positive charge and the cloth with excess negative charge.
- b) If the rod is brought near to a small piece of paper, electrons in the paper will move to the side nearest to the rod, leaving an excess of positive charge on the far side. The strong attraction between the positive glass and the nearby negative region of the paper causes the paper to stick to the rod.

2. a) Induction method

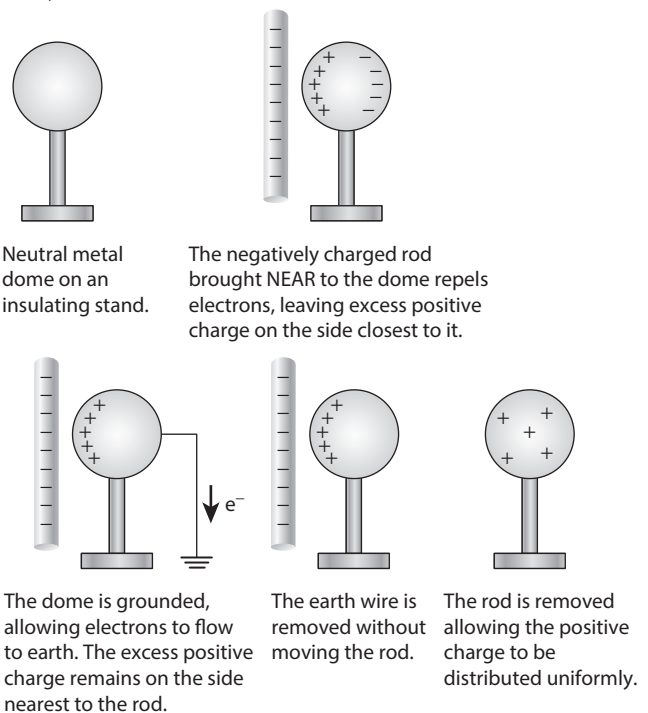

b) Contact method

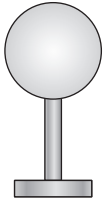

Neutral metal dome on an insulating stand.

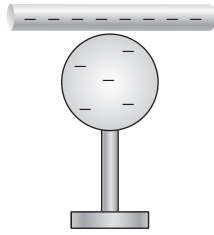

The negatively charged rod is rolled over the dome. The repulsive force between the electrons within it causes them to transfer onto the dome.

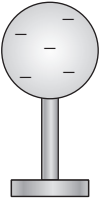

The contact method produces a charge of similar in sign to the charge producing it.

The rod is removed.

3. a) **Lightning**

Clouds become charged due to friction between layers of air and water molecules rising and falling within it. The base of the cloud usually becomes negatively charged and the top positively charged. Sparks occur between opposite charges within the cloud. The negative charge on the base of the cloud repels electrons further into the ground below, resulting in a net positive charge accumulating at the surface of the Earth. When the potential difference between the base of the cloud and the surface of the Earth is sufficiently large, electrons and negatively charged ions will rush from the cloud to the ground. These high speed ions crash into air molecules, knocking electrons out of them. The result is an avalanche of positive and negative ions being produced which rush to the cloud and Earth respectively. The discharge current can be as high as 20000 A! Electrical energy transforms into thermal energy and light energy, which transforms further into sound energy as the air rapidly expands, increasing the pressure and producing a sonic shock wave – thunder.

b) **How lightning conductors can protect buildings**

The diagram shows a lightning conductor protecting a tall building from the dangers of lightning strikes. The negative charge on the base of a nearby cloud induces opposite charge at the spikes by repelling electrons down the copper strip and into the ground. **The positive charge at the spikes is very concentrated due to the sharp curvature and it ionises nearby air molecules** by ripping electrons from them. The positive and negative ions produced rush to the base of the cloud and to the spikes respectively, cancelling the charges there and reducing the potential difference to a safe value. Even if the cloud did spark to the rods, the discharge will be less violent and would pass readily to the ground through the thick copper strip, instead of through the building.

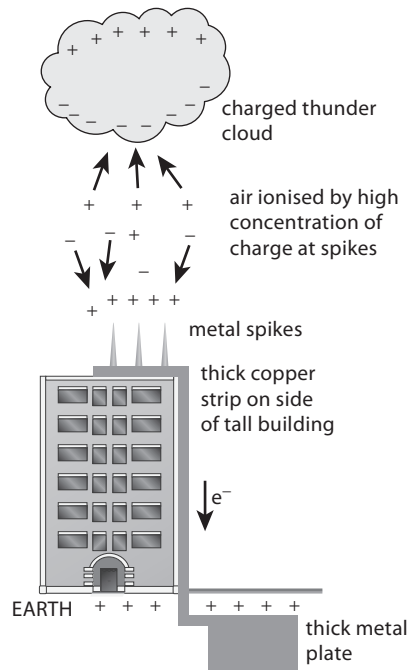

4. a)

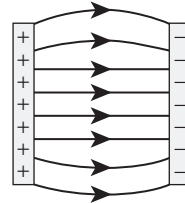

oppositely charged plates

b)

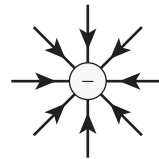

isolated negative charge

c)

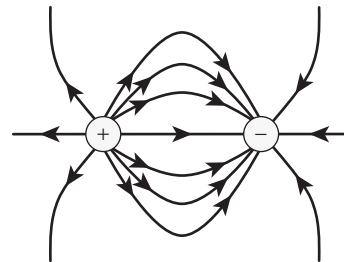

oppositely charged particles

d)

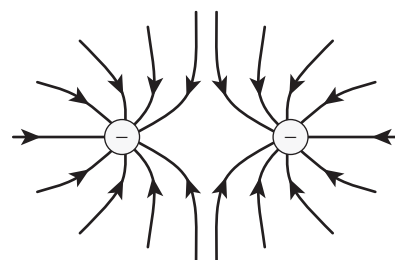

similarly charged particles

27 Current electricity

- Conductors are materials through which electrical charges can flow freely.
 - Insulators are materials in which electrical charges do not flow freely.
 - Current is the rate of flow of charge.
- Examples of conductors: copper, iron
 - Examples of insulators: rubber, plastic
 - Examples of semiconductors: silicon, germanium
- An alternating current is one which changes direction with time, whereas a direct current flows in one direction only.
 - Conventional current flows in the direction in which a POSITIVE charge would move if free to do so. Electron flow is the movement of NEGATIVE charge and is, therefore, opposite in direction to the flow of conventional current.

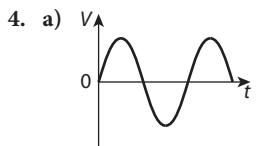

ac output from ac generator

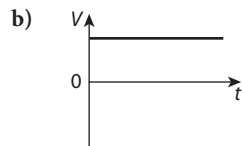

dc output from battery

5. $f = \frac{1}{T} = \frac{1}{16.7 \times 10^{-3}}$
 $(f = 60 \text{ Hz})$

6. $I = \frac{Q}{t} = \frac{8.0 \times 10^3}{4.0 \times 10^{-3}}$
 $(I = 2.0 \times 10^6 \text{ A})$

28 Electrical quantities

- The electromotive force of a cell is the energy used (or work done) in transferring unit charge around a complete circuit, including through the cell itself.

$$\text{electromotive force} = \frac{\text{energy}}{\text{charge}}$$
 - The potential difference between two points is the energy used (or work done) in transferring unit charge between those points.

$$\text{potential difference} = \frac{\text{energy}}{\text{charge}}$$

- $V = \frac{E}{Q} = \frac{20}{80 \times 10^{-3}}$
 $(V = 250 \text{ V})$
 - $I = \frac{Q}{t} = \frac{80 \times 10^{-3}}{5.0 \times 10^{-3}}$
 $(I = 16 \text{ A})$
 - $P = VI = 250 \times 16$
 $(P = 4.0 \times 10^3 \text{ W})$
 - $Q = Nq$
 $N = \frac{Q}{q} = \frac{80 \times 10^{-3}}{1.6 \times 10^{-19}} = 5.0 \times 10^{17}$
- Two reasons why electricity is important in our everyday lifestyles:
 - It can readily be transformed into other types of energy such as thermal, light, sound and kinetic.
 - It can be transmitted easily over long distances.

- Four ways to become more energy efficient in our homes:
 - Install photovoltaic panels to convert solar radiation to electrical energy.
 - Install solar water heaters instead of using gas or electric heaters.
 - Prevent solar radiation from easily entering our homes, so that our air conditioning cost can be reduced. Two ways of doing this are by placing hoods over windows and by installing thick reflective curtains.
 - Use certified energy-efficient refrigerators and other certified energy-efficient appliances.

29 Circuits and components

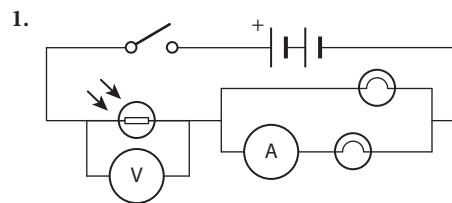

- A primary cell is one which cannot be recharged, whereas a secondary cell is rechargeable.

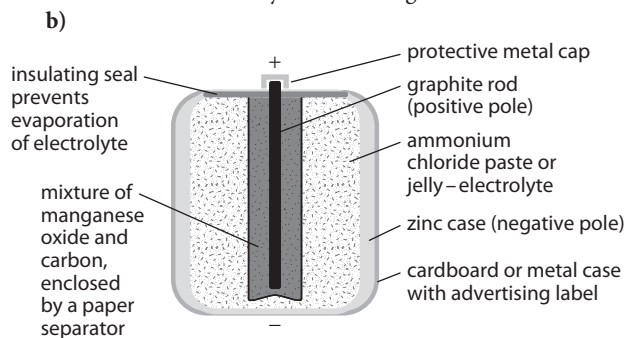

- The powdered mixture of manganese oxide and carbon around the carbon anode reduces the hydrogen bubbles which would tend to form there.
- Advantages of the zinc-carbon dry cell relative to the lead-acid accumulator**

- Small and light, whereas the accumulator is large and heavy.
- Unlike the accumulator, batteries of various voltages can easily be made by packing the cells in series or in parallel.
- Less costly than the lead-acid accumulator.

Advantages of lead-acid accumulator over zinc-carbon dry cell

- Can produce much larger currents than the zinc-carbon dry cell, since the electrolyte is liquid and the electrode plates have large surface areas for reaction.
- Has a much lower internal resistance than the zinc-carbon dry cell.
- Can be recharged, unlike the zinc-carbon cell.

e)

	Zinc-carbon dry cell	Lead-acid accumulator
Terminal voltage	1.5 V	2.0 V
Maximum current	a few amps – works well when delivering up to about 1 A	> 400 A
Internal resistance	high (0.5 Ω)	low (0.01 Ω)
Portability	small and light	large and heavy
Rechargeability	not rechargeable	rechargeable
Electrolyte	ammonium chloride paste	dilute sulfuric acid

3.

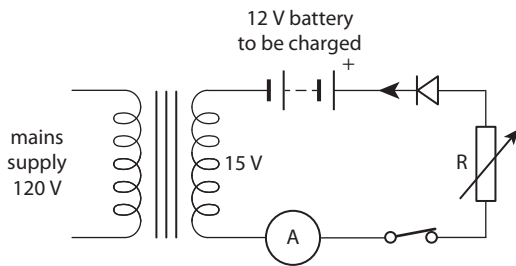

4. a)

$$Q = It$$

$$60 \text{ A} \times 1 \text{ h} = 60 \text{ A} \times 3600 \text{ s} = 216\,000 \text{ As} = 216\,000 \text{ C}$$

b) $Q = It$

$$t = \frac{Q}{I} = \frac{216\,000}{5.0}$$

$$(t = 43\,200 \text{ s})$$

$$(t = \frac{43\,200}{3600} \text{ h} = 12 \text{ h})$$

5. a) The resistance of a resistor is an electrical quantity which is a measure of the opposition provided to an electrical current flowing through it.

b) The resistance, R , of a resistor is proportional to its length, l , and inversely proportional to its cross-sectional area, A

$$R \propto \frac{l}{A}$$

c) i) $R = R_1 + R_2 = 8 + 8$
($R = 16 \Omega$)

ii) $R = \frac{R_1 \times R_2}{R_1 + R_2} = \frac{8 \times 8}{8 + 8}$
($R = 4 \Omega$)

iii) $\frac{1}{R} = \frac{1}{2} + \frac{1}{2} + \frac{1}{2} + \frac{1}{2} = \frac{2}{1}$
($R = \frac{1}{2} \Omega$)

6. a) i)

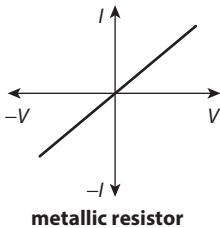

ii)

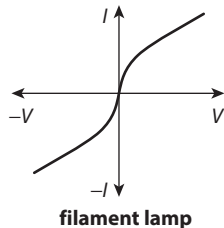

iii)

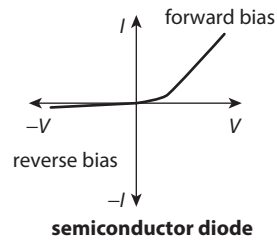

b) A conductor obeys Ohm's law if the current, I , through it is proportional to the potential difference, V , across it. This is verified by the straight line through the origin in graph (i). The metallic resistor is, therefore, the only one of the three which obeys Ohm's law (and so is an ohmic conductor).

c) The resistance of the lamp rises as the potential difference across it is increased.

As the voltage is increased, the electrons are pulled with greater force and collide more vigorously with the cations of the metallic filament. Their kinetic energy transforms into thermal energy, causing the vibration of the cations to increase. The increased vibration blocks the path of the electrons to a greater extent than previously and, therefore, the resistance rises.

7.

emf. = 5.0 V

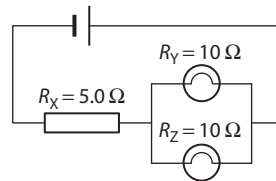

a) $R = R_X + \frac{R_Y \times R_Z}{R_Y + R_Z}$
 $R = 5.0 + \frac{10 \times 10}{10 + 10}$
 $R = 5.0 + 5.0$
($R = 10 \Omega$)

b) $I = \frac{V}{R} = \frac{5.0}{10}$
($I = 0.50 \text{ A}$)

c) $V_X = I_X \times R_X = 0.50 \times 5.0$
($V_X = 2.5 \text{ V}$)

d) p.d. across bulbs = e.m.f. – p.d. across X
p.d. across bulbs = 5.0 V – 2.5 V = 2.5 V

e) $P_X = V_X I_X = 2.5 \times 0.50$
($P_X = 1.25 \text{ W}$)

f) $P_Y = \frac{V_Y^2}{R_Y} = \frac{2.5^2}{10}$
($P_Y = 0.63 \text{ W}$)
 $(P_Z = \frac{V_Z^2}{R_Z} = \frac{2.5^2}{10})$
($P_Z = 0.63 \text{ W}$)

8. a) Advantages of parallel connection of domestic appliances

- Appliances can be switched on and off without affecting each other. If connected in series, switching off one would switch off all.
- Appliances can be designed to operate on a single voltage. If appliances were connected in series, they would have to share the voltage and would each obtain a smaller p.d. across their terminals.

- b) Fuses and circuit breakers are components placed in a circuit in series with a device in order to protect it from excessive currents. When the current is too high the circuit disconnects.
- c) Fuses should always be placed in the LIVE wire.
- d) Switches should always be placed in the live wire.
- e) A short circuit can occur if a piece of metal bridges the gap between a circuit and its metal case. If there is no EARTH wire and the case is touched, current may pass from it through the person to the ground. Since some of the resistance is now bypassed, the current is larger than before, the person will receive an electrical shock, and the fuse will blow.
- To avoid electrical shock, an EARTH wire is connected between the case of the appliance and the ground in the yard. As soon as the short circuit occurs, the high current will flow from the case through the earth wire to ground and the fuse (or breaker) will blow (or trip).
- f) Appliances are normally designed to operate on frequencies of either 50 Hz or 60 Hz. If the **frequency** of the supply voltage is incorrect they are likely to malfunction or even be damaged.
- If an appliance is supplied with a voltage which is **higher** than it is designed for, overheating due to excessive current may destroy it.
- If a **motor** is supplied with a voltage which is too **low**, the current in its coils will rise (due to reasons which are beyond the scope of this syllabus) and the device can be damaged due to overheating.

30 Electronics

1. a) Half-wave rectification is the process of converting ac to dc by preventing one half of each cycle from being applied to the load.
- b) Alternating current can be rectified to direct current through a device by connecting a semiconductor diode in series with it as shown in the diagram. Current can only flow in one direction through the diode.

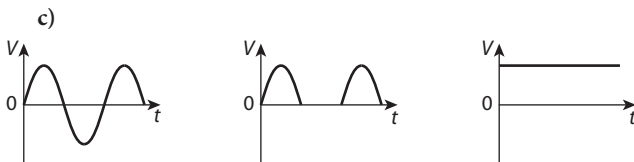
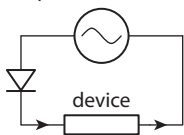

- i) domestic supply ac voltage ii) domestic supply ac-rectified to dc using a diode iii) dc output from battery

2. a)

AND		
input		output
0	0	0
0	1	0
1	0	0
1	1	1

b)

OR		
input		output
0	0	0
0	1	1
1	0	1
1	1	1

c)

NAND		
input		output
0	0	1
0	1	1
1	0	1
1	1	0

d)

NOT	
input	output
0	1
1	0

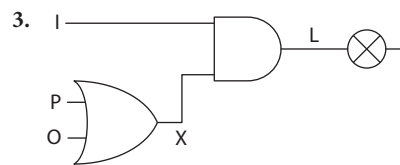

$$I \text{ AND } (P \text{ OR } O) = L$$

Ignition	Tyre pressure	Oil Level	X	Light
I	P	O	X	L
0	0	0	0	0
0	0	1	1	0
0	1	0	1	0
0	1	1	1	0
1	0	0	0	0
1	0	1	1	1
1	1	0	1	1
1	1	1	1	1

4. Electronic and technological advances have impacted positively and negatively on society today.

Positive impact:

- Businesses get a competitive edge when they use advanced technologies.
- The global pooling of information increases the rate of research and development.

- Improved transport through airplanes, trains, etc. as well as better communicating devices such as cell phones and the computer, has led to more efficient business transactions and to an increase in social contact.
- Better machinery leads to increased and improved productivity.
- Electronic banking has facilitated the process of financial transactions.

Negative impact:

- Incorrect information is common on the internet.
- Individuals can be addicted to social networking to such an extent that their productivity decreases.
- Excessive virtual communication leads to lack of real communication and to a fall in social skills.
- Exposure to movies with immoral sexual content and violence can eventually lead to persons accepting these acts as the norm.
- Hackers can intrude on computers and manipulate information such as bank accounts etc.
- More efficient machinery can result in a decrease in available jobs.

31 Magnetism

1. Magnetic materials may be identified by their attraction to or repulsion from a nearby magnet.
2. X is either:
 - a) an unmagnetised piece of magnetic material whose nearby end has been magnetised by **induction** with opposite polarity to the inducing pole of the magnet attracting it.
 - b) a magnet whose nearby pole is of opposite polarity to that of the magnetic pole of the magnet attracting it.
3. X is a magnet whose nearby pole is of similar polarity to that of the magnetic pole of the magnet repelling it.
4. Temporary magnetic materials: stalloy, mumetal
Permanent magnetic materials: alnico, alcomax
5. a) A magnetic field is the region in which a body experiences a force due to its magnetic polarity.
b) The direction of a magnetic field is the direction of motion of a free N-pole placed in the field.
- 6.

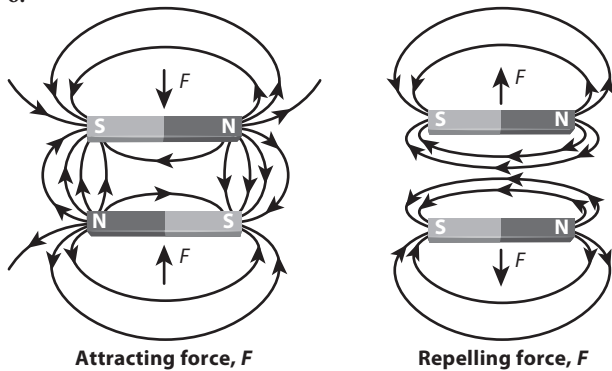

7. The field is uniform where the lines are parallel.

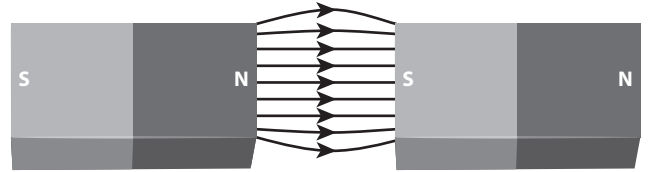

8. If a magnet is hung from a string it will align itself with the Earth's magnetic field as shown. It behaves as a compass, with its N-pole facing north.

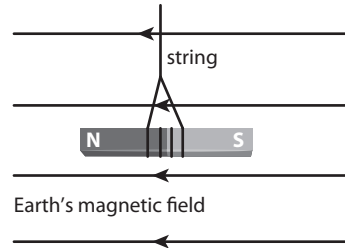

32 Electromagnetism

1. Electrical circuits are set up as shown in the diagrams. The horizontal pieces of card are tapped gently as iron filings are sprinkled onto them. The filings arrange in the patterns of the magnetic fields.

key: ⊗ = current into plane of paper
⊙ = current out of plane of paper

a) Field of a straight current-carrying conductor

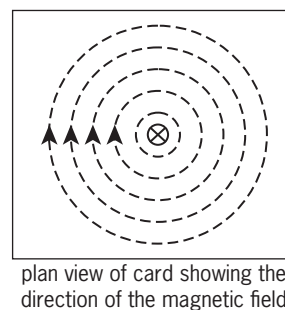
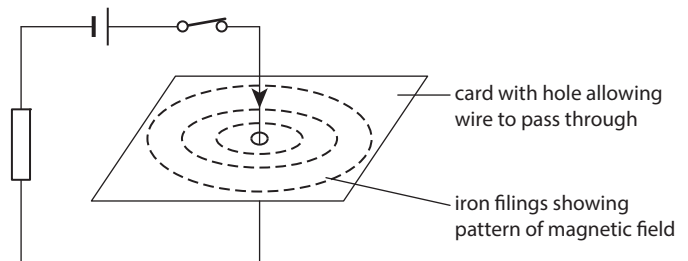

b) Field of a long current-carrying coil (solenoid)

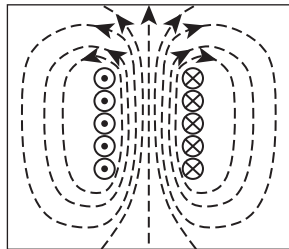
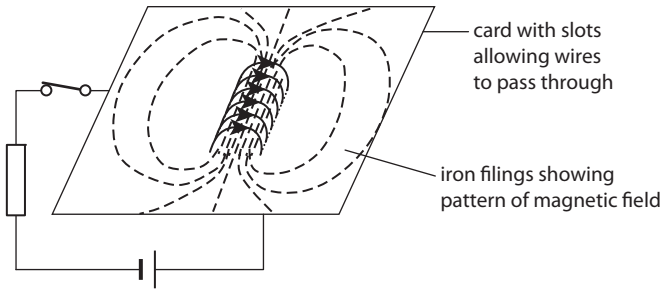

plan view of card showing the direction of the magnetic field

2. The electromagnetic relay

The diagram shows an electromagnetic relay. When S_1 is closed the current in the coil creates a magnetic field which magnetises the soft iron reeds. The adjacent ends of the reeds obtain opposite magnetic poles and attract each other, completing the circuit connected to terminals, T_1 and T_2 . The reeds are protected from the environment by the inert gas in the glass enclosure.

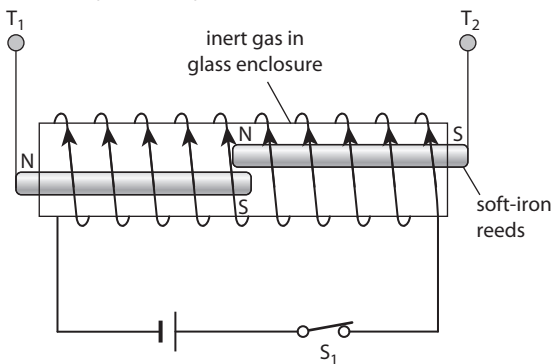

3. The diagram shows a stiff wire hanging from a metal loop and immersed in a magnetic field. When the current flows, a force (F) acts on the wire in accordance with Fleming's left-hand rule which pushes it out of the mercury and breaks the circuit. The current then diminishes to zero, the wire falls back into the mercury, and the process repeats.

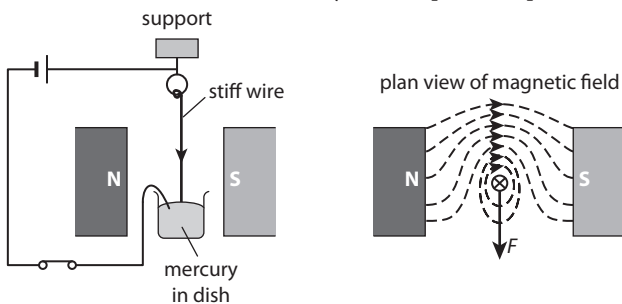

4. The direction of the thrust on each current-carrying conductor is found by using Fleming's left-hand rule.

- a) down to bottom of page
- b) perpendicularly out of plane of page

5.

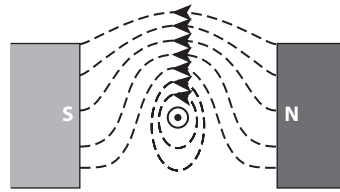

6.

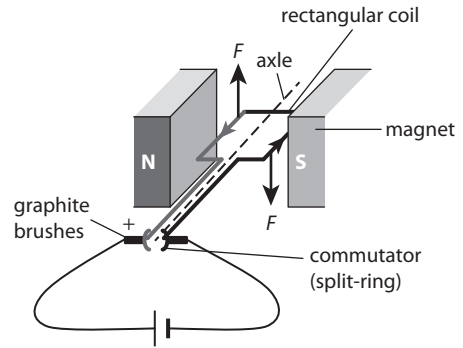

The current through the magnetic field produces forces, F , in accordance with Fleming's left-hand rule. Since the current flows in opposite directions on either side of the coil, the forces are also in opposite directions and the coil rotates about the axle.

The commutator ensures that the current through any particular side of the coil (left or right in the diagram) is always in the same direction by switching connection with the battery every half revolution. The force on the coil is, therefore, always in the same direction and it rotates continuously.

7. Moving the horizontal rod within the magnetic field induces an emf which drives a current through the circuit in accordance with Fleming's right-hand rule.

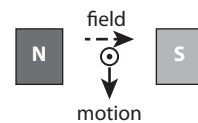
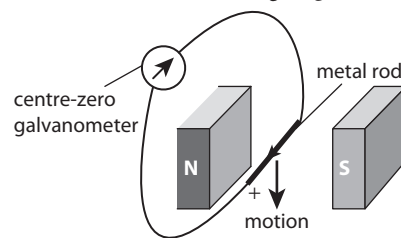

8. a) magnet pushed into coil

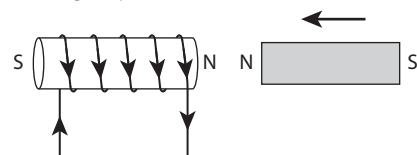

b) magnet at rest in coil

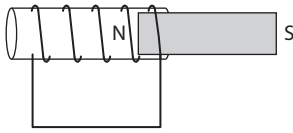

c) magnet pulled out of coil

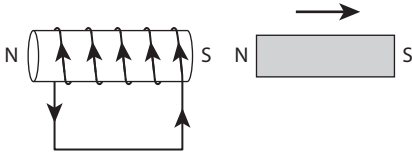

9. The induced current may be increased by any of the following:

- increasing the number of turns of the coil
- increasing the strength of the magnet
- increasing the speed at which the magnet moves relative to the coil.

10.

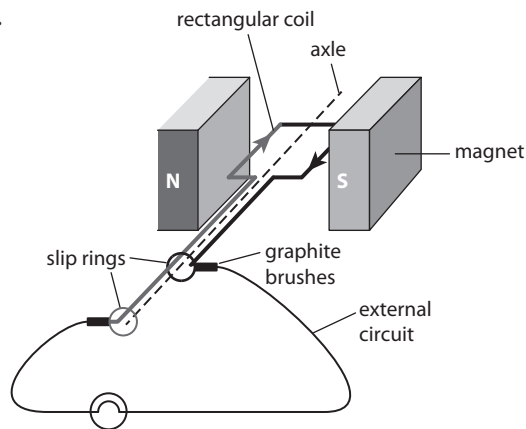

This ac generator is connected to a lamp.

11. The primary coil is connected to an ac supply and the secondary coil is connected to the device to be operated. The changing current in the primary coil produces a changing magnetic field which repeatedly grows into and diminishes from the secondary coil, thereby inducing an alternating voltage within it. The soft iron core allows the magnetic flux to pass readily between the coils. The alternating voltage induced in the secondary coil supplies the energy used by the device in the external circuit.

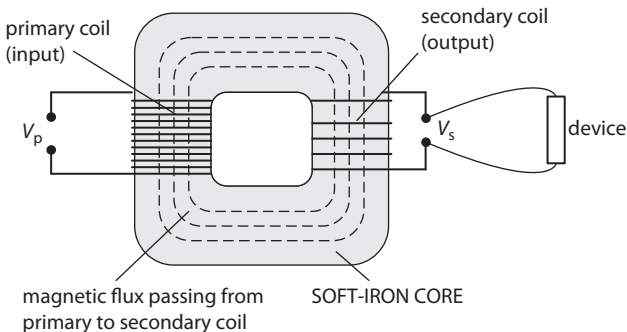

12. Advantages of using ac for transferring electrical energy over long distances:

- Alternating voltages can be stepped up by a transformer to be transferred from the power station at small currents. This results in **minimum energy being wasted as heat in the resistance of the transmitting cables.**
- By stepping down the transmission current from the power station, **thinner cables** can be used and, therefore, **the material cost is reduced.**

13.

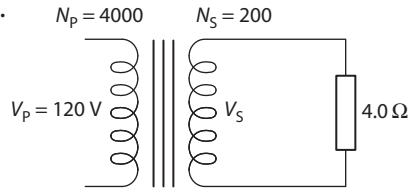

a) $\frac{V_s}{V_p} = \frac{N_s}{N_p}$
 $\frac{V_s}{120} = \frac{200}{4000}$
 $V_s = \frac{200}{4000} \times 120$
 $(V_s = 6.0 \text{ V})$

b) $V_s = I_s R_s$
 $6.0 = I_s \times 4.0$
 $\frac{6.0}{4.0} = I_s$
 $(1.5 \text{ A} = I_s)$

c) $\frac{I_p}{I_s} = \frac{N_s}{N_p}$
 $\frac{I_p}{1.5} = \frac{200}{4000}$
 $I_p = \frac{200}{4000} \times 1.5$
 $(I_p = 0.075 \text{ A})$

d) $P_s = V_s I_s$
 $P_s = 6.0 \times 1.5$
 $(P_s = 9.0 \text{ W (power output)})$

Since the transformer is ideal, no power is lost and therefore:
 $(P_p = P_s = 9.0 \text{ W (power input)})$

33 The atom

1. **Joseph John Thomson** viewed the atom as a positively charged sphere with smaller, negatively charged, fixed particles (electrons) interspersed within it, the resultant charge being zero. This is known as the 'plum pudding' model of the atom.

Ernest Rutherford proposed that most of the atom is empty space and that the nucleus has a very concentrated positive charge. He suggested that small negatively charged particles existed in a surrounding 'electron cloud', making the net charge zero.

Niels Bohr suggested that negatively charged particles orbit the nucleus in particular 'shells'. A unique energy value is required by an electron to exist within any shell.

James Chadwick discovered the **neutron**, an uncharged particle within the nucleus of an atom.

2. a) **Geiger and Marsden** shot α -particles through a thin sheet of gold foil and observed the scintillations they produced on striking a zinc sulfide screen. The experiment was performed in an evacuated chamber, since alpha particles are stopped by just a few cm of air. The zinc sulfide screen could be rotated to observe the scintillations received for any angle of deflection of the particles.

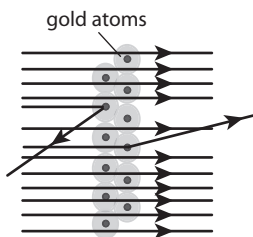
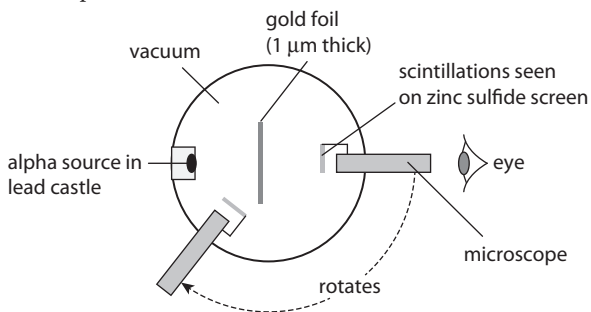

The arrows indicate the paths of the alpha particles. Very few were deflected.

b) Observations

- Most of the α -particles passed through the foil **without deflection**.
- Very few were deflected, but those that were, travelled with extremely **high velocities**, even at large angles of deflection.

Conclusions

- Most of the atom is **empty space**.
 - The nucleus is **extremely dense**, and consists of **positive charges** which repelled the positive α -particles.
- c) The neutron was difficult to detect since, unlike protons and electrons, it has no charge, and is therefore unaffected by electric and magnetic fields.

3. a)

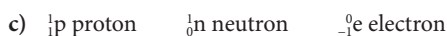
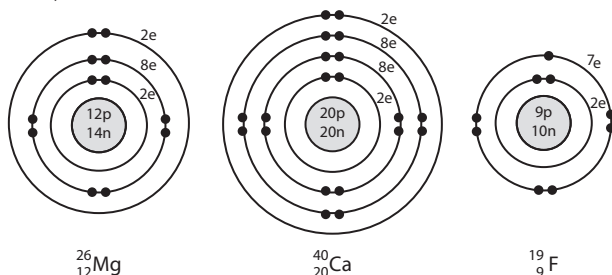

4.

	Proton	Neutron	Electron
Relative mass	1	1	$\frac{1}{1840}$
Relative charge	+1	0	-1

- If the electron has a mass of 1 unit, the proton has a mass of 1840 units.
 - The number of protons is equal to the number of electrons in a neutral atom.
5. a) The atomic number (proton number) of an element is the number of protons contained in the nucleus of an atom of the element.
- b) The mass number (nucleon number) of an element is the SUM of the protons and neutrons contained in the nucleus of an atom of the element.
- c) Isotopes are elements having the same atomic number but different mass numbers.

34 Radioactivity

- Since no environmental conditions could alter the intensity of radiation from the uranium, Marie Curie concluded that the rays emitted must be due to the atomic structure of the element.
 - In 1903 Marie and Pierre, her husband, shared the Nobel Prize in Physics with Henri Becquerel for their work on radioactivity. In 1911 she was awarded another Nobel Prize for the isolation of polonium and radium.
 - Her work has opened the field of radiotherapy and nuclear medicine.
- Radioactivity is the spontaneous disintegration of unstable atomic nuclei.
 - The activity of a sample of radioactive material is the rate at which its nuclei decay.
 - The becquerel, (Bq), is the rate of one nuclear disintegration per second.

3. a)



- b) **α -tracks:** An α -particle has a mass of more than 7000 times that of a β -particle. They are strongly ionising on collision with other particles and, therefore, produce **thick** tracks. The tracks are **straight** since α -particles are not easily deviated by collision with other particles.
- β -tracks:** β -particles are only weakly ionising due to their relatively small mass and, therefore, produce **weak** tracks. The tracks are **randomly directed** since these particles deviate readily on collision with other particles.
- γ -tracks:** These tracks are **extremely weak** and **dispersed**. The ions in this case are produced when a γ -wave is absorbed by an atom, thereby energising it and resulting in the ejection of an electron.

4. a) i) **α -particle:** Positively charged particle ejected from an atomic nucleus consisting of two protons and two neutrons.
 ii) **β -particle:** Negatively charged particle (an electron) ejected from an atomic nucleus.
 iii) **γ -wave:** An electromagnetic wave.
- b) i) alpha
 ii) alpha
 iii) gamma
 iv) gamma
 v) beta
 vi) beta
 vii) alpha
 viii) beta
 ix) alpha
 x) alpha

5. a) **Background radiation** is the ionising radiation within our environment.
 b) Radioactive elements in the Earth's crust and its surrounding atmosphere
 X-rays from medical equipment
 High-speed charged particles from the cosmos

6. a) **Absorption test**
- The background count rate is measured.
 - The source is then placed in front of the GM tube and the activity is again measured.
 - A thin sheet of paper is placed between the source and detector and the count rate is measured. If the activity is reduced to the background count rate, then the source is an α -emitter.
 - If the activity is unaffected, then the source is either a β -emitter or a γ -emitter. The paper is replaced by an aluminium sheet of thickness 5 mm. If the activity now returns to the background count rate, then the source is a β -emitter; otherwise, it is a γ -emitter.

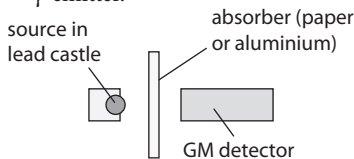

α -particles are readily stopped by air and, therefore, for experiments where there is the possibility of α -emission, the source must be placed very close to the detector or the apparatus should be set up in a vacuum.

b) **Electric field deflection test**

- The count rate is taken with the electric field switched off.
- The electric field is then switched on.
 - If the count rate is unaffected, the source is a γ -emitter.
 - If the count rate falls and only returns to its initial value when the detector is shifted towards the positive plate, then the source is a β -emitter. The positive plate will attract the negative β -particles.

- If the count rate falls and only returns to its initial value when the detector is shifted towards the negative plate, then the source is an α -emitter. The negative plate will attract the positive α -particles.

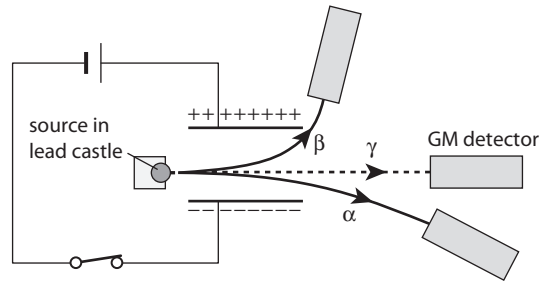

c) **Magnetic field detection test**

- The count rate is taken in the absence of the magnetic field.
- The magnetic field is then directed perpendicular to the path of the rays as shown in the diagram.
 - If the count rate is unaffected, the source is a γ -emitter.
 - If the count-rate falls, the detector should be shifted until it returns. Current is a flow of charge and therefore α and β particles will experience forces in accordance with **Fleming's left-hand rule**.

The direction of the current is the direction of flow of positive charge. Conventional current, therefore, has the same direction as α -flow but is opposite in direction to β -flow.

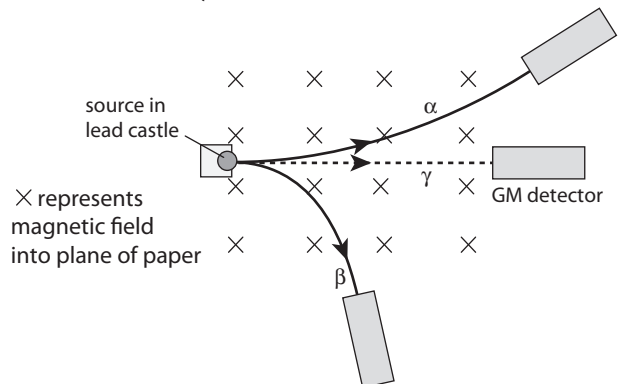

7. a) ${}_{84}^{214}\text{Po} \longrightarrow {}_2^4\alpha + {}_{82}^{210}\text{Pb}$
 b) ${}_{82}^{210}\text{Pb} \longrightarrow {}_{-1}^0\beta + {}_{83}^{210}\text{Bi}$
 c) ${}_{43}^{99\text{m}}\text{Tc} \longrightarrow \gamma + {}_{43}^{99}\text{Tc}$
8. a) The **half-life** of a radioisotope is the time taken for the mass (or activity) of a given sample of it to decay to half of its value radioactively.
- b) $\frac{24}{8} = 3$
 i.e. three half-lives
 $4.0 \text{ g} \longrightarrow 2.0 \text{ g} \longrightarrow 1.0 \text{ g} \longrightarrow 0.5 \text{ g}$
 After three half-lives 0.5 g of the sample remains.

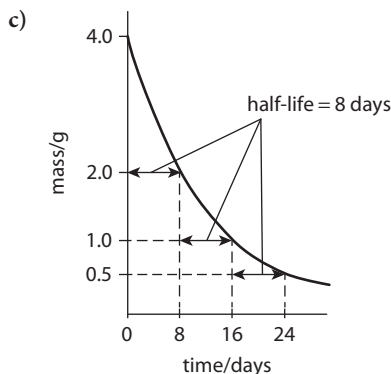

9. a) The activity falls by 75% and, therefore, to 25% of its original value.
 $100\% \rightarrow 50\% \rightarrow 25\%$
 Decays through two half-lives in 30 hours and, therefore, the half-life is $\frac{30}{2} = 15$ hours.
- b) The half-life would still be 15 hours.
- c) The half-life would not be affected.
 Half-life is not affected by factors external to the nucleus of the atom.
10. a) A radioactive source can be placed in front of the window of a Geiger detector which has been connected to a loudspeaker. The 'clicks' produced by the speaker will be observed with irregular timing, demonstrating the random nature of the decay.
- b) A smooth curve drawn through an experimental plot of count rate against time will not fall on all of the plotted points and, therefore, demonstrates the random nature of the decay.
11. a) $20 \text{ min}^{-1} \rightarrow 10 \text{ min}^{-1} \rightarrow 5 \text{ min}^{-1}$
 Since it has decayed through two half lives, the age of the relic is $2 \times 5700 \text{ years} = 11\,400 \text{ years}$
- b) In natural carbon there is only **ONE atom of C-14 in every 8×10^{11} atoms of carbon!** Due to this very small proportion of C-14 in a sample of carbon from even a living organism, the count rate obtained from very old specimens is very low. This type of dating is, therefore, not useful for determining the age of samples which have been dead for over 60 000 years (i.e. about 10 half-lives).
12. a) i) **A radioactive tracer** is a chemical compound in which one or more elements have been replaced by radioisotopes, and which can be used to investigate chemical reactions by tracking the path it follows. The tracer is given to the patient orally or as an injection and a detector is used to follow its path through the body. **Iodine-123**, is used as a tracer to investigate the function of the thyroid.
- ii) Gamma radiation from **cobalt-60** placed outside the patient can be used to destroy malignant growths. The treatment is only useful if the cancer is localised in a small region, since the radiation also destroys healthy cells.
- b) Problems associated with external beam radiotherapy:
- Normal tissue around the tumour is irradiated and damaged.
 - Bone may shield the tumour from the radiation.

13. a) Sources **given to patients orally or by injection** should have short half-lives so that they are not in the patient at dangerous levels for long periods. The half-life, however, **cannot be too short**, since time is needed for the radioisotope to be transported by the blood to the target site.

b) Gamma radiation is least absorbed by the body.

14. a) $\Delta E = \Delta mc^2$

b) $\Delta E = \text{energy released}$ $\Delta m = \text{mass defect}$
 $c = \text{speed of light in a vacuum}$

c) Albert Einstein

d) $\Delta E = 0.001 \times (3.0 \times 10^8)^2$
 $(\Delta E = 9.0 \times 10^{13} \text{ J})$

15. Power = $\frac{\text{energy}}{\text{time}}$

$$P = \frac{2.0 \times 10^8 (3.0 \times 10^8)^2}{1}$$

$$(P = 1.8 \times 10^{25} \text{ W})$$

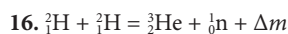

$$3.345 \times 10^{-27} + 3.345 \times 10^{-27} = 5.008 \times 10^{-27} + 1.675 \times 10^{-27} + \Delta m$$

$$6.690 \times 10^{-27} = 6.683 \times 10^{-27} + \Delta m$$

$$(7.0 \times 10^{-30} \text{ kg} = \Delta m)$$

$$\Delta E = \Delta mc^2$$

$$\Delta E = 7.0 \times 10^{-30} (3.0 \times 10^8)^2$$

$$(\Delta E = 6.3 \times 10^{-13} \text{ J})$$

17. Advantages

1. In the absence of natural disasters, they do not contaminate the environment if carefully managed. They do not produce greenhouse gases such as methane or carbon dioxide, or other hazardous gases such as sulfur dioxide or carbon monoxide.
2. A small amount of nuclear fuel produces an enormous amount of electricity and, therefore, delivery and storage of the material is relatively cheap.

Disadvantages

1. Nuclear radiation can destroy or damage living organisms. It can alter the DNA of cells and can produce cancers and other abnormal growths.
2. Used radioactive fuel still contains radioactive material and is, therefore, hazardous.

18. a) Ionising radiations can

- produce radiation burns
- alter DNA, producing cancer or genetic mutations.

b) The kinetic energies of alpha and beta particles are heavily absorbed by body cells. Gamma radiation, however, is not as dangerous since much of it passes through the body and only a portion of the electromagnetic energy is absorbed.

c) Precautions which can be taken as protection from ionising radiations:

- Never consume food or drink when in a location where there is radioactive material.
- All radioactive material should be labelled as being radioactive and dangerous.
- The use of tongs, robotic arms or gloves should be employed when working with radioisotopes.

19. a) i) **Nuclear fusion** is the joining of two small, atomic nuclei to produce a larger nucleus, resulting in a large output of energy and a decrease in mass.
- ii) **Nuclear fission** is the splitting of a large atomic nucleus into two nearly equal parts, resulting in a large output of energy and a decrease in mass.

- b) Atoms undergo nuclear fission in order to obtain a more stable nucleus.
- c) The Sun liberates energy by the process of nuclear fusion.
- d) Nuclear power stations generate electricity by the process of nuclear fission.

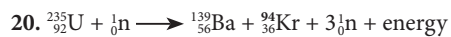

**Exam-style questions –
Chapters 1 to 9**

STRUCTURED

1. a) i) A scalar quantity is one which has only magnitude. (2 marks)
 ii) A vector quantity has magnitude and direction. (2 marks)

b)

Scalar	Vector
energy	force
pressure	displacement
power	momentum

(3 marks)

- c) i) Since the vectors are at right angles, a sketch can be made and the solution obtained from application of Pythagoras' theorem and simple trigonometry.

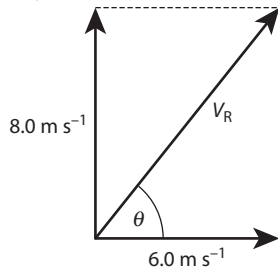

Resultant velocity

magnitude $V_R = \sqrt{8.0^2 + 6.0^2}$
 $(V_R = 10 \text{ m s}^{-1})$

direction, $\theta = \tan^{-1} \frac{8.0}{6.0} = 53^\circ$ (6 marks)

- ii) distance = speed \times time
 $d = 10 \times (5.0 \times 60)$
 $(d = 3000 \text{ m})$ (2 marks)

Total 15 marks

2. a) i) Displacement: The distance measured in a specified direction from some reference point. (2 marks)
 ii) Velocity: The rate of change of displacement. (2 marks)
 iii) Acceleration: The rate of change of velocity. (2 marks)

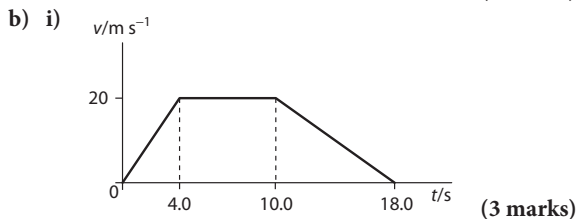

- ii) acceleration = $\frac{\Delta v}{\Delta t}$
 $a = \frac{20 - 0}{4.0 - 0}$
 $(a = 5.0 \text{ m s}^{-2})$ (2 marks)

- iii) distance = area under the graph to $t = 10 \text{ s}$

$$d = \frac{20 \times 4.0}{2} + 20 \times 6.0$$

$$(d = 160 \text{ m}) \quad (3 \text{ marks})$$

- c) An object moving at uniform speed in a circle is constantly changing direction. Its velocity is therefore constantly changing and it is accelerating.

$$a = \frac{\Delta v}{\Delta t} \quad (1 \text{ mark})$$

Total 15 marks

3. a) i) The moment of a force about a point is the product of the force and the perpendicular distance of its line of action from the point. (2 marks)
 ii) The centre of gravity of a body is the point through which the resultant gravitational force on the body acts. (2 marks)
 b) i) The principle of moments states that for a system of coplanar forces in equilibrium, the sum of the clockwise moments about any point is equal to the sum of the anticlockwise moments about that same point. (2 marks)
 ii) $N \text{ m}$ (1 mark)
 c) i) $W = mg$
 $W = 2.0 \times 10$
 $(W = 20 \text{ N})$ (2 marks)
 ii) Taking moments about point C:
 Σ anticlockwise moments = Σ clockwise moments
 $20 \times 0.15 = 0.40 P$
 $P = \frac{20 \times 0.15}{0.40}$
 $(P = 7.5 \text{ N})$ (4 marks)
 d) If the height of the cone is doubled, the force (P) required is halved, in order to provide the same clockwise moment as before. (2 marks)

Total 15 marks

EXTENDED RESPONSE

4. a) (Law 1) A body continues in its state of rest or uniform motion in a straight line unless acted on by a resultant force.
 (Law 2) The rate of change of momentum of a body is proportional to the applied force and takes place in the direction of the force. $F = \frac{mv - mu}{t}$.
 (Law 3) If body A exerts a force on body B, then body B exerts an equal but oppositely directed force on body A. (6 marks)
- b) i) $F_R = ma$
 $F_R = 4.0 \times 10^4 \times 3.6$
 $F_R = 1.44 \times 10^5$
 $(F_R = 1.4 \times 10^5 \text{ N})$ (2 marks)
 ii) The acceleration is proportional to the **resultant force** on the jet. The forward thrust of the engines must be greater than the resultant force by an amount equal to the **opposing** forces of friction. The resultant force will then be $1.44 \times 10^5 \text{ N}$. (2 marks)
 iii) $W = F \times s = 1.44 \times 10^5 \times 500$
 $(W = 7.2 \times 10^7 \text{ J or } 72 \text{ MJ})$ (3 marks)

- c) Constant velocity implies that the acceleration is zero. Since $F_R = ma$, the resultant force must also be zero. A forward thrust **equal but oppositely directed** to the opposing force of friction will produce a resultant force of zero. (2 marks)

Total 15 marks

5. a) There is a definite need to use alternative sources of energy in the Caribbean. The region depends heavily on the use of fossil fuels for its energy. These fuels are diminishing in availability and the sudden drop in oil prices has highlighted the high risk of investment in crude oil companies. Fossil fuels are also polluting the environment, increasing global warming, and are contributing to increased medical expenses caused particularly by respiratory illnesses. The Caribbean can take advantage of the excellent solar radiation available throughout the year by using it as an alternative energy source. Many homes are already using solar water heaters to heat water directly. These are relatively cheap to install and require very little maintenance. Photovoltaic panels are also becoming popular. These convert solar energy into electrical energy which is stored in batteries for later use or returned to the electrical grid supply. Biogas is another useful alternative source of energy. Gases produced from decayed animal wastes are now being used to power electrical generators on farms.

- b) i) max. $E_p = mg\Delta h$ (6 marks)

$$\text{max. } E_p = 0.500 \times 10 \times 30$$

(max. $E_p = 150 \text{ J}$) (2 marks)

- ii) The 150 J of potential energy transforms completely to 150 J of kinetic energy as the stone falls. (2 marks)

- iii) The 150 J of kinetic energy does 150 J of work as it bores into the soil. (1 mark)

- iv) Whenever work is done, an equal amount of energy is transformed. The 150 J of work done results in a transformation of 150 J of kinetic energy into 150 J of thermal energy and sound energy. (1 mark)

- v) work on boring hole = force \times distance moved in direction of force

$$150 = F \times 0.20$$

$$\frac{150}{0.20} = F$$

$$(750 \text{ N} = F) \quad (3 \text{ marks})$$

Total 15 marks

Exam-style questions –

Chapters 10 to 18

STRUCTURED

1. a) The heat capacity of a body is the heat required to raise the temperature of **the entire body** by one unit, whereas the specific heat capacity of a substance is the heat required to raise the temperature of only **unit mass** of the substance by one unit. (2 marks)

- b) i) $C = mc = 0.500 \times 4200$ (2 marks)
- ($C = 2100 \text{ J } ^\circ\text{C}^{-1}$)

ii) $P = \frac{mc\Delta T}{t}$

$$t = \frac{mc\Delta T}{P}$$

$$t = \frac{0.500 \times 4200 \times (100 - 30)}{600}$$

($t = 245 \text{ s}$) (2 marks)

iii) $E_H = ml$

$$E_H = 0.200 \times 2.3 \times 10^6$$

($E_H = 4.6 \times 10^5 \text{ J}$) (2 marks)

iv) $P = \frac{E_H}{t}$

$$t = \frac{E_H}{P} = \frac{4.6 \times 10^5}{600}$$

($t = 767 \text{ s}$) (2 marks)

- c) i) Temperature is a measure of the degree of hotness of a body. (1 mark)

- ii) Liquid-in-glass thermometer – the volume of liquid increases with increased temperature. Resistance thermometer – the resistance increases with increased temperature. (4 marks)

Total 15 marks

2. a)

Relation	Law
$V \propto T$ (P constant)	Charles' law
$P \propto \frac{1}{V}$ (T constant)	Boyle's law
$P \propto T$ (V constant)	Pressure law

(3 marks)

b) i) $P_1 V_1 = P_2 V_2$

$$8.0 \times 10^4 \times 10 = P_2 \times 5.0$$

$$\frac{8.0 \times 10^4 \times 10}{5.0} = P_2$$

($1.6 \times 10^5 \text{ Pa} = P_2$) (2 marks)

- ii) As a gas is compressed at constant temperature, the speed of its molecules is unchanged and therefore the **force, F , exerted by its molecules remains constant**. However, since the volume decreases, the collisions are on a **smaller area, A** . The force per unit area therefore increases, resulting in an increase in pressure, P .

$$P = \frac{F}{A} \quad (2 \text{ marks})$$

- iii) The molecules of mass, m , of a gas, bombard each other and the walls of their container. As they rebound, their velocity changes from u to v in a short time, t , and they impart forces, F , in accordance with Newton's second law of motion.

$$F = \frac{m(v - u)}{t} \quad (2 \text{ marks})$$

c) i) $P = \frac{mc\Delta T}{t}$

$$\frac{Pt}{c\Delta T} = m$$

$$\frac{300 \times 200}{4200 \times 70} = m$$

($0.20 \text{ kg} = m$) (3 marks)

ii) $P = \frac{ml}{t}$

$$t = \frac{ml}{P}$$

$$t = \frac{0.400 \times 3.4 \times 10^5}{300}$$

($t = 453 \text{ s}$) (3 marks)

Total 15 marks

EXTENDED RESPONSE

3. a) The heater is switched on and the water is brought to boiling point. The initial mass, m_1 , is measured and recorded and the stop watch is started. The readings of voltage, V , across the heater, and current, I , through it, are taken. After a few minutes, the new mass, m_2 , and the time, t , are measured and recorded.

Assuming that all the electrical energy is used in boiling the water, the following equation is used to calculate the specific latent heat of vaporisation, l_v .

electrical energy = heat to boil water

$$VIt = m_w l_v$$

$$VIt = (m_1 - m_2)l_v$$

$$\frac{VIt}{(m_1 - m_2)} = l_v \quad (6 \text{ marks})$$

- b) i) If P is the power of the heater, then electrical energy = heat to boil water

$$Pt = m_w l_v$$

$$\frac{Pt}{m_w} = l_v$$

$$\frac{1000(10 \times 60)}{0.250} = l_v$$

$$(2.4 \times 10^6 \text{ J kg}^{-1} = l_v) \quad (3 \text{ marks})$$

- ii) $E_H = ml = 0.250 \times 2.4 \times 10^6 = 6.0 \times 10^5 \text{ J}$ (3 marks)

- c) i) A portion, H , of the energy supplied by the heater was radiated to the surroundings. (1 mark)

- ii) The calculated value is greater than the true value. The true value of l_v can be found from

$$\frac{Pt - H}{m_w} = l_v \quad (2 \text{ marks})$$

Total 15 marks

4. a) **During the day**, the Sun's **radiation** warms the land more than it warms the sea. The air over the land is, therefore, heated by conduction to a greater extent than is the air over the sea. As the temperature increases, so does the kinetic energy of the air particles; the molecules take up more space and the region becomes less dense. Warm air then rises from over the land and **cooler breezes blow onshore** from over the sea to take its place. Coastal regions, therefore, do not experience extremely high temperatures during the day. (6 marks)

- b) i) $A = 8 \times 0.50$
($A = 4.0 \text{ m}^2$) (1 mark)

- ii) $P_T = 800 \times 4.0$
($P_T = 3200 \text{ W}$) (2 marks)

- iii) $P_w = 3200 \times \frac{60}{100}$
($P_w = 1920 \text{ W}$) (2 marks)

- iv) $P_w = \frac{mc\Delta T}{t}$
 $t = \frac{mc\Delta T}{P_w}$

$$t = \frac{250 \times 4200 \times 40}{1920}$$

$$t = 21\,875 \text{ s}$$

$$(t = 6.1 \text{ h}) \quad (4 \text{ marks})$$

Total 15 marks

Exam-style questions –

Chapters 19 to 25

STRUCTURED

1. a) i) X-rays, ultraviolet waves, light waves, radio waves. (2 marks)

ii)

Type of wave	Source	Use
Radio	Radio transmitter	Radio broadcasting
Gamma	Cobalt-60	Sterilisation

(4 marks)

- iii) Gamma diffracts least. (1 mark)

- b) $v = \lambda f$

$$\frac{3.0 \times 10^8}{1.5 \times 10^{17}} = \lambda$$

$$(2.0 \times 10^{-9} \text{ m} = \lambda) \quad (2 \text{ marks})$$

- c) i) $\eta = \frac{1}{\sin c} = \frac{1}{\sin 39^\circ} = 1.59$ (3 marks)

- ii) $\frac{\sin \theta_a}{\sin \theta_g} = \frac{\eta_g}{\eta_a}$

$$\sin \theta_a = \frac{\eta_g}{\eta_a} \sin \theta_g$$

$$\sin \theta_a = \frac{1.59}{1.0} \sin 33^\circ$$

$$(\theta_a = 60^\circ)$$

(3 marks)

Total 15 marks

2. a) i) Laws of reflection:

- The incident ray, the reflected ray and the normal, at the point of incidence, are on the same plane.
- The angle of incidence is equal to the angle of reflection. (2 marks)

- ii) Characteristics of the image formed in a plane mirror:

- It is the same size as the object.
- It is virtual.
- It is laterally inverted. (3 marks)

- b) i) amplitude = 2 m (1 mark)

- ii) period = 8.0 s (1 mark)

- iii) $f = \frac{1}{T} = \frac{1}{8.0}$
($f = 0.125 \text{ Hz}$) (2 marks)

- iv) $\lambda = \frac{v}{f} = \frac{4.0}{0.125}$
($\lambda = 32 \text{ m}$) (2 marks)

- v) The diffraction would be extensive since the wavelength is greater than the size of the gap. (2 marks)

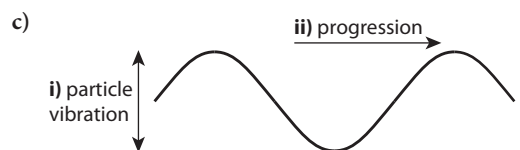

(2 marks)

Total 15 marks

EXTENDED RESPONSE

3. a) Monochromatic light from a sodium lamp is allowed to diffract through a narrow slit, S , and then to further diffract through two other narrow slits, S_1 and S_2 about 0.5 mm apart. The distance between the primary slit

S and the secondary slits S_1 and S_2 is about 1 m. A translucent screen positioned approximately 2 m in front of S_1 and S_2 displays the interference pattern of alternate bright and dark fringes. The experiment should be performed in a poorly lit laboratory.

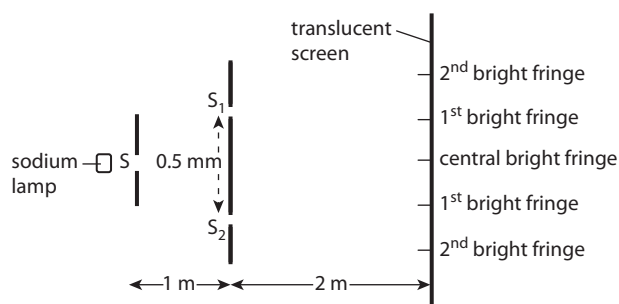

(6 marks)

b) i)
$$\text{speed} = \frac{\text{distance}}{\text{time}}$$

$$v = \frac{20(2 \times 60)}{7.0}$$

($v = 343 \text{ m s}^{-1}$) (5 marks)

ii) The result would be the same since the speed of sound is not affected by its volume. (1 mark)

iii)
$$v = \frac{d}{t}$$

$$343 = \frac{d}{6.0}$$

$$343 \times 6.0 = d$$

$$2058 = d$$

$$(2.1 \times 10^3 \text{ m} = d)$$
 (3 marks)

Total 15 marks

4. a) A converging lens is mounted as shown in the diagram below. The distance between the lens and the object (small gap with crossed wires) is altered until a sharp image of the crossed wires is observed next to the source. The rays of light would then be almost retracing their paths after reflection from the mirror. The distance between the centre of the lens and the object is measured. It is the focal length of the lens.

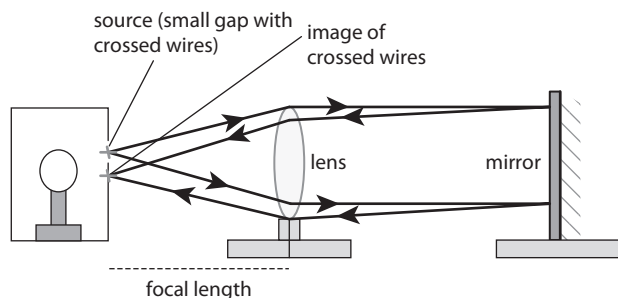

(6 marks)

b) i)
$$\frac{1}{u} + \frac{1}{v} = \frac{1}{f}$$

$$\frac{1}{v} = \frac{1}{f} - \frac{1}{u}$$

$$\frac{1}{v} = \frac{1}{15} - \frac{1}{20}$$

$$\frac{1}{v} = \frac{1}{60}$$

$$(v = 60 \text{ cm})$$

(3 marks)

ii) real since v is positive (1 mark)

iii) inverted (1 mark)

iv)
$$m = \frac{v}{u} = \frac{60 \text{ cm}}{20 \text{ cm}} = 3$$
 (2 marks)

v)
$$m = \frac{I}{O}$$

$$3 = \frac{I}{5}$$

($15 \text{ cm} = I$)

(2 marks)

Total 15 marks

Exam-style questions – Chapters 26 to 32

STRUCTURED

1. a)

	Zinc-carbon cell	Lead-acid accumulator
Electrolyte	ammonium chloride jelly	dilute sulfuric acid
Rechargeability	not rechargeable	rechargeable
Terminal voltage	1.5 V	2.0 V
Maximum current	a few amps – works well when delivering up to about 1 A	>400 A
Internal resistance	0.5 Ω	0.01 Ω

(4 marks)

b) i) Conventional current flows in the direction in which positive charge would move if free to do so. This is opposite to the direction in which electrons would flow, since electrons are negatively charged. (2 marks)

ii) An aqueous solution of sodium chloride contains both positive and negative ions which move freely in opposite directions when subjected to an electric field. (1 mark)

c) i)
$$I = \frac{Q}{t} = \frac{480 \times 10^{-6}}{12 \times 10^{-3}}$$

$$(I = 4.0 \times 10^{-2} \text{ A})$$
 (2 marks)

ii)
$$V = IR = 4.0 \times 10^{-2} \times 500$$

$$(V = 20 \text{ V})$$
 (2 marks)

iii)
$$Q = Nq$$

$$N = \frac{Q}{q} = \frac{480 \times 10^{-6}}{1.6 \times 10^{-19}} = 3.0 \times 10^{15}$$
 (2 marks)

iv)
$$E = QV = 480 \times 10^{-6} \times 20$$

$$(E = 9.6 \times 10^{-3} \text{ J})$$
 (2 marks)

Total 15 marks

2. a) i)

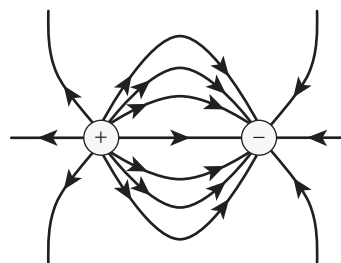

i) and ii)

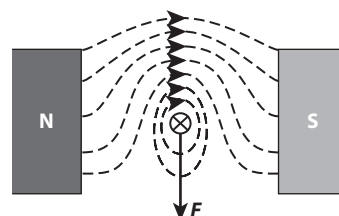

(7 marks)

b) i) $R_{XY} = \frac{5.0 \times 5.0}{5.0 + 5.0}$
 $(R_{XY} = 2.5 \Omega)$
 $R_{PQ} = 4 + \frac{2 \times 2}{2 + 2} = 4 + 1$
 $(R_{PQ} = 4 \Omega + 1 \Omega = 5 \Omega)$ (4 marks)

ii) From part (b) above the resistance across the parallel section was found to be 1Ω .
 Therefore the p.d. across the parallel section is

$$V = I \times R = 1 \times 1$$

$$(V = 1 \text{ V})$$

Alternatively, the 1 A flowing in the 4Ω resistor splits into branches carrying only 0.5 A. The p.d. across any of these branches is

$$V = IR = 0.5 \times 2$$

$$(V = 1 \text{ V})$$
 (2 marks)

iii) $P = I^2 R = 1^2 \times 5$
 $P = 5 \text{ W}$ (2 marks)

Total 15 marks

EXTENDED RESPONSE

3. a) i) filament lamp

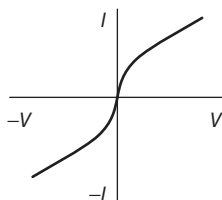

(3 marks)

ii) semiconductor diode

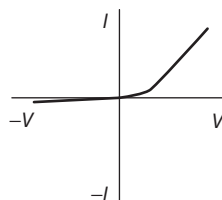

(3 marks)

iii) The resistance of the component is constant. (1 mark)

b) i) $I = \frac{V}{R} = \frac{5.0}{10}$
 $(I = 0.50 \text{ A})$ (2 marks)

ii) $I = \frac{5.0}{10 + 10}$
 $(I = 0.25 \text{ A})$ (2 marks)

iii) $V_A = I_A R_A = 0.25 \times 10$
 $(V_A = 2.5 \text{ V})$ (2 marks)

iv) $P_A = V_A I_A = 2.5 \times 0.25$
 $(P_A = 0.63 \text{ W})$ (2 marks)

Total 15 marks

4. a) i) An ac supply is applied to the primary coil. The changing current it creates produces a changing magnetic field, which repeatedly grows into and diminishes from the secondary coil via the permeable soft iron core. As the field repeatedly cuts into and then out of the secondary coil it induces an emf which repeatedly reverses direction. The emf produced in the secondary coil is proportional to the number of turns it has relative to that of the primary coil, and therefore by varying the ratio of turns, the secondary voltage can be altered.

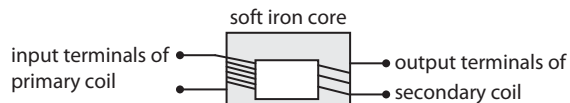

(3 marks)

ii) THREE advantages of using ac for transferring electrical energy:

- Consumer appliances operate on several voltages which can easily be obtained from an AC mains supply connected to a transformer.
- Transformers step up and down ac with minimum energy loss.
- ac can be transferred from the power station at small currents, resulting in **minimum energy being wasted as heat in the resistance of the transmitting cables.** (3 marks)

b) i) and iii)

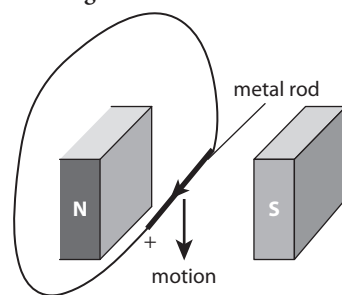

i) and ii)

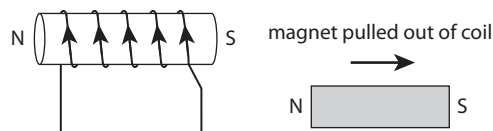

(5 marks)

c) i) $\frac{V_p}{V_s} = \frac{N_p}{N_s}$
 $\frac{V_p}{20} = \frac{6000}{1000}$
 $V_p = \frac{6000}{1000} \times 20$
 $(V_p = 120 \text{ V})$ (2 marks)

ii) $P = VI$
 $\frac{P}{V} = I$

$$\frac{100}{20} = I$$

$$(5.0 \text{ A} = I)$$
 (2 marks)

Total 15 marks

Exam-style questions – Chapters 33 and 34

STRUCTURED

1. a)

Mass number	14
Atomic number	6
An isotope represented in a similar manner	$^{12}_6\text{C}$
Number of electron shells in its atom	2
Number of electrons in its neutral atom	6

(5 marks)

	Proton	Neutron	Electron
Relative mass	1	1	$\frac{1}{1840}$
Relative charge	+1	0	-1

c) i) $\frac{17\ 100\ y}{5700\ y} = 3$ (decays for 3 half-lives) (2 marks)

100% → 50% → 25% → 12.5% (12.5% remains) (2 marks)

ii) In natural carbon there is only ONE atom of C-14 in every 8×10^{11} atoms of carbon. After a period of 60 000 years, the percentage of any given sample remaining would be much too small to provide a result with acceptable accuracy. (2 marks)

iii) The half-life is unaffected. (2 marks)

iv) ${}^{14}_6\text{C} \rightarrow {}^0_{-1}\text{e} + {}^{14}_7\text{N}$ (2 marks)

Total 15 marks

2. a)

Property	Type of emission
Tracks produced in a cloud chamber are thick and straight	alpha
Travels at the speed of light in a vacuum	gamma
Strongly ionises the air it passes through	alpha
Penetrates up to a few mm of aluminium	beta
Is deflected most by magnetic fields	beta
On emission, produces an element one place ahead in the Periodic Table	beta
Is electromagnetic in nature	gamma

(7 marks)



c) The background count rate remains constant. Only the count rate of the source diminishes.

Initial count rate of source = 85 Bq - 5 Bq = 80 Bq

1 hour is the time of 3 half-lives. ($3 \times 20\ \text{min.} = 1\ \text{hr}$)

80 Bq → 40 Bq → 20 Bq → 10 Bq (count rate from source = 10 Bq after 1 hour)

Count rate received by detector including background rate = 5 + 10 = 15 Bq (4 marks)

Total 15 marks

EXTENDED RESPONSE

3. a) i) α -particles were shot through a thin sheet of gold foil in an evacuated chamber. The paths of the particles were detected by a moveable eye-piece.

ii) Most of the particles passed through the foil without deflection. A few were deflected at large angles and with very high velocity.

iii) Most of the atom is empty space. A small concentrated positive nucleus existed in the atom which caused the strong deflections of the alpha particles of similar charge. (6 marks)



ii) $\frac{40\ \text{days}}{8\ \text{days}} = 5$ (It decays for five half-lives)

160 g → 80 g → 40 g → 20 g → 10 g → 5 g (Therefore, 5 g remains after 40 days) (3 marks)

iii)

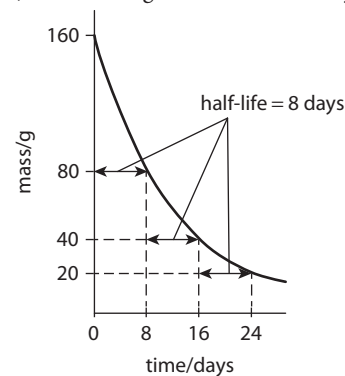

(3 marks)

Total 15 marks

4. a) **Advantages of nuclear generators**

- In the absence of natural disasters, they do not contaminate the environment if carefully managed. They do not produce greenhouse gases such as methane or carbon dioxide, or other hazardous gases such as sulfur dioxide or carbon monoxide.
- Many radioactive materials used in medicine are made available at the power plants.
- A small amount of nuclear fuel produces an enormous amount of electricity and, therefore, delivery and storage of the material is relatively cheap.

Disadvantages of nuclear generators

- Spent radioactive fuel still contains radioactive material and is hazardous. Proper disposal of radioactive waste is a problem that has not yet been overcome.
- Nuclear power stations have to be discarded after several years since the plant and machinery become heavily contaminated. To shut down these operations is very costly and hazardous.
- There is the possibility of a catastrophic effect if there is a critical malfunction at the plant. Huge explosions can spread the radioactive material over large areas and the radiation could impact heavily on the planet. (6 marks)

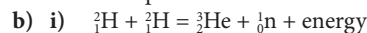

$2.015\ \text{u} + 2.015\ \text{u} = 3.017\ \text{u} + 1.009\ \text{u} + \Delta m$

$4.0 \times 10^{-3}\ \text{u} = \Delta m$

$E = \Delta mc^2$

$E = (4.0 \times 10^{-3} \times 1.66 \times 10^{-27})(3 \times 10^8)^2$

$E = 6.0 \times 10^{-13}\ \text{J}$ (5 marks)

ii) examining mass: $235 + 1 = 148 + 85 + x$

$3 = x$ (3 neutrons emitted) (1 mark)

c) $P = \frac{\Delta mc^2}{t} = \frac{5.0 \times 10^9(3.0 \times 10^8)^2}{1}$

$(P = 4.5 \times 10^{26}\ \text{W})$

(3 marks)

Total 15 marks