

SAT



Study Guide

Lessons, Strategies, and Diagnostic Tests

650+
Pages

Full
Practice
Test

475+
Practice
Questions

New SAT[®] Study Guide

LESSONS, STRATEGIES, AND DIAGNOSTIC TESTS



STUDY GUIDE

VARSITY TUTORS

St. Louis



Eric Forster
Editor-in-Chief

Laura Torp
Managing Editor

Kara Levis
Project Manager

Staff Editors

Aubtin Saedi
Kalea Sebesta
Armen Stromquist
Melissa Sweeterman
Joseph Ritchie
Andrew Ockert

Data Manager

Kara Levis

Layout

Laura Torp

VARSITY TUTORS
St. Louis

New SAT Study Guide: Lessons, Strategies, and Diagnostic Tests
Copyright © 2019 by Live Learning Technologies LLC

Published by Varsity Tutors LLC
101 S. Hanley Rd, Suite 300
St. Louis, MO 63105
www.varsitytutors.com

Email: books@varsitytutors.com

All rights reserved. The text of this publication, or any part thereof, may not be reproduced in any manner whatsoever without written permission from the publisher. This prohibition includes storage in a retrieval system or transmission in any form or by any means, electronic, mechanical, photocopying, recording, scanning, or otherwise, except as permitted under Sections 107 or 108 of the 1976 United States Copyright Act.

ISBN-13: 978-1-944204-04-4

2019 Edition

LIMIT OF LIABILITY/DISCLAIMER OF WARRANTY:

The publisher and the author make no representations or warranties with respect to the accuracy or completeness of the contents of this work and specifically disclaim all warranties, including without limitation warranties of fitness for a particular purpose. no warranty may be created or extended by sales or promotional materials. the advice and strategies contained herein may not be suitable for every situation. this work is provided with the understanding that the publisher is not engaged in rendering legal, accounting, or other professional services. if professional assistance is required, the services of a competent, professional person should be sought. neither the publisher nor the author shall be liable for damages arising herefrom.

Table of Contents

How to Use This Book	1
Introduction	2
The New SAT: New Content, New Format	3
Scoring	13
The Essay	18
Testing Tips	22
The SAT Reading Test	24
Review: SAT Reading	25
Review: Context, Connotation, Denotation, and Implication	26
Review: Close Reading	32
Information and Ideas	38
Deciphering Statements and Implications	39
Applying Inferences to New Scenarios	45
Citing Textual Evidence	53
Identifying Main Ideas and Themes	59
Summarizing and Paraphrasing	64
Deciphering Words and Phrases in Context	69
Interpreting Relationships in Context	77
Cause and Effect	78
Comparing and Contrasting	83
Sequence	91
Rhetoric and Passage Construction	97
Stylistic Word Choice	98
Text Structure	108
Point of View	113
Purpose	119
Claims, Evidence, and Reasoning	124
Synthesis	131
Paired Passages	132
Quantitative Information	147
The SAT Writing and Language Test	159
Expression of Ideas	160
Content and Development	161
Modifying Proposition Statements	162
Improving Focus and Purpose	170
Quantitative Accuracy and Application	173
Organization and Structure	179
Logical Sequence	180
Introductions, Transitions, and Conclusions	187
Effective Language Use	193
Word Choice	194
Concision	204
Tone and Style	209
Combining Sentences	216
Standard English Conventions	224
Sentence Structure	225
Complete and Incomplete Sentences	226
Coordination Between Clauses	234



Parallel Structure	238
Modifier Placement	240
Verb Tense, Mood, and Voice	248
Conventions of Usage	258
Pronoun Choice	259
Homophones, Possessives, and Contractions	264
Agreement	273
Logical Comparison	280
Conventions of Punctuation	285
Ending Sentence Punctuation	286
Internal Sentence Punctuation	288
Possessive Nouns and Pronouns	295
Items in Series	298
Nonrestrictive and Parenthetical Punctuation	305
The SAT Math Test	313
Review: SAT Math	314
Review: Given Equations	315
Review: Properties of Algebra	338
Review: Approaching Word Problems	342
Introductory Algebra	353
Absolute Value	354
Linear Equations and Inequalities	356
Systems of Linear Equations and Inequalities	365
Properties of Linear Graphs	372
Advanced Algebra	377
Simplifying, Expanding, and Rewriting Polynomial Expressions	378
Quadratic Functions and Equations	387
Exponential Expressions, Functions, Equations and Radicals	394
Rational Equations and Expressions	405
Systems of Equations	411
Function Notation	415
Graphing Algebraic Functions	418
Graphing Circles	429
Complex Equations in Context	432
Analytics and Problem Solving	441
Introductory Statistics	442
Modeling Data: Equations, Graphs, Scatter Plots, and Tables	451
Conversions: Units, Ratios, Proportions, and Percentage	458
Probability	466
Additional Topics and Geometry	475
Geometry	476
Lines and Angles	477
Length and Midpoint	478
Angles, Parallel Lines, and Perpendicular Lines	484
Triangles, Circles, and Polygons	495
Defining Polygons	496
Introduction to Right Triangles	503
Congruent Figures and Similar Figures	509
Quadrilaterals	513
Circles	518
Three-Dimensional Geometry	528



Trigonometry and Radians	542
Trigonometric Operations	543
Degrees, Radians, and the Unit Circle	548
Trigonometric Identities	553
Other Concepts	554
Complex Numbers	555
The New SAT Essay	557
SAT Essay: Reading	560
SAT Essay: Analysis	562
SAT Essay: Writing	564
Sample Prompt and Essay Response	565
Full-Length SAT Practice Test	568
Reading Test	569
Writing and Language Test	586
Math Test - No Calculator	606
Math Test - Calculator	613
Essay Section	624
Answer Key: Reading Test	626
Answer Key: Writing and Language Test	638
Answer Key: Math Test - No Calculator	649
Answer Key: Math Test - Calculator	654
Scoring Your Full-Length SAT Practice Test	665



How to Use This Book

Welcome to Varsity Tutors' *2016 New SAT Study Guide: Lessons, Strategies, and Diagnostic Tests*. We hope that you'll find the lessons contained herein useful for improving your scores on the new SAT, which can help you get into the college or university of your choice.

While you will find some advice for test-taking in this book, its primary focus is skills-based. In other words, if you can learn how to do the math or how to read passages effectively, just to name two specific examples, you'll do better on the test. Being able to apply your skills in a timely fashion is the main consideration in approaching the SAT as a test, but the skills you learn and use are broadly applicable, and will help you succeed in college. What that means for you is that we're not trying to sell you on a proprietary "method" or some made-up approach. This book is designed to teach you the skills you don't know and remind you of the skills you have, but may have forgotten.

This is an e-book, and the version of this book you are reading is a PDF, which is a feature-rich format. It may be available in other e-formats, like as an iBook or on Kindle, so be sure to check for availability on your preferred device.

In this book, you will find things that are familiar to you from other books, both of the physical and the electronic variety, but you may come across some features you haven't seen before. We're striving to push the electronic format in ways that are useful to you, our reader, while maintaining a recognizable and clean layout.

The first thing you might notice is that this book is heavily linked to itself. If you browse the Table of Contents, you'll see that its entries serve as active links that can get you to other parts of this book quickly and accurately. These links are not always perfectly obvious, so you should always try hovering your mouse over anything that might interest you, in order to see if you can click on it.

We have formatted links in a blue italicized font. Try clicking the following link:

[This is an example of a link. This link takes you back to the Table of Contents.](#)

As you go through this book, another thing you may notice are various blue boxes that prompt you to see the solutions to problems or give you a walkthrough of a reading passage. When you hover over these boxes, you'll see more text or graphics appear on the page in front of you. If you click on these buttons, you will make the text or graphics persistent, so you can scroll around the page as you will. If you want the text or graphics to disappear again, just click the button.

Incorrect answers are displayed with an "x" [X] next to them, so that you can immediately comprehend that they are answers to be avoided. Correct answers will appear with an arrow [→] next to them.

It's a big book, and there's a lot to cover: explore and have fun. We certainly had fun writing this for you!

- The Learning Tools Team



Introduction

The college admissions process is arduous at best, and at worst downright panic inducing. Heading up your academic profile—your grades, extracurriculars, personal statements—is one quantitative representation of your singular effort to compete against the national pool of students for a spot in a top university: your SAT score.

Unlike your GPA, which you have been building throughout your entire high school career, or your personal statement, which you likely spent hours crafting one line at a time to create a literary masterpiece, the SAT is a snapshot of your academic capabilities. You are given only a few hours to demonstrate the mental acuity you have developed over years of schooling.

Before continuing, take a deep breath. Yes, the SAT is a strong determinant in the evaluation of your college applications, but with proper preparation you can face the test with confidence. Learning the materials tested on the exam is only the first step to success. The following chapters will focus not only on rote knowledge but also on the application of academic principles to the question formats and presentations most common to the SAT exam.

Section Outline

The New SAT: New Content, New Format

- This section goes over the test’s new organization, providing detailed information about the changes that have been made to the test’s sections.
- It also introduces the new subscores—Words in Context, Command of Evidence, History/Social Science and Science—and explains exactly what questions are used when calculating them.

Scoring

- You may have heard that the revised SAT is reverting to the “old” scoring system, but more complex changes to it have also been made. This section provides a breakdown of how the revised SAT is scored.

The Essay

- The revised SAT’s optional Essay section is much different from the Essay section included on the old version of the exam. This section introduces you to the details of the new Essay section.

Testing Tips

- This section provides you with general tips on how to do your best on the revised SAT.



The New SAT: New Content, New Format

The SAT is designed to test critical thinking skills through practical application. What this means is that the professionals who design the test are constantly looking for the most realistic ways to present problems in order to mimic real-world applications and collegiate-level curricula.

The SAT has gone through many iterations, with the most recent modification going into effect in March of 2016. This version of the exam presents changes in both format and content.

Technical Changes in the March 2016 SAT

- No guessing penalty
- Scored out of 1600, with only two primary section scores: “Math” and “Evidence-Based Reading and Writing”
- Cross-sectional subscores for “Analysis of History/Social Science” and “Analysis of Science”
- Optional 50-minute Essay section at the end of the exam

Evidence-Based Reading and Writing Section

The Evidence-Based Reading and Writing section is a total of 96 passage-based questions, broken down into two tests: the Reading test and the Writing and Language test. Though each test is scored on a 40-point scale, resulting in two unique test scores, your combined performance on the two tests is used to produce the full section score for Evidence-Based Reading and Writing. This section is evenly weighted with the Math section, making it exactly half the weight of your final exam score. Each section is scored on a scale of 200 to 800.

While the Reading test and Writing and Language test each have their own themes and formats, the Evidence-Based Reading and Writing section has two primary focus areas, known as “Command of Evidence” and “Words in Context.” Questions related to “Command of Evidence” will require students to demonstrate reading comprehension skills and basic literary analysis to determine the relationships between passage concepts. In contrast, questions related to “Words in Context” will require students to draw on the thematic elements and stylistic construction of the given passage to determine relationships between word usage.

Aside from the change in exam construction—the innovation of the Evidence-Based Reading and Writing section—it is important to note the changes to individual question style in this section. Fill-in-the-blank questions from the obsolete SAT Reading section and stand-alone sentence corrections from the old SAT Writing section have been removed completely. All questions in the SAT Evidence-Based Reading and Writing section are passage-based. Questions on the Reading test require students to analyze passage concepts and compositional elements, while questions on the Writing and Language test will use a given passage as a baseline for critique and correction.



Math Section

Balancing the Evidence-Based Reading and Writing section of the SAT is the Math section. Each of these two sections is scored on a scale of 200 to 800, giving a maximum exam score of 1600. However, where the Evidence-Based Reading and Writing section draws results from both the SAT Reading test and the SAT Writing and Language test, the Math section draws only from the Math test. This means that the full section score is derived from only 58 questions, given over an 80-minute period.

The Math section is broken into four different format distinctions, based on two different timed subsections. Students are allocated 55 minutes to answer 38 questions with a calculator. Of these, 30 questions will be multiple-choice and 8 will be grid-in (free response). The final 20 questions of the Math test are given over 25 minutes without use of a calculator. 15 no-calculator questions are multiple-choice, while 5 are grid-in. The introduction of the no-calculator section is unique to SAT exams administered after March of 2016.

Math Section Format Breakdown

With Calculator	30 multiple-choice + 8 grid-in	55 minutes
Without Calculator	15 multiple-choice + 5 grid-in	25 minutes

While the format of the exam is divided between two primary domains (calculator and no-calculator), content coverage spans three primary disciplines, each resulting in a subscore. The content tested in the SAT Math test spans from general algebra and mathematical applications through advanced algebra and trigonometry. Most questions are presented as word problems or through formatted data, as opposed to simplistic equations to solve, and some set-ups may be used as reference material for multiple questions. The three content domains are “Heart of Algebra,” “Problem Solving and Data Analysis,” and “Passport to Advanced Math.” Questions that do not fall into any of these categories do appear on the test, but are not factored into a specific subscore. Such questions may address geometry, trigonometry, and complex numbers.



SAT Reading Test

The SAT Reading test is designed to evaluate proficiency in literary analysis and reading comprehension. Passages in this portion of the SAT cover a wide range of literary styles, as well as a multitude of different content areas, while questions focus on interpretation and inference based on the given prose.

SAT Reading Test Snapshot

- Part of Evidence-Based Reading and Writing section score (along with SAT Writing and Language)
- 52 questions (all passage-based)
- 65 minutes
- 4 stand-alone passages, 1 paired passage
- Question themes: Main idea, evidence, word meaning in context, authorial choice and style, interpretation of data (graphs, charts, tables)
- Content basis in literary analysis
- Involved subscores: Command of Evidence, Words in Context, Analysis in History/Social Science, Analysis in Science

Passages

- 1 Classical or Contemporary Literature
- 1 Historic Document or Speech (may be paired passage)
- 1 Social Science (may be paired passage)
- 2 Natural Science (may be paired passage)

The SAT Reading test consists of five passages, each with a distinct area of content coverage. There will be one excerpt of classical or contemporary literature, one excerpt of an historically relevant document or dictation, one passage related to social science (economics, psychology, sociology, etc.), and two passages related to natural sciences (biology, chemistry, case studies, etc.). One of the five given passages will be a paired passage, meaning that the given excerpt is divided between two separate sources and the questions address aspects of comparison and connection between the content of the two sources. Only one of the five passages will be a paired passage, and it will always be either the historical document, social science, or science passage; passages on classical literature will never be paired.

Questions about the passages fall into three general categories: Information and Ideas, Rhetoric and Passage Construction, and Synthesis. It is important to note that, while these distinctions can help shape your approach to a particular question, all questions on the SAT Reading test will be based in conceptual understanding, reading comprehension, and literary analysis. The SAT Reading test will never ask for grammatical corrections or critique of prose; these topics are addressed on the SAT Writing and Language test.



Questions involving Information and Ideas are related to the most classical definition of reading comprehension. These questions will ask test-takers to identify and analyze fundamental elements of the passage. In this book, we will address some of the most common types of questions in this area, such as those dealing with the passage main idea, thesis statement, and evidence presentation and application. Information and Ideas questions also ask students to demonstrate critical thinking skills, and may ask for a summary or conclusion based on a particular passage, paragraph, or sentence. The ability to paraphrase and draw meaning from passage details will help to approach these questions. Other questions may deal with analysis of conceptual relationships within a passage, such as cause and effect. These questions will require test-takers to interpret given information to draw conclusions about how various elements of the passage relate to one another. The final topic covered by Information and Ideas is inference. Questions may ask for test-takers to discern the meaning of a word based on the context of usage, especially for words used in unusual or metaphorical ways. Rarely will the word in question be used in an intuitive sense; the SAT does not test vocabulary, but rather the ability to use context clues to infer the meaning of the word in a particular instance. To perform well on Information and Ideas questions, students must feel confident in their ability to read quickly, draw conclusions based on the presented material, and apply those conclusions to the presented questions.

The second type of SAT Reading question deals with Rhetoric and Passage Construction. In the most basic sense, these questions deal with the effectiveness of language use and organization. In contrast to Information and Ideas questions—which deal with what content is presented—Rhetoric and Passage Construction questions deal with how content is presented. Questions in this area may ask about the purpose of a particular statement in the context of the passage, the tone or style of the passage, or the author’s choices in organizing the text. When dealing with Rhetoric and Passage Construction it is important not to lose the reference point of what is being said, as the content of the passage plays a critical role in shaping appropriate presentation. Questions will require test-takers to draw inferences about the author’s intent and choices based on content presentation and organization, requiring a critical eye to critique the efficacy of content placement in the passage. While identifying a piece of evidence in the passage may not be too difficult, establishing the author’s purpose in presenting that particular piece of evidence in a particular sequence in a passage can be more elusive. Mastering Rhetoric and Passage Construction questions requires students to look beyond the information presented and think critically about the methodology of the author.

The final type of question on the SAT Reading test is Synthesis. Though perhaps the easiest genre of question to recognize on the SAT Reading test—Synthesis questions will deal with paired passages or data interpretation—these questions are also commonly considered the hardest. Synthesis refers to the generation of a new idea based on given evidence. In essence, Synthesis questions require you to come up with new ideas or conclusions based on available information. This concept goes far beyond simple identification (as tested in Information and Ideas) or analysis (as tested in Rhetoric and Passage Construction); rather, Synthesis requires you to apply the concepts you’ve previously identified and analyzed in order to generate a whole new conclusion. Questions dealing with paired passages will focus on the relationship between two passages that are only tangentially related, requiring test-takers to develop their own theories about how the authors might have interacted or considered each other’s writings. Questions dealing with data interpretation will require students to draw conclusions based on data trends



by analyzing graphs, charts, and tables to develop theories about the topics at hand. In each case, you will be expected to discern information that is not readily apparent from the passage alone, which requires a great deal of critical evaluation to discover. To score well on Synthesis questions, students must review fundamental concepts in both literary analysis and basic scientific interpretation. These questions will equally value skills in both comparative literature and graphical analysis.

Tips for SAT Reading

- Underline, circle, and star important parts of the passage as you read
- Peek at questions that reference a specific line or passage excerpt, and mark that line in the passage
- Write short summaries for each paragraph or section of the passage
- Draw arrows to show trends on tables or charts
- Use the main idea or thesis of a passage to help give context for answering questions



SAT Writing and Language Test

The SAT Writing and Language test is built to evaluate student aptitude for writing, editing, and improving texts. Rather than identifying relationships and drawing conclusions about the content of a passage, the Writing and Language test asks students to evaluate the passage with a critical eye for improvement. Questions present students with a passage excerpt or point of reference and ask for potential areas of modification that would better present the information in the passage.

SAT Writing and Language Snapshot

- Part of Evidence-Based Reading and Writing section score (along with SAT Reading)
- 44 questions (all passage-based)
- 35 minutes
- 4 passages
- Question themes: Enhancing clarity of ideas, improving organization of information, correcting errors in grammar and syntax, evaluating word usage in context
- Content basis in literary review—corrections in passage syntax, grammar, clarity, and organization
- Involved subscores: Expression of Ideas (Writing test only), Standard English Conventions (Writing test only), Command of Evidence, Words in Context, Analysis in History/Social Science, Analysis in Science

Each of the four Writing and Language passages will be paired with 11 questions, spaced throughout the passage to address specific areas potentially in need of improvement. Most questions will reference an underlined portion of text, requiring you to either identify or correct an error in the underlined selection. The errors contained in the passage will be placed intentionally for use in the exam. Errors will fall into two primary classifications: Expression of Ideas and Standard English Conventions. Each of these two classifications is associated with a test subscore.

Questions that address Expression of Ideas will focus on identifying and improving errors in clarity and presentation of information in the passage. These questions will not necessarily address errors in grammar or language use, but will rather draw on the test-taker's ability to identify and correct inconsistencies in context. Corrections regarding Expression of Ideas will help to strengthen the argument made in the passage and the clarity with which the information is presented. Topics addressed may include the passage thesis, presentation and relevance of evidence, structure and organization of passage ideas, and the effectiveness and consistency of stylistic elements. Expression of Ideas questions will frequently ask for the modification, addition, or removal of full sentences and larger excerpts; questions in this category will rarely address single words. Additionally, this subscore will cover the application of data analysis within prose passages. Certain questions may require test-takers to evaluate the use of quantitative evidence within a passage, deciding on the best use of presented data in building the



effectiveness of a given argument. Preparing for the Expression of Ideas questions on the SAT Writing and Language test can be particularly difficult, as most questions address stylistic elements that may appear more abstract than other concepts tested on the exam. Good preparation will help you instinctively notice discrepancies in passage construction and presentation of information based on key features, such as disagreement in presented content or disruption in compositional flow.

In contrast to Expression of Ideas, questions related to Standard English Conventions will generally involve identification and/or modification of a single word or phrase within the context of a sentence. These questions are designed to test knowledge and application of English grammar and composition skills. Sentence structure and word choice are common areas of focus, with questions addressing both syntax and word usage. Errors in clause dependency, punctuation, word agreement, pronoun choice, and verb conjugation are all commonly tested. Studying for these questions involves simple review of fundamental writing conventions, with special attention to commonly overlooked conventions of sentence construction. Many English classes will teach a degree of creative license, encouraging students to experiment with the English language. For the SAT Writing and Language test, it is best to leave behind any unconventional habits that may have arisen during your compositional experience in order to focus on the strictest interpretation of standard English.

Tips for SAT Writing and Language

- Use the context of passage content to provide clues for selecting the best answer, especially when making content-based modifications
- Break down sentences into clauses, phrases, or segments to better identify disconnection or errors in agreement
- Read aloud when you study to practice identifying errors that may be evident when verbalizing a passage and to help build intuitive recognition skills
- Don't be afraid to select the "NO CHANGE" answer option. Not every question will contain an error!



SAT Math Test

The primary objective of the SAT Math test goes beyond simply assessing proficiency in mathematics. Instead, the exam is designed to evaluate preparedness for realistic applications of mathematical principles. In accordance with this goal, most questions on the SAT Math test will be presented as the application of a math principle within a greater context. Word problems and data interpretation questions are abundant, as these serve as the most practical source of realistic scenarios.

The administration of the SAT Math test is divided between two periods. The first period will allow for the use of a calculator; the second period will not. Each period will contain a combination of both multiple-choice and grid-in response questions.

Math Section Format Breakdown

With Calculator	30 multiple-choice + 8 grid-in	55 minutes
Without Calculator	15 multiple-choice + 5 grid-in	25 minutes

Multiple-choice questions present a question stem with four available answer options. Grid-in questions present a question stem with a gridded answer input, allowing students to freely write in their calculated responses. While the format for the SAT Math test may seem a bit complex, mastering the presentation of the materials is simply a matter of building confidence with the exam and learning to excel within the time periods allocated. In this instance, practice absolutely makes perfect.

The content covered on the SAT Math test can be broken into four general categories, loosely corresponding to three subscores. Questions for the “Heart of Algebra” subscore address content that would generally be covered in Algebra 1, such as linear functions and graphs. “Problem Solving and Data Analysis” questions involve more complex questions stems, frequently requiring basic statistical applications and graphical interpretations. Questions related to the “Passport to Advanced Math” subscore address concepts from Algebra 2 coursework, such as quadratic functions and polynomials. The final category of questions, “Additional Topics in Math,” is not associated with a subscore. These questions cover plane geometry, trigonometry, and complex numbers.

SAT Math Content

Classification	Heart of Algebra	Problem Solving and Data Interpretation	Passport to Advanced Math	Additional Topics in Math*
Questions with Calculator	11	17	7	3
Questions with No Calculator	8	0	9	3
Total Questions	19	17	16	6

*Additional Topics in Math does not have an associated subscore



Questions lent to the Heart of Algebra subscore are the most abundant on the SAT Math test, but are also the most focused. These 19 questions are heavily centered on linear relationships and properties of linear graphs. Many questions present a word problem or scenario, requiring test-takers to apply their knowledge of linear relationships to model the scenario and solve for a given variable. Common topics include determining a mathematical model of a given word problem, solving for a variable, solving systems of equations, inequalities, and absolute values. Other questions will deal with graphical analyses, presenting either a graph or an equation and asking for properties such as the slope or points of axial intercept. Students should be prepared to both generate graphs based on given equations and to reverse-engineer equations based on given graphs. Similarly, the SAT Math test will test your ability to determine a linear expression based on a word problem, as well as your skill to identify the significance of variables in a given equation based on a specific context. Being able to quickly shift focus between qualitative description of variable quantities and quantitative analysis of data is a critical skill in practical mathematical applications, and is thus widely addressed on the SAT.

The questions encompassed by the Problem Solving and Data Analysis subscore are generally recognizable based on problem set-up. These 17 questions deal with data distributions and statistical significance. Following the format of most questions on the SAT Math test, Problem Solving and Data Analysis questions are generally derived from word problems, tables, and scenario-based set-ups. Since these concepts are strongly rooted in statistics and data metrics, virtually all questions in this subscore deal with given sets of data. Whether the information is presented in a word problem, table, bar graph, or pie chart, questions will almost always deal with relationships between given values in a set. Common topics involve ratios; probability; mean, median, and mode; and calculations with realistic units. Questions may deal with units in currency or time, as well as standard numerical quantities. The emphasis on real-world applicability evident in the SAT Math test yields questions dealing with pricing of items during a sale, ratios of items or people in a group, basic statistical analyses of case studies, and other similar practical scenarios; be prepared to address these types of analysis in a larger context. Additionally, all questions for the Problem Solving and Data Analysis subscore are given during the calculator portion of the SAT Math test. This signifies that the questions are dealing more with application and comprehension of the presented scenarios than with the calculations themselves. To prepare for the Problem Solving and Data Analysis questions on the exam, practice identifying links between qualitative descriptions and quantitative applications, as well as your ability to interpret graphs, tables, and data sets. While studying the calculations used to derive basic statistical properties will be tested, the focus of this subscore is on analytical and critical thinking in a mathematical context.

The final subscore on the SAT Math test is Passport to Advanced Math. These questions primarily address content that would be covered in a standard high school Algebra 2 class—namely quadratic functions, polynomials, rational expressions, and exponent manipulations. Though the heavy emphasis of the exam on application of skills—beyond simple comprehension—lends itself to a proclivity for word problems, the Passport to Advanced Math questions frequently address concepts that are very difficult to articulate in qualitative formats. Thus, these questions have a tendency to break the mold and appear on the exam in discrete format, with a simple equation presentation and directive to simplify, expand, or solve. The word problems that do appear for these questions will generally address exponential functions and parabolic graphs, frequently playing into the subscores for Science and History/Social Science with topics such as exponential



growth/decay in biological and financial calculations. Solving questions for Passport to Advanced Math requires a strong comprehension relationships between exponents and rational expressions, as well as the ability to factor polynomials. Many of the questions related to this subscore will require you to solve for a given variable, solve using a given value, simplify, or simply rewrite or factor a given expression or equation. To properly perform these manipulations, it is essential to recognize instances where variables can be combined, canceled, or simplified. Reducing a radical expression or applying the rules of exponents can make calculations markedly simpler and more efficient, even for questions that allow the use of a calculator. To prepare for questions related to the Passport to Advanced Math subscore, practice manipulating and restructuring equations that deal with exponents, radicals, and rational expressions. Polynomials can be intimidating, but being able to recognize patterns in their construction can help you to speed through complex questions more easily.



Scoring

Scoring on the SAT can be broken down into three main tiers: section scores, test scores, and subscores. Each division is derived from performance on specific parts of the exam and is scored on a particular scale.

Section Scores

- Scale: 200-800
- Number of section scores: 2
- Evidence-Based Reading and Writing: 96 questions from the Reading test and Writing and Language test
- Math: 54 questions from the Math test

Section scores are the most general scores on the exam, and are also the most impactful. There are only two section scores. The first section score is Evidence-Based Reading and Writing, which is derived from performance on the SAT Reading and the SAT Writing and Language tests. The second section score is Math, which is based on performance on the SAT Math test. Each section is scored on a scale of 200 to 800. The sum of the two section scores determines your final exam score on a 400–1600 scale.

Test Scores

- Scale: 10–40
- Number of test scores: 5
- Reading: 52 questions from SAT Reading test
- Writing and Language: 44 questions from SAT Writing and Language test
- Math: 58 questions from SAT Math test
- Analysis in History/Social Science: 21 questions from Reading, 6 questions from Writing and Language, 8 questions from Math
- Analysis in Science: 21 questions in Reading, 6 questions from Writing and Language, 8 questions from Math

One tier below section scores are test scores. There are two different types of test scores. Three test scores correspond to the three test sections on the exam: Reading, Writing and Language, and Math. Two additional test scores are derived from specific questions that span all three tests. These are known as “cross-test” scores. The two cross-test scores are Analysis in History/Social Science and Analysis in Science. The five test scores are each scored on a 10–40 point scale.

Scores for these last two categories come from questions relating to various social or scientific concepts that appear in each test on the exam. For example, an SAT Math question that deals with exponential growth of a population of birds in a forest may also



be incorporated into the Analysis in Science test score. Common topics covered by the Analysis in History/Social Science score include US history, world history, psychology, sociology, finance, and economics. Commonly tested topics for the Analysis in Science score include biology, chemistry, physics, and case studies. Questions for the cross-test scores will pertain to passages and context related to these specific content areas, but will not require any conceptual knowledge. Rather, cross-test questions are designed to test the application of critical thinking skills to complex, real-world contexts in the natural and social sciences.

Contributions of each test toward the cross-test scores are broken down based on very specific distributions. The SAT Reading test will contain one passage about a historical document or speech and one passage about a social science topic. All questions from these two passages (21 questions total) contribute to the Analysis in History/Social Science score. Similarly, the SAT Reading test will contain two science-based passages; all questions from these passages (21 total) will contribute to the Analysis in Science score. The SAT Writing test will address cross-test scores only through questions classified as “Expression of Ideas.” Six questions from the SAT Writing test are allocated to each of the two cross-test scores; all of these will address fundamental editing concepts and principles of clarity and expression in writing (as opposed to grammatical construction and syntax). The Expression of Ideas subscore is addressed in further detail in the next section (titled Subscores). The SAT Math test provides eight questions for each cross-test score. These questions will be distributed throughout the Math test and will be distinguishable only by context and content presented in the question. Generally speaking, cross-test questions on the SAT Math test will be word problems.

Subscores

- Scale: 1–15
- Number of subscores: 7
- Expression of Ideas: 24 questions from SAT Writing and Language
- Standard English Conventions: 20 questions from SAT Writing and Language
- Heart of Algebra: 19 questions from SAT Math
- Problem Solving and Data Analysis: 17 questions from SAT Math
- Passport to Advanced Math: 16 questions from SAT Math
- Words in Context: 10 questions from SAT Reading, 8 questions from SAT Writing and Language
- Command of Evidence: 10 questions from SAT Reading, 8 questions from SAT Writing and Language

The seven subscores on the SAT are built to provide fine-tuned assessment of skill in particular areas. Two subscores are specific to skills tested on the Writing and Language test, while three subscores are specific to the Math test. The final two subscores, Words in Context and Command of Evidence, are derived from a series of questions spanning both the Reading test and the Writing and Language test. All subscores are scored on a scale of 1 to 15.



The Expression of Ideas subscore is meant to assess test-takers' ability to communicate effectively. Questions for this score will present passage excerpts from the Writing and Language test and require students to restructure, rewrite, or reinterpret the given text to help clarify the intended meaning of the selection. Rather than dealing with conventional grammar and word usage, these questions will require a more analytical approach. Students should be prepared to address excerpts that present muddled or conflicting ideas, and to modify the selections in order to clearly convey a consistent tone, purpose, and argument throughout the passage as a whole.

In contrast, questions for the Standard English Conventions subscore deal with minutiae more than with message. Intentional errors in English grammar and usage will be incorporated into passages in the Writing and Language test, with specific questions asking for the appropriate correction to the given selection. These questions frequently deal with word choice, syntax, punctuation, verb conjugation, and various forms of agreement in sentence construction. Performance on this subscore is highly dependent on the student's knowledge of grammatical practices and ability to quickly and accurately identify misuse of the English language.

The subscores incorporated into the SAT Math test are generally very straightforward. The Heart of Algebra subscore deals primarily with linear expressions, functions, and graphs. Generally, these topics will pertain to material covered in a standard Algebra 1 class in the high school curriculum. Questions may ask about linear inequalities, absolute value, evaluating expressions, systems of linear equations, the relationships between linear functions and graphs, and the properties of linear graphs (e.g. slope, axial intercepts, etc.). Oftentimes, these questions will be paired with short set-up scenarios to provide a real-world context for the calculations and variables. In most cases, variables will be representative of objects, currency, time, or other practical quantities.

The Problem Solving and Data Analysis subscore takes this idea of practical applicability one step further by introducing data sets under the pretext of statistical analysis and interpretation. Virtually all questions related to this subscore will rely on given tables, charts, graphs, or word problems and many questions will be cross-evaluated in the Analysis of History/Social Science and Analysis of Science test scores. Common topics tested by these questions related to probability, data distribution, and data representation. Students may be asked to identify correct correlations between quantitative figures and qualitative descriptions or to evaluate the properties of a given data set, such as the mean, median, and mode.

The third subscore rooted in the SAT Math test is Passport to Advanced Math, which covers a wide range of topics that would generally be presented in an Algebra 2 or Advanced Algebra course. Most prominently, these questions address quadratic functions and polynomials, as well as rational expressions, exponent manipulation, and radicals. Word problems are scarcer in this subscore and, when present, tend to be of higher complexity in order to deal with realistic presentations of higher level mathematical applications, such as exponential modeling. Students should be familiar with the rules governing exponents, as well as principles of factoring polynomials and the quadratic formula. Many questions in this subscore will ask for expansion, simplification, or reorganization of an expression; common directives include "reduce," "simplify," and "factor" as opposed to the more straightforward "solve."



Perhaps the most confusing subscores are those that span multiple test areas. The Words in Context and Command of Evidence subscores are derived from a subset of questions from both the Reading test and the Writing and Language test.

Questions used for the Words in Context subscore deal with the relevance and use of language. The Reading test evaluates through interpretation and evaluation, while the Writing and Language test focuses more on effectiveness. In both cases, it is important to consider the targeted word within the greater context of its usage in the passage as a whole. Questions from the Reading test will ask for definition, purpose, and effect of the word in context. It is important not to be fooled by conjecture and to instead look closely at how the given word is incorporated into the passage; colloquial and metaphorical uses can heavily influence the perceived meaning or effect of a word. For questions from the Writing and Language test, words or phrases may be put under scrutiny for their failure to align with the message or tone conveyed in the remainder of the passage. Questions will require students to make corrections, selecting replacements that produce more effective and consistent communication within the passage.

The Command of Evidence subscore addresses students' ability to draw conclusions from presented evidence and, conversely, to identify evidence that is not conducive to a given conclusion. Questions from the Reading test will be heavily rooted in analytical thought, requiring students to demonstrate a comprehension of the conclusions presented in a passage and the relationship between the conclusions and their supporting foundations. This includes the identification of evidence in a passage, as well as an evaluation of its effectiveness and relevance. Some evidence may be textual, while other supporting statements may rely on interpretation of a table, graph, or chart. Students should be prepared to glean information from these quantitative sources, as well as from traditionally tested literary analysis. Questions dealing with Command of Evidence on the Writing and Language test may also address quantitative interpretation, requiring test-takers to properly identify misrepresented data or to make corrections to claims based off of tables, graphs, and charts. Other Writing questions for this subscore may deal with building a stronger foundation for an argument, removal of conflicting data or viewpoints, or introduction of additional evidence to enhance a claim.



The Structure of the New SAT

Evidence-Based Reading and Writing Section		Math Section
Reading Test 52 Questions	Writing and Language Test 44 Questions	Math Test 58 Questions
Analysis in History/Social Science (Cross-Test)		
21 Questions	6 Questions	8 Questions
Analysis in Science (Cross-Test)		
21 Questions	6 Questions	8 Questions
Words in Context Subscore		Heart of Algebra Subscore
10 Questions	8 Questions	19 Questions
Command of Evidence Subscore		Problem Solving and Data Analysis Subscore
10 Questions	8 Questions	17 Questions
Expression of Ideas Subscore		Passport to Advanced Math Subscore
24 Questions		16 Questions
Standard English Conventions Subscore		Additional Topics in Math
20 Questions		6 Questions (NOT a Subscore)



The Essay

Quite separate from the discussion of the exam we have had thus far is the SAT Essay. Unlike past iterations of the exam, the current version of the SAT presents the Essay section as an optional element. Adding the Essay section to your exam will cost an additional \$11.50 and extend your total testing time by 50 minutes, for a total test duration of 3 hours and 50 minutes. The Essay section will be the final portion of the exam, following the Math section.

The choice to take the SAT Essay is dependent on a variety of factors. Though a shorter exam experience may be enticing, it is important to take a moment to consider whether or not the essay may be a beneficial addition to your test score. While many universities are listed as having no preference regarding the inclusion of an essay score for undergraduate applications, some academic institutions highly recommend or require the essay section when reviewing standardized test scores. Carefully review the list of schools you are considering before choosing to exclude the Essay section from your SAT registration, or you could find yourself lacking the admissions requirements necessary to apply. Additionally, many colleges accept certain exam scores in lieu of general education (GE) courses. A high score on the SAT Essay section can be used as credit for an undergraduate writing course at some universities. Again, it is important to research the policies of the individual institutions to which you intend to apply in order to ascertain if the Essay section may benefit your college application and admissions experience.

SAT Essay Snapshot

- Optional exam section (must be selected during registration)
- Entirely separate from rest of exam scores and structure
- 1 passage-based essay prompt
- 50 minutes
- Reading score, Analysis score, and Writing score (all separate from rest of exam)
- Each score based on two reviews with rubric of 1 (low) to 4 (high) per score. Two reviews summed for total scale of 2 to 8 per score area.

Passage and Prompt

The SAT Essay prompt is very specifically structured. Aside from testing compositional ability—authorial voice, spelling and grammar conventions, argument construction, etc.—the prompt is designed to evaluate your ability to recognize and evaluate the compositional ability and writing tactics employed by other authors. The prompt will challenge you to write an analytical essay, as opposed to a persuasive/argumentative piece. This means that you will be expected to deliver a critical essay grounded in fact and observation, as opposed to an opinion-based argument directing readers toward a specific conclusion.



The presentation of the Essay will be a passage followed by a prompt, directing you to write a response to the given text. The passage accompanying the prompt will be a 650 to 750 word persuasive passage, with a clear main point and evidence to support a position or claim, followed by a prompt directing students to critically evaluate the author's choices in presenting the argument in the passage. The passage will follow a typical persuasive structure, presenting some sort of claim with a wide variety of supporting evidence and corollary conclusions.

Unlike some standardized exams, where the prompt varies by test date and version, the SAT Essay prompt will always be the same:

“As you read the passage below, consider how [the author] uses

- evidence, such as facts or examples, to support claims.
- reasoning to develop ideas and to connect claims and evidence.
- stylistic or persuasive elements, such as word choice or appeals to emotion, to add power to the ideas expressed.

[650–750 word passage]

Write an essay in which you explain how [the author] builds an argument to persuade [his/her] audience that [author's claim]. In your essay, analyze how [the author] uses one or more of the features listed above (or features of your own choice) to strengthen the logic and persuasiveness of [his/her] argument. Be sure that your analysis focuses on the most relevant features of the passage. Your essay should not explain whether you agree with [the author's] claims, but rather explain how the author builds an argument to persuade [his/her] audience.”

As you can see, the prompt is heavily rooted in the accompanying passage, with the bulk of the essay content being derived from the presented text.

Essay Content and Approach

Developing a cohesive analytical essay requires a comprehensive understanding of the material provided to be analyzed. While traditional essay prompts tend to test your ability to express ideas and develop an argument through persuasive language, the SAT Essay relies on your ability to read critically and dissect the work of another author. To construct your essay, you will need to look closely at the presentation of the argument in front of you and pick apart the techniques employed by the author to support and strengthen their claim.

The essay prompt itself will present the main purpose or thesis of the given passage. In this sense, you will already have a head start: you know the main claim, and do not need to search the passage to determine the purpose. The crux, of course, is finding the strengths and flaws in the author's presentation of the claim. It is important to note that the argument itself is relatively irrelevant to your essay; you will not be asked to present your stance on the claim being made, nor will you be asked to present a rebuttal or subjective analysis of any sort. Instead, you must work with the materials given to determine how the argument is presented and why the author made certain stylistic choices.



When approaching the essay, the passage accompanying the prompt will be the source of all claims and evidence presented in your response. You will not need to introduce any new material. Instead, you will be expected to provide direct citation, quotation, and reference from the given selection. These direct pieces of evidence will be used to construct your analysis of how the author builds his/her argument and the effectiveness of the support used to back his or her claim.

Since the passage is the source of virtually all material relevant to your essay, it is important to take the time to carefully read and annotate the given text. With a full 50 minutes to complete the essay, there is ample time to underline, circle, summarize, and reread the given passage. Keep in mind that you will be looking for the use of evidence, reasoning, and style to further the author's argument. While tracking the development of content throughout the passage may be beneficial for your reading comprehension, tracking the introduction of new material and the presentation of logical reasoning is more in line with the final essay prompt. It is important to approach the essay with the intention of looking beyond what an author is saying, and to instead focus on how the argument is constructed and why certain stylistic choices were made.

Review and Scoring

The scoring for the SAT Essay is divided into three areas: Reading, Analysis, and Writing. These scores are entirely separate from the rest of the exam; the Essay Reading score, for example, is in no way linked to the SAT Reading test score.

The essay is graded by two reviewers, each giving their own independent assessment and scores of your writing. Each of the three focuses is given marks from 1 to 4, with 1 representing the lowest score and 4 representing the highest. The scores from each of the two reviewers are summed per focus area, but there is no combining of scores between focuses. In essence, this means that the essay is scored on a scale 2–8 for each of the three focuses: Reading, Analysis, and Writing.

The Essay Reading score is primarily based on basic understanding and interpretation of the passage presented. Reviewers look for comprehension and accurate paraphrase to determine your ability to effectively interact with the given text. Much of this score is rooted in objective review, ensuring that the evidence used from the text is accurately presented and does not contradict the explicit or implicit contexts of the passage. Additionally, this score takes into account your ability to parse out relevant quotations and references to use within your essay. The Essay Reading score seeks to assess your ability to interact with the given text, encompassing reading comprehension on both a general level (summary and paraphrase) and a direct level (quotation selection and recognition of evidence).

The Essay Analysis score is designed to bridge the gap between reading comprehension and critical thinking. This section requires that test-takers look beyond the simple presentation of information in the passage, and think critically about the purpose, goal, and authorial voice behind the inclusion of passage elements. Where the Reading score evaluates your most basic interaction with the given text, the Analysis score looks at your ability to critically review the text beyond its face value. This score should be directly linked to the content you present in your essay. Since the prompt asks for an in-depth analysis of the evidence presented in the passage, be prepared to construct an argument



rooted in attributions made about the author. The key to analyzing the passage is to build analysis that extends beyond simply what is presented in the passage as argument and evidence, and to look at why and how the author made unique choices about the passage content and construction. This is the critical element that separates the Reading score from the Analysis score (and a good analytical essay from a bad one!).

The Essay Writing score is perhaps the most self-explanatory of the three: it is the primary method of evaluation for your writing and compositional capabilities. The Writing score focuses on the structural elements of your essay and your rhetorical choices. A strong score in this area indicates a competent command of the English language and ability to formulate coherency in your writing. Reviewers will look for variability in sentence structure and vocabulary, fluency in grammar and spelling, and logical flow of ideas and constructions throughout the essay. To help scorers in this area, it is essential to present a cohesive layout for your essay: make your thesis statement and topic sentences easily identifiable, construct one paragraph per topic, and clearly identify the evidence you are pulling from the passage for each argument you make.



Testing Tips

Preparing to take the SAT is not an easy process. There are no shortcuts, and there is no singular secret to achieving a top score. To reach your target result, it is important to start studying early and to dedicate a great deal of time and energy toward your studies. However, just as important as recognizing the need for preparation is knowing how to properly prepare. The purpose of this book is to help you structure your study time in order to maximize the efficiency of the time you invest.

Before we delve into our lessons on the SAT content, take a moment to review these study tips and good practices for SAT exam review.

Exam Preparation

Materials: Make sure all of your preparation materials are for the correct version of the SAT exam. The SAT has gone through several changes over the years; don't get caught with the wrong materials!

Format: Studying the exam format is just as important as studying the exam content. Take the time to learn the different types of questions on the exam, and to practice techniques for each one.

Content: Revisit all content areas on the exam. Even if you think you remember a concept perfectly, it is important to make sure your skills translate well to the presentation of the questions on the exam. It never hurts to double check that your recognition of a concept matches your application of that concept to the exam format.

Study Plan: Build a study schedule that prioritizes review of problem areas. Don't waste too much time addressing areas in which you feel confident. Not all topics will need equal coverage; weight your study plan toward the topics that give you the most trouble.

Practice: Take practice tests. The SAT is probably going to be the longest exam you have taken up to this point. At 3 hours (or 3 hours and 50 minutes with the Essay), it can be rather overwhelming. It takes practice to maintain focus for that duration. Additionally, practice exams will help you build confidence with the exam structure, time limits, and question formats. It may seem like a challenge to find the time or energy for these practice exams, but that's the point! The exam is hard. Don't be left feeling unprepared on exam day.

Taking the SAT

Guessing: There is no guessing penalty on the SAT exam, so it is always best to answer every question, even if you have to guess.

Timing: Keep an eye on the time, but do not obsess. Some questions will take longer than others, and that's okay. When you find yourself feeling "stuck" on a question, though, know when to let it go.

Skipping Questions: It is okay to skip questions and return to them later, but always mark an answer option as a guess in case you run out of time. Remember, there is no penalty for guessing. Leave a faint pencil mark on your answer sheet or fold down the



corner of your testing book to mark the questions that need to be revisited.

Review: If you find yourself with a few extra minutes, take the time to revisit questions that you could not solve. However, do not revisit questions you answered with certainty. You don't want to overthink the question or second-guess yourself.

Draw, Mark, Annotate: Don't be afraid to mark up your testing book! Show your work so that you can revisit a question and pick up where you left off. Circle and underline passage excerpts so you know where to look for information. Write notes to yourself so you can follow your thoughts if you have a chance to come back to a specific question.

Trust Yourself: The day of the exam marks the culmination of your study efforts. All the time and energy you've invested will not yield zero results. Trust that you have developed the tools to succeed on the exam.

Mindset and Test Anxiety

Build Your Confidence: Comfort and confidence go hand in hand during preparation. Taking practice exams and developing comfort with the exam format will help you tackle the exam with confidence on test day.

Maintain Your Confidence: During the exam, focus on the concepts that you know. It is okay to skip questions and/or guess, and some questions will be harder than others. Focus on what you do know, rather than what you do not, and always keep moving forward on the exam. Each page will hold new opportunities to score points.

Leave It All Behind: When you walk out of the testing room, take a deep breath. Hold it in. Then let it go. There is no use stressing over an exam once you have turned it in.

Keep it in Perspective: The SAT is a snapshot of your academic preparedness for college, but it is not the only factor under consideration for college admissions. It is not the most important factor in determining your value as a student. Do not let it define your time commitments or self-concept. At the end of the day, it's only a test.

Test preparation is a stressful process, but equipping yourself with the right tools and study schedule can make the whole endeavor much less strenuous. The ensuing pages will provide you with a plethora of lessons, tutorials, walkthroughs, and practice problems to help you prepare and build confidence with the exam materials, both in content and in presentation. By dedicating the time and energy to gain familiarity with these materials and concepts, you can augment your classroom education with a targeted review of the SAT exam to be best-prepared on exam day.

Best of luck!



The SAT Reading Test

The purpose of the SAT Reading test is to establish proficiency in reading comprehension, literary analysis, and critical thinking in relation to a given text. The test is comprised of 52 passage-based questions, with a time limit of 65 minutes. Each question on this section of the exam will loosely fall into one of two categories: Information and Ideas or Rhetoric and Passage Construction. While these two classifications do not correlate to specific subscores on the exam, it can still be very useful to identify the general purpose behind each question being asked—namely whether it is dealing with authorial intent and context or whether it is dealing with construction and organization of the passage. The vast majority of questions on the Reading test will relate to the authorial purpose, argument, use of evidence, and compositional style.

There will be five passage presentations on the SAT Reading test: four single passages and one paired passage. The content of the passages will be highly structured. One passage will be an excerpt of classical literature; one passage will relate to social science (psychology, economics, behavioral science, etc.); one passage will be an excerpt from an historical document or dissertation; and two passages will be related to scientific material (biology, chemistry, physics, etc.). Each passage will be 500 to 750 words in length.

The practical skills tested on the SAT Reading test are tightly linked to close reading of literary works. You will be expected to closely examine the given texts, and to derive the meaning and primary argument or purpose of the passage. Beyond this cursory analysis, you will be expected to analyze how the argument is conveyed, identifying and inspecting the given evidence and supporting information presented by the author. The following pages will detail the different types of questions you can expect to see on this portion of the exam, as well as strategies, skills, and tips for how to perform your best on the SAT Reading test.

Review: SAT Reading

- This section goes over the test's new organization, providing detailed information about the changes that have been made to the test's sections.

Information and Ideas

- This section goes over the test's new organization, providing detailed information about the changes that have been made to the test's sections.

Rhetoric and Passage Construction

- This section goes over the test's new organization, providing detailed information about the changes that have been made to the test's sections.

Synthesis

- This section goes over the test's new organization, providing detailed information about the changes that have been made to the test's sections.



Review: SAT Reading

Before delving into the question types and classifications of the SAT Reading test, it is important to establish a grounded foundation in literary analysis. The SAT presents questions in a highly structured and nuanced context, with heavy restrictions on presentation and content coverage. However, the content addressed by the questions is rooted in the essential skill of purposeful reading. While you have likely had formal instruction in close reading and methods of parsing out messages from given texts, applying these techniques can be difficult in the time allotment for the SAT exam. The following review section is designed to provide a refresher of these functional concepts that may not be directly tested on the SAT Reading test, but are still considered critical elements to master the level of analytical skills necessary for the exam.

Section Outline

Review: Context, Connotation, Denotation, and Implication

- Connotation describes the feelings evoked by a word, while denotation describes its dictionary definition.
- An implication is a meaning that is implied indirectly by a word or phrase.

Review: Close Reading

- Close reading involves drawing evidence from a text in the form of direct quotations in order to support claims made about it.



Review: Context, Connotation, Denotation, and Implication

What's "Context"?

You may have heard the word “context” used before in phrases like “reading in context” or when someone is talking about a statement “taken out of context.” “Context” is just a fancy term for all of the information around the sentence, word, or grammatical item that you’re considering in a text. For instance, the word “blue” can refer to the color of the sky, or it can mean *sad and melancholy*. Both are completely valid meanings, so readers have to use context clues every time they see the word “blue” in order to figure out which meaning is being used in a given work. Consider the following sentence:

He was feeling blue and almost didn’t attend the party, which featured blue streamers.

This sentence uses both meanings of the word “blue,” but you can tell which is which by looking at what else is going on in the sentence—the “context.” The first use of “blue” is used in the context of someone’s emotion—the person being discussed is “feeling blue.” It doesn’t make sense for this use of “blue” to refer to a color, but it does make sense for it to refer to an emotion. This use of blue must mean *sad and melancholy*. As for the second use of blue, this one is referring to “blue streamers.” Streamers are inanimate objects that can’t feel emotions, so it doesn’t make sense for this use of blue to mean *sad and melancholy*. This use of “blue” must be referring to the color blue.

Understanding what clues the context of a term or sentence within a paragraph offers is a valuable skill on the SAT. On the SAT Reading test, contextual understanding is placed in the spotlight, but it also plays a role in certain questions on the SAT Writing and Language test—those which ask test-takers to consider entire passages and weigh the pros and cons of multiple potential adjustments to the text.

Connotation and Denotation

The meaning of a word can be defined in different ways; two of those ways are through its connotation(s) and its denotation. A word’s denotation is the meaning that you would expect to find if you looked it up in the dictionary; it’s denotation is what concrete idea it conveys. In contrast, a word’s connotations are the emotions or feelings it prompts in readers. Certain words can have near-identical denotations but differ wildly in the connotations they carry.

Words are often discussed in terms of having “positive” or “negative” connotations. For instance, consider the following words:

- To grace (a location) with one’s presence
- To visit
- To infest
- To plague

Each of these terms describes being in a location, but “to grace (a location) with one’s presence” has positive connotations about the person or thing in the location, whereas “to plague (a location)” has negative connotations. These connotations form part of the meaning of the word that can become the deciding factor when picking between two similar answer choices, so it’s important to be aware of these subtle shades of meaning.



You won't find much information about connotation in dictionaries, but if you've used a word before, you likely have all of the information you need about its connotation. Just consider the scenarios in which you would reach for that particular word—are they good situations or bad ones? You certainly wouldn't say “The cockroaches were gracing my apartment with their presence” unless you were purposely going against the grain of the phrase's connotation for a humorous effect. Similarly, you probably wouldn't say that your home was “infested with visiting friends and family,” or if you did, said friends and family might be offended if they heard you say that, because it characterizes them very negatively.

On the other hand, you could say that cockroaches were infesting your apartment or that a famous author or movie star was gracing your home with his or her presence. See how those connotations line up? In sum, if you're asked about the connotations of a term, take a moment to think about how you'd use that word in a sentence, and specifically what kind of emotions you'd be conveying in doing so.

Connotation may be at the core of certain SAT Writing and Language questions that ask you to pick out the best way to rephrase a specified word or phrase in the passage; similarly, connotation can play a large role in *SAT Reading questions* that ask you to characterize the rhetorical effects of specified excerpts. Distinguishing between terms based on their subtle connotations is a key skill tested on the SAT; being able to do so demonstrates a high-level grasp of the subtleties of language.

Implication

Sometimes, a sentence conveys more information than it directly states. This additional, “hidden” information is implied—strongly and indirectly suggested or necessary based on the sentence's logical claims. Consider the following paragraph:

I ran to school, but I still got soaked, and I even stepped in a giant puddle. Water was still squelching out of my sneakers by the time I got to my first class. If only I had brought an umbrella or worn waterproof boots!

Ok, pop quiz: what kind of weather has the speaker been experiencing? While the passage never directly states that it was raining, it is filled with information that implies that this is the case: the speaker got wet on the way to school despite running there, stepped in a giant puddle of water, and wishes that he or she would have brought an umbrella or waterproof boots. The speaker's statements wouldn't logically make sense if the weather were bright and sunny. Based on what is said, we can be very sure that it rained before the speaker got to school. The passage implies that before the speaker got to school, it rained.

Let's look at another sample passage. In this next one, try to figure out what is implied. What does the following conversation convey without anyone directly stating it?

Person 1: “Don't you want some of this ice cream cone?”

Person 2: “Doesn't it have peanuts in it?”

Person 1: “No, it's caramel pecan flavored, so it has pecans in it, not peanuts. It's really good!”



Person 2: "I'm sure it is, but I think I'll get a brownie instead."

Person 1: "I thought you loved caramels!"

Person 2: "I do! They're great! All the same, I think I'll get a brownie."

Person 2 is probably allergic to nuts. Did you pick up on that? Let's look at a play-by-play: when asked if he or she wants some ice cream, Person 2 responds with a question about whether there are nuts in the ice cream offered. That's clue number one. When told "it's really good," Person 2 agrees ("I'm sure it is"), yet still opts for a different dessert, even when it's revealed that he or she really likes caramel.

Let's look at one more example, this time a lengthier and far more subtle one. The following passage is chock-full of implied information, which is pointed out by the reading notes. Try reading it without the notes first to see what you pick up on, and then re-reading it, paying attention to the moments the notes emphasize.



Practice Passage

Adapted from “An Occurrence at Owl Creek Bridge” by Ambrose Bierce (1890)

Peyton Farquhar was a well-to-do planter, of an old and highly respected Alabama family. Being a planter and like other planters a politician, he was naturally an original secessionist and ardently devoted to the Southern cause. Circumstances of an imperious nature, which it is unnecessary to relate here, had prevented him from taking service with that gallant army which had fought the disastrous campaigns ending with the fall of Corinth, and he chafed under the inglorious restraint, longing for the release of his energies, the larger life of the soldier, the opportunity for distinction. That opportunity, he felt, would come, as it comes to all in wartime. Meanwhile he did what he could. No service was too humble for him to perform in the aid of the South, no adventure too perilous for him to undertake if consistent with the character of a civilian who was at heart a soldier, and who in good faith and without too much qualification assented to at least a part of the frankly villainous dictum that all is fair in love and war.

One evening while Farquhar and his wife were sitting on a rustic bench near the entrance to his grounds, a gray-clad soldier rode up to the gate and asked for a drink of water. Mrs. Farquhar was only too happy to serve him with her own white hands. While she was fetching the water, her husband approached the dusty horseman and inquired eagerly for news from the front.

“The Yanks are repairing the railroads,” said the man, “and are getting ready for another advance. They have reached the Owl Creek bridge, put it in order and built a stockade on the north bank. The commandant has issued an order, which is posted everywhere, declaring that any civilian caught interfering with the railroad, its bridges, tunnels, or trains will be summarily hanged. I saw the order.”

“How far is it to the Owl Creek bridge?” Farquhar asked.

“About thirty miles.”

“Is there no force on this side of the creek?”

“Only a picket post half a mile out, on the railroad, and a single sentinel at this end of the bridge.”

“Suppose a man—a civilian and student of hanging—should elude the picket post and perhaps get the better of the sentinel,” said Farquhar, smiling, “what could he accomplish?”

The soldier reflected. “I was there a month ago,” he replied. “I observed that the flood of last winter had lodged a great quantity of driftwood against the wooden pier at this end of the bridge. It is now dry and would burn like tinder.”

The lady had now brought the water, which the soldier drank. He thanked her ceremoniously, bowed to her husband and rode away. An hour later, after nightfall, he repassed the plantation, going northward in the direction from which he had come. He was a Federal scout.



Practice Passage

Adapted from “An Occurrence at Owl Creek Bridge” by Ambrose Bierce (1890)

Peyton Farquhar was a well-to-do planter, of an old and highly respected **Alabama** family. Being a planter and like other planters a politician, he was naturally **an original secessionist** and **ardently devoted to the Southern** cause. Circumstances of an imperious nature, which it is unnecessary to relate here, had prevented him from taking service with that gallant army which had fought the **disastrous campaigns** ending with the fall of Corinth, and he chafed under the inglorious restraint, longing for the release of his energies, the larger life of the soldier, the opportunity for distinction. That opportunity, he felt, would come, as it comes to all in wartime. Meanwhile he did what he could. **No service was too humble for him to perform in the aid of the South, no adventure too perilous for him to undertake if consistent with the character of a civilian who was at heart a soldier**, and who in good faith and without too much qualification assented to at least a part of the frankly villainous dictum that all is fair in love and war.

One evening while Farquhar and his wife were sitting on a rustic bench near the entrance to his grounds, **a gray-clad soldier** rode up to the gate and asked for a drink of water. Mrs. Farquhar was only too happy to serve him with her own white hands. While she was fetching the water, her husband approached the dusty horseman and inquired eagerly for news from the front.

“**The Yanks are repairing the railroads,**” said the man, “and are getting ready for another advance. **They have reached the Owl Creek bridge,** put it in order and built a stockade on the north bank. The commandant has issued an order, which is posted everywhere, declaring that **any civilian caught interfering with the railroad, its bridges, tunnels, or trains will be summarily hanged.** I saw the order.”

The passage starts by introducing a character. Through details and word choice, it gives readers enough details to realize that the story is set during the American Civil War and Farquhar supports the South.

This characterization tells us that Farquhar has helped the Southern cause even when faced with dangerous situations. Keep this in mind as you read the rest of the passage and consider what he might be planning.

History comes into play again, here: “the Yanks” are the Northern army. This army is repairing railroads at the Owl Creek bridge.

Anyone who messes with the railroads will be executed.

Historical context informs this point of the text. During the American Civil War, soldiers in the Southern army wore gray, whereas soldiers in the Northern army wore blue. This tells us that this man appears to be a Southern soldier.



Use the information the passage has provided to interpret Farquhar's responses. He's conveying much more than he's directly stating.

First, he asks how far it is to the bridge. Then, he confirms that it is unguarded.

"How far is it to the Owl Creek bridge?"

Farquhar asked.

"About thirty miles."

"Is there **no force** on this side of the creek?"

"Only a picket post half a mile out, on the railroad, and a single sentinel at this end of the bridge."

"Suppose a man—a civilian and student of hanging—should elude the picket post and perhaps get the better of the sentinel," said Farquhar, smiling, "what could he accomplish?"

The soldier reflected. "I was there a month ago," he replied. "I observed that the flood of last winter had lodged **a great quantity of driftwood against the wooden pier at this end of the bridge. It is now dry and would burn like tinder.**"

The lady had now brought the water, which the soldier drank. He thanked her ceremoniously, bowed to her husband and rode away. An hour later, after nightfall, he repassed the plantation, going northward in the direction from which he had come. **He was a Federal scout.**

The soldier lets Farquhar know that the bridge could be lit on fire very easily because of some piled-up dry firewood.

After asking the soldier about the bridge, Farquhar asks what a hypothetical civilian wanting to help the Southern cause could accomplish. Does this figure sound familiar? Farquhar is indirectly asking what *he* could accomplish.

This line is perhaps the most significant one in the entire passage. "Federal" refers to the Northern army. This line tells the reader that the man who looked to be a Southern soldier was actually a Northern scout. So, Farquhar, who we can infer wants to set Owl Creek bridge on fire, has been given information by a Northern spy.

When interpreting certain subtle passages like the one you just read, picking up on implications can make or break your comprehension of what's going on. Without paying attention to implications, the last passage may just seem like a man offering a soldier some water and making small talk. The implications make it clear not only that Farquhar is planning on burning down the bridge, but that he has been set up to do so by an enemy spy. (Note, however, that the SAT Reading test would likely provide you with footnotes regarding the meanings of the terms grounded in historical context, e.g. "gray-clad" and "Federal.")

Not all passages found on the SAT will be quite this subtle, but certain inference questions may direct you to interpret moments like those highlighted in this last example passage. Read carefully so as not to miss any part of the meaning the text is conveying!



Review: Close Reading

Close reading is one of the most useful tools you have at your disposal on the SAT Reading test. When you are asked to analyze a piece of writing, you are asked to formulate a thesis—your theory or argument about what is happening in the passage, and why it’s important—and to argue in support of that thesis. Close reading is how you gather evidence to support your argument. This style of reading focuses on noticing specific details within a text and using those details to support a position about the text’s overall meaning. Like proofs in math or experiments in science, close reading is the technical skill of English as an academic discipline. The small details you pick up on in your close reading will allow you to construct sturdy arguments.

When close reading a passage, there are many things to look for, but, since you’re the one making your argument, the most important things to look for and to look at in more detail are just what sticks out to you. If you’re reading a passage and you notice the author’s choice of words, or repetition, or a sentence that strikes you as odd or interesting, simply underline it or make a small note, then come back and read it more carefully. By noting your impressions as you go, you’ll be giving yourself a basis upon which to build an argument based on real, textual evidence, not just your suppositions about the text.

Close reading helps you gather information to explain why and how a text creates a certain effect. If you liked the text, you can close read it to find the specific, small details that added up to your enjoyment, and if you didn’t enjoy the text, you can close read it to explain exactly what about it you thought wasn’t enjoyable or good.

Diction is perhaps the most basic and rewarding area to mine when close reading: it refers to the words a writer chooses to use. That might sound obvious, but there are ways to look deeper into the language a text uses to better understand and make claims about the text overall.

For instance, if I say “I hate dogs,” it’s a lot different than saying that “I am not fond of dogs.” The meaning is roughly the same: I don’t like dogs (that’s not really true, but let’s press on with this example), but the intensity of my word choice changes the meaning of the statement. If you’re reading a passage and you notice a number of words that jump out at you as either expressing strong or notably mild emotions, this is a reasonable observation of which to take note. A writer might repeat a specific word several times through a passage, and observing and thinking about this repetition might give you some insight into what he or she is trying to convey.

Diction can also help determine the tone of a work. If an author chooses to say: “I took a mid-afternoon perambulation,” it creates a radically different effect than saying, “I took a walk at 2:30.” Again, the literal meaning is very close, but the diction of one is elevated, and that’s worth observing.

You can also take note of how the author chooses to arrange his or her words, in addition to noting the words themselves. A writer’s syntax (sentence structure) can tell you a lot about what he or she thinks is important about what they’re saying. For instance, if I say “The briefcase was thrown off the roof by that man,” I am using the passive voice, making the briefcase, which received the action of the man, the grammatical subject, and thus making it seem as though the briefcase is the most important thing in the situation. If I frame this sentence in the active voice—“That man



threw the briefcase off the roof”—the focus of the sentence is now on the agent, the man. If you notice a writer using an unconventional sentence structure, such as the passive voice, or maybe connecting two independent clauses with a semicolon, take a second and think about why the author might have done that. It might give you some clues as to what he or she thinks is important about the passage’s subject matter or how the different things being discussed relate to each other. Every sentence communicates meaning not just with the words it uses, but with its fundamental structure.

In analyzing texts (and writing your own) it is vital to keep in mind that every time a writer puts a word, punctuation mark, or even a letter, on the page that writer is making a choice. Close reading allows you to examine these choices in greater detail, and to see how these choices add up (or fail to add up) into a coherent whole.

Close reading underscores the key thing to know when analyzing any text: you need to support every claim you make with evidence. Just as a prosecutor can’t walk into a court of law and tell the jury that they should send someone to jail because he “just feels like” the defendant is guilty, a reader cannot make claims about a text without justifying those claims using evidence gathered from the text itself. To go further with this metaphor (Were you close reading this paragraph you might note my use of an extended metaphor, or that I used this annoying parenthetical!), in the case of close reading, you get to be both the prosecutor and the detective. First, you study the scene of the crime (the text) and form a theory about it; then, you gather evidence to support that theory (or maybe you form the theory by gathering evidence); then, you organize and argue for that case by citing the evidence you gathered. Fortunately, nobody goes to jail after you solve and prosecute your textual case.

What is really useful about close reading is that it can help you at every step of the analytical process. If you’re stuck and you really don’t have an argument or a theory about what is happening in the text, the best way to come up with something is to close read the text, paying careful attention to the text’s language, syntax, and tone to see what catches your attention. Any patterns or quirks you notice can lead you to a theory about what is being conveyed. On the other hand, if you read a text and you form an immediate, strong opinion about it, the best way to test and prove that theory is to go right back to the text and read it carefully, analyzing the details of the writing to see if or how they add up to what you think is happening overall.

In any case, close reading will always be one of the most useful tools at your disposal to form and argue a thesis about a passage, especially in a timed test situation.

Now we’ll look at some examples so you can see some close reading in action. The short passages found on the following pages have been taken from a variety of different sources and annotated to point out some of the details that you might notice when close reading them. Read them carefully, noting the textual features to which the reading notes draw your attention. Doing this can help you get in the habit of reading for the relevant details you can use to build an argument about what the text is doing and how it is doing it.



This passage's title tells us that it is in conversation with fairy tales, which often open with the phrase "once upon a time." That doesn't mean that it's a traditional fairy tale—it's a little different. But it involves some similar elements: kings, princesses, and magical items.

There are three characters in this passage: the King, the Princess, and the King of Barodia—a different King than the one who speaks in the third paragraph!

This passage starts in the middle of a conversation. Note how the King doesn't want to talk about something: he distracts himself by inspecting the flagon and how he pauses to say "er" while replying.

Sample Passage

Adapted from *Once on a Time* by A. A. Milne (1922)

The Princess was still puzzled. "But I'm grown up," she said. "I don't want a mother so much now."

The King turned his flagon round and studied the other side of it.

"A mother's—er—tender hand," he said, "is—er—never—"
and then the outrageous thing happened.

It was all because of a birthday present to the King of Barodia, and the present was nothing less than a pair of seven-league boots. The King being a busy man, it was a week or more before he had an opportunity of trying those boots. Meanwhile he used to talk about them at meals, and he would polish them up every night before he went to bed. When the great day came for the first trial of them to be made, he took a patronizing farewell of his wife and family, ignored the many eager noses pressed against the upper windows of the palace, and sailed off.

The motion, as perhaps you know, is a little disquieting at first, but one soon gets used to it. After that it is fascinating. He had gone some two thousand miles before he realized that there might be a difficulty about finding his way back. The difficulty proved at least as great as he had anticipated. For the rest of that day he toured backwards and forwards across the country, and it was by the merest accident that a very angry King shot in through an open pantry window in the early hours of the morning. He removed his boots and went softly to bed.

It was, of course, a lesson to him. He decided that in the future he must proceed by a recognized route, sailing lightly from landmark to landmark. Such a route his geographers prepared for him—an early morning constitutional, of three hundred miles or so, to be taken ten times before breakfast.

The conversation is interrupted by something to do with the King of Barodia and his magical seven-league boots. The timeline switches from present-tense to past in talking about how the King of Barodia obtained the boots.

The King of Barodia's behavior here doesn't make him seem like a very nice person.

The humor in this moment is amplified by the author's use of an even more distant third-person to describe it than he has been using ("a very angry King" instead of "he").

You could easily be asked about the definition of this word in context, as it's a little archaic. See how it means something like "exercise"?

If you're asked about the author's tone, this moment will be crucial. Look at how the author directly addresses the audience in a familiar, casual way, as if they're familiar with how seven-league boots work.

Cause: the King of Barodia gets lost the first time he uses his boots.

Effect: the King of Barodia asks his geographers to prepare a route for him so that he doesn't get lost again.



This passage is excerpted from a famous document from the history of the United States. Be careful not to rely on any outside knowledge you may have about *The Federalist Papers* or its authors!

The title of this passage is very straightforward. It primes you to pick up on the thesis statement in the first line.

“Notwithstanding” means *despite* or *ignoring* and makes a key logical maneuver. So, the author is *not* considering “the different modes in which they are appointed,” and is instead looking at state and federal government as both being dependent on citizens. The author doesn’t provide evidence or explanation showing that this is the case, but says he will do so in a different text.

The first line of the passage is its thesis statement. After “I proceed to inquire,” it lays out its trajectory for the rest of the paragraph. The author will consider whether the people will side with the state or federal government(s).

Sample Passage

Adapted from “Federalist No. 46. **The Influence of the State and Federal Governments Compared**” by James Madison in *The Federalist Papers* by Alexander Hamilton, James Madison, and John Jay (1788)

I proceed to inquire whether the federal government or the state governments will have the advantage with regard to the predilection and support of the people. **Notwithstanding** the different modes in which they are appointed, we must consider **both of them** as substantially dependent on the great body of the citizens of the United States. I assume this position here as it respects the first, **reserving the proofs for another place**. The federal and state governments are in fact but **different agents** and trustees of the people, **constituted with different powers**, and **designed for different purposes**. **The adversaries of the Constitution** seem to have **lost sight of the people altogether** in their reasonings on this subject, and to have viewed these different establishments not only as **mutual rivals and enemies**, but as **uncontrolled by any common superior** in their **efforts to usurp the authorities of each other**. **These gentlemen** must here be reminded of **their error**. They must be told that **the ultimate authority**, wherever the derivative may be found, **resides in the people alone**, and that it will **not** depend merely on the comparative ambition or address of **the different governments**, whether either, or which of them, will be able to enlarge its sphere of jurisdiction at the expense of the other. Truth, no less than decency, requires that the event in every case should be **supposed to depend on** the sentiments and sanction of their **common constituents**.

Our pro-Constitution author argues that by not considering the influence of the people, the Constitution’s opponents have mischaracterized the state and federal governments’ relationship as a competitive one and their power as unchecked.

The author characterizes the state and federal governments as inherently different. (Note how he repeats the word “different” three times in a row!) This suggests that the idea of them competing is silly; it assumes they are comparable, but they’re like apples and oranges.

The author concludes by asserting that the state and federal government are beholden to the people, so whether one will become more powerful than the other depends on what the people want and allow.



The title of this passage doesn't help you identify its subject matter unless you're familiar with it already, but the passage's first word establishes that it concerns sociology.

The first paragraph begins by categorizing society generally and then introducing a specific sociologist and his work.

While you may not immediately know what an "ethnographic methodology" is, the sentence tells you what it *does*: try to "understand social phenomena through direct observations and interactions." So, it's a way of collecting sociological data.

It looks like the author is leading into a discussion of the specifics of Goffman's research.

Sample Passage

"Goffman's Theory of Institutions" by Joseph Ritchie (2015)

Sociological inquiry often investigates members of society considered to be on its outer edges. These individuals often live in precarious and vulnerable situations. Traditionally, sociologists have studied these groups to gain insight into the lives of people who are forgotten victims of the blind eye of society. In 1961, **Erving Goffman** published the book ***Asylums: Essays on the Social Situation of Mental Patients and Other Inmates***. This book outlined the **theory of a total institution** as seen in **prisons and asylums for the clinically insane**. Goffman's interests and theory helped to reveal the inner mechanics of asylums and the **process of institutionalization** that takes place within a **total institution**.

Sociologists such as Goffman revolutionized the field by introducing **ethnographic methodologies** that **sought to understand social phenomena through direct observations and interactions**. Prior to this, sociologists conducted what has been satirically referred to as "**armchair sociology**." This methodology characterized early sociological inquiries. Pioneers of the field engaged with society in a **philosophical** manner that left them **disengaged from their targets of investigation**. Sociologists of the ethnographic school, **however**, actively engage in activities of **participant observation** with the subcultures under investigation. **Instead of theorizing from a distance**, Goffman carried out fieldwork within an **actual** asylum. Immersion into the institution and observation of social life within it enabled Goffman to document and theorize about the **characteristics of and methods of socialization used by total institutions**.

The passage opens by describing how sociology often focuses on members of society who are in specific, vulnerable situations. Later in the paragraph, we get a concrete example: such people might reside in prisons or insane asylums.

"Total institution" is a key term in this passage. Even though it's not defined in the passage, it keeps being mentioned.

The author introduces two competing ways of gathering sociological data: ethnographic methodologies and "armchair sociology." He then contrasts them: note the use of language like "however," "instead of," and "actual" used for emphasis.



The first sentence introduces this passage's main topic: the bee-moth.

Sample Passage

Adapted from *A Practical Treatise on the Hive and Honey-Bee* by Lorenzo Lorraine Langstroth (1857 ed.)

Of all the numerous enemies of the honey-bee, the Bee-Moth (*Tinea mellonella*), in climates of hot summers, is by far the most to be dreaded. So widespread and fatal have been its ravages in this country that thousands have abandoned the cultivation of bees in despair, and in districts which once produced abundant supplies of the purest honey, bee-keeping has gradually dwindled down into a very insignificant pursuit. Contrivances almost without number have been devised to defend the bees against this invidious foe, but still it continues its desolating inroads, almost unchecked, laughing as it were to scorn at all the so-called "moth-proof" hives, and turning many of the ingenious fixtures designed to entrap or exclude it into actual aids and comforts in its nefarious designs.

I should feel but little confidence in being able to reinstate bee-keeping in our country into a certain and profitable pursuit if I could not show the apiarian in what way he can safely bid defiance to the pestiferous assaults of this, his most implacable enemy. I have patiently studied its habits for years, and I am at length able to announce a system of management founded upon the peculiar construction of my hives, which will enable the careful bee-keeper to protect his colonies against the monster. The bee-moth infects our apiaries, just as weeds take possession of a fertile soil. Before explaining the means upon which I rely to circumvent the moth, I will first give a brief description of its habits.

The passage concludes with the author outlining what he will talk about next: first, he'll describe the bee-moth, and then he will explain how he stops the bee-moth from attacking his bees.

Check out all the terms highlighted in blue. This author is really using some strong and complex language to characterize the bee-moth!

Not familiar with the word "contrivance"? That's ok! What does it sound like? "Contrive," right? Well, "contrive" means *make*, and "contrived" means *purposely made or artificial*. We can use the sentence's context to figure out that "contrivances" are just things people have designed to protect bees from bee-moths.

The author bills this book as "Practical," and here's where that comes into play: he's going to explain how to build hives that will stop the bee-moth.

Note this direct comparison—it could easily be the focus of a question.

The bee-moth has caused many beekeepers to give up their hobby or livelihood.

The "as it were" conveys that the bee-moths aren't *actually* cackling maniacally, but you get the idea the author is painting them as villainous.

So, what's an apiarian? Read on a little farther and you'll find the word "apiary"—the bee-moth "infects" apiaries like weeds grow in fertile soil. So, if an "apiary" is a bee-hive, an "apiarian," being a person, must be a person who works with beehives—in other words, a beekeeper.



Information and Ideas

The SAT Reading test attempts to categorize questions into three primary areas: “Information and Ideas,” “Rhetoric and Passage Construction,” and “Synthesis.” The Information and Ideas questions are tightly related to the content of the text presented, asking test-takers to dissect and analyze the messages conveyed through the passage. Common topics for these questions include the passage main idea, presentation of evidence, implication and inference, and application of conclusions to the intent of the author. These questions are generally identifiable due to their reliance on critical thinking in relation of the meaning and content of material, as opposed to the method or structure of its presentation.

Section Outline

Deciphering Statements and Implications

- Identifying details and the implications of statements

Applying Inferences to New Scenarios

- Applying inferences to topics and situations outside of the passage’s scope

Citing Textual Evidence

- Identifying quotations from the passage that support given claims

Identifying Main Ideas and Themes

- Identifying the main point of a passage or paragraph

Summarizing and Paraphrasing

- Rephrasing passage excerpts in different words while conveying their main points

Deciphering Words and Phrases in Context

- Using context to figure out the meaning of unfamiliar language or familiar language used in a particular, unusual way

Interpreting Relationships in Context

- Working with different logically related facets of a text

Cause and Effect

- Spotting causes and effects in a passage’s content

Comparing and Contrasting

- Identifying similarities and differences of passage topics

Sequence

- Analyzing the temporal organization of a passage



Deciphering Statements and Implications

Some questions on the SAT Reading test seek to test your understanding of the passage by measuring your ability to recognize and contextualize specific details contained within the passage, and to interpret the implications of the author's claims. These questions will not simply ask you to regurgitate content straight from the passage—they will test your ability to synthesize the information with which these details provide you. This premise may sound intimidating, especially if you are not a particularly detail-oriented person. Let's practice answering some questions that deal with deciphering the passage in this way.

Practice Passage

Adapted from *Laughter: An Essay on the Meaning of the Comic* by Henri Bergson (1914 ed.)

What does laughter mean? What is the basal element in the laughable? What common ground can we find between the grimace of a merry-andrew, a play upon words, an equivocal situation in a burlesque and a scene of high comedy? What method of distillation will yield us invariably the same essence from which so many different products borrow either their obtrusive odor or their delicate perfume? The greatest of thinkers, from Aristotle downwards, have tackled this little problem, which has a knack of baffling every effort, of slipping away and escaping only to bob up again, a pert challenge flung at philosophic speculation. Our excuse for attacking the problem in our turn must lie in the fact that we shall not aim at imprisoning the comic spirit within a definition. We regard it, above all, as a living thing. However trivial it may be, we shall treat it with the respect due to life. We shall confine ourselves to watching it grow and expand. Passing by imperceptible gradations from one form to another, it will be seen to achieve the strangest metamorphoses. We shall disdain nothing we have seen. Maybe we may gain from this prolonged contact, for the matter of that, something more flexible than an abstract definition—a practical, intimate acquaintance, such as springs from a long companionship. And maybe we may also find that, unintentionally, we have made an acquaintance that is useful. For the comic spirit has a logic of its own, even in its wildest eccentricities. It has a method in its madness. It dreams, I admit, but it conjures up, in its dreams, visions that are at once accepted and understood by the whole of a social group. Can it then fail to throw light for us on the way that human imagination works, and more particularly social, collective, and popular imagination? Begotten of real life and akin to art, should it not also have something of its own to tell us about art and life?

At the outset we shall put forward three observations that we look upon as fundamental. They have less bearing on the actually comic than on the field within which it must be sought.

Links to
Sample Questions

[Sample Question #1](#)

[Sample Question #2](#)

[Sample Question #3](#)

[Sample Question #4](#)



The first point to which attention should be called is that the comic does not exist outside the pale of what is strictly HUMAN. A landscape may be beautiful, charming and sublime, or insignificant and ugly; it will never be laughable. You may laugh at an animal, but only and sublime, or insignificant and ugly; it will never be laughable. You may laugh at an animal, but only because you have detected in it some human attitude or expression. You may laugh at a hat, but what you are making fun of, in this case, is not the piece of felt or straw, but the shape that men have given it—the human caprice whose mold it has assumed. It is strange that so important a fact, and such a simple one too, has not attracted to a greater degree the attention of philosophers. Several have defined man as “an animal which laughs.” They might equally well have defined him as an animal which is laughed at; for if any other animal, or some lifeless object, produces the same effect, it is always because of some resemblance to man, of the stamp he gives it or the use he puts it to.

Here I would point out, as a symptom equally worthy of notice, the ABSENCE OF FEELING which usually accompanies laughter. It seems as though the comic could not produce its disturbing effect unless it fell, so to say, on the surface of a soul that is thoroughly calm and unruffled. Indifference is its natural environment, for laughter has no greater foe than emotion. I do not mean that we could not laugh at a person who inspires us with pity, for instance, or even with affection, but in such a case we must, for the moment, put our affection out of court and impose silence upon our pity.

Identifying Details

There are basically two species of detail-locating questions on the SAT Reading exam: those that ask you to account for details from a specific paragraph or section of the reading, and those that ask you to account for details from the passage as a whole, with no specific section isolated in which to look for the answer.

We will start by looking at the more direct of these two types: the questions about specific paragraphs. While these questions are obviously a little bit easier than their more expansive counterparts, the fundamental process by which you will be finding and understanding these details is the same for both types.

Identifying Details in a Specific Paragraph

A very important thing to keep in mind when approaching detail questions is that the questions most often will not ask for a detail using the exact language used in the text. Instead, they will rephrase or paraphrase the particulars of the detail as it is laid out in the passage. This means that the most important aspects of these detail questions is to read the paragraph carefully before looking at the answer choices. It is vital to form your own understanding of the passage overall, and the words, sentences, and paragraphs contained within the specified passage.

The test is written and constructed in such a way that you must be secure in your own



understanding of a text before attempting to answer for the specific details contained within that text. You may even find it helpful to make a brief note alongside each paragraph quickly summarizing its contents in your own words.

Sample Question #1

Which of the following statements is *not* established in the first paragraph?

- A. Scholars have tried and failed to define the foundation of humor.
- B. We should try to define the comic spirit.
- C. The comic spirit, and our relationship to it, changes and grows over time.
- D. The comic spirit may offer insight into the human imagination.

Click Here to
Revisit the
Passage

In order to raise the difficulty of detail questions, the test can ask you to identify which of a group of options was *not* stated, identified, supported, or argued for in the passage, as is the case here.

So, let us embark on our spirited journey through this question! First, we should return to the first paragraph and read it again, but this time with the statements named in the question firmly in mind.

The passage opens with a series of rhetorical questions that establish the author's focus for the passage that follows. Having thus established the focus of the passage, the author begins to make some direct statements. First, he states that "the greatest of thinkers," a group in which he includes the Greek philosopher Aristotle, have "tackle[d] this little problem." The author then makes clear that this "little problem" is not little in difficulty, as it has "baffled" these great minds, and been an extreme and difficult subject of "philosophic speculation." Now, we can swiftly eliminate option A. Philosophers, including Aristotle, are scholars, and the author's characterization of the relationship of scholars to this problem clearly support option A.

Remember that, for questions seeking the answer that does *not* appear in the text, as soon as you find a section you believe supports one of the options, you can eliminate that option. One option for answering these types of questions involves going through the passage and finding the answer options that are supported within the text. This way, you will end up, ultimately, with your answer after having eliminated all the options that *did* appear, in some form, in the passage.

In this case, however, the very next sentence (beginning with "our excuse"), we find a direct contradiction of one of our answer options! The author makes clear that he "does not aim at imprisoning the comic spirit within a definition." From the author's tone and word choice, he makes clear that he views attempts to "define the comic spirit" as inherently negative and foolhardy. Since the passage obviously emphasizes the goodness of humor, it would not make sense to "imprison" it. It does not require much interpretation to stretch the author's statement that his entire justification for "attacking the [intellectual] problem" of the comic spirit to the statement that "we" should not "try to define the comic spirit." Therefore, the answer is B.



If we want to double-check this answer, we can continue through the passage and find support for the statements “The comic spirit, and our relationship to it, changes and grows over time,” (“watching [the comic spirit] grow and expand. Passing by imperceptible gradations from one form to another”) and “The comic spirit may offer insight into the human imagination.” (“Can it then fail to throw light for us on the way that human imagination works, and more particularly social, collective, and popular imagination?”). Both of these statements are well-supported in the first paragraph.

Had you, on your first reading of the passage, noted the passage’s treatment of the concept of humor as a fluid, “living” being, you might have instinctively known that B was the least likely, since it was the least conceptually expansive in its treatment of the subject. So, you can see how a general understanding of the content of a passage will help you answer detail questions.

Identifying Details in a Full Passage

Not all detail questions will do you the favor of providing a specific paragraph in which to look. Some questions on the test will instead ask you to find whether or not statements, details, or arguments were made anywhere in the passage. In these types of questions, since you may not have time to parse the entire passage, line-by-line, your overall understanding of the passage’s organization, tone, and overall argument is even more crucial to answering for these details.

Sample Question #2

Which of the following is a claim supported by the passage?

- A. There is no method to the comic spirit; what is funny is completely random.
- B. Non-human animals, like dogs or cats, can be funny in their own right.
- C. If you laugh at a hat, you are laughing at the shape given to that hat by humans.
- D. A joke is funnier when told by a professional comedian.

This question, rather than asking us which claim is *not* made in the passage, is asking us to find the claim that *is* made somewhere in the passage. There are two reasonable approaches to doing so. The first is to find the one claim that is supported by the passage, and the second is to find and eliminate the three claims that are *not* supported by the passage.

Say we’re pressed for time: we can scan the passage for the word “hat.” After a couple of tense moments, we find it in the third paragraph! Reading the full sentence in which hats appear (“You may laugh at a hat, but what you are making fun of, in this case, is not the piece of felt or straw, but the shape that men have given it—the human caprice whose mold it has assumed”), we can easily see that option C is pretty much directly supported by the passage.

Click Here to
Revisit the
Passage



A fuller reading of the passage reveals that options A and B are directly refuted in the first and third paragraphs of the passage respectively. Option D simply does not appear in the passage; there is no mention of professional comedians anywhere.

Once again, an overall understanding of passage's content, and the author's attitude toward that content is helpful. The third paragraph's discussion of the uniquely human aspects of laughter is notable, and makes a number of interesting claims. If you had noted that this paragraph was about the role of the level of human involvement in objects of laughter, you may have simply gone right back to it and answered this question quite quickly and decisively.

Determining Implications

Sometimes authors get at their intended meanings without directly stating them, working through language that indirectly conveys implications. Along with asking you to identify directly stated details of the passage, the SAT Reading test can ask you to identify implications of the author's claims. Figuring out what the passage implies in a specified sentence, paragraph, or as a whole takes a great deal of skill in thinking about how the author's claims function outside of the context of the essay. In claiming one thing, the author may imply another that isn't addressed in the passage at all. Implications can certainly be drawn from a wide range of potential subjects not limited to those discussed in the passage, but keep in mind, you'll be choosing from a set of predefined answer choices. The test will not ask you to articulate implications without also placing the correct answer in front of you. All you have to do is figure out which answer choice is actually implied!

Sample Question #3

What is the author implying by the statement “[man is] an animal that is laughed at”?

- A. Every laughable element bears a resemblance to man.
- B. The physical appearance of humans is laughable.
- C. Animals cannot comprehend the concept of humor.
- D. Funny concepts always have something to do with living organisms.

Taking the context of the statement into account, the reader can see that the author is discussing how the human element is what makes something comic. The author goes on to say that man is the animal that laughs as well as the animal that is laughed at, implying that things are only laughable if they bear some resemblance to man.

Let's now widen our range of focus and consider the implications of an entire paragraph.

[Click Here to Revisit the Passage](#)



Click Here to
Revisit the
Passage

Sample Question #4

Which of the following is implied by the author's claims in the third paragraph?

- A. Situations in which you empathize with others are not funny.
- B. Someone who is heavily invested in a situation will easily see the humor inherent in it.
- C. If someone is laughing at someone else, the laugher has put him- or herself in the other person's shoes.
- D. The frustration of others invites comparison between the viewer and the subject and thus makes the frustrated individual a prime subject of humor.

In the third paragraph, the author claims that laughter and humor are predicated on an “absence of emotion.” “Indifference is its natural environment, for laughter has no greater foe than emotion,” he claims. This means that humor and empathy are antithetical to one another. Answer choices B, C, and D each suggest that this paragraph implies that empathy and humor can coexist; this is not the case. A is the correct answer because it is the only one that adheres to the author's claim.



Applying Inferences to New Scenarios

Inferences ask you to think beyond the passage by taking the information provided and figuring out points made indirectly, or things that must be true based on passage claims. While certain inference questions may ask you about material that pertains directly to what you've read in the passage, others may ask you not only to make inferences, but to take one more step and apply them to new, often hypothetical scenarios.

These questions can seem daunting because the material they concern isn't material in the passage, meaning that the answer isn't directly conveyed in the text. You need to employ sturdy logical reasoning twice to answer these questions correctly: once in making your inferences based on passage claims, and then again with figuring out how they relate to the presented scenario. Practicing answering these questions before test day can help you become more confident in your skills at extrapolating from the passage and making new meanings out of your extrapolations.

Practice Passage

Adapted from "Utopia" by Thomas More (1516) in *Ideal Commonwealths: Comprising More's Utopia, Bacon's New Atlantis, Campanella's City of the Sun, and Harrington's Oceans* (1901)

Thus have I described to you, as particularly as I could, the constitution of that commonwealth, which I do not only think the best in the world, but indeed the only commonwealth that truly deserves that name. In all other places it is visible that, while people talk of a commonwealth, every man only seeks his own wealth; but there, where no man has any property, all men zealously pursue the good of the public, and, indeed, it is no wonder to see men act so differently, for in other commonwealths every man knows that unless he provides for himself, how flourishing soever the commonwealth may be, he must die of hunger, so that he sees the necessity of preferring his own concerns to the public; but in Utopia, where every man has a right to everything, they all know that if care is taken to keep the public stores full no private man can want anything, for among them there is no unequal distribution, so that no man is poor, none in necessity, and though no man has anything, yet they are all rich; for what can make a man so rich as to lead a serene and cheerful life, free from anxieties, neither apprehending want himself, nor vexed with the endless complaints of his wife? He is not afraid of the misery of his children, nor is he contriving how to raise a portion for his daughters, but is secure in this, that both he and his wife, his children and grandchildren, to as many generations as he can fancy, will all live both plentifully and happily, since, among them, there is no less care taken of those who were once engaged in labor, but grow afterwards unable to follow it, than there is, elsewhere, of these that continue still employed. I would gladly hear any man compare the justice that is among them with that of all other nations; among whom may I perish if I see anything that looks either like justice or equity; for what justice is there in this: that a nobleman, a goldsmith, a banker, or

Links to
Sample Questions

[Sample Question #1](#)

[Sample Question #2](#)



any other man, who either does nothing at all, or, at best, is employed in things that are of no use to the public, should live in great luxury and splendor upon what is so ill acquired, and a mean man, a carter, a smith, or a plowman, who works harder even than the beasts themselves, and is employed in labors so necessary, that no commonwealth could hold out a year without them, can only earn so poor a livelihood and must lead so miserable a life, that the condition of the beasts is much better than theirs? For as the beasts do not work so constantly, so they feed almost as well, and with more pleasure, and have no anxiety about what is to come, whilst these men are depressed by a barren and fruitless employment, and tormented with the apprehensions of want in their old age; since that which they get by their daily labor does but maintain them at present, and is consumed as fast as it comes in, there is no overplus left to lay up for old age.

Before we begin talking about applying inferences to different scenarios, let's take a moment to talk about how to make a good inference. Making accurate and reasonable inferences based on what you read takes a certain discerning perspective. They need to be firmly rooted in specific evidence you can point to in the passage. If you can't articulate what material forms the basis of an inference, it might not be a reliable or reasonable one. Just like quoting material to back up your claims when writing a paper or *identifying evidence in the passage*, inferences need evidence to justify them. Even if questions aren't asking you about this evidence directly, it forms a crucial middle step in coming up with correct answers.

It's also crucial to base your inferences in the passage in the sense that you should never rely on any information you may know about a topic that is not mentioned in the passage. While it's not likely that the test will ask you to work with incorrect or outdated information, it may provide only certain, limited views of subjects and then ask you what inferences and predictions can be supported by the material at hand. If you incorporate outside knowledge into your responses, you're potentially no longer doing what the test is asking you to—determine information using critical thinking skills based on a passage.

For instance, let's say you are reading a passage about the first moon landing and asked to infer why the U.S. wanted to be the first to the moon. Let's say you're an expert in the history of NASA, Kennedy's speech, and the Russian-U.S. "space race"—if any of these are presented as answer options, they might look pretty appealing; however, the passage may be written to include support for the more general idea that the United States wanted to be the first to put a person on the moon because no one had done it before. Perhaps the passage conveys one author's personal analysis of the cause, and doesn't talk about a generally accepted historical cause. If one answer choice mentioned Kennedy's speech and the passage didn't talk about that speech at all, you'd get the question wrong simply because you knew about the topic! In sum, if you recognize that you know about the topic of a passage, pretend you're learning about it for the first time. Analyzing the information presented in SAT Reading passages this way can help you focus on making well-supported inferences and predictions.



Before making a sturdy inference, it may be necessary to figure out where you should focus in the passage—which part of it is relevant to the new presented scenario. Remember, the answer is conveyed by the passage somehow, even if the reasoning is very indirect. Try to pick out details of the question and/or answer choices that overlap with the passage’s subject matter, and revisit those moments in the text to see how they might interact.

With that warning out of the way, let’s tackle some practice problems!

Sample Question #1

Click Here to
Revisit the
Passage

Based on the information presented in the passage, which of the following is most likely to be true concerning theft of personal property in Utopia?

- A. This type of theft likely cannot occur in Utopia because no one owns any personal property.
- B. Such theft is likely rare in Utopia because the inhabitants are much more concerned with the public good than with private possessions.
- C. Such theft is likely rare in Utopia because everyone owns an identical set of personal possessions.
- D. Theft is likely much more prevalent in Utopia because its inhabitants spend so much time working outside of their homes.

The passage doesn’t say anything about theft of personal property in Utopia, but it does tell us something about property in general in Utopia, so let’s start there. The narrator tells us near the beginning of the passage that Utopia is a place “where no man has any property, [and] all men zealously pursue the good of the public.” He goes on to describe it as a place “where every man has a right to everything,” and says “[its inhabitants] all know that if care is taken to keep the public stores full no private man can want anything, for among them there is no unequal distribution, so that no man is poor, none in necessity, and though no man has anything, yet they are all rich.” Considering the question, the key phrases from these quotations are that “no man has any property” and “no man has anything, yet they are all rich.” This tells us that no one owns any personal property in Utopia, supporting answer choice A, “this type of theft likely cannot occur in Utopia because no one owns any personal property.”



Click Here to
Revisit the
Passage

Sample Question #2

Imagine you meet a Utopian who knows nothing of countries other than his or her own. Based on the passage, which of the following would likely be a new concept to him or her?

- A. Going to a hospital when feeling ill
- B. Taking off work for a national holiday
- C. Saving money for retirement
- D. Clearing a forest in order to make paper from the trees

The passage certainly doesn't mention any of these answer choices or give us any direct information about what to expect if we were to meet a Utopian only familiar with his or her own country. Answering this question is all about figuring out which answer choice has a basis in the passage.

Saving money for retirement would most likely be a new concept to a Utopian based on the passage, as it states that "among them, there is no less care taken of those who were once engaged in labor, but grow afterwards unable to follow it, than there is, elsewhere, of these that continue still employed." This quotation tells us that Utopians don't have to worry about saving money to live on when they are too old to work—or in other words, saving money for retirement.

Applying inferences about a fictional place like Utopia to more fictional scenarios might be expected of you on test day, but on the other hand, you could be presented with hypothetical surrounding a scientific passage like the next one. No matter what type of passage you encounter, you can approach inference questions the same way: make sure your reasoning has a basis in the passage and look for ways in which the new scenario relates to the passage.



Practice Passage

Adapted from “Birds in Retreat” in “Animal Defences—Active Defence” in Volume Four of *The Natural History of Animals: The Animal Life of the World in Its Various Aspects and Relations* by James Richard Ainsworth Davis (1903)

Among the large running birds are forms, like the African ostrich, in which the absence of powers of flight is largely compensated by the specialization of the legs for the purpose of rapid movement on the ground. For straightforward retreat in open country nothing could be more effective; but another kind of adaptation is required in birds like rails, which are deficient in powers of flight, and yet are able to run through thickly-growing vegetation with such rapidity as to commonly elude their enemies. This is rendered possible by the shape of their bodies, which are relatively narrow and flattened from side to side, so as to easily slip between the stems of grasses, rushes, and similar plants. Anyone who has pursued our native land-rail or corn-crake with intent to capture will have noted how extremely difficult it is even to get within sight of a bird of this sort.

Certain birds, unfortunately for themselves, have lost the power of flight without correspondingly increased powers of running, and have paid the penalty of extinction. Such an arrangement, as might be anticipated, was the result of evolution in islands devoid of any predatory ground-animals, and a classic example of it is afforded by the dodo and its allies, birds related to the pigeons. The dodo itself was a large and clumsy-looking species that at one time abounded in the island of Mauritius, which, like oceanic islands generally, possessed no native mammals, while its indigenous reptiles were only represented by lizards. The ubiquitous sailor, however, and the animals (especially swine) which he introduced, brought about the extinction of this helpless bird in less than a century after its first discovery in 1598. Its memory is now only kept green by a few contemporary drawings and descriptions, certain museum remains, and the proverb “as extinct as a dodo.” A similar fate must overtake any organism suddenly exposed to new and unfavorable conditions, if devoid of sufficient plasticity to rapidly accommodate itself to the altered environment.

Links to
Sample Questions

[Sample Question #3](#)

[Sample Question #4](#)



Click Here to
Revisit the
Passage

Sample Question #3

The kiwi is a bird that lives in New Zealand. New Zealand has no native ground-dwelling predatory animals. The stoat, a ground-dwelling carnivorous mammal, was introduced to New Zealand. Based on the passage, what can you predict happened?

- A. The kiwi population drastically decreased.
- B. The kiwi population rose.
- C. The stoats could not support themselves in the new environment and died off.
- D. The kiwis quickly learned to defend themselves against stoats.

The situation presented in this question lines up precisely with the dodo's story in the passage. The kiwi, like the dodo, would thus be unable to defend itself from introduced predators, since like on Mauritius, New Zealand has no native ground-dwelling predators. We can therefore predict that in this situation, the kiwi population would decrease drastically, if not go extinct, so "the kiwi population drastically decreased" is the correct answer. (In fact, the kiwi and stoat situation actually happened in New Zealand. While the kiwi remains a living species, New Zealand has had to work very hard to protect it from stoats).

Click Here to
Revisit the
Passage

Sample Question #4

What can you infer about the ocean island nation of Fiji based on the second paragraph?

- A. It likely has no native mammals.
- B. It likely has indigenous lizards.
- C. It likely was home to the dodo before it went extinct.
- D. It likely has no native birds.

The breadth of this question might be pretty imposing, since we could infer a lot of things about Fiji based on the second paragraph. Let's take a look at the answer choices for a bit more focus. One mentions mammals, one lizards, one the dodo, and one a lack of native birds. So, we need to find some information that tells us something about the animals found on the island nation of Fiji. Scanning the second paragraph, we find a line that mentions the dodo, lizards, and native mammals, points made in three of our four answer choices:

"The dodo itself was a large and clumsy-looking species that at one time abounded in the island of Mauritius, which, like oceanic islands generally, possessed no native



mammals, while its indigenous reptiles were only represented by lizards.”

Ok, we’re making some progress now. Fiji is an “island nation,” so it falls under the purview of the passage’s description of “oceanic islands generally.” What does the passage claim about these? It indirectly states that oceanic islands generally don’t have any native mammals. That lines up with answer choice A, the correct answer. Just because Mauritius has indigenous lizards doesn’t mean that Fiji does; we’re not told that dodos lived on Fiji, just on Mauritius; and no mention is made about Fiji or oceanic islands in general not having any native birds—if anything, it’s suggested that this isn’t true, as Mauritius, being the home of the dodo, is home to at least one type of bird.

Let’s look at one more passage and a related sample question—one that is phrased in the negative instead of the positive.

Practice Passage

Adapted from “Of One Defect in Our Government” in *Essays of Michael, Seigneur de Montaigne* in *The Complete Works of Michael de Montaigne* (1580, trans. C. Cotton, ed. W. Hazlitt 1842)

My father in his domestic economy had this rule (which I know how to commend, but by no means to imitate), namely, that besides the day-book or memorial of household affairs, where the small accounts, payments, and disbursements, which do not require a secretary’s hand, were entered, and which a steward always had in custody, he ordered him whom he employed to write for him, to keep a journal, and in it to set down all the remarkable occurrences, and daily memorials of the history of his house: very pleasant to look over, when time begins to wear things out of memory, and very useful sometimes to put us out of doubt when such a thing was begun, when ended; what visitors came, and when they went; our travels, absences, marriages, and deaths; the reception of good or ill news; the change of principal servants, and the like. An ancient custom, which I think it would not be amiss for every one to revive in his own house; and I find I did very foolishly in neglecting it.

Sample Question #5

The household journal described in the passage could potentially solve all but one of the following problems. Which problem would it NOT help to solve?

- A. Determining exactly how much rain fell on crops in the past month
- B. Remembering when one’s cousin was married
- C. Confirming the number of days a builder worked on a renovation project
- D. Determining how many days the resident family spent on vacation in the past year



To correctly answer this question, we have to consider the passage's description of the uses of the household journal: it contains "all the remarkable occurrences, and daily memorials of the history of [the] house" and is "very pleasant to look over, when time begins to wear things out of memory, and very useful sometimes to put us out of doubt when such a thing was begun, when ended; what visitors came, and when they went; our travels, absences, marriages, and deaths; the reception of good or ill news; the change of principal servants, and the like." From here, we can see that all but one of the answer choices matches up with a quotation from this part of the passage: "Remembering when one's cousin was married" matches up with "marriages," "Confirming the number of days a builder worked on a renovation project" matches up with "when such a thing was begun, when ended," "Determining how many days the resident family spent on vacation in the past year" matches up with "travels" and "absences," and "Recalling the exact date on which a new butler was hired" matches up with "the change of principal servants." The only answer choice that does not match up with a part of the quotation is "Determining exactly how much rain fell on crops in the past month," and this is the correct answer, because nowhere is quantitative data about the amount of rainfall included in the description of the things to be recorded in the journal.



Citing Textual Evidence

Many of the arguments the SAT Reading test presents are composed of two parts: the claims the author makes, and the evidence he or she points to in order to solidify those claims. Questions that concern argumentative passages can query your understanding of these two major components of persuasive writing in ways that focus on your understanding of textual evidence. Some questions may present you with a quotation in the question stem and then ask for specific analysis of how it fits into the passage's argument. Other questions may ask you to identify the particular quotation that supports a given assertion or that contains a particular type of rhetorical gesture. No matter how the SAT structures the specific details of questions about textual evidence, it's sure to test your understanding of the passage's structure. By practicing your ability to read the passage for its claims and support, you can take a step closer to being totally prepared for your exam.

Practice Passage

Adapted from "Humming-Birds: As Illustrating the Luxuriance of Tropical Nature" in *Tropical Nature, and Other Essays* by Alfred Russel Wallace (1878)

The food of hummingbirds has been a matter of much controversy. All the early writers down to Buffon believed that they lived solely on the nectar of flowers, but since that time, every close observer of their habits maintains that they feed largely, and in some cases wholly, on insects. Azara observed them on the La Plata in winter taking insects out of the webs of spiders at a time and place where there were no flowers. Bullock, in Mexico, declares that he saw them catch small butterflies, and that he found many kinds of insects in their stomachs. Waterton made a similar statement. Hundreds and perhaps thousands of specimens have since been dissected by collecting naturalists, and in almost every instance their stomachs have been found full of insects, sometimes, but not generally, mixed with a proportion of honey. Many of them in fact may be seen catching gnats and other small insects just like fly-catchers, sitting on a dead twig over water, darting off for a time in the air, and then returning to the twig. Others come out just at dusk, and remain on the wing, now stationary, now darting about with the greatest rapidity, imitating in a limited space the evolutions of the goatsuckers, and evidently for the same end and purpose. Mr. Gosse also remarks, "All the hummingbirds have more or less the habit, when in flight, of pausing in the air and throwing the body and tail into rapid and odd contortions. This is most observable in the *Polytmus*, from the effect that such motions have on the long feathers of the tail. That the object of these quick turns is the capture of insects, I am sure, having watched one thus engaged pretty close to me."

Links to
Sample Questions

[Sample Question #1](#)

[Sample Question #2](#)

[Sample Question #3](#)

[Sample Question #4](#)



Analyzing Presented Textual Evidence

Let's first focus on questions that either indicate or reproduce a specific quotation in order to draw your attention to some aspect of it. In the following sample question, the question stem indicates a multi-sentence quotation from a particular author found in the passage and asks specifically about how it interacts with the claims of other authors presented before it in the text. Obviously, identifying the correct quotation is crucial to getting this question correct! If you're sent to the passage to consider a particular quotation that is described instead of reproduced, make sure you're looking at the correct lines! Some of the incorrect answer choices may follow along with the logic that appears to be correct if you're looking at wrong lines easily confused with the indicated ones.

Sample Question #1

How does the quotation from Mr. Gosse relate to the evidence provided by other scientists earlier in the passage?

- A. It contradicts the previous evidence and supports a different hypothesis.
- B. It supports the same conclusions that the previous evidence supports.
- C. It suggests that some of the previous evidence may be true, but some may be false.
- D. It suggests that the earlier evidence applies not only to hummingbirds but to another type of bird as well.

Click Here to Revisit the Passage

To answer this question, we have to consider the quotation attributed to Mr. Gosse found at the end of the passage:

Mr. Gosse also remarks, "All the hummingbirds have more or less the habit, when in flight, of pausing in the air and throwing the body and tail into rapid and odd contortions. This is most observable in the *Polytmus*, from the effect that such motions have on the long feathers of the tail. That the object of these quick turns is the capture of insects, I am sure, having watched one thus engaged pretty close to me."

The evidence provided by scientists earlier in the passage supports the idea that hummingbirds eat insects, just like Mr. Gosse's does. We can't say that Gosse's evidence contradicts the earlier evidence, suggests that some of it may be false, or has nothing to do with the previous evidence. It also doesn't suggest that the previous evidence can be applied to birds other than hummingbirds, because Mr. Gosse says that he is only discussing hummingbirds and we are to infer that the *Polytmus* is a hummingbird. So, the correct answer is that "it supports the same conclusions that the previous evidence supports."

Now, let's take a look at a question that saves you the trouble of skimming the passage for a particular described line and presents the specified line in the question stem. Don't



assume this is going to be an easier question, though, even if its structure saves you a bit of work! Like the last sample question, this one asks about how the indicated line's claims interact with other claims, this time asking you to identify an interaction between the line and the claims of a specific quoted authority on hummingbirds.

Sample Question #2

Click Here to
Revisit the
Passage

Consider the following quotation taken from the passage:

Hundreds and perhaps thousands of specimens have since been dissected by collecting naturalists, and in almost every instance their stomachs have been found full of insects, sometimes, but not generally, mixed with a proportion of honey.

This excerpt presents evidence that supports the positions of each of the following individuals EXCEPT _____.

- A. Azara
- B. Bullock
- C. Waterton
- D. the “early writers” mentioned in the second sentence

In order to figure out how this sentence relates to the earlier positions advocated by the individuals named by the answer choices, we have to figure out what each of those people are saying. Azara says he saw hummingbirds eating spiders; Bullock says he saw them eating butterflies, and “a similar statement” to Bullock’s is attributed to Waterton. All of these individuals have one thing in common: they think hummingbirds eat things besides nectar. Consider, in contrast, how the “early writers” are introduced:

All the early writers down to Buffon believed that [hummingbirds] lived solely on the nectar of flowers, but since that time, every close observer of their habits maintains that they feed largely, and in some cases wholly, on insects.

After this point, Azara’s, Bullock’s, and Waterton’s points of view are listed. So, the “early writers” thought hummingbirds ate only nectar, but the underlined portion of the passage says that they eat insects, sometimes with honey. Thus, the underlined portion of the passage supports the viewpoints that hummingbirds eat insects, meaning that held by Azara, Bullock, and Waterton, but opposes the position held by the “early writers” mentioned in line 2.



Identifying Textual Evidence

Time to consider a slightly different style of question that still focuses on textual evidence. Instead of directly or indirectly presenting you with a quotation, these questions have answer choices that are quotations from the passage and ask you to pick out the one that fits described criteria. Recognizing the structure of these questions can help you move to and from them without confusion, saving you valuable time on your exam. Keep in mind that when presented as answer choices, statements from the passage are taken out of context. Make sure you understand exactly what is being stated; if anything is unclear or you remember the passage making dynamic shifts in direction around one or more of the listed statements, you may want to glance over the text again to note where exactly the quotations appear in the author's argument. Questions will vary as to how dependent they are on your understanding of the structure of the passage's argument as a whole, but for each of them, it's crucial that you note the subtleties being conveyed in each line. You don't want to miss an important detail, so take your time when reading these sentences. After all, you're only being presented with four options, not the entire passage. You don't need to rush!

The following sample question asks you to identify which of the four presented sentences makes a particular rhetorical move: using personal experience as evidence.

Sample Question #3

Click Here to
Revisit the
Passage

In which of the following sentences does Mr. Gosse use firsthand experience to support his claims?

- A. "That the object of these quick turns is the capture of insects, I am sure, having watched one thus engaged pretty close to me."
- B. "All the hummingbirds have more or less the habit, when in flight, of pausing in the air and throwing the body and tail into rapid and odd contortions."
- C. "This is most observable in the Polytmus, from the effect that such motions have on the long feathers of the tail."
- D. "Many of them in fact may be seen catching gnats and other small insects just like fly-catchers, sitting on a dead twig over water, darting off for a time in the air, and then returning to the twig."

Initially, it might look like context isn't the most relevant factor; the correct answer should contain the gesture to personal experience, so you might think that you won't have to go back to the passage to understand that that argumentative move is being made. Note, though, that you're specifically being asked to identify the sentence in which Mr. Gosse is making that argumentative move, not the author! It's important that you pick a sentence that is attributed to Mr. Gosse. This sort of detail allows one of the incorrect answers, D, to seem correct at first glance, as it seems to reference firsthand experience. Be careful, though! It relates to the author's opinion, not Mr. Gosse's! That means it's incorrect.



Focusing in on the quotation from Mr. Gosse allows us to narrow our answer choices down to A, B, and C. Mr. Gosse says that he has seen hummingbirds contort themselves in the air and he's pretty sure they're doing this in order to catch insects. He uses the claim that he has personally observed hummingbirds twisting and turning in midair to support his claims in the last line, when he says, "having watched one thus engaged pretty close to me." This means that answer choice A is the best answer.

For this last sample question, we're going to take a look at a question that looks at a hypothetical argument and asks you to pick out the line that would best support it. Don't let the fact that the argument isn't actually stated in full distract you: you're given all the information you need to pick out the correct answer.

Sample Question #4

Click Here to
Revisit the
Passage

If someone wanted to make the argument that flower nectar is a part of some hummingbirds' diets, which of the sentences listed below would provide the best evidence for this person's claim?

- A. "The food of hummingbirds has been a matter of much controversy."
- B. "Azara observed them on the La Plata in winter taking insects out of the webs of spiders at a time and place where there were no flowers."
- C. "Others come out just at dusk, and remain on the wing, now stationary, now darting about with the greatest rapidity, imitating in a limited space the evolutions of the goatsuckers, and evidently for the same end and purpose."
- D. "Hundreds and perhaps thousands of specimens have since been dissected by collecting naturalists, and in almost every instance their stomachs have been found full of insects, sometimes, but not generally, mixed with a proportion of honey."

A subtle inference is relevant to this question: hummingbirds consume flower nectar, which turns to honey in their stomachs. Without recognizing this, it might be much more difficult to identify the correct answer. In this way, your understanding of the entire passage is indirectly tested by a question that at the surface appears to only concern specified sentences.

Answer choice A doesn't support the claim that some hummingbirds' diets include flower nectar at all; it just conveys that people have argued for a long time about what hummingbirds eat. B provides one scientist's observation that some hummingbirds ate insects "at a time and place where there were no flowers." While this mentions flowers, it doesn't provide evidence that hummingbirds eat flower nectar, just that they eat insects.

Distinguishing the best answer between C and D gets a little trickier. Context comes into play in understanding answer choice C: you need to understand what the comparison to another type of bird, "the goatsuckers," is doing here. Is the author comparing hummingbirds to goatsuckers to suggest that they both eat flower nectar? No—he's suggesting that they both eat insects. While this isn't directly stated, this description is



sandwiched between a statement from the author that states that hummingbirds seem to appear to eat insects (“Many of them in fact may be seen catching gnats and other small insects just like fly-catchers . . .”) and a long quotation from Mr. Gosse that provides evidence that hummingbirds eat insects (“That the object of these quick turns is the capture of insects, I am sure, having watched one thus engaged pretty close to me”). Given this, C does not support the indicated argument, making D the best answer. D’s statement is the only point in the passage apart from “All the early writers down to Buffon believed that they lived solely on the nectar of flowers” that provides evidence that supports the claim that hummingbirds eat any flower nectar. While it doesn’t state that hummingbirds eat only honey, it does claim that “sometimes, not generally,” specimens have been found to have consumed flower nectar.



Identifying Main Ideas and Themes

Finding the main idea of a passage is an integral component in developing reading comprehension skills necessary to succeed on the SAT. The main idea of the passage can differ in each of its constituent paragraphs. Being able to recognize the nuances between these ideas and how they build upon one another to create a coherent narrative is crucial for succeeding on the SAT Reading test.

Practice Passage

Adapted from *Logic: Inductive and Deductive* by William Minto (1915)

We cannot inquire far into the meaning of proverbs or traditional sayings without discovering that the common understanding of general and abstract names is loose and uncertain. Common speech is a quicksand.

Consider how we acquire our vocabulary, how we pick up the words that we use from our neighbors and from books, and why this is so soon becomes apparent. Theoretically, we know the full meaning of a name when we know all the attributes that it connotes, and we are not justified in extending it except to objects that possess all the attributes. This is the logical ideal, but between the ought to be of Logic and the is of practical life, there is a vast difference. How seldom do we conceive words in their full meaning! And who is to instruct us in the full meaning? It is not as in the exact sciences, where we start with knowledge of the full meaning. In Geometry, for example, we learn the definitions of the words used, “point,” “line,” “parallel,” etc., before we proceed to use them. But in common speech, we hear the words applied to individual objects; we utter them in the same connection; we extend them to other objects that strike us as like without knowing the precise points of likeness that the convention of common speech includes. The more exact meaning we learn by gradual induction from individual cases. The individual’s extension of the name proceeds upon what in the objects has most impressed him when he caught the word: this may differ in different individuals; the usage of neighbors corrects individual eccentricities. The child in arms shouts “Da” at the passing stranger who reminds him of his father; for him at first it is a general name applicable to every man; by degrees he learns that for him it is a singular name.

It is obvious that to avoid error and confusion, the meaning or connotation of names, the concepts, should somehow be fixed; names cannot otherwise have an identical reference in human intercourse. We may call this ideal fixed concept the Logical Concept. But in actual speech we have also the Personal Concept, which varies more or less with the individual user, and the Popular or Vernacular Concept,

Links to
Sample Questions

[Sample Question #1](#)

[Sample Question #2](#)

[Sample Question #3](#)



which, though roughly fixed, varies from social sect to social sect and from generation to generation.

When we come to words of which the logical concept is a complex relation, an obscure or intangible attribute, the defects of the popular conception and its tendencies to change and confusion are of the greatest practical importance. Take such words as “monarchy,” “civil freedom,” “landlord,” “culture.” Not merely should we find it difficult to give an analytic definition of such words; we might be unable to do so, and yet flatter ourselves that we had a clear understanding of their meaning.

It was with reference to this state of things that Hegel formulated his paradox that the true abstract thinker is the plain man who laughs at philosophy as what he calls abstract and unpractical. He holds decided opinions for or against this or the other abstraction, “freedom,” “tyranny,” “revolution,” “reform,” “socialism,” but what these words mean and within what limits the things signified are desirable or undesirable, he is in too great a hurry to pause and consider.

The disadvantages of this kind of “abstract” thinking are obvious. The accumulated wisdom of mankind is stored in language. Until we have cleared our conceptions, and penetrated to the full meaning of words, that wisdom is a sealed book to us. Wise maxims are interpreted by us hastily in accordance with our own narrow conceptions. All the vocabulary of a language may be more or less familiar to us, and yet we may not have learnt it as an instrument of thought.

When tackling reading passages on the SAT Reading test, the best and most natural place to start is to interrogate and figure out the main idea or theme of the passage. Both terms basically refer to what the passage is about. In order to answer any questions about a passage with confidence, it is a massive help to have a general understanding of the main point or intent of the passage you are reading.

While it’s important to grasp the main point of a passage for your own understanding, some questions will specifically query the main points of entire passages or excerpts from them. The nice thing about these questions is that they are the most natural questions to answer, in that these questions most closely mirror the questions anyone asks themselves while reading a passage: what is happening in this passage, and what is the point of this passage?

While such questions can be quite general in nature, you should always base your notion of the main idea or theme of a passage on specific evidence drawn from the passage. The answer to a main idea question on the SAT will always be based directly on the text; you are not being asked to *make an inference* in order to answer a question interrogating the main point of a passage or excerpt.



Finding the Main Idea of a Selection from a Passage

One kind of main idea question you may be asked to answer concerns the main idea of a small part (usually a paragraph) of a passage. Note that if the question asks you about the meaning or main idea of a specific part of a passage. In specifying that part, the question is asking you only about that part. One paragraph may be conveying a completely different idea than the one conveyed by the passage as a whole. Be careful to read the question carefully, and answer for only the part of the passage selected if a particular part of the passage is specified.

Sample Question #1

Which of the following options best captures the main idea of the second paragraph?

- A. We learn the meaning of most words organically and as a result the exact definition and application of those words will differ from person to person.
- B. People learn the meaning of words best when those words are specifically and rigidly defined.
- C. It is impossible to define the vast majority of words because people have their own personal ideas about how each thing could best be described.
- D. Babies learn words without being intentionally taught them and seem to develop incorrect assumptions about the meanings of certain words.

Click Here to
Revisit the
Passage

The second paragraph begins with the author asking the reader to “Consider how we acquire our vocabulary, how we pick up the words that we use from our neighbors and from books.” We thus know that the second paragraph is going to be a consideration of how we acquire words and definitions for things. The author goes on to state that “We hear the words applied to individual objects; we utter them in the same connection; we extend them to other objects that strike us as like without knowing the precise points of likeness that the convention of common speech includes.” This tells us that the author believes we learn words “organically,” or naturally. Finally, the author says, “The individual’s extension of the name proceeds upon what in the objects has most impressed him when he caught the word: this may differ in different individuals.” This tells us that the author believes the result of our organic learning is that the exact definition and application of words differs from person to person. The other answer choices either summarize a small part of the paragraph, or else they draw incorrect conclusions from the author’s writing. You will not be able to find any evidence to support these summaries in the paragraph specified by the question.



Click Here to
Revisit the
Passage

Sample Question #2

Which of the following options best summarizes the main point of the sixth paragraph?

- A. In order to fix the problems associated with “abstract” thinking we must collectively focus on deep thinking and a scientific classification of words and names.
- B. Hegel’s “abstract” thinking is not applicable to the author’s argument because it ignores the preconceptions that blind each individual to the true meaning of words and names.
- C. Our individual preconceptions blind us to the true meaning of words and prevent us from accurately penetrating the combined knowledge of humanity.
- D. None of these answers accurately summarizes the point of the sixth paragraph.

The main point of the sixth paragraph is best captured in the following few sentences: “The accumulated wisdom of mankind is stored in language. Until we have cleared our conceptions, and penetrated to the full meaning of words, that wisdom is a sealed book to us. Wise maxims are interpreted by us hastily in accordance with our own narrow conceptions.” Here, the author discusses how people’s individual preconceptions blind them to the true meaning of words, and draws his conclusions on how this individual approach to definition and meaning prevents people from accessing to combined wisdom of humanity. The other answer choices either summarize the wrong paragraph, or else do not properly penetrate to the heart of the author’s argument in this paragraph. Note particularly that while the paragraph in question is concerned with “abstract thinking,” it makes no mention “scientific classification,” so answer A is clearly not correct. Answer B is similarly incorrect inasmuch as Hegel is mentioned in the fifth, not the sixth, paragraph.

Finding the Theme of an Entire Passage

Unless the question specifies a particular selection from the passage, main idea questions will concern the general, most important notion or idea from the entire passage—it’s “theme.” Answering these questions correctly requires pretty much the same process as answering questions about the main ideas of a particular sections. Even though these questions are more general in nature, it is still vital to root your interpretation of the text’s main idea in evidence drawn directly from the passage.

It is also important to note that, just as questions specifying a particular section of a passage will be concerned only with that section, questions interrogating the entire passage are focused on the passage as a whole. Some answers will try to trick you by summarizing the main point of a particular paragraph, not the passage as a whole. Make sure that the answer you claim represents the entire passage relates to each of its paragraphs in general, not just one or two of them in isolation!



Click Here to
Revisit the
Passage

Sample Question #3

The main argument made in this passage is that _____.

- A. a sophisticated understanding of the language people use will facilitate understanding of culture and thought
- B. it is impossible to learn the roots of words and expressions
- C. geometry is a more defined science than is abstract philosophy
- D. None of these answers accurately sums up the main point of the passage.

The key here is taking a holistic, appropriately open view of the entire passage. Answer option B makes a radical oversimplification of the passage's point. Options like this one appear often in main idea questions, and it's important to remember that passages chosen for the SAT Reading are chosen because they are sufficiently complex so as to be mined for a number questions, they will rarely boil down to main ideas that are blunt, simple, or aggressively overarching in their claims. While geometry is mentioned in the passage, a direct comparison of geometry to another discipline is clearly not the main idea of this passage. Now, having eliminated B and C, the only thing to decide is if answer option A is accurate, which in this case it is, both the first and last paragraph (usually good places to look for hints at the main idea) make this goal clear.



Summarizing and Paraphrasing

Summarizing and paraphrasing—two concepts often drastically underestimated in how difficult questions about them can be! Coming up with a good paraphrase or summary of a sentence, section, or passage involves discerning the perfect amount of detail to include. This gets more difficult as the focus of a question grows wider in scope; paraphrasing a sentence might be much easier than summarizing a passage. Read on to practice putting passage content into your own words with confidence!

Practice Passage

Prose Fiction: Adapted from “The McWilliamses and the Burglar Alarm” in *The Mysterious Stranger and Other Stories* by Mark Twain (1898; 1916 edition)

The conversation drifted along from weather to crops, from crops to literature, from literature to scandal, from scandal to religion; then took a random jump, and landed on the subject of burglar alarms. And now for the first time Mr. McWilliams showed feeling. Whenever I perceive this sign on this man’s dial, I comprehend it, and lapse into silence, and give him opportunity to unload his heart. Said he, with but ill-controlled emotion:

“I do not go one single cent on burglar alarms, Mr. Twain—not a single cent—and I will tell you why. When we were finishing our house, we found we had a little cash left over. I was for donating it to charity; but Mrs. McWilliams said no, let’s have a burglar alarm. I agreed to this compromise. Whenever I want a thing, and Mrs. McWilliams wants another thing, and we decide upon the thing that Mrs. McWilliams wants—as we always do—she calls that a compromise. Very well: the man came up from New York and put in the alarm, and charged three hundred and twenty-five dollars for it, and said we could sleep without uneasiness now. So we did for awhile—say a month. Then one night we smelled smoke. I lit a candle, and started toward the stairs, and met a burglar coming out of a room with a basket of tinware, which he had mistaken for solid silver in the dark. He was smoking a pipe. I said, ‘My friend, we do not allow smoking in this room.’ He said he was a stranger, and could not be expected to know the rules of the house: said he had been in many houses just as good as this one, and it had never been objected to before.

“I said: ‘Smoke along, then. But what business have you to be entering this house in this furtive and clandestine way, without ringing the burglar alarm?’

He looked confused and ashamed, and said, with embarrassment: ‘I beg a thousand pardons. I did not know you had a burglar alarm, else I would have rung it. **I beg you will not mention it where my parents may hear of it, for they are old and feeble, and such a seemingly wanton breach of the hallowed conventionalities of our civilization might all too rudely sunder the frail bridge which hangs darkling between the pale and evanescent present and the solemn great deeps of the eternities.** May I trouble you for a match?’

Links to
Sample Questions

[Sample Question #1](#)

[Sample Question #2](#)

[Sample Question #3](#)

[Sample Question #4](#)



Summarizing and paraphrasing are two different but closely related tasks that vary at the level of the material being considered. One is usually asked to paraphrase a sentence or a short paragraph, while material indicated by questions asking you to summarize can span from one paragraph to the entire passage. Because of its focus on relatively short amounts of text, paraphrasing requires you to pay attention to retaining the specific content of the sentence(s) at hand, whereas in summarizing, you are working with lots of material and should instead make sure your statement refers to all of the major units (e.g. paragraphs, sentences) that you are being asked to encompass while remaining relevant and not erring on the side of being too general in a way that doesn't represent the content you're summarizing. Let's work through a few sample questions so that you can understand how paraphrasing and summarizing slightly differ by trying out each task yourself.

Paraphrasing an Excerpt

As usual, we'll work from specific to general, so let's begin with paraphrasing. While some paraphrasing questions may focus on relatively simple sentences, their difficulty increases with the complexity of the sentence that you have to put into your own words, and literary devices like metaphor and figurative language can also present potential obstacles between you and the correct answer. For example, here's a rather challenging paraphrasing question:

Sample Question #1

Which of the following is the BEST paraphrase of the underlined and bold excerpt?

- A. They might learn that their son is a burglar.
- B. They might fall off of the bridge on which they are traveling.
- C. They may not be able to forgive the speaker for his breach of etiquette.
- D. The shock of the news might kill them.

The language used in the indicated part of the passage is much more complex and full of rhetorical flourishes than the rest of the passage, which may throw you off when answering this question. Let's consider the context of the entire sentence first, as this can help us figure out which of the answer choices' meanings don't make sense. The sentence is spoken by the burglar, who is replying to Mr. McWilliams; Mr. McWilliams has just asked him why the burglar didn't ring the burglar alarm, and the burglar has apologized for not doing so. The burglar then asks Mr. McWilliams to "not mention it where my parents may hear of it," so we know he is talking about his parents. He says his parents are "old and feeble," and then we run into the very complex part of the sentence. At this point we know the complex part is referring to the burglar's older parents. While there is a bridge mentioned, it is mentioned figuratively—there is not an actual bridge in the story being referred to here; this means that B, "they might fall off of the bridge on which they are traveling," cannot be correct.

Click Here to
Revisit the
Passage



This leaves us to choose between three remaining answer choices: “they might learn that their son is a burglar,” “they may not be able to forgive the speaker for his breach of etiquette,” and “the shock of the news might kill them.” While the first two of these answer choices may look correct, the third one is actually the best paraphrase. If Mr. McWilliams mentioned the burglar not ringing the burglar alarm where the burglar’s parents could hear of it, they “might learn their son is a burglar” and “they might not be able to forgive their son for his breach of etiquette.” Both of those are reasonable, even almost necessary conclusions. However, the underlined portion of the sentence is discussing the idea that the shock of this information might kill the burglar’s parents; the burglar is describing how the metaphorical “bridge” between “the pale and evanescent present” (in other words, the fleeting present) and “the solemn great deeps of the eternities” (a phrase that evokes the future, the passage of time, and most relevantly for our purposes in answering this question, death) would be broken. The underlined portion is thus saying that the shock of the news might kill the burglar’s parents, making D, “the shock of the news might kill them,” the correct answer.

When paraphrasing, it’s crucial to stick to what’s said in the passage, even if other answer choices make sense. This will help you to not introduce ideas that appear later or not at all in the passage into your answer choices. And watch out, because you may be asked to paraphrase some unique or unexpected sentences, and the test-writers may expect you to answer based on an assumption of what sounds logical or correct, as so much of the rest of the SAT is based on that set of expectations. Not in this case! If the passage is completely objectively wrong about something or not making logical sense, it doesn’t matter for this type of problem: the indicated part of the passage is still what you have to paraphrase!

Summarizing an Excerpt

Let’s take a look at summary now, zooming out to consider larger excerpts that encompass several sentences or more. The next question concerns a five-sentence excerpt. Can you condense it into a single line of summary?

Sample Question #2

Which of the following best summarizes the underlined selection in the second paragraph?

- A. After some debate, Mr. and Mrs. McWilliams agree to buy a burglar alarm.
- B. When Mr. and Mrs. McWilliams disagree, Mrs. McWilliams usually gets her way.
- C. Mr. McWilliams does not trust burglar alarms.
- D. The McWilliamses paid \$325.00 for their burglar alarm, and a man from New York installed it.

Click Here to
Revisit the
Passage



The trick to a good summary is all in the level of detail it conveys. We need the detail to cover what happens in all of the indicated sentences, so it can't just focus on one aspect of them while ignoring what happens in the rest of the excerpt. Also, a good summary won't introduce new information or generalities; this helps it stick closely to the meaning of the material being summarized.

Consider the indicated excerpt. If you were telling a friend what happens in this part of the story, what might you say? "Well, Mr. and Mrs. McWilliams had some extra money, and Mr. McWilliams wanted to give the money to charity, but Mrs. McWilliams wanted a burglar alarm, so they got one. It sounded expensive." That's a perfectly good, if casual and long, summary of the section. Quickly summarizing the indicated text for yourself before considering the answer choices can help you calibrate your thinking to the level of detail the correct answer will use, and maybe help incorrect answers that are too general or too specific stick out as incorrect.

For instance, in the summarizing-to-a-friend quotation above, the price of the burglar alarm and details about the person who installed it weren't included, yet we got a good sense of the events in the text. This (correctly) suggests that D isn't the correct answer—it's too detailed. The same thing can be said for B—while this forms a larger part of the excerpt, just relating how Mr. and Mrs. McWilliams handle compromises is also not an summary of the excerpt. Look at all sentences that are just about burglar alarms that follow the part about their compromises—B doesn't convey any information about those sentences, and when entire sentences have nothing to do with a statement that's supposed to include them in a summary, that's a pretty good indication that the summary isn't accurate to the text it's describing. B isn't correct either. C seems appropriately general, and might seem a little familiar; that's because it's describing the wrong part of the passage at the right level of specificity.

Summarizing a Passage

Time to look at the largest-scale question of this type and attempt to summarize the entire passage! Passage-level summary questions can take a few different forms, from the directive to just pick out the best summary sentence to others that focus on other, more general summaries about what kind of story or text you've read or even complex logical underpinnings of the text. Let's have a look at a few examples.

Sample Question #3

Which of the following best describes this passage?

- A. An educational story about why people shouldn't smoke
- B. A humorous story about burglar alarms
- C. A serious story about a man being robbed
- D. A funny story about purchases people regret

[Click Here to Revisit the Passage](#)



This story is best described as humorous because of several illogical details meant to strike the reader as funny: the fact that Mr. McWilliams meets a burglar and asks him why the burglar didn't ring the burglar alarm is a humorous detail, and the fact that the burglar asks for a match and we can infer that Mr. McWilliams provides him with one (from the statement "Spare your thigh; this kind light only on the box") is also meant to be a funny, unexpected interaction. So, we can narrow down our answer choices to "a humorous story about burglar alarms" or "a funny story about purchases people regret." The best answer is "a humorous story about burglar alarms" because it is the more specific answer choice; in the first paragraph, the story begins with a specific focus on burglar alarms, saying, "[The conversation] landed on the subject of burglar alarms. And now for the first time Mr. McWilliams showed feeling." The rest of the passage maintains this initial focus on burglar alarms.

The next question asks you not to summarize the text, but the logic at work in the story being told.

Sample Question #4

Click Here to
Revisit the
Passage

Which of the following accurately describes how the narrator believes the burglar alarm to work in the passage?

- A. A thief entering the McWilliams' house causes the burglar alarm goes off.
- B. The burglar alarm warns other burglars to avoid the McWilliams' house before any potential theft has occurred.
- C. If a theft is thought to have occurred, the McWilliamses are to ring the burglar alarm and ask the burglars if they have stolen anything.
- D. The burglar alarm is set off when a thief rings it.

A major part of this passage hinges on the faulty but humorous way in which Mr. McWilliams thinks the burglar alarm works. While "A thief entering the McWilliams' house causes the burglar alarm goes off" may look like the correct answer because that is how burglar alarms actually work, that is not the case in this passage. The line most crucial for understanding how Mr. McWilliams thinks the burglar alarm works is when he addresses the burglar and says, "But what business have you to be entering this house in this furtive and clandestine way, without ringing the burglar alarm?" Based on this sentence, Mr. McWilliams expected the burglar to ring the burglar alarm on his way into the house, so the correct answer is "The burglar alarm is set off when a burglar rings it."



Deciphering Words and Phrases in Context

The SAT's Reading section can include questions that test your ability to identify the meanings of various words and phrases; however, this doesn't mean that you need to start drilling vocabulary words! The skill being tested in these questions isn't rote memorization, or even breadth of vocabulary—the test is interested in how well you can pay attention to the elements of the text surrounding an indicated word or phrase and use it to ascertain its meaning.

Practice Passage

Adapted from *The Life and Adventures of Robinson Crusoe* by Daniel Defoe (1719)

I was now, in the months of November and December, expecting my crop of barley and rice. The ground I had manured and dug up for them was not great; for, as I observed, my seed of each was not above the quantity of half a peck, for I had lost one whole crop by sowing in the dry season. But now my crop promised very well, when on a sudden I found I was in danger of losing it all again by enemies of several sorts, which it was scarcely possible to keep from it; as, first, the goats, and wild creatures which I called hares, who, tasting the sweetness of the blade, lay in it night and day, as soon as it came up, and eat it so close, that it could get no time to shoot up into stalk.

This I saw no remedy for but by making an enclosure about it with a hedge; which I did with a great deal of toil, and the more, because it required speed. However, as my arable land was but small, suited to my crop, I got it totally well fenced in about three weeks' time; and shooting some of the creatures in the daytime, I set my dog to guard it in the night, tying him up to a stake at the gate, where he would stand and bark all night long; so in a little time the enemies forsook the place, and the corn grew very strong and well, and began to ripen apace.

But as the beasts ruined me before, while my corn was in the blade, so the birds were as likely to ruin me now, when it was in the ear; for, going along by the place to see how it throve, I saw my little crop surrounded with fowls, of I know not how many sorts, who stood, as it were, watching till I should be gone. I immediately let fly among them, for I always had my gun with me. I had no sooner shot, but there rose up a little cloud of fowls, which I had not seen at all, from among the corn itself.

This touched me sensibly, for I foresaw that in a few days they would devour all my hopes; that I should be starved, and never be able to raise a crop at all; and what to do I could not tell; however, I resolved not to lose my corn, if possible, though I should watch it night and day. In the first place, I went among it to see what damage was already done, and found they had spoiled a good deal of it; but that as it was yet too green for them, the loss was not so great but that the remainder was likely to be a good crop if it could be saved.

Links to
Sample Questions

[Sample Question #1](#)

[Sample Question #2](#)

[Sample Question #3](#)

[Sample Question #4](#)

[Sample Question #5](#)

[Sample Question #6](#)



I stayed by it to load my gun, and then coming away, I could easily see the thieves sitting upon all the trees about me, as if they only waited till I was gone away, and the event proved it to be so; for as I walked off, as if I was gone, I was no sooner out of their sight than they dropped down one by one into the corn again. I was so provoked, that I could not have patience to stay till more came on, knowing that every grain that they ate now was, as it might be said, a peck-loaf to me in the consequence; but coming up to the hedge, I fired again, and killed three of them. This was what I wished for; so I took them up, and served them as we serve notorious thieves in England—hanged them in chains, for a terror to others. It is impossible to imagine that this should have such an effect as it had, for the fowls would not only not come at the corn, but, in short, they forsook all that part of the island, and I could never see a bird near the place as long as my scarecrows hung there. This I was very glad of, you may be sure, and about the latter end of December, which was our second harvest of the year, I reaped my corn.

Did you notice that the previous passage contained some words and phrasing that aren't common parlance any more? That's because it's from a work of fiction published in 1719. It's reasonable to assume that the English language will have changed a bit over the course of nearly three hundred years! This archaic text makes it clear how important context clues can be in figuring out what exactly a passage means by them. Let's consider a few questions that fall into two general types: those that ask about the meaning of a single word, and those that ask about the meaning of a phrase or clause. Questions that concern a single word can be further divided into those that ask about words with which you are unfamiliar, and those that ask about words you've seen before. These latter questions may seem simpler, but can be extra tricky if the word in question has more than one accepted meaning!

Context-Based Meaning of Unfamiliar Words

Let's consider a sample question about a word that is most likely unfamiliar to you.

Sample Question #1

In the second paragraph, the underlined word “apace” most closely means _____.

- A. nearby
- B. with difficulty
- C. quickly
- D. without warning

Click Here to
Revisit the
Passage



It's unlikely that you know which answer is correct right off the bat, so getting this question right will be a matter of discerning what the word's meaning has to be from the way it is used in the context of the passage. Consider part of the sentence that precedes it:

I set my dog to guard [my arable land growing crops] in the night, tying him up to a stake at the gate, where he would stand and bark all night long; so in a little time the enemies forsook the place, and the corn grew very strong and well, and began to ripen apace.

In the first half of the sentence, the narrator has his dog guard his crops at night. The sentence concludes with the narrator reporting that “in a little time” “the enemies” (birds, in this case) stopped trying to eat his crops, and his corn grew well and began to ripen “apace.” What could “apace” mean? There seems to be an overall sense of cause-and-effect going on in this sentence, so “apace” might mean something like “therefore,” only appearing after the event being caused is described. Or, it might mean “well,” since the corn is growing well, but that means that “apace” would be a bit redundant, since the earlier part of the sentence says that “the corn grew very strong and well.”

We know that one of the answer choices is correct, so instead of trying to pinpoint the exact meaning of “apace” from its context, let's use the context to narrow down the possible answer choices and identify the correct one. The sentence doesn't convey anything about the distance between the corn and anything else, and nothing in the surrounding context of other sentences suggests that “apace” could logically mean “nearby,” so we can ignore answer choice A. Since we're told that the corn “grew very strong and well,” it seems that its ripening would have surprised anyone, so for “apace” to mean “without warning” doesn't make much sense either. Similarly, the fact that we're told that the corn “grew very strong and well” and told nothing to the contrary that would suggest it had a hard time growing means that it wouldn't logically follow from the earlier part of the sentence for “apace” to mean “with difficulty.” That means that there's only one answer choice that makes logical sense: “quickly.” The sentence uses the phrase “in a little time” a bit before it uses “apace,” so it's reasonable to assume that the corn might grow quickly, especially if it is, as we are told, “[growing] strong and well.” A is the correct answer.

You can approach any context-based meaning question in this manner: come up with your own idea of what the word could mean based on its context, and/or knock out answer choices until you've identified the one that makes the most sense given the specific usage of the word in the passage.

Words with Multiple Meanings

At first glance, context-based meaning questions that ask you about the definitions of familiar words may look entirely too easy in comparison to the rest of the questions you encounter on the SAT Reading test. You might suspect that there is some sort of “catch” to the question, and you'd be correct in your suspicions: these questions are rarely as straightforward as they initially seem to be. Like context-based meaning questions testing unfamiliar words, these are testing your ability to read the passage for context clues. They often contain answers that look like they are obviously correct, but upon further examination, are not! Take, for instance, the following sample question:



Click Here to
Revisit the
Passage

Sample Question #2

In the last paragraph, the underlined word “scarecrows” refers to

_____.

- A. corn dollies
- B. straw men
- C. birds’ remains
- D. dead rabbits

“I know what ‘scarecrows’ means,” you might be thinking to yourself as you read this question, ready to pick B, “straw men” as your answer and save time for more challenging problems. But do you really know what it means in context? Consider the passage’s usage of the term:

but coming up to the hedge, I fired again, and killed three of [the pests]. This was what I wished for; so I took them up, and served them as we serve notorious thieves in England—hanged them in chains, for a terror to others. It is impossible to imagine that this should have such an effect as it had, for the fowls would not only not come at the corn, but, in short, they forsook all that part of the island, and I could never see a bird near the place as long as my scarecrows hung there. This I was very glad of, you may be sure.

There no mention of anything resembling a traditional “straw men” scarecrows in this passage, so B cannot be correct, no matter how common a definition it is for the term when used in other contexts. Context-based meaning questions that use familiar words will often use terms that have multiple meanings, and expect to catch you off-guard by presenting you with correct meanings that don’t work in the passage’s context. Don’t let them fool you!

Now that we’ve figured out that B isn’t the correct answer, let’s figure out which answer choice *is* correct. The passage does talk about corn quite a bit, but it’s not because the narrator is constructing “corn dollies”—he’s growing a crop of corn. No mention is ever made of him making anything out of corn stalks, so A can’t be correct. This leaves us with C and D—dead birds or dead rabbits. What type of animal did the narrator actually shoot in the passage? To determine this, we have to look even further back in the passage for extended context, and things get a little tricky. Considering this question and skimming the passage starting with its first paragraph, we find that the narrator realized that the narrator, in guarding his crop, has “enemies of several sorts, which it was scarcely possible to keep from it; as, first, the goats, and wild creatures which I called hares, who, tasting the sweetness of the blade, lay in it night and day, as soon as it came up, and eat it so close, that it could get no time to shoot up into stalk.” This suggests that the correct answer might be D, “dead rabbits.” Keep reading to make sure, though, and you’ll find the last detail we need to answer this question in the third paragraph:

going along by the place to see how it throve, I saw my little crop surrounded with fowls, of I know not how many sorts, who stood, as it were, watching till I should



be gone. I immediately let fly among them, for I always had my gun with me. I had no sooner shot, but there rose up a little cloud of fowls, which I had not seen at all, from among the corn itself.

The part of the passage that specifically talks about the narrator shooting at anything doesn't involve him shooting at any rabbits—it involves him shooting at “fowls”—birds. Thus, the correct answer is C, “birds’ remains.” After taking so many steps to determine this answer to what may have first seemed like an obvious question, it's clear why you should approach any context-based meaning question involving a familiar word with caution and suspicion! It probably involves some form of catch.

Let's consider another sample question demonstrating the same thing in a slightly different way.

Click Here to
Revisit the
Passage

Sample Question #3

As it is used in the passage, the underlined word “blade” in the first paragraph most nearly means _____.

- A. leaf
- B. spade
- C. knife
- D. hedge

You likely recognize “blade” and immediately jump to answer choice C, “knife,” as the best option. But let's check how the passage uses the term:

But now my crop promised very well, when on a sudden I found I was in danger of losing it all again by enemies of several sorts, which it was scarcely possible to keep from it; as, first, the goats, and wild creatures which I called hares, who, tasting the sweetness of the blade, lay in it night and day, as soon as it came up, and eat it so close, that it could get no time to shoot up into stalk.

“Blade” does not mean “knife” in this passage; it means something that the goats and hares are eating; what's more, they are eating it “so close” that it then can't “shoot up into stalk.” So, this tells us that “blades” become “stalks.” They grow. “Blade” has to indicate something that can grow and be eaten, then.

We can ignore answer choices B and C and concentrate on A, “leaf,” and D, “hedge.” In deciding between these two, consider what plant the author is growing in the passage: it's not a plant that makes up hedges—it's corn. D isn't the correct answer as hedges aren't mentioned anywhere in the passage. A, “leaf,” is the best answer. The author is using “blade” like we use the term when we talk about “blades of grass.”

Let's look at one more example, this time with a new twist.



Click Here to
Revisit the
Passage

Sample Question #4

As it is used in the passage, the underlined word “peck” in the first paragraph most nearly means _____.

- A. a unit of agricultural measurement
- B. jab with a pointed beak
- C. a slight sensation of hunger
- D. annoyance with repeated questions

Once again, you may think that you’ve found an obvious question with an obvious answer, B, “jab with a pointed beak.” After all, the passage even talks about the narrator fighting off birds from his crops, right? As usual, with context-based meaning questions, it is imperative that you identify the word in the passage and consider how it is used *there*, not in common parlance, as the test often picks words in situations where these differ greatly:

I was now, in the months of November and December, expecting my crop of barley and rice. The ground I had manured and dug up for them was not great; for, as I observed, my seed of each was not above the quantity of half a peck, for I had lost one whole crop by sowing in the dry season.

While the sentence structure may sound strange due to the text being hundreds of years old, “My seed of each was not above the quantity of half a peck” gives you all of the information you need to answer this question correctly. Skimming the answer choices, did you notice something that makes this question different from the others we’ve considered? In this case, two of the answer choices (A and C) provide definitions of nouns, and the other two (B and D) provide definitions of verbs. This means that the first thing we need to do is figure out if “peck” is being used as a noun or a verb in the passage. Applying a little grammatical knowledge can be extremely helpful in scenarios like these: “peck” is contained in the prepositional phrase “of half a peck,” and in order to have half of something, it has to be, well, something—in grammatical terms, a noun. You can’t have half a verb! This simple observation allows us to knock out answer choices B and D. So, is “peck” being used to mean “a unit of agricultural measurement” or “a slight sensation of hunger?” Hunger could very well be discussed in the passage, as the narrator is worried about the amount of crops he will be able to grow, but there’s a big neon sign of a context clue hanging out right before the term in the passage that makes choosing between these answer choices very easy: “peck” appears in the phrase “the quantity of half a peck.” “Half a peck,” and by extension, a “peck,” are each designations of some agricultural quantity. Don’t quite know the exact details of how much seed is in a “peck?” That’s ok—all you need to do is say that’s how the word is being used. You don’t need to understand all of the subtleties of the term. The correct answer is A!



Context-Dependent Meaning of Phrases and Clauses

Certain context-based meaning questions ask about phrases and clauses instead of single words, but you can approach them in the same way—and with the same suspicions about any familiar-sounding phrases.

Sample Question #5

As it is used in the passage, the phrase “in the ear” underlined in the third paragraph most nearly means _____.

- A. failed
- B. finished growing
- C. rotten
- D. ripened

Click Here to
Revisit the
Passage

You might initially try to attribute a literal meaning to “in the ear,” but the author doesn’t talk about ears as a body part in the passage; he talks about ears of corn. Many of our answer choices have to do with meanings that could easily be applied to corn, so let’s consider the passage’s usage of “in the ear” to figure out what it means by it:

But as the beasts ruined me before, while my corn was in the blade, so the birds were as likely to ruin me now, when it was in the ear; for, going along by the place to see how it throve, I saw my little crop surrounded with fowls, of I know not how many sorts, who stood, as it were, watching till I should be gone.

Ok, this sentence is using some interesting parallel structure. Just as the beasts ruined the corn while it was “in the blade,” the birds were likely to ruin it “in the ear.” This phrase definitely has something to do with corn growing, but what? We can ignore answer choice A, “failed,” because if the crop failed, it doesn’t seem logical that the birds could threaten it at that point. Similar reasoning holds for answer choice C, “rotten.” How could birds threaten a rotten crop, and furthermore, why would the narrator care? We’re left to decide between answer choices B and D. Logic can help us here too: if the crop were finished growing completely, the narrator would likely harvest it as soon as possible, especially if it were threatened by birds. He doesn’t do this in the passage; instead, he guards it, so it can continue growing. So, the crop must not be done growing yet when it is “in the ear,” making the best answer choice D, “ripened.”

Let’s consider one more phrase-based sample question.



Click Here to
Revisit the
Passage

Sample Question #6

As it is used in the passage, the phrase “let fly among” underlined in the third paragraph most nearly means _____.

- A. defended oneself from
- B. released something into the wild in the direction of
- C. shot at
- D. yelled at

Once again, you may initially think that since the phrase in question involves the word “fly,” and we’re talking about birds in this passage, that the answer must be B, “released something into the wild in the direction of,” which could apply to birds as the subject. Consider the passage, though: the birds are the object of “let fly among,” not the subject.

I saw my little crop surrounded with fowls, of I know not how many sorts, who stood, as it were, watching till I should be gone. I immediately let fly among them, for I always had my gun with me. I had no sooner shot, but there rose up a little cloud of fowls, which I had not seen at all, from among the corn itself.

The most telling part of this context is the prepositional phrase that follows our phrase, “for I always had my gun with me.” This clue on its own can help us knock out answer choices B and D; we know that the phrase “let fly at” has to have something to do with the narrator having a gun. Is the narrator defending himself from the birds, or shooting at them as the attacker? The narrator is the attacker in the passage; he’s not defending himself from his birds—he’s defending his crops from them. This means that the correct answer is C.



Interpreting Relationships in Context

Within the framework of “Information and Ideas” content comes the need to determine meaningful relationships between different ideas and objects within a passage. These relationships are largely determined by context clues and the structure of the presented material. The following lessons will look in-depth at cause-and-effect, compare-contrast, and sequence relationships for ideas, events, characters, and other contextual elements of the passages on the SAT Reading test. Questions dealing with these topics will often require you to carefully analyze multiple aspects of the given material to determine implications and subtle clues that may not be readily apparent. For relationship questions, it is extremely important to look at the materials within the greater framework of the passage context and to delve beyond the surface value of the presented information.

Section Outline

Cause and Effect

- Spotting causes and effects in a passage’s content

Comparing and Contrasting

- Identifying similarities and differences of passage topics

Sequence

- Analyzing the temporal organization of a passage



Cause and Effect

Cause-and-effect questions can be some of the trickiest on the SAT, as they strike a challenging middle ground between questions where the answer is directly stated somewhere in the passage and more abstract questions that require skills like making generalizations, inferences, and predictions. Cause-and-effect questions combine concrete and abstract reasoning skills and throw in a little logical thinking as well, but by understanding how these questions function, you can be ready for them on test day.

Practice Passage

Adapted from “The Sisters” in *Dubliners* by James Joyce (1914)

There was no hope for him this time: it was the third stroke. Night after night I had passed the house (it was vacation time) and studied the lighted square of window, and night after night I had found it lighted in the same way, faintly and evenly. If he was dead, I thought, I would see the reflection of candles on the darkened blind, for I knew that two candles must be set at the head of a corpse. He had often said to me, “I am not long for this world,” and I had thought his words idle. Now I knew they were true. Every night as I gazed up at the window I said softly to myself the word “paralysis.” It had always sounded strangely in my ears, like the word “gnomon” in the Euclid and the word “simony” in the Catechism. But now it sounded to me like the name of some maleficent and sinful being. It filled me with fear, and yet I longed to be nearer to it and to look upon its deadly work.

Old Cotter was sitting at the fire, smoking, when I came downstairs to supper. While my aunt was ladling out my stirabout he said, as if returning to some former remark of his:

“No, I wouldn’t say he was exactly . . . but there was something queer . . . there was something uncanny about him. I’ll tell you my opinion . . .”

He began to puff at his pipe, no doubt arranging his opinion in his mind. Tiresome old fool! When we knew him first he used to be rather interesting, talking of fairs and worms, but I soon grew tired of him and his endless stories about the distillery.

“I have my own theory about it,” he said. “I think it was one of those . . . peculiar cases . . . But it’s hard to say . . .”

He began to puff again at his pipe without giving us his theory. My uncle saw me staring and said to me:

“Well, so your old friend is gone, you’ll be sorry to hear.”

“Who?” said I.

“Father Flynn.”

Links to
Sample Questions

[Sample Question #1](#)

[Sample Question #2](#)

[Sample Question #3](#)

[Sample Question #4](#)



“Is he dead?”

“Mr. Cotter here has just told us. He was passing by the house.”

I knew that I was under observation, so I continued eating as if the news had not interested me. My uncle explained to old Cotter.

“The youngster and he were great friends. The old chap taught him a great deal, mind you; and they say he had a great wish for him.”

“God have mercy on his soul,” said my aunt piously.

Old Cotter looked at me for a while. I felt that his little beady black eyes were examining me, but I would not satisfy him by looking up from my plate. He returned to his pipe and finally spat rudely into the grate.

Identifying Cause

Questions that ask you to identify the cause of something can ask you about causes presented rather directly in the passage, causes that you have to discern by using your critical thinking skills, and causes identified (perhaps incorrectly!) by certain characters. If there’s a particular part of the passage that comes to mind when you’re asked about the cause of something, by all means quickly skim it over, but be aware that many cause questions won’t correlate precisely to any particular line or lines—they’ll require you to ascertain a cause based on the passage as a whole.

Sample Question #1

To what does Old Cotter attribute the condition of the dying man?

- A. Paralysis
- B. Alcoholism
- C. Poisoning
- D. He doesn’t provide a distinct opinion on the subject.

Click Here to
Revisit the
Passage

You can knock out answers B and C, “Alcoholism” and “Poisoning,” immediately, as the passage never mentions either them. Choice A, “Paralysis,” is probably going to catch your eye immediately, not just because it’s the first listed answer choice, but because you should remember having read about it in specific before, in the passage’s first paragraph:

Every night as I gazed up at the window I said softly to myself the word “paralysis.” It had always sounded strangely in my ears, like the word “gnomon” in the Euclid and the word “simony” in the Catechism. But now it sounded to me like the name of some maleficent and sinful being. It filled me with fear, and yet I longed to be nearer to it and to look upon its deadly work.

From this, we can gather that the dying man is paralyzed at the point at which the story



is taking place. That might be enough for many test-takers to select A and move on to the next question—after all, the SAT Reading test isn’t known for lavishing you with tons of extra time! But it’s worth it to consider this question a bit more—it’s not asking about the condition of the dying man at the point in the story. It’s asking *what Old Cotter attributes it to*, and Old Cotter could very well be wrong in his opinion.

Glancing over the dialogue between the narrator and Old Cotter, we find this moment:

“I have my own theory about it,” [Old Cotter] said. “I think it was one of those . . . peculiar cases . . . But it’s hard to say . . .”

He began to puff again at his pipe without giving us his theory.

This swings the entire question. Old Cotter never specifies his opinion about what caused the dying man’s condition, so the correct answer is D. Be sure to read each question carefully and not skim over important aspects of what, exactly, it is asking!

Identifying Effect

Like questions that ask you to identify a cause, questions that ask you to identify effects can range from easier ones grounded in provided passage details to more challenging ones that expect you to do a lot of critical thinking.

Let’s start with a relatively easier example that is relatively direct, but still requires a bit of inference.

Sample Question #2

Click Here to
Revisit the
Passage

What effect has the third stroke had on the dying man described in the first paragraph?

- A. It has blinded him.
- B. It has made him unable to keep food down without being sick.
- C. It has resulted in him being partially or completely unable to move.
- D. It has given him amnesia.

The “third stroke” is mentioned in the passage’s opening lines: “There was no hope for him this time: it was the third stroke.” So, it shouldn’t be too difficult to figure out where to direct our focus: the first paragraph. We don’t hear anything about the man being blinded, unable to keep down food, or having lost his memory, but at the end of the paragraph, the narrator connects the concept of not being able to move—put in different terms, paralysis—with the stroke victim: “Every night as I gazed up at the window I said softly to myself the word ‘paralysis.’” Though this is not a directly stated connection, readers are expected to infer that the man who suffered from the third stroke is now paralyzed. The end of the paragraph offers context clues besides those conveyed by the sentence that initially mentions paralysis: “It filled me with fear, and yet I longed to be nearer to it and to look upon its deadly work.” If the narrator wants to “look upon [paralysis’s] deadly work” and is glancing up toward the stroke victim’s room, it’s safe to conclude that paralysis is one effect the stroke has had on its victim.



Let's consider an effect question that requires more drawn-out reasoning.

Sample Question #3

Click Here to
Revisit the
Passage

How would the narrator know were the man described in the first paragraph to die?

- A. The lighting seen through the window of the man's house would be uneven.
- B. Unlit candles would be placed at the man's head.
- C. An obituary would appear in the newspaper.
- D. He would hear sobbing from the house next door.

Put in different language, this question is asking, if the dying man passes away, how will the narrator know? The passage mentions nothing about sobbing, a funeral parade, or an obituary as the sign that the dying man has passed away, so none of those answers can be correct. This leaves us with "Unlit candles would be placed at the man's head" and "The lighting seen through the window of the man's house would be uneven." While "Unlit candles would be placed at the man's head" may seem like the correct answer, especially if one is reading very quickly, it's important to realize that the narrator thinks that lit candles would be the sign that the man has passed away, not unlit ones. We know this from the first paragraph, where the narrator states,

If he was dead, I thought, I would see the reflection of candles on the darkened blind, for I knew that two candles must be set at the head of a corpse.

We can tell that the candles mentioned in this sentence must be lit, because the narrator is describing their "reflection . . . on the darkened blind." We can also infer that lit candles would cause the lighting seen through the window of the man's house to be uneven, because the narrator says, "night after night I had found it lighted in the same way, faintly and evenly," describing his action of passing the house and assuming the man is still living. So, the correct answer is A, "The lighting seen through the window of the man's house would be uneven." As you answer this question, it's important to consider the whole of the first paragraph and put several details together instead of relying solely on the one sentence about the candles, which may lead you to the incorrect answer about unlit candles. Make sure to consider the entire surrounding context of a point, not just the immediately adjacent lines!



Identifying Cause and Effect Simultaneously

Perhaps the most challenging cause and effect questions are those that ask you to identify both concepts in a single question. Consider the one below.

Sample Question #4

The narrator is _____ by Old Cotter’s speech because _____.

- A. flattered . . . Old Cotter is subtly complimenting him
- B. annoyed . . . he doesn’t complete his sentences
- C. frustrated . . . the narrator knows that Old Cotter’s theory is not true, but cannot correct him
- D. pleased . . . Old Cotter can’t figure out the situation he’s considering, and the narrator takes pleasure in seeing him confused

Click Here to
Revisit the
Passage

Old Cotter’s speech is described and takes place in paragraphs two through five. Some things that may stick out about it as you read it were that it is filled with ellipses (“ . . . ”) and that it doesn’t form a complete thought; the narrator remarks upon this latter point at the end of the speech, saying, “He began to puff again at his pipe without giving us his theory.” The conversation then turns as the narrator’s uncle relays the news about Father Flynn’s death.

In looking at how the narrator reacts to Old Cotter’s speech, we can tell that he isn’t pleased by it, as the passage states from his perspective, “Tiresome old fool! When we knew [Old Cotter] first he used to be rather interesting, talking of faints and worms, but I soon grew tired of him and his endless stories about the distillery.” This allows us to eliminate the answer choices that begin with “flattered” and “pleased,” leaving us with those that begin with “annoyed” and “frustrated.”

At this point, we have to pick out the correct reason why the narrator is annoyed with or frustrated by the speech: “[Old Cotter] doesn’t complete his sentences,” or “the narrator knows that Old Cotter’s theory is not true, but cannot correct him.” Old Cotter never provides the narrator or readers with his theory, so “the narrator knows that Old Cotter’s theory is not true, but cannot correct him” cannot be the correct answer. This leaves us with “annoyed . . . he doesn’t complete his sentences” as the correct answer.



Comparing and Contrasting

Carefully weighing the similarities and differences between indicated things or characters in a passage requires an eye for detail and the ability to keep multiple details in mind at once. Comparison and contrast questions may involve overt comparisons already made in the text, or they may ask you to compare two things that aren't so explicitly related. Some questions may even involve structural components and ask you to compare various sentences or paragraphs. No matter what details a comparing-and-contrasting question concerns, you can conquer it with practiced critical thinking skills.

Practice Passage

Adapted from *The War of the Worlds* by H. G. Wells (1898)

No one would have believed in the last years of the nineteenth century that this world was being watched keenly and closely by intelligences greater than man's and yet as mortal as his own; that as men busied themselves about their various concerns they were scrutinized and studied, perhaps almost as narrowly as a man with a microscope might scrutinize the transient creatures that swarm and multiply in a drop of water. With infinite complacency men went to and fro over this globe about their little affairs, serene in their assurance of their empire over matter. It is possible that the infusoria under the microscope do the same. No one gave a thought to the older worlds of space as sources of human danger, or thought of them only to dismiss the idea of life upon them as impossible or improbable. It is curious to recall some of the mental habits of those departed days. At most terrestrial men fancied there might be other men upon Mars, perhaps ready to welcome a missionary enterprise. Yet across the gulf of space, minds that are to our minds as ours are to those of the beasts that perish, intellects vast and cool and unsympathetic regarded this earth with envious eyes, and slowly and surely drew their plans against us. And early in the twentieth century came the great disillusionment.

The planet Mars revolves about the sun at a mean distance of 140,000,000 miles, and the light and heat it receives from the sun is barely half of that received by this world. It must be, if the nebular hypothesis has any truth, older than our world; and long before this earth ceased to be molten, life upon its surface must have begun its course. The fact that it is scarcely one seventh of the volume of the earth must have accelerated its cooling to the temperature at which life could begin. It has air and water and all that is necessary for the support of animated existence.

Since Mars is older than our earth, it necessarily follows that it is not only more distant from time's beginning but nearer its end. The cooling that must someday overtake our planet has already gone far indeed with our neighbor. In its equatorial region, the midday temperature barely approaches that of our coldest winter. Its

Links to Sample Questions

[Sample Question #1](#)

[Sample Question #2](#)

[Sample Question #3](#)

[Sample Question #4](#)

[Sample Question #5](#)

[Sample Question #6](#)



air is much more attenuated than ours; its oceans have shrunk until they cover but a third of its surface. That last stage of exhaustion, which to us is still incredibly remote, has become a present-day problem for the inhabitants of Mars. The immediate pressure of necessity has brightened their intellects, enlarged their powers, and hardened their hearts. And looking across space with instruments, and intelligences such as we have scarcely dreamed of, they see, at its nearest distance only 35,000,000 of miles sunward of them, a morning star of hope, our own warmer planet, green with vegetation and grey with water, with a cloudy atmosphere eloquent of fertility, with glimpses through its drifting cloud wisps of broad stretches of populous country and narrow, navy-crowded seas.

And we men, the creatures who inhabit this earth, must be to them at least as alien and lowly as are the monkeys and lemurs to us. The intellectual side of man already admits that life is an incessant struggle for existence, and it would seem that this too is the belief of the minds upon Mars. Their world is far gone in its cooling and this world is still crowded with life, but crowded only with what they regard as inferior animals. To carry warfare sunward is, indeed, their only escape from the destruction that, generation after generation, creeps upon them.

And before we judge of them too harshly we must remember what ruthless and utter destruction our own species has wrought, not only upon animals, such as the vanished bison and the dodo, but upon itself. The Tasmanians were entirely swept out of existence in a war of extermination waged by European immigrants in the space of fifty years. Are we such apostles of mercy as to complain if the Martians warred in the same spirit?

Comparing and contrasting questions focus on the identification of similarities or differences between two or more things, people, or concepts in a passage. This presents the opportunity for a great deal of variation, and thus a wide variety of different levels of difficulty.

In this lesson, we'll consider questions that focus on overt comparisons and contrasts, as well as those that ask you to compare or contrast elements of the text that are not explicitly discussed together in the text. We'll also address how to handle questions that ask you to compare three or more things and take a closer look at those that look for similarities and differences in passage structure. Let's get going!



Identifying Comparisons and Contrasts

Let's begin by looking at a question that asks you to identify a contrast explicitly stated in the text.

Sample Question #1

It is clearly suggested in the passage that Mars, relative to Earth,

_____.

- A. is older
- B. is larger
- C. has a thicker atmosphere
- D. has a warmer average temperature

Click Here to
Revisit the
Passage

The planets Mars and Earth are specifically compared in the second and third paragraphs, and the reader encounters the following lines at the beginning of the second:

The planet Mars revolves about the sun at a mean distance of 140,000,000 miles, and the light and heat it receives from the sun is barely half of that received by this world. It must be, if the nebular hypothesis has any truth, older than our world; and long before this earth ceased to be molten, life upon its surface must have begun its course.

The passage clearly states that Mars must be older than Earth if the nebular hypothesis is true, and the author goes on to explain how Earth looks luxurious compared to the conditions of Mars, which are described as worsening. The passage overall operates on the assumption that Mars is older than Earth, as it states in the second paragraph, so A is the correct answer. B can't be correct because in the second paragraph, the passage states, "The fact that it is scarcely one seventh of the volume of the earth . . ." where "it" refers to Mars. C and D can both be disproven by the third paragraph when it states, "In its equatorial region, the midday temperature barely approaches that of our coldest winter. Its air is much more attenuated than ours." ("Attenuated" may be an unfamiliar term, but you can gather that since the author is describing how Mars has lower temperatures and less water than Earth, and temperature and water make a planet habitable, and air also makes a planet habitable, the author is describing how the Martian atmosphere is becoming less habitable—that is, thinner).

As you can see, questions that ask you to consider direct statements in the passage aren't necessarily straightforward. You may need to comb the passage looking for evidence that either supports or contradicts each answer choice. Approach each question with care, even if it initially seems uncomplicated!

Let's take a look at a similar question that asks you to identify a comparison instead of a contrast.



Click Here to
Revisit the
Passage

Sample Question #2

In the first paragraph, humanity is compared with which of the following?

- A. Monkeys and lemurs
- B. Infusoria
- C. Scientists
- D. Dodos

This time, we're directed to a particular paragraph, so we can concentrate our search. Skim over the first paragraph. Which of the answer choices are mentioned? Infusoria and scientists. While humans are compared to monkeys and lemurs and to dodos, these comparisons are located in the third and last paragraphs, respectively. Not missing that detail about location is key to answering this question correctly!

Now that we've identified two potentially correct answers, let's look at exactly what role each of their nouns plays in the passage. Which is compared to humans?

First, let's consider the mention of scientists:

No one would have believed in the last years of the nineteenth century that this world was being watched keenly and closely by intelligences greater than man's and yet as mortal as his own; that as men busied themselves about their various concerns they were scrutinized and studied, perhaps almost as narrowly as a man with a microscope might scrutinize the transient creatures that swarm and multiply in a drop of water.

Scientists are humans, so that may have clued you in that the comparison being made is not humans-scientists. Instead, the Martians are being compared to human scientists, while humanity is being compared to "the transient creatures that swarm and multiply in a drop of water." This comparison is echoed in later lines that use slightly different language:

With infinite complacency men went to and fro over this globe about their little affairs, serene in their assurance of their empire over matter. It is possible that the infusoria under the microscope do the same.

Aha! "Infusoria!" If you didn't know what it meant, you can note that the passage is continuing along the same lines as the earlier comparison. This means that "infusoria" means "the transient creatures that swarm and multiply in a drop of water." That's exactly what the author is comparing humanity to, so B is the correct answer!



Comparing and Contrasting Two Textual Features

Both of the previous sample questions have asked you to work with information directly stated in the passage, but not all comparison and contrast questions do this. Some, like the next few, ask you to do the comparing and contrasting!

Sample Question #3

The passage suggests that as a whole, Martians are generally _____ humans.

- A. smarter than
- B. less technologically advanced than
- C. more interested in justice than
- D. more motivated by guilt and shame than

Click Here to
Revisit the
Passage

While we're still dealing with Martians and humans in this question, now we have to figure out how they differ. How does the passage characterize Martians in contrast to humans? The passage never mentions anything about "justice," "guilt," or "shame"—the closest it gets to those topics is in the last paragraph, but no definitive ranking of Martian and human ruthlessness can be drawn from the information it provides.

Near the beginning of the first paragraph, the author introduces Martians indirectly, referring to them as "intelligences greater than man's and yet as mortal as his own." While this not be immediately clear when you encounter the line, the passage eventually provides the context that allows you to realize what the author is describing with that phrase. Later, near the end of the first paragraph, the author writes, "Yet across the gulf of space, minds that are to our minds as ours are to those of the beasts that perish, intellects vast and cool and unsympathetic regarded this earth with envious eyes." Here, the author is drawing an analogy: Martians are to humans as humans are to "the beasts that perish." Nothing found in the rest of the passage suggests that the Martians would be less technologically advanced than humans, and given that the Martians are characterized multiple times by their comparatively great intelligence, A is the best answer.

For questions like these in which the whole paragraph is fair game, it may help you to systemically account for each answer choice systematically. Identifying three incorrect answer choices might provide a more direct route to the correct answer than rereading the passage looking for particular details.

Let's try another more abstract comparison and contrast question. This next one is focused on identifying similarities.



Click Here to
Revisit the
Passage

Sample Question #4

According to the passage, what do humans have in common with Martians?

- A. Both humans and Martians are peaceful species.
- B. Both humans and Martians have the capacity to be destructive when colonizing a place.
- C. Both Martians and humans are interested in conserving natural resources.
- D. Humans and Martians must both deal with dwindling natural resources in the near future.

Ok, this time, we're looking for descriptions that apply to both Martians and humans equally. The Martians aren't set up to seem peaceful; a major point of the passage is that they want to take over Earth for its more abundant resources. Conserving natural resources is likely a Martian concern, given that their planet is becoming increasingly unlivable, but nothing is mentioned that suggests humans also want to conserve natural resources. D is perhaps the trickiest answer to discount—Martians have to deal with dwindling natural resources in the near future, but you can infer that the inhabitants of Earth don't have to deal with this problem any time soon given that Mars' problems are due to its age, and Earth is a much younger planet, as the passage explains in its second paragraph. This leaves us with the correct answer, B—that humans and Martians have the capacity to be destructive when colonizing a place. You can arrive at this answer without accounting for the incorrect ones by considering the last paragraph, where this is suggested in the author's discussion of why it would be hypocritical for humans to complain about the Martians' insensitive treatment of them. The author provides examples of the "ruthless and utter destruction our own species has wrought" and then asks, "Are we such apostles of mercy as to complain if the Martians warred in the same spirit?" There is an implicit comparison being made here equating human and Martian ruthlessness, so B is the best answer.

Comparing More than Two Textual Features

Comparing and contrasting two passage concepts is difficult enough, but what do you do when the test asks you to identify commonalities between three or more concepts? You approach the question the same way as you would approach a two-concept comparison question, with the added bonus that it will perhaps be easier to identify incorrect answers, as there are more concepts involved. You can ignore an answer choice for a two-concept comparison question if one of the two items is contradicted, so the more options you have to compare, the more chance for those options to be contradicted by something in the passage.



Click Here to
Revisit the
Passage

Sample Question #5

What do monkeys, lemurs, infusoria, and “the beasts that perish” have in common in this passage?

- A. They are all sources of food for humans.
- B. They are the organisms native to Earth that the Martians abducted before abducting a human.
- C. They are all things Martians are afraid of.
- D. They are all things compared to humans in the passage.

“Monkeys and lemurs” get mentioned in the same breath in the passage’s second-to-last paragraph:

And we men, the creatures who inhabit this earth, must be to them at least as alien and lowly as are the monkeys and lemurs to us.

“The beasts that perish” are mentioned in the first paragraph:

Yet across the gulf of space, minds that are to our minds as ours are to those of the beasts that perish, intellects vast and cool and unsympathetic regarded this earth with envious eyes, and slowly and surely drew their plans against us.

“Infusoria” are also mentioned in the first paragraph:

With infinite complacency men went to and fro over this globe about their little affairs, serene in their assurance of their empire over matter. It is possible that the infusoria under the microscope do the same.

So, what do these three topics have in common? While they are all “organisms native to Earth,” the passage doesn’t say anything about Martians abducting humans, so B can’t be the correct answer—it involves an unsubstantiated claim. Nothing is mentioned about humans eating any of the mentioned items, so A can’t be correct, either, and similarly, nothing is pointed out as something the Martians particularly fear, so we can ignore C as well. D is the correct answer; all of these concepts are compared with humans in the passage. You can see these comparisons at work in the excerpts above.

Comparing and Contrasting Passage Structures

For our last comparing and contrasting sample question, let’s consider one that only involves two elements, but can be tough because it asks about the passage’s structure (e.g. paragraphs) instead of specific concepts in the text.



Click Here to
Revisit the
Passage

Sample Question #6

The passage's second paragraph provides _____, whereas the its third paragraph uses that information _____.

- A. an astronomical history of the planet Mars . . . to explain why humans attacked Mars
- B. scientific information about Mars . . . to explain why the Martians wanted to colonize Earth
- C. direct explanation of what happened during “the great disillusionment” . . . to explain the Martians’ motivation for abducting humans
- D. comparisons between Martians and humans . . . to help readers see the Martians in a more positive light

Let's look over the second paragraph. What are its main topics? How is it presenting them? Paragraph two concerns a comparison between the planets Earth and Mars. It is objective in tone and simply presenting scientific information.

Paragraph three continues in the same vein for a while before suggesting that since Mars is becoming difficult to inhabit, the Martians are considering Earth as a potentially habitable planet:

That last stage of exhaustion, which to us is still incredibly remote, has become a present-day problem for the inhabitants of Mars. The immediate pressure of necessity has brightened their intellects, enlarged their powers, and hardened their hearts. And looking across space with instruments, and intelligences such as we have scarcely dreamed of, they see, at its nearest distance only 35,000,000 of miles sunward of them, a morning star of hope, our own warmer planet.

Let's look at the answer choices. D isn't right; no part of paragraph two includes comparisons between Martians and humans, and the third paragraph doesn't work to portray Martians in a more positive light. C can't be right, either; paragraph two doesn't explain what “the great disillusionment” was directly, and while the third paragraph does talk about the Martians' motivations, it sets up their motivations for attacking Earth, not for abducting humans in particular. The passage doesn't specify how abducting humans would help Martians take over Earth, so that's a bit of a stretch to assume. Both A and B provide accurate descriptions of paragraph two, so we need to pick the one that most accurately describes paragraph three. Does paragraph three “explain why humans attacked Mars,” or does it “explain why the Martians wanted to colonize Earth”? This question turns into one of understanding who is attacking whom in the passage; it is clearly the Martians who have set their sights on Earth. In addition, considering that the first paragraph suggests that humans had no idea that the Martians were going to attack, it doesn't make much sense to say that the humans attacked the Martians. B is the correct answer.



Sequence

Sequence questions run the gamut of potential difficulties. Some of them are incredibly straightforward, asking you to fetch overtly-stated details directly from the passage. Others are more challenging, dealing with passages in which the text itself and the events described in the text do not follow the same timeline. Others may ask you to make inferences based on how the passage is excerpted from another work and identify the ideas discussed immediately before and after the excerpt in the source text. We'll go over each of these specific question types in this lesson so that you can feel confident in your ability to approach each of them.

Sequence of Events

Sequence questions may ask about the order of events described in a passage, not the sequence of its text. Some of these questions may be rather obvious, while others may require you to take your time in order to put events in the correct order.

Practice Passage

Adapted from *The War of the Worlds* by H. G. Wells (1898)

The planet Mars revolves about the sun at a mean distance of 140,000,000 miles, and the light and heat it receives from the sun is barely half of that received by this world. It must be, if the nebular hypothesis has any truth, older than our world; and long before this earth ceased to be molten, life upon its surface must have begun its course. The fact that it is scarcely one seventh of the volume of the earth must have accelerated its cooling to the temperature at which life could begin. It has air and water and all that is necessary for the support of animated existence.

Sample Question

Which of the following accurately represents the order of events as the author believes they happened?

- A. Mars solidified, Earth solidified, life developed on Earth, life developed on Mars
- B. Mars solidified, life developed on Mars, Earth solidified, life developed on Earth
- C. Earth solidified, Mars solidified, life developed on Mars, life developed on Earth
- D. Mars solidified, Earth solidified, life developed on Mars, life developed on Earth



The author discusses the solidification and development of life on Mars and Earth in the provided paragraph. Let's narrow down what he says. First, he claims that Mars is older than Earth, but that doesn't tell us anything about when each planet solidified or when life began on each planet. He then states that life on Mars began before the Earth solidified. This allows us to eliminate any answer choice in which "Earth solidified" comes before "life developed on Mars," leaving us with only one answer choice, B: "Mars solidified, life developed on Mars, Earth solidified, life developed on Earth."

When Passage Text Sequence Does Not Equal Passage Event Sequence

SAT Reading questions can concern the sequence of passage text—the order in which paragraphs mention certain topics. Other questions concern the timeline of the events described; these are usually categorized as *text structure* questions, the trickiest questions occur when the order in which a passage describes events doesn't match up with the timeline of those events—in other words, when the first event isn't described first. Consider the following sample passage and question for an example of just such a "mismatched" sequence question, and be on your toes!

Practice Passage

Adapted from *The Harvard Classics Shelf of Fiction, Volume 16: Anna Karenina* by Leo Tolstoy (1877; 1917 ed., trans. Garnett)

Happy families are all alike; every unhappy family is unhappy in its own way.

Everything was in confusion in the Oblonskys' house. The wife had discovered that the husband was carrying on an intrigue with a French girl, who had been a governess in their family, and she had announced to her husband that she could not go on living in the same house with him.

This position of affairs had now lasted three days, and not only the husband and wife themselves, but all the members of their family and household were painfully conscious of it. The wife did not leave her own room, the husband had not been at home for three days. The children ran wild all over the house; the English governess quarreled with the housekeeper; the kitchen maid and the coachman had given warning.

Three days after the quarrel, Prince Stepan Arkadyevitch Oblonsky—Stiva, as he was called in the fashionable world—woke up at his usual hour, that is, at eight o'clock in the morning, not in his wife's bedroom, but on the leather-covered sofa in his study.

Noticing a gleam of light peeping in beside one of the serge curtains, he cheerfully dropped his feet over the edge of the sofa, and felt about with them for his slippers, a present on his last birthday, worked for him by his wife on gold-colored morocco. And, as he had done every day for the last nine years, he stretched out his hand, without getting up, towards the place where his dressing-gown always hung in his



bedroom. And thereupon he suddenly remembered that he was not sleeping in his wife's room, but in his study, and why: the smile vanished from his face, he knitted his brows.

Most unpleasant of all was the first minute when, on coming, happy and good-humored, from the theatre, with a huge pear in his hand for his wife, he had not found his wife in the drawing-room, to his surprise had not found her in the study either, and saw her at last in her bedroom with the unlucky letter that revealed everything in her hand. She, his Dolly, forever fussing and worrying over household details, and limited in her ideas, as he considered, was sitting perfectly still with the letter in her hand, looking at him with an expression of horror, despair, and indignation.

“What's this? This?” she asked, pointing to the letter.

Sample Question

Which of the following occurs first in the story's timeline?

- A. Stiva returns to his house from the theatre with a pear.
- B. Stiva's wife confronts him about a letter.
- C. Stiva wakes up on the sofa.
- D. The governess and the housekeeper argue.

Answering this question requires you to realize that the timeline of the story is very different from the order in which events are described in it. While the first answer choice's option to be described in the passage is “The governess and the housekeeper argued,” this happened after “Stiva's wife confronted him about a letter,” which happened after he “returned to his house from the theatre with a pear.”

Inferring the Previous Topic

What do you do when a question asks you to infer the topic of prose that's not even provided on the test—material that appears before or after the passage in the larger work from which its excerpted? This may seem like an impossible task, but the SAT Reading test won't ask you to grasp at straws when making inferences. Enough context clues will be located in the passage for you to draw a reasonable conclusion about what material must precede or follow the passage at hand. If you're asked about material that preceded the passage, focus on its first few lines. You should be able to identify some transitional reference to what the author was talking about immediately before the passage's start.



Practice Passage

Adapted from Volume Four of *The Natural History of Animals: The Animal Life of the World in Its Various Aspects and Relations* by James Richard Ainsworth Davis (1903)

It has just been shown that compact, curved forms are often made to appear flattish by a particular distribution of color and shading, but it is clear that similar advantages might be secured in an entirely different manner—for example, by the body actually becoming flat. A striking case of this is that afforded by the flat-fishes, such as sole, turbot, plaice, and the rest. These, when in the condition of young fry, swim about like ordinary fish, and possess the same bilateral symmetry. Very soon, however, they become laterally flattened, and take to living on the sea floor with either the left or right side downwards, according to the species. This side remains white or pale, and the fish's eye migrates to the side which is kept upwards; otherwise it would be of no use. And, further, the upwardly-directed surface becomes darkly pigmented so as to harmonize with the sand or mud upon which the animal lives, the resemblance often being enhanced by the presence of spots and blotches of darker or different tint. Here, however, as in so many other cases, protection is only afforded by the coloration and marking when the animal remains at rest. Movement at once destroys the illusion.

Sample Question

Which of the following topics was discussed immediately before this passage in the book from which this passage is taken?

- A. Prey animals can use other methods of defense, like mimicry, effectively in conjunction with being flat.
- B. Being flat is a trait that has helped many species of organisms survive.
- C. Appearance can make something that is not flat look like it is flat.
- D. Appearing flat is not as useful a defense as actually being flat.

Since this question is about preceding material, let's take a close look at the passage's first line.

It has just been shown that compact, curved forms are often made to appear flattish by a particular distribution of color and shading, but it is clear that similar advantages might be secured in an entirely different manner—for example, by the body actually becoming flat.



We're given a major context clue in the introductory phrase "It has just been shown that." This is the equivalent of a neon sign saying "This is what the passage just talked about!" We just need to pick out the answer choice that best rephrases the topic of "compact, curved forms are often made to appear flattish by a particular distribution of color and shading." Let's consider them.

This question comes down to a "calibration" exercise—like in many main idea, summary, and paraphrase questions, we need to pick the answer that is just detailed enough: not too detailed to the point where it doesn't apply to the whole phrase, and not too general to the point where points aren't accurately conveyed. While the passage discusses a certain type of fish that uses its flatness as camouflage, the phrase we're considering doesn't mention organisms—specific ones or living things in general—at all. We can ignore answer choices A and B because of this. B is too general and mentions "organisms," and while A may look like a potentially great answer choice because appearing flat might seem like a type of mimicry, the phrase doesn't discuss prey animals or mimicry in conjunction with actually being flat—the two types of defense aren't discussed in conjunction; the text moves from having discussed one, appearing flat, before the passage starts to discussing another, actually being flat.

This leaves us with C and D. Both are statements talking about appearance and flatness, so it looks like we're on the right track. C and D mainly differ in that C is a statement of fact whereas D involves a comparison of the two types of defense, looking flat and actually being flat. The phrase in question doesn't make any value judgment about these methods of defense—the author never states which one he considered to be the better one. Thus, D isn't accurate, and C is the correct answer. Before the passage started, the author discussed how visual camouflage can make something that isn't flat look as if it is.

Inferring the Next Topic

Some questions may ask you to predict the material that logically comes after a passage in the work from which it's taken. Having a general idea of what's discussed throughout the passage is important, but draw your attention to the last few lines of the passage and keep on the lookout for any constructions that could signal a transition to a new topic. If you don't see any, that's fine—there might not be any, as the work from which the passage is taken may just continue discussing the topic at hand.



Adapted from *Cowboy Songs and Other Frontier Ballads* by John A. Lomax (1910)

The big ranches of the West are now being cut up into small farms. The nester has come, and come to stay. Gone is the buffalo, the free grass of the open plain—even the stinging lizard, the horned frog, the centipede, the prairie dog, the rattlesnake, are fast disappearing. Save in some of the secluded valleys of southern New Mexico, the old-time round-up is no more; the trails to Kansas and to Montana have become grass-grown or lost in fields of waving grain; the maverick steer, the regal longhorn, has been supplanted by his unpoetic but more beefy and profitable Polled Angus, Durham, and Hereford cousins from across the seas. The changing and romantic West of the early days lives mainly in story and in song. The last figure to vanish is the cowboy, the animating spirit of the vanishing era. He sits his horse easily as he rides through a wide valley, enclosed by mountains, clad in the hazy purple of coming night—with his face turned steadily down the long, long road, “the road that the sun goes down.”

Sample Question

The next paragraph will most likely contain _____.

- A. a description of cowboy songs
- B. a comparison of cowboy and Arthurian legends
- C. a discussion of profitable ranching
- D. an introduction of the American cowboy

This paragraph is an introduction of the American cowboy, so it is unlikely that the next will be the same. More likely, the next paragraph will expound on what this one mentioned at the end: the cowboy song. Also, earlier in the paragraph the author mentions that “The changing and romantic West of the early days lives mainly in story and in song.” If he wants to tell us more about the West, it would make sense that he discuss the songs to do so.



Rhetoric and Passage Construction

Not all of a passage's meaning is conveyed by its content; a lot of it is generated by the language the author chooses to use when presenting it and the structure into which he or she shapes the different parts of the text. One of the SAT Reading test's aims is for it to query test-takers' varying abilities to understand how the language and structure of a passage work to generate meaning. Questions that fall under the label of Rhetoric and Passage Construction may ask you to analyze stylistic features like word choice and structure. They may ask you to intuit the author's opinion on the topics he or she discusses or ask about the purpose of lines, paragraphs, or the passage as a whole. In addition, they may ask about the structure of the author's argument, asking questions that test your understanding of the claims, evidence, and reasoning the author employs.

Students can have trouble with Rhetoric and Passage Construction questions simply because they are less familiar with them than questions about passage content, which are comparatively direct. Practicing your ability to read a text not just for its content but also for the more subtle meanings conveyed by its rhetoric and structure can help you approach these types of questions with confidence.

Section Outline

Stylistic Word Choice

- Analyzing how different words and phrases affect the tone and style of the passage

Text Structure

- Investigating the order of events described in the passage

Point of View

- Figuring out how the author feels about his or her subject matter

Purpose

- Considering either why the author may have included specified excerpts or what the author's motivation for writing the passage was

Claims, Evidence, and Reasoning

- Analyzing the specifics of the author's argument



Stylistic Word Choice

The SAT Reading test may draw your attention to specific words and phrases for a number of reasons. Questions may ask you to *use the context of a passage to figure out the dictionary meaning of a word or phrase*—its *denotation*. Other questions, though, focus on the way specific language affects the passage’s tone and style, and the meaning generated by the author’s choice of terms or use of language. These questions still rely on context, but aren’t constrained to the dictionary definition of a term, making them a bit more difficult for some test-takers.

Let’s practice identifying the effects generated by some specific words and phrases in a variety of sample passages, starting with an excerpt from a work of fiction. In literary fiction passages, dialogue can easily become the focus of questions that ask about word choice, as the meaning of dialogue is to a large degree determined by the context in which a statement is made. Imagine you’re overhearing the conversation the characters are having. What sort of subtle emotions would each statement convey? What would motivate a character to say exactly what they say? How would they deliver each line?

Practice Passage

Adapted from *A Room With a View* by E. M. Forster (1908)

“The Signora had no business to do it,” said Miss Bartlett, “no business at all. She promised us south rooms with a view close together, instead of which here are north rooms, looking into a courtyard, and a long way apart. Oh, Lucy!”

“And a Cockney, besides!” said Lucy, who had been further saddened by the Signora’s unexpected accent. “It might be London.” She looked at the two rows of English people who were sitting at the table; at the row of white bottles of water and red bottles of wine that ran between the English people; at the portraits of the late Queen and the late Poet Laureate that hung behind the English people, heavily framed; at the notice of the English church (Rev. Cuthbert Eager, M. A. Oxon.), that was the only other decoration of the wall. “Charlotte, don’t you feel, too, that we might be in London? I can hardly believe that all kinds of other things are just outside. I suppose it is one’s being so tired.”

“This meat has surely been used for soup,” said Miss Bartlett, laying down her fork.

“I want so to see the Arno. The rooms the Signora promised us in her letter would have looked over the Arno. The Signora had no business to do it at all. Oh, it is a shame!”

“Any nook does for me,” Miss Bartlett continued, “but it does seem hard that you shouldn’t have a view.”

Lucy felt that she had been selfish. “Charlotte, you mustn’t spoil me; of course, you must look over the Arno, too. I meant that. The first vacant room in the front—” “You must have it,” said Miss Bartlett, part of whose traveling expenses were paid by Lucy’s mother—a piece of generosity to which she made many a tactful allusion.

Links to
Sample Questions

[Sample Question #1](#)

[Sample Question #2](#)

[Sample Question #3](#)



“No, no. You must have it.”

“I insist on it. Your mother would never forgive me, Lucy.”

“She would never forgive me.”

The ladies’ voices grew animated, and—if the sad truth be owned—a little peevisish. They were tired, and under the guise of unselfishness they wrangled.

Now that you’ve read the passage, let’s begin by examining a question that concerns a specific phrase. To get this question right, you have to understand the tone with which the phrase is spoken in the passage. Though the author doesn’t directly characterize the character’s tone, the context of the situation provides enough clues for you to figure out the character’s motivation for saying it.

Sample Question #1

Click Here to
Revisit the
Passage

Miss Bartlett says “Oh, Lucy!” at the end of the first paragraph because

_____.

- A. she is frustrated with their situation
- B. she pities Lucy’s situation
- C. she has just been embarrassed by Lucy
- D. she has something important to tell Lucy

Answering this question correctly requires you to understand the author’s use of tone. Taken out of context, Miss Bartlett’s statement of “Oh, Lucy!” could have been inspired by the sources covered in many of the incorrect answer choices. However, we need to focus on the context in which the statement appears in the passage. What precedes it? “The Signora had no business to do it,” said Miss Bartlett, “no business at all. She promised us south rooms with a view close together, instead of which here are north rooms, looking into a courtyard, and a long way apart.” The only answer choice that makes sense is that Miss Bartlett is frustrated with their situation. The idea that she pities Lucy’s situation may look reasonable, but since neither of them have received the rooms they were promised, they are in the situation together, and it’s not just Lucy who is in a frustrating situation.

Now, let’s look at a similar question, but one that involves an entire line instead of a phrase. Again, the author doesn’t describe the statement using dialogue tags, but by considering the mood of the scene and what might motivate the character to say the line, you can figure out how the line is functioning in the scene.



Click Here to
Revisit the
Passage

Sample Question #2

When Miss Bartlett says “This meat has surely been used for soup,” the comment is intended to be _____.

- A. a criticism
- B. a compliment
- C. a statement of surprise
- D. an insult to the old man

Miss Bartlett’s comment about the meat having been used for soup follows two paragraphs in which she and Lucy lament that they have not been given the rooms they were promised, and that the pension is distinctly English and familiar whereas they were expecting it to seem more foreign. Thus, it makes sense that like the previous criticisms offered about the pension in the preceding paragraphs, Miss Bartlett’s comment about the meat is also a criticism.

None of the other answer choices make sense; the old man hasn’t been introduced in the passage when Miss Bartlett comments about the meat, so it can’t be an insult to him; the meat having been used for soup would not be “a compliment,” especially coming on the heels of criticisms with no indication that it isn’t a criticism too; and “a statement of surprise” doesn’t make sense as no indication is given that Miss Bartlett is surprised about the meat having been used for soup.

Word-choice questions can also concern the passage’s rhetoric, or ways in which it uses linguistic features like parallelism, repetition, and figures of speech to convey specific meaning. Let’s examine a question that concerns the effect of a rhetorical strategy that the author uses in the passage.

Click Here to
Revisit the
Passage

Sample Question #3

The author’s repetition of the word “English” in the second paragraph emphasizes _____.

- A. the unexpected presence of so many familiar details in a country foreign to the women
- B. the fact that the country in which the women are staying is an English colony
- C. the new and unexpected details of the women’s surroundings
- D. the fact that the Signora supports the English in the ongoing war

The word “English” appears four times in the second paragraph, and numerous other details about the pension and its inhabitants are portrayed as distinctly British. This repetition and portrayal comes immediately after Lucy expresses her sadness that the



Signora has a Cockney accent. From this set-up, we can infer that the author is repeating the word “English” in order to emphasize how familiar the pension’s qualities are to the women when they were expecting something quite different from what they were used to. Nothing about English colonies or wars is mentioned, and while “the fact that the pension is one that caters specifically to English guests” may seem like a likely answer, we are not specifically told this, and the repetition of the word “English” is emphasizing the disparity between the women’s expectations and reality more so than the fact that there are numerous English guests at the pension.

Word choice questions aren’t limited to literary fiction passages; they can be asked of passages from any genre and with any subject matter. Let’s next consider an older passage that addresses a major issue of social equality.

Practice Passage

Adapted from “Margaret Fuller and Mary Wollstonecraft” by George Eliot (Mary Ann Evans) (1855)

If you ask me what offices women may fill, I reply—any. I do not care what case you put; let them be sea-captains, if you will. I do not doubt there are women well fitted for such an office, and, if so, I should be glad to welcome the Maid of Saragossa. I think women need, especially at this juncture, a much greater range of occupation than they have, to rouse their latent powers.

Men pay a heavy price for their reluctance to encourage self-help and independent resources in women. The precious meridian years of many a man of genius have to be spent in the toil of routine, that an “establishment” may be kept up for a woman who can understand none of his secret yearnings, who is fit for nothing but to sit in her drawing-room like a doll-Madonna in her shrine. No matter. Anything is more endurable than to change our established formulae about women, or to run the risk of looking up to our wives instead of looking down on them. So men say of women, let them be idols, useless absorbents of previous things, provided we are not obliged to admit them to be strictly fellow-beings, to be treated, one and all, with justice and sober reverence.

This next question tests your understanding of a complex literary device that may have caught your attention as you read the passage. Make sure to go back and locate it and consider its surrounding context before choosing your answer!

Links to
Sample Questions

[Sample Question #4](#)

[Sample Question #5](#)



Click Here to
Revisit the
Passage

Sample Question #4

Which of these arguments is reinforced by the author's use of the stylistic device comparing women to a "doll-Madonna?"

- A. Women's natural talents are neglected when men make them into images and idols.
- B. Female identity is strengthened and reinforced by gendered stereotypes.
- C. Men have imagined women as powerful goddesses.
- D. Female stubbornness prevents a gendered revolution of our patriarchal society.

To answer this question, it is first necessary to identify which of the arguments offered as answer choices have been made in the essay. The idea that female identity has been strengthened by gendered stereotypes sounds like an argument opposite of the one made by the author. So, you can rule out that answer choice. The author makes no mention of female stubbornness as an obstacle to change, so that answer choice must be incorrect. The author makes some mention of the male imaginings of women, but never references an image to do with power or godliness. That leaves only "Women's natural talents are neglected when men make them into images and idols." If you read the context surrounding the reference to woman as a "doll-Madonna," the author expresses how such an affectation is wasteful for men and women. The comparison to a "doll-Madonna" reflects male imaginings of women that the author is trying to convey. Firstly, the doll aspect refers to making women idle and objectifying them. The Madonna aspect refers to making women into a figure of beauty and perfection. The author uses the comparison in the context of an argument meant to disparage male constructions.

Here's another question that concerns rhetoric. This time, the focus is placed on a pair of quotation marks. Quotation marks can be used to convey a variety of different meanings, and the question is asking you to articulate exactly how they are functioning in the text.



Click Here to
Revisit the
Passage

Sample Question #5

Which of the following best describes the rhetorical effect of the quotation marks surrounding the word “establishment?”

- A. The quotation marks suggest that the establishment described is not worth the time spent keeping it up.
- B. The quotation marks suggest that while many people refer to a household as an “establishment,” other terms are more often used for it.
- C. The quotation marks call attention to the establishment as a commonly disparaged concept as the author argues in favor of it.
- D. The quotation marks indicate dialogue in an imagined conversation between a married couple.

Where exactly do these quotation marks appear in the passage? Here are the relevant lines:

Men pay a heavy price for their reluctance to encourage self-help and independent resources in women. The precious meridian years of many a man of genius have to be spent in the toil of routine, that an “establishment” may be kept up for a woman who can understand none of his secret yearnings, who is fit for nothing but to sit in her drawing-room like a doll-Madonna in her shrine.

Taking the rest of the passage into consideration, we know this author is set against conventional ideas about the way her society views women. This allows us to ignore C—we know that the author isn’t “argu[ing] in favor of” the establishment; it’s one of the things she is arguing against. There’s no discussion or suggestion that other terms are more often used to mean “household”—in fact, there’s no discussion of synonyms for “establishment” at all, so it doesn’t look like that’s what the quotation marks are indicating. Though the author is talking about a hypothetical, generalized married couple, no dialogue is conveyed, so D isn’t correct. That leaves us with A, the correct answer. The quotation marks in this passage serve a function of conveying a specific perspective on the term “establishment”—it’s as if the author included the phrase “so-called” before it. It downplays both the significance of the “establishment” and the idea that it is worth all of the effort that the “man of genius” has to spend in keeping it up.

Let’s next take a look at a more modern passage that offers commentary on the aging process as the author has so far experienced it.



Practice Passage

Adapted from “What I Think and Feel at Twenty-Five” by F. Scott Fitzgerald (1922)

As a man grows older it stands to reason that his vulnerability increases. Three years ago, for instance, I could be hurt in only one way—through myself. If my best friend’s wife had her hair torn off by an electric washing-machine, I was grieved, of course. I would make my friend a long speech full of “old mans,” and finish up with a paragraph from Washington’s Farewell Address; but when I’d finished I could go to a good restaurant and enjoy my dinner as usual. In fact I was pretty much invulnerable. I put up a conventional wail whenever a ship was sunk or a train got wrecked; but I don’t suppose, if the whole city of Chicago had been wiped out, I’d have lost a night’s sleep over it—unless something led me to believe that St. Paul was the next city on the list. Even then I could have moved my luggage over to Minneapolis and rested pretty comfortably all night.

But that was three years ago when I was still a young man. I was only twenty-two. Now, I’m vulnerable. I’m vulnerable in every way. I used to have about ten square feet of skin vulnerable to chills and fevers. Now I have about twenty. I have not personally enlarged, the twenty feet includes the skin of my family, but I might as well have, because if a chill or fever strikes any bit of that twenty feet of skin I begin to shiver. And so I ooze gently into middle-age; for the true middle-age is not the acquirement of years, but the acquirement of a family.

When Life has used us for its purposes it takes away all our attractive qualities and gives us, instead, ponderous but shallow convictions of our own wisdom and “experience.” The older I grow the more I get so I don’t know anything. If I had been asked to do this article about five years ago it might have been worth reading.

This next question asks about the effect of a specified clause.

Sample Question #6

The underlined clause “I would make my friend a long speech full of ‘old mans,’ and finish up with a paragraph from Washington’s Farewell Address” _____.

- A. conveys how the author overplays his concern
- B. suggests that the author’s concern is genuine
- C. describes the author’s reaction to events that actually occurred
- D. suggests that the author is often criticized for appearing emotionally detached from tragic situations

Links to
Sample Questions

[Sample Question #7](#)

[Sample Question #8](#)



After skimming the answer choices, reread the indicated phrase in context. How does it strike you? The situation to which the author responds is tragic but oddly specific and (hopefully) rather unlikely, and this gives the passage something of a lighthearted tone even as the subject matter discusses disasters. This tone helps to convey the author's reaction to these events. Quoting Washington's "Farewell Address" makes the author seem extremely concerned about his friend's tragedy, but we learn later in the passage that afterward, the author goes about his business as usual, without concern. In this context, the quotation of Washington's "Farewell Address" works to make the narrator's concern appear overdramatized and inauthentic.

Sample Question #7

Click Here to
Revisit the
Passage

The author's use of the underlined word "conventional" _____.

- A. de-emphasizes the emotional authenticity that usually accompanies the word "wail"
- B. conveys how many people are, like the author, stricken by genuine and lingering feelings of grief when reading the news
- C. suggests that the author is ignoring social traditions by openly and emotionally responding to misfortune
- D. suggests that in the author's day and age, it was common for ships to sink and trains to get into accidents

"Conventional" appears in the following sentence:

I put up a conventional wail whenever a ship was sunk or a train got wrecked; but I don't suppose, if the whole city of Chicago had been wiped out, I'd have lost a night's sleep over it . . .

Ok, "conventional wail"—there's definitely some connotative dissonance going on in the author's putting these two words together. If you encountered "wail" in a different sentence, you'd probably expect it to be used in a serious way. People might "wail" in serious tragedies or after a disaster has struck. "Conventional," on the other hand, means *expected* or *everyday*. Describing a "wail" as "conventional" takes the emotional "oomph" out of the word—if someone is wailing every day, it's not as striking and attention-getting as if they wail rarely. The best answer is A. The passage doesn't suggest that the author feels stricken by genuine and lingering feelings of grief at reading the news. It isn't suggesting that the author is ignoring social traditions, and the use of the term isn't conveying anything about the rate of accidents involving ships and trains. The author has paired these terms to great rhetorical effect in order to convey how he reacts to bad news.

Here's one more phrase-based question about this passage. Whereas the previous question focused on an adjective and the noun it modifies, this one focuses on a verb and its associated adverb.



Click Here to
Revisit the
Passage

Sample Question #8

The author's use of the phrase "ooze gently" characterizes the aging process as _____.

- A. a slow but steady loss of confidence
- B. an increase in cynical self-reliance
- C. a sudden, overt shift from adolescent to adult
- D. a disdain for childish behavior slowly acquired by many adults

Take a moment to consider how the author is considering the aging process in the rest of the passage before answering this question. It's the theme of the passage, so we want to make sure our answer choice matches up with the author's general position on the topic. The author's main point is that as we get older, we get more vulnerable and not necessarily much smarter. This doesn't sound like "cynical self-reliance" at all. Now let's consider the terms in detail. "Oozing" is a slow movement. It takes time, and isn't like flipping a switch. This means that answer choice C isn't correct—"oozing" doesn't convey "a sudden, overt shift." While "oozing" also has connotations of being associated with things traditionally viewed as gross, and gross things can be associated with childish behavior, the author isn't using the term to convey "a disdain for childish behavior slowly acquired by many adults." The author is describing the aging process as a loss of confidence ("The older I grow the more I get so I don't know anything"), and A matches up with that perfectly. The "slow and steady" aspect matches with the connotations of both "ooze" and "gently," and the "loss of confidence" part matches with the passage's general claim.

Finally, let's take a look at a science passage. Even though science passages are often expected to be more objective and contain fewer stylistic flourishes than other types of passages, you can still be asked about the function of a particular word or phrase.

Adapted from Volume Four of *The Natural History of Animals: The Animal Life of the World in Its Various Aspects and Relations* by James Richard Ainsworth Davis (1903)

The common stoat is subject to similar color change in the northern parts of its range. In summer it is of a bright reddish brown color with the exception of the under parts, which are yellowish white, and the end of the tail, which is black. But in winter, the entire coat, save only the tip of the tail, becomes white, and in that condition the animal is known as an ermine. A similar example is afforded by the weasel. The seasonal change in the vegetarian Irish hare is purely of protective character, but in such an actively carnivorous creature as a stoat or weasel, it is aggressive as well, rendering the animal inconspicuous to its prey.



Sample Question #9

For what reason does the author describe the Irish hare as “vegetarian” in the underlined sentence?

- A. To contrast the hare with the stoat and the weasel
- B. To provide information about the hare’s diet that the reader may not know
- C. To help readers empathize with the hare
- D. To provide insight about what food is available in arctic environments

One could reasonably infer that a hare would be vegetarian, so “To provide information about the hare’s diet that the reader may not know” cannot be the correct answer. The section doesn’t aim to help readers empathize with the hare any more than the stoat and weasel, so “To help readers empathize with the hare” cannot be correct either. “To provide insight about what food is available in arctic environments” doesn’t make sense either, because we are not told about the food specifically available in arctic environments; we can’t even assume that there are only plants available, as the stoat and weasel eat meat. That brings us to the correct answer: “To contrast the hare with the stoat and the weasel.” The word “vegetarian” specifically contrasts with the word “carnivorous” used later in the sentence to describe the stoat and weasel. This contrast mirrors the contrast of defensive and aggressive and defensive color-changing adaptations which the author is discussing in the sentence.



Text Structure

It's easy to focus on developing reading comprehension skills that focus on the meaning of a passage's content, but the SAT Reading test also includes questions that ask you to consider the effects that form and structure have on the passage's overall effect. Questions that concern text structure concern the effects of authorial choices regarding the order of passage text and the motivations behind those choices. Some of these questions may ask you to characterize the passage's structure; others might ask you to infer why the author placed certain text in a certain part of the passage, or the effect that a certain order of text has on the reader's experience. Let's look over examples of each of these question types now so that you can be confident in your ability to analyze passage structure on test day.

Sequence of Passage Text

Let's start with the most direct type of sequence question: those that ask about the passage itself, not the events described. These questions may ask about words, phrases, or even paragraphs; they will also ask you to consider what these words are doing.

Practice Passage

Adapted from *Common Sense* by Thomas Paine (1776)

Society in every state is a blessing, but government even in its best state is but a necessary evil, in its worst state an intolerable one; for when we suffer, or are exposed to the same miseries heightened by reflecting that we furnish the means by which we suffer. Government, like dress, is the badge of lost innocence; the palaces of kings are built on the ruins of the bowers of paradise. For were the impulses of conscience clear, uniform, and irresistibly obeyed, man would need no other lawgiver; but that not being the case, he finds it necessary to surrender up a part of his property to furnish means for the protection of the rest; and this he is induced to do by the same prudence that in every other case advises him out of two evils to choose the least. WHEREFORE, security being the true design and end of government, it unanswerably follows that whatever FORM thereof appears most likely to ensure it to us, with the least expense and greatest benefit, is preferable to all others.

In order to gain a clear and just idea of the design and end of government, let us suppose a small number of persons settled in some sequestered part of the Earth, unconnected with the rest; they will then represent the first peopling of any country, or of the world. In this state of natural liberty, society will be their first thought. A thousand motives will excite them thereto, the strength of one man is so unequal to his wants, and his mind so unfitted for perpetual solitude, that he is soon obliged to seek assistance and relief of another, who in his turn requires the same. Four or five united would be able to raise a tolerable dwelling in the midst of a wilderness, but ONE man might labor out the common period of life without accomplishing any thing.



Sample Question

In the first paragraph, the author _____, whereas in the second paragraph, he _____.

- A. makes an argument . . . provides an extended example supporting his argument
- B. takes one position about an issue . . . changes his opinion and takes up the opposing position
- C. provides a counterargument to a commonly held position . . . argues there is no solution to the problem at hand
- D. presents his thesis . . . addresses his critics

While topic sentences often provide a good indication of a paragraph's function, the transition here is key in understanding what the author is doing. In the last sentence of the first paragraph, the author claims, "WHEREFORE, security being the true design and end of government, it unanswerably follows that whatever FORM thereof appears most likely to ensure it to us, with the least expense and greatest benefit, is preferable to all others." So, he is saying that the best government is the one that is most likely to keep its citizens safe, and in doing so, he is making an argument. In the second paragraph, he begins, "In order to gain a clear and just idea of the design and end of government, let us suppose . . ." Now, at the end of the first paragraph, he just declared "security being the true design and end of government," and now he is trying to "demonstrate" it in the second paragraph. The best answer is thus that the author makes an argument in the first paragraph and provides an extended example supporting his argument in the second paragraph.

Identifying the Reasoning Behind Sequence

Sequence questions may prompt you to determine why the author has chosen to introduce text and ideas in a certain sequence. In the following sample question, you are asked to discern why the author employs a certain device toward the beginning of the passage. When reading the sample passage, see if you can figure out why the author would want to use this device earlier rather than later in the text.



Adapted from *Cowboy Songs and Other Frontier Ballads* by John A. Lomax (1910)

The big ranches of the West are now being cut up into small farms. The nester has come, and come to stay. Gone is the buffalo, the free grass of the open plain—even the stinging lizard, the horned frog, the centipede, the prairie dog, the rattlesnake, are fast disappearing. Save in some of the secluded valleys of southern New Mexico, the old-time round-up is no more; the trails to Kansas and to Montana have become grass-grown or lost in fields of waving grain; the maverick steer, the regal longhorn, has been supplanted by his unpoetic but more beefy and profitable Polled Angus, Durham, and Hereford cousins from across the seas. The changing and romantic West of the early days lives mainly in story and in song. The last figure to vanish is the cowboy, the animating spirit of the vanishing era. He sits his horse easily as he rides through a wide valley, enclosed by mountains, clad in the hazy purple of coming night—with his face turned steadily down the long, long road, “the road that the sun goes down.”

Sample Question

Why does the author start the passage by listing disappearing species of the plains?

- A. To draw attention to the problem of endangered species
- B. To describe the sparse economic resources that cowboys had available to them
- C. To give the reader important context about the ecosystem of the American West
- D. To introduce the cowboy in the context of other disappearing figures of the American West

The author starts the paragraph by describing how the entire western landscape, including the variety of animals that live there, is changing. He then shifts to talking about cowboys with this transition: “The last figure to vanish is the cowboy, the animating spirit of the vanishing era.” In this way, the author puts the cowboy into context by comparing him to other classic—and disappearing—figures of the American West.

The next sample question also concerns the reasoning behind sequence, but instead of asking about one literary device, it asks about two sentences—specifically, why two lines of dialogue are placed immediately next to one another.



Practice Passage

Adapted from “The McWilliamses and the Burglar Alarm” in *The Mysterious Stranger and Other Stories* by Mark Twain (1898; 1916)

Then one night we smelled smoke. I lit a candle, and started toward the stairs, and met a burglar coming out of a room with a basket of tinware, which he had mistaken for solid silver in the dark. He was smoking a pipe. I said, ‘My friend, we do not allow smoking in this room.’ He said he was a stranger, and could not be expected to know the rules of the house: said he had been in many houses just as good as this one, and it had never been objected to before.

“I said: ‘Smoke along, then. But what business have you to be entering this house in this furtive and clandestine way, without ringing the burglar alarm?’

He looked confused and ashamed, and said, with embarrassment: ‘I beg a thousand pardons. I did not know you had a burglar alarm, else I would have rung it. I beg you will not mention it where my parents may hear of it, for they are old and feeble, and such a seemingly wanton breach of the hallowed conventionalities of our civilization might all too rudely sunder the frail bridge which hangs darkling between the pale and evanescent present and the solemn great deeps of the eternities. May I trouble you for a match?’

“I said: ‘Your sentiments do you honor, but metaphor is not your best hold. Spare your thigh; this kind light only on the box. But to return to business: how did you get in here?’”

Sample Question

The underlined sentences are placed immediately next to each other in order to emphasize _____.

- A. the contrast in the formality of their language and their lengths
- B. the unexpected similarity in their subject matter
- C. the difference between how the thief speaks to his parents and how he speaks to Mr. McWilliams
- D. the fact that they are saying the same thing but in different ways

The first sentence is notably wordy, uses a complex phrase structure, and uses advanced (and archaic!) vocabulary like “darkling.” The second sentence, on the other hand, is something someone might say in everyday conversation, very different from the first sentence in terms of style and length. The best answer to this question is thus that the sentences are placed immediately next to each other to emphasize “the contrast in the formality of their language and their lengths.” As for the other answer choices, the



sentences are talking about completely different subjects, so the sentences' placement can't be emphasizing "the unexpected similarity in their subject matter"; the thief is addressing Mr. McWilliams the entire time, so "the difference between how the thief speaks to his parents and how he speaks to Mr. McWilliams" can't be correct either; and "the fact that they are saying the same thing but in different ways" can't be the right answer because they are saying completely different things.



Point of View

In writing about their carefully chosen topics, many authors express overt opinions on their subject matter. It is a rare passage that remains completely objective about what it discusses, allowing the author’s views to remain elusive as they stand at a rhetorical distance. For most passages on the SAT—and especially those that will be the subject of point-of-view questions—the author’s opinion will be expressed somewhere in the passage. The “volume” at which this opinion comes across will vary, however; persuasive passages make the author’s opinion the main unmissable attraction as they attempt to convince you that the author’s opinion is correct. Other passages may seem objective at first glance, but let the author’s perspective show in small details of word choice, argument structure, and other subtle features that demonstrate a bias toward one side or the other of a presented argument.

Thinking of “point of view” may conjure up an idea of questions asking directly about whether the author is using “I,” “you,” or “he” and “she” in the text. Don’t expect these to appear on the new SAT; the point of view questions you’ll face will require much more thought. Practice picking up on cues littered throughout the text to discern how the author feels about various concepts; this can help you feel ready to address any point-of-view questions you are asked on test day.

Practice Passage

Adapted from “Introduced Species That Have Become Pests” in *Our Vanishing Wild Life, Its Extermination and Protection* by William Temple Hornaday (1913)

The man who successfully transplants or “introduces” into a new habitat any persistent species of living thing assumes a very grave responsibility. Every introduced species is doubtful gravel until panned out. The enormous losses that have been inflicted upon the world through the perpetuation of follies with wild vertebrates and insects would, if added together, be enough to purchase a principality. The most aggravating feature of these follies in transplantation is that never yet have they been made severely punishable. We are just as careless and easygoing on this point as we were about the government of the Yellowstone Park in the days when Howell and other poachers destroyed our first national bison herd, and when caught red-handed—as Howell was, skinning seven Park bison cows—could not be punished for it, because there was no penalty prescribed by any law. Today, there is a way in which any revengeful person could inflict enormous damage on the entire South, at no cost to himself, involve those states in enormous losses and the expenditure of vast sums of money, yet go absolutely unpunished!

The gypsy moth is a case in point. This winged calamity was imported at Maiden, Massachusetts, near Boston, by a French entomologist, Mr. Leopold Trouvelot, in 1868 or 69. History records the fact that the man of science did not purposely set free the pest. He was endeavoring with live specimens to find a moth that would produce a cocoon of commercial value to America, and a sudden gust of wind blew out of his study, through an open window, his living and breeding specimens of the

Links to
Sample Questions

[Sample Question #1](#)

[Sample Question #2](#)

[Sample Question #3](#)

[Sample Question #4](#)

[Sample Question #5](#)



gypsy moth. The moth itself is not bad to look at, but its larvae is a great, overgrown brute with an appetite like a hog. Immediately Mr. Trouvelot sought to recover his specimens, and when he failed to find them all, like a man of real honor, he notified the State authorities of the accident. Every effort was made to recover all the specimens, but enough escaped to produce progeny that soon became a scourge to the trees of Massachusetts. The method of the big, nasty-looking mottled-brown caterpillar was very simple. It devoured the entire foliage of every tree that grew in its sphere of influence.

The gypsy moth spread with alarming rapidity and persistence. In course of time, the state authorities of Massachusetts were forced to begin a relentless war upon it, by poisonous sprays and by fire. It was awful! Up to this date (1912) the New England states and the United States Government service have expended in fighting this pest about \$7,680,000!

The spread of this pest has been retarded, but the gypsy moth never will be wholly stamped out. Today it exists in Rhode Island, Connecticut, and New Hampshire, and it is due to reach New York at an early date. It is steadily spreading in three directions from Boston, its original point of departure, and when it strikes the State of New York, we, too, will begin to pay dearly for the Trouvelot experiment.

Characterizing the Author's Position

Some questions may ask about point of view in the most direct way possible: by presenting you with four different descriptions of the author's perspective in the passage and asking you to choose the one that is most accurate. For these questions, the challenge may come in the breadth of material you could possibly consider in picking out your answer. It's difficult to predict exactly where the author will reveal his or her opinion in the passage; while the thesis statements of persuasive essays certainly make the author's opinion known, not every passage you'll see on the SAT Reading test is going to be structured like this. Passages may aim to present information instead of persuade, and you may not be given the beginning of a work, but rather, an excerpt from the middle or end of it.

While reading the passage, jot down a note if the author really commits himself or herself to a certain point of view on the topic at hand. These claims should be relevant to the discussion at hand, so you'll be marking the passage's main ideas as well. If the author doesn't tend so strongly toward one side or the other, or the passage is informational, keep on the lookout from the start for any subtle moments in which you realize which side the author is on, and make a note by those. If you can incorporate considering the author's point of view into your passage-reading routine, point-of-view questions should seem much less imposing.



Click Here to
Revisit the
Passage

Sample Question #1

The perspective of the author in this passage is best described as which of the following?

- A. a frustrated environmentalist
- B. an angry entomologist
- C. a despondent farmer
- D. an optimistic proponent of national parks

We can split these answer choices into two features: an adjective and a noun. Let's consider the adjectives first. There is evidence in the passage that the author is "frustrated" and "despondent"—he certainly doesn't like how issues surrounding invasive species are handled, and he's not confident that the situation is going to improve anytime soon. One might perhaps call him "angry," although this is a bit of a stretch. One certainly can't call him "optimistic," so let's ignore D.

On to the nouns: is the author a "farmer"? No. While he discusses issues concerning land, he never claims to be a farmer, and we're not given any information that implies that he is one. We can ignore C. While the author discusses an entomologist, he doesn't claim to be one himself, nor does he provide any scientifically rigorous information about insects that might lead us to assume that he studies them for a living. His description of the gypsy moth and its larvae are decidedly nonscientific (e.g. "The moth itself is not bad to look at, but its larvae is a great, overgrown brute with an appetite like a hog."). This leaves us with the best answer choice, A. The author is best described as a frustrated environmentalist due to his concern for the environmental problems invasive species cause and the lack of legislation punishing individuals who purposely make choices that wreak havoc on the environment.

Note how splitting the answer choices into component parts allowed us to ignore answer choices C and D. While the author could easily be called "despondent" and "a proponent of national parks," he cannot accurately be called a farmer or "optimistic." Think of this strategy as "dividing and conquering" your answer choices: you only need to identify one reason the answer choice is incorrect, even if part of it sounds accurate!

Discerning the Author's View of Specified Passage Topics

Let's now consider a variety of point-of-view question that you may consider to be easier than the more general type we just examined. Certain point-of-view questions may direct your attention to specific topics mentioned in the passage and ask you to identify the author's perspective on them. These topics may not be main ideas, but they will likely be relevant enough to the progression of the passage that the author lets slip some opinion on them. As always, make sure you can point to specific evidence in the passage to substantiate your claims about how the author feels about a particular topic! Even if you're not directly asked for it by a question, it will help you avoid picking answer choices that sound correct but are unsubstantiated. These more specific point of view questions may require you to consider subtle details like the connotations of words that the author uses when talking about a particular topic, so be prepared to read closely to figure out the correct answer.



Click Here to
Revisit the
Passage

Sample Question #2

Which of the following best characterizes the perspective of the author on the gypsy moth?

- A. adores
- B. detests
- C. misunderstands
- D. underestimates

How does the author describe the gypsy moth caterpillar in the second paragraph? Well, we can tell he's not very fond of it at all because he says, "The moth itself is not bad to look at, but its larvae is a great, overgrown brute with an appetite like a hog." Similarly, at the end of the paragraph, he writes, "Every effort was made to recover all the specimens, but enough escaped to produce progeny that soon became a scourge to the trees of Massachusetts. The method of the big, nasty-looking mottled-brown caterpillar was very simple. It devoured the entire foliage of every tree that grew in its sphere of influence." Based on the strong negative language the author uses when discussing the gypsy moth caterpillars and the damage they cause, we can pick out B, "detests" as the correct answer.

Click Here to
Revisit the
Passage

Sample Question #3

How does the author feel about Howell?

- A. The author agrees with Howell that invasive species are often problematic.
- B. The author greatly dislikes Howell for his audacious disrespect for nature.
- C. The author thinks that Howell made a great mistake in releasing Gypsy moths into the United States.
- D. The author likes Howell because he helped identify a problem with the consequences available for environmental disruptors.

Let's look at the part of the first paragraph in which the author brings up Howell, paying attention to why he does so:

The most aggravating feature of these follies in transplantation is that never yet have they been made severely punishable. We are just as careless and easygoing on this point as we were about the government of the Yellowstone Park in the days when Howell and other poachers destroyed our first national bison herd, and when caught red-handed—as Howell was, skinning seven Park bison cows—could not be punished for it, because there was no penalty prescribed by any law.

In mentioning Howell, the author is providing an example supporting his argument



that harsher legal penalties are necessary for those who harm the environment. The author describes Howell as a “poacher” who “destroyed our first national bison herd” and was “caught red-handed.” From this, we can tell that the best answer choice is B, “the author greatly dislikes Howell for his audacious disrespect for nature.”

One of the other answer choices attempts to get you to confuse Howell with Mr. Trouvelot, who released the gypsy moths—don’t fall for that! Check the passage if you are worried at all about confusing the two so you can avoid pitfall answers like this one.

Understanding Point of View to Infer and Predict

The final type of point-of-view question we’ll consider is inference-based point of view questions: those that ask you to employ your skills in inferring and predicting in order to ascertain what the author would most likely think of a given topic or how he or she would feel in a given situation. It’s imperative that you make sure your inferences and predictions are based on the passage. Can you point to specific evidence that justifies them? Make sure you can!

Sample Question #4

If the author were to learn that the gypsy moth could be efficiently repelled from trees by coating them with a cheap, natural substance, he would likely feel

_____.

- A. exuberant
- B. horrified
- C. unsurprised
- D. anxious

Click Here to
Revisit the
Passage

Throughout the passage, the author makes it apparent that he feels that the gypsy moth is a very damaging invasive species that causes a lot of problems in the United States. He calls it a “winged calamity” and, in the third paragraph, describes how it spread:

The gypsy moth spread with alarming rapidity and persistence. In course of time, the state authorities of Massachusetts were forced to begin a relentless war upon it, by poisonous sprays and by fire. It was awful! Up to this date (1912) the New England states and the United States Government service have expended in fighting this pest about \$7,680,000!

From this paragraph, we can tell that if the author were to learn that the gypsy moth could be efficiently stopped from damaging trees, he would be most likely to feel “exuberant,” or excited and happy. Nothing in the passage supports any of the other answers.



Click Here to
Revisit the
Passage

Sample Question #5

Based on the first paragraph, the author would be most likely to support

_____.

- A. a law severely punishing those who introduce invasive species that damage the environment
- B. keeping bison out of Yellowstone National Park
- C. introducing damaging invasive species to the South
- D. granting Howell clemency for his actions

One of the author's main points in the first paragraph is that harsher legal repercussions are needed for those who release damaging invasive species into the United States. This is clear when the author writes, "The most aggravating feature of these follies in transplantation is that never yet have they been made severely punishable." Thus, we can infer that the author would be most likely to support "a law severely punishing those who introduce invasive species that damage the environment." Though the author does discuss the potential for someone to introduce invasive species to the South, he is not in favor of this, and he clearly doesn't want to grant Howell clemency for his actions. (Furthermore, "clemency" somewhat implies that Howell has been charged with a crime, and the author explains that this isn't the "case). "A law severely punishing those who introduce invasive species that damage the environment" the best answer. If you're unsure when picking between answers to an inference question, it's usually a good idea to see which one is more relevant to the passage's topic and has the most evidence supporting it.



Purpose

Questions that ask about the purpose of a passage, or identified parts of it, can seem difficult at first glance. They expect you to take in a great deal of information and distill from it not the main point of what it's saying, but why the author is making that particular point in the first place. Doing this requires analysis that moves beyond what is directly stated in the text, but with practice, you can start to put yourself in the author's shoes and gain insight on what each sentence, and the entire passage, is doing to create meaning.

Practice Passage

Adapted from *Walden* by Henry Thoreau (1854)

Still we live meanly, like ants; it is error upon error, and clout upon clout, and our best virtue has for its occasion a superfluous and evitable wretchedness. Our life is frittered away by detail. An honest man has hardly need to count more than his ten fingers, or in extreme cases he may add his ten toes, and lump the rest. Simplicity, simplicity, simplicity! I say, let your affairs be as two or three, and not a hundred or a thousand; instead of a million count half a dozen, and keep your accounts on your thumbnail. In the midst of this chopping sea of civilized life, such are the clouds and storms and quicksands and thousand-and-one items to be allowed for, that a man has to live, if he would not founder and go to the bottom and not make his port at all, by dead reckoning, and he must be a great calculator indeed who succeeds. Simplify, simplify. Instead of three meals a day, if it be necessary eat but one; instead of a hundred dishes, five; and reduce other things in proportion.

Our life is like a German Confederacy, made up of petty states, with its boundary forever fluctuating, so that even a German cannot tell you how it is bounded at any moment. The nation itself, with all its so-called internal improvements, which, by the way are all external and superficial, is just such an unwieldy and overgrown establishment, cluttered with furniture and tripped up by its own traps, ruined by luxury and heedless expense, by want of calculation and a worthy aim, as the million households in the land; and the only cure for it, as for them, is in a rigid economy, a stern and more than Spartan simplicity of life and elevation of purpose. It lives too fast. Men think that it is essential that the Nation have commerce, and export ice, and talk through a telegraph, and ride thirty miles an hour, without a doubt, whether they do or not, but whether we should live like baboons or like men is a little uncertain. If we do not get out sleepers, and forge rails, and devote days and nights to the work, but go to tinkering upon our lives to improve them, who will build railroads? And if railroads are not built, how shall we get to heaven in season? But if we stay at home and mind our business, who will want railroads? We do not ride on the railroad; it rides upon us. Did you ever think what those sleepers are that underlie the railroad? Each one is a man, an Irishman, or a Yankee man. The rails are laid on them, and they are covered with sand, and the cars run smoothly over them. They are sound sleepers, I assure you.

Links to
Sample Questions

[Sample Question #1](#)

[Sample Question #2](#)

[Sample Question #3](#)

[Sample Question #4](#)

[Sample Question #5](#)



A passage's purpose can be examined at many different levels of magnification. Certain purpose questions on the SAT Reading test may function at a microscopic level of single words, while others may ask you about the big picture of the purpose of an entire passage. Still others fall elsewhere on the spectrum between these two extremes. In learning to face purpose questions, let's start with the small-scale, ultra-focused questions and zoom out to more general and far-reaching ones.

Questions About the Purpose of a Single Word

Questions that ask about the purpose of a single word may seem like they can ask about any word in the passage, but that's just not true. These questions will focus in on a word of some significance to the passage, so if you notice particular words that stick out to you as functioning in unique and overt ways as you are reading the passage, take note of them; such attention could make it easier for you to reorient yourself when answering questions about these terms.

Sample Question #1

The author repeats the words “simplicity” and “simplify” in the first paragraph in order to _____.

- A. mimic his critics in a derogatory way
- B. emphasize what he sees as the solution to a problem
- C. suggest that this is the only solution that has been put forward, and it is ineffective
- D. convey that working toward simplicity takes a lot of hard work

Click Here to
Revisit the
Passage

The author's repetition of “Simplicity, simplicity, simplicity!” and “Simplify, simplify” in the first paragraph add emphasis exhorting the audience to make their lives simpler, a change Thoreau sees as the solution to many of the excesses of modern life and the problems they cause. There is no mention of any critics in the passage, and his repetition does not suggest simplicity is an ineffective solution. He certainly does not imply that there is too much simplicity in modern society—one might read this into the line out of context, but throughout the passage, one can tell that the author is writing in favor of simplifying. Finally, while repetition can often make something seem as if it is difficult or takes time (e.g. “Digging, digging, digging—all that digging and they were only a few feet closer to the center of the earth”), that is not what is going on here.

Questions About the Purpose of a Sentence

Purpose-of-sentence questions use entire lines as their building blocks, so when dealing with these, be sure to note any introductory, transitional, or concluding phrases as well as any other wording that interlocks specific lines together in particular ways.



Click Here to
Revisit the
Passage

Sample Question #2

The underlined sentence functions as _____ in context.

- A. a counterpoint to a critic's rebuttal
- B. concrete examples of how the reader can simplify
- C. a transition into the ideas discussed in the next paragraph
- D. a use of figurative language to emphasize the author's point

The underlined sentence is, "Instead of three meals a day, if it be necessary eat but one; instead of a hundred dishes, five; and reduce other things in proportion." Its position as the last line of the first paragraph may make it seem like "a transition into the ideas discussed in the next paragraph," but as the second paragraph begins on an entirely new point, this isn't the best answer. No critics are mentioned in the passage, so we can't claim it to be "a counterpoint to a critic's rebuttal." While it is emphasizing the author's point, it's not using figurative language to do so, so "a use of figurative language to emphasize the author's point" can't be correct either. This leaves us with one answer choice, the correct one: the sentence is functioning as "a concrete example of how the reader can simplify." This is especially visible in that it directly follows the author's exhortation of "Simplify, simplify."

Questions About a General Part of the Passage

Certain purpose questions fall between sentence-level and passage-level on the specificity spectrum. The biggest issue with addressing these should not be figuring out which part of the passage is being indicated; that much should be relatively obvious. Figuring out how an argument, a listing of evidence, or a description is functioning in the context of the entirety of the presented text means identifying other large sectional building blocks in the passage and figuring out what makes the specified one function in relation to them.

Click Here to
Revisit the
Passage

Sample Question #3

Thoreau's discussion of "sleepers" at the end of the passage helps him _____.

- A. emphasize how the railroad is a burden upon people and their resources
- B. underscore the dangers to workers involved in building contemporary railroads
- C. suggest that the railroad is a great boon to the nation
- D. comment on how hard it is to fall asleep on a moving train

Thoreau discusses sleepers in the final lines of the passage:



We do not ride on the railroad; it rides upon us. Did you ever think what those sleepers are that underlie the railroad? Each one is a man, an Irishman, or a Yankee man. The rails are laid on them, and they are covered with sand, and the cars run smoothly over them. They are sound sleepers, I assure you.

The key line necessary to figuring out what Thoreau's purpose is in discussing sleepers is the line that precedes any mention of them: "We do not ride on the railroad; it rides upon us." With this wordplay, Thoreau is suggesting that the railway burdens us; the correct answer is thus that his discussion of "sleepers" helps him "emphasize how the railroad is a burden upon people and their resources." While he is decidedly anti-railroad in this passage, he focuses on the building of railroads instead of the use of them, weakening the argument that the point of his mentioning "sleepers" is to "urge readers never to use railroads to travel." Similarly, while the image of the railroad riding upon men's sleeping bodies may seem to "underscore the dangers to workers involved in building contemporary railroads," this is not the case either. In stating, "We do not ride on the railroad; it rides upon us," the author makes his purpose in mentioning "sleepers" clear.

Questions About the Purpose of the Passage as a Whole

Finally, certain questions encompass the entirety of the text and ask why the author would write it at all. While the most broad type of purpose question, these are not necessarily the most challenging of the species. When considering an entire passage's purpose, remember to treat it in the same vein as picking main idea statements or looking for a good paraphrase or summary statement—answer choices must be just specific enough, mentioning relevant details that apply to—or together encompass—the entire passage while not succumbing to generalities, irrelevant minutiae, or false information.

Sample Question #4

Click Here to
Revisit the
Passage

Which of the following best describes the author's purpose in writing this passage?

- A. to complain that people are oversimplifying their lives
- B. to point out that the United States has become like a German Confederacy and recommend it continue in this direction
- C. to discuss the pros and cons of developing railroads
- D. to discuss how his contemporary culture is overly complex and recommend people take steps to combat this

The passage talks about simplicity vs. complexity, and two of the answer choices have to do with this contrast: A and D. Let's look over B and C first, starting with B. Does the author point out that the United States has become like a German Confederacy? Yes, at the start of the second paragraph. This may be enough for certain students, who may be rushing through this question due to time restrictions, to choose B and move on to the next question, but those students would get this question wrong. The rest of the answer choice, "and recommend it continue in this direction," invalidates it, as Thoreau is not



just pointing out the US-German Confederacy similarity, he's complaining about it. Plus, even if that weren't the case, this comparison only appears at the start of the second paragraph. The author doesn't talk about it in the rest of the passage, which suggests that B is not a good reflection of the purpose of the entire text. A purpose statement should encompass the entire passage, not just accurately describe the purpose of part of one paragraph.

Let's look at answer choice C. Again, the author does discuss the pros and cons of developing railroads, (though he focuses on the cons) in the passage's last paragraph. But he doesn't mention railroads in the previous paragraphs, making this answer choice unlikely to be the correct one. We can ignore it.

So, we've narrowed down the answer choices to A and D, the two options that discuss the author's views on simplicity and complexity. Before considering them in detail, consider the passage. How do these two terms relate in the author's opinion? He certainly seems to like simplicity and urges people to "simplify," while complaining about how modern life has gotten too complex. With that in mind, let's look over A and D. Is the purpose of the passage A "to complain that people are oversimplifying their lives"? Or is it D, "to discuss how his contemporary culture is overly complex and recommend people take steps to combat this"? A puts simplicity in a negative light, and D puts complexity in a negative light and simplicity in a positive light. Since the author urges people to "simplify" and considers simplicity to be a good thing throughout the passage, D is the correct answer.

Certain purpose questions may step out of the familiar "summary-esque" mode of the one presented above and instead ask you to describe the passage's purpose with a single word, much in the manner of a direct tone question.

Sample Question #5

Click Here to
Revisit the
Passage

This is best described as a(n) _____ passage.

- A. persuasive
- B. informational
- C. scientific
- D. descriptive

This passage doesn't mention scientific principles, phenomena, or lab experiments, so we can't accurately call it "scientific." Its main purpose is not to describe something, so it's not "descriptive." This leaves us with "informational" and "persuasive." "Persuasive" is the correct option; the passage is not simply conveying information, but attempting to get readers to change their opinions, behaviors, and lifestyle. The persuasive element of the passage is best seen in the first paragraph, in the author's urging of "Simplify, simplify."



Claims, Evidence, and Reasoning

Certain authors aim to convince readers of their opinions, other passages attempt to map out academic debates, and some passages do both, with the author describing the academic “lay of the land” surrounding a debate while also making a pitch for his or her own particular take on it. No matter what form an argumentative SAT Reading passage or what is being argued about, you need to be able not only to understand how different claims interact, but also to keep track of who agrees with whom. This requires paying attention to the subtleties of claims, evidence, and reasoning.

Practice Passage

Adapted from “Recent Views as to Direct Action of Light on the Colors of Flowers and Fruits” in *Tropical Nature, and Other Essays* by Alfred Russel Wallace (1878)

The theory that the brilliant colors of flowers and fruits is due to the direct action of light has been supported by a recent writer by examples taken from the arctic instead of from the tropical flora. In the arctic regions, vegetation is excessively rapid during the short summer, and this is held to be due to the continuous action of light throughout the long summer days. “The further we advance towards the north, the more the leaves of plants increase in size as if to absorb a greater proportion of the solar rays. M. Grisebach says that during a journey in Norway he observed that the majority of deciduous trees had already, at the 60th degree of latitude, larger leaves than in Germany, while M. Ch. Martins has made a similar observation as regards the leguminous plants cultivated in Lapland.” The same writer goes on to say that all the seeds of cultivated plants acquire a deeper color the further north they are grown, white haricots becoming brown or black, and white wheat becoming brown, while the green color of all vegetation becomes more intense. The flowers also are similarly changed: those which are white or yellow in central Europe becoming red or orange in Norway. This is what occurs in the Alpine flora, and the cause is said to be the same in both—the greater intensity of the sunlight. In the one the light is more persistent, in the other more intense because it traverses a less thickness of atmosphere.

Admitting the facts as above stated to be in themselves correct, they do not by any means establish the theory founded on them; and it is curious that Grisebach, who has been quoted by this writer for the fact of the increased size of the foliage, gives a totally different explanation of the more vivid colors of Arctic flowers. He says, “We see flowers become larger and more richly colored in proportion as, by the increasing length of winter, insects become rarer, and their cooperation in the act of fecundation is exposed to more uncertain chances.” (*Vegetation du Globe*, col. i. p. 61—French translation). This is the theory here adopted to explain the colors of Alpine plants, and we believe there are many facts that will show it to be the preferable one. The statement that the white and yellow flowers of temperate Europe become red or golden in the Arctic regions must we think be incorrect. By roughly tabulating the colors of the plants given by Sir Joseph Hooker as permanently Arctic, we find among fifty species with more or less conspicuous flowers, twenty-five white, twelve yellow, eight purple or blue, three lilac, and two red or pink; showing a very similar proportion of white and yellow flowers to what obtains further south.

Links to
Sample Questions

[Sample Question #1](#)

[Sample Question #2](#)

[Sample Question #3](#)

[Sample Question #4](#)



Questions about claims, evidence, and reasoning can focus on the author's argument or on those of other individuals. They can also ask you which roles certain parts of the passage play in relation to the argument at hand. Let's consider sample questions representative of each of these categories.

Let's start with the most direct type of argument-based question: that which concerns the argument the author is making. These won't necessarily ask directly about the argument at hand. You might be asked to identify the particular points of another individual's argument with which the author disagrees, or about why the author presents certain information—is it to support his or her own ideas? To dismantle a counter-argument? Maybe to make the other side look unreliable? Authorial-argument questions can take many forms, so let's consider a few of them now.

Questions About the Author's Claims

Certain questions that concern argument—perhaps the most direct of this type—will ask you to identify the argument that the author is making. While these problems can be as direct as those that ask you to identify a passage's main idea, they can also couch the author's argument in the context of those of the other figures with whom he agrees or disagrees, as in the following sample question.

Sample Question #1

In this passage, the author _____.

- A. disagrees with Martins but agrees with Grisebach
- B. disagrees with Hooker but agrees with Martins
- C. disagrees with the "recent writer" quoted in the first paragraph, but agrees with Grisebach
- D. disagrees with all of the writers and scientists mentioned in the passage

Click Here to
Revisit the
Passage

Answering this question requires you to read closely, as many theories are mentioned throughout the passage, and keeping track of them can be quite challenging. In the first paragraph, the writer quotes a "recent writer," who then quotes evidence in the form of observations by M. Grisebach and M. Ch. Martins. In the second paragraph, the writer says that he agrees with the evidence of the "recent writer" (in other words, Grisebach and Martins), but not with the theory the "recent writer" has come up with to explain that evidence. So, the author disagrees with the "recent writer," but agrees with Grisebach, because the author goes on to quote Grisebach's own theory, with which the author agrees.



Questions About the Author's Reasoning

Other argument-based SAT Reading questions may ask you to examine the author's argument not just to relay its main points, but to identify and analyze the logical reasoning supporting those points. Consider the following sample question, in which you're asked about how the author responds to a previously mentioned theory.

Sample Question #2

Click Here to
Revisit the
Passage

The author's critique of the theory presented in the first paragraph is that _____.

- A. they are true, but do not support the theory established based on them
- B. the facts supporting the theory are false, so the theory is also false
- C. only some of the facts are true, casting doubt on the reliability of the theory as a whole
- D. the facts were gathered in an unscientific manner and are thus not reliable, making the theory doubtful

At the start of the second paragraph, the author says, "Admitting the facts as above stated to be in themselves correct, they do not by any means establish the theory founded on them." So, the correct answer is that "[the facts] are true, but do not support the theory established based on them."

Questions about the Author's Evidence

Questions that concern the author's evidence can sway from direct identification questions to those that seem more like purpose questions in asking why the author brings up certain pieces of information. It's up to you to figure out how that evidence is functioning within the context of the argument the author is making.

Sample Question #3

Click Here to
Revisit the
Passage

The author brings up Joseph Hooker's research in order to _____.

- A. disprove the theory of the "recent writer" quoted in the first paragraph
- B. support Martins' theory
- C. demonstrate that the colors of flowers change at varying latitudes
- D. suggest that a follow-up experiment be performed to check his results



The author brings up Joseph Hooker’s research near the end of the second paragraph, stating, “By roughly tabulating the colors of the plants given by Sir Joseph Hooker as permanently Arctic, we find among fifty species with more or less conspicuous flowers, twenty-five white, twelve yellow, eight purple or blue, three lilac, and two red or pink; showing a very similar proportion of white and yellow flowers to what obtains further south.” This immediately follows the sentence, “The statement that the white and yellow flowers of temperate Europe become red or golden in the Arctic regions must we think be incorrect.” In this sentence, the author is doubting the veracity of the “recent writer” quoted in the first paragraph. The author then uses Hooker’s evidence to disprove the theory of the “recent writer,” because if the theory of the “recent writer” were correct, there would be very few white or yellow flowers in the Arctic and many red or golden ones, and Hooker’s evidence shows that this is not the case, as most of the Arctic flowers he observed were white. So, the correct answer is that the author uses Joseph Hooker’s evidence to “disprove the theory of the ‘recent writer’ quoted in the first paragraph.”

Questions About Other People’s Claims

You can also be asked about the opinions and arguments of other people mentioned in SAT Reading passages. Keep in mind that you are hearing these positions indirectly, from an author who may or may not be biased in favor of certain ideas and thus purposely presenting others’ opinions in a favorable or unfavorable light, depending on how they interact with the author’s own views.

Sample Question #3

Click Here to
Revisit the
Passage

The “recent writer” quoted in the first paragraph believes that _____.

- A. cultivated flowers have lighter colors in the South and darker colors in the North
- B. M. Ch. Martins’ theory is incorrect
- C. light is less persistent in the North than in the South
- D. the green color of plants becomes more intense in the South

Answering this question requires you to read the first paragraph very closely and to go back and figure out what exactly the “recent writer” is asserting, whether or not the author of the passage agrees with those assertions. Let’s consider each of the answer choices one by one:

B cannot be the correct answer, as the “recent writer” is quoted as mentioning M. Ch. Martins to bolster his own assertion about leaf size and latitude. C cannot be the correct answer because the author, in referring to the “recent writer,” says that “the same writer goes on to say that all the seeds of cultivated plants acquire a deeper color the further north they are grown . . . This is what occurs in the Alpine flora, and the cause is said to be the same in both—the greater intensity of the sunlight.” Answer choice D cannot be correct because the author, in discussing the “recent writer,” says, “The same writer goes on to say that all the seeds of cultivated plants acquire a deeper color the further north they are grown . . . while the green color of all vegetation becomes more intense.” A is the



correct answer! We can find evidence supporting it in that the author says (discussing the “recent writer”) “The same writer goes on to say that all the seeds of cultivated plants acquire a deeper color the further north they are grown, white haricots becoming brown or black, and white wheat becoming brown, while the green color of all vegetation becomes more intense. The flowers also are similarly changed: those which are white or yellow in central Europe becoming red or orange in Norway.”

Questions About the Structure of an Argument

Arguments unfold with a certain structure, often beginning with a thesis statement or proposition and then following that statement with evidence to back it up and address any counterarguments critics may put forward. Reading argumentative texts for practice can help you feel at ease when dealing with such pieces on the SAT Reading test and to identify parts of an argument quickly as they turn up. Such familiarity can come in very handy if certain questions focus not on what argument is being made in the passage, but on how it is being made.

Sample Question #4

Click Here to
Revisit the
Passage

What role does the underlined sentence play in the passage as a whole?

- A. It provides evidence that the phenomenon being discussed exists, but does not support one theory more than the other.
- B. It provides evidence that supports the theory of the writer quoted in the first paragraph, but casts doubt on other theories.
- C. It offers an opinion as to the validity of the theory of the “recent writer” quoted in the first paragraph.
- D. It provides a counterargument opposing the theory of the “recent writer” quoted in the first paragraph.

To answer this question correctly, you have to pay a great deal of attention to the way in which it is presented in the passage. It is quoted as evidence that the “recent writer” uses to support his or her theory that leaf size differs in this way due to a change in the intensity of the sunlight. So, “It provides a counterargument opposing the theory of the ‘recent writer’ quoted in the first paragraph” cannot be the correct answer. Since the statement in question is just presenting evidence, and not an opinion, “It offers an opinion as to the validity of the theory of the ‘recent writer’ quoted in the first paragraph” cannot be the correct answer either.

This leaves us with two possible answer choices: “It provides evidence that supports the theory of the writer quoted in the first paragraph, but casts doubt on other theories,” and “It provides evidence that the phenomenon being discussed exists, but does not support one theory more than the other.” The author of the passage, in the second paragraph, says that “the facts as above stated” are “in themselves correct, they do not by any means establish the theory founded on them.” Given this, along with the fact that the underlined sentence’s evidence never casts doubt on any theories in the passage, the correct answer is “It provides evidence that the phenomenon being discussed exists, but does not support one theory more than the other.”



Persuasive Language and Authorial Bias

The use of persuasive language is a rhetorical strategy likely to be found in any passage in which the author is attempting to convince readers that his or her argument about a given topic is correct. Most authors will attempt to use rhetoric to make their position sound like the inherently, obviously correct one; this is to be expected in any persuasive text. Certain authors may use the reverse tactic on their opponent's arguments, presenting them using language that makes them seem unreliable. When answering questions about views that you've learned about from the lens of a text supporting an opposing position, keep in mind that the author may be attempting to bias you against other positions with the very language of the text. If a question calls for objectivity in analyzing opposing positions, make sure to get to the logical arguments and counterarguments being made before picking your answer. Don't just rely on which position the passage makes sound like the better one—the author is likely biased in favor of his or her own position.



Counterarguments

Identifying a counterargument may seem like a particularly challenging task to be faced with on the SAT Reading test, but it's not as complex as it may seem. All you are looking for is the point where the author directly contradicts his or her opposition and explains why they are wrong, usually by presenting evidence to the contrary of the first argument.

It may be more helpful to point out an example of a counterargument than to describe counterarguments. Consider the following simple example argument:

Person 1: Ice cream is a better dessert than cake.

Person 2: No, cake is a better dessert than ice cream because cake has frosting and ice cream doesn't.

Person 1: Ice cream is a better dessert than cake because ice cream has calcium, making it healthier.

Person 2: Cake contains some calcium, too.

Person 1: Well, ice cream contains more calcium than cake, so it's healthier, and thus better.

Person 2: So the healthier dessert is necessarily the better one?

The truth of these claims aside, we can pick out two counterarguments in this little exchange. Person 2 makes a counterargument when he or she first speaks, directly refuting Person 1's position ("No, cake is a better dessert than ice cream") and then offering evidence as to why this is the case ("... because cake has frosting and ice cream doesn't.") This is an extremely simplified but valid counterargument, if one is judging desserts based on whether or not they include frosting.

Our little debate contains yet another counterargument as Person 1 replies to Person 2. This time, Person 1 restates his or her initial position ("Ice cream is a better dessert than cake") and backs this claim up with different evidence ("because ice cream has more calcium than cake, making it healthier").

Person 2 offers another counterargument: by pointing out that "Cake contains some calcium, too," Person 2 is weakening Person 1's position. You can't claim that ice cream is better than cake because it has calcium if cake also contains calcium.

Person 1 revises their statement about calcium levels ("Ice cream contains more calcium than cake, so it's healthier, and thus better"). and Person 2 gets to the heart of the matter: the participants in this debate need to agree on a single standard of judgment as to what constitutes "a better dessert" before they'll be able to agree about the relative merits of ice cream and cake. Person 2 doesn't agree with Person 1's assertion that the healthier dessert is necessarily the better one.

An actual SAT Reading passage is not likely to feature such a condensed argument with so many back-and-forth arguments and counterarguments being put forward, primarily because the majority of passages that you'll see on the SAT Reading test are single passages, not pairs of passages; they are thus each written by a single author and not presented in the form of dialogue. All the same, be on the lookout for moments at which the author directly engages critics of his or her ideas, and offers evidence to support his or her claims in the light of the critics' challenges. Do this, and you'll have no problems identifying counterarguments.



Synthesis

Before you sit for your exam, you should be prepared to face not just challenging passages, but also challenging passages that are placed in conversation with other passages or that include figures, graphs, or charts. Certain questions about passages presented this way will be “synthesis” questions, those that require you to understand both stimuli presented in order to reach the correct answer. Synthesis questions about paired passages may ask how the authors would feel about each others’ opinions on a topic they both consider, while questions about passages accompanied by figures can ask about the ways in which the information conveyed by the figure either supports or contradicts the passage.

One of the major changes made to the revised SAT is its inclusion of graphs, charts, and figures alongside passages on the reading section, and its paired passage questions have traditionally been considered the most challenging. Instead of struggling with these questions, practice them ahead of time so that you can be comfortable considering multiple sources of information when answering these types of questions on your SAT.

Section Outline

Paired Passages

- Answering questions that require you to understand both of two passages presented together

Quantitative Information

- Analyzing how figures like graphs, charts, and tables interact with prose passages



Paired Passages

Of the five passages you encounter on the SAT Reading test, one of them will be a paired passage section in which you are faced with not one, but two passages to interpret. These passages will be drawn from the subject areas of natural science, social science, or historical documents and speeches. Each of the passages in the pair will not be as long as a typical SAT Reading passage presented by itself; however, you will have to deal with the arguments and opinions of two authors, not just one. Some questions will direct your focus to one of the two passages and ask about it as a stand-alone text, but other questions will ask you about the relationship between the two passages. These are considered the tougher type of question, as students have often had less practice in querying exactly how two arguments interact than with interpreting a single text. With this in mind, this lesson will consider each type of paired passage question, but will focus on those problems that ask about how the passages relate in order to help you practice the skills they test.

There are two general categories into which SAT paired passages commonly fall: “Conflicting Views” and “Statement-Response.” You can think of these as differing in terms of authorial awareness, intent, and specificity. Conflicting Views paired passages involve the authors clashing over a topic, but with neither author particularly addressing the claims of the other. The passages are simply distinct opposing arguments that the test writers selected; the authors may have never heard of one another. This contrasts with “Statement-Response” passages. These paired passages have a distinct order; the author of Passage A makes some claim which the author of Passage B then addresses and (often) rebuts. Passage B specifically responds to the claims of Passage A, so the author of Passage B must be aware of the author of Passage A, as he or she is responding to it directly.

The SAT Reading test will not ask you to distinguish between these two types of paired passages, but we have structured this lesson so that you can practice reading, interpreting, and answering questions about each. Let’s start by taking a look at a pair of passages that would fall into the Conflicting Views category. Both of these authors are writing about a particular historical figure, but they have notably different opinions of her legacy. As you read, pay attention to literary cues of tone and rhetoric as well as claims and evidence that help you realize that the authors differ in their opinions. If you can’t put your finger on a specific topic about which the authors disagree, imagine what sort of conversation they might have if they met one another in person. About what would they agree? About what would they argue? Putting their opinions in perspective like this can help you identify the point of contention revealed by placing the passages in conversation with one another.



Passage A

Adapted from “Robespierre” in *Critical Miscellanies* by John Morley (1904)

But history must be just; and the character of [Marie Antoinette] had far more concern in the disaster of the first five years of the Revolution than had the character of Robespierre. Every new document that comes to light heaps up proof that if blind and obstinate choice of personal gratification before the common weal be enough to constitute a state criminal, then the Queen of France was one of the worst state criminals that ever afflicted a nation. The popular hatred of Marie Antoinette sprang from a sound instinct. We shall never know how much or how little truth there was in those frightful charges against her, that may still be read in a thousand pamphlets. These imputed depravities far surpass anything that John Knox ever said against Mary Stuart, or that Juvenal has recorded against Messalina; and, perhaps, for the only parallel we must look to the hideous stories of the Byzantine secretary against Theodora, the too-famous empress of Justinian and the persecutor of Belisarius. We have to remember that all the revolutionary portraits are distorted by furious passion, and that Marie Antoinette may no more deserve to be compared to Mary Stuart than Robespierre deserves to be compared to Ezzelino or to Alva. It is at least certain that, from the unlucky hour when the Austrian archduchess crossed the French frontier, a childish bride of fourteen, down to the hour when the Queen of France made the attempt to recross it in resentful flight one and twenty years afterwards, Marie Antoinette was ignorant, unteachable, blind to events and deaf to good counsels, a bitter grief to her heroic mother, the evil genius of her husband, the despair of her truest advisers, and an exceedingly bad friend to the people of France. She broke out in incredible dissipations; in indiscreet visits to the masked balls at the opera, in midnight parades and mystifications on the terrace at Versailles, in insensate gambling. “The court of France is turned into a gaming-hell,” said the Emperor Joseph, the Queen’s own brother: “if they do not amend, the revolution will be cruel.”

Passage B

Adapted from “On the Death of Marie Antoinette” by Edmund Burke (1793)

It is now sixteen or seventeen years since I saw the Queen of France, then the Dauphiness, at Versailles; and surely never lighted on this orb, which she hardly seemed to touch, a more delightful vision. I saw her just above the horizon, decorating and cheering the elevated sphere she had just begun to move in, glittering like the morning star full of life and splendor and joy.

Oh, what a revolution! And what a heart must I have, to contemplate without emotion that elevation and that fall! Little did I dream, when she added titles of veneration to those of enthusiastic, distant, respectful love, that she should ever be obliged to carry the sharp antidote against disgrace concealed in that bosom; little did I dream that I should have lived to see such disasters fallen upon her, in a nation of gallant men and of cavaliers! I thought ten thousand swords must have leaped from their scabbards, to avenge even a look that threatened her with insult.

But the age of chivalry is gone; that of sophistry, economists, and calculators has succeeded, and the glory of Europe is extinguished forever. Never, never more, shall we behold that generous loyalty to rank and sex, that proud submission, that dignified obedience, that subordination of the heart, which kept alive, even in servitude itself, the spirit of an exalted freedom! The unsought grace of life, the cheap defense of nations, the nurse of manly sentiment and heroic enterprise is gone. It is gone, that sensibility of principle, that chastity of honor, which felt a stain like a wound, which inspired courage whilst it mitigated ferocity, which ennobled whatever it touched, and under which vice itself lost half its evil, by losing all its grossness.

Links to Sample Questions

[Sample Question #1](#) [Sample Question #2](#) [Sample Question #3](#)
[Sample Question #4](#) [Sample Question #5](#) [Sample Question #6](#)
[Sample Question #7](#) [Sample Question #8](#)



Before approaching the questions, you may find it helpful to take a moment to characterize each author's perspective on Marie Antoinette. On test day, you might jot down a few notes in the margins of your test booklet next to each passage. This can help you avoid a major paired-passage-specific error: mixing up the passages. Certain answer choices might relate to the wrong passage on purpose to trick you should you accidentally confuse the two, so it's paramount that you keep them distinct when answering questions that relate to one or both.

For these passages, you might jot down some notes about how the author of Passage B likes Marie Antoinette and the author of Passage A does not. You could even write "Marie Antoinette" and then put a plus sign on the side of Passage B and a minus sign on the side of Passage A, like so:

-	Marie Antoinette	+
<p><i>Passage A</i></p> <p>Adapted from "Robespierre" in <i>Critical Miscellanies</i> by John Morley (1904)</p> <p>But history must be just; and the character of [Marie Antoinette] had far more concern in the disaster of the first five years of the Revolution</p>	<p><i>Passage B</i></p> <p>Adapted from "On the Death of Marie Antoinette" by Edmund Burke (1793)</p> <p>It is now sixteen or seventeen years since I saw the Queen of France, then the Dauphiness, at Versailles: and surely never lighted on this</p>	

What else can we compare right off the bat about these passages? Passage B's author has actually met Marie Antoinette, as he begins, "It is now sixteen or seventeen years since I saw the Queen of France." In contrast, the author of Passage A is talking about Marie Antoinette from a historical perspective. He draws evidence from pamphlets and uses quotations from other historical figures of the time period.

Our notes at this point might look something like this:

historical perspective	-	Marie Antoinette	+	personal perspective
<p><i>Passage A</i></p> <p>Adapted from "Robespierre" in <i>Critical Miscellanies</i> by John Morley (1904)</p> <p>But history must be just; and the character of [Marie Antoinette] had far more concern in the disaster of the first five years of the Revolution</p>		<p><i>Passage B</i></p> <p>Adapted from "On the Death of Marie Antoinette" by Edmund Burke (1793)</p> <p>It is now sixteen or seventeen years since I saw the Queen of France, then the Dauphiness, at Versailles: and surely never lighted on this</p>		

Ok, that's enough to distinguish the passages clearly. We don't want to go overboard in our note-taking and spend too much time on it; the above notes could be surmised and jotted down in about ten seconds after reading the passages, and can potentially save you valuable points in helping you to keep them distinct in your mind at a glance.



Single-Passage Questions

The following questions each relate to one passage or the other, but they don't ask about the relationships between the passages. Identify the passage that is being discussed and ignore the other; you can pretend you're answering questions about a single-passage SAT Reading test. All of the same question types you can potentially encounter in a single-passage section, you can encounter here. Let's try a few sample questions from this wide variety of possibilities.

Sample Question #1

Click Here to
Revisit the
Passage

In Passage B, the underlined statement “I thought ten thousand swords must have leaped from their scabbards, to avenge even a look that threatened her with insult” most nearly reflects the author’s _____.

- A. misery and disdain
- B. confusion and praise
- C. arrogance and apathy
- D. shock and disappointment

The author's statement highlights his shock and disappointment that his perceptions of the French ruling class was so far off the mark. He states that he believed the French aristocracy and people would spring to defend Marie Antoinette when the opportunity arose, and it is clear from his language that the failure of the French people to do so caused him to feel shocked and saddened. The phrase “Little did I dream” highlights the author's feelings of shock. The correct answer is D.

Sample Question #2

Click Here to
Revisit the
Passage

Passage A compares Mary Stuart, Messalina, and Theodora to Marie Antoinette in order to emphasize that _____.

- A. Marie Antoinette is more famous
- B. Marie Antoinette has been accused more harshly
- C. the listed rulers, who were unpopular, all governed better than Marie Antoinette
- D. Marie Antoinette's current situation isn't worse than what other historic rulers have experienced

Passage A compares Marie Antoinette with other historical figures in this excerpt:

The popular hatred of Marie Antoinette sprang from a sound instinct. We shall never know how much or how little truth there was in those frightful charges against her, that may still be read in a thousand pamphlets. These imputed



depravities far surpass anything that John Knox ever said against Mary Stuart, or that Juvenal has recorded against Messalina; and, perhaps, for the only parallel we must look to the hideous stories of the Byzantine secretary against Theodora, the too-famous empress of Justinian and the persecutor of Belisarius.

The accusations against Marie Antoinette are definitely negatively connoted—“imputed depravities” is very strong wording. We can ignore answer choice D, as the accusations against Marie Antoinette are said to be worse than those that were made against the other listed rulers. The varying famousness of the figures isn’t the thing being directly compared, so A isn’t correct either. While C is partially true—the listed rulers do seem to have all been unpopular—nothing is said about how they governed in relation to Marie Antoinette. The correct answer is B, that Marie Antoinette has been accused more harshly than the other listed rulers. This is the comparison being directly made in the passage.

Sample Question #3

Click Here to
Revisit the
Passage

The author’s tone in Passage B is primarily _____.

- A. optimistic and restrained
- B. condescending and apathetic
- C. celebratory and ecstatic
- D. pessimistic and admonishing

The author’s tone in this passage is primarily pessimistic and admonishing, so the correct answer is D. “Pessimistic” means having a negative outlook about past, current, or future events, and “admonishing” means condemning or telling off. The author’s pessimistic tone is evident throughout; one example can be found in the clause “the glory of Europe is extinguished forever.” Likewise, the author admonishes throughout the passage and really gets into his stride in the concluding paragraph, where he criticizes the characteristics of the current French nation by means of discussing their earlier, and opposite, virtues.

Sample Question #4

Click Here to
Revisit the
Passage

The quotation that ends Passage A serves what purpose in the text?

- A. It contradicts the author’s argument.
- B. It provides evidence that supports one of the author’s claims about Marie Antoinette.
- C. It provides a transition to a new idea discussed in the next paragraph in the larger work from which the passage is adapted.
- D. It suggests that Emperor Joseph was as unpopular as Marie Antoinette.



The quotation that ends Passage A is attributed to “Emperor Joseph, the Queen’s own brother:” “The court of France is turned into a gaming-hell . . . if they do not amend, the revolution will be cruel.” This ties into the passage’s discussion of Marie Antoinette’s “incredible dissipations,” one of which was “insensate gambling.” D isn’t correct; nothing about the quotation suggests that Emperor Joseph was as unpopular as Marie Antoinette. The fact that Emperor Joseph is quoted as being concerned about Marie Antoinette’s gambling suggests they disagree over it, which suggests that he might be more popular with the French people where Marie Antoinette might not be, but there is no evidence in the passage to go on. While found at the end of the passage, this quotation does not provide a clear transition to a new idea in the paragraph that follows in the larger work from which the passage is taken. Given that the rest of the passage discusses how unpopular Marie Antoinette was and to what actions and behavior this unpopularity can be attributed, A can’t be correct, as this quotation is supporting the author’s argument, not providing a dissenting opinion that contradicts it. This means that B is correct; the quotation supports one of the author’s claims about Marie Antoinette: that she gambled a great deal.

Meaningful Comparison Questions

Let’s now take a look at some tougher questions. The following sample questions each concern both passages, as they ask about the relationship between them. Any quick notes that you jotted down about the points at which the authors’ opinions agree, diverge, or clash may come in handy, as these questions will focus on the points of “overlap” in the passage topics.

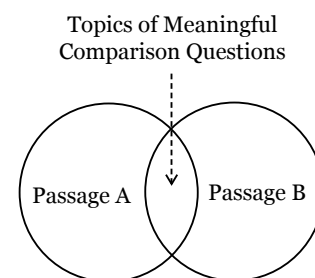

This part of the lesson will go over four general types of Meaningful Comparison question: direct comparison questions, which ask you to compare and contrast features of the passages; passage identification questions, which ask you to pick out which passage is described by or associated with a prompt in the question stem; general inference questions, which ask you to make an inference that requires you to understand both passages; and authorial opinion inference questions, which ask you about how one or both of the authors would react to a described set of circumstances. By working through each of these general question types, you’ll practice a broad set of skills that can be tested in paired passage sections.



Direct Comparison Questions

Perhaps the most direct type of meaningful comparison question, direct comparison questions function as *compare and contrast questions* applied to two different passages instead of different aspects of a single passage. You can use the same approach with little adjustment; just be sure to make sure you're talking about the correct passage. In questions that ask you to identify aspects of each passage, it's easy to get them mixed-up, especially in a stressful test-day environment. Refer to any notes you may have jotted down, and take an extra moment to make sure that your answer relates to the passages you think it does before recording your answer.

Sample Question #5

The author of Passage A _____ Marie Antoinette, while the author of Passage B _____.

- A. is critical of . . . idealizes her
- B. is biased in favor of . . . bemoans her loss
- C. detests . . . reluctantly admits that she had a few good characteristics
- D. praises . . . disparages her

Click Here to
Revisit the
Passage

How does the author of Passage A feel about Marie Antoinette? While he does say that we can't completely trust historical pamphlets complaining about her behavior because they are not objective, he also states later in the passage that "Marie Antoinette was ignorant, unteachable, blind to events and deaf to good counsels, a bitter grief to her heroic mother, the evil genius of her husband, the despair of her truest advisers, and an exceedingly bad friend to the people of France." This is not a good portrayal of her. In contrast to this, the author of Passage B idealizes her in extremely positive terms, calling her a "delightful vision" and saying, "I saw her just above the horizon, decorating and cheering the elevated sphere she had just begun to move in, glittering like the morning star full of life and splendor and joy."

If you took a few notes as described earlier in this lesson, this question becomes much easier to answer! You already have the accurate "+" and "-" symbols noted for each passage; all you have to do to answer the question is "translate" the answer choices into this notation and figure out which one matches your notes.

Based on the author's distinct contrast in opinions, A is the best answer. The author of Passage A is critical of Marie Antoinette, while the author of Passage B idealizes her. One way to make this question easier to parse is to consider each answer choice and figure out whether each part of it is positively or negatively connoted. Notes might look like those shown at right.

- A. - / +
- B. + / +
- C. -! / -
- D. + / -

Our analysis tells us that the first column (the answer choice associated with the author of Passage A) should be negative (-), and that the second column (the answer choice associated with the author of Passage B) should be positive (+). Answer choice A is the only one that fits these criteria.



Passage Identification Questions

Certain questions about paired passages may provide you with a stimulus and ask you which of the passages the stimulus describes or to which of the passages it pertains. Since these questions require you to distinguish between the passages, it's imperative that you be able to tell them apart without mixing them up!

Sample Question #6

Click Here to
Revisit the
Passage

Which of the authors considers Marie Antoinette's life in the context of history?

- A. The author of Passage A
- B. The author of Passage B
- C. Both authors
- D. Neither author

The author of Passage A considers Marie Antoinette's life in the context of history, whereas the author of Passage B presents only first-hand anecdotes. Passage A begins with historical context ("But history must be just . . ."), compares Marie Antoinette to several historical figures, mentions historical evidence ("those frightful charges against her, that may still be read in a thousand pamphlets") and even analyzes the reliability of that evidence to try and present an objective view of Marie Antoinette: ("We have to remember that all the revolutionary portraits are distorted by furious passion, and that Marie Antoinette may no more deserve to be compared to Mary Stuart than Robespierre deserves to be compared to Ezzelino or to Alva"). The author of Passage B offers no historical comparisons or textual evidence to support his claims, which are all based on his own personal but notably distant interaction with Marie Antoinette.

Authorial Opinion Inference Question

Other paired passage questions might ask you to infer the opinion of either of the authors on the author or subject material of the other passage. Consider how the authors might interact if the topic(s) about which they've written came up in casual conversation. Would they support each other's conclusions? Would they argue? You'll need to make these sorts of inferences to answer these paired passage questions.

Sample Question #7

Click Here to
Revisit the
Passage

If presented with Passage B, the author of Passage A would most likely _____.

- A. point out that Passage B's argument is unsubstantiated opinion
- B. agree with Passage B
- C. refuse to acknowledge that Marie Antoinette was well-liked due to being unable to offer evidence to the contrary
- D. accuse the author of Passage B of building his argument on evidence from unreliable sources



Imagine the authors of these two passages met each other and the topic of Marie Antoinette came up in conversation. Do you see them getting along and agreeing in their opinions of her? Not at all. We can immediately ignore answer choice B. Now, let's focus on the reaction of the author of Passage A to Passage B. Would he refuse to acknowledge that Marie Antoinette was well-liked because he would be unable to contradict it with evidence? No, that's not correct; the author of Passage A provides some evidence that Marie Antoinette was widely disliked by the French people in the form of mentioned pamphlets and direct quotations. So, would the author of Passage A accuse the author of Passage B of using evidence from unreliable sources (D) or say that Passage B is based on unsubstantiated opinion (A)? In other words, would he say that Passage B's sources are unreliable, or that there aren't any sources used? The latter is correct; the author of Passage B says he saw Marie Antoinette sixteen or seventeen years ago, and this firsthand eyewitness account seems reliable, but the argument that Passage B actually makes isn't substantiated by any other sources. The correct answer is A; if presented with Passage B, the author of Passage A would most likely "point out that Passage B's argument is unsubstantiated opinion."

General Inference Question

Some paired passage questions may ask you to make inferences that require consideration of both passages. Some, like the next question, may present you with different passages or different parts of those passages as answer options.

Sample Question #8

Click Here to
Revisit the
Passage

A historian is researching how the French population felt about Marie Antoinette in the period leading up to the French Revolution. Which aspect of which passage would this historian find most relevant?

- A. Passage A's discussion of historical pamphlets
- B. Passage A's quotation from Emperor Joseph
- C. The third paragraph of Passage B
- D. Passage B's anecdote about the last time the author saw Marie Antoinette

Time for some inferences! Passage B doesn't mention the French population at all; it consists just of the author's opinion and reactions to historical events. Given this, we can ignore answer choices C and D. So, we know that a historian would be more interested in Passage A, but which specific part of Passage A: the quotation from Emperor Joseph or its discussion of historical pamphlets? Context says the pamphlets would be more relevant:

The popular hatred of Marie Antoinette sprang from a sound instinct. We shall never know how much or how little truth there was in those frightful charges against her, that may still be read in a thousand pamphlets.

Note how the author begins his discussion of these pamphlets by mentioning "the popular hatred of Marie Antoinette." The word "popular" tells us that this "hatred" (and by extension, the pamphlets he mentions immediately afterward) have to do with the French population's views on Marie Antoinette before the French Revolution. A is the correct answer.



Paired Passages: Statement-Response

You can use many of the same analytical techniques that you used to approach Conflicting Views passages to approach Statement-Response passages. Instead of considering how each passage relates to a particular topic, though, add an element of progression: first, establish how Passage A relates to a topic. Then, consider how Passage B relates to that topic and to the argument Passage A makes. This additional layer of analysis is what distinguishes Statement-Response passages from Conflicting Views passage. Statement-Response passages are presented as a progression from one passage to another passage that remarks upon the first’s argument specifically. Keep that in mind as you read—sample questions that ask about Passage B may ask about the particular ways in which it addresses Passage A’s argument. Taking notes may still be helpful; in particular, very briefly summarizing the passage, coming up with a hypothetical title for it, and identifying the main point of each paragraph can be helpful and create a scaffold of its argument for you to reference without having to skim through the passage to find where it discusses something specific.

The next paired passages come from two authors who are at odds about the issue of allowing standing armies to exist in the United States. The country had only been independent for a few years at the time when the passages were written, and was governed by the Articles of Confederation—hence why Passage 1 refers to the U.S. as “the Confederacy.” Pay close attention to the argument made in Passage 1 and the way in which Passage 2 opposes that specific argument.



Passage A

Adapted from *Federalist No. 25: The Powers Necessary to the Common Defense Further Considered (continued)* by Alexander Hamilton (1787)

It may perhaps be urged that [standing armies] ought to be provided for by the State governments, under the direction of the Union. But this would be, in reality, an inversion of the primary principle of our political association, as it would in practice transfer the care of the common defense from the federal head to the individual members: a project oppressive to some States, dangerous to all, and baneful to the Confederacy.

The territories of Britain, Spain, and of the Indian nations in our neighborhood do not border on particular States, but encircle the Union from Maine to Georgia. The danger, though in different degrees, is therefore common. And the means of guarding against it ought, in like manner, to be the objects of common councils and of a common treasury. It happens that some States, from local situation, are more directly exposed. New York is of this class. Upon the plan of separate provisions, New York would have to sustain the whole weight of the establishments requisite to her immediate safety, and to the mediate or ultimate protection of her neighbors. This would neither be equitable as it respected New York nor safe as it respected the other States.

Links to Sample Questions

[Sample Question #1](#) [Sample Question #2](#)[Sample Question #3](#) [Sample Question #4](#)*Passage B*

Adapted from *Brutus No. 10* by Brutus (1788)

The liberties of a people are in danger from a large standing army, not only because the rulers may employ them for the purposes of supporting themselves in any usurpations of power, which they may see proper to exercise, but there is great hazard, that an army will subvert the forms of the government, under whose authority, they are raised, and establish one, according to the pleasure of their leader.

We are informed, in the faithful pages of history, of such events frequently happening. Two instances have been mentioned in a former paper: Rome and Britain. In the first, the liberties of the commonwealth were destroyed, and the constitution overturned, by an army lead by Julius Caesar, who was appointed to the command by the constitutional authority of that commonwealth. He changed it from a free republic, whose fame had sounded and is still celebrated by all the world, into that of the most absolute despotism. A standing army effected this change. The same army that in Britain vindicated the liberties of that people from the encroachments and despotism of a tyrant king assisted Cromwell, their General, in wresting from the people that liberty they had so dearly earned.

The advocates for power, in support of this right in the proposed government, urge that a restraint upon the discretion of the legislatures, in respect to military establishments in time of peace, would be improper to be imposed, because they say it will probably be necessary to keep up a small body of troops to garrison a few posts in order to guard against the sudden encroachments of the Indians, or of the Spaniards and British; and therefore, the general government ought to be invested with power to raise and keep up a standing army in time of peace, without restraint, at their discretion.

I confess, I cannot perceive that the conclusion follows from the premises. Logicians say, it is not good reasoning to infer a general conclusion from particular premises; though I am not much of a logician, it seems to me this argument is very like that species of reasoning.



Comparing Arguments: Where Do the Authors Agree?

Figuring out where the authors agree means considering the arguments being made, not just the topics being discussed. Both example passages mention the possibility of being attacked, for instance, but this information doesn't have the same importance in each passage, and it is used a different way in each as well. If the authors have differing opinions on a subject, as in this case, it may seem as if they don't agree about anything; however, certain questions can ask you to find the point that they both assert—perhaps a very general one, or the starting point of the debate at hand.

Sample Question #1

Click Here to
Revisit the
Passage

With which of the following assertions would both authors agree?

- A. No limitations should be placed on the federal government's ability to raise a standing army.
- B. If a country has a standing army, it can endanger the freedoms of its people.
- C. Whether or not the Union can raise a standing army in peacetime is important to its well-being.
- D. If a general conclusion is drawn from specific premises, we shouldn't consider that general conclusion at all.

Answer choices A, B, and D state points with which only one author clearly agrees. A is only supported by Passage 1, and B and D are each taken from Passage 2. We cannot say that the authors agree with each other if there is no evidence in each text that this is so, so none of these answers can be the correct one.

The correct answer is C. The author of Passage 1 is arguing that letting the federal government have a standing army in peacetime is a prudent idea; the author of Passage 2 is arguing against this point and saying it is a dangerous idea. The "whether or not" in this answer captures their disagreement about the specific effects of a standing army, but both authors clearly agree that the issue of the Union being able to raise a standing army in peacetime is important to its well-being: the author of Passage 1 thinks that if it cannot raise a standing army, it will be poorly defended against attacks, while the author of Passage 2 thinks that if it can raise a standing army, it might go the way of Rome and Britain and have negative changes made to its organization.



Contrasting Arguments: Where Do the Authors Disagree?

Questions that ask you to identify where the authors disagree can be tricky, as mixing up the passages becomes a distinct possibility. In addition, you don't want to infer too much, even in passages where the authors are overtly opposed to one another. Try to make sure each answer you select as correct has textual evidence in both passages; if it doesn't, you may want to consider the other answer choices to see if another is better supported.

Sample Question #2

Click Here to
Revisit the
Passage

Which of the following most accurately describes the difference of opinion found

- A. Passage 1 is in favor of a federally controlled standing army, whereas Passage 2 opposes one.
- B. The author of Passage 2 thinks that a state should not be liable for protecting other states; the author of Passage 1 disagrees.
- C. The author of Passage 2 thinks that protecting the country from attacks is more important than a potential misuse of federal power, but the author of Passage 1 disagrees.
- D. The author of Passage 1 thinks that principles of logic should be applied to political decisions, but the author of Passage 2 is opposed to this idea.

Questions like these make it really easy to mix up the passages and to accidentally infer more than you should, two of the major pitfalls of paired-passage questions. Considering each answer choice one at a time can help you narrow down your options. Remember, for the authors to disagree about something, it at least has to be mentioned in each passage!

“The author of Passage 1 thinks that principles of logic should be applied to political decisions, but the author of Passage 2 is opposed to this idea.” The author of Passage 2 is the one who applies formal logic to the situation, and logic isn't mentioned at all in Passage 1. We can't say that the author of Passage 1 disagrees with using the principles of logic if he doesn't mention logic at all, so this answer choice is incorrect.

“The author of Passage 2 thinks that protecting the country from attacks is more important than a potential misuse of federal power, but the author of Passage 1 disagrees.” Ok, who is afraid of the misuse of federal power? The author of Passage 2, with his examples of Rome and Britain. The author of Passage 2 does not think that protecting the country from potential attacks is more important than a misuse of federal power, so this answer choice cannot be correct.

“The author of Passage 2 thinks that a state should not be liable for protecting other states; the author of Passage 1 disagrees.” Ok, in which passage is the liability of states to protect other states mentioned? Passage 1, where it says, “Upon the plan of separate provisions, New York would have to sustain the whole weight of the establishments requisite to her immediate safety, and to the mediate or ultimate protection of her neighbors. This would neither be equitable as it respected New York nor safe as it respected the other States.” This answer choice is incorrect.



“Passage 1 is in favor of a federally controlled standing army, whereas Passage 2 opposes one.” This is the correct answer! Passage 1 is arguing against a state-controlled standing army, and we can tell that the author supports a federally controlled one when he says, “The danger, though in different degrees, is therefore common. And the means of guarding against it ought, in like manner, to be the objects of common councils and of a common treasury.” Passage 2 is arguing against a federally controlled standing army.

Passage Identification Questions

This type of question can be asked of Statement-Response passages as well as Conflicting Views passages. Again, make sure you’re referring to the correct passage when picking out your answer choice! Notes may come in handy, as they can allow you to confirm that you’re referring to the correct passage at a glance.

Sample Question #3

Click Here to
Revisit the
Passage

“The means of defense against foreign danger have been always the instruments of tyranny at home.” - James Madison in Volume I of *Records of the Federal Convention* by Max Farand (1787, ed. 1911)

Based on what you’ve read in the passages, with which author would Madison most likely side?

- A. Madison would likely side with the author of Passage 1.
- B. Madison would likely side with the author of Passage 2.
- C. Madison would likely oppose both authors.
- D. Madison would likely side with both authors.

We can infer that Madison could be talking about standing armies and calling them “means of defense against foreign danger” and “the instruments of tyranny at home.” Since the passages are arguing about the effects of having a federally controlled standing army, it’s highly unlikely that Madison would side with both or neither of the authors—he’ll side with one, since he’s talking about what they’re debating.

While “the means of defense against foreign danger” may seem to support Passage 1 and “the instruments of tyranny at home” may seem to support Passage 2, consider that the standing armies discussed in the passage are always discussed in terms of what changes they will cause “at home,” in times of peace. Neither author ever discusses the standing army going outside of the country to fight. Plus, the structure of Madison’s statement puts emphasis on the second phrase. If Madison thinks that standing armies in a country at peace are “instruments of tyranny,” he would most likely side with the author of Passage 2, who cites Rome and Britain as having developed tyrannical governments through the misuse of a standing army.



Making Inferences Based on Hypotheticals

Some questions on certain tests may present hypothetical “if” statements and ask how this could affect the authors’ arguments. This information will relate in some way to something you have just read, so even if it initially seems unrelated, skim the passages and try to figure out where it lines up with the arguments. Information that goes against what an author is arguing will weaken an argument, while information that provides more evidence to an argument will support it. Note that more information is enough to support an argument, even if the author has already made that point—giving more examples in support of a point already made is just fine; the new information doesn’t have to make a brand-new point.

Sample Question #4

Click Here to
Revisit the
Passage

If it were demonstrated that the a nation that allowed its city-states to keep their own standing armies was destroyed by a rebellion started by the strongest city-state, how would this affect the preceding arguments?

- A. It would support the argument of Passage 1.
- B. It would weaken the argument of Passage 2.
- C. It would support the argument of Passage 2.
- D. It would weaken the argument of Passage 1.

Armies causing rebellions sounds like a bad thing for a government. Which passage deals with the potential negative consequences of a federally controlled standing army? Passage 2. You can find supporting evidence that this point would support the argument of Passage 2 in that the author already provides two examples of similar historical events in Rome and Britain. Adding a third event to the author’s list would only strengthen his argument. This means that the correct answer is C.

Working with paired passages doesn’t have to seem nerve-wracking. These questions simply ask you to turn your analytical focus—the same focus tested by single-passage SAT Reading selections—on the relationship between two passages. Taking the time to jot down a few brief notes, summarize passages’ arguments, and consider how the authors might interact can help you shift your perspective from concerning yourself with the details of one written text to the details of how two interact.

For more practice with paired passages, try taking one of our SAT Diagnostic Tests! Like the actual revised SAT, the SAT Reading portion of our diagnostic test includes a pair of passages as one of its sections. We recommend taking the entire section to simulate a testing experience. That way, you can use your results to figure out which concepts you’ve mastered and which could still improve with a bit more practice!



Quantitative Information

One of the most overt changes to the structure and format of the new SAT is the inclusion of quantitative information throughout the entire exam. While seeing a graph or table on the SAT Math test may come as no surprise to prepared test-takers, seeing such data pop up in the Reading section may throw you off your game on test day if you've not readied yourself for a set of new challenges.

The SAT is interested in measuring your ability to read and understand information in a variety of different forms, from the traditional prose passages to bar charts, line graphs, tables, and scatter plots. The easy questions relating to data will simply ask you to read them for information, often combining what you learn from them with what you learn from the passage in order to answer straightforward questions about the topic being discussed and the points being made by the article and its graphics. More difficult questions will query your ability to draw conclusions and identify broader trends, again moving between the provided graphics and the prose passage. You may be asked to identify the specific parts of the passage supported by a graphic, and vice versa, to identify parts of the graph that relate to a given part of the passage.

Finally, perhaps the most difficult questions to anticipate will ask you to consider the inclusion of presented graphics as an editorial decision. Should a graph be included with the passage at all? Answering such a question requires you to analyze whether the graph is supporting the author's assertions or contradicting them, or perhaps doing both.

Learning to incorporate various kinds of graphs and charts into your reading comprehension repertoire will certainly take some time and practice, so if you want to be prepared for this new challenge, start early! Read newspaper articles that involve graphs and charts and identify why the authors of the articles included those specific charts. Look up different kinds of charts and practice reading them with ease so that you can concentrate on the questions being asked of you on test day without worrying whether you are interpreting a certain type of graphic incorrectly. For now, read on for a general introduction to what charts are doing on the SAT Reading test, and practice that can help you become an expert information synthesizer who can work with data presented in a number of different ways.

Quick Tip

We cover several of the more mathematically oriented chart types, including graphs, scatter plots, and tables, in our *Modeling Data* lesson in the SAT Math chapter.



Synthesizing Information from the Passage and Data

Some questions that accompany passages with related figures may require you to understand both the passage and the figure in order to identify the correct answer. Let's practice a few sample questions of this type that relate to the following sample passage.

Links to
Sample Questions

[Sample Question #2](#)

Practice Passage

The composition of an area's soil has a great effect on the fertility of that soil and the vegetation that can thrive in that environment. Soil is composed of materials that fall into a few major categories, mostly determined by the size of the particulates matter that composes it. Sand is the finest particulate matter that makes up soil, followed by silt, and then clay. Rocks, unsurprisingly, form the largest elements of the soil. Humus is not cataloged in terms of particle size; instead, it is defined as decomposing organic material that is mixed in with the soil. Humus is extremely important for the soil in that it replenishes key nutrients required for plants to grow. Plants grow well in loamy soil—soil made up of sand, clay, and humus; however, there are a wide variety of other factors that affect plant growth, such as rainfall and humidity.

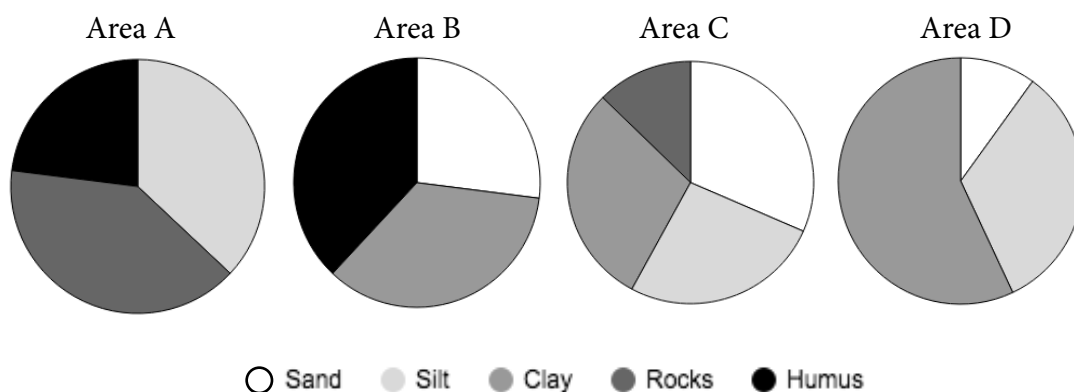

Analyzing a Figure for Information

While many questions will ask you to analyze the relationships between figures and their associated passages, certain questions may focus on just the figures. These questions could ask you to analyze the data presented in a table, graph, or chart. Keep in mind that the information you need to figure out the correct answer might not be found in the prose passage at all, and may be solely contained in the associated figure.

Sample Question #1

Which area's soil contains the most clay?

- A. Area A
- B. Area B
- C. Area C
- D. Area D



Consider each of the graphs. “Clay” is the middle shade of gray. This shade of gray appears in the pie charts associated with Areas B, C, and D. Area B and Area C each appear to have a sizable ratio of clay to other components in their soils, but Area D is primarily composed of clay. Given this, we can pick out D, Area D, as the correct answer.

Synthesizing Information from a Figure and the Passage

As the SAT seeks to test your ability to analyze both data and prose passages, it should not come as a surprise that certain questions require you to integrate information from both of these sources in order to get them correct. In the following sample question, you need to pick out information from the passage and use it to guide your analysis of the associated pie charts. Specifically, you’ll need to figure out what characterizes “loamy” soil in order to use the pie charts to identify which area’s soil qualifies as “loamy.”

Sample Question #2

Click Here to
Revisit the
Passage

Which area has soil that qualifies as “loamy”?

- A. Area A
- B. Area B
- C. Area C
- D. Area D

First, we need to figure out what defines soil as “loamy.” We can find this information in the passage, as it states in its last line, “Plants grow well in loamy soil—soil made up of sand, clay, and humus.” Ok, now we have the information we need to analyze the graphs: we need to pick out the area with the pie chart that contains sand, clay, and humus. Be sure to read the pie charts carefully—Area A contains silt, clay, and humus, which is close, but not exact enough to qualify as “loamy,” as it’s missing a key ingredient: sand. Area B’s pie chart shows that its soil contains sand, clay, and humus, so B is the correct answer.

Drawing Conclusions About the Passage and Data

Working with data won’t always mean picking out discrete pieces of information. Certain questions may task you with identifying larger, more general trends in the presented textual and visual information. Approach these questions like you would any question that asks you to draw a conclusion about passage text: make sure that you can back up your claims by pointing to specific evidence in the passage and data in the diagrams.



Links to
Sample Questions

[Sample Question #3](#)

[Sample Question #4](#)

A Spotlight on Technology for a Local Library

The local library was recently remodeled with the intention of creating a space in which patrons can easily make use of digital technology. The project was officially completed in May, opening its new wings to the public on June 1st. Beforehand, the library offered access to six relatively old computers during some of its open hours, but now, patrons have access to an up-to-date computer lab with printers and scanners that is always staffed with a technology expert when it is open. The library has hired three technology specialists to offer support to patrons and plan events around digital technology themes. The first of these, “Ebooks 101,” will be offered early next month. Patrons will be invited to bring their computers or handheld e-readers to the class to learn firsthand how to use some of their more advanced features. The librarians hope to better meet the needs of their patrons by combining a focus on digital resources with a sustained commitment to traditional print literature.

The success of the renovation is being measured using many different metrics. For example, the financial board measures the success of the recent renovation by its impact on patron donations. Their definition of a successful renovation is an increase patron donations to over \$7,500 a month until the end of the year. Patron surveys have also helped the library outreach committee analyze the renovation’s success in terms of whether or not it was successful in increasing interest in and engagement with library technology resources. Subjectively, the librarians all seem to consider the renovation to be successful and have reported being happy with the community engagement they have seen in response to their new digital initiatives.

Survey Question	Before Renovation		After Renovation	
	Yes	No	Yes	No
“Do you regularly make use of the technology available at the library?”	35%	65%	51%	49%
“Have you ever checked out an ebook?”	42%	58%	67%	33%
“Are you aware that the library offers drop-in classes about how to make the most of your technology?”	28%	72%	56%	44%
“Do you think the library should provide more technological resources for the public (“Yes” response), or are you happy with the current level of technology provided (“No” response)?	64%	36%	22%	78%
“Have you ever visited the library to do something other than check out a traditional book?”	37%	63%	61%	39%



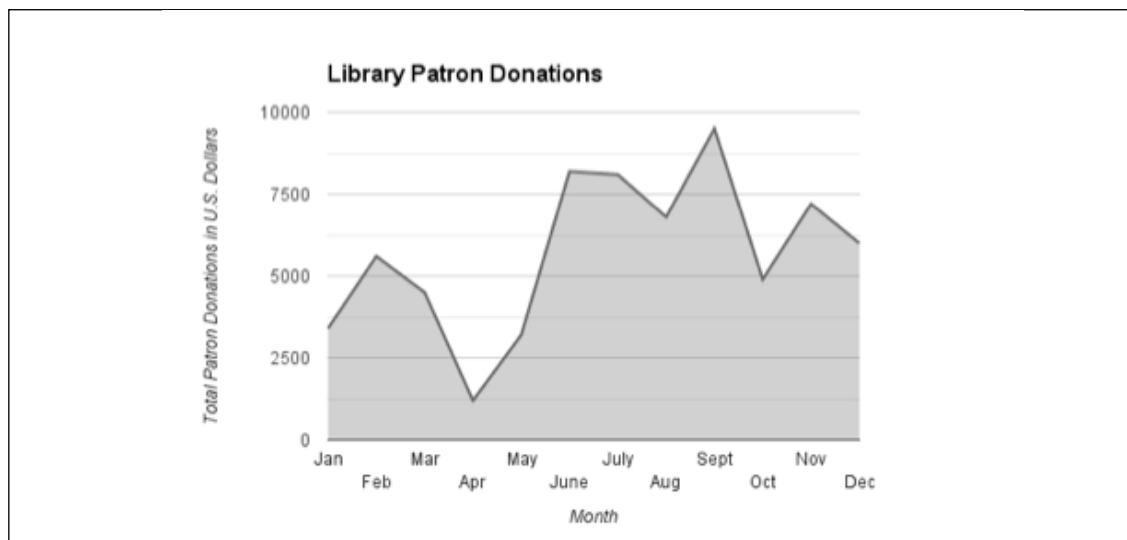

Sample Question #3

Click Here to
Revisit the
Passage

From the financial board's perspective, was the renovation successful?

- A. Yes
- B. No
- C. The data does not definitively support one position over the other.
- D. Different data would be required to answer this question.

Consider the passage's second paragraph. One sentence states, "the financial board measures the success of the recent renovation by its impact on patron donations. Their definition of a successful renovation is an increase patron donations to over \$7,500 a month from the month after the renovation is completed to the end of the year." Ok, now we have a way to interpret the data. But when was the renovation completed? To learn this, we'll have to skim the passage. Aha: "The project was officially completed in May." So, what this question is really asking us is "Did patron donations exceed \$7,500 per month from June to December?" No, they did not. They exceeded this goal in June, July, and September, but failed to meet it in August, October, November, and December. B is the correct answer.

Sample Question #4

Click Here to
Revisit the
Passage

From the library outreach committee's perspective, was the renovation successful?

- A. Yes
- B. No
- C. The data does not definitively support one position over the other.
- D. Different data would be required to answer this question.



What sort of metric is the library outreach committee using to evaluate the success of the renovation? The committee is only mentioned in one sentence, in the second paragraph: “Patron surveys have also helped the library outreach committee analyze the renovation’s success in terms of whether or not it was successful in increasing interest in and engagement with library technology resources.” While not as decisively phrased as the last question’s metric, this sentence does point us toward the table of included patron poll results. The committee wants to see if the renovation helped “increase interest in and engagement with library technology resources.” Did it do that? Well, the poll results reveal that after the renovation, more patrons regularly make use of technology at the library, have checked out an ebook, are aware that the library offers drop-in classes on technology, are happy with the current level of technology provided by the library, and have visited the library to do something other than check out a traditional book. Based on these results, the correct answer is A.

Debating the Inclusion of Data

Now that we’ve practiced mining data for information and identifying larger trends, it’s time to consider a different question: should specified data be included at all? These sorts of questions are going to engage your writerly sensibilities. Imagine you’re the author of the paper and now get to decide whether to include the indicated chart, graph, or table. Is it supporting your ideas? Is it contradicting them? Maybe it’s completely unrelated to the points you’re making. Try making use of this perspective as you try the next few sample questions.

Practice Passage: Tuna in Trouble

[1] Bluefin tuna is a delicacy in many sushi restaurants, but the increasing popularity of sushi has created a demand that is outstripping the fish’s ability to maintain a healthy population size. [2] In recent years, the fish’s populations have dropped dramatically. [3] Further compounding the problem, the bluefin tuna is an apex predator in many oceanic ecosystems, and its removal has trickle-down effects that upset the delicate balance of interspecific interactions that are required for health ecosystems. [4] So, the next time you get a craving for sushi, consider trying a different type of fish that is not threatened or endangered, like salmon. [5] If you absolutely must eat bluefin tuna, do your research and make sure your fish is sustainably and responsibly caught. [6] With your help, we can make sure that bluefin tuna keep their important place in the oceans—and remain on sushi menus.

Links to
Sample Questions

[Sample Question #5](#)

[Sample Question #6](#)

[Sample Question #7](#)



Sample Question #5

Click Here to
Revisit the
Passage

Should the author include the following table?

Species	U.S. Status
Coho Salmon	Threatened
Bluefin Tuna*	Not Currently Listed as Threatened or Endangered
Chinook Salmon	Endangered
Chum Salmon	Threatened
Sockeye Salmon	Endangered
Steelhead	Endangered
Gila Trout	Endangered
Apache Trout	Threatened
Bull Trout	Threatened

*National Marine Fisheries Service Species of Concern

- A. Yes, because it puts the bluefin tuna in the context of other threatened marine organisms and makes its situation look much worse than those of other threatened fish.
- B. Yes, because it stresses the severity of the recent decrease in the bluefin tuna population.
- C. No, because it suggests that other fish may be more threatened than the bluefin tuna.
- D. No, because it conveys that the bluefin tuna's population is completely healthy and stable.

What's the first thing you notice about the table? It talks about a lot of salmon and trout, but you really have to pay attention to detail to find information about the bluefin tuna. All of the other fish in the table are listed as either "Threatened" or "Endangered" in the second column, but the bluefin tuna is "Not Currently Listed as Threatened or Endangered." Huh? That's not very good support for a passage arguing that the bluefin tuna could soon be on the brink of extinction if we don't change our eating habits! And check out that asterisk—you have to take an additional step and direct your attention to the bottom of the chart to see that the bluefin tuna is listed as a "National Marine Fisheries Service Species of Concern." It's the only fish in the table listed like that, though, making it difficult to figure out where its status fits in amongst the other endangered and threatened species. Is a "species of concern" more threatened than an "endangered" species? Does it land somewhere between "threatened" and "endangered?" We're not give any information to help us determine that.

This table's information is certainly not supporting the passage very well, but let's look at each of the answer choices anyway. A isn't correct; since it's hard to figure out how a "species of concern" compares with "threatened" and "endangered" species in terms of how severely it's threatened, we can't say that it makes the bluefin tuna's situation look much worse than those of other fish. B isn't correct either—no information conveyed by the table tells us anything about "the severity of the recent decrease in the tuna



population,” just that it is a “species of concern.” So we know that we shouldn’t include the table, but why? “Because it conveys that the bluefin tuna’s population is completely healthy and stable” (D)? Nope! It still tells us that the bluefin tuna is a “species of concern”—that alone conveys that its population isn’t “completely healthy and stable.” That means our answer is C: we shouldn’t include the table because it suggests that other fish may be more threatened than the bluefin tuna. At first glance, (without paying attention to the asterisk), it’s easy to assume that because the bluefin tuna isn’t threatened or endangered, the many other species of threatened and endangered fish are actually worse off, even though this is not the case.

Sample Question #6

Click Here to
Revisit the
Passage

What sentence in the passage does the table shown in the previous question appear to contradict?

- A. Sentence 2
- B. Sentence 3
- C. Sentence 4
- D. Sentence 5

A good strategy for answering this question is to consider each of the listed sentences, skimming them for potential contradictions introduced by the table. Sentence 2 just tells us that the bluefin tuna’s population has dropped dramatically in recent years—no contradiction there. Sentence 3 concerns the effects of this drop, and explains why it’s particularly devastating ecologically because the tuna is an apex predator. This isn’t related to the information in the chart at all, and presents no contradictions. Sentence 5 recommends that if people eat bluefin tuna, they eat sustainably caught fish. No contradiction there, either. The correct answer is C. Sentence 4 states, “So, the next time you get a craving for sushi, consider trying a different type of fish that is not threatened or endangered, like salmon.” The table shows that many types of salmon are indeed either threatened or endangered, thus creating a contradiction.

Sample Question #7

Click Here to
Revisit the
Passage

Which of the following hypothetical figures would best support the passage?

- A. A line graph depicting changes in bluefin tuna population over the last twenty years
- B. An illustrated map of where bluefin tuna fishing occurs throughout the world
- C. An illustrated map showing which countries export and import large amounts of bluefin tuna
- D. A line graph depicting the price of bluefin tuna over the past twenty years



Ok, so over the course of answering the past two questions, we've concluded that this chart isn't a great one for the author to include with this particular passage to support his or her argument. This question asks us to consider four hypothetical figures and pick out which one would work best to support the author's points. The author's argument isn't directed at citizens of particular countries and doesn't concern exactly where the overfishing of bluefin tuna takes places, so including either of the maps described in answer choices B and C wouldn't make much sense. This leaves us to pick one of two line graphs: one showing the price of bluefin tuna over the last twenty years (D), and one showing the changes in bluefin tuna population size over the last twenty years (A). While price may be an indirect measure of demand, the author's argument specifically concerns the decline in the bluefin tuna population. Sentence 2 directly tells readers that the bluefin tuna population has "dropped dramatically in recent years." A line graph showing the bluefin tuna population over the past twenty years could support this point with factual evidence, so A is the best answer.

Analyzing Data Purpose and Supporting and Conflicting Relationships

Along with asking whether data should be included with a passage at all, the SAT Reading test can ask about the specific ways in which a figure supports a passage's claims or conflicts with them. These questions focus the passage at a zoomed-in level of focus; they may ask you to identify specific aspects of the table or excerpts from the paragraph that are specifically affected by the inclusion of data. In addition, the SAT may ask you to infer why the author included a figure with his or her work. These questions get at the same points; you'll need to have a good understanding of the specifics of the relationship between the prose passage and the figure in order to pick out the correct answer.

Practice Passage: Energy Dynamics and Diet

[1] While certain people choose to be vegetarian for philosophical or ethical reasons, there's plenty of research that shows eating a vegetarian meal instead of a meaty one even once a week can help the environment. [2] This beneficial effect has to do with resource management and the way that energy moves through food chains. [3] The majority of organisms in most food chains are autotrophs, or "producers"—in other terms, plants or photosynthetic bacteria that make their own energy. [4] These autotrophs are eaten by primary consumers, which are eaten by secondary consumers, which are eaten by tertiary consumers. [5] These different levels of organisms are called "trophic levels." [6] When energy (measured in kilojoules, kJ) moves from one trophic level to another, a lot of it is lost, and some of it is used by the organism that ingests it for homeostasis (biological upkeep); thus, it is more energetically efficient to eat organisms that occupy lower trophic levels. [7] In addition, it takes the investment of much more resources to raise animals for meat than it does to grow crops. [8] There are also health benefits that accompany eating a vegetarian meal once per week; meat can be high in fat and cholesterol, whereas vegetable-based meals can avoid this pitfall. [9] Considering these facts, it becomes apparent why vegetarian meals are more environmentally responsible than those that contain meat.

Links to
Sample Questions

[Sample Question #8](#)

[Sample Question #9](#)

[Sample Question #10](#)

[Sample Question #11](#)



Sample Food Pyramid

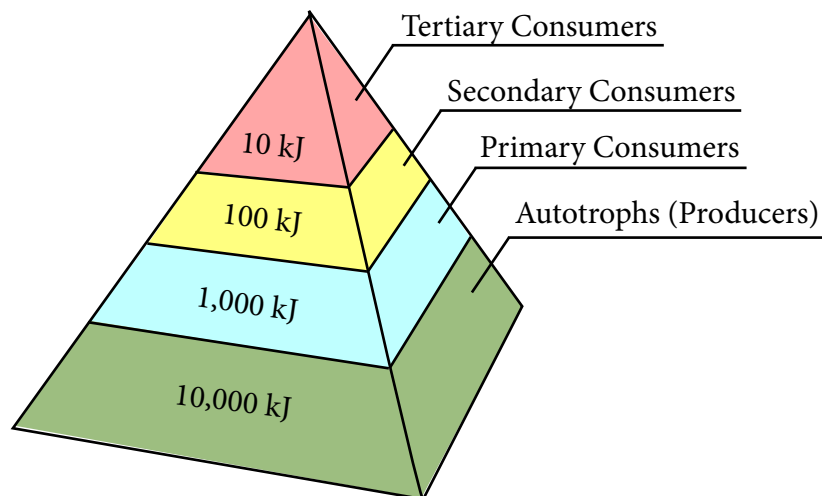

Sample Question #8

Click Here to
Revisit the
Passage

Why did the author include the depicted figure?

- A. To illustrate the scientific relationship between energy and trophic levels
- B. To visually depict recommended relative amounts of vegetables and meat that one should consume
- C. To convey the increased financial cost of raising animals for meat vs. growing crops
- D. To illustrate the biological mechanisms of the process of homeostasis in different animals

While this question may seem like a broad one that might be difficult to ascertain with certainty, the fact that you're presented with four answer choices, one of which is considered more correct than the others, is helpful. Analyze each in turn to figure out which is best. The sample food pyramid shows kilojoules, which the passage states is a measure of energy. It shows different amounts of kilojoules associated with autotrophs (producers), primary consumers, secondary consumers, and tertiary consumers. Does this subject matter illustrate the biological mechanisms of homeostasis in different animals? No. That means D isn't correct. Does it have anything to do with finances? Nope—that means C isn't correct either. What about B? B suggests that the chart is a recommendation of the amounts of vegetables and meat that one should eat. The chart is not doing that; it's showing energy associated with different levels of consumers, and it doesn't mention specific types of food. A is the correct answer: the chart is illustrating the scientific relationship between energy and trophic levels, a statement that matches up well with our initial analysis of it.



Click Here to
Revisit the
Passage

Sample Question #9

What part of the graph supports the line, “it is more energetically efficient to eat organisms that occupy lower trophic levels”?

- A. The volume of the lowest part of the pyramid as compared to the rest of the pyramid
- B. The color of the top part of the pyramid as compared to the color of the lowest part of the pyramid
- C. The color of the lowest part of the pyramid
- D. The height of the pyramid as a whole

This question indicates a specific line in the passage and asks what aspect of the figure supports it. At this point, saying that the figure supports the passage is a given; the test now wants you to identify the specifics of how it does this. Before answering the question, consider which parts of the figure are relevant to the information it is conveying. Is color significant? No, there’s no key provided, and the different trophic levels are different colors just to help you distinguish them. If the pyramid figure were printed in black and white, it would still convey the same information. Now for a more difficult question: is the height of the pyramid significant? No, you could convey the same information with a taller pyramid or a shorter one without affecting the information being conveyed. What about the height of each trophic level? This gets tricky. The height of each level is certainly related to the amount of space it takes up, which is relevant. But it’s actually volume that is of most concern in conveying the relationship between trophic levels. Now that we’ve identified that, answering this question should be a breeze. Answer choices B and C have to do with the colors of different parts of the pyramid, which are irrelevant to the information being conveyed, and we determined that the height of the entire pyramid, mentioned in answer choice D, is also not relevant to the data being conveyed. The correct answer is A; the fact that the bottom of the pyramid takes up more volume than the rest of it shows that it contains more energy than higher trophic levels. Thus, if you consume organisms from the lowest trophic level (plants), you’re avoiding the energy loss that occurs between trophic levels.

Click Here to
Revisit the
Passage

Sample Question #10

Which of the following claims is most directly depicted in the figure?

- A. “The majority of organisms in most food chains are autotrophs . . .”
- B. “Meat can be high in fat and cholesterol, whereas vegetable-based meals can avoid this pitfall.”
- C. “When energy moves from one trophic level to another, a lot of it is lost.”
- D. “It takes the investment of much more resources to raise animals for meat than it does to grow crops.”



Now we're being asked which specific excerpt from the passage is "most directly depicted" in the figure. The fact that the question uses the phrasing "most directly" indicates that while several of the answer choices may seem correct because they somewhat relate to the figure, there's going to be one answer choice that "most directly" correlates to the information shown in the figure. The figure doesn't say anything about the relative levels of fat and cholesterol in vegetables and meat, so B isn't correct. It also isn't showing populations of organisms, so A isn't correct either. While we could assume that there are way more producers than consumers in a food chain (and be correct in that assumption), that's not what the figure is directly showing us. It's directly showing us amounts of energy as they relate to the different trophic levels. Similarly, the figure might be able to be used to indirectly support D's claim, that it takes more resources to raise animals for meat than it does for crops; however, it's not showing us anything directly about resources used to raise animals for meat or grow crops. The best answer is C. As stated previously, the figure is directly correlating amounts of energy with different trophic levels. As you move up the pyramid, the amount of energy in each trophic level shrinks dramatically. This shows that "when energy moves from one trophic level to another, a lot of it is lost."

Sample Question #11

Click Here to
Revisit the
Passage

If the associated figure were shaped like a cube instead of a pyramid, what effect would this have on the author's argument?

- A. It would cause the author's argument to contradict the figure.
- B. It would provide further support for the author's argument.
- C. It would cause the figure to become irrelevant to the author's argument.
- D. It would not affect the author's argument.

This is an abstract question that requires you to make inferences in order to answer it correctly. Asked a different way, what is the significance of the figure being shaped like a pyramid? How does a pyramid differ from a cube? Well, the bottom of a pyramid is much larger than the top of it, while the bottom of a cube and the top of a cube are the same size. How does this interact with the trophic levels depicted in the figure? Well, the bottom trophic level has a lot of energy, as shown in its large volume, but as you go up the pyramid, each trophic level receives less and less energy from consuming organisms in the one below it. If the pyramid were a cube, this relationship would be completely different—each of the trophic levels would have the same amount of energy, and none would be lost. Didn't the author say something about energy being lost? Yes, in Sentence 6: "When energy (measured in kilojoules, kJ) moves from one trophic level to another, a lot of it is lost, and some of it is used by the organism that ingests it for homeostasis (biological upkeep); thus, it is more energetically efficient to eat organisms that occupy lower trophic levels." If the figure were shaped like a cube instead of a pyramid, it wouldn't show any energy being lost between trophic levels, so it wouldn't support the author's point and instead present a contradiction to the author's argument. This means that A is the correct answer.



The SAT Writing and Language Test

The SAT Writing and Language test primarily focuses on students' abilities to identify and remedy ineffective use of language in prose. Questions are presented in conjunction with a contrived passage that contains numerous errors in diction, syntax, logic, and construction. Each question will relate to a specific excerpt or selection within the passage, requiring students to either identify the error contained in the selection or choose the most appropriate revision for the selection.

The SAT Writing and Language test contains 4 passages, with 11 questions per passage, for a total of 44 questions. The allotted time for the Writing and Language test is 35 minutes. Many of the questions in this section will be used for cross-test subscores, as well as two subscores specific to the Writing and Language test alone. Relevant cross-test scores include Analysis in History/Social Science, Analysis in Science, Words in Context, and Command of Evidence. One passage will relate to historical/social science content, and one will relate to scientific content. The subscores specific to the Writing test include Expression of Ideas and Standard English Conventions. Each question on the Writing test will fall into one of these two classifications. Expression of Ideas questions will primarily deal with how arguments are conveyed and the effectiveness of language use, while Standard English Conventions questions will address errors in sentence construction, word choice, and grammar.

Studying for the SAT Writing test can be challenging due to the nuances involved in many of the questions. Passages on the exam are created with the intent of presenting erroneous arguments and grammatical constructions. Parsing through the presented material to identify the intended thesis and supporting evidence can be an entirely different process when some material in the passage is intentionally misleading or confusing. The following lessons will outline some of the most common types of questions on the SAT Writing test, as well as approaches and techniques for identifying and adjusting the errors in language use presented in this exam.

Chapter Outline

Expression of Ideas

- SAT subscore that requires modification of content presentation to improve effectiveness

Standard English Conventions

- SAT subscore that requires identification and correction of standard grammatical errors



Expression of Ideas

A huge part of writing and composition is learning to communicate ideas effectively. The Expression of Ideas subscore of the SAT Writing and Language test is designed to evaluate your ability to identify ineffective communication and to propose appropriate modifications to the poorly constructed text. 24 of the 44 questions on the SAT Writing and Language test fall into this category, with exactly 6 questions pertaining to Expression of Ideas for each given passage. Many of these questions also relate to cross-test scores dealing with Command of Evidence, Words in Context, Analysis in History/Social Science, and Analysis in Science. In fact, all elements of the Analysis in History/Social Science and Analysis in Science subscores derived from the Writing and Language test come from the Expression of Ideas questions for the relevant passages on those subjects.

The general effect of Expression of Ideas questions is to challenge students to think critically about the method of argument presentation and effectiveness of language use, as opposed to outright incorrect elements with regard to standard English language constructs. Many questions relating to Expression of Ideas will ask students to improve a given selection in order to more efficiently or more effectively convey the main idea and supporting evidence of the passage. Approaching these questions may require you to identify contradictory statements, inaccuracies and inconsistencies, and generally confusing or poorly constructed passage elements. Questions will present a combination of structural elements, as well as content and contextual elements; as such, answers may require either revision in the passage construction (such as reordering paragraphs or combining sentences) or revision in passage content (such as removal of contradictory claims or introduction of supporting evidence).

Section Outline

Content and Development

- Modifying the thesis and supporting evidence in a passage

Organization and Structure

- Recognizing and remedying discontinuity in passage construction

Effective Language Use

- Evaluating the effectiveness of choices made to communicate a point



Content and Development

Questions on the SAT Writing and Language test that deal with Expression of Ideas can be further broken down into three categories: Content and Development, Organization and Structure, and Effective Language Use. Each of these relates to a specific skill set used in the effective expression of arguments and conveyance of complex meaning through prose.

Content and Development questions are the quintessential passage-based questions, dealing with the purpose, thesis, and evidence presented throughout the material. In specific reference to the Writing and Language test, these questions will require critical analysis of the presentation methods and compositional choices made in the given passage. The passages presented on this test are highly contrived, in the sense that they are designed to contain errors in presentation and logical reasoning. Content and Development questions will challenge you to identify and rectify those errors that pertain specifically to the way that the author constructs his or her argument. These questions are highly reliant on contextual continuity and consistency of the argument presented throughout the passage. As you continue through this section, take note of overarching principles presented in each Writing and Language passage and consider any elements that seem inconsistent or vague; these areas are most likely the basis of Content and Development revisions.

Section Outline

Modifying Proposition Statements

- Improving the effectiveness of the thesis statement, topic sentences, and general claims

Improving Focus and Purpose

- Eliminating irrelevant content and evaluating consistency of passage purpose

Quantitative Accuracy and Application

- Incorporating quantitative data and claims based on given materials, including graphs and tables



Modifying Proposition Statements

In order to say what it says, every passage on the SAT Writing and Language test has at least one main idea. Argumentative passages' main ideas may take the form of claims, while other passages' main ideas may be encompassing statements about what occurs in a story. Main ideas in passages about natural science and social science topics can relate the primary facts the passage conveys. While the exact form of a proposition statement is closely associated with the type and topic of the presented passage, questions that ask you to edit the passage may focus on these important lines, as they form the crux of the text and the scaffolding on which the writer builds the rest of his or her piece. Being able to improve proposition statements with ease requires you to balance the details of each presented revision against your understanding of the passage as a whole unit. These questions can be challenging, but with a bit of practice, you can face them with confidence!

Before we get started, let's define our terms. "Proposition statement" is an umbrella term that describes a number of specific types of statements. It includes thesis statements, the core sentence that often appears in the first paragraph of a persuasive text and conveys the trajectory argument to follow. "Proposition statement" also encompasses topic sentences, the sentences in a paragraph that often begin it, but serve the same purpose of mapping out the argument of the text, just on a smaller scale: that of a single paragraph. Finally, the most general term of the lot, "main ideas" are also "proposition statements." Sentences that simply convey information important to the author's argument are considered "main ideas." These are most likely to be found in the middle of body paragraphs.

Now that we've considered three types of proposition statements, let's take a look at some example questions that focus on each of them in turn.

Improving Persuasive Thesis Statements

Let's start with considering modifications to what is often the most important sentence in a persuasive passage: its thesis statement. The SAT Writing and Language test will not ask you to identify a thesis statement in the passage; if it's asking about modifying one, it will point you to the right sentence; however, it will be your job to recognize the significance of that sentence in context. The question stem might simply call it a sentence, not the thesis statement of the passage.

So, how do you know if you're looking at a thesis statement? Consider if you were the author and had only one sentence to express the ideas you present in the passage. Which single sentence would best do that? Chances are, that's the thesis statement. Thesis statements serve to reveal the trajectory of the argument that follows in more detail in later paragraphs, so expect to see them move the passage forward by discussing and foreshadowing new material, not just restating ideas that have already been presented.

Keep in mind, while thesis statements often fall at the end of the first paragraph, there's no rule that says they have to. Where a thesis statement ends up in the organization of the essay depends on the structure of the argument the author is making. A passage might start with its thesis statements, or precede it with a paragraph of introduction before getting to it in the second paragraph. So, if you're asked about any particular sentence in the first two paragraphs of a passage, keep in mind that you might be looking at the text's thesis statement.



Links to
Sample Questions

[Sample Question #1](#)

[Sample Question #2](#)

Practice Passage

There are numerous pressing issues that our school system currently faces, including the debate over school uniforms, the loss of numerous textbooks in the recent flood, and the renovation of rooms dedicated to various electives. However, the one about which we have received the most complaints is the one we can fix most easily, most quickly, and most cheaply: falling participation in the school lunch program. Very few people currently have good things to say about the meals being offered, most of which focus on fast-food items like burgers and pizza and sometimes completely lack fruits or vegetables. In the past, efforts to change school lunches have failed because of financial concerns, but we have a plan to make our ideas a reality.

1 We want to solve this problem as well as others simultaneously by making school lunches better. With the support of the Culinary Club as well as Student Council, we're sure that school lunches will look much more appetizing in the near future.

2 The Culinary Club has been a big supporter of this initiative, taking the time to attend Student Council meetings as well as School Board meetings at which the issue has been discussed. We want to hear your ideas! Suggestions so far have included revamping the salad bar to make it more appetizing, incorporating a fresh fruit stand, and building a vegetable stir-fry station where students can build their own stir-fries. If you have a suggestion for a way to make school lunches healthier and more delicious, please submit them in writing to the student council so that they can be discussed at their next meeting. The ideas that you help us brainstorm could change what's served in the cafeteria later this year!



Click Here to
Revisit the
Passage

Sample Question #1

Which of the following sentences would best serve as a thesis statement for the passage at Location **1** ?

- A. NO CHANGE
- B. The Culinary Club has recommended that vegetables be incorporated into every student's meal, and we want to start doing this by offering steamed, seasonal vegetables from the local farmer's market.
- C. By focusing on improving the quality and variety of fresh foods available to students as part of school lunches, we can help the school system generate extra revenue while encouraging students to try different foods and make more nutritious choices.
- D. By focusing on how to make school improvement projects profitable, we can help them appeal to the school board, garner widespread support from the administration and the student body, and come to fruition.

This question asks you to consider replacing it, so before considering each answer choice, take a look at the context that surrounds the sentence in question.

In the past, efforts to change school lunches have failed because of financial concerns, but we have a plan to make our ideas a reality. [1] We want to solve this problem as well as others simultaneously by making school lunches better. With the support of the Culinary Club as well as Student Council, we're sure that school lunches will look much more appetizing in the near future.

The sentence presented in the paragraph doesn't work so well. Can you identify why? The sentence that precedes it seems to suggest that the author will then present a bit more detail about the plan that's mentioned in the concluding clause, "but we have a plan to make our ideas a reality." Readers are set up to expect specifics, but the sentence that follows is very general. It doesn't provide any specific information about the writer's "plan." So, we can confidently say that A, "NO CHANGE," isn't the correct answer.

In order to differentiate between the other answer choices, we need to get a better idea of what specifics readers expect at the end of the sentence before the one we're replacing. The writer tells us that previous plans to improve school lunches "have failed because of financial concerns," but that his or her plan will work. This means that the writer's plan to improve school lunches will have to be one that avoids causing financial concern. With that in mind, let's check out the answer choices!

Let's start with B. While this sentence is grammatically correct and talking about student meals, it doesn't answer the question posed by the preceding sentence: "How will the writer's plan improve school lunches while avoiding causing financial concerns?" A isn't correct. D looks like a better option; it's discussing finances. But it's missing a key element: it doesn't mention the specifics of how the writer's plan will improve school lunches. D isn't correct either.



C is the correct answer. It provides detail about how the writer’s plan will improve school lunches (“By focusing on improving the quality and variety of fresh foods available to students as part of school lunches . . .”), and it also tells readers how this improvement will be implemented without causing financial concerns (“we can help the school system generate extra revenue”).

This question might have initially seemed overwhelming, but by considering the context of the passage, we were able to identify two points that the correct answer had to include based on reader expectations. Once we’d identified these two elements, picking out the correct answer was relatively easy. Always take a moment to consider how the indicated sentence fits into the context of the passage before picking out your answer to a question like this one!

Improving Topic Sentences

You can think of a topic sentence as a miniature thesis statement that functions on a smaller scale. Topic sentences, like thesis statements, give readers a sneak peak of the upcoming argument or presented information. Whereas thesis statements encompass the entire text, topic statements summarize a single paragraph. Because they focus on paragraphs and often appear near the beginning of a paragraph, picking the best topic sentence often means figuring out the best way to transition from one topic to another. This effect can be particularly strong when dealing with the topic sentence of the second paragraph in an argumentative passage in which the thesis appears near the end of the first paragraph. The second paragraph’s topic sentence provides structure for the first of the body paragraphs in the text, so it’s important that it fits into the structure of the entire text correctly. Let’s try picking out the best option for a topic sentence. Approach it like you would a question that asks you to pick out the best thesis statement, but zoom in on the second paragraph—and don’t forget to consider the context established by the last line of the first paragraph!

Sample Question #2

Which of the following sentences would best serve as the opening statement for the passage’s second paragraph at Location **2** ?

- A. NO CHANGE
- B. Before we can make school lunches more palatable, we need to know what changes the student body wants to see made to them.
- C. Many students have requested that pizza, burgers, and fries be served every day.
- D. Which parts of school lunches are considered to be the grossest?

Click Here to
Revisit the
Passage

Ok, first things first: let’s look at the context of this statement.

With the support of the Culinary Club as well as Student Council, we’re sure that school lunches will look much more appetizing in the near future.



[2] The Culinary Club has been a big supporter of this initiative, taking the time to attend Student Council meetings as well as School Board meetings at which the issue has been discussed. We want to hear your ideas! Suggestions so far have included

While the indicated sentence does talk about the Culinary Club like the last sentence of the first paragraph does, the second paragraph's transition to asking for suggestions seems a bit out of the blue. This suggests that A isn't the best answer. Let's not rule out leaving the sentence in the passage alone, but let's look at each of the other answer choices.

C can't be the correct answer; while it does have to do with student suggestions, it doesn't fit with the passage's main argument. The passage is talking about how to improve school lunches by making them healthier; adding in more days in which the cafeteria serves pizza, burgers, and fries doesn't seem like it will accomplish that goal. Note that nothing in the immediate context of the sentence makes this obvious; you have to go back to the first paragraph and note the disconnect between it and answer choice C's sentence.

D can't be correct either. While calling for student opinions, it focuses on the negative aspects of school lunch instead of asking for positive suggestions. Only examples of positive suggestions are presented later in the paragraph, and the passage clearly calls only for positive suggestions when it says, "If you have a suggestion for a way to make school lunches healthier and more delicious . . ."

The correct answer is B. This answer choice transitions from the first paragraph's consideration of how to accomplish the stated goal ("Before we can make school lunches more palatable") and establishes the topic of discussion for the second paragraph: a call to action asking for students to suggest possible improvements that could be made to school lunches ("we need to know what changes the student body wants to see made to [school lunches]"). B's sentence incorporates this transition where the sentence in the passage does not. Furthermore, B's sentence flows into the rest of the second paragraph more naturally, as it brings up the topic of asking students for their opinions.

Context was again important in this last sample question, and you had to look beyond the immediately adjacent sentences in order to figure out which answer choice's sentence was best. In addition, you had to pay attention to how some of the answer choices interacted with the passage's main idea or the way in which the passage presented a topic. Remember to read the entire passage carefully before answering questions that ask you about entire sentences. You need to make sure that ideas presented later in the passage than the indicated line don't clash with potential alternate sentences!

Let's next consider a passage that is informative instead of persuasive. You can use the same approach when answering questions about how to best modify proposition statements; the only difference is you will be working with a passage that is just presenting facts rather than attempting to convince readers of the author's opinion.



Link to
Sample Question

[Sample Question #4](#)

Practice Passage

3 The Earth's magnetic field is a fascinating scientific phenomenon that can be quite difficult to study. One scientific experiment has demonstrated that homing pigeons make use of the planet's magnetic field to augment their sense of direction. **4** Arctic foxes' behavioral patterns involve a fascinating hunting process. These predators hunt by leaping into the air and diving through the snow to catch small mammals scurrying around under the snow. Scientists have noticed a large discrepancy between the success of their hunting attempts made when facing north and those made when facing any other direction; the former are much more successful. It is thought that many other animals that undertake migrations use the planet's magnetic field as a map to direct them to their intended destination. As scientists further research the interactions between our planet and the myriad organisms that inhabit it, we are sure to uncover more fascinating connections.

Improving Informational Thesis Statements

Little needs to be said about modifying an informational thesis statement as opposed to a persuasive one as the distinction does not need to affect your approach to the question. Take the same factors into account: context, transitions, flow, and relevance to the passage's content.

Sample Question #3

Which of the following sentences would best serve as a thesis statement for the passage at Location **3**?

- A. NO CHANGE
- B. Animal behavior often involves an organism interacting with aspects of its environment to better its chances of survival.
- C. Biology and physics, while separate disciplines in natural science, often overlap and interact.
- D. Certain animals' behavior suggests that they sense and make use of the Earth's magnetic field.

Let's scan the passage and see what its major topics are. Identifying these can help us pick out the correct answer easily. The passage begins by talking about homing pigeons and the Earth's magnetic field. Then, it talks about arctic foxes, which also seem to use the Earth's magnetic field somehow when hunting. The passage concludes by talking about how migrating animals use the Earth's magnetic field and how many more relationships between the Earth and its animals are yet to be discovered.

This passage specifically concerns how different animals interact with Earth's magnetic field. With that in mind, we can consider the answer choices. A is far too general to be



the correct answer. While the passage is talking about an intersection between topics in biology and physics, it's talking about one specific intersection. Moving from a general topic sentence right into the first point made about homing pigeons would be jarring for the reader. C is not the correct answer.

Neither A nor B is correct, for similar reasons. B only focuses on how animals interact with their environment; it doesn't mention the Earth's magnetic field at all. A only talks about the Earth's magnetic field; it doesn't talk about how animals interact with it. D strikes the correct balance by mentioning both animals and the Earth's magnetic field, making it the correct answer.

Let's look at one more sample question, one that focuses on improving the presentation of one of the passage's main ideas, but not one that serves as a thesis statement or topic sentence. When dealing with these sentences, it is perhaps most important that you focus on context, as they will be embedded into the existing structure of the passage. After all, whether or not a main idea makes sense in a passage has a lot to do with what the thesis and topic sentences of that passage are!

Improving the Presentation of Main Ideas

Some SAT Writing and Language questions might ask you to pick out the best sentence that expresses a main idea of the passage. Consider the context of the argument around the specified location when choosing your answer!

Sample Question #4

Which of the following sentences would best function in the passage at Location **4**?

- A. NO CHANGE
- B. Arctic foxes use the details of their environment not only for camouflage, but also when hunting.
- C. Arctic foxes may also make use of the magnetic field when hunting.
- D. The magnetic field also affects how certain predators hunt.

Let's take a look around Location **4**.

One scientific experiment has demonstrated that homing pigeons make use of the planet's magnetic field to augment their sense of direction. [4] Arctic foxes' behavioral patterns involve a fascinating hunting process. These predators hunt by leaping into the air and diving through the snow to catch small mammals scurrying around under the snow. Scientists have noticed a large discrepancy between the success of their hunting attempts made when facing north and those made when facing any other direction; the former are much more successful.

The entire passage conveys different examples of animals that are thought to interact with the Earth's magnetic field, and arctic foxes are mentioned as a second example, after homing pigeons. What's the connection between these two topics? Well, both arctic foxes and homing pigeons use the Earth's magnetic field somehow. This also matches up

Click Here to
Revisit the
Passage



with the main idea of the passage. We need to pick out an answer choice that makes this relationship between the two topics apparent.

Now that we've looked at the context of the indicated line, let's consider the answer choices. D mentions only the magnetic field but doesn't introduce arctic foxes specifically, so it can't be correct. B mentions arctic foxes but doesn't mention the specific connection they have to the Earth's magnetic field. This connection is why they are being discussed in the passage, so B can't be correct either. The sentence as it appears in the passage talks about arctic foxes and their hunting process, but doesn't mention the connection to the Earth's magnetic field. C mentions both arctic foxes and the Earth's magnetic field, making it the best answer.



Improving Focus and Purpose

Certain SAT Writing and Language questions may indicate a sentence in the passage and ask you whether it belongs in the passage at all. Make sure you're focusing on the passage as a whole when you analyze whether the sentence contributes to it or should be omitted.

Link to
Sample Question

[Sample Question #2](#)

Practice Passage: Recyclable Plastics: What Do Those Symbols Mean?

[1] Most people are aware that a symbol composed of three arrows forming a triangle indicates that a container is somehow associated with recycling. [2] Far fewer individuals know what the little letters and numbers in the center of this symbol indicate. [3] These markings designate the particular kind of plastic from which the item is made. [4] The letters are acronyms that designate the item's broad category of plastic and provide detail about the specific thickness, density, and durability of the material. [5] For instance, "PET" and "PETE" both stand for the same thing, "post-consumer polyethylene terephthalate," while "HDPE" stands for "high-density polyethylene." [6] The numbers provide the same information in a different way—a PET bottle can be designated by a numeral 1 inside the recycling arrows, while an HDPE bottle can be identified by a 2. [7] By referring to these symbols, consumers can discern where each item should be recycled. [8] Recycled materials should always be placed in the correct stream. [9] While this system is very accurate, it is not consumer-friendly; people glancing over a product's packaging they wish to recycle might encounter the symbol and not know what it means, resulting in their recycling it incorrectly. [10] So, the next time you purchase something made of plastic, make sure to decode these symbols!

Sample Question #1

The author is considering removing Sentence 4 from the passage. Should he or she do this?

- A. Yes, because this sentence is beyond the scope of the passage because it provides unnecessary details about only letters when letters and numbers are each being discussed.
- B. Yes, because this sentence disrupts the flow of the passage.
- C. No, because the passage would lose valuable details and its parallel structure of discussing both letters and numbers would be disrupted.
- D. No, because it is functioning as a transition in order to introduce a concept different from the one that has been discussed thus far in the passage.



We first need to consider Sentence 4: “The letters are acronyms that designate the item’s broad category of plastic and provide detail about the specific thickness, density, and durability of the material.” Ok, so this sentence is telling us exactly what the letters stand for. How does it fit into the paragraph as a whole? The two sentences before it tell us that recycling symbols include letters and numbers that provide information about the specific type of plastic from which something is made. The sentence immediately after it provides examples of such letters and their meanings, and the sentence after that explains how numbers relate.

Should we remove this sentence? No, it fits well in the paragraph’s two-pronged discussion of both letters and numbers. If we removed this sentence, the passage wouldn’t mention letters in general at all; it would jump to examples and then proceed to discussing the numbers in recycling symbols. Plus, this sentence lets us know details about what information is conveyed by these markings. It’s a pretty useful sentence that doesn’t appear to stick out as extraneous, and it connects nicely with the sentence that follows it, which starts with the phrase “For instance” and provides examples specifically of the meanings of various letters, which the sentence in question discusses more generally.

Given that reasoning, we can consider the two answer choices that begin with “No”: C and D. C says we should keep the sentence because it’s providing useful information and contributing to parallel structure; D says we should keep it because it’s a transition to a new idea. Well, it’s not a transition to a new idea; the sentence in question is functioning to convey information about the letters in recycling symbols, one of two major points the passage is addressing, along with numbers in those symbols. If we removed the sentence, it would disrupt the paragraph’s parallel structure of discussing both letters and numbers, though. That means that the correct answer is C.

Let’s consider another sample question:

Sample Question #2

The author is considering removing Sentence 8 from the passage. Should he or she do this?

- A. Yes, because the sentence is extraneous and doesn’t fit the tone of the rest of the passage.
- B. Yes, because the sentence provides information that conflicts with other information in the passage.
- C. No, because the sentence provides information necessary to understanding the passage’s main idea.
- D. No, because the sentence is transitioning to the passage’s conclusion.

Sentence 8 states the following: “Recycled materials should always be placed in the correct stream.” Before it in the passage, we find, “By referring to these symbols, consumers can discern where each item should be recycled.” After it, we find discussion of the pros and cons of this recycling symbol system: “While this system is very accurate, it is not consumer-friendly . . .”

Click Here to
Revisit the
Passage



Did Sentence 8 stick out to you as you were initially reading the passage? You may have noticed its slight shift in tone. Whereas the rest of the passage is declarative and aims to provide general information to its reader until the last line, this sentence tells readers what they “should” do, as if providing direct instructions. Sentence 8 might also have seemed a bit extraneous because of the way in which it repeats information conveyed by the sentence that precedes it:

[7] By referring to these symbols, consumers can discern where each item should be recycled. [8] Recycled materials should always be placed in the correct stream.

Sentence 7, in telling us that the symbols allow consumers to figure out where to recycle each item, conveys the implicit idea that it is important that items be placed in the correct location. If where each type of plastic was recycled wasn’t an issue, the symbols wouldn’t be necessary. Thus, Sentence 8 isn’t necessary to this passage, and we can omit it.

Having made that decision, we can turn our attention to deciding between the two “Yes” answer choices. A says that we should omit Sentence 8 because it’s extraneous and differs in tone, while B says that we should omit it because its information conflicts with information elsewhere in the passage. Viewing Sentence 7 side-by-side with Sentence 8 should demonstrate that the problem with Sentence 8 isn’t that it contains conflicting information—it’s that it says something directly that’s already been conveyed in the passage. Answer A, which identifies both the extraneous information issue and the slight shift in tone, is spot-on.



Quantitative Accuracy and Application

With other revisions to the SAT has come the inclusion of graphs, charts, and tables in the new Writing and Language section. Never before seen on this part of the test, these graphics are being introduced in order for the test writers to examine your skill in assessing information not only in the form of text passages, but also when presented as graphics.

With all of the other changes being made to the old SAT Writing section, it is easy to get overwhelmed, and the sight of graphs—*graphs!*—on the Writing section may be enough to bewilder some students momentarily and make them wonder if they're studying for the Math section instead. If the thought of having to interpret graphics is worrying you, take a moment to consider how often in your daily life you read tables, charts, and graphs without giving it a second thought. The SAT is merely giving you the opportunity to showcase these skills in ways that interact with your other editing abilities. Preparing yourself for the types of data-related questions that could appear on your SAT Writing and Language test can help you add figure-related skills into your repertoire and leave you feeling prepared to analyze the data presented to you on test day and approach it from an editorial perspective.

Practice Passage: Student Opinion on School Uniforms

[1] The possible adoption of school uniforms has become the hot topic of debate at the local high school, and one Statistics class has taken a poll about students' feelings on the subject. [2] The results are in, and if you expected all of the classes to uniformly oppose the idea of school uniforms, you may be in for a surprise. [3] School uniforms can help make students' academic lives more efficient and set them up for success; perhaps students have been reading up on all of these benefits. [4] In order for the student government to either support or oppose the decision, the majority of students in each grade would have to come to the same conclusion. [5] Currently, the majority of two classes is against the idea, and the majority of one class is for it. [6] One class remains undecided as a whole.

2

1 [7] If the motion passes, we can anticipate a great deal of opposition—especially from the underclassmen. **3** [8] The majority of the Board of Education is in favor of the proposal. [9] Many people consider the decision to adopt school uniforms as good as already made. [10] The Board will make their decision by vote at their next meeting, after it hears the opinions of the student classes from their representatives. [11] The Statistics class will conduct a follow-up poll the day before the Board of Education meeting to track any change in opinion.

Links to
Sample Questions

[Sample Question #1](#)

[Sample Question #2](#)

[Sample Question #3](#)

[Sample Question #4](#)



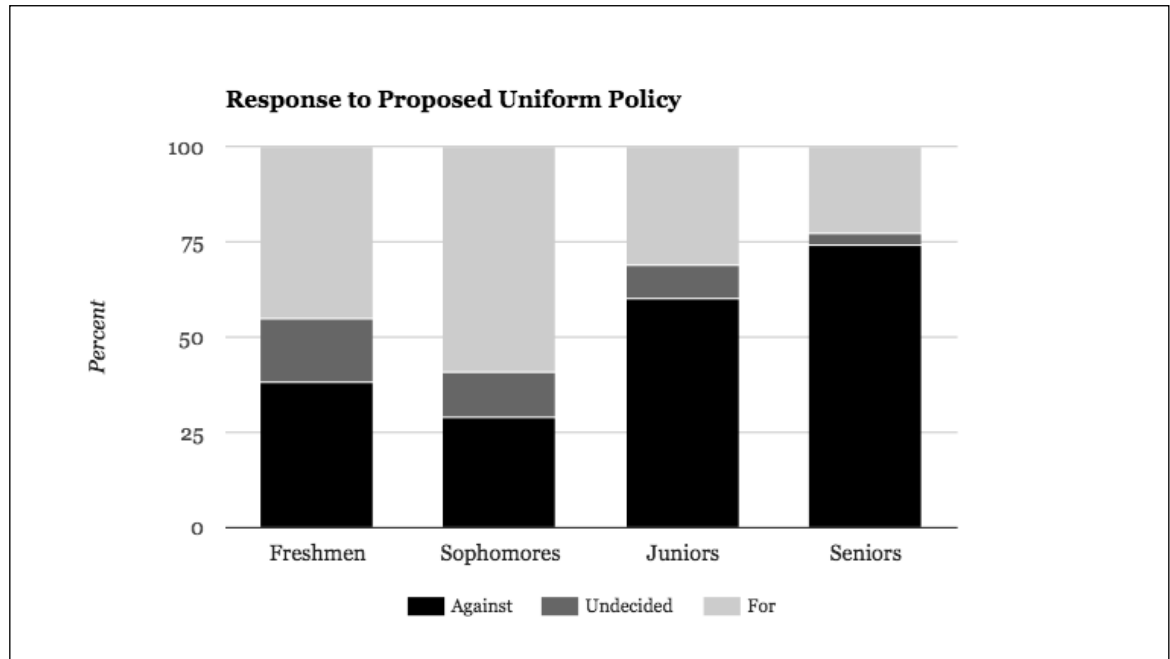

Modifying Claims Based on Presented Data

One way in which a figure can weigh in on the editorial decision-making process is if the writer makes any mistaken claims that are proven wrong by the data in the figure. While such inconsistencies might jump out at you when you're reading outside of a test environment, keep in mind that it's easy to get focused on the nitty-gritty details of comma splices, agreement, and choosing the correct preposition on the SAT Writing and Language test. You may end up missing "big-picture" errors. For example, the following sample question concerns an inconsistency in the passage brought out by the associated bar graph. The sentence in question is grammatically correct, as are all of the presented answer choices. Coming across this on test day might give you pause if you are in error-seeking mode. Should this happen to you when dealing with a passage with an associated figure, take a moment to "step back" in perspective and consider whether the author's statements, grammatical or not, line up with the facts presented graphically.

Sample Question #1

Click Here to
Revisit the
Passage

- A. NO CHANGE
- B. If the motion passes, we can anticipate a great deal of opposition—especially from the upperclassmen.
- C. If the motion passes, we can anticipate a great deal of opposition—especially from the Juniors.
- D. If the motion passes, we can anticipate a great deal of opposition—especially from the Freshmen.



The only way in which the presented answer choices differ is in their choice of the word that concludes the sentence. Glancing at the graph reveals that “underclassmen” (A) is not correct; we should not expect opposition to the school uniform proposal in particular from the underclassmen, as the freshmen are undecided as a class, with no majority for or against the proposal, and the Sophomores are, as a whole, in favor of it. “Freshmen” can’t be the answer either, then, allowing us to ignore answer choice D. This leaves us to choose between “Juniors” and “upperclassmen.” Juniors are part of the group “upperclassmen,” so this can get a bit tricky—let’s focus on just the Juniors initially, then consider the upperclassmen (juniors and seniors) as a different group. Are the juniors in favor of school uniforms? No: more than 50% of them are against the idea. However, this doesn’t necessarily mean that C is the best answer. Consider this: why would the author specifically say that we should expect opposition from the juniors and not the seniors, who are as a whole even more against the idea of school uniforms? That doesn’t make sense. Because the majority of both the junior and senior classes is against the idea of school uniforms, the best answer is B. It is reasonable to claim that if school uniforms are instated, one should expect the most opposition from the juniors and the seniors—the upperclassmen.

Inserting Claims Based on Presented Data

Another type of data-related question the Writing and Language section might present you with is a take off on a “choose the best sentence for the passage” question. Having to weigh the data presented in a graph, chart, or table while making this editorial decision can make the correct answer considerably more difficult to reach, particularly because each answer option may encompass a different claim about the topic at hand, and thus relate to the presented information in a different way. Going through the answer choices one by one and analyzing them for factual soundness is one method of carefully working toward the best option.

Sample Question #2

The author of the article wants to include another sentence. Which of the following would be best for him or her to add at Location **3**?

- A. Any students campaigning for the adoption of the new policy would do well to focus their efforts on members of the Sophomore class in particular.
- B. If all of the undecided sophomores and juniors decide to support the idea, it could affect how their classes vote, shifting the majority position from one side of the debate to the other.
- C. It’s difficult to predict whether the Senior class will recommend or oppose the uniform policy.
- D. One fascinating trend that emerges from the poll results is that older students are more decisive in their opinions than are younger ones.

Click Here to
Revisit the
Passage



As mentioned above, let's consider each answer choice individually and analyze whether its claim is correct.

A. Should students who want school uniforms focus on getting members of the sophomore class to change their minds? No, the graph shows that over half of the sophomore class already supports adopting school uniforms. Students campaigning for the adoption of school uniforms should focus on the senior class or all the upperclassmen, or even freshmen, juniors, and seniors—just not sophomores, as a whole, the sophomores are already in support of school uniforms. This answer choice isn't correct.

B. Look at what relative percents of the sophomore and junior classes are undecided. You don't have to come up with an exact percentage to answer this question—this isn't the Math section. Put in different terms, this answer choice is claiming that if all the undecided students in the sophomore and junior classes support school uniforms, they will each “switch sides.” Is that true? Nope—if all of the sophomore undecided students support school uniforms, the sophomore class will still be in favor of school uniforms, and if all of the undecided junior students support the idea of school uniforms, the class as a whole will still be against the idea. This answer choice is incorrect.

C. Consider the senior class's poll results. Is it easy to predict how they will come down on the issue of school uniforms? Yes. A large majority of the senior class is against school uniforms, and a very small percentage of the class is undecided. No matter which side the undecided students in the senior class decide to support, the class as a whole will still oppose school uniforms. This answer choice's claim about being “easy to predict” is a bit less objective than the other choices' assertions, but it's still incorrect.

D. This answer choice's claim can be restated as “every time you move from a younger grade to an older one, the percent of undecided students decreases.” Is this true? Yes! Again, you don't have to identify specific percentages, just the general trend. This is the correct answer.



Considering Revisions to Data

Whereas certain SAT Writing and Language questions present you with alternative, revised versions of sentences and ask about the possibility of using them in the passage, other questions might do this same thing with figures. Focus on what is different about an alternative figure; the question will have to concern the change, not the parts of the figure that remain constant.

The sample question that follows asks you to consider a change in the graph in light of the entire passage, as it introduces information that contradicts one of the sentences.

Sample Question #3

Click Here to
Revisit the
Passage

The author of the article is considering changing out the graph included in the passage with the one that appears below.

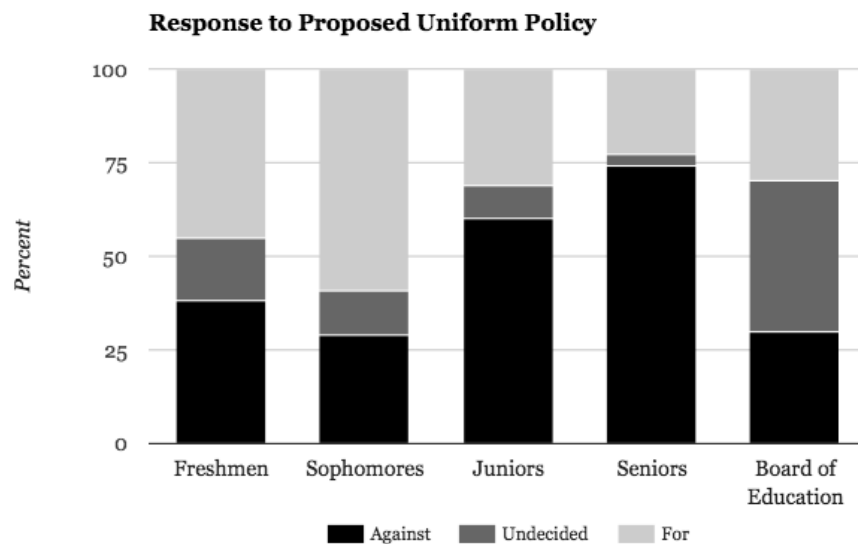

If the author makes this substitution, which sentence would he or she need to revise to avoid contradiction?

- A. Sentence 3
- B. Sentence 5
- C. Sentence 8
- D. Sentence 9

Let's start by analyzing the new graph. What's different about it? The data for the high school class poll remains identical; the only difference is that the author has added a fifth data bar labeled "Board of Education." The ratio of opinions in this bar tell us that the Board of Education is neither concretely in favor of nor set against school uniforms; the majority of its members are undecided, and the vote could go either way depending on what they decide.



That analysis makes it much easier to pick out the sentence that necessarily needs to contain the contradiction. We know that the sentence in question has to concern the Board of Education; sentences 3 and 5 don't discuss the Board of Education at all, and a quick glance over them reveals no contradictions.

Sentence 9, "Many people consider the decision to adopt school uniforms as good as already made," does not concern a contradiction because it is relaying what "many people" think. There's a possibility that "many people" might be wrong in their assumptions, as turns out to be the case here! Sentence 8 contains the contradiction; the graph shows that most of the Board of Education is undecided, so it contradicts the statement "The majority of the Board of Education is in favor of the proposal." The correct answer is C.

Suggesting Additional Data that Could Support the Passage's Claims

SAT Writing and Language questions can concern figures that aren't even presented in the sense that they may ask you to consider descriptions of figures that might be included along with a passage and analyze how their inclusion would affect the passage. Would such a figure support the passage, contradict it, or have no effect on it? It's up to you to think like a writer and figure that out.

Sample Question #4

Click Here to
Revisit the
Passage

Which of the following, if included with the passage, would support claims made in it?

- A. A graph correlating an increase in student grades with the adoption of a school uniform policy at a number of nearby schools
- B. A table detailing the costs of one of the proposed school uniforms
- C. A table showing the way in which the Board of Education has voted on previous issues brought before it
- D. A graph correlating an increase in the number of students suspended per semester at a nearby school with the school's adoption of school uniforms

In the first paragraph, the author says of the surprising result that not all students oppose school uniforms, "School uniforms can help make their academic lives more efficient and set them up for success; perhaps students have been reading up on all of these benefits." This statement would be supported by a graph correlating an increase in student grades with the adoption of a school uniform policy at a number of nearby schools. B and C do not support any statements made in the passage, and D contradicts the author's statement.



Organization and Structure

When you think of a “typical” SAT Writing and Language question, you may think of a question that asks you to correct a grammatical error, as these were common on the SAT Writing section of the last version of the test. The revised SAT’s focus on passage-level editing shines through in particular in questions that consider the structure and organization of a passage from an editorial perspective. These questions treat the order in which a passage presents its information as a dynamic feature, inviting you to weigh in on which order of items most efficiently conveys the author’s message.

We’ve split this section into two lessons. The first, “Logical Sequence,” considers questions that ask where a new sentence should be placed, where a sentence in the passage should be moved, and where a paragraph break would best be inserted. These questions function like puzzles defined by the passage’s context and flow, challenging you to find the perfect spot for a particular editing decision. The second lesson, “Introductions, Conclusions, and Transitions,” focuses on these textual hinge points. Revising them calls for a keen eye to issues of argument and context as well as passage organization, so we walk through a few focused examples in detail.

There are two things to keep in mind as you work with questions asking you to alter passage organization and structure. The first is to take each question one at a time and not assume that changes you have recommended making in one question are actually made to the passage and carry over to later questions you encounter about it. If it helps, you can pretend that you’re working with a writer who will consider your recommended edits, but not immediately make them. The second point to keep in mind is to not get overwhelmed by the scale of these questions. Many SAT Writing and Language questions focus in on details like comma placement, subject-verb agreement, and the tone of specific words or phrases, and it can be disorienting to suddenly have to shift your focus from these microscopic concerns to an expansive view of the entire passage as you juggle answer options that present entire sentences. Take the time to practice questions that function at each “scale” to downplay any difficulties you may encounter in switching between them. Being able to seamlessly move from considering punctuation in one sentence to looking at how entire paragraphs connect as you look for the best place for a paragraph break takes skill, and developing that skill takes practice—practice with which this book can help you!

Section Outline

Logical Sequence

- Ordering and organizing presentation of ideas, events, and arguments

Introductions, Transitions, and Conclusions

- Creating fluidity in passage construction and logical progression between paragraphs



Logical Sequence

The SAT Writing and Language test examines your skill in figuring out the best order for information presented. Questions might present you with a sentence and ask where it would be best placed in the passage; alternatively, they might ask you to identify a new location for a sentence already in the passage. Consider these questions to be like puzzles: it's your job to pick out the spot in which a sentence perfectly fits. The "pieces" are all unique and their "shapes" are determined by the context of the passage as well as its argument, tone, and structure. On a related note, a closely-related question type might ask you to identify the best spot at which to break a single paragraph into two shorter ones. No matter the particulars of a question concerned with logical sequence, it will ask you to move between considering discrete sentences and considering the passage as a whole text made up of many of these individual pieces. Practicing your ability to consider a passage through this specific editorial lens will help you do so with ease on test day.

Choosing the Best Spot for a Sentence

Sometimes, the SAT inverts a common question formula: instead of presenting you with multiple sentences and asking which one goes best in a specified location, it presents you with a single sentence and asks where that sentence should go in the passage. While the factors have been inverted, the skills being tested are similar. You still need to understand the passage's context, but instead of paying special attention to tone, scope, and voice, you can turn your attention to how the passage progresses line-by-line in moving from one topic to another.

Practice Passage: Japanese Tea Ceremonies

[1] Tea is found in a myriad of different varieties throughout the world and plays an important part in a great many cultures. [2] In traditional Japanese culture, tea ceremonies play a special role in creating a social space in which tea is enjoyed with others. [3] Matcha is a kind of green tea that has been ground into a fine powder. [4] Japanese tea ceremonies vary in their details; there are many different schools that all differ in the details of how one prepares and serves the tea. [5] During a ceremony, the tea is prepared carefully in a manner according to tradition. [6] Whereas some people can down a cup of tea in minutes, tea ceremonies draw out the tea-drinking process. [7] Tea certainly plays a special role in traditional Japanese culture, as tea ceremonies demonstrate.

Links to
Sample Questions

[Sample Question #1](#)

[Sample Question #2](#)

[Sample Question #3](#)



Click Here to
Revisit the
Passage

Sample Question #1

The sentence “A particular tea is often used in these ceremonies: matcha.” would be best inserted into the paragraph in which of the following locations?

- A. Before Sentence 2
- B. Before Sentence 3
- C. Before Sentence 4
- D. Before Sentence 7

Consider the sentence we’re handed. It moves from general to specific, specifying one tea that is often used in “these ceremonies.” The use of the demonstrative pronoun “these” tells us that at the point in the passage where this sentence makes sense, the Japanese tea ceremonies have already been introduced. Otherwise, it doesn’t make much sense to refer to them as “these ceremonies”—readers would ask, “Which ceremonies?” and get terribly confused. This allows us to rule out “Before Sentence 2,” as at that point in the passage, tea ceremonies have yet to be introduced. “Before Sentence 7” doesn’t make much sense either. At that point in the passage, the focus is on the timing of the ceremony, not on any particular kind of tea.

This leaves us with answer choices B and C to choose from. Skimming the passage, you can see that matcha is discussed in only one place: in the sentence, “Matcha is a kind of green tea that has been ground into a fine powder.” How does the question’s sentence relate to this sentence? The question’s sentence seems like it’s introducing matcha to the reader for the first time, whereas the sentence in the passage provides a definition of what matcha is. Thus, it makes sense for the question’s sentence to precede the sentence in the passage, making “Before Sentence 3” the right answer:

In traditional Japanese culture, tea ceremonies play a special role in creating a social space in which tea is enjoyed with others. A particular tea is often used in these ceremonies: matcha. Matcha is a kind of green tea that has been ground into a fine powder.

This makes sense because the inserted sentence provides a general introduction to matcha that leads in to the following sentence’s more detailed definition.

Click Here to
Revisit the
Passage

Sample Question #2

The sentence “No matter which school is followed, many tea ceremonies involve the consumption of light food along with the tea.” would be best inserted into the paragraph in which of the following locations?

- A. Before Sentence 4
- B. Before Sentence 5
- C. Before Sentence 6
- D. Before Sentence 7



In this question's sentence, details are again our friends. Look at how the sentence begins: "No matter which school is followed . . ." In order for a sentence to start this way, a variety of schools needs to have just been introduced in the previous sentence. Which sentence in the passage does that? "Japanese tea ceremonies vary in their details; there are many different schools that all differ in the details of how one prepares and serves the tea." This means that the location that immediately follows this sentence, "Before Sentence 5," is the correct answer.

Sample Question #3

Click Here to
Revisit the
Passage

The sentence "Ceremonies can span hours." would be best inserted into the paragraph in which of the following locations?

- A. Before Sentence 2
- B. Before Sentence 5
- C. Before Sentence 6
- D. Before Sentence 7

Ok, we don't have any obvious context clues to go on in this sentence. It's talking about details, and specifically emphasizing how long tea ceremonies can last. The passage only discusses the timing of a tea ceremony near its conclusion, so we can discard "Before Sentence 2" as a potentially correct answer and narrow our focus to the remaining three answer choices, all which fall around the part of the passage where timing is discussed:

[5] During a ceremony, the tea is prepared carefully in a manner according to tradition. [6] Whereas some people can down a cup of tea in minutes, tea ceremonies draw out the tea-drinking process. [7]

We can ignore "Before Sentence 5" because our sentence provides more detail about the speed of a tea ceremony than does the sentence that begins with "During a ceremony." This means that our sentence comes after this one, leaving us to decide whether it best fits into the passage before Sentence 6 or Sentence 7. Again, consider levels of specificity: whereas the sentence in the passage tells us that "tea ceremonies draw out the tea-drinking process," a general statement, our sentence specifies that "Ceremonies can span hours." This sentence thus best fits into the passage after the more general statement, before Sentence 7, making D the correct answer.

Rearranging Content

Just as certain questions on the SAT Writing and Language test may ask you about where in the passage to place a new sentence, other questions can ask you where to move a sentence that is already part of the paragraph. The sentences indicated by these questions may stick out to you as you read the paragraph, as there are better spots for them to be placed—places in which they fit perfectly into the order in which the passage presents its information. Still other questions may ask you to consider a lengthy paragraph and deduce where it would be best to break it into two smaller paragraphs. Mastering both of these question types requires you to train a keen eye for the progression of topics in a passage.



Link to
Sample Question

[Sample Question #5](#)

Practice Passage: National Parks and National Monuments

[1] National Parks in the United States serve as a way for the government to officially protect pristine natural ecosystems, and each park has characteristic features that make it famous. [2] Yellowstone National Park, the first to be protected, is renowned for its geysers (like the famous “Old Faithful”) and sulfur pools. [3] Other national parks like Yosemite and Glacier are famous for their beautiful mountain vistas, while Sequoia National Park contains some of the oldest and tallest trees in the world. [4] The U.S. also maintains a different category of protected land: national monuments. [5] In contrast to national parks, which are treasured for their natural landscapes, national monuments are protected for their historical significance. [6] National monuments may include such things as landmark sites where historically significant documents were signed, battlefields, and homes of individuals famous in U.S. history. [7] There are currently 59 national parks in the U.S.—at least one in each state—and millions of people visit them every year. [8] The next time you pass a federally protected site, whether it’s a national park or a national monument, be sure to visit and enjoy it yourself!

Moving Sentences

SAT Writing and Language questions that ask you to consider rearranging content may ask about potentially moving one of the sentences in the passage to a different location. These questions are likely to focus on issues of sequence and logic, since shifting a sentence in this way alters not the information the passage presents, but the order in which that information is presented.

Sample Question #4

In order for the paragraph to make the most logical sense, Sentence 7 should be placed at which of the following locations?

- A. After Sentence 1
- B. After Sentence 2
- C. After Sentence 3
- D. It should be left where it is in the passage now.

First things first: consider the sentence in question, Sentence 7: “There are currently 59 national parks in the U.S.—at least one in each state—and millions of people visit them every year.” Looking over the passage as a whole, we can see that this sentence connects to the main topic of U.S. National Parks. The passage discusses both national parks and national monuments, though, and this allows us to narrow our focus to those sections that discuss national parks, not national monuments. Our sentence will go somewhere in that part of the passage. The passage discusses national parks near the beginning and national monuments near the end, so we can predict that our sentence will go somewhere near the beginning of the passage. This doesn’t do us much good in this question as we’re given the first three sentences of the passage as potential answer choices, but it does allow us to take a critical glance at where the sentence is now: smack-dab in the middle of the



part about national monuments. It's in the wrong spot, so we certainly won't be leaving it where it is now, and D isn't the correct answer.

In deciding whether our sentence belongs after Sentences 1, 2, or 3, we need to pay extra special attention to how sentences next to one another work together. If two consecutive sentences are particularly tight-knit in terms of content and transitions, it won't benefit the passage to break up that flow by inserting a different sentence between them. Let's consider Sentences 1 and 2, as we're asked about inserting Sentence 7 after Sentence 1:

[1] National Parks in the United States serve as a way for the government to officially protect pristine natural ecosystems, and each park has characteristic features that make it famous. [2] Yellowstone National Park, the first to be protected, is renowned for its geysers (like the famous "Old Faithful") and sulfur pools.

If you were to characterize how these sentences relate to one another, how would you do so? Well, you might notice that we're going from a general introduction of national parks and a foreshadowing of details ("each park has characteristic features that make it famous") to specific details about Yellowstone that fulfill that foreshadowing by telling us what makes it famous ("Yellowstone . . . is renowned for its geysers"). These sentences directly connect to one another, so we don't want to insert a new sentence between them. It would make it difficult for the reader to jump from the concept of "there are things that make national parks unique" to "here is an example of what makes a national park unique." Answer option A isn't the correct answer.

On to considering Sentences 2 and 3:

[2] Yellowstone National Park, the first to be protected, is renowned for its geysers (like the famous "Old Faithful") and sulfur pools. [3] Other national parks like Yosemite and Glacier are famous for their beautiful mountain vistas, while Sequoia National Park contains some of the oldest and tallest trees in the world.

These sentences have a lot in common because they are both serving the same purpose in this passage: providing more details and examples about what makes different national parks unique. This is particularly evident in how the passage moves from a simple declarative example about Yellowstone to more examples using the words "Other" and "while": "Other (example does this), while (yet another example does this)." It wouldn't make sense to place Sentence 7 between these two lines, so answer choice B is incorrect.

We've figured out the correct answer using process of elimination: C, after Sentence 3, is the best spot in which to place Sentence 7. To check our answer, let's see how the paragraph reads when we do that:

[1] National Parks in the United States serve as a way for the government to officially protect pristine natural ecosystems, and each park has characteristic features that make it famous. [2] Yellowstone National Park, the first to be protected, is renowned for its geysers (like the famous "Old Faithful") and sulfur pools. [3] Other national parks like Yosemite and Glacier are famous for their beautiful mountain vistas, while Sequoia National Park contains some of the oldest and tallest trees in the world. [7] There are currently 59 national parks in the U.S.—at least one in each state—and millions of people visit them every



year. [4] The U.S. also maintains a different category of protected land: national monuments.

This is a great spot for Sentence 7: it doesn't interrupt the tight-knit construction of the earlier sentences about national parks, and it switches the topic from listing national parks (neatly wrapping up the example-naming by providing an encompassing statistic) to a different fact about them—how popular they are as tourist destinations. The correct answer to this question is C, After Sentence 3.

Paragraph Breaks

Breaking apart a paragraph can be tricky business. The very fact that the SAT Writing and Language test presents material as a single paragraph can predispose you to assume that the single-paragraph format is the best one when that isn't the case. As you read through passages, be on the lookout for moments where it seems the author needs to take a pause, but doesn't—and not in terms of comma placement. A paragraph break inserts a specific kind of moment into the reader's experience—a short pause in which his or her brain keeps digesting information while his or her eyes move on to the next segment of the text. Think of a paragraph break in a passage as functioning something like a comma in a sentence, but know that whereas commas can break apart sentences regardless of how material ending up on each side of the comma relates, paragraph breaks are always entrenched in what the author is saying. You don't break up a paragraph in the middle of talking about a point—you start a new paragraph when you're introducing a new point.

Sample Question #5

The author wants to separate the passage into two paragraphs. Before which of the following sentences would it be most logical for him or her to do this?

- A. Sentence 2
- B. Sentence 3
- C. Sentence 4
- D. Sentence 5

Click Here to
Revisit the
Passage

You can apply the same skill of analyzing the relationships between various sentences to questions that ask you about breaking a paragraph into smaller paragraphs. Reconsidering the passage, we can see that it moves from introducing national parks and foreshadowing details (Sentence 1) to providing details about what makes national parks unique (Sentences 2 and 3) before beginning to talk about national monuments in contrast to national parks (Sentence 4) and giving examples of sites that might be protected as national monuments (Sentence 5). Did you notice that shift—the large-scale idea shift from national parks to national monuments? That shift occurs in Sentence 4, where national monuments are introduced as a topic of discussion. The best place to break apart the passage would therefore be right before Sentence 4, so Sentence 4 could serve as the introduction to a second paragraph about national monuments. This means that C is the correct answer.



Let's take a look at how the passage would flow if it was broken into two paragraphs right before Sentence 4:

[1] National Parks in the United States serve as a way for the government to officially protect pristine natural ecosystems, and each park has characteristic features that make it famous. [2] Yellowstone National Park, the first to be protected, is renowned for its geysers (like the famous “Old Faithful”) and sulfur pools. [3] Other national parks like Yosemite and Glacier are famous for their beautiful mountain vistas, while Sequoia National Park contains some of the oldest and tallest trees in the world.

[4] The U.S. also maintains a different category of protected land: national monuments. [5] In contrast to national parks, which are treasured for their natural landscapes, national monuments are protected for their historical significance. [6] National monuments may include such things as landmark sites where historically significant documents were signed, battlefields, and homes of individuals famous in U.S. history. [7] There are currently 59 national parks in the U.S.—at least one in each state—and millions of people visit them every year. [8] The next time you pass a federally-protected site, whether it's a national park or a national monument, be sure to visit and enjoy it yourself!

One important thing to keep in mind is that if you should have to deal with both sentence-rearranging questions and paragraph-breaking questions that concern a single passage, do not assume that sentences have actually been moved as you suggested. Treat each question as distinct and as referencing the passage as it is written, not as it would look if the writer took your suggestions and made each change you decided was best in previous questions. In short, does Sentence 7 sound awkward where it is currently placed? Yes. But you have to assume it's still there, and that Sentence 7 hasn't been moved. Regardless of whether Sentence 7 were moved, it is best to break apart the paragraph before Sentence 4. The SAT Writing and Language test will likely avoid “stacking questions” like this, but always remember to consider the passage as it's written in each question presented to you about it.



Introductions, Transitions, and Conclusions

SAT Writing and Language questions may ask you to take a critical look at the sentences that begin and end a passage, as well as those that help the reader move from one paragraph to the other. These various “hinge-points” of the passage are the most important for the writer’s construction and the reader’s experience. Learning how to identify the best option for each scenario can help you approach the new Writing and Language section with confidence.

Links to
Sample Questions

[Sample Question #2](#)

[Sample Question #3](#)

Practice Passage: The Big Impact of Monet’s *Impression, Sunrise*

1 [1] When Claude Monet’s painting of his hometown’s harbor titled *Impression, Sunrise* debuted in a Paris art show, critics had no idea what to make of it. [2] Despite the qualms and complaints of art critics, Monet’s piece became famous.

2 [3] Many artists began to mimic the style of Monet’s painting, which departed from the carefully realistic portraiture and history paintings of previous works and instead aimed to present the suggestion of a subject, paying special attention to the interaction of light with the subject. This style eventually developed into an entire artistic movement that took its name from Monet’s painting and came to be called “Impressionism.” **3**

Choosing an Introductory Sentence

When choosing an introductory sentence for a passage, even if this is the first question of the set, don’t answer it without first reading the entire passage! Introductory sentence options can differ based on their varying ability to foreshadow or reference material that is mentioned later in the passage, starting it by pointing it in the direction of topics later discussed. Discerning between these answer options obviously requires you to know what the passage talks about in each of its sections, so read the entire passage first before picking the best opening line.

Sample Question #1

Which of the following would best function as the first sentence of the passage, at Location **1**?

- A. Claude Monet’s most famous painting is without a doubt *Impression, Sunrise*, though critics hated it when it first debuted.
- B. Claude Monet is famous in art history for producing the first work in a famous and important movement in painting that also gave that movement its name.
- C. Artists like Claude Monet have proceeded despite criticism, providing a great example of why artists shouldn’t be discouraged by critical disparagement.
- D. Claude Monet is a painter who is known for his beautiful landscapes, which many people love for their bright colors.



A few factors determine this question's correct answer: sequence, type of passage, and scope.

Sequence: When picking a sentence to add to an SAT Writing and Language passage, it's important to consider the sequence of the resulting work. Certain information can be presented too early, or it might not make sense given the context of other lines. This is the case in this sample question. Answer choice A, "Claude Monet's most famous painting is without a doubt *Impression, Sunrise*, though critics hated it when it first debuted," might seem like a perfect choice for the passage given that it mentions the specific painting that is discussed and the initial critical reaction to it; however, take a closer look of how this topic sentence would actually function in the first paragraph:

Claude Monet's most famous painting is without a doubt *Impression, Sunrise*, though critics hated it when it first debuted. When Monet's painting of his hometown's harbor titled *Impression, Sunrise* debuted in a Paris art show, critics had no idea what to make of it.

Getting déjà vu? This topic sentence tells us much of the information that the paragraph's second sentence provides, creating a bit of confusion for the reader as they encounter details like the painting's name twice. Plus, we're told in the first sentence that "critics hated [Monet's painting] when it first debuted"—a very specific reaction—before the second sentence provides a more general description of their reaction: "critics had no idea what to make of it." This also creates confusion for the reader, as the passage doesn't read as if a more specific description of the critics' reaction was given in the first sentence. The sequence problems created by this answer choice mean that it isn't the best topic sentence for the passage after all.

Type of Passage: This is not an argumentative passage. The writer is not attempting to convince us of his or her opinion on anything by providing evidence; he or she is simply providing facts. Once you've picked up on the general purpose of the passage, any answer choices that don't jive with that purpose, such as answer choice C, stick out like a sore thumb: "Artists like Claude Monet have proceeded despite criticism, providing a great example of why artists shouldn't be discouraged by critical disparagement." Why do we need "a great example of why artists shouldn't be discouraged by critical disparagement?" In this passage, we clearly don't. At no point in the passage do we hear the author's opinion and voice as strongly as it comes through in this answer choice. We don't want to begin an informative passage with an exhortatory sentence; this is an incorrect answer.

Scope: The scope of a passage is a crucial aspect of any answer choice. It can easily be the determining factor that separates the correct answer from incorrect options. Any correct answer needs to introduce the content of the passage—but think of it as "just the content, and nothing but the content." Introductory sentences that overreach and talk about other things, or that focus on only one detail of many discussed in the passage should immediately catch your eye as potentially incorrect, as issues of scope are major red flags.

Answer choice D is incorrect because its scope does not match that of the rest of the passage. "Claude Monet is a painter who is known for his beautiful landscapes, which many people love for their bright colors" could be a great topic sentence for a different passage, but not for this one, since the focus is just on one of Monet's works—*Impression, Sunrise*—the critical reaction to it, and its lasting effects on the art world. The difference



in scope is emphasized if you consider how the passage would read with this sentence as its opener:

Claude Monet is a painter who is known for his beautiful landscapes, which many people love for their bright colors. When Monet’s painting of his hometown’s harbor titled *Impression, Sunrise* debuted in a Paris art show, critics had no idea what to make of it.

While the sentence does introduce Claude Monet, it focuses on his landscapes and doesn’t mention anything about the critical reaction to his first painting or how he changed the art world. There are better answer options for this passage’s opening line.

Eliminating those three answer choices leaves us with the correct answer, B: “Claude Monet is famous in art history for producing the first work in a famous and important movement in painting that also gave that movement its name.” While this information is presented later in the passage, it is presented much later, in its second paragraph, and in greater detail. It isn’t a shock to the reader to hear about Monet’s relationship to Impressionism in both the topic sentence and in later body paragraphs. In fact, this is helpful: it assists the reader in knowing what to expect from the rest of the passage. In addition, it flows nicely into the passage’s second line:

Claude Monet is famous in art history for producing the first work in a famous and important movement in painting that also gave that movement its name. When Monet’s painting of his hometown’s harbor titled *Impression, Sunrise* debuted in a Paris art show, critics had no idea what to make of it.

This answer choice flows nicely and foreshadows the rest of the passage’s content. It is the best option presented.

Choosing a Transition Sentence

Good, logical transitions are one of the features that can make good writing great, bringing the reader out of the last few details of the concluding body paragraph and helping them realize how those details fit into the “big picture” that the entire passage is trying to convey. Like picking out a body paragraph sentence, picking out a good transition sentence also requires you to pay attention to context clues. Instead of working only at the sentence-level, though, you need to pick the sentence that best bridges ideas conveyed by entire paragraphs as well as those conveyed by the surrounding sentences. This may sound more challenging, and frankly, it can be; however, the increased specificity of having to bridge both details and big-picture ideas can help you in identifying answer choices that don’t meet the necessary criteria.



Click Here to
Revisit the
Passage

Sample Question #2

Which of the following would best function if inserted at the beginning of the second paragraph at Location **2**?

- A. Monet painted other famous works, including a series of works in which he portrayed the water lilies in his pond.
- B. Many critics thought that Monet's painting didn't demonstrate any artistic talent whatsoever.
- C. Not only did Monet's painting become well-known; it also had a large effect on the art world.
- D. Like the critics, artists of Monet's era didn't know what to make of *Impression, Sunrise* either.

Let's consider the specified spot in the passage:

. . . Despite the qualms and complaints of art critics, Monet's piece became famous.

[3] Many artists began to mimic the style of Monet's painting, which departed from the carefully realistic portraiture and history paintings of previous works and instead aimed to present the suggestion of a subject, paying special attention to the interaction of light with the subject.

We need to pick out an answer choice that helps the reader move from the idea of Monet's unliked piece becoming famous to the idea that lots of other artists began to paint in his new style. Answer choice A, "Monet painted other famous works, including a series of works in which he portrayed the water lilies in his pond," can be immediately discarded because discussion of Monet's other works has nothing to do with *Impression, Sunrise* or the reaction of critics and artists to it. Answer choice B, "Many critics thought that Monet's painting didn't demonstrate any artistic talent whatsoever," works in continuing discussion of the critical reaction to the painting, but it doesn't flow very nicely into the second sentence of the second paragraph:

Many critics thought that Monet's painting didn't demonstrate any artistic talent whatsoever. Many artists began to mimic the style of Monet's painting, which departed . . .

It's a bit of a jolt to jump from discussion of critics to discussion of artists with no connecting phrases or sentences. We need to pick out a connecting sentence, and this isn't it.

Answer choice C, "Like the critics, artists of Monet's era didn't know what to make of *Impression, Sunrise* either" looks like a decent choice in that it makes a comparison between the critics discussed in the first paragraph and the artists discussed in the second paragraph; however, it doesn't make sense to say that "artists didn't know what to make of *Impression, Sunrise*" because we're then told that the style of the work became very popular. It sounds like the artists liked the work. This isn't the best answer option either.



The correct answer choice is D, “Not only did Monet’s painting become well-known; it also had a large effect on the art world.” This sentence helps the reader jump from the final clause of the first paragraph, “Monet’s piece became famous,” to the idea that the painting affected the art world in that artists started mimicking its style.

Choosing a Concluding Sentence

Choosing a sentence to end a passage is much like choosing one to begin it, except instead of taking into account what’s going to be said, you have to take into account what has been said. Both question types require understanding of the passage as a whole unit.

Sample Question #3

Click Here to
Revisit the
Passage

Which of the following would best function as a concluding sentence for this passage at Location **3**?

- A. If only Claude Monet could see the effect that his painting had on the art world!
- B. Artists should study great masters like Monet in order to learn how to produce truly original work.
- C. Impressionism is just as popular today as other famous artistic styles such as Post-Impressionism and Cubism.
- D. Despite the art world’s initial resistance to the style, Impressionism has become a beloved style of painting, all thanks to Claude Monet and his *Impression, Sunrise*.

Let’s consider what the passage discusses. The first paragraph introduces Monet’s work *Impression, Sunrise* and talks about its debut. The second paragraph tells us that artists began copying the style of the painting, and that the title of the Impressionist artistic movement was derived from its name. The sentence before the concluding one we need to pick reads as follows:

This style eventually developed into an entire artistic movement that took its name from Monet’s painting and came to be called “Impressionism.” [4]

Voice: Considering the answer choices, we can discard B because it doesn’t match the voice of the rest of the passage. This is an opinionated answer choice that tells readers what the writer thinks artists “should” do; the rest of the passage doesn’t sound like that! It provides information, not the writer’s opinion, so this answer choice is incorrect.

Scope: Answer choice C is also incorrect, because instead of concluding the passage by remaining focused on its topic of Impressionism, Monet, and *Impression, Sunrise*, it introduces two artistic styles that haven’t been mentioned in the passage: Post-Impressionism and Cubism. This makes the concluding sentence off-topic in comparison to the rest of the passage and this answer choice incorrect.

This leaves us to choose between two answer choices: A and D. What sticks out about each answer choice? Well, A is exclamatory. The rest of the passage doesn’t include



any exclamatory statements, but it very well could conclude with one. It's discussing a hypothetical: "If only . . ." The effect of this hypothetical is to emphasize the effect of Monet's work on the art world, which is something the passage discusses; however, it does this in an indirect way that doesn't really match the rest of the passage. Answer choice D, on the other hand, directly connects to ideas that have been previously mentioned in the passage: it mentions "the art world's initial resistance to the style" which is discussed in the critics' reactions at the end of the first paragraph, and it again links Impressionism with Monet and *Impression, Sunrise*. This is the better answer choice because it is more directly related to more ideas discussed in the paragraph and matches the rest of the text in terms of tone and style.



Effective Language Use

The final question type belonging to the Expression of Ideas subscore of the SAT Writing and Language test is Effective Language Use. We have already discussed the questions related to Content and Development and Organization and Structure, but the content and organization of a passage are meaningless without a masterful grasp of Effective Language Use.

Keep in mind that these questions deal with choices in diction and style, as opposed to the correct implementation of grammatical principles; those questions would fall within the realm of Standard English Conventions. Questions relating to Effective Language Use draw heavily on the authorial choices in content portrayal, in the sense that illustrative language and tone can significantly impact the strength of an argument or description. These questions are designed to identify weaknesses in presentation or content, and will require you to develop expressive and effective means of restating the given argument.

When approaching Effective Language Use questions, carefully consider the style and syntax of the selection. Does the highlighted content “mesh” with the rest of the passage? The following lessons will help you to identify and correct the most common sources of stylistic discontinuity tested on the SAT Writing and Language test, including Word Choice, Concision, Tone and Style, and Combining Sentences.

Section Outline

Word Choice

- Improving effectiveness of diction in context

Concision

- Removing excessive clauses to eliminate redundancy and wordiness

Tone and Style

- Maintaining consistent style to enhance a rhetorical goal

Combining Sentences

- Improving communication in instances of incorrect sentence placement or construction



Word Choice

Questions that ask you to analyze word choice in context can be tough, as they ask you to weigh different options that often only differ in terms of subtle connotations. When rephrasing, don't limit your focus only to the indicated portion of the passage. Make sure to pay attention to elements of context such as parallel structure and the sequence in which information is introduced in the passage to discern all the relevant ways in which the presented phrasing options differ from one another.

Practice Passage: The Eiffel Tower

[1] The Eiffel Tower in modern times is viewed as a symbol of Paris, France in specific and Europe overall, but it hasn't always been such a popular tourist destination. [2] Originally planned to be the highlight of the 1889 World's Fair, the tower was opposed by numerous individuals. [3] Much of this opposition was composed of artists, and their complaints were primarily visual in nature: the tower, they argued, would be a blot on the Parisian skyline and steal the thunder from the city's prominent landmarks located near where it would be constructed. [4] Eiffel, the architect who built the tower and after whom it is named, wasn't worried. [5] In addressing the artists' concerns, he drew flattering comparisons between the to-be-constructed tower and the Pyramids of Giza. [6] And indeed, after Eiffel completed his tower, the city grew to regard it proudly. [7] Originally intended to be taken apart twenty years after its construction, it was never dismantled, and today it still stands as one of the most famous architectural cultural icons in the world.

Links to
Sample Questions

[Sample Question #2](#)

[Sample Question #3](#)

[Sample Question #4](#)

To Rephrase Word Choice or Not—and Why

Let's start at the narrowest focus: that of changing out a single word or two in a passage. Connotation is often the name of the game at this zoomed-in level, so make sure to think not just about what each word means in terms of dictionary definitions (“denotation”), but what other feelings and associations it conjures up (“connotations”).

Sample Question #1

The author is considering changing the underlined phrase “tourist destination” in Sentence 1 to “icon.” Should he or she make this change?

- A. Yes, because “icon” works better in parallel with “symbol” than does “tourist destination.”
- B. Yes, because “tourist destination” has only tropical connotations that don't apply to the Eiffel Tower.
- C. No, because “tourist destination” is less visually specific than “icon.”
- D. No, because the passage discusses the international appeal of the Eiffel Tower more than it discusses the French population's reaction to it.



Let's consider the sentence in which the word in question appears:

[1] The Eiffel Tower in modern times is viewed as a symbol of Paris, France in specific and Europe overall, but it hasn't always been such a popular tourist destination.

Ok, what's going on in this sentence? Simplified, the sentence's structure goes, "The Eiffel Tower is viewed as a symbol, but it hasn't always been such a popular destination. "Destination" is working in parallel with another noun, "symbol." That's something to consider. In addition, notice that the rest of the passage doesn't discuss tourism apart from the 1889 World's Fair, a specific event. If the Eiffel Tower "hasn't always been such a popular tourist destination," that clashes a bit with the information about how it was designed to be the main attraction at the World's Fair. That would make it a pretty popular tourist destination.

Let's consider the answer choices. Should we not swap out "tourist destination" for "icon" because "tourist destination" is less visually specific? The two options are both general phrases that don't indicate any specific imagery, so this isn't the correct answer. Should we not edit the phrasing because the passage discusses the international appeal of the Eiffel Tower more than it discusses the French population's reaction to it? No; while the passage does discuss the Eiffel Tower being built for the 1889 World's Fair, it discusses the specific reaction of French people to the building of it, not the opinion of residents of other countries. So, we should make the edit. But why? Because "tourist destination" has tropical connotations that don't apply to the Eiffel Tower, or because "icon" works better in parallel with "symbol?" "Tourist destination" can have tropical connotations, but it can also be used to describe colder locales. For example, Hawaii is a tourist destination that happens to be tropical, and Yellowstone National Park is a tourist destination that happens to not be tropical. The best answer is that the suggested change should be made because "icon" works better in parallel with "symbol" than "tourist destination" does. These two nouns are both referring to the Eiffel Tower in a specific role, that of a famous, representative structure. Choosing two synonyms to describe the tower in modern times as opposed to the tower when it was initially built and not as popular as it is today makes the sentence flow well and helps readers realize that the same thing is being referred to by each noun. A is the correct answer!

Let's consider another question, this time one that includes additional information about the passage's topic to help you decide between the presented phrasing options.



Click Here to
Revisit the
Passage

Sample Question #2

The author is considering changing the underlined phrase “the highlight” in Sentence 2 to “a feature.” Given that the tower was designed to attract arguably the most attention out of any exhibit at the 1889 World’s Fair, should he or she make this change?

- A. Yes, because “a feature” puts more emphasis on the tower as the main attraction of the 1889 World’s Fair.
- B. Yes, because the visual connotation of “the highlight” clashes with the subject matter.
- C. No, because “the highlight” conveys a more specific focus on the tower as the most prominent exhibit France planned for the 1889 World’s Fair.
- D. No, because other exhibits at the 1889 World’s Fair also wanted to attract a lot of attention.

Here’s Sentence 2:

[2] Originally planned to be the highlight of the 1889 World’s Fair, the tower was opposed by numerous individuals.

So, should we change “a highlight” to “a feature?” Before we consider whether we should make the change or not, consider what that change would do to the sentence and the passage. How does “the highlight” differ from “a feature?” While considering, we should keep in mind that we’re told that “the tower was designed to attract arguably the most attention out of any exhibit at the 1889 World’s Fair.” The question wouldn’t provide information like this if it wasn’t relevant. Well, one answer choice uses the word “the” (a definite article) while the other uses the word “a” (an indefinite article). It turns out that this choice of article makes a pretty big difference to the meaning of each option. “A feature” is grammatically equal with every other attraction at the 1889 World’s Fair; the “a” conveys that it is one of many. In contrast, “the highlight” conveys that it is the main attraction—that it is more important than the other attractions. This matches the information that we’re told about the Eiffel Tower having been “designed to attract arguably the most attention out of any exhibit at the 1889 World’s Fair.” Plus, “highlight” conveys some of this focused attention, whereas “feature” doesn’t. It looks like changing out “the highlight” for “a feature” wouldn’t be a great editing decision, but let’s consider each of the answer choices to make sure.

Should we change “the highlight” to “a feature” because “a feature” emphasizes how the tower is the main attraction of the 1889 World’s Fair? Nope—we just determined the opposite to be true: “the highlight” emphasizes this more than “a feature.” Should we change “the highlight” to “a feature” because the visual connotation of “the highlight” clashes with the subject matter? Did you read that answer choice only to wonder, “Wait, does “the highlight” visually clash with its subject matter?” Many people probably did. As a rule of thumb, if you didn’t notice anything at all wrong with a word, phrase, or sentence that an answer choice claims contains a specific phrasing error it, the answer choice should be considered with some suspicion. In this case, “the highlight” doesn’t clash with its subject matter at all, and that answer choice is incorrect. So, our initial



idea was correct: we should not change “the highlight” to “a feature.” But why? You can correctly figure out that you need to make a change or not and still get the question wrong if you can’t identify why that change should or shouldn’t be made. So, should we leave the phrasing as-is because other exhibits at the 1889 World’s Fair also wanted to attract a lot of attention, or because “the highlight” conveys a more specific focus on the tower as the most prominent exhibit France planned for the 1889 World’s Fair. If the latter sounds familiar, it’s because it matches the previous reasoning about the options perfectly. Even though other exhibits at the 1889 World’s Fair surely also wanted to attract a lot of attention, this has nothing to do with the purpose for which the Eiffel Tower was designed. The correct answer is C!

Let’s zoom out a bit and consider questions that ask you to decide whether phrases and clauses should be rephrased.

Sample Question #3

Click Here to
Revisit the
Passage

The author is considering changing the underlined phrase “a blot on the Parisian skyline” in Sentence 3 to “a silhouette in the Paris cityscape.” Should he or she make this change?

- A. Yes, because “a silhouette” has positive visual connotations, whereas “a blot” has negative visual connotations.
- B. Yes, because “cityscape” better suits the subject matter than does “skyline.”
- C. No, because “a blot” has connotations that have to do with ink that “a silhouette” doesn’t have.
- D. No, because “a blot” is interpreted as a bad thing, whereas “a silhouette” is not.

Sentence 3, for your consideration, with this question’s indicated phrase underlined:

[3] Much of this opposition was composed of artists, and their complaints were primarily visual in nature: the tower, they argued, would be a blot on the Parisian skyline and steal the thunder from the city’s prominent landmarks located near where it would be constructed.

Skimming over the answer choices, did you notice that three of them have to do with *connotations*, and two specifically with which option has positive connotations and which has negative connotations? Let’s keep connotation in mind as we consider the phrase that’s in the sentence to begin with. The sentence is discussing artists’ complaints about the Eiffel Tower before it was built. They had two main complaints: that it would overshadow other major Parisian landmarks and not look nice in the city from a distance because it would be so much taller than other buildings. This sounds like we’re looking for a term to describe the Eiffel Tower that has negative connotations—these artists certainly aren’t happy and excited that it is going to be built!

Since many of the answer choices discuss connotation, let’s consider each option’s connotations before we attempt to match our reasoning to an answer choice. “A blot



on the city’s skyline”—does that sound like a nice thing? No, not at all. What about “a Silhouette in the Paris cityscape?” That could be a good thing or a bad thing; it’s hard to tell. It’s pretty neutral. It’s certainly not negative like “a blot on the city’s skyline” is negative. It makes sense that when the passage explains the artists’ complaints, it might use negatively connoted language, so leaving “a blot on the Parisian skyline” in the passage is looking like a pretty smart choice. Ok, time to consider the answer choices.

Answer choice C may stick out a bit because “blot” does have some connotations to do with ink (e.g. “ink blot”). Does that have anything to do with the passage’s subject matter, though? Nope! We can ignore answer choice C. Make sure to distinguish between a reason that is true and an entire answer choice that is true! Incorrect answers may still include true statements that just function as bad reasons for making a given editing decision. “Cityscape” doesn’t suit the subject matter any better than “skyline” does—again, if you have to really wonder about which option suits the passage better, they might suit the passage equally, as in this case. Answer B is incorrect. This leaves us with A and D. Should we change “a blot . . .” to “a silhouette . . .” in the passage because “a silhouette” has positive connotations and “a blot” has negative connotations, or should we leave “a blot . . .” in the passage because “a blot” is interpreted as a bad thing whereas “a silhouette” is not? Did you notice that both of these answer choices are essentially using the same reasoning and only differing in which editing decision they support? Read them carefully, and you can figure out that answer choice A doesn’t make any sense. Yes, it’s true that “a silhouette” is less negatively connoted than “a blot,” but we are looking to make use of those negative connotations in the sentence, which is describing why the artists objected to the Eiffel Tower. It makes more sense for people to object to something considered a bad thing (“a blot . . .”) than to something that is neutral or good (“a silhouette . . .”). Answer choice D is correct!

Let’s consider another phrase-based question, this time one that concerns a verb phrase:

Sample Question #4

The author is considering changing the underlined phrase “steal the thunder from” in Sentence 3 to “compete for attention with.” Should he or she make this change?

- A. Yes, because “compete for attention with” makes the opposition seem less reliable in their research and opinions.
- B. Yes, because “compete for attention with” is both more formal and more appropriate in meaning.
- C. No, because “steal the thunder from” is more appropriate given the meteorological significance of the tower discussed in the passage.
- D. No, because “steal the thunder from” better conveys the opposition’s distaste for the planned Eiffel Tower.

Click Here to
Revisit the
Passage



Here's Sentence 3 with the indicated part of the sentence underlined:

[3] Much of this opposition was composed of artists, and their complaints were primarily visual in nature: the tower, they argued, would be a blot on the Parisian skyline and steal the thunder from the city's prominent landmarks located near where it would be constructed.

Let's consider each answer choice individually. Answer choice D claims that the writer should not make this change because "steal the thunder from" conveys the distaste of the artists for the planned Eiffel Tower better than "compete for attention with" does. That's not true; neither phrase conveys distaste notably more than the other one. Consider answer choice C: is the Eiffel Tower's "meteorological significance" ever discussed in the passage? Nope! We can ignore that answer choice, too, thus figuring out that the correct answer involves making the suggested change. Ok, if "steal the thunder from" should be changed out for "compete for attention with," why is that so? Let's take a moment to consider the subtleties of each phrase. "Steal the thunder from" is a casual phrase most often used for people; to "steal someone's thunder" is to draw attention to oneself when it more properly should be directed to someone else for that person's accomplishment. On the other hand, "compete for attention with" is a straightforward, more formal phrase that is often used to describe people or things. Let's now consider the remaining answer choices, A and B: should the phrase be swapped out because "compete for attention with" makes the artists seem "less reliable in their research and opinions?" If you got a little confused when reading that answer choice and wondered if you missed something to that effect in the passage, you're probably not the only one. This is an answer choice that sounds reasonable, until you realize that nothing about "compete for attention with" makes the artists seem unreliable. If anything, the phrase's formality makes the artists seem more reliable than when they are the subject of the more causal "steal the thunder from." This leaves us with one answer choice, B: yes, "steal the thunder from" should be changed out for "compete for attention with" because the latter is both more formal and more appropriate in meaning. We've found the correct answer using process of elimination.

Identifying the Effects of Rephrasing Word Choice

Questions that ask about rephrasing content may only ask about changing a single word or short phrase. These questions ask you to focus on a very specific part of the passage with an eye for how even subtle changes in word choice and tone can affect a reader's experience.

Practice Passage: New Zealand's Rabbit and Stoat Problems

[1] New Zealand has historically had to deal with a number of threats to its native ecosystem, many of which were caused by imprudent but purposeful human decisions to attempt to adjust the environment's delicate balances. [2] For instance, when European colonists began living in New Zealand, they brought rabbits with them. [3] What the rabbit importers did not consider is that New Zealand, unlike Europe, does not have any endemic predatory mammals.

Link to
Sample Question

[Sample Question #5](#)

[Sample Question #6](#)

[Sample Question #7](#)

[Sample Question #8](#)



[4] Put another way, no animals that live there eat rabbits! [5] The rabbit population exploded, creating an imbalance in the native ecosystem and threatening native plants as well as farmers' crops. [6] At this point, to combat the rabbit population, New Zealand began to import stoats—small, predatory, weasel-like mammals that eat rabbits—despite the protestations of ornithologists (bird scientists). [7] New Zealand's bird populations suffered greatly from this sudden introduction of a predator for which they were not evolutionarily prepared. [8] The beloved national bird of New Zealand, the kiwi, provides the most overt example of just such an unprepared species. [9] Having adapted to an environment with no native mammalian carnivores, it roams around the ground and has very poor flying skills. [10] The stoat population wreaked havoc on the kiwi population. [11] Conservation efforts aimed at reducing the stoat population and protecting kiwis are still ongoing. [12] New Zealand's ecological history serves as a poignant lesson of how dangerous it is for people to attempt to change an ecosystem without fully understanding the repercussions that may arise from such changes.

If you spot a question that asks about how rephrasing one word in the passage will affect its meaning, you might think it's going to be particularly easy—after all, how much meaning could be conveyed by a single word amongst so many others in the passage? Alternatively, you might get a bit suspicious and anticipate that your ability to pick up on subtle meanings at the word-by-word level is about to be tested. Don't think these questions are necessarily going to be easier than others, but don't let the zoomed-in focus of the question throw you off, either. These questions function just like those that test phrases and clauses and test the same skills.

Sample Question #5

If the author were to change the underlined word “exploded” in Sentence 5 to “increased,” it would _____.

- A. de-emphasize the degree to which the rabbit population grew
- B. suggest that New Zealand's rabbit problem was worse than anticipated
- C. convey the colonists' shock at the effect of importing rabbits
- D. suggest that New Zealand had bigger environmental problems to deal with than rabbits at this point in history

Click Here to
Revisit the
Passage

Consider the indicated sentence:

The rabbit population exploded, creating an imbalance in the native ecosystem and threatening native plants as well as farmers' crops.

The violent and emphatic connotations of “exploded” make it seem like a pretty strong



word—especially in comparison to “increased.” “Increased” is something you might expect to read in an official scientific report, “exploded” perhaps not so much. If the author changes the word “exploded” to “increased,” is it going up or down in intensity? Down. With that in mind, let’s look over the answer choices describing this change’s effect.

Does downgrading the intensity of this word “suggest that New Zealand’s rabbit problem was worse than anticipated?” Not in the slightest. Out goes answer choice B. Does it have anything to do with conveying the colonists’ shock at the effect of importing rabbits? Changing this word only changes readers’ understanding of how the rabbit population changed in size; it doesn’t relate to the colonists’ reaction to this change. So, answer choice C isn’t correct either. What about answer choice D? It might look potentially correct because the word is decreasing in emphasis/strength, which could potentially work to indirectly emphasize another problem by reducing the emphasis on the rabbit problem. No other problem is mentioned at this point in the passage, though, so that doesn’t make much sense. In considering answer choice D, we’ve stumbled across the correct answer: that changing “exploded” to “increased” would de-emphasize the degree to which the rabbit population grew. That’s our correct answer, answer choice A!

Consider another example of an effect-of-editing question that deals with a single word:

Sample Question #6

If the author were to change the underlined word in Sentence 7 to “abrupt,” it would _____.

- A. emphasize how quickly the decision to introduce stoats was made
- B. suggest that the colonists deliberated about introducing stoats for a long time
- C. draw readers’ attention to how quickly the introduction of a new predator can affect a prey population
- D. have little effect on the sentence overall

The sentence we need to consider is as follows:

New Zealand’s bird populations suffered greatly from this sudden introduction of a predator for which they were not evolutionarily prepared.

Changing “sudden” to “abrupt” doesn’t appear to change much about the sentence. After all, the two words are synonyms that don’t differ greatly in terms of severity, emphasis, or tone. Let’s consider the answer choices.

“Sudden” in this sentence is talking about how quickly the stoats were actually introduced to New Zealand—almost from the birds’ perspective, as the birds are the focus of the sentence. The sentence actually uses the phrasing “for which they were not evolutionarily prepared,” so “sudden” is meant to complement that. The term isn’t talking about the colonists’ decision to introduce the stoats at all; that realization can help us

Click Here to
Revisit the
Passage



knock out both answer choices A and B, leaving us with C, the idea that the change in terms “draws readers’ attention to how quickly the introduction of a new predator can affect a prey population,” or D, that the shift in word choice doesn’t change the sentence much at all. The shift certainly isn’t emphasizing how quickly the stoats affected the bird population. One might argue that the terms on their own each do that to a degree, but we’re not talking about what the terms each do on their own—we’re talking about the shift between terms. Changing between terms doesn’t affect that sort of emphasis, especially as both terms are about equal in terms of emphasis. The correct answer is D; changing “sudden” to “abrupt” doesn’t affect the sentence’s meaning much at all.

Just like single-word effect identification questions, those based on phrases or clauses expect you to pay attention to a detailed level of meaning in a passage when considering changes the author might make.

Sample Question #7

Click Here to
Revisit the
Passage

If the author were to change the underlined phrase “despite the protestations of” in Sentence 6 to “against the recommendation of,” it would _____.

- A. reduce the degree to which the ornithologists seem to oppose the decision
- B. emphasize the colonists’ stubbornness in proceeding with a decision the ornithologists thought to be unwise
- C. suggest that the ornithologists’ opinions were unreliable
- D. convey a sense of competition between the ornithologists and the colonists

Consider Sentence 6:

At this point, to combat the rabbit population, New Zealand began to import stoats—small, predatory, weasel-like mammals that eat rabbits—despite the protestations of ornithologists (bird scientists).

Changing “despite the protestations of” to “against the recommendation of” does change the meaning of the sentence somewhat. Going against someone’s recommendation when making a decision means they advise against it, but aren’t actively complaining. Going ahead and doing something “despite the protestations of” someone does indicate active complaint and opposition against that action. This shift in meaning also inherently suggests a shift in emphasis; there is a shift in emphasis between not actively complaining and actively complaining about something.

On to the answer choices: changing this phrasing has nothing to do with the reliability of the ornithologists, so C isn’t correct. Neither is D; nothing about the change in phrasing suggests a sense of competition between the ornithologists and the colonists. This leaves us with A and B. The first words of these answer choices are telling: A begins with “reduce” and B begins with “emphasize.” Since changing the wording appears to be reducing the intensity of the phrase, A is looking like a good answer choice, but let’s check



B to make sure we're on the right track. Does rephrasing from "despite the protestations of" to "against the recommendation of" "emphasize the colonists' stubbornness in proceeding with a decision the ornithologists thought to be unwise?" Not at all. The intensity of the phrase is being decreased by the change, so if anything, it looks like it is deemphasizing how stubborn the colonists look. This means that the correct answer is indeed A. The change in phrasing reduces the degree to which the ornithologists seem to oppose the colonists' decision to import stoats.

Sample Question #8

Click Here to
Revisit the
Passage

If the author were to change the underlined phrase "wreaked havoc on" in Sentence 10 to "impacted," it would _____.

- A. make the kiwis seem weaker and pitiable
- B. make the author's tone more formal, but de-emphasize the effect of the stoats
- C. switch the sentence's focus from the kiwis to the stoats
- D. evoke phrasing the passage used in the preceding line

Let's consider Sentence 10 as it appears in the passage. It's relatively short and to the point:

The stoat population wreaked havoc on the kiwi population.

"Wreaked havoc on" is a relatively informal but very intense and emphatic phrase that conveys one thing having a huge negative effect on another. "Impacted," by contrast, doesn't convey as great of an effect as "wreaked havoc on" does, and it doesn't necessarily indicate a positive or negative effect. So, we are decreasing the intensity of the phrase by changing it to "impacted," and potentially losing the clear negative gist conveyed by "wreaked havoc on." With that, let's look over the answer choices.

We can consider D immediately by comparing this line to the previous line, which is talking about the kiwi: "Having adapted to an environment with no native mammalian carnivores, it roams around the ground and has very poor flying skills." Nothing about "wreaked havoc on" or "impacted" connects to any particular phrasing in the previous line, so D is incorrect. Changing the phrase also doesn't change the focus from the kiwis to the stoats, so C isn't correct either. This leaves us with A and B. Which of the two phrasing options makes the kiwis seem "weaker and pitiable?" The initial one, "wreaked havoc on," as it conveys the greater effect. So, the change isn't having that effect; it's having an opposite one. The correct answer is B. Changing "wreaked havoc on" to "impacted" would make the author's tone more formal, but it would also de-emphasize the effect that the stoats had on the kiwi population.



Concision

Errors of expression, as recognized by the revised SAT, are not restricted to technical errors of grammar. You will also be asked to edit a presented passage for style in addition to editing for basic grammatical correctness. A key element of style for which you will be asked to edit is concision, or, in other (less concise) words, making sure that a passage is phrased in as clear, lean, and brief a manner as possible so as to express the text's meaning and fulfill its intended purpose.

The goals of the revisions to the SAT Writing and Language test are to move away from discrete, “cram-able” content and towards more expansive, passage-based skills testing. The skills these passages interrogate are intended to test your ability to think in a fluid and nuanced manner about the content you encounter. Rather than looking at a single sentence and identifying the comma splice, you are being asked to read an entire paragraph and form an idea of how that passage should look. This will include identifying all of the grammatical errors in that text, but it will also include, as mentioned above, editing for style.

Because these questions are asking you to make necessary stylistic changes, it's important for you to get to know the style of writing the SAT prefers. When completing these passage-based questions, it's important not only to select the correct answer, but also to look at and analyze that answer in its intended context. While preparing for the test, it's important to put that correction back into the paragraph (rewrite the section of the reading if you have to) and read the passage over with that correction incorporated, so you can get a sense of the style the test prefers. This is probably the most important single hint included in this section. If you take no other piece of advice, take this one.

Recognizing Errors of Concision

In asking you to edit passages for concision, the SAT is building on one very basic principle: it is incorrect to use ten words to express an idea you could express using five. In such cases, multiple-choice answers will include an alternate version of the sentence that reduces its volume while maintaining its original meaning.

The key to seeing the most concise version of a sentence or passage is to understand the basic fundamentals of what that sentence or passage is saying. A major key to doing this is to have a strong base of vocabulary that you are comfortable recognizing. Many errors of concision are simply the result of an inefficient use of vocabulary.

For example:

I went ahead and cleaned the floor even though I was not absolutely sure Kevin, my boss, would not mind, but I acted as if I was sure.

I assumed Kevin wouldn't mind, so I went ahead and cleaned the floor.

These two sentences convey the exact same meaning, but the first sentence uses thirteen more words than does the second, and those thirteen words not only fail to add further clarity, but also hamper the reader's understanding of the sentence's basic meaning. Simply by knowing and correctly using the word “assumed,” one is able to make the first sentence both more concise and clear.



The very word “concision” works beautifully as an example of the way a command of relevant vocabulary can help to make sentences shorter and more clear.

Take these two sentences, paraphrased from earlier in this very lesson:

You will be asked to edit to make sure that passages are phrased in as clear, lean, and brief a manner as possible so as to express the text’s meaning and fulfill its intended purpose.

You will be asked to edit passages for concision.

These two sentences are conveying the exact same thought. “Editing for concision” means “mak[ing] sure that passages are phrased in as clear, lean, and brief a manner as possible so as to express the text’s meaning and fulfill its intended purpose.” If you change the meaning of a text, you haven’t merely edited it for concision, you’ve edited for content. Just by knowing the full meaning of “concision,” you would have been able to make this sentence twenty-six words shorter, as well as far, far smoother and easier to understand.

It is key, however, to note that not all long sentences need to be made more concise! Some sentences are expressing extremely complex thoughts, and are, even if they seem long, exactly as long as they need to be. In asking you to edit for concision, the SAT does not simply want to test your ability to make any sentence shorter; they want to test your faculty of judgment in reading and composing sentences. Some relatively short sentences could be edited and made more concise, and some extremely long sentences are as concise as they could possibly be.

Sample Question

I was strongly considering buying a painting the other day. # I liked the piece, but it was because of the expense that I chose not to buy the piece. I ended up purchasing a book of photography instead.

- A. NO CHANGE
- B. I liked the piece, but because of the expense I chose not to buy it.
- C. I liked the piece, but it was on cause of the expense that I chose not to buy the piece.
- D. I liked the piece, but it was only and simply and rightly because of the expense that I chose not to buy the piece.

The sentence highlighted is extremely wordy and awkward. The only answer option that successfully eliminates the wordiness while maintaining the grammatical structure and meaning of this compound sentence is option B. This option cuts the unnecessary addition of “it was” and the repetition of “the piece,” which can easily and clearly be replaced with the pronoun “it.” Answer choice D is correct.



Recognizing Redundancy

Some sentences are not merely overly wordy, they are wordy (or overlong) because they contain redundancies, which is to say they repeat some information or content more than is necessary (as this very clause did just now).

Redundancies are fairly easy to spot—you just need to be on the lookout for them and avoid allowing yourself to be swept along by the flow of the passage or sentence you are reading. Consider the following examples:

✗ I'm asking to take at least two or more days off.

(The phrases “at least two” and “two or more” convey the same meaning).

✗ The stock market rose up by 6% in just a week and a half.

(The words “rose” and “up” convey the exact same thing in this context).

✗ We need to collaborate together if we're going to finish this project.

(The word “collaborating” means to work “together” with others; it is impossible to “collaborate” alone).

Errors of redundancy, as you can see from these examples, can often be easy to miss, especially in long or complicated passages or passages containing data; however, they are exceptionally easy to fix once spotted. In all of the examples above, and in all cases of redundancy, the error can be fixed by simply removing one of the redundant phrasings. Either one will do, since by definition they will convey the same meaning!

Sample Question

That deep-sea sub can't fit very many people. # During its last solo expedition, it carried just one scientist. She not only collected data about rarely seen sea creatures, but also piloted the sub and helped run checks on its navigation system and safety features.

- A. NO CHANGE
- B. During its last solo expedition, it carried just scientists.
- C. During its solo expedition, it carried just one scientist.
- D. During its last expedition, it carried just one scientist.

The word “solo” conveys the same information as the phrasing of “carried just one scientist.” Because “carried just one scientist” is not easily omitted from the sentence, as it is the predicate, omitting “solo” is the easiest way to fix this redundancy error. Saying that the sub “carried just scientists” changes the meaning of the sentence, and omitting “last” does nothing to fix the redundancy problem.



Fixing Errors of Concision Without Altering Meaning

The real test for fixing errors of concision comes in recognizing and fixing these errors over full passages, rather than in discrete sentences. It is important to clarify a key aspect of fixing wordy sentences: realizing that part of your charge is to make the selection more concise without excluding necessary information. Any answer choice that removes a vital piece of information from the sentence has not made the sentence more concise, it has altered the sentence's meaning. For example, consider the following sentences:

Wilson Ramos is one of the best players in the South Korean baseball league; he led the league in triples and steals last season.

X Wilson Ramos is one of the best baseball players; he led the league in triples and steals last season.

The second version of this sentence is *not* a more concise version of the first. Rather, the second sentence has altered the meaning, making the context more general, and adding a grammatical error by making “the league” in the second clause reference an unclear referent.

Sample Question

Completed in 1889, the Eiffel Tower was designed to be the main attraction for the 1889 World's Fair in Paris. # It received a great deal of criticism for disrupting the Parisian skyline and was originally planned as a temporary structure intended to be torn down after the World's Fair, but it came to be seen as a cultural icon and remains in the city to this day.

- A. NO CHANGE
- B. It received a great deal of criticism for disrupting the Parisian skyline and was originally planned as a temporary structure intended to be torn down after the World's Fair, but it remains in the city to this day.
- C. It received a great deal of criticism for disrupting the Parisian skyline and was originally intended to be torn down after the World's Fair, but it came to be seen as a cultural icon and remains in the city to this day.
- D. It received a great deal of criticism for disrupting the Parisian skyline and was originally planned as a temporary structure intended to be torn down after the World's Fair, but it came to be seen as a cultural icon.



The correct answer choice, C, omits the phrase “originally planned as a temporary structure” because the phrase “intended to be torn down after the World’s Fair” conveys the same information. (Answer choice A is incorrect because it includes the redundant phrase “originally planned as a temporary structure.”) Omitting either of the phrases “it came to be seen as a cultural icon” and “it remains in the city to this day” results in the sentence losing vital information, so the answer choices that make these editing decisions—B and D—are incorrect.



Tone and Style

The questions we'll consider in this lesson all combine editing decisions with specific goals. No longer are you being asked to identify the "best" answer choice—the one that best fits the tone, flow, and logic of the passage. Here, you are being asked to pick the rephrasing option that best creates a certain effect. The author might want to play up one particular aspect of a topic, or use a negatively-connoted word to help bias the reader against it. He or she may want to foreshadow a discussion that appears later in the passage, or suddenly shift tones. You may not agree with all of the writer's decisions to change the passage in specific ways, but keep in mind: you're not the one setting the goal. You just need to figure out how to best accomplish it.

These questions can present more trouble than more direct ones that ask you to identify the best revision or why a selection should be revised or not. This is because it is completely possible for each of the answer choices presented for effect-driven questions can sound perfectly good in the passage and match flow, tone, style, logic—none of the typical concerns may throw up red flags. You may be initially confused, being asked to pick from multiple answer choices that sound "correct." It is crucial that you analyze the answer choices not from a perspective of asking which is grammatically correct (they all should be) or even which sounds the best (they all might sound equally good). Use the described effect as a lens through which you can structure your response to the question.

Practice Passage: Tourism vs. Preservation in the Lascaux Caves

[1] Should historical monuments be completely open for the public to examine, or is there greater value in **5** protecting them for everyone? [2] While many people are willing to travel thousands of miles to view ancient works of art and architecture up close and in person, the more visitors an ancient site has, the more quickly it **2** crumbles. **6** [3] The history of the Lascaux caves in France attests to this fact. Discovered by accident in 1940, the caves are covered in breathtaking Paleolithic artwork portraying a wide variety of animals in motion. [4] Visitors poured into the site as it **4** got really popular, but such a high rate of tourism has damaged the art, causing chemical changes as well as **3** the introduction of lichen and black mold, as well as other deposits. [5] Overinteraction with the caves has turned them from a fascinating tourist destination into a world wonder desperately in need of **1** help. **7** [6] If you want to experience the beauty of the Lascaux caves, visiting the replica site Lascaux II can help you have the experience of exploring the caves without damaging their fragile art.

Link to
Sample Question

[Sample Question #1](#)

[Sample Question #2](#)

[Sample Question #3](#)

[Sample Question #4](#)

[Sample Question #5](#)

[Sample Question #6](#)

[Sample Question #7](#)



Rephrasing a Single Word

Let's first consider a question that asks about options for changing out one word for another one. Note that it's a completely valid option to say that the passage best achieves the stated goal the way it is written. If you find yourself wondering if you've picked "too many" or "too few" of this particular answer choice, approach these questions as if there is a blank in the passage and you need to fill it with whichever option best fulfills the goal. Don't let the fact that the "NO CHANGE" option is already in the passage and accompanied by an all caps phrase sway you in favor of it or away from it, and don't try to base any guesswork that becomes necessary on how many of these particular answers you've picked.

Sample Question #1

Click Here to
Revisit the
Passage

Which of the following best conveys both that the site's current problems need to be addressed and that future damage needs to be prevented?

- A. NO CHANGE
- B. preservation
- C. assistance
- D. protection

This question focuses on the subtle variation in meaning between four closely-related words. We need to pick out the one that expresses two things simultaneously: the treatment of current problems and the avoidance of future issues.

Even though a distinct goal is provided, let's look at the sentence to see what contextual information we can glean:

Overinteraction with the caves has turned them from a fascinating tourist destination into a world wonder desperately in need of help.

"Help" and "assistance" seem particularly close in meaning—definitely synonyms, and often interchangeable. Do their meanings skew in particular toward current or future problems? Current. You ask for help or assistance with a current issue; the word doesn't focus much on helping to avoid later problems. While it may have seemed worrisome that two of the listed words were so close in meaning, in this case, it becomes a non-issue, as neither of these answers looks like the best one. Let's consider the other two options: "protection" and "preservation." "Protection" skews in the opposite "direction" of "help" and "assistance"—"protecting" something means helping it avoid future damage in particular, with little to no focus given to remedying current problems. "Preservation" strikes the best balance between these two needs: "preserving" a document, building, work of art, or other object means working to keep it in good condition (thus addressing any current problems) as well as helping it to avoid accruing damage in the future. For example, if historians uncovered a faded painting by a famous artist, preservation work might involve restoring the painting's original colors (addressing a current problem) as well as placing it behind special glass when displaying it in a museum (helping to avoid future problems). The correct answer is A!



Let's consider another single-word-based sample question:

Sample Question #2

Which of the following best encompasses both two-dimensional works of art as well as three-dimensional works of art and architecture?

- A. NO CHANGE
- B. fades
- C. breaks
- D. deteriorates

Click Here to
Revisit the
Passage

Again, we're going to be focusing on shades of meaning, so none of these terms may seem like a bad or incorrect choice initially. Differentiating between them might take some digging, but let's first glance over the sentence at hand:

While many people are willing to travel thousands of miles to view ancient works of art and architecture up close and in person, the more visitors an ancient site has, the more quickly it crumbles.

Ok, the distinction here is one of logical reference: we need to pick out the term that best refers to two-dimensional and three-dimensional works. (Don't let the phrasing of "best" throw you off, here—as you may have guessed, there's only one correct answer choice that refers to both). "Crumbles," the word in the passage, isn't cutting it—a painting can't really "crumble." The paint could potentially crumble off of the painting, but the work itself wouldn't likely be described as "crumbling." Using similar logic in the opposite "direction," paintings can "fade," but buildings can't. We've knocked out two answer choices! Now we're down to "breaks" and "deteriorates," both relatively general terms; however, "breaks" conveys a physicality that "deteriorates" does not, and that physicality only really jives with three-dimensional works. Think about it: when was the last time you heard someone refer to "a broken painting?" That might be the first time you've heard or considered that phrase. "Deteriorates" is the best answer. A painting can "deteriorate" just as a building can because the word is so general in its meaning. D is the correct answer.

Let's look at one more word-based question, this time one that asks you to consider connotation instead of denotation.

Sample Question #3

Which of the following best conveys the author's distaste for the lichen and black mold?

- A. NO CHANGE
- B. colonies
- C. infestations
- D. appearances

Click Here to
Revisit the
Passage



Here is the sentence in question:

Visitors poured into the site as it got really popular, but such a high rate of tourism has damaged the art, causing chemical changes as well as the introduction of lichen and black mold, as well as other deposits.

This is a perfectly good sentence; “the introduction” doesn’t clash with the passage in terms of tone or logic, and it doesn’t interrupt the flow of the text. But don’t let that sway you: one of the other presented options might better meet the stated goal. We’re looking for the answer choice that best demonstrates “the author’s distaste for the lichen and black mold,” so we’re most likely going to be looking for a negative word. Make sure to distinguish between the connotation of the passage’s content (mold in Lascaux is clearly a bad thing) and the connotation of the words themselves. Try considering how the words would sound when used to describe other subjects—neutral ones and good ones. If the words have negative connotations, they’ll probably be thrown into sharp relief. “The introduction” is neutral—not particularly positive or negative. The phrase could refer to “the introduction” of something great. What about “appearances?” No bad connotations there. Good or bad things could make appearances. “Colonies?” Colonies of things might be bad, but you can also have colonies of people; let’s call this one somewhere between neutral and negative. “Infestations?” Bingo! An “infestation” is never a good thing. You wouldn’t refer to an “infestation” of positively-connoted things. (e.g. “infestation of kittens,” “infestation of gifts,” and “infestation of friends” all sound strange). C is the correct answer; if the author wants to emphasize his or her dislike for the lichen and black mold in the Lascaux caves, referring to their presence as “infestations” will help get that meaning across.

Rephrasing a Phrase or Clause

Onto considering rephrasing questions that present a goal for a phrase or clause. The following question focuses on how a phrase interacts with the tone and style of the passage.

Sample Question #4

The author wants to maintain a formal tone throughout the passage. Which of the following options best accomplishes this?

- A. NO CHANGE
- B. blew up
- C. grew in renown
- D. became infamous

Click Here to
Revisit the
Passage

This time, we’re looking for the answer choice that most helps give the passage a formal tone. The sentence in question is as follows:

Visitors poured into the site as it got really popular, but such a high rate of tourism has damaged the art, causing chemical changes as well as the introduction of lichen and black mold, as well as other deposits.



“Got really popular” is a very casual phrase, not a formal one. “Got” isn’t the most specific verb, and the use of “really” instead of a stronger adjective again lacks specificity and creates a low-key tone. You would expect to hear someone use the phrase “got really popular” in casual conversation, not in a formal paper. That’s not the best option; let’s consider the other answers. What about “blew up?” This is again a casual expression of something increasing in popularity. If you wouldn’t hear it in an academic paper or write it in an assignment, chances are it’s not a formal expression. “Became infamous” starts to look like a good option until you realize that “infamous” and “famous” aren’t synonyms—“infamous” is negatively connoted and specifically means famous for a bad reason. This varies too much from the original meaning of the phrase “got really popular” to be correct. We don’t want to introduce new shades of meaning into the passage; we only want to adjust the tone. C is the correct answer; “grew in renown” elevates the formality of the passage’s tone while retaining the same meaning as “got really popular.”

Let’s consider a phrase-based question that focuses on injecting a new idea into the passage instead of creating or maintaining a particular tone and style.

Sample Question #5

Click Here to
Revisit the
Passage

The author wants to emphasize that the historical sites being discussed are areas of potential academic interest. Which of the following choices best accomplishes this?

- A. NO CHANGE
- B. safeguarding them for future studies
- C. shielding them from thoughtless damage and vandalism
- D. defending them against artistic criticism

The sentence in question:

Should historical monuments be completely open for the public to examine, or is there greater value in protecting them for everyone?

Again, this is a perfectly correct sentence that doesn’t have any obvious problems. But we’re told that the author wants to emphasize the sites as being of potential interest to academia, so a change might be necessary in order to achieve that goal. After all, “protecting them for everyone” doesn’t suggest an academic focus at all—it’s a general phrase. (Case in point: the use of the word “everyone.”) Another option is likely better for the stated goal. What about “shielding them from thoughtless damage and vandalism?” Again, a perfectly correct phrase that could work in the passage without causing problems, but not an answer choice that works toward creating an academic focus. “Defending them against artistic criticism” begins to approach an academic context in mentioning “artistic criticism,” which could be part of academic debates. The best answer, though, is “safeguarding them for future studies.” This phrase suggests that in the future, people might be interested in studying sites like the Lascaux caves. The focus on the sites being potentially studied in the future portrays them as “areas of academic interest.” B is correct!



Rephrasing a Sentence

Having worked through rephrasing single words and phrases, let's take a look at working with entire sentences while trying to focus on the author's particular goals.

Sample Question #6

Click Here to
Revisit the
Passage

The author wants to introduce the Lascaux caves as an example of a historic site that has been damaged. Which of the following sentences best accomplishes this?

- A. NO CHANGE
- B. You may think this isn't true, but the Lascaux caves prove it is.
- C. Works of art like those found in the Lascaux caves form the most important type of historic site to protect.
- D. The Lascaux caves show just how selfish some people can be.

When working with sentences, we need to consider the indicated sentence alongside its “bookend” sentences—the ones that appear immediately before and immediately after.

While many people are willing to travel thousands of miles to view ancient works of art and architecture up close and in person, the more visitors an ancient site has, the more quickly it crumbles. The history of the Lascaux caves in France attests to this fact. Discovered by accident in 1940, the caves are covered in breathtaking Paleolithic artwork portraying a wide variety of animals in motion.

The author's goal for this sentence is to introduce the caves as an example of a historic site that's been damaged. That doesn't sound like it will require a lot of authorial opinion or strong wording, but a lot of the answer choices appear to veer in that direction. Answer choice A introduces a lot of value judgment into the passage, none of which is called for by the prompt. B does something similar, but instead of judging people, it makes a comparison between works of art and other types of historic sites, claiming the works of art are the most important ones to protect. That's not called for in the prompt, either. What about A? While this answer doesn't introduce any tone issues, its logic is off; nothing in the passage suggests that the author has to work against an audience that doubts the veracity of the previous statement. Thus, the phrasing of “You may think this isn't true” isn't called for. This leaves us with the phrasing that we started with, which in this case, accomplishes the stated goal best of all the presented options. It simply connects the general idea of damaged historic sites to the specific example of the Lascaux caves without introducing any elements that aren't mentioned in the question. The correct answer is A!

Let's consider one more sentence-based question—one that focuses on picking out a sentence that serves a specific purpose in the passage.



Click Here to
Revisit the
Passage

Sample Question #7

The author wants to end the passage with a call to action. Which of the following sentences best accomplishes this?

- A. NO CHANGE
- B. Who knows what other sites have yet to be discovered and potentially better preserved?
- C. We should learn from what has happened to the Lascaux caves and be content to appreciate unique historic sites from afar so as not to damage them.
- D. Scientists hope to eventually restore Lascaux caves to the condition in which they were initially discovered, but this will take a great deal of time and effort to fix a problem that could have been avoided.

Here's the relevant portion of the passage. Note that this time, we only have to consider the sentence that precedes the underlined one, because the underlined one is the passage's concluding sentence:

Overinteraction with the caves has turned them from a fascinating tourist destination into a world wonder desperately in need of help. If you want to experience the beauty of the Lascaux caves, visiting the replica site Lascaux II can help you have the experience of exploring the caves without damaging their fragile art.

The author is looking to end his or her passage with a “call to action,” or in other words, to urge the reader to actually change their behavior or go and do something based on what they've read. B, a question, doesn't do this at all. D is a statement of what scientists intend to do to help restore the caves, but it's just informative and doesn't directly ask the reader to do anything. A, the option written in the passage, recommends that readers visit a replica site to avoid damaging the caves, but it begins with a conditional statement, “If you want to experience the beauty of Lascaux caves.” This means that it's not addressing all readers, which takes its strength down a notch. A call to action is typically a strong statement aimed at all readers, not a weaker one giving some advice to some of them. C is the best answer, as it provides a recommendation as to what everyone should do in lieu of recognizing the damage that people have caused by visiting Lascaux. The “should” is a major clue that a recommendation is being given—in this case, a recommendation about how people should change their behavior to assist in the preservation of historic sites.



Combining Sentences

Certain SAT Writing and Language questions may point out sentences in the passage and ask you how to best combine them into a single compound sentence. Deciding between the presented options requires skill in the grammatical nuts and bolts of combining sentences, covered in *a different lesson*, but it also requires an eye for the details of passage context and the logical relationship between the two input sentences. Does one directly support the other's conclusion? Do they introduce conflicting data or opinions? Do they have a cause-and-effect relationship? This lesson will take a look at how to select the best option when asked to combine specific sentences on the SAT Writing and Language test by introducing you to these details and helping you learn to combine grammatical rules with stylistic concerns to identify the best possible result.

Let's take a brief look at some of the options in our sentence-combining "tool kit." To combine two sentences, we can use any of the following methods:

1. Connect the sentences with an appropriate conjunction followed by a comma
2. Connect the sentences with a semicolon

Combining sentences on the SAT often demands more subtlety than simply merging the two independent clauses so that one immediately follows the other. This often involves turning one of the sentences into a phrase and then inserting it into the first sentence at a strategic, logical point. Let's look at an example of this by trying to combine the first two sentences of a passage, presented below:

Since its popularization in the nineteenth century, photography has played various and complex roles. Crude pinhole cameras first appeared in antiquity.

We can't just connect these sentences with "and." There's a temporal element to the topics being discussed that just doesn't flow well as presented: the first sentence discusses a nineteenth-century occurrence, and the second sentence discusses something invented "in antiquity"—way earlier than the nineteenth century. When working with a timeline of events, it often makes sense to discuss the events that happened earliest first. This creates a logical progression to the passage's events that make its points easier to follow. Instead of discussing what happened before a described event, we move from one event to what happened next.

Adjusting the timeline of these two sample sentences is a bit more complex than just switching the order in which they appear. Even if we weren't tasked with combining the sentences, it wouldn't make much sense to just switch their order, since the first sentence introduces photography as the subject of the passage. We don't want to lose that focus by starting the passage talking about pinhole cameras before this main idea is introduced.

Let's try turning the second sentence into a phrase and inserting that phrase into the first sentence. We need that phrase to appear before the mention of the nineteenth-century popularization of photography, so let's try leading the sentence off with it:

Crude pinhole cameras first appearing in antiquity, since its popularization in the nineteenth century, photography has played various and complex roles.

Ok, we're not done yet. Stacking two phrases before finally mentioning "photography" makes the sentence pretty confusing. Let's turn the phrase "since its popularization in the



nineteenth century” into the sentence’s main clause and move that information so that it follows “photography”:

Crude pinhole cameras first appearing in antiquity, photography was only popularized in the nineteenth century, and has played various and complex roles.

Now we’re getting somewhere! There’s a bit of a contrast between the idea that pinhole cameras were invented so early in history while photography was only popularized in the nineteenth century. This is stressed by “only,” but we can add in a conjunction that introduces this idea earlier:

While crude pinhole cameras first appeared in antiquity, photography was only popularized in the nineteenth century, and has played various and complex roles.

Ok, let’s add one more change to that last part of the sentence so that it is clear where it fits in the timeline.

While crude pinhole cameras first appearing in antiquity, photography was only popularized in the nineteenth century, after which it has played various and complex roles.

There! Now, you may be thinking, “That took a while. Will I really need to do that for every sentence combination question on the SAT Writing and Language test? I might run out of time at that rate!” While revising a sentence step-by-step appears to take a while, rearranging and adjusting each piece takes merely moments. Furthermore, and more importantly, you are presented with your answer options on the SAT Writing and Language test. The best answer is right there in front of you—you just have to pick it out. We walked you through the steps of sentence revision to help you get a sense for the sorts of grammatical shifts and changes you’ll be considering as you look at your options. Doing this also helps get you in the mindset that the combined sentence options won’t just utilize conjunctions to connect two independent clauses—they’re going to involve complex editing, rephrasing, and rearranging, and it’s your job to keep the sentences as close to their original meanings as possible while making the combined sentence express its point(s) as clearly as it can.

Let’s now try some sample problems like those you might see on test day so that you can practice picking out the best answer instead of coming up with a revised sentence from scratch.



Sample Question #1

[1] During the 1960s, many directors from Czechoslovakia contributed to a film movement called “Czechoslovak New Wave.” [2] This period is often considered to be the golden age of Czechoslovak cinema. [3] These films often used improvised dialogue rather than a script and featured many non-professional actors. [4] The directors from this period wished to capture the authentic experience of living in Czechoslovakia at the time.

What is the best option for combining Sentences 1 and 2?

- A. During the 1960s, a period often considered to be the golden age of Czechoslovak cinema, many directors from Czechoslovakia contributed to a film movement called “Czechoslovak New Wave.”
- B. During the 1960s, many directors from Czechoslovakia contributed to a film movement called “Czechoslovak New Wave,” this period is often considered to be the golden age of Czechoslovak cinema.
- C. During the 1960s, many directors from Czechoslovakia contributed to a film movement called “Czechoslovak New Wave” because this period is often considered to be the golden age of Czechoslovak cinema.
- D. During the 1960s, many directors from Czechoslovakia, often considered to be the golden age of Czechoslovak cinema, contributed to a film movement called “Czechoslovak New Wave.”

The correct answer is A. This phrasing most clearly indicates that the 1960s are the period considered to be the golden age of Czechoslovak cinema. Answer choice C adds “because,” and as a result, it appears that the movement came about because the period was the golden age, when in actuality the reverse is true. Answer choice B only adds a comma and creates a run-on sentence. Answer choice D moves the phrase “often considered to be the golden age of Czechoslovak cinema” after “Czechoslovakia,” it remains unclear to what period the phrase refers.



Sample Question #2

[1] Cowboys have long been a symbol in American society. [2] On the one hand, they represent American strength, adventurousness, and indefatigability. [3] They also call up images of oppression, racism, and exploitation. [4] However, both of these romanticized views of cowboys betray the dull routine and everyday realities of the lives that many cowboys lived.

What is the best option for combining Sentences 2 and 3?

- A. While they also call up images of oppression, racism, and exploitation, they represent American strength, adventurousness, and indefatigability.
- B. They represent American strength, adventurousness, and indefatigability, and they call up images of oppression, racism, and exploitation.
- C. On the one hand, they represent American strength, adventurousness, and indefatigability; moreover, they call up images of oppression, racism, and exploitation.
- D. On the one hand, they represent American strength, adventurousness, and indefatigability; on the other hand, they call up images of oppression, racism, and exploitation.

These sentences are meant to contrast with one another; the phrase “On the one hand” that begins the first of the two sentences conveys that, and later in the passage, the sentence that begins “However, both of these romanticized views . . .” also works in that direction, pointing out a similarity between two opposing views. So, we need to pick out an answer choice that emphasizes the disparity in the views discussed.

B can't be correct, as it uses “and” to connect the two sentences and omits the introductory phrase “On the one hand.” This de-emphasizes the contrast that we want to emphasize! C can't be correct because it uses the conjunction “moreover” to begin the second independent clause. “Moreover” suggests that a point begun in the first independent clause will be continued, or more evidence presented that supports it. That's not what we're looking for either. A and D may each look like a good option, but A's use of “also” before the first view instead of between the first and the second makes its phrasing slightly awkward. D is the best answer. It adds in the phrase “on the other hand” to complement “On the one hand,” and as a result stresses the disparity in views being presented.



Sample Question #3

[1] While perhaps not as well-known as Bluebeard or Captain Kidd, Bill Johnston was still known as a feared pirate and river smuggler in his day.

[2] That day was the War of 1812. [3] He came from a British Loyalist family and settled in Upper Canada before beginning a career as a Lake Ontario schooner captain. [4] His ships carried some legal cargo, but they also smuggled tea and rum into Canada.

What is the best option for combining Sentences 1 and 2?

- A. While perhaps not as well-known as Bluebeard or Captain Kidd, Bill Johnston was still known as a feared pirate and river smuggler in his day, the War of 1812.
- B. While perhaps not as well-known as Bluebeard or Captain Kidd, Bill Johnston was still known as a feared pirate and river smuggler during the War of 1812.
- C. While perhaps not as well-known as Bluebeard or Captain Kidd, Bill Johnston was still known as a feared pirate and river smuggler in his day: that of the War of 1812.
- D. While maybe he wasn't as well known as Bluebeard or Captain Kidd, Bill Johnston was still known as a feared pirate and river smuggler in his day of the War of 1812 era.

This question revolves around one main issue: how to mesh the phrasing “in his day” from Sentence 1 with Sentence 2, “That day was the War of 1812.” First of all, note that describing the War of 1812 as a/one “day” is both historically inaccurate and linguistically imprecise. Recognizing this point allows us to omit A, C, and D as potential answer choices, as they each attempt to keep both phrases in play, and the effect is a confusing and awkwardly phrased sentence. B is the best answer because it doesn't equate the War of 1812 with a single “day” or “day” as meaning era. Instead, this option omits the use of the “in his day” phrase completely and instead opts for the more linguistically precise phrase “during the War of 1812.”



Sample Question #4

[1] While many people feel strongly about the genetic modification of foods, most do not understand the full nature of genetically modified (GM) plants and animals. [2] Genetic modification is defined as the artificial manipulation of a species' DNA usually for the purpose of improving crop yield, resistance to disease, or nutritive value. [3] It has been going on for millennia: ancient farmers were selectively breeding foods to provide better flavor, produce smaller seeds, or withstand drought and flooding.

[4] Today, more sophisticated tools allow scientists to transfer genes for desirable characteristic such as better resistance to pests from one organism to another. [5] Opponents of genetic modification argue that the DNA modifications are unstable, undesirable, and unhealthy for the environment, though scientific evidence suggests this is not true. [6] Additionally, some also argue that consuming GM foods is unsafe for humans, despite much scientific evidence to the contrary.

What is the best option for combining Sentences 5 and 6?

- A. Arguing that DNA modifications are unstable, undesirable, and unhealthy for the environment, opponents of genetic modification argue that consuming GM foods is unsafe for humans, despite much scientific evidence to the contrary.
- B. Opponents of genetic modification argue that the DNA modifications are unstable, undesirable, and unhealthy for the environment, and additionally, some also argue that consuming GM foods is unsafe for humans, despite much scientific evidence to the contrary.
- C. Opponents of genetic modification argue that the DNA modifications are unstable, undesirable, and unhealthy for the environment as well as unsafe for human consumption, despite much scientific evidence to the contrary.
- D. Though arguing that DNA modifications are unstable, undesirable, and unhealthy for the environment, opponents of genetic modification argue that consuming GM foods is unsafe for humans, despite much scientific evidence to the contrary.

There's a lot of redundancy going on in these sentences. We're told in the first sentence that opponents of genetic modification (GM) argue three things despite scientific evidence, and the second sentence tells us that they also argue an additional point despite scientific evidence. We can combine these oppositional points into a list of four and then say that opponents of genetic modification argue the entire list despite scientific evidence. The only answer choice that does this is C, which creates a clearer, simpler structure not found in any of the other answer options, each of which maintains the three-point-then-one-point split in some fashion.



Sample Question #5

[1] As anyone who has tried it can tell you, Filipino food involves an exciting and intriguing blend of flavors. [2] Due to its interaction with various nations and cultures, it's cuisine is marked by influences from Austronesia, Spain, China, Malaysia, and the United States. [3] For example, if you walked into a Filipino restaurant, you might encounter paella, a traditionally Spanish dish, or spring rolls, which are part of Chinese cuisine.

[4] Street food is another important aspect of Filipino cuisine. [5] Filipino street food includes a wide variety of fried items, such as bananas, plantains, dumplings, squid balls, battered quail eggs, and fruit or vegetable spring rolls.

Which of the following is the best option for combining Sentences 4 and 5?

- A. Another important aspect of Filipino cuisine is street food, which includes many fried items such as bananas, plantains, dumplings, squid balls, battered quail eggs, and fruit or vegetable spring rolls.
- B. Another important aspect of Filipino cuisine, including many fried foods, such as bananas, plantains, dumplings, squid balls, battered quail eggs, and fruit or vegetable spring rolls, is street food.
- C. Street food—including many fried foods such as bananas, plantains, dumplings, and squid balls—is another important aspect of Filipino cuisine, and it can also include battered quail eggs, and fruit or vegetable spring rolls.
- D. Including many fried foods such as bananas, plantains, dumplings, squid balls, battered quail eggs, and fruit or vegetable spring rolls, street food is another important aspect of Filipino cuisine.

These two sentences have an overt common topic: Filipino street food. The first introduces Filipino street food as an important part of Filipino cuisine, and the second details some fried items Filipino street food features. We don't want to redundantly mention the noun "Filipino street food" more than once, so we can use this concept as our "hinge" between the sentences.

Furthermore, we have a very long list of fried items to include. We want to make sure that this list doesn't break up the flow of the sentence. B isn't correct because this list separates the phrase "Another important aspect of Filipino culture" from its conclusion, "is street food." This is confusing and difficult for the reader to encounter, as they have to keep the introductory phrase in mind while they read the list before concluding it after



the list concludes. D is incorrect for a similar reason; it's not clear to what the long list is referring since it leads off the sentence. C is incorrect because it needlessly breaks up the list. This doesn't help the sentence become clearer; it just creates needless complexity in the order of phrases. The correct answer is A. This answer choice introduces Filipino street food in its initial independent clause before detailing all of the fried items that fall under its purview.



Standard English Conventions

Standard English Conventions is the second subscore specific to the SAT Writing and Language test, supplementing the Expression of Ideas subscore. Together, these two classifications cover every question on the SAT Writing and Language test.

For each passage on the SAT Writing and Language test, 5 questions pertain to Standard English Conventions material, for total of 20 questions on this subject matter. These questions are highly specific, dealing with traditional syntax and grammatical conventions of the English language. Unlike previous iterations and formats of the SAT exam, all questions on the SAT Writing and Language test are passage-based; however, questions dealing with Standard English Conventions will still generally relate only to single-sentence excerpts.

Questions will frequently reference specific line numbers, words in context, selections, and excerpts. Most Standard English Conventions questions will be self-contained in these excerpts, addressing grammatical principles without the necessity of incorporating surrounding context. Certain questions, particularly those dealing with pronouns, may occasionally require a more in-depth look at surrounding material. In general, these questions will be more suited to quick evaluation and correction in accord with widely recognized conventions of the English language.

Preparing for Standard English Conventions questions requires an in-depth understanding of language use and syntactical constructions. The following lessons will outline common grammatical and structural topics covered by this class of questions, as well as the most effective approaches for quickly and correctly evaluating the presentations of these questions on the SAT Writing and Language exam.

Section Outline

Sentence Structure

- Identifying errors in syntax and clausal relationships

Conventions of Usage

- Identifying errors in word usage in context

Conventions of Punctuation

- Identifying errors in punctuation usage in context



Sentence Structure

The following group of lessons addresses the topic of Sentence Structure. The Standard English Conventions subscore of the SAT Writing and Language test is designed to test student familiarity with English grammar and compositional elements. Questions dealing with Sentence Structure require the application of revisions to fundamental errors and inefficiencies in sentence construction, with a focus on ameliorating problems in clausal relationships and agreement within a given sentence or set of sentences.

Syntax and sentence construction are governed by a complex and unforgiving set of rules and grammatical principles. Compounding the difficulty of these questions are the modern colloquialisms that may not conform to traditional English standards. Proper evaluation of sentence structure on the SAT Writing and Language exam takes a keen and critical eye for inconsistency with these rigid grammatical constructs.

The following lessons will outline the most common errors covertly inserted into the syntax of SAT Writing and Language questions, including coordination between clauses, parallelism, verb tense, and pronoun agreement.

Section Outline

Complete and Incomplete Sentences

- Recognizing and modifying fragments and incomplete sentences

Coordination Between Clauses

- Implementing effective conjunctions and identifying errors in coordinating clauses

Parallel Structure

- Correcting errors in parallel sentence structure and parallelism

Modifier Placement

- Identifying dangling modifiers and correcting misplaced modifiers

Verb Tense, Mood, and Voice

- Evaluating standard errors in verb conjugation and usage



Complete and Incomplete Sentences

To be grammatically correct in standard modern formal English, a sentence must be complete. Casual conversations and their representations in writing follow a similar but more lax set of rules that provide a few key exceptions. Sentence completeness errors fall into two major categories: sentences that are incomplete and sentence combination errors. The first type of error involves sentence fragments—errors that appear when a sentence doesn't contain a subject and a verb (and isn't one of the aforementioned exceptions). Sentence combination errors involve run-on sentences. Examining these errors with a critical eye and learning what to look for to spot them can help prepare you for any incomplete or run-on sentences you might encounter on the SAT Writing and Language test.

Incomplete Sentences: Sentence Fragments

Almost* any sentence that doesn't contain a subject and a predicate is a sentence fragment and grammatically incorrect. Sometimes these sentence fragments are easy to spot:

- ✗ The manatee, also know as a “sea cow.”
- ✗ Swimming along peacefully.

*Three exceptions exist. Note that they are not terribly likely to show up on the SAT Writing and Language test as each one is limited to being used specifically in conversation, and so would need to be represented as speech or dialogue.

1. Commands don't have a subject in the sentence, but can be read as having an understood or implied subject of “you,” the person being addressed:

(You) Come look out the window right now!

2. It's permissible in formal standard English for certain exclamations or verbal expressions to lack a subject or a predicate. These are often single-word expressions or extremely short ones.

“Stop! Thief!”

“What?”

“Ouch!”

3. Also, in written dialogue or when speaking, when providing the answer to a question that someone has asked, it's completely permissible to leave out the subject, as long as it is clearly understood.

“Where's the pizza?”

“Over there.” (Meaning “The pizza is over there.” “The pizza” is the understood subject).



While informal communication is relatively lax about the demand for both a subject and a verb in each non-imperative sentence, the SAT Writing and Language test is examining your understanding of formal standard English, so if you see an incomplete sentence, make sure and correct it, no matter how casual the tone of the passage.

✗ When Amy got back and found her car was missing, she was flabbergasted.
And mad!

If you want to keep the emphasis on information conveyed in a sentence fragment that appears after a complete sentence to emphasize some aspect of what's being discussed, you can use a hyphen to set off the emphasis material in a way that results in a grammatically correct, but just as emphasized, construction:

When Amy got back and found her car was missing, she was flabbergasted—and mad.

Questions and certain constructions like those that use the subjunctive may require a bit of hypothetical rearranging into a more declarative-like order in order to confirm that they contain a subject and a verb.

Did you not anticipate that many guests? --> (You did not anticipate that many guests).

You saw the balloon floating away, too? --> (You saw the balloon floating away, too).

✗ If only a double batch of cookies! (Missing a verb)

If only we had made a double batch of cookies! (Implied: If only we had made a double batch of cookies, the situation would have generally turned out better).

Even if a sentence looks like it contains a verb, check to make sure that verb isn't actually a verbal—while infinitives are easy to spot, gerunds and participles can be sneakier. If the word that looks like a verb is actually, say, a participle, as in the next example, the sentence may not contain an actual verb.

✗ The general dancing a lively polka with his archnemesiis.

This is an incomplete sentence that might be easy to miss due to its use of a participle. It leaves the reader asking, "What did 'the general dancing a lively polka with his archnemesiis' do?" It can be fixed by adding a helping verb to create a present progressive verb or by changing "dancing" to another form of the verb "dance." Of course, you can always add a predicate to the sentence as well to complete it.

The general is dancing a lively polka with his archnemesiis.

The general danced a lively polka with his archnemesiis.

The general, dancing a lively polka with his archnemesiis, certainly appeared to be having fun.



Sample Question

[1] Claudia didn't enjoy following the news. No matter the topic, every reported story seemed to fall under a general pessimistic trend. **1** [2] In every part of the world, troubling developments in politics. **2** [3] Worried about economic markets and concerned about environmental changes. [4] So, while Claudia kept watching the news to remain up-to-date about current events, she started to seek out happy news stories to balance out the negative ones.

1.
 - A. NO CHANGE
 - B. In every part of the world, trouble developments in politics.
 - C. In every part of the world, there were troubling developments in politics.
 - D. In every part of the world, politics was developing trouble.

2.
 - A. NO CHANGE
 - B. People were worried about economic markets and concerned about environmental changes
 - C. People worrying about economic markets and being concerned about environmental changes
 - D. By worrying about economic markets and being concerned about environmental changes



1. C, “In every part of the world, there were troubling developments in politics.”

The error in the sentence as it is written is that it doesn't contain a verb. “Troubling” is a participle, a verbal that acts like an adjective; in the sentence given, it is describing “developments.” To make a participle into a verb, one needs to introduce a form of the verb “to be” immediately before it; therefore, C is the correct answer choice, as it is the only one that correctly inserts a verb.

B changes “troubling” to “trouble.” It may look like a potentially correct answer, since “trouble” can function as a verb (as in “The questions he cannot answer trouble him”), but in this case, the verb “trouble” doesn't have a plural noun to refer to; it is followed by “developments,” but “trouble” is a transitive verb—you don't just “trouble,” you “trouble” something, so even if it were intended to refer to “developments,” it would still be grammatically incorrect from having nothing to refer to.

D makes politics the subject of the verb phrase “was developing trouble.” The idea of “politics” developing trouble is slightly different from there being “troubling developments in politics.” This creates unnecessary confusion, and the sentence sounds awkwardly phrased.

2. B, “People were worried about economic markets and concerned about environmental changes”

This sentence is incomplete; it doesn't contain a subject. Readers are left wondering, “Who is ‘worried about economic markets and concerned about environmental changes’?” C changes “Worried” to “People worrying” and “concerned” to “being concerned,” but look closely: this introduces a new error, and we're still left with a sentence fragment. Instead of lacking a subject, we now lack a verb. It's not clear what “People worrying about economic markets and being concerned about environmental changes” are doing, since they don't do anything in the sentence fragment. D changes “Worried” to “By worrying” and “concerned” to “being concerned,” turning the sentence fragment into a prepositional phrase. This phrase is still a sentence fragment, as it does not connect to an independent clause. Reading it, you might wonder, “By worrying about economic markets and being concerned about environmental changes, what does that help accomplish?” B is the correct answer because it creates a complete sentence that includes a subject and a verb.



Sentence Combination Errors and “Run-On” Sentences

Sometimes multiple independent clauses (those that could stand on their own as a grammatically correct sentence) are combined to form what is known as a compound sentence. Compound sentences are not strictly grammatically necessary—you can split any compound sentence into two or more full, correct sentences; however, compound sentences are often necessary to express a complex point, and to clarify the connection between ideas. Without complex multi-clause sentences and compound sentences, the tone of a piece of writing would take on a extremely clipped, telegram-like feel.

Let’s start by looking at the ways in which sentences can correctly, and generatively, be combined. From these correct points of connection, we will see that weight of potential error which forever hangs as counterbalance to the rewards of linguistic complexity.

There are two correct ways to combine complete independent clauses into one compound sentence.

1. Insert a semicolon where a period would be between the two sentences—at the end of the first clause and before the first word of the second independent clause.

or

2. Place a comma with an appropriate coordinating conjunction in that same space between the two independent clauses.

Take a look, for instance, at these two sentences.

Although it was raining, I walked to the store. I got soaking wet.

These are two clearly complete independent clauses; however, these two grammatically complete clauses are also directly thematically related, so let’s try to combine them.

Although it was raining, I walked to the store; I got soaking wet.

Although it was raining, I walked to the store, so I got soaking wet.

Both of these sentences are grammatically correct, and they say approximately the same thing as one another, as well as the first two sentences (though the use of the coordinating conjunction “so” implies a slightly more direct causal connection). The point of connecting these two sentences is that the fact that I walked to the store is not independent from the idea that I got soaking wet—in fact, it’s the reason I was soaked, so it makes logical and stylistic sense to connect the ideas as closely as correct grammar allows me to.

Sentence Combination Errors

Sticking with our two sentences, let’s try combining the two methods of sentence combination.

✗ Although it was raining, I walked to the store; so I got soaking wet.

This sentence is categorically wrong. Semicolons, when being used to connect two



independent clauses, can never be followed by a coordinating conjunction. If you wish to use a coordinating conjunction like “and,” “but,” or “so” to connect two independent clauses in this manner, the punctuation mark preceding the coordinating conjunction must be a comma.

It is also incorrect to try to connect two independent clauses with only a coordinating conjunction or only a comma. (This latter option results in a comma splice error).

✗ Although it was raining, I walked to the store so I got soaking wet.

This sentence gives us no appropriate indication that, “I got soaking wet” is an independent clause; connecting this second main clause to the first with only a coordinating conjunction suggests, grammatically, that it is a part of the same clause, not its own independent clause with a subject and a verb. This error is called a “run-on” sentence.

✗ Although it was raining, I walked to the store, I got soaking wet.

This sentence is incorrectly connecting two independent clauses with only a comma. This forms a type of grammatical error known as a “comma splice.” Connecting two sentences with a comma as demonstrated in the above sentence is always ungrammatical.

✗ Although it was raining, I walked to the store I got soaking wet.

Here, we note that it is also incorrect to just jam two sentences together.

Spotting Run-on Sentences in a Full Passage

The major difficulty most people have with recognizing run-on sentences is that while grammar tries to organize human thought into a relatable and understandable format, we tend to think faster and make connections more quickly between ideas than correct grammatical format allows for. For instance, when you’re reading a passage about a complex idea, it might seem perfectly clear that, “walking to the store” in the rain would make a person “soaking wet,” making it incredibly easy to gloss over a missing comma before the coordinating conjunction “so.”

Fortunately, when you are asked to fix and find errors on the SAT, you will be asked to do so for individual sentences within a larger paragraph. As discussed elsewhere in this book, this is where it will be useful to read the paragraphs twice: once for a logical understanding of the content, and once with an eye for the technical aspects of grammar. Any run-on sentence is easily spotted if you keep consistent, accurate track of the fundamental mechanics of the sentence, in particular the verbs.

Verbs are a clear, functional, and distinctive word type. They are the fundamental engine of any sentence: the action words. If you see a verb paired appropriately with a subject or subjects, pay close attention to how that structure fits into the sentences and punctuation around it. Full, grammatically complete independent clauses should not just be thrown into other sentences without appropriate punctuation, whether that be with a semicolon or a comma paired with a coordinating conjunction. Special attention needs to be paid anytime a full, independent clause is connected to another main clause. By keeping an eye on the verbs, you will be naturally more cognizant of the fundamental structure of the sentences you encounter in SAT Writing and Language passages.



Sample Questions

Josh is one of the best players I've ever seen. # He does everything so naturally and so confidently and he never misses a practice. Talent can only be fully realized when it is combined with hard work and a good mindset.

- A. NO CHANGE
- B. He does everything so naturally and so confidently plus he never misses a practice.
- C. He does everything so naturally and so confidently, and he never misses a practice.
- D. He does everything so naturally and so confidently; and he never misses a practice.

The first and third sentences in this passage are correct as written. The second sentence is a run-on sentence due to the incorrect combination of independent clauses without appropriate punctuation. "He never misses a practice," is a full, independent main clause, and is logically separate from the clause discussing the nature of Josh's actions on the field (referring instead simply to when he gets to the practice field). The three options to correct this sentence are to simply split the sentence into two sentences, add a comma before "and," or delete "and" and add a semicolon. The only one of these options provided, option C, simply adds the comma. Note that a coordinating conjunction like "and" cannot follow a semicolon when combining sentences.

Sample Questions

John and I have been trying to get together for weeks now. # Sometimes it is just hard to coordinate plans, people have responsibilities, after all. Maybe one day soon we'll be able see each other again.

- A. NO CHANGE
- B. Sometimes it is just hard to coordinate plans; people have responsibilities after all.
- C. Sometimes it is just hard to coordinate plans people have responsibilities, after all.
- D. Sometimes it is just hard, to coordinate plans, people have responsibilities, after all.



Here, the writer has tried to connect two independent clauses with merely a comma, thus creating what is known as a “comma splice” error. The simplest way to resolve such an error is to replace the comma with a semicolon, as the correct answer, B, here does. Other options include splitting the sentence in two and adding an appropriate coordinating conjunction after the comma.



Coordination Between Clauses

Quick Tip

The seven coordinating conjunctions are “and,” “but,” “for,” “yet,” “so,” “or,” and “nor.”

Conjunctions are basic words used to join words, phrases, or clauses together. While conjunctions are simple words, they also have a variety of uses, and rules inherent to those uses. Conjunctions can open many wonderful doors to you in your writing, but you must know what is behind each door before you open it. There are no universal rules that govern every situation, but there are consistent rules for each of conjunctions' various uses. In grammar, you never get something for nothing, each tool must be mastered, and in order to be mastered must be understood. Conjunctions do not just connect elements of written discourse, they also, through this functional role, clarify the relationship between these elements. In writing, as in life, it is just as, if not more, important to understand the relationship of a thing to the things with which it interacts as it is to understand the thing itself.

Coordinating Conjunction Errors

Coordinating conjunctions are used to connect words, phrases, and clauses (both dependent and independent). The coordinating conjunction is the most commonly used, and misused, form of conjunction. A key thing to remember about coordinating conjunctions is that, unlike subordinate conjunctions, they connect ideas of equal grammatical rank.

✗ Jerry is an accomplished writer and he travels to Ireland for residencies quite often.

Coordinating conjunctions can be used to connect two independent clauses into one compound sentence (semicolons can fulfill the same function, but note that semicolons can never be followed by coordinating conjunctions). Since both clauses could stand on their own as grammatically complete sentences, they require a comma followed by a coordinating conjunctions to be connected into one compound sentence. The sentence above makes an error of punctuation, omitting a necessary comma before the coordinating conjunction “and.”

Jerry is an accomplished writer, and he travels to Ireland for residencies quite often.

Coordinating conjunctions can also be used to directly connect two grammatical items in a sentence.

✗ William, and I are best friends.

The sentence above makes a common error. Many people, in search of the comfort that so often accompanies solidity, make the mistake of always inserting a comma before a coordinating conjunction. Coordinating conjunctions need to be preceded by a comma if they are connection two independent clauses. When they are directly connecting two grammatical items of equal rank, it is incorrect to place a comma before the conjunction.

William and I are best friends.

A brief note on conjunctions at the start of sentences: strict, conservative grammarians will say that it is incorrect to begin a sentence with a conjunction. At this point in English grammar it is considered, on occasion and with care, allowable to begin a sentence



with a conjunction (usually “and” or “but”) followed immediately by a comma. But this practice should not be overused. It is often unnecessary, if not overtly incorrect, to begin a sentence with a conjunction.

Subordinating Conjunction Errors

As we all know far too well, not all relationships are equal; this is as solid a truth on the field of grammar as it is on the sports field. Subordinate clauses transition between two ideas of unequal grammatical standing in a sentence, and in so doing they assert and express the inequality of the grammatical relationship they are facilitating. The transition facilitated by a subordinate conjunction will point to the causal, temporal, and spatial relationship of the two items being connected.

Coordinating conjunctions join items of equal grammatical rank, like one word to another, or one independent clause to another. Subordinating conjunctions connect a lower-ranked word, clause, or phrase to a higher-ranked one, but how are we ranking these grammatical items?

In this case, the most obvious and illustrative unequal grammatical relationship is that of a dependent clause to an independent clause. An independent clause is considered a higher-ranking grammatical unit than is a dependent clause, which cannot stand on itself as a sentence and makes grammatical sense only in its relationship to a main clause (also known as an independent clause).

✗ Whenever I go to the store.

This sentence is a fragment; it is a dependent clause connected to nothing. Now, we see how subordinating conjunctions not only signal, but also help determine the grammatical status of a sentence. “I go to the store” is a grammatically complete and correct sentence, but “whenever I got to the store” is a dependent clause. The addition of the subordinating conjunction “whenever” necessitates a main clause explaining what the speaker does “whenever” he or she is at the store. Adding “whenever” has made this phrase into an introductory phrase.

A possible correct version of this sentence is,

Whenever I go to the store, I spend at least twenty dollars.

Correlative Conjunctions

Certain conjunctions require a second, correctly paired conjunction in order to be complete. These are called correlative conjunctions. The rules governing correlative conjunctions are probably the simplest of any of the conjunction rules. Basically, a correlative conjunction will have an accompanying conjunction that it requires in order to be correct.

✗ Neither you or your brother are allowed back in my steak house, if that’s how you talk!

The error here is simple. The correct correlative conjunction for “neither” is “nor.” Anytime you see “neither,” you must see “nor” connecting the two items being discussed



or the sentence will be incorrect.

Neither you nor your brother are allowed back in my steak house, if that's how you talk!

The table to the right contains a list of some of the most commonly used correlative conjunctions.

As . . . as

Hardly . . . when

Either . . . or

Neither . . . nor

What with . . . and

Just as . . . so

Both . . . and

If . . . then

Conjunction Logic Errors

Conjunctions are not just words used to connect grammatical items, they are words themselves, and as such they carry meaning and impose logic on the sentences to which they are added. No two conjunctions are interchangeable; they each carry their own meaning and signal different types of relationships.

Here is an example of such an error:

✗ Although William is a large, strong man, he was able to lift the bag of flour easily.

Here, the subordinating conjunction “although” goes against the meaning and logic of the rest of the sentence. “Although” is used to suggest that in spite of whatever dynamic or fact is being stated, a result that runs counter to what that fact would suggest is true. The fact here is that “William is a large, strong man,” which, in this case lines up perfectly with the result of him being “able to lift the bag of flour easily.”

A correct version of this sentence reads,

Because William is a large, strong man he was able to lift the bag of flour easily.

Since “because” is a straight-line indicator of causality, it makes sense here to explain that William’s size and strength allow him to be “able to lift” heavy things.

If you are ever in doubt about the logic of a sentence as it relates to conjunction, first look at the subordinate conjunctions in the sentence, and decide if they signal a temporal (or order of events), cause-and-effect, or a spatial relationship. If the kind of relationship signaled by the conjunction is appropriate to the sentence, you should then look at the rest of the sentence and decide in what way the dependent clause logically relates to the main clause. Sometimes this relationship will be counterintuitive to the results (signaled by “although,” “even if” etc.), and sometimes the relationship will be consistent with, or suggestive of, the results (“because,” “as,” “provided that,” etc.). Errors of conjunction logic will mostly be a thing to look out for in cases where the relationship is related to causality (illogical temporal relations are usually fairly obvious).

✗ Because I ate so much steak, I was still hungry a mere hour later.

Here, we have an illogical logical relationship. Steak is a protein-heavy food, and quite unlikely to actually cause further hunger. But, hey, everyone has a different metabolism,



so let's look for a grammatical suggestion of the illogic of this sentence. "Because" is a one-and-done coordinating conjunction, it does not require a correlative conjunction, and especially should never be followed by a correlative conjunction suggestive of a contradictory relationship (like "still"). If you see because in the dependent clause, you should never see a conjunction like "still" in the main clause.

A correct version of this sentence reads,

Even though I ate so much steak, I was still hungry a mere hour later.

Sample Question

Because the giant squid is an elusive creature rarely seen by humans, scientists are beginning to gain a better understanding of the creature by studying it using remote cameras. Several videos showing giant squid have caught the attention of the general public.

- A. NO CHANGE
- B. As
- C. Although
- D. Considering

The sentence is trying to explain that in spite of the giant squid's elusiveness, scientists are finding new ways of studying it. The sentence therefore is trying to contrast two ideas, as opposed to showing causation with the word "because." The only answer choice that uses a contrasting conjunction is C, "Although," so it is the correct answer.



Parallel Structure

Parallel sentence structures occur when a matching pattern of words is used. You use a parallel structure to suggest similarity, especially a similarity in terms of importance, between two or more items in a sentence. Parallel structures will often include the conjunctions “or” or “and.” As you may guess from that feature, parallel structure is an important component of all comparisons. Parallel structures can occur within phrases, between two words, or within entire clauses.

Examples of Correct Parallel Structure

I went to the greenhouse and purchased petunias, tulips, and chrysanthemums for the garden.

This sentence uses correct parallel structure because each of the items in its list is a plural noun.

My favorite sports are hockey and swimming.

This sentence’s parallel structure is also correct because the two favorite sports listed are both nouns. (Though “swimming” is a gerund, it is acceptable because there is no noun naming the sport in common parlance that is not a gerund).

I think that my grandmother’s cookies are better than anyone else’s.

This sentence may look a bit tricky, but it also demonstrates a correct use of parallel structure because “anyone else’s” implies the meaning “anyone else’s cookies.” That means that two types of cookies are being compared: those that the speaker’s grandmother makes and those that anyone else makes.

Parallel Structure Errors

Parallel structures can be useful in suggesting parity between things and in formatting lists of three or more items, but it is important to keep in mind that once you begin using a parallel structure, you are committed! Parallel structures must remain consistent throughout a sentence.

Examples of Parallel Structure Errors

✗ You must get results quickly, efficiently, and at a low cost.

✗ I enjoy reading novels, playing poker, and to ride my bicycle along the Olentangy River.

✗ He likes to eat but not cooking.

In the first sentence, we see parallel structure set up with the adverbs “quickly” and “efficiently”; therefore, the third item in the list should also be an adverb that refers to the verb “get.” A good option would be “cheaply.” If the first two items in a list are adverbs, the third item should also take an adverbial form.



You must get results quickly, efficiently, and cheaply.

In the second sentence, a parallel structure is set up with the use of the gerundive forms of “reading novels” and “playing poker,” so the third item needs to match this form. “Riding my bicycle” would correct this error.

I enjoy reading novels, playing poker, and riding my bicycle along the Olentangy River.

The third sentence highlights an important rule for parallel structures. When two items are connecting with a coordinating conjunction (these items can be words, clauses, or phrases) the structure of the items must be parallel.

He likes to eat but not to cook.

A Note on Lists

Lists of three or more items should be framed in parallel structures. Note that the rules surrounding lists of three or more items remain consistent whether or not the list is preceded by a colon.

✗ Max loved only three things: model airplanes, fast cars, and going fishing.

This sentence is incorrect, since the third “thing” is not a “thing” like the first two, but is instead an activity. Since “going fishing” is fundamentally a different kind of “thing” than the other two, it would be best to split this sentence in two.

Max loved model airplanes and cars. He also loved to go fishing.



Modifier Placement

What are Modifiers?

In writing, modifiers are words or phrases that alter, clarify, or place limits/restrictions on a particular word within a sentence. Modifiers are an important foothold in the long, forever steep climb to the peak of fluent and advanced prose writing. By providing detail about, and context for, basic elements of a sentence, modifiers are a great way to elevate your sentences beyond a basic Subject-Verb-Object structure.

An Example Illustrating the Necessity of Modifiers

Consider the following sentence:

✗ Dmitri took my sandwich and tapped my cheek with the back of his hand.

In this case, all we, as readers, know is what actions Dmitri took.

Dmitri, my best friend and trusted business partner, took my sandwich and tapped my cheek with the back of his hand.

Now, we not only know what Dmitri did, but we also have a better clue as to why he did those things and how the speaker would have felt about his actions. In other words, the modifier here provides us with an opportunity to know not just what happened, but the spirit in which events were made to happen and the way in which they were received.

Now, to solidify this point, let's insert a different modifier in place of "my best friend and trusted business partner":

Dmitri, a known bully, took my sandwich and tapped my cheek with the back of his hand.

Now, thanks simply to a change in the modifier, the meaning, tone, and emotional content of this sentence is fundamentally altered. What we see here, is that modifiers add content to sentences, and when you add content you are making positive change to the meaning of your sentence.

"Dmitri took my sandwich and tapped my cheek with the back of his hand," is a certainly a grammatically complete sentence, but as we can see, there is so much more to this life than context-less, basic correctness. Writing, at its heart, is about expressing thought, and thoughts are rarely simple enough to be expressed with just a subject and a verb.

While modifiers are helpful and necessary, they do add complexity to sentences, and anytime you make something more complex (and interesting) you open the door to that ever-willing house guest, error. There are three basic types of errors specific to the addition of a modifier to a sentence, and we'll look at them one at a time.



Dangling Modifiers

Dangling Modifiers occur when a subject is clearly tied to the main clause of a sentence, and is then forgotten (left hanging or, you might even say, “dangling”) in a modifying clause. Always keep the basic, fundamental grammatical structure of your sentence in mind. The modifier must always match the subject of the main clause of the sentence.

Spotting Dangling Modifiers

You can spot a dangling modifier by paying close attention to what thing or object the introductory phrase refers to, and how it interacts with the noun that immediately follows it. Consider the following sentence:

✗ Having finished his book, the lights were turned out.

In this example, “having finished his book” seems to describe “the lights.” This doesn’t make any sense—lights don’t read books! They also aren’t assigned genders in English, so the sentence’s use of “his” provides a major clue that something is grammatically incorrect. Consider another example:

✗ After reading the book, the movie seemed shallow and simple-minded.

In the second sentence, “After reading the book” appears to describe “the movie.” Again, it doesn’t make sense for a movie to read a book, so this sentence also has the potential to confuse readers.

Keep in mind that dangling modifiers don’t have to be phrases: they can consist of single misplaced words:

✗ Burnt, the campers ate the marshmallow.

In this example, it is unclear whether “burnt” refers to the campers (ouch!) or the marshmallow.

Fixing Dangling Modifiers

On the SAT Writing and Language test, you might be asked to fix dangling modifiers by choosing the best way to rephrase a sentence containing one, so let’s talk about some strategies to fix these errors. In both cases, the main clauses come after the comma.

One option is to name the subject of the sentence in the first clause.

After Kevin had finished his book, he turned the lights out.

After I had read the book, the movie seemed shallow and simple-minded.

Another option is to add the appropriate subject to the main clause.

Having finished his book, Kevin turned the lights out.

After reading the book, I found the movie shallow and simple-minded.

This also makes the sentence smoother by removing an unnecessary and confusing use



of the passive voice.

A final, probably less common option, is to simply combine the two clauses into one.

Kevin finished his book and turned out the light.

Note that in this case the modifier has simply been re-formed as a second verb in the sentence.

Sample Question

Our understanding of the atom has changed a great deal over time, and older models can differ significantly from current views. **1** The Bohr model states that electrons travel in fixed paths around the nucleus, unlike the modern model of the atom. Newer models of the atom are less simple but more accurate. **2** The modern model of the atom, quantum theory supports the quantum model, which models electron behavior in terms of orbitals that map probability and location.

- 1.**
 - A.** NO CHANGE
 - B.** Electrons travel in fixed paths around the nucleus, the Bohr model says, unlike the modern model of the atom.
 - C.** Unlike the modern model of the atom, the Bohr model states that electrons travel in fixed paths around the nucleus.
 - D.** The Bohr model states that unlike the modern model of the atom, electrons travel in fixed paths around the nucleus.

- 2.**
 - A.** NO CHANGE
 - B.** Quantum theory supports the modern model of the atom, the quantum model, which models electron behavior in terms of orbitals that map probability and location.
 - C.** Quantum theory, the modern model of the atom, supports the quantum model, which models electron behavior in terms of orbitals that map probability and location.
 - D.** In the modern model of the atom, quantum theory is used to support the quantum model, which models electron behavior in terms of orbitals that map probability and location.



1. C, “Unlike the modern model of the atom, the Bohr model states that electrons travel in fixed paths around the nucleus.”

As written, the sentence places the phrase “unlike the modern model of the atom” immediately after “the nucleus.” This isn’t the noun to which this phrase is referring; it’s referring to “the Bohr model.” The correct answer moves the phrase so that it is next to “the Bohr model”; it does this by using the phrase as an introductory phrase and immediately following it with “the Bohr model” to avoid ambiguity.

2. B, “Quantum theory supports the modern model of the atom, the quantum model, which models electron behavior in terms of orbitals that map probability and location.”

This sentence is a little bit trickier than the last one because it’s easy to confuse the noun phrase to which the modifier refers (“the quantum model”) with another noun phrase (“quantum theory”). Note that the modifier specifically refers to “the modern model of the atom”; this helps clarify which noun phrase is the intended recipient of the modifier’s shift in meaning. C doesn’t make sense because it makes it seem as if “quantum theory” is “the modern model of the atom”; the modifier modifies the wrong noun in this sentence, so it can’t be correct. D leads off with the modifier, but then immediately follows it with the phrase “quantum theory,” creating another mismatched situation in which the modifier is not directly associated with the correct noun phrase. The correct answer is B because it is the only answer choice in which “the modern model of the atom” is immediately adjacent to “the quantum model.”

Ambiguous Modifiers

Ambiguous modifiers are errors that occur when a modifier could logically refer to more than one element of the sentence. Modifiers must always clearly refer to one, and only one, specific element of the sentence. Whereas dangling modifiers tend to occur when modifying phrases are used, ambiguous modifiers often occur when one word modifiers are used to describe an element of the sentence. This is not an absolute rule for either case; one-word dangling modifiers exist, as do ambiguous modifying phrases, but one-word ambiguous modifiers can often be the most difficult to spot.

Ambiguous modifiers are errors because they confuse the reader, rather than helping clarify the situation described in the sentence for the reader.

Examples of Ambiguous Modifiers

- ✗ Kevin’s ophthalmologist told him to strictly read during the day.
- ✗ People who enter movie theaters with popcorn are often asked to discard it.

First, let’s identify the modifiers in each of these sentences, and the parts of the sentences to which they refer. In the first sentence “strictly” modifies either the manner in which Kevin’s ophthalmologist instructed him or the manner in which he is told to read, hence the ambiguity. In the second sentence, the modifying phrase “with their own popcorn” refers to either the people bringing popcorn from home or the theaters that have “their own popcorn.” While the rest of the sentence makes it clear that the first meaning is intended, the ambiguity is confusing and distracting.



To fix these errors, we simply need to move the modifiers so that they are as close as possible to the grammatical item to which they refer.

Kevin’s ophthalmologist strictly told him to read during the day.

Kevin’s ophthalmologist told to read strictly during the day.

People with popcorn who enter movie theaters are often asked to discard it.

Note that since the modifier was ambiguous in the first sentence, there are two grammatically correct options to change the sentence. Whether one option is more logical is another question. For the second sentence, there is only one correct option, because the sentence makes it clear that the modifier “with popcorn” applies to the people and not to the movie theaters, since only in that reading does it make sense that people would be asked to discard popcorn, and only in that reading does the pronoun “it” that concludes the sentence have an antecedent.

A Note on Limiting Modifiers

Be especially careful with the placement of limiting modifiers (“only,” “nearly,” “just,” etc.). Limiting modifiers can often be ambiguous, as they can correctly refer to many parts of a sentence, so they should be placed directly in front of the thing they are placing a limit on.

For example, notice the difference in meaning between these two sentences:

Only Jim hates that movie.

Jim hates only that movie.

The first sentence means that Jim and Jim alone “hates that movie.” The second sentence means that Jim does not hate any other movie other than the one being discussed. The entire meaning of a sentence can be changed simply by moving a limiting modifier. Both these sentence are correct, grammatically, but if you intended one meaning and ended up with the other it would be a completely misleading communication of your intended meaning.



Sample Question

1 Janet thinks that people should see their primary physician to ask them with health questions, even small queries. **2** In contrast, Lee thinks that they should go to the doctor if they think they only have a serious medical problem. The two of them are going to collaborate on a project about insurance and hospital visitation rates. It will be interesting to see if they end up coming to a consensus.

1.
 - A. NO CHANGE
 - B. Janet thinks that people, even with small queries, should immediately see their primary physician to ask them with any health questions.
 - C. Janet thinks that people with any health questions should immediately see their primary physician to ask them, even with small queries.
 - D. Janet thinks that people with any health questions, even small queries, should see their primary physician to ask them.

2.
 - A. NO CHANGE
 - B. In contrast, Lee thinks that they should go to the doctor if they only think they have a serious medical problem.
 - C. In contrast, Lee thinks that they should go to the doctor only if they think they have a serious medical problem.
 - D. In contrast, Lee only thinks that they should go to the doctor if they think they have a serious medical problem.



1. D, “Janet thinks that people with any health questions, even small queries, should see their primary physician.”

As the sentence is written in the passage, “with any health questions” can easily be interpreted as modifying “their primary physician,” when this modifier adjusts the meaning of “people.” The best answer choice is D because it follows “people” with “with any health questions, even with small queries.” In this order, the sentence is much clearer. C isn’t correct because “even with small queries” concludes the sentence at a confusing distance from “with health questions,” the phrase with which it is associated. B is incorrect because it also splits the phrases, ending the sentence with “with any health questions.”

2. C, “In contrast, Lee thinks that they should go to the doctor only if they think they have a serious medical problem.”

The error in this sentence as it is written is in the placement of the limiting modifier “only.” As written, the sentence’s use of “only” downplays the concern over “serious health problems” and doesn’t make much sense. D places “only” after “Lee,” (“Lee only thinks”) making it seem as if Lee only holds one opinion or downplaying his opinion’s significance. B makes a similar error (“should go to the doctor if they only think”), making it seem as if the people being discussed have only serious health problems, not minor or moderate ones. The best answer choice is C. This sentence places “only” in the phrase “should only go to the doctor,” which limits the situations in which Lee recommends people go see their doctors. This placement makes the most sense in contrasting the indicated sentence to the preceding sentence.



Misplaced Modifiers

Misplaced Modifiers are similar in nature to Ambiguous Modifiers. They are modifiers that are incorrectly placed in a sentence; however, instead of possibly referring to two items in the sentence, through their inaccurate placement misplaced modifiers do not correctly modify anything in the sentence. Consider the following example of a misplaced modifier:

✗ In the locker room, I found a silver man's tie clip.

This sentence is clearly incorrect, both grammatically and in terms of its relation to reality. At this particular juncture of history, humans are not made of silver; they are flesh and bone. Some human men do, however, own "silver tip clip[s]." Also, note that in this case, if you were reporting on finding a tie-clip and wished to categorize the department in which the tie clip would be sold, the correct wording would be "a silver men's tie-clip."

Sample Question

We didn't have to look too hard for the owner of the green striped men's socks; only Jeremy would ever wear socks that bright. Sure enough, the socks were his. He even had a scarf to match them!

- A. NO CHANGE
- B. the green men's striped socks
- C. the striped green men's socks
- D. the men's green striped socks

This sentence is incorrect because as written, it concerns the socks green striped men, which doesn't make much sense in the realistic context in which its events appear to take place. B discusses the striped socks of green men and C discusses the socks of striped green men. The correct answer is D, as this is the only answer choice that leads the phrase with "men's and thus discusses the green striped socks designed to be worn by a man.



Verb Tense, Mood, and Voice

The importance of verbs is clear and can be overstated only with great difficulty. Verbs are an essential part of every complete sentence, and are the words concerned with the actions taken by a subject. Everything that is done by a noun is a verb. As a fundamental aspect of any basic sentence structure, it is important to understand the rules governing the use of verbs, and to know about, in order to avoid, some of the most common species of verb errors.

This lesson will help you sharpen your skills in working with verbs by reviewing three prominent grammatical features of verbs: tense, mood, and voice. The sample questions it includes will present verb conjugation errors so that you can practice responding to a wide variety of grammatical situations that fall under this general label.

Verb Tense

Verb tenses are used to indicate the time and order in which events occur. Tenses tell us the time and are regulated by that temporal information. If an event occurred at one discrete time in the past, you must use the past tense to describe it. There are three simple verb tenses, and three “perfect” verb tenses.

On the SAT Writing and Language test, you will never be required to name a tense, merely to identify errors. Tense errors primarily focus on situations in which a verb’s tense does not agree with or make sense in the context of the rest of the sentence.

Simple Tenses

The Simple Present is used to describe events that are currently happening. It is formed with a “-s” verb ending.

Kevin cooks.

The Simple Past is used to describe events that have already occurred. It is formed with an “-ed” ending.

Kevin cooked.

The Simple Future is used to describe events that will occur, but have not yet occurred. It is formed with “will” and a verb or a properly conjugated “be” verb followed by “going” and then the verb as an infinitive.

Kevin will cook.

Kevin is going to cook.

Perfect Tenses

The Present Perfect is used to describe events that began in the past and have continued into the present. It is also used to describe events that occurred in the past whose consequences continue to be relevant in the present. The present perfect is formed with a past participle and “has” or “have.”



Kevin has cooked for years.

The Future Perfect is used to describe events that will have been completed by some future date. It is formed with “will have” and a past tense verb.

Kevin will have cooked the bird by Thanksgiving.

The Past Perfect is used to describe events or actions that have occurred before another action or event that has also occurred in the past. It is formed with “had” and a past tense verb.

By the time we arrived, Kevin had eaten the bird that he had cooked.

Verb Tense Errors

Many verb tense errors occur simply in the formation of the verb. If you know the correct way to form each verb tense, you can avoid this species of error.

Errors of verb tense consistency are much more complex, and are worthy of some explanation. As a general rule, you must avoid shifting verb tenses if the time frame of the events or actions discussed has not changed.

✗ The wind blew, clouds appeared on the horizon, and a huge wave crashes into the seawall.

This sentence incorrectly shifts between the past tense to the present when no shift in time has been indicated. To make the correction more clear, let’s add a specific time.

Yesterday evening, the wind blew, clouds appeared on the horizon, and a huge wave crashed into the seawall.

Over the course of a paragraph, especially a paragraph describing a complex series of events, tenses may shift between simple and perfect tenses. For instance, a simple past action might precede the discussion of other events that occurred in the past and whose actions or consequences continued into the present. But, as long as the tenses are correctly used, tense shifts between different sentences are allowed, and often needed. An error occurs when the verb tense shifts within a sentence and without cause.



Sample Question

As part of a prolonged effort to curb abuses, # the governments reduce the amount of bonuses given for arrests. The hope behind this effort was that with fewer perks for arresting people, fewer needless and illegal arrests would be made. Since the new policies went into effect only two weeks ago, it remains to be seen if it will be an effective change of course in the long run.

- A. NO CHANGE
- B. the governments are to reduce the amount of bonuses given for arrests
- C. the governments reduced the amount of bonuses given for arrests
- D. the government's reduction in the amount of bonuses given for arrests

The opening clause of the sentence notes a “prolonged effort,” which indicates the government action has taken place over a long time period in the past. The proper verb will either be in the past tense or span a long amount of time. C, “The governments reduced . . .” is the best choice among the answers. “The government’s reduction” creates a sentence fragment by eliminating the main verb from the sentence, and “the governments are to reduce” conveys that the action has not yet taken place, when later in the passage we are told that “the new policies went into effect . . . two weeks ago.”

Verb Mood

Verb moods show the mode or manner in which a thought, idea, or action is expressed. Whereas verb tenses are obviously used to show time and order, verb moods are used to show states of being. There are four verb moods in English, and knowing the form and conditions in which these moods are used will help you both to recognize errors and to compose your own writing.

The Indicative Mood is by far the most commonly used verb mood. It expresses a state of reality. As the name suggests, the indicative mood is used to simply indicate that an event or action has or will occur in actuality. You can think of the indicative verb mood as the default mood in which verbs are usually phrased, unless one of the other verb mood conditions exist.

The sky is blue.

That movie was upsetting.

The fish swam away from me right as I was about to grab it.

According to the forecast, it's going to rain this afternoon.



All of these examples correctly express facts. Note that verb tense is immaterial to verb mood. The indicative mood can be used with any verb tense.

The **Imperative Mood** is used to indicate a command or request, or to give permission or issue a restriction.

Correct examples of the imperative mood:

Please, give me some more.

Move over so I can sit down.

Stop doing that!

I am going to be waiting in the surveillance truck across the street. Signal with your arms when you want me to pick you up.

All four of these examples correctly use the imperative mood. The first three examples are isolated and fairly clear. The verb comes at the beginning of the sentence and issues a command/request or places a restriction on someone's behavior. The final example includes multiple sentences, the first is in the indicative mood and the second is in the imperative, as the speaker is asking or telling his/her interlocutor which action to take.

The **Subjunctive Mood** is the most commonly misused verb mood in English. This verb mood should be used to express a statement contrary to fact, an untrue or hypothetical condition, a wish, or a doubt. An excellent indicator that the subjunctive mood should be used is the word "if."

I would if I could.

The judge demanded that he be banished from the county.

If I were a better fiscal planner, I would not be writing this sentence right now.

These sentences express, in order, a hypothetical condition, a wish, an order, and another hypothetical condition.

Quick Tip

A good indicator that the subjunctive mood will be required for a dependent clause expressing an order or recommendation is the subordinating conjunction "that," as shown in the second example sentence.

Subjunctive Mood Errors

The vast majority of verb mood errors occur in the use of the subjunctive mood. The following sentence, for example, is incorrect:

✗ It is vital that the students are told what to do in the event of a fire.

This sentence is incorrect. Since the dependent clause "that the students are told what to do in the event of a fire," expresses a recommendation it should be expressed in the subjunctive mood.

The corrected version of this sentence reads,

It is vital that the students be told what to do in the event of a fire.

Another common error made in the subjunctive mood involves the past tense of "is."

✗ If I was tall, I would be a basketball player.



This sentence is incorrect. The correct past tense form of “is” in the subjunctive is “were” not was. “If I was” is never a correct formulation. This thought should be formed as: “If I were.”

The corrected version reads,

If I were tall, I would be a basketball player.

Sample Questions

1 He said he wouldn't have jumped into the murky lake if someone else would not have jumped in before him. You could see the trail of water behind him that led back to the lake, and as he walked away, his shoes squelched. I was left holding a heavy, damp sweater at arm's length and surrounded by the smell of algae, **2** wishing that someone made him think about consequences once in a while.

1.
 - A. NO CHANGE
 - B. if someone else hadn't jumped in before him
 - C. if someone else hasn't jumped in before him
 - D. if someone else were not to have jumped in before him
2.
 - A. NO CHANGE
 - B. wishing for that someone would make him
 - C. wishing someone would have made him think
 - D. wishing someone would make him think



1. B, “if someone else hadn’t jumped in before him”

This sentence will try to trick you into using the subjunctive mood, but remember that the subjunctive is only used to describe hypothetical situations and dreams. Because the character actually did jump into the murky lake, the correct mood is simply the past indicative: “He said he wouldn’t have jumped into the murky lake if someone else hadn’t jumped before him.”

2. D, “wishing someone would make him think”

This sentence is expressing a wish of the speaker’s, so it calls for the use of the subjunctive mood. The rest of the passage is in past tense, so you may assume that you need to choose an answer choice that uses the past tense so that tense remains consistent. However, the “once in a while” calls for the present tense, not the paste tense, because it is applying to actions that have yet to occur, not actions that have already occurred. In answer choice B, the “for” in “wishing for that” makes the phrase ungrammatical, and C can’t be correct because while it employs the subjunctive mood, it also employs present tense. D is the correct answer.

The next two sample questions require knowledge of tense and mood in order to be correctly answered.

Sample Question

1 “Were you to have chosen that restaurant, we have to dress up,” she offered, sitting across from him outside the café and putting down her menu. “I’m glad we didn’t have to do that. I like this place better, and **2** knowing me, I always spill something on myself if I wore a nice dress.”

1.
 - A. NO CHANGE
 - B. Were you to choose that restaurant, we would have to dress up
 - C. Were you to have chosen that restaurant, we would have had to dress up
 - D. If you choose that restaurant, we would have had to dress up
2.
 - A. NO CHANGE
 - B. knowing me, I always spill something on myself when I wore a nice dress
 - C. knowing me, I spill something on myself if I wore a nice dress
 - D. knowing me, I would spill something on myself if I wore a nice dress



1. C, “Were you to have chosen that restaurant, we would have had to dress up”

As written, the sentence does not correctly use the subjunctive mood where it is called for. “Were you to have chosen that restaurant” means that the verb phrase “have to” needs to be subjunctive, not indicative.

Next, let’s analyze each potential edit for grammatical correctness. D doesn’t make sense; “choose” is a present tense verb, but “would have had to dress up” is a past-tense construction. This leaves us to choose between B and C. Things get a bit subtle, here: pay attention to the context of the passage. Where is this conversation taking place? The speaker is addressing her dining partner at dinner. We can tell this because she “puts down her menu” and says, “I’m glad we didn’t have to do that, I like this place better.” Given this, B does not make sense, as the restaurant was chosen in the past, and if they would have had to dress up for dinner, they would have had to have done so already before going to dinner, not in the future. They’re at dinner already. Thus, C is the best answer, because it properly uses the subjunctive and fits within the passage’s timeline.

2. D, “knowing me, I would spill something on myself if I wore a nice dress”

As it’s written, the underlined portion of the sentence is incorrect because it uses the word “always” to describe a general situation that needs to be specified further. (The implicit question posed by the use of “always” is “When does the speaker never fail to spill on herself?”) This calls for present tense, but the sentence uses the past-tense “wore.” B changes out “if” for “when,” which doesn’t remedy this error. C omits “always,” but contains an awkward clash between the present-tense verb “spill” and the past-tense verb “wore.” D is the correct answer; it uses an “if-then”-style construction that makes proper use of the subjunctive. “If I wore a nice dress” is the “if” part of the construction, and “I would spill something on myself” is the “then” part that correctly employs the subjunctive.

Mood Shifts

Mood shifts, while a natural and relatively constant aspect of any person’s inner emotional life, are frowned upon in English grammar. Most of these shifts are similar in nature to the errors discussed above—shifts from subjunctive to indicative, or vice-versa, due to improper verb formation. Verb mood can also inappropriately shift between complete sentences, if this shift is misleading or arbitrary. Usually, these kinds of errors occur when the mood shifts between the indicative and the imperative clause.

✗ The teacher gave very specific instructions for what to do in a fire. Exit the classroom calmly and in a single file line.

Here, the “specific instructions” are given by “the teacher.” By shifting the verb mood from the indicative to the imperative, the instructions go from being given by the teacher to the students to being given by the writer to the reader.



Corrected, this sentence reads,

The teacher gave very specific instructions for what to do in a fire. She told them to exit the classroom calmly and in a single file line.

Sample Question

Jill's idea for increasing campus knowledge of the club was a good one, if a little hard to implement. # Give out free cookies between classes with the club's website written on them in frosting. Printing out the URL on a tag and attaching it to a cookie bag seemed more prudent; it was terribly easy to smudge frosting, and no one was sure that their culinary handwriting was that accurate.

- A. NO CHANGE
- B. To give out free cookies between classes
- C. She wanted to give out free cookies between classes
- D. Giving out free cookies between classes

This sentence, as it's written in the passage, switches to the imperative tense unnecessarily and ungrammatically. B and D both create sentence fragments by conjugating "Give" to the infinitive "To give" (B) and the gerund "Giving" (D) and not adding in a new main verb. The correct answer is C because it changes the mood of the sentence from imperative to declarative to match the rest of the passage while keeping the sentence complete.

Voice

Verb voice is determined by how the agent of action (the "do-er") is situated in the overall sentence structure. The active voice is used when the agent of action is used as the grammatical subject of the sentence. For example,

Kevin cooked our meal.

The passive voice is used when the agent of action is a grammatical object in the sentence, and the target of the action is used as the subject. For example,

The meal was cooked by Kevin.

There is a common, and unfortunate, myth that has been promulgated by some misguided would-be arbiters of English grammar that it is always incorrect to use the passive voice. While it is true that the active voice is most often the clearer, more succinct choice, there are still some instances in which it is correct to use the passive voice construction (I have used it plenty of times in this very lesson!).



Grammatically speaking, as long as they are used correctly, the two voices are equally grammatically correct; the general preference for the active voice is a matter of style, clarity, and concision.

The passive voice should be used in instances when the agent of action is relatively unimportant contextually, as compared to the recipient or target of the action, or when the agent of the action is unknown.

The important documents were delivered by a delivery guy.

Here, obviously, the “important documents” should be emphasized, as opposed to the agent of action, an anonymous “delivery guy.”

The potential awkwardness of the passive voice is probably clear, but we’ll look at one example of an unnecessary and awkward use of the passive voice to make this point clear.

All the mats were cleaned yesterday by Matt, the new P. E. teacher.

That sentence is much more awkward, and less clear in its intent, than this one:

Yesterday, Matt, the new P. E. teacher, cleaned all the mats at the gym.

Another illustrative example of the potential awkwardness is made obvious when the subject of the sentence is also the speaker.

All the mats were cleaned yesterday by me.

Since the subject is recipient of the action here, the speaker (the agent of action in this case) becomes the object, so the objective pronoun case is required, as opposed to the subjective pronoun case, which is much smoother for discussing action.

I cleaned all the mats yesterday.



Sample Question

Scenes from daily life were painted by the French Impressionists, in a break with their predecessors. While Monet is famous for his landscapes, he also created some works showing daily scenes, such as *Le Déjeuner* (*The Lunch*). Degas took viewers behind the scenes at dance studios and in theaters, and Manet's *Music in the Tuileries* shows a large group of people enjoying music in a park. Each artist created famous works showing their subjects in the midst of everyday activities.

- A. NO CHANGE
- B. In a break with their predecessors, the French Impressionists painted scenes from daily life.
- C. Breaking from their predecessors, scenes from daily life were painted by the French Impressionists.
- D. The French Impressionists' scenes from daily life painted in a break with their predecessors.

The initial sentence is in passive voice. The correct answer conveys the proper meaning while changing it to active voice.

The focus of the passage is arguably the French Impressionists mores than the “scenes from daily life,” as the rest of the passage details how various French Impressionist artists participated in this movement. We're not given very many details about the works themselves or how they represent “scenes from daily life.” Furthermore, the last sentence keeps the focus on “each artist.” Thus, there's no reason to use the passive voice in the first sentence.

In figuring out how to make the sentence use the active voice, we need to be careful that we don't rearrange it so that it includes a dangling participle. C makes this mistake; “Breaking from their predecessors” does not apply to “scenes,” the noun that immediately follows the phrase; it describes “the French Impressionists,” a noun phrase that appears near the end of the sentence, far from its opening phrase. The way that answer choice D begins with “The” somewhat presumes that the reader is already familiar with the scenes from daily life painted by the French Impressionists. Furthermore, D's sentence is actually a sentence fragment; it lacks a verb. “Painted” is acting as a participle. The correct answer is B, which uses the active voice and does not insert additional errors.



Conventions of Usage

Effectively coordinating usage and congruency within the rigid constructs of standard English grammar can be a frustrating endeavor. The most simplistic communications can be easily confounded with the introduction of basic mistakes. The Conventions of Usage questions within the Standard English Conventions subscore of the SAT is designed to test fluency in recognizing and modifying errors in basic usage.

While the Expression of Ideas subscore addresses the efficiency of language use via questions about word choice, tone, and style, Conventions of Usage questions deal more exclusively with fundamental errors in implementation. Rather than requiring improvements to clarify the conveyance of a given idea or argument, these questions will require outright rectification of errors in usage. Common topics involve agreement, comparisons, and homophones, in the sense that the errors presented directly invalidate the integrity of the content being communicated. Fixing errors in Conventions of Usage will allow the given sentence to be read legibly.

The following lessons will outline a series of topics critical to Conventions of Usage: pronoun usage, homophones, agreement, and logical comparisons. Mastering these concepts will help you root out usage errors in sentence selections on the SAT Writing and Language test, and can help you with constructing your Essay too!

Section Outline

Pronoun Choice

- Evaluating pronoun usage in the context of pronoun-antecedent errors

Homophones, Possessives, and Contractions

- Identifying homophones and selecting correct terms in context

Agreement

- Structuring subject agreement in context, including subject-verb agreement

Logical Comparison

- Recognizing and correcting comparison of unlike terms



Pronoun Choice

Before we delve too deeply into questions interrogating pronoun choices, let's be absolutely clear about what pronouns are. Pronouns are simply substitutions for other nouns. The noun to which a pronoun refers is called its "antecedent." The reason we use pronouns is that we may need to refer to a specific noun (a.k.a. thing) several times in short order; pronouns allow writers to avoid (or at least mitigate) the redundancy of using the same noun over and over again in quick succession.

Quick Tip

The pronoun "it" nor the should never be used to refer to a person. In addition, you should never use the phrase "The person that . . ."—it's always "The person who . . ." or "the person whom . . ."

The best examples of this are personal pronouns. Personal pronouns are direct substitutes for proper nouns. Any personal pronoun used in a passage should be directly tied to a name or list of names.

Singular pronouns ("he" and "she") replace individual names (like "Kevin" or "Jenna"), while plural pronouns ("they" or "them") replace plural proper noun phrases ("Kevin and Jenna").

Let's look at a very brief passage to illustrate the necessity of pronouns.

Rusty walked to the store. After Rusty arrived, Rusty realized that Rusty had forgotten Rusty's wallet at home. Sighing angrily, Rusty walked home empty-handed.

That was a whole lot of Rusty, which was unavoidable since those three sentences were exclusively concerned with Rusty's thoughts, feelings, and actions. So, to vary this insanely repetitive structure, we can instead use a simple personal pronoun, which will allow us to mix up the language, even if just a little.

Rusty walked to the store. After he arrived, Rusty realized that he had forgotten his wallet at home. Sighing angrily, he walked home empty-handed.

Every use of the personal pronoun "he" or the possessive pronoun "his" could be replaced with "Rusty" or "Rusty's," but the mere removal of several repetitions smooths out the sentence considerably.

Pronoun Ambiguity

Now, having extolled the virtues of pronouns, it is time to look upon some of the difficulties inherent to their use in writing. Nouns have almost infinite variety, while pronouns are severely limited. There are millions of male names, but only one personal pronoun ("he"), which naturally can lead to some confusion, if the pronouns are improperly used.

Anytime a pronoun is used in a passage, that pronoun must have a clear antecedent; that is, it must directly connect to a noun or pronoun that was mentioned before it. If it does not do this, it will result in an error. For example:

Jim, Jerry, and Frank were best friends; unfortunately he never talks to them anymore.

Whoa now! Who is this "he" we are all of a sudden talking about in the second clause? And what group of people makes up "them"? The sentence, as it stands, does not give us enough context to justify its use of a pronoun.



Jim, Jerry, and Frank were best friends; unfortunately Jerry never speaks to the other two anymore.

Anytime you are reading a test passage and you find yourself confused by a pronoun, look over the sentence again and try to clarify it; if you can't, make a note on it. That unclear pronoun may come back as a question in mere moments!

Sample Question

Penelope made her fortune baking the best banana bread in town, but Sam is an up-and-coming baker who is known for her chocolate brownies.

Both Penelope's and Sam's bakeries are full of delicious deserts, but I personally prefer hers. My opinion is biased, though, as Sam made the cake that was served at my sister's birthday party. It was absolutely delicious!

- A. NO CHANGE
- B. Both Penelope and Sam bakeries are full of delicious deserts, but I personally prefer hers.
- C. Both Penelope's and Sam's bakeries are full of delicious deserts; I personally prefer hers.
- D. Both Penelope's and Sam's bakeries are full of delicious deserts; I personally prefer Sam's.

The sentence in question contains an error in that it is unclear whether “hers” refers to Penelope’s bakery or Sam’s, as they are both presented in the sentence’s opening clause. The correct answer is D, as it identifies a specific, unambiguous antecedent to “hers” that also makes sense given the logic of the rest of the passage.

The trickiest pronoun usage questions, like this next one, might require you to consider the entire passage in order to ascertain which logic makes the most sense when choosing a clear replacement pronoun for an ambiguous one.



Sample Question

As the group waited to spot the comet in the dark field outside of town, it struck me that Rachel and Nancy were polar opposites. Rachel laughed and chatted with her friends while eagerly watching the night sky, while all Nancy did was complain about the mosquitoes and ask when they were going back. # She was certainly having the better time.

- A. NO CHANGE
- B. Rachel was certainly having the better time.
- C. Nancy was certainly having the better time.
- D. Rachel and Nancy were certainly having the better time.

All of the listed sentences could be grammatically correct, and in the right logical context, any of them could make sense. This particular paragraph describes Rachel “laughed” and “chatted” “while eagerly watching the night sky,” while it says Nancy “complained” and “asked when they were going back.” The paragraph’s details convey that Rachel had the better time, so B is the correct answer. To change the “she” in question to “Nancy” would insert a logical inconsistency into the paragraph, while to change it to “Rachel and Nancy” wouldn’t make sense at all, as the comparison is being made between their experiences, not between their experiences and some one else’s or some other group’s.



Pronoun Agreement

Any time a pronoun is used to replace a noun, that pronoun must agree (link to Agreement) in both number and gender with the antecedent noun to which it refers.

✗ The football players were all multi-sport athletes; as only a basketball player, I admired that about him.

Here the pronoun “him” does not correspond in number to the only available antecedent “the football players,” which is plural. (Note the presence of “all” in the sentence). Since we know that there is more than one football player, and because these two clauses are connected into a compound sentence, the sentence must be rewritten either to specify which specific player the speaker admired or change pronouns so as to agree with the antecedent.

The football players were all multi-sport athletes; as only a basketball player, I admired that about them.

Sample Question

Things have changed in the workplace, let me just tell you. # I remember back when I was herding sheep, each man and sheep had their own sleeping bag. Nowadays, you’d be lucky to get your hands on a pillow, let alone an entire sleeping bag for a woolly friend!

- A. NO CHANGE
- B. I remember back when I was herding sheep, each man and sheep had they’re own sleeping bag.
- C. I remember back when I was herding sheep, each man and sheep had his or her own sleeping bag.
- D. I remember back when I was herding sheep, each man and sheep had some of their own sleeping bags.

This sentence uses the incorrect pronoun to stand in for “each man and sheep.” The use of each individualizes the subject here, making the plural pronoun “their” incorrect. The singular pronoun “his or her” agrees with the subject, so C is the correct answer.

Be particularly vigilant when dealing with sentences that involve phrases that are set apart from the rest of the sentence by commas before the sentence returns to its main clause (and main point). It’s easy to get distracted or confused if the last noun mentioned in the set-apart phrase doesn’t match up with the noun to which a pronoun needs to refer back to after the phrase is complete.



Sample Question

Brightly colored tropical birds are native to many equatorial countries. One such bird, the toucan is primarily recognized by its prominent beak and bright colors; # they are painted a vibrant mixture of black, white, red, yellow, and blue. Toucans love to eat fruit and can use their large beaks to eat even small items like grapes with ease.

- A. NO CHANGE
- B. they are painted a vibrant mixture of black; white; red; yellow; and blue
- C. it is painted a vibrant mixture of black, white, red, yellow, and blue
- D. they are painted a vibrant mixture of colors

The plural pronoun “they” refers back to the subject of the first part of the sentence, “The toucan.” Since this noun is singular, the pronoun should be too. Changing “they” to “it” corrects the sentence’s error. The corrected sentence reads, “One such bird, the toucan is primarily recognized by its prominent beak and bright colors; it is painted a mixture of vibrant red, yellow, and blue.” C is the correct answer!



Homophones, Possessives, and Contractions

Whether it's figuring out whether to use "it's" and "its" or telling apart "affect" and "effect," or distinguishing between "to," "two," and "too," it seems as if everyone trips up on one of the SAT Writing and Language test's commonly featured grammatical snags. This lesson will go over groups of terms that are often and easily confused by test-takers, giving advice about how to determine which one is called for in a sentence.

Let's start by looking at "the big three": "it's"/"its," "they're"/"their"/"there," and "you're"/"your."

"Its" vs. "It's"

This distinction can be tricky to remember because "it's" looks like a possessive formed in the typical way—by adding an apostrophe and an "s." Instead, for this specific situation, think of the apostrophe as representing a break between two words.

"Its" = possessive

"It's" = the contraction of "it is"

Its a good thing you gave the dog **its** chew toy before it chewed up all our shoes!

"They're" vs. "Their" vs. "There"

The apostrophe in "they're" represents a break between two words—this form is the contraction. As for "their" vs. "there," "their" is a possessive pronoun and is the one that contains the letter "I" (also a pronoun).

"They're" = contraction of "they are"

"Their" = possessive form of the pronoun "they"

"There" = demonstrative adverb conveying location at a distance

They're really lucky that **their** luggage was at the hotel when they got **there**.

"You're" vs. "Your"

Apostrophe to the rescue again! As usual, it represents a break between two words, meaning that "you're" is the contraction of "you are" and "your" is the possessive form of "you."

"You're" = contraction of "you are"

"Your" = possessive form of the pronoun "you"

You're probably wondering where all the food in **your** fridge went.

Quick Tip

Instead of thinking of apostrophes as always meaning that the words containing them are possessive, for these particular terms, consider the apostrophe to mark a break between two words.



Sample Question

1 My cat likes to bury its toy mice in the couch as well as bat them under it; their also its preferred gift to visitors. **2** As a result, after you're done visiting my house, you might find in your bag a drool-covered old cat toy, its ears frayed from having been chewed on. **3** If that happens (and it's likely it will), your welcome to keep it or to return it; we have plenty and they're inexpensive.

1.
 - A. NO CHANGE
 - B. My cat likes to bury it's toy mice in the couch as well as bat them under it; their also it's preferred gift to visitors.
 - C. My cat likes to bury it's toy mice in the couch as well as bat them under it; they're also it's preferred gift to visitors.
 - D. My cat likes to bury its toy mice in the couch as well as bat them under it; they're also its preferred gift to visitors.

2.
 - A. NO CHANGE
 - B. As a result, after your done visiting my house, you might find in your bag a drool-covered old cat toy, its ears frayed from having been chewed on.
 - C. As a result, after you're done visiting my house, you might find in you're bag a drool-covered old cat toy, it's ears frayed from having been chewed on.
 - D. As a result, after your done visiting my house, you might find in your bag a drool-covered old cat toy, its ears frayed from having been chewed on.

3.
 - A. NO CHANGE
 - B. If that happens (and it's likely it will), you're welcome to keep it or to return it; we have plenty and they're inexpensive.
 - C. If that happens (and its likely it will), your welcome to keep it or to return it; we have plenty and they're inexpensive.
 - D. If that happens (and its likely it will), you're welcome to keep it or to return it; we have plenty and their inexpensive.



1. D, “My cat likes to bury its toy mice in the couch as well as bat them under it; they’re also its preferred gift to visitors.”

“Its” is the possessive pronoun, whereas “it’s” is the contraction meaning “it is,” so the “its” in “My cat likes to bury its toy mice” is correct because this “its” conveys the ownership of the cat over the toy mice. The “their” that follows the semicolon is incorrect; “their” is a possessive pronoun, but what is being claimed in the phrase “their also its preferred gift to visitors”? We need “they’re,” the contraction of “they are.” The “its” in the phrase “its preferred gift to visitors” is also correct. It wouldn’t make sense to use a contraction here. This means that D is the correct answer.

2. A, NO CHANGE (“As a result, after you’re done visiting my house, you might find in your bag a drool-covered old cat toy, its ears frayed from having been chewed on”).

The “you’re” in this sentence is correct; it can be replaced with “you are” and the sentence still makes grammatical sense. The “your” in “your bag” is also correct, as it is indicated that you own the bag. The “its” is also correct; it conveys the possession of “ears” by “old cat toy.” This means that the sentence is correct as written, and A is the correct answer.

3. B, “If that happens (and it’s likely it will), you’re welcome to keep it or to return it; we have plenty and they’re inexpensive.”

The “it’s” in “it’s likely it will” is correct—“it is” can be substituted into the sentence for “it’s” and it still makes sense, so we’re using the correct form of “its”/“it’s.” The “your” in “your welcome to keep it or to return it” should be changed to “you’re,” which means “you are.” “Your” is a possessive pronoun and doesn’t make sense in the sentence as written. The “they’re” in “they’re inexpensive” is correct because “they’re” is a contraction for “they are.” Thus, B is the correct answer.

Now, let’s take a look at three more often-confused terms.

“Who’s” vs. “Whose”

“Who’s” = contraction of “who is”

“Whose” = possessive form of the pronoun “who”

Whose idea was it to toss out the paper that said who’s sitting by whom?

“We’re” vs. “Were”

“We’re” = contraction of “we are”

“Were” = past-tense indicative or subjunctive verb, depending on context

We were all just discussing this, and we’re all in agreement that were we to explain where all your food went, you might get a bit frustrated with us.

“Wear” vs. “Where”

“Wear” = a verb that means *to style one one’s body as clothing*

“Where” = an adverb that means *at what location*

Where did I put the shirt that I wanted to wear today?



Sample Question

1 We we're just about to buy tickets for the party when I realized something: I don't have anything I can where to it because of the strict dress code. Everyone who's going to the party will have difficulty with it. **2** We're still going because the bowling alley where it's being held is a fun place, but who's idea was it to make bowling a black tie event? **3** Were going to have to pile up our fancy shoes and sort through them afterward to figure out whose is whose, and I might not find where mine are until way after I need to wear them again.

1.
 - A. NO CHANGE
 - B. We we're just about to buy tickets for the party when I realized I didn't have anything I could wear to it because of the strict dress code. Everyone who's going to the party will have difficulty with it.
 - C. We were just about to buy tickets for the party when I realized I didn't have anything I could wear to it because of the strict dress code. Everyone who's going to the party will have difficulty with it.
 - D. We were just about to buy tickets for the party when I realized I didn't have anything I could wear to it because of the strict dress code. Everyone whose going to the party will have difficulty with it.

2.
 - A. NO CHANGE
 - B. We're still going because the bowling alley where it's being held is a fun place, but whose idea was it to make bowling a black tie event?
 - C. Were still going because the bowling alley wear it's being held is a fun place, but whose idea was it to make bowling a black tie event?
 - D. Were still going because the bowling alley wear it's being held is a fun place, but who's idea was it to make bowling a black tie event?

3.
 - A. NO CHANGE
 - B. We're going to have to pile up our fancy shoes and sort through them afterward to figure out whose is whose, and I might not find where mine are until way after I need to wear them.
 - C. Were going to have to pile up our fancy shoes and sort through them afterward to figure out whose is whose, and I might not find where mine are until way after I need to wear them.
 - D. Were going to have to pile up our fancy shoes and sort through them afterward to figure out who's is who's, and I might not find where mine are until way after I need to where them.



1. C, “We were just about to buy tickets for the party when I realized I didn’t have anything I could wear to it because of the strict dress code. Everyone who’s going to the party will have difficulty with it.”

The “we’re” in “We we’re just about to buy tickets for the party” is incorrect; we need a past-tense verb here (“were”), not a pronoun-and-present-tense-verb contraction (“we’re”). We also need to change “where” in “I didn’t have anything I could where” to “wear,” the verb meaning *to style one one’s body as clothing*. The “who’s” in “Everyone who’s going” is correct, though—“who’s” is the contraction of “who is,” which makes sense in the sentence. The correct answer is C.

2. B, “We’re still going because the bowling alley where it’s being held is a fun place, but whose idea was it to make bowling a black tie event?”

This sentence’s use of the contraction “We’re” in “We’re still going” is correct. Its uses of “where” and “it’s” in “the bowling alley where it’s being held” are each correct as well; “where” is an adverb that relates to location, and “it’s” is the contraction of “it is.” The sentence’s use of “who’s” is not correct, though; we need a possessive pronoun (“whose”), not a contraction of “who is” (“who’s”). The correct answer is B!

3. B, “We’re going to have to pile up our fancy shoes and sort through them afterward to figure out whose is whose, and I might not find where mine are until way after I need to wear them.”

The “were” that begins this sentence is incorrect—one could say “We are going to have to pile up our fancy shoes” and be correct, so the contraction “we’re” should be used. The phrase “whose is whose” is correct as written; this phrase calls for the possessive pronoun, not the contraction of a pronoun and a present-tense verb. The clause “I might not find where mine are until way after I need to wear them again” is correct as written. It uses “where” when discussing location and “wear” when talking about putting shoes on one’s feet. So, C is the correct answer.



Let's look at a few more terms that are very easy to mix up.

Imminent vs. Eminent

“Imminent”: adjective meaning unavoidable and often used to refer to bad occurrences, e.g. the phrase “imminent danger” or “The strong storm was imminent, so we decided to head home.”

“Eminent”: adjective meaning well-respected and famous in a particular field, e.g. “The eminent scholar who spoke at the conference was extremely eloquent.”

Effect vs. Affect

“Effect,” noun = the result of an action or cause

“Effect,” verb = to cause a particular specified change to take place

“Affect,” noun = a false mannerism, often one used with the intention of impressing others

“Affect,” verb = to alter or cause a change in a specified subject

Rule of Thumb: you effect (*cause*) a change, which might affect (*alter*) others.

People who put on affects often do so because they are trying to affect the way that others view them, but often, others see through the charade, so it doesn't have its intended effect. As a result, affects are not an advisable way of effecting positive changes in the way others perceive you.

Elude vs. Allude and Allusion vs. Illusion

“Elude” = to avoid or remain out of reach, e.g. “The answer eluded her.”

“Allude” = to refer in a work of literature to another, famous work of literature, e.g. “By naming the main character of the novel “Ishmael,” the writer alludes to *Moby Dick*.”

“Allusion” = the noun form of “allude,” a literary reference to another work of literature, e.g. “I almost missed the short story's allusion to Chaucer's *Canterbury Tales*, but when I noticed that each of the characters were taking turns telling stories on their way to the grocery store, I caught on to what the author's reference.”

More casually, the term can also be used to mean *a subtle reference*. (“I caught the tactful allusion to the surprise party in the way she talked about the weather.”)

“Illusion” = a visual trick that makes something untrue appear to be true, or the thing that appears true when it is not, e.g. “The magician performed an illusion in which he appeared to conjure up a rabbit out of thin air, but really, he had it hiding in his hat the entire time.”



Sample Question

1 The answer to the question on the literature exam was alluding her. It was about the rhetorical affects of certain lines in which a character put on an affect and began speaking in an epic poetic style. She skimmed the passage again and spotted something. **2** It wasn't an illusion, it was really there: an allusion to Homer. After she answered each question, she turned in her exam happily. **3** The class was done and she could no longer affect any changes in her grade, but she was happy with her work—she had started studying for this exam long before it seemed like an imminent concern. **4** She hoped the reasoning of her written responses wouldn't elude the professor, an imminent scholar in the field.

1.
 - A. NO CHANGE
 - B. The answer to the question on the literature exam was eluding her. It was about the rhetorical effects that certain lines in which a character put on an affect and began speaking in an epic poetic style.
 - C. The answer to the question on the literature exam was alluding her. It was about the rhetorical effects that certain lines in which a character put on an effect and began speaking in an epic poetic style.
 - D. The answer to the question on the literature exam was eluding her. It was about the rhetorical affect that certain lines in which a character put on an effect and began speaking in an epic poetic style.

2.
 - A. NO CHANGE
 - B. It wasn't an illusion, it was really there: an illusion to Homer.
 - C. It wasn't an allusion, it was really there: an illusion to Homer.
 - D. It wasn't an allusion, it was really there: an allusion to Homer.



3. A. NO CHANGE
 B. The class was done and she could no longer affect any changes in her grade, but she was happy with her work—she had started studying for this exam long before it seemed like an imminent concern.
 C. The class was done and she could no longer effect any changes in her grade, but she was happy with her work—she had started studying for this exam long before it seemed like an eminent concern.
 D. The class was done and she could no longer effect any changes in her grade, but she was happy with her work—she had started studying for this exam long before it seemed like an imminent concern.
4. A. NO CHANGE
 B. She hoped the reasoning of her written responses wouldn't elude the professor, an eminent scholar in the field.
 C. She hoped the reasoning of her written responses wouldn't allude the professor, an imminent scholar in the field.
 D. She hoped the reasoning of her written responses wouldn't allude the professor, an eminent scholar in the field.

Archaic Language

These terms are unlikely to show up on the SAT, but are still worth being familiar with.

“Won't” vs. “Wont”

“Won't”: a contracted verb phrase meaning “will not”

“Wont”: an archaic adjective meaning “used to (doing something)”

“I know you're **wont** to have coffee with every meal, but **won't** you consider trying some tea instead?”

“Can't” vs. “Cant”

“Can't”: a contracted verb phrase meaning “cannot”

“Cant”: an archaic noun meaning “hypocritical talk,” “popular phrasing,” or “slang”

“The common **cant** in the 60s was for everything cool to be “far out,” and you **can't** use this phrase today without evoking that era.”

Tip: Both of these distinctions can be drawn easily by answering the question, “Is this word acting as a noun or a verb?” Contractions are verbs, and the alternate spellings and meanings of these terms are both nouns.



1. B, “The answer to the question on the literature exam was eluding her. It was about the rhetorical effect of certain lines in which a character put on an affect and began speaking in an epic poetic style.”

The use of “alluding” in “the answer . . . was alluding her” is incorrect. She can’t find the answer, so one could say it is avoiding her. This calls for the use of “eluding,” not “alluding.” The use of “affect” in “rhetorical affect of certain lines” is incorrect; you need “effect,” as rhetoric isn’t being personified and can’t be said to be putting on an “affect.” A character can, though, so “lines in which a character put on an affect” is correct. This makes B the correct answer.

2. A, “NO CHANGE” (“It wasn’t an illusion, it was really there: an allusion to Homer.”)

This sentence is correct as written! The first use of “illusion” is correct because the context (“it was really there”) calls for a word that would mean “something that isn’t really there,” which “illusion” does. “An allusion to Homer” makes sense as a phrase, as text might allude to an author or poet, and Homer is a poet.

3. D, “The class was done and she could no longer effect any changes in her grade, but she was happy with her work—she had started studying for this exam long before it seemed like an imminent concern.”

Quick—do you “affect” or “effect” change? You “effect” change and can “affect” other people. So, “effect any changes” should be “affect any changes.” “Imminent” is correctly used; it means *impending* or *unavoidable*. “Eminent,” on the other hand, means *well known and esteemed*. Using that word to describe an exam wouldn’t make sense.

4. B, “She hoped the reasoning of her written responses wouldn’t elude the professor, an eminent scholar in the field.”

The test-taker is hoping that her responses make sense to her professor, so she doesn’t want their meaning to avoid the professor. This calls for “elude,” not “allude.” It makes sense for the professor to be described as an “eminent scholar”—a well known and esteemed one. It wouldn’t make much sense for him or her to be described as an “imminent scholar,” as “imminent” means *impending* or *unavoidable*.



Agreement

While it is natural for humans to disagree amicably with one another, such flexibility is not afforded the various parts of English sentences. All parts of grammatically correct English sentences must agree with one another. This includes all grammatically related nouns, as well as nouns and the verbs that describe their actions.

Noun-Noun Agreement

Related nouns in a sentence should agree in number. When we say “agree in number,” we mean that plural nouns most often suggest that a corresponding, logically related noun should be plural as well. The same goes for singular nouns. This is probably best illustrated with an example.

✗ During our panel, we came up with an answer to all the questions that were asked.

Here, it does not really make sense that “we” had a single answer to “all the questions.” These related nouns should agree in number.

During our panel, we came up with answers to all the questions that were asked.

The exception to this rule of noun-noun agreement can be found with abstract nouns, which should usually remain singular, as they are concepts, even if they are represented by multiple objects.

✗ His loves for his wife were shown by the many books of poems he dedicated to her.

This sentence, as you can see, reads quite oddly. While “love” and “many books of poems” are, indeed, directly logically related in this sentence (the “books” show the “love”), since “love” is being used here as an abstract noun to represent a singular emotional state, it must remain grammatically singular.

His love for his wife was shown by the many books of poems he dedicated to her.

Sample Question

The frazzled librarian scampered back to the desk. # “We checked the cover of all of the books in that section, but couldn’t find the title Amy requested,” she reported. “We need to log it in the ‘Missing Titles’ list.”

- A. NO CHANGE
- B. We checked the cover of all of the book in that section of the library, but couldn’t find the title Amy requested
- C. We checked the covers of all of the books in that section of the library, but couldn’t find the title Amy requested
- D. We checked the covers of all of the books in that sections of the library, but couldn’t find the title Amy requested



“Books” is a plural noun, and multiple tangible books presumably have multiple covers, so “cover” needs to be changed to “covers.” The correct answer choice, C, makes this change. While D also makes this same change, it also changes “section” to “sections,” creating an ungrammatical phrase in “that sections.” “That” is always used to refer to a singular noun; if referring to a plural noun, “these” should be used instead.

Sample Question

Polydactyl cats are a special type of cat that can have seven toes on each feet. That fact makes me wonder whether the extra digits make it easier for them to scratch things. If I had a polydactyl cat as a pet, I’d make sure it had a good scratching post.

- A. NO CHANGE
- B. Polydactyl cats are a special type of cats that can have seven toes on each feet.
- C. Polydactyl cats are special types of cats that can have seven toes on each foot.
- D. Polydactyl cats are a special type of cat that can have seven toes on each foot.

The sentence uses the phrase “seven toes on each feet,” and this is incorrect because “each” is used to describe a singular noun, but “feet” is plural. Changing “feet” to “foot” corrects this error. Two answer choices do this, but the incorrect one also uses the plural phrase “special types of cats” to refer to “polydactyl cats.” In this case, “polydactyl cats” are being referred to as one type of cat, so it is correct to call them “a special type of cat.” Answer choice D is correct.

Subject-Verb Agreement

Nouns encompass a very diverse part of speech. They will interact with, and thus need to agree with, plenty of other parts of a sentence other than other nouns. When a noun is acting as the subject of a sentence, that noun must always agree with the main verb in number. This is most clearly seen with “be” verbs.

~~X~~ That man at the park are always shouting at the ducks.

Clearly, this sentence is incorrect. There is only one “man,” so the plural form of the verb “are” must be changed.

That man at the park is always shouting at the ducks.

This can also go the other way, necessitating that noun be changed.



Those men at the park are always shouting at the ducks.

In most cases, the subject of a sentence will precede the verb, but there are some exceptions to this.

✗ There is so many things wrong with the way you do business, sir.

This sentence begins with “there is” (a common structure that allows the verb to precede the subject). Thus, we see the verb in its singular form before we realize that a plural form is required (as there are “so many things wrong”). The key to navigating these sentences is to keep track of the grammatical subject and verb. Do not assume that the subject will follow the verb, but rather read the sentence as it stands and identify the subject, verb, and objects.

There are so many things wrong with the way you do business, sir.

A common error in the agreement of subjects and verbs comes in the use of collective nouns. Collective nouns refer to groups of things or people but act, grammatically, as singular objects. If the subject of a sentence is a collective noun, the verb of that sentence should remain in its singular form.

✗ The firm are still making a decision on your employment status at the moment.

While “the firm” is composed of many more than two people, here the collective stands a singular grammatical entity.

The firm is still making a decision on your employment status at the moment.

The coordinating conjunction “or,” when used to connect two nouns in a sentence, renders the subjects it connects singular. When “and” is used in this fashion, the two subjects connected are joined, and must be treated as plural.

✗ The umbrella or the hat are at the bottom of the stairs.

This sentence is incorrect, since the use of “or,” while connecting the two subjects, treats them both as singular entities.

The umbrella or the hat is at the bottom of the stairs.

Now, let’s try it with “and,” remembering that the “and” connects the two items, making them into a plural group.

The umbrella and the hat are at the bottom of the stairs.

If you’re mathematically inclined, think of “and” as a plus sign between the two items, while “or” puts brackets around the two subjects.

Watch out for “every” and “each”! When used as adjectives and adverbs, these words individualize the noun they modify.

After the exciting win, each member of the baseball team was elated.

Basically, when “every” and “each” are being used as adjectives, you can imagine the word “one” right after them, individualizing the subject.



The subject and verb are fundamental parts of every sentence, so it is vital to keep track of them in each sentence you encounter and to make sure they agree with one another. This can get tricky when a phrase intervenes between the subject and verb.

✗ The children, who had all eaten far more sweets than caution would naturally dictate, was upset.

This sentence features a long, extremely wordy (link to **Concision**) parenthetical providing context about how much the children had eaten, which might lead you to miss the flagrant disagreement between the main subject and the main verb. Since there are many “children,” the verb should agree with this plural subject.

The children, who had all eaten far more sweets than caution would naturally dictate, were upset.

Watch out also for singular nouns ending in “s.” Just because a noun ends in “s” does not necessarily mean it will be plural. Generally, singular nouns ending in “s” refer to subjects, games, or diseases. For example:

Mathematics is a subject that I just cannot get my head around.

This sentence is correct! The speaker is referring to one subject, the noun for which ends in a “s.” He or she is not referring to many “mathematics,” just the one subject.

Sample Questions

1 That pair of ice skaters glide over the ice so beautifully, yet whenever I try to skate, I trip and fall. I guess more practice is in order before I can skate with such balance. **2** Each of the best skaters have probably fallen down a lot while practicing, too.

1.
 - A. NO CHANGE
 - B. Those pair of ice skaters glide over the ice so beautifully
 - C. That pair of ice skaters glides over the ice so beautifully
 - D. That ice skaters glide over the ice so beautifully
2.
 - A. NO CHANGE
 - B. The best skaters has probably fallen down a lot while practicing, too.
 - C. Each of the best skaters has probably fallen down a lot while practicing, too.
 - D. Each of the best skater has probably fallen down a lot while practicing, too.



1. C, “That pair of ice skaters glides over the ice so beautifully”

“Pair” is a singular collective noun. While it represents a group of two, it represents one group, and is grammatically treated as singular in terms of its agreement with other nouns and with verbs. Thus, “glide,” which agrees with plural nouns, should be changed to “glides,” which agrees with singular nouns. Only one answer choice features this change: C, the correct answer.

2. C, “Each of the best skaters has probably fallen down a lot while practicing, too.”

Remember, phrases that begin with “each” are singular, so “Each of the best skaters” needs to be paired with a singular verb. B can be ignored because “The best skaters,” a plural phrase, does not agree with “has,” which is used with singular nouns. C uses the correct verb “has” with the subject “Each of the best skaters,” so it is the correct answer. D is incorrect because it says “Each of the best skater,” which is ungrammatical.

Noun Agreement Within Longer Passages

The key thing to keep in mind throughout this lesson is that on the New SAT, you will not be asked to simply identify the elements of a solitary sentence that fail to agree and fix them. You will be asked to read a passage, or a section of a passage, and in the flow of reading for content and style, still identify grammatical errors like noun agreement in sentences within that passage. It will always be worthwhile to read these passages twice, once for meaning and once for editing purposes. You can’t edit a passage (outside of the most obvious errors) without first understanding the passage’s meaning. In your second, editing-focused reading, try to think structurally and grammatically about what you are reading. When we read for comprehension, we tend to gloss over grammatical errors so we can understand the basic meaning of what is being said. When you go back over a passage to edit it and spot any errors, you should be reading with a critical, analytical eye.

In terms of spotting subject-verb agreement errors, this will involve reading each sentence (or at least the sentence a question specifically asks you to look at) in terms of its technical grammatical components. Identify the main clause and their key elements of that clause: subject, verb, and objects. Once you’ve identified those, you can look at the subject and make a clear decision about that subject, whether it is plural or singular, and then look at the verb and see how that verb is conjugated.



Sample Questions

Succulents have become popular houseplants as of late. **1** A few details suggests why this is the case. **2** The plants are adapted to arid climates, so it requires very little water, sometimes needing attention as rarely as once a month. **3** Furthermore, a succulent encompasses a wide variety of unusual forms. Compared to traditional houseplants, succulents look fascinatingly alien. **4** It's easy to see why they've become so popular!

1.
 - A. NO CHANGE
 - B. A few details suggest why these are the cases.
 - C. A few details suggests why this is the cases.
 - D. A few details suggest why this is the case.

2.
 - A. NO CHANGE
 - B. The plant is adapted to an arid climate, so they require very little water, sometimes needing attention as rarely as once a month.
 - C. The plants are adapted to arid climates, so they require very little water, sometimes needing attention as rarely as once a month.
 - D. The plant is adapted to arid climates, so it requires very little water, sometimes needing attention as rarely as once a month.

3.
 - A. NO CHANGE
 - B. Furthermore, succulents encompass a wide variety of unusual forms.
 - C. Furthermore, succulents encompasses a wide variety of an unusual form.
 - D. Furthermore, a succulent encompasses wide varieties of unusual forms.

4.
 - A. NO CHANGE
 - B. It's easy to see why it's become so popular!
 - C. They're easy to see why they've become so popular!
 - D. They're easy to see why it's become so popular!



1. D, “A few details suggest why this is the case.”

In this sentence as it is written in the passage, the plural subject “a few details” does not agree with the verb “suggests,” which is conjugated to agree with a singular subject. Changing “suggests” to “suggest” corrects this sentence’s error, but two answer choices do this. One of these, D, leaves the phrasing of “why this is the case” unchanged, but the other, B, changes that phrasing to “why these are the cases.” There is no reason to use the plural in this instance, as the phrase “why this is the case” is typically singular. Answer choice D is correct.

2. C, “The plants are adapted to arid climates, so they require very little water, sometimes needing attention as rarely as once a month.”

This question presents multiple answer choices that when read by themselves outside of the context of the passage are grammatically correct. These are C and D. Answer choice A begins by referring to “The plants” (plural) before using a singular pronoun “it” to refer to them incorrectly. Answer choice B does the opposite, beginning with the singular “The plant” and using a plural pronoun, “they.”

In choosing between C and D, we need to consider the rest of the passage. The passage begins by talking about “succulents,” a plural noun. Nothing in the second sentence suggests that a switch to talking about a singular plant is called for. Answer choice C, the one that refers to the plural noun “the plants,” is thus the correct answer, as it keeps consistent with the passage’s initial choice of a plural subject.

3. B, “Furthermore, succulents encompass a wide variety of unusual forms.”

It doesn’t make much sense that a single succulent would “encompass a wide variety of unusual forms,” so the plural is called for in this sentence, allowing us to narrow our answer choices down to B and C. “A wide variety of an unusual form” is ungrammatical, as you inherently need more than one of something to represent “a wide variety” of it. Thus, the correct answer is B.

4. A, “NO CHANGE”

This sentence is correct as written. “It’s easy to see” is a correct use of a common phrase, and nothing in the passage calls for the use of “they’re” instead of “it’s” in this instance. While B is grammatically correct when read out of the context of the passage, the passage has discussed succulents in the plural, not as “a succulent.” Thus, it makes the most sense to remain consistent with this stylistic choice, which the correct answer, A, does.



Logical Comparison

When making direct comparisons in English, writers need to abide by certain grammatical rules so that the comparisons you state make logical sense and your readers are able to understand them without confusion. The SAT Writing and Language test may scatter some comparison errors throughout the presented passages and ask you to correct them.

Comparisons are signaled by language such as “more than,” “more _ than,” “less than,” “less _ than,” “better than,” “worse than,” or “as _ as.” Items are also implicitly compared when someone is choosing “between x and y” or “amongst x, y, and z,” so the same rules about parallelism apply.

Two general types of comparison errors can arise: comparisons may be faulty because they compare unlike parts of speech, or they may compare two correct part of speeches that do not logically equate. Let’s look at some examples of each of these.

Terms Being Compared Must Be the Same Part of Speech

When directly comparing two terms, those terms need to be the same part of speech. This is because comparisons require a strict form of parallel structure in which the two terms being compared are equated. Consider the following two example sentence:

✗ It takes much less time to drive there than it does flying.

In this sentence, an infinitive (“to drive”) is equated with a verb (“flying”). To correct this sentence, we would need to change one of the words to be the same part of speech as the other. While it doesn’t matter which one we change, in this sentence, it’s easiest to change “flying” to an infinitive, “to fly.” This is because this change doesn’t require us to adjust the rest of the sentence like changing “to drive” to “driving” would.

It takes much less time to drive there than it does flying.

Let’s look at another example.

✗ She had a hard time choosing between signing up for swimming and soccer as her elective.

There’s a lot going on in this sentence, which can be a little overwhelming when you first read it. Complex errors like this one take a moment to unravel, so the correct answer may not be immediately apparent to you. If you find yourself confused about a comparison, first identify the terms being compared. Here, we’re told that the subject had difficulty choosing between “signing up for swimming” and “soccer.” Wait, those aren’t the same part of speech! There’s the error. “Signing up for swimming” is a gerund phrase because “swimming” is acting like a noun in this sentence, but “soccer” is just a regular noun. Really, the comparison being made is whether the subject wanted to sign up for swimming or sign up for soccer, not just “soccer.” How can we adjust the sentence to convey that? Sometimes we can move the part of the comparison that needs to apply to both terms so that it appears before the comparison word (here, “between”), but we can’t do that here. Instead, we can adjust the sentence a bit and move “signing up for” outside of the comparison.



She had a hard time choosing between swimming and soccer when signing up for her elective.

Let's go over one more example. This next one is pretty tricky! Can you spot the error on the first read-through?

- ✕ Waiting for that unheated bus to the store in this blizzard seems like it would be as bad as freezing cold walking there, and take as long if not longer.

This sentence's error is pretty well hidden. What two things are being compared? "Waiting for that unheated bus to the store in this blizzard" is the first term, and the second is "freezing cold walking there." "Waiting" and "freezing" seem to be the same part of speech; they both end in "-ing." But look again with an eye for how the words are behaving in the sentence: "waiting" is a gerund because it's acting like a noun, but "freezing" isn't a gerund; it's acting as a participle modifying "cold." So, this sentence is effectively equating a noun and an adjective. We can fix this issue in a few ways. We could omit the word "cold"; that would mean that "freezing" wasn't modifying it and was instead acting as a gerund. Alternatively, we could insert the word "being" before "freezing"; "being" would then be the gerund equated with "waiting."

Waiting for that unheated bus to the store in this blizzard seems like it would be as bad as freezing walking there, and take as long if not longer.

Waiting for that unheated bus to the store in this blizzard seems like it would be as bad as being freezing cold walking there, and take as long if not longer.

Words that end in "-ing" can act as verbs, as gerunds (which act like nouns), or as participles (which act like adjectives). Pay extra attention when such words show up in comparisons!

Verb: Before freezing the water in the ice tray, make sure you actually need more ice cubes.

Gerund: Freezing ice is easy if you own a refrigerator with a freezer.

Participle: The ice was freezing cold, as I found out when I slipped and fell on it.



Sample Question

Many people struggle to learn to type, but shouldn't get discouraged if they find the process to be more difficult than anticipated. **1** It is a more difficult task to learn to type than mastering a simple word-processing program. **2** Like video games or playing the piano, typing requires a great deal of hand-eye coordination, and it is a skill that can deteriorate over time if not practiced.

1.
 - A. NO CHANGE
 - B. It is a more difficult task to learn to type than to mastering a simple word-processing program.
 - C. To master a simple word-processing program is a more difficult task than to learn to type.
 - D. Learning to type is a more difficult task than mastering a simple word-processing program.

2.
 - A. NO CHANGE
 - B. Like the piano or video games, typing requires a great deal of hand-eye coordination
 - C. Like playing the piano or maneuvering in video games, typing requires a great deal of hand-eye coordination
 - D. Like the piano and video games, typing requires a great deal of hand-eye coordination

1. D, "Learning to type is a more difficult task than mastering a simple word-processing program."

This sentence is comparing "to learn to type" with "mastering a simple word-processing program." These two terms need to be the same part of speech. We either need to change "mastering" to "to master" or "to learn" to "learning" so that parallel structure is maintained. The only answer choice that does without introducing other errors is D; B uses the ungrammatical "to mastering" and C inverts the logic of the sentence, claiming that mastering the word-processing program is the more difficult task.

2. C, "Like playing the piano or maneuvering in video games, typing requires a great deal of hand-eye coordination"

What's being compared in this sentence? Three terms are in play: "video games," "playing the piano," and "typing." Two of these are gerunds and one is not: "video games." We need to insert an "-ing" verb in front of "video games" so that it acts as a gerund and matches the other terms being compared. The answer choice that does this is C. A and D change "playing the piano" to "the piano" and differ only in their selection of conjunction ("and" or "or"); this may initially look correct, but neither "the piano" nor "video games" matches "typing," so these answer choices are incorrect.



Terms Being Compared Must Be Logically Equivalent

The more difficult type of comparison error to spot is the one in which the terms being compared are the same part of speech, but they're not logically equivalent—they're not the same type or category of thing. This results in a sentence that just doesn't make sense. Consider the following incorrect example:

- ✗ Wandering around the furniture store, she decided that while burgundy and taupe would work well in her living room, the bright aquamarine lampshade would probably hog the spotlight.

This complex comparison involves the colors “burgundy” and “taupe” and “the bright aquamarine lampshade,” a tangible item. To fix this sentence, we need to either adjust “the bright aquamarine lampshade” to refer to just a color (e.g. “bright aquamarine”) or change “burgundy” and “taupe” so that they specify tangible items (e.g. “the burgundy drapes” and “the taupe carpet”).

Wandering around the furniture store, she decided that while burgundy and taupe would work well in her living room, bright aquamarine would probably hog the spotlight.

Wandering around the furniture store, she decided that while the burgundy drapes and the taupe carpet would work well in her living room, the bright aquamarine lampshade would probably hog the spotlight.

This type of error often appears when possessive nouns or phrases (e.g. “the _ of _”) are in play.

- ✗ Which is larger, the population of New York or Los Angeles?

This sentence compares “the population of New York” with the entire city “Los Angeles.” We can fix this error by adding “the population of” before “Los Angeles,” or revising the sentence so that the information specifying population size appears before the comparison.

Which is larger, the population of New York or that of Los Angeles?

Which is larger, the population of New York or the population of Los Angeles?

Be especially careful when dealing with comparisons that involve possessive nouns.

- ✗ I think that Sheila's painting is much more original than Bob.

While “Sheila's painting” and “Bob” are both nouns, we are comparing a painting to a person, and we need to compare a painting to a painting. Editing “Bob” to read “Bob's painting” fixes this error:

I think that Sheila's painting is much more original than Bob's painting.



Sample Question

As far as places to eat for lunch, I recommend going to the deli across the street. # At that deli, the sandwiches are similar to the cafeteria, but they are slightly larger, a bit healthier, and definitely fresher. Plus, you can eat your sandwich on one of the benches in the nearby park and enjoy the weather.

- A. NO CHANGE
- B. That deli's sandwiches are similar to the cafeteria's
- C. Deli sandwiches are similar to cafeteria sandwiches
- D. At that deli, the cafeteria sandwiches are similar to its sandwiches

“Sandwiches” cannot be compared to “the cafeteria”—these are very different things. What the speaker seems to be comparing are the sandwiches at the deli and the sandwiches at the cafeteria. D makes this comparison but inverts the sentence’s syntax in a way that is needlessly confusing; mention of the deli’s sandwiches should immediately follow the introductory prepositional phrase “At that deli.” Answer choice C is grammatically correct, but doesn’t work in the passage because it is much more general than the statement in the passage. The speaker is not talking about “deli sandwiches” in general, i.e. all of them. Similarly, he or she isn’t talking about all “cafeteria sandwiches.” He or she is talking about the sandwiches one can order at a particular deli vs. those you can order at a particular cafeteria. B is the correct answer; it discusses sandwiches associated with the specific deli and cafeteria being discussed, and uses possessive punctuation to convey that the comparison is being made between the “deli’s sandwiches” and “the cafeteria’s.” It is perfectly grammatically correct to not repeat the word “sandwiches” after “cafeteria’s” here; the structure of the sentence conveys that the comparison is being made between the sandwiches from the two venues.



Conventions of Punctuation

For some, punctuation is the bane of their grammatical existence. Even if an argument is worded with precision and presented in a perfectly constructed sentence, incorrect punctuation can devalue the desired message and undermine the intended argument. The Standard English Conventions subscore of the SAT requires mastery of grammatical principles on all levels, including the implementation of correct punctuation.

Developing an eye for Conventions of Punctuation may initially seem straightforward: there are a small number of variables when implementing punctuation. The problem lies in the nuances of the rules governing punctuation. Many punctuation elements can be implemented in non-traditional ways without actually violating grammatical constructs. As such, identifying and correcting errors in punctuation can become a mentally trying task. You may be forced to sift through clauses that appear strangely constructed, but are actually grammatically sound.

The following lessons will outline the Conventions of Punctuation that govern the use of commas, colons, semicolons, dashes, and periods. Within the constructs of the SAT Writing and Language exam, identifying the instances of incorrect grammatical implementation is an essential tool in ruling out answer options for those questions dealing with Standard English Conventions.

Section Outline

Ending Sentence Punctuation

- Selecting effective usage of periods, question marks, and exclamation points

Internal Sentence Punctuation

- Selecting effective usage of colons, dashes, and semicolons

Possessive Nouns and Pronouns

- Implementing apostrophes to signify possession and plurality

Items in Series

- Utilizing commas and semicolons to construct lists and series

Nonrestrictive and Parenthetical Punctuation

- Recognizing correct usage of parentheses and dashes in asides



Ending Sentence Punctuation

Every independent clause needs to end with one of three punctuation marks: a period, a question mark, or an exclamation point.

Periods end declarative sentences, or sentences which simply provide information.

I need to take out the trash.

Question marks end interrogative sentences, or questions.

How did you forget to take out the trash?

Exclamation points end exclamatory sentences, or sentences that are said with a lot of emotion—in other words, sentences that you need to convey would be shouted or at least said with greater intensity, were they to be read.

I can't believe you forgot to take out the trash after I asked you to do so five times!

Imperative sentences, or commands, can end with periods or exclamation points, depending on the tone the writer wishes to convey.

Take out the trash

or

Take out the trash!

These three punctuation marks are only used to end sentences; they should never appear in the middle of a sentence, or they will create sentence fragments.

You should only ever use one punctuation mark at the end of a sentence; multiple punctuation marks, while perhaps somewhat common in informal writing, are never grammatically correct.

Note that when dealing with direct quotations, this rule may require that a period be implied, as in the following sentence:

I heard that George asked the grocer, "What is the most expensive coffee you carry?"

Here, the question mark ends George's question, which is being repeated to us in the declarative sentence; however, since a period would need to go inside the quotation marks and a question mark is already there, the period is left off entirely and implied.

As a final note, while end-of-sentence punctuation may seem relatively straightforward, complex sentences like the following one can toe the line between declarative and interrogative, resulting in a bit of confusion about which punctuation mark to use when concluding them.



Sample Question

Joe and Jenna were wondering if Sheila could bring a light snack – a fruit or cheese platter, for example – to the faculty meeting? They think it might be easier to start the meeting on time if people get there earlier, and serving food might help with that.

- A. NO CHANGE
- B. Joe and Jenna were wondering if Sheila could bring a light snack, a fruit or cheese platter, for example, to the faculty meeting?
- C. Joe and Jenna were wondering if Sheila could bring a light snack – a fruit or cheese platter, for example – to the faculty meeting.
- D. Joe and Jenna were wondering if Sheila could bring a light snack, a fruit or cheese platter, for example, to the faculty meeting.

This sentence is declaratory, not interrogative. In other words, the writer is describing a situation (Joe and Jenna are wondering something) and not asking a question (such as “were Joe and Jenna wondering?”). Even though the sentence is expressing uncertainty, it is not an interrogative sentence and therefore should not have a question mark. A period is the correct punctuation to end this sentence. Thus, C is the correct answer. While D also ends the sentence with a period, its use of commas to set apart a phrase that itself employs a comma is a bit confusing, and C, which uses hyphens to set apart the phrase, is the clearer and better option.

If you find yourself confused about whether a sentence like the previous one is declarative or interrogative, focus on the main nouns and verbs in the subject and predicate. In the last example sentence, the subject is “Joe and Jenna” and the main verb phrase is “were wondering.” There’s no question that they “were wondering”—they have a question, but the sentence is not itself a question; it is declaratively stating that they had a question, that they “were wondering” something. Focusing on these main verbs is a good way to figure out what type of sentence you’re dealing with and therefore which punctuation mark is needed to conclude it.



Internal Sentence Punctuation

A variety of punctuation marks are available in standard modern English for writers to use in the middle of sentences. Dashes, colons, and semicolons all concern the insertion of pauses into the reader's experience of the text, but they vary in terms of their specific connotations. Let's consider each of these punctuation marks in turn to get a sense of how they function individually and how they relate to one another, in addition to investigating the particular grammatical and stylistic errors that are associated with each one.

Single Dashes

You can think of a dash by itself as functioning something like a blend between a comma and a colon. Like a comma, a dash provides a pause in a sentence, but like a colon, its use conveys that the material to follow will answer some crucial question, rename the last noun discussed, or dramatically emphasize the last point made.

Answering some crucial question:

There's only one thing we can do now—run!

(The crucial question: What's the one thing we can do now?).

Renaming the last noun discussed:

She offered me a choice between cherry or mint ice cream—my two least favorite flavors.

(“Cherry” and “mint ice cream” are the speaker's “two least favorite flavors”).

Adding emphasis to the material that follows:

Camping is my family's favorite pastime—but not mine.

I was ordered to go defeat the dragon in the dungeon—or else.

Context is very important when deciding whether to use a comma, a semicolon, a colon, or a dash. While several can be grammatically correct in a given sentence, each one conveys a subtly different meaning. Dashes can also be used in pairs, a use which is covered in our [Nonrestrictive and Parenthetical Punctuation lesson](#).



Sample Question

The detective let a smug expression creep onto her face; the case was nearly solved. # Only one aspect of the mystery remained for her to unravel, the location of the missing prized chihuahua? She had determined that the butler had been framed for its theft due to his dislike of small dogs and that the mailman had actually stolen it, but she wasn't any closer to locating the missing canine.

- A. NO CHANGE
- B. Only one aspect of the mystery remained for her to unravel, the location of the missing prized chihuahua.
- C. Only one aspect of the mystery remained for her to unravel—the location of the missing prized chihuahua.
- D. Only one aspect of the mystery remained for her to unravel—the location of the missing prized chihuahua?

The latter part of the sentence that appears after the comma as it is written in the paragraph is answering an implicit question: what is the last aspect of the mystery remaining for the detective to solve? Because of this overarching question, it is appropriate to use a single dash to introduce this material. While answer choices C and D both do this, only C correctly changes the question mark to a period. The sentence is declarative; it is asserting that there is only one more detail for the detective to figure out. Don't get confused just because no one knows where the chihuahua is! The sentence's content doesn't automatically make it interrogative.



Colon Errors

Colons (:) are used for two very specific purposes in standard modern English: introducing lists, and providing emphasis. To be prepared to face colon errors on the SAT Writing and Language test, you just have to do one thing: remember these two uses!

Colons for Introducing Lists

Colons are used to introduce lists. The part of a sentence that precedes a colon should be an independent clause, whereas the list should simply consist of a phrase made up of items that are each grammatically phrased / conjugated in the same way—in other words, a list should employ parallel structure.

I went to the bakery and bought three things: donuts, pretzels, and a cake.

Independent Clause

List of Items

You really need that independent clause, or the sentence becomes ungrammatical:

✗ That time I went to the bakery and bought: donuts, pretzels, and a cake.

Dependent Clause

List of Items

Subject with No Predicate - Incomplete Sentence

Colons for Emphasis

Colons can also be used to introduce information in a way that emphasizes it. The first part of the sentence still needs to form an independent clause for this to be grammatically correct, and the latter part of the sentence can be either a phrase or an independent clause; its relationship to the first part of the sentence is what's key.

The content of the two parts of a sentence in which a colon is used for emphasis need to be very closely related. Make sure that the part of the sentence being introduced by the colon is providing some necessary information or answering some crucial question without which the first part of the sentence wouldn't make much sense.

There was only one thing to do: fight the pirates head-on.

Independent Clause

Verb Phrase

Second part of the sentence answers the question, "What was the only thing to be done?"

Independent Clause

We'd attempted a sneak attack with the worst results yet: we'd been forced to make a hasty retreat.

Independent Clause

Second part of the sentence answers the (implicit) question "What were the worst results yet?"



Sample Question

1 I was wondering why he urged the group to go to the new restaurant when it dawned on me: the restaurant had a special on macaroni and cheese, his favorite meal. **2** It was adding a few extra ingredients, too, bacon, breadcrumbs, and chopped-up onion rings. Of course he would want us to go there for dinner!

- A.** NO CHANGE
- B.** I was wondering why he urged the group to go to the new restaurant when it dawned on me; the restaurant had a special on macaroni and cheese; his favorite meal.
- C.** I was wondering why he urged the group to go to the new restaurant when it dawned on me that the restaurant had a special on macaroni and cheese; his favorite meal.
- D.** I was wondering why he urged the group to go to the new restaurant when it dawned on me, the restaurant had a special on macaroni and cheese: his favorite meal.
- A.** NO CHANGE
- B.** It was adding a few extra ingredients, too: bacon, breadcrumbs, and chopped-up onion rings.
- C.** It was adding a few extra ingredients, too; bacon, breadcrumbs, and chopped-up onion rings.
- D.** It was adding a few extra ingredients, too. Bacon, breadcrumbs, and chopped-up onion rings.



1. A, “NO CHANGE”

The clause that follows the colon is answering the implicit question “What dawned on the speaker?” set up by the first clause. Thus, a colon is an appropriate punctuation mark to use when moving from one clause to the other. B uses a semicolon to connect the clauses, which might be permissible, but B cannot be correct because it also replaces the comma that appears later in the sentence with a semicolon. A semicolon can’t be used there because the last phrase, “his favorite meal,” isn’t an independent clause. (Remember, semicolons can only connect independent clauses). C also replaces the comma with a semicolon and thus cannot be correct either. By replacing the colon with a comma, D creates a comma splice, so it is not correct either. A is the correct answer.

2. B, “It was adding a few extra ingredients, too: bacon, breadcrumbs, and chopped-up onion rings.”

The phrase “bacon, breadcrumbs, and chopped-up onion rings” is a specific list detailing the “extra ingredients” this particular restaurant is adding to its macaroni and cheese. A colon should be inserted before this list, after “too.” The correct answer, B, is the only answer choice that does this. Introducing the list with a comma results in a confusing run-on sentence; introducing it with a semicolon is incorrect because the list itself is not an independent clause; and using a period to end the sentence and start a new one results in the list standing alone as an ungrammatical sentence fragment.



Semicolon Errors

Semicolons have two major uses in standard modern English. The first, and most common, is to combine sentences. Semicolons should be used to combine two independent clauses that are thematically related.

When asked what my favorite kind of sandwich was, I faltered; I have several favorites and didn't want to choose.

Semicolons should not be followed by any sort of conjunction, or the compound sentence will become ungrammatical.

✗ Grilled cheese is one of the best, in my opinion; and roast beef is pretty good as well.

In addition, both the material before a semicolon and the material after a semicolon should be able to stand on its own as a sentence. If either can't, the sentence containing the semicolon is ungrammatical.

✗ My favorite breakfast sandwich, eggs on a biscuit; I often make one and eat it before work.

✗ I thought about what kind of sandwiches to bring to the picnic; tuna salad sandwiches.

The second, and rarer, role semicolons play in standard modern English involves a scenario in which items in a list of three or more items are themselves phrases that involve commas. One common example of this is when listing cities followed by the states or countries in which they are located.

✗ I visited Seattle, Washington, Los Angeles, California, and San Antonio, Texas on my vacation.

See how confusing it is to read that? Without prior knowledge, it's very difficult to keep track of which place names refer to cities and which refer to states. Use semicolons in the place of commas in this specific scenario to avoid that confusion:

I visited Seattle, Washington; Los Angeles, California; and San Antonio, Texas on my vacation.

Note that if a comma appears in one item in a list, it is appropriate to use semicolons for the entire list:

I packed my sleeping bag; a pop up tent, which I had borrowed from a friend and only used a few times; a cast-iron skillet; and some popcorn to bring on the camping trip.



Sample Question

When one thinks of American writers who have commented on self-sufficiency, one naturally thinks of Ralph Waldo Emerson. # Leading the Transcendentalist movement, Emerson championed individualism; and spoke against slavery. One can see Emerson’s literary interest in individualism perhaps most strongly in his essay “Self-Reliance.”

- A. NO CHANGE
- B. Leading the Transcendentalist movement; Emerson championed individualism; and spoke against slavery.
- C. Leading the Transcendentalist movement, Emerson championed individualism and spoke against slavery.
- D. Leading the Transcendentalist movement Emerson championed individualism; and spoke against slavery.

C, “Leading the Transcendentalist movement, Emerson championed individualism and spoke against slavery.”

The semicolon used in the passage is used incorrectly. Semicolons can only be used to connect two independent clauses or in place of a comma to distinguish the items in complex lists. There’s no list in this passage, and “and spoke against slavery” is a phrase, not an independent clause. The best answer is simply to remove the semicolon; a comma is not needed because the phrase being introduced after the “and” is a verb phrase, not an independent clause.



Possessive Nouns and Pronouns

Possessive Pronouns

It is vital to the content and clarity of prose to distinguish when an object, trait, or person belongs to another person, organization, or group. For instance, if I say that there are three coffees on a table, and that I drank one of them, it's a pretty vital contextual detail that the coffee I drank belonged to me, as opposed to someone else.

People often own or possess things, especially in a grammatical sense; grammatically speaking, people possess the traits that describe them ("Kenny's confidence"). So, it is important to understand how to modify pronouns in order to denote possession.

If a possessive word is called for in a sentence, make sure that you are clear as to whether a possessive adjective (e.g. "my," "his," "our") or a possessive pronoun (e.g. "mine," "hers," "ours") is needed. Certain pronouns use possessive adjectives and possessive pronouns that are identical, but for others, these are different words.

That's my blanket—it's mine, not yours! Your blanket is over there.

There is one tricky situation to remember when working with possessive pronouns, and it has to do with gerunds. Because gerunds act as nouns, pronouns immediately preceding them referring to their action should be possessive adjectives, not subjective pronouns. This can sometimes be counterintuitive, for example:

✗ Do you think the teacher will mind me eating in class?

This seems correct, and you would probably say it this way out loud, but it is wrong! On the SAT you will always be responsible for the strictly grammatical formation of sentences, and the strictly grammatically correct formation of this question is as follows:

Do you think the teacher will mind my eating in class?

Possessive Nouns

In English grammar, it is not just people who can possess things. Objects may possess properties ("the castle's size was impressive"), organizations or groups may own things, and a person may belong to a group (which would be a noun). In each of these cases, possessive constructions are required.

To make a noun possessive, you need to consider whether the noun is singular or plural, and, if plural, whether or not it ends in an "s."

For singular nouns, simply add an apostrophe followed by an "s" to indicate possession.

I really like Mike's car.

Note also that this applies even to singular nouns that end with "s."

Mitosis's properties are fascinating.

For plural nouns not ending in "s," again simply add an "s" and an apostrophe.

Quick Tip

Remember that possessive pronouns do not include apostrophes!



I'm always amazed by children's capacity for wonder.

For plural nouns ending in an "s" add an apostrophe without an "s."

The class' size is getting unmanageable.

Compound nouns follow this rule, but the apostrophe or apostrophe and "s" need to be placed at the end of the entire compound noun, not at the end of the single-word noun.

My father-in-law's taste in wine is very refined.

The bus station's rules were pretty complicated.

Noun phrases involving two or more listed subjects follow the rule as well, placing the apostrophe or apostrophe and "s" after the last listed noun to convey group ownership of the object of possession. If both nouns are singular, treat the phrase as singular.

Orange juice and grapefruit juice's best property is their vitamin content.

If both nouns are plural, make each plural noun possessive independently.

The companies' and lobbyists' argument was that corporations should be treated as people.

If one of the nouns is plural and the other is singular, make them possessive independently.

My cat's and dogs' shots are all taken care of.

Generally speaking, questions interrogating possessive errors on the new SAT are less affected by the switch to an exclusively passage-based format. Even within a paragraph, these errors are discrete errors based on the presence of an "s" or an apostrophe at the end of a word. These are circumstances of which you should always be aware, and if you are vigilant and you know the rules surrounding them, you will spot these errors easily.

Sample Question

I have started two companies, which I run simultaneously. # Both mine
companies's profits have soared over the last six years. I think it's safe to say
 that I am a valuable employee.

- A. NO CHANGE
- B. Both my companies' profits have soared over the last six years.
- C. Both my companies's profits have soared over the last six years.
- D. Both my company's profits have soared over the last six years.



1. B, “Both my companies’ profits have soared over the last six years.”

The highlighted sentence features two errors of possession that were discussed in the lesson. The first is the incorrect use of the possessive adjective “mine” instead of the possessive pronoun “my.” The second error incorrectly places an “s” after the apostrophe of “companies.” Since “companies” is a plural noun ending in an “s” only the apostrophe is required to demonstrate the “companies” possession of something, in this case “profits.”

Sample Question

Most of the parties involved in the trial expected it to be relatively short and to the point, so its conclusion caused a large stir. # The jury’s decision was affected when a single piece of evidence swayed the final jurors’ opinion. This significantly prolonged their deliberation.

- A. NO CHANGE
- B. The jurys’ decision was affected when a single piece of evidence swayed the final jurors’ opinion.
- C. The jurys’ decision was affected when a single piece of evidence swayed the final juror’s opinion.
- D. The jury’s decision was affected when a single piece of evidence swayed the final juror’s opinion.

“Jury’s” is correct. Even though “jury” describes a group of people, it is a singular noun, like “team” or “committee.” Even though we often speak of multiple “jurors,” here, our attention is being directed to just one of them: “the final [juror],” a singular noun. Thus, “jurors” is incorrect; it should instead be “juror’s.” The only answer choice that makes this change while leaving “jury’s” as written is answer choice D.



Items in Series

There are a few rules of punctuation that specifically relate to the presentation of lists in prose format. Specifically, these rules concern the usage and placement of commas and, in special circumstances, semicolons. Let's begin with a discussion of commas in lists.

Commas in Lists

Of all the many ways in which commas are used, one of the most common is to separate the distinct items in a list. Not all lists need commas, though: only lists with three or more items use commas. Lists of two items don't need commas. Lists with three or more items also need to insert a conjunction (e.g. "and") before the last item.

I bought apples and bananas.

I bought apples, bananas, and pears.

I bought apples, bananas, pears, oranges, coconuts, strawberries, and a pineapple.

These are grammatically incorrect sentences messing up this comma rule:

✗ I bought apples, and bananas.

✗ I bought apples bananas and pears.

For sentences that do not conclude with the lists they contain, you do not need to follow the last item in a list with a comma. This is grammatically incorrect if the comma is solely inserted in relation to the list. A comma may follow the last item in the list if the end of the phrase of which the list is a part calls for it. For example:

✗ I bought apples, bananas, and pears, when I went to the market.

I bought apples, bananas, and pears, but I forgot to buy a pineapple.

The first example is incorrect, and you can tell by omitting all but one item in the list and seeing if the comma is necessary or not. "I bought apples, when I went to the market" is not correct because that comma is not called for. On the other hand, "I bought apples, but I forgot to buy a pineapple" is a correct sentence, because a comma must precede a conjunction when the two are used to combine two independent clauses into a compound sentence.

These rules hold true for much more complex sentences in which phrases form the constituent parts of the list instead of single-word nouns:

I swept the floor so that all of the dust bunnies ran for cover, dusted them out from underneath the furniture, gathered them all into a big pile, decided I was too lazy to wrangle them into the trash can, and brushed them all under the rug.

That sentence may look imposing, but it's still a list. To make its structure more obvious, try writing out the items in the list:



I . . .

1. swept the floor so that all of the dust bunnies ran for cover,
2. dusted them out from underneath the furniture,
3. gathered them all into a big pile,
4. decided I was too lazy to wrangle them into the trash can,
and
5. brushed them all under the rug.

There's a comma after each item except the last one, and "and" is immediately before that. This sentence is correct!

Sample Questions

The history of the English language is a fascinating one that reveals influences from a wide variety of different languages, **1** including French Latin and Anglo-Saxon. This last language came to Great Britain **2** when the country was invaded by Angles Jutes and Saxons groups of people who spoke varieties of German. The country's linguistic landscape was changed drastically when William the Conqueror invaded and brought with him continental French, which became the language of the courts and nobles.

1.
 - A. NO CHANGE
 - B. including French, Latin, and Anglo-Saxon
 - C. including French, Latin, and, Anglo-Saxon
 - D. including French Latin, and Anglo-Saxon

2.
 - A. NO CHANGE
 - B. when the country was invaded by Angles, Jutes, and Saxons groups of people who spoke varieties of German
 - C. when the country was invaded by Angles, Jutes, and Saxons, groups of people who spoke varieties of German
 - D. when the country was invaded by Angles Jutes and Saxons, groups of people who spoke varieties of German



1. B, “including French, Latin, and Anglo-Saxon”

If “French Latin” were a language, the sentence would be corrected, but “French Latin” is not a language; “French” is a language, and “Latin” is a language. Thus, three things are being listed, not two, which means that we need to use commas to separate the items in the list. Neither A nor D can be the correct answer because neither insert a comma between “French” and “Latin,” creating confusion. There’s no reason to include the comma after “and” as in answer choice C, as only one more item in the list is being stated after it; we’re not introducing a new independent clause. Thus, the correct answer is B!

2. C, “when the country was invaded by Angles, Jutes, and Saxons, groups of people who spoke varieties of German”

In this sentence, our list concludes at a point at which we need to use a comma, as “groups of people who spoke varieties of German” is restating the list in a different way. There are three items in the list: (1) Angles (2) Jutes (3) Saxons. We need to insert a comma between “Angles” and “Jutes” and one between “Jutes” and “Saxons.” We also need to follow “Saxons” with a comma so that the noun phrase that concludes the sentence is properly introduced as being apart from the sentence’s main structure. The only answer choice that does both of these is C; as written, the sentence omits both of the needed commas, B omits the necessary comma after Saxons, and D omits the comma needed between “Angles” and “Jutes.”



The Oxford (or Serial) Comma

The “Oxford comma” is the specific comma used to distinguish the second-to-last item in a list from the last item in a list. Some people don’t think it’s absolutely necessary, and some people do. Why use it? Well, in certain sentences, if you don’t use it, you create a lot of confusion:

✗ Some of my favorite foods are muffins, ravioli, ice cream and anchovies.

A reader could potentially interpret “ice cream and anchovies” as being a single item, and we can’t be sure whether the writer meant to indicate “ice cream” and “anchovies” as two of his or her favorite foods or “ice cream and anchovies” as one of them. We recommend always using the Oxford comma so you don’t have to worry about the possibility of phrasing a list ambiguously:

Some of my favorite foods are muffins, ravioli, ice cream, and anchovies.

Because people are still arguing about the Oxford comma, the SAT Writing and Language test won’t test it in unambiguous sentences. The test covers ambiguity, though, so be on your toes for any confusing lists that can be fixed by a well-placed Oxford comma!

Sample Question

“Be sure to invite # the caterers, the bride and the groom, to the planning meeting,” the wedding planner instructed her assistant, who hurriedly jotted down a reminder. “The caterers can start to help the couple pick out the meal, while I have a word with the chefs about the presentation of the cake.” The assistant nodded absently and kept scribbling notes.

- A. NO CHANGE
- B. the caterers, the bride, and the groom, to the planning meeting
- C. the caterers the bride and the groom to the planning meeting
- D. the caterers, the bride, and the groom to the planning meeting

As the sentence is written, it can be interpreted that “the caterers” are “the bride and the groom.” Logic suggests that this is not the sentence’s intended meaning; the sentence is referring to (1) the caterers, (2) the bride, and (3) the groom. To clearly convey this, commas should be used after “caterers” and “bride.” There’s no grammatical need here to end the list with a comma; in fact, that comma should be omitted because it is ungrammatical. This makes the correct answer D.



Semicolons in Lists

Semicolons occasionally make an appearance in lists in standard modern English, but they are only used in a few special circumstances. Semicolons are used to separate items in lists in sentences where items in a list of three or more items are themselves phrases that involve commas. One common example of this is when listing cities followed by the states or countries in which they are located.

✘ I visited Seattle, Washington, Los Angeles, California, and San Antonio, Texas on my vacation.

See how confusing it is to read that? Without prior knowledge, it's very difficult to keep track of which place names refer to cities and which refer to states. Use semicolons in the place of commas in this specific scenario to avoid that confusion:

I visited Seattle, Washington; Los Angeles, California; and San Antonio, Texas on my vacation.

Keep in mind that you do not need a semicolon to distinguish two items in a list, even if they use commas.

✘ Two of my favorite Shakespearian plays are going to be performed this weekend at my town's local art festival: my favorite play, *Much Ado About Nothing*; and my favorite ballet, *Swan Lake*.

Two of my favorite Shakespearian plays are going to be performed this weekend at my town's local art festival: my favorite play, *Much Ado About Nothing*, and my favorite ballet, *Swan Lake*.

Note that if a comma appears in one item in a list, it is appropriate to use semicolons for the entire list.

I packed my sleeping bag; a pop up tent, which I had borrowed from a friend and only used a few times; a cast-iron skillet; and some popcorn to bring on the camping trip.

It is considered appropriate to use semicolons instead of commas to separate the items of a list of the items are each clauses or phrases that are lengthy. Using semicolons inserts a more significant break between the items that helps the reader parse the sentence correctly; however, this distinction is not be tested on the SAT.

Quick Tip

The commas in these example sentences are used to indicate *appositives*.



Sample Question

The federal government of the United States is made up of three branches: the legislative branch, which includes the House of Representatives and the Senate, the executive branch, which includes the Presidency and law enforcement, and the judicial branch, which includes the federal courts, including the Supreme Court. These branches were designed to keep each other in balance through a system of what are called “checks and balances.”

- A. NO CHANGE
- B. the legislative branch, which includes the House of Representatives; and the Senate; the executive branch, which includes the Presidency; and law enforcement; and the judicial branch, which includes the federal courts, including the Supreme Court
- C. the legislative branch, which includes the House of Representatives and the Senate; the executive branch, which includes the Presidency and law enforcement; and the judicial branch, which includes the federal courts, including the Supreme Court
- D. the legislative branch, which includes the House of Representatives; and the Senate the executive branch, which includes the Presidency and law enforcement; and the judicial branch, which includes the federal courts, including the Supreme Court

Let’s map out the items in this list, as they each involve commas and can create a lot of confusion if not approached carefully.

The federal government of the United States is made up of three branches:

1. the legislative branch, which includes the House of Representatives and the Senate
2. the executive branch, which includes the Presidency and law enforcement and
3. the judicial branch, which includes the federal courts, including the Supreme Court

This question isn’t intended to test your knowledge of the U.S. federal government. If you find yourself unsure about where to divide the items in this list—in other words, which governmental bodies and agencies get their own distinct items in the list and which are covered by others—consider parallel structure. We’re told that there are three branches in the federal government, and then three items involving the word “branch”



are listed afterward. These are our “main” items in the list; the other nouns mentioned, like “the Presidency” and “the House of Representatives,” are sub-items that fall under the three branches. Consider it this way: we could omit the phrases beginning with “which” and still have a complete sentence, though it would lack the detail that the one in the passage includes: “The federal government of the United States is made up of three branches: the legislative branch, the executive branch, and the judicial branch.” This clearly reveals what the main listed items are. So, we need to include a semicolon after each “which” phrase describing each of the branches. The answer choice that does this correctly is C, so it is the correct answer.



Nonrestrictive and Parenthetical Punctuation

Not every word in a sentence is absolutely essential. Certain phrases can be omitted without creating an incorrect sentence. Editing decisions surrounding certain uses of punctuation rely on you making the distinction between elements that are absolutely necessary to a sentence's structure and elements that can be omitted without disrupting that structure. In this lesson, we'll first go over the distinction between essential and inessential elements before considering various editing scenarios in which distinguishing between the two makes the difference between coming up with a correct sentence and coming up with one that is grammatically incorrect. Let's get started!

Essential vs. Nonessential Sentence Elements

You may have heard someone try to explain the distinction between “essential” and “inessential” sentence elements in a way similar to this: “Essential elements change the meaning of the sentence when omitted, but you can remove inessential sentence elements without changing the sentence's meaning.” When articulated this way, this distinction confuses many people. After all, isn't every word in a sentence conveying information? The omission of even a small phrase can be said to change the meaning of the sentence, if very slightly. So how do you tell what sentence elements are “essential” and which aren't?

Removing essential sentence elements results in ambiguity, confusion, or an ungrammatical construction. Removing inessential sentence elements does not.

We're going to highlight the distinction between “essential” and “inessential” sentence elements by looking at appositives. Appositives are nouns or noun phrases that immediately follow and rename a given noun or noun phrase in a sentence. We bring appositives up now because those that contain grammatically inessential information must be set apart from the rest of the sentence by commas; appositives that contain grammatically essential information must not be surrounded by commas. So, the distinction is a grammatically important one.

Examples of Appositives

Consider the following sentence, which contains an appositive:

My cat, Bill, likes to eat biscuits.

The word “Bill” is set apart from the rest of the first sentence by commas because it is an appositive. An appositive is a type of noun phrase that renames its subject; here “Bill” is renaming “my cat.” Appositives must be surrounded by commas if they consist of “extraneous” or “grammatically inessential information.” This is the case here. Consider how the sentence sounds if we omit the appositive:

My cat likes to eat biscuits.



Appositives can also appear at the beginning or the end of a sentence, in which case they only require a single comma to be correctly set apart:

I never seem to stock enough of his favorite kind, slightly burnt biscuits.

Strange behavior for a cat, Bill's biscuit-eating habit prompted a trip to the vet.

You can test whether an appositive contains essential or inessential information by removing it from the sentence and seeing whether what is left makes sense and doesn't change the sentence's initial meaning. That sounds complex, but is easier to see in action:

My cat, Bill, likes to eat biscuits. → My cat likes to eat biscuits.

In this sentence, "Bill" is extraneous, and so must be surrounded by commas. You don't "lose" any specificity contained in "My cat likes to eat biscuits" if you don't know that my cat is named Bill. Let's look at another example:

Louis Armstrong, my favorite musician, was a trumpet virtuoso.

→

Louis Armstrong was a trumpet virtuoso.

The same thing happens here: you may not know that Louis Armstrong is my favorite musician, but not knowing that doesn't change the specificity of "Louis Armstrong was a trumpet virtuoso."

Let's take a look at what happens when you try to remove grammatically essential information:

The science fiction writer Isaac Asimov is perhaps best known for his *Foundation* series.

✗ The science fiction writer is perhaps best known for his *Foundation* series.

Removing the appositive drastically changes this sentence's meaning, and introduces confusion by omitting necessary information. Readers are left wondering, "Which science fiction writer are you talking about?" If you're left with a similar question after removing an appositive, chances are it is essential information. Leave it in the sentence and avoid surrounding it with commas.



Sample Question

Pets can have pretty funny names sometimes. # Tiny Tim my neighbor's dog is a Great Dane the size of a small horse. When he stands on his hind legs, he's as tall as I am!

- A. NO CHANGE
- B. Tiny Tim, my neighbor's dog, is a Great Dane the size of a small horse.
- C. Tiny Tim, my neighbor's dog is a Great Dane the size of a small horse.
- D. Tiny Tim, my neighbor's dog is a Great Dane, the size of a small horse.

From the context of the sentence, we can tell that “Tiny Tim” is not the name of a person being directly addressed; it’s the name of the speaker’s neighbor’s dog. Does the sentence make sense without the information conveyed by “my neighbor’s dog”?

“Tiny Tim is a Great Dane the size of a small horse.”

Yes, it does! That means we’ve identified some grammatically inessential information. If we’re keeping this information in the sentence, we need to set it apart with a comma before it begins and a comma after its last word. The only answer choice that does this is B. C could be grammatically correct in a scenario in which the speaker is addressing someone named Tiny Tim, but that’s not what’s going on in the passage. Answer choice D includes too much information in the set-apart appositive phrase. Removing all that information leaves an incomplete sentence, as it omits the main verb, “is”:

“Tiny Tim the size of a small horse.”

D can’t be correct, then. As it’s written, the sentence is confusing, as the noun phrase “Tiny Tim” is immediately followed by the noun phrase “my neighbor’s dog,” with little direction given to the reader about how to interpret the relationship between these phrases. By setting apart the grammatically inessential appositive, you make it clear to the reader what is going on.



That vs. Which: Punctuating Restrictive and Nonrestrictive Clauses

Now that you can distinguish essential and inessential sentence elements, it will be much easier to understand a rule of punctuation that some people find to be particularly finicky. This rule involves the word “that,” the word “which,” and commas.

The diamond that was in the display case was stolen last night.

The diamond, which was in the display case, was stolen last night.

In the first example sentence, “that” begins a restrictive clause. You can think of a restrictive clause as “restricting” the meaning of the noun that it modifies. In this case, it specifies that “the diamond” we’re discussing is the one that specifically “was in the display case”—not any other diamond, such as one in a museum or a private collection. The restrictive clause changes the meaning of the noun directly by restricting the possible meanings of other nouns: it suggests that only one diamond was in the display case and uses this information to focus the reader’s attention. If more than one diamond were in the display case, then it would not make sense to specify “the diamond that was in the display case” because this would be an ambiguous statement. The author used the clause specifying that the diamond was in the display case; therefore, we can assume that there was only one diamond in the case.

The second example sentence uses “which” to begin a nonrestrictive clause. This type of clause does not restrict the meaning of the noun, but merely adds nonessential additional information to the sentence. This clause leaves the possibility open that many diamonds were in the display case, not just the one we’re talking about. That one just happened to be in the display case when it was stolen.

Restrictive clauses are essential in a sentence, while nonrestrictive clauses are not. This means that they must be punctuated differently. Traditionally, “that” is used to begin restrictive clauses, while “which” is used to begin nonrestrictive clauses. What this translates to in terms of grammatical relevance on the SAT is that “that” should never be preceded by a comma, while when the word “which” is used to begin a nonrestrictive clause, it should always be preceded by a comma. Learn that rule, and you’ll be prepared for any restrictive vs. nonrestrictive clause questions without having to recall the exact details behind the pattern.

So, the following sentences is definitely incorrect:

✗ The diamond, that was on display at the museum, was stolen last night.

This next sentence may be incorrect depending on who you ask:

(✗) The diamond which was on display at the museum was stolen last night.

The lack of consensus here is because language changes over time, and “which” can sometimes begin nonrestrictive clauses in modern parlance. Sticking to the traditional distinction, though, means that last sentence is incorrect.



Sample Question

The town's local garlic festival had gotten a little out of hand, she thought, observing the year's specialty foods with a grimace. # The newest fad food was garlic ice cream, that included entire chunks of roasted garlic as well as garlic sauce. She thought it was a bit much.

- A. NO CHANGE
- B. The newest fad food was garlic ice cream. That included entire chunks of roasted garlic; as well as garlic sauce.
- C. The newest fad food was garlic ice cream, it included entire chunks of roasted garlic as well as garlic sauce.
- D. The newest fad food was garlic ice cream, which included entire chunks of roasted garlic as well as garlic sauce.

The sentence isn't correct as written because "that" is used to introduce restrictive clauses, and restrictive clauses are always grammatically essential to the sentence because they change the reader's understanding of the noun(s) they modify. That means that they shouldn't be preceded by commas.

B isn't correct; splitting the sentence after "ice cream" would be grammatically correct if a semicolon weren't also inserted between "garlic" and "as." This semicolon incorrectly separates the phrase "as well as garlic sauce" from the rest of the sentence. Remember, semicolons can only be used when the material in front of them and after them each forms an independent clause.

C isn't correct, either; it contains a comma splice. "The newest fad food was garlic ice cream" is an independent clause that could stand by itself, and so is "it included entire chunks of roasted garlic as well as garlic sauce." That means that these clauses can't be combined using a comma; a conjunction would need to follow that comma for this sentence to be correct.

That leaves us with the correct answer, D, which changes out the original sentence's "that" for "which," removing its error. "Which" can be used to introduce nonrestrictive clauses and should be preceded by a comma.



Parenthetical Elements: Parentheses and Pairs of Dashes

Dashes are used in pairs to set unnecessary material apart from the rest of the sentence. In plays, characters sometimes have “asides,” during which they directly address the audience as if no other characters on stage can hear them. Dashes are often used to convey extraneous material in a manner much like an aside. Dashes should never be used to separate essential information from the rest of a sentence. When used in pairs this way, dashes function something like parentheses, but in contrast to parentheses, they emphasize the material being set apart as much as material in the main sentence instead of downplaying its importance.

They were waiting for a response—anything would have sufficed—but I couldn’t get a word out.

I read my favorite poem—Keats’s “Ode on a Grecian Urn”—but no one seemed to get it.

Most of the time, wherever you can use a pair of dashes, you can use parentheses, and vice versa.

They were waiting for a response (anything would have sufficed), but I couldn’t get a word out.

I read my favorite poem (Keats’s “Ode on a Grecian Urn”), but no one seemed to get it.

Notice how in the first two example sentences, we had to add in a comma after the closing parenthesis in order to correctly connect two independent clauses with a comma and a conjunction.

Certain parentheticals could also potentially be set apart from the sentence using commas, but this doesn’t apply to all of them:

✗ They were waiting for a response, anything would have sufficed, but I couldn’t get a word out.

I read my favorite poem, Keats’s “Ode on a Grecian Urn,” but no one seemed to get it.

Why don’t commas work in the first sentence? Well, the parenthetical is an entire independent clause, and we need “stronger” punctuation—punctuation that conveys more of an “aside,” more distance between the parenthetical element and the main clause—in order to use a full sentence as a parenthetical. Using commas makes the entire sentence seem like it’s intended as one clause instead of a clause with a grammatical “aside” in it; the first comma creates a comma splice, making it incorrect.

In the second sentence, though, the parenthetical, “Keats’s ‘Ode on a Grecian Urn,’” renames and specifies “my favorite poem.” So, it’s functioning as an appositive. Appositive phrases are typically set apart by commas, so this sentence is correct.

As a final note, any material used in a parenthetical needs to be grammatically inessential, necessitating punctuation distinguishing it from the main clause. We can take the parenthetical elements out of the sample sentences without making them



grammatically incorrect. We lose some important details, but grammatically the sentences are still complete:

They were waiting for a response, but I couldn't get a word out.

I read my favorite poem, but no one seemed to get it.

As a rule of thumb, remember that if you can take a phrase or clause out of a sentence without making the sentence grammatically incorrect, that phrase or clause should be separated from the main clause of the sentence with commas, parentheses, or dashes. Remembering this general point can help you if you get confused about which commas are necessary and which are not.

Sample Question

Amidst the group's various complaints—including concern about a sprained ankle and the request for a bandage, mine ("How did that get on my shoe? Ugh!") seemed relatively unimportant. I scraped off whatever I'd stepped in and started digging in my bag for a first-aid kit. Camping in these woods was not for the faint of heart.

- A. NO CHANGE
- B. Amidst the group's various complaints, including concern about a sprained ankle and the request for a bandage—mine, "How did that get on my shoe? Ugh!"—seemed relatively unimportant.
- C. Amidst the group's various complaints, including concern about a sprained ankle and the request for a bandage, mine "How did that get on my shoe? Ugh!" seemed relatively unimportant.
- D. Amidst the group's various complaints—including concern about a sprained ankle and the request for a bandage—mine "How did that get on my shoe? Ugh!" seemed relatively unimportant.

Setting a phrase apart with a pair of dashes or with parentheses tells the reader that it is grammatically inessential information, and to understand it as an "aside." That means that we have to be able to take any information introduced between dashes or parentheses out of the sentence and the sentence still has to make sense. Try omitting this information from answer choice B, and you'll see why it's incorrect.

Amidst the group's various complaints, including concern about a sprained ankle and the request for a bandage seemed relatively unimportant.

Readers are left asking, "What 'seemed relatively unimportant?'" Vital information is missing from the sentence.



C isn't correct either. Not setting it apart using punctuation suggests that it is essential information, but it's not clear how it fits into the rest of the sentence.

D isn't the correct answer either; doing the same "omit the material between the hyphens" test, we end up with a confusing, incomplete sentence:

Amidst the group's various complaints mine "How did that get on my shoe? Ugh!" seemed relatively unimportant.

This sentence includes the same error that B does; it's not clear how the quotation relates to the rest of the clause in which it appears.

The best answer is to leave this sentence as it's written in the passage. As is, it correctly uses parentheses to set apart the quotation from the rest of the sentence, allowing the reader to understand that the quotation is the speaker's complaint that "seemed relatively unimportant." A is the correct answer.



The SAT Math Test

The SAT Math test is heavily weighted on the SAT exam, comprising the entirety of the Math section score and corresponding to 800 of the 1600 points possible on the exam. In short, the SAT Math test is a big deal.

The SAT Math test is broken down into two primary sections. The first section allows the use of a standard calculator—including any basic or scientific calculators and most graphing calculators—and includes 38 questions over a 55-minute period. The second section prohibits calculator use, and consists of 20 questions over a 25-minute period.

Each of the two primary sections has a secondary division, based on question format. Of the 38 questions in the calculator portion of the exam, 30 are multiple-choice and 8 are grid-in. Of the 20 questions on the “no calculator” portion of the exam, 15 are multiple-choice and 5 are grid-in. Multiple-choice questions consist of a question stem, followed by four possible answer options to choose from. In contrast, grid-in questions present a question stem followed by a grid system that allowed students to submit any 4-digit response, including a selection of fractions and decimals.

The content covered on the SAT Math test is quite diverse. Subscores for this section of the exam include Heart of Algebra (Introductory Algebra), Passport to Advanced Math (Advanced Algebra), and Problem Solving and Data Interpretation (Analytics and Problem Solving). The following chapter will address the topics covered by each of these subscores in more depth, and present relevant approaches to studying the material most pertinent to the exam.

Chapter Outline

Review: SAT Math

- A short review of fundamental concepts and assumed knowledge for SAT Math

Introductory Algebra

- SAT subscore evaluating fluency in linear equations, functions, and inequalities

Advanced Algebra

- SAT subscore evaluating fluency in non-linear equations, polynomials, and function notation

Analytics and Problem Solving

- SAT subscore evaluating fluency in data evaluation and statistical analysis

Additional Topics and Geometry

- An amalgam of math topics not covered by any specific SAT subscore



Review: SAT Math

Before beginning to review for the SAT Math test in earnest, it may help to revisit some basic concepts that turn up again and again as the basis of more complex problems. We begin by reviewing the fundamental properties of algebra, namely the commutative property, associative property, and distributive property. All of the book's later treatment of algebra topics assumes that these concepts are second nature to you, so if it's been a while since you considered them, refreshing your knowledge before beginning to review in earnest can help you understand the more difficult topics on which the SAT Math test focuses.

This review section also includes two lessons that help you bolster two more relevant skills: making the most of the information provided in the Given Equations box of your test booklet, and knowing how to approach word problems confidently. Taking a good look at all of the formulae and diagrams provided as Given Equations can save you time and help you focus on learning the material that won't be so concisely provided to you on test day. Furthermore, the new SAT presents many questions in the form of word problems, so familiarizing yourself with this particular type of problem presentation and approaches to solving word problems can increase your efficiency and confidence in using your math skills.

Section Outline

Review: Given Equations

- Gaining familiarity with the given content and equations within the SAT Math test

Review: Properties of Algebra

- Reviewing the fundamentals of algebraic properties and relationships

Review: Approaching Word Problems

- Developing strategies for complex setups and word problems in math



Review: Given Equations

When you sit down to take the Math part of your SAT, you'll be presented with a great deal of information in the form of the given equations included on the page that presents the directions to this part of the exam. You'll be provided with the following equations and diagrams:

You'll be given these diagrams both on the section in which you can use a calculator and on the section in which you can't.

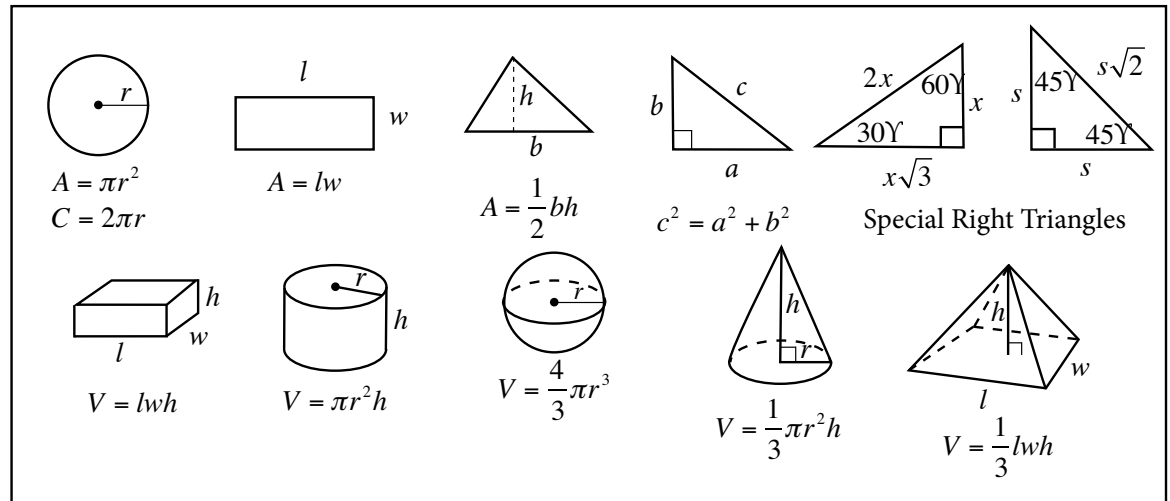

Faced with eleven different shapes and nine equations, you might find yourself feeling overwhelmed. Worse, even if you scramble to familiarize yourself with them in the few moments before you begin your exam, you might assume that you've been given information that isn't provided or forget that you've been given certain information when it could help save you time solving a problem. This lesson will walk you through what each of these diagrams and equations conveys so that on test day, you can minimize page-flipping and know exactly what mathematical information you have referenced at your fingertips.

Circles

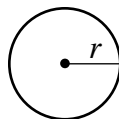

$$A = \pi r^2$$

$$C = 2\pi r$$

A = area
 C = circumference
 r = radius

This diagram demonstrates the definition of a radius: half of a circle's diameter. If you're confused about whether radius or diameter is half of the other, it can help clear up that confusion. The equations are of more use to you, though, defining the area of a circle and the circumference of a circle. If you're given diameter but not radius, you can divide the diameter by two in order to get the radius and make use of these equations as written.

Let's try a simple sample question that requires you to calculate the area of a circle and its circumference.



Sample Question

Consider a circle with a radius of 5 cm. Ignoring units, what is the difference between the area and the circumference of this circle?

- A. 4π
- B. 5π
- C. 12π
- D. 15π

To figure out the correct answer, we will need to calculate both the area and the circumference of the circle using the provided formulae.

$$A = \pi r^2 \quad C = 2\pi r$$

$$A = \pi(5)^2 \quad C = 2\pi(5)$$

$$A = 25\pi \quad C = 10\pi$$

At this point, we can calculate the difference between the circle's area and circumference:

$$A - C = 25\pi - 10\pi = 15\pi$$

The correct answer is D, 15π . Now let's try a more difficult question that relies on the same equations.

Sample Question

A chef wants to wrap a string around a giant wheel of cheese to support a paper label. The wheel of cheese has a diameter of 24 inches. How much string is needed to go around the wheel of cheese exactly once?

- A. 6π in
- B. 24π in
- C. 36π in
- D. 144π in

This question gives us several clues in its wording (e.g. "around," "wheel") that it concerns circumference specifically. We need to calculate the distance around the wheel of cheese. Even though the cheese wheel is technically a three-dimensional object, we need only consider it in two dimensions—in other words, as a circle, or the yellow part of the diagram to the right—to find the correct answer.

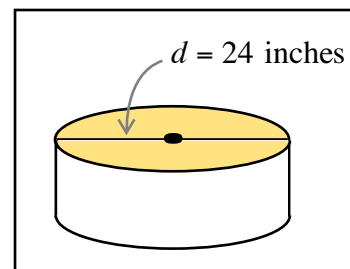

Don't get confused by the fact that a cheese wheel is a three-dimensional object. To answer this question, we will need to calculate the distance around the edge of the circle representing the top of the cheese wheel. We don't need to calculate the area, so be careful that you use the correct equation—using the area equation results in a listed wrong answer.



$$d = 2r = 24 \text{ in}$$

$$2r = 24$$

$$r = 12$$

$$C = 2\pi r$$

$$C = 2(12)\pi$$

$$C = 24\pi \text{ in}$$

The correct answer is B, 24π in.

Rectangles

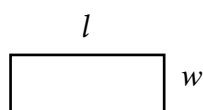

$$A = lw$$

l = length of rectangle
 w = width of rectangle
 A = area of rectangle

This equation defines the area of a rectangle as the product of its length and width, and labels a sample rectangle accordingly. Note that this formula also implicitly tells you how to calculate the area of a square: as a square is a specific type of rectangle, you also multiply the square's length by its width to find its area. The only difference is that with a square, its length and width are equal, making the simplified equation $A = s^2$, where s is the length of one of the square's sides.

Sample Question

A rectangle has an area of 20 square centimeters. Which of the following can NOT be the dimensions of this rectangle?

- A. $l = 10$ cm, $w = 2$ cm
- B. $l = 5$ cm, $w = 4$ cm
- C. $l = 7$ cm, $w = 3$ cm
- D. $l = 1$ cm, $w = 20$ cm

This problem requires you to calculate the area for each of the answers. All but one of them—C—result in 20cm^2 . Because C is the only answer choice that does not result in an area of 20cm^2 ($7\text{cm} \times 3\text{cm} = 21\text{cm}^2$), C is the correct answer.



Sample Question

Sam is planting a vegetable garden. The seeds she wants to plant need a total of **96 square feet** of fertile land on which to grow. If she is planning to **use a twelve-foot wall as one of the sides of her garden** and wants to make it **rectangular**, how much fencing does she need **to construct the other three sides?**

- A. $28m$
- B. $30m$
- C. $40m$
- D. $45m$

The tricky part of this problem is working out exactly how the relationship between area and perimeter is changed by the incorporation of the twelve-foot wall as one side of Sam's garden. Sketching out a diagram might be helpful in this regard—it can help you realize that while the area calculation is unaffected, one of the rectangle's dimensions (the one we labeled w) is fixed by the length of the wall. While many different rectangles might have areas of 96 square feet, this locked-in width will allow you to calculate the specific length of the rectangle that allows its area to be 96 square feet. After that, you can sum two lengths and a width to find how much fencing Sam needs. Dodge a trap by remembering not to use the regular formula for perimeter—Sam only needs three sides of fencing, not four!

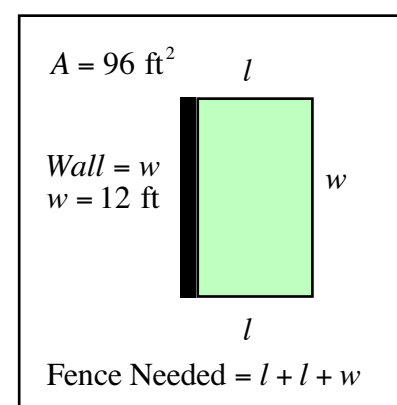

This complex problem boils down to the simple calculation used to find the area of a rectangle based on the length of its sides, except while we are usually given the side lengths and asked to find the area, in this problem, we are given the area and asked to find the side lengths to find the correct answer. Let's call the side that is the 12-foot wall w and solve for the length of the other side, l .

$$A = l \times w$$

$$96 = l \times 12$$

$$l = \frac{96}{12} = 8$$

Now that we have calculated that the missing measurement of a side is $8m$, we can solve the problem by finding the sum of two of the initially missing length sides and one of the given width sides to find how much fence Sam will need for her garden.

$$l = 12$$

$$w = 8$$

$$w + w + l = 8 + 8 + 12 = 28$$

Sam will need 28 m of fencing for her garden, so the correct answer is A.

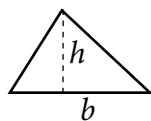

Triangles: Area of a Triangle

$$A = \frac{1}{2}bh$$

While perhaps the least complex information about triangles presented amongst the given equations, this diagram can nevertheless provide a useful reminder that a triangle's area can be calculated if you know the length of its base and its height. It doesn't matter if the triangle is acute, isosceles, right, or obtuse—this formula holds for all triangles.

A = area of a triangle

b = length of base

h = height

Sample Question

A triangle has a height of 4 cm and an area of 24 cm^2 . What is the length of this triangle's base?

- A. 4 cm
- B. 6 cm
- C. 12 cm
- D. 20 cm

We can solve this question by using the formula for the area of a triangle. While we're not solving for the area, this information is provided, allowing us to solve for one of the other variables in the equation, the length of the triangle's base.

$$A = \frac{1}{2}bh$$

$$24 = \frac{1}{2}b(4)$$

$$24 = 2b$$

$$\frac{24}{2} = b$$

$$b = 12$$

The base of the triangle is 12 cm long, so C is the correct answer.



Sample Question

A surveyor is measuring a piece of property shaped like an **isosceles triangle**. She knows that one side of the property is **five miles long**. The area of the property is **40 square miles**. How far is it from the **middle of the five-mile-long side of the property to the intersection of the two other sides**?

- A. 5 miles
- B. 7.5 miles
- C. 14 miles
- D. 16 miles

To solve this problem, you need to know what an isosceles triangle is. If you want to refresh your knowledge of different triangles, [click here](#).

This problem can be solved in several ways, but first you have to figure out what to call the distance for which you are solving. Sketching out the situation in a diagram like the one to the right can help. You need to find the height given the area and the length of one side.

Even though this problem deals with an isosceles triangle, we can still use the equation for the area of a triangle to solve it. In addition, even though the problem doesn't provide a diagram and instead verbally describes the measurement for which you need to solve, making a quick sketch can help you figure out that you being asked to solve for the height of the triangle and have been given the length of its base.

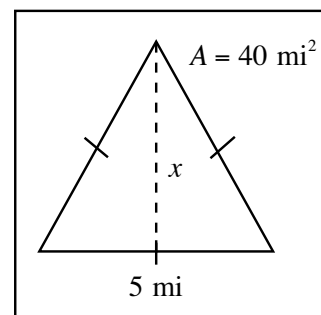

$$A = \frac{1}{2}bh$$

$$40 = \frac{1}{2}(5)h$$

$$40 = 2.5h$$

$$\frac{40}{2.5} = h$$

$$h = 16$$

The height of the triangle is 16 miles, so the correct answer is D.

Triangles: Pythagorean Theorem

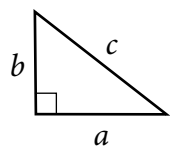

$$c^2 = a^2 + b^2$$

a and b = "legs" of the triangle
 c = hypotenuse

The next triangle diagram provided for you amongst the given equations demonstrates the Pythagorean Theorem. This important equation can be used to calculate the length of one of the sides of a right triangle if know the lengths of two of the other sides, regardless of its specific angles. Furthermore, note that while c always indicates the triangle's hypotenuse, it doesn't matter which of the triangle's "legs" you label a and which you label b . Just don't mix them up once you've labeled them a certain way!



Sample Question

One leg of an isosceles triangle is 3 cm long. How long is the triangle's hypotenuse?

- A. 3 cm
- B. $2\sqrt{3}\text{ cm}$
- C. $3\sqrt{2}\text{ cm}$
- D. $2\sqrt{6}\text{ cm}$

By definition, the two legs of an isosceles triangle are equal in length, so we have all of the information we need to solve for the hypotenuse using the Pythagorean theorem.

$$\begin{aligned} a^2 + b^2 &= c^2 \\ (3)^2 + (3)^2 &= c^2 \\ 9 + 9 &= c^2 \\ 18 &= c^2 \\ c &= \sqrt{18} = \sqrt{9} \times \sqrt{2} = 3\sqrt{2} \end{aligned}$$

The hypotenuse of the triangle is $3\sqrt{2}\text{ cm}$, so the correct answer is C.

Sample Question

An explorer hikes **North** from her camp for **eight miles** and then hikes **East** for **six miles**. Assuming the explorer takes the **most direct route** back to her starting point, how far is she from her camp?

- A. 8 miles
- B. 10 miles
- C. 12 miles
- D. 15 miles

You may need to sketch out this problem's scenario before you realize that you're being asked to find the hypotenuse of a right triangle. You have all of the information you need to use the Pythagorean Theorem to calculate the correct answer.

$$\begin{aligned} a^2 + b^2 &= c^2 \\ (8)^2 + (6)^2 &= c^2 \\ 64 + 36 &= c^2 \\ 100 &= c^2 \\ c &= \sqrt{100} = 10 \end{aligned}$$

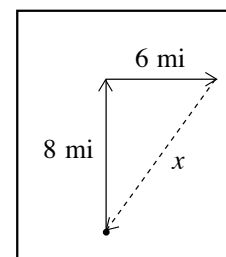

The hiker is ten miles as the crow flies from her starting camp, so B is correct.



Special Right Triangles

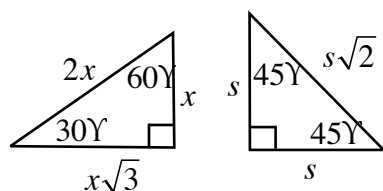

Special Right Triangles

It's worth noting that you are given diagrams depicting the side ratios particular to special right triangles that you can reference on the SAT Math test. These diagrams show that 30-60-90 triangles have a side lengths in the ratio $x : x\sqrt{3} : 2x$, and that 45-45-90 triangles have side lengths in the ratio $s : s : s\sqrt{2}$. This means that if you know the length of one side of a special right triangle, you can use these ratios to calculate the length of either of the triangle's other two sides.

Sample Question

How long is the hypotenuse of the triangle depicted to the right?

- A. $8\sqrt{3}$ cm
- B. $16\sqrt{3}$ cm
- C. 12.5 cm
- D. 32 cm

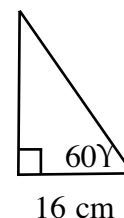

At first glance, you may think that you aren't given enough information to solve this problem. You're only given the length of one side of the triangle, so you can't use the Pythagorean Theorem to figure out the answer.

What other information are you given? You're told that one of the angles in the triangle measures 60° , and that another is a right angle, so it measures 90° . A triangle's angles must add up to 180° , so that means that the unlabeled angle measures $180^\circ - 90^\circ - 60^\circ = 30^\circ$. Aha! We have a 30-60-90 triangle, and that means that we can employ the ratios that hold true for this special right triangle in order to find the length of the missing side. The labeled side on our triangle is located directly across from the angle we've deduced must be 30° , and the hypotenuse is located directly across from the 90° angle. Knowing this and the ratio of sides to angles for this special right triangle, we can set up the following ratio, substitute in our known side, and solve for the hypotenuse:

$$\frac{30^\circ}{s} = \frac{90^\circ}{2s}$$

$$s = 16\text{cm}$$

$$2s = 32\text{cm}$$

The hypotenuse is 32 cm long, so D is the correct answer. Be on the lookout for non-obvious special right triangles! Recognizing one may help you go from having no idea how to approach a problem to solving it quickly and efficiently.



Sample Question

Your friend challenges you to figure out the length of the side labeled x in the triangle shown on the right. Your friend will provide some information about the triangle. Which of the following would NOT allow you to calculate x ?

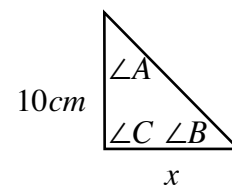

- A. $\angle A = \frac{1}{2} \angle B$ and $\angle A = \frac{1}{3} \angle C$.
- B. The triangle is an isosceles triangle, and $\angle A = 45^\circ$, and $\angle C = 2\angle A$.
- C. The triangle is a right triangle and its hypotenuse measures 12 cm.
- D. All of these facts would allow you to calculate x .

This question might catch you off-guard because it isn't actually asking you to solve for x ; instead, it's asking about the information that you *would* need to calculate x . Consider a few of the ways you might go about calculating x based on different information you might be given about the triangle:

- If you knew the triangle to be a right triangle as well as the length of its hypotenuse, you could use the Pythagorean theorem to find x .
- If you knew the triangle to be a 45-45-90 triangle, you could calculate x based on ratios associated with special right triangles.
- If you knew the triangle to be a 30-60-90 triangle, you could calculate x based on ratios associated with special right triangles.

Now, with those options in mind, let's look at each of the answer choices:

“A. $\angle A = \frac{1}{2} \angle B$ and $\angle A = \frac{1}{3} \angle C$.” - Since a triangle's angles have to add up to 180°, this answer gives us enough information to calculate angles A, B, and C:

$$\angle A + \angle B + \angle C = 180^\circ$$

$$\angle A = \frac{1}{2} \angle B \rightarrow 2\angle A = \angle B$$

$$\angle A = \frac{1}{3} \angle C \rightarrow 3\angle A = \angle C$$

$$\angle A + 2\angle A + 3\angle A = 180^\circ$$

$$6\angle A = 180^\circ$$

$$\angle A = \frac{180^\circ}{6} = 30^\circ$$

$$\angle A = 30^\circ$$

$$\angle B = 60^\circ$$

$$\angle C = 90^\circ$$



In this case, the triangle would turn out to be a 30-60-90 triangle. We can stop analyzing this answer choice here; knowing one side of a 30-60-90 triangle and the locations of its angles is enough to calculate any of its other sides.

“**B.** The triangle is an isosceles triangle and $\angle A = 45^\circ$, and $\angle C = 2\angle A$.” - This information tells us a few things: an isosceles triangle is defined as a triangle in which its legs are the same length, and knowing that one of its angles measures 45° , we can tell that another of the triangle’s angles must also measure 45° because the triangle is isosceles. We also know that since $\angle A = 45^\circ$, $\angle C = 90^\circ$. This means that the triangle is a 45-45-90 triangle. Knowing this along with the precise location of each angle would allow us to solve for x using the ratios associated with special right triangles.

“**C.** The triangle is a right triangle and its hypotenuse measures 12 cm.” - Knowing that the triangle contains a right angle the length of its hypotenuse along with the provided information that one of its legs is 10cm long would allow us to use the Pythagorean Theorem to solve for the length of the missing side.

Each of the answer choices A, B, and C would allow us to calculate x , so the correct answer is D!

Warning: Don’t Make Too Many Assumptions About Diagrams!

When you’re working with diagrammed shapes on the SAT, be sure not to make assumptions that cannot be substantiated mathematically by information provided based on how the diagrams appear. Unless otherwise stated, assume that diagrams are NOT drawn to scale. For instance, in the previous sample problem, you may have assumed that because $\angle C$ looks to be a right angle in the diagram, you can assume that it is. You can’t! It’s not labeled as such. Don’t assume that angles that look like right angles, 45° angles, or any other measurement are in fact those angles in the problem. Diagrams are provided on the SAT merely to help you conceptualize the problem, *not* to provide information about angles that aren’t marked as certain measurements. Before bubbling in your answers for triangle problems that involve geometric diagrams, make sure you didn’t work from an assumption about one or more of a shape’s angles!

Prisms

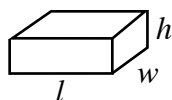

$$V = lwh$$

l = length
 w = width
 h = height

The SAT’s provided diagrams include one that shows how to solve for the volume of a right rectangular prism using its length, width, and height. While the diagram doesn’t depict a cube, this formula can be applied to cubes as well, with the understanding that the length, width, and height of a cube will all be the same number, resulting in a formula of $V = s^3$ where s is the length of one of the cube’s sides.



Sample Question

A right rectangular prism is as long as it is wide. It is 4 cm tall and has a volume of 576 cm^3 . What is its width?

- A. 10 cm
- B. 11 cm
- C. 12 cm
- D. 13 cm

We're told that this particular right rectangular prism "is as long as it is wide." In mathematical terms, this means that its length is equal to its width. Knowing this, we either substitute in length for width or width for length into the volume equation to show that these two measurements must be equal. Then, we can simplify the equation by representing the two w variables as w^2 :

$$\begin{aligned}V &= l \times w \times h \\V &= w \times w \times h \\V &= w^2 \times h\end{aligned}$$

Once we fill in the volume and height given in the question, we get a single-variable equation that we can solve:

$$\begin{aligned}576 &= w^2 \times 4 \\ \frac{576}{4} &= \frac{4w^2}{4} \\ 144 &= w^2 \\ 12 &= w\end{aligned}$$

The width (and length) of the prism are each 12 cm, so C is the correct answer.

Sample Question

Sturgis is in charge of designing a new exhibit in the shape of a rectangular prism for a local aquarium. The exhibit needs to have a volume of 150 m^3 , and it will be 15 m long and 5 m wide. If three-quarters of the exhibit's volume will be water, what will the height (or the depth) of the water be?

- A. 1.00 m
- B. 1.50 m
- C. 1.75 m
- D. 2.00 m

The trickiest part of this question is its wording. This problem is asking for the height of the water in the exhibit if the exhibit is three-quarters full. There are several ways in which you can solve this problem; we'll go over two of them in detail.



1. Find the fraction of the volume, then the height

We can begin by finding three-quarters of the total volume:

$$150 \text{ m}^3 \cdot \frac{3}{4} = 112.5 \text{ m}^3$$

Knowing this, we can go back to our volume equation. Since we are again looking for height, we want to solve for h , so we can rearrange the equation to make this easier:

$$V = l \cdot w \cdot h \rightarrow \frac{V}{l \cdot w} = h$$

Now we can plug in our known variables, including the three-quarters-of-the-total-height that we solved for, and solve for three-quarters of the total height.

$$h = \frac{112.5 \text{ m}^3}{15 \text{ m} \cdot 5 \text{ m}} = 1.5 \text{ m}$$

2. Find the height, then the fraction of it

An easier way to solve this problem requires that we recognize a key detail. If we take three-quarters of the volume without changing our length or width, our new height will just be three-quarters of the total height. We can solve for the total height of the exhibit by using the volume equation and rearranging it to solve for h :

$$\frac{V}{l \cdot w} = h$$

At this point, we can substitute in our given values and solve for h :

$$\frac{150 \text{ m}^3}{15 \text{ m} \cdot 5 \text{ m}} = 2 \text{ m}$$

So, the total height of the exhibit is 2m. We can now easily solve for three-quarters of the total height:

$$h = h \cdot \frac{3}{4}$$
$$h = 2 \text{ m} \cdot \frac{3}{4} = 1.5 \text{ m}$$

No matter which method you use, you should come up with the answer that the height of the water in the exhibit will be 1.5 m, so B is the correct answer.



Cylinders

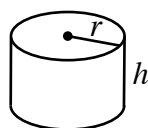

$$V = \pi r^2 h$$

r = radius

h = height

V = volume

The SAT tells you how to find the volume of a right cylinder. Note that the formula uses radius, not diameter. The πr^2 part of the given volume-of-a-cylinder equation should be recognizable, as it's also presented on the equations sheet as the formula for the area of a circle. This part of the cylinder volume equation gets you the surface area of one of the two circular bases; multiplying it by the cylinder's height adds in consideration of that third dimension and yields a volume measurement.

Sample Question

A cannery wants to manufacture miniature soup cans that are 4.5 inches tall and that can hold 150 mL of soup each. 1 milliliter is equal to approximately 0.061 cubic inches. In order to meet these specifications, what must the approximate diameter of each can be?

- A. 0.645 inches
- B. 0.805 inches
- C. 1.12 inches
- D. 1.61 inches

This problem requires you to solve for a variable that isn't directly represented in the provided equation, but that's nothing you need to worry about. You're asked for diameter, but the relevant provided formula uses radius. You can simply double the radius after you're done solving for it—but don't forget! It's likely that the length of the radius will show up as one of the incorrect answer choices to trap students who don't take note of this important distinction.

Before you can start plugging in variables, you have to take stock of your units. This problem provides a unit ratio, which is a major red flag signaling that you're going to need to do some unit conversion before you'll be able to calculate the correct answer. The volume of the can is presented in milliliters, but its height is given in inches, and the correct answers are given in inches. You need to convert the volume of the can from milliliters to cubic inches, and you can do that by using dimensional analysis. Starting with the given information, we multiply it by different unit conversion fractions until you get a number that uses the correct units.

$$150\text{mL} = \frac{0.061\text{in}^3}{1\text{mL}} = 9.15\text{in}^3$$

Now that all of your data is in inch-based units, you can substitute those values into the volume equation. After doing that, you'll have an equation with a single variable in it—radius, r , the variable for which you need to solve in order to find the can's diameter.



$$V = \pi r^2 h$$

$$9.15 = \pi r^2 (4.5)$$

$$\frac{9.15}{4.5\pi} = r^2$$

$$r = \sqrt{\frac{9.15}{4.5\pi}} = 0.805$$

So, the radius of the can must be 0.805 inches in order to meet the manufacturer's specifications. But wait! Don't pick B as the correct answer—that's *radius*, not diameter! You need to double the radius to find the correct answer:

$$d = 2r = 2(0.805) = 1.61$$

The necessary diameter of each can is 1.61 inches, so D is the correct answer.

Finding the Formula for Cylindrical Surface Area

What if you need to find the surface area of a cylinder? The cylinder diagram the SAT Math test provides and the one concerning a basic circle can together help you work out that formula. To find surface area, you need to sum the areas of three shapes: the circle that forms the top of the cylinder, the rectangle that (wrapped around the circles) forms the height of the cylinder, and the circle that forms the bottom of the cylinder.

Start by finding the area of the top circle—it's the same as the area of the bottom circle. As an equation, the area of one circle would be πr^2 , so the area of both circles would be $2(\pi r^2)$. Now for the rectangle. Its height is the cylinder's height, and its length is the circle's circumference. Circumference is provided on the Given Equations section as $2\pi r$. So, the area of the rectangle is $2\pi r h$. Summing that all together, you get the equation $2\pi r h + 2\pi r^2$, the formula for the surface area of a cylinder. If you find yourself in need of a relatively simple formula associated with the shapes addressed by the given diagrams and formulae, try to see if you can calculate it yourself by working from the provided information!



Sample Question

The manufacturer of the miniature soup cans from the previous question now wants to create a label for the soup can discussed in the last question. How much paper will be needed for each soup label, assuming that the label is as tall as the can and winds completely around it?

- A. 15.40 in^2
- B. 18.75 in^2
- C. 21.34 in^2
- D. 22.76 in^2

More cans! Specifically, the same can. Be ready for questions that run together like this when you take your exam. Let's take stock of what we know about this can:

$$V = 150 \text{ mL} \approx 9.15 \text{ in}^3$$

$$h = 4.5 \text{ in}$$

$$r = 0.805 \text{ in}$$

$$d = 1.61 \text{ in}$$

That's quite a bit of information! The trick to solving this question involves interpreting the question stem and figuring out which part of the equation you need. This is because we're not going to be solving for the entire surface area of the can, just the part that the label would go around—the "rectangle" that forms the can's height.

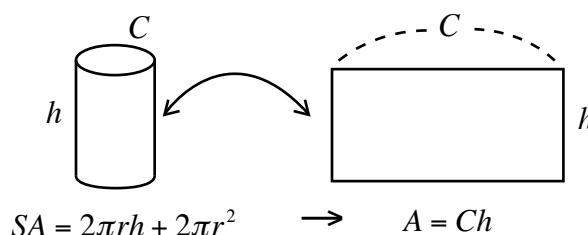

From the volume diagram, we can figure out that this rectangle's height is the same as the height of the entire cylinder (which we know!). Let's call that the rectangle's width. The rectangle's length, then, is the circumference of either of the circles that form the top and bottom of the cylinder. We know from a different given equation that the circumference of a circle is defined as $\neq 2r$. You know the radius of the can from the last question, so we have all of the information we need to answer this question.

To find the area of the rectangle, then, we need to calculate the following:

$$A = l \times w$$

$$A = \pi d \times h$$

All have to do now is substitute in the known values and solve for A:

$$A = \pi(1.61)(4.5) = 22.76$$

This matches answer choice D, so D is the correct answer!



Spheres



$$V = \frac{4}{3}\pi r^3$$

r = radius

V = volume

This included diagram reveals that to solve for the volume of a sphere, you only need one piece of information: the radius of that sphere. Keep in mind that if you are given the diameter or are able to calculate it, you can find radius from diameter by dividing it by two. So, knowing either radius or diameter is enough to find a sphere's volume.

Sample Question

A spherical planetarium has a 20m diameter. What is its volume?

- A. $750\pi \text{ m}^3$
- B. $1000\pi \text{ m}^3$
- C. $1333\pi \text{ m}^3$
- D. $2200\pi \text{ m}^3$

We're told the planetarium is in the shape of a sphere, and we're given its diameter. The given equation for volume of a sphere uses radius, so we just need to make sure that we use the diameter to find the radius before plugging that value into the equation and solving.

$$V = \frac{4}{3}\pi r^3$$

$$d = 20 \text{ m}$$

$$d = 2r$$

$$20 = 2r$$

$$r = 10 \text{ m}$$

$$V = \frac{4}{3}\pi r^3$$

$$V = \frac{4}{3}\pi(10)^3$$

$$V = \frac{4}{3}\pi 1000$$

$$V = 1333\pi \text{ m}^3$$

The planetarium's volume is $1333\pi \text{ m}^3$, so the correct answer is C.



Sample Question

A swimming pool with a **radius of 9 meters** is constructed in the shape of a **hemisphere** and filled to its brim with water. (Consider the thickness of the pool's walls negligible in your calculations). A team of **two dozen** synchronized swimmers uses this pool for practice. If each swimmer has an approximate **volume of 0.05 cubic meters** and they all dive underwater at once, **how much of the pool's total volume do they take up while they are all underwater?**

- A. 0.263%
- B. 0.318%
- C. 0.345%
- D. 0.422%

Let's figure out exactly what we need to calculate to figure out the correct answer for this problem. We'll need to know the volume of water the pool can hold. You're first told that the pool is a "hemisphere"—half a sphere—and full to the brim, with a radius of 9 meters. Then, we'll need to calculate the volume of the synchronized swimming team. Finally, we'll need to construct a fraction, placing the volume of the swim team in the numerator and the volume of water in the pool in the denominator. After we convert that fraction to a percentage, we'll have our final answer. To the right, you can see the plan for attacking this problem diagrammed.

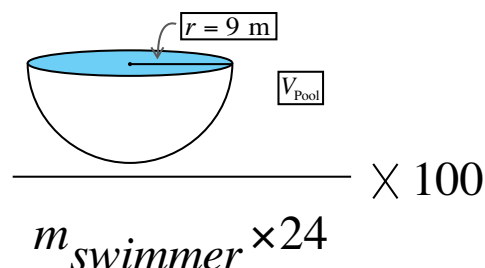

To figure out the volume of water the pool can hold, we need to use the formula for the volume of a sphere, but we need to divide the result by two because the pool is a hemisphere, not a sphere. We'll multiply the equation by $\frac{1}{2}$ to accomplish this:

$$V_{Pool} = \frac{1}{2} \left(\frac{4}{3} \pi r^3 \right)$$

$$V_{Pool} = \frac{1}{2} \left(\frac{4}{3} \pi (9)^3 \right)$$

$$V_{Pool} = \frac{1}{2} \left(\frac{4}{3} \pi 729 \right)$$

$$V_{Pool} = \frac{1}{2} (911.25\pi)$$

$$V_{Pool} = 455.625\pi \text{ m}^3$$

Now that we know the volume of the pool, let's calculate the volume taken up by the synchronized swimming team. We're told that each swimmer has an approximate volume of 0.05 cubic meters, and that there are two dozen of them on the team, so all we have to do is multiply the approximate volume of one swimmer by twenty-four.



$$V_{\text{Swimmer}} \approx 0.05 \text{ m}^3$$

$$V_{\text{Swim Team}} = 0.05 \text{ m}^3 \times 24 = 1.2 \text{ m}^3$$

To find the correct answer, we now need to construct a fraction and convert it to a percentage.

$$\frac{V_{\text{Swim Team}}}{V_{\text{Pool}}} = \frac{1.2 \text{ m}^3}{455.625 \text{ m}^3} = 0.002633745 \times 100 = 0.2633745\% \approx 0.263\%$$

0.263% is the value listed for answer choice A, so A is the correct answer.

Half-Shapes and Symmetry

In the last problem, we solved for the volume of a hemisphere. We were able to do this by taking the provided formula for the volume of a sphere and multiplying it by one-half. You can use this method to find the volumes of half-shapes so long as the full shape to which the volume formula relates is symmetrical. If you're asked to find "half of the volume" of a shape, on the other hand, symmetry doesn't matter. To illustrate this difference, consider a right cone. If you're asked for half of the cone split vertically, you can just multiply the formula for the volume of a cone by one-half, since both halves of the divided cone will be symmetrical and thus have the same volume. If you're asked for the volume of half of the cone split horizontally, that's an entirely different problem that will result in an entirely different answer. This is because if the cone is divided horizontally, the two resulting sides will not be symmetrical or equal in volume. You'll need to know which one you're specifically being asked to solve for!

Cones

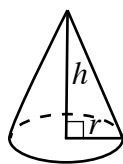

$$V = \frac{1}{3} \pi r^2 h$$

Amongst the SAT's given equations and diagrams you'll find a pair depicting how to solve for the volume of a cone given its radius and height. Keep in mind that you can also use this formula to solve for the radius given the volume and height, or the height given the volume and radius. When using this formula, use the radius of the bottom circle, not its diameter, and remember to square it!

Sample Question

A right cone has a volume of 273 cubic centimeters and a height of 7 centimeters. What is its radius?

- A. 64π cm C. $\sqrt{\frac{117}{\pi}}$ cm
- B. 124π cm D. $\sqrt{\frac{640}{\pi}}$ cm



Due to the amount of information we're given, this problem is relatively straightforward, especially since the test provides the relevant formula. Just take the equation for the volume of a cone, plug in the given volume and height, and solve for the radius.

$$V = \frac{1}{3}\pi r^2 h$$

$$273 = \frac{1}{3}\pi r^2 (7) = \frac{7}{3}r^2 \pi$$

$$\frac{3}{7}(273) = \frac{3}{7}\left(\frac{7}{3}\right)r^2 \pi$$

$$117 = r^2 \pi$$

$$\frac{117}{\pi} = \frac{r^2 \pi}{\pi}$$

$$\sqrt{\frac{117}{\pi}} = \sqrt{r^2}$$

$$r = \sqrt{\frac{117}{\pi}}$$

The correct answer is C!

Sample Question

An ice cream cone is 5 inches long and has a diameter of 3.5 inches. Approximately how much melted ice cream could it hold if it were three-fourths as full as it could possibly be? (Consider the width of the cone to be negligible).

- A. $1.95\pi \text{ in}^3$
- B. $2.45\pi \text{ in}^3$
- C. $2.60\pi \text{ in}^3$
- D. $2.75\pi \text{ in}^3$

While this question is based on finding the volume of a cone, it has a few additional challenges. Note that you're given the diameter, not the radius, so you'll need to divide it in half before plugging it into the volume of a cone equation. In addition, you're not solving for the total volume of the cone—you're solving for three-fourths of it.

First, we should start by finding the total volume of melted ice cream that the ice cream cone can hold. After that, we can multiply it by 0.75 to find the correct answer.

$$d = 2.5''$$

$$r = \frac{d}{2} = \frac{2.5}{2} = 1.25''$$

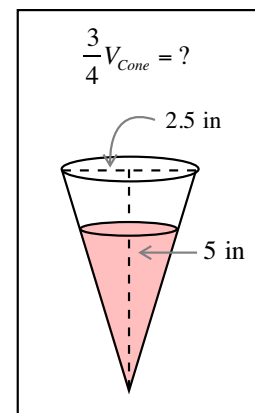

Now that you know the radius, plug in the given information and solve for V .

$$V = \frac{1}{3}\pi r^2 h$$

$$V = \frac{1}{3}\pi(1.25)^2(5)$$

$$V = \frac{1}{3}\pi(1.5625)(5)$$

$$V = \frac{7.8125}{3}\pi$$

$$V = 2.604166667\pi \approx 2.60\pi$$

Now that we've solved for the total volume of the cone, we can finally figure out how much the cone can hold when it's three-fourths as full as it could be.

$$2.60\pi \times \frac{3}{4} = 1.95\pi$$

The correct answer is A!

Pyramids

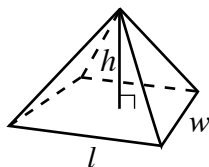

$$V = \frac{1}{3}lwh$$

Somewhat similar to the formula for the volume of a cone (and reasonably so), the formula for the volume of a right regular rectangular pyramid also appears in the SAT's list of given equations. Where for a cone you would need to know height and the radius of the circle that forms the bottom of it, here you need to know the length and width of the rectangle that forms the bottom of the pyramid, as well as the height, of course.

Sample Question

A particular ancient sarcophagus has a volume of 2.4 meters cubed. It is located in a right pyramid that is 20 m tall, 15 m wide, and 7.5 m long. How much of the pyramid's volume is taken up by the sarcophagus?

- A. 0.28%
- B. 0.32%
- C. 0.36%
- D. 0.45%

To solve this problem, we need to create a fraction that has the volume of the sarcophagus as its numerator and the volume of the right pyramid as its denominator. We're given the volume of the sarcophagus directly in the question, so solving it becomes a matter of calculating the pyramid's volume.



$$V_{\text{Pyramid}} = \frac{1}{3}(7.5)(15)(20)$$

$$V_{\text{Pyramid}} = \frac{1}{3}(2250)$$

$$V_{\text{Pyramid}} = 750 \text{ m}^3$$

At this point, all we have to do is construct our fraction and change it into a percentage.

$$\frac{V_{\text{Sarcophagus}}}{V_{\text{Pyramid}}} = \frac{2.4 \text{ m}^3}{750 \text{ m}^3} = 0.0032 \times 100 \approx 0.32\%$$

The correct answer is B.

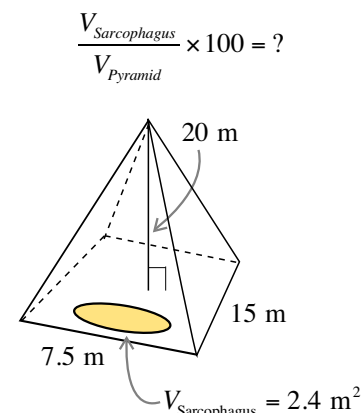

Pyramids vs. Prisms

Heads up: prisms and pyramids are *different shapes!* Here they are compared.

Prism

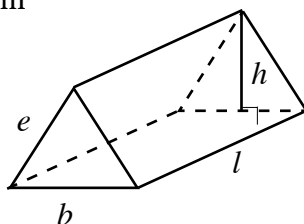

To find the volume of a right regular prism, calculate the area of one of the triangular ends of the prism and multiply that area by its length.

$$V_{\text{Prism}} = A_{\text{Triangle}} l = \frac{1}{2} bhl$$

While the Given Equations section doesn't mention prisms, you can easily solve for the volume of a prism or the surface area of a prism or pyramid by using what you know and composing an equation from more basic shapes.

$$SA = 2(A_{\text{Triangle}}) + 2(A_{\text{Side}}) + A_{\text{Bottom}}$$

$$SA = 2\left(\frac{1}{2}bh\right) + 2(le) + lb$$

Pyramid

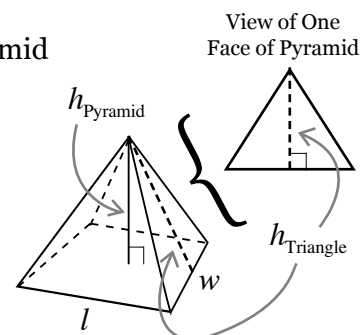

As covered in the previous section, the SAT provides the formula for the volume of a right prism as one of its given equations.

$$V_{\text{Pyramid}} = \frac{1}{3}lwh$$

Finding the surface area of a pyramid requires you to pay attention to a subtle distinction: the height of the triangular faces may not be equal to the height of the pyramid.

$$SA_{\text{Pyramid}} = 4(A_{\text{Triangle}}) + A_{\text{Rectangle}}$$

$$SA_{\text{Pyramid}} = 4\left(\frac{1}{2}bh_{\text{Triangle}}\right) + lw$$



Sample Question: Economics

A jewelry artist wants to make gold earrings in the shape of tiny right pyramids to sell. The pyramids will each be 4 cm tall, 2.5 cm long, and 2.5 cm wide. At the time the artist is working, gold costs \$1,200 per ounce. 1 ounce of gold is approximately 29.574 cubic centimeters. Which of the following represents the cost of the materials needed to make the gold pyramids for one pair of earrings?

- A. \$498.50
- B. \$532.70
- C. \$540.50
- D. \$676.80.

Let's approach this problem stepwise so as to not get confused. There are a lot of small but important details in this problem, and you'll need to keep track of them to arrive at the correct answer. Sketching out a plan as to how you're going to calculate the answer, step-by-step, can help you in this regard.

First, you need to calculate the volume of one of the gold pyramids in cubic centimeters. Then, you need to take that volume and use the provided unit conversion to convert cubic centimeters to ounces. Then, you need to use the second unit conversion, the ratio between ounces of gold and dollars, to figure out the cost of making a pyramid. Finally, you need to multiply that figure by two, since you're asked about the cost of making pyramids "for one pair of earrings." Tricky!

1. Finding the volume of a pyramid

This part of the problem is straightforward. You have access to the formula for volume of a pyramid as a Given Equation, and you're given measurements for this pyramid's length, width, and height.

$$V_{\text{Pyramid}} = \frac{1}{3}lwh$$

$$V_{\text{Pyramid}} = \frac{1}{3}(2.5)(2.5)(4)$$

$$V_{\text{Pyramid}} = \frac{1}{3}(25)$$

$$V_{\text{Pyramid}} = 8.33 \text{ cm}^3$$

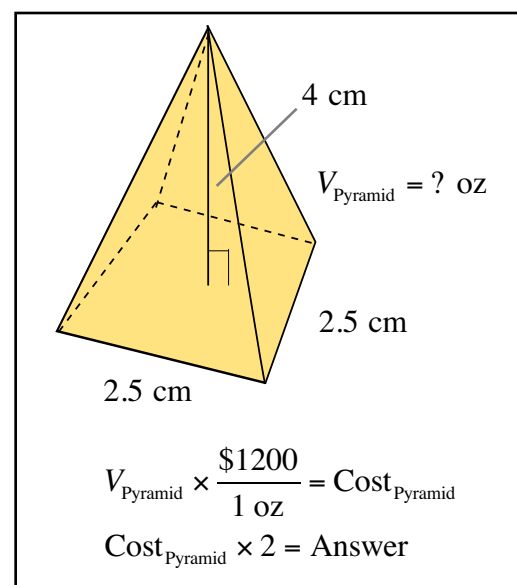

2. Finding the cost of one pyramid

At this point in the problem, we need to make use of the provided unit conversions between ounces of gold and the cost of that gold. We can't go straight from cubic centimeters to dollars, though: this will take two steps.

First step: converting cubic centimeters to ounces

$$8.33 \text{ cm}^3 \times \frac{1 \text{ oz}}{29.574 \text{ cm}^3} = 0.282 \text{ oz}$$

Second step: converting ounces of gold to the price of that gold in dollars

$$0.282 \text{ oz gold} \times \frac{\$1200.00}{1 \text{ oz gold}} = \$338.40$$

$$\text{Cost}_{\text{Pyramid}} = \$338.40$$

3. Calculating the cost of two pyramids

The final step is simple, but perhaps easy to accidentally forget. We need to multiply the cost of the materials needed to make one pyramid by two, since we're specifically asked about the cost of creating pyramids for "one pair" of earrings.

$$\text{Cost}_{\text{Pyramid}} \times 2 = \text{Answer}$$

$$\$338.40 \times 2 = \$676.80$$

To make two pyramids for a pair of earrings, the jewelry artist will need an amount of gold that costs \$676.80. This means that the correct answer is D!



Review: Properties of Algebra

Three simple properties form a major part of the core of algebra. If you don't understand them well, you'll be confused by the more advanced principles covered later in this book. By taking the time to reexamine them, you can brush up on your knowledge of these key mathematical principles and lay the groundwork required to understand advanced algebra topics.

This review lesson examines the three main properties of algebra in detail: the commutative property, the associative property, and the distributive property. While the SAT Math test won't directly ask you to identify demonstrations of each individual property, they form the bedrock of algebra upon which the rest of its topics are built. You have to understand these basics before you can master the more complex topics, so let's review them now.

Commutative Property

The commutative property tells us that the order of the terms in addition and multiplication operations does not change the outcome of the operation. Note that the commutative property only applies for addition and multiplication, not for subtraction or division. General mathematical definitions of this property are as follows:

$$a + b = c$$
$$b + a = c$$

$$a \times b = c$$
$$b \times a = c$$

To illustrate this, let's look at some applications of the commutative property of addition.

Example 1:

$$12 + 7 = 19$$
$$7 + 12 = 19$$

The above equations exemplify the commutative property; the order of the operands 12 and 7 has no effect on the final answer of the summation.

Example 2:

$$1 + 2 + 3 = 6$$
$$1 + 3 + 2 = 6$$
$$2 + 1 + 3 = 6$$
$$2 + 3 + 1 = 6$$
$$3 + 1 + 2 = 6$$
$$3 + 2 + 1 = 6$$

Again, notice that the order of the operands 1, 2, and 3 does not affect the final answer. Now, let's look at some examples of applying the commutative property to multiplication operations.



Example 1:

$$3 \times 4 = 12$$
$$4 \times 3 = 12$$

Like with addition, the order of the operands does not change the final answer. To further illustrate this point, let's consider another example:

Example 2:

$$2 \times 2 \times 2 = 8$$

Here, it is impossible to tell the order of the operands. No matter their order, the product of three 2's is always 8.

The following examples show that the commutative property does not apply to subtraction and division operations:

Example 1:

$$10 - 2 = 8$$
$$2 - 10 = -8$$

Example 2:

$$20 \div 5 = 4$$
$$5 \div 20 = \frac{1}{4}$$

As we can see, changing the order of the operands when performing subtraction and/or division *does* change the final outcome. Be careful with the order of the operands in these calculations because the commutative property does not apply.

Associative Property

The associative property states that when adding or multiplying numbers, we can group them (“associate” them) in different ways without changing the final answer. Like the commutative property, the associative property does not apply to subtraction or division. Written mathematically, the associative property looks like this:

$$(a + b) + c = d$$
$$a + (b + c) = d$$

$$(a \times b) \times c = d$$
$$a \times (b \times c) = d$$

Note that the order of the operands does not change; these are not examples of the commutative property. The difference lies in the groupings or “associations” of the operands with respect to each other. In all cases, we perform the operation that is in the parenthesis first.



Example 1: $(9 + 5) + 2 = ?$

Upon simplification, we have:

$$(14) + 2 = ?$$

$$14 + 2 = 16$$

We can rewrite the original equation using the associative property without changing the final answer as follows:

$$9 + (5 + 2) = ?$$

Upon simplification, we have:

$$9 + (7) = ?$$

$$9 + 7 = 16$$

Example 2: $(5 \times 6) \times 3 = ?$

Upon simplification, we have:

$$(30) \times 3 = ?$$

$$30 \times 3 = 90$$

We can rewrite the original equation using the associative property without changing the final answer as follows:

$$5 \times (6 \times 3) = ?$$

Upon simplification, we have:

$$5 \times (18) = ?$$

$$5 \times 18 = 90$$

Distributive Property

The distributive property is useful when multiplying a group of terms in parenthesis. In general mathematical terms, the distributive property is as follows:

$$a(b + c) = ab + bc$$

Example 3: $2(3 + 4 + 5) = ?$

This can be rewritten using the distributive property as follows:



$$(2 \times 3) + (2 \times 4) + (2 \times 5) = ?$$

$$6 + 8 + 10 = 24$$

Let's check to make sure we get the same answer when we do the addition in the parenthesis first, then multiply that sum by 2:

$$2(3 + 4 + 5) = ?$$

$$2(12) = ?$$

$$2 \times 12 = 24$$

Example 4: $-3(10 - 4) = ?$

Rewrite using the distributive property, and be sure to distribute the both the negative and the subtraction sign correctly:

$$(-3 \times 10) - (-3 \times 4) = ?$$

$$(-30) - (-12) = ?$$

$$-30 + 12 = -18$$

Let's check to make sure we get the same answer when we do the subtraction in the parenthesis first, then multiply that sum by -3 :

$$-3(10 - 4) = ?$$

$$-3(6) = ?$$

$$-3 \times 6 = -18$$

Therefore, we see that using the distributive property does indeed work.

The distributive property is especially useful when dealing with expressions in which not all terms in the parenthesis are able to be summed. For example:

$$2(4x^2 + 3x^3)$$

$4x^2$ and $3x^3$ are not like terms and thus cannot be summed. We must use the distributive property to get the most simplified answer, which is

$$8x^2 + 6x^3$$



Review: Approaching Word Problems

The new SAT Math test has an increased focus on and use of word problems. At first, word problems can seem intimidating and complex; however, there are strategies when approaching and dealing with them that can minimize this complexity. Regardless of the type of word problem, the approach to solve it is the same. First, identify what the question is asking for. Sometimes this may be the most difficult step out of them all in solving word problems. After identifying what the question is asking for, identify what information the question provides. Knowing what is given and what is being asked for, one can create functions to solve for the specific question. It is important to remember that in word problems, extra information can be included in the question that is not necessarily needed to solve the problem.

Currency/Economics

Word problems on the SAT Math test may deal with economics and currency; therefore, understanding the basics is necessary to solving these problems. Common word problems dealing with currency and economics deal with making change, money conversion, exponential growth and decay, and simple and compounded interest.

Making change is not only an important test subject but also a crucial life skill. There are two main approaches when making change, counting up or subtracting down. Before jumping into the different approaches for making change, let's discuss the basics of money. All money can be broken down into the basic measurement of a cent. The four most commonly used measurements of U.S. coins are pennies, nickels, dimes, and quarters. When it comes to U.S. paper money, there are the one-, two-, five-, ten-, twenty-, fifty-, and one-hundred-dollar bills. All U.S. paper money can be broken down to a basic measurement of the one-dollar bill. The key to remember when dealing with money is that a one-dollar bill is made up of one hundred cents. The following table depicts the different bills and coins broken down into their cent equivalences.

Type of Coin	Amount of Cents
Penny	1 cent = \$0.01
Nickel	5 cents = \$0.05
Dime	10 cents = \$0.10
Quarter	25 cents = \$0.25

Type of Bill	Amount of Dollars	Amount of Cents
One Dollar	1 Dollar = \$1.00	100
Two Dollar	2 Dollars = \$2.00	200
Five Dollar	5 Dollars = \$5.00	500
Ten Dollar	10 Dollars = \$10.00	1000
Twenty Dollar	20 Dollars = \$20.00	2000
Fifty Dollar	50 Dollars = \$50.00	5000
One-Hundred Dollar	100 Dollars = \$100.00	10000



Making change occurs when someone wants a different coin or bill make up for the amount they currently have. Making change also occurs when something is bought with a higher money amount than the cost of what is bought. To make change means to get back to an equivalent state. Now let's go through the two different approaches for making change.

Approach One: Counting Up

Say an item costs \$8.50 and Bob only has a \$20 bill with which to pay. Ignoring sales tax, how much change will he get back?

To find Bob's change by counting up, we will start at the price of the item and count up until we get to the price of the payment. In this particular case, we start at \$8.50 and count up until we reach \$20. To do this, we will say a quarter (\$0.25) makes \$8.75. Adding another quarter will make \$9.00. From here, we can add one dollar to get to \$10.00. Finally, we add a ten dollar bill to get to \$20.

Now we add up all of the change we made by "counting up." Since we started by adding two quarters, that becomes \$0.50. Then, if we add the paper money amounts together, we get: $\$1.00 + \$10.00 = \$11.00$. Lastly, we add the coin amount to the paper amount: $\$0.50 + \$11.00 = \$11.50$. A quick way to check that the change is the correct amount, add it to the item amount; the sum should be the payment.

$$\begin{array}{r}
 11 \\
 \$8.50 \\
 + \$11.50 \\
 \hline
 00 \\
 0.00 \\
 \$20.00
 \end{array}$$

Approach Two: Subtracting Down

Using the same example from above but this time we will take the payment amount and subtract the item amount to find the change. Let's set up the subtraction problem.

$$\begin{array}{r}
 \$20.00 \\
 - \$8.50 \\
 \hline
 \end{array}$$

First step is to borrow a one from the 2 and move it to the furthest right position.

$$\begin{array}{r}
 19.1 \\
 \$20.00 \\
 - \$8.50 \\
 \hline
 0
 \end{array}$$



Now that there is a ten in the tens place we can subtract five from it.

$$\begin{array}{r} 19.1 \\ \$20.00 \\ - \$8.50 \\ \hline .50 \end{array}$$

From here we continue to subtract as normal from right to left.

$$\begin{array}{r} 19.1 \\ \$20.00 \\ - \$8.50 \\ \hline \$11.50 \end{array}$$

Notice that the change is the same regardless of which approach we use.

Money conversions, in simple terms, involve changing how a certain amount of money is displayed mathematically. Recall the table of coins and dollars above, as we will use these units and values frequently when converting money. Many word problems that deal with converting money will not be straightforward in the way they are presented; therefore, it is important to recognize trigger words for these types of questions. The most commonly used words in money conversion problems are, “in _____ number of coins/bills”, “using _____ number of coins/bills,” etc. This is usually accompanied by the amount of money the question requires you to convert to coins/bills. Common words for converting include “make,” “find,” etc. Let’s look at an example.

Example 1: Express \$1.00 using eleven total coins and at least one coin of each type.

Step 1: Identify what the question is asking us to do.

Using eleven coins, make \$1.00.

Looking at the trigger words, we can identify this word problem as a money conversion problem.

Step 2: Identify what the question is asking for.

This particular problem is asking us to find the coin combination that will result in a value of one dollar.

Step 3: Identify what the problem gives.

In this particular case, we have \$1.00 and need to find the 11-coin equivalency. To do this, let’s identify the different coin values.



Type of Coin	Amount of Cents
Penny	1 cent = \$0.01
Nickel	5 cents = \$0.05
Dime	10 cents = \$0.10
Quarter	25 cents = \$0.25

Step 4: Create an equation(s) to solve using the known information.

$$0.01P + 0.05N + 0.10D + 0.25Q = 1.00$$

$$P + N + D + Q = 11$$

Before we start to manipulate our system of equations, let's do some simple conversions that we can confirm will not be the solution for our specific problem.

$$10 \text{ dimes} = \$1.00 \text{ but } 10 \neq 11$$

$$4 \text{ quarters} = \$1.00 \text{ but } 4 \neq 11$$

$$20 \text{ nickels} = \$1.00 \text{ but } 20 \neq 11$$

$$100 \text{ pennies} = \$1.00 \text{ but } 100 \neq 11$$

From here, we can make some basic assumptions. We know that we will have fewer than ten dimes, fewer than four quarters, fewer than twenty nickels, and fewer than one hundred pennies.

Now, let's assume we will use three quarters. This means we have \$0.75. Since the question tells us that there is at least one coin of each type, we know we will also need to use at least one dime, one nickel, and one penny. Let's move on to the number of dimes. Since we have used only three coins and are at \$0.75, if we use one dime, we will have \$0.85. Now we have used a total of four coins, which means we have seven coins left to use and \$0.15 to create using nickels and pennies.

If we add two nickels, we will have \$0.95. Now we have used six coins and have five coins left to create \$0.05. Since each penny is worth one cent, five of them would give us a total coin count of 11, worth \$1.00. Let's write out our solution and use the original equation to double check our answer.

$$\text{Pennies} = 5$$

$$\text{Nickels} = 2$$

$$\text{Dimes} = 1$$

$$\text{Quarters} = 3$$

$$\text{Total coin count} : 5 + 2 + 1 + 3 = 11$$

$$\text{Total value} : \$0.01(5) + \$0.05(2) + \$0.10(1) + \$0.25(3)$$

$$\$0.05 + \$0.10 + \$0.10 + \$0.75 = \$1.00$$



Word problems that include money conversions, like other word problems, can be filled with extraneous information that makes them look more complicated than they actually are. It is important to remember to break word problems down into their most basic elements. This includes remembering how to convert between units and being able to apply the algebraic operations associated with specific trigger words to the context of the question. Let's review common trigger words and their meanings for the various algebraic operations.

Addition: "more than," "greater than," "increased by," "combined," "together," "sum," "added to"

Subtraction: "less than," "difference between," "decreased by," "fewer than"

Multiplication: "times," "multiply by," "increased/decreased by a factor," "product of"

Division: "out of," "per," "ratio of," "percent"

Equals: "is," "will give," "yields," "comes out to," "has," "costs"

Now, let's use this and the money conversion knowledge to break down and solve some example word problems.

Example 2: Jane and Bob want to buy their sister Jenny a stuffed animal for her birthday. Jenny likes bears, tigers, and dogs. The store that Bob and Jane go to have bear candy that costs \$6.00 and a jump rope that costs \$4.25. The store also sells tiger stuffed animals for \$6.00 more than the candy bar added to 87 cents. If Jane has \$6.00 and Bob has a ten-dollar bill, how much will they have left after purchasing the stuffed tiger?

Step 1: Identify what the question is asking for.

This particular question is asking for the amount of change Bob and Jane will have after they purchase the tiger stuffed animal.

Step 2: Identify the information the question gives by identifying trigger words.

Candy = \$6.00

Jump rope = \$4.25

Tiger = \$6.00 + Candy + \$0.87

Bob has \$10.00

Jane has \$6.00

Step 3: Identify any information that is extraneous that we can ignore.

In this particular case we do not need to know about the jump rope nor its price.

Step 4: Create an equation to calculate the price of the stuffed tiger.



$$\text{Tiger} = \$6.00 + \text{Candy} + \$0.87$$

$$\text{Candy} = \$6.00$$

$$\text{Tiger} = \$6.00 + \$6.00 + \$0.87 = \$12.87$$

Step 5: Calculate the total amount used to buy the item.

$$\text{Total Money} = \text{Bob's money} + \text{Jane's money}$$

$$\text{Total Money} = \$10.00 + \$6.00 = \$16.00$$

Step 6: Calculate the change by either counting up or subtracting down.

Let's use the counting up method.

We start with \$12.87. If we add three pennies, we will have \$12.90. Now, add a dime to get to \$13.00. From here, we will add three dollars to reach the total amount of \$16.00. Finally, combine the money added to \$12.87 to reach \$16.00 and that will be the amount of change.

$$\$0.01P + \$0.10D + \$1.00D$$

$$\$0.01(3) + \$0.10(1) + \$1.00(3)$$

$$\$0.03 + \$0.10 + \$3.00 = \$3.13$$

Therefore the amount of change is \$3.13.

Time

To succeed on the SAT Math test, you must be prepared to convert between units of time and to deal with time-based word problems. Remember that time-related problems can also include dates as these are also a form of time. Also, many time-related questions will also include rates such as miles per hour. As previously stated, word problems that involve time also include trigger words. Before we start dealing with time-related word problems, let's review some common units of time and how to convert between them.

Starting Unit	Conversion	New Unit
60 miles per hour (mph)	$\frac{60 \text{ miles}}{1 \text{ hour}} \times \frac{1 \text{ hour}}{60 \text{ min}} = \frac{1 \text{ mile}}{1 \text{ min}}$	1 mile per minute
20 hours	$20 \text{ hours} \times \frac{60 \text{ min}}{1 \text{ hour}} \times \frac{60 \text{ sec}}{1 \text{ min}} = 72000 \text{ sec}$	72000 sec



Example 3: Sarah walks to the gym and it takes her 35 minutes. When she rides her bike to the gym it takes her three-eighths of her walking time. When Sarah goes to the gym, she goes to the 5:00 pm yoga class, meaning she must leave her house no later than 4:25 pm. If Sarah rides her bike, at what time does she need to leave her house to be on time to her yoga class!

Step 1: Identify the unknown for which you need to solve.

What time does Sarah leave her house to make it to the gym by 5:00pm?

Step 2: Identify what is known.

Walking time = 35 minutes

Biking time = three-eighths times walking time = $\frac{3}{8} \times 35$

When walking she leaves her house 5:00pm minus walking time =

$$5:00 \text{ pm} - 35 \text{ minutes} = 4:60 - 0:35 = 4:25 \text{ pm}$$

(Recall that one hour is 60 minutes; thus, we can rewrite 5:00 as 4:60 for the purpose of time subtraction).

Step 3: Find the biking time and then subtract it from 5:00pm to find the time she leaves her house.

Biking time = three-eighths times walking time = $\frac{3}{8} \times 35 = 13.125$

$$5:00 \text{ pm} - 13.125 \text{ min} = 4:60 - 0.13.125 = 4:46.875 \approx 4:46 \text{ pm}$$

To make it to her 5:00 pm yoga class, Sarah can leave no later than 4:46 pm.

Century and decade math is easier to deal with if the following table of unit conversions is memorized. Just like with money, all time can be broken down into smaller pieces. In the following table we will use days as the smallest measurement of time.

Unit of Time	Number of Years	Number of Days
Decade	10	10×365
Quarter Century	25 years	25×365
Half Century	50 years	50×365
Century	100 years	100×365
Millennium	1000 years	1000×365



Example 4: Betty is ninety-eight years old and graduated from high school in 1924 at the age of seventeen. Her graduating class had a half-century reunion. During what year was it held?

Step 1: Identify what the question is asking for.

Find the year of Betty's fiftieth year class reunion.

Step 2: Identify the given information

This question contains a lot of extraneous information, such as Betty's current age and her age when she graduated. The only thing that is needed to calculate the year of her fiftieth class reunion is the year in which she graduated.

Graduation year = 1924

Half century = 50 years

Step 3: Set up equation, substitute known values and solve.

Reunion Year = Graduation Year + 50

Reunion Year = 1924 + 50

Reunion Year = 1974



Science Principles

Science principles are often used to test mathematical knowledge. They are also used to make basic math seem slightly more complicated. Many science-related word problems can be quite lengthy, but once you are able to decipher the math within the science, the problems become quite simple. Remember, all word problems, including those that involve science principles, can be written in mathematical terms, and equations can be created to solve the problem using basic algebraic operations. Don't let any science terminology blind you from the math rooted within it.

Example 5: The following graph depicts the bird population for five different species.

- Which of the five species of birds has experienced exponential growth in the time depicted on the graph?
- Which bird species' population has decreased in the time depicted on the graph?
- Which bird species' population was approximately 600 in 1980?

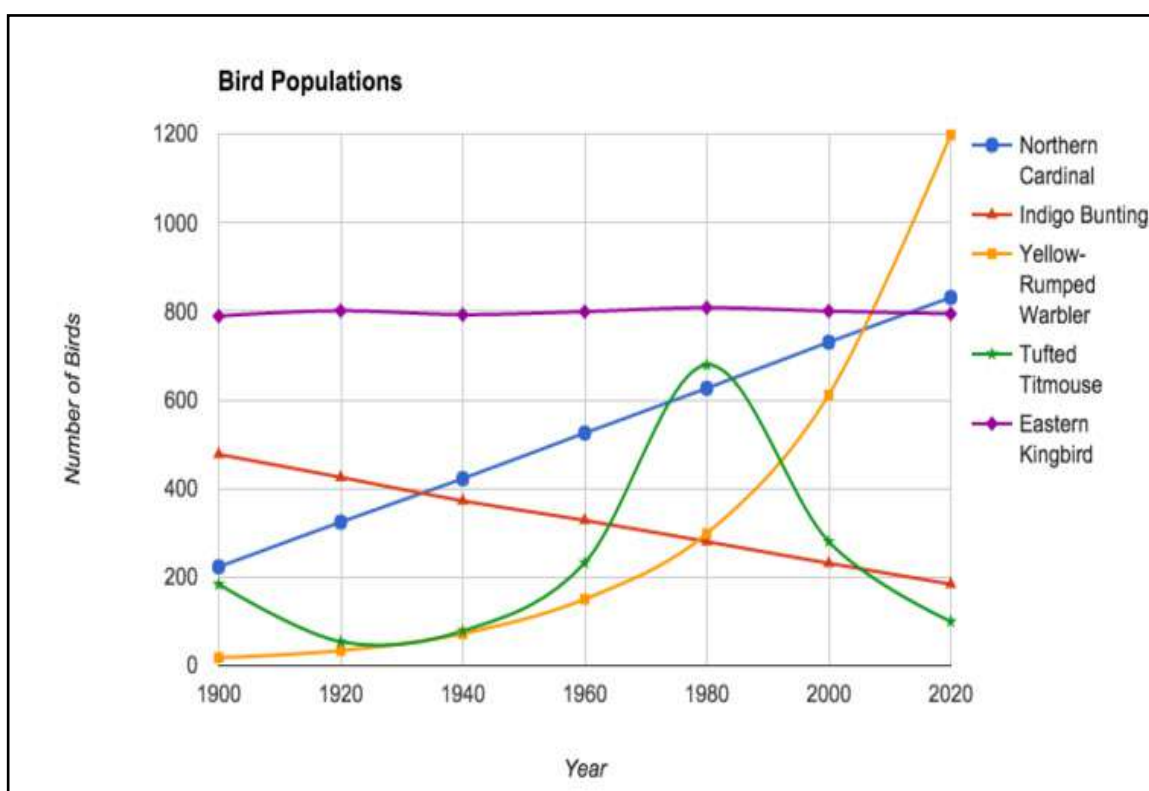

Step 1: Identify what the question is asking for.

This particular question is made up of three separate questions:

1. Which function is exponential?
2. Which function is decreasing?



3. Which species of bird had a population of 600 in 1980?

Step 2: Recall what makes a function exponential.

Exponential functions are those that increase in terms of e^x . These correspond to graphs that first changes slowly, and then changes at an increasingly fast rate. Looking at the graph given, the line that demonstrates exponential growth is the yellow square line, and that line is associated with the Yellow-Rumped Warbler.

Step 3: Recall what makes a function decreasing.

A function is considered decreasing if its y -values drop as its x -values (here, its time values) increase. In this particular question, only one line is consistently decreasing: the red triangle line. That line is associated with the Indigo Bunting.

Step 4: Find which species has population 600 in 1980.

To find this, look at the point on the x -axis marked 1980. Go up and find the y -values of 600 that occur at this point. Which line is that point on? In this particular case, the blue circle function associated with the Northern Cardinal lies closest to that point.

Example 6: The following bar chart depicts the bacterial growth of four bacterial strains at different pH levels. Which bacteria has the highest number of colonies combined across the different pH levels?

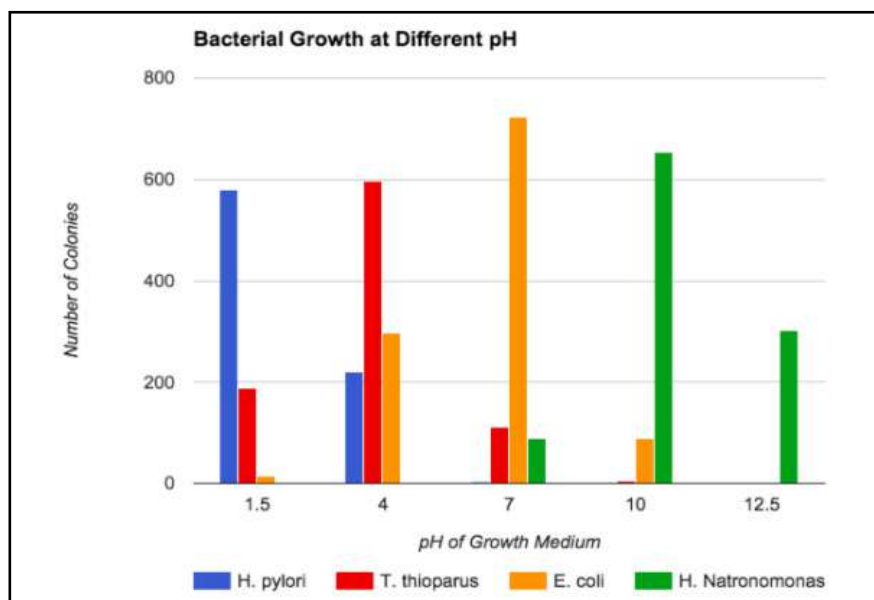

Step 1: Identify what the question is asking for.

The question asks you to find “which bacteria has the highest number of colonies combined over the different pH levels.” This means we will need to add (combine) all the colonies of each bacteria for the five different pH levels.



Step 2: Identify the number of colonies for each bacteria at each pH level. The specific pH level is not relevant to this question.

$$H. pylori: 590 + 210 = 800$$

$$T. thioparus: 190 + 600 + 100 + 2 = 892$$

$$E. coli: 10 + 300 + 760 + 75 = 1145$$

$$H. natronomonas: 60 + 620 + 300 = 980$$

Step 3: Answer the question

Comparing the results found in Step 2, it is seen that *E. coli* has the highest number of colonies across the pH spectrum.



Introductory Algebra

The algebra that is covered on the SAT Math test can be broken down into two general categories: “Introductory Algebra” and “Advanced Algebra.” In this section, we cover the basic mathematical principles you need in order to master introductory algebra. Introductory algebra forms a significant part of the SAT Math test; 19 questions, or a third of the section, are based on its principles. These concepts form the groundwork for more advanced math, so understanding them well and completely is crucial to preparing for success on the SAT Math test.

We’ve broken down our coverage of the basics of algebra into three lessons. The first, “Linear Equations, Inequalities, and Functions,” introduces you single-variable equations and explains how to interpret and solve them. The second lesson, “Systems of Linear Equations and Inequalities,” focuses on systems of simple equations—that is, multiple equations that are presented as a set. We walk through how to solve such systems using three methods: substitution, elimination, and graphing. Finally, the section’s last lesson, “Properties of Linear Graphs,” investigates the relationship between an equation and its graph. We look at how to solve for slope, x- and y-intercepts, and unknown values both graphically and algebraically.

You might be tempted to skip this section, especially if you’re worried about a particular concept covered later in the chapter. Our advice is to slow down and review the basics before moving on to material you find more troublesome. This can help you review material that due to its relative simplicity you may have covered in class a year or more ago and build confidence in your mathematical abilities. After brushing up on the basics of algebra, you may find that more advanced topics that particularly concerned you are much easier to master!

Section Outline

Absolute Value

- Understanding absolute value notation and working with it algebraically

Linear Equations and Inequalities

- Solving linear equations and graphing linear functions

Systems of Linear Equations and Inequalities

- Solving systems of linear equations and determining graphical intercepts

Properties of Linear Graphs

- Identifying axial intercepts, slope, and other properties of linear graphs



Absolute Value

Theoretically, absolute value is a signal for you to understand the specified numbers in terms of their distance from zero. Since distance measured is always positive in this scenario, what this amounts to practically is that the absolute value of any negative term is positive. The absolute value of positive terms remains positive.

Absolute value is indicated by placing a term or terms within a pair of upright bars, as shown below.

$$|x| = x$$

$$|-2| = 2$$

$$|2| = 2$$

When working with absolute value in a problem, treat the absolute value bars like special parentheses. Pay attention to which details of a problem lie within the bars and which lie outside of them; this can significantly change the results of your math, as shown below.

$$|x - 4| \neq |x| - 4$$

In particular, focus on any negative signs that accompany absolute value elements. Pay attention to whether these appear inside or outside of the absolute value bars. Location is crucial here.

$$|-4x| = 4x$$

$$-|4x| = -4x$$

See how that second expression has a negative result? That's because the negative sign was outside of the absolute value bars. The absolute value of $4x$ is $4x$, and the negative sign is tacked on afterward.

Absolute value bars that encompass multiple terms present another wrinkle. Treat each term as a distinct entity, figure out what its absolute value is, and then figure out how they go together. Remember that the subtraction of a term can always be rewritten as the addition of a negative term. For example, consider the following expression.

$$-|3x - 5|$$

We can rewrite it like this:

$$-|3x + (-5)|$$

And we can rewrite that like this:

$$-|3x| + |-5|$$

This is a lot easier to deal with! We just need to pay attention to the negative signs.



$$-3x + 5$$

These little details can make or break your work to answer a question, so it's important to know for which of them you need to be on the lookout! Practice working with them in the sample question below.

Sample Question

Evaluate the following expression when $x = -2$.

$$|-8 + 4x| - |2x^3| + |x^2|$$

- A. 4
- B. 28
- C. 32
- D. 36

First, let's split the first absolute value expression into distinct terms. This will make it easier to deal with when it comes to substituting in a negative variable.

$$|-8| + |4x| - |2x^3| + |x^2|$$

Now we can substitute in the negative variable, -2 .

$$|-8| + |4(-2)| - |2(-2)^3| + |(-2)^2|$$

Now for the exponents. Remember, a negative number squared becomes positive, but a negative number cubed remains negative.

$$|-8| + |-8| - |2(-8)| + |4|$$

Multiply the 2 by the -8 in the third absolute value term.

$$|-8| + |-8| - |-16| + |4|$$

Now that we've gotten our expression down to individual numbers in absolute value bars, we can process the absolute value part of the expression.

$$8 + 8 - 16 + 4$$

All that remains to be done is to add and subtract the operands.

$$16 - 16 + 4$$

$$4$$

The correct answer is A.



Linear Equations and Inequalities

In mathematics, the algebraic relationships between data sets can be presented in two ways. They can either be shown as an equation or inequality, or they can be displayed graphically. A “linear” equation is a special type of algebraic relationship in which a certain change in the x -value creates the same change in the y -value. Put a slightly different way, the ratio of the change in y to the change in x is always the same.

Linear equations and inequalities are always straight lines when graphed. Slope is defined as change in y over change in x . Since the same change in y always causes the same change in x at all points on the line in a linear equation, the line’s slope is consistent at all points. Let’s imagine that for a given linear equation, for every 1.0 unit y increases, x decreases by 2.0 units. This would produce a consistent slope that we can express as follows:

$$\text{Slope} = \frac{\Delta y}{\Delta x} = \frac{1.0}{-2.0} = -\frac{1}{2}$$

Even if a slope isn’t presented as a fraction, you can read it in terms of rise over run to figure out how it would appear graphically. Say a linear equation has slope of -3 ; put differently, this would be a slope of $\frac{-3}{1}$. This means that for every three units y is decreased, x increases by 1. Learning to interpret equations graphically and graphs in terms of the equations that they depict is an extremely important skill necessary for success on the SAT Math test.

One last note about linear equations and inequalities before we get to the nuts and bolts of how to work with them mathematically: a linear equation is a *function* by definition.

The SAT Math test examines your knowledge of linear equations and inequalities in both equation-based and graph-based problems, so let’s learn to read each of these forms for relevant information when formatting, solving, and graphing them.

Finding Linear Equations from Given Data

Standardized tests generally test students’ abilities to write linear equations in three ways. These are, in order of least to most difficult:

1. Write a linear equation when you know the **slope** and the **y-intercept**.
2. Write a linear equations when you know the **slope** and **one point** on the line.
3. Write a linear equation when you know **two points** on the line.

Many students find #1 to be easy, and struggle much more with #2 and #3. For the purposes of college-admission testing, students tend to struggle with #2 because they forget the correct formula to use (the point-slope formula), and they struggle with #3 because they forget the correct method to use to solve the problem.



Before getting started, there are two golden rules to keep in mind.

1. You always need to know the slope of a linear line to write its equation.
2. You want to use the formula with the name that matches the information that you have. If you have a slope and a y-intercept, then you want to use the slope-intercept formula. If you have a point and a slope, then you want to use the point-slope formula.

There are three formulas that you will need to memorize to solve these types of problems.

Slope-intercept formula: $y = mx + b$

Point-slope formula: $y - y_1 = m(x - x_1)$

Slope of a line through 2 points: $m = \frac{y_2 - y_1}{x_2 - x_1}$

Now, let's write the equation of a line using each of the three methods.

1. Equation of a line when you know the slope and y-intercept

This is the easiest method. Since you are given the slope and a y-intercept, you can just use the slope-intercept formula, substituting your slope for m and your y-intercept for b .

Example 1: Give the equation of a line with a slope of 3 and a y-intercept of 6.

$$y = mx + b$$

$$y = (3)x + (6)$$

$$y = 3x + 6$$

2. Equation of a line when you know the slope and a point on the line

In this case, we cannot start with the slope-intercept form of a line. We must use a formula that accommodates the information at hand—the slope and a point; therefore, we use the point-slope formula, and substitute the slope in for m and our point in for (x_1, y_1) .

Example 2: Give the equation of a line that travels through the point $(2, 12)$ and has a slope of 3.

$$y - y_1 = m(x - x_1)$$

$$y - (12) = (3)(x - (2))$$

$$y - 12 = 3(x - 2)$$

Now that you have written the equation in point-slope form, you usually have to convert the equation to slope-intercept form. You do this by simplifying the equation and then solving for y .



$$y - 12 = 3(x - 2)$$

Distribute the 3:

$$y - 12 = (3 \times x) - (3 \times 2)$$

Simplify:

$$y - 12 = 3x - 6$$

Add 12 to both sides to get y by itself:

$$y - 12 + 12 = 3x - 6 + 12$$

$$y = 3x + 6$$

3. Equation of a line when you know two points on a line

This is the most difficult equation to determine. Many students get stuck because they don't know the slope of the line, and don't realize that they need to calculate that before applying one of the equations.

In this case, you know two points. The slope-intercept form requires you to know the slope and the y -intercept (you have neither), and the point-slope form requires the slope and one point (you only have half of the information you need). In both cases, you need the slope, so you need to use the formula for the slope of a line between two points before you can apply either formula to solve for the equation of the line.

Example 3: Find the slope of the line that goes through the points (1,9) and (3,15).

First, use the slope formula and substitute (1,9) in for (x_1, y_1) and (3,15) in for (x_2, y_2) .

$$m = \frac{y_2 - y_1}{x_2 - x_1}$$

$$m = \frac{15 - 9}{3 - 1}$$

$$m = \frac{6}{2}$$

$$m = 3$$

Now that you have the slope, you can choose either of the two points that were given and plug that point and the slope into the point-slope formula.

$$y - y_1 = m(x - x_1)$$

$$y - 9 = 3(x - 1)$$

Use (1,9) for the point and $m = 3$ for the slope.

$$y - 9 = (3 \times x) - (3 \times 1)$$

Distribute the 3:



$$y - 9 = 3x - 3$$

Simplify:

$$y - 9 + 9 = 3x - 3 + 9$$

Add 9 to both sides to get y by itself:

$$y = 3x + 6$$

Graphing Linear Equations

When it comes to graphing linear equations, there are four possible outcomes: an increasing line, a decreasing line, a horizontal line with a constant slope, or a vertical line with an undefined slope. To graph a linear equations, you can either create a table and plotting its points, or you can use the slope and y -intercept of the equation. The latter method is the faster one. The y -intercept is the point at which the line intercepts the y -axis. The slope of the equation governs the direction of the line and the grade at which it increases or decreases. If the slope is positive, the equation is an increasing line; if it is negative, the line is decreasing; and if the slope is zero, the line is horizontal. The following are examples of each of these possibilities:

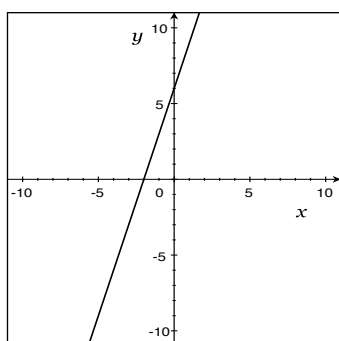

$$y = 3x + 6$$

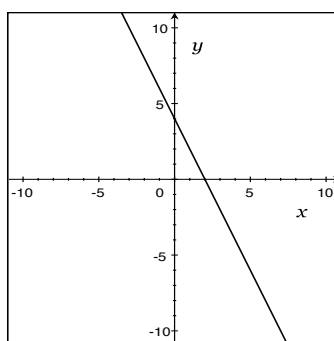

$$y = -2x + 4$$

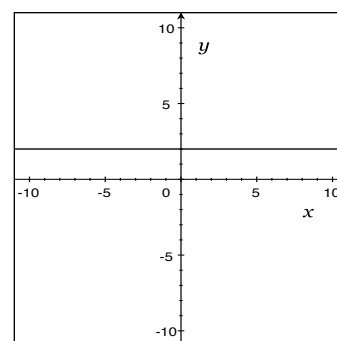

$$y = 2$$

Just as it is important to be able to graph an equation you are given, it is equally important to be able to determine the equation of a graphed line. There are two aspects of a graph for which to look that will help you write the equation for that graph.

1. What y -value does the graph hit when $x = 0$? This represents the y -intercept or the b value in the standard form: $y = mx + b$.
2. What is the slope of the graph? You can find the slope using any two points on the graph. Recall the slope formula: $m = \frac{y_2 - y_1}{x_2 - x_1}$. After finding the slope, m , you can write the equation depicted by the graph.

If it's not easy to determine the exact y -value when $x = 0$, you can solve for the y -intercept, b , after you know the slope, m . All you have to do is plug in any of the points



on the line into the equation and substitute the known slope, m , before solving for b as the unknown. Let's practice this:

Example 4: What is the equation of a line that goes through the point $(2,4)$ and has a slope of 8?

$$y = mx + b$$

$$4 = (8)(2) + b$$

$$4 = 16 + b$$

$$\frac{1}{4} = b$$

This means that the equation of this line is $y = 8x + \frac{1}{4}$.

Linear Inequalities

Inequalities are mathematical expressions that relate two quantities without stating that they are just equal to one another. Solving inequalities is very similar to solving equations, but there are a few key differences. As the name suggests, the quantities on either side of an inequality may be not equal to each other. Rather, they are compared using relative terms such as greater than or less than. Inequalities can be related using the terms greater than or equal to and less than or equal to, each of which allows for the possibility that the two quantities are equal but does not limit the quantities' relationship to this one possibility. Below is the list of the symbols used when representing inequalities mathematically and their definitions.

$<$ Quantities on the left side of this symbol are said to be "less than" quantities on the right side of this symbol.

Ex: $5 < 7$

$>$ Quantities on the left side of this symbol are said to be "greater than" quantities on the right side of this symbol.

Ex: $20 > 7$

\leq Quantities on the left side of this symbol are said to be "less than or equal to" quantities on the right side of this symbol.

Ex: $9 \leq 15$

Ex: $15 \leq 15$

\geq Quantities on the left side of this symbol are said to be "greater than or equal to" quantities on the right side of this symbol.

Ex: $11 \geq 6$

Ex: $11 \geq 11$

Note that all of these inequalities are true, and still uphold the definition of each



symbol. For example, 9 is indeed less than or equal to 15; it is less than it. Similarly, 15 is indeed less than or equal to 15; it is equal to it. One way to remember the definitions of these inequalities is to think of the symbols as the open mouth of a hungry alligator. The alligator always opens his mouth toward and “eats” the larger number.

Rules of Inequalities

The two symbols $<$ and $>$ are said to be non-inclusive, or exclusive. Consider the following inequality:

$$x < 4$$

For this inequality to be true, x can be equal to any values less than 4. Presented in a different way,

$$x < \overline{3.9}$$

Like equations, whatever operation is done to one side of the inequality must be done to the other side.

Ex: $x + 2 < 10$

To solve this inequality, we must subtract 2 from both sides of the inequality.

$$x + 2 - 2 < 10 - 2$$

Simplify.

$$x < 8$$

The same is true for multiplication and division.

Ex: $2x \geq 20$

To solve this inequality, we must divide both sides by 2.

$$\frac{2x}{2} \geq \frac{20}{2}$$

Simplify.

$$x \geq 10$$

However, one important rule when solving inequalities that is different from solving equations is that **if we multiply or divide by a negative number, then the direction of the inequality switches.**

Ex: $-\frac{1}{2}x > 14$

To solve this inequality for x , we must multiply both sides by (-2) :



$$(-2) - \frac{1}{2}x > 14(-2)$$

Remember that when we multiply or divide by a negative number, our inequality changes direction! Thus,

$$x < -28$$

Note that this is true (although easy to miss) for multiplying both sides by (-1) .

$$\text{Ex: } -x \geq 7$$

This means that:

$$x \leq -7$$

To illustrate this property, let's pick a number that satisfies the previous inequality, say, -10 . -10 is indeed less than or equal to -7 (it is less). Now, if we plug in -10 to the original inequality, we are left with the inequality $-(-10) \geq 7$ or just $10 \geq 7$, which are both true.

Linear Inequalities

Solving linear inequalities is just like solving linear equations, with the exception of the rule listed above.

Example 5: $3x - 23 < 4$

Start by adding 23 to both sides of the inequality:

$$3x < 27$$

Next, divide each side by 3:

$$\frac{3}{3}x < \frac{27}{3}$$

Simplify.

$$x < 9$$

Example 6: $-\frac{1}{6}x - 16 \geq -4$

We notice that all terms have a negative sign in front of them, so we can multiply both sides of the inequality by -1 .

$$\frac{1}{6}x + 16 \leq 4$$

Remember to switch the sign of the inequality since we multiplied by a negative



number! Next, subtract 16 from each side:

$$\frac{1}{6}x - 12$$

Multiply each side by 6 and simplify.

$$x - 72$$

If you have any time left over in the mathematics section, be sure to check your work. Let's check our answer for Example 2 by plugging in any value for x that is less than or equal to -72 to ensure that the inequality holds true. Let's choose -90 .

$$-\frac{1}{6}(-90) - 16 \geq -4$$

Simplify.

$$15 - 16 \geq -4$$

$$-1 \geq -4$$

Is -1 greater than or equal to -4 ? Yes, it is greater. Thus, we see our answer is correct.

Example 7: $2(5x + 8) < 100 - 4x$

Start by distributing the multiplication on the left side of the inequality:

$$10x + 16 < 100 - 4x$$

Next, add $4x$ to both sides:

$$14x + 16 < 100$$

Subtract 16 from both sides:

$$14x < 84$$

Divide both sides by 14:

$$x < 6$$

Note that since we did not divide or multiply by any negative numbers, we never had to change the direction of the inequality symbol.

Example 8: $2y < 6x + 4$

Treat this inequality as if it were an equation and solve.

$$y < 3x + 2$$

This is our final answer.



Graphing Linear Inequalities

Graphing linear inequalities is similar to graphing linear equations, but the process involves two major differences. The first difference is in regards to the line itself, depending on whether it is an inclusive or non-inclusive inequality. For inequalities that are inclusive (\geq or \leq), a solid line is used. For inequalities that are non-inclusive ($>$ or $<$), a dashed line is used.

The next aspect of graphing an inequality involves shading a region. If an inequality reads y is less than or y is less than or equal to, the area below the line will be shaded. If an inequality reads y is greater than or y is greater than or equal to, the area above the line will be shaded. If you're ever unsure about which side of an inequality to shade, you can always choose a point to test.

Consider the inequality $y > x - 4$. Let's say that we're unsure about which side of the inequality to shade. We can choose the value of $(0,0)$ and plug it into the equation:

$$0 > 0 - 4$$

$$0 > -4$$

With these values inserted, the inequality holds true, so we want to shade the side of the line on which the origin $(0,0)$ falls. Any point can function as your test point; the origin is just an example.

The following are graphs of linear inequalities.

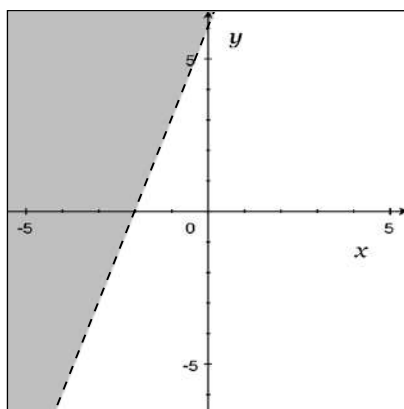

$$y > 3x + 6$$

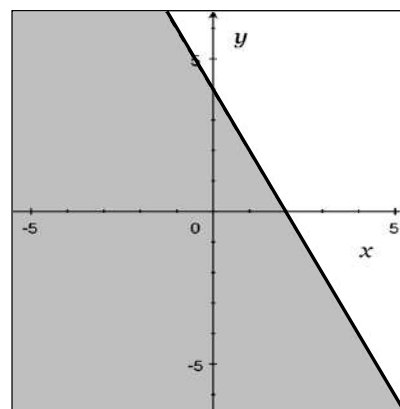

$$y \leq -2x + 4$$



Systems of Linear Equations and Inequalities

A system of equations is comprised of two or more algebraic equations that contain the same number of unknown variables. These equations can be linear or nonlinear; however, the number of unknowns must be the same for every equation in the system. For a solution to a system of equations to exist, the solution to one equation must be the solution to each and every equation in the system.

To solve a system of equations, the number of equations must be greater than or equal to the number of unknowns for which you are trying to solve. For example, if there are two unknowns in an equation—say, x and y —then there must be at least two equations in the system in order to find the solution. If an equation has x , y , and z as unknown variables, then there must be at least three equations in the system in order to solve the problem. Examples of systems of equations are as follows.

Example 1:

$$\begin{aligned}y + x &= 7 \\2y + 4x &= 22\end{aligned}$$

Example 2:

$$\begin{aligned}x + y &= 5 \\z &= 2 \\2x + 3z &= 18\end{aligned}$$

There are two primary ways to go about solving a system of equations: substitution and elimination.

Solving Using Substitution

Substitution refers to the process of solving one equation for one variable, getting the variable by itself on one side of the equation. Then, it involves substituting everything on the other side of the solved equation in place of the variable in one of the other equations of the system. This substitution creates a new equation comprised of one variable that can be solved for using algebraic operations. Once one variable is solved for, its value can be substituted back into the original equation, creating another one-variable equation and allowing you to solve for the other unknown variable. This process may need to be repeated depending on the number of unknown variables in the system.

Working with Example 1, let's use substitution to solve the system of equations:

$$\begin{aligned}y + x &= 7 \\2y + 4x &= 22\end{aligned}$$

Step 1: Solve the first equation for y . Subtract x from both sides. The new equation for equation one is:

$$y = 7 - x$$

Step 2: Substitute the new equation, $7 - x$, in for each y in equation two.



$$2y + 4x = 22 \rightarrow 2(7 - x) + 4x = 22$$

Step 3: Use algebraic operations to solve for x . First, distribute the 2 to each term inside the parentheses.

$$2(7 - x) + 4x = 22$$

Combine like terms.

$$14 - 2x + 4x = 22$$

$$14 + 2x = 22$$

Subtract fourteen from both sides.

$$2x = 8$$

Divide by two on both sides.

$$x = 4$$

Step 3: Substitute the value found for x into the y equation and solve for y .

$$y = 7 - x$$

$$y = 7 - 4$$

$$y = 3$$

Step 4: State the solution.

$$x = 4, y = 3$$

Solving Using Elimination

Elimination is the process by which adding or subtracting one equation from another equation cancels one of the variables out, creating a single-variable equation and allowing you to solve for the other variable. With elimination, sometimes one or more of the equations must be multiplied by a constant prior to adding or subtracting the equations. Once one variable is solved for by the process of elimination, you can substitute that value into one of the original equations and solve for the other unknown variable. If you are working with a system of more than two equations, this process may need to be repeated in order to solve for all the unknown variables.

Working with Example 2, let's use elimination to solve the system of equations:

$$x + y = 5$$

$$z = 2$$

$$2x + 3z = 18$$

Step 1: Subtract two times the first equation from the third equation. Notice that the x 's cancel out. (This is the elimination step).



$$2x + 3z = 18$$

$$\underline{-2(x + y = 5)}$$

$$2x + 3z = 18$$

$$\underline{-2x - 2y = -10}$$

$$3z - 2y = 8$$

Step 2: Substitute the second equation into the new equation found in the previous step.

$$\text{Given } z = 2$$

$$3z - 2y = 8 \rightarrow 3(2) - 2y = 8$$

Multiply two and three together.

$$6 - 2y = 8$$

Subtract six from both sides.

$$-2y = 2$$

Divide by negative two on both sides.

$$y = -1$$

Step 3: Substitute the value found for y into the first equation to solve for x .

$$x + y = 5$$

$$x + (-1) = 5$$

$$x - 1 = 5$$

$$x = 5 + 1$$

$$x = 6$$

Step 4: State the solution.

$$x = 6, y = -1, z = 2$$



Graphing Systems of Linear Equations

Solving a system of equations by graphing is not the most time-efficient approach. Therefore, when it comes to taking the SAT, substitution and elimination are better choices for solving system of equations. Graphing a system of linear equations requires three basic steps.

1. Manipulate the equations in the system so that they are in slope-intercept form.
2. Plot the y -intercept and use the slope to create the line of the equation.
3. Plot the points on a graph. The point at which the equations of the system intersect is the solution to the system. There may be multiple such points.

Example 1

Step 1: Write the equations in slope-intercept form.

$$y + x = 7$$

$$y = x + 7$$

$$2y + 4x = 22$$

$$y = \frac{22 - 4x}{2}$$

$$y = 11 - 2x$$

$$y = -2x + 11$$

Step 2: Since the system is linear, identify the y -intercept and slope of each equation.

Equation 1: y -intercept = 7, $m = -1$

Equation 2: y -intercept = 11, $m = -2$

Step 3: Graph the equations and identify where they intersect.

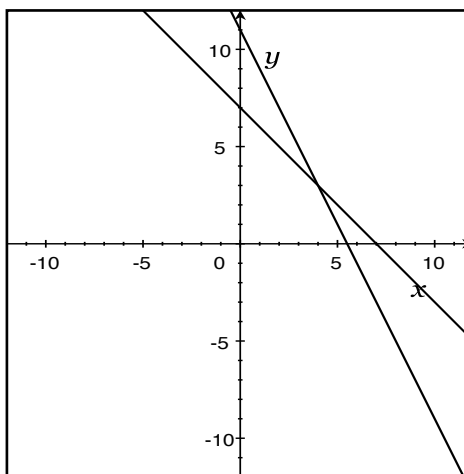

Solution: (4,3)



Systems of Inequalities

Systems of inequalities are similar to systems of equations in regards to the algebraic operations needed to solve them, with the exception of the multiplication and division of negative numbers. The main difference occurs when one arrives at the solution—specifically how it is seen in the final equation and the corresponding graph. Instead of having a specific value for each variable in the system, a solution to a system of inequalities has a range of values for each variable.

Inclusive and Noninclusive Inequalities

There are two types of inequalities: inclusive and noninclusive. In a system of inequalities, the functions can be inclusive, noninclusive, or a combination of both. For an inequality to be inclusive, it must include either a “greater than or equal to” sign (\geq) or a “less than or equal to” sign (\leq). For an inequality to be noninclusive, it must include either a “greater than” sign ($>$) or a “less than” sign ($<$).

When it comes to knowing whether a word problem involves inclusive or noninclusive inequalities, there are a few key identifiers for which to look. Common phrases used to describe inclusive inequalities include terms that convey a range of values including the specific number mentioned, such as “no more than,” “no less than,” “cannot exceed,” “at least,” and “cannot drop below.” Noninclusive inequalities use phrases that convey a range of values not including the specific number mentioned, such as “is less than,” “is greater than,” “exceeds,” and “approaches.” Let’s look at a few examples.

Sample Question

Consider the following word problem:

“Jane is selling cookies and brownies for a fundraiser. Each brownie is \$2.50 and each cookie is \$1.85. Jane wants to make at least \$80 and sell at minimum 10 brownies.”

If c refers to the number of cookies Jane sells and b to the number of brownies she sells, which of the following systems of inequalities models the word problem?

- A. $2.50b + 1.85c \leq 80$
 $b \geq 10$
- B. $2.50b + 1.85c \geq 80$
 $b \geq 10$
- C. $2.50c + 1.85b \geq 80$
 $b \geq 10$
- D. $2.50c + 1.85b \geq 80$
 $b \leq 10$

This system of inequalities contains two inclusive inequalities. As shown in the answer choices, the first one listed models the various prices of the baked goods and the total amount that Jane wants to make for the fundraiser, and the second models the statement that she wants to sell a minimum of ten brownies.



First, let's make sure that the correct coefficients are used for the variables c and b , or in other words, that the correct prices of the cookies and brownies are represented. According to the word problem, each brownie costs \$2.50 and each cookie costs \$1.85, so the first inequality should include the terms $2.50b$ and $1.85c$. Only answer choices A and B do this; C and D both switch the variables' coefficients.

The only detail in which A and B differ from one another is in the direction of the inequality sign used in the first inequality. So, which is true—do we want the sum of the variables to be greater than or equal to or less than or equal to 80? Keep in mind what the 80 is representing in this context: the amount of money that Jane wants to make at the fundraiser. What type of wording is used to convey this amount? We're told that Jane wants to make "at least" eighty dollars. This tells us that we want the variables to equal or be greater than 80, making B the correct answer.

Sample Question

Consider the following word problem:

Bob rides his bike to and from school. It takes him more than four minutes but less than six minutes to bike the first three blocks to school, and he is able to get to school in less than 20 minutes.

If x represents the number of minutes it takes Bob to ride the first three blocks to school and y represents the number of minutes it takes him to ride the rest of the way to his school, which of the following systems of inequalities models the word problem?

A. $4 < x < 6$
 $x + y < 20$

B. $4 < x < 6$
 $x - y < 20$

C. $4 \leq x \leq 6$
 $x + y < 20$

D. $4 \leq x \leq 6$
 $x - y < 20$

Let's focus on the x -variable first. We're told that it takes Bob "more than four minutes but less than six minutes" to ride the first three blocks to school. This language indicates a non-inclusive inequality; "more than four minutes" does not include exactly four minutes as a possibility. So, we can ignore answer choices C and D, because they use inclusive inequalities.

How do answer choices A and B differ? Their first inequalities are identical, but A uses the sum of x and y in its second inequality and B uses the difference between x and y in its. Which models the problem? Consider what x and y represent in relation to twenty. Both variables are measuring the amount of time it takes Bob to ride his bike a certain distance to school, and the twenty represents how Bob "is able to get to school in under twenty minutes." We need to add the variables together to find the total time it takes Bob to ride his bike to school, and then state that that is less than twenty. Finding the difference between the two variables does not relate to the phrasing of the word problem. A is the correct answer.



Graphing Systems of Linear Inequalities

To graph a system of inequalities, there are a few different approaches. You can solve the inequalities and put them in slope-intercept form if possible. Another approach is to create a table and plug in x -values to solve for the y -values. Then, identify if the system includes inclusive or noninclusive inequalities, as this will decide whether the graph should use solid or dotted lines. Next, graph the inequalities, or plot and connect the points from the table. Finally, shade the correct region of each inequality. Where the shaded regions overlap is the solution to the system.

Let's graph the following system of inequalities:

$$y + x > 7$$

$$2y + 4x \leq 22$$

Step 1: Write the inequalities in slope-intercept form.

$$y > -x + 7$$

$$y \leq -2x + 11$$

Step 2: Since the system is linear, identify the y -intercept and slope of each equation.

$$\text{Inequality 1: } y\text{-intercept} = 7, m = -1$$

$$\text{Inequality 2: } y\text{-intercept} = 11, m = -2$$

Step 3: Graph the inequalities and identify whether they are inclusive or noninclusive and shade the regions related to the inequalities. Inequality graphs differ in a few ways from typical graphed equations:

- Shaded regions indicate the side of the line that contains points that, when plugged into the inequality, make the inequality true.
- Noninclusive inequalities are depicted as dashed lines, while inclusive inequalities are shown as solid lines.
- Regions in which the shaded regions of both inequalities overlap represent the solution to the system.

$y > -x + 7$ is a dotted line because it is a noninclusive inequality; $y \leq -2x + 11$ is a solid line because it is an inclusive inequality.

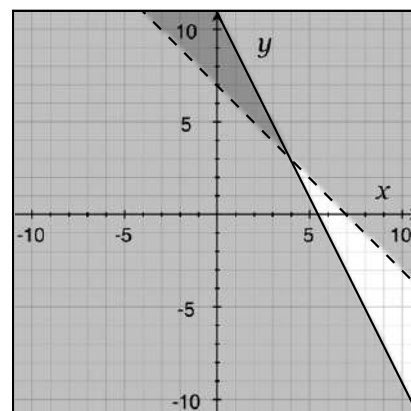

Properties of Linear Graphs

The most common form in which equations of lines are written is slope-intercept form:

$$y = mx + b$$

In this equation, y is the y -coordinate of the point of interest on the line, m is the slope of the line $\left(\frac{\Delta\text{rise}}{\Delta\text{run}}\right)$, x is the x -coordinate of the point of interest on the line, and b is the y -intercept (the y -coordinate of the point on the line that intersects the y -axis).

Another form in which equations of lines are commonly written is point-slope form:

$$y - y_1 = m(x - x_1)$$

In this equation, (x_1, y_1) is a point on the line, (x, y) is any point in the coordinate plane, and m is the slope of the line. Point-slope form is useful when, as the name suggests, we know a point on a line and the slope of that line. If the point (x, y) is on the line, we know that the slope between the two points (x, y) and (x_1, y_1) is m . Recall that the equation for slope is $\frac{y_2 - y_1}{x_2 - x_1}$. Also, recall that on a straight line, any two points have the same slope between them. Point-slope form is useful if we are given the slope of a particular line and a point through which it passes.

Sample Question

What is the equation of a line that passes through the point $(-3, 1)$ and has a slope of 2?

- A. $y = 3x - 2$
- B. $y = 2x + 7$
- C. $y = 2x + 4$
- D. $y = 3x + 1.5$

We can plug this point into point-slope form to find the equation of the line:

$$y - 1 = 2(x - (-3))$$

$$y - 1 = 2x + 6$$

$$y = 2x + 7$$

This means that the line has a slope of 2 and a y -intercept of 7.

The correct answer is B.



Sample Question

Find the x - and y -intercepts of the line that has the equation $y = 3x - 9$.

- A. x -intercept = $(3,0)$
 y -intercept = $(0,-9)$
- B. x -intercept = $(5,0)$
 y -intercept = $(0,-3)$
- C. x -intercept = $(9,0)$
 y -intercept = $(0,-3)$
- D. x -intercept = $(3,0)$
 y -intercept = $(0,-5)$

The x -intercept is the x -coordinate of the point on the line that intersects the x -axis. By definition, this point will have the form $(x,0)$ since it is on the x -axis. The y -intercept is the y -coordinate of the point on a line that intersects the y -axis. By definition, this point will have the form $(0,y)$ since it is on the y -axis. Since this equation is already in slope-intercept form, we know that the y -intercept, b , is -9 . Thus, the line intersects the y -axis at the point $(0,-9)$. To find the x -intercept, we must use our knowledge that the x -intercept has a y -coordinate of zero. Thus, we plug in zero for y into our equation and solve for x .

$$0 = 3x - 9$$

$$-3x = -9$$

$$x = 3$$

Thus, the x -intercept is $(3,0)$, so the correct answer is A.

Vertical Line Graphs

Suppose there is a vertical line that has an x -intercept of 4. A vertical line has slope that is undefined by definition. Slope is $\frac{\Delta \text{rise}}{\Delta \text{run}}$. A vertical line does not have any change in x . Thus, the denominator of our expression for the slope of a vertical line is zero. Now, it is a rule that we cannot divide any number (change in rise) by zero. Thus, the slope of a vertical line is said to be undefined. The equation for this particular vertical line is $x = 4$.

Horizontal Line Graph

In the graph of a horizontal line, all of the points on that line will have the same y -value, and an infinite number of x -values. The slope of a horizontal line graph is thus $\frac{0}{\text{infinity}}$. By definition, any fraction that has zero in the numerator is equal to zero, so the slope of a horizontal line is zero. Another way to remember this is by thinking of a graph with a very small positive slope, say $\frac{1}{100}$. The more this slope flattens out (i.e.



$\frac{1}{1000}$, $\frac{1}{10000}$, etc.) the closer the slope gets to zero. Note that this is the opposite case for vertical lines, where the highest positive slope approaches verticality.

Parallel Lines

Parallel lines in the same plane never intersect. The only way for this to be true is for the slopes of the lines to be equal. Here are some examples of parallel lines in the same plane:

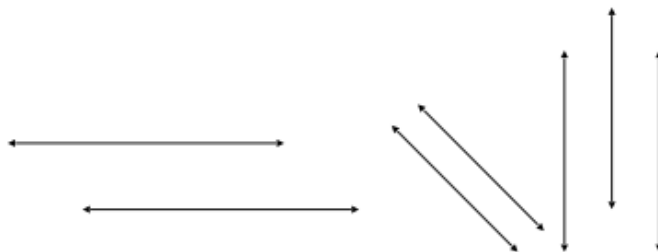

Example 1: What are the slopes of the three sets of lines shown above?

The first pair of lines are horizontal. Thus, their “rise” does not change, yielding zero in the numerator for our expression for slope. Zero in the numerator of a fraction means that fraction is equal to zero. The middle pair of parallel lines are pointing down and to the right, thus they have a negative slope. Lastly, the triplet of parallel lines on the right are vertical. They do not have a change in run, and thus the expression for their slopes have zero in the denominator. We cannot divide any number by zero, so their slopes are undefined.

Perpendicular Lines

Perpendicular lines intersect at 90° . Thus, they create a pair of right angles. Perpendicular lines have slopes that are opposite reciprocals. For example, a line with a slope of $\frac{1}{3}$ will be perpendicular to any line with a slope of -3 .

Some common notation that will tell you if lines are perpendicular or parallel:

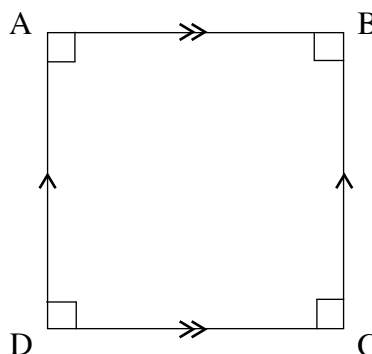

In square ABCD above, angles A, B, C, and D are all right angles, as indicated by the small two-legged tick marks, which are also at right angles to each other. Since these angles are right angles we know that sides AD and BC are perpendicular to sides AB and



CD. Also note the arrows on sides AD and BC and the double arrows on sides AB and CD. These symbols indicate that lines with the same arrows are parallel to each other. Thus, sides AD and BC are parallel to each other and sides AB and CD are parallel to each other.

Sample Question

What is the equation of the line passing through the point $(1,2)$ that is perpendicular to a line that passes through the point $(5,3)$ and has a slope of -6 ?

- A. $y = \frac{5}{6}x + \frac{1}{6}$
- B. $y = \frac{5}{6}x + \frac{4}{5}$
- C. $y = \frac{1}{6}x + \frac{7}{6}$
- D. $y = \frac{1}{6}x + \frac{11}{6}$

First, recognize what this question is asking. We are looking for the equation of the line that passes through the point $(1,2)$ and is perpendicular to the line that has a slope of -6 and passes through $(5,3)$. We know that our line of interest is perpendicular to the one with a slope of -6 , so our slope is the opposite reciprocal of -6 , which is $\frac{1}{6}$. The perpendicular line passes through $(1,2)$, so we set up an equation in point-slope form:

$$y - 2 = \frac{1}{6}(x - 1)$$

Simplify to the this into slope-intercept form:

$$y - 2 = \frac{1}{6}x - \frac{1}{6}$$

$$y = \frac{1}{6}x - \frac{1}{6} + 2$$

$$y = \frac{1}{6}x - \frac{1}{6} + \frac{12}{6}$$

$$y = \frac{1}{6}x + \frac{11}{6}$$

The correct answer is D. Note that to answer this question we did not have to use the extraneous information about the point $(5,3)$. All we needed to know about the line passing through this point was its slope.



Use the graph at right to answer the following questions.

Example 1: What is the slope of the line?

Pick any two points on the line and use the slope formula:

$$\frac{\Delta \text{rise}}{\Delta \text{run}} = \frac{y_2 - y_1}{x_2 - x_1}$$

Let's pick the points $(0,4)$ and $(1,1)$.

$$m = \frac{1 - 4}{1 - 0} = -3$$

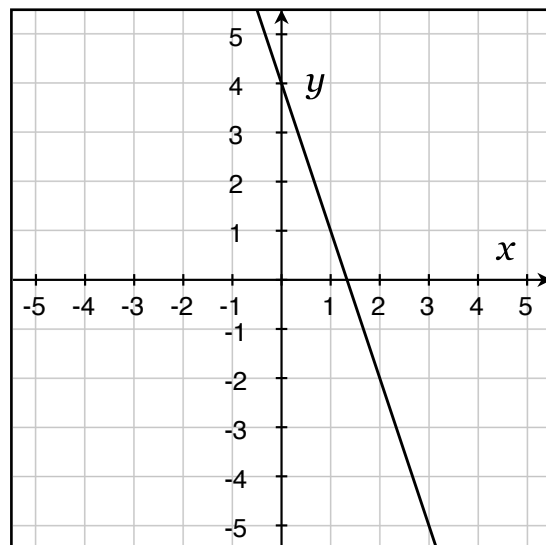

Example 2: What is the equation of this line?

Since we already calculated the slope, and we can easily find a point through which the line passes, we can use point-slope form to find the equation for this line. Let's use the point $(0,4)$.

$$\begin{aligned} y - 4 &= -3(x - 0) \\ y - 4 &= -3x \\ y &= -3x + 4 \end{aligned}$$

Double check to make sure the answer looks reasonable. Does the line have a negative slope? Yes—the line points down and to the right. Where does the line cross the y -axis? From the graph, we see that it intersects the y -axis at the point $(0,4)$. This means that in our equation for this line, the y -intercept in slope-intercept form (b) is also 4.

Example 3: What is the x -intercept of this line?

At first glance, this line does not look like it crosses the x -axis at a whole number. This would have been the quickest way to find the x -intercept; however, we can move on to our next option: substituting values into the equation of the line. The x -intercept is the point at which the line intersects the x -axis. We know that this point has a y -coordinate of zero, so we plug in 0 for y in our equation.

$$\begin{aligned} 0 &= -3x + 4 \\ 3x &= 4 \\ x &= \frac{4}{3} \end{aligned}$$

Thus, the x -intercept is $\left(\frac{4}{3}, 0\right)$.



Advanced Algebra

Some of the most advanced topics covered in the SAT Math test come from content derived from Algebra 2, and even some elementary Pre-Calculus coursework. These topics fit into the SAT subscore known as “Passport to Advanced Math,” and address topics that are fundamental to more advanced mathematical applications.

Advanced Algebra questions account for 16 of the 58 questions on the SAT Math test, and appear in all divisions of the Math assessment (calculator multiple-choice, calculator grid-in, no calculator multiple-choice, no calculator grid-in). Of the question classifications presented on the SAT Math test, Advanced Algebra questions are the least likely to be structured in a word problem format. More frequently, these questions will involve complicated equations and expressions that require a more practical and simplistic presentation.

Common topics tested by Advanced Algebra questions involve quadratics and polynomials, rational expressions, function notation, and non-linear graphs. Parabolic functions and quadratic functions, as well as principles for factoring polynomials, are especially popular testing materials.

The skills required for the Advanced Algebra questions on the SAT Math test are more complex than those on any other section of the exam, and require a dedicated amount of study time and preparation. The following pages provide a thorough outline of the topics covered by these questions and an in-depth exploration of the skills necessary to perform well on the Passport to Advanced Math subscore.

Section Outline

Simplifying, Expanding, and Rewriting Polynomial Expressions

- Factoring and manipulating algebraic components of polynomial expressions

Quadratic Functions and Equations

- Factoring and manipulating elements of quadratic functions and using the quadratic formula

Exponential Expressions, Functions, Equations and Radicals

- Simplifying and solving exponential and radical equations

Rational Equations and Expressions

- Dividing polynomials and simplifying rational expressions

Systems of Equations

- Solving systems of non-linear equations, including systems of quadratic equations

Function Notation

- Evaluating function notation and solving for complex functions

Graphing Algebraic Functions

- Identifying graph behaviors and properties, such as maxima, minima, continuity, intercepts, and transformations

Graphing Circles

- Determining equations for circular graphs

Complex Equations in Context

- Interpreting complex word problems in relation to polynomial and exponential equations



Simplifying, Expanding, and Rewriting Polynomial Expressions

A polynomial is an algebraic expression comprised of more than two terms usually of like bases and different powers. Polynomials frequently have integer terms in them as well. Some examples of polynomial are as follows.

$$\begin{aligned}(3x^2 + 2x - 4) \\ (x^4 - 6x^2 + x - 10) \\ (7x^3 + x^2 + x + 1)\end{aligned}$$

Adding Polynomials

The process used to add polynomials together is the same one that is used to add monomials and binomials. The key to adding polynomials is identifying the various like bases and then proceeding to add their coefficients. For instance, let's add the following polynomials:

$$(x^2 + 2x - 1) + (3x - 2x^2 + 4)$$

The first step is to drop the parentheses, making the expression

$$x^2 + 2x - 1 + 3x - 2x^2 + 4$$

Next, identify the like terms. In this particular case, the like terms include x^2 , x , and the integer terms. Add the coefficient of each like base together to create the new term. For the like base of x^2 , the coefficients are 1 and -2 . After adding them, this results in $-x^2$. Now, for the like base of x , the coefficients are 2 and 3. After adding them, this results in $5x$. From here, add the integer portions of the polynomials, which in this case are -1 and 4: $-1 + 4 = 3$. The final step is to combine all the terms to create the new simplified polynomial:

$$-x^2 + 5x + 3$$

Sample Question

Simplify the following expression: $(3x^4 + x^2 - 12) + (x^4 + x^3 - 3x^2 + 10)$

- A. $4x^4 + x^3 + 2x^2 + 2$
- B. $4x^4 + x^3 - 2x^2 - 2$
- C. $2x^4 + x^3 + 2x^2 + 2$
- D. $2x^4 + x^3 - 2x^2 - 2$

Step 1: Drop the parentheses and identify like bases.

$$3x^4 + x^2 - 12 + x^4 + x^3 - 3x^2 + 10$$



Like bases: x^4 , x^2 , and the integer terms

Step 2: Add the coefficients of like bases.

Coefficients of x^4 : $3 + 1 = 4$, so $3x^4 + x^4 = 4x^4$

Coefficients of x^2 : $1 + -3 = -2x^2$

Integer terms: $-12 + 10 = -2$

Step 3: Combine the terms together to get the simplified polynomial.

In this problem, it is important to notice that x^3 was only in the second polynomial and still needs to be included in the final polynomial.

$$4x^4 + x^3 - 2x^2 - 2$$

B is the correct answer.

Subtracting Polynomials

The process to subtract polynomials is the same as the one used to subtract monomials and binomials. In order to drop the parentheses and simply combine like terms, one must first distribute the negative sign in front of the second polynomial through to each term within the polynomial.

Take, for example the following polynomial:

$$(x^3 + 4x^2 - x + 3) - (x^3 + 2x^2 - 2x - 7)$$

Distributing the negative sign to each term in the second polynomial will change each term's sign. Remember, when a negative is multiplied by a positive, the term becomes negative. Likewise, if a negative is multiplied by another negative, then the term becomes positive. Applying these rules to the example above results in:

$$(x^3 + 4x^2 - x + 3) + (-x^3 - 2x^2 + 2x + 7)$$

From here, the parentheses can be dropped:

$$x^3 + 4x^2 - x + 3 - x^3 - 2x^2 + 2x + 7$$

Now we can combine like terms. Our expression has like terms of x , x^2 , x^3 , and the integer terms. To combine like terms, add their coefficients. The coefficients on the cubed terms are 1 and -1 . When added, these coefficients cancel each other out, resulting in a zero cubed term. The coefficients on the squared term are 4 and -2 , which when added together, yield a sum of 2: $4 + (-2) = 4 - 2 = 2$. The coefficients on the x term are -1 and 2, which when added together sum to $-1 + 2 = 1$. Adding the integer terms gives $3 + 7 = 10$. From here, all the coefficients, bases, and integer portions are combined to give the final polynomial:

$$2x^2 + x + 10$$



Sample Question

Simplify the following expression: $(12x^2 + 3x - 4) - (x^3 + 2x^2 - x)$

- A. $9x^2 + 4x - 4$
- B. $-x^3 + 14x^2 + 4x - 4$
- C. $-x^3 + 10x^2 - 4x - 4$
- D. $-x^3 + 10x^2 + 4x - 4$

Step 1: Distribute the negative sign to each term in the second polynomial. Once the negative sign is distributed, the parentheses can be dropped.

After the negative is distributed, the second polynomial becomes $-x^3 - 2x^2 + x$. Remember, when two negatives are multiplied together, they create a positive number.

$$12x^2 + 3x - 4 - x^3 - 2x^2 + x$$

Step 3: Identify like bases and add their coefficients.

Like bases: x^2 and x

The coefficients for x^2 are 12 and -2 . $12 + (-2) = 10$, so $12x + (-2x) = 10x$.

The coefficients for x are 3 and 1. $3 + 1 = 4$, so $3x + x = 4x$.

Step 4: Combine terms to create a simplified polynomial.

In this problem, remember to include the terms that were not in both polynomials: -4 and $-x^3$.

$$-x^3 + 10x^2 + 4x - 4$$

D is the correct answer.

Multiplying Polynomials

Multiplying polynomials is extremely beneficial when it comes to simplifying an expression. When it comes to multiplying polynomials, the most important thing to remember is that each term from one polynomial will need to be multiplied with each term from the other polynomials. Rule of multiplying exponents and order of operations are key in correctly multiplying polynomials as well. The larger the polynomials is, more computations are done to arrive at the simplified polynomial. Such an example of polynomial multiplication is $(x + 3 - x^2)(2x - 1 + 2x^2)$. First, multiply the first term from the first polynomial with each term in the second polynomial; this results in $x \times 2x = 2x^2$, $x \times -1 = -x$, and $x \times 2x^2 = 2x^3$. Next, multiply the second term in the first polynomial with each term in the second polynomial; this results in $3 \times 2x = 6x$, $3 \times -1 = -3$, and $3 \times 2x^2 = 6x^2$. Then, multiply the third



term in the first polynomial with each term in the second polynomial; this results in $-x^2 \times 2x = -2x^3$, $-x^2 \times -1 = x^2$, and $-x \times 2x^2 = -2x^3$. From here, we combine all terms into a polynomial, $2x^2 - x + 2x^3 - 2x^3 + x^2 - 2x^3$. Now, combine like base terms to simplify further. In this particular case, the x^3 terms will cancel out since they have coefficients that add up to zero. The final simplified polynomial is $3x^2 - x - 2x^4$.

Sample Question

Simplify the following expression: $(3x^3 + 2x^2 - 5)(x^3 + 5x^2 - x + 6)$

- A. $3x^6 + 17x^5 + 7x^4 + 11x^3 - 13x^2 + 5x - 30$
- B. $4x^6 + 15x^5 + 6x^4 + 5x^3 - 7x^2 + 15x - 25$
- C. $3x^6 + 14x^5 + 4x^4 + 8x^3 - 12x^2 + 10x - 24$
- D. $4x^6 + 18x^5 + 5x^4 + 9x^3 - 10x^2 + 11x - 16$

Step 1: Distribute the first term in the first polynomial to each term in the second polynomial.

$$\begin{aligned} 3x^3 \times x^3 &= 3x^6 \\ 3x^3 \times 5x^2 &= 15x^5 \\ 3x^3 \times -x &= -3x^4 \\ 3x^3 \times 6 &= 18x^3 \end{aligned}$$

Step 2: Distribute the second term from the first polynomial to each term in the second polynomial.

$$\begin{aligned} 2x^2 \times x^3 &= 2x^5 \\ 2x^2 \times 5x^2 &= 10x^4 \\ 2x^2 \times -x &= -2x^3 \\ 2x^2 \times 6 &= 12x^2 \end{aligned}$$

Step 3: Distribute the third term in the first polynomial to each term in the second polynomial.

$$\begin{aligned} -5 \times x &= -5x^3 \\ -5 \times 5x^2 &= 10x^4 \\ -5 \times -x &= 5x \\ -5 \times 6 &= -30 \end{aligned}$$

Step 4: Identify and combine like terms.

$$\begin{aligned} 3x^6 + 15x^5 + 2x^5 - 3x^4 + 10x^4 + 18x^3 - 2x^3 - 5x^3 + 12x^2 - 25x^2 + 5x - 30 \\ 3x^6 + 17x^5 + 7x^4 + 11x^3 - 13x^2 + 5x - 30 \end{aligned}$$

The correct answer is A.



Dividing Polynomials

When dividing polynomials, it is important to identify like bases and use the rule of exponents to simplify the terms which contain variables. Similarly to multiplying polynomials, when dividing polynomials each term in the dividend must be divided by each term in the divisor. One way to accomplish division with polynomials is to perform long division, which is also known as synthetic division. An example of using long division with polynomials is as follows: in $(12x^2 + 2x + 4) \div (2x + 1)$, the dividend is $(12x^2 + 2x + 4)$ and the divisor is $(2x + 1)$. Performing this division will result in finding the quotient.

$$(2x + 1) \overline{)12x^2 + 2x + 4}$$

In order to start dividing, look at the first term in the divisor and the first term in the dividend. In this particular case, $2x$ goes into $12x^2$ $6x$ times. In other words $2x \cdot 6x = 12x^2$. Now multiply $6x$ to each term in the divisor.

$$(2x + 1) \overline{)12x^2 + 2x + 4} \begin{array}{r} 6x \\ \hline \end{array}$$

From here, subtract the multiplied-out terms from the terms in the dividend.

$$(2x + 1) \overline{)12x^2 + 2x + 4} \begin{array}{r} 6x \\ \hline -12x^2 \quad 6x \\ \hline 0 - 4x + 4 \end{array}$$

Now, look at the second term in the dividend and see how many times the first term in the divisor can go into it. In this particular case, $2x$ goes into $2x$ one time. Thus, we have:

$$(2x + 1) \overline{)12x^2 + 2x + 4} \begin{array}{r} 6x + 1 \\ \hline -12x^2 \quad 6x \\ \hline 0 - 4x + 4 \end{array}$$

From here, multiply the second term of the quotient with the divisor and subtract from the dividend.



$$\begin{array}{r}
 6x + 1 \\
 (2x + 1)\overline{)12x^2 + 2x + 4} \\
 \underline{-12x^2 \quad 6x} \\
 0 - 4x + 4 \\
 \underline{-2x + 1} \\
 -6x + 3
 \end{array}$$

Since there are no terms left to subtract from, we place the remainder $(-6x + 3)$ over the divisor in the quotient to create the final polynomial, $6x + 1 + \frac{-6x + 3}{2x + 1}$.

$$\begin{array}{r}
 6x + 1 + \frac{-6x + 3}{2x + 1} \\
 (2x + 1)\overline{)12x^2 + 2x + 4} \\
 \underline{-12x^2 \quad 6x} \\
 0 - 4x + 4 \\
 \underline{-2x + 1} \\
 -6x + 3
 \end{array}$$

Factoring Polynomials

Factoring polynomials is a technique which is beneficial to simplify expressions. When dividing polynomials, factoring requires less computations and time than long division and thus is more efficient. Factoring polynomials is also the opposite operation of FOIL. FOIL is a method for multiplying two binomials. In this method, you multiply the first terms, then the outer terms, then the inner terms, and then the last terms, and finally, you add together the four products.

When you factor polynomials in which the highest degree is a squared term, you get two binomial factors. When factoring a second-degree polynomial, the factors of the integer term, when multiplied and then added to the factors of the squared term, should result in the coefficient of the single variable term. If both signs are negative, that comes from one binomial that has addition in it and one binomial that has subtraction in it. If the middle sign is negative and the last sign is positive, then both binomial factors have subtraction within them. If both signs in the polynomial are positive, then both signs in the binomial factors are positive. For example, $x^2 - 3x - 10$, has a squared term that has factors x, x . The integer term has factors of $2 \cdot 5$ and $1 \cdot 10$. Now, find the combination of the factors that when added together give -3 as an answer. In this particular case, one binomial factor will have addition, and the other will have subtraction. What this means is that one of the factors from ten will be negative and one will be positive. From here it can be seen that $-5 + 2 = -3$; therefore, the binomial factored form of this particular polynomial is $(x + 2)(x - 5)$. To double check that this is the correct factorization, FOIL the two binomials and see if it is the original polynomial.



Sample Question

Factor $x^2 - 6x + 8$.

- A. $(x - 1)(x - 8)$
- B. $(x + 1)(x + 8)$
- C. $(x - 2)(x - 4)$
- D. $(x + 2)(x + 4)$

Step 1: Identify the factors of the squared and integer terms.

$$x^2 : x, x$$
$$8 : 1, 8 \text{ and } 2, 4$$

Step 2: Identify the signs in the binomial factors.

Since the second term in the polynomial is a negative sign and the last term is a positive, that means both binomial factors will have negative signs.

Step 3: Find the terms from the integer factors that will add to give the coefficient of the middle term.

Since both signs in the binomial factors will be negative that means each of our factors are negative. Which factors of eight added together create a sum of negative 6?

$$-2 + -4 = -6$$

Step 4: Create the binomial factors.

$$(x - 2)(x - 4)$$

The correct answer is C.

Sample Question

Factor $x^2 + 2x + 1$.

- A. $(x - 2)(x + 1)$
- B. $(x + 2)(x - 1)$
- C. $(x - 1)(x + 1)$
- D. $(x + 1)(x + 1)$

Step 1: Identify the factors of the squared and integer term.



$$\begin{array}{l} x^2 : x, x \\ 1 : 1, 1 \end{array}$$

Step 2: Identify the signs in the binomial factors.

Since both signs in the polynomial are positive, then both signs in the binomial factors are positive.

Step 3: Find which factors add together to get the middle term in the polynomial.

$$1 + 1 = 2$$

Step 4: Create the binomial factors.

$$(x + 1)(x + 1)$$

The correct answer is D.

Expanding Polynomials

Expanding polynomials is a key approach when asked to find the coefficient on a specific variable, specifically when the polynomial is given in the form $(x - a)^c$.

Example 1: Find the coefficient of the squared term of $(x + 3)^3$.

Step 1: Expand the polynomial by writing all three binomials multiplied together.

$$(x + 3)^3 = (x + 3)(x + 3)(x + 3)$$

Step 2: Use FOIL to multiply two of the binomials together.

$$(x^2 + 6x + 9)(x + 3)$$

Step 3: Use FOIL to multiply the entries in the polynomial with the entries in the binomial.

$$x^3 + 6x^2 + 9x + 3x^2 + 18x + 27$$

Step 4: Combine like terms

$$x^3 + 9x^2 + 27x + 27$$

Step 5: Identify the coefficient on the squared term.

$$\text{Coefficient} = 9$$



Evaluating a Polynomial with a Given Variable Value

In many cases, after simplifying, expanding, or manipulating polynomials tests will ask for the evaluation of the polynomial at a given x value.

Example 2: Find $f(x)$ at $x = 3$ of $f(x) = (x^2 - 1) + (x^3 - 2x + 4)$.

Step 1: Simplify the polynomial by adding like terms.

$$f(x) = x^2 - 1 + x^3 - 2x + 4$$

Step 2: Rearrange the polynomial to be in descending order of exponents.

$$f(x) = x^3 + x^2 - 2x + 4 - 1$$

$$f(x) = x^3 + x^2 - 2x + 3$$

Step 3: Substitute in 3 for every x in the polynomial.

$$f(3) = 3^3 + 3^2 - 2(3) + 3$$

$$f(3) = 27 + 9 - 6 + 3$$

$$f(3) = 33$$



Quadratic Functions and Equations

Quadratic Equations

A quadratic equation is a special type of polynomial that has a highest degree of two. When graphed, these equations create smooth parabolas. Algebraically, they can be solved by factoring or through the use of the quadratic formula. Quadratic equations can have up to three terms: one squared term, one single-variable term, and one constant term. Although quadratics can have three terms, it doesn't mean that they always do. The important characteristic to remember, and the determining factor that identifies a quadratic equation, is that its highest term is two. The following are all examples of quadratic equations.

$$y = x^2$$

$$y = 3x^2 - 1$$

$$y = x^2 + 2x + 4$$

Solving Quadratic Equations

When solving quadratic equations, there are three methods you can use: using the quadratic formula, factoring, and graphing. Depending on the specific quadratic equation, factoring may not be the easiest method; however, all quadratic equations can be solved quite easily using the quadratic formula. Graphing can be used to solve the quadratic equation by simply plugging in various x -values to solve for the y -values and then plotting them on a graph. The answers to the equation are the x -values of the graph's x -intercept(s). Let's consider how to use each of these methods now.

Quadratic Formula

The quadratic formula is used to solve an quadratic equation that is in the form of $ax^2 + bx + c = 0$, where a is the coefficient on the quadratic term, b is the coefficient on the single variable term, and c is the constant term. The quadratic formula is as follows:

$$x = \frac{-b \pm \sqrt{b^2 - 4ac}}{2a}$$

To solve the equation, plug in the coefficients of the quadratic equation into the above formula. For example, let's use the quadratic formula to solve $3x^2 - 4x + 1$. In this particular case, let's first identify the coefficients to be used in the quadratic formula: $a = 3$, $b = -4$, and $c = 1$. When you plug these values into the quadratic formula, you get the following equation:

$$x = \frac{-(-4) \pm \sqrt{(-4)^2 - 4(3)(1)}}{2(3)}$$

Recall that when a negative sign is applied to a negative number, the number becomes positive. This is also true when a negative number is squared; squaring a negative number means that a negative number is multiplied by itself. It becomes a positive number; therefore, this particular solution becomes:



$$x = \frac{4 \pm \sqrt{16 - 12}}{2(3)}$$

$$x = \frac{4 \pm \sqrt{4}}{6}$$

$$x = \frac{4 \pm 2}{6}$$

$$x = \frac{2 \pm 1}{3}$$

With quadratic equations, there will be two solutions.

$$x = \frac{3}{3} \text{ and } \frac{1}{3}$$

$$x = 1 \text{ and } \frac{1}{3}$$

Sample Question

Solve $6x^2 - 2x - 7$.

A. $x = \frac{1 \pm 1\sqrt{43}}{6}$

B. $x = \frac{2 \pm 1\sqrt{43}}{3}$

C. $x = \frac{2 \pm 3\sqrt{37}}{5}$

D. $x = \frac{1 \pm 3\sqrt{37}}{2}$

Step 1: Identify the coefficients.

$$a = 6, b = -2, c = -7$$

Step 2: Plug coefficients into the quadratic formula.

$$x = \frac{-(-2) \pm \sqrt{(-2)^2 - 4(6)(-7)}}{2(6)}$$

Step 3: Simplify. Recall that a negative multiplied by a negative becomes a positive.



$$x = \frac{2 \pm \sqrt{4 + 168}}{12}$$

$$x = \frac{2 \pm \sqrt{172}}{12}$$

$$x = \frac{2 \pm 2\sqrt{43}}{12}$$

$$x = \frac{1 \pm \sqrt{43}}{6}$$

The correct answer is A.

Sample Question

Solve $x^2 - 18$.

- A. $x = \pm\sqrt{9}$
- B. $x = \pm\sqrt{14}$
- C. $x = \pm\sqrt{18}$
- D. $x = \pm 6$

Step 1: Identify the coefficients.

$$a = 1, b = 0, c = -18$$

Step 2: Plug coefficients into the quadratic formula.

$$\frac{-0 \pm \sqrt{(0)^2 - 4(1)(-18)}}{2(1)}$$

Step 3: Simplify.

$$x = \frac{\pm\sqrt{72}}{2}$$

$$x = \frac{\pm 2\sqrt{18}}{2}$$

$$x = \pm\sqrt{18}$$

The correct answer is C.



Factoring Quadratics

Factoring is a key concept used to solve quadratics. In many cases, factoring a quadratic is more efficient than using the quadratic formula. First, let's recall the form of a quadratic: $ax^2 + bx + c$. Factoring a quadratic results in two binomials that are multiplied together in the form $(ex \pm d)(fx \pm h)$. The sign within each binomial depends on the signs of the b and c terms. Let's assume the sign of a is positive; however, if a is negative, then factor out a negative one, and then the relationships below will hold true.

When a is positive . . .

Sign of b term	Sign of c term	Result
+	+	$(x + _)(x + _)$
-	+	$(x - _)(x - _)$
+	-	$(x - _)(x - _)$
-	-	$(x + _)(x - _)$

Once the signs in the binomials are found, values for the positions within the binomials can be found. Use the variable in the binomial terms as $(ex + d)(fx + h)$ for the factorization of $ax^2 + bx + c$. The terms e and f are going to be factors of a , and d and h are factors of c . More specifically, the factors of c , when multiplied with the factors of a , will sum to equal the term b .

Let's next walk through an example of factoring a quadratic equation, specifically the equation $x^2 - 7x + 12$.

Step 1: Identify the a , b , and c terms.

$$a = 1, b = -7, c = 12$$

Step 2: Identify the signs that will be in the binomials. Since the b term is negative and the c term is positive, both binomials will have negative signs.

$$(x - _)(x - _)$$

Step 3: Identify the factors of the c term.

$$12 : (-1, -12) (-2, -6) (-3, -4)$$

Step 4: Identify which factors of c , when added together, result in the b term.

$$-3 + -4 = -7$$

Step 5: Substitute the factors into the binomial factors.

$$(x - 3)(x - 4)$$

Try this next question on your own!



Sample Question

Factor $3x^2 + 4x + 1$.

- A. $(2x + 1)(x + 2)$
- B. $(3x - 1)(x - 1)$
- C. $(2x - 1)(x - 2)$
- D. $(3x + 1)(x + 1)$

Step 1: Identify the a , b , and c terms.

$$a = 3, b = 4, c = 1$$

Step 2: Identify the signs that will be in the binomials. Since b and c are both positive, both of the signs in the binomials are positive.

$$(x + _)(x + _)$$

Step 3: Identify the factors of a to fill in the first blank in each binomial.

$$3x^2 : (3x, x)$$
$$(3x + _)(x + _)$$

Step 4: Identify the factors of c which, when multiplied by the factors of a and added together, result in b .

$$1 : (1, 1)$$

Step 5: Substitute the factors into the binomials.

$$(3x + 1)(x + 1)$$

The correct answer is D.

Characteristics of Quadratic Graphs

Many standardized tests, including the SAT, evaluate students' knowledge of the graphs associated with various functions. It is not necessary to graph a function to know how the graph will look. Each function's equation has markers that can identify different characteristics of its graph. To quickly identify the graph characteristics of a quadratic function, one must first manipulate the standard-form equation into vertex form.

Standard form of a quadratic: $f(x) = ax^2 + bx + c$ **Vertex form of a quadratic:** $a(x - h)^2 + k$ 

First things first: by definition, quadratics form parabolas. In the vertex form, the vertex of the parabola is located at the point (h, k) . The sign of a determines whether the parabola opens upward or downward. A positive a means the parabola opens upward; a negative a means the parabola opens downward. The width of the parabola also depends on the value of a . If $|a| < 1$, the parabola becomes wider. On the other hand, if $|a| > 1$, the parabola becomes narrower. The axis of symmetry occurs at $x = h$.

Let's consider a few example questions, beginning with this one: which of the following functions has a wider parabola?

$$E_1: f(x) = 4x^2 - 8x + 1$$

$$E_2: f(x) = -\frac{1}{4}(x - 2)^2 + 5$$

Step 1: Identify the a values for each quadratic.

$$a_{E_1} = 4$$

$$a_{E_2} = -\frac{1}{4}$$

Step 2: Compare the $|a|$.

$$E_1: |4| = 4$$

$$E_2: \left| -\frac{1}{4} \right| = \frac{1}{4}$$

Since $\frac{1}{4} < 4$, this means that E_2 has a wider parabola. You can see that this is true graphically:

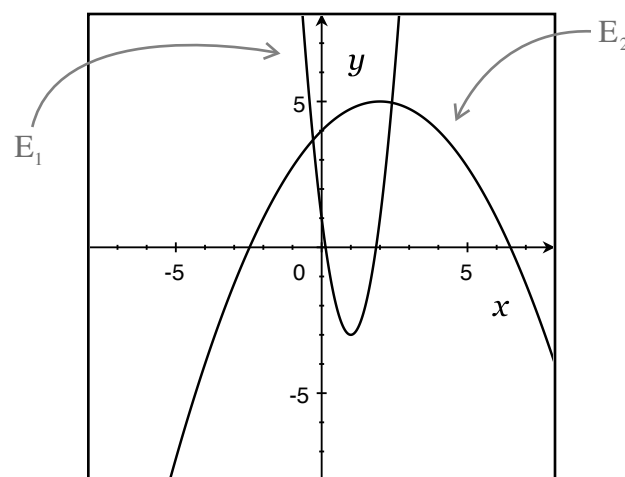

Sample Question

Where is the axis of symmetry for the quadratic defined by the function $f(x) = 2(x - 1)^2 + 9$?

- A. $x = 0$
- B. $x = 1$
- C. $x = -1$
- D. $x = 1.5$

Identify the vertex.

$$f(x) = a(x - h)^2 + k$$



Thus, in this particular function, $h = 1$; therefore, the axis of symmetry is $x = 1$. The solution holds true even when observed graphically.

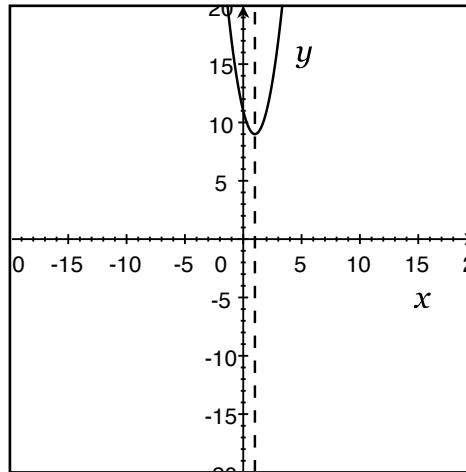

The correct answer is B.



Exponential Expressions, Functions, Equations and Radicals

As you probably know, the SAT Math test does not restrict itself to problems that make use of only the basic operations, addition, subtraction, multiplication, and division. You can expect problems featuring more complex mathematical concepts such as exponents, and square roots to make an appearance on this section. In this lesson, we'll take a look at each of these topics and brush up on the specific rules used when mathematically working with them. By working through this lesson and its practice problems, you can refresh your knowledge of these core concepts and be ready to demonstrate your expertise.

Exponents

The rules of exponents are a significant part of the SAT Math test. These rules may be tested as straightforward questions about the rules themselves (e.g. $x^2 \times x^3 = ?$), but they're more likely to be incorporated into broader questions about simplifying expressions. Given the SAT's penchant for word problems and problems based in the natural and social sciences, it's likely that the rules of exponents will show up in questions asking about real-life scenarios.

For the purposes of the SAT Math test, it is important to familiarize yourself with six rules of exponents. These can be divided into two groups of three: one group of basic rules to be aware of, and a group of more complex rules to be aware of when mathematically working with exponents. We'll refer to the first group as "Awareness" rules and the second as "Application" rules. Let's get started going over each of them!

"Awareness" Rules	"Application" Rules
Identity Property of Exponents $x^1 = x$	Product of Exponents with the Same Base $x^a \times x^b = x^{(a+b)}$
Zero Exponents $x^0 = 1$	Quotient of Exponents with the Same Base $\frac{x^a}{x^b} = x^{(a-b)}$
Negative Exponents $x^{-a} = \frac{1}{x^a}$	Power-to-a-Power Rule $(x^a)^b = x^{(a \times b)}$

The Identity Property and the Zero Exponent rules are pretty straightforward. They can be broken down as follows.

Identity Property : "Any number raised to the power of 1 is equal to itself."

$$2^1 = 2$$

$$1,000,000^1 = 1,000,000$$



Zero Exponents: “Any number raised to the power of 0 is equal to 1.”

$$2^0 = 1$$

$$5^0 = 1$$

$$1,000,000^0 = 1$$

The Negative Exponent rule is a little trickier. This rule states that if you raise a number to a negative power, you need to divide the expression by 1 and change the sign on the exponent.

So, for instance, 5^{-3} becomes $\frac{1}{5^3} = \frac{1}{125}$.

Similarly, if you have a negative exponent in the denominator, that expression moves to the numerator (dividing by 1):

$$\frac{1}{3^{-2}} = 3^2 = 9$$

Perhaps the most basic way to view a negative exponent is to look at your negative exponential expression and do two things:

1. Flip it
2. Change the sign of the exponent

It is worth noting that it is extremely common for high-school students to forget or misapply the rule for negative exponents. Students generally want to change the sign of the base rather than the sign of the exponent. Don't let this happen to you, especially on test day! Negative exponents do not affect whether the final answer is positive or negative.

Examples:

$$10^{-2} = \frac{1}{10^2} = \frac{1}{100} \qquad \frac{1}{4^{-3}} = 4^3 = 64$$
$$(-3)^{-2} = \frac{1}{(-3)^2} = \frac{1}{9} \qquad \frac{1}{2^{-2}} = 2^2 = 4$$

Now let's look at the rules of exponents that require some application. These rules will be the most frequently encountered on an SAT Math test, as they are prominent features of simplification questions and may also show up in word problems.

The Product Rule and the Quotient Rule can be summed up as follows:

Product Rule: “If you are MULTIPLYING exponential terms that have the same base, you can simply add the exponents, and raise the common base to that exponent.”



$$x^2 \times x^3 = x^{(2+3)} = x^5$$

$$2^5 \times 2^4 = 2^{(5+4)} = 2^9 = 512$$

Quotient Rule: “If you are DIVIDING exponential terms that have the same base, you can subtract the exponent of the denominator from the exponent of the numerator.”

$$\frac{2^5}{2^4} = 2^{(5-4)} = 2^1 = 2$$

$$\frac{x^2}{x^3} = x^{(2-3)} = x^{-1} = \frac{1}{x^1} = \frac{1}{x}$$

Finally, we have the Power to a Power Rule. This rule states, “When raising a power to a power, you multiply the exponents.”

$$(2^3)^2 = 2^{(3 \times 2)} = 2^6 = 64$$

$$((3^2)^3)^2 = 3^{(2 \times 3 \times 2)} = 3^{12} = 531,441$$

Another important reason to know the rules of exponents for the SAT is because of your calculator. It is easy for test makers to construct questions that, while not difficult, are easy to miss if you rely too heavily on a calculator. And the more complicated the exponential expression, the more likely you are to input the expression incorrectly.

Squaring and Square Roots

When a given term is raised to the second power, it is said to be squared. In other words, when a number is squared, it has an exponent of 2 and is multiplied by itself. Three squared is equal to 3^2 , which is equal to $3 \cdot 3$.

Taking the square root of a term is the inverse function of squaring. In other words, the solution to a square root answers the question, “What number can be squared to get the starting value in this problem?”

Perfect Squares

A perfect square is a term that is equal to a single number squared. A short list of perfect squares is given below.

$$\begin{array}{ll} 1^2 = 1 & 6^2 = 36 \\ 2^2 = 4 & 7^2 = 49 \\ 3^2 = 9 & 8^2 = 64 \\ 4^2 = 16 & 9^2 = 81 \\ 5^2 = 25 & 10^2 = 100 \end{array}$$

A perfect square will always have a whole number square root. Since the square root operation is the inverse function of squaring, we can create a second list of equations showing the roots of each perfect square.



$$\begin{array}{ll} \sqrt{1} = 1 & \sqrt{36} = 6 \\ \sqrt{4} = 2 & \sqrt{49} = 7 \\ \sqrt{9} = 3 & \sqrt{64} = 8 \\ \sqrt{16} = 4 & \sqrt{81} = 9 \\ \sqrt{25} = 5 & \sqrt{100} = 10 \end{array}$$

Looking at a basic example, we can see how these operations function.

Sample Question

Solve: $5^2 - \sqrt{49}$

- A. 18
- B. 24
- C. 16 or 24
- D. 18 or 32

To find the final answer, simply evaluate each term. We can expand 5^2 to become $5 \cdot 5$, which is equal to 25.

$$5^2 - \sqrt{49} = 25 - \sqrt{49}$$

The square root of 49 is either 7 or -7 because $7 \times 7 = 49$ and $-7 \times -7 = 49$. 49 is a perfect square.

$$5^2 - \sqrt{49} = 25 - \sqrt{49} = 25 - 7 = 18$$

OR

$$5^2 - \sqrt{49} = 25 - \sqrt{49} = 25 - (-7) = 32$$

The final answer will be 18 or 32; either answer is equally acceptable. The correct answer is D.

Simplifying Square Roots

The square root function is simplest when applied to perfect squares, but what about other numbers? On the SAT Math test, you may be asked to simplify an expression that contains the square root of a number that is not a perfect square, but you will not be asked to solve for the value of this term. Most often, solving for these values results in an irregular decimal or other such inconvenient term. To avoid these scenarios, the exam will focus on simplification of terms as opposed to direct solutions.

Simplifying a square root will ultimately lead to factoring out terms from under the square root and extracting factors until the term cannot be further simplified. Remember that taking the square root is the inverse function of squaring a number. If we can identify instances where there is a square underneath a square root, we can factor out that term.



For example:

$$\sqrt{4^2} = 4$$

The easiest method for simplifying a square root is to identify all of the prime factors of the term under the square root operation, and then identify duplicate factors. These duplicates indicate squared terms. Prime factors can be found by building a factor tree or using any other method to identify factors. Let's look at $\sqrt{75}$ as an example. The prime factors of 75 are 3, 5, and 5 because $3 \cdot 5 \cdot 5 = 75$. There are two ways to represent this in a factor tree.



Once we have identified the factors, look for any duplicates. In the case of 75, we can see that 5 appears twice. In other words, $5 \cdot 5 \cdot 3 = 5^2 \cdot 3 = 75$. Since taking the square root is the inverse of squaring a number, we can factor out the 5 from under the square root.

$$\sqrt{75} = \sqrt{5^2 \cdot 3} = 5\sqrt{3}$$

Note that only the 5 can be factored out of the square root. Since the 3 is not a duplicate in the factor tree, it cannot be simplified. $5\sqrt{3}$ is the most simplified answer possible.

Equations with Square Roots

Now that we have looked at simplifying individual square root terms, we can start evaluating how these terms interact within equations and expressions. When a square root appears in an expression, the first step will always be to simplify the square root via the process we discussed previously. Once the square root cannot be simplified further, we can start applying other operations, such as addition, subtraction, multiplication, and division. Within expressions, the simplified square roots can be treated just like variables.

Let's start with a simple example of addition with square roots.

$$\sqrt{2} + \sqrt{2}$$

Treating the term " $\sqrt{2}$ " like a variable, we can imagine that this expression is the same as $x + x$, which simplifies to $2x$. In the same way, $\sqrt{2} + \sqrt{2}$ simplifies to $2\sqrt{2}$.

$$\sqrt{2} + \sqrt{2} = 2\sqrt{2}$$

The same process is used for simplification of addition and subtraction. As long as the same number is under the square root, the terms can be combined. Let's look at a full problem:

$$\sqrt{9} - \sqrt{12} + \sqrt{75}$$

Simplify the square roots.



$$3 - 2\sqrt{3} + 5\sqrt{3}$$

Combine terms that contain $\sqrt{3}$.

$$3 + 3\sqrt{3}$$

This problem cannot be simplified any further because the leading term is not associated with a square root. Remember, you can only combine terms with the same value under the square root; in this problem, we can only combine the terms that contain $\sqrt{3}$.

When there are different values under the square roots, the terms cannot be simplified. For example, $2\sqrt{3} + \sqrt{5}$ cannot be simplified any further.

Example:

$$\begin{aligned}\sqrt{40} + \sqrt{18} \\ 2\sqrt{10} + 3\sqrt{2}\end{aligned}$$

Because the base terms cannot be combined, the expression cannot be further simplified.

When dealing with multiplication and division of square roots, there is a bit more flexibility. When multiplying or dividing square roots, the terms under the square root are combined.

$$\begin{aligned}\sqrt{2} \cdot \sqrt{3} &= \sqrt{2 \cdot 3} = \sqrt{6} \\ \sqrt{14} \div \sqrt{7} &= \sqrt{14 \div 7} = \sqrt{2}\end{aligned}$$

Since the terms under the square root can be combined, multiplication and division can lead to additional simplification of the final answer. Many times, you will be able to factor out a term after multiplying two square roots.

Example: $\sqrt{40} \cdot \sqrt{15}$

Simplify the square roots.

$$2\sqrt{10} \cdot \sqrt{15}$$

Multiply.

$$\begin{aligned}2\sqrt{10 \cdot 15} \\ 2\sqrt{150}\end{aligned}$$

Simplify the final square root.

$$\begin{aligned}2 \cdot 5\sqrt{6} \\ 10\sqrt{6}\end{aligned}$$

In this example, combining $\sqrt{10}$ and $\sqrt{15}$ allowed us to factor out a 5 before arriving at our final answer.



Squaring and Square Roots with Fractions

The critical element to recognize when dealing with squares, square roots, and fractions is that the exponent and square root both distribute to the terms in the fraction. In other words, the square root or the exponent can be applied separately to both the numerator and denominator.

For example:

$$\left(\frac{3}{5}\right)^2 = \frac{3^2}{5^2} = \frac{9}{25}$$

and

$$\sqrt{\frac{4}{9}} = \frac{\sqrt{4}}{\sqrt{9}} = \frac{2}{3}$$

Squares and square roots can also cancel in fractions to produce a more reduced final answer. Treat the term as if it were a variable that can be factored out of the fraction.

For example:

$$\frac{5 \cdot 2^2}{2^2} = 5$$

$$\frac{\sqrt{21}}{\sqrt{63}} = \frac{\sqrt{3} \cdot \sqrt{7}}{3\sqrt{7}} = \frac{\sqrt{3}}{3}$$

In the first example, we are able to cancel out the 2^2 term. In the second example, we can cancel out the $\sqrt{7}$ term.

Try a more complex example:

$$\frac{(\sqrt{12} + \sqrt{27})(\sqrt{45} + \sqrt{20})^2}{\sqrt{14} \cdot \sqrt{28} \cdot \sqrt{75}}$$

Answer:

$$\frac{(\sqrt{12} + \sqrt{27})(\sqrt{45} + \sqrt{20})^2}{\sqrt{14} \cdot \sqrt{28} \cdot \sqrt{75}}$$

$$\frac{(2\sqrt{3} + 3\sqrt{3})(3\sqrt{5} + 2\sqrt{5})^2}{\sqrt{14} \cdot 2\sqrt{7} \cdot 5\sqrt{3}}$$

$$\frac{(5\sqrt{3})(5\sqrt{5})^2}{\sqrt{14} \cdot 2\sqrt{7} \cdot 5\sqrt{3}}$$



$$\frac{(5\sqrt{3})(5)^2(\sqrt{5})^2}{\sqrt{14} \cdot 2\sqrt{7} \cdot 5\sqrt{3}}$$

$$\frac{(5\sqrt{3})(25)(5)}{2\sqrt{98} \cdot 5\sqrt{3}}$$

$$\frac{(5\sqrt{3})(125)}{2\sqrt{98} \cdot 5\sqrt{3}}$$

$$\frac{125}{2\sqrt{98}}$$

$$\frac{125}{2 \cdot 7\sqrt{2}}$$

$$\frac{125}{14\sqrt{2}}$$



Squaring and Square Roots with Decimals

Generally speaking, there are very few differences between decimals and whole numbers when applying square roots and exponents. While the mechanics of the operations do not change, decimals can make things a bit more complex, and they also introduce a new set of perfect squares that may not be entirely intuitive. Just remember, if you ever feel stuck on a question with squares, square roots, and decimals, you are still only dealing with a single term multiplied by itself. Even if the numbers appear complex, you are still dealing with a relatively simple concept.

Let's look at the perfect squares of some decimal quantities. The values are given as both decimals and fractions to help show the values in multiple formats.

Perfect Squares with Decimals

$$0.5^2 = \left(\frac{1}{2}\right)^2 = \frac{1}{4} = 0.25$$

$$0.25^2 = \left(\frac{1}{4}\right)^2 = \frac{1}{16} = 0.0625$$

$$0.2^2 = \left(\frac{1}{5}\right)^2 = \frac{1}{25} = 0.04$$

$$0.1^2 = \left(\frac{1}{10}\right)^2 = \frac{1}{100} = 0.01$$

Remember that when multiplying one decimal by another, the answer will generally be equal to the product of the terms after the decimal, but with the decimal point shifted to the left.

$$\text{Example: } 0.3 \cdot 0.3 = 0.09$$

This is especially important when dealing with squaring or taking the square root of decimals. Squaring the decimal will shift the decimal point to the left:

$$0.2^2 = 0.2 \cdot 0.2 = 0.04$$

$$0.6^2 = 0.6 \cdot 0.6 = 0.36$$

$$0.14^2 = 0.14 \cdot 0.14 = 0.0196$$

Taking the square root will shift the decimal point to the right:

$$\sqrt{0.0121} = 0.11$$

$$\sqrt{0.0001} = 0.01$$

$$\sqrt{0.0441} = 0.21$$



Radical Equations

Radical equations are, quite simply, equations that involve a radical. Radicals can take the form of any root (square root, 4th root, 10th root). On the ACT, however, you are most likely to encounter a square root symbol ($\sqrt{\quad}$), or possibly a cube root ($\sqrt[3]{\quad}$).

There are three steps to apply to every question that involves radicals.

- 1. Isolate the radical**
- 2. Get rid of the radical**
- 3. Solve the equation**

Isolating the Radical

Isolating the radical means that the radical expression is the only thing left on the left or right side of the equation. For easy radical equations, the radical is already isolated.

For instance, $\sqrt{x+3} = 10$ and $\sqrt{x^2+1} = 2$ are already isolated.

For more complex equations, you use the same skills that you use to isolate a variable in an algebraic equation to isolate a radical in a radical equation. Thus, in order to isolate the radical in the equation $2\sqrt{x^2-5} + 3 = 11$, we would use the same steps as if we were isolating the “ x ” in $2x + 3 = 11$, which is to subtract 3 from both sides, and then divide by two on both sides.

Get Rid of the Radical

Once you isolate the radical, you can get rid of the radical by raising both sides of the equation to the exponent that corresponds to the root of the radical. Thus, if you have a square root (most likely), you raise both sides of the equation to a power of 2. If you have a cube root (less likely) you raise both sides of the equation to a power of 3. If you have a higher root (unlikely) you raise both sides to corresponding power (4th root to a power of 4, 5th root to a power of 5, and so on).

Once this is accomplished, you can then solve the equation as any other algebraic equation. However, once you solve the equation, make sure you plug your solution(s) back into the original equation to make sure they aren't extraneous solutions.

Example:



$$\begin{aligned}4\sqrt{x+3} + 8 &= 4 \\(4\sqrt{x+3} + 8) - 8 &= (4) - 8 \\4\sqrt{x+3} &= -4 \\\frac{4\sqrt{x+3}}{4} &= \frac{-4}{4} \\\sqrt{x+3} &= -1 \\(\sqrt{x+3})^2 &= (-1)^2 \\x+3 &= 1 \\(x+3) - 3 &= 1 - 3 \\x &= -2\end{aligned}$$

Plug $x = -2$ back into the original equation:

$$\begin{aligned}4\sqrt{-2+3} + 8 &= 4 \\4\sqrt{1} + 8 &= 4 \\4 \cdot 1 + 8 &= 4 \\4 + 8 &= 4 \\12 &= 4\end{aligned}$$

This is a false statement, so the solution is extraneous.



Rational Equations and Expressions

For purposes of the SAT, a rational equation is an equation that involves polynomials as part of the a fraction. In other words there is a quotient of polynomials. For example:

$$\frac{x+1}{x-1} + \frac{1}{x+1} = \frac{1}{(x+1)(x-1)}$$

or

$$\frac{2s-3}{s+2} = 4$$

Rational equations give many students trouble in the SAT Math test. This is mostly because they involve fractions, a common source of frustration for high-school students. Many student are out of practice, lack confidence, or both when it comes to dealing with fractions. However, it is important to focus on the fraction skills that students learn in elementary and middle school in order to make rational equations manageable. Here are a few simple rules to keep in mind:

1. Any number divided by itself is equal to 1.

This is an extremely basic rule, but very important. This is an identity property. So:

$$\frac{1}{1} = 1$$

and

$$\frac{4}{4} = 1$$

and

$$\frac{1,343,565}{1,343,565} = 1$$

and perhaps most importantly,

$$\frac{x}{x} = 1$$

and

$$\frac{x+1}{x+1} = 1$$



2. You can only add and subtract fractions that have a common denominator.

This is another basic rule. When you add or subtract fractions with a common denominator, you simply rewrite the denominator, and add or subtract the numerators. For example:

$$\frac{1}{4} + \frac{1}{4} = \frac{1+1}{4} = \frac{2}{4} = \frac{1}{2}$$

or a rational expression:

$$\frac{1}{x} + \frac{1}{x} = \frac{1+1}{x} = \frac{2}{x}$$

If you have two fractions with different denominators, you need to find the least common denominator for the two fractions before you can add or subtract. For example, consider the following expression:

$$\frac{1}{2} + \frac{1}{3} = ?$$

We cannot add them together without finding the least common denominator for the two fractions. An example of a similar rational expression would be:

$$\frac{1}{x} + \frac{1}{y} = ?$$

3. In order to get a common denominator, you can multiply EACH term by the identity fraction you need.

Let's go straight to our previous example:

$$\frac{1}{2} + \frac{1}{3} = ?$$

We need to multiply 2 by 3, and 3 by 2 in order to get the least common denominator:

6. Therefore, we multiply by the identity fractions $\frac{3}{3}$ and $\frac{2}{2}$:

$$\left(\frac{1}{2} \times \frac{3}{3}\right) + \left(\frac{1}{3} \times \frac{2}{2}\right) = \frac{3}{6} + \frac{2}{6} = \frac{5}{6}$$

Now, you can apply the same principle to a rational expression, where there are variables instead of numbers. Your identity fraction is just either of the variables divided by itself. For example:

$$\frac{1}{x} + \frac{1}{y} = ?$$

$$\left(\frac{1}{x} \times \frac{y}{y}\right) + \left(\frac{1}{y} \times \frac{x}{x}\right) = \frac{y+x}{xy}$$



4. If a denominator has a “+” or “-” sign, you cannot break it up.

This is a more difficult rule. An example will help demonstrate this:

$$\frac{1}{2+3} \neq \frac{1}{2} + \frac{1}{3}$$

As we demonstrated above, $\frac{1}{2} + \frac{1}{3} = \frac{5}{6}$

If we add the 2 and the 3 first, we get $\frac{1}{5}$, a different value. The same principle holds true with variables:

$$\frac{1}{x+3} \neq \frac{1}{x} + \frac{1}{3}$$

Now, let’s put this all together for rational equations.

Let’s say we have an equation that looks like this:

$$\frac{1}{x} + \frac{1}{x^2} = \frac{1}{2x^2}$$

First, we see that this equation is a rational equation with addition. To add these fractions, we need to have a common denominator, which we don’t have. We have three different denominators: x , x^2 , and $2x^2$.

Our lowest common denominator here is $2x^2$. We need to multiply each term by the identity fraction that will give us the lowest common denominator:

$$\left(\frac{1}{x} \times \frac{2x}{2x}\right) + \left(\frac{1}{x^2} \times \frac{2}{2}\right) = \left(\frac{1}{2x^2} \times \frac{1}{1}\right)$$

This is where students tend to get confused. We multiplied each of our three original terms by three DIFFERENT fractions. However, these fractions only appear different, as their value is the same. Remember, any number divided by itself is equal to one.

*When working with rational equations, we change the appearance of the equation without changing its value.

Now let’s finish with the example above:

$$\frac{2x}{2x^2} + \frac{2}{x^2} = \frac{1}{2x^2}$$

We have a common denominator, so we can combine the left side of the equation into one fraction:

$$\frac{2x+2}{2x^2} = \frac{1}{2x^2}$$



Now, since we can multiply both sides by the common denominator in order to simplify the equation (and get rid of the fractions):

$$\frac{2x+2}{2x^2} \times \frac{2x^2}{1} = \frac{1}{2x^2} \times \frac{2x^2}{1}$$

and we are left with our numerators:

$$2x+2 = 1$$

Now finish the simplification:

$$2x + 2 - 2 = 1 - 2$$

$$2x = -1$$

$$\frac{2x}{2} = \frac{-1}{2}$$

$$x = -\frac{1}{2}$$

With a basic grasp of the principles that govern the manipulation of rational expressions, we can look at the more complex applications of these principles in the context of polynomials. Polynomial expressions involve complex exponential structures. What this means in terms of rational expressions is that the simplification or expansion of a given polynomial can be essential to identifying a common denominator and, eventually, eliminating the fractional elements of the expression altogether.

Multiplying polynomials is extremely beneficial when it comes to simplifying an expression. When it comes to multiplying polynomials, the most important thing to remember is that each term from one polynomial will need to be multiplied with each term from the other polynomials. Rule of multiplying exponents and order of operations are key in correctly multiplying polynomials as well. The larger the polynomials is, more computations are done to arrive at the simplified polynomial. Such an example of polynomial multiplication is $(x + 3 - x^2)(2x - 1 + 2x^2)$. First, multiply the first term from the first polynomial with each term in the second polynomial; this results in $x \cdot 2x = 2x^2$, $x \cdot -1 = -x$, and $x \cdot 2x^2 = 2x^3$. Next, multiply the second term in the first polynomial with each term in the second polynomial; this results in $3 \cdot 2x = 6x$, $3 \cdot -1 = -3$, and $3 \cdot 2x^2 = 6x^2$. Then, multiply the third term in the first polynomial with each term in the second polynomial; this results in $-x^2 \cdot 2x = -2x^3$, $-x^2 \cdot -1 = x^2$, and $-x^2 \cdot 2x^2 = -2x^4$. From here, we combine all terms into a polynomial, $2x^2 - x + 2x^3 - 2x^3 + x^2 - 2x^4$. Now, combine like base terms to simplify further. In this particular case, the x^3 terms will cancel out since they have coefficients that add up to zero. The final simplified polynomial is $3x^2 - x - 2x^4$.

When dividing polynomials, it is important to identify like bases and use the rule of exponents to simplify the terms which contain variables. Similarly to multiplying polynomials, when dividing polynomials each term in the dividend must be divided



by each term in the divisor. One way to accomplish division with polynomials is to perform long division, which is also known as synthetic division. An example of using long division with polynomials is as follows: in $(12x^2 + 2x + 4) \div (2x + 1)$, the dividend is $(12x^2 + 2x + 4)$ and the divisor is $(2x + 1)$. Performing this division will result in finding the quotient.

$$(2x + 1) \overline{)12x^2 + 2x + 4}$$

To start dividing, look at the first term in the divisor and the first term in the dividend. In this particular case, $2x$ goes into $12x^2$ $6x$ times. In other words $2x \cdot 6x = 12x^2$. Now multiply $6x$ to each term in the divisor.

$$(2x + 1) \overline{)12x^2 + 2x + 4}$$

From here, subtract the multiplied-out terms from the terms in the dividend.

$$\begin{array}{r} 6x \\ (2x + 1) \overline{)12x^2 + 2x + 4} \\ \underline{-12x^2 - 6x} \\ 0 - 4x + 4 \end{array}$$

Now, look at the second term in the dividend and see how many times the first term in the divisor can go into it. In this particular case, $2x$ goes into $2x$ one time. Thus, we have:

$$\begin{array}{r} 6x + 1 \\ (2x + 1) \overline{)12x^2 + 2x + 4} \\ \underline{-12x^2 - 6x} \\ 0 - 4x + 4 \end{array}$$

From here, multiply the second term of the quotient with the divisor and subtract from the dividend.

$$\begin{array}{r} 6x + 1 \\ (2x + 1) \overline{)12x^2 + 2x + 4} \\ \underline{-12x^2 - 6x} \\ 0 - 4x + 4 \\ \underline{-2x - 1} \\ -6x + 3 \end{array}$$

Since there are no terms left to subtract from, we place the remainder $(-6x + 3)$ over the divisor in the quotient to create the final polynomial, $6x + 1 + \frac{-6x + 3}{2x + 1}$.

$$\begin{array}{r} 6x + 1 + \frac{-6x + 3}{2x + 1} \\ (2x + 1) \overline{)12x^2 + 2x + 4} \\ \underline{-12x^2 - 6x} \\ 0 - 4x + 4 \\ \underline{-2x - 1} \\ -6x + 3 \end{array}$$



Sample Question

Simplify the following expression: $(3x^3 + 2x^2 - 5)(x^3 + 5x^2 - x + 6)$

A. $3x^6 + 17x^5 + 7x^4 + 11x^3 - 13x^2 + 5x - 30$

B. $4x^6 + 15x^5 + 7x^4 + 12x^3 - 10x^2 + 4x - 25$

C. $3x^6 + 14x^5 + 5x^4 + 10x^3 - 13x^2 + 4x - 30$

D. $4x^6 + 17x^5 + 5x^4 + 12x^3 - 10x^2 + 5x - 25$

Step 1: Distribute the first term in the first polynomial to each term in the second polynomial.

$$3x^3 \cdot x^3 = 3x^6$$

$$3x^3 \cdot 5x^2 = 15x^5$$

$$3x^3 \cdot -x = -3x^4$$

$$3x^3 \cdot 6 = 18x^3$$

Step 2: Distribute the second term from the first polynomial to each term in the second polynomial.

$$2x^2 \cdot x^3 = 2x^5$$

$$2x^2 \cdot 5x^2 = 10x^4$$

$$2x^2 \cdot -x = -2x^3$$

$$2x^2 \cdot 6 = 12x^2$$

Step 3: Distribute the third term in the first polynomial to each term in the second polynomial.

$$-5 \cdot x^3 = -5x^3$$

$$-5 \cdot 5x^2 = -25x^2$$

$$-5 \cdot -x = 5x$$

$$-5 \cdot 6 = -30$$

Step 4: Identify and combine like terms.

$$3x^6 + 15x^5 + 2x^5 - 3x^4 + 10x^4 + 18x^3 - 2x^3 - 5x^3 + 12x^2 - 25x^2 + 5x - 30$$

$$3x^6 + 17x^5 + 7x^4 + 11x^3 - 13x^2 + 5x - 30$$



Systems of Equations

Nonlinear systems of equations should be dealt with in a similar manner to linear systems of equations. The deciding factor on whether a system is linear or nonlinear relies on the degree of the polynomials that comprise the system. Variables in linear equations all have a degree of one, while nonlinear equations contain at least one variable that has a degree higher than one.

Example 1

$$x^2 + y = 2$$

$$2x - y = 1$$

Example 2

$$4y^2 - 16x = 0$$

$$x^2 - 4y = 8$$

Example 3

$$z = 2y^3$$

$$16 = 2z + x^2$$

$$y = 1$$

You can use the substitution and elimination methods discussed in the previous lesson to solve nonlinear systems of equations; however, such complex systems may require more repeated steps than simpler ones. In nonlinear systems of equations, unlike in linear ones, algebraic operations performed in order to enable substitution and elimination may include multiplication or division of variables. Let's look at Example 1 and solve the nonlinear system of equations.

Example 1

$$x^2 + y = 2$$

$$2x - y = 1$$

Step 1: Use elimination by adding the two equations together. Doing so will result in the elimination of the y -variable.

$$x^2 + y = 2$$

$$+2x - y = 1$$

$$\hline x^2 + 2x = 3$$

Step 2: Move all terms to one side and use factoring or the quadratic formula to solve for the x -variable.



$$x^2 + 2x - 3 = 0$$

$$(x + 3)(x - 1)$$

$$x + 3 = 0 \quad x - 1 = 0$$

$$x = -3 \quad x = 1$$

Step 3: Substitute the x -variables found in step two back into the equations to solve for the y -variable.

When $x = 1$:

$$2x - y = 1$$

$$2(1) - y = 1$$

$$2 - y = 1$$

$$-y = 1 - 2$$

$$-y = -1$$

$$y = 1$$

Thus, the solutions to the system of equations are $(-3, -7)$ and $(1, 1)$.

Example 2

$$4y^2 - 16x = 0$$

$$x^2 - 4y = 8$$

Step 1: Multiply the second equation by y .

$$4y^2 - 16x = 0$$

$$y(x^2 - 4y = 8)$$

$$4y^2 - 16x = 0$$

$$yx^2 - 4y^2 = 8y$$

Step 2: Rearrange the second equation so that the y^2 terms are located in the same spot.

$$4y^2 - 16x = 0$$

$$-4y^2 + yx^2 = 8y$$

Step 3: Use elimination to cancel the y^2 variables. To accomplish this, add the two equations together.



$$\begin{array}{r}
 4y^2 - 16x = 2 \\
 + -4y^2 + yx^2 = 8y \\
 \hline
 -16x + yx^2 = 8y
 \end{array}$$

Step 4: Manipulate equation so that all terms are on one side of the equation. Then use either factoring or the quadratic formula to solve for the x -variable.

$$\begin{array}{r}
 -16x + yx^2 - 8y = 0 \\
 yx^2 - 16x - 8y = 0
 \end{array}$$

Using the quadratic formula where $a = y$, $b = -16$, $c = -8y$:

$$\begin{aligned}
 x &= \frac{-b \pm \sqrt{b^2 - 4ac}}{2a} \\
 x &= \frac{16 \pm \sqrt{(-16)^2 - 4(y)(-8y)}}{2y} \\
 x &= \frac{16 \pm \sqrt{256 + 32y^2}}{2y}
 \end{aligned}$$

Step 5: Plug in the two x -values found into the original equation to solve for the y -variable.

$$y = \pm \sqrt{\frac{2 + 16\left(16 \pm \frac{\sqrt{256 + 32y^2}}{2y}\right)}{4}}$$

Graphing a System of Nonlinear Equations

It is unlikely that graphing systems of nonlinear equations will be the fastest, most efficient way to solve them while taking the SAT Math test; however, you may be faced with a graphed system of equations and be asked to identify its solutions. It is worth being familiar with how you can use graphing to solve such systems. Let's solve Example 1 again, but this time, let's graph the equations to reach our answers.

Example 1

$$\begin{array}{r}
 x^2 + y = 2 \\
 2x - y = 1
 \end{array}$$

Step 1: Write the equation in slope-intercept form.



$$y = 2 - x^2$$

$$y = 2x - 1$$

Step 2: Since the system is nonlinear, create a table of points for each equation to plot.

x -values	Equation 1: $y = 2 - x^2$	y -values
-3	$y = 2 - (-3)^2 = 2 - 9 = -7$	-7
-2	$y = 2 - (-2)^2 = 2 - 4 = -2$	-2
-1	$y = 2 - (-1)^2 = 2 - 1 = 1$	1
0	$y = 2 - (0)^2 = 2$	2
1	$y = 2 - (1)^2 = 2 - 1 = 1$	1

x -values	Equation 2: $y = 2x - 1$	y -values
-3	$y = 2(-3) - 1 = -6 - 1 = -7$	-7
-2	$y = 2(-2) - 1 = -4 - 1 = -5$	-5
-1	$y = 2(-1) - 1 = -2 - 1 = -3$	-3
0	$y = 2(0) - 1 = 0 - 1 = -1$	-1
1	$y = 2(1) - 1 = 2 - 1 = 1$	1

Step 3: Graph the points on a coordinate grid and find their intersection points.

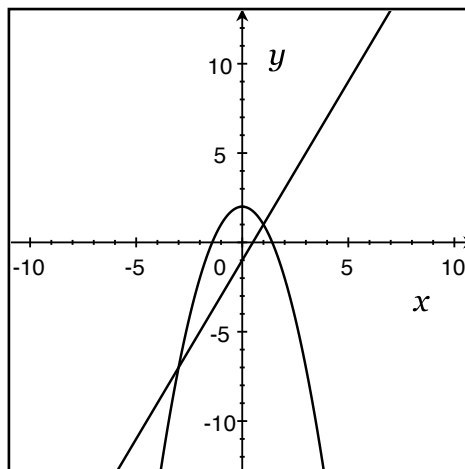

Solutions for the system of equations are $(-3, -7)$ and $(1, 1)$.



Function Notation

Function notation is an alternative form of formatting certain equations. A function is defined as an algebraic equation for which each input term has exactly one output term. In general, this means that for every value of x , there is only one possible solution for y . Multiple inputs can result in equal outputs (multiple values of x can give the same value of y), but a single input cannot give two solutions.

By this definition, all functions will adhere to the vertical line test. In other words, when a function is graphed, it will be impossible for a vertical line on the graph to intersect multiple points.

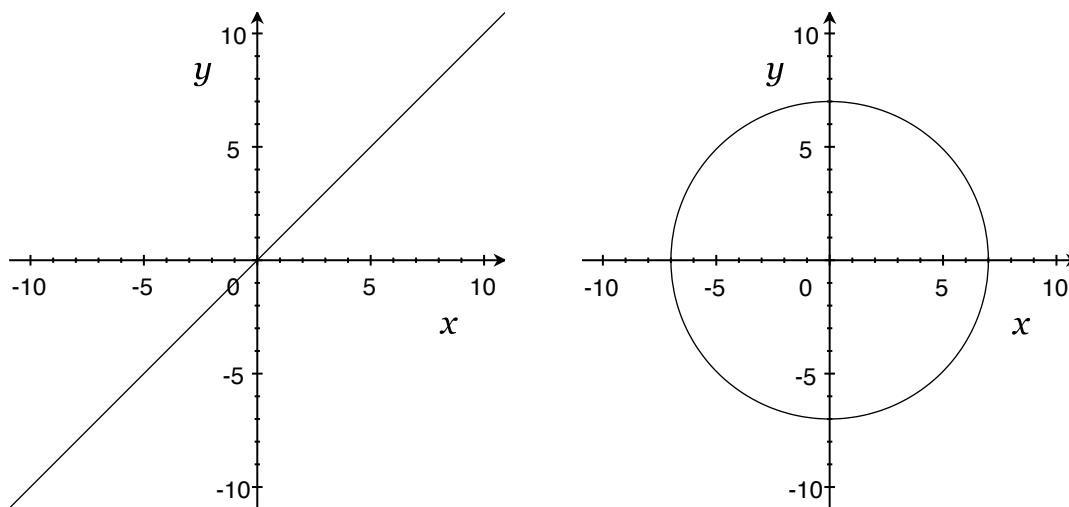

Note that for the equation $x = y$, a vertical line cannot possibly intersect the graph more than once. In contrast, there are values on the graph of a circle where a vertical line will intersect the graph twice. All linear equations are functions, with the exception of those that generate a vertical line such as $x = 5$. By definition, these graphs would fail the vertical line test. All vertically-oriented parabolas (those that open upwards or downwards) are also functions.

Function notation provides a different method of writing these special equations. Instead of the traditional format using an input variable (typically x) and an output variable (typically y), function notation implies a function being applied to a set of input variables, generating a set of outputs.

Let's examine a simple linear function:

$$y = 4x + 3$$

We can rewrite this equation using function notation:

$$f(x) = 4x + 3$$

The implication is that for any value of x , the function can be applied to give a single output. $f(x)$ denotes "the function of x ," or the set of all output values corresponding to the available set of input values. In many cases, it is still practical to think of $f(x)$ as equal to y , but function notation provides a framework to look at trends in the graph of the function as opposed to singular values.

Consider evaluating the function above when x is equal to 5. In function notation, this would be written as $f(5)$. On the SAT, this question would be asked in the following format:



Sample Question

$f(x) = 4x + 3$. Find $f(5)$.

- A. 20
- B. 23
- C. 25
- D. 28

To solve this question, you need to plug in 5 as the value of x and evaluate the result.

$$f(5) = 4(5) + 3 = 20 + 3 = 23$$

The correct answer is B.

In function notation, the term in parentheses is the input. Though this may seem like an obvious statement, consider the following example:

Sample Question

Find $f(x^2 + 3) = x^2 - x + 7$.

- A. $5x^2 + 4$
- B. $5x^2 - 3$
- C. $4x^2 + 4$
- D. $4x^2 + 7$

Instead of a single variable input, function notation allows us to evaluate more complex applications of the given equation. To solve this problem, we need to replace every instance of x in the right side of the equation with the term given as the input: $x^2 + 3$.

$$f(x^2 + 3) = (x^2 + 3)^2 - (x^2 + 3) + 7$$

Simplify to find the final answer.

$$f(x^2 + 3) = (x^2 + 3)(x^2 + 3) - (x^2 + 3) + 7$$

$$f(x^2 + 3) = x^4 + 6x^2 + 9 - x^2 - 3 + 7$$

$$f(x^2 + 3) = x^4 = 5x^2 + 4$$

The correct answer is A.

In some instances, the SAT may ask you to apply one function to another. These questions will provide two separate functions, then ask you to evaluate an input for one function in terms of another. The format of these questions will appear as $f(g(x))$.



Sample Question

$$f(x) = x^2 - 14$$

$$g(x) = -x + 4$$

Find $g(f(6))$.

- A. 11
- B. 12
- C. -18
- D. -21

What does $g(f(6))$ mean? We need to apply the function $g(x)$ to the outcome of $f(6)$. To start, we need to find $f(6)$.

$$f(6) = (6)^2 - 14 = 36 - 14 = 22$$

Now, we can rewrite $g(f(6))$ as $g(22)$, because $f(6) = 22$. To find the final answer to this question, simply solve for $g(22)$.

$$g(22) = -(22) + 4 = -18$$

So, the final answer will be C, because $g(f(6)) = -18$.



Graphing Algebraic Functions

Graphing algebraic functions involves depicting an equation as a visual representation of its points. It requires the understanding of some key concepts. The basic concept of graphing can be distilled down to plotting the x, y pairs on a coordinate plane for a given function. More detailed concepts relevant to graphing algebraic functions with which you should be familiar include axial intercepts, domain and range, maximum and minimum values, behavior on intervals and end behavior, asymptotes, symmetry, and transformations. This lesson will cover each of these concepts so that you can feel confident in your graphing skills even when dealing with complex functions and graphs that are to challenging analyze.

Axial Intercepts

Axial intercepts refer to the points on a graph that are located on the x - or y -axis. Algebraically, y -intercepts are those values produced when the x -value is zero. Similarly, x -intercepts are points where the y -value is zero. Graphically, these intercepts are located on the axes themselves.

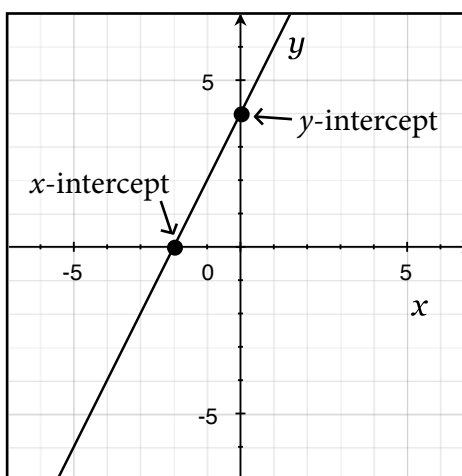

To find the x - or y -intercept(s) of a given function, simply plug in zero for the variable that you are not solving for and then solve for the variable whose intercept you need to calculate.

For example, say we want to find the x -intercept of this function: $f(x) = 3x^2 - 7$. By definition, the y -value of the x -intercept has to be zero, so we plug in zero for $f(x)$.

$$f(x) = 3x^2 - 7$$

$$0 = 3x^2 - 7$$

Now we can solve for x :

$$7 = 3x^2$$

$$\pm\sqrt{7} = 3x$$

$$x = \pm\frac{\sqrt{7}}{3}$$



This means that the function $f(x) = 3x^2 - 7$ has two x -intercepts: one at $(\frac{\sqrt{7}}{3}, 0)$ and one at $(-\frac{\sqrt{7}}{3}, 0)$. This makes sense, because the function contains a term that is squared, meaning that it will be graphed as a parabola. You can see the two x -intercepts on the function graphed below.

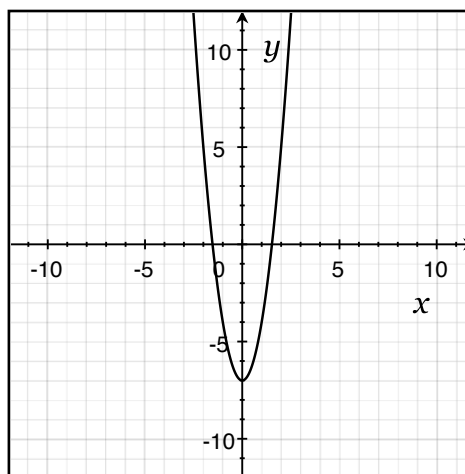

Domain and Range

Domain and range are algebraically known as the possible inputs and the outputs of the function. Graphically, the domain is the x -values and the range is the y -values that the graph depicts. Consider the graph below, which shows the function $f(x) = x^2 + 4$. In the graph below, the part of the x -axis shown in red is the domain of the function, and the part of the y -axis shown in blue is the function's range. The domain of the function is all real numbers, and the range of the function is $y \geq 4$.

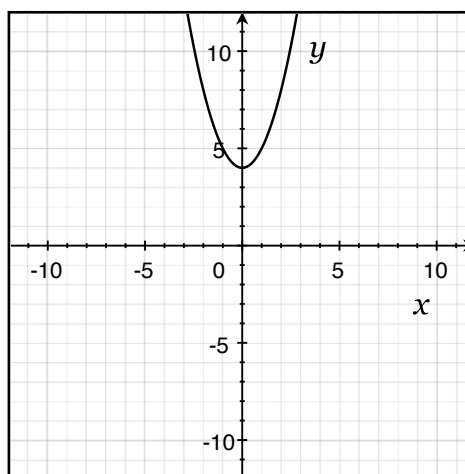

Minima and Maxima

Maximum and minimum values are the peaks and valleys of the graphed function. For a maximum to occur, all values to the left and right of the graph must be less than the point in question. Likewise, for a minimum to occur, all values to the left and right of the point must be greater than the point in question. Algebraically, the maximum and minimum are the highest and lowest y -values when inputting any and all x -values.



Function Behavior

Intervals of increasing or decreasing behavior depend on the type of function with which you are dealing. For example, if a function is linear, then the function will either have increasing or decreasing interval behavior. If a function is nonlinear, then it can have both increasing and decreasing intervals. An interval is the domain or x -values over which the function continues to increase or decrease. If the function is increasing, then the y -values will increase as the x -values increase. If the function is decreasing, then the y -values will decrease as the x -values increase.

End behavior refers to the ending y -value that will be reached when the last x -value in the domain is inputted. In many cases, the end behavior is positive or negative infinity.

Consider the function $f(x) = -(x - 1)^2 + 2$. Let's figure out its maximum. We can do this algebraically by plugging in points and noting when the points stop increasing and start decreasing.

x -value		y -value
-2	$f(-2) = -(-2 - 1)^2 + 2$ $f(-2) = -(-3)^2 + 2$ $f(-2) = -9 + 2$ $f(-2) = -7$	-7
-1	$f(-1) = -(-1 - 1)^2 + 2$ $f(-1) = -(-2)^2 + 2$ $f(-1) = -4 + 2$ $f(-1) = -2$	-2
0	$f(0) = -(0 - 1)^2 + 2$ $f(0) = -(-1)^2 + 2$ $f(0) = -1 + 2$ $f(0) = 1$	1
1	$f(1) = -(1 - 1)^2 + 2$ $f(1) = -(0)^2 + 2$ $f(1) = 0 + 2$ $f(1) = 2$	2
2	$f(2) = -(2 - 1)^2 + 2$ $f(2) = -(1)^2 + 2$ $f(2) = -1 + 2$ $f(2) = 1$	1

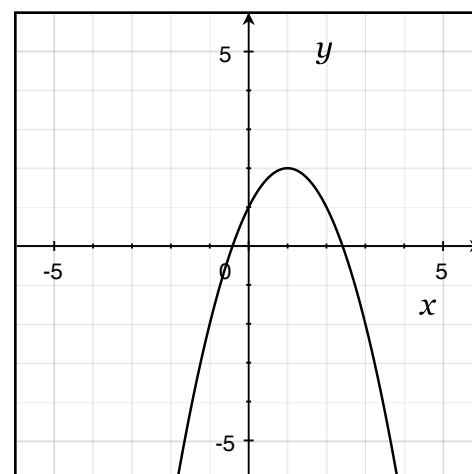

The maximum for this function occurs at $(1, 2)$, where the y -value reaches a maximum of 2. We can see that this is the case by looking at the graph of the function, shown at right.



Asymptotes

Asymptotes are lines that functions approach but never reach. Functions that have vertical asymptotic behavior have values that get infinitely close to the asymptote(s), but they never meet it. Not all functions have asymptotes.

There are two types of asymptotes: vertical asymptotes and horizontal asymptotes. Vertical asymptotes are key places where there is discontinuity in the function, whereas horizontal asymptotes describe general behavior at the ends of a function.

Vertical Asymptote

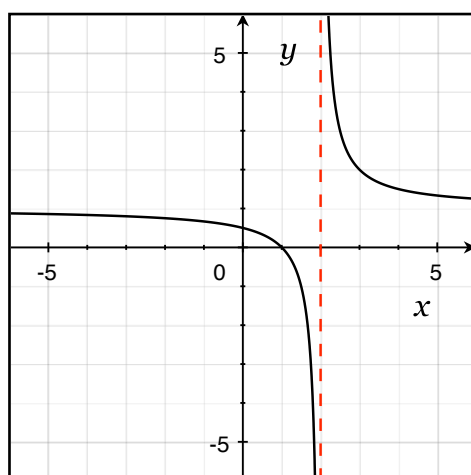

Horizontal Asymptote

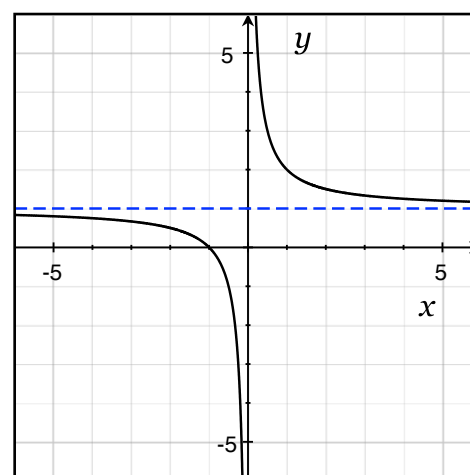

Asymptotes are quite apparent in graphs of functions; however, if you are only given the equation of a function, there are some techniques that can be used to identify different asymptotes.

Graphically, vertical asymptotes are the x -values that do not have a y -value associated with them. In other words, the vertical asymptote corresponds to the x -value of the domain that doesn't exist. When dealing with a function where there are variables in the denominator, a vertical asymptote corresponds to the zeros of the denominator. If a function isn't a quotient, then it will not include a vertical asymptote.

Sample Question

What are the vertical asymptotes of the function $f(x) = \frac{x^2 + 1}{x - 9}$?

- A. $x = -9$ and $x = 9$
- B. $x = -9$
- C. $x = -3$
- D. $x = 9$



Step 1: Set the denominator equal to zero.

$$x - 9 = 0$$

Step 2: Use algebraic manipulation to solve for x .

$$x - 9 = 0$$

$$(x - 9) + 9 = (0) + 9$$

$$x = 9$$

This function has one vertical asymptote located at $x = 9$. We can see that this is the case by considering the graph of the function, shown below.

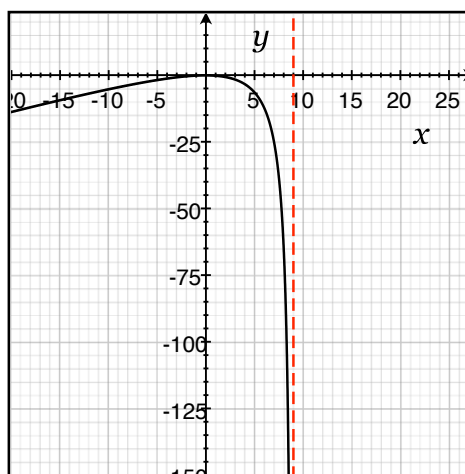

There are a few key rules to help determine if a function has a horizontal asymptote. If the highest degree of power in the numerator is greater than the highest degree in the denominator, then no horizontal asymptote exists. If the highest degree in the numerator and denominator are equal, then a horizontal asymptote occurs at the fraction of the terms with the highest coefficients. For example, consider the following function:

$$y = \frac{2x^2 + 3x - 1}{4x^2 - 16}$$

Highest degree power in numerator: 2

Highest degree power in denominator: 2

$$\text{Horizontal asymptote: } \frac{2x^2}{4x^2} = \frac{2}{4} = \frac{1}{2}$$

This function has one horizontal asymptote at $y = \frac{1}{2}$.



Sample Question

Find the horizontal and vertical asymptotes of the function $y = \frac{x^4 + 3x}{6x^4 - x^2}$.

- A. $x = 0, y = \frac{1}{6}$
- B. $x = 0, x = \pm\sqrt{\frac{1}{6}},$ and $y = \frac{1}{6}$
- C. $x = \frac{1}{6}$ and $y = 0$
- D. $x = \frac{1}{6}, x = \sqrt{\frac{1}{6}},$ and $y = 0$

Step 1: Calculate vertical asymptotes.

$$6x^4 - x^2 = 0$$

$$x^2(6x^2 - 1) = 0$$

$$x^2 = 0$$

$$6x^2 - 1 = 0$$

$$x = 0$$

$$6x^2 = 1$$

$$x^2 = \frac{1}{6}$$

$$x = \pm\sqrt{\frac{1}{6}}$$

Vertical asymptotes: $x = 0$ and $x = \pm\sqrt{\frac{1}{6}}$

Step 2: Calculate horizontal asymptotes.

Highest term in numerator: x^4

Highest term in denominator: $6x^4$

Since the powers on the terms are the same, the horizontal asymptote occurs at the leading coefficient:

$$\frac{x^4}{6x^4} = \frac{1}{6}$$

Horizontal asymptote: $y = \frac{1}{6}$



Symmetry

When discussing graphing algebraic functions, “symmetry” refers to when a graph has exactly the same dimensions on one side as it does on another side. This involves a line of symmetry, and in many cases, an axis of symmetry.

Standardized tests usually ask questions associated with the symmetry of parabolas. To algebraically calculate the line/axis of symmetry of a parabola, find the x -value of the vertex. When a function takes the form $ax^2 + bx + c$, the axis of symmetry occurs at

$$x = \frac{-b}{2a}.$$

Let’s try finding the axis of symmetry for the function $f(x) = 9x - 4 + x^2$. First, we need to put the function into standard form ($ax^2 + bx + c$).

$$f(x) = x^2 + 9x - 4$$

Now, we can identify a and b :

$$a = 1$$

$$b = 9$$

Now we can substitute these values into the axis of symmetry formula and solve.

$$x = \frac{-b}{2a}$$

$$x = \frac{-(9)}{2(1)}$$

$$x = \frac{-9}{2}$$

$$x = -4.5$$

This function’s axis of symmetry is $x = -4.5$. We can see that this is true by considering the graph of the function, shown below. The axis of symmetry is shown as the dotted line.

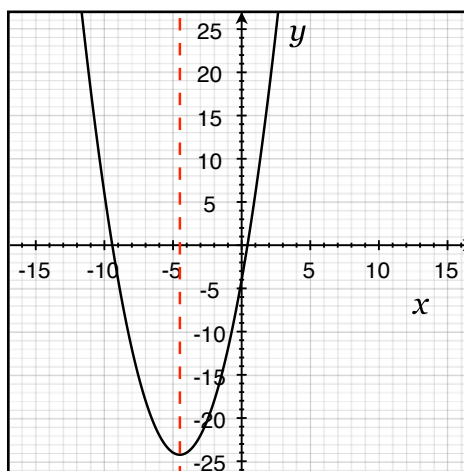

Symmetry

When discussing graphing algebraic functions, “symmetry” refers to when a graph has exactly the same dimensions on one side as it does on another side. This involves a line of symmetry, and in many cases, an axis of symmetry.

Standardized tests usually ask questions associated with the symmetry of parabolas. To algebraically calculate the line/axis of symmetry of a parabola, find the x -value of the vertex. When a function takes the form $ax^2 + bx + c$, the axis of symmetry occurs at

$$x = \frac{-b}{2a}.$$

Let’s try finding the axis of symmetry for the function $f(x) = 9x - 4 + x^2$. First, we need to put the function into standard form ($ax^2 + bx + c$).

$$f(x) = x^2 + 9x - 4$$

Now, we can identify a and b :

$$a = 1$$

$$b = 9$$

Now we can substitute these values into the axis of symmetry formula and solve.

$$x = \frac{-b}{2a}$$

$$x = \frac{-(9)}{2(1)}$$

$$x = \frac{-9}{2}$$

$$x = -4.5$$

This function’s axis of symmetry is $x = -4.5$. We can see that this is true by considering the graph of the function, shown below. The axis of symmetry is shown as the dotted line.

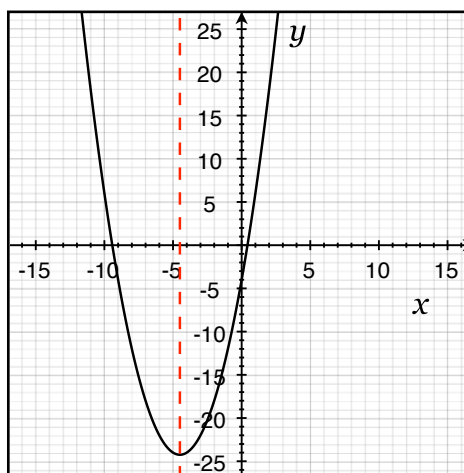

Sample Question

Find the axis of symmetry for the following function.

$$f(x) = 3x^2 - 7x + 21$$

A. $x = \frac{2}{5}$

B. $x = \frac{3}{7}$

C. $x = \frac{5}{4}$

D. $x = \frac{7}{6}$

Step 1: Identify the coefficients.

$$a = 3, b = -7, c = 21$$

Step 2: Substitute the values into the formula to find the axis of symmetry.

$$x = \frac{-b}{2a}$$

$$x = \frac{-(-7)}{2 \cdot (3)}$$

$$x = \frac{7}{6}$$

Step 3: State the solution.

The axis of symmetry for the function $f(x)$ occurs at $x = \frac{7}{6}$.



Transformations

Graphical transformations of functions fall into three categories: horizontal and vertical shifts, reflections, and the widening and narrowing of the width of parabolas.

Horizontal and Vertical Shifts

Algebraic Change	Graphical Result
$f(x) \rightarrow f(x) + a$	Shifts graph upward a units
$f(x) \rightarrow f(x) - a$	Shifts graph downwards a units
$f(x) \rightarrow f(x + a)$	Shifts graph to the left a units
$f(x) \rightarrow f(x - a)$	Shifts graph to the right a units

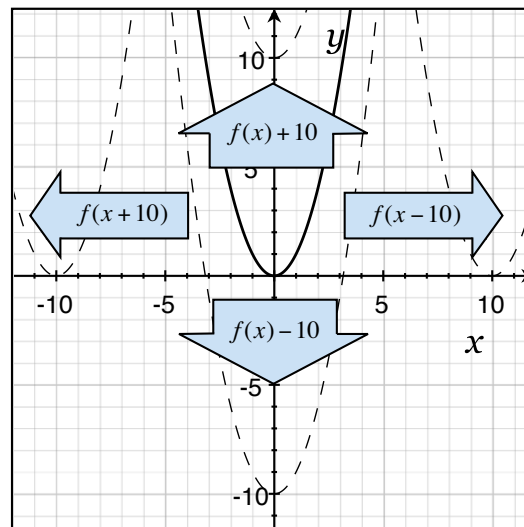

Reflections Over Axis

Algebraic Change	Graphic Result
$f(x) \rightarrow -f(x)$	Reflection over the x -axis
$f(x) \rightarrow f(-x)$	Reflection over the y -axis

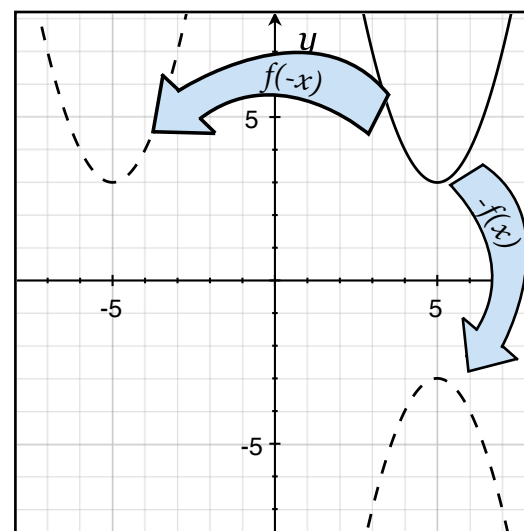

Widening and Narrowing

For equations in the form of $ax^2 + bx + c$:

Algebraic Change	Graphic Result
$a > 1$	Parabola becomes narrower
$0 < a < 1$	Parabola becomes wider

$$f(x) = -0.25x^2$$

$$f(x) = -x^2$$

$$f(x) = -4x^2$$

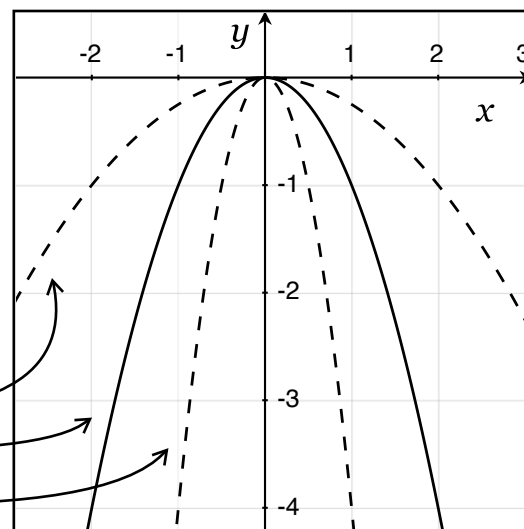

Sample Question

If $f(x) = x^2 + 2$ and $g(x)$ is a transformation of $f(x)$ when the graph is moved three units up and six units to the left, what is $g(x)$?

- A. $g(x) = (x + 6)^2 + 5$
- B. $g(x) = (x + 3)^2 + 8$
- C. $g(x) = (x + 5)^2 + 8$
- D. $g(x) = (x + 2)^2 + 9$

Step 1: Identify the type of transformation.

In this particular case there are two transformations from $f(x)$ to $g(x)$:

1. A vertical shift up

$$f(x) \rightarrow f(x) + a \text{ shifts upward } a \text{ units.}$$

2. A horizontal shift to the left

$$f(x) \rightarrow f(x + a) \text{ shifts to the left } a \text{ units.}$$

Combining these two statements into one, we get

$$f(x) \rightarrow f(x + h) + v$$

where h = horizontal shift = 6 and v = vertical shift = 3

Step 2: Substitute the defined shifts into the equation for $f(x)$.

$$f(x) \rightarrow f(x + 6) + 3$$

$$g(x) = (x + 6)^2 + 2 + 3$$

$$g(x) = (x + 6)^2 + 5$$

A is the correct answer.



Graphing Circles

The standard equation for a circle is in the form $(x - h)^2 + (y - k)^2 = r^2$, where the circle with radius r has its center at (h, k) . Let's consider an example.

Sample Question

What is the equation of the circle shown below?

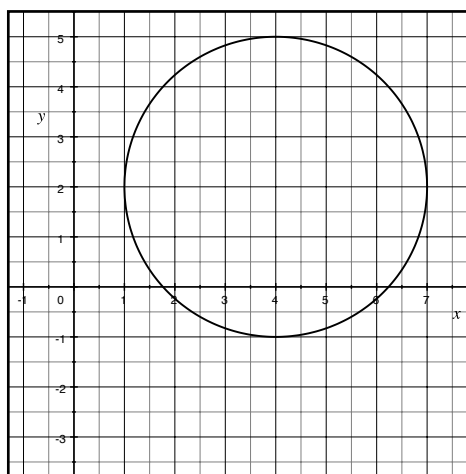

- A. $(x - 4)^2 + (y - 2)^2 = 9$
- B. $(x + 4)^2 + (y + 2)^2 = 9$
- C. $(x - 4)^2 + (y - 2)^2 = 36$
- D. $(x + 4)^2 + (y + 2)^2 = 36$

From the graph, we can see that the center of the circle is at $(4, 2)$. At this point, you can count the number of units over to the edge of the circle in any direction (up, down, left, and right are the clearest) and find that it is three units. This means that the radius of the circle is 3.

At this point, we have all of the information that we need to solve the problem; we just have to substitute it into the equation of a circle properly. Instead of trying to determine the correct equation in a single step, write it out and then substitute in the graphed values. This helps you keep your data in order when working with multiple variables and can help you avoid making simple mistakes. For example, answer choice B adds h and k to x and y , respectively. Because you're dealing with positive values (measured distance on the graph), it could be easy to mistakenly choose B if you don't write out the equation first.

$$(x - h)^2 + (y - k)^2 = r^2$$

$$(x - 4)^2 + (y - 2)^2 = (3)^2$$

$$(x - 4)^2 + (y - 2)^2 = 9$$

The correct answer is A.



Let's try another sample problem, this time one that asks you to picture a graphed circle instead of providing one for you to analyze.

Sample Question

In which quadrant(s) will the graph of the circle with equation $(x + 8)^2 + (y - 15)^2 = 49$ be contained?

- A. I only
- B. II only
- C. II and III
- D. IV only

To orient this graph on the coordinate plane, begin by finding the center of the circle. The x -coordinate of the center of the circle is -8 and the y -coordinate of the center of the circle is 15 . This means that the center of the circle is at $(-8, 15)$, which is in Quadrant II.

The next step is to realize that the radius of this circle is 7 . Now, we need to consider the four points seven units in the positive/negative x -direction and positive/negative y -direction. These will be on the line of the circle and mark the farthest points in those directions. If all of those points are located in Quadrant II, we know that the entire circle is located in that quadrant. Let's consider those points now:

$$\text{Up: } (-8, (15 + 7)) = (-8, 22)$$

$$\text{Down: } (-8, (15 - 7)) = (-8, 8)$$

$$\text{Left: } ((-8 - 7), 15) = (-15, 15)$$

$$\text{Right: } ((-8 + 7), 15) = (-1, 15)$$

Points in Quadrant II have negative x -values and positive y -values. Each of the points we tested also fit those criteria, so the entire circle is located in Quadrant II, and B is the correct answer.

We can see that our method works by considering how the circle looks when graphed.

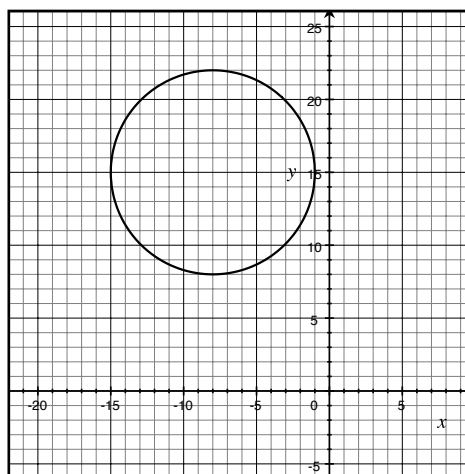

Let's look at one more sample problem. This next one describes a circle's dimensions and location and asks you to come up with the equation, without any graphs being presented. Graphing skills are still in play, though!

Sample Question

Which of the following equations represents a circle with center at $(-4, 6)$ and a radius of 6 units?

- A. $(x - 6)^2 + (y - 4)^2 = 9$
- B. $(x - 6)^2 + (y - 4)^2 = 36$
- C. $(x + 4)^2 + (y - 6)^2 = 36$
- D. $(x - 4)^2 + (y + 6)^2 = 36$

Let's start by writing out the equation of a circle:

$$(x - h)^2 + (y - k)^2 = r^2$$

We're told that the radius of our circle is 6 units, so go ahead and substitute in 6 for r .

$$(x - h)^2 + (y - k)^2 = (6)^2$$

$$(x - h)^2 + (y - k)^2 = 36$$

We're also told that the center of our circle is at $(-4, 6)$. This means that for this circle, $h = -4$ and $k = 6$. Substitute those values in for those variables in the equation, and be careful to track the negative sign on that -4 .

$$(x - (-4))^2 + (y - 6)^2 = 36$$

$$(x + 4)^2 + (y - 6)^2 = 36$$

The correct answer is C.



Complex Equations in Context

The revised SAT puts a large emphasis on word problems. If you're used to being presented with an equation or a graph instead of a paragraph of text to translate into mathematical terms, a little practice can help you adapt to this common format of problem presentation.

At first, word problems can seem intimidating and complex; however, there are strategies you can use when approaching them to streamline your process of solving them. First, identify what the question is asking you. Is it asking you to solve for a particular quantity or to model the situation with an equation? Perhaps it is presenting you with a mathematical model of a described scenario and asking you to weigh in about that model's correctness.

Once you've clearly identified what you need to figure out in order to answer the question, you may realize you need to solve for a variable by modeling the scenario. To do this, start by identifying the information that the question provides. Take your time and pay attention as you identify the facts you're given; sometimes the question will provide information that indirectly conveys other facts. Quickly listing out your data or underlining it in the question can help you to focus on these core parts of the question. At this point, you can create a function or multiple functions to solve for a specific variable. And remember, you might not use all of the information you're given; word problems can include extra information that is not necessarily relevant to the question asked.

Let's practice applying this general approach to a few general types of word problems likely to appear on the revised SAT's Math section: those that require knowledge of simple and compound interest and those that ask you to model increasing or decreasing populations using exponential functions. Each of these may sound like a difficult concept to face because they hail directly from specific subjects—economics and natural science. If you're not an expert in either of these, that's ok! You don't need to be. The SAT isn't trying to test your knowledge of economics or natural science—it's testing your mathematical skills. By understanding a few equations, you'll have all the knowledge you'll need to solve these questions with confidence.

Simple and Compound Interest

In economics, "interest" refers to the amount of money someone collects on a lump sum kept in a bank or the amount of additional money one must pay to a creditor along with an amount loaned. Mathematically, interest is a defined percentage or proportion of the principal amount that is added or subtracted to the principal amount as time passes.

The SAT tests two related but distinct types of interest: simple interest and compound interest. Both types of interest deal with a principal amount of money and the interest accrued on that specific amount of money. Let's go over each type of interest individually while focusing on the details that tell you which type is relevant to a given problem.

Simple interest reflects the interest taken on amount after one given period of time based on a rate, percentage, or ratio. To solve for simple interest, you need to know three things: the principle (initial amount of money borrowed or invested), the interest rate, and the amount of time. If you're asked to solve for a different variable, just make sure you know three of the four, with interest being one of the three we just listed.



Compounded interest differs from simple interest in that while simple interest models one discrete “collection” of interest based on an unchanging principle, compound interest models interest in situations in which the interest is added to the principle over time. Thus, the principle changes over time, and a different equation must be used to reflect this. Compound interest still involves the same four variables as simple interest, but it adds in one more: n , the number of times the amount is compounded per the specified time. You can think of this as how many distinct times interest is “collected” and added to the principle per amount of time, t .

Simple Interest

$$I = P \times r \times t$$

P = Principal Amount
(Starting amount of money)
 R = Rate/Percentage/Ratio of
Increase
 T = Time

Compound Interest

$$A = P\left(1 + \frac{r}{n}\right)^{nt}$$

P = Principal Amount
(Starting amount of money)
 r = Rate/Percentage/Ratio
 n = Number of times amount is
compounded per specific time
 t = Time

So, how do you distinguish between problems that call for simple interest calculations and those that call for compound interest calculations? It’s all in the wording of the problem, specifically in the way that the problem refers to time. If you’re told that a loan or investment is “compounded” at a specified regular interval, you need the compound interest formula. If nothing seems to suggest that the interest was re-invested after regular periods—that is, the problem only describes one single period of investment—you need the simple interest formula.

As an added wrinkle, pay careful attention to how the problem is worded. Are you solving for the interest, or the final sum? Amount of interest will be defined as the variable I , but total final amount will be $I + P$, so you’ll need to perform one last simple calculation to arrive at the correct answer. In addition, there’s a good chance some of the answer choices will present the alternate option, making it all too easy to miss your mistake should you make one at this point in the problem. Read and interpret carefully!

Sample Question

Billy invests \$1500 in a fifteen-year CD that has a 2.3% interest rate. How much money will be in the CD’s account at the end of the fifteen-year period?

- A. \$517.50
- B. \$604.25
- C. \$2017.50
- D. \$2104.25



Step 1: Identify the type of interest the question is using.

This is a simple interest question. We're asked to solve for the total amount of money in the account after one period of fifteen years. No mention is made of interest being reinvested, and we're not given any information about the periods of time at which such reinvestment might occur (n).

Step 2: Identify the given information.

$$\begin{aligned}a &= 1500 \\r &= 2.3\% = 0.023 \\t &= 15 \\I &= ?\end{aligned}$$

Step 3: Write the formula and substitute in the given information to solve.

$$\begin{aligned}I &= P \times R \times T \\I &= \$1500(0.023)(15) \\I &= \$517.5\end{aligned}$$

This is the amount of interest Billy's money has made. But you're not solving this problem yet! The question asks you to find "how much money will be in the CD's account" after the fifteen-year investment period. That means we need to add the interest made to the principal amount to answer the question.

$$\begin{aligned}T &= I + P \\T &= \$517.5 + \$1500 \\T &= \$2017.50\end{aligned}$$

Sample Question

Dan took out a \$2000 from his bank. His loan is compounded quarterly at a rate of 1.95%. How much interest will Dan owe on his loan after 3 years?

- A. \$94.72
- B. \$98.34
- C. \$108.24
- D. \$120.19

Step 1: Identify the type of interest problem to use.

We need to use the compound interest formula. We're told that the interest on Dan's loan is "compounded quarterly," specifying this type of interest.

Step 2: Identify the given information.



$$\begin{aligned}P &= 2000 \\r &= 1.95\% = 0.0195 \\t &= 3 \\n &= 4 \text{ (There are four quarters in a year.)} \\A &= ?\end{aligned}$$

Step 3: Write the interest equation and substitute in the given information.

$$\begin{aligned}A &= P\left(1 + \frac{r}{n}\right)^{nt} \\A &= 2000\left(1 + \frac{0.0195}{4}\right)^{4 \cdot 3} \\A &= 2000(1 + 0.004875)^{12} \\A &= 2000(1.004875)^{12} \\A &= 2000(1.06) \\A &= 2120.188 \\A &= \$2120.19\end{aligned}$$

The compound interest formula that we use gives us the total amount of the loan after the specific time period because we are adding 1 to the rate. So, we are calculating the initial amount added to the interest made. To figure out how much of Dan's amount owed is interest accrued on his initial loan, we need to subtract the amount of the initial loan from the result of the compound interest equation.

$$\begin{aligned}A &= I + P \\A - P &= I \\\$2120.19 - \$2000.00 &= I \\I &= \$120.19\end{aligned}$$

The correct answer is D.



Exponential Growth and Decay

SAT Math problems that deal with the growth or decline of populations of bacteria or other organisms may seem very far removed from the interest problems that we looked at earlier in this lesson; however, they can both be mathematically modeled with exponential equations. Whereas interest is calculated using one of two predetermined equations, populations can be modeled by adapting one general equation to the specifics of a presented scenario.

Exponential Growth

$$f(t) = a \times e^{rt}$$

- a = Constant specified in problem
- e = Numerical constant $\oplus 2.718$
- r = Rate of growth
- $-r$ = Rate of decay
- t = Time

Exponential Decay

$$f(t) = a \times e^{-rt}$$

This is the general form of an exponential equation; it can model increasing exponential scenarios (exponential growth) or decreasing exponential scenarios (exponential decay). The key thing to remember when dealing with exponential growth and decay is to remember they are functions with the numerical constant e and exponents—that is all. The numerical constant e is roughly 2.718. a is a constant specified in the problem, r is the rate of growth/decay, and t represents the time. Remember that $f(t)$ means the function value at time t ; it's another way to say y .

The key difference between growth and decay is that growth has an exponential increase while decay has an exponential decrease. In the case of decay, the rate will be negative, causing the general function to look like $f(t) = a \times e^{-rt}$.

Exponential Growth

$$f(t) = e^t$$

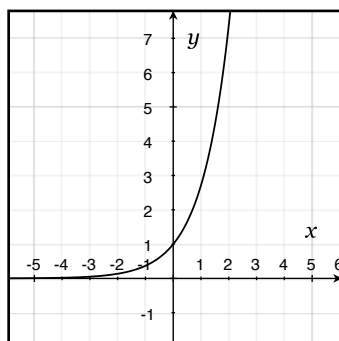

Exponential Decay

$$f(t) = e^{-t}$$

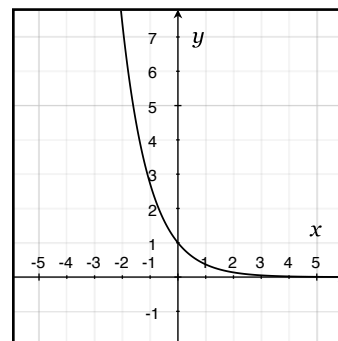

To identify the different values used in the growth and decay formulas, look for the following words in the problem.

- a = “initial amount,” “beginning deposit,” “starts with”
- r = “rate of growth/decay,” “rate of increase/decrease,” “percentage of increases/decreases,” “increases/decreases by”
- t = “time,” “over time,” “months,” “bi-annually,” “annually,” “quarterly,” “weekly”



Sample Question

A scientist places an initial population of 3.5×10^4 bacteria on a plate containing glucose. She knows that this type of bacteria, when supplied with abundant glucose, can double every two hours. When she checks on the bacteria at the same time the next day, approximately how many should she expect to find, assuming the bacteria do not run out of glucose to eat?

- A. 9.27×10^{12}
- B. 9.27×10^{14}
- C. 9.35×10^{14}
- D. 9.35×10^{16}

This is an exponential growth question, so we need to start with the correct formula.

$$f(t) = a \times e^{rt}$$

Next, we should organize the information we're given in the question stem and figure out what we're solving for.

$$a = 3.5 \times 10^4 \text{ (Initial population)}$$

$$t = 12 \text{ (The scientist checks on the bacteria at "the same time the next day," so 24 hours have passed. The rate of this problem is given as applying every two hours, though, so we have twelve two-hour periods' worth of bacteria growth to account for).}$$

$$r = 2 \text{ (Population is said to "double" every two hours).}$$

We're solving for the number of bacteria after twenty-four hours have passed—in mathematical terms, $f(t)$. Plugging the given information into the exponential growth formula, we can solve for the unknown variable.

$$f(t) = 3.5 \times 10^4 \times e^{2 \times 12}$$

$$f(t) = 3.5 \times 10^4 \times e^{24}$$

$$f(t) = 9.27 \times 10^{14}$$

The correct answer is B.



Sample Question

A special lizard population is in danger of becoming extinct. In 1920, the blue speckled lizard population contained 3.78×10^7 individuals. It has decreased by 2% every year since. If the rate of decay continues in this fashion, in what year will the population be roughly 6.25×10^6 ?

- A. 2008
- B. 2010
- C. 2012
- D. 2014

Step 1: Identify what the question is asking for.

What year will the population reach 6.25×10^6 ; we want to solve for $t + 1920$.

Step 2: Identify all known information

Initial year = 1920

Initial population = 3.78×10^7

Decaying exponential problem—"decreasing by 2%" represents the rate of decay

Final population = 6.25×10^6

In mathematical terms we have:

$$\begin{aligned}P &= ae^{-rt} \\P &= 6.25 \times 10^6 \\a &= 3.78 \times 10^7 \\r &= 2\% = 0.02\end{aligned}$$

Step 3: Set up equation, substitute in known values, and solve for t .

$$\begin{aligned}P &= ae^{-rt} \\6.25 \times 10^6 &= 3.78 \times 10^7 e^{-0.02t}\end{aligned}$$

Divide by 3.78×10^7 .

$$0.165 = e^{-0.02t}$$

Take the natural log of both sides. (The natural log and e cancel each other out).

$$\begin{aligned}\ln(0.165) &= \ln(e^{-0.02t}) \\ \ln(0.165) &= -0.02t\end{aligned}$$

Divide by -0.02 .



$$\frac{\ln(0.165)}{-0.02} = t$$

$$t = 90$$

From here, to find the year, we will need to add t to the initial year.

$$Y = t + 1920$$

$$Y = 90 + 1920$$

$$Y = 2010$$

B is the correct answer!

These equations aren't just relevant to biology and the natural sciences. You can also use exponential functions to model increasing and decreasing populations in social science contexts.

Sample Question

Tina works at a university where the student population has seen growth over the last 50 years. In 1950 the student population was 500 and on average, every year it increases by 4%. If the university continued to grow in this way, how many students were in the class of 2015?

- A. 6732
- B. 6740
- C. 6774
- D. 6791

Step 1: Identify what the question is asking for.

Population in 2015

Step 2: Identify what is known.

- “Growth” represents an exponential growth problem.
- “In 1950 student population was 500” gives the starting time and the starting population.
- “Every year” represents our time unit. We will need to calculate the specific time by subtracting the initial time from the time in question: 2015 – 1950.
- “Increases by 4%” represents the rate.

In mathematical terms, we have:

$$P = ae^{rt}$$

$$P = \text{population in 2015}$$

$$a = 500$$

$$r = 4\% = 0.04$$

$$t = 2015 - 1950 = 65$$



Notice that in this problem, “over the last 50 years” is extraneous information.

Step 3: Set up equation, substitute known values in and solve.

$$P = 500e^{0.04 \cdot 65}$$

$$P = 500e^{2.6}$$

$$P = 6,731.869$$

$$P \approx 6,732$$

The correct answer is A.



Analytics and Problem Solving

While the primary focus of the SAT Math test tends to linger on algebraic calculations, manipulations, and graphs, questions related to the Problem Solving and Data Interpretation subscore are somewhat different. These questions deal directly with Problem Solving and Analytics, frequently drawing upon accompanying tables, charts, graphs, and figures as tools for demonstrating mathematical principles.

The goal of Analytics and Problem Solving questions is to test critical understanding and application of materials presented in a format outside of standard functions or equations. These questions rely heavily on word problem set-ups and visual aids. The mathematical principles tested generally require interpreting the presented scenarios in the textual and visual set-ups and analyzing their significance through statistical analysis or mathematical modeling.

Unlike the other subscores specific to the SAT Math test, Analytics and Problem Solving questions are sequestered in the calculator portion of the exam. All 17 of these questions are contained in this portion of the test due to their reliance on specific calculation and graphical modeling. Calculating probability, statistics for a given set, and correlation patterns between two variables in a table can be very time-consuming by hand; don't be afraid to use your calculator heavily on these types of questions. Additionally, many questions involving data interpretation can relate to the SAT subscores for Analysis in History/Social Science and Analysis in Science; be prepared for complex set-ups that may deal with contextual topics that are unfamiliar to you. Despite these topics, never lose sight of the underlying mathematical principles. Even in unfamiliar contexts, most math topics will be relatively standard and recognizable. As long as you prepare yourself for questions on basic statistics, graphical modeling and analysis, and probability principles, you can be confident in your skills for the Analytics and Problem Solving questions in SAT Math.

Section Outline

Introductory Statistics

- Reviewing the basics of mean, median, mode, range, standard deviation, and error

Modeling Data: Equations, Graphs, Scatter Plots, and Tables

- Visualizing data and determining correlations between graphs and equations

Conversions: Units, Ratios, Proportions, and Percentage

- Performing conversions between mathematical modes and calculations

Probability

- Calculating probability and predictability of events and outcomes



Introductory Statistics

Statistics have been a notoriously feared SAT topic for many test takers. The fear-inducing notoriety and intimidating reputation associated with these mathematical operations have been the product of a lack of understanding of the somewhat vague and confusing mathematical operations used to calculate statistical measures. The goal of this section is to break down statistical measures into their constituent parts. As a result, the mystery and enigma of the operations are elucidated and they become logical problems easily solved through the use of deductive reasoning. This section of the SAT will cover topics associated with measures of centrality (i.e. mean, median, and mode), range, standard deviation, error, and confidence intervals.

We perform statistical calculations on data sets in order to discern trends, relationships, and variation between data points. Included in these operations are methods of measuring centrality. There are three different measures of centrality: mean, median, and mode. Each one is a unique measure of central tendency; therefore, they are not interchangeable. Other calculations that are often used when answering statistical questions include range, standard deviation, error, and confidence levels and intervals. This section will explain these calculations, address their importance and describe the relevancy of the information gathered from each.

Mean

The mean is one measure of central tendency and is the one most commonly referred to as the arithmetic “average” of a data set. This is because the mean is calculated by adding all the data values together and dividing by the number of data entries; thus, it averages them. In other words, if the data set were to be described by only one value that is representative of every entry in the set, then it would be best illustrated by the mean. It is important to note that the sum of the data values in a set will equal the sum of the mean multiplied by the number of data entries in the series. In summation notation this looks like:

$$\bar{x} = \frac{\sum_{i=1}^n x_i}{n}$$

\bar{x} = mean
 x_i = individual data values
 n = number of data entries

Example 1: What is the mean of the following data set? {3,8,5,1,1,6}

Step 1: Add all the data values together.

$$3 + 8 + 5 + 1 + 1 + 6 = 24$$

Step 2: Identify the number of data entries.

$$n = 6$$

Step 3: Divide the sum found in step 1 by the number of data entries found in step 2. Simplify if possible.

$$\bar{x} = \frac{24}{6} = \frac{4 \times 6}{6} = 4$$



Example 2: If the mean of the set $\{2, 4, 5, 1, x, 3, 2\}$ is 5, what is the value of the missing number x ?

Step 1: Set up an equation to solve using the summation notation for mean.

$$\frac{2 + 4 + 5 + 1 + x + 3 + 2}{7} = 5$$

Step 2: Use algebraic manipulation to isolate x .

$$\frac{2 + 4 + 5 + 1 + x + 3 + 2}{7} = 5$$

$$\frac{17 + x}{7} = 5$$

$$7 \cdot \frac{17 + x}{7} = 5 \cdot 7$$

$$17 + x = 35$$

$$17 - 17 + x = 35 - 17$$

$$x = 18$$

Median

The median is another measure of central tendency and is known for describing the middle of a data set when the set is organized in either ascending or descending order. When the set is comprised of an odd number of data points, the median will be the value directly in the middle of the set with an even number of data entries to both the left and right of it. In order to calculate where the median occurs in a set with odd number entries, simply add one to the number of entries and divide that new number by 2. This will result in the entry that holds the median. For example, say there are five entries in a data set,

$\{2, 7, 4, 5, 1\}$. The entry that will hold the median will be at $\frac{5+1}{2} = \frac{6}{2} = 3$; therefore, the

third entry is the median. Once the set is placed in ascending or descending order locate the third entry and there lies the median. After being reordered, $\{2, 7, 4, 5, 1\}$ becomes $\{1, 2, 4, 5, 7\}$. The third entry in this set is 4; therefore, the median is 4. If the number of data entries is even, then after reordering the set in either ascending or descending order, take the average of the two numbers that are in the middle of the set. If there are, say, 8 data entries, then take the average of the values in entry 4 and entry 5. It is important to note that the median is particularly useful in situations where there are outliers that would throw off the ability of the mean to accurately gauge central tendency.

Example 3: Sarah spends 2 hours on Tuesday, Thursday, and Saturday practicing her violin. On Monday she practices for 90 minutes, and on Friday she practices for 1 hour. What is the median time she spends practicing her violin in a given week?



Step 1: Convert all the given time values into the same unit of measure.

For this particular case, let's use hours as the unit of measure.

Monday: 90 mins = 1.5 hours

Tuesday = 2 hours

Thursday = 2 hours

Friday = 1 hour

Saturday = 2 hours

Step 2: Organize the times in ascending order.

1, 1.5, 2, 2, 2

Step 3: Calculate the entry that will hold the median; the middle number in the data set.

Since there are an odd number of data entries, 5, in the set, we can use the following formula to find the space that holds the median.

$$\frac{5 + 1}{2} = \frac{6}{2} = 3$$

This means that the median occurs at the third entry in the data set.

1, 1.5, 2, 2, 2

Another way to think of it is to cross off a value from each end and working towards the middle.

~~1~~, 1.5, 2, 2, ~~2~~

~~1~~, ~~1.5~~, 2, ~~2~~, ~~2~~

Each method leads to the same median value, 2.

Example 4: In Billy's 5th grade class, the test scores for the final math exam were, 87, 54, 77, 92, 95, 91, x, and 90. What is the value of x if the median of the test scores is 82?

Step 1: Reorder the data set in ascending order.

54, 77, 87, 90, 91, 92, 95, x

Step 2: Identify which entry should hold the median based on the number of values in the set.

Since the set has an even number of data entries, the median will be the average of the two middle numbers.

The two middle numbers are located at entries 4 and 5.



~~54, 77, 87, 90, 91, 92, 95, x~~

Take the average of these two numbers to see if it will be the desired median.

$$\frac{90 + 91}{2} = \frac{181}{2} = 90.5 \neq 82$$

Let's reorder our data set with the x on the other end of the set.

$x, 54, 77, 87, 90, 91, 92, 95$

In this case the median would be,

$$\frac{87 + 90}{2} = \frac{177}{2} = 88.5 \neq 82$$

Now we know that the x -value will need to be one of the middle numbers that the average is being taken from; therefore, we can rewrite the set as follows.

$54, 77, 87, x, 90, 91, 92, 95$

$$\frac{x + 90}{2} = 82$$

$$2 \cdot \frac{x + 90}{2} = 82 \cdot 2$$

$$x + 90 = 164$$

$$x + 90 - 90 = 164 - 90$$

$$x = 74$$

Step 3: Answer the question.

For the median of the test scores to be 82, the missing value of x must be 74.

Mode

The mode is the last measure of central tendency and represents the value or values in a data set that is/are repeated the most. It is possible for a data set to have one, multiple, or no modes. For example, there is no mode in the data set $\{1, 2, 3, 4, 5\}$ since each value is never repeated. In the data set $\{2, 4, 5, 2, 3, 1, 2, 2\}$, 2 is the mode, as it is seen four times within the set—more than any other value. In the data set $\{1, 1, 2, 2, 3, 4\}$, there are two modes, 1 and 2, since each is seen twice in the set.

Example 5: What is the mode of the following data set? $\{2, 4, 6, 7, 18, 2, 3, 1, 1, 2\}$

Step 1: Rearrange the data set in ascending order

$\{1, 1, 2, 2, 2, 3, 4, 6, 7, 18\}$



Step 2: Identify which values repeat and how many times.

$$\{1,1,2,2,2,3,4,6,7,18\}$$

One is seen twice in the data set and two is seen three times.

Step 3: Answer the question.

2 is the mode of the data set because it appears three times—more than any other value in the set.

Example 6: Given the set $\{72, 75, 85, 90, 90, x\}$, what is the value of x if a mode of the set is 90 and its average is 85?

Step 1: Calculate the average.

There are three possible places x can be located:

$$\{72, 75, 85, 90, 90, x\}$$

$$\{x, 72, 75, 85, 90, 90\}$$

$$\{72, 75, x, 85, 90, 90\}$$

Take the average in each scenario.

$$\{72, 75, 85, 90, 90, x\}$$

$$\frac{85 + 90}{2} = \frac{175}{2} = 87.5 \neq 85$$

$$\{x, 72, 75, 85, 90, 90\}$$

$$\frac{75 + 85}{2} = \frac{160}{2} = 80 \neq 85$$

$$\{72, 75, x, 85, 90, 90\}$$

$$\frac{x + 85}{2} = 85$$

$$\{72, 75, x, 85, 90, 90\}$$

$$\frac{x + 85}{2} = 85$$

$$2 \cdot \frac{x + 85}{2} = 2 \cdot 85$$

$$x + 85 = 170$$

$$x + 85 - 85 = 170 - 85$$

$$x = 85$$



Step 2: Write the set with the found value of x .

$$\{72, 75, 85, 85, 90, 90\}$$

Step 3: Identify the mode(s)

$$\{72, 75, 85, 85, 90, 90\}$$

Both 85 and 90 are modes of this set, so the correct value for x is 85.

Range

In statistics, “range” refers to the difference between the largest value and the smallest value in a given data set. The smaller the range of a set, the closer its data entries are to one another. If the range is large, then either there is more space between the data entries or there are outliers in the data.

Example 7: What is the range of the following data set? $\{2, 5, 1, 2, -7, 6, 19\}$

Step 1: Arrange the data set in ascending order.

$$\{2, 5, 1, 2, -7, 6, 19\}$$

$$\{-7, 1, 2, 2, 5, 6, 19\}$$

Step 2: Identify the lowest value of the data set and the highest value of the data set.

$$\text{Lowest value} = -7$$

$$\text{Highest value} = 19$$

Step 3: Take the difference of the highest and lowest values.

$$\text{Range} = \text{Highest Value} - \text{Lowest Value}$$

$$\text{Range} = 19 - (-7)$$

Remember, when subtracting a negative number, the two negative signs become an addition sign.

$$\text{Range} = 19 - (-7) = 19 + 7 = 26$$

It is important to remember that range is the total distance between the highest and lowest number in a data set and distance is never negative.

Example 8: What is the value of x if the range is 12? $\{2, 3, x, 5, 12\}$

Step 1: Find the range of the set, assuming x lies in the middle of the set.

$$\text{Range} = 12 - 2 = 10 \neq 12$$



This tells us that x must be either greater than 12 or less than 2.

Step 2: Set up equations to solve for the possible values of x .

Possibility 1: $\{x, 2, 3, 5, 12\}$

$$R = 12 - x = 12$$

$$x = 0$$

Possibility 2: $\{2, 3, 5, 12, x\}$

$$R = x - 2 = 12$$

$$x - 2 + 2 = 12 + 2$$

$$x = 14$$

Step 3: Answer the question.

In order for the range of this particular data set to be 12, x must be 0 or 14.

Standard Deviation

Standard deviation is a slightly more involved calculation, but describes the spread or variance of the data in relation to the mean. To find the standard deviation, the mean needs to be calculated first. From there, the difference of each data value and the mean will need to be squared. After that, all the squared terms will need to be added together and then divided by the number of data entries. The final step to calculate standard deviation is taking the square root. The formula for standard deviation in mathematical terms is as follows.

$$\sigma = \sqrt{\frac{1}{N} \sum_{i=1}^N (x_i - \bar{x})^2}$$

σ = Standard deviation

N = Number of data entries

x_i = Individual data values

\bar{x} = Mean

Example 9: Find the standard deviation of the following set. $\{2, 3, 1, 6, 7, 8\}$

Step 1: Calculate the mean.

$$\frac{2 + 3 + 1 + 6 + 7 + 8}{6} = \frac{27}{6} = 4.5$$

Step 2: Find the difference between each value in the set and the mean, and square it.

$$(2 - 4.5)^2 = (-2.5)^2 = 6.25$$

$$(3 - 4.5)^2 = (-1.5)^2 = 2.25$$

$$(1 - 4.5)^2 = (-3.5)^2 = 12.25$$

$$(6 - 4.5)^2 = (1.5)^2 = 2.25$$



$$(7 - 4.5)^2 = (2.5)^2 = 6.25$$

$$(8 - 4.5)^2 = (3.5)^2 = 12.25$$

Step 3: Add all the values found in step 2 together.

$$6.25 + 2.25 + 12.25 + 2.25 + 6.25 + 12.25 = 41.5$$

Step 4: Divide the value in step 3 by the number of entries in the data set.

$$\frac{41.5}{6} = 6.917$$

Step 5: Take the square root of the value found in step 4.

$$\sqrt{6.917} = 2.63$$

Example 10: In the United States a study measured the average height of males. The study found that in a representative, randomly selected population the average height of men was 72 inches. Further tests were conducted to find that the data set had a normal distribution and standard deviation of 3.8 inches. What can be said about the data set?

The standard deviation is the amount of variance from the mean that exists within a given data set. In the question, we know that the population under study was a normal distribution. This means that 68 percent fall within one standard deviation of the mean. This means that 68 percent of the population are between the heights of 68.2 (mean – standard deviation) and 75.8 (mean + standard deviation) inches. It also means that 95 percent of the population falls between 2 standard deviations of the mean. This means that 95 percent of the male population is between 64.4 (mean – (2 × standard deviation)) and 79.6 (mean + (2 × standard deviation)) inches.

Error

Error is a way to describe the accuracy of a data set on a specific population. When dealing with error in statistics, it is important to pay special attention to the hypothesis that is being used. The hypothesis will give a specific expected result, or “theoretical value.” In contrast, the values actually obtained through a study or other method of data collection will represent the “actual value.” Calculating the error for a given measure will tell you how much your actual values deviate from your theoretical values. To find the error subtract the theoretical value from the actual value, then divide the result by the theoretical value. If asked for percent error, multiply this result by 100.

$$\text{Error} = \frac{\text{Theoretical Value} - \text{Actual Value}}{\text{Theoretical Value}} \times 100$$



Example 11: A researcher studies a certain species of fish. He finds that the size of the fish population is limited by the size of the lakes in which they live, and derives an equation to model the expected population size, P , based on surface area, A , of the lake in square feet:

$$P = 5 + 0.83A$$

If the researcher finds that a particular lake has a surface area of 342 ft^2 and a population of 310 fish, what is the percent error from the predicted value?

Step 1: Identify the theoretical and actual values. The actual value is 310 fish, given in the question. The theoretical value can be calculated using the researcher's equation to predict the expected fish population in a lake with surface area 342 ft^2 :

$$P = 5 + 0.83(342)$$

$$P = 288.86$$

The theoretical value is 288.86 and the actual value is 310 fish.

Example 12: Use the given values to calculate the error. Subtract the theoretical value from the actual value, divide by the theoretical value, and multiply 100 (to get the percent error).

$$\text{Error} = \frac{310 - 288.86}{288.86} \times 100\%$$

$$\text{Error} = \frac{21.14}{288.86} \times 100\%$$

$$\text{Error} = (0.0732) \times 100\%$$

$$\text{Error} = 7.32\%$$

A positive error value indicates that the actual value was greater than the theoretical value, while a negative error value indicates a smaller actual value than expected. In this case, the population of fish in the lake was 7.32% larger than predicted.



Modeling Data: Equations, Graphs, Scatter Plots, and Tables

The SAT Math test includes questions that has data presented in equations, graphs, and tables. You should feel comfortable being able to relate the data from different figures and be familiar with some commonly used graphs and equations.

Equations

Some equations will be provided on test day, while others should be memorized. However, understand that the SAT's focus is to test critical thinking and problem solving skills, not retention and regurgitation of facts and/or equations; therefore, it is likely that you will encounter equations on the SAT that you may or may have not seen before. Don't panic. You will be given all the information you need to answer the questions in the question stem; the question may ask you to apply the information in a new or specific way.

Sample Question

Newton's law of gravitational force denotes that two objects exert equal and opposite attractive gravitational forces on each other. The equation is as follows:

$$F_G = G \frac{m_1 m_2}{r^2}$$

In this equation, F_G is the gravitational force, m_1 is the mass of the first object in kilograms, m_2 is the mass of the second object in kilograms, r is the distance between the centers of the two objects in meters, and G is the gravitational constant, which is equal to $6.7 \times 10^{-11} \frac{N \cdot m^2}{kg^2}$.

If two objects experience a gravitational force of F_{G1} when they are a distance r away from each other, what is the new gravitational force, F_{G2} experienced by the objects if the mass of the second object is doubled and the distance between them is halved?

- A. $F_{G2} = \frac{1}{4} F_{G1}$
- B. $F_{G2} = \frac{1}{16} F_{G1}$
- C. $F_{G2} = F_{G1}$
- D. $\frac{F_{G2}}{F_{G1}} = 8$



We only need to deal with part of the equation, so get rid of G and m_1 since they are constant in both situations. This yields:

$$F_{G1} = \frac{m_2}{r^2}$$

Now plug in the coefficients of the new conditions relative to the initial ones:

$$F_{G2} = \frac{2m_2}{\left(\frac{1}{2}\right)r^2}$$

Now we can compare the gravitational forces of the new conditions to that of the old conditions:

$$\frac{F_{G2}}{F_{G1}} = \frac{2m_2}{\left(\frac{1}{2}r\right)^2}$$

We cancel out m_2 and r and we are left with:

$$\frac{F_{G2}}{F_{G1}} = \frac{2m_2}{\frac{1}{4}r^2}$$

The coefficients that affect F_{G2} when simplified, are: $\frac{F_{G2}}{F_{G1}} = \frac{2}{\frac{1}{4}} = 8$

Thus, $F_{G2} = 8F_{G1}$, and so the correct answer is D.

Tables and Graphs

Tables are a common format of presenting data. When dealing with tables on the SAT, make sure to identify what information is being presented (including units) before you analyze the data. Be prepared to understand general trends in data, identify specific data points, translate data from tables into graphs, and calculate general information such as range, median, mode, and mean.

A student has measured the heights (in inches) and weights (in pounds) of all the individuals at a particular birthday party. His results are shown in the table below.

From the table, we can see a general trend that as the height of the individual being measured increases, so does his/her weight, however, the relationship between height and weight is not strictly linear, rather, it is roughly linear. To depict this study, the graph of the data points shown below.

Height (in in)	44	44	47	47	48	49	50	52	58	60	61	65	65	65	67	70	70	68	68	62	72	75	76	75
Weight (in lbs)	60	55	62	66	60	70	75	81	90	98	111	99	118	109	127	133	159	134	175	146	120	170	190	185



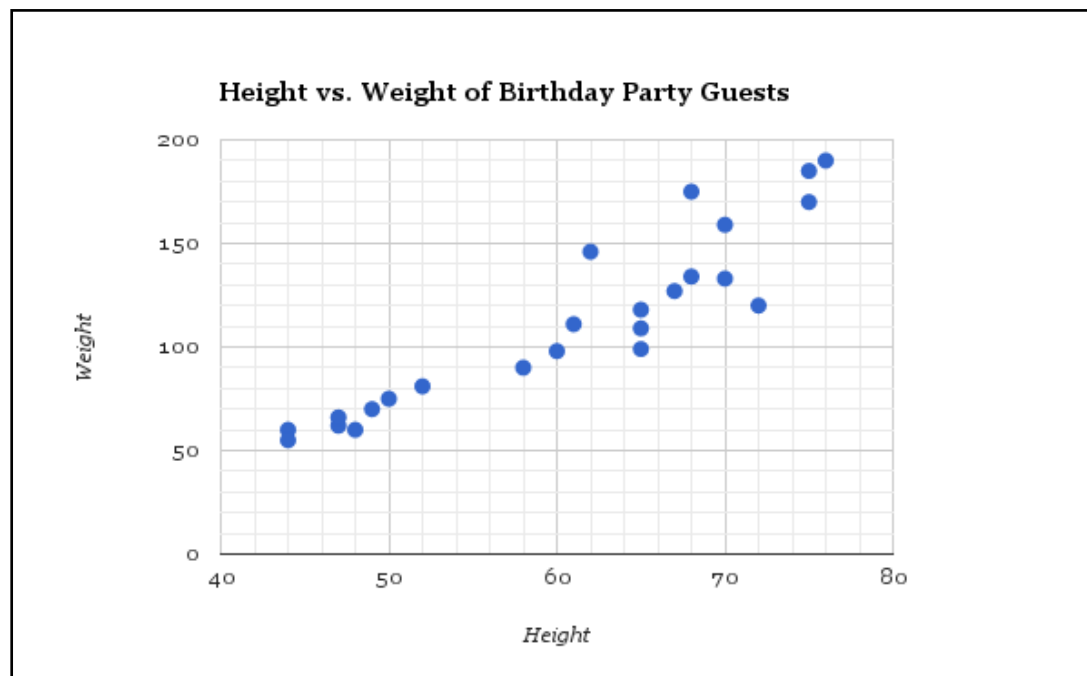

The above graph is called a scatter plot. Scatter plots are best used for illustrating data that is quantitative (can be measured with numbers) as opposed to qualitative (can be grouped into categories), and is especially useful when the data does not follow a strict linear or exponential relationship.

Sample Question

What is the average weight of a 65-inch individual at the party?

- A. 103.50 lb
- B. 104.33 lb
- C. 108.67 lb
- D. 109.25 lb

We can look at either the graph or the table above to recognize there are three individuals who are 65 inches tall. Their weights are: 99lb, 118lb, and 109lb. To get the average, we take the sum of the three weights and divide that by the total number of data entries, which in this case, is three.

$$\frac{99 \text{ lb} + 118 \text{ lb} + 109 \text{ lb}}{3} = 108.67 \text{ lb}$$

C is the correct answer.



Sample Question

How many individuals at the party are between five and six feet tall?

- A. 6
- B. 12
- C. 15
- D. 16

Since we are given the heights of all individuals in inches, we first need to convert the units so they are the same.

$$5 \text{ ft} \times \frac{12 \text{ in}}{1 \text{ ft}} = 60 \text{ in}$$

$$6 \text{ ft} \times \frac{12 \text{ in}}{1 \text{ ft}} = 72 \text{ in}$$

Now, use the table and/or the graph to find how many individuals are between 60 and 72 inches tall, regardless of their height.

We find that there are 12 individuals between 60 and 72 inches tall, so B is the correct answer.



Graphical data is presented throughout the SAT Math test in the form of bar graphs, line graphs, scatter plots, and pie charts. Typically, these graphs will depict data from information given in the question stem. The first thing to do when analyzing graphs is to get oriented by identifying the axes. This will tell us what exactly is being presented. In most cases, the y -axis (vertical) is the dependent variable, and the x -axis (horizontal) is the independent variable. Graphs can be named “ y -axis vs. x -axis” shorthand. Next, find any additional information that may be pertinent to analyzing the graph like figure legends, dual axes labels, equations that are graphed, data tables that contain points plotted on the graph, etc.

The graph below represents the favorite foods of 100 individuals.

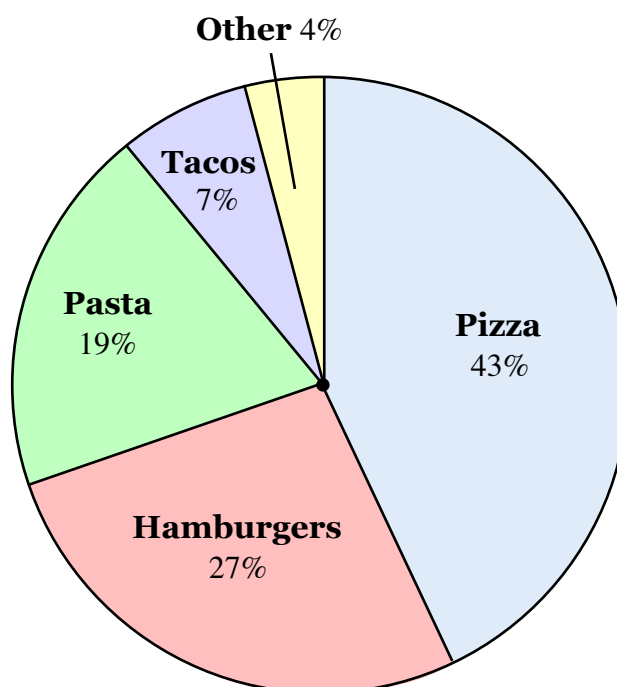

Sample Question

What is the area of the pie chart that is represented by those who chose hamburgers as their favorite food?

- A. 97.2Y
- B. 97.4Y
- C. 98.4Y
- D. 98.8Y

We know that 27% of those in the survey chose hamburgers as their favorite food. This corresponds to 27% of the area of the circle, which means that the central angle of the circle accounts for 27% of the measure of the sum of all central angles in a circle (360Y).



In other words, we are looking for the angle that makes up 0.27 of the entire circle.

$$0.27 \times 360^\circ = 97.2^\circ$$

The correct answer is A.

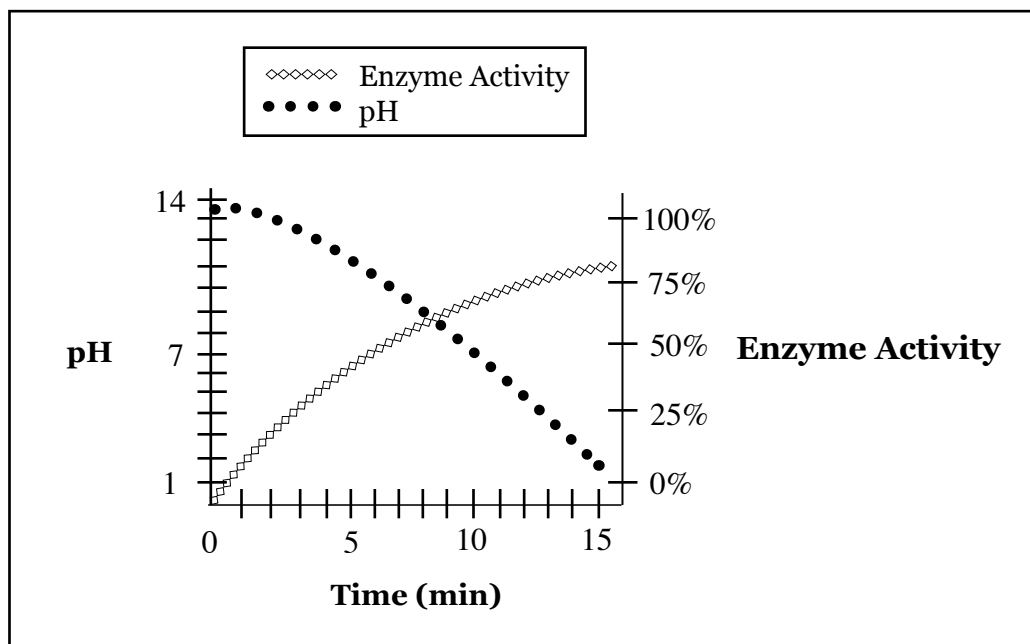

Sample Question

What is the approximate enzyme activity when the pH is 12?

- A. 0%
- B. 35%
- C. 65%
- D. 100%

Find the line that corresponds to pH—it is the line represented by x 's. Its trend is up and to the right, and it approaches a plateau towards the right. Note the axes—the y -axis that corresponds to this line is the left-vertical axis, ranging from pH = 0 to pH = 14. The point at which the pH is at 12 corresponds to about the 8-minute mark on the x -axis. Now we must find what the approximate enzyme activity at the 8-minute mark. To do this we must use the other curve and the other vertical axis. Using the right vertical axis, we see that the line represented by the o 's starts at a high enzyme activity percentage and slowly decreases until about the 5 minute mark, when it begins to rapidly decline. Trace over to the 8-minute mark on the x -axis, and find the point represented by the o , and use the right vertical axis to determine that the enzyme activity when pH = 12 is about 35%.



Sample Question

At what pH is the enzyme activity at its maximum?

- A. 1
- B. 7
- C. 10
- D. 14

Our answer will be a pH, not a percentage; however, it is the pH that corresponds to the maximum enzyme activity, which can be found using the right vertical axis and the curve represented by the circles. Enzyme activity is at its maximum in the earliest stages of the experiment at about time = 0. To find the pH at this time, we use the left vertical axis and the line represented by the x 's to see that the pH at which the enzyme activity is at its maximum is about 1.5.



Conversions: Units, Ratios, Proportions, and Percentage

Units are incredibly important for almost all questions in the SAT Math test. Answer choices may have the same numerical value but different units, (ex: 10km; 10m; 10cm; 10mm) so it is vital to keep them organized throughout calculations. A basic understanding of the relative magnitude of units will be helpful. Also, keep in mind which values can be measured by which units.

Commonly Used Prefixes and Values

$$\text{"milli-"} = 10^{-3} \text{ (e.g. } 1 \text{ mm} = 10^{-3} \text{ m} = \frac{1}{1000} \text{ m)}$$

$$\text{"centi-"} = 10^{-2} \text{ (e.g. } 1 \text{ cm} = 10^{-2} \text{ m} = \frac{1}{100} \text{ m)}$$

$$\text{"deci-"} = 10^{-1} \text{ (e.g. } 1 \text{ dm} = 10^{-1} \text{ m} = \frac{1}{10} \text{ m)}$$

$$\text{"kilo-"} = 10^3 \text{ (e.g. } 1 \text{ km} = 10^3 \text{ m} = 1000 \text{ m)}$$

$$\text{"mega-"} = 10^6 \text{ (e.g. } 1 \text{ Mm} = 10^6 \text{ m} = 1000000 \text{ m)}$$

Length

1 millimeter (1 mm) ⊕ the thickness of a guitar string

1 centimeter (1 cm) ⊕ 0.4 inches (in) ⊕ length of a sugar cube

1 meter (1 m) ⊕ 3.3 feet (ft) ⊕ length of a guitar (think of a yard or meter stick)

1 kilometer (1 km) ⊕ 0.62 miles (mi) ⊕ three laps around an athletic track

Volume

1 milliliter (1 mL) ⊕ 0.2 teaspoon (tsp) ⊕ 20 drops of liquid

1 liter (1L) ⊕ 34 fluid ounces (oz) ⊕ two standard plastic water bottles

Weight

1 gram (1 g) ⊕ 0.033 ounces (oz) ⊕ weight of a medium paper clip

1 kilogram (1 kg) ⊕ 2.2 pounds (lb) ⊕ weight of an average text book



Keep Track of Unit Conversions Using Dimensional Analysis

It's all too easy to get tripped up in the middle of a complex calculation when you have to convert from one unit, to another to another, all while keeping your figures in order. When do you multiply? When do you divide? By using a method called "dimensional analysis," you can keep track of your units and make your work incredibly easy to check at a single glance.

"Dimensional analysis" sounds like an imposing name, but really, all it involves is writing out each unit conversion as a multiplication step in which the units of the denominator of the fraction cancel with those of the number you start with. You can strike out the canceled units to clearly establish the new units of the resulting answer, and you can convert from one unit to another several times without losing track of them and while establishing a single expression that will yield your final answer.

We'll now demonstrate unit conversion with a basic unit conversion problem: how many ounces are in 20g?

For unit conversions, start by writing the given value. Then, construct a fraction to represent the unit conversion. The units of the denominator of the fraction should match with the units of the number you started with. (Remember, that number is essentially a fraction over one). When you multiply across, those units will cancel, leaving you with the units found in the numerator.

$$20 \text{ g} \times \frac{0.033 \text{ oz}}{1 \text{ g}} = 0.66 \text{ oz}$$

Let's next try a more challenging, multi-step unit analysis problem.

Sample Question

How many seconds are there in a year?

- A. 31236000 seconds
- B. 31536000 seconds
- C. 31625000 seconds
- D. 31825000 seconds

Take the same approach, starting with the given value and multiply it by the appropriate conversion factor such that we cancel each unit, until we reach seconds.

$$1 \text{ year} \times \frac{365 \text{ days}}{1 \text{ year}} \times \frac{24 \text{ hours}}{1 \text{ day}} \times \frac{60 \text{ minutes}}{1 \text{ hour}} \times \frac{60 \text{ seconds}}{1 \text{ minute}} = 31536000 \text{ seconds}$$

Certain problems might ask you to work with variables standing for units without the inclusion of any discrete numbers. These may seem challenging due to how abstract they are, but approaching them with the same skills you've practiced on problems that involve both variables and numbers can help you to solve them without much difficulty.



Sample Question

Newton's second law states that the net force, F , given in Newtons, is the product of the mass, m and acceleration, a . The standard unit for mass is kilograms, and the standard unit for acceleration is meters per second squared. Which of the following is equivalent to the unit Newtons?

A. $\frac{kg \cdot m}{s}$

B. $\frac{kg}{m \cdot s}$

C. $\frac{kg}{m \cdot s^2}$

D. $\frac{kg \cdot m}{s^2}$

To find out what units make up a Newton, use the given equation and standard values.

$$F = ma$$

Substitute the units for each variable assume all values are 1 since we are not concerned with numerical quantities.

$$N = kg \cdot \frac{m}{s^2}$$

We see that choice D corresponds to this, and indeed, the standard unit of force, a Newton is equal to a kilogram meter per second squared.



Ratios

Ratios are mathematical relationships between two (or more) numbers that indicate how many times the first number is contained in the second (or third, fourth, etc.) number(s). Ratios may be represented using colons and/or fractions. Ratios do not say anything about the quantities other than their relative abundances.

Sample Question

There are 24 people at a party, and 20 slices of cake. What is the ratio of people to cake?

- A. $\frac{4}{5}$
- B. $\frac{6}{5}$
- C. $\frac{8}{5}$
- D. $\frac{9}{5}$

It may be helpful to use the word “to” in ratios as a place marker for where to put the colon, or where to draw the line between the numerator and denominator. We are looking for the ratio of people to cake, so our answer will be in the form “people : cake” or

“ $\frac{\text{people}}{\text{cake}}$ ”. We have 24 units of people and 20 units of cake, therefore, our ratio of people to cake is 24:20, or $\frac{24}{20}$. Note that this reduces to 6:5 or $\frac{6}{5}$, which is our final ratio.

Since ratios can be written as fractions and as numbers separated by colons, they are usually written in whole numbers.

Sample Question

A parking lot has 500 cars parked in it. 300 of the cars are black, 150 are white, 25 are silver, and 25 are red. What is the ratio of red cars to black cars to white cars to silver cars?

- A. 1:12:6:1
- B. 1:6:12:1
- C. 1:5:9:1
- D. 1:9:5:1



Especially when dealing with multiple values, it is often easiest to write out the verbal ratios before plugging in numbers. We are looking for the following ratio:

red cars : black cars : white cars : silver cars

Now go back to the question and insert the appropriate numbers of each color car.

25:300:150:25

This answer can be reduced by dividing its numbers by 25. Our new, simplified ratio is:

1:12:6:1

Proportions

Proportions are similar to ratios in that they compare two values. For example, what proportion of a 10 inch sandwich have you eaten if you eat 5 inches of it? $\frac{1}{2}$. This can also be expressed as a ratio of eaten sandwich to total sandwich, 5in:10in. Both proportions and ratios do not necessarily need to be different, for example, if there are 3 people in a room, all wearing baseball caps, the proportion of people wearing caps is 1. This comes from reducing the raw number ratio of 3:3.

Sample Question

If Quinn is working on an 11-page essay and has written four pages of it, what proportion of her essay does she still need to write?

- A. $\frac{4}{7}$
- B. $\frac{4}{11}$
- C. $\frac{7}{11}$
- D. $\frac{7}{4}$

Quinn has 7 pages left to write, but this is not a proportion. Of the 11 pages total, she has 7 pages left to write, thus the proportion of unfinished pages is $\frac{7}{11}$.

Although it is not explicitly stated, proportions are most commonly used in situations in which the denominator of a fraction is the whole or total of the value of interest.



Sample Question

In a room of 66 people, 22 of them currently play sports, 33 of them watch sports, and 11 of them have never played sports. What is the proportion of people in the room that currently play sports?

- A. $\frac{1}{6}$
- B. $\frac{1}{3}$
- C. $\frac{1}{2}$
- D. $\frac{2}{3}$

Recognize that the number of people who watch sports, and whom have never played sports is extraneous information. The proportion of people in the room who currently play sports is $\frac{22 \text{ current athletes}}{66 \text{ total people in the room}}$. This reduces to $\frac{1}{3}$. Also note that proportions are usually not written with units.

Percentage

The definition of the word percent comes from the Latin word “cent,” which means 100. Thus a per-cent is a special ratio for a number to 100, since per indicates division/proportionality. Since percents are special proportions, we can readily interchange between them.

Sample Question

A pair of shoes costs \$60. The store is having a sale in which there is 15% off on shoes. What is the sale price of the shoes? (Assume no sales tax).

- A. \$9.00
- B. \$16.00
- C. \$44.00
- D. \$51.00

First, find out how much money the sale is saving the shoe purchaser, that is, what is 15 percent of \$60? To do this we set up a proportion:



$$\frac{15}{100} = \frac{x}{\$60.00}$$

Now, we must cross-multiply to solve for x .

$$100x = \$900.00$$

$$x = \$9.00$$

This is not our final answer, rather, this is the amount of money that is saved due to the sale. To find the final cost of the shoes we subtract the saved amount from the original amount.

$$\$60.00 - \$9.00 = \$51.00$$

Sample Question

26 is what percent of 84?

- A. 27.75%
- B. 28.50%
- C. 30.95%
- D. 31.25%

Since we are looking for the percent, we know that unknown value in our proportion will be in the numerator of our set of proportions.

$$\frac{26}{84} = \frac{x}{100}$$

Cross-multiply and solve for x .

$$84x = 2600$$

$$x = 30.95\%$$

For this problem, you can also change out the mathematical language with the symbols they “translate” to. The phrase “is” can be replaced by an equals sign, “what percent” by x , and “of” by a multiplication symbol.

$$26 = x \times 84$$

You just need to remember to convert your answer into a percent by converting it into a decimal and then multiplying that decimal by 100.

$$x = \frac{26}{84} = 0.3095 \times 100 = 30.95\%$$



As stated above, percentages are all proportions of a total: 100; therefore, we can use a shortcut when converting percentages into proportions by moving the decimal point two places to the left. 26 is 39.95% of 84. Similarly, 26 is 0.3995 of 84. If we multiply 84 by 0.3995, we get 26.

Sample Question

A brand new car is \$33504. Sales tax is 8.275%. What proportion of the total price of the car after tax is the untaxed price of the car?

- A. 0.8744
- B. 0.8921
- C. 0.9184
- D. 0.9236

This is a two-part question. First, we need to calculate the final price of the car after taxes. To do this, we multiply the original price by the tax proportion then add that number to the original price of the car.

$$\$33504 \times 0.08275 = \$2772.46$$

$$\$2772.46 + \$33504 = \$36276.46$$

Alternatively, we could have multiplied the original price of the car by the proportion of the sales tax percentage plus one: 1.08275

$$\$33504 \times 1.08275 = \$36276.46$$

Now we need to find the proportion of the total after-tax price that was due to the price of the care alone (excluding tax). We set up a simple proportion/fraction:

$$\frac{\$33504}{\$36276.46} = 0.9236$$

Notice that our proportion does not have any units associated with it because it is a comparison between two relationships that are in the same units (dollars), so they cancel.



Probability

Probability of Single Events

You can mathematically model the chances of a specified event happening using fractions or decimals with values between 0 and 1. 0 and 1 form the boundaries of the probability system: a probability of 1 means that the event is certain to happen, while a probability of 0 means that the event is certain not to happen.

Consider a fair coin. There are two possible outcomes: heads or tails. If we want to model the probability (the “chances”) of a fair coin landing on heads, we could do so by placing the number of outcomes we want to occur over the number of total outcomes. In this case, there are two total outcomes possible (heads or tails) and we want to calculate the odds of one of them occurring (heads), so we could model the situation using either the fraction $\frac{1}{2}$ or the decimal 0.5.

Let’s try a slightly more complex example:

Sample Question

You are eating lunch at a restaurant and want to order a sandwich. There are twenty-five sandwiches on the menu, and six of them are toasted. If you order a sandwich at random, what is the probability of you ordering a sandwich that is *not* toasted?

- A. $\frac{6}{25}$
- B. $\frac{9}{25}$
- C. $\frac{16}{25}$
- D. $\frac{19}{25}$

Let’s take stock of the situation described. To calculate probability, we need to know the total number of possible outcomes. In this case, that’s the total number of sandwiches the restaurant serves: 25. This will form the denominator of our fraction. But what do we put in the numerator? The only other number mentioned in the question is six, but before jumping to conclusions, be careful to look at the designation. The menu lists six sandwiches that *are* toasted; we want to calculate the probability of a sandwich that is *not* toasted. We can do this in one of two ways:

1. Take the total number of sandwiches (25) and subtract the options that are toasted. Then, make the resulting number the numerator in a fraction with 25 in the denominator.



$$25 - 6 = 19$$

$$\frac{19}{25}$$

2. Since we only have two options (toasted or not), we can subtract the probability of ordering a toasted sandwich from 1 to find the probability of ordering a sandwich that is not served toasted. Six out of the twenty-five possible sandwiches are served toasted, so the probability of ordering one of these is $\frac{6}{25}$.

$$1 - \frac{6}{25} = \frac{19}{25}$$

No matter which method you use, you get the same answer: if you order a sandwich at random, you have a $\frac{19}{25}$ chance of ordering a sandwich that is not served toasted.

If you need to apply a probability statistic to a larger group, you can do so using multiplication, as in the next example.

Sample Question

You are told that two-thirds of the incoming freshmen at your school are interested in helping out with the school play. There are one hundred and twenty-five freshmen in the incoming class. How many freshmen are interested in helping out with the school play?

- A. 82
- B. 83
- C. 84
- D. 85

We need to find out what $\frac{2}{3}$ of 125 is, and we can do so using multiplication:

$$\frac{2}{3} \cdot 125 = 83.\bar{3}$$

In this case, our calculation resulted in a repeating decimal. Since we are talking about people, we need to round to the nearest whole number: 83. 83 of the 125 incoming freshmen are interested in helping out with the school play.

Let's try some sample problems.



Sample Question

If you pick a card from a standard deck of playing cards (without jokers) at random, what is the probability of drawing a queen?

- A. $\frac{3}{52}$
- B. $\frac{1}{13}$
- C. $\frac{5}{52}$
- D. $\frac{7}{52}$

How many queens are in a standard deck of cards without jokers? Well, there are four suits, and each suit has one queen, so there are four queens. 52 will be the denominator of our probability fraction since there are 52 possible cards you could draw. We're looking for the probability of drawing a queen, so 4 becomes the numerator, and the answer is $\frac{4}{52}$, which can be reduced to $\frac{1}{13}$. This means that the correct answer is B.

Sample Question

If you pick a card from a standard deck of playing cards (without jokers) at random, what is the probability of drawing a red face card?

- A. $\frac{1}{26}$
- B. $\frac{1}{13}$
- C. $\frac{3}{26}$
- D. $\frac{2}{13}$

How many red face cards are in a deck of cards? Be careful, this question is a little tricky. A "face card" refers to a jack, a queen, or a king. There are four suits, each with a jack, queen, and king, but only two of them are red (hearts and diamonds); the other two are black (spades and clubs). This means that there are six red face cards in the deck. 52 becomes the denominator of our probability fraction since there are 52 total cards from which to pick, and 6 becomes the numerator, making the probability $\frac{6}{52}$, which reduces to $\frac{3}{26}$, making C the correct answer.



Probability of Multiple Events: “And” and “Or”

When considering multiple events, you have two things to keep track of:

1. Whether the problem is asking about one event “and” another or one event “or” another
2. Whether the events are independent or dependent

If a problem asks about the probability of one event happening OR the other event happening, calculate the probability of each event happening and then add them together. The two specified results are both valid, so you need to find one, more likely probability to represent either of them being the result.

If a problem asks about the probability of one event happening AND another event happening, calculate the probability of each event happening and then multiply them together. Multiplying a number by a fraction or decimal between 0 and 1 makes that number smaller. A smaller probability indicates a less likely result. If you want to calculate the probability of two events happening together, that is going to be less likely than either of them happening alone.

Dependent vs. Independent Events

Calculating probability requires you to determine whether the events that you are modeling are “dependent” on one another or “independent” of one another. Dependent events are events in which one event is necessary for the other event to happen, or in which you are considering the probability of both events as a pair. Independent events happen independently; the probability of one happening has no effect on the probability of another happening.

Let’s look at an independent event problem now.

Sample Question

You have a fair coin and a fair six-sided die. What is the probability of both getting tails on a coin flip and rolling a 4 on the die?

- A. $\frac{1}{20}$
- B. $\frac{1}{12}$
- C. $\frac{1}{10}$
- D. $\frac{1}{6}$



Whether you get heads or tails on the coin flip has nothing to do with which number you roll on the die: these events are independent. This means that we're going to multiply their discrete probabilities together to figure out the probability of them both happening.

$$P_{\text{Tails}} = \frac{1}{2}$$

$$P_{\text{Rolling a 4}} = \frac{1}{6}$$

$$P_{\text{Both}} = \frac{1}{2} \cdot \frac{1}{6} = \frac{1}{12}$$

The probability of both getting tails on a coin flip and rolling a 4 on the die is $\frac{1}{12}$.

In contrast to independent events, dependent events affect one another, often making the order of actions significant. A good example of dependent events would be drawing cards out of a standard deck and not replacing them. Order becomes important, because if you draw a card out first and then ask about the probability of drawing out another card, the deck has one less card in it.

Watch out for questions about drawing multiple cards! Unlike questions about flipping multiple coins or rolling multiple dice (independent events), cards that are not replaced affect how large the deck is from which you're drawing the next card. Similar problems might also involve drawing items out of a bag and not replacing them. If you replace them, the denominator in your fraction will stay the same, and you won't have to adjust the starting ratio of items. But, if you pull cards out of a deck or items from a bag and don't put them back, you have to reconsider the probability of drawing the next item, and the denominator of your fraction will change. For instance, if you draw a card from a standard deck of cards without jokers, the probability of drawing that particular card is $\frac{1}{52}$. But if you don't put it back, you only have 51 cards in the deck for the next time you draw a card!

Some questions may specify a specific order of events, while others do not. Let's consider a two-part sample question that demonstrates the importance of realizing whether order is specified or not.

1. What is the probability of drawing one face card and one four from a standard deck of cards (without jokers)?
2. What is the probability of drawing one four and then one face card from a standard deck of cards (without jokers)?

Question 1 does not imply a specific order: you could either draw a face card and then a four, or a four and then a face card. Question 2 specifies a specific order: first you draw a four, and then you draw a face card.

Question 1 gets a bit complex; since either order would fulfill the criteria, we have to calculate the probability of each order and then add together the results.



$$P_{\text{Face card and then four}} = \frac{12}{52} \cdot \frac{4}{51} = \frac{48}{2652} = \frac{24}{1326} = \frac{12}{663} = \frac{4}{221}$$

$$P_{\text{Four and then face card}} = \frac{4}{52} \cdot \frac{12}{51} = \frac{48}{2652} = \frac{24}{1326} = \frac{12}{663} = \frac{4}{221}$$

$$P_{\text{Drawing one face card and one four in either order}} = \frac{4}{221} + \frac{4}{221} = \frac{8}{221}$$

The second question is a lot more straightforward to solve because it provides a more specific set of circumstances:

$$P_{\text{Four and then face card}} = \frac{4}{52} \cdot \frac{12}{51} = \frac{48}{2652} = \frac{24}{1326} = \frac{12}{663} = \frac{4}{221}$$

Let's try out some sample problems involving multiple events.

Sample Question

A hotel offers complementary breakfast that includes a guest's choice of one of five types of breakfast cereal, eggs, either bacon, ham, or sausage, and either orange juice or milk. If you order a breakfast combination at random, what are the odds that you will receive a breakfast that includes ham or orange juice?

- A. $\frac{1}{6}$
- B. $\frac{1}{4}$
- C. $\frac{1}{3}$
- D. $\frac{5}{6}$

This question isn't as tough as it looks! You don't have to take into account anything other than the breakfast meat selections in order to calculate the probability in this case. While the breakfast choices will differ in the types of cereal they include, we are only interested in picking out how many will include ham and orange juice, so we can simply ignore the information presented about cereal. Of the three choices (bacon, ham, and sausage), we are only interested in one (ham), so that means that $\frac{1}{3}$ of the breakfast options will include ham. Similarly, we're interested in the half of the choices that include orange juice. We want to find the probability of picking out a breakfast that includes ham OR orange juice, so we add the fractions together:



$$\left(\frac{1}{3} \cdot \frac{2}{2}\right) + \left(\frac{1}{2} \cdot \frac{3}{3}\right)$$
$$\frac{2}{6} + \frac{3}{6}$$
$$\frac{5}{6}$$

$\frac{5}{6}$ of the breakfast choices include both ham and orange juice. We can check our answer by considering that these choices will differ in only one aspect: the type of cereal included with each. Since there are five types of cereal offered, it stands to reason that there should be five options that include both ham and orange juice. This is true, as $\frac{1}{6} \cdot 30 = 5$.

Sample Question

At your local no-kill animal shelter, $\frac{1}{3}$ of the pets available for adoption are cats, and of those cats, $\frac{2}{5}$ are kittens; the rest are adult cats. Half of the cats at the shelter have green eyes, and a third of them are declawed. If someone adopts a pet at random from this shelter, what are the odds that they will adopt an adult cat with green eyes that has not been declawed?

- A. $\frac{1}{45}$
- B. $\frac{1}{30}$
- C. $\frac{1}{25}$
- D. $\frac{1}{20}$

Let's write out all of the information we've been given:



$$P_{cat} = \frac{1}{3}$$

$$P_{kitten} = \frac{2}{5}$$

$$P_{cat \text{ with green eyes}} = P_{cat} \cdot \frac{1}{2}$$

$$P_{declawed \text{ cat}} = P_{cat} \cdot \frac{1}{3}$$

That's a lot of information! Next, let's construct an expression of the probability we need to calculate: we're looking for the odds of someone adopting at random an adult declawed cat with green eyes.

$$P_{declawed \text{ adult cat with green eyes}} = P_{cat} \cdot (1 - P_{kitten}) \cdot \frac{1}{3} \cdot \frac{1}{2}$$

Since declawed cats and cats with green eyes are drawn from the group of cats, and we started the equation with P_{cat} , we don't need to put P_{cat} in the equation multiple times. This is because we want to multiply the fractions representing green-eyed cats and declawed cats with the initial fraction of cats, since we're narrowing in our focus on that one particular group of animals.

At this point, we can substitute in the data presented in the problem and solve by multiplying:

$$P_{declawed \text{ adult cat with green eyes}} = \frac{1}{3} \cdot \left(1 - \frac{3}{5}\right) \cdot \frac{1}{3} \cdot \frac{1}{2} = \frac{1}{3} \cdot \frac{2}{5} \cdot \frac{1}{3} \cdot \frac{1}{2} = \frac{2}{60} = \frac{1}{30}$$

Sample Question

Your friend has a bag containing twelve marbles. Four are red, four are blue, and four are yellow. What is the probability of your drawing a blue marble first, and then a yellow marble, if you don't replace the first marble you draw?

A. $\frac{71}{144}$

B. $\frac{1}{9}$

C. $\frac{4}{33}$

D. $\frac{7}{20}$



This is an “and” problem in disguise—we could rephrase it as “first a blue marble and then a yellow marble.” So, we’ll be multiplying. The odds of drawing a blue marble

from the bag first are $\frac{4}{12}$, but you don’t replace it, so this affects the odds of drawing

a yellow marble. There are as many yellow marbles in the bag as before you drew the blue marble, so the numerator will be 4, but there is one fewer marble in the bag, so

the total marbles (the denominator) will be reduced by 1, resulting in odds of $\frac{4}{11}$.
Multiplying these fractions together results in the answer:

$$\frac{4}{12} \cdot \frac{4}{11} = \frac{16}{132} = \frac{4}{33}$$



Additional Topics and Geometry

The questions on the SAT Math test that do not fall into one of the primary subscores (Heart of Algebra, Passport to Advanced Math, and Problem Solving and Data Interpretation) are designated as “Additional Topics.” While this title may not seem intimidating, the number of topics that fall into this classification is rather daunting. Only 6 of the 58 questions on the SAT Math test address Additional Topics, yet the breadth of material available for those questions makes them some of the most difficult on the test.

The most prevalent content tested by these questions is derived from classical geometry and geometric principles. The interplay between parallel and perpendicular lines, complementary and supplementary angles, basic polygons, right triangles, and fundamental trigonometry make up the bulk of the Additional Topics questions. Considering that entire courses could be taught on each of these individual principles, the reduction of their collective material to such a small testing sample means that you must be over-prepared in order to perform well on these questions. The following lessons will outline the most popular topics covered by the Additional Topics questions in SAT Math, with the intent of presenting this collection of material in a condensed and accessible manner.

Section Outline

Geometry

- Reviewing standard geometric properties and constructs

Trigonometry and Radians

- Evaluating trigonometric relationships and applying trigonometric identities

Other Concepts

- Reviewing non-standard concepts in math



Geometry

Despite the tremendous volume of content that falls under the umbrella of high school geometry, the SAT Math test dedicates only a few questions to this subject matter. Preparing for these questions requires a substantial time investment, but can pay off by gaining points on some of the hardest questions on the exam.

Geometry questions on the SAT address topics related to lines, angles, triangles, polygons, and solids. For the most part, these questions will focus on critical thinking in relations to applying simple principles to given scenarios. Geometry word problems and diagrams are common, and often integral to the questions at hand. Learning to identify the most relevant parts of these set-ups can help you solve these problems quickly and correctly. The lessons that follow will detail the skills necessary to address these questions, both in terms of focal elements in the set-ups and in terms of the fundamental mathematical skills most relevant to these questions.

Section Outline

Lines and Angles

- Analyzing relationships between lines and angles

Triangles, Circles, and Polygons

- Defining and recognizing the properties of standard shapes and figures



Lines and Angles

The most fundamental geometric constructs involve simple lines and angles. In order to understand the more complex elements of geometry, it is first necessary to recognize the rules and principles that govern the interaction of these fundamentals.

The interactions of parallel and perpendicular lines in relation to one another, as well as in relation to other lines, build very specific constructs. In particular, they create the dimensions by which we define complementary and supplementary angles. Concepts like interior and exterior angles or the midpoint formula may seem relatively arbitrary when taken out of context, but when evaluated in coordination with larger geometric constructs, such as triangles and other polygons, they can become much more significant. The lessons of this section will lay the foundation for your ability to break down high-level geometric constructions into their component parts, ultimately paving the way for success on the geometry questions on the SAT Math test.

Section Outline

Length and Midpoint

- Applying the distance formula and midpoint formula to lines and segments

Angles, Parallel Lines, and Perpendicular Lines

- Evaluating relationships between complementary and supplementary angles and parallel and perpendicular lines



Length and Midpoint

SAT Math questions that concern lines and line segments may ask you to calculate their lengths and midpoints. Even if such lines are graphed on a Cartesian plane, finding their length isn't as simple as counting the number of spaces between the endpoints. The lines that appear in these questions will most likely be diagonal lines that are impossible to accurately measure by eye. Diagonal lines present similar problems for identifying the midpoint of a line, which may not fall on a point in which the coordinates are whole numbers. Luckily, there are two formulae that you can use just in these instances. They're not provided in the Given Equations section, so you'll need to memorize them. Let's review them now.

Distance Formula

Consider a line with endpoints A and B. $A = (x_1, y_1)$ and $B = (x_2, y_2)$. The following formula yields the distance between the two points.

$$D = \sqrt{(x_2 - x_1)^2 + (y_2 - y_1)^2}$$

Basically, what this formula is doing is treating the distance between the two points as the hypotenuse of a triangle formed by the rise (Δy) and run (Δx) between them.

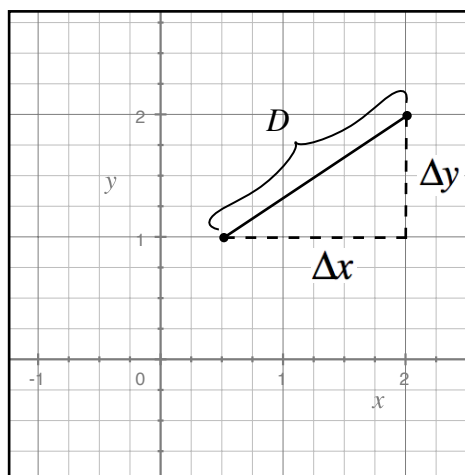

To demonstrate this, we can derive the distance formula from the Pythagorean theorem.

$$a^2 + b^2 = c^2$$

Let's rename our variables to keep things consistent.

$$(\Delta x)^2 + (\Delta y)^2 = D^2$$

Let's define Δx and Δy with variables related to our two points.

$$(x_2 - x_1)^2 + (y_2 - y_1)^2 = D^2$$



Starting to look familiar? All we have to do now is take the square root of each side to solve for D:

$$D = \sqrt{(x_2 - x_1)^2 + (y_2 - y_1)^2}$$

Voila! There's our formula. If you forget it on test day, just remember, it's just the Pythagorean theorem written a little differently so as to be easy to apply to points in the coordinate plane. Let's next try out a sample problem making use of this formula. Practicing actually using formulae to solve problems is a great way to help you remember them!

Sample Question

How far is the point $(-3, 3)$ from the point $(4, 4)$ on a standard coordinate plane?

- A. $3\sqrt{5}$
- B. $4\sqrt{3}$
- C. $7\sqrt{3}$
- D. $5\sqrt{2}$

First, we need to assign the values in our points to the correct variables in the distance formula. It can be very helpful to write out which value is which in order to prevent confusion, especially in a test situation. It also makes checking your work much easier, and therefore faster, should you want to glance over how you arrived at your answer. For this problem, let's call $(-3, 3)$ point 1 and $(4, 4)$ point 2. That means that $x_1 = -3$, $y_1 = 3$, $x_2 = 4$, and $y_2 = 4$. Now we can plug our data into the distance formula and solve.

$$D = \sqrt{(x_2 - x_1)^2 + (y_2 - y_1)^2}$$

$$D = \sqrt{(4 - (-3))^2 + (4 - 3)^2}$$

$$D = \sqrt{7^2 + 1^2}$$

$$D = \sqrt{49 + 1}$$

$$D = \sqrt{50}$$

At this point, we can simplify the square root to come up with our final answer.

$$D = \sqrt{50} = \sqrt{25 \times 2} = \sqrt{25} \times \sqrt{2} = 5\sqrt{2}$$

It is $5\sqrt{2}$ units from $(-3, 3)$ to $(4, 4)$, so D is the correct answer!

Let's now try a more complex sample question.



Sample Question

A scientist is taking ice core samples in Antarctica near her base camp. The first site at which she plans to drill for ice cores, Site A, next is located three miles north of the base camp, and the second site at which she plans to collect samples, Site B, is located four miles east of her base camp.

The scientist plans to use a 15 mpg snowmobile to travel to Site A, then to Site B, and return back to base camp. How many gallons of fuel will she use in traveling from Site A to Site B?

- A. $\frac{1}{4}$ gallon
- B. $\frac{1}{3}$ gallon
- C. $\frac{1}{2}$ gallon
- D. $\frac{2}{5}$ gallon

Don't let the context of this problem fool you—it looks complex, but really, it's just a distance problem combined with a rate of fuel use. So, to solve it, we need to first calculate how far it is from Site A to Site B. Then, we need to take that distance and multiply it by the snowmobile's fuel consumption rate, 15 miles per gallon.

Even though this problem isn't presented as being on a coordinate plane, we can imagine it on a plane in which the units are miles and the base camp is the origin point (0,0). Site A is located at the point (0,3) and Site B at the point (4,0).

Now that we've identified our points, we can substitute them into the distance formula and solve. Let's call Site A point 1 and Site B point 2. That means that $x_1 = 0$, $y_1 = 3$, $x_2 = 4$, and $y_2 = 0$.

$$D = \sqrt{(x_2 - x_1)^2 + (y_2 - y_1)^2}$$

$$D = \sqrt{(4 - 0)^2 + (0 - 3)^2}$$

$$D = \sqrt{(4)^2 + (-3)^2}$$

$$D = \sqrt{16 + 9}$$

$$D = \sqrt{25}$$

$$D = 5$$

It is exactly five miles from Site A to Site B. We can now use this information to calculate how much gas the scientist's snowmobile will use when making this trip. Using dimensional analysis can help keep units in an easy-to-view order. You can see that the miles cancel and leave us with gallons as our unit.

$$5 \text{ miles} \times \frac{1 \text{ gallon}}{15 \text{ miles}} = \frac{5}{15} \text{ gallon} = \frac{1}{3} \text{ gallon}$$

The scientist's snowmobile will use $\frac{1}{3}$ gallon of gas when traveling between Site A and Site B, so B is the correct answer.



Midpoint Formula

If you know the endpoints of a line segment and need to figure out its midpoint, the following formula can help you find it. Consider a line with endpoints A and B. $A = (x_1, y_1)$ and $B = (x_2, y_2)$.

$$(x_n, y_n) = \left(\frac{x_1 + x_2}{2}, \frac{y_1 + y_2}{2} \right)$$

This formula is not using the Pythagorean theorem like the distance formula is. Instead, it is simply taking the average of the x -coordinates and the y -coordinates, which yields the “average” of the two points—the midpoint. We don’t have to worry about using the Pythagorean theorem in this scenario because we can treat the x - and y -variables independently instead of having to find the length of a diagonal, which requires consideration of both.

Let’s try out some practice problems to cement your knowledge of this formula!

Sample Question

Point A is located at (2,2) and Point B is located at (0,3). Find the midpoint of \overline{AB} .

- A. (1, 2.5)
- B. (1, 1.5)
- C. (1,1)
- D. (1,2)

First, we need to assign our data to the correct variables. Let’s call Point A point 1 and Point B point 2. That means that $x_1 = 2$, $y_1 = 2$, $x_2 = 0$, and $y_2 = 3$. Substitute these values into the midpoint equation, and you’ll then be able to solve for the correct answer.

$$(x_n, y_n) = \frac{x_1 + x_2}{2}, \frac{y_1 + y_2}{2}$$

$$(x_n, y_n) = \frac{2 + 0}{2}, \frac{2 + 3}{2}$$

$$(x_n, y_n) = \frac{2}{2}, \frac{5}{2}$$

$$(x_n, y_n) = (1, 2.5)$$

The midpoint of \overline{AB} is the point (1, 2.5), so A is the correct answer.

Midpoint questions can also be presented in a slightly different manner. Certain problems might give you the midpoint of a line segment and one of the endpoints and ask you to calculate the other endpoint. Let’s practice this type of problem next.



Sample Question

Point A is located at $(4,5)$. The midpoint of \overline{AB} is $(1,2)$. What are the coordinates of Point B?

- A. $(-3, -1)$
- B. $(-2, -1)$
- C. $(2, -1)$
- D. $(-2, 0)$

To solve this problem, create two separate equations to figure out where B is located: one that relates to the x -values of A, B, and the midpoint, and another that relates to their y -values.

We know that $x_1 = 4$ and $y_1 = 5$. We also know that the x -value of the midpoint is 1. Knowing that that midpoint's x -value must be the average of the x -values of points A and B, we can write the following equation:

$$\frac{4 + x_2}{2} = 1$$

Solving for x_2 , we get:

$$\begin{aligned} 4 + x_2 &= 2 \\ x_2 &= -2 \end{aligned}$$

The x -coordinate of B is -2 . Now for the y -coordinate! We can set up the same equation using information that relates to the y -coordinates of the relevant points. $y_1 = 5$, and the y -coordinate of the midpoint is 2.

$$\frac{5 + y_2}{2} = 2$$

Solving for y_2 , we get:

$$\begin{aligned} 5 + y_2 &= 4 \\ y_2 &= -1 \end{aligned}$$

The y -coordinate of point B is -1 . Putting our results together, we find that the coordinates of point B are $(-2, -1)$. That means that B is the correct answer!

Let's tackle one more midpoint problem, this time one presented as a word problem.



Sample Question

Emily is setting up flags for a relay race. The race's starting line is one hundred meters north and one hundred meters east from the concession stand, and it will be run in a straight line to the finish line, located five hundred meters north of the concession stand and three hundred meters east of it. Emily has been instructed to set up flags halfway to the finish line. Where should she set up the flags relative to the concession stand?

- A. 200 m north and 300 m east
- B. 250 m north and 250 m east
- C. 300 m north and 200 m east
- D. 350 m north and 200 m east

This problem might look overwhelming at first. There's a lot of data being thrown around, but once you take a moment to process it, you'll realize that you're being asked to find the midpoint of a line. This line isn't presented on a traditional coordinate plane, though, which may have you wondering how to approach it. How is the line defined? The points are presented as distances north and east from the concession stand. Aha! If we label the location of the concession stand the origin, increasing x -values "north," and increasing y -values "east," and we can translate the distances from it into coordinates. Dividing each of the distances by 100 makes them much more manageable:

Starting point: 100 meters north, 100 meters east $\rightarrow (1,1)$

Finish line: 500 meters north, 300 meters east $\rightarrow (5,3)$

We have our points; the next step is to assign the values to the variables in the midpoint formula. Calling the starting point point 1 and the finish line point 2, $x_1 = 1$, $y_1 = 1$, $x_2 = 5$, and $y_2 = 3$. We can substitute these values into the equation and find our answer in coordinates.

$$(x_n, y_n) = \left(\frac{x_1 + x_2}{2}, \frac{y_1 + y_2}{2} \right)$$

$$(x_n, y_n) = \left(\frac{1 + 5}{2}, \frac{1 + 3}{2} \right)$$

$$(x_n, y_n) = \left(\frac{6}{2}, \frac{4}{2} \right)$$

$$(x_n, y_n) = (3, 2)$$

The midpoint of the race route is found at $(3, 2)$. But wait, we need to identify that midpoint in terms of meters from the concession stand! All we need to do is multiply each of the terms by 100 m. Remember, x -values relate to distance north from the concession stand, and y -values relate to distance east from it.

$(3, 2) \rightarrow$ 300 m north, 200 m east

Emily needs to set up the flags 300 m north from the concession stand and 200 m east of it. C is the correct answer.



Angles, Parallel Lines, and Perpendicular Lines

Part of succeeding on the SAT Math test involves knowing your way around line diagrams and being able to calculate the measures of angles indicated on them. While they may appear similar to graphed linear equations, these lines are distinguished by one important feature: they're not placed in the context of a coordinate plane. Instead, they convey information about the relationships between different lines and the angles formed by their intersections. In this lesson, we'll go over how to read a line diagram, relationships between collinear angles, and various crucial types of relationships between lines that you need to know to solve certain angle problems. Having mastered these elementary but important points, you'll have the groundwork knowledge required to handle any line diagram that the SAT Math test can throw at you. Let's get started!

Reading Line Diagrams: The Basics

Line diagrams can seem intimidating at first glance due to the numerous specific symbols that can appear in them. Let's review them and make sure that you have the basic knowledge needed to understand what's being asked of you in a line diagram problem.

Points, whether they are on lines or not, are given single-letter names and indicated with dots. Points A, B, and C are shown below. Points that are said to be "collinear" are located on the same line. In the diagram below, points B and C are collinear, but points A and B are not.

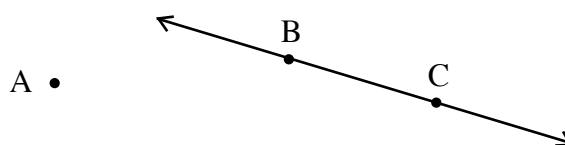

A line is named after points that are on it. Points B and C are on a line. This line is indicated with the following notation: BC . A line segment refers to only the part of the line that falls between the two indicated points. Line segments are indicated with the following notation: \overline{BC} .

Note that lines can have multiple names. If there were a point D between points B and C on the same line, we could refer to the line as BD , DC , or BC and be talking about the same line. Note, also, that the order in which we refer to the points does not matter; BC and CB refer to the same line.

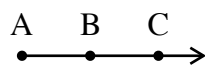

A ray is a line that begins at a specified point. The first point in the name of a ray is its starting point, and the second point is a point through which it passes. We could refer to the following ray as either AB or AC , but calling it BC would be incorrect.

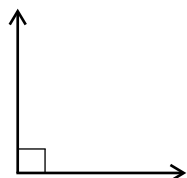

A symbol that looks like two sides forming a square in the corner of two intersecting lines indicates that the two lines form a 90° angle. This means that the lines are perpendicular to one another.



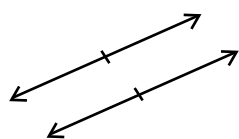

A pair of lines marked by a pair of tick marks are parallel to one another.

Pairs of lines that are either parallel or perpendicular lines may also be indicated in the question stem through the use of the following notation:

$AB \parallel CD$ This means that line AB and line CD are parallel.

$AB \perp CD$ This means that line AB and line CD are perpendicular.

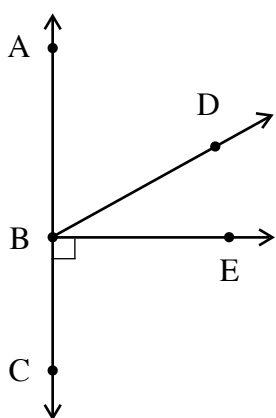

Angles are named from the points that compose them using the following notation: $\angle ABC$ means “the measure of angle ABC.” Always use three points to refer to an angle, or it could become unclear which angle you are referring to. In the diagram shown on the left, $\angle ABC$ is 180° ; it’s called a “straight angle” because it forms a straight line. $\angle CBE$ is 90° . Note that the middle letter in an angle name stands for the vertex. The order of the other letters doesn’t matter; we could refer to the ninety-degree angle in the diagram as either $\angle EBC$ or $\angle CBE$.

While these definitions may seem simple, they can form the basis of some challenging questions, like this one:

Sample Question

A, B, and C are distinct points. Which of the following establishes that AB and BC are the same ray?

- A. Points A, B, and C are collinear.
- B. $\overline{AB} + \overline{BC} = \overline{AC}$
- C. It is farther from point A to point B than from point B to point C.
- D. Points A and B are collinear, but points A and C are not.

Answer choice A does not prove the rays to be the same or different, as seen in the following diagram:

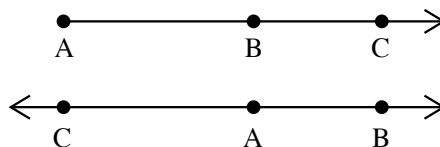

In both figures, A, B, and C are collinear, satisfying the condition of answer choice A. But in the top figure, AB and AC are the same ray, since C is on AB ; in the bottom figure, since C is not on AB , AB and AC are distinct rays.



Answer choice C does not provide any information relevant to determining whether \overline{AB} and \overline{AC} are the same ray or not. As you can see in the diagrams above, the distance between the three points could be varied without affecting the name of the ray(s) they form.

Answer choice D is not correct. \overline{AB} and \overline{AC} can't be the same ray if A and B are colinear, but A and C are not. In this case, the three points would form a triangle.

The correct answer is B. If $\overline{AB} + \overline{BC} = \overline{AC}$, this means that point B must fall between points A and C.

We can prove this using segment addition and contradiction. Consider the bottom arrow diagram, in which A falls between C and B and \overline{AB} is different from \overline{AC} .

$$\begin{aligned}\overline{AB} + \overline{AC} &= \overline{BC} \\ \overline{AB} + \overline{AC} + \overline{AB} &= \overline{BC} + \overline{AB} \\ \overline{AB} + \overline{BC} &= \overline{AC} + 2 \cdot \overline{AB} > \overline{AC}\end{aligned}$$

This result contradicts what we're told in answer choice B, meaning that answer choice B tells us that \overline{AB} and \overline{AC} are the same ray.

Complementary and Supplementary Angles

Adjacent angles that sum to 90° are called complementary angles.

Adjacent angles that sum to 180° are called supplementary angles.

Memorizing these definitions is crucial to being able to solve line diagram questions on the SAT Math test, because sometimes, not all of the information you need will be contained in the diagram itself; the question stem might reveal that two of the angles are either complementary or supplementary, and you'll need to be able to recognize the mathematical significance of such a clue.

Consider the following sample question, which demonstrates just such a situation:

Sample Question

What is the measure of angle B?

- A. 60°
- B. 70°
- C. 110°
- D. 150°

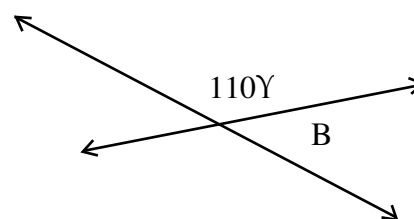

One thing you can assume on the SAT Math test is that in a line diagram, a line that appears to be a straight line is a straight line. This may seem like a minor point, but it's all you need to answer the above question. You can think of a straight line as forming a 180° angle on each of its sides, and when such a line is intersected, the 180° angle is split into multiple angles that still sum to 180° . The angle labeled as being 110° and angle B are supplementary angles—they are adjacent and must necessarily sum to 180° . Thus, you can find angle B by subtracting 110° from 180° :

$$180^\circ - 110^\circ = 70^\circ$$

Angle B is 70° , so the correct answer is B.

Let's try another sample question that tests the other relationship we touched upon: complementary angles.

Sample Question

$\angle ABD = 60^\circ$. What is $\angle DBE$?

- A. 30°
- B. 45°
- C. 60°
- D. 90°

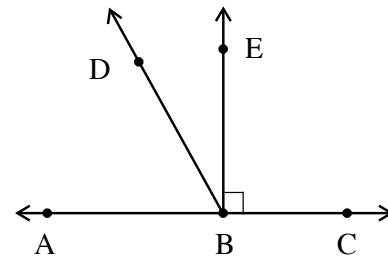

There's a lot more going on in this diagram, but the question still boils down to recognizing the significance of a simple mathematical relationship. Let's take stock of what we know. If we only knew that $\angle ABC = 60^\circ$, we wouldn't be able to solve this problem; however, we're also told that $\angle CBE = 90^\circ$. Don't scan the question stem for that information—it's not there. It's in the diagram—note the right angle symbol. Now we can solve the problem! $\angle ABD$, $\angle DBE$, and $\angle EBC$ must necessarily sum to 180° because they are all contained on one side of AC , and you can think of straight lines as being 180° angles. We can write the following equation:

$$\angle ABD + \angle DBE + \angle EBC = 180^\circ$$

We know that $\angle ABD = 60^\circ$ and that $\angle EBC = 90^\circ$, so we can substitute in those values to create an equation with a single variable that we can then solve for.

$$\begin{aligned} 60^\circ + \angle DBE + 90^\circ &= 180^\circ \\ 150^\circ + \angle DBE &= 180^\circ \\ \angle DBE &= 30^\circ \end{aligned}$$

The correct answer is A.

Quick Tip

Don't let working with degrees throw you off; an equation is an equation!



Parallel and Perpendicular Lines

If you are told that a pair of lines is parallel or perpendicular, you can be confident that this information will be relevant to any questions you are being asked about these lines or the angles they form. A number of rules become apparent when you combine angle measurement problems with parallel and perpendicular lines.

Let's begin with perpendicular lines, the simpler case. Perpendicular lines by definition form four 90° angles. If you are asked to find the measurement of an angle in one "quadrant" of a pair of perpendicular lines, you can do so by using the fact that all of the angles in each of the spaces between the lines must sum to 90° . In the diagram below, $AB \perp CD$. This establishes the following relationships between the angles:

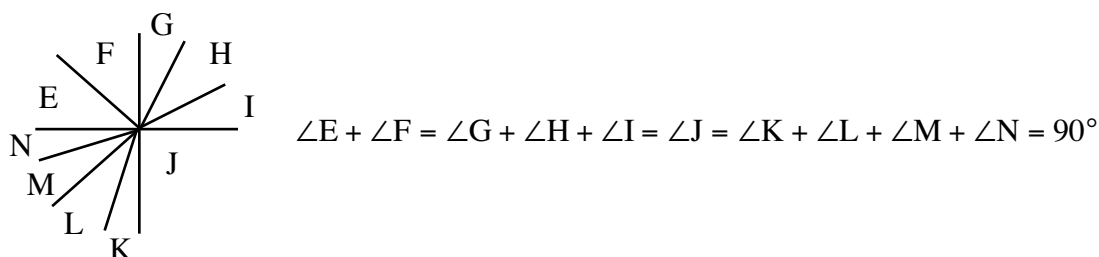

A Shortcut: Vertical Angles

The rule of supplementary angles results in vertical angles, a distinct, easily identifiable relationship between pairs of angles that are formed by the intersection of two lines and have exactly one angle between them. (Put more casually, they are "vertical" from one another). Two lines that intersect will always form two pairs of vertical angles. In the following diagram, $\angle A$ and $\angle C$ are vertical angles and $\angle B$ and $\angle D$ are also vertical angles. Each angle in a pair of vertical angles always has the same angle measurement as the other in the pair, and we can prove this relationship by considering the following scenario.

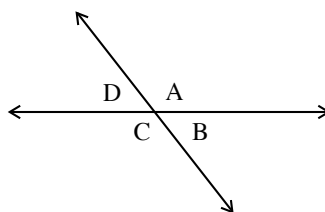

A straight line has an angular measurement of 180° . Because of this, we know that angles A and B must sum to 180° , and angles C and D must also sum to 180° . Furthermore, angles D and A must sum to 180° , and angles B and C must also sum to 180° —we're dealing with two straight lines, after all, so this makes sense.

$$\begin{aligned} A + B &= 180^\circ \\ B + C &= 180^\circ \\ C + D &= 180^\circ \\ D + A &= 180^\circ \end{aligned}$$

Because of the tight-knit relationship between these angles, if you define the value of one of them, you define the value of the other three. Let's say that a question stem tells us that $\angle A = 120^\circ$. If we fill in that information to the equations listed above, we get:



$$\begin{aligned}\angle 120^\circ + B &= 180^\circ \\ B + C &= 180^\circ \\ C + D &= 180^\circ \\ D + \angle 120^\circ &= 180^\circ\end{aligned}$$

We can now solve for $\angle B$ and $\angle D$. From the equations, you can see that they both result in a measurement of 60° . Note that they're vertical angles and have the same measurement, as we just found. We know $\angle B$ and $\angle D$, so we can replace the middle two equations with the following:

$$\begin{aligned}60^\circ + C &= 180^\circ \\ C + 60^\circ &= 180^\circ\end{aligned}$$

Solving either of these equations reveals that $\angle C = 120^\circ$ —just like $\angle A$! This set of relationships holds true for any intersecting lines. So, whenever you work with a line diagram, make sure to take vertical angles into account!

Sample Question

$\angle FCB$ and which angle are examples of a pair of vertical angles?

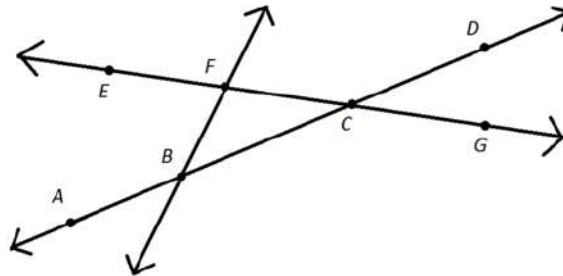

- A. $\angle DCG$
- B. $\angle DCF$
- C. $\angle ECB$
- D. $\angle FCB$

Explanation: Two angles are vertical if they have the same vertex and if their sides form two pairs of opposite rays. The correct choice will have vertex C, which is the vertex of $\angle FCB$. Its rays will be the rays opposite CF and CB , which are, respectively, CG and CD , respectively. The angle that fits this description is $\angle DCG$.



Another Shortcut: Transverse Lines + Vertical Angles

Adding in consideration of transverse lines to your knowledge of vertical angles can help you easily note even more information contained in a line diagram at first glance. A transverse line is a line that intersects both of a pair of parallel lines. EF is a transverse line in the following diagram, as it intersects AB and CD .

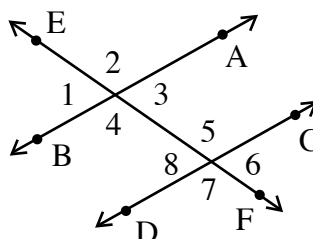

What does the fact that EF is transverse tell us? A lot. Because EF is a straight line and AB and CD are parallel, EF crosses AB at the same angle at which it crosses CD . This means that the measures of certain pairs of vertical angles at the intersection are going to be identical to certain other pairs of vertical angles.

$$\begin{aligned}\angle 1 &= \angle 3 = \angle 6 = \angle 8 \\ \angle 2 &= \angle 4 = \angle 5 = \angle 7\end{aligned}$$

“Corresponding angles” are pairs of angles in the same relative (“corresponding”) position formed by each of the parallel lines and the transversal. $\angle 1$ and $\angle 8$ are corresponding angles, as are $\angle 2$ and $\angle 5$, $\angle 3$ and $\angle 6$, and $\angle 4$ and $\angle 7$. Note that each of these pairs of angles is identical in measurement.

Keep these particular relationships in mind when dealing with any diagram that presents you with a transverse line!

Triangles and Quadrilaterals

Keep in mind, the lines that make up a line diagram can form familiar shapes with rules governing their angles—rules you can make use of to solve problems. If three lines form a triangle, the interior angles of that triangle must sum to 180° . Equilateral triangles contain three 60° angles, and isosceles triangles are 45-45-90 triangles.

If four lines form a quadrilateral, the interior angles must sum to 360° . Don’t get confused and assume this rule only holds true for regular rectangles and squares, where each of the shape’s interior angles is 90° .

It’s easy to forget about these rules as you may have trained yourself to consider them only in other specific scenarios—when answering questions about the length of a triangle’s hypotenuse, for example. Combining your knowledge of mathematics from different contexts may be necessary in this case to solve some of the line problems the SAT Math test presents.



Solving Line Diagrams for Missing Angles

Let's try some sample problems that require you to work with line diagrams. The following question asks you to use your knowledge of geometric relationships to find the measure of an angle.

Sample Question

Refer to the diagram below. $\angle DCG = 43^\circ$. What is the measure of $\angle FCB$?

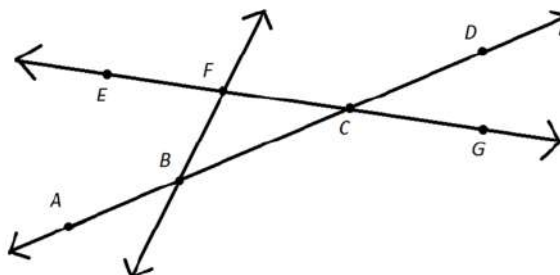

- A. 43°
- B. 47°
- C. 133°
- D. 137°

$\angle FCB$ and $\angle DCG$ are vertical angles, which must be congruent, so if we know $\angle DCG = 43^\circ$, then $\angle FCB = 43^\circ$ also. The correct answer is A.

Sample Question

Statement A: $\angle 3 + \angle 4 + \angle 5 = 131^\circ$

Statement B: $\angle 6 + \angle 7 + \angle 8 = 131^\circ$

Refer to the above figure and two statements. Evaluate $\angle 1 + \angle 2$.

- A. 82°
- B. 98°
- C. 180°
- D. 262°

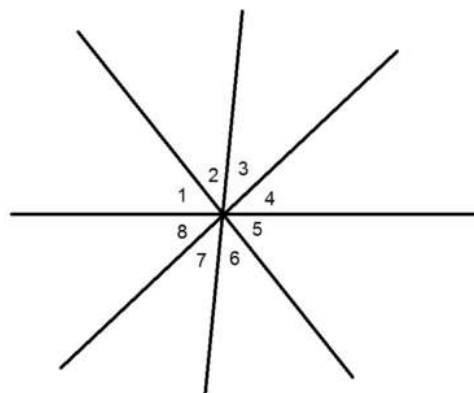

Let's consider the first statement by itself. $\angle 2$, $\angle 3$, $\angle 4$, and $\angle 5$ together form a straight angle, so their degree measures total 180° .

$$\angle 2 + \angle 3 + \angle 4 + \angle 5 = 180^\circ$$

$$\angle 2 + 131^\circ = 180^\circ$$

$$\angle 2 = 49^\circ$$

Without further information, no other angle measures, including that of $\angle 1$, can be found. So, let's consider the second statement. $\angle 1$, $\angle 6$, $\angle 7$, and $\angle 8$ together form a straight angle, so their degree measures total 180° .

$$\angle 1 + \angle 6 + \angle 7 + \angle 8 = 180^\circ$$

$$\angle 1 + 131^\circ = 180^\circ$$

$$\angle 1 = 49^\circ$$

We've found both $\angle 1$ and $\angle 2$, so all we have to do is add them together to solve the problem:

$$\angle 1 + \angle 2 = 49^\circ + 49^\circ = 98^\circ$$

The correct answer is B.

Sample Question

Refer to the diagram shown at right.

OPQ is an equilateral triangle. Evaluate

$\angle 3 + \angle 4$.

- A. 60°
- B. 75°
- C. 120°
- D. 150°

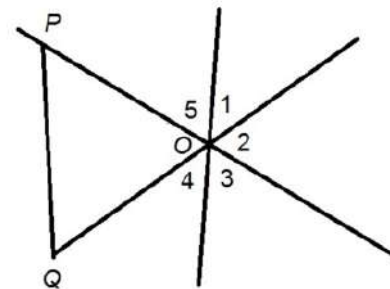

The angles of an equilateral triangle all measure 60° , so $\angle POQ = 60^\circ$. $\angle 3$, $\angle 4$, and $\angle POQ$ together form a straight angle, so we can write the following equation:

$$\angle 3 + \angle 4 + \angle POQ = 180^\circ$$

$$\angle 3 + \angle 4 + 60^\circ = 180^\circ$$

$$\angle 3 + \angle 4 = 120^\circ$$

Note that we don't have to find the individual measurements of $\angle 3$ and $\angle 4$, just their sum. The correct answer is C, 120° .



Solving Line Diagrams for Linear Relationships

Some line diagrams may not provide you with information about parallel and perpendicular lines and ask you to calculate the measure of a missing angle. Instead, they may ask you to work “in reverse” and provide you with information about the angles in a diagram in order to ask about which lines must necessarily be parallel or perpendicular based on those angles’ relationships. Let’s take a look at an example of this type of question.

Sample Question

Statement A: $\angle 2 = 89^\circ$

Statement B: $\angle 3 = \angle 6$

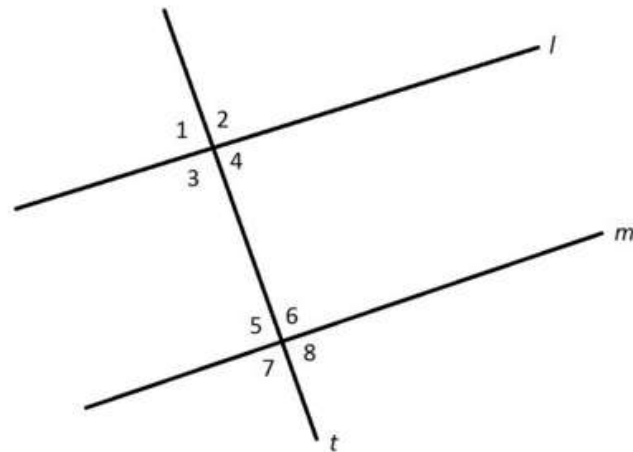

Given the above figure and two statements, which of the following is true?

- A. Line m is perpendicular to line t
- B. Line m is not perpendicular to line t
- C. $\angle 4 = \angle 7$
- D. $\angle 1 = \angle 6$

Statement A alone establishes by definition that line l is not perpendicular to line t , but it does not establish any relationship between line m and line t .

By Statement B alone, since alternating interior angles are congruent, line l is parallel to line m . We can’t yet draw any conclusion about the relationship of line t , since we haven’t found the actual measures of the angles.

By Statement B, line l is parallel to line m . $\angle 2$ and $\angle 6$ are corresponding angles formed by a transversal across parallel lines, so $\angle 6 = \angle 2 = 89^\circ$. $\angle 6$ is not a right angle, so line m is not perpendicular to line t and B is the correct answer.



Sample Question

Consider the line diagram shown at right. Which of the following pieces of information is enough to prove that AB is parallel to CD?

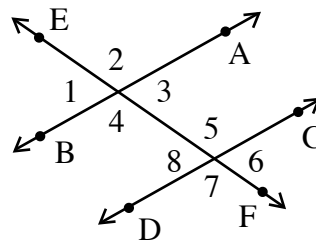

- A. $\angle 1 = \angle 3$
- B. $\angle 4 = 120^\circ$ and $\angle 8 = 60^\circ$
- C. $\angle 5 = 120^\circ$ and $\angle 6 = 60^\circ$
- D. $\angle 2 = \angle 6 = 100^\circ$

We know that $\angle 1 = \angle 3$ because they are vertical angles, so this information doesn't tell us anything about the relationship between AB and CD. The same thing can be said of answer choice C; $\angle 5$ and $\angle 6$ form a straight-angle pair that sums to 180° , but knowing the specific angle values associated with each doesn't tell us anything about whether AB and CD are parallel.

Answer choice D provides information that, if true, means that AB is not parallel to CD. For the lines to be parallel, corresponding angles would need to have the same measurements. That is, $\angle 2$ would need to have the same measurement as $\angle 5$, and $\angle 3$ would need to equal $\angle 6$. If $\angle 2 = \angle 6 = 100^\circ$, $\angle 3$ and $\angle 5$ would each equal 80° . This means that the corresponding angles would have different measurements, meaning that AB would not be parallel to CD.

The correct answer choice is B. By learning that $\angle 4 = 120^\circ$ and $\angle 8 = 60^\circ$, we have enough information to determine that $\angle 1 = 60^\circ$ (because it forms a straight angle with $\angle 4$) and that $\angle 7 = 120^\circ$ (since it forms a straight angle with $\angle 8$). At this point, we can see that the pairs of corresponding angles, angles 1 and 8 and angles 4 and 7, match in value. This means that AB is parallel to CD.



Triangles, Circles, and Polygons

The prototypical vision that tends to spring to mind at the mention of “geometry” is an assortment of polygons and circles: squares, rectangles, triangles, etc. With a firm understanding of these shapes’ construction—based on rudimentary properties of lines, planes, angles, and axes—you can begin to piece together the parts that define these geometric constructs and gain an understanding of the rules governing their dimensions.

While many of the equations for evaluating geometric properties are given on the SAT Math test, applying these equations in the proper ways is one of the more challenging concepts on the SAT. Geometric figures are often complex and require critical thinking. Just because the equations are given, do not take these questions for granted!

The following lessons go into detail on some of the most common geometric principles tested on the SAT. Take careful note of how these principles can interplay; rarely will you be asked about a single shape. SAT Math questions often require collective measurements of multiple components, inscribed shapes or structures, and contrived geometric constructions with limited or missing components. Consider this carefully as you advance through the following pages.

Section Outline

Defining Polygons

- Identifying types of triangles, quadrilaterals, and regular polygons

Introduction to Right Triangles

- Applying the Pythagorean Theorem and special right triangle properties

Congruent Figures and Similar Figures

- Testing figures for similarity and congruence

Quadrilaterals

- Performing calculations on squares, rectangles, parallelograms, and trapezoids

Circles

- Performing calculations involving radius, circumference, inscribed angles, and arcs

Three-Dimensional Geometry

- Performing calculations on prisms, pyramids, spheres, and cylinders



Defining Polygons

When two line segments intersect at a common point, an angle is formed, as shown at right. When the ends of these segments intersect they form a polygon—a triangle, in this case. A polygon is defined as a figure in two-dimensional space that possesses three or more sides. Several examples of polygons are depicted and named below.

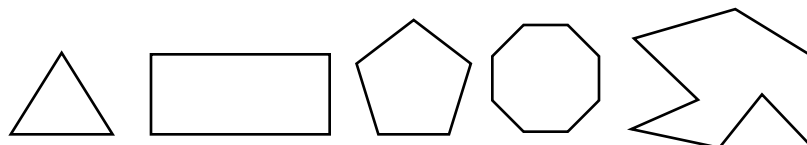
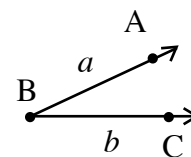

Number of Sides	Name of Shape
Three	Triangle
Four	Quadrilateral
Five	Pentagon
Six	Hexagon
Seven	Heptagon
Eight	Octagon
Nine	Nonagon
Ten	Decagon
Eleven	Hendecagon
Twelve	Dodecagon
n	n -gon

The SAT will require you to understand and manipulate the relationships between the formulas associated with polygons (e.g. area and perimeter formulas). While this may seem to be a simple and trivial task, the SAT may attempt to encumber the task by utilizing complex shape combinations. In order to be equipped to solve these more complex and multi-step problems on test day, you need to familiarize yourself with the most basic operations associated with polygons.

Basic Polygons: Types of Triangles

Triangles can be categorized by their side length characteristics, angle characteristics, or both. There are three common types of side length triangles which include the equilateral, isosceles, and scalene triangles. An equilateral triangle, by definition, has three equal side lengths. On the other hand, an isosceles triangle has two sides of equal lengths and a third side that is unique in its length. Last, the side lengths of a scalene triangle are all unique, in other words, not equal to each other.

Triangle taxonomy may be also based upon the characteristics of their angles. The angle characteristics of a triangle can be one of three: acute, obtuse, or right. It is important to note that in a triangle the sum of all the angles must equal 180 degrees. The angles of an acute triangle will each be less than 90 degrees. The angles of an obtuse triangle will have one angle that is greater than 90 degrees. A right triangle is a special



triangle which has one angle of 90 degree. Trigonometry will help to calculate missing angle or side information when dealing with triangles these special triangles. Right triangles may also have special characteristics. See the figure below for descriptions of the relationships of side lengths in 30-60-90 degree triangles and 45-45-90 degree triangles respectively.

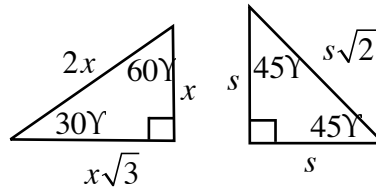

Special Right Triangles

Triangle Inequality

The triangle inequality states that the sum of any two sides of a triangle must be greater than the third side in order for the triangle to exist. This is crucial to remember when dealing with triangles that are not right triangles. The following relationships are true for **all** triangles; a , b , and c refer to the side lengths of a triangle.

$$\begin{aligned} a + b &> c \\ b + c &> a \\ c + a &> b \end{aligned}$$

Example 1: If a triangle has side lengths of 7, 7, and 10, what type of triangle is it?

Step 1: First use the triangle inequality to verify that the triangle exists.

$$\begin{aligned} 7 + 7 &> 10 \\ 7 + 10 &> 7 \\ 10 + 7 &> 7 \end{aligned}$$

Step 2: Identify the type of triangle by the side length characteristics.

Since this triangle has two equal sides and one unique side length, it is an isosceles triangle.

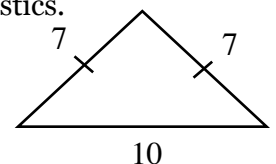

Example 2: What type of triangle is depicted in the image below, where $AB \perp BC \perp CA$?

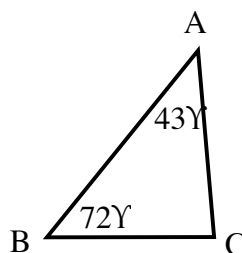

Step 1: Identify the type of triangle based on angle characteristics.

Add up the two angles given and then calculate the third angle.

$$72^\circ + 43^\circ = 115^\circ$$

$$180^\circ - 115^\circ = 65^\circ$$

Since all the angles of the triangle are less than 90 degrees, categorizes this triangle as an acute triangle.

Step 2: Identify the type of triangle based on side characteristics.

Since the question states that all sides lengths are not equal to each other, the triangle is categorized as scalene.

Step 3: Answer the question.

The image in this question depicts an acute scalene triangle.

It is important to note that if all angles are different in a triangle, this means that all three of its sides are of different lengths. Likewise, if there are two angles that are the same, then the two sides across from those angles are the same length. If a triangle has three angles that are the same, it is an equilateral triangle and they are all 60 degrees. In addition, all of its side lengths are by definition the same.

Types of Quadrilaterals

A quadrilateral is an object comprised of four sides. There are four known quadrilaterals: squares, rectangles, rhombuses, and trapezoids. Squares are defined by having four equal sides and four 90 degree angles. A square is shown at right.



Example 3: The vertices of an object lie on a coordinate grid at (0,4), (4,4), (4,0), and (0,0). What type of an object is described and how do you know?

Step 1: Draw and connect the vertices.

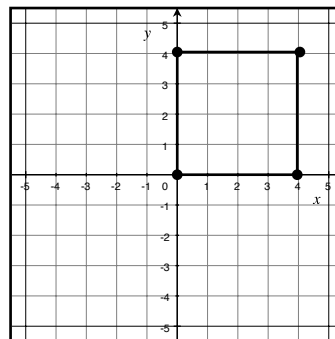

Step 2: Calculate the length of each side.

To calculate the length of each side, one can either count from one vertex to another or use the distance formula.



$$d = \sqrt{(x_1 - x_2)^2 + (y_1 - y_2)^2}$$

$$d = \sqrt{(4 - 0)^2 + (4 - 4)^2} = \sqrt{16} = 4$$

$$d = \sqrt{(4 - 0)^2 + (0 - 0)^2} = \sqrt{16} = 4$$

$$d = \sqrt{(4 - 4)^2 + (0 - 4)^2} = \sqrt{16} = 4$$

$$d = \sqrt{(0 - 0)^2 + (0 - 4)^2} = \sqrt{16} = 4$$

Step 3: Identify the angles of the object.

For this particular object the connection of all the sides create four 90 degree angles. This is because the width of the object is perpendicular to the length of the object.

Step 4: Identify the object.

Since the object has four sides it is a quadrilateral and because all sides have equal length and all angles are 90 degrees the object is a special type of equilateral, a square.

Rectangles

A rectangle is a quadrilateral that has two pairs of equal opposite leg lengths and four 90 degree angles.

Example 4: The image at right is a rectangle with a width of 10 and a length of five less than three times the width. What is the area of the rectangle?

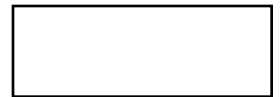

Step 1: Calculate the length of the rectangle.

First write a mathematical expression to express the English sentence given.

$$w = 10$$

$$l = 3w - 5$$

$$l = 3(10) - 5$$

$$l = 30 - 5$$

$$l = 25$$

Step 2: Find the area by using the formula for area of a rectangle.

$$A = l \cdot w$$

Since $L = 25$ and $W = 10$, we can find the area by substituting these values in.

$$A = 25(10)$$

$$A = 250$$



Rhombuses

A rhombus can be thought of as a square that has been squished. What this means is that a rhombus has four equal side lengths, but its angles are no longer 90 degrees. A rhombus has two pairs of opposite angles that are equal.

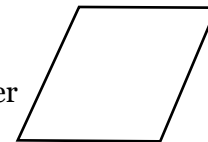

Example 5: A figure ABCD has an angle A that measures 120 degrees and angle B, which measures 60 degrees. Angle C is congruent to angle A and angle D is congruent angle B, and side length AB is equal to side length BC. What type of figure is ABCD?

Step 1: Identify object characteristics.

This object has four angles and four sides; thus, it is a type of quadrilateral.

Step 2: Use angle and side characteristics to further identify the object.

The question states that side $AB = BC$, but angle A is different from angle B. This means we are dealing with a rhombus. A rhombus's side lengths are all equal, but it doesn't have 90-degree angles. Instead, a rhombus has two pairs of opposite angles that are equal to each other; therefore, figure ABCD is a rhombus.

Trapezoids

Trapezoids are quadrilaterals that have two parallel sides; these are commonly referred to as the "bases" of the trapezoid.

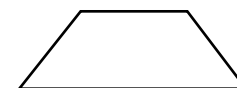

Example 6: A figure ABCD has side lengths $AB = CD = 4$, $BC = 10$, $AD = 15$, and a height of 3.12. If BC and AD are parallel to one another, what type of figure is ABCD, and what is its area?

Step 1: Identify the figure based on side characteristics.

Since AD and BC are parallel but AB and CD are not then the figure is a trapezoid with the bases being AD and BC.

Step 2: Find the area.

$$\text{Area} = \frac{\text{base}_1 + \text{base}_2}{2} \cdot \text{height}$$

Since $\text{base}_1 = 15$, $\text{base}_2 = 10$, and $\text{height} = 3.12$, the area formula becomes the following.

$$\text{Area} = \frac{15 + 10}{2} \cdot 3.12$$

$$\text{Area} = \frac{25}{2} \cdot 3.12$$

$$\text{Area} = 12.5 \cdot 3.12$$

$$\text{Area} = 39$$



Regular Polygons

A regular polygon is any connected figure whose side lengths are all equal and all angles are equal. A square for example, is considered a regular polygon. The number of side lengths is not restricted; thus, as long as the sides and angles are equal, the figure would be a regular polygon. There is a simple formula that will calculate the sum of the interior angles of any polygon. Once the sum of the interior angles is known, any and all of the angles within the regular polynomial can be found. The formula to calculate the sum of the interior angles is as follows.

$$\text{Sum} = 180(n - 2)$$

n = number of sides

Example 7: A regular polygon has seven sides. What is the value of one of its interior angles?

Step 1: Identify what is known.

The question states that it is a regular polygon, thus, by definition all side and angles are equal.

Step 2: Use the sum of interior angles formula to calculate the total value of all interior angles.

$$\text{Sum} = 180(n - 2)$$

$$n = 7$$

$$\text{Sum} = 180(7 - 2)$$

$$\text{Sum} = 180(5)$$

$$\text{Sum} = 900$$

Step 3: Calculate the value of a single angle. Use the value from step one and divide it by the total number of angles.

$$\frac{900}{7} \approx 128.57^\circ$$

Example 8: Consider the regular polygon shown at right. If each of its sides is three units long, what is the area of the shaded region?

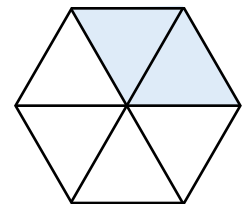

Step 1: Calculate the area of the entire polygon.

To calculate the area, use the formula



$$A = \frac{1}{2} \cdot \text{apothem} \cdot \text{perimeter}$$

The apothem is the length from the center of the polygon to the midpoint of any side. In other words if the polygon was broken down into equilateral triangles, the apothem would be the height of one of the triangles.

The formula to calculate the height of an equilateral triangle is $h = \frac{s\sqrt{3}}{2}$, where s is the side length of the triangle. In this particular example, the height or apothem would be as follows.

$$h = \frac{3\sqrt{3}}{2}$$

The perimeter would be $P = 6(3) = 18$

The area would then be

$$A = \frac{1}{2} \cdot \frac{3\sqrt{3}}{2} \cdot 18$$

$$A = \frac{27\sqrt{3}}{2}$$

Step 2: Calculate the area of the shaded region.

If we were to split this polygon into triangles, we would have six triangles. The shaded region is two of the triangles; therefore, the shaded region is $\frac{2}{6} = \frac{1}{3}$ of the total area of the polygon. To find the area of the shaded region, multiply the total area by one third.

$$A_{\text{shaded region}} = \frac{27\sqrt{3}}{2} \cdot \frac{1}{3} = \frac{27\sqrt{3}}{6} = \frac{9\sqrt{3}}{2}$$



Introduction to Right Triangles

Triangles are three-sided shapes with internal angles that sum to 180° . Right triangles are a particular type of triangle in which one of those three angles is exactly 90° —a right angle. The other two interior angles will sum to 90° , and when added to the right angle, the three will sum to 180° like in any other triangle.

Pythagorean Theorem

If you're asked for the length of a side of a right triangle, consider if you know or can find the lengths of the other two sides before assuming that you'll need to use trigonometry. The Pythagorean theorem, shown below, can save you unnecessary calculations. It is used on right triangles only.

$$a^2 + b^2 = c^2$$

In this equation, a and b are the side lengths of the triangle and c is the length of the hypotenuse.

Sample Question

A right triangle has leg lengths of 4 cm and 7 cm. What is the length of its hypotenuse?

- A. $\sqrt{50}$
- B. $\sqrt{65}$
- C. $\sqrt{95}$
- D. $\sqrt{150}$

We can predict that the hypotenuse of this triangle must be more than 3 cm and less than 11 cm using the law that the length of one side of a triangle cannot exceed the sum of the lengths of the other two sides. This simple rule can help you ignore answer choices very quickly should you find yourself needing to guess on a problem related to triangle side lengths, and to make sure that a calculated answer falls in a realistic range of possibilities. Considering this, we can tell that D can't be correct, since the square root of 144 is 12, and that's above the range into which our answer can fall.

Let's get to calculating the length of that hypotenuse using the Pythagorean Theorem. We're given the lengths of the triangle's legs, so $a = 4$ cm and $b = 7$ cm. (Note that it doesn't matter which leg we call a and which we call b as long as we are consistent).

Having defined our variables, we can substitute them into the Pythagorean theorem and solve for the length of the hypotenuse:

$$a^2 + b^2 = c^2$$



$$(4 \text{ cm})^2 + (7 \text{ cm})^2 = c^2$$

$$16 \text{ cm}^2 + 49 \text{ cm}^2 = c^2$$

$$65 \text{ cm}^2 = c^2$$

$$\sqrt{65 \text{ cm}^2} = \sqrt{c^2}$$

$$\sqrt{65} \text{ cm} = c$$

Don't worry if you end up with an answer that takes the form of a square root; that just means that the sum of the triangle's legs wasn't a *perfect square*. It doesn't mean it's incorrect! The length of this triangle's hypotenuse is $\sqrt{65}$ cm.

Quick Tip

If you're only given one side length of a right triangle that is not one of the "special" kinds of right triangles, you'll need to use *trigonometric functions* in order to find the lengths of the other sides.

Special Right Triangles

Certain right triangles are referred to as "special" because of their particular combinations of angles. These "special" combinations have set side length ratios. What this means for you as you study for the SAT is that if a triangle is a special right triangle, you don't need to know the lengths of two of its sides to calculate the length of the third side. You just need to identify the type of special right triangle and know the length of one of its sides; that's all the information you need! Furthermore, even if you know the lengths of both sides, you might find it easier and faster to make use of the special right triangle ratios instead of the Pythagorean theorem. Both are given to you as part of the *Given Equations* section on your test booklet, so it's really a matter of choosing the mathematical route you prefer or think more efficient.

Text box: If you're only given one side length of a right triangle that is not one of the "special" kinds of right triangles, you'll need to use *trigonometric functions* in order to find the lengths of other sides.

There are two types of special right triangles: 30-60-90 triangles and 45-45-90 triangles. (This second type can also be called an isosceles right triangle). These two special triangles have specific ratios between their sides. Certain problems may be set up to require you to use these ratios. In others problems, making use of the ratios might be optional, but it can make your calculations easier and faster.

30-60-90 special right triangles have a side ratio of $1 : 2 : \sqrt{3}$ in the form short side : hypotenuse : long side. 45-45-90 special right triangles each have a side ratio of $1 : 1 : \sqrt{2}$ in the form side : side : hypotenuse. These ratios are provided on the Given Equations box in your text booklet in the following form:

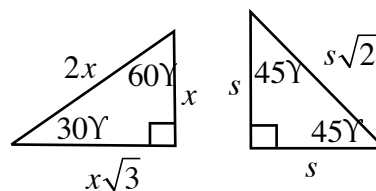

Special Right Triangles

So how exactly do you make use of these ratios? You set up a proportion. First, create a fraction using the information you have and the information you want; then, you set



it equal to a fraction made up of the relevant sides' ratio. At this point, you can cross-multiply and solve. Let's practice doing this in the next two sample problems.

Sample Question

Find the lengths of sides a and c of the triangle shown below.

- A. $a = 7.5\sqrt{3}$ cm
 $c = 21$ cm
- B. $a = 10.5\sqrt{3}$ cm
 $c = 21$ cm
- C. $a = 7.5\sqrt{3}$ cm
 $c = 30$ cm
- D. $a = 10.5\sqrt{3}$ cm
 $c = 30$ cm

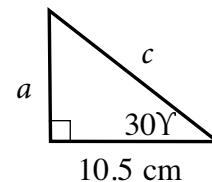

We're only given the length of one side of this triangle, but look at the angles. Since this triangle contains a 90° angle and a 30° angle, it must be a 30° - 60° - 90° triangle. That means we can use our special right triangle ratios to set up a proportion. We know that one side is 10.5 cm long, and that that side must be across from the 60° angle. In the side ratio, that side is $x\sqrt{3}$. Let's calculate the length of side a , the side across from the 30° angle. That side is x in the side ratio. Let's set up our proportion with the lengths of the triangles' sides above their ratio variables.

$$\frac{10.5 \text{ cm}}{x} = \frac{a}{x\sqrt{3}}$$

We could also set up our fraction with information about the triangle on one side and information about the side ratios on the other.

$$\frac{10.5 \text{ cm}}{a} = \frac{x}{x\sqrt{3}}$$

No matter which way you set up your proportion, we get the same answer, as the next step is cross-multiplying, and cross-multiplying yields the same thing in both proportions.

$$10.5 \times x\sqrt{3} = c \times x$$

Now we can divide each side by x to remove that variable from the equation.

$$10.5 \times \sqrt{3} = c$$

This answer may look a bit convoluted, but it is correct! Now we need to calculate c . We could use the Pythagorean theorem at this point, since we know the lengths of two sides,



but our last answer looks like it would be difficult to work with, so let's set up another proportion. We can reuse our first fraction, but need to set it equal to another. Side c is across from the 90° angle in the triangle, making it the $2x$ side in the ratio.

$$\frac{10.5 \text{ cm}}{x} = \frac{c}{2x}$$

Cross-multiply and solve for the correct answer.

$$10.5 \text{ cm} \times 2x = c \times x$$

$$10.5 \text{ cm} \times 2 = c$$

$$21 \text{ cm} = c$$

B is the correct answer!

Next, let's try a sample problem that involves an isosceles special right triangle. A similar approach can be used, but the ratios are different.

Sample Question

One leg of an isosceles right triangle is 5 m long. What is the length of this triangle's hypotenuse?

- A. 5 m
- B. 10 m
- C. $5\sqrt{2}$ m
- D. $5\sqrt{3}$ m

This problem is a little bit tricky: there's a bit of information it is subtly hiding. It gives you the length of "one leg" of the triangle and tells you that the triangle is an isosceles right triangle; isosceles triangles by definition have two legs that are the same length, so that means that you know the length of both of the triangle's legs!

At this point, you could take your pick of methods and use either the Pythagorean theorem or special right triangle ratios to solve. Let's practice using the ratios. Each of the triangle's legs are across from a 45° angle, so they'll be labeled s in the ratio. The hypotenuse for which we're solving is across from the right angle, so it will be labeled $s\sqrt{2}$ in the ratio. Let's set up our proportion.

$$\frac{5 \text{ m}}{s} = \frac{c}{s\sqrt{2}}$$

Cross-multiplying, we get the following:

$$5 \text{ m} \times s\sqrt{2} = s \times c$$



We can divide by s to remove that variable from the equation and find our answer.

$$5 \text{ m} \times \sqrt{2} = c$$

$$5\sqrt{2} \text{ m} = c$$

C is the correct answer!

Further Application: Diagonal of a Square

If you're asked to calculate the diagonal of a square, don't scramble for a formula. Knowing how to work with special right triangles means that you can handle such a question with ease. Consider what shapes you create if you divide a square along its diagonal. You get two triangles, but these are special triangles with specific proportions. A square by definition has four right angles, so guess what's in the corner of each of the two triangles? A right angle! Furthermore, consider the side lengths of these triangles. Each side of a square is equal in length to its other three sides, so the legs of each of these triangles are identical. That means that we're dealing with isosceles right triangles. One more key point: consider the angles in play here. The diagonal divided two 90° angles in half, so the triangles formed are 45° - 45° - 90° triangles. We can thus apply the ratios associated with 45° - 45° - 90° triangles in this scenario to calculate the length of the diagonal so long as we know one side of the square, or calculate one side of the square so long as we know the length of the diagonal. Keep on the lookout for ways in which geometry problems can be presented in different ways; it may help you switch from being completely lost as to how to approach a problem to solving it as an example of familiar principles!

Sample Question

Herbert is in charge of maintaining a square flower garden in a public park with edges of 200 m, but rabbits keep nibbling at it. Herbert chases a rabbit directly from one corner of the garden to the other while running at 7 meters per second. Approximately how long does it take Herbert to chase the rabbit out of his garden in this manner? Round your final answer only.

- A. 40.41 s
- B. 41.54 s
- C. 42.35 s
- D. 43.07 s

This is a multi-layered word problem, but at its core, it's a diagonal of a square problem. After you find the length of the square's diagonal, you need to use Herbert's provided running speed to convert the distance into the time it takes him to dash across the garden.

We're working with the diagonal of a square, so we can use the ratio of sides for a 45° -



45-90 triangle: $s : s : \sqrt{2}s$. Let's set up our proportion.

$$\frac{200 \text{ m}}{s} = \frac{c}{s\sqrt{2}}$$

At this point, we can cross-multiply and solve for c .

$$200 \times s\sqrt{2} = c \times s$$

$$200 \times \sqrt{2} = c$$

We know that the hypotenuse of the triangle, and the diagonal of the square, is $200\sqrt{2}$ m. Now we need to calculate how long it took Herbert to run this distance at a pace of 7 meters per second. We can do this by multiplying our distance by the ratio of distance to time so that we end up with a result with seconds as the units. Just make sure the units cancel! In this case, we need to flip the fraction upside down to get the correct answer, and the units make this apparent.

$$200\sqrt{2} \text{ m} \times \left(\frac{1 \text{ s}}{7 \text{ m}}\right) = \frac{200\sqrt{2}}{7} \approx 40.41 \text{ s}$$

The correct answer is A.



Congruent Figures and Similar Figures

For congruent figures and similar figures on the SAT, we will need to know the following concepts in order to answer the questions successfully: identifying congruent triangles, identifying and comparing similar triangles, identifying similar polygons, and finding area and perimeter relations in similar polygons. Before we launch into these concepts, let's go over the basics of what congruent figures and similar figures are.

In simple terms, congruent figures are figures that have equal sides and equal angles. Similar figures are those that have equal angles, but the sides are not equal.

Identifying Congruent Triangles

Two triangles are congruent if they have exactly the same three sides and three angles. We can prove this by using the methods of side-side-side (SSS), side-angle-side (SAS), angle-angle-side (AAS), and angle-side-angle (ASA). If both the triangles are congruent, they will have the same perimeter and area.

Identifying and Comparing Similar Triangles

Two triangles are similar if the three angles are equal and the ratio of the side lengths are the same. We can prove this by using the methods of side-side-side (SSS), side-angle-side (SAS), angle-side-angle (ASA), angle-angle-side (AAS), and angle-angle-angle (AAA) to show that two triangles are similar. If both triangles are similar in the ratio $R : 1$, then the ratio of their perimeters is $R : 1$, and the ratio of their areas is $R^2 : 1$.

Identifying Similar Polygons

For a general shape, it can be tricky to determine if the shapes are similar because we need to check all corresponding angles and ratios of the sides. For example, comparing a 2×3 rectangle to a 3×4 rectangle, even though the four interior angles are equal, the ratio of their sides aren't equal. Also, a square with side length of two is not similar to a rhombus with side length of two and vertex angle of 60° , even though their side lengths are equal.

Area and Perimeter Relations in Similar Polygons

If polygons are similar in the ratio $R : 1$, then the ratio of their perimeters is $R : 1$, and the ratio of their areas is $R^2 : 1$.



Sample Question

If the sides of two rectangles are in the ratio 4 : 8, what is the ratio of their areas?

- A. 1 : 2
- B. 1 : 3
- C. 1 : 4
- D. 1 : 5

The ratio of these rectangles' areas is simply the square of the ratio of their side lengths.

$$\begin{aligned} &4 : 8 \\ &4^2 : 8^2 \\ &16 : 64 \end{aligned}$$

This ratio can then be reduced to reach the correct answer, C:

$$\begin{aligned} &4 : 16 \\ &1 : 4 \end{aligned}$$

Sample Question

If the area of a square is increased by 28%, what is the percent increase in perimeter of the same square?

- A. 7%
- B. 13%
- C. 14%
- D. 28%

Let L denote the length of one side of the square and L' denote the square's new side length after its area is increased. Using this notation, we can write the ratio of the sides in the following way.

$$\frac{(L')^2}{L^2} = 1.28$$

Take the square root of each side.

$$\frac{L'}{L} = \sqrt{1.28} \approx 1.13$$

Since we know that the ratio of the side lengths is equal to the ratio of perimeter, we know that the perimeter will increase as if multiplied by 1.13, or put a different way, by a factor of about 13%. The correct answer is thus C.



Sample Question

In the figure shown below, \overline{AB} is parallel to \overline{DE} , and \overline{AE} intersects \overline{BD} at point C. Triangle ABC and triangle CDE are similar. What is the perimeter of triangle CDE?

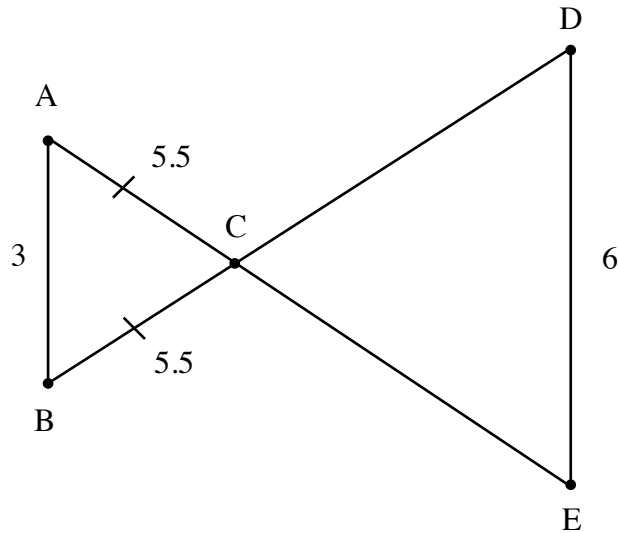

Note: figure not drawn to scale.

- A. 20
- B. 24
- C. 28
- D. 30

This question is testing your knowledge of similar triangles. What we need to figure out is the ratio of the side lengths. In order to do this, we will take the base side length from triangle CDE and divide it by the base side length for triangle ABC.

$$\frac{\text{Triangle CDE}}{\text{Triangle ABC}} = \frac{6}{3} = 2$$

Now that we have a ratio of 2 : 1, we can multiply the side lengths in triangle ABC by 2 to calculate the corresponding side lengths for triangle CDE.

$$5.5 \times 2 = 11$$

The perimeter is then simply the sum of the sides of triangle CDE.

$$\text{Perimeter of triangle CDE} = 11 + 11 + 6 = 28$$

The correct answer is C.



Sample Question

In the figure shown below, the four squares have the same center. What is the ratio of the perimeter of the outermost square to the perimeter of the innermost square?

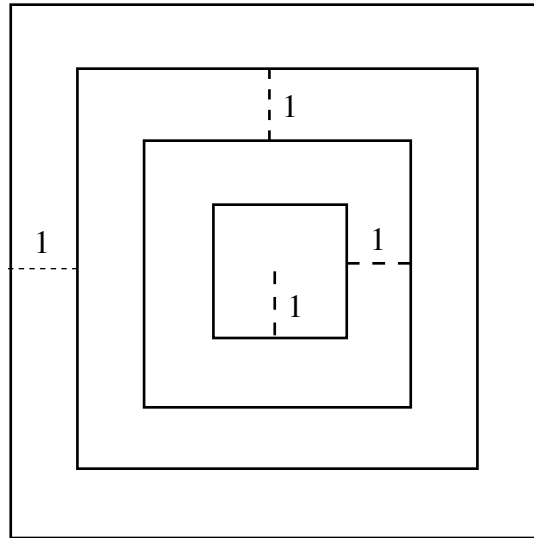

- A. 1 : 4
- B. 4 : 1
- C. 4 : 5
- D. 5 : 4

In this problem, we are given the distance from the center to a side of the innermost square of the most inner square, which is 1. This gives us enough information to calculate the perimeter of the innermost square.

We multiply by two to get one side length, and then multiply by four to get the sum of the side lengths—the perimeter.

$$P_{\text{innermost square}} = 1 \times 2 \times 4 = 8$$

To figure out the side length of the outer square, we need to add up all the 1's given in the diagram. We then multiply by two to get the side length, and then multiply by four to get the sum of the side lengths.

$$P_{\text{outermost square}} = (1 + 1 + 1 + 1) \times 2 \times 4 = 32$$

Now we divide the perimeter of the outermost square by the perimeter of the innermost square.

$$\frac{P_{\text{outermost square}}}{P_{\text{innermost square}}} = \frac{32}{8} = 4$$

So, the outermost square has a perimeter four times as large the perimeter of the most inner square. Written as a ratio, this is 4 : 1, so B is the correct answer.



Quadrilaterals

Quadrilaterals are shapes composed of four sides. Rectangles and squares—shapes you'll likely find very familiar—fall into this category, as do parallelograms and trapezoids, which are perhaps a bit unfamiliar and imposing. This lesson looks at each of these geometric figures and considers how information like side length, angles, perimeter, area, and length of the diagonal interact mathematically and how you can solve for each if asked to do so on the SAT Math test.

Squares

In many ways, squares are the simplest of geometrical shapes. They have four sides of equal length connected by four ninety-degree angles. This means that there's very little to figure out regarding a simple square: if you know the length of one side, you know the length of each of the sides. Draw a diagonal line between two opposing corners of any square and you've divided it into two identical right triangles. A square's diagonal will always have the same length relative to the sides of the square. Simply multiply any side of a square by the square root of two to find the length of its diagonal. This works because it uses the ratio for 45-45-90 special right triangles, two of which are always formed by the diagonal of a square.

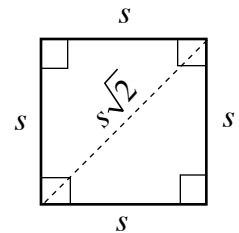

$$A = s^2$$

$$P = 4s$$

$$d = s\sqrt{2}$$

One of the key elements in understanding geometry is realizing that what you are doing is calculating an unknown quantity from a known quantity (or quantities). With a simple shape like a square, perimeter, side-length, and area work together in such a way that if you know one quantity, you can always calculate the other two.

Sample Question

Jenna uses 28 feet of fencing to create a square pen in her yard for her puppy to play in. How far is it from one corner of the pen to the opposite corner?

- A. $4\sqrt{2}$ ft
- B. 7 ft
- C. $7\sqrt{2}$ ft
- D. 49 ft

This problem is asking us to solve for the diagonal of a square. To do that, we need to first determine the length of the square's sides. We're told that Jenna used 28 feet of fencing to create the pen, meaning that the square's perimeter is 28. We can divide 28 by four to find the length of one side of the square pen.



$$\frac{28}{4} = 7$$

Now that we know the length of one of the square's sides, we can calculate the length of its diagonal by multiplying it by $\sqrt{2}$:

$$7\sqrt{2}$$

The correct answer is C.

Rectangles

If a quadrilateral has four ninety degree angles but its two pairs of sides each have different lengths, the shape is a rectangle. You can solve for the area of a rectangle by multiplying its length by its width, and you can solve for its perimeter by summing its sides ($2l + 2w$). To calculate a rectangle's diagonal, you'll need to break out the Pythagorean Theorem. You can't use the shortcut that you can use for squares ($s\sqrt{2}$) because when dividing a rectangle into two right triangles, these triangles are only 45-45-90 triangles if the rectangle's length equals its width, making it a square.

Derived from
the Pythagorean theorem

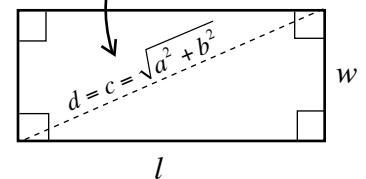

$$a = l \times w$$

$$p = 2l + 2w$$

Sample Question

The area of a rectangular painting is 24.5 ft^2 . If the painting is 3.5 ft tall, what is its width?

- A. 6.5 ft
- B. 7 ft
- C. 7.5 ft
- D. 8 ft

How far is it from one corner of the painting to the opposite corner?

- A. $7\sqrt{2} \text{ ft}$
- B. $3.5\sqrt{2} \text{ ft}$
- C. $\sqrt{59.50} \text{ ft}$
- D. $\sqrt{61.25} \text{ ft}$

We're given the area and the height of the painting in the first problem and asked to solve for the width. We can do this by substituting in the information we're given into the equation for the area of a rectangle and solving for the unknown variable, the width.



$$A = l \times w$$

$$24.5 \text{ ft}^2 = 3.5 \text{ ft} \times w$$

$$\frac{24.5 \text{ ft}^2}{3.5 \text{ ft}} = w$$

$$w = 7 \text{ ft}$$

The correct answer to the first problem is B. Now we have enough information to solve the second problem, which asks for the diagonal of the rectangle. We'll have to use the Pythagorean Theorem for this one—don't let answer choices A or B fool you!

$$\text{Diagonal} = c = \sqrt{a^2 + b^2} = \sqrt{7^2 + 3.5^2} = \sqrt{49 + 12.25} = \sqrt{61.25}$$

D is the correct answer to the second problem.

Parallelograms

If a quadrilateral has two sides of equal length (like a rectangle) but its angles are not each 90° , it is a parallelogram. Since a parallelogram and a rectangle only differ in their angles, you can solve for the perimeter of a parallelogram the same way you solve for the perimeter of a rectangle. Finding the area of a parallelogram is a little more involved, however. You calculate a parallelogram's area by multiplying its base by its height. If you're not given the height of a parallelogram, you can solve for it by creating a triangle out one of the sides of the parallelogram, the height, and part of the base. You'll need to be given part of the base, but if you need to solve for the base of a parallelogram to solve an SAT Math problem, you'll be given enough information to do so in the problem. You're not likely to be asked to solve for the diagonal of a parallelogram because the two triangles this creates are not necessarily right triangles. This means that you cannot employ the Pythagorean theorem to solve for the length of the diagonal.

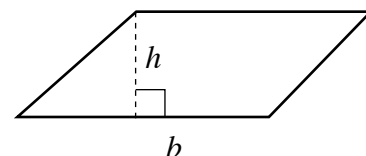

$$A = b \times h$$

$$P = 2w + 2l$$

Sample Question

What is the area of the parallelogram shown below?

- A. 15 cm^2
- B. 36 cm^2
- C. 60 cm^2
- D. 72 cm^2

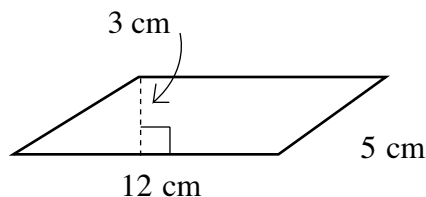

The trick to getting this question correct is to remember the formula and not use the wrong numbers in it! The area of a parallelogram is calculated by multiplying its base and its height, not by multiplying the lengths of its two different sides. If you do that, you'll get answer choice C, but C is incorrect. Similarly, you don't want to multiply the base by the shorter side, which will get you answer choice A, a different incorrect answer. The height of this parallelogram is 3 cm and its base is 12 cm; multiplying these, you get 36 cm^2 , B.

Trapezoids

Trapezoids are perhaps the most complex quadrilateral you'll have to deal with on the SAT Math test. One pair of opposing sides in a quadrilateral are of equal length, but the other pair of sides (the top and the bottom of the shape) are of different lengths. The angles are determined by the relationship between the sides, and since the sides can relate to one another in different ratios, the angles are not consistent between shapes. The only thing we can confidently say about the angles of a trapezoid is what we can say about all quadrilaterals: that they sum to 360° .

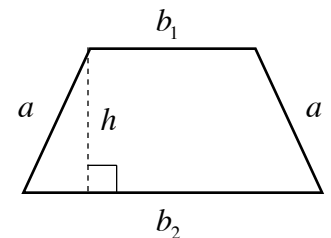

$$A = \frac{b_1 + b_2}{2} \times h$$

$$P = a + a + b_1 + b_2$$

Calculating the perimeter of a trapezoid means summing each of the sides. You may find that it's best to do this as an addition problem, not a multiplication problem, so that you don't forget to account for each of the different bases. Finding the area of a trapezoid means taking the average of the two bases and multiplying it by the height. Like when working with a parallelogram, you may need to solve for the height. The SAT Math test may covertly convey the height of a trapezoid as the difference between the shorter and longer base, as in the sample problem below. Watch out for this particular scenario: it's easy to miss that the information you need!

Sample Question

The area of the trapezoid shown below is 72 cm^2 . What is the length of side x ?

(Shape not drawn to scale).

- A. 15 cm
- B. 16 cm
- C. 17 cm
- D. 18 cm

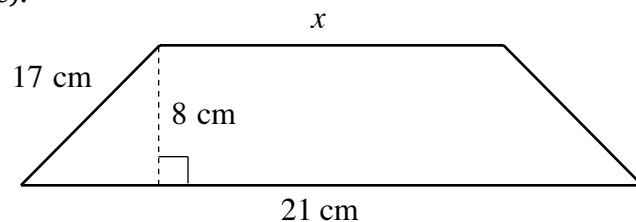

In this problem, we need to work backwards. We're given the area of the trapezoid and asked to solve for one of its bases—the shorter one. This may seem imposing, especially because calculating a trapezoid's area requires averaging the bases. Let's substitute the information we know into the equation for the area of a trapezoid and see if we can solve for the missing base.



$$A = \frac{b_1 + b_2}{2} \times h$$
$$72 \text{ cm}^2 = \frac{x + 21 \text{ cm}}{2} \times 8 \text{ cm}$$

At this point, we can use algebra to rearrange the equation and solve for x .

$$\frac{72 \text{ cm}^2}{8 \text{ cm}} = x + \frac{21 \text{ cm}}{2}$$
$$\frac{72 \text{ cm}^2}{8 \text{ cm}} \times 2 = x + 21 \text{ cm}$$
$$x = \frac{144 \text{ cm}^2}{8 \text{ cm}} \times 2 - 21 \text{ cm}$$
$$x = 15 \text{ cm}$$

A is the correct answer.



Circles

Circles are two-dimensional shapes that lack straight edges. Before we begin solving questions involving circles, we must first gain a basic understanding of circles and the measurements that are commonly referenced when manipulating them mathematically.

Radius

The radius (r) of a circle is any straight line spanning from the center of the circle, indicated by the point in the figure below, to any point on the circumference (edge) of the circle. A circle has infinite radii, all of which are the same length, and this value is important in many calculations involving circles.

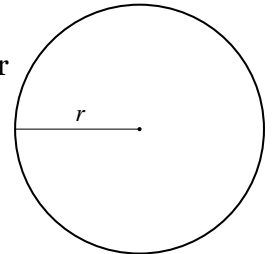

Diameter

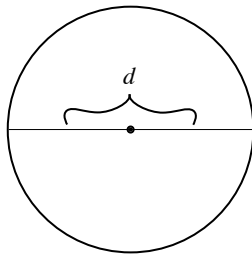

A diameter of a circle is any straight line from one end of the circle to the other end that passes through the center of the circle. Like with radii, a circle has an infinite number of diameters. This measure is also useful in circle calculations. It can be directly used when finding the circumference of a circle, and can also be used to find the radius of a circle. (Recall that the length of the diameter is always twice that of the radius).

Introducing Pi (π)

When working with circles mathematically, you will need to work with π . Quite simply, π is the ratio of the circumference of a circle to its diameter. π is roughly equivalent to 3.14. While that's a nice bit of information to have, it is often just better to think of π as π , i.e., as a number just as actual as 1 or 2. This can take some getting used to, but it results in much more accurate calculations.

π is the key to calculating the area or circumference of any circle. This is conveyed by the equations for the area and circumference of a circle, which are provided for you in the SAT's *Given Equations* section in the form shown at right.

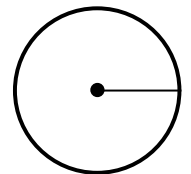

$$A = \pi r^2$$

$$C = 2\pi r$$

In addition, π enables you to calculate the volume of three-dimensional forms, like cylinders and spheres, but we'll talk about that more later.

Answering in Terms of Pi: Don't Let It Throw You Off!

It will actually save you time in most instances, whether you are taking the SAT or not, simply to calculate answers to mathematical problems dealing with circles in terms of π . Many questions give answer choices in terms of π , so using π directly can help you streamline your problem-solving process and save valuable time! Just remember to treat π as a variable with a defined value instead of as a unit. Saying " 3π " isn't like saying "3 meters" or "3 inches"—saying " 3π " is similar to saying " $3x$," with the implication that $x \oplus 3.14$.



Area of a Circle

The area of a circle is defined as $A = \pi r^2$. This means that you can calculate the area of a circle as long as you know (or can calculate) the diameter or radius of that circle. The inverse of this statement is also true: if you know the area of a circle, you can calculate its diameter and radius.

Sample Question

What is the radius of a circle with an area of 110.25 ft^2 ?

- A. -33.5 ft
- B. 33.5 ft
- C. -25 ft
- D. 25 ft

Use the equation for the area of the circle to solve for radius:

$$A = \pi r^2$$
$$r = \sqrt{\frac{A}{\pi}}$$

Plug in and simplify:

$$r = \sqrt{\frac{110.25\pi \text{ ft}^2}{\pi}}$$
$$r = 10.5 \text{ ft}$$



Circumference

Knowing radius and/or diameter also allows you to calculate another circle measurement: circumference. Circumference is the linear distance around a circle. Another word for circumference is “perimeter.” While you may think of perimeter as relating to quadrilaterals and triangles, it applies to circles as well—we just use a more specific name for it in this context. Mathematically, circumference is defined as $d\pi$, where d is the diameter of the circle. If you’re given radius instead, just double it to find the diameter. Alternatively, adjust the formula so that it is written in terms of radius: $2r\pi$.

Sample Question

Joe is walking around a circular pond because the bridge connecting the two opposite ends is out of order. He knows that the bridge is 300 feet long. How far does Joe walk to get to the other side of the lake?

- A. 300 ft
- B. 22,500 ft
- C. 150 ft
- D. 11,250 ft

First, realize that the bridge connecting the two opposite ends is a diameter, thus $d = 300$ ft. Since Joe has to walk around the pond, not through it, we know we are dealing with circumference. The circumference of this pond is:

$$C = d\pi = 300\pi \text{ ft}$$

This is not our final answer, though. Joe does not walk all the way around the pond; rather, he walks around half of it, to the other side (i.e., half of the circumference). Thus, to get our final answer, we divide the circumference by two: C, 150 ft.

Sample Question

Sophia is riding her bicycle across a basketball court. She knows her bicycle wheel has a radius of 1 ft and that the basketball court is about 94 ft long. Approximately how many times does her bicycle wheel rotate over the course of her ride across the basketball court?

- A. 28 times
- B. 30 times
- C. 36 times
- D. 45 times

First, we must notice that each time Sophia’s bicycle wheel makes a full rotation, she travels a linear distance of one circumference across the court. Find the circumference of her wheel:



$$C = d\pi = 2r\pi = 2(1)\pi = 2\pi \text{ ft}$$

Now divide the length of the entire basketball court by the diameter of the wheel in order to find the number of revolutions/turns/circumferences Sophia's wheel must complete to get her to the other side.

$$\frac{94 \text{ ft}}{2\pi \text{ ft}} \approx 30 \text{ revolutions}$$

revolution

Tangent

A tangent is a line that intersects a circle at exactly one point. A tangent is shown at the bottom of the circle below, and the point at which it intersects with the circle is marked in red. Note that a radius drawn to a tangent is perpendicular to it.

Sample Question

There is a circle on a coordinate plain. Its perimeter passes through the point $(1,0)$. At this point meets a tangent line, which also passes through the point $(5,7)$. What is the slope of the line perpendicular to this tangent line?

- A. $-\frac{4}{7}$
- B. $\frac{4}{7}$
- C. $-\frac{7}{4}$
- D. $\frac{7}{4}$

In this kind of problem, it's important to keep track of information given about your line of interest. In this case, the coordinates given set up the stage for us to be able to get to our line of focus—the line perpendicular to the tangent line. In order to determine the perpendicular line's slope, the tangent line's slope must be calculated. Keeping in mind that:

$$\text{slope} = \frac{\text{rise}}{\text{run}} = \frac{\Delta y}{\Delta x} = \frac{y_2 - y_1}{x_2 - x_1}$$

where (y_1, x_1) and (y_2, x_2) are assigned arbitrarily as long as the order of assignment is maintained.



$$\frac{y_2 - y_1}{x_2 - x_1} = \frac{7 - 0}{5 - 1} = \frac{7}{4}$$

$\frac{7}{4}$ is the slope of the tangent line. To calculate the perpendicular line, we have to remember that the product of the tangent slope and the perpendicular slope will equal -1 .

$$\frac{7}{4} \times \frac{?}{?} = -1$$

The slope of the perpendicular line always ends up being the opposite reciprocal of the initial line's slope. That is, you flip the fraction upside down and change its sign. In this case, the perpendicular slope is $-\frac{4}{7}$, so the correct answer is A.

Central Angles

A central angle of a circle is an angle whose vertex is the center of the circle (C) and whose legs are radii. Note that the sum of the measures of the central angles of a circle is always 360° . The figure below illustrates the central angle $\angle YCZ$, while \overline{CY} and \overline{CZ} are radii. Note that the measure of the central angle is equal to the measure of the inscribed arc, that is, $m\angle YCZ = m\widehat{YZ}$. Furthermore, note that the central angle is always one of two angles created in a circle, depending which direction you travel around the circle from the first point on the circumference to the second point on the circumference. By definition, the central angle is the smaller of the two, so it can be a maximum of 180° .

Sample Question

$\widehat{AO} = 15$ cm and $\widehat{ADC} = 18\pi$ cm. What is the measure of $\angle AOC$? (Figure not drawn to scale).

- A. 125°
- B. 133°
- C. 144°
- D. 152°

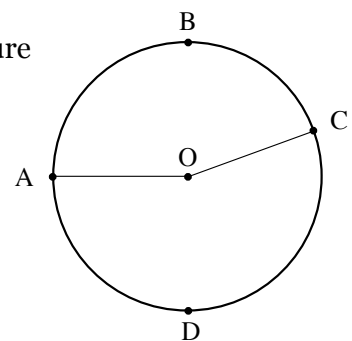

Since the measure of a central angle is equal to the measure of the corresponding inscribed arc, all we need to do to solve this problem is calculate the circumference of the circle and subtract the given measure of \widehat{ADC} from it to find \widehat{ABC} . From there, we can create a proportion that compares arc length to central angles that will allow us to find $\angle AOC$. Doing this, we find that the correct answer is C:



$$C = d\pi = 2r\pi = 2(15)\pi = 30\pi$$

$$30\pi - 18\pi = 12\pi$$

$$\frac{12\pi}{30\pi} = \frac{AOC}{360^\circ}$$

$$12\pi \times 360^\circ = 30\pi \times AOC$$

$$AOC = \frac{12\pi \times 360^\circ}{30\pi}$$

$$AOC = 144^\circ$$

Chords and Inscribed Angles

To understand what an inscribed angle is, we must first understand what a chord is. A chord is a line segment that connects any two points on the circumference of a circle. This means that a chord does not necessarily pass through the center of the circle, and thus does not necessarily represent the circle's diameter. Now, an inscribed angle is an angle whose vertex is anywhere on the circumference of the circle, and its legs are chords, intersecting two distinct points on the circumference of the circle. In the circle shown at right, \overline{AB} and \overline{BC} are chords, and angle $\angle ABC$ is an inscribed angle.

Sample Question

A circle has a maximum chord length of 16 inches. What is its radius in inches?

- A. 6 in
- B. 7 in
- C. 8 in
- D. 9 in

Keep in mind that the largest possible chord of a circle is its diameter. This means that the diameter of the circle is 16 inches, which means an 8-inch radius.

Remember that $d = 2r$:

$$16 = 2r$$

$$\frac{16}{2} = \frac{2r}{2}$$

$$r = 8$$



Arc Length

An arc is a portion of the circumference of a circle. The arc length is the measure of the linear distance covered by an arc. The legs of both central and inscribed angles intersect the circumference of the circle, forming arcs.

In the figure above, the *measure* of \widehat{YZ} is 36° since the measure of the central angle that forms that arc is also 36° . The *length* of \widehat{YZ} is a part of the circumference of the entire circle.

Sample Question

Use the given radius and central angle measure to find the length of \widehat{YZ} .

- A. 0.75π m
- B. π m
- C. 1.25π m
- D. 1.50π m

To find the length of \widehat{YZ} , we need some information. The first step to finding the arc length is to find the circumference in meters:

$$C = \pi d = 2\pi r$$

$$C = 10\pi \text{ m}$$

Now that we know the circumference of the whole circle is 10π m, we use the given information regarding the measure of the central angle \widehat{YZ} to find the proportion of the entire circle that makes up the arc \widehat{YZ} . To do this, we set up a proportion relating the following two ratios: 1) the length of arc \widehat{YZ} to the length of the entire circle (circumference) and 2) the measure of the inscribed arc to the total measure of the entire circle:

$$\frac{\widehat{YZ}}{10\pi \text{ m}} = \frac{36^\circ}{360^\circ}$$

We may solve by cross-multiplying, or we can notice that the right side of the equation simplifies to $\frac{1}{10}$ and then solve to make the left side of the equation also equal to $\frac{1}{10}$. No matter which method is used, our answer is $\widehat{YZ} = \pi$ m. In other words, since the arc measure (which is equal to the measure of the central angle) is $\frac{1}{10}$ of the measure of entire circle (360°), the arc length is also $\frac{1}{10}$ of the length of the circumference ($C = 10\pi$ m).



Area of a Sector

A sector is a portion of a circle enclosed by two radii and an arc. In other words, it is a “slice of the pie,” if the pie were two-dimensional. In the circle below, the measure of the central angle (60°) is equal to the measure of the intercepted arc. Sector YCZ is a portion of the entire circle.

What portion of the entire circle is sector YCZ? $\frac{60^\circ}{360^\circ} = \frac{1}{6}$ because the central angle that makes up the sector has a measure of 60° , and the central angles of a circle always equal 360° . Thus, to find the area of any sector, we must set up an equation relating these two ratios: 1) central angle of the sector to the sum of all central angles in the circle, and 2) area of the sector to area of the whole circle. Mathematically:

$$\frac{60^\circ}{360^\circ} = \frac{\text{Area of Sector YCZ}}{\pi 9^2 \text{ m}}$$

$$\frac{1}{6} = \frac{\text{Area of Sector YCZ}}{81\pi \text{ m}^2}$$

Cross-multiply and simplify.

$$6(\text{Area of Sector YCZ}) = 81\pi \text{ m}^2$$

$$\text{Area of Sector YCZ} = \frac{81\pi \text{ m}^2}{6}$$

$$\text{Area of Sector YCZ} = 13.5\pi \text{ m}^2$$

Sample Question

Dave claims to have only eaten 120° of a circular apple pie that has a radius of 7.8 cm. When looking at the leftover pie from the top, it is found that $23.14 \neq \text{cm}^2$ of the flat plate underneath the pie is exposed in the area that Dave ate. Did Dave truly eat 120° of the pie?

- A. Yes, he ate exactly 120° of the pie.
- B. No, he ate less than 120° of the pie.
- C. No, he ate more than 120° of the pie.
- D. No, he ate more than 120° of the pie—he ate exactly 180° of the pie.

The question asks us to find the proportion of the pie that Dave ate—the area of a sector. Since we are given radius, we can find the area of the circle.

$$A_{\text{Pie}} = \pi \times (7.8 \text{ cm})^2$$

$$A_{\text{Pie}} = 60.84\pi \text{ cm}^2$$



Since the measure of all angles of the circle equal 360° , we find that $\frac{120^\circ}{360^\circ} = \frac{1}{3}$.

Now, we must divide the area of pie that Dave ate (which is given directly in the question) by the area of the whole pie to determine the proportion of pie he really ate.

$$\frac{23.14\pi \text{ cm}^2}{60.84\pi \text{ cm}^2} = 0.38$$

Since we know that $0.38 < \frac{1}{3}$, we determine that Dave actually ate *more* than

$\frac{1}{3}$ (one third) of the pie. We can tell that he did not eat exactly $\frac{1}{2}$ of the pie, as $\frac{180^\circ}{360^\circ} = 0.5$ and $0.38 \neq 0.5$. So, the correct answer is C.

Sample Question

What is the measure of the central angle of the piece of pie Dave ate?

- A. 133.4°
- B. 136.8°
- C. 138.9°
- D. 140.3°

We solve this by converting the proportion of the entire pie that Dave ate (0.38) into an angle by multiplying it by 360° .

Clock Math

The SAT may ask you to apply your knowledge of circle geometry to situations specific to clocks. The test isn't asking if you know how to tell time, but whether you are able to figure out various angles and arcs of a circle. Don't let these questions throw you off: at this point, you have all of the knowledge of circles you need to solve them, even if they seem somewhat unfamiliar.

Sample Question

What is the measure, in degrees, of the acute angle formed by the hands of a twelve-hour clock that reads exactly 3:10?

- A. 30°
- B. 35°
- C. 40°
- D. 45°



One hand is pointing at the 2, while the other is pointing at the 3, so they're $\frac{1}{12}$ of a 360° circle apart (there are 12 numbers on a typical clock), right? $\frac{360}{12} = 30$, so the answer must be 30°, right?

Not so fast. The entire clock measures 360°. As the clock is divided into twelve sections, the distance between each number is equivalent to $30^\circ \left(\frac{360^\circ}{12} \right)$. The distance between the two and the three on the clock is 30°. One has to account, however, for the ten minutes that have passed. Ten minutes is $\frac{1}{6}$ of an hour, so the hour hand has also moved $\frac{1}{6}$ of the distance between the three and the four, which adds $5^\circ \left(\frac{1}{6} \text{ of } 30^\circ \right)$. The total measure of the angle, therefore, is B: 35°.

That's right, the hour hand is moving too: five degrees every ten minutes. Forgetting to account for the movement of the hour hand is what trips up most students dealing with clock math, which is otherwise easy. Here's another for practice:

Sample Question

On a standard analog clock, what is the angle between the hands when the clock reads 11:20? Give the smaller of the two angles.

- A. 60°
- B. 70°
- C. 75°
- D. 80°

To find the degrees of a clock hand, first find the angle between each hour-long sections. Since there are 12 evenly spaced sections, we find that each section has an angle of $\frac{360^\circ}{12} = 30^\circ$. At 11:20, the hour hand has gone one-third of the way between the 11 and the 12. Thus, there are two-thirds of 30° between the hour hand and the 12. $\frac{2}{3} \times 30^\circ = 20^\circ$. There are 60° between 12 and 2, where the minute hands is. Thus, there's a total of $20^\circ + 60^\circ = 80^\circ$ between the hands. The correct answer is D.



Three-Dimensional Geometry

While problems testing your knowledge of three-dimensional geometry don't compose the majority of the SAT Math test, you're likely to encounter a few when you sit for your exam. Three-dimensional problems go one step farther than problems about simple flat shapes like squares and circles. By adding an additional dimension into play, they require knowledge of different formulae while retaining all of the complexity of the two-dimensional shapes with which their three-dimensional shapes correlate.

This lesson will cover information associated with cubes, prisms, pyramids, cones, cylinders, and spheres. It will also discuss how to calculate certain attributes of three-dimensional shapes for which you may be asked to solve, from the obvious and familiar ones like volume and surface area to the more obscure ones like lateral area, the area of inscribed objects, and negative space. Reviewing approaches to solving for these different details can help you confidently approach any three-dimensional geometry on your revised SAT.

Cubes

The cube is a common shape that has some specific and unique attributes certain questions may require you to be familiar with. A cube is created by the connection of 6 square faces. Since a cube is made up of squares of the same size, we can infer that all the side lengths of a cube are equal. Furthermore, a cube is composed of 12 lines and 8 vertices. Questions regarding cubes often ask you to solve for the volume or surface area.

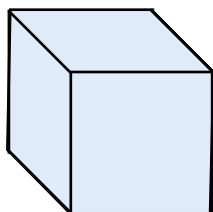

The formula for the volume of a cube is as follows. Volume is a representation of the amount of space that the shape takes up. You can also think of it as the amount of liquid that could fill the three-dimensional shape.

$$V_{cube} = l \cdot w \cdot h = s^3$$

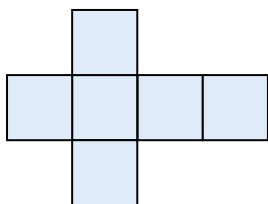

The surface area can be thought of as the wrapping around the object. In the case of the cube, the surface area is the sum of the area of the faces.

$$SA_{cube} = 6s^2$$

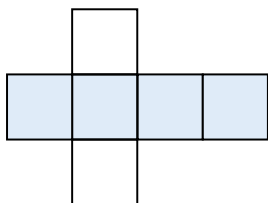

Questions about cubes may also ask you to solve for lateral area, though they might not use that specific phrase; instead, they may ask you to solve for the surface area that a label around a cube's middle covers, or how much space must be painted in a room for its walls to be repainted. In this case, remember that you just want to calculate the surface area of four sides. You can do this by finding the surface area of one side and multiplying it by four, or by adjusting the formula for surface area appropriately so that it applies to four sides instead of six.

$$LA_{cube} = 4s^2$$



Some questions may ask you to find a percentage of a cube's volume or surface area; this requires a two-step process. The first step is to calculate the total value using the relevant equation. After the calculation is made, one can either use decimals or fractions to perform the necessary algebraic operations to find the desired percentage.

Sample Question

A cube has a volume of 64 cm^3 . If the side length is expressed as $x - 6$, what is the value of x ? Calculate the surface area of the cube.

- A. 72 cm^2
- B. 80 cm^2
- C. 84 cm^2
- D. 96 cm^2

Step 1: Use the formula for volume and work backwards.

$$V = 64 \text{ cm}^3$$

$$V = s^3$$

$$64 \text{ cm}^3 = s^3$$

$$\sqrt[3]{64 \text{ cm}^3} = s$$

$$4 = s$$

Step 2: Use the given expression and the side length found in step 1 to solve for the missing variable.

$$4 = x - 6$$

$$x = 10$$

Step 3: Calculate surface area by using the length of the side found in step 1.

$$SA = 6s^2$$

$$SA = 6(4)^2$$

$$SA = 6(16)$$

$$SA = 96 \text{ cm}^2$$

The correct answer is D.



Sample Question

Johnny is painting a room in his house where the wall are all square. One wall takes roughly two gallons of paint and one gallon of paint covers 32 ft^2 . If there are four walls in the room that Johnny is painting, approximately how many square feet does he paint?

- A. 216 ft^2
- B. 224 ft^2
- C. 256 ft^2
- D. 264 ft^2

Step 1: Identify what the question is asking for.

In this particular case, a room is made up of four walls therefore, we are being asked to find the lateral surface area of a cube.

Step 2: Identify what is known.

$$1 \text{ wall} = 2 \text{ gallons}$$

$$1 \text{ gallon} = 32 \text{ ft}^2$$

therefore

$$1 \text{ wall} = 2(32 \text{ ft}^2) = 64 \text{ ft}^2$$

Since a cube is made up of all square faces, then

$$A = 64 \text{ ft}^2$$

$$A = s^2$$

$$s = 8 \text{ ft}$$

Step 3: Find lateral surface area given what is known.

$$SA = 4s^2$$

$$SA = 4(8^2)$$

$$SA = 4(64)$$

$$SA = 256 \text{ ft}^2$$

To quicken this calculation, recall that $SA = 4A$.



Prisms

There are two types of prisms: rectangular and triangular. These prisms differ in the shapes that form their bases. If a prism's base is made up of a triangle, it is classified as a triangular prism. If its base is a rectangle, it is called a rectangular prism.

Rectangular prisms are objects that have either a square or rectangular face on two opposite sides. Rectangular prisms are similar to cubes when it comes to the number of lines, vertices, and faces they involve; however, the key difference is that not all of the lines have the same length. You can think of a rectangular prism as a cube that has been stretched in one of its dimensions. When it comes to calculating the surface area and lateral surface area of the prism, the orientation of the prism affects the calculation!

Volume

$$V = l \cdot w \cdot h$$

Surface Area

$$SA = 2lw + 2lh + 2wh = 2(lw + lh + wh)$$

Lateral Area

$$LA = 2hw + 2lh = 2(hw + lh)$$

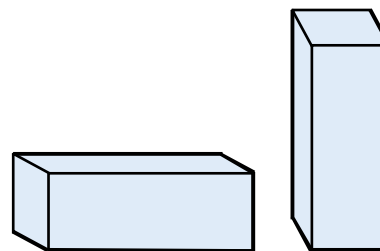

Let's look at a question about a rectangular prism before going over one about a triangular prism.

Sample Question

Sally has a fish tank shaped like a rectangular prism. It has a width that is three times its length and twice its height. If the tank is 75% full when holding 3375 cm^3 of water, what are the dimensions of the tank?

- A. $l = 10 \text{ cm}$, $w = 30 \text{ cm}$, $h = 15 \text{ cm}$
- B. $l = 12 \text{ cm}$, $w = 36 \text{ cm}$, $h = 12 \text{ cm}$
- C. $l = 8 \text{ cm}$, $w = 24 \text{ cm}$, $h = 15 \text{ cm}$
- D. $l = 15 \text{ cm}$, $w = 15 \text{ cm}$, $h = 25 \text{ cm}$

Step 1: Identify what is known.

$$V = l \cdot w \cdot h$$

$$w = 3l$$

$$w = 2h$$

$$3375 = 0.75V$$



Step 2: Set up equations and manipulate to solve for the dimensions.

$$3375 = 0.75V$$

$$\frac{3375}{0.75} = V$$

$$V = 4500$$

$$4500 = lwh$$

$$\frac{w}{2} = h \rightarrow \frac{3l}{2} = h$$

$$4500 = l(3l)\left(\frac{3l}{2}\right)$$

$$4500 = \frac{9l^3}{2}$$

$$9000 = 9l^3$$

$$1000 = l^3$$

$$l = 10$$

Step 3: Substitute the value for the length to find the width and height.

$$l = 10$$

$$w = 3l = 3(10) = 30$$

$$w = 2h$$

$$30 = 2h$$

$$\frac{30}{2} = h$$

$$h = 15$$

Step 4: State solution

The dimensions of the tank are length 10 cm, width of 30 cm, and height of 15 cm, so the correct answer is A.



Triangular prisms are made up of 9 lines and 6 vertices. They contain 2 triangular faces and 3 rectangular faces.

Volume

$$V = \frac{1}{2} a \cdot c \cdot h$$

a = height of the triangular base
 c = side length of triangle
 h = height of the prism

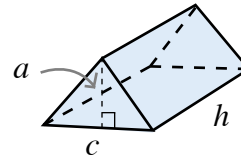

Surface Area

$$SA = 2(A_t) + A_{l1} + A_{l2} + A_{l3}$$

A_t = area of the triangle faces

A_{l1} , A_{l2} , and A_{l3} = the areas of each of the rectangular faces

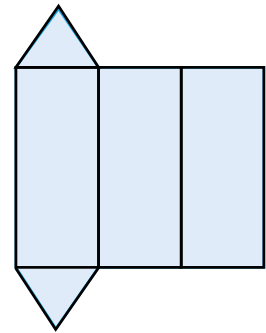

Sample Question

Diane is creating a triangular prism and wants to know how many jelly beans can fill the object. The triangular base has a side length of 4 in and a height of 3 in. The height of the prism is 10 in and 20 jellybeans fill 25 in^3 . Approximately how many jellybeans will fill the prism?

- A. 48
- B. 52
- C. 60
- D. 64

Step 1: Calculate the volume of the prism.

$$V = \frac{1}{2} bhH$$

$$b = 4$$

$$h = 3$$

$$H = 10$$

$$V = \frac{1}{2}(4)(3)(10)$$

$$V = \frac{1}{2}12(10)$$

$$V = \frac{1}{2}120$$

$$V = 60$$

The prism's volume is 60 in^3 .



Step 2: Calculate the number of jelly beans that fit in the prism

Knowing the volume of the prism, we can proceed to solve for how many jelly beans will fill it. We know that 20 jelly beans fill 25 in^3 of space, so we can set up a proportion to solve for how many jelly beans fill 60 in^3 of space:

$$\frac{20 \text{ jelly beans}}{25 \text{ in}^3} = \frac{x \text{ jelly beans}}{60 \text{ in}^3}$$

To solve, we need to cross-multiply and solve for x :

$$1200 = 25x$$

$$\frac{1200}{25} = x$$

$$x = 48$$

Approximately 48 jelly beans would fit in the prism described, so A is the correct answer.

Pyramids

Pyramids have two different types depending on the shape of the base, triangular or square. For triangular base pyramids, the three dimensional object is created by four triangular faces. Rectangular based pyramids are created from four triangular faces and one rectangular face.

Triangular-base pyramids have six lines, four vertices, and four faces.

Volume

$$V = \frac{1}{3} \frac{1}{2}bh \quad H = \frac{1}{6}bhH$$

b = base of the triangle
 h = height of the triangular face
 H = height of the pyramid

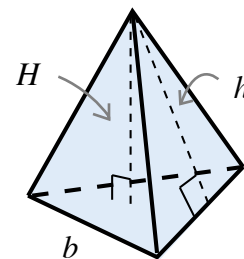

Surface Area

$$SA = 4 \frac{1}{2}bh = 2bh$$



Sample Question

Hannah has a die in the shape of a triangular pyramid. The side length of one of the triangular faces is 2 cm and its height is 1.732 cm. The height from the base of the pyramid to the top of the pyramid is 4 cm. How much volume does the die have?

- A. 2.236 cm³
- B. 2.309 cm³
- C. 2.405 cm³
- D. 2.525 cm³

Step 1: Identify what the question is asking for.

$$\text{Triangular Pyramid Volume: } \frac{1}{3} \left(\frac{1}{2} bh \right) H$$

Step 2: Identify the variables.

$$b = 2$$

$$h = 1.732$$

$$H = 4$$

Step 3: Substitute the variable into the volume equation.

$$V = \frac{1}{3} \left(\frac{1}{2} (2)(1.732) \right) (4)$$

$$V = \frac{1}{3} (1.732)(4)$$

$$V = 2.309 \text{ cm}^3$$

The correct answer is B.

Square-base pyramids have 8 lines, 5 vertices, and 5 faces.

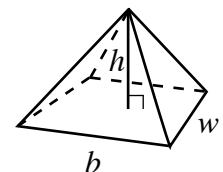

Volume

$$V = \frac{b^2 h}{3}$$

b = base length

Surface Area

$$SA = b^2 + 2b \sqrt{\frac{b^2}{4} + h^2}$$

b = base edge
 h = height

Lateral Area

$$LA = 2b \sqrt{\frac{b^2}{4} + h^2}$$

b = base edge
 h = height



Sample Question

The square pyramid on a miniature golf course has a volume of 20 square feet. What is the lateral surface area of the pyramid if the length and width of the base are 13 less than the height?

- A. 12 in^3
- B. 16 ft^3
- C. 18 ft^3
- D. 20 ft^3

Step 1: Identify what the question is asking for.

$$LA = 2b\sqrt{\frac{b^2}{4} + h^2}$$

Step 2: Identify the variables and what is given.

$$V = \frac{b^2h}{3} = 20 \text{ ft}^3$$

$$b = h - 13$$

Step 3: Substitute in the variables to solve for the dimensions.

$$20 = \frac{(h-13)^2h}{3}$$

$$60 = h(h-13)^2$$

$$60 = h(h-13)(h-13)$$

$$h = 15$$

$$b = h - 13 = 15 - 13 = 2$$

Step 4: Substitute in the values found in step 3 and solve for lateral area.

$$LA = 2b\sqrt{\frac{b^2}{4} + h^2}$$

$$b = 2$$

$$h = 15$$

$$LA = 2(2)\sqrt{\frac{2^2}{4} + 15^2}$$

$$LA = 4\sqrt{1 + 225}$$

$$LA = 4\sqrt{226} \text{ ft}^2$$

D is the correct answer.



Cones

Cones are unique three dimensional objects that have a circular base and only one vertex which occurs at the tip of the cone. Also, if a cone was to be cut from the tip of the vertex to the edge of the circular base, then two dimensional object that would result would be a rectangle.

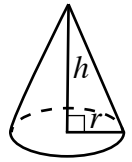

Volume

$$V = \pi r^2 \frac{h}{3}$$

Surface Area

$$SA = \pi r(r + \sqrt{r^2 + h^2})$$

Lateral Area

$$LA = \pi r \sqrt{r^2 + h^2}$$

Sample Question

Tommy has an ice cream cone that is four inches long with a diameter of two inches. How much ice cream can fill the cone?

- A. $\frac{1}{4} \pi \text{ in}^3$
- B. $\frac{1}{2} \pi \text{ in}^3$
- C. $\frac{4}{3} \pi \text{ in}^3$
- D. $\frac{5}{4} \pi \text{ in}^3$

Step 1: Identify the variables given

$$r = \frac{1}{2} \cdot 2 = 1$$

$$h = 4$$

Step 2: Substitute the values from step 1 into the volume formula.

$$V = \pi r^2 \frac{h}{3}$$

$$V = \pi 1^2 \frac{4}{3}$$

$$V = \frac{4\pi}{3}$$

The correct answer is C.



Cylinders

Cylinders are another class of unique three dimensional objects, which only contain two lines that each create the circumference of the two circular bases of the object. Similar to a cone, if a cylinder is cut from one circumference to the other, the two dimensional object that is created is a rectangle.

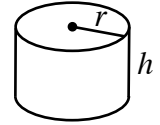

r = radius
 h = height
 V = volume

Volume	Surface Area	Lateral Area
$V = \pi r^2 h$	$SA = 2\pi r h + 2\pi r^2$	$LA = 2\pi r h$

Sample Question

A can of peaches has a label that stretches all around it. If the height of the can is 5 inches and the length across the can is 3 inches what is the area of the label?

- A. $8\pi \text{ in}^2$
- B. $10\pi \text{ in}^2$
- C. $12\pi \text{ in}^2$
- D. $15\pi \text{ in}^2$

Step 1: Identify what the question is asking for.

Area of the label means the lateral area of the cylinder.

$$SA_L = 2\pi r h$$

$$SA_L = 2\pi(1.5)(5)$$

$$SA_L = 15\pi \text{ in}^2$$

The correct answer is D.



Spheres

Spheres can be described as the three dimensional equivalent of a circle. They have perfect symmetry, which means that all lines drawn from the center of the sphere to any point on the edge possess an equal length. Spheres are also unique three dimensional objects because they have no lines and no vertices: they are a completely smooth object.



r = radius
 V = volume

Volume

$$V = \frac{4}{3}\pi r^3$$

Surface Area

$$SA = 4\pi r^2$$

Sample Question

Jenny gave Melissa a basketball for her birthday and she wrapped it in decorative paper. If the basketball has a diameter of 6 inches, how much paper does Jenny use?

- A. 112π in²
- B. 124π in²
- C. 144π in²
- D. 160π in²

Step 1: Identify what the question is asking for.

A basketball is a sphere, when wrapping the outside of the sphere one is calculating the surface area.

Step 2: Substitute the values given into the surface area equation.

$$SA = 4\pi r^2$$

$$SA = 4\pi 6^2$$

$$SA = 4\pi 36$$

$$SA = 144\pi$$

C is the correct answer.



Inscribed Three-Dimensional Objects

Many standardized test including the SAT will gauge one's knowledge of three dimensional objects by increasing the complexity of questions. Inscribed objects is one way to add complexity to a question. The most common combinations of inscribed objects include spheres in cubes, cubes in spheres, pyramids in spheres, prisms in cylinders, and cylinders in prisms. Calculating the area of shaded regions of inscribed objects as well as negative space are additional ways test questions are made more complex. This added complexity also makes questions more computationally demanding. Negative space refers to the area or volume of an inscribed object that is not shaded or filled. It can be thought of as the compliment of the shaded region or that which is not shaded.

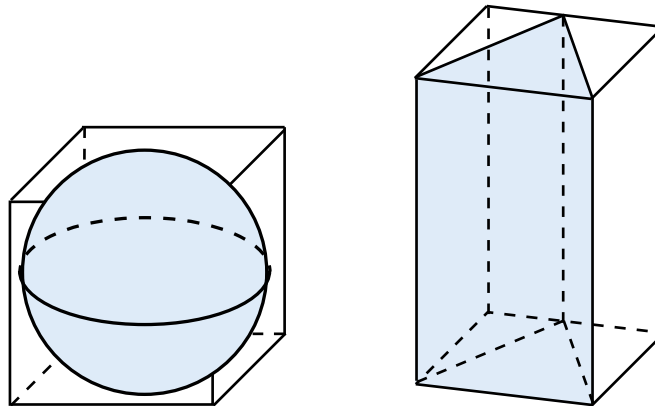

Sample Question

Suppose there is a sphere inscribed in a cube like the one shown above on the left. The cube has a side length of 8 cm. If the sphere is filled completely with water, what is the volume of the cube that is **not** filled with water?

- A. 243.93 cm³
- B. 252.54 cm³
- C. 264.25 cm³
- D. 270.42 cm³

Step 1: Calculate the volume of the sphere and cube.

$$V_{cube} = s^3 = 8^3 = 512$$

$$V_{sphere} = \frac{4}{3}\pi r^3$$

$$r = \frac{8}{2} = 4$$

$$V_{sphere} = \frac{4}{3}\pi 4^3 = 85.333\pi$$



Step 2: Take the difference between the cube's volume and the sphere's volume.

$$\text{Negative Volume} = V_{\text{cube}} - V_{\text{sphere}}$$

$$\text{Negative Volume} = 512 - 85.33\pi$$

$$\text{Negative Volume} \approx 243.93 \text{ cm}^3$$

The correct answer is A.



Trigonometry and Radians

Trigonometry is a branch of mathematics that primarily focuses on triangles and relationships between their side lengths and angles. The study of trigonometric relationships as well as algebraic techniques forms a foundation for applications in the natural and physical sciences. Many students find trigonometry topics challenging, as information can be presented in degrees or radians, and other core concepts like the unit circle and trigonometric identities may require students to combine their graphical and algebraic knowledge to understand new topics.

Trigonometry is not covered extensively on the 2016 SAT; along with plane geometry and complex numbers, it forms part of the “Additional Topics in Math” section represented by six questions total. Trigonometry is nonetheless an important branch of mathematics that you should feel confident working with in order to be fully prepared to answer each SAT Math question with which your particular test presents you. Understanding these relationships and practicing problems associated with them will help you to familiarize yourself with common topics that can appear on the SAT Math test. This section will introduce you to trigonometric operations identities, conversion between degrees and radians, and the unit circle. Practicing and mastering the skills covered in these lessons will help you to feel prepared on test day.

Section Outline

Trigonometric Operations

- Using the fundamental operations of trigonometry: sine, cosine, and tangent

Degrees, Radians, and the Unit Circle

- Establishing relationships between angle measurements and trigonometry in the unit circle

Trigonometric Identities

- Gaining familiarity with complex trigonometric calculations



Trigonometric Operations

Trigonometric operations are equations that involve trigonometric functions that hold true for all angles. The SAT will test you by giving you a complex equation, and you have to simplify by using algebra and trigonometric identities (see trigonometric identities table). Some of these exercises may seem trivial and their purpose not entirely clear at this point; however, they are crucial in understanding topics such as physical tension, magnitude and direction of forces, and geometric proofs. In physics these three identities can be used to find missing angles and sides based upon information given in the problem. The basic skills presented in this exercise, as well as the SAT, will help you build a foundation in trigonometry and mathematics.

Try to master your skills with the practice exercise presented below.

SOHCAHTOA

Trigonometry is based upon three primary relationships within a triangle. The mnemonic SOHCAHTOA has been commonly used to help students memorize the associations between the sine, cosine, and tangent in a right triangle. These trigonometric identities are used to find missing components of a right triangle.

SOH: Sine of θ equals **O**pposite side divided by the **H**ypotenuse

$$\sin \theta = \frac{opp}{hyp}$$

CAH: Cosine of θ equals **A**djacent side divided by the **H**ypotenuse

$$\cos \theta = \frac{adj}{hyp}$$

TOA: Tangent of θ equals **O**pposite side divided by the **A**djacent side

$$\tan \theta = \frac{opp}{adj}$$

These exercises may seem trivial and their purpose not entirely clear at this point; however, they are crucial in understanding topics such as physical tension, magnitude and direction of forces, and geometric proofs. In physics these three identities can be used to find missing angles and sides based upon information given in the problem. The basic skills presented in this exercise, as well as the ACT, will help you build a foundation in trigonometry and mathematics that is necessary for any career in medicine, engineering, and the sciences. Try to master your skills with the practice exercise presented below.

Practice Exercise

Find the sine, cosine, and tangent of the triangle pictured at right.

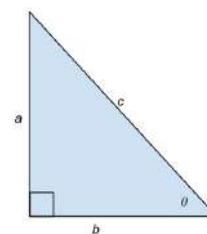

Find the sine of θ :

Remember SOHCAHTOA.

SOH: Sine of θ equals **O**pposite side divided by the **H**ypotenuse

$$\sin \theta = \frac{opp}{hyp}$$

In the figure, the side opposite of θ is side a and the hypotenuse is side c . In order to obtain the correct answer, substitute these variables into the above sine equation.

$$\sin \theta = \frac{a}{c}$$

Find the cosine of θ :

Remember SOHCAHTOA.

CAH: Cosine of θ equals **A**djacent side divided by the **H**ypotenuse

$$\cos \theta = \frac{adj}{hyp}$$

In the figure, the side adjacent to θ is side b and the hypotenuse is side c . In order to obtain the correct answer, substitute these variables into the above cosine equation.

$$\cos \theta = \frac{b}{c}$$

Find the tangent of θ :

Remember SOHCAHTOA.

TOA: Tangent of θ equals **O**pposite side divided by the **A**djacent side

$$\tan \theta = \frac{opp}{adj}$$

In the figure, the side opposite of θ is side a and the side adjacent to θ is side b . In order to obtain the correct answer, substitute these variables into the above tangent equation.

$$\tan \theta = \frac{a}{b}$$



Trigonometric Identities

In mathematics, trigonometry refers to the relationships between the angles and sides of triangles. As seen in the previous section, there are special relationships which are known as sine, cosine, and tangent. These are the foundational trigonometric relationships or identities, on which all other identities are built.

Reciprocal Identities (Trigonometric Ratios)

Since there are three foundational identities, there are also three reciprocal identities. Reciprocal identities are also known as trigonometric ratios because by definition, a reciprocal is a ratio where the numerator and denominator are switched. The three foundational identities along with their reciprocal identities are as follows. Notice that the reciprocal of sine is cosecant, the reciprocal of cosine is secant, and the reciprocal of tangent is cotangent.

$$\begin{aligned}\sin(x) &= \frac{\text{opp}}{\text{hyp}} & \csc(x) &= \frac{1}{\sin(x)} = \frac{\text{hyp}}{\text{opp}} \\ \cos(x) &= \frac{\text{adj}}{\text{hyp}} & \sec(x) &= \frac{1}{\cos(x)} = \frac{\text{hyp}}{\text{adj}} \\ \tan(x) &= \frac{\text{opp}}{\text{adj}} & \cot(x) &= \frac{1}{\tan(x)} = \frac{\text{adj}}{\text{opp}}\end{aligned}$$

Sample Question

Simplify $\sin(x)\cot(x)\csc(x)$.

- A. $\cot(x)$
- B. $\sec(x)$
- C. $\csc(x)$
- D. $\sin(x)$

Step 1: Write the cotangent and cosecant in terms of sines and cosines.

$$\sin(x) \frac{\cos(x)}{\sin(x)} \frac{1}{\sin(x)}$$

Step 2: Reduce fractions that have common factors. In this particular case, sine multiplied by cosecant will reduce to one.

$$\frac{\cos(x)}{\sin(x)}$$

Step 3: Rewrite term using the quotient identity: $\frac{\cos(x)}{\sin(x)} = \cot(x)$

The correct answer is A.



Sample Question

Simplify $\frac{1}{\csc(x)} \cos(x) \tan^2(x)$.

- A. $\tan(x) \csc(x)$
- B. $\tan(x) \cos^2(x)$
- C. $\tan(x) \sin^2(x)$
- D. $\tan^2(x) \sin(x)$

Step 1: Rewrite all terms in terms of sine and cosine.

$$\sin(x) \cos(x) \frac{\sin^2 x}{\cos^2 x}$$

Step 2: Reduce fractions that have common factors. In this particular case, the cosine in the numerator and one in the denominator will cancel.

$$\sin(x) \frac{\sin^2 x}{\cos(x)}$$

Step 3: Multiply numerators together.

$$\frac{\sin^3 x}{\cos(x)}$$

Step 4: Simplify terms using the quotient identity.

$$\tan(x) \sin^2(x)$$

Quotient Identities

Quotient identities are those in which one trigonometric function can be written as the quotient of two other trigonometric functions. There are only two functions that fit this criteria: tangent and cotangent.

$$\tan(x) = \frac{\sin(x)}{\cos(x)} \quad \cot(x) = \frac{\cos(x)}{\sin(x)}$$



Pythagorean Identities

Pythagorean identities are directly derived from the Pythagorean Theorem. There are three Pythagorean identities; however, knowing one of these identities allows one to find the other two through algebraic manipulation and the use of trigonometric ratios. The foundational Pythagorean identity uses the relationship of sine and cosine.

$$\sin^2 x + \cos^2 x = 1$$

Manipulating this equation can result in the other two Pythagorean identities, which use tangent, secant, cotangent, and cosecant.

$$1 + \tan^2 x = \sec^2 x$$

$$1 + \cot^2 x = \csc^2 x$$

Let's take a closer look at the algebraic manipulations performed on the sine-cosine identity that result in the other two Pythagorean identities:

1. $\boxed{\sin^2 x + \cos^2 x = 1}$

Step 1: First, multiply each term by $\frac{1}{\cos^2 x}$:

$$\frac{1}{\cos^2 x} \sin^2 x + \frac{1}{\cos^2 x} \cos^2 x = 1 \frac{1}{\cos^2 x}$$

Step 2: Reduce fractions and ratios.

Recall that $\tan(x) = \frac{\sin(x)}{\cos(x)}$ and $\sec(x) = \frac{1}{\cos(x)}$. Therefore, the equation becomes:

$$\tan^2 x + 1 = \sec^2 x$$

Step 3: Rewrite the equation to look like the Pythagorean identity:

$$1 + \tan^2 x = \sec^2 x$$

2. $\boxed{\sin^2 x + \cos^2 x = 1}$

Step 1: Multiply each term by $\frac{1}{\sin^2 x}$:

$$\frac{1}{\sin^2 x} \sin^2 x + \frac{1}{\sin^2 x} \cos^2 x = 1 \frac{1}{\sin^2 x}$$

Step 2: Reduce fractions and ratios.

Recall that $\cot(x) = \frac{\cos(x)}{\sin(x)}$ and $\csc(x) = \frac{1}{\sin(x)}$. Therefore, the equation becomes:

$$1 + \cot^2 x = \csc^2 x$$



Degrees, Radians, and the Unit Circle

When dealing with trigonometric functions, it is important to know how and when to convert between the two units of measurement, radians and degrees. Radians deal in terms of π while degrees are numerical values. The key to converting between these two measurements is knowing that $180^\circ = \pi$. Therefore, to convert a measurement from radians to degrees, simply multiply the measurement by 180 and then divide by π . To convert from degrees to radians, multiply the measurement by $\frac{\pi}{180}$ and then divide by 180. For example, convert 45° into radians. First, multiply $45 \cdot \frac{\pi}{180} = \frac{45\pi}{180}$. Now divide by 180. This results in the following expression:

$$\frac{45\pi}{180} = \frac{45\pi}{45 \cdot 4}$$

Since there is a common factor of 45 in the numerator and denominator, they cancel each other out, and the simplified radian form is $\frac{\pi}{4}$.

Now convert $\frac{2\pi}{3}$ into degrees. First, multiply the numerator by 180:

$$2\pi \cdot 180 = 360\pi$$

Now divide by the denominator times π .

$$\frac{360\pi}{3\pi} = \frac{3 \cdot 120\pi}{3\pi} = 120$$

Notice that the numerator can be factored, and that there is a common factor of 3π in both the numerator and denominator. These cancel, and the simplified degree measurement is 120.

Sample Question

Convert 210° to radians.

- A. $\frac{7\pi}{6}$
- B. $\frac{7\pi}{5}$
- C. $\frac{5\pi}{7}$
- D. $\frac{6\pi}{7}$

Step 1: Multiply the measurement by $\frac{\pi}{180}$.

$$210^\circ \cdot \frac{\pi}{180} = 210\pi$$



Step 2: Divide by 180. Remember to factor the numerator and denominator in order to reduce and simplify the fraction. In this particular case, there is a 30 in the numerator and in the denominator; thus, they reduce to one.

$$\frac{210\pi}{180} = \frac{30 \cdot 7\pi}{30 \cdot 6} = \frac{7\pi}{6}$$

A is the correct answer.

Sample Question

Convert $\frac{15^\circ}{8}$ to degrees.

- A. 216.5°
- B. 245.5°
- C. 320.5°
- D. 337.5°

Step 1: Multiply the numerator by 180.

$$\frac{15\pi \cdot 180}{8} = \frac{2700\pi}{8}$$

Step 2: Divide by the denominator times π . In this particular case, 4 is a common factor in both the numerator and denominator and thus cancels out.

$$\frac{2700\pi}{8\pi} = \frac{4 \cdot 675\pi}{4 \cdot 2\pi} = \frac{675}{2} = 337.5^\circ$$

The correct answer is D.

Unit Circle

The unit circle is an extremely helpful tool in solving trigonometric problems. For the purpose of trigonometry, the unit circle is located at the origin and has a radius of one unit. This is because right triangles can be formed using the x -axis as one leg of the triangle and the line from the origin to a point on the circle as the hypotenuse with a measurement of one. Therefore, the point on the circle has coordinates of $(\cos(x), \sin(x))$ for the angle that is created by the x -axis and the hypotenuse. It is important to know that $(x, y) = (\cos(x), \sin(x))$ and can be found using the triangle that is created on the unit circle. The unit circle is primarily used for angles with multiples of 30° , 45° , 60° , and 90° . It is also important to recall the signs for the different trigonometric functions in each quadrant. In quadrant one, all functions are positive.



In quadrant two, sine and cosecant are positive while the rest of the trigonometric functions are negative. In quadrant three, tangent and cotangent are positive and all other trigonometric functions are negative, and lastly, in quadrant four, cosine and secant are positive while the rest of the functions are negative. The (x,y) measurements in quadrant one will be the same in the other quadrants with the same basic angle, but with different signs based on the quadrant in which they are located.

The figure below has four different colored lines: black, red, blue, and yellow. The red lines are multiples of 30° or $\frac{\pi}{6}$, the blue lines are multiples of 45° or $\frac{\pi}{4}$, the yellow lines are multiples of 60° or $\frac{\pi}{3}$, and the black lines are multiples of 90° or $\frac{\pi}{2}$.

The $(x,y) = (\cos(x), \sin(x))$ measurements for these specific angles are as follows.

Quadrant II:

Red: $\angle \frac{5\pi}{6} = \left(-\frac{\sqrt{3}}{2}, \frac{1}{2}\right)$

Blue: $\angle \frac{3\pi}{4} = \left(-\frac{1}{\sqrt{2}}, \frac{1}{\sqrt{2}}\right)$

Yellow: $\angle \frac{2\pi}{3} = \left(-\frac{1}{2}, \frac{\sqrt{3}}{2}\right)$

Black: $\angle \pi = (-1, 0)$

Quadrant I:

Red: $\angle \frac{\pi}{6} = \left(\frac{\sqrt{3}}{2}, \frac{1}{2}\right)$

Blue: $\angle \frac{\pi}{4} = \left(\frac{1}{\sqrt{2}}, \frac{1}{\sqrt{2}}\right)$

Yellow: $\angle \frac{\pi}{3} = \left(\frac{1}{2}, \frac{\sqrt{3}}{2}\right)$

Black: $\angle \frac{\pi}{2} = (0, 1)$

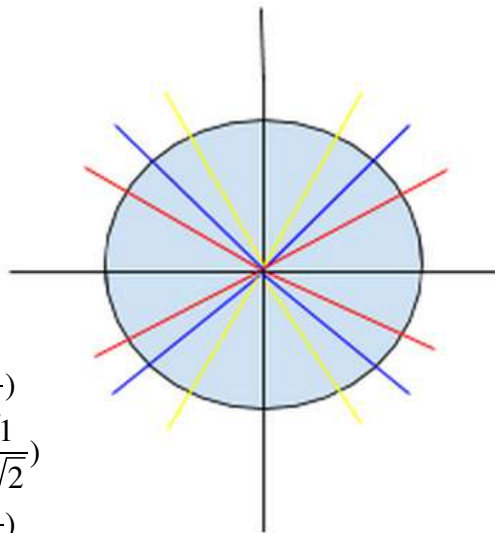

Quadrant III:

Red: $\angle \frac{7\pi}{6} = \left(-\frac{\sqrt{3}}{2}, -\frac{1}{2}\right)$

Blue: $\angle \frac{5\pi}{4} = \left(-\frac{1}{\sqrt{2}}, -\frac{1}{\sqrt{2}}\right)$

Yellow: $\angle \frac{4\pi}{3} = \left(-\frac{1}{2}, -\frac{\sqrt{3}}{2}\right)$

Black: $\angle \frac{3\pi}{2} = (0, -1)$

Quadrant IV:

Red: $\angle \frac{11\pi}{6} = \left(\frac{\sqrt{3}}{2}, -\frac{1}{2}\right)$

Blue: $\angle \frac{7\pi}{4} = \left(\frac{1}{\sqrt{2}}, -\frac{1}{\sqrt{2}}\right)$

Yellow: $\angle \frac{5\pi}{3} = \left(\frac{1}{2}, -\frac{\sqrt{3}}{2}\right)$

Black: $\angle 2\pi = (1, 0)$



Sample Question

Using the sum and difference formula for cosine, which states $\cos(u + v) = \cos(u)\cos(v) - \sin(u)\sin(v)$, what is $\cos\left(\frac{5\pi}{6}\right)$?

A. $-\frac{\sqrt{5}}{2}$

C. $-\frac{\sqrt{3}}{2}$

B. $\frac{\sqrt{5}}{2}$

D. $\frac{\sqrt{3}}{2}$

Step 1: Break down the angle into two angles of addition that are used on the unit circle:

$$\text{Let } u = \frac{\pi}{3} \text{ and } v = \frac{\pi}{2}.$$

Step 2: Set up the sum formula for cosine:

$$\cos\left(\frac{5\pi}{6}\right) = \cos\left(\frac{\pi}{3} + \frac{\pi}{2}\right) = \cos\left(\frac{\pi}{3}\right)\cos\left(\frac{\pi}{2}\right) - \sin\left(\frac{\pi}{3}\right)\sin\left(\frac{\pi}{2}\right)$$

Step 3: Plug in the specific values for the cosine and sine functions:

$$\cos\left(\frac{\pi}{3}\right) = \frac{1}{2}$$

$$\cos\left(\frac{\pi}{2}\right) = 0$$

$$\sin\left(\frac{\pi}{3}\right) = \frac{\sqrt{3}}{2}$$

$$\sin\left(\frac{\pi}{2}\right) = 1$$

$$\cos\left(\frac{\pi}{3} + \frac{\pi}{2}\right) = \cos\left(\frac{\pi}{3}\right)\cos\left(\frac{\pi}{2}\right) - \sin\left(\frac{\pi}{3}\right)\sin\left(\frac{\pi}{2}\right)$$

$$\cos\left(\frac{\pi}{3} + \frac{\pi}{2}\right) = \frac{1}{2}(0) - \frac{\sqrt{3}}{2}(1)$$

$$\cos\left(\frac{\pi}{3} + \frac{\pi}{2}\right) = 0 - \frac{\sqrt{3}}{2}$$

$$\cos\left(\frac{\pi}{3} + \frac{\pi}{2}\right) = -\frac{\sqrt{3}}{2}$$

The correct answer is C.



Sample Question

What is $\tan\left(\frac{5\pi}{3}\right)$?

- A. $\sqrt{3}$
- B. $-\sqrt{3}$
- C. $\sqrt{5}$
- D. $-\sqrt{5}$

Step 1: Rewrite the trigonometric function using the quotient identity.

$$\tan\left(\frac{5\pi}{3}\right) = \frac{\sin\left(\frac{5\pi}{3}\right)}{\cos\left(\frac{5\pi}{3}\right)}$$

Step 2: Identify the $(x, y) = (\cos(x), \sin(x))$ for the specific angle.

$$\left(\cos\left(\frac{5\pi}{3}\right), \sin\left(\frac{5\pi}{3}\right)\right) = \left(\frac{1}{2}, -\frac{\sqrt{3}}{2}\right)$$

Step 3: Plug in the exact values and solve for tangent.

$$\frac{-\sqrt{3}}{\frac{1}{2}}$$

Since there is a fraction being divided by another fraction, multiply the top fraction by the reciprocal of the bottom fraction.

$$\frac{\sqrt{3}}{2} \times \frac{2}{1} = -\sqrt{3}$$

In this particular case, the 2 in the numerator and the 2 in the denominator cancel each other out, and we are left with our final answer. B is the correct answer.

$$\tan\left(\frac{5\pi}{3}\right) = -\sqrt{3}$$



Trigonometric Identities

A trigonometric identity is an equation that involves trigonometric functions that hold true for all angles. All of these identities come from the Pythagorean theorem. The SAT will test you by giving you a complex equation, and you have to simplify by using algebra and the identities in the table below.

Reciprocal Identities	Pythagorean Identities	Quotient Identities
$\sin(u) = \frac{1}{\csc(u)}$	$\sin^2(u) + \cos^2(u) = 1$	$\tan(u) = \frac{\sin(u)}{\cos(u)}$
$\cos(u) = \frac{1}{\sec(u)}$	$1 + \tan^2(u) = \sec^2(u)$	$\cot(u) = \frac{\cos(u)}{\sin(u)}$
$\tan(u) = \frac{1}{\cot(u)}$	$1 + \cot^2(u) = \csc^2(u)$	
$\csc(u) = \frac{1}{\sin(u)}$		
$\sec(u) = \frac{1}{\cos(u)}$		
$\tan(u) = \frac{1}{\cot(u)}$		
Sum-Difference Formulas	Double Angle Formulas	Half Angle Formulas
$\sin(u \pm v) = \sin(u)\cos(v) \pm \cos(u)\sin(v)$	$\sin(2u) = 2\sin(u)\cos(u)$	$\sin^2(u) = \frac{1 - \cos(2u)}{2}$
$\cos(u \pm v) = \cos(u)\cos(v) \mp \sin(u)\sin(v)$	$\cos(2u) = 1 - 2\sin^2(u)$	$\cos^2(u) = \frac{1 + \cos(2u)}{2}$
$\tan(u \pm v) = \frac{\tan(u) \pm \tan(v)}{1 \mp \tan(u)\tan(v)}$	$\tan(2u) = \frac{2\tan(u)}{1 - \tan^2(u)}$	$\tan^2(u) = \frac{1 - \cos(2u)}{1 + \cos(2u)}$
Product to Sum Formulas	Sum to Product Formulas	
$\sin(u) + \sin(v) = 2\sin\left(\frac{u+v}{2}\right)\cos\left(\frac{2-v}{2}\right)$	$\sin(u)\sin(v) = \frac{1}{2}(\cos(u-v) - \cos(u+v))$	
$\sin(u) - \sin(v) = 2\cos\left(\frac{u+v}{2}\right)\sin\left(\frac{2-v}{2}\right)$	$\cos(u)\cos(v) = \frac{1}{2}(\cos(u-v) + \cos(u+v))$	
$\cos(u) + \cos(v) = 2\cos\left(\frac{u+v}{2}\right)\cos\left(\frac{2-v}{2}\right)$	$\sin(u)\cos(v) = \frac{1}{2}(\sin(u+v) + \sin(u-v))$	
$\cos(u) - \cos(v) = -2\sin\left(\frac{u+v}{2}\right)\sin\left(\frac{2-v}{2}\right)$	$\cos(u)\sin(v) = \frac{1}{2}(\sin(u+v) - \sin(u-v))$	



Other Concepts

Now that we have covered the majority of concepts on the SAT Math test, it is important to acknowledge that there are a few concepts that do not fall into any real category. In particular, this pertains to calculations involving complex or imaginary numbers. The nature of these calculations makes them separate and difficult to classify, affording them their own section in this book.

Section Outline

Complex Numbers

- Performing calculations with imaginary numbers



Complex Numbers

Have you ever been taught that you couldn't evaluate a negative number in a square root? Well there is a new "number" that we associate negative numbers under the square root. These are called complex numbers, and they are indicated with the letter i , where $i = \sqrt{-1}$. We can do regular operations like addition, subtraction, multiplication, and division with complex numbers.

Keep the following in mind, to make complex multiplication simpler.

$$\begin{aligned} i &= \sqrt{-1} \\ i^2 &= i \times i = \sqrt{-1} \times \sqrt{-1} = -1 \\ i^3 &= i \times i \times i = \sqrt{-1} \times \sqrt{-1} \times \sqrt{-1} = -1 \times \sqrt{-1} = -i \\ i^4 &= i^2 \times i^2 = -1 \times -1 = 1 \\ i^5 &= i^4 \times i = i \\ i^6 &= i^4 \times i^2 = -1 \\ i^7 &= i^4 \times i^3 = -i \\ i^8 &= i^4 \times i^4 = 1 \\ i^9 &= i^4 \times i^4 \times i = i \\ i^{10} &= i^4 \times i^4 \times i^2 = -1 \end{aligned}$$

For complex division, we need to know what a conjugate is. For starters, all complex numbers take the form of $a + bi$, where a is the x -coordinate and b is the y -coordinate. A complex conjugate is changing the $+$ in $a + bi$ to $a - bi$ or vice versa. When we have complex division, we multiply by a clever form of "one," which will be the conjugate of the denominator.

Let's do a few examples:

Example 1: Simplify $\sqrt{-9}$

Step 1: Get rid of the negative sign by substituting it with i , and put i outside the square root.

$$\sqrt{-9} = i\sqrt{9}$$

Step 2: Use regular square root rules and simplify.

$$\sqrt{9}i = 3i$$

Example 2: Simplify $\sqrt{-144}$

Step 1: Get rid of the negative sign by substituting it with i , and put the i outside the square root.

$$\sqrt{-144} = i\sqrt{144}$$

Step 2: Use regular square root rules and simplify.

$$\sqrt{144}i = 12i$$



Example 3: Simplify $\frac{1+i}{1-i}$

Step 1: Multiply by the conjugate of the denominator. The “conjugate” is the number or expression that when multiplied with the denominator yields a product of 1. When working with expressions in the form $a + bi$, the conjugate will be the same expression with the opposite sign— $a - bi$. The opposite is also true; the conjugate of $a - bi$ is $a + bi$.

$$\frac{1+i}{1-i} \times \frac{1+i}{1+i}$$

Step 2: Foil out the numerator and denominator.

$$\frac{1+i}{1-i} \times \frac{1+i}{1+i} = \frac{1^2 + i + i + i^2}{1^2 + i - i - i^2} = \frac{2i + 1 - 1}{1 + 0 + 1} = \frac{2i}{2} = i$$

Example 4: Simplify $\frac{1-i}{1+i}$

Step 1: Multiply by the conjugate of the denominator.

$$\frac{1-i}{1+i} \times \frac{1-i}{1-i}$$

Step 2: Foil out the numerator and denominator.

$$\frac{1-i}{1+i} \times \frac{1-i}{1-i} = \frac{1^2 - i - i + i^2}{1^2 + i - i - i^2} = \frac{-2i + 1 - 1}{1 + 0 + 1} = -\frac{2i}{2} = -i$$

Example 5: Simplify $\frac{2-i}{3-2i}$

Step 1: Multiply by the conjugate of the denominator.

$$\frac{2-i}{3-2i} \times \frac{3+2i}{3+2i}$$

Step 2: Foil out the numerator and denominator and simplify.

$$\frac{2-i}{3-2i} \times \frac{3+2i}{3+2i} = \frac{3 \times 2 + 4i - 3i - 2i^2}{3^2 + 6i - 6i - 4i^2} = \frac{6 + i + 2}{9 + 0 + 4} = \frac{8 + i}{13} = \frac{8}{13} + \frac{i}{13}$$



The New SAT Essay

The Prompt

The changes to your task as a writer on the new SAT's essay section are reflected mostly in the prompt. In the past, the test included a brief passage whose sole purpose was to stimulate the student's thinking on a given issue. The prompt would ask you to construct an argumentative essay that argued an opinion or point about that issue using evidence derived exclusively from your own life and studies. This essay was then scored on a 200-to-800-point scale, and it was scored as a whole; that is to say, your essay would be given one score intended to reflect its overall quality.

The new SAT features a 650- to 750-word passage designed to be the exclusive focus of the essay. **All** evidence and support for your essay must be drawn from this passage. Rather than arguing a position on an issue, you will now be analyzing the argument made in the prompt itself. You will be supporting your analysis with your own reasoning and evidence drawn from a direct reading of the text. Rather than being judged as a whole entity, the essay will be given three category scores, which will not be combined in any way.

In the old format, the prompt was simply a jumping-off point; the real core of the scoring was the presentation of your own ideas, and your ability to formulate and structure an argument in support of one particular side of an issue. In the new test, two-thirds of the scoring is based on your ability to read and analyze the prompt's text and argument, and one third on your ability to formulate your response.

The change in the prompt thus reflects a fundamental shift in what is being asked of you. Rather than coming up with your own opinion and argument, you are being asked to ascertain the author's argument and then analyze the rhetoric, evidence, and stylistic tools he or she uses to convince their audience. Notice that the term there is "audience," not "you." This is key, because you—as a reader—are not being asked to make a statement as to whether or not you are convinced by the author's argument. Instead, your job is to analyze how the author is seeking to convince a generalized audience or archetypal reader.

This can't really be overstated. The test wants you to make an objective analysis of the provided text. Specifically, they do not want you to offer a personal opinion about the issue or even the text at hand.

The language of SAT essay prompts is fairly consistent and specific in what it asks of you. It will ask you to consider the reasoning, evidence, and stylistic devices the author uses to make a specific claim about the passage. The prompt will often even specify the author's main claim, and ask you to focus your analysis on the most important tools, reasoning, and evidence he or she uses to support this claim. Your task will be to identify which elements are most relevant, rather than forming your own idea about what this main claim is.



The Prompt Passage

Since the prompt passage itself is so important to the new SAT's essay section, let's take a moment to discuss the specifics of what you can expect. As mentioned earlier, the prompt will be a passage of 650–750 words in length. The passage will be non-fiction, and it will be written as a specific argument in favor or against something. The passage will also be written for a popular or broad audience. This just means that the passage won't be specific to any one discipline, such as science, English, or math; rather, the passage will be about something fairly universal that just about anyone could understand or care about.

Scoring

The key thing to know about the scoring of the new SAT essay section is that it will span three categories. The scores you receive in each of these categories are equally important and will be reported as discrete scores. Your essay will be scored against the following three criteria on a 2-8 point scale:

Reading	Judges your literal understanding of the content, fundamental thesis, and logical basis of the passage
Analysis	Judges your ability to read critically and formulate an argument about the author's techniques and use of structure to further his or her argument
Writing	Judges your own use of grammar, style, and structure in crafting your analysis of the prompt text

All three of these scores will appear on your results; they will not be combined. If your essay receives a 7 on Analysis, a 7 on Reading, and a 2 on Writing, your score will **not** be recorded as a 16 out of 24. It will be recorded exactly as it was listed originally, which is to say that your 2 on the Writing section will appear on your results.

The separate judging of the categories counterintuitively puts a premium on being balanced in your skills and approach to the new SAT essay. Since all areas will be judged and recorded discretely, it is impossible to hide areas of weakness. As such, we will divide our advice for you into these three categories, defining the skills necessary to receive a high score in each category individually while writing one cohesive, coherent essay.

Note that although you are scored in three discrete categories, your essay should **not** be separated into three distinct categories. Structure your essay in a logical, coherent series of paragraphs, all of which are related to one another, you simply must keep these three categories in mind as you write your entire essay.

Optionality

The other notable change to the SAT Essay section is that it is now optional. As of this writing, there is no real way to know exactly how “optional” the essay really will be, which schools or departments will require it, or which will prefer but not require it, and so on, but one thing is certain: a good score on the optional essay will not be considered an undesirable detail. In preparing for the new SAT, the best thing to do is to prepare sufficiently so that you can look at this optional section not as a risk that you can avoid, but rather as an opportunity to score well.



Practice

The key to preparing for this section of the exam, as with all sections of the new SAT, is not merely to review the concepts and structure of the essay question, but to practice actually writing your essay. Even if you feel confident in your analytical writing ability, encountering a text for the first time and writing an analytical essay within a specific time window (in this case, 50 minutes) is a challenging task requiring very specific skills—skills specific enough that they can only really be developed by practicing for that particular task. When practicing, make sure you give yourself the exact time you will be given on the test so that you can learn to recognize the pace at which you need to work in order to complete your essay in the given time limit without having to rush.



SAT Essay: Reading

The first and most fundamental aspect for which your essay will be scored is classified as reading. This score will reflect how well you have demonstrated a basic, comprehensive grasp of the content, structure, and logical reasoning behind the essay prompt. This is a foundational score, in the sense that it is the most basic, and thus most fundamental aspect of your passage response. If you do not understand the literal meaning of the passage, you will have a pretty difficult time making a reasonable and nuanced analysis of it.

This category is foundational, not just in terms of your score, but also in terms of your ability to write an essay you're happy with. If you are secure in your grasp of the content of the prompt passage, you'll be able to make stronger claims, and you'll be able to make those claims confidently.

Demonstrating Comprehension

Now, your process for reading and understanding the prompt passage should not be fundamentally different from your process for reading passages for *the Reading test*. The difference is that instead of being asked discrete questions testing your comprehension, for the Essay section you must demonstrate your comprehension throughout your essay. The big thing to keep in mind here is that your literal comprehension of the passage is being directly examined and graded, so you must attend to showing your understanding specifically, using a few tools that the exam likes to see.

The first of these tools is the identification and referencing of specific, important details about the text. Now, the key to this is that your task is NOT to simply regurgitate an exhaustive list or summary of everything that is said in the passage. Not only would this be extremely lengthy and time consuming, but it also would leave no space for analysis; furthermore, such listing does not actually demonstrate comprehension. By the rubric of this exam, comprehension is demonstrated through the selective, thoughtful inclusion and discussion of the most important details in the text, those details that reflect the author's main point or argument and the examples and tools the author used to support that point. Being selective but thorough in your use of examples and details will show the people grading your exam that you understand the text. Being accurate in your paraphrasing or description of parts of the passage is key to this, as actively inaccurate statements about the text are actively punished.

The best tool at your disposal in terms of demonstrating your comprehension of the text is the prompt itself. In this vein, you will be well served to quote directly from the language of the text itself. You will be judged not only on your choice of details and quotations from the text, but also on the smoothness with which you integrate these quotations into your essay. Many students' first instinct is to preface each quotation with a colon.

The author often tells us how she goes about her daily events, as when she says: "I went to the store in a hurry."

Too many uses of this structure will be considered overly literal, and can often break the flow of one's writing. The smoother way to integrate a quotation is directly into your own sentence.



The author does not just tell us that she “went to the store,” but that she did so “in a hurry.”

Integrating quotations into the flow of your own sentences and paragraphs helps you to assure the marker that you have noticed and focused on the key details and quotations of the passage, while also giving the impression that you are making your own analysis of the passage.



SAT Essay: Analysis

When it asks you to analyze the prompt text, the new format of the SAT Essay wants to see you make a sophisticated reading of the reasoning of the passage. As opposed to demonstrating comprehension, this task asks you to also show insight into why and how the passage employs various tools in order to argue its point.

To support his point that the government was right to shut down the water park the author cites a study that found that the park “was only at 6% capacity on its best day.”

That example would be perfectly fine in terms of the reading evaluation. It demonstrates a solid comprehension of the overall argument (of an imagined essay, but take our word for it) and effectively integrates a relevant quotation smoothly into the structure of the sentence, but it makes no additional analysis of why or how this use of evidence might work in the passage.

To support her point that the government was right to shut down the water park, the author cites a study that found that the park “was only at 6% capacity on its best day.” It is key to note the author’s specific choice of language surrounding this statistic. By saying that the capacity “was only at 6% on its best day,” the author effectively makes clear (with the word “only”) that this number is too small, even at the “best” of times. Overall, the use of statistical evidence feeds into the author’s broader thesis that public spending should be decided by rational policies based on empirical data. The statistic the author cites as evidence is the exact kind of statistic that she argues the decision to build the water park should have been based on in the first place.

Here, you can see how a solid demonstration of basic Reading Comprehension will usually create a bridge right into a sophisticated analysis of the overall effect of the evidence, and the argument overall.

The analysis category of your essay grade is designed to make sure you make an extra interpretive step, not just citing and contextualizing evidence, but providing insight into why and how that evidence or detail works within the overall framework of the text.

A proper analysis will demonstrate how the evidence and details work to argue the point, and will also make a case as to how the overall tone and style of the work furthers the thesis.

Thesis Statement

Both to appeal to your markers, and for your own organization you will need to make a strong, central thesis statement in your essay. Your thesis statement will distill, in a short statement, the overall result of your analysis and the thrust of the argument you are making about the passage. This will be the jumping off point of your analysis, and will be a key signpost for your marker, so it is important to have a thesis, and to give that thesis a lot of thought. We’ll look at an example of a strong thesis in the example.



Objective Analysis

The pitfall of analyzing these passages will lie between making enough of an interpretive claim and injecting personal opinion into what should be an objective rhetorical analysis. This basic difference can be seen in the idea of “feelings.” There are no feelings expressed in an objective rhetorical analysis, you may think or argue that a piece of evidence is or isn’t effective within a passage’s overall logical framework, but you may not argue that you don’t “agree” or “like” an aspect of an argument. You should talk exclusively about the passage and its argument, never about how that argument affects or seems to you. Pretend the prompt passage is an object in a science experiment. You are dissecting it, analyzing, and reporting your findings, not offering an opinion on what you’ve found.

This test asks you to make an objective academic analysis. For that reason always restrict your discussion to the passage and how it functions. Do not use the first person “I” or the second person “you.” These will be major red flags for your markers that you have not maintained an objective stance on the passage.



SAT Essay: Writing

The writing category of the new SAT scoring is the only category that does not, in some way, grade your response to the prompt text. Rather, this category will grade you on the effectiveness of your use of language, and the overall cohesiveness and organization of your essay.

In terms of style and grammar, the SAT Writing and Language test is quite comprehensive, if you are fully prepared to write that mandatory section you should be well-versed on the basics of written English grammar and style (at least for the purposes of this test), and if you have been developing your own writing style and voice (which is a vital thing to do just for your own life and education outside of the specifics of the SAT) you will be prepared for the sentence to sentence writing aspect of the essay. The only way to get comfortable writing is to sit down and write.

Grammatical correctness is important on this test, but remember that your essay will be graded by two human beings, who, being human, will understand that you have completed your work in a timed, high-pressure setting. A 4/4 score does NOT need to have perfect grammar and no errors, it needs to have generally excellent command of the English language, including grammar. Correctness is important, but sentence variety and complexity is as well. An essay that contains all short, simple, very similar sentences will NOT receive a 4/4, an essay with effective, varied sentences and diction that, due to this added complexity, makes one or two small errors will. The key for this and all essays is to try to write in a fluid manner that expresses your thought in a holistic sense, not to write perfectly in one specific realm, like grammar to the detriment of complexity and flow.

There are some aspects of the Writing scoring rubric that are particular to this test, and for which you must prepare adequately. Mostly these have to do with tone and organization. For the purposes of your scoring on the Writing category, your essay should follow a basic structure containing a clear introduction (including a strong, clear thesis statement), body paragraphs (in which you analyze and demonstrate comprehension of the text and its logical and argumentative structures through the citation of specific details and examples), and a concise conclusion (in which you sum up your arguments and address the larger implications of the arguments made in the passage and your essay).

This is not necessarily a structure of essay that will follow you to College, but for the purposes of an on-the-spot essay that you're writing under time pressure at the end of a long test, a simple, clear structure will help you generate and express your ideas for analysis.

Having a clearly structured paper will also help you maintain an objective analytical tone, which will be a necessity for the new SAT Essay. It has been said elsewhere, but it bears restating, make sure you restrict your analysis to the text itself and issues directly raised by the text. Leave your "I"s at home. An analytical tone focuses on the evidence that it is analyzing, and it discusses that evidence in as clear and thorough a manner as possible.



Sample Prompt and Essay Response

Practice Passage: Adapted from “The Art of Procuring Pleasant Dreams”
by Benjamin Franklin (1786)

A good way to stay healthy, and one that needs to be talked about more often, is having a consistent flow of fresh air in your bedroom. For a long time people have made the mistake of sleeping in rooms that are closed off, often even surrounding their beds with curtains for privacy’s sake or because it seems cozy.

I would argue that no outside air could come into your room that would be as unhealthy as the old, stale, already breathed air you’ll find in a closed up bedroom. Just as boiling water will not get hotter, no matter how long you boil it, if you allow the steam to escape, people’s bodies will stay healthy if you just let them cleanse themselves. Our bodies “let off steam” by expelling toxins through our pores, digestive system, and even our mouths. When we sleep in a stuffy, enclosed room we simply breath in or re-absorb these particles, which our bodies wanted gone in the first place, again and again. A crowd of people in a small room will spoil the air in just a few minutes, and, if absolutely no new air is let in, the very act of everyone breathing will make that room a death trap. Now, a single person in a bedroom will obviously take much longer to render the air stuffy and uncomfortable, and a single person probably could never render the air actually deadly, but the principle still applies: it is only the scale that is reduced.

There is an old legend that Methuselah lived for many centuries, and he always slept in the open air, often outside. The story goes that after he was already over five hundred years, an angel told him that he needed to build a house for himself if he hoped to live another five hundred years. Methuselah responded by saying that if all living in a house would get him was 500 more years, he may as well stick to his plan of sleeping outside, which he thought would let him live even longer. Methuselah’s point was that if he’d already lived 500 years it stood to reason that he knew quite a bit about staying healthy.

For a long time doctors thought that sick people should be kept inside, in other words away from fresh air, before finally realizing that fresh, clean air could only help the sick, almost regardless of their disease. Nowadays, if you’re sick, you’ll have a hard time finding a doctor who tells you to avoid fresh air. If fresh air can make the sick healthier, doesn’t it stand to reason that the same principle could be applied to anyone, even someone who is totally healthy? If you’re going to tell sick people to go outside, it makes sense to tell healthy people to crack a window once in a while.



Once air has been trapped in a room, breathed and re-breathed, it will only keep becoming saturated with CO₂ and whatever germs you might be coughing up. This dank air lets us know that it's bad for us just by making us uncomfortable; we all know the feeling of being in a stuffy room, how it makes your skin and your lungs chafe a little, how your face gets hot. We've all woken up uncomfortably in our beds. You might toss and turn, shift around trying to go back to sleep, with no luck. This fidgetiness is caused by the retention of sweat in the sheets, and by extension on our skin. We shed our skin all the time, and when we shed something it is meant to go away, not stay stuck to us and our bedclothes. You can fidget and roll around all night trying to get back to sleep, but next time you find yourself in this position try simply staying still and throwing your bedclothes off and letting some fresh air in. Any part of your body touched by the fresh air will feel refreshed immediately. Discomfort isn't just discomfort; it is the canary in the mineshaft of poor health.

Sample Essay Response

Franklin's stated topic in this passage is specific: one "good way to stay healthy," that "way" being the maintenance of "a consistent flow of fresh air in your bedroom." As the argument progresses, however, the very logical basis and types of examples and evidence Franklin uses reveal the overarching principle behind this specific argument, namely that human life is dependent on loss and regeneration, and that people's everyday thinking and practices should reflect this. Franklin's use of analogy and appeals to personal experience are not specific to the exact particulars of his argument, but rather rely on the reader's logical process, which fundamentally reinforces the kind of thinking and daily practice Franklin is advocating, and in the process justify the particular claim about staying healthy by allowing appropriate airflow in one's living space that he uses to ground the passage.

It bears noting that after his initial introduction of his specific claim about "the mistake of sleeping in rooms that are close off," Franklin uses an analogy about "boiling water" and "letting off steam" that both reinforces his point and expands beyond the initial scope of the argument. The metaphor of the boiling water that "will not get hotter no matter how long you boil it" unless enclosed with a lid is extended directly to the human body and its process of regeneration, before being tied to the specific anecdotal example of the "crowd of people in a small room" rendering the air toxic if no new air is allowed in, before bringing the reader back to the specific case of "a single person in a bedroom." To close this first body paragraph arguing and providing evidence in support of his thesis, Franklin explicitly states that it is not the empirical specifics of his examples that are important, but rather the "principle" and logical process inherent to his evidence.

Franklin moves on to cite the story of Methuselah, which is invoked not just to further reinforce his fundamental arguments (which it does), but also to expand the scope of the discussion. In just two paragraphs he has gone from the enclosed, specific space of a "closed off bedroom" to "the open air" of the world, spanning over 500 years of a myth,



the story itself drawn from a myth that has itself been preserved for hundreds of years. When Franklin mentions “doctors” advice to patients regarding the discussion is not specific or statistics-based (it is not in the rhetorical mode of “four out of five dentists recommend!”), but rather is concluded with a rhetorical question and another instance in which he asks the reader to extend “the same principle” upon which the doctors’ advice was based. The specific choice of language here is revealing, as this is the second time that Franklin has summarized the specifics of his evidence in terms of the “principle” and logical process underlying it.

In his final body paragraph Franklin calls upon his readers’ personal experience in their own bedrooms, citing the universal act of “fidgeting” in bed. Franklin gives his reader some practical advice that he hopes will, in the actual lives and experiences of his readers prove his point that the discomfort of lying in bed at night is often caused by the lack of proper flow, which interrupts the essential process by which humans “shed” water and skin, Franklin asserts that “when [humans] shed something it is mean to go away, not stay stuck to us.” After his last piece of evidence, which was decidedly personalized and given in the form of practical advice or experiment, Franklin closes with the more general statement that “discomfort isn’t just discomfort; it is the canary in the mineshaft of poor health,” thus logically tying his claims about nighttime discomfort back to his specific thesis about promoting health through proper airflow in one’s sleeping chamber, while also tying that specific thesis to his deeper points about the necessity of embracing the body’s process of regeneration.

The nature of Franklin’s argument is illuminated by the kinds of evidence he uses, and by extension, the kinds he does not. By using anecdotal examples and analogy, relying on the reader’s own logic and experience, Franklin makes it clear that he is making a general argument about day-to-day human experience and decision-making, not a scientific argument based on precise research. This is not a weakness in Franklin’s argument, but rather a signal about the kind of reasoning and decision-making he wishes to endorse. Franklin’s primary argument is not about the exact level of CO_2 in a given room—it is about the general process of loss and regeneration that takes place in the body, and the ways in which he believes people should adjust and accept this process as part of a holistic life-practice and worldview. By proving his case with examples and analogies that rely on the reader’s application of the “principles” for which he is advocating, Franklin both argues his specific point about sleeping in rooms with proper ventilation and makes a more overarching argument about accepting loss and regeneration in people’s daily, bodily lives.



Full-Length SAT Practice Test #1

IMPORTANT REMINDERS

1. The SAT is a paper exam and requires use of a No. 2 pencil and multiple-choice answer sheet. Fill in bubbles completely, and clearly erase any stray marks on your exam.
2. The SAT adheres to strict time limits. You may wear a wristwatch, but cell phone timers, stopwatches, and any device with an alarm will be disallowed by the test proctor.
3. A scientific or graphing calculator is allowed only for the calculator portion of the Math section. The calculator may not have any wireless capabilities and may not be used for any reason during other portions of the exam.
4. Remember, there is no guessing penalty on the revised SAT exam.

This page is similar to the one you'll see on test day.

Reading Test

65 MINUTES, 52 QUESTIONS

DIRECTIONS

Each passage or pair of passages below is followed by a number of questions. After reading each passage or pair, choose the best answer to each question based on what is stated or implied in the passage or passages and in any accompanying graphics (such as a table or graph).

Questions 1-10 are based on the following passage.

This passage is adapted from “Introductory Remarks” in *The Interpretation of Dreams* by Sigmund Freud (trans. 1913).

In attempting to discuss the interpretation of dreams, I do not believe that I have overstepped the bounds of neuropathological interest. For, when investigated
Line 5 psychologically, the dream proves to be the first link in a chain of abnormal psychic structures whose other links—the hysterical phobia, the obsession, and the delusion—must interest the physician for practical
10 reasons. The dream can lay no claim to a corresponding practical significance; however, its theoretical value is very great, and one who cannot explain the origin of the content of dreams will strive in vain to
15 understand phobias, obsessive and delusional ideas, and likewise their therapeutic importance.

While this relationship makes our subject important, it is responsible also for the
20 deficiencies in this work. The surfaces of

fracture, which will be frequently discussed, correspond to many points of contact where the problem of dream formation informs more comprehensive problems of
25 psychopathology which cannot be discussed here. These larger issues will be elaborated upon in the future.

Peculiarities in the material I have used to elucidate the interpretation of dreams have rendered this publication difficult. The
30 work itself will demonstrate why all dreams related in scientific literature or collected by others had to remain useless for my purpose. In choosing my examples, I had to limit myself to considering my own dreams
35 and those of my patients who were under psychoanalytic treatment. I was restrained from utilizing material derived from my patients’ dreams by the fact that during their treatment, the dream processes were
40 subjected to an undesirable complication—the intermixture of neurotic characters. On the other hand, in discussing my own dreams, I was obliged to expose more of the intimacies of my psychic life than I should
45 like, more so than generally falls to the task



of an author who is not a poet but an investigator of nature. This was painful, but unavoidable; I had to put up with the inevitable in order to demonstrate the truth
50 of my psychological results at all. To be sure, I disguised some of my indiscretions through omissions and substitutions, though I feel that these detract from the value of the examples in which they appear. I can only
55 express the hope that the reader of this work, putting himself in my difficult position, will show patience, and also that anyone inclined to take offense at any of the reported dreams will concede freedom of thought at least to the
60 dream life.

1

The author can be most accurately described as _____.

- A. furious and insulted
- B. defensive and meticulous
- C. imploring and desperate
- D. unreliable and suspicious

2

The author discusses a topic that he plans to pursue in future work _____.

- A. in the first sentence of the passage
- B. in the last sentence of the passage
- C. in the second paragraph of the passage
- D. in the first and last paragraphs of the passage

3

According to the author, studying phobias, obsessions, and delusions is _____, but studying dreams is not.

- A. practical
- B. possible
- C. useless
- D. easy

4

When he uses the phrase “the inevitable” in lines 48–49, the author is referring to _____.

- A. the fact that he had to publish some of his own dreams, which made him uncomfortable
- B. the idea that all dreams contain significant meaning
- C. the gradual loss of detail in what one can remember about a dream
- D. the discomfort that everyone feels when discussing dreams with other people



5

The author could not rely upon the dreams related in scientific literature because _____.

- A. the author couldn't be sure if material had been changed in or censored from them
- B. the author needed to interview people himself in order to discuss their emotional reactions to their dreams
- C. no work of scientific literature had discussed dreams at the time the author began his study
- D. the author does not give a reason for this in the passage, but says that the rest of his work explains why this is the case

6

In the third paragraph, what does the author tell us about the omissions and substitutions he made when discussing his own dreams in the work that follow the passage?

- A. He is not responsible for these; his editors are.
- B. He feels that the adjusted examples would be more useful had they remained unadjusted.
- C. He was forced to make these, or journals would not accept his work.
- D. He is glad that he had the opportunity to reconsider his initial presentation of his dreams.

7

The author has written this passage in order to _____.

- A. propose a psychological experiment
- B. justify his work and address some of its limitations
- C. respond to a specific critic who has cast doubt on his work's reliability
- D. teach the reader how to interpret his or her own dreams

8

The author argues that understanding the content of dreams is necessary for _____.

- A. comprehending the therapeutic importance of dreams
- B. understanding delusional ideas
- C. accurately diagnosing a number of psychological conditions in patients
- D. understanding why he had difficulty choosing dreams to discuss in the work that follows

9

Based on the way in which the word "informs" is used in line 24 of the passage, the author is using it to mean _____.

- A. tells
- B. ignores
- C. solves
- D. influences



In the last sentence of the passage, the author attempts to _____.

- A. encourage the reader to read the work of a variety of psychologists
- B. inspire the reader to conduct his or her own scientific experiments
- C. get the reader to empathize with him
- D. explain why he made certain redactions to the dreams he later discusses

Questions 11–21 are based on the following passage.

**“How Energy-Efficient is That Plant?”:
Photosynthetic Adaptations**

Energy efficiency is a large concern in the modern world. When looking at purchasing vehicles or smaller appliances like refrigerators and televisions, consumers
Line 5 want to know how much energy the device will use while it is running. The most efficient machines will do a given amount of work with the least amount of energy.

You may be surprised to learn that
Line 10 energy efficiency is also an aspect of the natural world. A great number of factors are important when growing crops, but along with nutrients, water, and sunshine, the efficiency of a plant’s photosynthetic
Line 15 functions play a role in how quickly crops are able to mature. Plants take in carbon dioxide and water in a biochemical cycle called photosynthesis and convert these ingredients into oxygen and glucose, a form of
Line 20 sugar used for energy storage. Specifically, the plant breaks a carbon dioxide molecule into

oxygen gas and a carbon atom, which with other carbon atoms is then used to generate glucose in a process called “carbon fixation.”

25 There are a few different pathways plants can take to perform carbon fixation. These vary at the level of enzyme activity and the minor variations in the molecules produced, but these microscopic variations
30 result in some macroscopic differences. The general, most common pathway used in photosynthesis is called the C₃ pathway. It is named for a three-carbon molecule produced during the process. Certain plants have
35 evolved and can use a C₄ pathway instead of a C₃ pathway when it is more efficient to do so. The C₄ pathway results in the saturation of a particular enzyme, RuBisCo, with carbon dioxide. RuBisCo’s job is to fix carbon, and
40 when saturated with its raw materials, it can perform this function more efficiently.

CAM plants have evolved a different method of making photosynthesis more efficient. CAM plants do not alter the
45 saturation of carbon dioxide around RuBisCo. Instead, they change the way in which they collect the raw ingredients of photosynthesis from the environment. Plant leaves contain “stomata,” openings
50 through which carbon dioxide is collected, but through which water can also be lost. CAM plants close openings in their stomata during the day and open them at night. This prevents water from evaporating out of their
55 stomata during the day and is an especially useful adaptation in hot, arid environments.

You may be wondering: don’t CAM plants need carbon dioxide and sunlight at the same time to photosynthesize? They do,
60 and this has a dramatic affect on when they



they photosynthesize. The reactions involved in photosynthesis fall into two categories: the “light” reactions, which require light, and the “light-independent” or “dark” reactions, which do not. At night, CAM plants do not completely photosynthesize anything; they collect carbon dioxide, perform the light-independent part of the photosynthetic process, and wait. In the daytime, they perform the light-dependent reactions and use the available sunlight and the carbon dioxide they collected at night to generate glucose and oxygen.

It may be strange to think of plants varying in the way they perform such a core process as photosynthesis, but common examples of such plants abound: sugarcane and corn are C4 plants, while many cacti are CAM plants, as are pineapples. By better understanding the different ways in which plants have evolved to perform photosynthesis more efficiently, we can capitalize on their efficiency in ways that have direct implications on human society, and that’s certainly an efficient endeavor.

11

Which of the following is implied by lines 34–39?

- A. Any plant that can use a C4 pathway can use a C3 pathway.
- B. Any plant that can use a C3 pathway can use a C4 pathway.
- C. Only C4 plants contain RuBisCo.
- D. Only C3 plants contain RuBisCo.

12

A farmer decides to grow sugarcane in the desert due to its photosynthetic-efficient evolutionary adaptations. Is this farmer correct in his logic? Why?

- A. Yes, because C4 plants are well-adapted to arid environments.
- B. Yes, because CAM plants are well-adapted to arid environments.
- C. No, because C4 plants aren’t necessarily adapted to arid environments.
- D. No, because CAM plants aren’t necessarily adapted to arid environments.

13

Based on the passage, what is the likely meaning behind the name “C4”?

- A. C4 plants likely require four more carbon molecules than plants that do not use the pathway to perform photosynthesis.
- B. The C4 pathway likely generates a four-carbon molecule where the C3 pathway generates a three-carbon molecule.
- C. C4 plants likely have been found on four continents, whereas C3 plants have only been found on three.
- D. C4 plants are able to function normally at temperatures up to four degrees Celsius higher than the maximum temperature at which C3 plants can function.



14

What is the author's likely reason for talking about cars and appliances in the first paragraph?

- A. The author uses appliance efficiency as a familiar touchstone to introduce the reader to the idea of photosynthetic efficiency.
- B. This passage is likely excerpted from a larger work at a point just after the author concluded discussing appliance efficiency.
- C. The author talks about appliance efficiency to lead into a discussion of how photosynthetic efficiency can be used to improve appliance efficiency.
- D. The author introduces an argument made about appliance efficiency in order to demonstrate how it is incorrect using evidence taken from photosynthetic efficiency.

15

C₄ plants are similar to CAM plants in that _____, but different in that _____.

- A. they have both evolved to increase photosynthetic efficiency by saturating RuBisCo with carbon dioxide . . . they gather that carbon dioxide at different times of day
- B. they both close their stomata during the day . . . CAM plants perform only the light-dependent photosynthetic reactions during the day whereas C₄ plants perform only the light-independent reactions during the day
- C. they are both well suited to arid environments . . . C₄ plants use RuBisCo, but CAM plants lack RuBisCo
- D. they both use evolutionary adaptation to perform photosynthesis more efficiently . . . they use different mechanisms to do so

16

You're talking to a friend about what you learned in the article when your friend says, "But isn't photosynthesis just one cycle? Why would it function differently in the day than at night?"

Which of the following sentences most directly answers your friend's questions?

- A. "Plants take in carbon dioxide and water in a biochemical cycle called photosynthesis and convert these ingredients into oxygen and glucose, a form of sugar used for energy storage."
- B. "The C₄ pathway results in the saturation of a particular enzyme, RuBisCo, with carbon dioxide."
- C. "The reactions involved in photosynthesis fall into two categories: the 'light' reactions, which require light, and the 'light-independent' or 'dark' reactions, which do not."
- D. "CAM plants close openings in their stomata during the day and open them at night."

17

Before a CAM plant can generate glucose and oxygen, it must _____.

- A. have collected water during the previous day
- B. switch from using the C₃ pathway to using the C₄ pathway
- C. open its stomata
- D. have collected carbon dioxide during the previous night



18

As used in line 39, the word “fix” is closest in meaning to which of the following?

- A. Repair
- B. Focus on
- C. Choose
- D. Change

19

An illustrator has prepared the following sketch of a graph to accompany the passage, but has lost the notes he took on which label should be applied to each line. Which of the following options is supported by the information in the passage?

Glucose Produced at Different Times of Day
by Plants from Different Photosynthetic Pathways

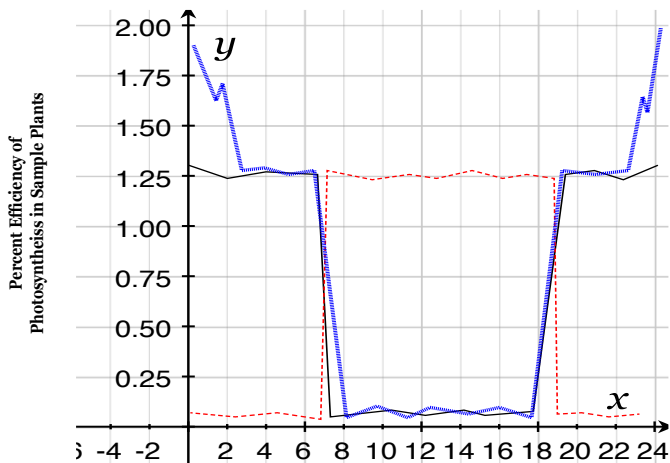

- A. Blue hashed circle line - CAM plants
Black triangle line - C₄ plants
Red dotted square line - C₃ plants
- B. Blue hashed circle line - C₄ plants
Black triangle line - C₃ plants
Red dotted square line - CAM plants
- C. Blue hashed circle line - C₃ plants
Black triangle line - C₄ plants
Red dotted square line - CAM plants
- D. Blue hashed circle line - C₄ plants
Black triangle line - C₃ plants
Red dotted square line - CAM plants

20

A CAM plant opens its stomata. What can now happen?

- A. The plant can perform the light-dependent reactions of photosynthesis.
- B. The plant can collect carbon dioxide.
- C. The plant can prevent excess water from being lost.
- D. The plant can release carbon dioxide.

21

This author is best described as _____.

- A. objective yet engaged
- B. eager yet biased
- C. fascinated but patronizing
- D. didactic but frustrated



Questions 22–31 are based on the following passage.

This passage is adapted from *Middlemarch: A Study of Provincial Life* by George Eliot (Mary Anne Evans) (1874)

And how should Dorothea not marry? A girl so handsome and with such prospects? Nothing could hinder it but her love of extremes, and her insistence on regulating life according to notions which might cause a wary man to hesitate before he made her an offer, or even might lead her at last to refuse all offers. A young lady of some birth and fortune, who knelt suddenly down on a brick floor by the side of a sick laborer and prayed fervidly as if she thought herself living in the time of the apostles, who had strange whims of fasting and of sitting up at night to read old theological books! Such a wife might awaken you some fine morning with a new scheme for the application of her income which would interfere with political economy and the keeping of saddle-horses; a man would naturally think twice before he risked himself in such fellowship. Women were expected to have weak opinions, but the great safeguard of society and of domestic life was that opinions were not acted on. Sane people did what their neighbors did, so that if any lunatics were at large, one might know and avoid them.

The rural opinion about the new young ladies, even among the cottagers, was generally in favor of Celia, as being so amiable and innocent-looking, while Miss Brooke's large eyes seemed, like her religion, too unusual and striking. Poor Dorothea! Compared with her, the innocent-looking Celia was knowing and worldly-wise; so much

35 subtler is a human mind than the outside tissues which make a sort of blazonry or clock-face for it.

Yet those who approached Dorothea, though prejudiced against her by this alarming hearsay, found that she had a charm unaccountably reconcilable with it. Most men thought her bewitching when she was on horseback. She loved the fresh air and the various aspects of the country, and when her eyes and cheeks glowed with mingled pleasure she looked very little like a devotee. Riding was an indulgence which she allowed herself in spite of conscientious qualms; she always looked forward to renouncing it.

50 She was open, ardent, and not in the least self-admiring; indeed, it was pretty to see how her imagination adorned her sister Celia with attractions altogether superior to her own, and if any gentleman appeared to come to the Grange from some other motive than that of seeing Mr. Brooke, she concluded that he must be in love with Celia. Sir James Chettam, for example, whom she constantly considered from Celia's point of view, inwardly debating whether it would be good for Celia to accept him. That he should be regarded as a suitor to herself would have seemed to her a ridiculous irrelevance. Dorothea, with all her eagerness to know the truths of life, retained very childlike ideas about marriage.



22

The second paragraph specifically serves to _____.

- A. describe Dorothea's love of horseback riding
- B. introduce the character of Sir James Chettam
- C. describe how Celia and Dorothea are perceived by their community
- D. describe Dorothea's religious tendencies, which are unusual in her community

23

In lines 33–37, the author is _____.

- A. contrasting the depth of interior mental processes with the shallowness of exterior appearances
- B. explaining why Dorothea chooses to dress with such care
- C. emphasizing the traits that Dorothea and Celia have in common
- D. contrasting clock faces with designs on ancient shields

24

According to the reasoning of the passage, why might a man hesitate to make Dorothea an offer of marriage?

- A. She spends too much time horseback riding.
- B. She is far more intelligent than any of her potential suitors.
- C. She plans her life out according to unusual religious principles.
- D. She is jealous and spiteful.

25

In the specific context in which it is used, the underlined word “pretty” in line 51 most nearly means _____.

- A. physically beautiful
- B. rather
- C. shocking
- D. charming

26

As a whole, the passage begins by discussing _____, and then it transitions into discussing _____.

- A. Dorothea's religious tendencies . . . Celia's religious tendencies
- B. aspects of Dorothea's personality that bias the rural opinion against her . . . aspects of her personality that people find appealing
- C. Dorothea's love of horseback riding . . . Dorothea's cluelessness about romantic relationships
- D. Dorothea's behavior . . . Dorothea's hobbies

27

Dorothea is most accurately described as _____.

- A. cruel, calculating, and irreverent
- B. well-meaning, naïve, and self-assured
- C. talented, wise, and irreligious
- D. confident, clever, and bored



28

In context, the underlined word “ardent” in line 50 most closely means _____.

- A. passionate
- B. hard
- C. opaque
- D. calm

29

Which physical feature of Dorothea’s helps bias the community against her?

- A. Her nose
- B. Her ears
- C. Her lips
- D. Her eyes

30

Which of the following is the best evidence that the narrator sympathizes with Dorothea?

- A. “Poor Dorothea!”
- B. “Yet those who approached Dorothea, though prejudiced against her by this alarming hearsay found that she had a charm unaccountably reconcilable with it.”
- C. “She was open, ardent, and not in the least self-admiring”
- D. “Women were expected to have weak opinions, but the great safeguard of society and of domestic life was that opinions were not acted on.”

31

The main purpose of this passage is _____.

- A. to contrast Dorothea with Celia
- B. to foreshadow that Dorothea will become very ill
- C. to provide a detailed description of Dorothea
- D. to elaborate on Dorothea’s opinion of men



Questions 32–41 are based on the following passages.

Passage A is adapted from *A Vindication of the Rights of Woman* by Mary Wollstonecraft (1792).
Passage B is adapted from John Stuart Mill's *The Subjection of Women* (1869)

Passage A

Line After considering the historic page, and viewing
the living world with anxious solicitude, the most
melancholy emotions of sorrowful indignation
have depressed my spirits, and I have sighed when
5 obliged to confess, that either nature has made a
great difference between man and man, or that the
civilization, which has hitherto taken place in the
world, has been very partial. I have turned over
various books written on the subject of education,
10 and patiently observed the conduct of parents and
the management of schools; but what has been the
result? A profound conviction, that the neglected
education of my fellow creatures is the grand
source of the misery I deplore; and that women
15 in particular are rendered weak and wretched by
a variety of concurring causes, originating from
one hasty conclusion. The conduct and manners
of women, in fact, evidently prove, that their
minds are not in a healthy state; for, like the
20 flowers that are planted in too rich a soil, strength
and usefulness are sacrificed to beauty; and the
flaunting leaves, after having pleased a fastidious
eye, fade, disregarded on the stalk, long before
the season when they ought to have arrived at
25 maturity. One cause of this barren blooming I
attribute to a false system of education, gathered
from the books written on this subject by men,
who, considering females rather as women than
human creatures, have been more anxious to make
30 them alluring mistresses than rational wives; and
the understanding of the sex has been so bubbled
by this specious homage, that the civilized women
of the present century, with a few exceptions, are
only anxious to inspire love, when they ought to
35 cherish a nobler ambition, and by their abilities
and virtues exact respect.

In a treatise, therefore, on female rights and
manners, the works which have been particularly
written for their improvement must not be
40 overlooked; especially when it is asserted, in direct
terms, that the minds of women are enfeebled by
false refinement; that the books of instruction,

written by men of genius, have had the same
tendency as more frivolous productions; and that
45 they are only considered as females, and not as a part
of the human species, when improvable reason is
allowed to be the dignified distinction, which raises
men above the brute creation, and puts a natural
scepter in a feeble hand.

Passage B

The object of this Essay is to explain as clearly as
I am able grounds of an opinion which I have held
from the very earliest period when I had formed
any opinions at all on social political matters, and
5 which, instead of being weakened or modified, has
been constantly growing stronger by the progress
reflection and the experience of life. That the
principle which regulates the existing social relations
between the two sexes — the legal subordination of
10 one sex to the other — is wrong itself, and now one
of the chief hindrances to human improvement; and
that it ought to be replaced by a principle of perfect
equality, admitting no power or privilege on the one
side, nor disability on the other.

15 The very words necessary to express the task I
have undertaken, show how arduous it is. But it
would be a mistake to suppose that the difficulty of
the case must lie in the insufficiency or obscurity of
the grounds of reason on which my convictions. The
20 difficulty is that which exists in all cases in which
there is a mass of feeling to be contended against.
So long as opinion is strongly rooted in the feelings,
it gains rather than loses instability by having a
preponderating weight of argument against it.
25 For if it were accepted as a result of argument, the
refutation of the argument might shake the solidity
of the conviction; but when it rests solely on feeling,
worse it fares in argumentative contest, the more
persuaded adherents are that their feeling must have
30 some deeper ground, which the arguments do not
reach; and while the feeling remains, it is always
throwing up fresh entrenchments of argument to
repair any breach made in the old. And there are so
many causes tending to make the feelings connected
35 with this subject the most intense and most deeply-
rooted of those which gather round and protect old
institutions and custom, that we need not wonder
to find them as yet less undermined and loosened
than any of the rest by the progress the great modern
40 spiritual and social transition; nor suppose that the
barbarisms to which men cling longest must be less
barbarisms than those which they earlier shake off.



32

What is the “one hasty conclusion” that Passage A refers to in line 17?

- A. The idea that women and men should be equally educated in the same manner
- B. The idea that men are too focused on getting women to behave in a certain culturally prescribed way
- C. The idea that men of the author’s era only treat women the way they do because they are adhering to tradition views
- D. The idea that women are somehow inferior to men

33

In the context in which it appears in Passage A, the word “bubbled” in line 31 means _____.

- A. flattered
- B. addled
- C. misunderstood
- D. angered

34

This passage’s main idea can best be summarized by which of the following sentences?

- A. There is a definite need for books about education to be written by women.
- B. Educational works written by men for women treat women unfairly as females instead of human beings.
- C. Women are being failed by an educational system that does not allow them to reach their full potential.
- D. Gender inequality is a terrible problem in the author’s society.

35

In Passage A, the author’s use of the phrase “barren blooming” (line 25) emphasizes what she perceives as _____.

- A. the unequal power dynamic between men and women during the author’s era
- B. the lack of any education for women whatsoever during the author’s era
- C. the wasted potential of the women of the society of her era
- D. the proliferation of the treatment of women as females rather than human beings

36

Which of the following best paraphrases lines 25–34 of Passage B?

- A. While beliefs based on logical reasoning can be corrected, it is very difficult to change beliefs founded on emotion.
- B. People who can distinguish their arguments from emotions are generally more fervent in defending them.
- C. We should only accept arguments that incorporate both emotion and logic.
- D. People who argue from an emotional basis rarely change the opinions of those who make logical arguments.



37

Imagine that another author argues that during a time of great social change, the first beliefs and actions widely altered in a culture are those that at the time are considered the most backward and in need of change. Which excerpt from Passage B most directly contradicts this claim?

- A. “[W]e need not . . . suppose that the barbarisms to which men cling longest must be less barbarisms than those which they earlier shake off.”
- B. “But it would be a mistake to suppose that the difficulty of the case must lie in the insufficiency or obscurity of the grounds of reason on which my convictions.”
- C. “[T]here are . . . many causes tending to make the feelings connected with this subject the most intense and most deeply-rooted of those which gather round and protect old institutions and custom.”
- D. “So long as opinion is strongly rooted in the feelings, it gains rather than loses instability by having a preponderating weight of argument against it.”

38

The author of Passage B thinks it will be difficult to convince people of his argument because _____.

- A. he realizes that the opposition is emotionally grounded in their traditional views
- B. he realizes that he lacks evidence with which to argue his case
- C. he admits that his argument is complex and difficult to follow
- D. he knows himself to be arguing from an emotional standpoint, not a logical one

39

One of the main points argued by the author of Passage B is _____.

- A. we should consider emotional arguments and logical arguments to be of equal validity
- B. every valid logical argument should also be able to be backed up with emotions
- C. if someone’s conclusion is based on emotion, arguing against it with logic will weaken it
- D. people often refuse to see reason when arguing a point based on emotional evidence

40

From these passages it is reasonable to infer that the two authors both value _____.

- A. exclusively women’s rights
- B. ethical equality in general
- C. social order
- D. social decorum

41

Which of the following inferences could NOT reasonably be drawn from both of these passages?

- A. The fundamental structure of society, both on a social and a legal level, is inherently biased against women.
- B. Social customs reinforce cultural biases.
- C. The subjugation of women is restricted to the area of social mores and education.
- D. There is no reasonable ethical or factual basis for treating women as inferior members of society.



42

It is reasonable to assume that the positions advocated in these passages were _____ at the time they were published.

- A. in the mainstream
- B. popular only among academics and social elites
- C. deeply unpopular and unconventional
- D. None of these are reasonable assumptions to make about the contemporary popularity of these positions.

Questions 43–52 are based on the following passage and supplementary materials.

“Dark Matter: Mapping the Invisible”

Line One of the most prominent astronomical
 5 advances in the last century has been the
 hypothesis that the universe contains dark
 matter. In fact, dark matter is thought to
 10 compose most of the known universe! Thus,
 it’s imperative that we better understand it.
 However, studying dark matter is inherently
 problematic because it’s invisible not just
 to the naked eye, but to our most powerful
 15 telescopes. In fact, dark matter can’t be seen
 with any telescope because it absorbs light.
 Our eyes register things based on reflected
 light, so if something doesn’t reflect any
 light, it can’t be seen. This has presented
 20 a significant problem to researching dark
 matter: how do you properly study something
 at astronomical distances without being able
 to see it?

Dark matter isn’t a new idea; Jan
 Oort (after whom Oort clouds are named)

20 proposed the concept in 1932 after he figured
 out that the mass of the Milky Way galaxy
 must exceed its visible mass in order for its
 rotation to conform to the laws of physics.
 Technology wasn’t advanced enough to lend
 25 him much evidence for his theory, but by
 the 1970s, Vera Rubin and Kent Ford had
 more evidence to work with in the form of
 galaxy rotation curves they constructed. A
 galaxy rotation
 30 curve is a graph
 that plots the
 velocity at which
 a star is orbiting
 the center of a
 galaxy against
 35 the distance of
 that star from
 the center of
 the galaxy. The
 time-tested laws
 of physics suggested that we could expect a
 40 star at a certain distance to orbit at a certain
 velocity, but the stars actually orbited much
 faster than predicted. Dark matter could
 account for the difference between expected
 and observed results.

45 Since Rubin and Ford’s discovery,
 scientists have been able to map out the
 hypothesized location of dark matter by
 observing the gravitational lensing of galaxy
 clusters. Gravitational lensing is one of the
 50 effects of the theory of general relativity
 articulated by Albert Einstein in a 1936
 paper. Basically, it states that if light is
 traveling from a distant star to your eyes
 observing the star on Earth, a lot of different
 55 things can get in the way of the traveling
 light, and due to their mass, can act as a lens
 and bend the light. As a result of this bent

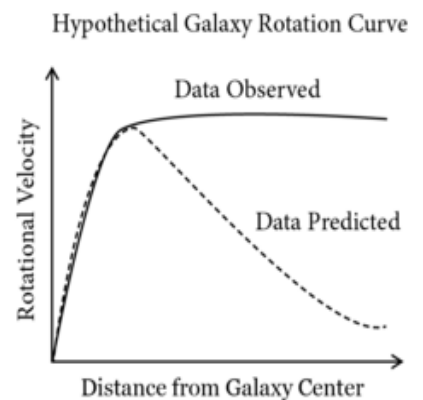

light, the observer may see multiple images scattered around the source. The number of images the observer sees, and how complete they are, depends on the relative orientation of the bodies involved: the closer the lens is to the source, the more complete the images the observer sees. This relationship is important, because it allows scientists who know where the observer is standing and where a light source is located to figure out the location of the lens—whatever is making the light bend. Scientists have found that light is bent in instances where no regular, observable matter accounts for it, suggesting that dark matter gets in the way and causes the lensing effect. By analyzing images of many galaxy clusters, scientists are able to map out the hypothesized location of dark matter. This adds to the evidence for the existence of dark matter along with other measurements that have suggested that there is more mass in galaxy clusters than we can see.

43

In the phrase “gravitational lensing,” “lensing” most nearly means _____.

- A. orbiting
- B. mapping
- C. absorbing
- D. bending

44

Which of the following best describes the author’s likely motivation for including the graph with this passage?

- A. To supplement the passage’s claims with specific evidence from an experiment.
- B. To help the reader visualize the discrepancy between the predicted and observed data.
- C. To provide additional information not mentioned anywhere in the passage.
- D. To show an example of the type of data that Oort worked with.

45

Which of the following best summarizes this passage’s first paragraph?

- A. Dark matter, a relatively recent scientific discovery, is difficult but rewarding to study.
- B. Dark matter cannot be seen because it absorbs light.
- C. Studying anything that you cannot see is inherently difficult.
- D. Our understanding of the universe has improved vastly in the last century.



46

According to the passage and the graph, the observed results are _____ the predicted results because of _____.

- A. faster than . . . gravitational lensing
- B. faster than . . . dark matter
- C. slower than . . . gravitational lensing
- D. slower than . . . dark matter

47

Which of the following answer choices puts the scientists in the order in which their referenced works were published, from earliest in history to most recent?

- A. Oort, Rubin and Ford, Einstein
- B. Einstein, Oort, Rubin and Ford
- C. Einstein, Rubin and Ford, Oort
- D. Oort, Einstein, Rubin and Ford

48

For what likely purpose does the author include the phrase “time-tested”?

- A. To suggest that just because the laws are traditional does not make them reliable
- B. To suggest that the laws involve time as a variable in their equations
- C. To convey that scientific evidence has proven the laws to be true over time
- D. To convey that the laws have been tested and found to be true in timed experiments

49

Whereas the second paragraph focuses on _____, the third paragraph focuses on _____.

- A. how dark matter was discovered . . . how it is researched
- B. what dark matter is . . . how it is researched
- C. how dark matter is researched . . . how dark matter was discovered
- D. how dark matter is researched . . . what dark matter is

50

Which of the following is conveyed by the graph?

- A. The predicted data accounts for the presence of dark matter.
- B. Predicted and observed data differ more for stars relatively far away from the galaxy center than for stars relatively close to the galaxy center.
- C. The observed data includes a decrease in rotational velocity that has been attributed to the presence of dark matter.
- D. The predicted and observed data correspond very nearly for stars near the galaxy center due to gravitational lensing.

51

The author claims that _____ function(s) as evidence supporting the existence of dark matter.

- A. gravitational lensing
- B. differences in observed and predicted data in galaxy rotation curves and gravitational lensing
- C. differences in observed and predicted data in galaxy rotation curves
- D. differences in observed and predicted data in galaxy rotation curves and the locations of galaxies relative to Earth



Astronomer A is studying a new galaxy cluster. She sees three complete images of the cluster projected around the light source. Astronomer B, another scientist in the same lab, is studying a different galaxy cluster. She only sees one incomplete image of the cluster projected near the light source. Based on the passage, what can they conclude?

- A. Astronomer B's galaxy cluster is located nearer to its source than Astronomer A's cluster is to its source.
- B. Astronomer A is closer to her galaxy cluster than is Astronomer B.
- C. Nothing can be concluded about the relative locations of the astronomers' galaxy clusters based on this observation because the astronomers don't have any information about the rotational velocities of galaxies in either galaxy cluster.
- D. The astronomical object bending the light around Astronomer A's galaxy cluster is located nearer to its source than the astronomical object bending the light around Astronomer B's galaxy cluster is to its source.

STOP

**If you finish before time is called, you may check your work on this section only.
Do not turn to any other section.**



Writing and Language Test

35 MINUTES, 44 QUESTIONS

DIRECTIONS

Each passage below is accompanied by a number of questions. For some questions, you will consider how the passage might be revised to improve the expression of ideas. For other questions, you will consider how the passage might be edited to correct errors in sentence structure, usage, or punctuation. A passage or a question may be accompanied by one or more graphics (such as a table or graph) that you will consider as you make revising and editing decisions.

Some questions will direct you to an underlined portion of a passage. Other questions will direct you to a location in a passage or ask you to think about the passage as a whole.

After reading each passage, choose the answer to each question that most effectively improves the quality of writing in the passage or that makes the passage conform to the conventions of standard written English. Many questions include a “NO CHANGE” option. Choose that option if you think the best choice is to leave the relevant portion of the passage as it is.

Questions 1–11 are based on the following passage.

Living Walls

The practice of building living walls (also known as vertical gardens) has exploded in popularity in recent years, and promises only to increase in the future as a premium continues to be placed on space, greenery, and food independence in the face of urbanization and



global climate change.

Living walls are, essentially, gardens (of either decorative or produce plants, like leafy greens) that through careful cultivation and construction and the use of hydroponic technology can be made to flourish inside an urban home. **1**

When a vertical garden is built, wherever it is built and by whomever it is built, a frame is constructed around a specifically designed vertical irrigation platform. This allows the plants to grow upwards along a specifically designed pattern, and in a particular location within a home. Instead of taking up essential floor space, thoughtfully designed vertical gardens can inhabit negative space along walls, or sometimes even on roofs, growing in specified locations rather than inhabiting entire rooms of a home or apartment. In addition to providing

1

- A. NO CHANGE
- B. When a vertical garden is built, wherever it is built and whoever builds it, a frame is constructed around a specifically designed vertical irrigation platform.
- C. When a vertical garden is built, a frame is constructed around a specifically designed vertical irrigation platform.
- D. When someone builds a vertical garden is built, no matter where that person builds it, a frame is constructed around a specifically designed vertical irrigation platform.



food or greenery, that is practical or aesthetic value, **2** such walls can also help to keep the temperature in an enclosed space down.

These gardens, by virtue of being in an enclosed space, also save their owners the trouble of protecting the gardens from insects and rodents. Whereas an outdoor garden may require **3** elaborate fencing to keep away animals and may even require the use of pesticides to keep away bugs, not to mention growing season limited by weather, indoor gardens are kept a steady temperature year round and, unless the gardener happens to have deers or rabbits running free in their home, are protected from **4** animals'.

The practice of keeping houseplants for decorative purposes has been common for

2

Which of the following options provides the most relevant detail?

- A. NO CHANGE
- B. such walls can also help to keep the temperature in an enclosed space perfectly regular.
- C. such walls can also help to keep the temperature in an enclosed space down, as the plants absorb heat and light.
- D. such walls also help to decrease one's energy, as they convert the sun's energy into fuel.

3

The use of the word "elaborate" has what effect on the author's description of outdoor gardens?

- A. It helps convey the ornate nature of some garden fences.
- B. It helps highlight the hassle and complications associated with outdoor gardens.
- C. It helps ground the description by providing realistic details.
- D. It helps demonstrate the greater skill needed to maintain an outdoor garden.

4

- A. NO CHANGE
- B. animal's
- C. animal
- D. animals



many years, but with recent developments in technology, the idea of a potted plant has been expanded, both in terms of its **5** aesthetic potential (e.g. a whole wall as opposed to an isolated plant on a shelf) and its practical, environmental application (e.g. a living wall that reuses water and provides food as opposed to a purely decorative plant that is maintained with tap water).

It is no secret that the world has been undergoing a massive and fundamental shift towards urbanization in the last two centuries.

6 Clearly, as people move from the country to the city and from houses to condominiums or apartments, the possibility of urban-dwelling families and individuals growing their own food and plants within their living space only makes more and more sense. **7** In 2014 the World

5

Which of the following best emphasizes the potential importance of how the vertical gardens look?

- A. NO CHANGE
- B. acetic
- C. artistic
- D. visual

6

To make this paragraph the most logical, the underlined sentence would best be placed _____.

- A. NO CHANGE
- B. The sentence is irrelevant and incoherent, and should be removed entirely.
- C. at the beginning of the paragraph
- D. at the end of the paragraph, following the sentence citing a World Health Organization statistic

7

- A. NO CHANGE
- B. In 2014, the World Health Organization estimated that 54% of the world's population lived in cities or suburbs,
- C. In 2014, the World Health Organization estimated that 54% of the world's population lived in cities or suburbs.
- D. In 2014, the World Health Organization estimated that 54% of the world's population lived in cities or suburbs . . .



Health Organization estimated that 54% of the world's population lived in cities or suburbs; meaning that almost four billion people lived in these urban areas.

8 All this is not to say that vertical gardens is the perfect solution to all of our problems. **9** The hydroponic systems required to maintain these gardens are costly, complicated, and require a good deal of energy to maintain, leading critics to question their practical and environmental value. Those concerns are certainly important and probably valid **10** because as the technology continues to develop and urban space continues to become inhabited, **11** the desire city-dwellers all have that is to grow their own fresh vegetables right in their living room will almost certainly grow as well.

8

- A. NO CHANGE
- B. All this is not to say that vertical gardens are being the perfect solution to all of our problems
- C. All this is not to say that vertical gardens are the perfect solution to all of our problems
- D. All this is not to say that vertical gardens were the perfect solution to all of our problems

9

The writer is considering deleting the underlined sentence. Should he or she do so, and why or why not?

- A. Yes, the underlined sentence undermines the overall thesis by presenting the views of those critical of the passage's overriding thesis about vertical gardens.
- B. Yes, the underlined sentence discusses views that are irrelevant to the passage's overall argument about the popularity and viability of vertical gardens.
- C. No, the underlined sentence provides useful context that supports the passage's overall argument about the popularity and viability of vertical gardens.
- D. No, the underlined sentence provides useful context, and lends the author's argument legitimacy by providing and addressing alternative viewpoints.

10

- A. NO CHANGE
- B. but
- C. after
- D. Delete "because"; the first word of the second sentence should be "as."



11

How can the underlined portion best be rewritten to convey the author's conclusion more efficiently?

- A. NO CHANGE
- B. the desire city dwellers all have is to grow
- C. the desire of city dwellers to grow
- D. the desire city dwellers that is to grow



Questions 12–22 are based on the following passage.

“Japanese Internment”

In October of 1990, the Attorney General of the United States met with nine elderly Japanese Americans, in a ceremony in Washington D.C. The ceremony focused on the actions of the United States government in World War II. Unlike typical World War II ceremonies celebrating heroism, sacrifice, leadership, and victory, this ceremony undertook an entirely different task— **12** apology. The nine individuals represented the most elderly surviving Japanese Americans who were incarcerated and **13** forcefully relocated during the war. The attorney general presented each of them with a formal apology from President George Bush and a check for 20,000 dollars

12

- A. NO CHANGE
- B. apologies
- C. apologizing
- D. apologize

13

Which choice most effectively sets up the information that follows and transitions into the next sentence?

- A. NO CHANGE
- B. forcibly
- C. enforcibly
- D. enforced



as redress for the forced internment that was, as Congress admitted, “motivated largely by racial prejudice, wartime hysteria, and a failure of political leadership.” **14** By the end of the decade, the American government would pay reparations to more than 80,000 survivors and their descendants, 1.6 billion dollars in all.

On December 7, 1941, Japan attacked the United States at Pearl Harbor. The next day, the Congress formally declared war on Japan. Within two months, the popular opinion in the United States had turned against the Japanese American population and placed enormous pressure on the government to take action against them. On February 19, 1942, President Roosevelt signed Executive Order 9066, which allowed all or part of Washington, Oregon, California, and Arizona to be declared military

14

Which of the following statements would be most relevant to the passage if added after Location **14**?

- A. This pairing of specified bureaucratic language, whereby longtime residents of America of Japanese descent were specifically precluded from acquiring citizenship and then systematically punished for the lack of that citizenship, is a classic example of institutionalized racial and cultural prejudice.
- B. The conditions of these camps, in particular were deplorable in the sense that the residents of these camps had no say in the administration of food, and no choice as to which camp or location they were placed.
- C. This forcible internment was exacerbated by the extremely poor conditions at the camps themselves. In particular the aforementioned lack of medical care and food in the camps form a particularly convincing case against any societal or security value such internment camps were said to provide.
- D. The dollar amount of the reparations is clear evidence of not only the grievous nature of the violation of the individual human rights of those held, but of the extremely wide scale of the internment.



zones, **15** and all people of Japanese descent being excluded from those areas unless they were residing in government camps. In March, residents of these areas began to report to Civilian Assembly Centers, and the forced relocation to internment camps began. From here, they were sent to Relocation Centers located, for the most part, on Native American reservations in remote areas.

The forced relocation was widespread and systematic. At the time, nearly ninety percent of all Japanese Americans in the continental United States resided in the West-coast areas that comprised the military zone. **16** By the end of the war, perhaps as many as 120,000 of the 127,000 Japanese Americans living in the continental United States were relocated. Two-thirds of these people were U.S. citizens.

15

- A. NO CHANGE
- B. and all people of Japanese descent to be excluded
- C. and all people of Japanese descent to be excluding
- D. and all people of Japanese descent's exclusion

16

Which choice most effectively sets up the information that follows and transitions into the next sentence?

- A. The language and regional focus of the Order was hardly an accident, and as a result
- B. Because the relocation occurred only in war zones,
- C. On the other hand,
- D. In spite of this,



17 The majority of the non-citizens had actually resided in the United States for a longer period of time, but racially-specific laws passed in the 1920's prevented Japanese immigrants (but not their children, who were born on American soil) from ever acquiring citizenship.

Conditions in the Relocation Centers were often poor. Many of the camps were located in **18** urban desert locations with extreme weather conditions. Camps such as Manzanar, located at the base of the Sierra Nevada Mountains in California, **19** featured incessant high winds as well as large fluctuations between day and night. **20** Additionally, the barracks-style housing featured shoddy, threadbare construction, as well as cramped living conditions.

17

The author's inclusion of this statement serves to _____.

- A. indicate that the given statistics are inaccurate
- B. suggest that the source of the given statistics was biased
- C. illustrate the validity of the given statistics
- D. provide context for the previous statement

18

Which of the following could replace the word "urban" to better describe the placement of the camps in remote deserts?

- A. crowded
- B. tempered
- C. uninhabitable
- D. sparse

19

- A. NO CHANGE
- B. featured incessantly high winds as well as many large fluctuations between day and night.
- C. featured incessant high winds as well as large fluctuations in temperature between day and night.
- D. featured incessant high winds as well as large fluctuations in between day and night.

20

- A. NO CHANGE
- B. But
- C. In addition to
- D. On top of this,



21 Multiple families were packed into areas built for a single family. Medical care and food were often lacking. **22**

21

Which of the following is the best way to combine the final two sentences of this passage?

- A. Multiple families were packed into areas built for a single family; medical care and food were often lacking.
- B. Multiple families were packed into areas built for a single family, medical care and food were often lacking.
- C. Multiple families were packed into areas built for a single family, and medical care and food were often lacking.
- D. All of the provided options create grammatical errors. The sentences cannot be combined.

22

The author of this passage wants to break the final paragraph into two paragraphs, both discussing different aspects of the conditions of the internment. What is the best point at which to do so?

- A. Before the sentence beginning with “Additionally”
- B. After the sentence ending with “extreme weather conditions”
- C. Before the sentence beginning with “Multiple families”
- D. There is no logical point at which to break this paragraph.



Questions 23–33 are based on the following passage.

A History of Chess

23 People have been playing the game of chess for centuries with relatively little variation, and the ways in which the game has changed over the ages and in different countries offers an interesting look at some of the details of history.

24 The game originated in sixth-century BCE India, originally called “chaturanga.” **25** This name, which roughly translated means “four parts,” references what were the four traditional parts of the Indian military. The modern bishops began as elephants, rooks as chariots, knights as cavalry units, and pawns as infantry units.

23

The first sentence’s underlined claim performs which of the following functions?

- A. It sets the tone with a bold, aggressive claim.
- B. It provides an initial thesis statement about the historical development of chess through the ages that is supported by the rest of the passage.
- C. It provides an initial perspective against which the rest of the passage argues.
- D. It fulfills a purely grammatical function, linking the clauses of the sentences. This claim is irrelevant to the content of the passage itself.

24

- A. NO CHANGE
- B. The game originally originated in sixth-century BCE India, called “chaturanga.”
- C. The game originated as “chaturanga” in sixth-century BCE India.
- D. Originally called “chaturanga” in sixth-century BCE India, the game originated.

25

The author’s inclusion and explanation of the initial Indian name for chess serves what purpose in the passage overall?

- A. Provides initial historical detail and context, setting the tone for this historical treatment of the subject.
- B. Provides key details needed to support the author’s overall claims about the progress of the social significance of the game.
- C. It serves very little purpose, and is just included as a noteworthy historical aside.
- D. It serves no purpose, and should be removed for concision and clarity.



26 [1] The game arrived in Europe as early as the ninth century by way of contact with Persia and the Byzantine and Arabian empires. [2] There, it continued to be associated with royalty and nobles. [3] Coverage of the game can be found in books from the period, and ornate chessboards were constructed. [4] Eventually, chess became popular with laypeople. Chess didn't just remain in India; it spread as the culture contacted others. People would gather to bet on the game at noisy tournaments, resulting in the Catholic Church and various monarchs banning the game at various points of European history. Not every ruler and ecclesiastical official was set against the game, though; some saw merit in it because **27** it is based on skill and not on just being lucky. **28**

26

Which of the following locations is the best location for the sentence, "Chess didn't just remain in India; it spread as the culture contacted others"?

- A. Location [1]
- B. Location [2]
- C. Location [3]
- D. Location [4]

27

- A. NO CHANGE
- B. it is based on skill and just not on luck
- C. it is just based on skill, and not on luck
- D. it is based on skill and not on luck

28

If a sentence directly comparing the complexity of the gameplay of chess and checkers were inserted at the end of the second paragraph it would _____.

- A. help to emphasize the passage's fundamental purpose of highlighting the beauty and complexity of chess gameplay through a meaningful comparison
- B. help to improve the overall focus of the essay by ending a digression about monarchs and ecclesiastical leaders and refocusing the paragraph on the logistics of chess gameplay
- C. distract from the historical focus of the passage by inserting completely irrelevant content about the gameplay of another game
- D. distract from the logistical, game-theoretical focus of the passage by inserting content about the gameplay of a totally separate, unrelated game



At this point in history, the chess played was still a bit different from chess as it's played today. The queen was comparatively underpowered. Around the end of the fifteenth century, a special version of chess called "queen's chess" introduced the more powerful move sets for these two pieces. It became popular in Spain and spread across Europe, leading to the game taking a form close to its modern one. **29**

These adapted rules changed the strategy players used, since a pawn moved all the way to the opponents' side of the board can become a queen and dramatically change the balance of power in a game, the new rules made moving one's pawns to the other side of the board a more crucial part of chess strategy.

30 Standardized competitive chess tournaments became popular as a sport in

29

- A. NO CHANGE
- B. These adapted rules changed the strategy players used: since a pawn moved all the way to the opponents' side of the board can become a queen and dramatically change the balance of power in a game, the new rules made moving one's pawns to the other side of the board a more crucial part of chess strategy.
- C. These adapted rules changed the strategy players used, and since a pawn moved all the way to the opponents' side of the board can become a queen and dramatically change the balance of power in a game, the new rules made moving one's pawns to the other side of the board a more crucial part of chess strategy.
- D. These adapted rules changed the strategy players used, and since a pawn moved all the way to the opponents' side of the board can become a queen and dramatically change the balance of power in a game, the new rules made moving one's pawns to the other side of the board a more crucial part of chess strategy.

30

- A. NO CHANGE
- B. Standardized and competitive chess tournaments became popular as a sport
- C. Standardized-competitive chess tournaments became popular as sporting events
- D. Standardized, competitive chess tournaments became popular as sporting events



Europe beginning around the mid-nineteenth century, though they did not yet involve time limits. This aspect of tournament play was only added after players **31** considered potential moves for hours during the first European chess tournament, held in 1851 London. Time limits began to be implemented in the following years **32**. Strategically impressive games and famous players became touchstones of the growing community. **33** The World Chess Federation (FIDE), founded in 1924 and presiding over the titles of “Grand Master” and “World Chess Champion” ever since. Since then, people have continued to enjoy the game of chess in casual and competitive environments.

31

Which of the following options best emphasizes that the players took a long time in making their moves?

- A. NO CHANGE
- B. deliberated about
- C. critiqued
- D. selected

32

Which of the following details would be most relevant to the passage if inserted after a comma at Location **33**? (Assume they are all true statements.)

- A. but many people who play chess casually today don't use time limits
- B. even though hourglasses could be unreliable
- C. with the first timed tournament being held in 1861
- D. but some people didn't like the change

33

- A. NO CHANGE
- B. The World Chess Federation (FIDE) was founded in 1924, and has presided over the titles of “Grand Master” and “World Chess Champion” ever since.
- C. The World Chess Federation (FIDE), founded in 1924, presided over the titles of “Grand Master” and “World Chess Champion” ever since.
- D. The World Chess Federation (FIDE) founded in 1924 has presided over the titles of “Grand Master” and “World Chess Champion” ever since.



Questions 34–44 are based on the following passage.

“Two Perspectives in Studying Physics”

34 Quantum mechanics and classical mechanics represents two different ways of looking at the world when studying physics. Classical mechanics investigates the laws governing physical motion. **35** This can range from the small-scale, such as an apple falling off of a tree—to the large-scale, such as the orbits of planets. Many students find classical mechanics to be challenging, but they can take heart in the fact that most if not all of the examples they are likely to come across in a high school or college introductory physics class involve visible, tangible objects. **36** **37** [1] Even if a problem is purely hypothetical, it’s easy to imagine observing it. [2] Quantum mechanics is very

34

- A. NO CHANGE
- B. Mechanics, quantum and classical, represent two different ways
- C. Quantum mechanics is one representation, and classical mechanics another,
- D. Quantum mechanics and classical mechanics represent two different ways

35

- A. NO CHANGE
- B. This can range from the small-scale, such as an apple falling off of a tree, to the large-scale, such as the orbits of planets.
- C. This can range from the small-scale—such as an apple falling off of a tree—to the large-scale such as the orbits of planets.
- D. This can range, from the small-scale such as an apple falling off of a tree, to the large-scale, such as the orbits of planets.

36

Which of the following could be added to the passage at Location **36** to connect the sentences before and after this location?

- A. Problems in classical mechanics involve rolling, pushing, dropping, falling, throwing, and bouncing.
- B. High school physics classes frequently cover classical mechanics.
- C. Hypothetical problems are considered commonplace in quantum mechanics.
- D. Classical mechanics, also known as Newtonian mechanics, was initially proposed by Sir Isaac Newton.



different. [3] This system grew out of classical mechanics' inability to answer certain questions or offer explanations for certain observed phenomena. [4] **38** Experiments in this field involve electrons, photons, particles, waves, and other phenomena that are either not visible with the naked eye and often not visible with powerful microscopes. As a result, understanding quantum mechanics' major breakthroughs and discoveries often involves thought experiments and theoretical situations that may leave students without tangible intellectual ground to stand on.

37

The author of this passage wants to break apart the first paragraph into two paragraphs at a point that will most distinguish quantum mechanics from classical mechanics. At which of the following points should the author break apart the paragraph?

- A. Location [1]
- B. Location [2]
- C. Location [3]
- D. Location [4]

38

- A. NO CHANGE
- B. Experiments in this field involve electrons, photons, particles, waves, and other phenomena that are either not visible with the naked eye or not visible with powerful microscopes.
- C. Experiments in this field involve electrons, photons, particles, waves, and other phenomena that are not visible with the naked eye and are often not visible with powerful microscopes.
- D. Experiments in this field involve electrons, photons, particles, waves, and other phenomena that are on the one hand not visible with the naked eye and on the other not visible with powerful microscopes.



39 In addition, many of quantum mechanics' core experiments yield inherently puzzling results that are not as neat and tidy as those produced by classical mechanics' calculations.

As an example of such an experiment, let's consider Thomas Young's famous 1803 double-slit experiment. Young observed characteristics of light that **40** demonstrated that light behaves like a stream of discrete particles, but in the same experiment, he observed characteristics that suggested light behaves as a wave. These results flummoxed scientists and **41** created confusion; they helped generate the modern view of light as a "wave-particle duality."

39

- A. NO CHANGE
- B. In addition, many of quantum mechanics core experiments yield inherently puzzling results that are not as neat and tidy as those produced by classical mechanics calculations
- C. In addition, many of quantum mechanic's core experiments yield inherently puzzling results that are not as neat and tidy as those produced by classical mechanic's calculations
- D. In addition, many of quantum mechanics's core experiments yield inherently puzzling results that are not as neat and tidy as those produced by classical mechanics's calculations

40

Which of the following could replace the word "demonstrated" to indicate the theoretical nature of Young's conclusions from the double-slit experiment?

- A. proved
- B. indicated
- C. suggested
- D. illustrated

41

Which of the following verb phrases can best replace the underlined phrase to emphasize the effort that scientists put into attempting to make sense of the phenomena being discussed?

- A. NO CHANGE
- B. did not make sense in terms of traditional concepts
- C. dodged traditional explanations
- D. were revolutionary in the scientific community



That concept is difficult for many students and scientists to picture—**42** much more so than picturing a falling apple.

42

The author is considering omitting the phrase “much more so than picturing a falling apple” that concludes the second paragraph. Should the author do this?

- A.** Yes, because the author has associated the falling apple with classical mechanics, not quantum mechanics, so it interrupts the flow of the paragraph.
- B.** Yes, because falling apples are associated with Newton, and the paragraph has concluded talking about Young.
- C.** No, because the phrase is necessary to lead the reader into the next paragraph and without it, the passage would be confusing.
- D.** No, because the phrase contrasts quantum mechanics with classical mechanics, working toward the purpose of the passage.



43 Modern scientists continue to investigate

the ways in which the two systems of thought

interact. They pay particular attention to

moments in which they are incompatible.

If you like really difficult puzzles, maybe

studying quantum mechanics is for you! **44**

Just remember: just because classical mechanics

isn't as active in pushing the frontiers of

scientific knowledge doesn't mean that it is a

core part of a physics education. Many of its

tenets still hold, and quantum mechanics often

functions in the interstices where they do not.

Understanding both systems is the best way to

approach learning about the world through the

lens of physics.

43

Which of the following is the best way to combine the underlined sentences?

- A. Modern scientists, paying particular attention to moments in which they are incompatible, continue to investigate the ways in which the two systems of thought interact
- B. Paying particular attention to moments in which they are incompatible, modern scientists continue to investigate the ways in which the two systems of thought interact.
- C. Modern scientists continue to investigate the ways in which the two systems of thought interact, paying particular attention to moments in which they are incompatible.
- D. The two systems of thought continue to be investigated by modern scientists, paying particular attention to moments in which they are incompatible.

44

- A. NO CHANGE
- B. Just remember: just because classical mechanics is as active in pushing the frontiers of scientific knowledge doesn't mean that it is a core part of a physics education.
- C. Remember: just because classical mechanics isn't as active in pushing the frontiers of scientific knowledge means that it isn't a core part of a physics education.
- D. Remember: just because classical mechanics isn't as active in pushing the frontiers of scientific knowledge doesn't mean that it isn't a core part of a physics education.





Math Test - No Calculator

25 MINUTES, 20 QUESTIONS

DIRECTIONS

For questions 1–15, solve each problem and choose the best answer from the choices provided. For questions 16–20, solve the problem. No answer choices are provided because on the actual exam, you will enter your answer in a grid on the answer sheet. You may use any available space in your test booklet for scratch work.

NOTES

1. The use of a calculator **is not permitted**.
2. All variables and expressions used represent real numbers unless otherwise indicated.
3. Figures provided in this test are drawn to scale unless otherwise indicated.
4. All figures lie in a plane unless otherwise indicated.
5. Unless otherwise indicated, the domain of a given function f is the set of all real numbers x for which $f(x)$ is a real number.

REFERENCE

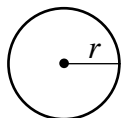

$$A = \pi r^2$$

$$C = 2\pi r$$

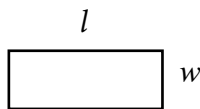

$$A = lw$$

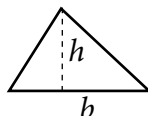

$$A = \frac{1}{2}bh$$

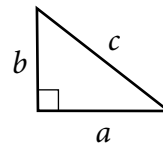

$$c^2 = a^2 + b^2$$

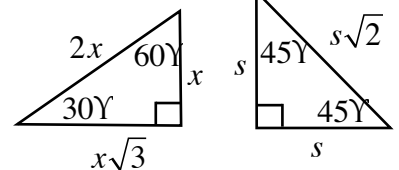

Special Right Triangles

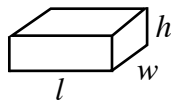

$$V = lwh$$

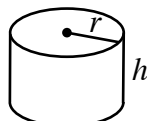

$$V = \pi r^2 h$$

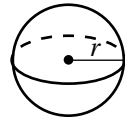

$$V = \frac{4}{3}\pi r^3$$

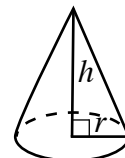

$$V = \frac{1}{3}\pi r^2 h$$

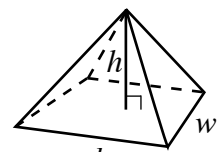

$$V = \frac{1}{3}lwh$$

The number of degrees of arc in a circle is 360.

The number of radians of arc in a circle is 2π .

The sum of the measures in degrees of the angles of a triangle is 180.





Questions 1–2 refer to the following information.

Equation of Object A:

$$x^2 - 4x + 4 + 6y + 9 = -y^2 + 9$$

Equation of Object B:

$$x^2 = 16 - y^2$$

Equation of Object C:

$$y = (x + 2)^2$$

1

What is the shape of Object A?

- A. Circle centered at $(-2, 3)$ with radius of 3
- B. Ellipse centered at $(4, 9)$ with major axis 2
- C. Parabola with vertex at $(-3, 2)$, opening upwards
- D. Circle centered at $(2, -3)$ with radius of 3

2

Which is a point where Object B and Object C intersect?

- A. $(-1, 4)$
- B. $(2, 4)$
- C. $(0, 4)$
- D. $(-2, 4)$

3

A chemical solution is made of water and some mystery Liquid Q. There is 9 ml of Liquid Q and a total of 15 ml of the new chemical solution. If the new chemical solution is 78% Liquid Q, what is the equation to solve for the amount of water, W , in the solution?

- A. $W(0.22) + 9(0.78) = 15$
- B. $W(0.78) + 9(0.22) = 15$
- C. $9W + 0.78 = 15$
- D. $(1 + W)W + 9 = 15$

4

Let x and y be numbers such that x and y are both nonzero and $x > y$. If half of x is equal to thirty percent of the positive difference between x and y , then what is the ratio of x to y ?

- A. $\frac{2}{3}$
- B. $-\frac{3}{2}$
- C. $\frac{3}{2}$
- D. $-\frac{2}{3}$





5

According to a recent sociological study, it was found that the likelihood of a bystander responding to an incident, r , decreased linearly with respect to the number of bystanders, b , present at the time of the incident. Which of the given functions could potentially represent this phenomenon mathematically?

- A. $r = -0.35b + 2$
- B. $r = 1.36b - 0.4$
- C. $b = -0.8r + 2.5$
- D. $b = 4r - 0.12$

Questions 6–7 refer to the following information.

Line 1 is depicted by the equation $y = 2x - 7$ and Line 2 is depicted by the equation $2y + x = 8$.

6

What is the relationship between Line 1 and Line 2?

- A. The lines are parallel.
- B. The lines are perpendicular.
- C. The equations result in the same line.
- D. The lines intersect at $(\frac{22}{3}, \frac{22}{3})$.

7

What is the function value of Line 2 when $x = 8$?

- A. 2
- B. 4
- C. -1
- D. 0

8

A farm in Oklahoma is circular in shape. If the irrigation system dispenses 300 gallons of water

a day to $\frac{5\pi}{6}$ of the farm, in degrees, how much of the farm is receiving irrigation?

- A. 150Y
- B. 130Y
- C. 92Y
- D. 125Y

9

Solve for x : $4^{5x+10} = 2(2^{3x-1})$

- A. $x = \frac{20}{7}$
- B. $x = -\frac{7}{20}$
- C. $x = -\frac{20}{7}$
- D. $x = \frac{7}{20}$





10

Kim is selling tickets for the fall showcase at her school. Adult tickets cost \$5 each and a children's ticket costs \$2. Kim has 150 tickets to sell and wants to make at least \$375. Which system of inequalities represents this scenario?

- A. $5c + 2a \geq 375$
 $c + a \leq 150$
- B. $5c + 2a \leq 375$
 $c + a \geq 150$
- C. $5c + 2a = 375$
 $c + a \leq 150$
- D. $2c + 5a \geq 375$
 $c + a = 150$

11

Expand the polynomial:

$$(x - 2y + z)^2$$

- A. $x^2 + 4y^2 + z^2 + 4xy - 4yz + 2xz$
- B. $x^2 + 4y^2 + z^2 - 4xy - 4yz + 2xz$
- C. $x^2 + 4y^2 + z^2 - 4xy - 4yz - 2xz$
- D. $x^2 - 4y^2 + z^2 - 4xy - 4yz + 2xz$

Questions 12–13 refer to the following information.

There is a sale going on at the local mall. For five days everything in the mall is discounted 25%.

12

A sweater that was originally \$80.00 is part of the mall-wide discount. If the sales tax is 7.5%, how much does the sweater cost?

- A. \$64.50
- B. \$64.00
- C. \$72.25
- D. \$74.50

13

If the sales tax is uniform across the stores in the mall at 7.5%, what would the equation to find the total cost of a discounted item be and what would $f(44)$ be?

- A. $f(x) = \frac{3x}{4}(1 + 0.075)$; $f(44) = \$35.48$
- B. $f(x) = \frac{x}{4}(1 + 0.075)$; $f(44) = \$35.48$
- C. $f(x) = \frac{3x}{4}(1 + 0.075)$; $f(44) = \$45.48$
- D. $f(x) = \frac{1x}{4}(1 + 0.075)$; $f(44) = \$55.48$





14

Given $(x - 4)^2 + y^2 - 14y + 49 = 36$, what is the center, radius, and equation of the circle in standard form?

- Center = $(-4, -7)$
A. Radius = 6
 $(x - 4)^2 + (y - 7)^2 = 36$
- Center = $(4, -7)$
B. Radius = 36
 $(x - 4)^2 + (y - 7)^2 = 36$
- Center = $(-4, 7)$
C. Radius = 6
 $(x - 4)^2 + (y - 7)^2 = 36$
- Center = $(4, 7)$
D. Radius = 6
 $(x - 4)^2 + (y - 7)^2 = 36$

15

Which of the following is equivalent to the given expression?

$$(8 - 3i)(6 + 4i) - \sqrt{(16i \times 4i)}$$

- A.** $36 + 22i$
- B.** $28 + 14i$
- C.** $60 + 6i$
- D.** $28 - 18i$





DIRECTIONS

For questions 16–20, solve the problem and enter your answer in the grid, as described below, on the answer sheet.

- Although not required, it is suggested that you write your answer in the boxes at the top of the columns to help you fill in the circles accurately. You will receive credit only if the circles are filled in correctly.
- Mark no more than one circle in any column.
- No question has a negative answer.
- Some problems may have more than one correct answer. In such cases, grid only one answer.
- Mixed numbers** such as $3\frac{1}{2}$ must be gridded as 3.5 or $\frac{7}{2}$. (If “(3)(1)(/)(2)” is entered into the grid, it will be interpreted as $\frac{31}{2}$, not $3\frac{1}{2}$.)
- Decimal answers**: if you obtain a decimal answer with more digits than the grid can accommodate, it may be either rounded or truncated, but it must fill the entire grid.

16

Bob lives 8 blocks east and 2 blocks north of his school. If he walked a straight line to his school and that line is then written as a function on a graph, what would be the slope of the line?

		/	/	
.
	0	0	0	
1	1	1	1	
2	2	2	2	
3	3	3	3	
4	4	4	4	
5	5	5	5	
6	6	6	6	
7	7	7	7	
8	8	8	8	
9	9	9	9	

17

Find the solution to the following equation:

$$4x^2 - 12x + 9 = 0$$

		/	/	
.
	0	0	0	
1	1	1	1	
2	2	2	2	
3	3	3	3	
4	4	4	4	
5	5	5	5	
6	6	6	6	
7	7	7	7	
8	8	8	8	
9	9	9	9	





Questions 18–19 refer to the following information.

A line on a graph is seen to have the format of $y = ax + b$. The line has a y-intercept at 2.

18

What is the slope of the line if it contains the point (4,6)?

.	/	/	.
.	.	.	.
	0	0	0
1	1	1	1
2	2	2	2
3	3	3	3
4	4	4	4
5	5	5	5
6	6	6	6
7	7	7	7
8	8	8	8
9	9	9	9

19

If the slope of the line is -10 , what is the x-coordinate of the x-intercept of the line?

.	/	/	.
.	.	.	.
	0	0	0
1	1	1	1
2	2	2	2
3	3	3	3
4	4	4	4
5	5	5	5
6	6	6	6
7	7	7	7
8	8	8	8
9	9	9	9

20

In an isosceles right triangle, if the hypotenuse is $10\sqrt{2}$, what is the area of the triangle?

.	/	/	.
.	.	.	.
	0	0	0
1	1	1	1
2	2	2	2
3	3	3	3
4	4	4	4
5	5	5	5
6	6	6	6
7	7	7	7
8	8	8	8
9	9	9	9

STOP

If you finish before time is called, you may check your work on this section only.
Do not turn to any other section.





Math Test - Calculator

55 MINUTES, 38 QUESTIONS

DIRECTIONS

For questions 1–15, solve each problem and choose the best answer from the choices provided. For questions 16–20, solve the problem. No answer choices are provided because on the actual exam, you will enter your answer in a grid on the answer sheet. You may use any available space in your test booklet for scratch work.

NOTES

1. The use of a calculator **is not permitted**.
2. All variables and expressions used represent real numbers unless otherwise indicated.
3. Figures provided in this test are drawn to scale unless otherwise indicated.
4. All figures lie in a plane unless otherwise indicated.
5. Unless otherwise indicated, the domain of a given function f is the set of all real numbers x for which $f(x)$ is a real number.

REFERENCE

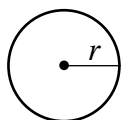

$$A = \pi r^2$$

$$C = 2\pi r$$

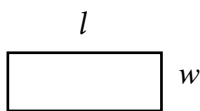

$$A = lw$$

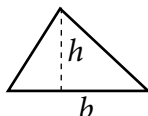

$$A = \frac{1}{2}bh$$

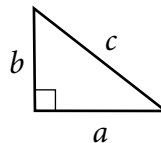

$$c^2 = a^2 + b^2$$

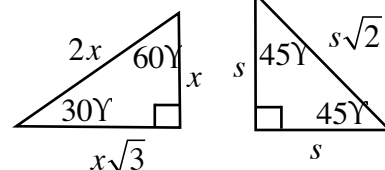

Special Right Triangles

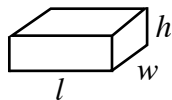

$$V = lwh$$

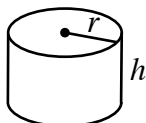

$$V = \pi r^2 h$$



$$V = \frac{4}{3}\pi r^3$$

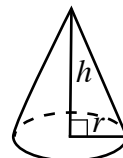

$$V = \frac{1}{3}\pi r^2 h$$

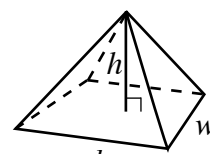

$$V = \frac{1}{3}lwh$$

The number of degrees of arc in a circle is 360.

The number of radians of arc in a circle is 2π .

The sum of the measures in degrees of the angles of a triangle is 180.





1

An engineer is plotting a grid over a section of farm land. There are 36 parallel rows of 18 plants, with a perpendicular irrigation line every 6 plants. If the first plant is plotted at the point $(-10, 2)$, and the second is plotted at $(-8, 2)$, and so forth, which of the following equations could represent the path of an irrigation line?

- A. $x = 0$
- B. $y = -6$
- C. $y = -16$
- D. $x = 10$

Questions 2–4 refer to the following information.

A field is surveyed and found to have 235 wildflowers in a variety of colors: red, blue, yellow, and purple. There are 45 blue flowers. One-fifth of the flowers are red. Forty percent are purple. The rest are yellow.

2

Which color of flower is most abundant?

- A. Blue
- B. Red
- C. Yellow
- D. Purple

3

A flower is picked at random from the field. What is the chance that the flower is yellow?

- A. $\frac{1}{5}$
- B. $\frac{49}{235}$
- C. $\frac{2}{5}$
- D. $\frac{9}{47}$

4

What percentage of the flowers are blue?

- A. 20.0%
- B. 19.1%
- C. 20.9%
- D. 21.2%

5

$$f(x) = x^2 - 7x + 14$$

$$g(x) = -\frac{1}{2}x^2 + 3x - 6$$

Solve $g(f(3))$.

- A. 2
- B. $-\frac{3}{2}$
- C. -2
- D. $\frac{5}{4}$





Questions 6–8 refer to the following information.

Line A is defined as $y = 4x + 2$. Line B intersects Line A at the point $(-1, -2)$ and has an x-intercept of $(1, 0)$.

6

Which of the given points is a point on Line A?

- A. $(-16, -62)$
- B. $(14, 50)$
- C. $(8, 46)$
- D. $(-10, -24)$

7

What is the equation for Line B?

- A. $y = -2x - 1$
- B. $y = -2x + 1$
- C. $y = x + 1$
- D. $y = x - 1$

8

Line C has a slope of $-\frac{1}{2}$ and a y-intercept of $\frac{1}{2}$. Where does Line C intersect Line A?

- A. $(-\frac{1}{3}, \frac{2}{3})$
- B. $(\frac{1}{2}, 0)$
- C. $(2, \frac{1}{4})$
- D. $(-\frac{4}{3}, \frac{1}{2})$

9

What is the area of the triangle enclosed by the lines below?

$$y = 2x - 6$$

$$x = 1$$

$$y = -2x + 6$$

- A. 6
- B. 16
- C. 12
- D. 8

10

The laws of kinematics and Newtonian mechanics result in the following equation to describe the velocity of an object traveling at a constant acceleration over a period of time:

$$v = v_o + at$$

If a car is moving at $36 \frac{m}{s}$ when it hits the brakes, decelerating at a rate of $144 \frac{m}{s^2}$,

how long does it take for the car to come to a complete stop?

- A. 3.6 seconds
- B. 0.25 seconds
- C. 1.4 seconds
- D. 6.3 seconds





Questions 11–13 refer to the following information.

A historian hypothesizes that there was a correlation between the average age of members an ancient society and the consumption of cultivated grains in that society. After researching the topic, she collected the following data:

	Average Age (years)	Grain Consumption (kg/person/year)
Society 1	34.2	146.13
Society 2	24.6	144.69
Society 3	27.4	145.11
Society 4	25.3	144.80
Society 5	20.1	144.02

11

Does a correlation exist between average age and grain consumption?

- A. Yes; there is negative linear correlation
- B. Yes; there is a positive exponential correlation
- C. Yes; there is a positive linear correlation
- D. No; there is no correlation

12

What is the median grain consumption of the societies surveyed?

- A. 144.80 kg/person/year
- B. 144.69 kg/person/year
- C. 144.95 kg/person/year
- D. 144.75 kg/person/year

13

Society 3 invades the territory of Society 1, merging the two into a new demographic. What is the average age of the newly formed society if the populations of the two original societies were equal?

- A. 27.4 years
- B. 30.8 years
- C. 32.3 years
- D. 26.9 years

14

A 10-foot ladder leans against a vertical wall. The base of the ladder is 4.5 feet from the base of the wall. What is the angle between the top of the ladder and the wall? Round to the nearest hundredth.

- A. 26.74Y
- B. 32.46Y
- C. 36.18Y
- D. 37.96Y





15

The position of a remote control car in relation to the time in seconds, t , is given by the function below.

$$f(t) = -1.8 + 0.4t + 0.25t^2$$

At what time is the car's position equal to 0?

- A. 3.6 seconds
- B. 1 second
- C. 2 seconds
- D. 1.8 seconds

16

Simplify the given expression.

$$\frac{(6x^2 + 5x - 4)(8x^3 - 36x^2 - 72x)}{(x - 3)(3x^2 - 14x - 24)}$$

- A. $\frac{x - 1}{3x - 2}$
- B. $\frac{x^2 + 3}{(x - 6)(3x + 3)}$
- C. $\frac{2x(x - 1)(x + 3)}{(2x + 4)(2x - 4)}$
- D. $\frac{4x(2x - 1)(2x + 3)}{x - 3}$

Questions 17–19 refer to the following information.

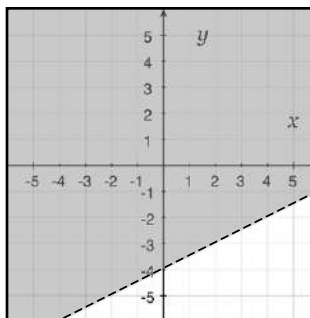

Graph of Function A

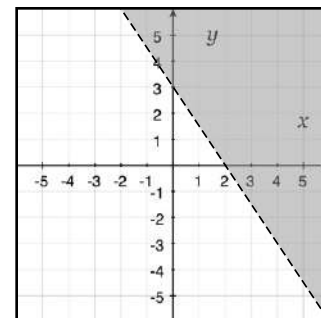

Graph of Function B

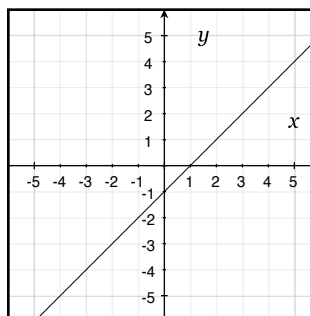

Graph of Function C

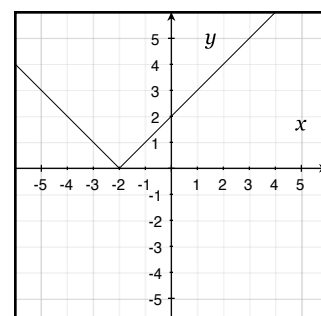

Graph of Function D

17

Which of the given functions has the greatest y-intercept?

- A. Function A
- B. Function B
- C. Function C
- D. Function D





18

Which of the following is a solution to both Function A and Function B?

- A. $(-\frac{3}{2}, \frac{21}{4})$
 B. $(\frac{7}{2}, -\frac{9}{4})$
 C. $(1, -\frac{7}{2})$
 D. $(\frac{11}{2}, -\frac{5}{2})$

19

What is Function D?

- A. $y = |x + 2|$
 B. $y = x^2 + 2$
 C. $y = \sqrt{x + 2}$
 D. $y = x^2 + 2x$

20

Alison deposits \$324 in the bank. The deposit accumulates interest such that the amount in her account is given by the function:

$$f(t) = 324 \left(1 + \frac{0.021}{12} \right)^{12t}$$

If t is the time in years, what is Alison's bank balance after 37 years?

- A. \$1028.20
 B. \$648.00
 C. \$498.15
 D. \$704.20

Questions 21–23 refer to the following information.

A chemist mixing a solution of cobalt (II) chloride to a very specific concentration. To test the accuracy of the solution concentration, the chemist evaluates the absorbance of samples from several different trials using spectrophotometry. His results are given in the table below.

	Absorbance
Trial 1	0.7321
Trial 2	0.7364
Trial 3	0.7342
Trial 4	0.7330
Trial 5	0.7283

The concentration, C , is related to the absorbance, A , via the equation $A = 4.86C + 0.0038$.

21

What is the average absorbance of the samples tested?

- A. 0.7330
 B. 0.7338
 C. 0.7328
 D. 0.7317

22

What is the average concentration in moles, M , of the solutions tested?

- A. 0.95 M
 B. 3.57 M
 C. 0.15 M
 D. 2.81 M





23

The chemist attempts to mix another solution with a concentration of 0.08M. Testing the absorbance of the sample results in a reading of 0.3649. What is the percent error in the concentration of the sample?

- A. 7.05%
- B. 6.97%
- C. 7.12%
- D. 7.18%

24

A sculptor has exactly 420 grams of a particular metal alloy that has a density of $1.4 \frac{g}{cm^3}$.

Which of the following constructions could not be created with these materials?

- A. A cube with a diagonal of 9.6 cm across each face
- B. A sphere with a radius of 3.95 cm
- C. A cone with a radius of 3.2 cm and a height of 19.4 cm
- D. A cube with a height of 1.8 cm attached to the top of a cylinder with a radius of 3 cm and a height of 1.8 cm

Questions 25–26 refer to the following information.

An ecologist finds that the amount of cyanobacteria in a river water sample varies by a linear relationship with the distance of the sample from the point where the river meets the ocean. His results are given below.

	Distance from Mouth of River (m)					
	0	25	50	100	500	1000
Cyanobacteria (ppm)	1050	1040	1030	1010	850	650

25

Given his findings in the table, which of the given graphs represents the relationship described?

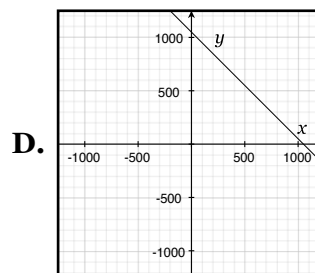
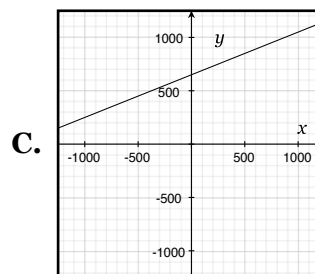
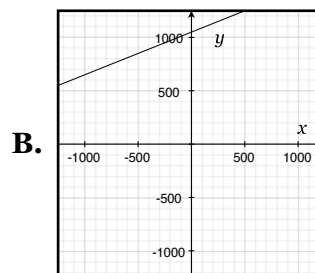
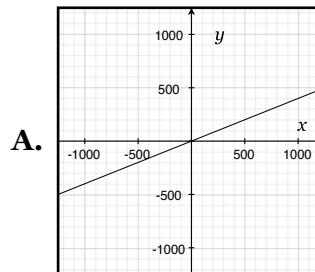



26

The ecologist finds that a water sample taken 250 meters from the river mouth contains 1000ppm of cyanobacteria, and suspects an error in the calibration of his testing equipment. What is the percent error in these findings, with respect to the linear trend?

- A. 0.3%
- B. 8.2%
- C. 1.9%
- D. 5.3%

27

A student flips a coin four times. What is the probability that at least half of the results are heads?

- A. 50%
- B. 25%
- C. 40%
- D. 69%

28

A researcher is attempting to model the native population of an isolated island in the Pacific Ocean. She finds that the population is 2500 people in 2014 and 2545 in 2015. What exponential function could be used to describe the native population in terms of years, t , after 2014?

- A. $(2500 + 0.018)^t$
- B. $2500(1 + 0.018)^t$
- C. $2500 + (1 + 0.018)^t$
- D. $2500(1 - 0.018)^t$

Questions 29–30 refer to the following information.

The average age of Ms. Meyer's children is 12.4. She has four children. Abigail is 9 years and 3 months. Brett is 11 years and 8 months. Candice is 15 years and 2 months.

29

How old is Ms. Meyer's fourth child, Dallas?

- A. 13 years and 6 months
- B. 12 years and 4 months
- C. 16 years and 2 months
- D. 14 years and 3 months

30

What is the range of the ages of Ms. Meyer's children?

- A. 9 years and 3 months
- B. 4 years and 5 months
- C. 5 years and 11 months
- D. 7 years and 8 months



DIRECTIONS

For questions 31–38, solve the problem and enter your answer in the grid, as described below, on the answer sheet.

- Although not required, it is suggested that you write your answer in the boxes at the top of the columns to help you fill in the circles accurately. You will receive credit only if the circles are filled in correctly.
- Mark no more than one circle in any column.
- No question has a negative answer.
- Some problems may have more than one correct answer. In such cases, grid only one answer.
- Mixed numbers** such as $3\frac{1}{2}$ must be gridded as 3.5 or $\frac{7}{2}$. (If “(3)(1)(/)(2)” is entered into the grid, it will be interpreted as $\frac{31}{2}$, not $3\frac{1}{2}$.)
- Decimal answers**: if you obtain a decimal answer with more digits than the grid can accommodate, it may be either rounded or truncated, but it must fill the entire grid.

31

A team of three archaeologists are capable of excavating 6 m^3 per day. After two days, a fourth archaeologist joins the team, allowing them to excavate 8 m^3 per day. After another two days, a fifth archaeologist joins the team. If the addition of the fifth archaeologist follows the same function as the addition of the fourth, how many cubic meters of the site will have been excavated by the end of the seventh day?

	/	/	
.	.	.	.
	0	0	0
1	1	1	1
2	2	2	2
3	3	3	3
4	4	4	4
5	5	5	5
6	6	6	6
7	7	7	7
8	8	8	8
9	9	9	9

32

a is a constant such that the equation is true for all values of x . What is the value of a ?

$$(x - 1)(2x^2 - ax + 6) = 2x^3 - 6x^2 + 10x - 6$$

	/	/	
.	.	.	.
	0	0	0
1	1	1	1
2	2	2	2
3	3	3	3
4	4	4	4
5	5	5	5
6	6	6	6
7	7	7	7
8	8	8	8
9	9	9	9





Questions 33–34 refer to the following information.

Mrs. Sally's eighth grade class has four unit tests throughout the school year along with a midterm test and a final test. There are eight students in Mrs. Sally's class and the class average after the midterm test is 82. The midterm test is worth 100 points and is composed of thirty multiple choice questions, which are worth two points each, and five essay questions that are worth eight points a piece. All of the tests are worth the same number of points.

33

If the class average on the first two unit tests was 85, what was the class average on the midterm test?

.	.	.	.
	0	0	0
1	1	1	1
2	2	2	2
3	3	3	3
4	4	4	4
5	5	5	5
6	6	6	6
7	7	7	7
8	8	8	8
9	9	9	9

34

Billy is a student in Mrs. Sally's class. He answers 20 out of the 35 midterm questions correctly. Of those answered correctly, 15 of them were multiple choice. What was Billy's grade on the midterm test?

.	.	.	.
	0	0	0
1	1	1	1
2	2	2	2
3	3	3	3
4	4	4	4
5	5	5	5
6	6	6	6
7	7	7	7
8	8	8	8
9	9	9	9

35

k and m are constants. The function

$f(x) = x^2 - kx + 3$ intersects the function

$g(x) = -kx + m$ at the point $(-1, 6)$. What is

the value of $\frac{k}{m}$?

.	.	.	.
	0	0	0
1	1	1	1
2	2	2	2
3	3	3	3
4	4	4	4
5	5	5	5
6	6	6	6
7	7	7	7
8	8	8	8
9	9	9	9





36

If $f(x)$ has a positive slope of 2 and a y-intercept at $(0,3)$ and $g(x) = 7x - 7$, what is the x-coordinate of the point where these two lines intersect?

	/	/	
.	.	.	.
	0	0	0
1	1	1	1
2	2	2	2
3	3	3	3
4	4	4	4
5	5	5	5
6	6	6	6
7	7	7	7
8	8	8	8
9	9	9	9

37

A recipe calls for 2 cups of flour, 4 tablespoons of baking soda, 12 ounces of sugar, and 1 cup of water. If there are 16 tablespoons in a cup and 2 tablespoons per ounce, how many tablespoons of dry ingredients does the recipe call for?

	/	/	
.	.	.	.
	0	0	0
1	1	1	1
2	2	2	2
3	3	3	3
4	4	4	4
5	5	5	5
6	6	6	6
7	7	7	7
8	8	8	8
9	9	9	9

38

Solve for y in the following system of linear equations.

$$x + 2y + 3z = 10$$

$$y - 4z = 5$$

$$x + y = 4$$

	/	/	
.	.	.	.
	0	0	0
1	1	1	1
2	2	2	2
3	3	3	3
4	4	4	4
5	5	5	5
6	6	6	6
7	7	7	7
8	8	8	8
9	9	9	9



Essay Section

50 MINUTES, 1 WRITTEN RESPONSE

“As you read the passage below, consider how the author uses

- evidence, such as facts or examples, to support claims.
- reasoning to develop ideas and to connect claims and evidence.
- stylistic or persuasive elements, such as word choice or appeals to emotion, to add power to the ideas expressed.

The Necessity of Public Libraries

As the Internet continues to gain cultural and practical importance and as books are made increasingly available through digital formats, funding and support for public libraries has continued to fall throughout North America. Some commenters are even going so far as to argue not only that funding for these institutions should be reduced, but also that the entire idea of publicly funded libraries is obsolete in the face of developing technology and the public’s increasing access to information.

These arguments are spurious on two fronts: they underrate the importance of and show an ignorance about the social history and relevance of libraries as an institution, while also not sufficiently interrogating the extent to which the digital revolution has been equitable, and how many people actually have access to the information resources many people of middle-upper socioeconomic classes now take for granted.

First, let’s examine the social history of libraries. Libraries were generally started as gathering places and respites for the indigent in seventeenth-century England. The earliest public libraries supported literacy by making books (a scarce and valuable resource prior to the invention of the Gutenberg printing press) available to the public at no cost, while also providing a public space in which literacy could be fostered. As the literacy rate of England at the time was only around 30%, many children and adults alike relied on the free public space of the library for information and culture, including access to religious texts like the Bible. Aided by the proliferation and development of libraries and the advances in education that came alongside it, the literacy rate in England exploded, reaching 70% by the mid-eighteenth century. The role of public libraries in the proliferation of literacy cannot be overrated, as it helped to eliminate one of the primary impediments to widespread literacy across social classes: basic access to reading materials.

Those who argue for the obsolescence of libraries today would counter this point by simply asserting that libraries may have helped in the development of literacy, they are no longer a necessary resource, as public education has developed and literacy rates are now much higher. This argument, however, ignores the fact that there are still over 781 million illiterate adults in the modern world, most of whom are unable to read in large part due to a lack of access to educational resources. Eliminating the practice of public libraries entirely would only serve to remove a still needed bridge to what has become an absolutely essential tool in modern society: the ability to read and write.



Opponents of public libraries in the twenty-first century also tend to assert the primacy of the Internet, and the previously unthinkable level of access to information it provides. If a major argument for libraries in the sixteenth century was that they simply made books available where they weren't before, that function is clearly obsolete, as one can find far more books freely available on the Internet than were accounted for in the entire British Public Library system of the sixteenth century.

As ubiquitous as the Internet has become in recent years, it is often easy to forget just how many people do not have access to personal computers except through public institutions, particularly libraries. As of 2013, 73% of U.S. households had access to personal computers with a broadband connection. While that number seems high—almost three-fourths—it is important to extrapolate that percentage to the actual number of people without access to the Internet in their homes: that's over 85 million people in the United States alone without access to a home computer with the Internet.

Here we can see where the argument against public libraries truly falls apart: it asserts the obsolescence of libraries by citing a resource, the Internet, that is only available to a non-insignificant number of people through the free access to the Internet provided by the very public libraries they wish to abolish.

The value of libraries at their inception was the universal, public, and free access to information and resources that they provided to even the poorest individuals in a society. And in so doing they facilitated the massive growth in literacy and education that allowed for the development of technologies like the Internet. To argue for their obsolescence ignores the very real role that class and financial resources continue to play in individuals' access to education.

Write an essay in which you explain how the author builds an argument to persuade his/her audience that public libraries remain an essential social institution. In your essay, analyze how the author uses one or more of the features listed above (or features of your own choice) to strengthen the logic and persuasiveness of his/her argument. Be sure that your analysis focuses on the most relevant features of the passage. Your essay should not explain whether you agree with the author's claims, but rather explain how the author builds an argument to persuade his/her audience.



1 *Point of View*

The author can be most accurately described as _____.

- A. furious and insulted
- B. defensive and meticulous
- C. imploring and desperate
- D. unreliable and suspicious

Subscore(s): Analysis in History/Social Science

2 *Text Structure*

The author discusses a topic that he plans to pursue in future work _____.

- A. in the first sentence of the passage
- B. in the last sentence of the passage
- C. in the second paragraph of the passage
- D. in the first and last paragraphs of the passage

Subscore(s): Analysis in History/Social Science

3 *Comparing and Contrasting*

According to the author, studying phobias, obsessions, and delusions is _____, but studying dreams is not.

- A. practical
- B. possible
- C. useless
- D. easy

Subscore(s): Analysis in History/Social Science

4 *Words and Phrases in Context*

When he uses the underlined phrase “the inevitable” in lines 57–58, the author is referring to _____.

- A. the fact that he had to publish some of his own dreams, which made him uncomfortable
- B. the idea that all dreams contain significant meaning
- C. the gradual loss of detail in what one can remember about a dream
- D. the discomfort that everyone feels when discussing dreams with other people

Subscore(s): Analysis in History/Social Science
Words in Context

5 *Claims, Evidence, and Reasoning*

The author could not rely upon the dreams related in scientific literature because _____.

- A. the author couldn't be sure if material had been changed in or censored from them
- B. the author needed to interview people himself in order to discuss their emotional reactions to their dreams
- C. no work of scientific literature had discussed dreams at the time the author began his study
- D. the author does not give a reason for this in the passage, but says that the rest of his work explains why this is the case

Subscore(s): Analysis in History/Social Science
Command of Evidence



6 *Statements and Implications*

In the third paragraph, what does the author tell us about the omissions and substitutions he made when discussing his own dreams in the work that follow the passage?

- A. He is not responsible for these; his editors are.
- B. He feels that the adjusted examples would be more useful had they remained unadjusted.
- C. He was forced to make these, or journals would not accept his work.
- D. He is glad that he had the opportunity to reconsider his initial presentation of his dreams.

Subscore(s): Analysis in History/Social Science
Command of Evidence

7 *Main Ideas and Themes*

The author has written this passage in order to _____.

- A. propose a psychological experiment
- B. justify his work and address some of its limitations
- C. respond to a specific critic who has cast doubt on his work's reliability
- D. teach the reader how to interpret his or her own dreams

Subscore(s): Analysis in History/Social Science

8 *Purpose*

The author argues that understanding the content of dreams is necessary for _____.

- A. comprehending the therapeutic importance of dreams
- B. understanding delusional ideas
- C. accurately diagnosing a number of psychological conditions in patients
- D. understanding why he had difficulty choosing dreams to discuss in the work that follows

Subscore(s): Analysis in History/Social Science

9 *Words and Phrases in Context*

Based on the way in which the underlined word "informs" is used in line 26 of the passage, the author is using it to mean _____.

- A. tells
- B. ignores
- C. solves
- D. influences

Subscore(s): Analysis in History/Social Science
Words in Context

10 *Summarizing and Paraphrasing*

In the last sentence of the passage, the author attempts to _____.

- A. encourage the reader to read the work of a variety of psychologists
- B. inspire the reader to conduct his or her own scientific experiments
- C. get the reader to empathize with him
- D. explain why he made certain redactions to the dreams he later discusses

Subscore(s): Analysis in History/Social Science



11 *Statements and Implications*

Which of the following is implied by the excerpt underlined in lines 35–40?

- A. Any plant that can use a C4 pathway can use a C3 pathway.
- B. Any plant that can use a C3 pathway can use a C4 pathway.
- C. Only C4 plants contain RuBisCo.
- D. Only C3 plants contain RuBisCo.

Subscore(s): Analysis in Science

12 *Applying Inferences to New Scenarios*

A farmer decides to grow sugarcane in the desert due to its photosynthetic-efficient evolutionary adaptations. Is this farmer correct in his logic? Why?

- A. Yes, because C4 plants are well-adapted to arid environments.
- B. Yes, because CAM plants are well-adapted to arid environments.
- C. No, because C4 plants aren't necessarily adapted to arid environments.
- D. No, because CAM plants aren't necessarily adapted to arid environments.

Subscore(s): Analysis in Science

13 *Words and Phrases in Context*

Based on the passage, what is the likely meaning behind the name “C4”?

- A. C4 plants likely require four more carbon molecules than plants that do not use the pathway to perform photosynthesis.
- B. The C4 pathway likely generates a four-carbon molecule where the C3 pathway generates a three-carbon molecule.
- C. C4 plants likely have been found on four continents, whereas C3 plants have only been found on three.
- D. C4 plants are able to function normally at temperatures up to four degrees Celsius higher than the maximum temperature at which C3 plants can function.

Subscore(s): Analysis in Science
Words in Context

14 *Text Structure*

What is the author's likely reason for talking about cars and appliances in the first paragraph?

- A. The author uses appliance efficiency as a familiar touchstone to introduce the reader to the idea of photosynthetic efficiency.
- B. This passage is likely excerpted from a larger work at a point just after the author concluded discussing appliance efficiency.
- C. The author talks about appliance efficiency to lead into a discussion of how photosynthetic efficiency can be used to improve appliance efficiency.
- D. The author introduces an argument made about appliance efficiency in order to demonstrate how it is incorrect using evidence taken from photosynthetic efficiency.

Subscore(s): Analysis in Science



15 *Comparing and Contrasting*

C4 plants are similar to CAM plants in that _____, but different in that _____.

- A. they have both evolved to increase photosynthetic efficiency by saturating RuBisCo with carbon dioxide . . . they gather that carbon dioxide at different times of day
- B. they both close their stomata during the day . . . CAM plants perform only the light-dependent photosynthetic reactions during the day whereas C4 plants perform only the light-independent reactions during the day
- C. they are both well suited to arid environments . . . C4 plants use RuBisCo, but CAM plants lack RuBisCo
- D. they both use evolutionary adaptation to perform photosynthesis more efficiently . . . they use different mechanisms to do so

Subscore(s): Analysis in Science

16 *Citing Textual Evidence*

You're talking to a friend about what you learned in the article when your friend says, "But isn't photosynthesis just one cycle? Why would it function differently in the day than at night?"

Which of the following sentences most directly answers your friend's questions?

- A. "Plants take in carbon dioxide and water in a biochemical cycle called photosynthesis and convert these ingredients into oxygen and glucose, a form of sugar used for energy storage."
- B. "The C4 pathway results in the saturation of a particular enzyme, RuBisCo, with carbon dioxide."
- C. "The reactions involved in photosynthesis fall into two categories: the 'light' reactions, which require light, and the 'light-independent' or 'dark' reactions, which do not."
- D. "CAM plants close openings in their stomata during the day and open them at night."

Subscore(s): Analysis in Science

Command of Evidence

17 *Sequence*

Before a CAM plant can generate glucose and oxygen, it must _____.

- A. have collected water during the previous day
- B. switch from using the C3 pathway to using the C4 pathway
- C. open its stomata
- D. have collected carbon dioxide during the previous night

Subscore(s): Analysis in Science



18 *Words and Phrases in Context*

As used in line 40, the underlined word “fix” is closest in meaning to which of the following?

- A. Repair
- B. Focus on
- C. Choose
- D. Change

Subscore(s): Analysis in Science
Words in Context

19 *Quantitative Information*

An illustrator has prepared the following sketch of a graph to accompany the passage, but has lost the notes he took on which label should be applied to each line. Which of the following options is supported by the information in the passage?

Glucose Produced at Different Times of Day
by Plants from Different Photosynthetic Pathways

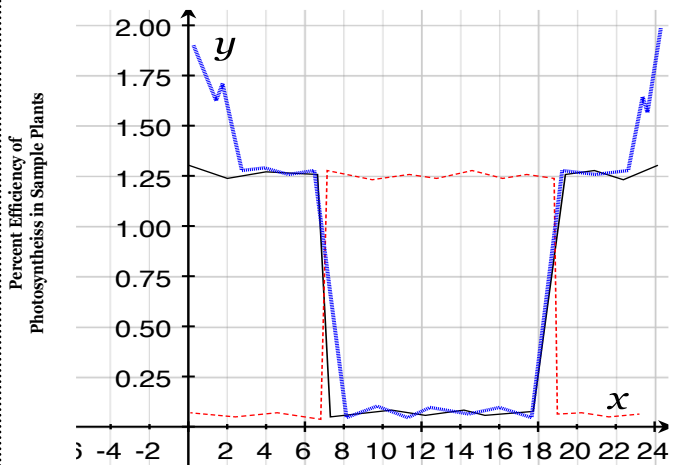

- A. Blue hashed circle line - CAM plants
Black triangle line - C4 plants
Red dotted square line - C3 plants
- B. Blue hashed circle line - C4 plants
Black triangle line - C3 plants
Red dotted square line - CAM plants
- C. Blue hashed circle line - C3 plants
Black triangle line - C4 plants
Red dotted square line - CAM plants
- D. Blue hashed circle line - C4 plants
Black triangle line - C3 plants
Red dotted square line - CAM plants

Subscore(s): Analysis in Science
Command of Evidence



20 *Cause and Effect*

A CAM plant opens its stomata. What can now happen?

- A. The plant can perform the light-dependent reactions of photosynthesis.
- B. The plant can collect carbon dioxide.
- C. The plant can prevent excess water from being lost.
- D. The plant can release carbon dioxide.

Subscore(s): Analysis in Science

21 *Point of View*

This author is best described as _____.

- A. objective yet engaged
- B. eager yet biased
- C. fascinated but patronizing
- D. didactic but frustrated

Subscore(s): Analysis in Science

22 *Purpose*

The second paragraph specifically serves to _____.

- A. describe Dorothea's love of horseback riding
- B. introduce the character of Sir James Chettam
- C. describe how Celia and Dorothea are perceived by their community
- D. describe Dorothea's religious tendencies, which are unusual in her community

23 *Comparing and Contrasting*

In the underlined section in lines 35–37, the author is _____.

- A. contrasting the depth of interior mental processes with the shallowness of exterior appearances
- B. explaining why Dorothea chooses to dress with such care
- C. emphasizing the traits that Dorothea and Celia have in common
- D. contrasting clock faces with designs on ancient shields

24 *Claims, Evidence, and Reasoning*

According to the reasoning of the passage, why might a man hesitate to make Dorothea an offer of marriage?

- A. She spends too much time horseback riding.
- B. She is far more intelligent than any of her potential suitors.
- C. She plans her life out according to unusual religious principles.
- D. She is jealous and spiteful.

Subscore(s): Command of Evidence

25 *Words and Phrases in Context*

In the specific context in which it is used, the underlined word “pretty” in line 51 most nearly means _____.

- A. physically beautiful
- B. rather
- C. shocking
- D. charming

Subscore(s): Words in Context



26 *Text Structure*

As a whole, the passage begins by discussing _____, and then it transitions into discussing _____.

- A. Dorothea's religious tendencies . . . Celia's religious tendencies
- B. aspects of Dorothea's personality that bias the rural opinion against her . . . aspects of her personality that people find appealing
- C. Dorothea's love of horseback riding . . . Dorothea's cluelessness about romantic relationships
- D. Dorothea's behavior . . . Dorothea's hobbies

27 *Summarizing and Paraphrasing*

Dorothea is most accurately described as _____.

- A. cruel, calculating, and irreverent
- B. well-meaning, naïve, and self-assured
- C. talented, wise, and irreligious
- D. confident, clever, and bored

28 *Words and Phrases in Context*

In context, the underlined word "ardent" in line 50 most closely means _____.

- A. passionate
- B. hard
- C. opaque
- D. calm

Subscore(s): Words in Context

29 *Deciphering Statements and Implications*

Which physical feature of Dorothea's helps bias the community against her?

- A. Her nose
- B. Her ears
- C. Her lips
- D. Her eyes

30 *Citing Textual Evidence*

Which of the following is the best evidence that the narrator sympathizes with Dorothea?

- A. "Poor Dorothea!"
- B. "Yet those who approached Dorothea, though prejudiced against her by this alarming hearsay found that she had a charm unaccountably reconcilable with it."
- C. "She was open, ardent, and not in the least self-admiring"
- D. "Women were expected to have weak opinions, but the great safeguard of society and of domestic life was that opinions were not acted on."

Subscore(s): Command of Evidence

31 *Identifying Main Ideas and Themes*

The main purpose of this passage is _____.

- A. to contrast Dorothea with Celia
- B. to foreshadow that Dorothea will become very ill
- C. to provide a detailed description of Dorothea
- D. to elaborate on Dorothea's opinion of men

32 *Deciphering Statements and Implications*

What is the "one hasty conclusion" that Passage A refers to in line 17?

- A. The idea that women and men should be equally educated in the same manner
- B. The idea that men are too focused on getting women to behave in a certain culturally prescribed way
- C. The idea that men of the author's era only treat women the way they do because they are adhering to tradition views
- D. The idea that women are somehow inferior to men

Subscore(s): Analysis in History/Social Science



33 *Words and Phrases in Context*

In the context in which it appears in Passage A, the word “bubbled” in line 31 means _____.

- A. flattered
- B. addled
- C. misunderstood
- D. angered

Subscore(s): Analysis in History/Social Science
Words in Context

34 *Identifying Main Ideas and Themes*

This passage’s main idea can best be summarized by which of the following sentences?

- A. There is a definite need for books about education to be written by women.
- B. Educational works written by men for women treat women unfairly as females instead of human beings.
- C. Women are being failed by an educational system that does not allow them to reach their full potential.
- D. Gender inequality is a terrible problem in the author’s society.

Subscore(s): Analysis in History/Social Science

35 *Stylistic Word Choice*

In Passage A, the author’s use of the phrase “barren blooming” (line 25) emphasizes what she perceives as _____.

- A. the unequal power dynamic between men and women during the author’s era
- B. the lack of any education for women whatsoever during the author’s era
- C. the wasted potential of the women of the society of her era
- D. the proliferation of the treatment of women as females rather than human beings

Subscore(s): Analysis in History/Social Science
Words in Context

36 *Summarizing and Paraphrasing*

Which of the following best paraphrases lines 25–34 of Passage B?

- A. While beliefs based on logical reasoning can be corrected, it is very difficult to change beliefs founded on emotion.
- B. People who can distinguish their arguments from emotions are generally more fervent in defending them.
- C. We should only accept arguments that incorporate both emotion and logic.
- D. People who argue from an emotional basis rarely change the opinions of those who make logical arguments.

Subscore(s): Analysis in History/Social Science



37 *Citing Textual Evidence*

Imagine that another author argues that during a time of great social change, the first beliefs and actions widely altered in a culture are those that at the time are considered the most backward and in need of change. Which excerpt from Passage B most directly contradicts this claim?

- A. “[W]e need not . . . suppose that the barbarisms to which men cling longest must be less barbarisms than those which they earlier shake off.”
- B. “But it would be a mistake to suppose that the difficulty of the case must lie in the insufficiency or obscurity of the grounds of reason on which my convictions.”
- C. “[T]here are . . . many causes tending to make the feelings connected with this subject the most intense and most deeply-rooted of those which gather round and protect old institutions and custom.”
- D. “So long as opinion is strongly rooted in the feelings, it gains rather than loses instability by having a preponderating weight of argument against it.”

Subscore(s): Analysis in History/Social Science
Command of Evidence

38 *Claims, Evidence, and Reasoning*

The author of Passage B thinks it will be difficult to convince people of his argument because _____.

- A. he realizes that the opposition is emotionally grounded in their traditional views
- B. he realizes that he lacks evidence with which to argue his case
- C. he admits that his argument is complex and difficult to follow
- D. he knows himself to be arguing from an emotional standpoint, not a logical one

Subscore(s): Analysis in History/Social Science
Command of Evidence

39 *Identifying Main Ideas and Themes*

One of the main points argued by the author of Passage B is _____.

- A. we should consider emotional arguments and logical arguments to be of equal validity
- B. every valid logical argument should also be able to be backed up with emotions
- C. if someone’s conclusion is based on emotion, arguing against it with logic will weaken it
- D. people often refuse to see reason when arguing a point based on emotional evidence

Subscore(s): Analysis in History/Social Science



40 *Paired Passages*

From these passages it is reasonable to infer that the two authors both value _____.

- A. exclusively women's rights
- B. ethical equality in general
- C. social order
- D. social decorum

Subscore(s): Analysis in History/Social Science

41 *Paired Passages*

Which of the following inferences could NOT reasonably be drawn from both of these passages?

- A. The fundamental structure of society, both on a social and a legal level, is inherently biased against women.
- B. Social customs reinforce cultural biases.
- C. The subjugation of women is restricted to the area of social mores and education.
- D. There is no reasonable ethical or factual basis for treating women as inferior members of society.

Subscore(s): Analysis in History/Social Science

42 *Paired Passages*

It is reasonable to assume that the positions advocated in these passages were _____ at the time they were published.

- A. in the mainstream
- B. popular only among academics and social elites
- C. deeply unpopular and unconventional
- D. None of these are reasonable assumptions to make about the contemporary popularity of these positions.

Subscore(s): Analysis in History/Social Science

43 *Words and Phrases in Context*

In the phrase "gravitational lensing," "lensing" most nearly means _____.

- A. orbiting
- B. mapping
- C. absorbing
- D. bending

Subscore(s): Analysis in Science
Words in Context

44 *Purpose*

Which of the following best describes the author's likely motivation for including the graph with this passage?

- A. To supplement the passage's claims with specific evidence from an experiment.
- B. To help the reader visualize the discrepancy between the predicted and observed data.
- C. To provide additional information not mentioned anywhere in the passage.
- D. To show an example of the type of data that Oort worked with.

Subscore(s): Analysis in Science

45 *Summarizing and Paraphrasing*

Which of the following best summarizes this passage's first paragraph?

- A. Dark matter, a relatively recent scientific discovery, is difficult but rewarding to study.
- B. Dark matter cannot be seen because it absorbs light.
- C. Studying anything that you cannot see is inherently difficult.
- D. Our understanding of the universe has improved vastly in the last century.

Subscore(s): Analysis in Science



46 *Quantitative Information*

According to the passage and the graph, the observed results are _____ the predicted results because of _____.

- A. faster than . . . gravitational lensing
- B. faster than . . . dark matter
- C. slower than . . . gravitational lensing
- D. slower than . . . dark matter

Subscore(s): Analysis in Science
Command of Evidence

47 *Sequence*

Which of the following answer choices puts the scientists in the order in which their referenced works were published, from earliest in history to most recent?

- A. Oort, Rubin and Ford, Einstein
- B. Einstein, Oort, Rubin and Ford
- C. Einstein, Rubin and Ford, Oort
- D. Oort, Einstein, Rubin and Ford

Subscore(s): Analysis in Science

48 *Stylistic Word Choice*

For what likely purpose does the author include the phrase “time-tested”?

- A. To suggest that just because the laws are traditional does not make them reliable
- B. To suggest that the laws involve time as a variable in their equations
- C. To convey that scientific evidence has proven the laws to be true over time
- D. To convey that the laws have been tested and found to be true in timed experiments

Subscore(s): Analysis in Science
Words in Context

49 *Text Structure*

Whereas the second paragraph focuses on _____, the third paragraph focuses on _____.

- A. how dark matter was discovered . . . how it is researched
- B. what dark matter is . . . how it is researched
- C. how dark matter is researched . . . how dark matter was discovered
- D. how dark matter is researched . . . what dark matter is

Subscore(s): Analysis in Science

50 *Quantitative Information*

Which of the following is conveyed by the graph?

- A. The predicted data accounts for the presence of dark matter.
- B. Predicted and observed data differ more for stars relatively far away from the galaxy center than for stars relatively close to the galaxy center.
- C. The observed data includes a decrease in rotational velocity that has been attributed to the presence of dark matter.
- D. The predicted and observed data correspond very nearly for stars near the galaxy center due to gravitational lensing.

Subscore(s): Analysis in Science
Command of Evidence



51 *Claims, Evidence, and Reasoning*

The author claims that _____ function(s) as evidence supporting the existence of dark matter.

- A. gravitational lensing
- B. differences in observed and predicted data in galaxy rotation curves and gravitational lensing
- C. differences in observed and predicted data in galaxy rotation curves
- D. differences in observed and predicted data in galaxy rotation curves and the locations of galaxies relative to Earth

Subscore(s): Analysis in Science

52 *Applying Inferences to New Scenarios*

Astronomer A is studying a new galaxy cluster. She sees three complete images of the cluster projected around the light source. Astronomer B, another scientist in the same lab, is studying a different galaxy cluster. She only sees one incomplete image of the cluster projected near the light source. Based on the passage, what can they conclude?

- A. Astronomer B's galaxy cluster is located nearer to its source than Astronomer A's cluster is to its source.
- B. Astronomer A is closer to her galaxy cluster than is Astronomer B.
- C. Nothing can be concluded about the relative locations of the astronomers' galaxy clusters based on this observation because the astronomers don't have any information about the rotational velocities of galaxies in either galaxy cluster.
- D. The astronomical object bending the light around Astronomer A's galaxy cluster is located nearer to its source than the astronomical object bending the light around Astronomer B's galaxy cluster is to its source.

Subscore(s): Analysis in Science



1 *Coordination Between Clauses*

- A. NO CHANGE
- B. When a vertical garden is built, wherever it is built and whoever builds it, a frame is constructed around a specifically designed vertical irrigation platform.
- C. When a vertical garden is built, a frame is constructed around a specifically designed vertical irrigation platform.
- D. When someone builds a vertical garden is built, no matter where that person builds it, a frame is constructed around a specifically designed vertical irrigation platform.

Subscore(s): Standard English Conventions

2 *Improving Focus and Purpose*

Which of the following options provides the most relevant detail?

- A. NO CHANGE
- B. such walls can also help to keep the temperature in an enclosed space perfectly regular.
- C. such walls can also help to keep the temperature in an enclosed space down, as the plants absorb heat and light.
- D. such walls also help to decrease one's energy, as they convert the sun's energy into fuel.

Subscore(s): Expression of Ideas

3 *Tone and Style*

The use of the word “elaborate” has what effect on the author’s description of outdoor gardens?

- A. It helps convey the ornate nature of some garden fences.
- B. It helps highlight the hassle and complications associated with outdoor gardens.
- C. It helps ground the description by providing realistic details.
- D. It helps demonstrate the greater skill needed to maintain an outdoor garden.

Subscore(s): Expression of Ideas
Words in Context

4 *Possessive Nouns and Pronouns*

- A. NO CHANGE
- B. animal’s
- C. animal
- D. animals

Subscore(s): Standard English Conventions

5 *Word Choice*

Which of the following best emphasizes the potential importance of how the vertical gardens look?

- A. NO CHANGE
- B. acetic
- C. artistic
- D. visual

Subscore(s): Expression of Ideas
Words in Context



6 *Logical Sequence*

To make this paragraph the most logical, the underlined sentence would best be placed

_____.

- A. NO CHANGE
- B. The sentence is irrelevant and incoherent, and should be removed entirely.
- C. at the beginning of the paragraph
- D. at the end of the paragraph, following the sentence citing a World Health Organization statistic

Subscore(s): Expression of Ideas
Command of Evidence

7 *Internal Sentence Punctuation*

- A. NO CHANGE
- B. In 2014, the World Health Organization estimated that 54% of the world's population lived in cities or suburbs,
- C. In 2014, the World Health Organization estimated that 54% of the world's population lived in cities or suburbs.
- D. In 2014, the World Health Organization estimated that 54% of the world's population lived in cities or suburbs . . .

Subscore(s): Standard English Conventions

8 *Agreement*

- A. NO CHANGE
- B. All this is not to say that vertical gardens are being the perfect solution to all of our problems
- C. All this is not to say that vertical gardens are the perfect solution to all of our problems
- D. All this is not to say that vertical gardens were the perfect solution to all of our problems

Subscore(s): Standard English Conventions

9 *Modifying Proposition Statements*

The writer is considering deleting the underlined sentence. Should he or she do so, and why or why not?

- A. Yes, the underlined sentence undermines the overall thesis by presenting the views of those critical of the passage's overriding thesis about vertical gardens.
- B. Yes, the underlined sentence discusses views that are irrelevant to the passage's overall argument about the popularity and viability of vertical gardens.
- C. No, the underlined sentence provides useful context that supports the passage's overall argument about the popularity and viability of vertical gardens.
- D. No, the underlined sentence provides useful context, and lends the author's argument legitimacy by providing and addressing alternative viewpoints.

Subscore(s): Expression of Ideas
Command of Evidence



10 *Coordination Between Clauses*

- A. NO CHANGE
- B. but
- C. after
- D. Delete “because”; the first word of the second sentence should be “as.”

Subscore(s): Standard English Conventions

11 *Concision*

How can the underlined portion best be rewritten to convey the author’s conclusion more efficiently?

- A. NO CHANGE
- B. the desire city dwellers all have is to grow
- C. the desire of city dwellers to grow
- D. the desire city dwellers that is to grow

Subscore(s): Expression of Ideas

12 *Verb Tense, Mood, and Voice*

- A. NO CHANGE
- B. apologies
- C. apologizing
- D. apologize

Subscore(s): Standard English Conventions

13 *Modifier Placement*

Which choice most effectively sets up the information that follows and transitions into the next sentence?

- A. NO CHANGE
- B. forcibly
- C. enforcibly
- D. enforced

Subscore(s): Standard English Conventions
Words in Context



14 *Improving Focus and Purpose*

Which of the following statements would be most relevant to the passage if added after Location **14**?

- A. This pairing of specified bureaucratic language, whereby longtime residents of America of Japanese descent were specifically precluded from acquiring citizenship and then systematically punished for the lack of that citizenship, is a classic example of institutionalized racial and cultural prejudice.
- B. The conditions of these camps, in particular were deplorable in the sense that the residents of these camps had no say in the administration of food, and no choice as to which camp or location they were placed.
- C. This forcible internment was exacerbated by the extremely poor conditions at the camps themselves. In particular the aforementioned lack of medical care and food in the camps form a particularly convincing case against any societal or security value such internment camps were said to provide.
- D. The dollar amount of the reparations is clear evidence of not only the grievous nature of the violation of the individual human rights of those held, but of the extremely wide scale of the internment.

Subscore(s): Expression of Ideas
Command of Evidence
Analysis in History/Social Science

15 *Verb Tense, Mood, and Voice*

- A. NO CHANGE
- B. and all people of Japanese descent to be excluded
- C. and all people of Japanese descent to be excluding
- D. and all people of Japanese descent's exclusion

Subscore(s): Standard English Conventions

16 *Introductions, Transitions, and Conclusions*

Which choice most effectively sets up the information that follows and transitions into the next sentence?

- A. The language and regional focus of the Order was hardly an accident, and as a result
- B. Because the relocation occurred only in war zones,
- C. On the other hand,
- D. In spite of this,

Subscore(s): Expression of Ideas
Analysis in History/Social Science

17 *Quantitative Accuracy and Application*

The author's inclusion of this statement serves to _____.

- A. indicate that the given statistics are inaccurate
- B. suggest that the source of the given statistics was biased
- C. illustrate the validity of the given statistics
- D. provide context for the previous statement

Subscore(s): Expression of Ideas
Command of Evidence
Analysis in History/Social Science



18 *Tone and Style*

Which of the following could replace the word “urban” to better describe the placement of the camps in remote deserts?

- A. crowded
- B. tempered
- C. uninhabitable
- D. sparse

Subscore(s): Expression of Ideas
Words in Context
Analysis in History/Social Science

19 *Complete and Incomplete Sentences*

- A. NO CHANGE
- B. featured incessantly high winds as well as many large fluctuations between day and night.
- C. featured incessant high winds as well as large fluctuations in temperature between day and night.
- D. featured incessant high winds as well as large fluctuations in between day and night.

Subscore(s): Standard English Conventions

20 *Introductions, Transitions, and Conclusions*

- A. NO CHANGE
- B. But
- C. In addition to
- D. On top of this,

Subscore(s): Standard English Conventions

21 *Combining Sentences*

Which of the following is the best way to combine the final two sentences of this passage?

- A. Multiple families were packed into areas built for a single family: medical care and food were often lacking.
- B. Multiple families were packed into areas built for a single family, medical care and food were often lacking.
- C. Multiple families were packed into areas built for a single family, and medical care and food were often lacking.
- D. All of the provided options create grammatical errors. The sentences cannot be combined.

Subscore(s): Expression of Ideas
Analysis in History/Social Science

22 *Logical Sequence*

The author of this passage wants to break the final paragraph into two paragraphs, both discussing different aspects of the conditions of the internment. What is the best point at which to do so?

- A. Before the sentence beginning with “Additionally”
- B. After the sentence ending with “extreme weather conditions”
- C. Before the sentence beginning with “Multiple families”
- D. There is no logical point at which to break this paragraph.

Subscore(s): Expression of Ideas
Analysis in History/Social Science



23 *Modifying Proposition Statements*

The first sentence's underlined claim performs which of the following functions?

- A. It sets the tone with a bold, aggressive claim.
- B. It provides an initial thesis statement about the historical development of chess through the ages that is supported by the rest of the passage.
- C. It provides an initial perspective against which the rest of the passage argues.
- D. It fulfills a purely grammatical function, linking the clauses of the sentences. This claim is irrelevant to the content of the passage itself.

Subscore(s): Expression of Ideas
Command of Evidence

24 *Modifier Placement*

- A. NO CHANGE
- B. The game originally originated in sixth-century BCE India, called "chaturanga."
- C. The game originated as "chaturanga" in sixth-century BCE India.
- D. Originally called "chaturanga" in sixth-century BCE India, the game originated.

Subscore(s): Standard English Conventions

25 *Modifying Proposition Statements*

The author's inclusion and explanation of the initial Indian name for chess serves what purpose in the passage overall?

- A. Provides initial historical detail and context, setting the tone for this historical treatment of the subject.
- B. Provides key details needed to support the author's overall claims about the progress of the social significance of the game.
- C. It serves very little purpose, and is just included as a noteworthy historical aside.
- D. It serves no purpose, and should be removed for concision and clarity's sake.

Subscore(s): Expression of Ideas
Words in Context

26 *Logical Sequence*

Which of the following locations is the best location for the sentence, "Chess didn't just remain in India; it spread as the culture contacted others"?

- A. Location [1]
- B. Location [2]
- C. Location [3]
- D. Location [4]

Subscore(s): Expression of Ideas

27 *Parallel Structure*

- A. NO CHANGE
- B. it is based on skill and just not on luck
- C. it is just based on skill, and not on luck
- D. it is based on skill and not on luck

Subscore(s): Standard English Conventions



28 *Improving Focus and Purpose*

If a sentence directly comparing the complexity of the gameplay of chess and checkers were inserted at the end of the second paragraph it would _____.

- A. help to emphasize the passage's fundamental purpose of highlighting the beauty and complexity of chess gameplay through a meaningful comparison
- B. help to improve the overall focus of the essay by ending a digression about monarchs and ecclesiastical leaders and refocusing the paragraph on the logistics of chess gameplay
- C. distract from the historical focus of the passage by inserting completely irrelevant content about the gameplay of another game
- D. distract from the logistical, game-theoretical focus of the passage by inserting content about the gameplay of a totally separate, unrelated game

Subscore(s): Expression of Ideas

29 *Internal Sentence Punctuation*

- A. NO CHANGE
- B. These adapted rules changed the strategy players used: since a pawn moved all the way to the opponents' side of the board can become a queen and dramatically change the balance of power in a game, the new rules made moving one's pawns to the other side of the board a more crucial part of chess strategy.
- C. These adapted rules changed the strategy players used, and since a pawn moved all the way to the opponents' side of the board can become a queen and dramatically change the balance of power in a game, the new rules made moving one's pawns to the other side of the board a more crucial part of chess strategy.
- D. These adapted rules changed the strategy players used, and since a pawn moved all the way to the opponents' side of the board can become a queen and dramatically change the balance of power in a game, the new rules made moving one's pawns to the other side of the board a more crucial part of chess strategy.

Subscore(s): Standard English Conventions



30 *Agreement*

- A. NO CHANGE
- B. Standardized and competitive chess tournaments became popular as a sport
- C. Standardized-competitive chess tournaments became popular as sporting events
- D. Standardized, competitive chess tournaments became popular as sporting events

Subscore(s): Standard English Conventions

31 *Tone and Style*

Which of the following options best emphasizes that the players took a long time in making their moves?

- A. NO CHANGE
- B. deliberated about
- C. critiqued
- D. selected

Subscore(s): Expression of Ideas
Words in Context

32 *Modifying Proposition Statements*

Which of the following details would be most relevant to the passage if inserted after a comma at Location **33** (Assume they are all true statements).

- A. but many people who play chess casually today don't use time limits
- B. even though hourglasses could be unreliable
- C. with the first timed tournament being held in 1861
- D. but some people didn't like the change

Subscore(s): Expression of Ideas
Command of Evidence

33 *Complete and Incomplete Sentences*

- A. NO CHANGE
- B. The World Chess Federation (FIDE) was founded in 1924, and has presided over the titles of "Grand Master" and "World Chess Champion" ever since.
- C. The World Chess Federation (FIDE), founded in 1924, presided over the titles of "Grand Master" and "World Chess Champion" ever since.
- D. The World Chess Federation (FIDE) founded in 1924 has presided over the titles of "Grand Master" and "World Chess Champion" ever since.

Subscore(s): Standard English Conventions

34 *Agreement*

- A. NO CHANGE
- B. Mechanics, quantum and classical, represent two different ways
- C. Quantum mechanics is one representation, and classical mechanics another,
- D. Quantum mechanics and classical mechanics represent two different ways

Subscore(s): Standard English Conventions



35 *Nonrestrictive/Paranthenetical Punctuation*

- A. NO CHANGE
- B. This can range from the small-scale, such as an apple falling off of a tree, to the large-scale, such as the orbits of planets.
- C. This can range from the small-scale—such as an apple falling off of a tree—to the large-scale such as the orbits of planets.
- D. This can range, from the small-scale such as an apple falling off of a tree, to the large-scale, such as the orbits of planets.

Subscore(s): Standard English Conventions

36 *Concision*

Which of the following could be added to the passage at Location **36** to connect the sentences before and after this location?

- A. Problems in classical mechanics involve rolling, pushing, dropping, falling, throwing, and bouncing.
- B. High school physics classes frequently cover classical mechanics.
- C. Hypothetical problems are considered commonplace in quantum mechanics.
- D. Classical mechanics, also known as Newtonian mechanics, was initially proposed by Sir Isaac Newton.

Subscore(s): Expression of Ideas
Command of Evidence
Analysis in Science

37 *Logical Sequence*

The author of this passage wants to break apart the first paragraph into two paragraphs at a point that will most distinguish quantum mechanics from classical mechanics. At which of the following points should the author break apart the paragraph?

- A. Location [1]
- B. Location [2]
- C. Location [3]
- D. Location [4]

Subscore(s): Expression of Ideas
Analysis in Science

38 *Coordination Between Clauses*

- A. NO CHANGE
- B. Experiments in this field involve electrons, photons, particles, waves, and other phenomena that are either not visible with the naked eye or not visible with powerful microscopes.
- C. Experiments in this field involve electrons, photons, particles, waves, and other phenomena that are not visible with the naked eye and are often not visible with powerful microscopes.
- D. Experiments in this field involve electrons, photons, particles, waves, and other phenomena that are on the one hand not visible with the naked eye and on the other not visible with powerful microscopes.

Subscore(s): Standard English Conventions



39 *Possessive Nouns and Pronouns*

- A. NO CHANGE
- B. In addition, many of quantum mechanics core experiments yield inherently puzzling results that are not as neat and tidy as those produced by classical mechanics calculations
- C. In addition, many of quantum mechanic's core experiments yield inherently puzzling results that are not as neat and tidy as those produced by classical mechanic's calculations
- D. In addition, many of quantum mechanics's core experiments yield inherently puzzling results that are not as neat and tidy as those produced by classical mechanics's calculations

Subscore(s): Standard English Conventions

40 *Word Choice*

Which of the following could replace the word "demonstrated" to indicate the theoretical nature of Young's conclusions from the double-slit experiment?

- A. proved
- B. indicated
- C. suggested
- D. illustrated

Subscore(s): Expression of Ideas
Words in Context
Analysis in Science

41 *Tone and Style*

Which of the following verb phrases can best replace the underlined phrase to emphasize the effort that scientists put into attempting to make sense of the phenomena being discussed?

- A. NO CHANGE
- B. did not make sense in terms of traditional concepts
- C. dodged traditional explanations
- D. were revolutionary in the scientific community

Subscore(s): Expression of Ideas
Words in Context
Analysis in Science

42 *Improving Focus and Purpose*

The author is considering omitting the phrase "much more so than picturing a falling apple" that concludes the second paragraph. Should the author do this?

- A. Yes, because the author has associated the falling apple with classical mechanics, not quantum mechanics, so it interrupts the flow of the paragraph.
- B. Yes, because falling apples are associated with Newton, and the paragraph has concluded talking about Young.
- C. No, because the phrase is necessary to lead the reader into the next paragraph and without it, the passage would be confusing.
- D. No, because the phrase contrasts quantum mechanics with classical mechanics, working toward the purpose of the passage.

Subscore(s): Expression of Ideas
Command of Evidence
Analysis in Science



43 *Combining Sentences*

Which of the following is the best way to combine the underlined sentences?

- A. Modern scientists, paying particular attention to moments in which they are incompatible, continue to investigate the ways in which the two systems of thought interact
- B. Paying particular attention to moments in which they are incompatible, modern scientists continue to investigate the ways in which the two systems of thought interact.
- C. Modern scientists continue to investigate the ways in which the two systems of thought interact, paying particular attention to moments in which they are incompatible.
- D. The two systems of thought continue to be investigated by modern scientists, paying particular attention to moments in which they are incompatible.

Subscore(s): Expression of Ideas
Analysis in Science

44 *Coordination Between Clauses*

- A. NO CHANGE
- B. Just remember: just because classical mechanics is as active in pushing the frontiers of scientific knowledge doesn't mean that it is a core part of a physics education.
- C. Remember: just because classical mechanics isn't as active in pushing the frontiers of scientific knowledge means that it isn't a core part of a physics education.
- D. Remember: just because classical mechanics isn't as active in pushing the frontiers of scientific knowledge doesn't mean that it isn't a core part of a physics education.

Subscore(s): Standard English Conventions



Questions 1–2 refer to the following information.

Equation of Object A:

$$x^2 - 4x + 4 + 6y + 9 = -y^2 + 9$$

Equation of Object B:

$$x^2 = 16 - y^2$$

Equation of Object C:

$$y = (x + 2)^2$$

1 *Graphing Circles*

What is the shape of Object A?

- A. Circle centered at $(-2, 3)$ with radius of 3
- B. Ellipse centered at $(4, 9)$ with major axis 2
- C. Parabola with vertex at $(-3, 2)$, opening upwards
- D. Circle centered at $(2, -3)$ with radius of 3

Subscore(s): Passport to Advanced Math

2 *Systems of Equations*

Which is a point where Object B and Object C intersect?

- A. $(-1, 4)$
- B. $(2, 4)$
- C. $(0, 4)$
- D. $(-2, 4)$

Subscore(s): Passport to Advanced Math

3 *Linear Equations and Inequalities*

A chemical solution is made of water and some mystery Liquid Q. There is 9 ml of Liquid Q and a total of 15 ml of the new chemical solution. If the new chemical solution is 78% Liquid Q, what is the equation to solve for the amount of water, W , in the solution?

- A. $W(0.22) + 9(0.78) = 15$
- B. $W(0.78) + 9(0.22) = 15$
- C. $9W + 0.78 = 15$
- D. $(1 + W)W + 9 = 15$

Subscore(s): Heart of Algebra
Analysis in Science

4 *Complex Equations in Context*

Let x and y be numbers such that x and y are both nonzero and $x > y$. If half of x is equal to thirty percent of the positive difference between x and y , then what is the ratio of x to y ?

- A. $\frac{2}{3}$
- B. $-\frac{3}{2}$
- C. $\frac{3}{2}$
- D. $-\frac{2}{3}$

Subscore(s): Passport to Advanced Math



5 *Linear Equations and Inequalities*

According to a recent sociological study, it was found that the likelihood of a bystander responding to an incident, r , decreased linearly with respect to the number of bystanders, b , present at the time of the incident. Which of the given functions could potentially represent this phenomenon mathematically?

- A. $r = -0.35b + 2$
 B. $r = 1.36b - 0.4$
 C. $b = -0.8r + 2.5$
 D. $b = 4r - 0.12$

Subscore(s): Heart of Algebra
 Analysis in History/ Social Science

Questions 6–7 refer to the following information.

Line 1 is depicted by the equation $y = 2x - 7$ and Line 2 is depicted by the equation $2y + x = 8$.

6 *Properties of Linear Graphs*

What is the relationship between Line 1 and Line 2?

- A. The lines are parallel.
 → B. The lines are perpendicular.
 C. The equations result in the same line.
 D. The lines intersect at $(\frac{22}{3}, \frac{22}{3})$.

Subscore(s): Heart of Algebra

7 *Linear Equations and Inequalities*

What is the function value of Line 2 when $x = 8$?

- A. 2
 B. 4
 C. -1
 → D. 0

Subscore(s): Heart of Algebra

8 *Linear Equations and Inequalities*

A farm in Oklahoma is circular in shape. If the irrigation system dispenses 300 gallons of water a day to $\frac{5\pi}{6}$ of the farm, in degrees, how much of the farm is receiving irrigation?

- A. 150Y
 B. 130Y
 C. 92Y
 D. 125Y

Subscore(s): Additional Topics in Math
 Analysis in History/Social Science

9 *Exponential Expressions*

Solve for x : $4^{5x+10} = 2(2^{3x-1})$

- A. $x = \frac{20}{7}$
 B. $x = -\frac{7}{20}$
 → C. $x = -\frac{20}{7}$
 D. $x = \frac{7}{20}$

Subscore(s): Passport to Advanced Math



10 *Systems of Linear Equations and Inequalities*

Kim is selling tickets for the fall showcase at her school. Adult tickets cost \$5 each and a children's ticket costs \$2. Kim has 150 tickets to sell and wants to make at least \$375. Which system of inequalities represents this scenario?

- A. $5c + 2a \geq 375$
 $c + a \leq 150$
- B. $5c + 2a \leq 375$
 $c + a \geq 150$
- C. $5c + 2a = 375$
 $c + a \leq 150$
- D. $2c + 5a \geq 375$
 $c + a = 150$

Subscore(s): Heart of Algebra

11 *Expanding Polynomial Expressions*

Expand the polynomial:

$$(x - 2y + z)^2$$

- A. $x^2 + 4y^2 + z^2 + 4xy - 4yz + 2xz$
- B. $x^2 + 4y^2 + z^2 - 4xy - 4yz + 2xz$
- C. $x^2 + 4y^2 + z^2 - 4xy - 4yz - 2xz$
- D. $x^2 - 4y^2 + z^2 - 4xy - 4yz + 2xz$

Subscore(s): Passport to Advanced Math

Questions 12–13 refer to the following information.

There is a sale going on at the local mall. For five days everything in the mall is discounted 25%.

12 *Complex Equations in Context*

A sweater that was originally \$80.00 is part of the mall-wide discount. If the sales tax is 7.5%, how much does the sweater cost?

- A. \$64.50
- B. \$64.00
- C. \$72.25
- D. \$74.50

Subscore(s): Passport to Advanced Math

13 *Function Notation*

If the sales tax is uniform across the stores in the mall at 7.5%, what would the equation to find the total cost of a discounted item be and what would $f(44)$ be?

- A. $f(x) = \frac{3x}{4}(1 + 0.075)$; $f(44) = \$35.48$
- B. $f(x) = \frac{x}{4}(1 + 0.075)$; $f(44) = \$35.48$
- C. $f(x) = \frac{3x}{4}(1 + 0.075)$; $f(44) = \$45.48$
- D. $f(x) = \frac{1x}{4}(1 + 0.075)$; $f(44) = \$55.48$

Subscore(s): Passport to Advanced Math



14 *Graphing Circles*

Given $(x - 4)^2 + y^2 - 14y + 49 = 36$, what is the center, radius, and equation of the circle in standard form?

A. Center = $(-4, -7)$
 Radius = 6
 $(x - 4)^2 + (y - 7)^2 = 36$

B. Center = $(4, -7)$
 Radius = 36
 $(x - 4)^2 + (y - 7)^2 = 36$

C. Center = $(-4, 7)$
 Radius = 6
 $(x - 4)^2 + (y - 7)^2 = 36$

→ D. Center = $(4, 7)$
 Radius = 6
 $(x - 4)^2 + (y - 7)^2 = 36$

Subscore(s): Passport to Advanced Math

15 *Complex Numbers*

Which of the following is equivalent to the given expression?

$$(8 - 3i)(6 + 4i) - \sqrt{(16i \times 4i)}$$

A. $36 + 22i$

B. $28 + 14i$

→ C. $60 + 6i$

D. $28 - 18i$

Subscore(s): Additional Topics in Math

16 *Properties of Linear Graphs*

Bob lives 8 blocks east and 2 blocks north of his school. If he walked a straight line to his school and that line is then written as a function on a graph, what would be the slope of the line?

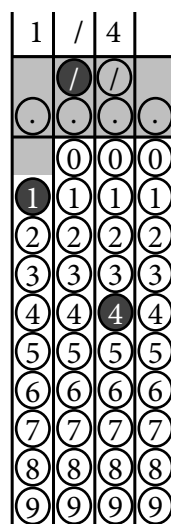

or

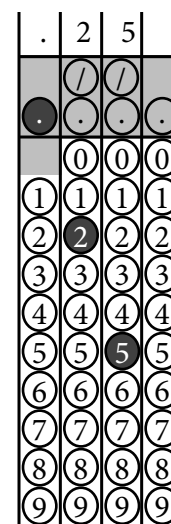

Subscore(s): Heart of Algebra

17 *Quadratic Functions and Equations*

Find the solution to the following equation:

$$4x^2 - 12x + 9 = 0$$

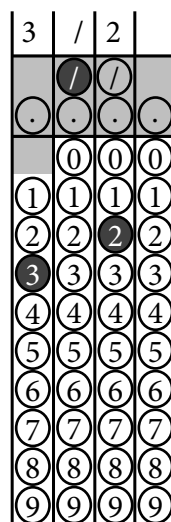

or

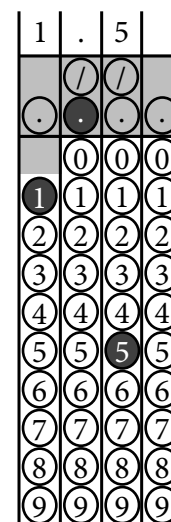

Subscore(s): Passport to Advanced Math



Questions 18–19 refer to the following information.

A line on a graph is seen to have the format of $y = ax + b$. The line has a y-intercept at 2.

18 Linear Equations and Inequalities

What is the slope of the line if it contains the point (4,6)?

1			
	/	/	
.	.	.	.
	0	0	0
1	1	1	1
2	2	2	2
3	3	3	3
4	4	4	4
5	5	5	5
6	6	6	6
7	7	7	7
8	8	8	8
9	9	9	9

Subscore(s): Heart of Algebra

19 Properties of Linear Graphs

If the slope of the line is -10 , what is the x-coordinate of the x-intercept of the line?

1	/	5	
	/	/	
.	.	.	.
	0	0	0
1	1	1	1
2	2	2	2
3	3	3	3
4	4	4	4
5	5	5	5
6	6	6	6
7	7	7	7
8	8	8	8
9	9	9	9

or

.	2		
	/	/	
.	.	.	.
	0	0	0
1	1	1	1
2	2	2	2
3	3	3	3
4	4	4	4
5	5	5	5
6	6	6	6
7	7	7	7
8	8	8	8
9	9	9	9

Subscore(s): Heart of Algebra

20 Defining Polygons

In an isosceles right triangle, if the hypotenuse is $10\sqrt{2}$, what is the area of the triangle?

5	0		
	/	/	
.	.	.	.
	0	0	0
1	1	1	1
2	2	2	2
3	3	3	3
4	4	4	4
5	5	5	5
6	6	6	6
7	7	7	7
8	8	8	8
9	9	9	9



1 *Properties of Linear Graphs*

An engineer is plotting a grid over a section of farm land. There are 36 parallel rows of 18 plants, with a perpendicular irrigation line every 6 plants. If the first plant is plotted at the point $(-10,2)$, and the second is plotted at $(-8,2)$, and so forth, which of the following equations could represent the path of an irrigation line?

- A. $x = 0$
 B. $y = -6$
 C. $y = -16$
 D. $x = 10$

Subscore(s): Heart of Algebra

Questions 2–4 refer to the following information.

A field is surveyed and found to have 235 wildflowers in a variety of colors: red, blue, yellow, and purple. There are 45 blue flowers. One-fifth of the flowers are red. Forty percent are purple. The rest are yellow.

2 *Conversions: Units, Ratios, Proportions, and %*

Which color of flower is most abundant?

- A. Blue
 B. Red
 C. Yellow
 → D. Purple

Subscore(s): Problem Solving and Data Analysis

3 *Probability*

A flower is picked at random from the field. What is the chance that the flower is yellow?

- A. $\frac{1}{5}$
 → B. $\frac{49}{235}$
 C. $\frac{2}{5}$
 D. $\frac{9}{47}$

Subscore(s): Problem Solving and Data Analysis

4 *Conversions: Units, Ratios, Proportions, and %*

What percentage of the flowers are blue?

- A. 20.0%
 → B. 19.1%
 C. 20.9%
 D. 21.2%

Subscore(s): Problem Solving and Data Analysis

5 *Function Notation*

$$f(x) = x^2 - 7x + 14$$

$$g(x) = -\frac{1}{2}x^2 + 3x - 6$$

Solve $g(f(3))$.

- A. 2
 B. $-\frac{3}{2}$
 → C. -2
 D. $\frac{5}{4}$

Subscore(s): Passport to Advanced Math



Questions 6–8 refer to the following information.

Line A is defined as $y = 4x + 2$. Line B intersects Line A at the point $(-1, -2)$ and has an x-intercept of $(1, 0)$.

6 *Linear Equations and Inequalities*

Which of the given points is a point on Line A?

- **A.** $(-16, -62)$
B. $(14, 50)$
C. $(8, 46)$
D. $(-10, -24)$

Subscore(s): Heart of Algebra

7 *Linear Equations and Inequalities*

What is the equation for Line B?

- A.** $y = -2x - 1$
B. $y = -2x + 1$
C. $y = x + 1$
 → **D.** $y = x - 1$

Subscore(s): Heart of Algebra

8 *Systems of Linear Equations and Inequalities*

Line C has a slope of $-\frac{1}{2}$ and a y-intercept of $\frac{1}{2}$. Where does Line C intersect Line A?

- **A.** $(-\frac{1}{3}, \frac{2}{3})$
B. $(\frac{1}{2}, 0)$
C. $(2, \frac{1}{4})$
D. $(-\frac{4}{3}, \frac{1}{2})$

Subscore(s): Heart of Algebra

9 *Defining Polygons*

What is the area of the triangle enclosed by the lines below?

$$y = 2x - 6$$

$$x = 1$$

$$y = -2x + 6$$

- A.** 6
B. 16
C. 12
 → **D.** 8



10 *Linear Equations and Inequalities*

The laws of kinematics and Newtonian mechanics result in the following equation to describe the velocity of an object traveling at a constant acceleration over a period of time:

$$v = v_o + at$$

If a car is moving at $36 \frac{m}{s}$ when it hits the brakes, decelerating at a rate of $144 \frac{m}{s^2}$, how long does it take for the car to come to a complete stop?

- A. 3.6 seconds
- B. 0.25 seconds
- C. 1.4 seconds
- D. 6.3 seconds

Subscore(s): Heart of Algebra
Analysis in Science

Questions 11–13 refer to the following information.

A historian hypothesizes that there was a correlation between the average age of members an ancient society and the consumption of cultivated grains in that society. After researching the topic, she collected the following data:

	Average Age (years)	Grain Consumption (kg/person/year)
Society 1	34.2	146.13
Society 2	24.6	144.69
Society 3	27.4	145.11
Society 4	25.3	144.80
Society 5	20.1	144.02

11 *Modeling Data*

Does a correlation exist between average age and grain consumption?

- A. Yes; there is negative linear correlation
- B. Yes; there is a positive exponential correlation
- C. Yes; there is a positive linear correlation
- D. No; there is no correlation

Subscore(s): Problem Solving and Data Analysis
Analysis in History/Social Science



12 *Introductory Statistics*

What is the median grain consumption of the societies surveyed?

- A. 144.80 kg/person/year
B. 144.69 kg/person/year
C. 144.95 kg/person/year
D. 144.75 kg/person/year

Subscore(s): Problem Solving and Data Analysis
Analysis in History/Social Science

13 *Introductory Statistics*

Society 3 invades the territory of Society 1, merging the two into a new demographic. What is the average age of the newly formed society if the populations of the two original societies were equal?

- A. 27.4 years
→ B. 30.8 years
C. 32.3 years
D. 26.9 years

Subscore(s): Problem Solving and Data Analysis
Analysis in History/Social Science

14 *Trigonometric Operations*

A 10-foot ladder leans against a vertical wall. The base of the ladder is 4.5 feet from the base of the wall. What is the angle between the top of the ladder and the wall? Round to the nearest hundredth.

- A. 26.74°
B. 32.46°
C. 36.18°
D. 37.96°

15 *Quadratic Functions and Equations*

The position of a remote control car in relation to the time in seconds, t , is given by the function below.

$$f(t) = -1.8 + 0.4t + 0.25t^2$$

At what time is the car's position equal to 0?

- A. 3.6 seconds
B. 1 second
→ C. 2 seconds
D. 1.8 seconds

Subscore(s): Passport to Advanced Math
Analysis in Science



16 *Rational Equations and Expressions*

Simplify the given expression.

$$\frac{(6x^2 + 5x - 4)(8x^3 - 36x^2 - 72x)}{(x - 3)(3x^2 - 14x - 24)}$$

A. $\frac{x - 1}{3x - 2}$

B. $\frac{x^2 + 3}{(x - 6)(3x + 3)}$

C. $\frac{2x(x - 1)(x + 3)}{(2x + 4)(2x - 4)}$

→ D. $\frac{4x(2x - 1)(2x + 3)}{x - 3}$

Subscore(s): Passport to Advanced Math

17 *Properties of Linear Graphs*

Which of the given functions has the greatest y-intercept?

A. Function A

→ B. Function B

C. Function C

D. Function D

Subscore(s): Heart of Algebra

18 *Systems of Linear Equations and Inequalities*

Which of the following is a solution to both Function A and Function B?

A. $(-\frac{3}{2}, \frac{21}{4})$

→ B. $(\frac{7}{2}, -\frac{9}{4})$

C. $(1, -\frac{7}{2})$

D. $(\frac{11}{2}, -\frac{5}{2})$

Subscore(s): Heart of Algebra

19 *Linear Equations and Inequalities*

What is Function D?

→ A. $y = |x + 2|$

B. $y = x^2 + 2$

C. $y = \sqrt{x + 2}$

D. $y = x^2 + 2x$

Subscore(s): Heart of Algebra

Questions 17–19 refer to the following information.

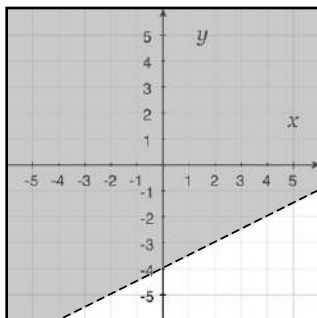

Graph of Function A

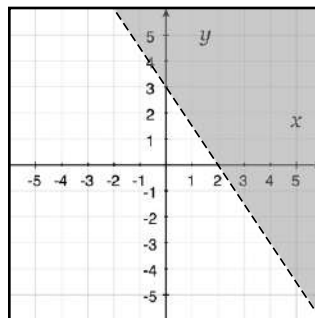

Graph of Function B

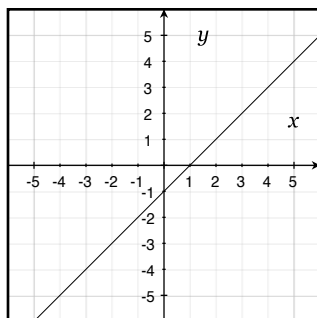

Graph of Function C

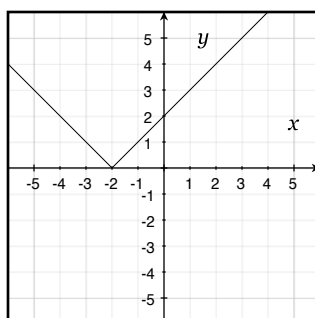

Graph of Function D



20 *Exponential Functions*

Alison deposits \$324 in the bank. The deposit accumulates interest such that the amount in her account is given by the function:

$$f(t) = 324 \left(1 + \frac{0.021}{12} \right)^{12t}$$

If t is the time in years, what is Alison's bank balance after 37 years?

- A. \$1028.20
 B. \$648.00
 C. \$498.15
 → D. \$704.20

Subscore(s): Passport to Advanced Math
 Analysis in History/Social Science

Questions 21–23 refer to the following information.

A chemist mixing a solution of cobalt (II) chloride to a very specific concentration. To test the accuracy of the solution concentration, the chemist evaluates the absorbance of samples from several different trials using spectrophotometry. His results are given in the table below.

	Absorbance
Trial 1	0.7321
Trial 2	0.7364
Trial 3	0.7342
Trial 4	0.7330
Trial 5	0.7283

The concentration, C , is related to the absorbance, A , via the equation $A = 4.86C + 0.0038$.

21 *Introductory Statistics*

What is the average absorbance of the samples tested?

- A. 0.7330
 B. 0.7338
 → C. 0.7328
 D. 0.7317

Subscore(s): Problem Solving and Data Analysis
 Analysis in Science

22 *Modeling Data*

What is the average concentration in moles, M , of the solutions tested?

- A. 0.95 M
 B. 3.57 M
 → C. 0.15 M
 D. 2.81 M

Subscore(s): Problem Solving and Data Analysis
 Analysis in Science

23 *Introductory Statistics*

The chemist attempts to mix another solution with a concentration of 0.08M. Testing the absorbance of the sample results in a reading of 0.3649. What is the percent error in the concentration of the sample?

- A. 7.05%
 B. 6.97%
 → C. 7.12%
 D. 7.18%

Subscore(s): Problem Solving and Data Analysis
 Analysis in Science



24 *Three-Dimensional Geometry*

A sculptor has exactly 420 grams of a particular metal alloy that has a density of $1.4 \frac{g}{cm^3}$. Which of the following constructions could not be created with these materials?

- A. A cube with a diagonal of 9.6 cm across each face
- B. A sphere with a radius of 3.95 cm
- C. A cone with a radius of 3.2 cm and a height of 19.4 cm
- D. A cube with a height of 1.8 cm attached to the top of a cylinder with a radius of 3 cm and a height of 1.8 cm

Questions 25–26 refer to the following information.

An ecologist finds that the amount of cyanobacteria in a river water sample varies by a linear relationship with the distance of the sample from the point where the river meets the ocean. His results are given below.

	Distance from Mouth of River (m)					
	0	25	50	100	500	1000
Cyanobacteria (ppm)	1050	1040	1030	1010	850	650

25 *Modeling Data*

Given his findings in the table, which of the given graphs represents the relationship described?

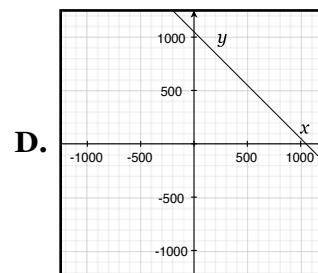
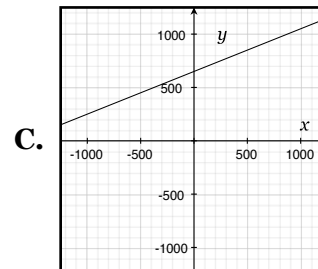
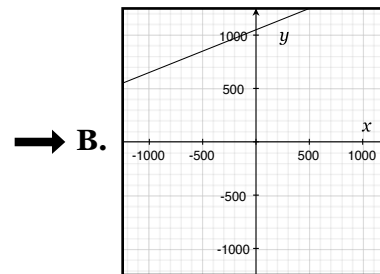
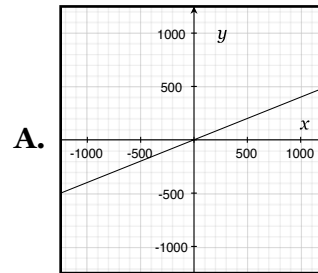

Subscore(s): Problem Solving and Data Analysis
Analysis in Science



26 *Introductory Statistics*

The ecologist finds that a water sample taken 250 meters from the river mouth contains 1000ppm of cyanobacteria, and suspects an error in the calibration of his testing equipment. What is the percent error in these findings, with respect to the linear trend?

- A. 0.3%
- B. 8.2%
- C. 1.9%
- D. 5.3%

Subscore(s): Problem Solving and Data Analysis
Analysis in Science

27 *Probability*

A student flips a coin four times. What is the probability that at least half of the results are heads?

- A. 50%
- B. 25%
- C. 40%
- D. 69%

Subscore(s): Problem Solving and Data Analysis

28 *Exponential Functions*

A researcher is attempting to model the native population of an isolated island in the Pacific Ocean. She finds that the population is 2500 people in 2014 and 2545 in 2015. What exponential function could be used to describe the native population in terms of years, t , after 2014?

- A. $(2500 + 0.018)^t$
- B. $2500(1 + 0.018)^t$
- C. $2500 + (1 + 0.018)^t$
- D. $2500(1 - 0.018)^t$

Subscore(s): Passport to Advanced Math
Analysis in History/Social Science

Questions 29–30 refer to the following information.

The average age of Ms. Meyer's children is 12.4. She has four children. Abigail is 9 years and 3 months. Brett is 11 years and 8 months. Candice is 15 years and 2 months.

29 *Introductory Statistics*

How old is Ms. Meyer's fourth child, Dallas?

- A. 13 years and 6 months
- B. 12 years and 4 months
- C. 16 years and 2 months
- D. 14 years and 3 months

Subscore(s): Problem Solving and Data Analysis



30 *Conversions: Units, Ratios, Proportions, and %*

What is the range of the ages of Ms. Meyer's children?

- A. 9 years and 3 months
 B. 4 years and 5 months
 → C. 5 years and 11 months
 D. 7 years and 8 months

Subscore(s): Problem Solving and Data Analysis

31 *Linear Equations and Inequalities*

A team of three archaeologists are capable of excavating 6 m^3 per day. After two days, a fourth archaeologist joins the team, allowing them to excavate 8 m^3 per day. After another two days, a fifth archaeologist joins the team. If the addition of the fifth archaeologist follows the same function as the addition of the fourth, how many cubic meters of the site will have been excavated by the end of the seventh day?

5	8		
/	/		
.	.	.	.
0	0	0	0
1	1	1	1
2	2	2	2
3	3	3	3
4	4	4	4
5	5	5	5
6	6	6	6
7	7	7	7
8	8	8	8
9	9	9	9

Subscore(s): Heart of Algebra
 Analysis in History/Social Science

32 *Simplifying Polynomial Expressions*

a is a constant such that the equation is true for all values of x . What is the value of a ?

$$(x - 1)(2x^2 - ax + 6) = 2x^3 - 6x^2 + 10x - 6$$

4			
/	/		
.	.	.	.
0	0	0	0
1	1	1	1
2	2	2	2
3	3	3	3
4	4	4	4
5	5	5	5
6	6	6	6
7	7	7	7
8	8	8	8
9	9	9	9

Subscore(s): Passport to Advanced Math

Questions 33–34 refer to the following information.

Mrs. Sally's eighth grade class has four unit tests throughout the school year along with a midterm test and a final test. There are eight students in Mrs. Sally's class and the class average after the midterm test is 82. The midterm test is worth 100 points and is composed of thirty multiple choice questions, which are worth two points each, and five essay questions that are worth eight points a piece. All of the tests are worth the same number of points.



33 *Introductory Statistics*

If the class average on the first two unit tests was 85, what was the class average on the midterm test?

7	6		
.	/	/	.
.	.	.	.
	0	0	0
1	1	1	1
2	2	2	2
3	3	3	3
4	4	4	4
5	5	5	5
6	6	6	6
7	7	7	7
8	8	8	8
9	9	9	9

Subscore(s): Problem Solving and Data Analysis

34 *Conversions: Units, Ratios, Proportions, and %*

Billy is a student in Mrs. Sally's class. He answers 20 out of the 35 midterm questions correctly. Of those answered correctly, 15 of them were multiple choice. What was Billy's grade on the midterm test?

7	0		
.	/	/	.
.	.	.	.
	0	0	0
1	1	1	1
2	2	2	2
3	3	3	3
4	4	4	4
5	5	5	5
6	6	6	6
7	7	7	7
8	8	8	8
9	9	9	9

Subscore(s): Problem Solving and Data Analysis

35 *Systems of Equations*

k and m are constants. The function $f(x) = x^2 - kx + 3$ intersects the function $g(x) = -kx + m$ at the point $(-1, 6)$. What is the value of $\frac{k}{m}$?

1	/	2	
.	/	/	.
.	.	.	.
	0	0	0
1	1	1	1
2	2	2	2
3	3	3	3
4	4	4	4
5	5	5	5
6	6	6	6
7	7	7	7
8	8	8	8
9	9	9	9

or

.	5		
.	/	/	.
.	.	.	.
	0	0	0
1	1	1	1
2	2	2	2
3	3	3	3
4	4	4	4
5	5	5	5
6	6	6	6
7	7	7	7
8	8	8	8
9	9	9	9

Subscore(s): Passport to Advanced Math

36 *Systems of Linear Equations and Inequalities*

If $f(x)$ has a positive slope of 2 and a y -intercept at $(0, 3)$ and $g(x) = 7x - 7$, what is the x -coordinate of the point where these two lines intersect?

2			
.	/	/	.
.	.	.	.
	0	0	0
1	1	1	1
2	2	2	2
3	3	3	3
4	4	4	4
5	5	5	5
6	6	6	6
7	7	7	7
8	8	8	8
9	9	9	9

Subscore(s): Heart of Algebra



37 *Conversions: Units, Ratios, Proportions, and %*

A recipe calls for 2 cups of flour, 4 tablespoons of baking soda, 12 ounces of sugar, and 1 cup of water. If there are 16 tablespoons in a cup and 2 tablespoons per ounce, how many tablespoons of dry ingredients does the recipe call for?

6	0		
.	/	/	
.	.	.	.
	0	0	0
1	1	1	1
2	2	2	2
3	3	3	3
4	4	4	4
5	5	5	5
6	6	6	6
7	7	7	7
8	8	8	8
9	9	9	9

Subscore(s): Problem Solving and Data Analysis

38 *Systems of Linear Equations and Inequalities*

Solve for y in the following system of linear equations.

$$x + 2y + 3z = 10$$

$$y - 4z = 5$$

$$x + y = 4$$

3	9	/	7
.	/	/	
.	.	.	.
	0	0	0
1	1	1	1
2	2	2	2
3	3	3	3
4	4	4	4
5	5	5	5
6	6	6	6
7	7	7	7
8	8	8	8
9	9	9	9

or

5	.	5	7
.	/	/	
.	.	.	.
	0	0	0
1	1	1	1
2	2	2	2
3	3	3	3
4	4	4	4
5	5	5	5
6	6	6	6
7	7	7	7
8	8	8	8
9	9	9	9

Subscore(s): Heart of Algebra



Scoring Your Full-Length SAT Practice Test

Calculating Your Raw Scores

Before you can calculate any scaled scores, you will need to find your raw scores. Scaled scores are representative of the test curve and correlate with national percentiles, whereas raw scores are strictly indicative of your individual performance on the exam. We will start with raw scores for the three primary test portions: Reading, Writing and Language, and Math. Raw scores for cross-tests and subscores will be calculated later.

Reading Test Raw Score (0–52)

The Reading test raw score is the number of questions answered correctly on the Reading test. The maximum Reading test raw score is 52.

Find your Reading test raw score:

$$52 - \# \text{ incorrect questions on Reading test} = \text{■}$$

Writing and Language Test Raw Score (0–44)

The Writing and Language test raw score is the number of questions answered correctly on the Writing and Language test. The maximum Writing and Language test raw score is 44.

Find your Writing and Language test raw score:

$$44 - \# \text{ incorrect questions on Writing and Language test} = \text{■}$$

Math Test Raw Score (0–58)

The Math test raw score is the number of questions answered correctly on the Math test, including both the calculator and no calculator portions. The maximum Math test raw score is 58.

Find your Math test raw score:

$$58 - (\# \text{ incorrect questions on Math - Calculator test} \\ + (\# \text{ incorrect questions on Math - No Calculator test})) = \text{■}$$

Section and Test Scores

The SAT has two section scores: Evidence-Based Reading and Writing, and Math. The Evidence-Based Reading and Writing section score is drawn from the questions on the Reading test and the Writing and Language test. The Math section score is drawn from the calculator and no calculator portions of the Math test. The section scores and test scores are calculated by converting the raw scores (found previously) into scaled scores, using the tables below.



Test Scores

To determine your scores for the Reading test and the Writing and Language test, use Table 1. Use your raw score in the left column to find your scaled test score in the right column. Test scores range from 10 to 40.

Table 1: Conversion Tables for Test Scores

Reading Test Conversion Table	
Raw Score	Reading Test Score
0–2	10
3	11
4	12
5	13
6	14
7	15
8	16
9–10	17
11–12	18
13–14	19
15–16	20
17–18	21
19–20	22
21–22	23
23–24	24
25–26	25
27–28	26
29–30	27
31–32	28
33–34	29
35–36	30
37–38	31
39–40	32
41–42	33
43	34
44	35
45	36
46–47	37
48–49	38
50–51	39
52	40

Writing and Language Test Conversion Table	
Raw Score	Writing and Language Test Score
0–3	10
4	11
5	12
6	13
7	14
8	15
9–10	16
11	17
12–13	18
14	19
15–16	20
17–18	21
19	22
20–21	23
22	24
23–24	25
25	26
26–27	27
28	28
29–30	29
31–32	30
33	31
34–35	32
36	33
37–38	34
39	35
40	36
41	37
42	38
43	39
44	40

Find your Reading Test score:

Find your Writing and Language Test score:



Section Scores

To find your Evidence-Based Reading and Writing section score, you will need to use the test scores you just found. Find the sum of the Reading test score and the Writing and Language test score; then multiply that sum by 10. To find your Math section score, you will need to use your Math test raw score and Table 2, given below.

Table 2: Conversion Tables for Section Scores

Math Section Conversion Table			
Raw Score	Math Section Score	Raw Score	Math Section Score
0–1	200	30	530
2	210	31	540
3	230	32	550
4	240	33	560
5	260	34–35	570
6	280	36	580
7	290	37	590
8	310	38	600
9	320	39–40	610
10	330	41	620
11	340	42	630
12	360	43	640
13	370	44	650
14	380	45–46	660
15	390	47	670
16	410	48	680
17	420	49	690
18	430	50	700
19	440	51	710
20	450	52	730
21	460	53	740
22	470	54	750
23	480	55	760
24–25	490	56	780
26	500	57	790
27	510	58	800

Evidence-Based Reading and Writing Conversion Table

Reading Test Score



+

Writing and Language Test Score



=



Multiply by 10

× 10 =

Evidence-Based Reading and Writing Section Score



Composite Score

Your final exam score is known as your composite score. This score, along with your Section scores, will be sent out to colleges for review. The composite score is given on a scale of 200 to 800. Find your composite score by summing your Evidence-Based Reading and Writing section score and your Math section score.

Evidence-Based Reading and Writing Section Score		Math Section Score		Composite Score
■	+	■	=	■

Cross-Test Scores

Cross-test scores draw a targeted score from a selection of specific questions on multiple tests within the SAT exam. There are two cross-test scores: Analysis in History/Social Science and Analysis in Science. Each cross-test has a raw score between 0 and 35; each cross-test score is scaled from 10 to 40.

Use Table 3 to calculate your cross-test raw scores from the specified questions. Use Table 4 to convert your raw scores to scaled scores.

Table 3: Cross-Test Raw Scores

	Analysis in History/Social Science		Analysis in Science	
	Questions Included in Cross-Test	Raw Score of Indicated Questions	Questions Included in Cross-Test	Raw Score of Indicated Questions
Reading	1–10; 32–42		11–21; 43–52	
Writing and Language	13; 17–19; 22		36–37; 40–43	
Math (No Calculator)	5, 8		3	
Math (Calculator)	11–13; 20; 28; 31		10; 15; 21–23; 25–26	
		+		+
Total Raw Score				



Table 4: Conversion Tables for Cross-Test Scores

Analysis in History/Social Science Cross-Test Conversion Table	
Raw Score	History/Social Science Cross-Test Score
0-1	10
2	11
3	12
4	14
5	15
6	16
7	17
8	18
9	20
10	21
11	22
12	23
13	24
14	25
15	26
16-17	27
18-19	28
20	29
21-22	30
23	31
24-25	32
26	33
27-28	34
29	35
30	36
31-32	37
33	38

Find your Analysis in History/Social Science Cross-Test score:

Analysis in Science Cross-Test Conversion Table	
Raw Score	Science Cross-Test Score
0	10
1	11
2	12
3	13
4	14
5	15
6	16
7	17
8	18
9	19
10	20
11	21
12	22
13-14	23
15	24
16-17	25
18	26
19-20	27
21	28
22	29
23-24	30
25	31
26	32
27-28	33
29	34
30	35
31	36
32	37
33	38
34	39

Find your Analysis in Science Cross-Test score:



Subscores

The SAT provides additional depth in analyzing your testing performance through the use of subscores. There are seven subscores on the exam. Two of these subscores span both the Reading and the Writing and Language tests. Two of these subscores are exclusive to the Writing and Language test. Three of these subscores are exclusive to the Math test. All seven subscores are given on a scale from 1 to 15.

We will start by identifying the questions pertinent to each subscore. Use Table 5 to calculate your raw subscores from the specified questions. Then, use Table 4 to convert your raw scores to scaled scores.

Table 5: Raw Subscores

	Reading Test	Writing and Language Test	Math Test - No Calculator	Math Test - Calculator	Total Correct (Raw Subscore)	
Words in Context	4, 9, 13, 18, 25, 28, 33, 35, 43, 48	2, 4, 15, 18, 23, 29, 40-41				(max. 18)
Command of Evidence	5-6, 16, 19, 24, 30, 37-38, 46, 50	7, 9, 14, 17, 26, 33, 36, 42				(max. 18)
Expression of Ideas		2-4, 7, 9, 11, 13-14, 17-19, 22-26, 29, 33, 36-37, 40-43				(max. 24)
Standard English Conventions		1, 5-6, 8, 10, 12, 15-16, 20-21, 27-28, 30-32, 34-35, 38-39, 44				(max. 20)
Heart of Algebra			3, 5-7, 10, 16, 18-19	1, 6-8, 10, 17-19, 31, 36, 38		(max. 19)
Problem Solving and Data Analysis				2-4, 11-13, 21-23, 25-27, 29-30, 33-34, 37		(max. 17)
Passport to Advanced Math			1-2, 4, 9, 11-14, 17	5, 15-16, 20, 28, 32, 35		(max. 16)



Table 6: Conversion Tables for Subscores

Subscore	Words in Context	Command of Evidence	Expression of Ideas	Standard English Conventions	Heart of Algebra	Problem Solving and Data Analysis	Passport to Advanced Math
1	0-1	0-1	0-2	0-2	0-1	0-1	0
2	2	2	3	3	2	2	-
3	3	3	4	4	3	3	1
4	4	4	5	5	4	4	2
5	5	5	6	6-7	5	5	3
6	6	6	7-8	8-9	6	6	4
7	7-8	7	9-10	10-11	7-8	7	5
8	9-10	8-9	11-12	12-13	9-10	8-9	6
9	11-12	10-11	13-14	14	11-12	10-11	7
10	13	12-13	15-16	15	13-14	12	8-9
11	14	14	17-18	16	15	13	10-11
12	15	15	19-20	17	16	14	12-13
13	16	16	21-22	18	17	15	14
14	17	17	23	19	18	16	15
15	18	18	24	20	19	17	16
Your Subscores:							

Final Score Snapshot

Composite Score		(Scale of 400-1600)
Evidence-Based Reading and Writing Section		(Scale of 200-800)
Math Section		(Scale of 200-800)
Reading Test		(Scale of 10-40)
Writing and Language Test		(Scale of 10-40)
Analysis in History/Social Science		(Scale of 10-40)
Analysis in Science		(Scale of 10-40)
Words in Context		(Scale 1-15)
Command of Evidence		(Scale 1-15)
Expression of Ideas		(Scale 1-15)
Standard English Conventions		(Scale 1-15)
Heart of Algebra		(Scale 1-15)
Problem Solving and Data Analysis		(Scale 1-15)
Passport to Advanced Math		(Scale 1-15)

