



2018

MyLink Infotainment Manual



chevrolet.com

Contents

| | |
|--|-----|
| Introduction | 2 |
| Radio | 19 |
| Audio Players | 25 |
| OnStar System | 33 |
| Rear Seat Infotainment | 34 |
| Navigation | 54 |
| Voice Recognition | 85 |
| Phone | 93 |
| Settings | 102 |
| Trademarks and License Agreements | 109 |
| Index | 120 |

Introduction



The names, logos, emblems, slogans, vehicle model names, and vehicle body designs appearing in this manual including, but not limited to, GM, the GM logo, CHEVROLET, the CHEVROLET Emblem, and the names SILVERADO, TAHOE, SUBURBAN, COLORADO, EQUINOX, TRAVERSE, CAMARO, CRUZE, MALIBU, IMPALA, VOLT, and MYLINK are registered trademarks of General Motors Corporation LLC, its subsidiaries, affiliates, or licensors.

The information in this manual supplements the owner's manual. This manual includes the latest information available at the time it was printed. We reserve the right to make changes in the product after that time without notice. For vehicles first sold in Canada, substitute the name General Motors of Canada Company for Chevrolet Motor Division whenever it appears in this manual.

This manual describes features that may or may not be on the vehicle because of optional equipment that was not purchased on the vehicle, model variants, country specifications, features/applications that may not be available in your region, or changes subsequent to the printing of this manual.

Keep this manual with the owner's manual in the vehicle, so it will be there if it is needed. If the vehicle is sold, leave this manual in the vehicle.

Overview

Read the following pages to become familiar with the infotainment system features.



Taking your eyes off the road for too long or too often while using any infotainment feature can cause a crash. You or others could be injured or killed. Do not give extended attention to infotainment tasks while driving. Limit your glances at the vehicle displays and focus your attention on driving. Use voice commands whenever possible.

The infotainment system has built-in features intended to help avoid distraction by disabling some functions when driving. These functions may gray out when they are unavailable. Many infotainment

features are also available through the instrument cluster and steering wheel controls.

Before driving:

- Become familiar with the system operation, controls on the center stack, steering wheel controls, and infotainment display.
- Set up the audio by presetting favorite stations, setting the tone, and adjusting the speakers.
- Set up phone numbers in advance so they can be called easily by pressing a single control or by using a single voice command if equipped with Bluetooth phone capability.

See “Distracted Driving” in the owner’s manual.

To play the infotainment system with the ignition off, see “Retained Accessory Power (RAP)” in the owner’s manual.

Infotainment System

The infotainment system is controlled by using the infotainment display, controls on the center stack, steering wheel controls, and voice recognition.





Radios with CD and Storage Behind Display

- | | |
|--------------|-----------------|
| 1. (Power) | 6. (Eject) |
| 2. MEDIA | 7. (Home Page) |
| 3. RADIO | 8. BACK |
| 4. or | 9. CD Slot |
| 5. (Screen) | 10. MENU |

4 Introduction

Instrument Panel Storage

If equipped with storage behind the radio, press  and hold to open. There is a USB port inside.

Press  and hold again to close. Keep the storage area closed when not in use. See the owner's manual.

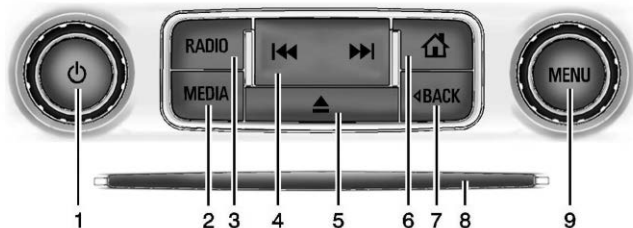

Radio with CD and without Storage Behind Display

1.  (Power)
2. MEDIA

3. RADIO
4.  or 

5. ▲ (Eject)
6. 🏠 (Home Page)
7. ◀ BACK
8. CD Slot
9. MENU



Radio without CD and Storage Behind Display

This radio is the same as above
except TONE replaces ▲

6 Introduction

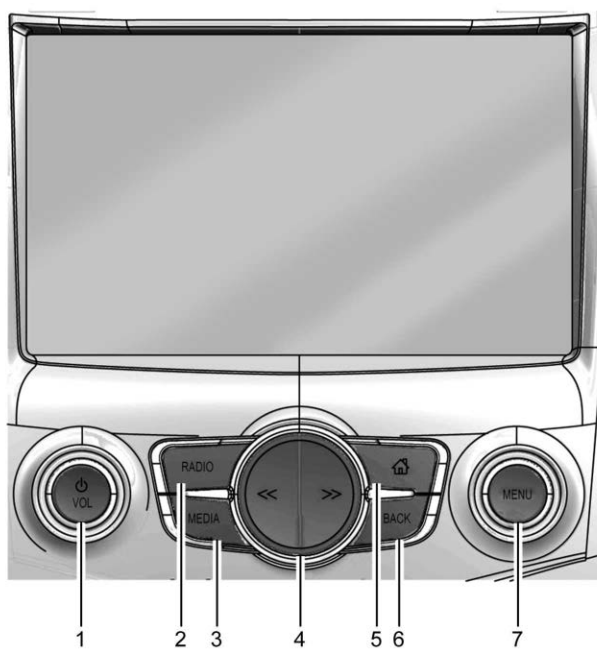

Cruze

5.  (Home)
6. BACK
7. MENU

1.  /VOL (Power/Volume)
2. RADIO

3. MEDIA
4.  or  (Previous/Next)

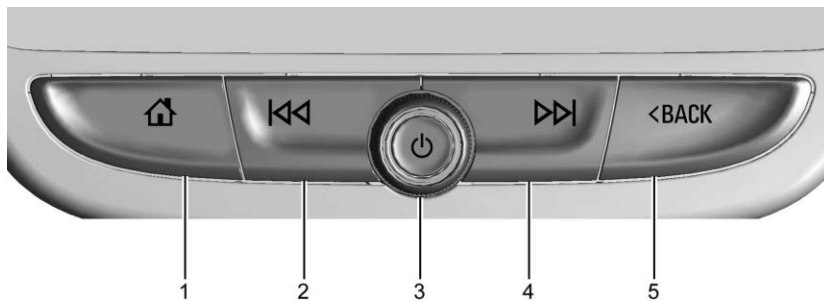

Camaro, Equinox, Malibu, Volt

- | | |
|--|---|
| 1.  (Home Page) | 4.  |
| 2.  | 5.  BACK |
| 3.  (Power) | |

8 Introduction

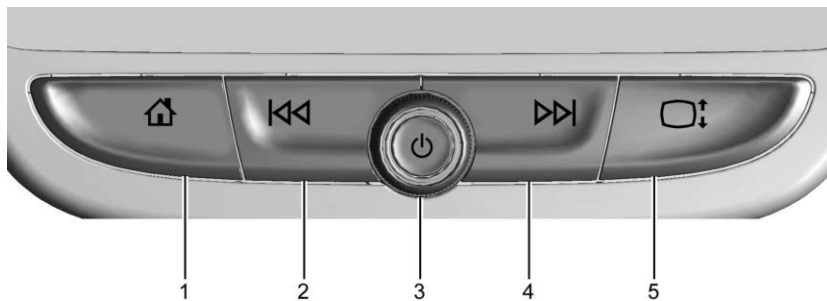

Traverse

This radio is the same as above except  replaces < BACK.

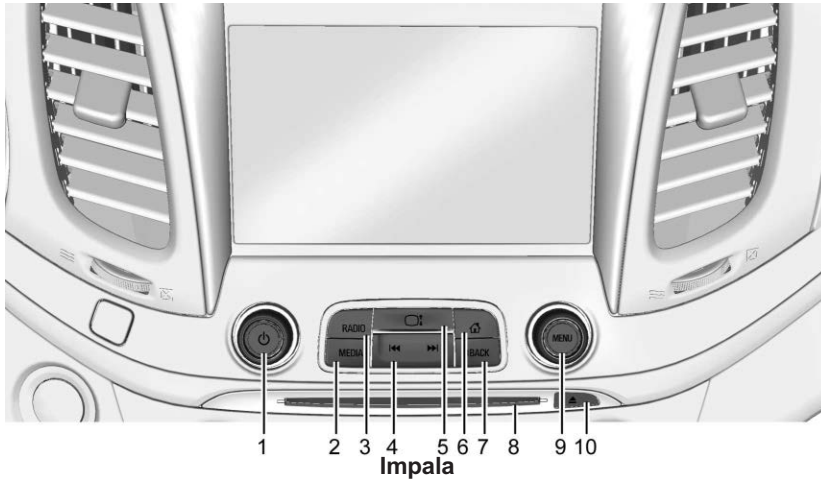

1. (Power)
2. MEDIA
3. RADIO
4. or
5. (Screen)
6. (Home Page)
7. BACK
8. CD Slot

9. MENU
10. (Eject)

or /VOL:

- When off, press or /VOL to turn the system on. Press and hold to turn off.

- When on, press or /VOL to mute the system. Press or /VOL again to unmute the system.
- Turn or /VOL to increase or decrease the volume.

When the power is on and the system is not muted, a quick status pane will display when or /VOL is pressed. Pressing or /VOL will mute the system and trigger this pane to show a long press is required to actually power down the system.

: Press to go to the Home Page. See “Home Page” in this section.

RADIO : Press to change the audio source to AM, FM, or SXM (if equipped).

MEDIA : Press to change the media source to USB, CD (if equipped), Bluetooth, or AUX.

MENU : Turn to highlight a feature. Press to activate the highlighted feature.

10 Introduction

⏮, ⏪, ⏩, ⏭ :

- AM or FM: Press to seek to the previous strong station. See *AM-FM Radio* ⇨ 19.
- CD (if equipped), USB, AUX, or Bluetooth Audio: Press to seek to the beginning of the current or previous track.
- CD (if equipped), USB, AUX, or Bluetooth Audio: Press and hold to quickly reverse through a track. Release to return to playing speed. See *CD Player* ⇨ 25, *USB Port* ⇨ 28, *Auxiliary Jack* ⇨ 31, or *Bluetooth Audio* ⇨ 32.

⏮, ⏪, ⏩, ⏭ :

- AM or FM: Press to seek to the next strong station.
- CD (if equipped), USB, AUX, or Bluetooth Audio: Press to seek the next track.

- CD (if equipped), USB, AUX, or Bluetooth Audio: Press and hold to fast forward through a track. Release to return to playing speed. See *CD Player* ⇨ 25, *USB Port* ⇨ 28, *Auxiliary Jack* ⇨ 31, or *Bluetooth Audio* ⇨ 32.

◀ **BACK** or < **BACK** : Press to return to the previous display in a menu.

Home Page

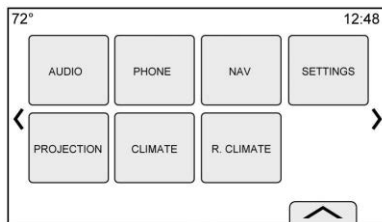

The Home Page is where vehicle application icons are accessed. Some applications are disabled when the vehicle is moving.

The Home Page can be set up to have up to five pages with eight icons per page.

Touch ◀ or ▶ to access the pages of icons.

◀ : Touch to go to the previous Home Page.

▶ : Touch to go to the next Home Page.

⤴ : Touch this interaction selector to display the favorites list.

Touch a preset in the favorites to begin the process of saving a favorite application.

Touch and hold the application icon to store as a favorite. The name of the application will show in favorites.

Managing Home Page Icons

1. Touch and hold any of the Home Page icons to enter edit mode.
2. Continue holding the icon and drag it to the desired position.
3. Release your finger to drop the icon in the desired position.
4. To move an application to another page, drag the icon to the edge of the display toward the desired page.
5. Continue dragging and dropping application icons as desired.
6. Press  to exit edit mode.



Steering Wheel Controls (Silverado, Tahoe, and Suburban shown; Colorado and Traverse similar)





If equipped, some audio controls can be adjusted at the steering wheel.

 : Press to answer an incoming call or start voice recognition. See *Bluetooth (Overview)* ⇨ 93 or *Bluetooth (Infotainment Controls)* ⇨ 94 or *Bluetooth (Voice Recognition)* ⇨ 98 or “OnStar Overview” in the owner’s manual.

 : Press to decline an incoming call or end a current call. Press to mute or unmute the infotainment system when not on a call.

 or  : Press the five-way control to go to the previous or next area of a display on the instrument cluster.

 or  : Press the five-way control to go up or down in a list on the instrument cluster.

 : Press to select a highlighted menu option.

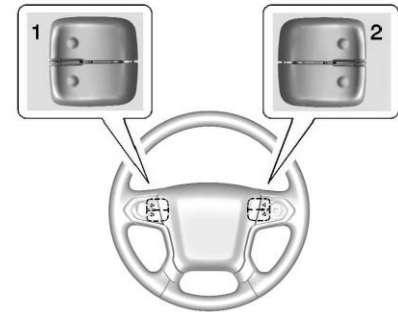

The favorites and volume switches are on the back of the steering wheel.

12 Introduction

1. **Favorite:** When on a radio source, press to select the next or previous audio broadcast favorite. When listening to a media device, press to select the next or previous track.
2. **Volume:** Press to increase or decrease the volume.

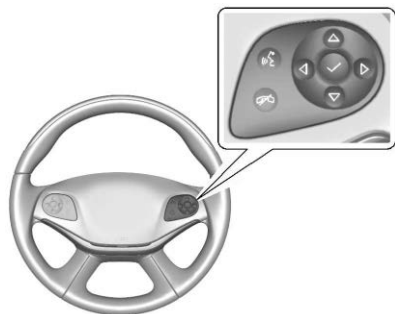

Steering Wheel Controls (Impala)





If equipped, some audio controls can be adjusted at the steering wheel.

 : Press to answer an incoming call or start voice recognition. See *Bluetooth (Overview)* ⇨ 93 or *Bluetooth (Infotainment Controls)* ⇨ 94 or *Bluetooth (Voice Recognition)* ⇨ 98 or “OnStar Overview” in the owner’s manual.

 : Press to decline an incoming call or end a current call. Press to mute or unmute the infotainment system when not on a call.

 or  : Press the five-way control to go to the previous or next menu on the instrument cluster.

 or  : Press the five-way control to go up or down in a list on the instrument cluster.

 : Press to select a highlighted menu option.

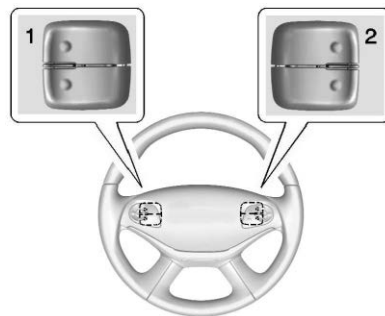

The favorite and volume switches are on the back of the steering wheel.

1. **Favorites:** Press to select the next or previous favorite radio station. While playing media, press to select the next or previous track or song.
2. **Volume:** Press to increase or decrease the volume.

Steering Wheel Controls (Cruze, Equinox, and Malibu)

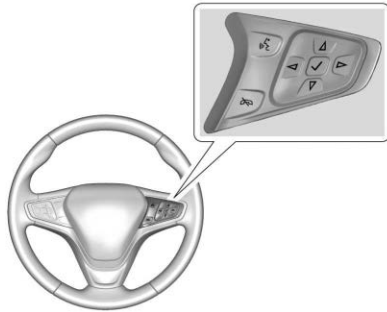

If equipped, some audio controls can be adjusted at the steering wheel.

: Press to answer an incoming call or start voice recognition. See *Bluetooth (Overview)* ⇨ 93 or *Bluetooth (Infotainment Controls)* ⇨ 94 or *Bluetooth (Voice Recognition)* ⇨ 98 or “OnStar Overview” in the owner’s manual.

: Press to reject an incoming call or end a current call. Press to mute or unmute the infotainment system when not on a call.

or : Press to go to the previous or next menu on the instrument cluster.

or : Press to go to the next or previous list on the instrument cluster.

: Press to select a highlighted menu option.

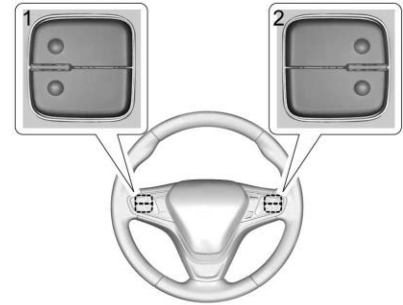

The favorite and volume switches are on the back of the steering wheel.

1. Favorite: When on a radio source, press to select the next or previous favorite. When on a media source, press to select the next or previous track.
2. Volume: Press to increase or decrease the volume.

Steering Wheel Controls (Camaro)

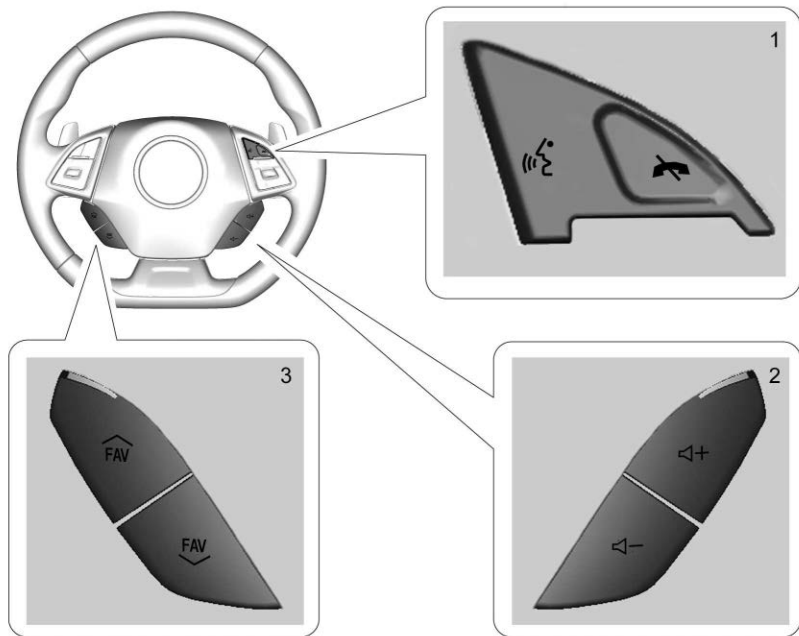

If equipped, some audio controls can be adjusted at the steering wheel.

 **(1)** : Press to answer an incoming call or start voice recognition. See *Bluetooth (Overview)* ⇨ 93 or *Bluetooth (Infotainment Controls)* ⇨ 94 or *Bluetooth (Voice Recognition)* ⇨ 98 or “OnStar Overview” in the owner’s manual.

 **(1)** : Press to decline an incoming call or end a current call. Press to mute or unmute the infotainment system when not on a call.

 **+ or - (2)** : Press to increase or decrease volume.

 **FAV or FAV (3)** : Press to display a list of favorites. Press again to select the next or previous favorite when listening to the radio.

Steering Wheel Controls (Volt)

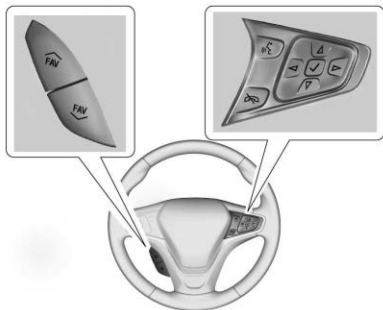

If equipped, some audio controls can be adjusted at the steering wheel.

: Press to answer an incoming call or start voice recognition. See *Bluetooth (Overview)* ⇨ 93 or *Bluetooth (Infotainment Controls)* ⇨ 94 or *Bluetooth (Voice Recognition)* ⇨ 98 or “OnStar Overview” in the owner’s manual.

: Press to decline an incoming call or end a current call. Press to mute or unmute the infotainment system when not on a call.

◀ or ▶ : Press the five-way control to go to the previous or next menu on the instrument cluster.

△ or ▽ : Press the five-way control to go up or down in a list on the instrument cluster.

✓ : Press to select a highlighted menu option.

⤴ **FAV or FAV** ⤵ : Press to display a list of favorites. Press again to select the next or previous favorite when listening to the radio.

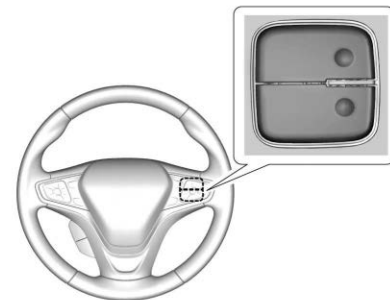

The volume switches are on the back of the steering wheel. Press to increase or decrease the volume.

Using the System

Infotainment Display Features

Infotainment display features show on the screen when available. When a feature is unavailable, the option may gray out. When a feature is selected, the option may highlight.

Home Page Features

Touch the icons on the Home Page to launch an application.

Audio

Touch the Audio icon to display the active audio source page. Available sources are AM, FM, SXM (if equipped), CD (if equipped), MyMedia, USB, Bluetooth, and AUX Input.

Phone

Touch the Phone icon to display the Phone main page. See *Bluetooth (Overview)* ⇨ 93 or *Bluetooth (Infotainment Controls)* ⇨ 94 or *Bluetooth (Voice Recognition)* ⇨ 98.

Projection

Touch the Projection icon to activate Android Auto or Apple CarPlay (if equipped) after a supported device is connected. See *Apple CarPlay and Android Auto* ⇨ 100.

Apps

If equipped, in-vehicle apps are available for download. Touch the APPS icon on the MyLink Home Page to begin.

Downloading and using apps requires Internet connectivity and a data plan, which can be accessed through the vehicle's built-in 4G LTE Wi-Fi hotspot, if equipped, or a compatible mobile device hotspot. On most mobile devices, activation of the Wi-Fi hotspot is in the vehicle's Settings menu under Mobile Network Sharing, Personal Hotspot, Mobile Hotspot, or similar.

To purchase data for the in-vehicle Wi-Fi hotspot, if equipped, touch APPS on the MyLink Home Page or contact an OnStar Advisor. The vehicle must have active OnStar service and a payment method on file.

Availability of apps and connectivity varies by vehicle, conditions, and location. Data plan rates apply. For more information, see www.my.chevrolet.com/learn.

NAV/ OnStar NAV

Touch the Nav icon to display the navigation map or OnStar Turn-by-Turn Navigation. See *Using the Navigation System* ⇨ 54 or "OnStar Overview" in the owner's manual.

Settings

Touch the Settings icon to display the Settings menu. See *Settings* ⇨ 102.

Lighting

If equipped, touch the Lighting icon to display Settings on the infotainment display for the ambient light modes. See "Interior Lighting" in the owner's manual.

Weather

If equipped, touch the Weather icon to display the Weather main page. See "SiriusXM Travel Link Weather" under *Destination* ⇨ 63.

OnStar

If equipped, touch the Onstar icon to display the OnStar main page and start OnStar voice recognition. See “OnStar Overview” in the owner’s manual.

Video

If equipped, touch the Video icon to display the video Rear Seat Infotainment main page. See *Rear Seat Infotainment (RSI) System* ⇨ 34.

Applications Tray



The applications tray is at the top-center of the display. The applications tray can have three to five applications.

To add an application from the Home Page to the applications tray:

1. Touch and hold any icon on the Home Page to enter edit mode.
2. Drag the icon to the applications tray.

To remove an item from the applications tray, drag the icon from the applications tray back to the Home Page.

Press  to exit edit mode.

Adding or removing applications from the applications tray will not remove them from the Home Page.

Infotainment Gestures

Use the following finger gestures to control the infotainment system.

Touch/Tap

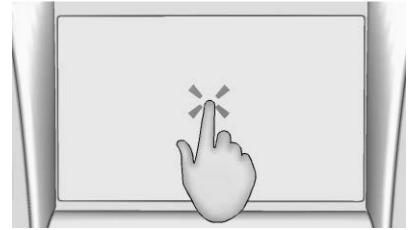

Touch/tap is used to select an icon or option, activate an application, or change the location inside a map.

Touch and Hold

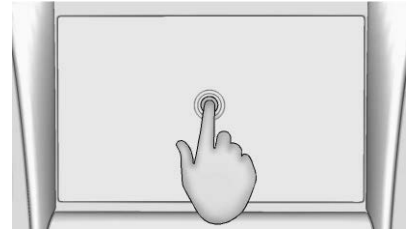

Touch and hold can be used to start another gesture, move, or delete an application.

Drag

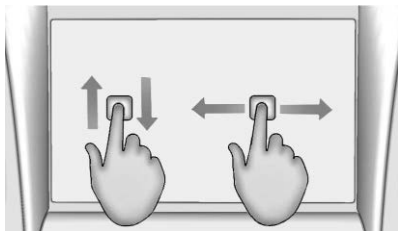

Drag is used to move applications on the Home Page, or to pan the map. To drag the item, it must be held and moved along the display to the new location. This can be done up, down, right, or left.

Nudge

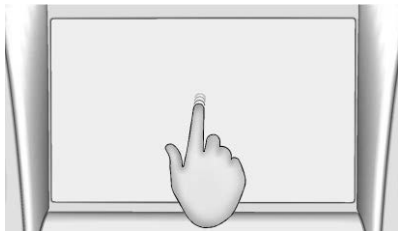

Nudge is used to move items a short distance on a list or a map. To nudge, hold and quickly move the selected item up or down to a new location.

Fling or Swipe

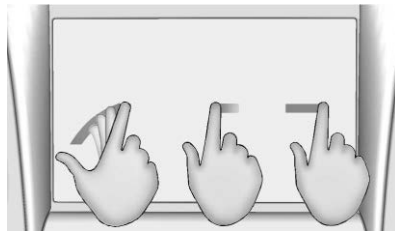

Fling or swipe is used to scroll through a list, pan the map, or change page views. Do this by placing a finger on the display then moving it rapidly up and down or right and left.

Turn

Turn MENU or  on the center stack to perform functions such as tuning the radio or scrolling lists.

Cleaning High Gloss Surfaces and Vehicle Information and Radio Displays

For vehicles with high gloss surfaces or vehicle displays, use a microfiber cloth to wipe surfaces. Before wiping the surface with the microfiber cloth, use a soft bristle brush to remove dirt that could scratch the surface. Then use the microfiber cloth by gently rubbing to clean. Never use window cleaners or solvents. Periodically hand wash the microfiber cloth separately, using mild soap. Do not use bleach or fabric softener. Rinse thoroughly and air dry before next use.

Software Updates

Over-the-Air Software Updates

See *Settings* ⇨ 102 for details on software updates.

Radio

AM-FM Radio

Playing the Radio

While on the Audio main page the available sources are: AM, FM, SXM (if equipped), CD (if equipped), USB, Bluetooth, and AUX Input.

- Press RADIO on the center stack or touch the Audio icon on the Home Page to scroll through AM, FM, or SiriusXM (if equipped).
- Press MEDIA on the center stack or touch the Audio icon on the Home Page to scroll through CD (if equipped), USB, Bluetooth, and AUX Input.

Infotainment System Settings

Press RADIO on the center stack to access broadcast sources.

Touch the Menu icon on the infotainment display or press MENU on the center stack to display the following menus:

Tone Settings:

- Bass, Midrange, Treble, Surround (if equipped): Touch + or - to adjust. Surround adjusts the headrest speaker volume only.
- Balance: Touch < or > for more sound from the left or right speakers. The middle position balances the sound between the left and right speakers.
- Fade: Touch ^ or v for more sound from the front or rear speakers. The middle position balances the sound between the front and rear speakers.

DSP Modes (If Equipped):

- Bose Centerpoint surround sound system has four DSP modes:
 - Normal: Adjusts the audio to provide the best sound for all seating positions.
 - Driver: Adjusts the audio to provide the best sound for the driver.

- Rear: Adjusts the audio to provide the best sound for the rear seat occupants.
- Centerpoint: Turns on Bose Centerpoint surround technology. This setting creates a surround sound listening experience from nearly any audio source: existing stereo, CD collection, satellite radio, and MP3 players. For more information on Bose Centerpoint surround technology, see www.boseautomotive.com.

Categories : Touch Categories under the Audio menu to access the categories list for AM-FM. The list contains names associated with the AM-FM channels. Touch on a category name to display a list of channels for that category. Selecting a station from the list tunes the radio to that channel and returns the display to Now Playing.

20 Radio

EQ : If equipped with a Bose sound system, the Equalizer settings are selected through the tone settings menu. Touch the left or right arrows to cycle through the EQ options. The available choices are Custom or Talk.

Auto Volume (If Equipped) : This feature adjusts the volume based on vehicle speed. The options are Off, Low, Medium - Low, Medium, Medium - High, or High. Touch Back on the infotainment display to go to the previous menu.

Bose AudioPilot Noise Compensation Technology (If Equipped) : When turned on, AudioPilot technology detects ambient noise and vehicle speed to continuously adjust many aspects of the audio signal so that music will sound the same at a set volume level.

The options are On and Off.

This feature is most effective at lower radio volume settings where background noise can affect how well the music is being played through the vehicle's audio system. At a higher volume setting, where the music is louder than the background noise, there may be little or no adjustments by AudioPilot.

For more information on Bose AudioPilot Noise Compensation Technology, see www.boseautomotive.com.

HD Radio (If Equipped) : For AM and FM only, touch to turn HD Radio reception on or off. Touch Back on the infotainment display to go to the previous menu.

Update Station List : For AM and FM only, touch to update the station list. Touch Back on the infotainment display to go to the previous menu.

Finding a Station

Seeking a Station



Press , , or , , to search for the previous or next strongest station.

Tuning a Station

Touch the Tune icon on the infotainment display to access Direct Tune.

Direct Tune

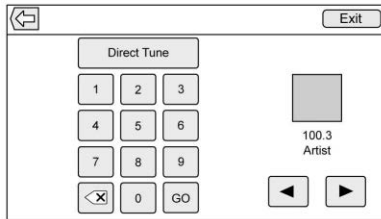

Access Direct Tune on the infotainment display to bring up the keypad. Navigate up and down through all frequencies or directly enter a station using the keypad. When a new station is entered, the information about that station displays on the right side. This information will update with each new valid frequency tuned to.

The keypad will gray out entries that do not contribute to a valid frequency and will automatically place a decimal point within the frequency number, as needed.

A valid station will automatically tune to the new frequency but not close the Direct Tune window. Touch the Back icon or Exit on the infotainment display.

The tune arrows on the right side of the Direct Tune display tunes through the complete station list one station step at a time per touch. A touch and hold advances 10 frequency steps per second.

Touch (X) to delete one character at a time. Touch and hold (X) to delete all characters.

In AM-FM modes, touch << or >> for the radio to go to the next or previous strong station. Touch Direct Tune to advance to the next or previous frequency step in AM or FM mode or directly enter or tune to the frequency on the keypad.

HD Radio multicast stations cannot be tuned directly through the direct tune feature. Only the analog or HD1 station can use that feature. Use the Tune icon on the infotainment display to adjust to the multicast stations.

AM-FM Categories

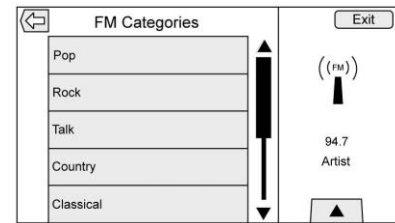

AM-FM Categories are available under the AM-FM audio menu. Touch AM-FM Categories to access the AM-FM Categories list.

The categories list contains category names associated with AM-FM stations. Selecting a given category name displays a list of channels for that category.

Storing Presets

Favorites are stored in the area at the bottom of the infotainment display.

22 Radio

Up to 60 preset favorites can be stored under the following:

AM, FM, SXM (if equipped), and HD Radio Stations : Touch and hold a favorite preset to save the current station as a favorite. Touch a favorite preset in the favorites location to recall a favorite station.

Mixed-Audio Favorites

While in the respective menu, drag up on the top border of the favorites bar to view favorites. Touch and hold a favorite preset and then select the desired item to save as a favorite.

Favorites that can be stored include media, contacts, destinations, navigation, or applications.

| | | | | |
|-------|-------|-------|-------|-------|
| 72° | | 12:48 | | |
| < > | | | | |
| 100.3 | 104.3 | 105.1 | 106.7 | 95.5 |
| 99.5 | 96.3 | 97.1 | 92.3 | 88.7 |
| 92.3 | 101.1 | 93.1 | 93.9 | 108.1 |
| < > | | | | ●○○○○ |

To scroll through the favorites:

- Drag up on the top border of the favorites bar to view the favorites. To close the favorites, drag them down.
- Slide a finger to the right or left to scroll through each page of favorites.

Tone Settings : Touch and hold a preset to save the current tone settings as a favorite in the tone settings menu. Drag up on the display arrow at the bottom to bring up favorites. Touch a saved favorite to recall a favorite tone setting.

The number of favorites displayed is automatically adjusted by default, but can be manually adjusted in the Settings menu under Radio and then Number of Favorites Shown.

HD Radio Technology

If equipped, HD Radio Technology is a free service with features such as digital quality sound, more stations available on a single

frequency such as HD2 and HD3, and display information such as artist and song title.

From the AM or FM display, touch HD Radio to turn HD Radio reception on or off.

Station Access

To access HD Radio stations:

1. Tune the radio to the station. If the HD Radio reception is turned on and the station is broadcasting with HD Radio technology, the radio will display the HD2/HD3 channels available and will automatically switch to digital audio indicated with the HD logo.
2. Touch << or >> on the infotainment display to tune to the previous or next HD Radio station.

There may be a delay before the station starts playing.

The HD Radio station number is indicated next to the HD logo.

HD Radio stations can be saved as favorites.

For a list of all stations, see www.hdradio.com.

HD Radio Troubleshooting

Digital Audio Delay : Wait for the signal to process. This can take several seconds.

Volume Change, Audio Skip, Echo, Digital Audio Lost : Station signal strength may be weak, the station is out of range, or the station may be out of alignment. Verify proper reception on another station.

If the HD Radio signal loses reception while listening to HD1, the radio will go back to the analog version of the radio station.

If the HD Radio signal loses reception while listening to stations HD2 to HD8, the radio mutes until the signal can be recovered or until the station is changed.

HD Radio reception can be disabled if driving in a weak signal area. Touch HD Radio On/Off to toggle HD Radio reception on and off.

Satellite Radio

SiriusXM Satellite Radio Service



If equipped, vehicles with a valid SiriusXM satellite radio subscription can receive SiriusXM programming.

SiriusXM satellite radio has a wide variety of programming and commercial-free music, coast to coast, and in digital-quality sound. In the U.S., see www.siriusxm.com or call 1-888-601-6296. In Canada, see www.siriusxm.ca or call 1-877-438-9677.

When SiriusXM is active, the station name, number, category name, song title, and artist display.

SiriusXM Menu

SiriusXM has a menu to adjust different features.

Touching the Menu icon on the infotainment display may show the following:

Tone Settings : Touch + or – to adjust the tone settings. See *AM-FM Radio* ⇨ 19.

TuneSelect : For SiriusXM only, this feature allows for an alert to be set for artists or songs that are played on any channel. Touch Manage TuneSelect to turn the alerts On and Off or manage the saved selection of Artists or Songs. To turn off an alert, touch the Song or Artist and uncheck the box. To delete an alert, touch –. Touch the Back icon on the infotainment display to go back to the previous menu.

Auto Volume (If Equipped) : This feature adjusts the volume based on the vehicle speed. See *AM-FM Radio* ⇨ 19.

Bose AudioPilot Noise Compensation Technology (If Equipped) : This feature adjusts the volume based on the noise in the vehicle and speed. See *AM-FM Radio* ⇨ 19.

Radio Reception

Unplug electronic devices from the accessory power outlets if there is interference or static in the radio.

FM

FM signals only reach about 16 to 65 km (10 to 40 mi). Although the radio has a built-in electronic circuit that automatically works to reduce interference, some static can occur, especially around tall buildings or hills, causing the sound to fade in and out.

AM

The range for most AM stations is greater than for FM, especially at night. The longer range can cause station frequencies to interfere with each other. Static can also occur when things like storms and power

lines interfere with radio reception. When this happens, try reducing the treble on the radio.

SiriusXM Satellite Radio Service

If equipped, SiriusXM Satellite Radio Service provides digital radio reception. Tall buildings or hills can interfere with satellite radio signals, causing the sound to fade in and out. In addition, traveling or standing under heavy foliage, bridges, garages, or tunnels may cause loss of the SiriusXM signal for a period of time.

Cell Phone Usage

Cell phone usage, such as making or receiving phone calls, charging, or just having the phone on may cause static interference in the radio. Unplug the phone or turn it off if this happens.

Antenna (Camaro Convertible Only)

The AM-FM antenna is integrated in the rear spoiler.

No maintenance or adjustments are needed. Do not place loads on the spoiler.

If the spoiler is replaced, be sure it is replaced with the correct GM parts for the best AM or FM reception.

Fixed Mast Antenna

The fixed mast antenna will go through most car washes as long as it is securely attached. If the antenna becomes slightly bent, straighten it out by hand. If it is badly bent, replace it.

Occasionally check that the antenna is tight at the base. If tightening is required, protect the paint from damage.

Multi-Band Antenna

The roof antenna is for OnStar and GPS (Global Positioning System). Keep clear of obstructions for clear reception. If the vehicle has a sunroof, and it is open, reception can also be affected.

Audio Players

Avoiding Untrusted Media Devices

When using media devices such as CDs, DVDs, Blu-ray Discs, SD cards, USB devices, and mobile devices, consider the source. Untrusted media devices could contain files that affect system operation or performance. Avoid use if the content or origin cannot be trusted.

CD Player

If equipped, use the CD player to play CDs and MP3 audio.

The system may support:

- Most audio CDs
- CD-R
- CD-RW
- MP3 or unprotected WMA formats

When playing any compatible recordable disc, the sound quality can be reduced due to disc quality, the method of recording, the quality of the music that has been recorded, or the way the disc has been handled.

There can be increased skipping, difficulty in recording tracks, difficulty in finding tracks, and/or difficulty in loading and ejecting. If these problems occur, check the disc for damage or try a known good disc.

To avoid damage to the CD player:

- Do not use scratched or damaged discs.
- Do not apply labels to discs. The labels could get caught in the player.
- Insert only one disc at a time.
- Keep the loading slot free of foreign materials, liquids, and debris.
- Use a marking pen to label the top of the disc.

Loading and Ejecting Discs

To load a disc:

1. Turn the vehicle on.
2. Insert a disc into the slot, label side up. The player pulls it in the rest of the way. If the disc is damaged or improperly loaded, there is an error and the disc ejects.

Press  to eject a disc from the CD player. If the disc is not removed within a short period of time, it is automatically pulled back into the player.

Playing an Audio CD

Press MEDIA on the center stack or touch the Audio icon on the Home Page until CD Audio Now Playing view is selected.

On the CD main page, a track number displays at the beginning of each track or Song, Artist, and Album information displays when available.

Use the following controls to play the disc:



- Press to seek to the beginning of the current or previous track. If the track has been playing for less than five seconds, it seeks to the previous track. If longer than five seconds, the current track starts from the beginning.
- Press and hold to fast reverse through a track. Release to return to playing speed. Elapsed time displays.



- Press to seek to the next track.
- Press and hold to fast forward through a track. Release to return to playing speed. Elapsed time displays.

For vehicles equipped with Rear Seat Infotainment (RSI), touch the Video icon to play Blu-ray or DVD discs.

Storing Media Favorites

To store media favorites, touch and hold a favorite preset to display a list of media types for the currently playing item. Select from this list.

The lists that may display are:

Genres : Touch and hold a preset to store the current genre as a favorite. Touch a saved favorite to recall a favorite genre. The first song of the genre begins to play.

Artists : Touch and hold a preset to store the current artist as a favorite. Touch a saved favorite to recall a favorite artist. The first song in the artist list begins to play.

Albums : Touch and hold a preset to store the current album as a favorite. Touch a saved favorite to recall a favorite album. The first song in the album list begins to play.

Playlists : Touch and hold a preset to store the current playlist. Touch a saved favorite to recall a favorite playlist. The first song in the playlist begins to play.

Songs : Touch and hold a preset to store the current song as a favorite. Touch a saved favorite to recall a favorite song.

Podcasts or Podcast Episode : Touch and hold a preset to store the current podcast as a favorite. Touch a saved favorite to recall a favorite podcast or podcast episode. The podcast or podcast episode begins to play.

Audiobooks : Touch and hold a preset to store the current audiobook as a favorite. Touch a saved favorite to recall a favorite audiobook. The first chapter begins to play.

Videos : Touch and hold a preset to store the current video as a favorite. Touch a saved favorite to recall a favorite video. Not all formats are supported.

Error Messages

If Disc Error displays and/or the disc comes out, it could be for one of the following reasons:

- The disc has an invalid or unknown format.
- The road is very rough. Try the disc again when the road is smoother.
- The disc is dirty, scratched, wet, or upside down.
- The air is very humid. Try the disc again later.
- There was a problem while burning the disc.
- The label is caught in the CD player.

If Disc Player Error displays, it could be for one of the following reasons:

- The player temperature is too high.
- There are load or eject errors.

If the CD is not playing correctly, for any other reason, try a known good CD.

If any error continues, contact your dealer.

Playing an MP3 CD

To play an MP3 CD, follow the same instructions as “Playing an Audio CD.”

The following guidelines must be met when creating an MP3 disc, otherwise the CD might not play:

- Sampling rate: 16 kHz, 22.05 kHz, 24 kHz, 32 kHz, 44.1 kHz, and 48 kHz.
- Bit rates supported: 8, 16, 24, 32, 40, 48, 56, 64, 80, 96, 112, 128, 144, 160, 192, 224, 256, and 320 kbps.
- Recorded on a CD-R or CD-RW.

MP3 CD playback is unavailable when both screens in the rear seat area are in use. Turn off one of the rear screens to allow MP3 playback.

MP3 Music Menu

Touch the Menu icon on the infotainment display while that source is active to access the menu.

Touch any of the following options on the MP3 Menu:

Shuffle : Touch to play the tracks randomly. Touch again to stop shuffle.

Tone Settings : Touch + or – to adjust Bass, Midrange, Treble, or Surround. See *AM-FM Radio* ⇨ 19.

Auto Volume (If Equipped) : This feature adjusts the volume based on vehicle speed. See *AM-FM Radio* ⇨ 19.

Bose AudioPilot Noise Compensation Technology (If Equipped) : This feature adjusts the volume based on the noise in the vehicle and speed. See *AM-FM Radio* ⇨ 19.

MP3 Folder Information

Touch anywhere between the top applications tray and the bottom menu to show the Browse display.

Root Directory : To access, touch the display anywhere between the top and bottom menu or touch the Browse icon. The root directory is

treated as a folder. All files contained directly under the root directory are accessed prior to any root directory folders.

No Folder : When the CD only contains compressed audio files without any folders or playlists, all files are under the root folder.

File System and Naming : The song titles, artists, albums, and genres are taken from the file's ID3 tag and are only displayed if present in the tag. If a song title is not present in the ID3 tag, the radio displays the file name as the track name.

USB Port

This vehicle is equipped with two USB ports in the center console. These ports are for data and charging.

The vehicle may have USB ports in the armrest, in the upper glove box, in the storage bin behind the radio (if equipped) and if equipped with Rear Seat Infotainment (RSI), there

may be one USB port for charging in the rear media console storage area.

Playing from a USB

A USB mass storage device can be connected to the USB port.

Gracenote

When plugging in a USB device, Gracenote service builds voice tags for music. Voice tags allow artists, albums with hard to pronounce names, and nicknames to be used to play music through voice recognition.

While indexing, infotainment features are available.

My Media Library

Allows access to content from all indexed media sources. Touch the Media icon on the infotainment display to scroll through the options until MyMedia is selected. Use gestures or touch the display to scroll through the content.

USB MP3 Player and USB Devices

- The USB MP3 players and USB devices connected must comply with the USB Mass Storage Class specification (USB MSC).
- Hard disk drives are not supported.
- The following restrictions apply for the data stored on a USB MP3 player or USB device:
 - Applicable audio extensions are mp3, wma, aac, m4a, and aif.
 - WMA and Apple lossless files are not supported.
 - Supported file systems are FAT32 and NTFS.

To play a USB device, do one of the following:

- Connect the USB.
- Press MEDIA on the center stack until the connected device is shown.

Use the following when playing an active USB source:

 : Touch to play the current media source.

 : Press to pause play of the current media source.

, ,  :

- Press to seek to the beginning of the current or previous track. If the track has been playing for less than two seconds, the previous track plays. If playing longer than 2–5 seconds, depending on the device, the current track restarts.
- Press and hold to reverse quickly through playback. Release to return to playing speed. Elapsed time displays.

, ,  :

- Press to seek to the next track.
- Press and hold to advance quickly through playback. Release to return to playing speed. Elapsed time displays.

USB Menu

Touch the Menu icon to display the USB menu. The following may be available:

Shuffle : Touch to play the tracks randomly. Touch again to stop shuffle.

Tone : Touch + or – to adjust the tone settings. See *AM-FM Radio* ⇨ 19.

Auto Volume (If Equipped) : This feature adjusts the volume based on the vehicle speed. See *AM-FM Radio* ⇨ 19.

Bose AudioPilot Noise Compensation Technology (If Equipped) : This feature adjusts the volume based on the noise in the vehicle and speed. See *AM-FM Radio* ⇨ 19.

USB Browse Menu

Touch anywhere between the top and bottom menus or touch the Browse on the infotainment display to view the Browse menu and the following options are displayed along the bottom of the display:

Playlists:

1. Touch to view the playlists stored on the USB.
2. Select a playlist to view the list of all songs in that playlist.
3. Select a song from the list to begin playback.

Artists:

1. Touch to view the list of artists stored on the USB.
2. Select an artist name to view a list of all albums by the artist.
3. To select a song, touch All Songs or touch an album and then select a song from the list.

Albums:

1. Touch to view the albums on the USB.
2. Touch the album to view a list of all songs on the album.
3. Select a song from the list to begin playback.

30 Audio Players

Songs:

1. Touch to display a list of all songs on the USB.
2. To begin playback, select a song from the list.

Genres:

1. Touch to view the genres on the USB.
2. Touch a genre to view a list of artists.
3. Touch an artist to view albums by that artist.
4. Touch an album to view songs on the album.
5. Touch a song to start playback.

Podcasts, Composers, Audiobooks, and Folder View (if equipped) are shown when More is selected from the bottom of the display.

Podcasts:

1. Touch to view the podcasts on the USB.
2. Select a podcast.

3. Select an episode to start playback.

Composers:

1. Touch to view the composers on the USB.
2. Touch Composers to view a list of albums by that composer.
3. Touch an album to view a list of songs.
4. Touch a song from the list to begin playback.

Audiobooks:

1. Touch to view the audiobooks stored on the device.
2. Touch the audiobook from the list. Touch a chapter to begin playback.

Folder View (If Equipped):

1. Touch to view the directories on the USB.
2. Touch a folder to view a list of all files.
3. Touch a file from the list to begin playback.

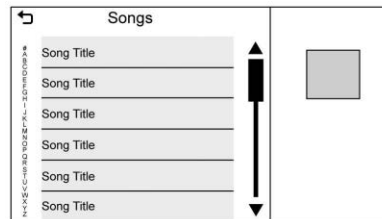

When a list of songs, albums, artists, or other types of media display, a vertical keyboard appears on one side of the list and a scroll bar on the other side. When using the vertical keyboard, touch the beginning character of the desired name to display the zoom bubble of that character. Release the finger from the infotainment display and the zoom bubble disappears.

Touch the scroll bar to move the list up and down.

File System and Naming

The songs, artists, albums, and genres are taken from the file's song information and are only displayed if present. The radio

displays the file name as the track name if the song information is not available.

Supported Apple Devices

To view supported devices in USA, see www.my.chevrolet.com/learned.

Loss of Audio

If a phone currently paired over Bluetooth is plugged in with a USB cable, the system will automatically mute the phone audio. Playback can be resumed by changing the audio source from Bluetooth to USB cable.

Source USB from the Media icon on the infotainment display to resume playback.

Bluetooth Streaming Audio and Voice Recognition

See *Bluetooth Audio* ⇨ 32 for information using voice recognition with Bluetooth streaming audio.

Make sure all devices have the latest software downloaded.

Auxiliary Jack

This vehicle has an auxiliary input jack. This may be located in the center stack or center console under the armrest. Possible auxiliary audio sources include:

- Laptop computer
- Audio music player

This jack is not an audio output. Do not plug headphones into the auxiliary input jack. Set up an auxiliary device while the vehicle is in P (Park).

Connect a 3.5 mm (1/8 in) cable from the auxiliary device to the auxiliary input jack. When a device is connected, the system can play audio from the device over the vehicle speakers.

If an auxiliary device has already been connected, but a different source is currently active, press MEDIA on the center stack or touch the Media icon on the infotainment display to scroll through audio source menus, until the AUX Input source appears.

Playing from the AUX Port

An auxiliary device is played through the audio system and controlled through the device itself.

AUX Menu

Press MENU on the center stack to display the AUX Input menu and the following may display:

Tone Settings : Touch to adjust Bass, Midrange, Treble, Balance, Fade, and EQ (Equalizer). See *AM-FM Radio* ⇨ 19.

Auto Volume (If Equipped) : This feature adjusts the volume based on the vehicle speed. See *AM-FM Radio* ⇨ 19.

Bose AudioPilot Noise Compensation Technology (If Equipped) : This feature adjusts the volume based on the noise in the vehicle and speed. See "Bose AudioPilot" in *AM-FM Radio* ⇨ 19.

Bluetooth Audio

If equipped, music may be played from a paired Bluetooth device. See *Bluetooth (Overview)* ⇨ 93 or *Bluetooth (Infotainment Controls)* ⇨ 94 or *Bluetooth (Voice Recognition)* ⇨ 98 for help pairing a device.

The music can be controlled by either the infotainment controls or the controls on the device.

Music can be launched by pressing MEDIA on the center stack or touching the Media icon on the infotainment display.

To play music via Bluetooth:

1. Power on the device, and pair to connect the device.
2. Once paired, go into the audio application from the Home Page or through the applications tray. Touch the Media icon until Bluetooth displays.

Bluetooth Audio Menu

Touch the Menu icon on the infotainment display or MENU on the center stack to display the Bluetooth Audio menu. The following may be available:

Tone Settings : Touch + or – to adjust the tone settings. See *AM-FM Radio* ⇨ 19.

Auto Volume (If Equipped) : This feature adjusts the volume based on the vehicle speed. See *AM-FM Radio* ⇨ 19.

Bose AudioPilot Noise Compensation Technology (If Equipped) : This feature adjusts the volume based on the noise in the vehicle and speed. See *AM-FM Radio* ⇨ 19.

Touch the Back icon on the infotainment display to go back to the previous menu.

Manage Bluetooth Devices :

Touch to go to the Bluetooth page to add or delete devices.

When using the Bluetooth audio source, the radio may not be able to launch specific applications on your device. Use the device to start audio playback when it is safe to do so.

All devices launch audio differently. When selecting Bluetooth audio as a source, the radio may show as paused on the display. Touch play on the device or touch ► to begin playback.

Some phones support sending Bluetooth music information to display on the radio. When the radio receives this information, it will check to see if any is available and display it. For more information about supported Bluetooth features, see www.gm.com/bluetooth.

OnStar System

OnStar 4G LTE



If equipped with OnStar 4G LTE, up to seven devices, such as smartphones, tablets, and laptops, can be connected to high-speed Internet through the vehicle's built-in Wi-Fi hotspot.

Call 1-888-4ONSTAR (1-888-466-7827) to connect to an OnStar Advisor for assistance. See www.onstar.com for vehicle availability, details, and system limitations. Service and connectivity may vary by make, model, year, carrier, availability, and conditions. 4G LTE service is available in select markets. 4G LTE performance is based on industry averages and vehicle systems design. Some services require a data plan.

The OnStar App

If equipped, the infotainment system has OnStar controls in the embedded OnStar app on the Home Page. All OnStar functions that can be performed with the buttons can be done using the app. To open the app, select the OnStar icon on the Home Page. Features vary by region and model.

OnStar Smart Driver

OnStar Smart Driver provides information about driving behavior to help maximize overall vehicle performance, reduce wear and tear, and enhance fuel efficiency. An Insurance Discounts Eligibility feature is also offered within OnStar Smart Driver. See www.onstar.com for details regarding vehicle eligibility and system limitations.

OnStar, General Motors, and their affiliates are not insurance providers. Obtain insurance only from licensed insurance providers.

Rear Seat Infotainment

Rear Seat Infotainment (RSI) System

If equipped, the system includes a Blu-ray/DVD/CD player, two USB ports, HDMI/MHL input, wireless headphones, and a remote control.

The remote control is used to select the same or a different source for each screen from the rear seats.

Video can be viewed from the front by touching the Video icon on the Home Page, if the vehicle is in P (Park). Audio will be heard over the speakers. If another display icon is selected, the video on the rear screen will continue to play but the audio on the speakers will change to the source selected.

To resume play of the video where it left off, Pseudo Resume must be on. See "Player Setup BD/DVD" later in this section.

The RSI system may not operate properly until the temperature is above -20°C (-4°F) and below 55°C (131°F).

System Operation

The video screens are overhead in the second or third row (if equipped).

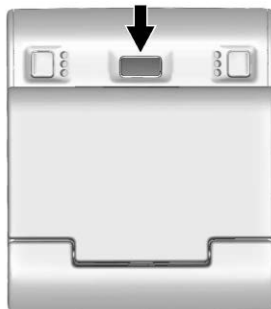

To use:

1. Press the release control in front of the overhead screen. Do not pull on the sides of the screen.



2. Move the screen to the viewing position. Remove the remote from the storage location to use.

Caution

When storing the remote, place it in the storage area with the buttons facing toward you or damage to the screen could occur.

3. Opening a screen will turn the system on. If the screens are open with the system off, press power on the remote to turn the system on.

The system can also be turned on from the front infotainment system by touching the Video icon on the Home Page and then touching the On/Off option.

If RSI audio is desired without video being displayed, stow the display in the closed position.

To turn the audio off, press power on the remote or press On/Off on the front infotainment Video page.

Push the video screen into the locked position when it is not in use. The screen turns off automatically.

Caution

Avoid directly touching the video screen, as damage may occur.

Sources

Sources include AM, FM, SXM (if equipped), HDMI/MHL, CD/DVD/Blu-Ray, and USB.

Menus and Features

AM/FM Menu

Press RADIO on the remote control, then select AM or FM.

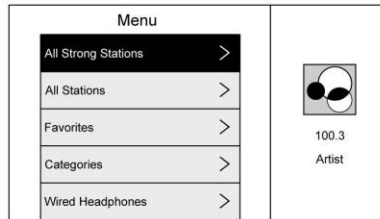

Press MENU on the remote control to select All Strong Stations, All Stations, Favorites, Categories, Wired Headphones, or other RSI functions.

Only one tuner source may be active at a time.

To close, press MENU or  (Back), or wait for the time out.

SXM Menu (If Equipped)

Press RADIO on the remote control, then select SXM.

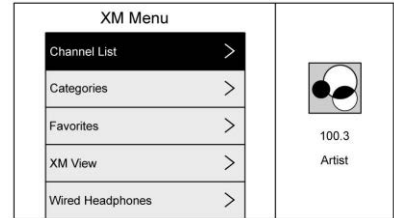

Press MENU to select Channel List, Categories, Favorites, SXM View, Wired Headphones, or other RSI functions.

Only one tuner source may be active at a time.

To close, press MENU or  (Back), or wait for the time out.

Disc Menu BD (Blue-Ray Disc)

With a Blu-ray disc in the player, press MEDIA on the remote control and then select Blu-ray.

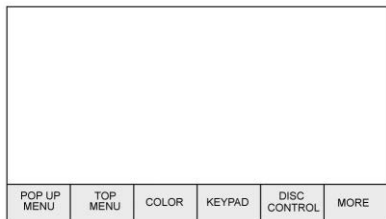

Press MENU on the remote control once to display menus based on the media.

Choose from POP UP MENU (BD Only), TOP MENU, COLOR, KEYPAD, DISC CONTROL, and MORE (SETTINGS, PREVIOUS, NEXT, STILLS OFF).

To close, press MENU or  (Back), or wait for the time out.

Disc Menu DVD

Press MENU on the remote control once to select from TOP MENU, KEYPAD, STOP DISC, PHOTO, and SETTINGS.

To close, press MENU or  (Back), or wait for the time out.

CD Menu

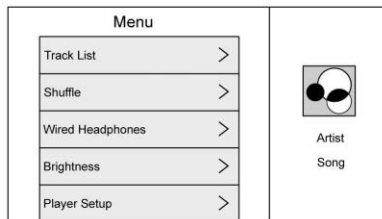

Select from:

- Track List
- Shuffle
- Disc Information (if available)
- Wired Headphones
- Brightness
- Player Setup: Audio Compression, Auto Enter (if available)
- Title Search (if available)
- Software Information

If no disc is present, not all choices are available.

To close, press MENU or  (Back), or wait for the time out.

Pop Up Menu (BD Only)

Select to display the on-screen menu options. To exit the Pop Up menu, make a selection or wait for the timeout. When the Pop Up menu is opened, the overlay/interaction selector menu will be closed.

Top Menu BD/DVD

Select to display the DVD or BD menu. Make a selection to exit the Top menu. TOP MENU is not available for BDAV, DVD-VR, and AVCREC discs.

Color (BD Only)

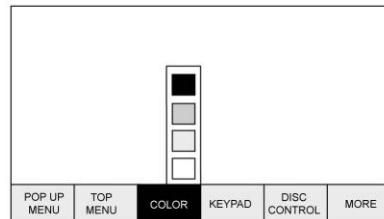

Select COLOR to display the four color options: blue, yellow, red, and green. Highlight a color and press ENTER and the appropriate action will be carried out. Press  (Back), MENU, or wait for the 15-second time out to close the menu. Press the down arrow on the yellow color to keep the overlay menu up, but close the color menu. The color menu is disc dependent; selecting colors for discs that do not support this feature will have no function.

Keypad BD/DVD

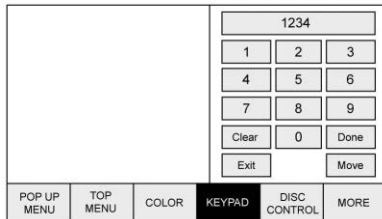

Select to display. To close, press  (Back) or MENU, wait for the menu to time out, or press the down arrow from the 0 or Done

options. The keypad is disc dependent and may have no function.

The keypad input is limited to four digits.

Select Clear to clear one digit at a time. Press and hold to clear all entered digits.

Disc Control (BD/AV and BDMV Only)

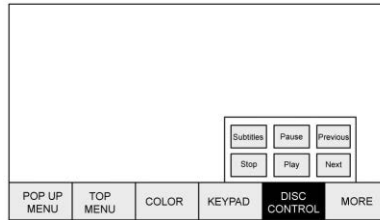

Select to display the disc options Subtitles, Play, Pause, Next, Previous, and Stop. Press  (Back) or MENU, or wait for the time out to close. Press the down arrow from Stop, Play, or Next to keep the overlay up but close the menu. The

Disc Control menu is disc dependent and may have no function.

Stop Disc (DVD Only)

Select to close the overlay menu. Touch Menu on the screen to open the Disc Stopped menu.

Select from:

- Resume Playback: Returns to the current position on the disc and resumes play.
- Title Search (if available)
- Restart Disc
- Screen Mode
- Wired Headphones
- Brightness
- Player Setup: Audio Compression, Auto Enter (if available)
- Software Information

Not all options are available while the disc is playing.

38 Rear Seat Infotainment

Browse Media (AVCREC, BDAV, DVD-A, DVD-VR discs only) allows the media on the disc to be searched in a list format.

More

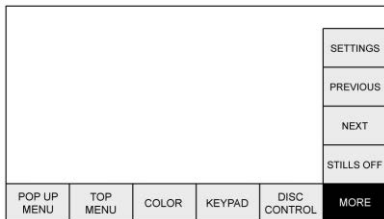

The MORE submenu includes SETTINGS and items related to still pictures.

Previous/Next/Stills Off

Select PREVIOUS to turn off or advance to the prior still picture. NEXT advances to the next picture. Select STILLS OFF to return to the home still, if available. Press  (Back) or MENU, or wait for the time out to close the menu. Press the

down arrow on the bottom option to close the next still pop-up. The still picture feature is disc dependent.

This feature can also be accessed by selecting Photo on the DVD Disc menu.

Settings BD/DVD

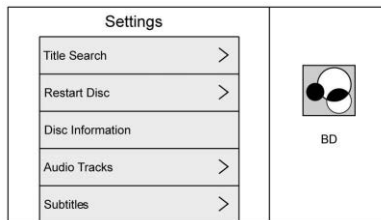

Select to access:

- Resume Playback: Returns to the current position on the disc and resumes play.
- Browse Media (BDAV, AVCREC, DVD-A, DVD-VR discs only): Allows browsing by Video List or Playlist.
- Title Search (AVCHD, DVD-V, BDMV discs only): Allows the titles provided by the disc to be

searched. Select this option to bring up a keypad to search for specific titles.

- Top Menu
- Restart Disc: Restarts the disc from the beginning.
- Disc Information (if available)
- Audio Tracks
- Subtitles
- Angle (BDMV, DVD-V, DVD-A only): Select an angle by using the up and down arrows to highlight the option and pressing ENTER or the right arrow.
- Screen Mode: Adjusts the framing on the RSI display. Select Normal, Wide, or Zoom. Screen Mode only applies to video sources and should be maintained if the disc is ejected.
- Wired Headphones: Use to listen to audio on the wired headphones. The headphone audio plays depending on which screen is selected. The default is screen 1 audio.

- Brightness: Increase the brightness by using the up or right arrow and decrease the brightness by using the down or left arrow. Each screen brightness can be adjusted separately.
- Player Setup: See "Player Setup BD/DVD" later in this section.
- Software Information

Player Setup BD/DVD



Player Setup may include:

- Default Menu Language: With no disc inserted, select from a list of languages or enter a language code.
- Default Audio Language: With no disc inserted, select from a list of languages or enter a language code.
- Default Subtitle Language: With no disc inserted, select from a list of languages or enter a language code.
- Audio Compression: When on, the RSI will attempt to reduce the difference between the audio highs and lows. CUSTOM will increase dialog volume.
- Pseudo Resume: When on, the RSI will attempt to resume play of the video where it left off after the vehicle has been turned off. This can be turned on or off.
- Auto Enter: When on, the RSI will attempt to start play of the video when the disc is inserted. This feature can be turned on or off. Not all discs support this feature.
- Audio Channel (AVCREC, DBAV, DVD-VR discs only) contains: Stereo, Left Mono, and Right Mono. Audio Channel is available from the Settings menu. Default will be determined by the disc.
- Format Internal User Memory: Only shown when no disc is inserted. To format internal user memory, select OK. A message and the activity indicator display. A message displays when the format is complete. To close, press  (Back) or MENU, or wait for the time out.

Errors

Errors can occur if the local storage area has been broken or if the ignition is turned off during formatting. Closing the screen during formatting will not interrupt it. If the screen is opened again, the current state of format will be displayed. If an error occurs, the Error screen will display when the ignition is turned on.

40 Rear Seat Infotainment

Enter Language Code

Enter the desired language code.

| Language/Code | | User Code |
|---------------|-----|-----------|
| Japanese | JPN | 7465 |
| English | ENG | 6978 |
| French | FRA | 7082 |
| German | DEU | 6869 |
| Italian | ITA | 7384 |
| Spanish | SPA | 6983 |
| Dutch | NLD | 7876 |
| Russian | RUS | 8285 |
| Chinese | ZHO | 9072 |
| Korean | KOR | 7579 |
| Greek | ELL | 6976 |
| Afar | AAR | 6565 |
| Abkhazian | ABK | 6566 |
| Afrikaans | AFR | 6570 |
| Amharic | AMH | 6577 |
| Arabic | ARA | 6582 |
| Assamese | ASM | 6583 |

| | | |
|--------------|-----|------|
| Aymara | AYM | 6589 |
| Azerbaijani | AZE | 6590 |
| Bashkir | BAK | 6665 |
| Byelorussian | BEL | 6669 |
| Bulgarian | BUL | 6671 |
| Bihari | BIH | 6672 |
| Bislama | BIS | 6673 |
| Bengali | BEN | 6678 |
| Tibetan | BOD | 6679 |
| Breton | BRE | 6682 |
| Catalan | CAT | 6765 |
| Corsican | COS | 6779 |
| Czech | CES | 6783 |
| Welsh | CYM | 6789 |
| Danish | DAN | 6865 |
| Bhutani | DZO | 6890 |
| Esperanto | EPO | 6979 |
| Estonian | EST | 6984 |
| Basque | EUS | 6985 |
| Persian | FAS | 7065 |

| | | |
|--------------|-----|------|
| Finnish | FIN | 7073 |
| Fiji | FIJ | 7074 |
| Faroese | FAO | 7079 |
| Friesian | FRY | 7089 |
| Irish | GLE | 7165 |
| Scots-Gaelic | GLA | 7168 |
| Galician | GLG | 7176 |
| Guarani | GRN | 7178 |
| Gujarati | GUJ | 7185 |
| Hausa | HAU | 7265 |
| Hindi | HIN | 7273 |
| Croatian | HRV | 7282 |
| Hungarian | HUN | 7285 |
| Armenian | HYE | 7289 |
| Interlingua | INA | 7365 |
| Interlingue | ILE | 7369 |
| Inupiak | IPK | 7375 |
| Indonesian | IND | 7368 |
| Icelandic | ISL | 7383 |
| Hebrew | HEB | 7269 |

| | | |
|-------------|-----|------|
| Yiddish | YID | 8973 |
| Javanese | JAV | 7487 |
| Georgian | KAT | 7565 |
| Kazakh | KAZ | 7575 |
| Greenlandic | KAL | 7576 |
| Cambodian | KHM | 7577 |
| Kannada | KAN | 7578 |
| Kashmiri | KAS | 7583 |
| Kurdish | KUR | 7585 |
| Kirghiz | KIR | 7589 |
| Latin | LAT | 7665 |
| Lingala | LIN | 7678 |
| Laothian | LAO | 7679 |
| Lithuanian | LIT | 7684 |
| Latvian | LAV | 7686 |
| Malagasy | MLG | 7771 |
| Maori | MRI | 7773 |
| Macedonian | MKD | 7775 |
| Malayalam | MAL | 7776 |
| Mongolian | MON | 7778 |

| | | |
|----------------|-----|------|
| Moldavian | MOL | 7779 |
| Marathi | MAR | 7782 |
| Malay | MSA | 7783 |
| Maltese | MLT | 7784 |
| Burmese | MYA | 7789 |
| Nauru | NAU | 7865 |
| Nepali | NEP | 7869 |
| Norwegian | NOR | 7879 |
| Occtian | OCI | 7967 |
| Oromo | ORM | 7977 |
| Oriya | ORI | 7982 |
| Panjabi | PAN | 8065 |
| Polish | POL | 8076 |
| Pashto, Pushto | PUS | 8083 |
| Portuguese | POR | 8084 |
| Quechua | QUE | 8185 |
| Rhaeto-Romance | ROH | 8277 |
| Kirundi | RUN | 8278 |
| Romanian | RON | 8279 |
| Kinyarwanda | KIN | 8287 |

| | | |
|----------------|-----|------|
| SanSkrit | SAN | 8365 |
| Sindhi | SND | 8368 |
| Sangho | SAG | 8371 |
| Serbo-Croatian | SCR | 8372 |
| Singhalese | SIN | 8373 |
| Slovak | SLK | 8375 |
| Uzbek | UZB | 8590 |
| Vietnamese | VIE | 8673 |
| Volapuk | VOL | 8679 |
| Wolof | WOL | 8779 |
| Xhosa | XHO | 8872 |
| Yoruba | YOR | 8979 |
| Zulu | ZUL | 9085 |
| Slovenian | SLV | 8376 |
| Samoan | SMO | 8377 |
| Shona | SNA | 8378 |
| Somali | SOM | 8379 |
| Albanian | SQI | 8381 |
| Serbian | SRP | 8382 |
| Siswaiti | SSW | 8383 |

| | | |
|-----------|-----|------|
| Sesotho | SOT | 8384 |
| Sundanese | SUN | 8385 |
| Swedish | SWE | 8386 |
| Swahili | SWA | 8387 |
| Tamil | TAM | 8465 |
| Telugu | TEL | 8469 |
| Tajik | TGK | 8471 |
| Thai | THA | 8472 |
| Tigrinya | TIR | 8473 |
| Turkmen | TUK | 8475 |
| Tagalog | TGL | 8476 |
| Setswana | TSN | 8478 |
| Tonga | TON | 8479 |
| Turkish | TUR | 8482 |
| Tsonga | TSO | 8483 |
| Tatar | TAT | 8484 |
| Twi | TWI | 8487 |
| Ukrainian | UKR | 8575 |
| Urdu | URD | 8582 |

Wired Headphones

Select from the Settings menu, then select the headphone audio for the wired headphone jack based on screen 1 or screen 2 and press ENTER or the right arrow.

Press  (Back) to exit.

The headphones are set to screen 1 by default.

Title Search (CD-DA Only)

This displays a list of titles to select by using the up and down arrows.

Disc Information (CD-DA Only)

If the inserted disc is BDMV, BDAV, AVCHD, AVCREC, DVD-Video, or DVD-VR the disc title should display. If the inserted disc is DVD-Audio, DTS-CD, CDDA, or Mixed-CD the track number will display.

Software Information

This allows access to Version information, Save Vehicle Info to USB, and Open Source Info.

Save Vehicle Info to USB allows the current version to be saved to a jump drive, which must be done before an update can be performed.

Open Source Info shows where software information can be found.

Changing Between SCREEN 1 and SCREEN 2

For single overhead screen systems only:

Although two audio sources can be listened to at one time, only one video source can be viewed on the overhead screen at a time.

Press SCREEN 1 or SCREEN 2 on the remote control to change which source will display on the overhead screen.

When SCREEN 1 is displayed and SCREEN 2 on the remote control is pressed, the source for SCREEN 2 will display. The audio for SCREEN 1 is available on channel 1 of the headphones and the audio for SCREEN 2 is available on channel

2 of the headphones. Change the channel on the headphones to the desired screen source.

One user can listen to the audio from SCREEN 1 and view the source on the overhead display while another user can listen to a separate audio source by changing the channel on the wireless headphones or setting their wired headphones to SCREEN 2 in the MENU.

RSI Controls Available from the Front Screen

To access the RSI, touch the Video icon from the Home Page. The Video app may also be selected from the applications tray if it has been stored in one of the five locations.

Sourcing to DVD/BD

This allows for watching a DVD/BD video on the front screen when the vehicle is in P (Park).

After a disc is inserted, it will automatically begin playing. To resume play of the video where it

left off, Pseudo Resume must be on. See "Player Setup BD/DVD" previously in this section.

With the vehicle in P (Park), icons display along the bottom of the front screen. When a DVD, VCD, USB, or HDMI source is inserted:



When a BD is inserted:



Rear Media

This allows for transitioning between Disc, USB, and HDMI sources for the rear screens. Sources selected

will be automatically sourced for both rear screens and will begin playback from the first available file.

The video will only appear on the front screen with the vehicle in P (Park). In any other gear, the front screen displays the active media source.

DVD/BD Disc Menu

With the vehicle in P (Park), select DISC MENU to access the DVD/BD disc menu.

Next Track/Previous Track

Use to skip ahead or to skip back chapters. Press less than five seconds into the current track to start at the beginning of the previous track. Press more than five seconds into the current track to start at the beginning of the current track.

Fast Forward/Fast Rewind

With the vehicle in P (Park), hold or for approximately one and one-half

44 Rear Seat Infotainment

seconds to fast forward or fast rewind. If , , or , , are held for approximately six seconds, the rate of fast forward or fast rewind will increase.

Play/Pause

Touch to play or to pause, depending on the current selection.

Keypad for DVD/VCD/USB

With the vehicle in P (Park), select to display the DVD keypad. DVD keypad functionality is disc dependent and may not be available on all DVDs. Up to four digits can be entered. Select Clear to remove one digit in the entry field. Touch and hold Clear to remove all digits in the entry field.

Pop Up Menu (BD Only)

This displays the pop up menu contents for the BD. Make a selection or use the interaction selector to exit pop up menu view.

Cursor

Use to navigate and select items in the disc menu. Press the up, down, right, or left arrows, or ENTER. Touch cursor to close the interaction selector and display a vertical menu of cursors. The cursor will time out and close.

Sourcing USB/VCD/HDMI with Video

This allows for watching videos on the front screen from devices plugged into the rear module when in P (Park).

With the vehicle in P (Park), icons display:



These features will function the same as in DVD/BD sources, with the following exceptions:

- KEYPAD is only available for VCD in P (Park).
- DISC MENU is only available for disc sources such as VCD. The system displays the menu provided by the disc.

Sourcing DVD/BD/USB/VCD/AUX

With the vehicle in D (Drive), the following icons display along the bottom of the front screen when one of these sources is active:



DVD/BD/USB/VCD: All options are available.

HDMI: Only REAR MEDIA and MENU are available.

Rear Media

Use to select Disc, USB, or HDMI sources. Both rear screens will be sourced and will begin playback of the first available file. The video will

only display on the front screen if the vehicle is in P (Park). In any other gear, the front screen displays the active media source.

Previous Track/Next Track

Press **⏮**, **⏪**, **⏩** or **⏮**, **⏪**, **⏩** to select the previous or next track on the current media.

Play/Pause

Press **▶** to play or **⏸** to pause, depending on the current selection.

Menu (DVD/BD/USB/HDMI/VCD)

Only available in D (Drive). Press MENU to display these options:

- **Tone Settings:** Use to set bass, mid, and treble on speakers only. Once set, tone settings are for all sources.
- **Auto Volume Control:** Adjusts the volume of the audio based on the speed or ambient noise of the vehicle. Some vehicles may be equipped with the Bose AudioPilot system. In these cases, the Auto Volume main menu item is replaced with the

Bose AudioPilot menu item. AVC or Bose AudioPilot is available to use with any source mode.

- **Traffic Announcements:** Displays traffic alerts in the RSI system. The video will continue to play and the audio will mute, depending on the alert.

Closing the Menu (DVD/BD)

Touch Back or Exit to close a menu. This will return to the previously viewed screen.

Power

Press power on the front display to turn the RSI screen on or off. The front display will continue to operate when the overhead screen(s) are turned off. A red lit power icon indicates the rear screens are on. A white lit power icon indicates the rear screens are off.

Headphones

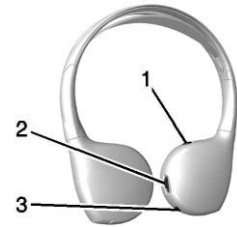

1. Power Button
2. Volume Control
3. Channel 1 or 2 Switch

RSI includes two or four 2-channel new digital wireless headphones depending on the vehicle model.

The headphones are used to listen to various multimedia. The wireless headphones have a power control, Channel 1 or 2 switch, and a volume control. The digital headphones cannot be interchanged with previous models of GM headphones.

Press the power button to turn on the headphones. A light on the headphones comes on. A flashing

46 Rear Seat Infotainment

light indicates the headphones are not in range. Move them closer to the forward overhead screen until the light stops flashing. If the light does not come on, check the batteries. Intermittent sound or static can also indicate weak batteries. See "Battery Replacement" later in this section.

Turn the headphones off when not in use.

Move the channel switch to channel 1 or channel 2. Channel 1 will play audio from screen 1 and channel 2 will play audio from screen 2. When a third row screen is available, the screen will display the selection related to 1 on the remote control. If 1 is not available, press 2 on the remote control. Channel 2 will provide audio based on its setting.

- Screen 1 is overhead in the second row.
- Screen 2 is overhead in the third row.

Infrared transmitters are on the top of the second row video screen. The headphones shut off automatically if

the RSI system is off or if the headphones are out of range of the transmitters for more than three minutes. Moving too far forward or stepping out of the vehicle can cause the headphones to lose the signal or have static.

Use the volume control on the headphones to adjust the volume.

For best audio performance, wear the headphones as indicated with L (Left) and R (Right) on the ear pads. Do not let anything cover the ear pads.

Caution

Do not store the headphones in heat or direct sunlight. This could damage the headphones and repairs will not be covered by the warranty. Storage in extreme cold can weaken the batteries. Keep the headphones stored in a cool, dry place.

If the foam ear pads become worn or damaged, the pads can be replaced separately. To purchase replacement ear pads, contact your dealer.

Battery Replacement

To change the batteries:

1. Loosen the screw to the battery door on the left side of the headphones.
2. Slide the battery door open.
3. Replace the two AAA batteries.
4. Replace the battery door and tighten the screw.

Remove the batteries if the headphones will not be used for a long time.

Rear Seat Infotainment (RSI) Wi-Fi (If Equipped)

The RSI Wi-Fi allows the user to access music, videos and pictures that are saved or taken with a smart device to the RSI system through Digital Living Network Alliance

(DLNA) applications. Only one smart device can be connected to the RSI at one time.

Placement for Optimal Performance

The RSI Wi-Fi antenna is near the RSI disc player. The smart device connection is stronger when it is near the Wi-Fi antenna.

If the network is not operating at its maximum effectiveness, try the following:

- Disconnect the smart device from any other connected network to improve the audio/video performance.
- Switch the band. While in any Wi-Fi screen, select Menu, then select Switch Band to access a band that is available. Some marketing regions will only support 2.4 GHz.

Digital Living Network Alliance (DLNA) (If Equipped)

To establish an initial connection:

1. From the RSI Wireless Display menu, select DLNA. The RSI screen will display a Wi-Fi network name, such as "DIRECT-xx-Rear Seat", as well as the required password necessary to complete the connection.
2. Make sure the smart device's Wi-Fi is enabled, and open the device's Wi-Fi menu.
3. From the smart device's Wi-Fi menu, select the "DIRECT-xx-Rear Seat" network. If this network is not shown at the smart device, it will be necessary to re-scan for available networks.
4. Enter the RSI Password at the smart device to complete the connection. Once entered, the "DIRECT-xx-Rear Seat" network will display as connected.

5. From the smart device's DLNA application, select Rear Seat 1 or 2 as the screen to display the desired video, audio, or picture files on the RSI.

Once the connection process is done for the first time, the Wi-Fi connection will be made whenever the device is within Wi-Fi range or the smart device Wi-Fi is turned on.

Select Menu from the remote control to access the options to switch Wi-Fi band, disconnect the smart device from the RSI Wi-Fi, or to remove all DLNA passwords that have been saved.

Supported DLNA media types are:

- Video: .mp4 and .mpg
- Audio: .mp3 and .aac
- Picture: .jpeg and .jpg

Viewing the Other Display

While the left or right screen is connected by DLNA, the other screen can access the same source

48 Rear Seat Infotainment

by selecting View Screen 1 or View Screen 2 in the Wireless Display menu.

Connecting Wireless Android Devices

Many Android devices come with pre-installed audio and video players that support Wi-Fi streaming; consult your smart device manual for more information. Android devices will also support various DLNA applications to allow the device to connect to the RSI wirelessly. Search the Google Play store for DLNA applications to install on the Android device.

Connecting Wireless Apple Devices

Apple will support various DLNA apps to allow the device to connect to the RSI wirelessly. Search the App Store for DLNA applications to install on the Apple device.

Auxiliary Inputs

Rear Media Connections

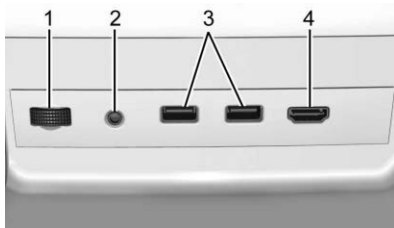

1. Volume Control for Wired Headphones
2. Wired Headphone Jack
3. USB Ports
4. HDMI Input

If equipped with RSI, the features above will be in the rear of the center console. These ports are for the primary use of the rear passengers and not all media is available to the front passengers.

HDMI Input

An HDMI cable is required to connect an HDMI device to the RSI hub. The RSI HDMI input allows connection to:

- Video games, disc players, cameras, smart phones, tablets, A/V dongles that have HDMI (version 1.4a) outputs.
- Smart devices that support Mobile High-Definition Link (MHL) version 2.0.
- Apple devices. A supporting HDMI cable from Apple is required.

For certain HDMI devices that support USB charging, the USB ports can be used as a power source.

To use the HDMI input of the RSI system:

1. Connect the auxiliary device with an HDMI cable.
2. Power on both the auxiliary device and the RSI video screen.

- Press MEDIA on the remote control and use the arrows to change the source to HDMI.

USB

There are two USB ports to provide the RSI system audio/video from supported devices, as well as provide device charging.

Audio from these ports can only be heard and controlled by the rear seat passengers. Video can be heard, shown, and controlled by the rear and front passengers.

To use the USB:

- Insert the device into one of the two ports.
- Select the source (USB 1 or USB 2) through the rear screen menu using MEDIA on the remote control.
- Select the source via the front by touching the Video icon on the Home Page.

Audio Output

Audio from a Blu-ray/DVD/CD player or HDMI inputs can be heard through:

- Wireless headphones: Available for any source depending on the selected channel.
- Vehicle speakers: Touch the Video icon on the Home Page. Select any other source to stop the speaker audio; rear audio will continue to play.
- Vehicle wired headphone jack: See “Wired Headphone Jack” following.

The RSI system transmits the audio signal to the wireless headphones if an audio signal is available. See “Headphones” earlier in this section.

Front seat passengers can listen to playback from the attached rear device through the vehicle speakers by selecting that source from the Video Application on the front display Home Page.

Wired Headphone Jack



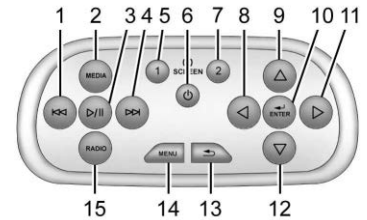

Select MENU on the remote control, then select Settings and then Wired Headphones to listen to audio on the wired headphones. The headphone audio plays depending on which screen is selected. The default is screen 1 audio.





Remote Control



Remote Control Buttons

-  (Previous/Reverse)
 - Radio: Press to seek the previous radio station.
 - CD: Press to seek the previous track.

- Blu-ray/DVD: Press to seek the previous chapter.
 - Press and hold for fast reverse.
2. MEDIA
- Press to scroll through the menus including: BD/DVD/CD, USB 1, USB 2, HDMI.
3.  (Play/Pause)
- Press to start playing. Press to pause. Press again to continue playing.
4.  (Next/Fast Forward)
- Radio: Press to seek the next radio station.
 - CD: Press to seek the next track.
 - Blu-Ray/DVD: Press to seek the next chapter.
 - Press and hold to fast forward.
5. SCREEN 1
- For single overhead screens:
Press to change the source displayed on the overhead screen to SCREEN 1 selected source. Select audio sources. Only one video can be played on the screen at a time. Audio for both sources will continue on the headphones. Once pressed, all remote control commands will correspond to SCREEN 1.
 - For dual overhead screens:
Press to select the second row overhead screen. Once pressed, all remote control commands will correspond to SCREEN 1.
6.  (Power)
- Press to turn the video screens on and off.
7. SCREEN 2
- For single overhead screens:
Press to change the source displayed on the overhead screen to SCREEN 2 selected source. Only one video can be played on the screen at a time. Audio for both sources will continue on the headphones. Once pressed, all remote control commands will correspond to SCREEN 2.
 - For dual overhead screens:
Press to select the optional third row overhead screen. Once pressed, all remote control commands will correspond to SCREEN 2.
8.  (Previous/Reverse/Decrease)
- Radio and CD: Press to go to the previous station or track.
 - Press to go to the previous menu.

- Press to decrease the brightness of the RSI screen.
9.  (Up Arrow)
- Press to scroll up a list.
10.  /ENTER
- Press to select the highlighted choice in any menu.
 - Press and hold for quick play.
11.  (Next/Forward/Increase)
- Radio and CD: Press to go to the next station or track.
 - Press to go to the next menu.
 - Press to increase the brightness of the RSI screen.
12.  (Down Arrow)
- Press to go down a list.

13.  (Back)
- Press to go back to the previous menu.
 - Press and hold to go back to the now playing screen.
14. MENU
- Press to go to the menu of the now playing screen.
15. RADIO
- Press to scroll through the radio sources including AM and FM.

To use the remote control, aim it at the receiver window at the forward overhead screen and press the controls firmly. Direct sunlight or very bright light could affect the ability of the RSI receiver to receive signals from the remote control. Check the batteries if the remote control does not seem to be working. See "Battery Replacement" following. Objects blocking the line of sight could also affect the function of the remote control.

If a CD, Blu-ray/DVD, or MP3 disc is in the CD slot, the remote control  power button can be used to turn on the video screen display and start the disc. The infotainment system can also turn on the video screen display.

Caution

Storing the remote controls in a hot area or in direct sunlight can damage them, and the repairs would not be covered by the vehicle warranty. Storage in extreme cold can weaken the batteries. Keep the remote controls stored in a cool, dry place.

Battery Replacement

To change the remote control batteries:

1. Insert a coin or key to pull up the rear cover on the remote control.

52 Rear Seat Infotainment

2. Replace the two AAA batteries in the compartment.
3. Replace the battery cover.

Remove the batteries from the remote control if it will not be used for an extended period of time.

Video Voice Over

If equipped, the RSI system has a Video Voice Over feature to benefit the visually and hearing impaired.

When activated, the RSI will read aloud menu titles, menu listings, pop-ups, alerts, and file titles from audio and video media. Titles with gibberish, special characters, or foreign text may not be read aloud.

Use one of the following to turn Video Voice Over on or off:

- Select Video Voice Over from the Front Display menu.
- Select Video Voice Over from the RSI menu.
- Press and hold the Remote Control Menu and Play/Pause controls for five seconds.

Video Voice Over will remain active over ignition cycles until it is turned off.

RSI Troubleshooting

No power : The ignition might not be on or in ACC/ACCESSORY.

The picture does not fill the screen. There are black borders on the top and bottom or on both sides, or it looks stretched out : Press MENU on the remote control to change the display mode setting.

The remote control does not work : Check to make sure the remote control is programmed to the correct screen. Make sure there is no obstruction between the remote control and the transmitter window and check the batteries to make sure they are not dead or installed incorrectly.

There is no sound from the headphones with the indicator light on : If the batteries are good, make sure the headphones are programmed to the correct screen and on the correct channel for the screen being viewed.

The HDMI source is running but there is no picture or sound : Check that the RSI video screen is in the HDMI mode by pressing MEDIA on the remote control. Check the HDMI connections at both devices.

Sometimes the wireless headphone audio cuts out or buzzes : Check for obstructions, low batteries, reception range, and interference from cell phone towers or from cellular telephone use in the vehicle. Check that the headphones are on correctly using the L (Left) and R (Right) on the headphones. Check that the headphones are positioned properly with the headband across the top of the head.

I lost the remote and/or the headphones : See your dealer for assistance.

The Blu-Ray/DVD is playing, but there is no picture or sound : Check that the RSI video screen is sourced to the Blu-ray/DVD player by pressing MEDIA on the remote control.

Videos from my phone are played back sideways or upside-down when the phone is connected via DLNA : This cannot be corrected by the RSI system. While playing through DLNA, the RSI will only play back videos in the orientation in which they were recorded.

Video Display Error Messages

The video screen may display one of the following:

Disc Error : There are disc load or eject problems, the disc is inserted with the disc label wrong side up, the disc is damaged, or the disc is not from the correct region.

No Disc Inserted : No disc is present.

Disc Player Error : The temperature is outside the operating range of the RSI system. If the temperature is within range, see your dealer.

Video Distortion

Video distortion can occur when operating cellular phones, scanners, CB radios, Global Positioning Systems (GPS), two-way radios, mobile faxes, or walkie talkies.

It might be necessary to turn off the video player when operating one of these devices in or near the vehicle.

Navigation

Using the Navigation System

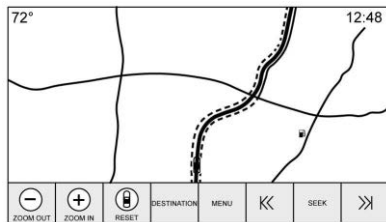

Touch the Nav icon on the Home Page or the Nav icon in the applications tray to access the navigation application.

Touch the Menu icon from the map view to access the Navigation Menu. Features displayed in the Navigation Menu can be selected to adjust navigation preferences.

To exit out of a list, touch Exit in the top right corner of the map to return to the main map view.

When the display is not in use, it will time out and remove the controls. Touch anywhere along the bottom or top of the display to show the controls.

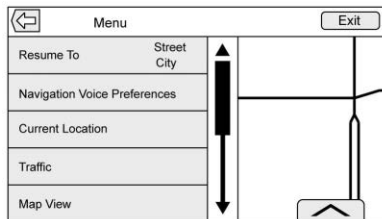

Additional navigation features are:

- Cancel Route/Resume To
- Navigation Voice Preferences
- Current Location
- Map View
- Traffic
- Routing Preferences
- Display “Places of Interest” Icons
- Personal Data

Cancel Route/Resume To

- While under route guidance, this option displays Cancel Route. Touch Cancel Route to cancel route guidance. No further prompts will be given. This option then changes to Resume To.
- Touch the Resume To option to resume route guidance to the last entered destination.
- The last location that the system has provided guidance to can be resumed by touching on this option.
- If the route includes waypoints, the entire route can be suspended using the Cancel Route option. When Resume To is touched, all waypoints are resumed for guidance.

Navigation Voice Preferences

Touch the Navigation Voice Preferences option to adjust the voice preferences.

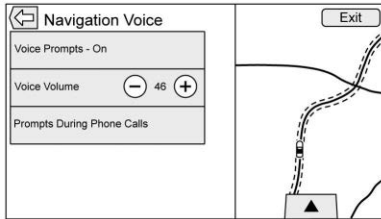

The following options can be adjusted:

- Voice Prompts On-Off
- Voice Volume
- Prompts During Phone Calls On-Off

Voice Prompts

Touch the Voice Prompts option to toggle voice prompts On and Off.

Voice Volume

Adjust the loudness of the audio feedback by touching – or +. If a maneuver prompt is being played, and the main volume is adjusted, the prompt volume will update and be saved.

Prompts During Phone Calls

When enabled, the system plays a shorter prompt while on a phone call. This setting can be configured as to whether a prompt would be heard during a phone conversation.

When this setting is Off, only the short alert tone is played when approaching the maneuver.

Voice Prompts Mute Icon

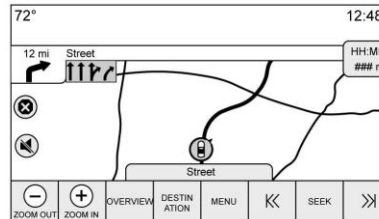

Touch the Mute icon on the left side of the map while in map view to turn voice prompts On or Off.

Current Location

Touch the Current Location feature to display a Current Location list.

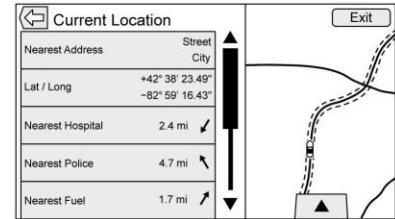

The following information is displayed on the Current Location options:

- Nearest Address
- Lat/Long
- Nearest Hospital
- Nearest Police
- Nearest Fuel
- Nearest Service

Touch on any of the options to display the Destination Details view for the selected location to begin guidance.

Touch Nearest Address and then the Save option to store the current location to the Address Book.

Map View

Touch to select the desired map view. A checkmark appears to indicate a view has been selected.

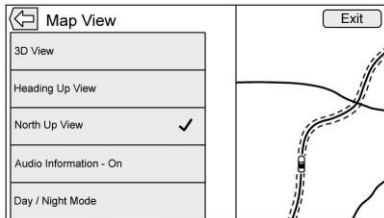

3D View : The 3D View is a Heading Up view but it includes perspective. Map items will appear larger as the vehicle comes closer.

Heading Up View : The Heading Up View keeps the vehicle's current heading at the top of the view. The vehicle icon always faces the top of the view as the map rotates.

North Up View : The North Up View keeps north at the top of the view. The vehicle icon is placed in the center of the view and rotates to indicate the heading for the vehicle.

Audio Information : Touch to turn the audio information view on or off from the main map view.

The audio status screen contains:

- Station Frequency
 - Artist Information
 - Song Information
 - ▶ / || or ◀◀, ◀◀, ◀◀ or ▶▶, ▶▶ ▶▶
- Station and Channel Controls

Touch the ◀◀, ◀◀, ◀◀ or ▶▶, ▶▶ ▶▶ Station controls to go to the next or previous strong signal station or digital channel.

When the audio status pane displays Artist and Song Information, touch ◀◀, ◀◀, ◀◀ or ▶▶, ▶▶ ▶▶ to go to the next or previous track based on the current media mode.

Day/Night Mode

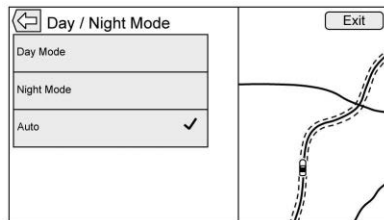

Touch to access the Day/Night Mode menu.

The options are:

- Day Mode: Brightens the map background.
- Night Mode: Darkens the map background.
- Auto: Adjusts the display background automatically depending on the exterior lighting conditions.

Traffic (If Equipped)

Touch to browse the traffic in the area as well as adjust the traffic settings. Where traffic information is available, it is displayed on the map.

Where live traffic flow data is available, it is displayed as a solid line adjacent to the road. The road is displayed in colors to show the flow rate as:

- Black – Stopped or Closed
- Red – Poor
- Yellow – Slow
- Green – Normal

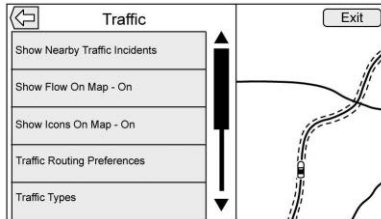

There are several options on the Traffic menu:

- Show Nearby Traffic Incidents
- Show Flow On Map On/Off
- Show Icons On Map On/Off
- Traffic Routing Preferences
- Traffic Types

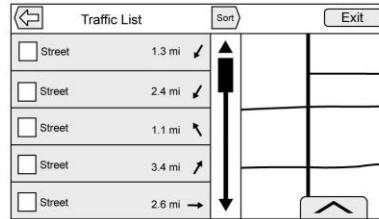

1. Touch Show Nearby Traffic Incidents to access the Traffic List menu. This menu displays the incident symbol and highway name, along with the distance and heading to the incident.
2. Touch on the incident to display additional details about the incident as well as an option to avoid that particular incident if it is along the current route.

Traffic Routing Preferences

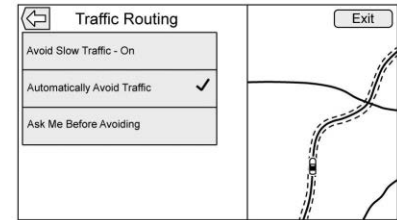

The system can be configured as to how it reacts when receiving traffic information. Touch Traffic Routing Preferences to access the Traffic Routing menu.

When this setting is Off, the system will never take traffic conditions into account when creating routes. In addition, the two options below are grayed out. If one of the grayed-out options is touched, it automatically turns the traffic avoidance feature On and performs the desired selection.

58 Navigation

The two options, Ask Me Before Avoiding and Automatically Avoid Traffic will adjust the system as follows:

- If the Automatically Avoid Traffic list item is touched, the system will automatically adjust the route based on traffic without notifying the driver.
- If the Ask Me Before Avoiding list item is touched, the system will always use Alerts to show when there is an incident and allow it to be avoided by touching Avoid.

If the Traffic list item is touched from the Map Menu and Traffic is not available because the SiriusXM subscription is not valid, a pop-up will display with information on how to reactivate the subscription along with the SiriusXM radio ID.

Traffic Types

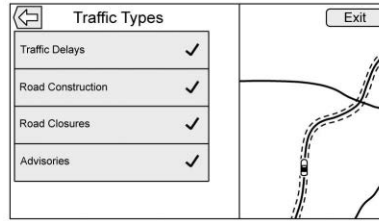

Touch to access the Traffic Types menu.

The system can be configured to filter out certain types of traffic events. If a particular type has been turned off, the system does not display it on the map, and does not alert the driver.

Routing Preferences

Touch the Routing Preferences list item to access the Routing Preferences menu. Options on how the routes are created for route guidance are listed on this menu.

Route Style

Touch this list item to change the route type preferences.

The options are:

- Fast (default)
- Eco Friendly (if equipped)
- Short
- Configure Eco Profile

The Configure Eco Profile can be used to configure two parameters for the Eco Friendly route. These parameters are roof load and trailer. For each parameter, the options are None, Small, Medium, and Large. Touch to scroll through the list. The default for both is None.

These preferences are used for all routes generated.

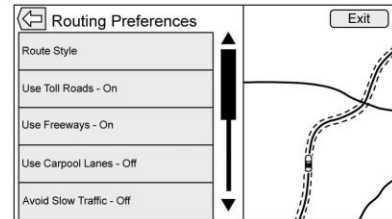

Route segment preferences are other options showing on the Routing Preferences menu.

This includes:

- Use Toll Roads On/Off
- Use Freeways On/Off
- Use Carpool Lanes On/Off
- Avoid Slow Traffic On/Off
- Use Tunnels On/Off
- Use Time Restricted Roads On/Off

Display Places of Interest Icons

Places of Interest (POI) icons can be displayed on the map using this view.

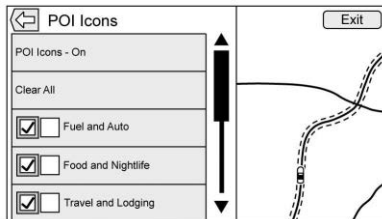

- The POI icons can be turned On and Off. Touch the check box next to the POI icon to display the icon.
- Touch Clear All to reset the icons that are displayed on the map.
- A subcategory can be selected instead of the entire category. Touch the list item itself rather than the check box. The subcategories will display. Select any of those categories to navigate down the hierarchy.
- When a higher-level category has some of its subcategories selected, the checkmark next to it is grayed out. This indicates that only some of the categories below are shown. Touch the grayed-out checkmark to turn all of the icons for that category on or off.

Personal Data

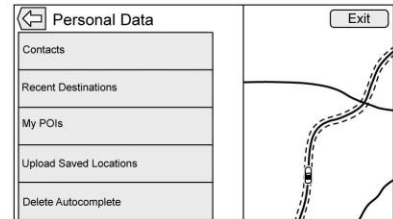

Data that the system has saved during the course of using the navigation system can be managed through:

- Contacts
- Recent Destinations
- My POIs (if equipped)
- Upload Saved Locations

Contacts

1. Touch Delete All Entries to delete the entire list of contacts. A pop-up displays to confirm.
2. Touch Edit Contacts List to display the Contacts to edit.

Recent Destinations

- Touch Delete Individual Destinations to display a recent destinations list. Select the individual entry to delete.
- Touch Delete All Destinations to delete the entire recent destination list. A pop-up displays asking to confirm the deletion.

My POIs

- Touch My POIs to display a menu of other options.
- Select Delete Individual Categories. A My POIs category list displays.
- Select the individual entry to delete.
- Touch Delete All My POIs to delete the entire list of categories. A pop-up displays asking to confirm the deletion.

Upload Saved Locations

Touch to upload any saved locations such as downloaded POIs and all entries in the vehicle address book to the USB device.

- Touch Upload Saved Locations to save the Vehicle Contacts list and any MyPOIs that have been saved to the vehicle.
- Once saved locations have been uploaded to a USB, they can be transferred to a different vehicle or restored to the current address book.

Map Adjustments

ZOOM -/+ can be used to adjust the scale of view on the map. When the end of the zoom level is reached, ZOOM -/+ will gray out.

The zoom scales can be configured for English or metric units. To change from English to metric, see “Instrument Cluster” in the owner’s manual.

Scroll Features

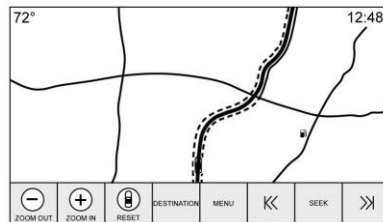

- To scroll within the map, touch anywhere on the map view.
- Nudge or slide a finger on the map; the map moves in the direction of the finger.
- Fling a finger on the map; the map will start scrolling in a short continuous scroll.
- Touch the location on the map; the map recenters to the location that was touched on.
- Touch a location twice on the map; the map zooms in one level to the location that was touched twice on.

- When the map is recentered away from being locked to the vehicle position, the crosshairs will show in the center of the map. As the map continues to be recentered, the crosshairs will remain on the screen. When the crosshairs are shown on the screen, a callout with more information displays. If the map is moved from the current location, the crosshairs will disappear along with the callout.
- Touch on the callout next to the crosshairs and the destination details view displays. From this view, route guidance can be received or saved to the vehicle's contact list.
- When the map is recentered, the straight-line distance from the vehicle to the selected point is displayed in the callout. In addition, a heading direction in the form of an arrow is displayed to indicate the direction. The arrow is shown in relation to the current vehicle heading.

- Touch on a POI icon shown on the map; the name of the POI is shown in the address callout, along with the city name and state. If the callout is selected, the destination details view for the POI is shown.
- After panning the map away from the vehicle, touch Reset to return the map back to the current position.
- Touch Overview to quickly get a view of the entire route. The route Overview takes the place of the Reset option while under route guidance. Touch Reset to return the map to the current position.

Maps

The map database is stored in the internal flash memory that is used in the navigation system.

Detailed Areas

Road network attributes are contained in the map database for detailed areas. Attributes include information such as street names, street addresses, and turn restrictions. A detailed area includes all major highways, service roads, and residential roads. The detailed areas include Places of Interest (POIs) such as restaurants, airports, banks, hospitals, police stations, gas stations, tourist attractions, and historical monuments. The map database may not include data for newly constructed areas or map database corrections that are completed after production. The navigation system provides full route guidance in the detailed map areas.

Navigation Symbols

Following are the most common symbols that appear on a map view.



or



The vehicle symbol indicates the current position and heading direction of the vehicle on the map. When under route guidance, a circle with an arrow is added to the vehicle symbol which indicates the direction to the destination.

Vehicle Address Callout

Tap on the vehicle icon to have the current address of the vehicle overlaid on the map next to the vehicle icon in a callout. Another tap hides the information.

Any address information about the vehicle's current location will be shown, including the street, city, and state/province names.

Tap on this callout to save the current address to the vehicle address book.

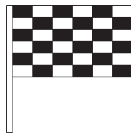

The destination symbol marks the final destination after a route has been planned.

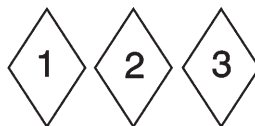

The waypoint symbol marks one or more set waypoints.

A waypoint is a stopover destination point added to the planned route.



The estimated time to the destination displays. Touch Arrival to toggle to duration and to the distance of the destination.



This symbol indicates the recommended maneuver that should be performed. Touch it to display the turn list or waypoint list.



The No GPS symbol appears when there is no Global Positioning System (GPS) satellite signal. When the GPS is gone, the vehicle position on the map may not be accurate.

Autozoom

As a maneuver is being approached, the map automatically zooms in to give greater detail.

If lane guidance is available for the maneuver, this is also shown.

When the system begins to autozoom, it zooms in to its minimum level. After the maneuver is performed, the system slowly zooms back out.

Destination

If route guidance is not active, touch the Nav icon on the Home Page to access the map view. Touch the Destination icon from the map view to enter a destination. Available methods of entering a destination are Voice Recognition, Address, Recent Destination, Contacts, and POIs. Several options can be selected to plan a route. Some destination items may be grayed out if no destination was previously entered or saved.

Another way to enter a destination is to touch the blue OnStar icon and ask an OnStar Advisor to download a destination into the embedded navigation system. See *OnStar System* ⇨ 81.

Touch the Destination icon on the infotainment display to go to the destination entry views.

Available Methods of Search

- Address (entries by hierarchy)
- Intersection
- Places of interest (POIs)

- Recent (destinations)
- Contacts

Touch the Destination icon on the infotainment display and the last used destination view is shown. This mode is retained. The initial default is Address.

Navigation Next Turn Maneuver Alert

The navigation system may need to get the attention of the driver in certain situations.

If not in the navigation application when a near maneuver prompt is given, it is shown as an alert. The alert contains the turn indicator and the option to display the main navigation view, or dismiss the alert.

The alert also contains the name of the street to turn on and a countdown bar.

Auto-Capitalization

The shift key is automatically enabled when a period is entered on the keyboard. Once the first

character is typed after the period, the next character will change to lower-case.

Alpha-Numeric Keyboard

The keyboard is used in multiple locations throughout the system and can be used with many features.

The navigation system uses the keyboard's alpha-numeric keyboard.

The keyboard can also be modified to include characters appropriate for the region configured in the vehicle settings.

✓ : Touch to search for the destination details of an address or place of interest entered in the text field. Once ✓ is touched, the activity indicator displays in the list of possible matches.

▽ : Touch to display a list of matches.

When there are multiple matches, a dropdown arrow is shown after the autocomplete text. This dropdown displays an entire list of matches. Touch the appropriate match without having to enter more text.

✕ : Touch to delete the last typed character. Touch and hold this icon to clear the entire text field. If the entire text field has been deleted, this icon becomes an Undo option. Touching Undo will restore the deleted text.

Exit : Touch to return to the previous Map view.

SYM : Touch to show the symbol keyboard.

Space : Touch to enter a space between characters or the words of a name.

⤴ : Touch to display the interaction selector.

🌐 : If equipped, touch to switch between Alpha-Numeric Keyboard and Character Recognition.

Special Characters

As the characters are typed on the keyboard, a pop-up of the letter touched displays above the key that was touched.

Continue to touch and hold, and any additional special characters associated with that letter are displayed around the current letter. To select one of the special characters, slide a finger left or right to adjust the highlight of the special character.

Special Character List

The following characters have special characters beneath them:

| | |
|-----------------------------|------------------|
| E - É Ê Ë Ì Í Î Ï | More Characters: |
| Y - Ÿ | 0 - ° |
| U - Ů Ú Û Ü Ů | ! - ¡ |
| I - Ī Ĳ Ĵ Ķ | \$ - ¥ £ ¢ |
| O - Ō Ŏ Ø œ Ö Õ Ö Ö | & - § |
| A - Ā Ă Ą Ą Ą Ą Ą | " - « » |
| S - Š (for lowercase s) Š Š | ? - ¿ |
| L - Ł | { - { |
| Z - Ź Ż | } - } |
| C - Ć Ć Ć | .com - .net .org |
| N - Ń Ń | |
| | |

Character Handwriting Recognition

Character handwriting recognition is offered as an alternative to using a keyboard. This character input method allows the drawing out of characters instead of picking them

out from the keyboard. Character handwriting recognition has two main modes, upper case and mixed case. The upper case mode is used for Destination Entry while mixed case is used for all other character entry modes. This feature is available by touching the globe icon from the keyboard display.

The Handwriting Recognition screen is split into different zones:

- **Drawing Pad:** This is the area to draw a character. Draw a character in the display area.

When the first character is complete, a representation of that character can be seen, and there is an audible response. If the character is correct, the next character can be started immediately.

- To delete the last entered character, draw a line from left to right across the character field.
- To create a space, draw a line from right to left across the character field.

- **Prioritized Guess List:** This area displays a list of guesses for the character drawn. If character recognition displays the incorrect character, look at this list and see if the desired character is available to select. Scroll up or down the list, then highlight the desired character. Selecting a character from the list will replace the incorrect character with the desired character. The character is displayed in the character entry section of the display.
- **Character Entry:** This is the area across the top of the display. This section can look different depending on which feature is being used.

Option Settings

This section is an area on the right side of the Character Recognition display. This section will only look different if the characters showing on the display are in upper case or mixed case.

- : Select from the infotainment display. The draw speed setting will adjust the speed of the character recognition feature. The settings are: Faster, Default, and Slower.
- **Audio Feedback:** Touch to turn Audio Feedback On or Off.
Audio feedback is an audible response to an action that has occurred while using the Character Recognition.
- **ABC/abc:** Select from the infotainment display to view the available character sets. Select a character set to change. Multiple character sets may not be supported by some regions. This option also displays the sentence case of upper or lower case characters that are currently active in a mixed case mode. If only one character set is available for the desired region, touching the character recognition will only open and close the character recognition window.

If mixed case character mode is supported, the last characters of character recognition will be upper and lower case.

One-Shot Search

Enter a full or partial Address, Contact, or POI into the search bar and the system will search and display all of the matches.

The contacts that are searched include both connected phone's contacts list and the vehicle's contacts list.

Search Process

The process of prioritizing the search is to help shorten the length of time at finding the results. If there is a 100% match found when a search type is carried out, the remaining searches abort.

The system conducts the search in the following order:

1. Vehicle Contacts List
2. Connected Phone Contacts List

3. POIs

4. Addresses

The Contacts are done first because the list will be relatively short and can be done quickly.

POIs are done next because the amount of time it takes to search for the average POI is consistent. The less deviation during a search would mean an average of less time taken.

The Addresses are last because the standard deviation for an address search is very large. Some address searches are very quick, but others may take very long. Because of this, the address search would not be conducted unless a good match could not be found in either Contacts or POIs.

Autocomplete

The autocomplete is preloaded with all recent destinations and POI category names. Previous POI name searches are remembered.

If only one type of result is found, the single type result screen is shown. Within each group, they are listed in confidence order. This means the highest confidence result will be at the top.

If multiple types of matches are found, the result list with the highest confidence match displays.

Address and Contact matches are shown in full width list format. The match results will display unique icons for full addresses, streets, intersections, cities, states/province, and countries.

POIs show in a split list format with the map on the right displaying the locations of the matches. The brand icon or category icon will display for the match results.

When a list displays, the results for a particular type can be filtered by touching the filters along the top of the screen. If there are no particular results for a selected type, a message is indicated in the list.

For example:

- For no addresses: “No Addresses Found Within <state/region>.”
- For no POIs: “No POIs Found Within <75 km/50 mi/ 800 km/ 500 mi>.” This distance is shown depending on what radius is completed and what current units are selected.
- For no contacts: “No Contacts Found.”

The system performs partial searches on contacts, so typing a first name or last name would find a match. The entire contact name does not need to be entered for it to be found in a search.

Touching a contact listed on the results list displays the standard contact details view to select an item, such as an address to start routing, or a phone number to place a call.

Address

- A destination can be searched by typing out the address, intersection, highway, or freeway entrance ramps on the keyboard. This information is typed and displayed in the information field. Touch the search icon to start the search.

For example:

City: Crawford

Street: Main Rd

House #: 12334

- State/province information does not have to be included in the search field if entering an address that is located in the same state/province.

- Whenever the keyboard view is entered, the last text that was typed, even if it was not searched on, will display.
- A partial or complete address can be typed in the search field. If a partial address is typed, the system attempts to use local knowledge to fill in additional information. For example, if no city name or state/province are given, the system assumes a search for something in the current city or a nearby city in the current state/province. The system is also capable of recognizing address formats according to other regions.

If a destination address or location being entered is outside of the country, the country abbreviation must be added after the address.

Spelling Mistakes

The system is able to offer alternatives if the searched term is not found exactly. The system uses the closest term it finds and provides those results.

The system first searches the entered term exactly. If no matches are found, partial words are used.

Search in Process

Touch Search and the results screen displays with the activity indicator. There is a non-selectable List item in the list that says "Searching" to indicate that it is in process.

Once the results are found, the correct list screen will display.

No Results Found

If no results are found from an entered search term, a pop-up displays indicating there are no results found. Touch OK to return to the keyboard view.

Results Display

If only a single match is found at the end of a search, the list is not shown but the Destination Details view is shown. Touch Back from the Destination Details view to go back to the results list screen. If it was a

POI search, Continue POI Search is available in case that was not the desired POI.

Places of Interest (POI)

While at the Home Page, touch the Nav icon to display a view of the map. Touch the Destination icon on the infotainment display to go to the destination entry views.

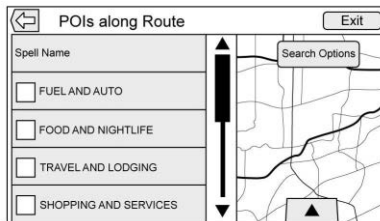

1. Touch the POIs option to display a list of POI categories.

The first list item in every POI list is a search function. For the highest level of categories, touch Spell Name or select a category and search within that selection.

2. Select a POI category to display subcategories.
3. If a selected subcategory has no results in the surrounding area, the search is expanded until a result is found.
4. If a high-level category is selected, such as restaurants, the map zooms in to the region near the vehicle's position to show the nearest matches. When a list displays, it can be filtered for a particular type by touching the filter along the top of the screen. If there are no particular results for a selected filter type, it is indicated in the list.
5. Pan or zoom the map using the finger gestures to minimize the POI list and to interact with the map. The icons that were shown before continue to be displayed and updated. The list is also updated based on where the map was panned or zoomed. The search for POIs is constrained to where the map has been moved to.

- If the search map is touched to re-center, the crosshairs are shown to indicate the center of the new search location. If a POI icon is touched on while in the full expanded map, a callout for that location displays. Touch the callout to display the destination details view.
- Touch the map reset option to return the map to automatic zooming and searching. It is recentered around the vehicle's position, the route, the destination, or another location that was specified for the search. The map Reset option is only displayed if the map was manually adjusted.

If multiple types of matches are found, the All list is shown with the results sorted by confidence order with the highest confidence result at the top.

Using the Keyboard

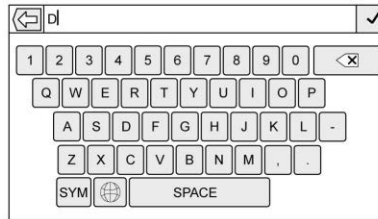

The POI can be searched by entering a POI name, category, name and category, or phone number on the keyboard.

For example, enter the information as:

POI Name: Worldwide Food

POI Category: Restaurants

POI Name and Category:
Worldwide Food Restaurants

POI Phone Number: 0001222555

Additionally, a location may be entered if the POI is not nearby. This search will then be made around the location that is given.

For example, enter the information as:

POI Name and Location:
Worldwide Food Chicago IL

The POI keyboard search results will display in the order in which they were found.

POI Search Location

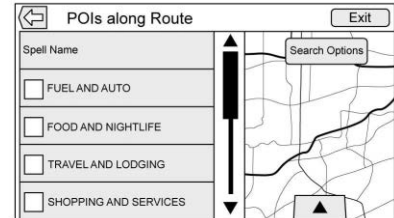

If browsing for POIs or searching for results on a keyboard in a different location than what was searched previously, touch Search Options on the map view to specify a different location.

Touch an option displayed on the Select Search Area menu.

- POIs Along Route

- POIs Nearby
- POIs Near Destination
- POIs at Another Location

Favorite POIs

Locations, categories, or a particular POI chain ID can be saved as Favorites in the POIs view.

Drag up the arrow to display the Favorites locations.

Touch and hold on a favorite location, then touch on the category to be saved. Whenever a set of POIs is grouped, such as in a category, the whole category is saved in the favorites for recall. Whenever a set of POIs that belong to the same chain ID is saved in the favorites, a POI chain saving pop up message displays asking to save only that location, or to save the entire chain. POIs are only grouped by chain when the sorting order is Alphabetical. Touch Sort to change the sorting order.

Recalling a POI Category or Chain

If a POI category or chain favorite is recalled, the system displays a list of matching results defaulting to nearby, but allows a search of other locations. Touch Search Options to specify a different location.

Creating and Downloading Predefined POIs (My POIs)

In addition to the POIs already stored in the Infotainment system, predefined POIs can be created.

While creating a predefined POI, the GPS coordinates for longitude and latitude of the POI's location and a descriptive name will need to be entered.

After creating the predefined POIs, they can be downloaded to the infotainment system from either a USB device.

Once downloaded, the POI data becomes a selectable destination in the My POIs menu.

Creating a Text File with Information

Create a text file by using a simple text editor software. Save this file with a name and extension of .csv, for example, "TomsPOI.csv."

Enter the POI information into the text file in the following format:

- Longitude coordinate, Latitude coordinate, "Name of POI," "Additional information," "Phone number."

Example: 7.0350000,
50.6318040, "Michaels Home,"
"123 Maple Lane,"
"02379234567."

- The GPS coordinates must be expressed in decimal degrees and can be taken from a geographical map. The additional information and phone number strings are optional.
- The POI name and the additional information string may not exceed 60 characters.

- POI information for each destination address must be entered in a single separate line.

Storing the POI on a USB Device

In the root directory of a USB device, create a folder name “myPOIs,” for example, “F:\” is the root directory of the USB device.

In the “myPOIs” folder, store the text file with your POIs, for example, “F:\myPOIs\TomsPOIs.csv.”

Downloading the POI to the Infotainment System

Connect the USB drive containing the POI information to the USB port of the infotainment system.

A message displays prompting whether or not to download the POI information from the USB stick. All POIs found are saved even if they are in multiple folders.

Subfolders can also be created to organize the POIs into categories, for example, “F:\myPOIs\Restaurants\TomsPOIs.csv.”

If the message is dismissed or ignored, no POI information is downloaded. This prompt will not reoccur for the current ignition cycle.

When the system is finished downloading, a pop-up displays asking to specify a category for the new POIs, if desired.

Importing and Overwriting Categories

When POIs are found on a media device, the date of the file is examined and compared to the date for the files already in the system. If the file being downloaded is newer than the one on the system, that particular category of POIs is overwritten. Any other POIs that had previously been saved in other categories are not affected.

Address Book Download

If an Address Book is found on the connected USB device, the same alert is used to indicate that locations have been found and they can be downloaded. If there is already content in the vehicle Address Book, the system prompts

if the stored content should be overwritten. Select Save to overwrite the existing Address Book information. Select Cancel to abort the import of information.

Browsing Downloaded POIs

Access the downloaded POIs by selecting the My POIs list item in the POIs list.

Editing My POIs

Downloaded POIs can be edited at a category level. These POIs can either be deleted as an entire category or be reassigned as another category. To edit the categories:

- Select Edit at the main category view to edit the POIs. Edit icons display next to each category name. There is no POI browsing in this mode. Only edit functions are available.
- Once an action such as deleting or reassigning has been selected, the changes are saved immediately.

72 Navigation

Changing POI Categories

POI categories can be assigned to a different category by using the same method as assigning a category for an Address Book entry. When editing, the right side of the displays the current category name.

Deleting POI Categories

POI categories can be deleted by selecting Edit and then Delete. A pop-up displays to confirm the deletion.

Saved Destinations

Select a saved destination from the Contacts or Recent Destinations.

Contacts

Select Contacts to view the vehicle's contact list or a connected Bluetooth device. If a particular contact has a single address associated with it, that contact has a Quick Route icon next to it. Contacts without this Quick Route icon either have multiple addresses or no address at all. Touch Quick Route to go to the Destination Details view.

Touch an address, either from the Quick Route on the contact list or a specific address from the contact detail list, to go to the destination view showing that address on the map.

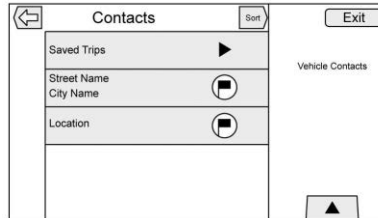

Trips from Contacts can be saved and recalled. The order is based on when the trip was last used. When the trips are saved, they are given a default title of the final destination name. If there are no saved trips, this list item is hidden.

Favorite Destinations

- Destinations can be saved as Favorites for recall later. Depending on the favorite, when

an address or POI favorite is recalled, the Destination Details view is shown.

- When a favorite address is being routed to, it is shown active. Touch on the active favorite, to suspend that route.
- Save locations as Favorites for recall later in the Destination Details view.
- Save trips from the Address Book.

Storing Favorites from the Contact Details List

A contact name or any of the contact's information such as phone number or address from Contact Details can be stored as a Favorite.

- Touch and hold on the favorite location while viewing a contact on the Contact Details List. The contact name and all contact information can be stored.
- Touch to save as a favorite. The favorite label will be the name of the contact.

- Touch on the Favorite to display the destination view.

Storing Favorites from Map

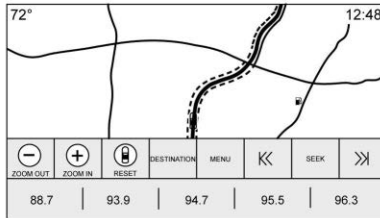

Favorite locations can be stored from the Map View.

If not under route guidance, the current vehicle location will be saved as a Favorite. If under route guidance, the final destination will be saved.

Touch and drag up on the row of interaction selector presets to reveal Favorites. Touch and hold on the favorite location from the map view to save it.

Route Guidance

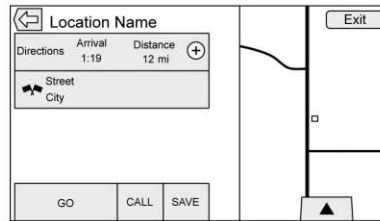

- Touch Go to go to the main navigation view and to start route guidance.
- If the system has an active route, a pop-up will display, "What would you like to do with this destination?" The options are: Add As Waypoint, Set New Destination, or Cancel.
- If a waypoint is added, it is placed in the location that leads to the most efficient route.
- There is a maximum number of waypoints that can be added to the system. When the maximum number of waypoints has been reached, a pop-up displays indicating that a waypoint must

first be deleted before a new one can be added. The system will hold this waypoint into a Pending Waypoints list and it will automatically be added to the route once a position is available, either by arriving at a waypoint, or by deleting one.

- To save a location, tap on the ▲ to display the Favorites. Touch and hold a favorite location to save the shown location as a Favorite.

Estimated Time of Arrival (ETA) and Distance

- When under route guidance, the system shows the ETA or travel time, or the driving distance.
- The ETA and travel time are calculated using any available traffic information.
- If in a waypoint trip, the ETA, travel time, and driving distance are all shown relative to the final destination.

74 Navigation

- The final ETA is shown taking into consideration any time zone crossings that the route has traveled through.
- Touch the ETA information area to switch between the estimated arrival time, total driving time resulting, and driving distance.

Current Street Name

The current street name that the vehicle is driving on is displayed along the bottom center of the display.

When driving off-road or on an unknown road, “Off Road Location” displays.

City Lane Guidance

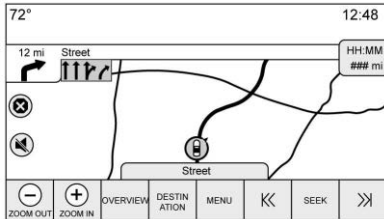

When a maneuver is approached that has city lane guidance information, it replaces the normal maneuver indicator.

The arrows will expand toward the center of the screen so that the maneuvers can be identified in an easier way.

Highway Lane Guidance

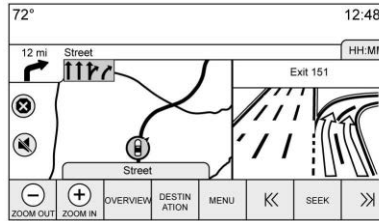

The junction view image displays on the right edge of the screen and temporarily covers the Distance information. The current vehicle position and street name is moved left and centered in the available map display when this is displayed.

Off-Road Mode

When the vehicle is off-road, the system displays the off-road arrow in the turn indicator and displays “Off Road Location” in the street name field.

Destination Arrival

The route review information displays in the turn indicator location and the destination address displays in the street name field.

Audio Information

The audio information remains in the same position in the lower right corner of the display.

The current street name information remains in the same location, but will truncate if needed.

Turn List

Touch on the next turn indicator shown on the map to display the turn list or waypoint list. The Interaction Selector is minimized automatically. Drag up to display the following options:

Destination

Touch Destination on the infotainment display to add a waypoint or change the destination while viewing the turn list. When Destination is touched, the display shows the Destination menus.

End Guidance

Touch End Guidance to suspend the current route in the turn list. When End Guidance is touched, the turn list is exited and the display returns to the main map view.

Avoid Areas

Touch Avoid Areas to select the highway name that is to be avoided. The system shows a pop-up asking how many miles or if the entire road should be avoided.

Turn List

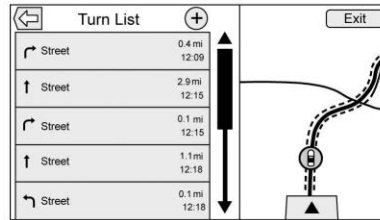

- When under a waypoint trip, touch Turn List on the infotainment display to show the turn list. When entering a turn list, the next maneuver instruction is spoken.
- The turn list title is the name or address of the destination. Touch on the information icon next to the name of the destination to display the destination information.
- The turn list is sorted in order with the next maneuver at the top of the list and the subsequent maneuvers listed below it. The next maneuver is

always highlighted upon entry into the Turn List to quickly show what the next maneuver is.

- Each maneuver indicates the distance between it and the previous maneuver or the vehicle's current location. The next maneuver at the top will count down until the maneuver is reached, and then the next maneuver will begin to count down.
- Each maneuver has an estimated time of arrival based on the current driving conditions.

Saved Trips

Waypoint trips can be saved for later recall. Touch Add in the waypoints list to save the trip to the Saved Trips list in the vehicle's contacts list. When trips are saved, they are given a default title of the final destination. Saved trips can be edited by selecting the Edit list option to access the edit screen for the saved entry. The only field that can be edited is the name field. Touch the name field to access the

76 Navigation

keyboard view. Type the name change. This change is automatically saved when executed by the keyboard.

The saved trip can also be deleted from the edit mode. Touch Delete and a delete confirmation pop-up will display.

Waypoints

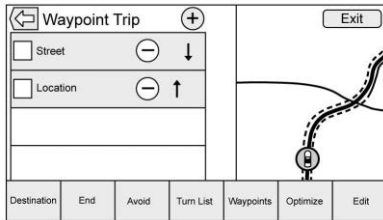

- When under a waypoint trip, touch the next turn indicator to bring up the waypoint list. The last waypoint view is shown, which could be Waypoints, Turn List, or Edit Route.
- The waypoint list is sorted in order with the next waypoint at the top of the list. Each waypoint

is indicated with a numbered icon, starting with the next waypoint.

- To indicate what segment of the route is for the next waypoint, and what is for the remainder of the route, they appear in different colors.

Optimized Route

- Touch Optimize to optimize the current waypoint trip.
- The optimization is done according to how the preferences are set for new routes, for example, fastest route, shortest distance, or eco friendly.
- While the system is optimizing the route, the waypoint trip has the Activity Indicator displayed over top of it. If the system is calculating the ETA and travel distance for a waypoint, the Activity Indicator is displayed in the list header.

- When either a waypoint trip is first created, or additional waypoints are added to an existing waypoint trip, they are added in the location that would lead to an optimized route.
- If a destination is already planned and a waypoint is added, it is either added before or after the current destination, whichever leads to the most optimal route.
- If under an existing waypoint trip consisting of two or more destinations, any additional waypoints are added in the location that would lead to the most optimal route.

Edit Route

- Touch Edit Route to modify the order or remove a waypoint from the route. Touch Delete to remove a waypoint from the route.
- A pop-up displays asking for confirmation of the waypoint deletion.

SiriusXM Travel Link Weather

If equipped, SiriusXM Travel Link Weather is available on the navigation system through a service fee subscription.

Touch the Weather icon on the Home Page. The system displays a weather page with a default view of the hourly forecast. The other available views are tabs on the bottom of the display.

These weather option displays are:

1. Hourly: The Hourly Forecast view shows the current day's forecast split into 3-hour increments.
2. 5-day: The 5-day view shows the current day's forecast as well as the next four days.
3. On Route: The On Route view shows the forecasted weather for the route. This feature is only available while under route guidance.

4. Location: The Location view is where the city can be selected to receive and display weather data.
5. Map: The Map view shows three levels of zoom on the left side of the map. These zoom views are Near, Mid, and Far. Touch any one to change the zoom level.
6. Menu

Allow approximately 15 minutes for the current weather in the area to display.

Weather Screen Not Under Guidance

The weather application uses the navigation system to provide the appropriate information for the guidance route. When not under guidance, it defaults to the current location.

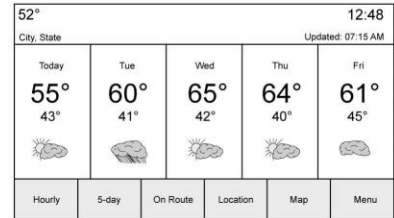

City and State/Province : The city and state/province are displayed for the view currently shown. The default is the current city and state/province that the vehicle is in.

Forecast Information

- The map can be panned to another location. The forecast information is updated to the new location.
- The city and state/province update to reflect the current location.

Location

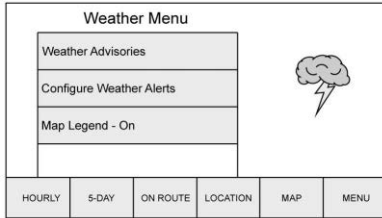

Under the Location view there are options to select for displaying the desired location.

These options are:

1. Search

Touch Search to access the keyboard. The city or zip code can be typed in. If there is a single match, the map view returns to the last known view before clicking on the location tab. If there are multiple matches, there is a list with the possible choices. Select one to return to the last known view.

2. Recent

Recent locations are a standard list. The Recent Locations are chronologically ordered.

3. Nearby

Nearby locations are a standard list. The Nearby Locations are based on how many miles away.

Map

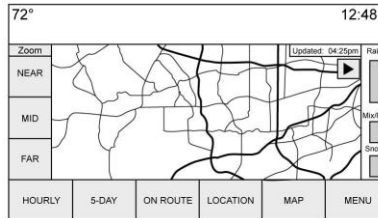

The Map view shows three levels of zoom on the left side of the map. There is also a play icon to start the weather map moving. For the moving map, the other interaction elements will fade away except for the time and a pause icon. Touch

anywhere on the display to return the view to pause. There is a Reset option in the lower left corner of the map. Touch Reset to go back to the current vehicle position.

Weather Menu

Touch the Menu icon on Weather along the bottom of the map view to display the Weather Menu.

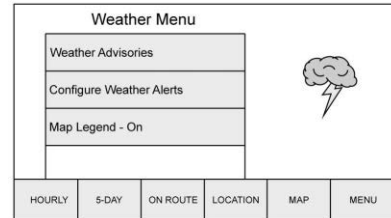

The options are:

- **Weather Advisories:** Any weather advisories that are in effect for the local area or while on route are displayed in a list. Touch on an advisory from the list to display a screen that gives additional details about the advisory and shows the advisory location on the map.

- **Configure Weather Alerts:** Touch to access the Weather Alerts menu. Touch the Weather Alerts line item to turn the alerts On or Off. Touch to select any one of the other line items such as High Alert, Low Alert, Informational Alert to filter the selected alerts for display, while the others will be suppressed.
- **Map Legend:** Touch to display the Map Legend.

Interaction Selector

The interaction selector near the bottom of the display can be used to switch between different views within the weather display.

These options are:

- **ZOOM:** Touch to zoom the map in or out.
- **HOURLY:** Touch to display the hourly forecast for the current vehicle location. A forecast icon is shown for each period available.

- **5 DAY:** Touch to display the current weather, six-hour forecast, and tomorrow's weather. A forecast icon is shown for each period available.
- **LOCATION:** Touch to select a city to receive and display weather data.
- **MAP:** Touch to display a map view of the current weather around the area of the vehicle's position.
- **MENU:** Touch to display the current advisories, turn weather alerts on or off, and view the map legend.

The map legend explains each type of color or symbol on the map.

SiriusXM NavTraffic

If equipped, the infotainment system may have SiriusXM NavTraffic. It is a subscription service provided through SiriusXM Satellite Radio. A service fee is required to receive the SiriusXM NavTraffic service.

Detailed traffic information is delivered to the vehicle's navigation system by the SiriusXM Radio satellites. SiriusXM NavTraffic provides continuously updated traffic information.

The service may be available in more cities in the future. See www.siriusxm.com/navtraffic/marketcoverage for more details on local coverage.

To access the traffic features, touch Traffic on the Map Menu.

If traffic is not available because there is no valid SiriusXM subscription, a pop-up displays information on how to reactivate the subscription and SiriusXM radio ID.

Traffic Alert While Under Guidance

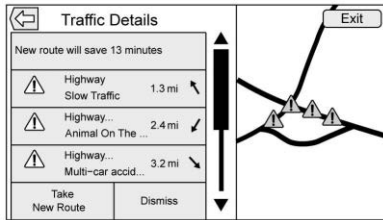

If data is received about a traffic development on the route ahead, a search for a better route is performed. If a better route is found, information may be displayed in an alert. This alert displays the route information and how much time may be saved. If the alternative route is accepted, the current route will be altered.

If the alert is not acknowledged, the alert automatically times out and does not modify the route.

The detail view of the incident shows any data about the incident as well as how much time could be saved by avoiding it. The map view shows the incident, the original

route, and the suggested route. If voice prompts are enabled, the incident information is spoken. Touch the Take New Route option to change to the new route.

Traffic Alert While Not Under Guidance

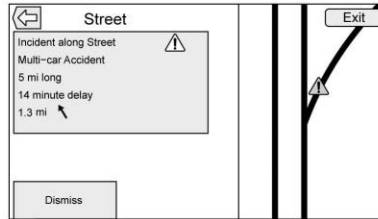

While driving and not under guidance, the system can receive data indicating an accident or slow traffic flow. The information about the incident or slow traffic is displayed as an alert when the incident is 5 km (3 mi) ahead. The incident can be viewed on the map. Touch the Dismiss option to return to the previous map.

SiriusXM Travel Link Movie Listings

A movie theater POI can be searched through a POI search or browsed through the POI category structure. When SiriusXM Travel Link Movie Listings information is available for the selected theater, this detailed information is shown in the additional details area of the display.

The details that are shown depend on the source of the information.

Details shown include:

- Movie Names
- Parental Ratings (G, PG-13, R, etc.)
- Showtimes
- Runtime

SiriusXM Travel Link Fuel Pricing

When SiriusXM Travel Link Fuel Pricing information is available for a particular fuel station, the price

displays for the regular unleaded or diesel fuel, depending on the fuel type configured in the system.

This fuel station POI can either be searched for through a POI search or browsed through the POI category structure.

- Touch Sort to change the sort method. The default sort method is based on distance with the closest fuel stations shown at the top of the list.
- Touch Sort to cycle through the sorting options of distance, price, or name. The last viewed sorting method is displayed and is retained over ignition cycles.

If the sorting method of price has been selected, the fuel stations in the list will appear from the lowest to the highest price based on the fuel type selected. For gasoline, the price shown is for regular unleaded. When diesel is selected as the fuel type, the diesel price is shown.

OnStar System

With an OnStar subscription to the Guidance Plan, an OnStar Advisor can download a destination to the vehicle or into the built-in navigation system. If an OnStar Turn-by-Turn route is in progress, all other internal navigation functions are disabled until the route is completed.

When navigation is selected, the OnStar Turn-by-Turn screens display.

Turn-by-Turn Navigation

Touch MENU on the infotainment display to go to the Turn-by-Turn Menu.

The following options display:

- Plan Route (if the vehicle is off the route)
- Cancel

Plan Route

Select My Destination to display a special version of the Maneuver View. The Destination Address is displayed in the Street Name and

the total distance to the destination is displayed in the Distance to Maneuver View. Touch Done to return to the Maneuver View.

Cancel a Route

If a route is in progress using either the vehicle navigation system or the OnStar Turn-by-Turn route, and a new route is requested, the current route in progress will be canceled.

An OnStar Advisor can cancel the vehicle navigation system route. Route guidance can be resumed by selecting Resume To in the Map Menu.

Settings

Touch the Settings icon on the Home Page to adjust features and preferences, such as Time and Date, Sport Mode, Language, Valet Mode, or Radio. For setting options, see *Settings* ⇨ 102.

A few of the setting options change the way the navigation system displays or reacts while in use.

82 Navigation

1. Touch the Settings icon on the Home Page.
2. Touch the scroll bar until the desired option displays. Select the desired settings to change.

Voice

Voice recognition allows for hands-free operation within the navigation, audio, phone, and weather applications. See *Voice Recognition* ⇨ 85.

Touch the voice icon to display the Voice menu.

Prompt Length : Touch to change the prompt length to Short or Long.

Audio Feedback Speed : Touch to change the audio feedback speed to Slow, Medium, or Fast.

Display

Mode : Touch Mode to change the display background. This setting controls map colors.

- The Auto setting adjusts the display background automatically depending on the exterior lighting conditions.

- The Day setting brightens the map background.
- The Night setting darkens the map background.

Calibrate Touchscreen : Touch to display the infotainment display calibration screen.

Turn Display Off : Touch to turn the Display option off.

Low Fuel Alert

If the vehicle reaches a low fuel level, the system displays an alert about the low fuel condition. Touch the More Info option to view nearby gas stations, and start guidance if desired.

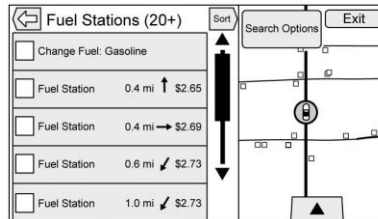

If the remaining driving distance is available from the system, this is included in the alert.

Global Positioning System (GPS)

The position of the vehicle is determined by using satellite signals, various vehicle signals, and map data.

At times, other interference such as the satellite condition, road configuration, condition of the vehicle, and/or other circumstances can affect the navigation system's ability to determine the accurate position of the vehicle.

The GPS shows the current position of the vehicle using signals sent by GPS satellites. When the vehicle is not receiving signals from the satellites, a symbol appears on the map screen. See *Navigation Symbols* ⇨ 62.

This system might not be available or interference can occur if any of the following are true:

- Signals are obstructed by tall buildings, trees, large trucks, or a tunnel.
- Satellites are being repaired or improved.

For more information if the GPS is not functioning properly, see *Problems with Route Guidance* ⇨ 83 and *If the System Needs Service* ⇨ 84.

Vehicle Positioning

At times, the position of the vehicle on the map could be inaccurate due to one or more of the following reasons:

- The road system has changed.
- The vehicle is driving on slippery road surfaces such as sand, gravel, or snow.
- The vehicle is traveling on winding roads or long straight roads.

- The vehicle is approaching a tall building or a large vehicle.
- The surface streets run parallel to a freeway.
- The vehicle has been transferred by a vehicle carrier or a ferry.
- The current position calibration is set incorrectly.
- The vehicle is traveling at high speed.
- The vehicle changes directions more than once, or the vehicle is turning on a turn table in a parking lot.
- The vehicle is entering and/or exiting a parking lot, garage, or a lot with a roof.
- The GPS signal is not received.
- A roof carrier is installed on the vehicle.
- Tire chains have been installed.
- The tires are replaced or worn.
- The tire pressure for the tires is incorrect.

- This is the first navigation use after the map data is updated.
- The 12-volt battery is disconnected for several days.
- The vehicle is driving in heavy traffic where driving is at low speeds, and the vehicle is stopped and started repeatedly.

Problems with Route Guidance

Inappropriate route guidance can occur under one or more of the following conditions:

- The turn was not made on the road indicated.
- Route guidance might not be available when using automatic rerouting for the next right or left turn.
- The route might not be changed when using automatic rerouting.
- There is no route guidance when turning at an intersection.
- Plural names of places might be announced occasionally.

- It could take a long time to operate automatic rerouting during high-speed driving.
- Automatic rerouting might display a route returning to the set waypoint if heading for a destination without passing through a set waypoint.
- The route prohibits the entry of a vehicle due to a regulation by time or season or any other regulation which may be given.
- Some routes might not be searched.
- The route to the destination might not be shown if there are new roads, if roads have recently changed, or if certain roads are not listed in the map data. See *Maps* ⇨ 61.

To recalibrate the vehicle's position on the map, park with the vehicle running for two to five minutes, until the vehicle position updates. Make sure the vehicle is parked in a

location that is safe and has a clear view of the sky and away from large obstructions.

If the System Needs Service

If the navigation system needs service and the steps listed here have been followed but there are still problems, see *Problems with Route Guidance* ⇨ 83.

Map Data Updates

The map data in the vehicle is the most up-to-date information available when the vehicle was produced. The map data is updated periodically, provided that the map information has changed.

For questions about the operation of the navigation system or the update process, contact the GM Nav Disc Center toll-free phone number, 1-877-NAV-DISC (1-877-628-3472) or go to the center's website,



www.gmnavdisc.com. If updates are needed, call the GM Nav Disc Center or order online.

To order, have the vehicle's Vehicle Identification Number (VIN) available ensure the correct and most up-to-date map data for the vehicle is sent. See "Vehicle Identification Number (VIN)" in the owner's manual.

Database Coverage Explanations

Coverage areas vary with respect to the level of map detail available for any given area. Some areas feature greater levels of detail than others. If this happens, it does not mean there is a problem with the system. As the map data is updated, more detail can become available for areas that previously had limited detail. See *Map Data Updates* ⇨ 84.

Voice Recognition

Voice recognition allows for hands-free operation within the navigation, audio, phone, and weather applications. This feature can be started by pressing either  on the steering wheel or touching  on the infotainment display.

However, not all features within these areas are supported by voice commands. Generally, only complex tasks that require multiple manual interactions to complete are supported by voice commands.

For example, tasks that take more than one or two control presses such as selecting a song or artist to play from a media device would be supported by voice commands. Other tasks, like adjusting the volume or seeking up or down are audio features that are easily performed by pressing one or two controls, and are not supported by voice commands.



In general there are flexible ways to speak commands for completing the tasks. Most of them, except destination entry and voice keypad, can be completed in a single command. If the task takes more than one command to complete, the first command should be to indicate the kind of task to be performed, like “Navigation Destination Entry.” The system replies with prompts that lead you through a dialog to enter the necessary information. For example, if a destination for route guidance is needed, say “Navigation” or “Destination Entry.”

If your language supports it, try stating a One-Shot command, such as “Navigate to Address <number, street, city, state/province>.” This type of destination entry command is supported in some languages. Another example of a One-Shot Destination Entry command is, “Navigate to Place of Interest – Hotels.” If these commands don’t work, try saying, “Navigate to Place of Interest” or “Navigate to Address” and the system will do the rest.

Voice recognition can be used when the ignition is on or when Retained Accessory Power (RAP) is active. See “Retained Accessory Power (RAP)” in the owner’s manual.

Using Voice Recognition

Voice recognition becomes available once the system has been initialized. This begins when the ignition is turned on. Initialization may take a few moments.

1. Press  on the steering wheel controls to activate voice recognition, or touch  on the infotainment display.
2. The audio system mutes and the system plays a prompt followed by a beep.
3. Wait until after the beep completes, then clearly speak one of the commands described in this section.

Press  to interrupt any voice recognition system prompt. For example, if the prompt seems

to be taking too long to finish, press  again and the beep should happen right away.

There are two voice prompt modes supported:

- Long verbal prompts: The longer prompts provide more information regarding the supported actions.
- Short prompts: The short prompts provide simple instructions about what can be stated.

If a command is not spoken, the voice recognition system says a help prompt.

Prompts and Screen Displays

While a voice recognition session is active, there will be corresponding options on screens displayed. Manual interaction in the voice recognition session is permitted. Interaction during a voice session may be completed entirely using voice commands, or some selections may expedite a session. If a selection is made using a

manual control, the dialog will progress in the same way as if the selection was made through a voice command. Once the system is able to complete the task, or the session is terminated, the voice recognition dialog stops.

An example of this type of manual intervention is touching on an entry of a displayed number list instead of speaking the number associated with the entry desired.

Canceling Voice Recognition

- Touch the voice icon. Touching this icon will terminate a voice recognition session which was initiated by touching the icon on the infotainment display.
- Touch or say “Cancel” or “Exit” to terminate the voice recognition session and show the display from which voice recognition was initiated.

- Press  on the steering wheel controls to terminate the voice session and show the display from which voice recognition was initiated.

Helpful Hints for Speaking Commands

Voice recognition can understand commands that are either naturally stated in sentence form, or direct commands that state the application and the task.

Most languages do not support natural language commands in sentence form. For those languages, use direct commands like the examples shown on the display.

For best results:

- Listen for the prompt and wait for the beep before saying a command or reply.
- Say “Help” or look at the screen display for example commands.

- A voice recognition system prompt can be interrupted while it is playing by pressing \mathbb{L} .

For example, if the prompt seems to be taking too long to finish, to speak the command without waiting for the prompt to complete, press \mathbb{L} .

- Speak the command naturally, not too fast, not too slow. Use direct commands without a lot of extra words.
- Usually Phone and Audio commands can be spoken in a single command.

For example say, "Call <name> at work," "Play" followed by the artist or song name, or "Tune" followed by the radio station number.

- Navigation destinations are too complex for a single command. First, say a command that explains the type of destination needed, such as I want directions to an "Address," "Navigate to an Intersection," "I

need to find a Place of Interest or POI," or "Directions to a Contact." The system responds by requesting more details. After saying "Place of Interest," only major chains are available by name. Chains are businesses with at least 20 locations. For other POIs, say the name of a category like "Restaurants," "Shopping Malls," or "Hospitals."

Most languages do not support natural language commands in sentence form. For those languages, use direct commands like the examples shown on the display.

There is no need to memorize specific command words. Direct commands might be more clearly understood by the system. An example of a direct command would be "Call <number>." Examples of these direct commands are displayed on most of the screens while a voice session is active. If "Phone" or "Phone Commands," is stated, the system understands that

a phone call is requested and will respond with questions until enough details are gathered.



If the phone number has been saved with a name and a place, the direct command should include both, for example "Call <name> at work."

Using Voice Recognition for List Options

When a list is displayed, a voice prompt will ask to confirm or select an option from that list. A selection can be made by manually selecting the item, or by speaking the line number for the item to select.



When a screen contains a list, there may be options that are available but not displayed. The list on a voice recognition screen functions the same as a list on other screens. Scrolling or flinging can be used to help display other entries from the list.

Manually scrolling or paging the list on a screen during a voice recognition session suspends the current voice recognition event and

plays the prompt “Make your selection from the list using the manual controls or press  BACK or  BACK to try again.”

If manual selection takes more than 15 seconds, the session terminates and prompts that it has timed out. The display returns back to where voice recognition was initiated.

The Back Command

Say “Back” or press  BACK or  BACK to go to the previous menu.

If in voice recognition, and “Back” is stated all the way through to the initial display, then “Back” is stated one more time, the voice recognition session will cancel.

Help

Say “Help” on any voice recognition display and the help prompt for the display is played. Additionally, a pop-up displays a text version of the help prompt. Depending on how voice recognition was initiated, the Help pop-up will either display on

the instrument cluster or the infotainment display. Touch Dismiss to make the pop-up go away.

Pressing  while the help prompt is playing will terminate the prompt and a beep will be heard. Doing this will stop the help prompt so that a voice command can be used.

Voice Recognition for the Radio

Some audio displays have a voice recognition icon () to launch audio voice recognition. If the voice icon is touched in a radio display, the voice commands for radio and media features are available.

“Switch to AM” : Switch bands to AM and tune to the last AM radio station.

“Switch to FM” : Switch bands to FM and tune to the last FM radio station.

“Switch to SXM” : Switch bands to SiriusXM and tune to the last SXM channel.

“Tune to <AM frequency> AM” : Tune to the radio station whose frequency is identified in the command (like “nine fifty”).

“Tune to <FM frequency> FM” : Tune to the radio station whose frequency is identified in the command (like “one o one point one”).

If equipped, “Tune to <AM frequency> AM HD” : Tune to the HD Radio station whose frequency is identified in the command.

If equipped, “Tune to <FM frequency> FM HD” : Tune to the HD Radio station whose frequency is identified in the command.

If equipped, “Tune to <FM frequency> FM HD <HD channel number>” : Tune to the HD Radio station whose frequency and HD channel is identified in the command.

“Tune to SXM <SXM channel number>” : Tune to the SiriusXM radio station whose channel number is identified in the command.

“Tune to SXM <SXM channel name>” : Tune to the SiriusXM radio station whose channel name is identified in the command.

Voice Recognition for Audio My Media

If browsing My Media when the voice icon is selected, the voice recognition commands for My Media features are available.

“Play Artist” : Begin a dialog to enter a specific artist name.

“Play Artist <artist name>” : Begin playback of the media selection identified in the command.

“Play Album” : Begin a dialog to enter a specific album name.

“Play Album <album name>” : Begin playback of the identified album name in the command.

“Play Song” : Begin a dialog to enter a specific song name.

“Play Song <song name>” : Begin playback of the identified song name in the command.

“Play Genre” : Begin a dialog to enter a specific genre.

“Play Genre <genre name>” : Begin playback of the media selection identified in the command.

“Play Playlist” : Begin a dialog to enter a specific playlist name.

“Play Playlist <playlist name>” : Begin playback of the identified playlist in the command.

“Play <device name>” : Play music from a specific device identified by name. The device name is the name shown on the display when the device is first selected as an audio source.

“Play Chapter” : Begin a dialog to enter a specific name.

“Play Chapter <chapter name>” : Begin playback of the media selection identified in the command.

“Play Audiobook” : Begin a dialog to enter a specific name.

“Play Audiobook <audiobook name>” : Begin playback of the media selection identified in the command.

“Play CD Track <track number>” : Begin playback of the CD at the track identified in the command.

“Play Episode” : Begin a dialog to enter a specific name.

“Play Episode <episode name>” : Begin playback of the media selection identified in the command.

“Play Podcast” : Begin a dialog to enter a specific name.

“Play Podcast <podcast name>” : Begin playback of the media selection identified in the command.

“Play Video” : Begin a dialog to enter a specific name.

“Play Video <video name>” : Begin playback of the media selection identified in the command.

“My Media” : Begin a dialog to enter the desired media content.

Handling Large Amounts of Media Content

It is expected that large amounts of media content will be brought into the vehicle. It may be necessary to handle large amounts of media content in a different way than smaller amounts of media. The system may limit the options of voice recognition by not allowing selection of song titles by voice at the highest level if the number of songs exceeds the maximum limit.

Voice command option changes through media content limits are:

- Song files including other individual files of all media types such as audiobook chapters, podcast episodes, and videos.
- Album type folders including types such as albums and audiobooks.

There are no restrictions if the number of song files and albums is less than 4,000. When the number of song files connected to the system is between 4,000 and 8,000,

the content cannot be accessed directly with one command like "Play <song name>."

The restriction is that the command "Play Song" must be spoken first; the system will then ask for the song name. The reply command would be to say the name of the song to play.

Similar limits exist for album content. If there are more than 4,000 albums, but less than 8,000, the content cannot be accessed directly with one command like, "Play <album name>." The command "Play Album" must first be spoken; the system will then ask for the album name. The reply would be to say the name of the album to play.

Once the number of songs has exceeded approximately 8,000, there is no support for accessing the songs directly through voice commands. There will still be access to the media content by using commands for playlists, artists, and genres.

The access commands for playlists, artists, and genres are prohibited after the number of this type of media exceeds 4,000.

The system will provide feedback the first time voice recognition is initiated if it has become apparent that any of these limits are reached during a device initializing process.

Voice Recognition for Navigation

"Navigation" : Begin a dialog to enter specific destination information.

"Navigation Commands" : Begin a dialog to enter specific destination information.

"Destination Address" : Begin a dialog to enter a specific destination address, which includes the entire address consisting of the house number, street name, and city and state/province.

"Destination Intersection" : Begin a dialog to enter a specific destination intersection.

“Destination Place of Interest” : Begin a dialog to enter a destination Place of Interest category or major brand name (if equipped).

Not all brand names of businesses are available for voice entry. Most major chains, such as chains with more than 20 locations, should be available to search for by name, but the name must be precisely spoken. Nicknames or short names for the businesses will not likely be found. Lesser known businesses might have to be located by category, such as fast food, hotels, or banks.

“Destination Contact” : Begin a dialog to enter a specific destination contact name.

“Cancel Route” : End route guidance.

Voice Recognition for the Phone

“Call <contact name>” : Initiate a call to an entered contact. The command may include location if the contact has location numbers stored.

“Call <contact name> At Home,” “At Work,” “On Mobile,” or “On Other” : Initiate a call to an entered contact and location at home, at work, on mobile device, or on another phone.

“Call <phone number>” : Initiate a call to a standard phone number or emergency number.

If the call is being initiated outside of North America, state “Call <phone number>,” then after the system reads back the number, repeat the “Call” command to initiate the call. If the number is not correct, “Delete” will delete the number and allow it to be entered again. If the number is not complete, speak the remaining digits.

“Pair Phone” : Begin the Bluetooth pairing process. Follow instructions on the radio display.

“Switch Phone” : Select a different phone for outgoing calls.

“Voice Keypad” : Begins a dialog to enter special numbers like international numbers. The numbers can be entered in groups of digits with each group of digits being repeated back by the system. If the group of digits is not correct, the command “Delete” will remove the last group of digits and allow them to be re-entered. Once the entire number has been entered, the command “Call” will start dialing the number.

“Voice Mail” : Initiate a call to voice mail numbers.

Voice Pass-Thru

Voice pass-thru allows access to the voice recognition commands on the cell phone, for example, Siri or Voice Command. See the cell phone manufacturer’s user guide to see if the cell phone supports this feature. To activate the phone voice recognition system, press and hold  on the steering wheel for a few seconds.

92 Voice Recognition

Voice Recognition for OnStar (If Equipped)

“**OnStar**” : Begin Onstar Voice Recognition.

Voice Recognition for Weather (If Equipped)

“**Weather**” : Begin a dialog to enter a weather location.

Phone

Bluetooth (Overview)

The Bluetooth-capable system can interact with many cell phones, allowing:

- Placement and receipt of calls in a hands-free mode.
- Sharing of the cell phone's address book or contact list with the vehicle.

To minimize driver distraction, before driving, and with the vehicle parked:

- Become familiar with the features of the cell phone. Organize the phone book and contact lists clearly and delete duplicate or rarely used entries. If possible, program speed dial or other shortcuts.
- Review the controls and operation of the infotainment system.

- Pair cell phone(s) to the vehicle. The system may not work with all cell phones. See "Pairing" in this section.

Vehicles with a Bluetooth system can use a Bluetooth-capable cell phone with a Hands-Free Profile to make and receive phone calls. The infotainment system and voice recognition are used to control the system. The system can be used while the ignition is on or in ACC/ACCESSORY. The range of the Bluetooth system can be up to 9.1 m (30 ft). Not all phones support all functions and not all phones work with the Bluetooth system. See www.gm.com/bluetooth for more information about compatible phones.

Bluetooth Controls

Use the features on the infotainment system and the steering wheel to operate the Bluetooth system.

Steering Wheel Controls

 : Press to answer incoming calls, confirm system information, and start voice recognition.

 : Press to end a call, decline a call, or cancel an operation. Press to mute or unmute the infotainment system when not on a call.

Infotainment System Controls

For information about how to navigate the menu system using the infotainment controls, see *Using the System* ⇨ 15.

Phone : Touch the Phone icon on the Home Page to enter the phone main menu.

Audio System

When using the Bluetooth system, sound comes through the vehicle's front audio system speakers and overrides the audio system. Turn the volume knob during a call to change the volume level. The adjusted volume level remains in memory for later calls. The system maintains a minimum volume level.

Bluetooth (Infotainment Controls)

For information about how to navigate the menu system using the infotainment controls, see *Using the System* ⇨ 15.

Pairing

A Bluetooth-enabled cell phone must be paired to the Bluetooth system and then connected to the vehicle before it can be used. See the cell phone manufacturer's user guide for Bluetooth functions before pairing the cell phone. If a Bluetooth phone is not connected, calls can be made using OnStar Hands-Free Calling (if equipped). See "OnStar" in the owner's manual.

Pairing Information

- A Bluetooth phone with music capability can be paired to the vehicle as a phone and a music player at the same time.
- Up to 10 devices can be paired to the Bluetooth system.

- The pairing process is disabled when the vehicle is moving.
- Pairing only needs to be completed once, unless the pairing information on the cell phone changes or the cell phone is deleted from the system.
- One Bluetooth device can be connected to the Bluetooth system at a time.
- If multiple paired cell phones are within range of the system, the system connects to the paired cell phone in the order that they were last used in the system. To link to a different paired phone, see "Linking to a Different Phone" later in this section.

Pairing a Phone

1. Touch the Phone icon on the Home Page.
2. Touch Phone and select Pair Device.

3. A four-digit Personal Identification Number (PIN) appears on the display. The PIN, if required, may be used in Step 5.
4. Start the pairing process on the cell phone to be paired to the vehicle. See the cell phone manufacturer's user guide for information on this process.
5. Locate "Chevrolet MyLink" on the display. Follow the instructions on the cell phone to enter the PIN provided in Step 3 or confirm the six-digit code shown on the display. After the PIN is successfully entered or the code is confirmed, the system responds with "<Device name> has been successfully paired" when the pairing process is complete.
6. If "Chevrolet MyLink" does not appear, turn the phone off or remove the phone battery and retry.

- If the phone prompts to accept connection or allow phone book download, select always accept and allow. The phone book may not be available if not accepted.
- Repeat Steps 1–7 to pair additional phones.

Listing All Paired and Connected Phones

- Touch the Phone icon on the Home Page.
- Touch Phones.

Disconnecting a Connected Phone

- Touch the Phone icon on the Home Page.
- Touch Phones.
- Touch **X** next to the phone to disconnect.

Deleting a Paired Phone

Only disconnected phones can be deleted.

- Touch the Phone icon on the Home Page.

- Touch Phones.
- Touch the **⊖** next to the phone to delete and follow the on screen prompts.

Linking to a Different Phone

To link to a different phone, the new phone must be in the vehicle and paired to the Bluetooth system.

- Touch the Phone icon on the Home Page.
- Touch Phones.
- Touch the new phone to link to from the not connected device list.

Switching to Handset or Handsfree Mode

To switch between handset or handsfree mode, touch the Phone icon on the Home Page to display Call View.

- While the active call is hands-free, touch the Handset option to switch to the handset mode. The option changes to

Handsfree once the Bluetooth device confirms it is operating as handset.

- While the active call is handset, touch the Handsfree option to switch to the hands free mode. The option changes to Handset once the Bluetooth device confirms it is operating as handsfree.

Making a Call Using Contacts and Recent Calls

Calls can be made through the Bluetooth system using personal cell phone contact information for all phones that support the Phone Book feature. Become familiar with the phone settings and operation. Verify the cell phone supports this feature.

When supported, the Contacts and Recent Calls menus are automatically available.

The Contacts menu accesses the phone book stored in the cell phone.

The Recent Calls menu accesses the recent call list(s) from your cell phone.

To make a call using the Contacts menu:

1. Touch the Phone icon on the Home Page.
2. Touch Contacts.
3. Touch the name to call.
4. Touch the desired contact number to call.

To make a call using the Recent Calls menu:

1. Touch the Phone icon on the Home Page.
2. Touch Recent.
3. Touch the name or number to call.
4. If necessary, select between Missed, Recent, and Sent calls by touching View in the top right corner of the list.

Making a Call Using the Keypad

To make a call by dialing the numbers:

1. Touch the Phone icon on the Home Page.
2. Touch Keypad and enter a phone number.
3. Touch Call to start dialing the number.

Accepting or Declining a Call

When an incoming call is received, the infotainment system mutes and a ring tone is heard in the vehicle.

Accepting a Call

There are a few ways to accept a call:

- Press  on the steering wheel controls.
- Touch Answer on the infotainment display.

Declining a Call

There are a few ways to decline a call:

- Press  on the steering wheel controls.
- Touch Ignore on the infotainment display.

Call Waiting

Call waiting must be supported on the Bluetooth phone and enabled by the wireless service carrier to work.

Accepting a Call

There are two ways to accept a call:

- Press  on the steering wheel controls.
- Touch Answer on the infotainment display.

Declining a Call

There are two ways to decline a call:

- Press  on the steering wheel controls.

- Touch Ignore on the infotainment display.

Switching Between Calls (Call Waiting Calls Only)

To switch between calls, touch the Phone icon on the Home Page to display Call View. While in Call View, touch the call information of the call on hold to change calls.

Three-Way Calling

Three-way calling must be supported on the Bluetooth phone and enabled by the wireless service carrier to work.

To start a three-way call while in a current call:

1. In the Call View, touch Add to add another call.
2. Initiate the second call by selecting from Recent, Contacts, or Keypad.
3. When the second call is active, touch Merge to conference the three-way call together.

4. Once all calls are merged, the Merge option becomes an Unmerge option. Touch to unmerge the calls. Some wireless service carriers may not allow a merged call to become unmerged.

Ending a Call

- Press  on the steering wheel controls.
- Touch End on the infotainment display to end all existing calls, or touch End next to a call to end only that call.

Some wireless service carriers may not allow a merged call to become unmerged.

Dual Tone Multi-Frequency (DTMF) Tones

The in-vehicle Bluetooth system can send numbers during a call. This is used when calling a menu-driven phone system.

1. Touch the Phone icon on the Home Page.

2. While in the Call View, drag  up to raise the interaction selector.
3. Touch Keypad and enter the number.

Voice Mail

The default voice mail number is the phone number of the currently connected phone. The voice mail number can be changed in Bluetooth settings.

To dial a voice mail number:

1. Touch the Phone icon on the Home Page.
2. Touch Voice Mail.
3. Touch Call.
4. Enter the DTMF tones using the keypad if needed.

Bluetooth (Voice Recognition)

Using Bluetooth Voice Recognition

To use voice recognition, press \mathbb{V} on the steering wheel controls. Use the commands below for the various voice features. For additional information, say “Help” while in a voice recognition menu. See *Voice Recognition* ⇨ 85 for help using voice recognition commands.

Making a Call

Calls can be made using the following commands.

Using the “Dial” or “Call” Command

To call a number:

1. Press \mathbb{V} . The system responds “Command Please,” followed by a tone.
2. Say “Dial” or “Call” followed by the complete phone number.

Use the “Voice Keypad” command for international numbers or special numbers which include * or #.

Once connected, the person called will be heard through the audio speakers.

To call using a contact from your phone book:

1. Press \mathbb{V} . The system responds “Command Please,” followed by a tone.
2. Say “Dial” or “Call” and then say the contact name. For example “Call <name> at Work.”

Once connected, the person called will be heard through the audio speakers.

Calling Local Emergency Numbers

1. Press \mathbb{V} . The system responds “Command Please,” followed by a tone.
2. Say “Call <emergency number>.”

Once connected, the person called will be heard through the audio speakers.

Using the “Switch Phone” Command

1. Press \mathbb{V} . The system responds “Command Please,” followed by a tone.
2. After the tone, say “Switch Phone.” The system displays a list of phones to select.

Using the “Voice Keypad” Command

1. Press \mathbb{V} . The system responds “Command Please,” followed by a tone.
2. After the tone, say “Voice Keypad.” The system allows entry of special numbers and characters.

Using the “Voice Mail” Command

1. Press \mathbb{V} . The system responds “Command Please,” followed by a tone.

- After the tone, say "Voice Mail."
The system dials the voice mail number of the connected phone.

Clearing the System

Unless information is deleted out of the vehicle Bluetooth system, it will be retained. This includes phone pairing information. For directions on how to delete this information, see "Deleting a Paired Phone."

Text Messaging



If equipped, the infotainment system may allow text messages to be received and replied to. Received messages can also be read aloud.

Before using the text messaging feature, check to see if the phone is compatible.

To view compatible phones in USA, see www.my.chevrolet.com.

Text Menu

Inbox : Touch to display incoming messages. To view a message, touch on the name of the sender.

Touch  to listen to the text message. Press  BACK or  BACK on the center stack or touch the Back icon on the infotainment display to go back to the previous menu.

Settings : See "Text Settings" later in this section.

Reply : Touch to reply using a predefined text message. See "Text Settings" later in this section.

Call : Touch to place a call to the sender of the text message.

Viewing a Text Message

While viewing a text message:

- Touch Reply to reply using a predefined text message.
- Touch Call to place a call to the sender of the text message.

Viewing Sender Information

If equipped, touch the name of the sender to view sender information if this information matches contact information already stored.

Select a Predefined Message :



Touch to select from a set of quick messages. Touch the message to send.

Predefined Messages

These are short text messages that can be used to send so responses will not have to be typed.

The messages can be deleted or a new message can be added.

To add a new message:

- Touch Text Settings, then touch Manage Predefined Messages.
- While in the predefined messages list view, select Add New Predefined Message and a keyboard displays.
- Type a new message and touch NEW MSG when done to add the message.
Press  BACK or  BACK on the center stack or touch the Back icon on the infotainment display to go back to the

predefined messages list.
Touch **X** to delete one character at a time.

Memory Full

This message may display if there is no more room on the phone to store messages.

Text Settings

Text Alerts : When on, this feature will display an alert when a new text message has been received. Touch to turn on or off.

Manage Predefined Messages :

Touch to add, change, or delete predefined messages.

Apple CarPlay and Android Auto

If equipped, Android Auto and/or Apple CarPlay capability may be available through a compatible smartphone. If available, PROJECTION will appear on the Home Page of the infotainment display.

To use Android Auto and/or Apple CarPlay:

1. Download the Android Auto app to your phone from the Google Play store. No app is required for Apple CarPlay.
2. Connect an Android phone or iPhone by using the compatible phone USB cable and plugging into a USB data port. For best performance it is highly recommended to use the device's factory-provided USB cable. Aftermarket or third-party cables may not work.
3. When the phone is first connected to activate Apple CarPlay or Android Auto, the message "Device Projection Privacy Consent" will appear.
 - Touch Continue to launch Apple CarPlay or Android Auto.

- Touch Disable to remove Apple CarPlay and Android Auto capability from the vehicle Settings menu. Other functions may still work.

PROJECTION on the Home Page will change to Android Auto or Apple CarPlay depending on the phone. Android Auto and/or Apple CarPlay may automatically launch upon USB connection. If not, touch the ANDROID AUTO and/or APPLE CARPLAY icon on the Home Page to launch.

Press Home on the center stack to return to the Home Page.

For further information on how to set up Android Auto and Apple CarPlay in the vehicle see www.my.chevrolet.com or "Customer Assistance" in the owner's manual.



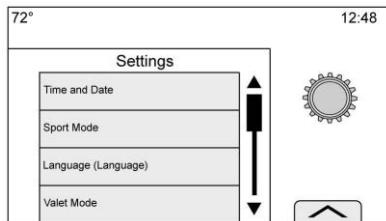

Android Auto is provided by Google and is subject to Google's terms and privacy policy. Apple CarPlay is provided by Apple and is subject to Apple's terms and privacy policy. Data plan rates apply. For Android Auto support see <https://support.google.com/androidauto>. For Apple CarPlay support see www.apple.com/ios/carplay/. Apple or Google may change or suspend availability at any time. Android Auto, Android, Google, Google Play, and other marks are trademarks of Google Inc.; Apple CarPlay is a trademark of Apple Inc.

Settings



The Settings menu allows adjustment of different vehicle and radio features. The menu may contain the following:

Time and Date

Touch  or  to increase or decrease hours, minutes, and AM or PM. Press 12Hr or 24Hr for 12 or 24 hour clock. Touch  or  to increase or decrease month, day, or year. See “Clock” in the owner’s manual.

Language

This will set the display language in the radio, instrument panel, and voice recognition. Press Language and select the appropriate language. Touch the Back icon on the infotainment display to go back to the previous menu.

Valet Mode

If equipped, this will lock the infotainment system and steering wheel controls. It may also limit top speed, power, and access to vehicle storage locations (if equipped).

To enable valet mode:

1. Enter a four-digit code on the keypad.
2. Touch Enter to go to the confirmation screen.
3. Re-enter the four-digit code.

Touch Lock or Unlock to lock or unlock the system. Touch the Back icon on the infotainment display to go back to the previous menu.

Radio

Touch to display the Radio menu and the following may display:

- **Manage Favorites:** Touch to highlight a favorite to edit. Touch Rename to rename the favorite or Delete to delete it. Touch and hold the station to drag it to a new location. Touch Done to go back to the previous menu.
- **Number of Favorites Shown:** Touch to set the number of favorites to display. Select Auto, 5, 10, 15, 20, 25, 30, 35, 40, 45, 50, 55, or 60. Auto will adjust the number of favorite locations that can be seen. Touch the Back icon on the infotainment display to go back to the previous menu.
- **Auto Volume (If Equipped):** This feature adjusts the volume based on the vehicle speed. See *AM-FM Radio* ⇨ 19.
- **Bose AudioPilot Noise Compensation Technology (If Equipped):** This feature adjusts

the volume based on the noise in the vehicle and speed. See *AM-FM Radio* ⇨ 19.

- **Maximum Startup Volume:** This feature sets the maximum startup volume. If the vehicle is started and the volume is greater than this level, the volume is adjusted to this level. To set the maximum startup volume, touch + or – to increase or decrease. Touch the Back icon on the infotainment display to go back to the previous menu.
- **Audio Cue Volume (If Equipped):** This feature adjusts the startup and shutdown sounds. To adjust the volume, touch + or – to increase or decrease. This feature can be turned on or off. Touch the Back icon on the infotainment display to go back to the previous menu.

Vehicle Settings

See “Vehicle Personalization” in the owner’s manual.

Bluetooth

From Bluetooth on the infotainment display, the following may appear:

- **Pair New Device:** Touch to add a new device.
- **Device Management:** Touch to connect to a different phone source, disconnect a phone, or delete a phone.
- **Ringtones:** Touch to change the ring tone for the specific phone. The phone does not need to be connected to change the ring tone.
- **Voice Mail Numbers:** This feature displays the voice mail number for all connected phones. The voice mail number may be changed by touching Edit, typing in the new number, and touching Save. Touch the Back icon on the infotainment display to go back to the previous menu.
- **Text Message Alerts:** This feature will turn text message alerts on or off. Touch Text

Message Alerts and then select Off or On. Touch the Back icon on the infotainment display to go back to the previous menu. See *Text Messaging* ⇨ 99.

Voice

From Voice on the infotainment display, the following may appear:

- **Confidence Threshold:** Select Confirm More for a system response to a command. Select Confirm Less for the system to proceed with the command without responding.
- **Prompt Length:** Select Short for brief, direct feedback or Long for more information feedback. Touch the Back icon on the infotainment display to go to the previous menu.
- **Audio Feedback Speed:** Touch Slow, Medium, or Fast for feedback speed. Touch the Back icon on the infotainment display to go back to the previous menu.

Display

From Display on the infotainment display, the following may appear:

- **Mode:** Touch Auto, Day, or Night to adjust the display. Touch the Back icon on the infotainment display to go to the previous menu.
- **Calibrate Touchscreen:** Touch to calibrate the infotainment display and follow the prompts. Touch the Back icon on the infotainment display to go back to the previous menu.
- **Turn Display Off:** Touch to turn the display off. Touch anywhere on the display area or any center stack control again to turn the display on.

Rear Camera

Touch to display the Rear Camera menu. See “Driver Assistance Systems” in the owner’s manual.

Return to Factory Settings

Touching Continue restores all factory settings.

Select Return to Factory Settings and the following list may display:

- **Restore Vehicle Settings:** Restores factory vehicle personalization settings. Touch Restore Vehicle Settings. Touch Cancel or Continue. If continue is touched, a confirmation pop-up will appear indicating the vehicle settings have been restored.
- **Clear All Private Data:** If available, use to erase personal private data before loaning or selling the vehicle. Touch Clear All Private Data. Touch Cancel or Continue. If Continue is touched, a confirmation pop-up will appear indicating all private data has been cleared from the system.
- **Restore Radio Settings:** Restores factory radio settings. Touch Restore Radio Settings. Touch Cancel or Continue. If Continue is touched, a confirmation pop-up will appear indicating the radio settings have been restored.

Press \triangleleft BACK or \leftarrow BACK on the center stack or touch the Back icon on the infotainment display to go back to the main settings menu.

Over-the-Air Software Updates

If equipped, the infotainment system can download and install select software updates over a wireless connection. The system will prompt for certain updates to be downloaded and installed. There is also an option to check for updates manually.

To manually check for updates, touch SETTINGS on the Home Page, followed by Software Information, and then System Update. Follow the on-screen prompts. The steps to check for, download and install updates may vary by vehicle.

Downloading Over-the-Air vehicle software updates requires Internet connectivity, which can be accessed through the vehicle’s built-in OnStar 4G LTE connection, if equipped and active. If required, data plans are provided by a third party. Optionally,

a secure Wi-Fi hotspot such as a compatible mobile device hotspot, home hotspot or public hotspot can be used. Applicable data rates may apply.

To connect the infotainment system to a secured mobile device hotspot, home hotspot, or a public hotspot, touch SETTINGS on the Home Page, followed by Wi-Fi, and then Manage Wi-Fi Networks. Select the appropriate Wi-Fi network, and follow the on-screen prompts. Download speeds may vary.

On most compatible mobile devices, activation of the Wi-Fi hotspot is in the Settings menu under Mobile Network Sharing, Personal Hotspot, Mobile Hotspot or similar.

Availability of Over-the-Air software updates varies by vehicle and country. For more information on this feature, see www.my.chevrolet.com/learn.

English and Metric Unit Conversion

To change the display units between English and metric units, see “Instrument Cluster” in the owner’s manual.

Teen Driver

If equipped, this allows multiple keys to be registered for beginner drivers to encourage safe driving habits. When the vehicle is started with a Teen Driver key, it will automatically activate certain safety systems, allow setting of some features, and limit the use of others. The Report Card will record vehicle data about driving behavior that can be viewed later. When the vehicle is started with a registered key, the Driver Information Center (DIC) displays a message that Teen Driver is active.

To access:

1. Touch Settings on the Home Page, then touch Teen Driver.

2. Create a Personal Identification Number (PIN) by choosing a four-digit PIN. Re-enter the PIN to confirm. To change the PIN, touch Change PIN.

The PIN is required to:

- Register or unregister keys.
- Change Teen Driver settings.
- Change or clear the Teen Driver PIN.
- Access or delete Report Card data.

Register keys to activate:

Any vehicle key can be registered, up to a maximum of eight keys. Label the key to tell it apart from the other keys.

For a pushbutton start system:

1. Start the engine.
2. For automatic transmissions, the vehicle must be in P (Park). For manual transmissions, the vehicle must be stopped with the parking brake set.

3. From the Settings menu, touch Teen Driver.
4. Enter the PIN.
5. Place the Remote Keyless Entry (RKE) transmitter key in the transmitter pocket. See “Remote Keyless Entry (RKE) System Operation” in the owner’s manual for transmitter pocket location.
6. From the Teen Driver Menu, touch Key Registration.
 - If the transmitter key is in the transmitter pocket, it will identify whether the transmitter key is registered or unregistered.
 - If the transmitter key is not registered, the option to register displays. Touch Register and a confirmation message displays.
 - If the transmitter key is already registered, the option to unregister displays. If Unregister is touched, the transmitter key

is no longer registered and a confirmation message displays.

In vehicles with a pushbutton start system, if a Teen Driver transmitter key and a non-Teen Driver transmitter key are both present at start up, the vehicle will recognize the non-Teen Driver transmitter key to start the vehicle. The Teen Driver settings will not be active.

For a keyed ignition system:

1. Start the engine.
2. For automatic transmissions, the vehicle must be in P (Park). For manual transmissions, the vehicle must be stopped with the parking brake set.
3. From the Settings menu, touch Teen Driver.
4. Enter the PIN.
5. Touch Key Registration. The system displays instructions for registering or unregistering a key. A confirmation message displays.

Manage Settings

Use the PIN to change the following settings:

Audio Volume Limit : Allows a maximum radio volume to be set. Turn the audio volume limit On or Off, and if equipped, choose the maximum level for the audio volume.

Teen Driver Speed Warning :

Allows for setting a visual and audible warning when a certain speed is exceeded. The speed warning is selectable from 64 km/h (40 mph) to 121 km/h (75 mph). The speed warning does not limit the speed of the vehicle.

Teen Driver Speed Limiter (If Equipped) :

Allows the maximum speed of the vehicle to be limited to 137 km/h (85 mph). When the speed limiter is turned On and the vehicle is started with a Teen Driver key, the DIC displays a message that the top speed is limited to 137 km/h (85 mph).

When Teen Driver is Active:

- The radio will mute when the driver seat belt is not fastened, and in some vehicles, when the right front passenger seat belt is not fastened. The audio from any device paired to the vehicle will also be muted.
- Certain electronic devices placed on the front passenger seat could cause the passenger sensing system to falsely sense an unbuckled front passenger and mute the radio. See "Passenger Sensing System" in the owner's manual.
- Some safety systems, such as Forward Automatic Braking, if equipped and supported, cannot be turned off.
- The gap setting for the Forward Collision Alert and Adaptive Cruise Control, if equipped, cannot be changed.
- Super Cruise, if equipped, is not available.

- Enhanced Low Fuel Warning (if equipped) – When the vehicle is low on fuel, the low fuel light on the instrument cluster flashes and the DIC low fuel warning cannot be dismissed.

Report Card

The vehicle owner must secure the driver's consent to record certain vehicle data when the vehicle is driven with a registered Teen Driver key. There is one Report Card per vehicle. Data is not recorded when Teen Driver is not active.

The Report Card data is collected from the time Teen Driver is activated or the last time the Report Card was reset. The following items may be recorded:

- Distance Driven – the total distance driven.
- Maximum Speed – the maximum vehicle speed recorded.
- Overspeed Warnings – the number of times the speed warning setting was exceeded.
- Forward Collision Alerts – the number of times the driver was notified when approaching a vehicle ahead too quickly and at potential risk for a crash.
- Forward Collision Avoidance Braking (if equipped) – Also referred to as Forward Automatic Braking, this is the number of times the vehicle detected that a forward collision was imminent and applied the brakes.
- Stability Control – the number of events which required the use of electronic stability control.
- ABS Active – Also referred to as Antilock Brake System Active, the number of Antilock Brake System activations.
- Tailgating Alerts – the number of times the driver was alerted for following the vehicle ahead too closely.
- Traction Control – the number of times the traction control system activated to reduce wheel spin or loss of traction.

- Wide Open Throttle – the number of times the accelerator pedal is pressed nearly all the way down.

Delete Report Card Data

Data is saved for all trips until the data is deleted using the PIN or until the maximum count is exceeded.

Each item will report a maximum of 1,000 counts. The distance driven will report a maximum of 64,374 km (40,000 mi).

To delete Report Card data, do one of the following:

- From the Report Card display, touch Reset.
- Touch Clear All Teen Keys/PIN from the Teen Driver menu. This will also unregister any Teen Driver keys and delete the PIN.

Forgotten PIN

See your dealer to reset the PIN.

Trademarks and License Agreements

FCC Information

See "Radio Frequency Statement" in the owner's manual.



"Made for iPod," and "Made for iPhone," mean that an electronic accessory has been designed to connect specifically to iPod or iPhone, respectively, and has been certified by the developer to meet Apple performance standards. Apple is not responsible for the operation of this device or its compliance with safety and regulatory standards. Please note that the use of this accessory with iPod or iPhone may affect wireless performance. iPhone, iPod, iPod classic, iPod nano, iPod shuffle, and

iPod touch are trademarks of Apple Inc., registered in the U.S. and other countries.



Fees and Taxes: Subscription fee, taxes, one time activation fee, and other fees may apply. Subscription fee is consumer only. All fees and programming subject to change. Subscriptions subject to Customer Agreement available at www.siriusxm.com. SiriusXM service only available in the 48 contiguous United States and Canada.

In Canada: Some deterioration of service may occur in extreme northern latitudes. This is beyond the control of SiriusXM Satellite Radio.

Explicit Language Notice: Channels with frequent explicit language are indicated with an "XL" preceding the channel name. Channel blocking is available for SiriusXM Satellite Radio receivers by notifying SiriusXM:

- USA Customers — See www.siriusxm.com or call 1-888-601-6296.
- Canada Customers — See www.siriusxm.ca or call 1-877-438-9677.

It is prohibited to copy, decompile, disassemble, reverse engineer, hack, manipulate, or otherwise make available any technology or software incorporated in receivers compatible with the SiriusXM Satellite Radio System or that support the SiriusXM website, the Online Service or any of its content. Furthermore, the AMBER voice compression software included in this product is protected by intellectual property rights including patent rights, copyrights, and trade secrets of Digital Voice Systems, Inc.

General Requirements:

1. A License Agreement from SiriusXM is required for any product that incorporates SiriusXM Technology and/or for use of any of the SiriusXM marks to be manufactured, distributed, or marketed in the SiriusXM Service Area.
2. For products to be distributed, marketed, and/or sold in Canada, a separate agreement is required with Canadian Satellite Radio Inc. (operating as SiriusXM Canada).

Bose

Bose, AudioPilot, Centerpoint, and Bose Surround are registered trademarks of Bose Corporation in the U.S. and other countries.

HD Radio Technology



If equipped, HD Radio Technology manufactured under license from iBiquity Digital Corporation. U.S. and Foreign patents. HD Radio and the HD, HD Radio, and "Arc" logos are proprietary trademarks of iBiquity Digital Corp.

DTS

Manufactured under license under U.S. Patent Nos: 5,956,674; 5,974,380; 6,487,535 & other U.S. and worldwide patents issued & pending.

For DTS patents, see <http://patents.dts.com>. Manufactured under license from DTS Licensing Limited. DTS, the Symbol, & DTS, and the Symbol together are

registered trademarks, and DTS 2.0 Channel is a trademark of DTS, Inc. ©DTS, Inc. All Rights Reserved.

Dolby

Manufactured under license from Dolby Laboratories. Dolby and the double-D symbol are trademarks of Dolby Laboratories.

BDA

Blu-ray Disc, Blu-ray, Blu-ray 3D, BD-Live, BONUSVIEW, BDXL, AVCREC, and the logos are trademarks of the Blu-ray Disc Association.

AVCHD

AVCHD and the AVCHD logo are trademarks of Panasonic Corporation and Sony Corporation.

AVCREC

Blu-ray Disc, Blu-ray, Blu-ray 3D, BD-Live, BONUSVIEW, BDXL, AVCREC, and the logos are trademarks of the Blu-ray Disc Association.

Java

Java is a registered trademark of Oracle and/or its affiliates.

Cinavia

Cinavia Notice: This product uses Cinavia technology to limit the use of unauthorized copies of some commercially-produced film and videos and their soundtracks. When a prohibited use of an unauthorized copy is detected, a message will be displayed or copying will be interrupted.

More information about Cinavia technology is provided at the Cinavia Online Consumer Information Center at <http://www.cinavia.com>. To request additional information about Cinavia by mail, send a postcard with your mailing address to: Cinavia Consumer Information Center, P.O. Box 86851, San Diego, CA, 92138, USA.

This product incorporates proprietary technology under license from Verance Corporation and is protected by U.S. Patent

7,369,677 and other U.S. and worldwide patents issued and pending as well as copyright and trade secret protection for certain aspects of such technology. Cinavia is a trademark of Verance Corporation. Copyright 2004-2015 Verance Corporation. All rights reserved by Verance. Reverse engineering or disassembly is prohibited.

RMVB



Portions of this software are included under license from RealNetworks, Inc. Copyright 1995-2015, RealNetworks, Inc. All rights reserved

Bluetooth

The Bluetooth word mark and logos are owned by the Bluetooth SIG, Inc. and any use of such marks by

General Motors is under license. Other trademarks and trade names are those of their respective owners.

Schedule I: Gracenote EULA



Music recognition technology and related data are provided by Gracenote. Gracenote is the industry standard in music recognition technology and related content delivery. For more information visit www.gracenote.com.

Music-related data from Gracenote, Inc., copyright © 2000 to present Gracenote. Gracenote Software, copyright © 2000 to present Gracenote. One or more patents owned by Gracenote may apply to this product and service. See the Gracenote website for a non-exhaustive list of applicable

Gracenote patents. Gracenote, CDDB, MusicID, MediaVOCS, the Gracenote logo and logotype, and the "Powered by Gracenote" logo are either registered trademarks or trademarks of Gracenote in the United States and/or other countries.

Gracenote Terms of Use

This application or device contains software from Gracenote, Inc. of Emeryville, California ("Gracenote"). The software from Gracenote (the "Gracenote Software") enables this application to do disc or file identification and obtain music-related information, including name, artist, track, and title information ("Gracenote Data") from online servers or embedded databases (collectively, "Gracenote Servers") and to perform other functions. You may use Gracenote Data only by means of the intended End-User functions of this application or device.

This application or device may contain content belonging to Gracenote's providers. If so, all of

the restrictions set forth herein with respect to Gracenote Data shall also apply to such content and such content providers shall be entitled to all of the benefits and protections set forth herein that are available to Gracenote.

You agree that you will use Gracenote Data, the Gracenote Software, and Gracenote Servers for your own personal non-commercial use only. You agree not to assign, copy, transfer or transmit the Gracenote Software or any Gracenote Data to any third party. **YOU AGREE NOT TO USE OR EXPLOIT GRACENOTE DATA, THE GRACENOTE SOFTWARE, OR GRACENOTE SERVERS, EXCEPT AS EXPRESSLY PERMITTED HEREIN.**

You agree that your non-exclusive license to use the Gracenote Data, the Gracenote Software, and Gracenote Servers will terminate if you violate these restrictions. If your license terminates, you agree to cease any and all use of the Gracenote Data, the Gracenote

Software, and Gracenote Servers. Gracenote reserves all rights in Gracenote Data, the Gracenote Software, and the Gracenote Servers, including all ownership rights. Under no circumstances will Gracenote become liable for any payment to you for any information that you provide. You agree that Gracenote may enforce its rights under this Agreement against you directly in its own name.

The Gracenote service uses a unique identifier to track queries for statistical purposes. The purpose of a randomly assigned numeric identifier is to allow the Gracenote service to count queries without knowing anything about who you are. For more information, see the web page for the Gracenote Privacy Policy for the Gracenote service.

The Gracenote Software and each item of Gracenote Data are licensed to you "AS IS." Gracenote makes no representations or warranties, express or implied, regarding the accuracy of any Gracenote Data. Gracenote reserves the right to

delete data from the Gracenote Servers or to change data categories for any cause that Gracenote deems sufficient. No warranty is made that the Gracenote Software or Gracenote Servers are error-free or that functioning of Gracenote Software or Gracenote Servers will be uninterrupted. Gracenote is not obligated to provide you with new enhanced or additional data types or categories that Gracenote may provide in the future and is free to discontinue its services at any time.

GRACENOTE DISCLAIMS ALL WARRANTIES EXPRESS OR IMPLIED, INCLUDING, BUT NOT LIMITED TO, IMPLIED WARRANTIES OF MERCHANTABILITY, FITNESS FOR A PARTICULAR PURPOSE, TITLE, AND NON-INFRINGEMENT. GRACENOTE DOES NOT WARRANT THE RESULTS THAT WILL BE OBTAINED BY YOUR USE OF THE GRACENOTE SOFTWARE OR ANY GRACENOTE SERVER. IN NO CASE WILL GRACENOTE BE

LIABLE FOR ANY CONSEQUENTIAL OR INCIDENTAL DAMAGES OR FOR ANY LOST PROFITS OR LOST REVENUES.

© 2015. Gracenote, Inc. All Rights Reserved.

MPEG4-AVC (H.264)

THIS PRODUCT IS LICENSED UNDER THE AVC PATENT PORTFOLIO LICENSE FOR THE PERSONAL AND NON-COMMERCIAL USE OF A CONSUMER TO (i) ENCODE VIDEO IN COMPLIANCE WITH THE AVC STANDARD (“AVC VIDEO”) AND/OR (ii) DECODE AVC VIDEO THAT WAS ENCODED BY A CONSUMER ENGAGED IN A PERSONAL AND NON-COMMERCIAL ACTIVITY AND/OR WAS OBTAINED FROM A VIDEO PROVIDER LICENSED TO PROVIDE AVC VIDEO. NO LICENSE IS GRANTED OR SHALL BE IMPLIED FOR ANY OTHER USE. ADDITIONAL

INFORMATION MAY BE OBTAINED FROM MPEG LA, LLC. SEE [HTTP://WWW.MPEGLA.COM](http://www.mpegla.com).

VC-1

THIS PRODUCT IS LICENSED UNDER THE VC-1 PATENT PORTFOLIO LICENSE FOR THE PERSONAL AND NON-COMMERCIAL USE OF A CONSUMER TO (i) ENCODE VIDEO IN COMPLIANCE WITH THE VC-1 STANDARD (“VC-1 VIDEO”) AND/OR (ii) DECODE VC-1 VIDEO THAT WAS ENCODED BY A CONSUMER ENGAGED IN A PERSONAL AND NON-COMMERCIAL ACTIVITY AND/OR WAS OBTAINED FROM A VIDEO PROVIDER LICENSED TO PROVIDE VC-1 VIDEO. NO LICENSE IS GRANTED OR SHALL BE IMPLIED FOR ANY OTHER USE. ADDITIONAL INFORMATION MAY BE OBTAINED FROM MPEG LA, LLC. SEE [HTTP://WWW.MPEGLA.COM](http://www.mpegla.com).

MPEG4–Visual

USE OF THIS PRODUCT IN ANY MANNER THAT COMPLIES WITH THE MPEG-4 VISUAL STANDARD IS PROHIBITED, EXCEPT FOR USE BY A CONSUMER ENGAGING IN PERSONAL AND NON-COMMERCIAL ACTIVITIES.

MP3

MPEG Layer-3 audio coding technology licensed from Fraunhofer IIS and Thomson.

WMA

This product is protected by certain intellectual property rights of Microsoft. Use or distribution of such technology outside of this product is prohibited without a license from Microsoft.

For more information on the Software, including any open source software license terms (and available source code) as well as copyright attributions applicable to the Runtime Configuration indicated above, please contact the Manufacturer or contact QSSC at

175 Terence Matthews Crescent,
Kanata, Ontario, Canada K2M 1W8
(licensing@qnx.com).

Map End User License Agreement

END USER TERMS

The Map Data Disc (“Data”) is provided for your personal, internal use only and not for resale. It is protected by copyright, and is subject to the following terms (this “End User License Agreement”) and conditions which are agreed to by you, on the one hand, and HERE North America, LLC (“HERE”) and its licensors (including their licensors and suppliers) on the other hand.

The Data for areas of Canada includes information taken with permission from Canadian authorities, including: © Her Majesty the Queen in Right of Canada, © Queen's Printer for Ontario, © Canada Post Corporation, GeoBase.

HERE holds a nonexclusive license from the United States Postal Service to publish and sell ZIP +4 information.

© United States Postal Service 2015. Prices are not established, controlled, or approved by the United States Postal Service. The following trademarks and registrations are owned by the USPS: United States Postal Service, USPS, and ZIP+4.

TERMS AND CONDITIONS

Personal Use Only: You agree to use this Data for the solely personal, noncommercial purposes for which you were licensed, and not for service bureau, timesharing or other similar purposes. Except as otherwise set forth herein, you agree not to otherwise reproduce, copy, modify, decompile, disassemble or reverse engineer any portion of this Data, and may not transfer or distribute it in any form, for any purpose, except to the extent permitted by mandatory laws. You may transfer the Data and all accompanying materials on a

permanent basis if you retain no copies and the recipient agrees to the terms of this End User License Agreement. Multi-disc sets may only be transferred or sold as a complete set as provided to you and not as a subset thereof.

Restrictions

Except where you have been specifically licensed to do so by HERE and without limiting the preceding paragraph, you may not (a) use this Data with any products, systems, or applications installed or otherwise connected to or in communication with vehicles capable of vehicle navigation, positioning, dispatch, real time route guidance, fleet management or similar applications; or (b) with, or in communication with, including without limitation, cellular phones, palmtop and handheld computers, pagers, and personal digital assistants or PDAs.

Warning

This Data may contain inaccurate or incomplete information due to the passage of time, changing circumstances, sources used, and the nature of collecting comprehensive geographic data, any of which may lead to incorrect results.

No Warranty

This Data is provided to you “as is,” and you agree to use it at your own risk. HERE and its licensors (and their licensors and suppliers) make no guarantees, representations, or warranties of any kind, express or implied, arising by law or otherwise, including but not limited to, content, quality, accuracy, completeness, effectiveness, reliability, fitness for a particular purpose, usefulness, use or results to be obtained from this Data, or that the Data or server will be uninterrupted or error free.

Disclaimer of Warranty

THE DATABASE IS PROVIDED ON AN “AS IS” AND “WITH ALL FAULTS BASIS” AND BOSCH (AND THEIR LICENSORS AND SUPPLIERS) EXPRESSLY DISCLAIM ALL OTHER WARRANTIES, EXPRESS OR IMPLIED, INCLUDING BUT NOT LIMITED TO, THE IMPLIED WARRANTIES OF NON-INFRINGEMENT, MERCHANTABILITY, SATISFACTORY QUALITY, ACCURACY, TITLE AND FITNESS FOR A PARTICULAR PURPOSE. NO ORAL OR WRITTEN ADVICE OR INFORMATION PROVIDED BY BOSCH (OR ANY OF THEIR LICENSORS, AGENTS, EMPLOYEES, OR THIRD PARTY PROVIDERS) SHALL CREATE A WARRANTY, AND YOU ARE NOT ENTITLED TO RELY ON ANY SUCH ADVICE OR INFORMATION. THIS DISCLAIMER OF WARRANTIES IS AN ESSENTIAL CONDITION OF THIS AGREEMENT.

Disclaimer of Liability

HERE AND ITS LICENSORS (INCLUDING THEIR LICENSORS AND SUPPLIERS) SHALL NOT BE LIABLE TO YOU IN RESPECT OF ANY CLAIM, DEMAND OR ACTION, IRRESPECTIVE OF THE NATURE OF THE CAUSE OF THE CLAIM, DEMAND OR ACTION ALLEGING ANY LOSS, INJURY OR DAMAGES, DIRECT OR INDIRECT, WHICH MAY RESULT FROM THE USE OR POSSESSION OF THIS DATA; OR FOR ANY LOSS OF PROFIT, REVENUE, CONTRACTS OR SAVINGS, OR ANY OTHER DIRECT, INDIRECT, INCIDENTAL, SPECIAL OR CONSEQUENTIAL DAMAGES ARISING OUT OF YOUR USE OF OR INABILITY TO USE THIS DATA, ANY DEFECT IN THIS DATA, OR THE BREACH OF THESE TERMS OR CONDITIONS, WHETHER IN AN ACTION IN CONTRACT OR TORT OR BASED ON A WARRANTY, EVEN IF HERE OR ITS LICENSORS HAVE BEEN ADVISED OF THE POSSIBILITY OF SUCH DAMAGES. Some

States, Territories, and Countries do not allow certain liability exclusions or damages limitations, so to that extent the above may not apply to you.

Export Control

You agree not to export from anywhere any part of the Data provided to you or any direct product thereof except in compliance with, and with all licenses and approvals required under, applicable export laws, rules and regulations. Entire Agreement: These terms and conditions constitute the entire agreement between HERE (and its licensors, including their licensors and suppliers) and you pertaining to the subject matter hereof, and supersedes in their entirety any and all written or oral agreements previously existing between us with respect to such subject matter.

Governing Law

The above terms and conditions shall be governed by the laws of the State of Illinois, without giving effect

to (i) its conflict of laws provisions, or (ii) the United Nations Convention for Contracts for the International Sale of Goods, which is explicitly excluded. You agree to submit to the jurisdiction of the State of Illinois for any and all disputes, claims, and actions arising from or in connection with the Data provided to you hereunder.

Government End Users

If the Data is being acquired by or on behalf of the United States government or any other entity seeking or applying rights similar to those customarily claimed by the United States government, this Data is a "commercial item" as that term is defined at 48 C.F.R. ("FAR") 2.101, is licensed in accordance with this End User License Agreement, and each copy of Data delivered or otherwise furnished shall be marked and embedded as appropriate with the following "Notice of Use," and be treated in accordance with such Notice:



Maps for Life

NOTICE OF USE

CONTRACTOR (MANUFACTURER/
SUPPLIER)

NAME:

HERE North America, LLC

CONTRACTOR (MANUFACTURER/
SUPPLIER)

ADDRESS:

**425 West Randolph Street,
Chicago, IL 60606.**

This Data is a commercial item as defined in FAR 2.101 and is subject to the End User License Agreement under which this Data was provided.

© 2015 HERE North America, LLC.
All rights reserved.

If the Contracting Officer, federal government agency, or any federal official refuses to use the legend provided herein, the Contracting Officer, federal government agency, or any federal official must notify HERE North America, LLC prior to seeking additional or alternative rights in the Data.

Unicode

Copyright © 1991-2015 Unicode, Inc. All rights reserved. Distributed under the Terms of Use in <http://www.unicode.org/copyright.html>.

Free Type Project

Portions of this software are copyright © 2015 The FreeType Project (<http://www.freetype.org>). All rights reserved.

Open Source SW

Further information concerning the OSS licenses is shown on the infotainment display.

QNX

Portions of this software are copyright © 2008-2015, QNX Software Systems. All rights reserved.

Part C – EULA

Copyright 2015, Software Systems GmbH & Co. KG. All Rights Reserved.

The product you have purchased ("Product") contains Software (Runtime Configuration No. 505962; "Software") which is distributed by or on behalf of the Product manufacturer "Manufacturer") under license from Software Systems Co. ("QSSC"). You may only use the Software in the Product and in compliance with the license terms below.

Subject to the terms and conditions of this License, QSSC hereby grants you a limited, non-exclusive, non-transferable license to use the Software in the Product for the purpose intended by the Manufacturer. If permitted by the Manufacturer, or by applicable law,

you may make one backup copy of the Software as part of the Product software. QSSC and its licensors reserve all license+C31 rights not expressly granted herein, and retain all right, title and interest in and to all copies of the Software, including all intellectual property rights therein. Unless required by applicable law you may not reproduce, distribute or transfer, or de-compile, disassemble or otherwise attempt to unbundle, reverse engineer, modify or create derivative works of, the Software. You agree: (1) not to remove, cover or alter any proprietary notices, labels or marks in or on the Software, and to ensure that all copies bear any notice contained on the original; and (2) not to export the Product or the Software in contravention of applicable export control laws.

EXCEPT TO THE EXTENT OTHERWISE REQUIRED BY APPLICABLE LAW, QSSC AND ITS LICENSORS PROVIDE THE SOFTWARE ON AN "AS IS" BASIS, WITHOUT WARRANTIES OR

CONDITIONS OF ANY KIND, EITHER EXPRESS OR IMPLIED INCLUDING, WITHOUT LIMITATION, ANY WARRANTIES OR CONDITIONS OF TITLE, NON-INFRINGEMENT, MERCHANTABILITY OR FITNESS FOR A PARTICULAR PURPOSE. ANY WARRANTIES OR OTHER PROVISIONS OFFERED BY THE MANUFACTURER OR ITS DISTRIBUTOR(S) THAT DIFFER FROM THIS LICENSE ARE OFFERED BY THE MANUFACTURER OR ITS DISTRIBUTOR(S) ALONE AND NOT BY QSSC, ITS AFFILIATES OR THEIR LICENSORS. YOU ASSUME ANY RISKS ASSOCIATED WITH YOUR USE OF THE SOFTWARE UNDER THIS LICENSE.

EXCEPT TO THE EXTENT OTHERWISE REQUIRED BY APPLICABLE LAW (SUCH AS IN THE CASE OF DELIBERATE OR GROSSLY NEGLIGENT ACTS), IN NO EVENT SHALL QSSC, ITS AFFILIATES OR THEIR LICENSORS BE LIABLE TO YOU

UNDER ANY LEGAL THEORY, WHETHER IN TORT (INCLUDING NEGLIGENCE), CONTRACT OR OTHERWISE, FOR DAMAGES, INCLUDING ANY DIRECT, INDIRECT, SPECIAL, INCIDENTAL, OR CONSEQUENTIAL DAMAGES OF ANY CHARACTER ARISING AS A RESULT OF THIS LICENSE OR OUT OF THE USE OR INABILITY TO USE THE PRODUCT (INCLUDING BUT NOT LIMITED TO DAMAGES FOR LOSS OF GOODWILL, WORK STOPPAGE, PRODUCT FAILURE OR MALFUNCTION, OR ANY AND ALL OTHER COMMERCIAL DAMAGES OR LOSSES), EVEN IF QSSC, ITS AFFILIATES OR THEIR LICENSORS HAVE BEEN ADVISED OF THE POSSIBILITY OF SUCH DAMAGES.

WMA

This product is protected by certain intellectual property rights of Microsoft. Use or distribution of such technology outside of this product is prohibited without a license from Microsoft.

For more information on the Software, including any open source software license terms (and available source code) as well as copyright attributions applicable to the Runtime Configuration indicated above, please contact the Manufacturer or contact QSSC at 175 Terence Matthews Crescent, Kanata, Ontario, Canada K2M 1W8 (licensing@qnx.com).

Linotype

Helvetica is a trademark of Linotype Corp. registered in the U.S. Patent and Trademark Office and may be registered in certain other jurisdictions in the name of Linotype Corp. or its licensee Linotype GmbH.

Usage in text form of each of the Licensed Trademarks is:

The trademark attribution requirements for the Licensed Trademarks may be viewed at <http://www.linotype.com/2061-19414/trademarks.html>.

END USER NOTICE

The marks of companies displayed by this product to indicate business locations are the marks of their respective owners. The use of such marks in this product does not imply any sponsorship, approval, or endorsement by such companies of this product.

Index

A

| | |
|-------------------------------|-----|
| Accepting or Declining a Call | 96 |
| Agreements | |
| Trademarks and License | 109 |
| AM | 24 |
| AM-FM Categories | 21 |
| AM-FM Radio | 19 |
| Antenna | 24 |
| Fixed Mast | 24 |
| Multi-band | 24 |
| Apple CarPlay and | |
| Android Auto | 100 |
| Applications Tray | 17 |
| Apps | 16 |
| Audio | 16 |
| Bluetooth | 32 |
| Audio Output | 49 |
| Audio Players | |
| CD | 25 |
| Audio System | 93 |
| Auxiliary Inputs | 48 |
| Auxiliary Jack | 31 |
| Avoiding Untrusted Media | |
| Devices | 25 |

B

| | |
|--------------------|------------|
| Bluetooth | 103 |
| Overview | 93, 94, 98 |
| Bluetooth Audio | 32 |
| Bluetooth Controls | 93 |

C

| | |
|------------------------------|-------|
| Call Waiting | 96 |
| Canceling Voice Recognition | 86 |
| CD Player | 25 |
| Cell Phone Usage | 24 |
| Character Handwriting | |
| Recognition | 64 |
| Cleaning High Gloss Surfaces | |
| and Vehicle Information and | |
| Radio Displays | 18 |
| Clearing the System | 99 |
| Controls | |
| Steering Wheel | 11–15 |
| Coverage Explanations | 84 |

D

| | |
|-------------------|----|
| Database Coverage | |
| Explanations | 84 |
| Destination | 63 |
| Detailed Areas | 61 |

| | |
|---|---------|
| Digital Living Network Alliance (DLNA) (If Equipped) | 47 |
| Display | 82, 104 |
| Driver | |
| Teen | 105 |
| Dual Tone Multi-Frequency (DTMF) Tones | 97 |
| E | |
| Ending a Call | 97 |
| English and Metric Unit Conversion | 105 |
| Error Messages | 27 |
| F | |
| Finding a Station | 20 |
| Fixed Mast Antenna | 24 |
| FM | 24 |
| G | |
| Global Positioning System (GPS) | 82 |
| Guidance | |
| Problems with the Route | 83 |

| | |
|--|-----|
| H | |
| HD Radio Technology | 22 |
| Headphones | 45 |
| Helpful Hints for Speaking Commands | 86 |
| Home Page Features | 15 |
| I | |
| If the System Needs Service | 84 |
| Infotainment Display Features ... | 15 |
| Infotainment Gestures | 17 |
| Infotainment System | 3 |
| Rear Seat | 34 |
| Infotainment System Settings | 19 |
| Introduction | 2 |
| J | |
| Jack | |
| Auxiliary | 31 |
| L | |
| Language | 102 |
| Lighting | 16 |
| Loading and Ejecting Discs | 25 |
| Low Fuel Alert | 82 |

| | |
|--|-----|
| M | |
| Making a Call | 98 |
| Making a Call Using Contacts and Recent Calls | 95 |
| Making a Call Using the Keypad | 96 |
| Map Adjustments | 60 |
| Map Data Updates | 84 |
| Map End User License Agreement | 114 |
| Maps | 61 |
| Media | |
| Avoiding Untrusted Devices | 25 |
| Menus and Features | 35 |
| Messaging | |
| Text | 99 |
| Mixed-Audio Favorites | 22 |
| Multi-band Antenna | 24 |
| N | |
| NAV/ OnStar NAV | 16 |
| Navigation | |
| Destination | 63 |
| Using the System | 54 |
| Navigation Symbols | 62 |

O

| | |
|---------------------------|---------|
| OnStar | 17 |
| OnStar 4G LTE | 33 |
| OnStar Smart Driver | 33 |
| OnStar System | 33, 81 |
| Over-the-Air Software | |
| Updates | 18, 104 |
| Overview | 2 |

P

| | |
|---------------------------|------------|
| Pairing | 94 |
| Phone | 16 |
| Apple CarPlay and | |
| Android Auto..... | 100 |
| Bluetooth | 93, 94, 98 |
| Playing an Audio CD | 25 |
| Playing an MP3 CD | 27 |
| Playing from a USB | 28 |
| Playing the Radio | 19 |
| Port | |
| USB..... | 28 |
| Positioning | |
| Vehicle..... | 83 |
| Problems with Route | |
| Guidance | 83 |
| Projection | 16 |

R

| | |
|----------------------------------|-----|
| Radio | 102 |
| HD Radio Technology..... | 22 |
| Radio Reception | 24 |
| Radios | |
| AM-FM Radio | 19 |
| Satellite | 23 |
| Rear Camera | 104 |
| Rear Seat Infotainment (RSI) | |
| System | 34 |
| Rear Seat Infotainment (RSI) | |
| Wi-Fi (If Equipped) | 46 |
| Recognition | |
| Voice..... | 85 |
| Remote Control | 49 |
| Return to Factory Settings | 104 |
| RSI Controls Available from | |
| the Front Screen | 43 |

| | |
|--------------------------------|-------------|
| S | |
| Satellite Radio | 23 |
| Schedule I: Gracenote EULA ... | 111 |
| Scroll Features | 60 |
| Servicing System | 84 |
| Settings | 81, 102, 16 |
| SiriusXM Menu | 23 |
| SiriusXM NavTraffic | 79 |

SiriusXM Satellite Radio

| | |
|----------------------------------|--------|
| Service | 23, 24 |
| SiriusXM Travel Link Fuel | |
| Pricing | 80 |
| SiriusXM Travel Link Movie | |
| Listings | 80 |
| SiriusXM Travel Link Weather ... | 77 |
| Software Updates | 18 |
| Sources | 35 |
| Steering Wheel Controls | 11–15 |
| Storing Media Favorites | 26 |
| Storing Presets | 21 |
| Switching to Handset or | |
| Handsfree Mode | 95 |
| Symbols | |
| Navigation..... | 62 |
| System | |
| Global Positioning..... | 82 |
| OnStar..... | 81 |
| Rear Seat Infotainment (RSI)... | 34 |
| System Operation | 34 |

T

| | |
|----------------------|-----|
| Teen Driver | 105 |
| Text Menu | 99 |
| Text Messaging | 99 |
| Text Settings | 100 |
| The OnStar App | 33 |

- Three-Way Calling 97
- Time and Date 102
- Trademarks and License
 - Agreements 109
- Turn List 74
- U**
- Updates
 - Map Data 84
 - Software 18
- USB Port 28
- Using Bluetooth Voice
 - Recognition 98
- Using the Navigation System 54
- Using the System 15
- Using Voice Recognition 85
- Using Voice Recognition for
 - List Options 87
- V**
- Valet Mode 102
- Vehicle Positioning 83
- Vehicle Settings 103
- Video 17
- Video Display Error Messages ... 53
- Video Distortion 53
- Video Voice Over 52
- Viewing a Text Message 99
- Viewing Sender Information 99
- Voice 82, 103
- Voice Mail 97
- Voice Pass-Thru 91
- Voice Recognition 85
- Voice Recognition for Audio
 - My Media 89
- Voice Recognition for
 - Navigation 90
- Voice Recognition for OnStar
 - (If Equipped) 92
- Voice Recognition for the
 - Phone 91
- Voice Recognition for the
 - Radio 88
- Voice Recognition for Weather
 - (If Equipped) 92
- W**
- Weather 16



U.S. Only



23428864 D

