

hp 33s scientific calculator

user's guide



i n v e n t

Edition 3

HP part number F2216-90001

Notice

REGISTER YOUR PRODUCT AT: www.register.hp.com

THIS MANUAL AND ANY EXAMPLES CONTAINED HEREIN ARE PROVIDED "AS IS" AND ARE SUBJECT TO CHANGE WITHOUT NOTICE. HEWLETT-PACKARD COMPANY MAKES NO WARRANTY OF ANY KIND WITH REGARD TO THIS MANUAL, INCLUDING, BUT NOT LIMITED TO, THE IMPLIED WARRANTIES OF MERCHANTABILITY, NON-INFRINGEMENT AND FITNESS FOR A PARTICULAR PURPOSE.

HEWLETT-PACKARD CO. SHALL NOT BE LIABLE FOR ANY ERRORS OR FOR INCIDENTAL OR CONSEQUENTIAL DAMAGES IN CONNECTION WITH THE FURNISHING, PERFORMANCE, OR USE OF THIS MANUAL OR THE EXAMPLES CONTAINED HEREIN.

© Copyright 1988, 1990-1991, 2003 Hewlett-Packard Development Company, L.P. Reproduction, adaptation, or translation of this manual is prohibited without prior written permission of Hewlett-Packard Company, except as allowed under the copyright laws.

Hewlett-Packard Company
4995 Murphy Canyon Rd,
Suite 301
San Diego, CA 92123

Printing History

Edition 3

November 2004

Contents

Part 1. Basic Operation

1. Getting Started

Important Preliminaries.....	1-1
Turning the Calculator On and Off.....	1-1
Adjusting Display Contrast.....	1-1
Highlights of the Keyboard and Display	1-2
Shifted Keys.....	1-2
Alpha Keys.....	1-3
Cursor Keys	1-3
Silver Paint Keys	1-4
Backspacing and Clearing.....	1-4
Using Menus	1-7
Exiting Menus	1-9
RPN and ALG Keys	1-10
The Display and Annunciators	1-11
Keying in Numbers.....	1-14
Making Numbers Negative	1-14
Exponents of Ten	1-14
Understanding Digit Entry.....	1-15
Range of Numbers and OVERFLOW	1-16
Doing Arithmetic	1-16
One-Number Functions.....	1-17
Two-Number Functions	1-17
Controlling the Display Format	1-18

Periods and Commas in Numbers.....	1-18
Number of Decimal Places	1-19
SHOWing Full 12-Digit Precision.....	1-20
Fractions.....	1-21
Entering Fractions.....	1-21
Displaying Fractions	1-23
Messages	1-23
Calculator Memory	1-24
Checking Available Memory	1-24
Clearing All of Memory	1-24

2. RPN: The Automatic Memory Stack

What the Stack Is	2-1
The X and Y-Registers are in the Display	2-2
Clearing the X-Register	2-2
Reviewing the Stack.....	2-3
Exchanging the X- and Y-Registers in the Stack	2-4
Arithmetic – How the Stack Does It	2-4
How ENTER Works	2-5
How CLEAR x Works	2-6
The LAST X Register	2-7
Correcting Mistakes with LAST X.....	2-8
Reusing Numbers with LAST X.....	2-9
Chain Calculations in RPN mode	2-11
Work from the Parentheses Out	2-11
Exercises.....	2-13
Order of Calculation	2-13
More Exercises	2-14

3. Storing Data into Variables

Storing and Recalling Numbers	3-2
Viewing a Variable without Recalling It	3-3
Reviewing Variables in the VAR Catalog	3-3
Clearing Variables	3-4
Arithmetic with Stored Variables	3-4
Storage Arithmetic	3-4
Recall Arithmetic	3-5
Exchanging x with Any Variable	3-6
The Variable "i"	3-7

4. Real-Number Functions

Exponential and Logarithmic Functions	4-1
Quotient and Remainder of Division	4-2
Power Functions	4-2
Trigonometry	4-3
Entering π	4-3
Setting the Angular Mode	4-4
Trigonometric Functions	4-4
Hyperbolic Functions	4-6
Percentage Functions	4-6
Physics Constants	4-8
Conversion Functions	4-9
Coordinate Conversions	4-10
Time Conversions	4-12
Angle Conversions	4-13
Unit Conversions	4-13
Probability Functions	4-14

Factorial	4-14
Gamma.....	4-14
Probability	4-14
Parts of Numbers	4-16
Names of Functions.....	4-17

5. Fractions

Entering Fractions	5-1
Fractions in the Display.....	5-2
Display Rules.....	5-2
Accuracy Indicators.....	5-3
Longer Fractions.....	5-4
Changing the Fraction Display.....	5-4
Setting the Maximum Denominator	5-5
Choosing a Fraction Format.....	5-5
Examples of Fraction Displays	5-6
Rounding Fractions.....	5-7
Fractions in Equations.....	5-8
Fractions in Programs	5-9

6. Entering and Evaluating Equations

How You Can Use Equations	6-1
Summary of Equation Operations.....	6-3
Entering Equations into the Equation List	6-4
Variables in Equations	6-4
Numbers in Equations	6-5
Functions in Equations.....	6-5
Parentheses in Equations	6-6
Displaying and Selecting Equations	6-6

Editing and Clearing Equations	6-7
Types of Equations.....	6-9
Evaluating Equations.....	6-9
Using ENTER for Evaluation	6-11
Using XEQ for Evaluation	6-12
Responding to Equation Prompts	6-12
The Syntax of Equations	6-13
Operator Precedence.....	6-13
Equation Functions.....	6-15
Syntax Errors	6-18
Verifying Equations.....	6-18
7. Solving Equations	
Solving an Equation.....	7-1
Understanding and Controlling SOLVE	7-5
Verifying the Result	7-6
Interrupting a SOLVE Calculation	7-7
Choosing Initial Guesses for SOLVE.....	7-7
For More Information	7-11
8. Integrating Equations	
Integrating Equations (\int FN).....	8-2
Accuracy of Integration	8-5
Specifying Accuracy	8-6
Interpreting Accuracy	8-6
For More Information	8-8
9. Operations with Complex Numbers	
The Complex Stack.....	9-1
Complex Operations	9-2

Using Complex Numbers in Polar Notation.....	9–5
--	-----

10. Base Conversions and Arithmetic

Arithmetic in Bases 2, 8, and 16.....	10–2
The Representation of Numbers.....	10–4
Negative Numbers.....	10–4
Range of Numbers.....	10–5
Windows for Long Binary Numbers.....	10–6

11. Statistical Operations

Entering Statistical Data.....	11–1
Entering One–Variable Data.....	11–2
Entering Two–Variable Data.....	11–2
Correcting Errors in Data Entry.....	11–2
Statistical Calculations.....	11–4
Mean.....	11–4
Sample Standard Deviation.....	11–6
Population Standard Deviation.....	11–6
Linear Regression.....	11–7
Limitations on Precision of Data.....	11–9
Summation Values and the Statistics Registers.....	11–10
Summation Statistics.....	11–10
The Statistics Registers in Calculator Memory.....	11–11
Access to the Statistics Registers.....	11–11

Part 2. Programming

12. Simple Programming

Designing a Program.....	12–3
--------------------------	------

Selecting a Mode.....	12-3
Program Boundaries (LBL and RTN)	12-3
Using RPN, ALG and Equations in Programs.....	12-4
Data Input and Output	12-4
Entering a Program.....	12-5
Keys That Clear	12-6
Function Names in Programs.....	12-7
Running a Program.....	12-9
Executing a Program (XEQ).....	12-9
Testing a Program.....	12-9
Entering and Displaying Data	12-11
Using INPUT for Entering Data	12-11
Using VIEW for Displaying Data.....	12-13
Using Equations to Display Messages.....	12-14
Displaying Information without Stopping	12-16
Stopping or Interrupting a Program	12-17
Programming a Stop or Pause (STOP, PSE).....	12-17
Interrupting a Running Program	12-17
Error Stops	12-17
Editing a Program	12-18
Program Memory	12-19
Viewing Program Memory	12-19
Memory Usage	12-20
The Catalog of Programs (MEM).....	12-20
Clearing One or More Programs	12-20
The Checksum.....	12-21
Nonprogrammable Functions	12-22
Programming with BASE.....	12-22

Selecting a Base Mode in a Program	12-22
Numbers Entered in Program Lines	12-23
Polynomial Expressions and Horner's Method	12-23

13. Programming Techniques

Routines in Programs	13-1
Calling Subroutines (XEQ, RTN)	13-2
Nested Subroutines	13-3
Branching (GTO)	13-4
A Programmed GTO Instruction	13-5
Using GTO from the Keyboard	13-5
Conditional Instructions.....	13-6
Tests of Comparison ($x?y$, $x?0$)	13-7
Flags.....	13-8
Loops.....	13-16
Conditional Loops (GTO).....	13-17
Loops with Counters (DSE, ISG)	13-18
Indirectly Addressing Variables and Labels	13-20
The Variable "i"	13-20
The Indirect Address, (i)	13-21
Program Control with (i)	13-22
Equations with (i)	13-24

14. Solving and Integrating Programs

Solving a Program	14-1
Using SOLVE in a Program.....	14-6
Integrating a Program.....	14-7
Using Integration in a Program	14-9
Restrictions on Solving and Integrating	14-11

15. Mathematics Programs

Vector Operations	15-1
Solutions of Simultaneous Equations	15-12
Polynomial Root Finder	15-20
Coordinate Transformations	15-32

16. Statistics Programs

Curve Fitting	16-1
Normal and Inverse-Normal Distributions	16-11
Grouped Standard Deviation	16-17

17. Miscellaneous Programs and Equations

Time Value of Money	17-1
Prime Number Generator	17-6

Part 3. Appendixes and Reference

A. Support, Batteries, and Service

Calculator Support	A-1
Answers to Common Questions	A-1
Environmental Limits	A-2
Changing the Batteries	A-2
Testing Calculator Operation	A-4
The Self-Test	A-5
Warranty	A-6
Service	A-7
Regulatory Information	A-9

B. User Memory and the Stack

Managing Calculator Memory	B-1
----------------------------------	-----

Resetting the Calculator	B-2
Clearing Memory	B-3
The Status of Stack Lift	B-4
Disabling Operations	B-4
Neutral Operations	B-4
The Status of the LAST X Register	B-6

C. ALG: Summary

About ALG	C-1
Doing Two-number Arithmetic in ALG	C-2
Simple Arithmetic	C-2
Power Functions	C-2
Percentage Calculations	C-3
Permutations and Combinations	C-4
Quotient and Remainder Of Division.....	C-4
Parentheses Calculations	C-5
Chain Calculations	C-5
Reviewing the Stack	C-6
Coordinate Conversions.....	C-7
Integrating an Equation	C-8
Operations with Complex Numbers.....	C-9
Arithmetic in Bases 2, 8, and 16.....	C-11
Entering Statistical Two-Variable Data	C-12

D. More about Solving

How SOLVE Finds a Root	D-1
Interpreting Results	D-3
When SOLVE Cannot Find a Root	D-8
Round-Off Error	D-13

UnderflowD-14

E. More about Integration

How the Integral Is Evaluated E-1
Conditions That Could Cause Incorrect Results E-2
Conditions That Prolong Calculation Time E-7

F. Messages

G. Operation Index

Index

Part 1

Basic Operation

Getting Started







Watch for this symbol in the margin. It identifies examples or keystrokes that are shown in RPN mode and must be performed differently in ALG mode.

Appendix C explains how to use your calculator in ALG mode.

Important Preliminaries



Turning the Calculator On and Off

To turn the calculator on, press . ON is printed below the key.

To turn the calculator off, press  . That is, press and release the  shift key, then press  (which has OFF printed in purple above it). Since the calculator has *Continuous Memory*, turning it off does not affect any information you've stored.

To conserve energy, the calculator turns itself off after 10 minutes of no use. If you see the low-power indicator () in the display, replace the batteries as soon as possible. See appendix A for instructions.





Adjusting Display Contrast

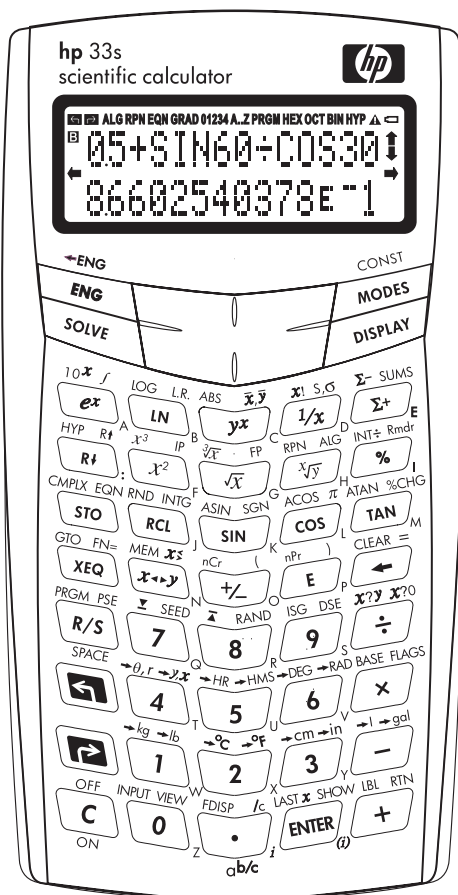



Display contrast depends on lighting, viewing angle, and the contrast setting. To increase or decrease the contrast, hold down the  key and press  or .

Highlights of the Keyboard and Display



Shifted Keys

Each key has three functions: one printed on its face, a left-shifted function (Green), and a right-shifted function (Purple). The *shifted* function names are printed in green and purple above each key. Press the appropriate shift key ( or ) before pressing the key to the desired function. For example, to turn the calculator off, press and release the  shift key, then press .

Pressing  or  turns on the corresponding  or  annunciator symbol at the top of the display. The annunciator remains on until you press the next key. To cancel a shift key (and turn off its annunciator), press the same shift key again.

Alpha Keys

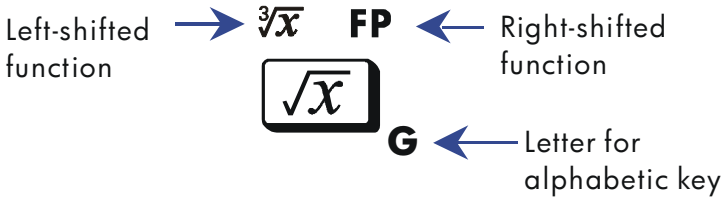

Most keys have a letter written next to them, as shown above. Whenever you need to type a letter (for example, a variable or a program *label*), the **A..Z** annunciator appears in the display, indicating that the alpha keys are "active".

Variables are covered in chapter 3; labels are covered in chapter 12.

Cursor Keys

Note that the cursor key itself is not actually marked with arrows. To make the explanations in this manual as easy to understand as possible, we will refer to specific cursor keys as noted in the illustration below.

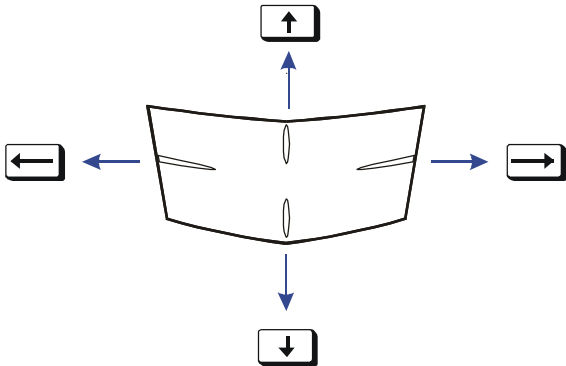

Silver Paint Keys

Those eight silver paint keys have their specific pressure points marked in blue position in the illustration below.

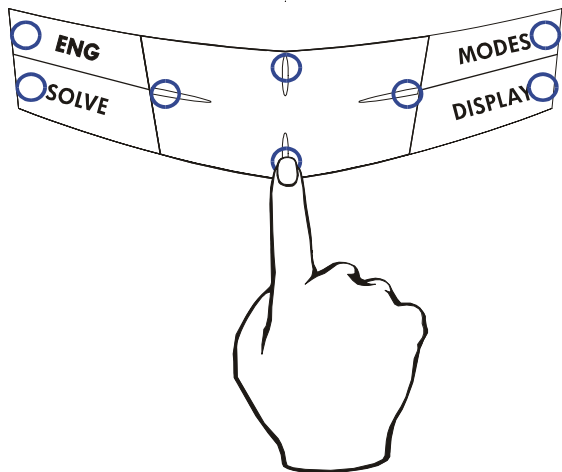

To use those keys, make sure to press down the corresponding position for the desired function.

Backspacing and Clearing

One of the first things you need to know is how to *clear*: how to correct numbers, clear the display, or start over.

Keys for Clearing (continued)

Key	Description
 CLEAR	<p><i>The CLEAR menu</i> ({X} {VARS} {ALL} {Σ})</p> <p>Contains options for clearing x (the number in the X-register), all variables, all of memory, or all statistical data.</p> <p>If you select {ALL}, a new menu (CLR ALL? {Y} {N}) is displayed so you can verify your decision before erasing everything in memory.</p> <p>During program entry, {ALL} is replaced by {PGM}. If you select {PGM}, a new menu (CLR PGMS? {Y} {N}) is displayed, so you can verify your decision before erasing all your programs.</p> <p>During equation entry (either keyboard equations or equations in program lines), the CLR EQN? {Y} {N} menu is displayed, so you can verify your decision before erasing the equation.</p> <p>If you are viewing a completed equation, the equation is deleted with no verification.</p>

Using Menus

There is a lot more power to the HP 33s than what you see on the keyboard. This is because 14 of the keys are *menu* keys. There are 14 menus in all, which provide many more functions, or more options for more functions.

HP 33s Menus

Menu Name	Menu Description	Chapter
Numeric Functions		
L.R.	\hat{x} \hat{y} r m b Linear regression: curve fitting and linear estimation.	11
\bar{x} , \bar{y}	\bar{x} \bar{y} \bar{xw} Arithmetic mean of statistical x - and y -values; weighted mean of statistical x -values.	11
s, σ	s_x s_y σ_x σ_y Sample standard deviation, population standard deviation.	11
CONST	Functions to use 40 physics constants—refer to "Physics constants" on page 4–8.	4
SUMS	n Σx Σy Σx^2 Σy^2 Σxy Statistical data summations.	11
BASE	DEC HEX OCT BIN Base conversions (decimal, hexadecimal, octal, and binary).	11
Programming Instructions		
FLAGS	SF CF FS? Functions to set, clear, and test flags.	13
$x?y$	$\neq \leq < > \geq =$ Comparison tests of the X- and Y-registers.	13
$x?0$	$\neq \leq < > \geq =$ Comparison tests of the X-register and zero.	13

Example:

$6 \div 7 = 0.8571428571\dots$

Keys:

✓ 6 [ENTER] 7 [÷] [DISPLAY]

[4] ({{ALL}})
(or [↓] [→] [ENTER])

Display:

1FIX 2SCI
3ENG 4ALL
8.5714285714E-1

Menu help you execute dozens of functions by guiding you to them with menu choices. You don't have to remember the names of the functions built into the calculator nor search through the names printed on its keyboard.

Exiting Menus

Whenever you execute a menu function, the menu automatically disappears, as in the above example. If you want to leave a menu *without* executing a function, you have three options:

- Pressing [←] backs out of the 2-level CLEAR or MEM menu, one level at a time. Refer to [↶] [CLEAR] in the table on page 1-6.
- Pressing [←] or [C] cancels any other menu.

Keys:

Display:

123.5678	123.5678_
[DISPLAY]	<u>1</u> FIX 2SCI
	3ENG 4ALL
[←] or [C]	123.5678

- Pressing another menu key replaces the old menu with the new one.

Keys:

Display:

123.5678	123.5678_
[DISPLAY]	<u>1</u> FIX 2SCI
	3ENG 4ALL
[↶] [CLEAR]	<u>1</u> X 2VARS
	3ALL 4Σ
[C]	123.5678



RPN and ALG Keys

The calculator can be set to perform arithmetic operations in either RPN (Reverse Polish Notation) or ALG (Algebraic) mode.

In Reverse Polish Notation (RPN) mode, the intermediate results of calculations are stored automatically; hence, you do not have to use parentheses.

In algebraic (ALG) mode, you perform addition, subtraction, multiplication, and division in the traditional way.

To select RPN mode:



Press   to set the calculator to RPN mode. When the calculator is in RPN mode, the **RPN** annunciator is on.



To select ALG mode:





Press   to set the calculator to ALG mode. When the calculator is in ALG mode, the **ALG** annunciator is on.

Example:

Suppose you want to calculate $1 + 2 = 3$.

In RPN mode, you enter the first number, press the  key, enter the second number, and finally press the arithmetic operator key: .

In ALG mode, you enter the first number, press , enter the second number, and finally press the  key.

RPN mode	ALG mode
1  2 	1  2 

In ALG mode, the results and the calculations are displayed. In RPN mode, only the results are displayed, not the calculations.

Note



You can choose either ALG (Algebraic) or RPN (Reverse Polish Notation) mode for your calculations. Throughout the manual, the “✓” in the margin indicates that the examples or keystrokes in RPN mode must be performed differently in ALG mode. Appendix C explains how to use your calculator in ALG mode.

The Display and Annunciators

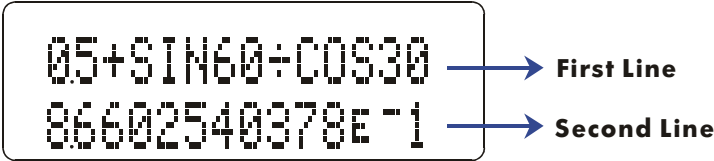



The display comprises two lines and *annunciators*.

The first line can display up to 255 characters. Entries with more than 14 characters will scroll to the left. However, if entries are more than 255 characters, the characters from the 256th onward are replaced with an ellipsis (. . .).



















During inputting, the second line displays an entry; after calculating, it displays the result of a calculation. Every calculation is displayed in up to 14 digits, including an E sign (exponent), and exponent value up to three digits.

The symbols on the display, shown in the above figure, are called *annunciators*. Each one has a special significance when it appears in the display.

HP 33s Annunciators

Annunciator	Meaning	Chapter
B	The " B (Busy)" annunciator blinks while an operation, equation, or program is executing.	
▲ ▼	When in Fraction–display mode (press  [FDISP]), only one of the " ▲ " or " ▼ " halves of the " ▲▼ " annunciator will be turned on to indicate whether the displayed numerator is slightly less than or slightly greater than its <i>true</i> value. If neither part of " ▲▼ " is on, the <i>exact</i> value of the fraction is being displayed.	5
	Left shift is active.	1
	Right shift is active.	1
RPN	Reverse Polish Notation mode is active.	1, 2
ALG	Algebraic mode is active.	1, C
PRGM	Program–entry is active.	12
EQN	Equation–entry mode is active, or the calculator is evaluating an expression or executing an equation.	6
0 1 2 3 4	Indicates which flags are set (flags 5 through 11 have no annunciator).	13
RAD or GRAD	Radians or Grad angular mode is set. DEG mode (default) has no annunciator.	4
HEX OCT BIN	Indicates the active number base. DEC (base 10, default) has no annunciator.	10

HP 33s Annunciators (continued)

Annunciator	Meaning	Chapter
←, →	<p>The  or  keys are active to scroll the display, i.e. there are more digits to the left and right. (Equation-entry and Program-entry mode aren't included)</p> <p>Use  SHOW to see the rest of a decimal number; use the left and right-cursor keys (, ) to see the rest of an equation or binary number.</p> <p>Both these annunciators may appear simultaneously in the display, indicating that there are more characters to the left <i>and</i> to the right. Press either of the indicated cursor keys (, ) to see the leading or trailing characters.</p> <p>When an entry or equation has more than one display, you can press  or  followed by  to skip from the current display to the first one. To skip to the last display, press  or  followed by .</p> <p>In the CONST and SUMS menus, you can press  and  to access the next menu page.</p>	1, 6
↑, ↓	<p>The  and  keys are active for stepping through an equation list or program lines.</p>	1, 6, 12
A..Z	<p>The alphabetic keys are active.</p>	3
	<p>Attention! Indicates a special condition or an error.</p>	1
	<p>Battery power is low.</p>	A

Keying in Numbers

You can key in a number that has up to 12 digits plus a 3–digit exponent up to ± 499 . If you try to key in a number larger than this, digit entry halts and the **A** annunciator briefly appears.

If you make a mistake while keying in a number, press **←** to backspace and delete the last digit, or press **C** to clear the whole number.

Making Numbers Negative

The **+/-** key changes the sign of a number.

- To key in a negative number, type the number, then press **+/-**.
- To change the sign of a number that was entered previously, just press **+/-**. (If the number has an exponent, **+/-** affects only the *mantissa* — the non–exponent part of the number.)

Exponents of Ten

Exponents in the Display

Numbers with exponents of ten (such as 4.2×10^{-5}) are displayed with an **E** preceding the exponent (such as **4.2000E-5**).

A number whose magnitude is too large or too small for the display format will automatically be displayed in exponential form.

For example, in **FIX 4** format for four decimal places, observe the effect of the following keystrokes:

Keys:	Display:	Description:
.000062	0.000062_	Shows number being entered.
ENTER	0.0001	Rounds number to fit the display format.
.000042 ENTER	4.2000E-5	Automatically uses scientific notation because otherwise no significant digits would appear.

Keying in Exponents of Ten

Use **[E]** (*exponent*) to key in numbers multiplied by powers of ten. For example, take Planck's constant, 6.6261×10^{-34} :

1. Key in the *mantissa* (the *non-exponent* part) of the number. If the mantissa is negative, press **[+/-]** after keying in its digits.

Keys:

6.6261

Display:

6.6261_

2. Press **[E]**. Notice that the cursor moves behind the E:

[E]

6.6261E_

3. Key in the exponent. (The largest possible exponent is ± 499 .) If the exponent is negative, press **[+/-]** after you key in the E or after you key in the value of the exponent:

34 **[+/-]**

6.6261E-34_

For a power of ten without a multiplier, such as 10^{34} , just press **[E]** 34. The calculator displays $1E34$.

Other Exponent Functions

To calculate an exponent of ten (the base 10 antilogarithm), use **[10^x]**. To calculate the result of *any* number raised to a power (exponentiation), use **[y^x]** (see chapter 4).

Understanding Digit Entry

As you key in a number, the cursor (**_**) appears in the display. The cursor shows you where the next digit will go; it therefore indicates that the number is not complete.

Keys:	Display:	Description:
-------	----------	--------------

123	123_	Digit entry <i>not</i> terminated: the number is not complete.
-----	------	--

If you *execute a function* to calculate a *result*, the cursor disappears because the number is complete — digit entry has been terminated.

\sqrt{x}	11.0905	Digit entry is terminated.
------------	---------	----------------------------

Pressing **ENTER** terminates digit entry. To separate two numbers, key in the first number, press **ENTER** to terminate digit, entry, and then key in the second number

✓ 123 ENTER	123.0000	A completed number.
✓ 4 +	127.0000	Another completed number.

If digit entry is *not* terminated (if the cursor is present), **←** backspaces to erase the last digit. If digit entry is terminated (no cursor), **←** acts like **C** and clears the entire number. Try it!

Range of Numbers and OVERFLOW

The smallest number available on the calculator is 1×10^{-499} . The largest number is $9.9999999999 \times 10^{499}$ (displayed as $1.0000E500$ because of rounding).

- If a calculation produces a result that exceeds the largest possible number, $9.9999999999 \times 10^{499}$ is returned, and the warning message **OVERFLOW** appears.
- If a calculation produces a result smaller than the smallest possible number, zero is returned. No warning message appears.

Doing Arithmetic

All operands (numbers) must be present *before* you press a function key. (When you press a function key, the calculator immediately executes the function shown on that key.)

All calculations can be simplified into one-number functions and/or two-number functions.

One-Number Functions

To use a one-number function (such as $1/x$, \sqrt{x} , x^2 , $\sqrt[3]{x}$, x^3 , INTG , $x!$, $\%$ or $+/-$)

1. Key in the number. (*You don't need to press* **ENTER** .)
2. Press the function key. (For a *shifted* function, press the appropriate SHIFT or 2ND shift key first.)

For example, calculate $1/32$ and $\sqrt{148.84}$. Then square the last result and change its sign.

Keys:	Display:	Description:
32	32_	Operand.
$1/x$	0.0313	Reciprocal of 32.
148.84 \sqrt{x}	12.2000	Square root of 148.84.
x^2	148.8400	Square of 12.2.
$+/-$	-148.8400	Negation of 148.8400.

The one-number functions also include trigonometric, logarithmic, hyperbolic, and parts-of-numbers functions, all of which are discussed in chapter 4.

✓ Two-Number Functions

In RPN mode, to use a two-number function (such as $+$, $-$, \times , \div , y^x , $\text{INT}\div$, Rmdr , $\sqrt[y]{x}$, nCr , nPr , $\%$ or $\%CHG$):

1. Key in the first number.
2. Press **ENTER** to separate the first number from the second.
3. Key in the second number. (Do *not* press **ENTER** .)
4. Press the function key. (For a shifted function, press the appropriate shift key first.)

Note

In RPN mode, type in *both* numbers (separate them by selecting **ENTER**) *before* selecting a function key.



For example,

To calculate:	Press:	Display:
$12 + 3$	12 ENTER 3 +	15.0000
$12 - 3$	12 ENTER 3 -	9.0000
12×3	12 ENTER 3 x	36.0000
12^3	12 ENTER 3 y^x	1,728.0000
Percent change from 8 to 5	8 ENTER 5 ⇨ %CHG	-37.5000

The order of entry is important only for *non*-commutative functions such as **⇩**, **⇧**, **y^x**, **⇨** **INT⇧**, **⇨** **Rmdr**, **⇧** **y^y**, **⇨** **nCr**, **⇨** **nPr**, **%**, **⇨** **%CHG**. If you type numbers in the wrong order, you can still get the correct answer (without re-typing them) by pressing **x↔y** to swap the order of the numbers on the stack. Then press the intended function key. (This is explained in detail in chapter 2 under "Exchanging the X- and Y-Registers in the Stack.")

Controlling the Display Format

Periods and Commas in Numbers

To exchange the periods and commas used for the decimal point (radix mark) and digit separators in a number:

1. Press **MODES** to display the MODES menu.
2. Specify the decimal point (radix mark) by pressing **{·}** or **{,}**.

For example, the number one million looks like:

- 1,000,000.0000 if you press **{·}** or
- 1.000.000,0000 if you press **{,}**.

Number of Decimal Places

All numbers are *stored* with 12-digit precision, but you can select the number of decimal places to be *displayed* by pressing **DISPLAY** (the display menu). During some complicated internal calculations, the calculator uses 15-digit precision for intermediate results. The displayed number is *rounded* according to the display format. The DISPLAY menu gives you four options:

FIX SCI ENG ALL

Fixed-Decimal Format ({FIX})

FIX format displays a number with up to 11 decimal places (11 digits to the *right* of the "." or "," radix mark) if they fit. After the prompt **FIX_**, type in the number of decimal places to be displayed. For 10 or 11 places, press **0** or **1**.

For example, in the number 123.4567889 , the "7", "0", "8", and "9" are the decimal digits you see when the calculator is set to FIX 4 display mode.

Any number that is too large or too small to display in the current decimal-place setting will automatically be displayed in scientific format.

Scientific Format ({SCI})

SCI format displays a number in scientific notation (one digit before the "." or "," radix mark) with up to 11 decimal places (if they fit) and up to three digits in the exponent. After the prompt, **SCI_**, type in the number of decimal places to be displayed. For 10 or 11 places, press **0** or **1**. (The mantissa part of the number will always be less than 10.)

For example, in the number $1.2346E5$, the "2", "3", "4", and "6" are the decimal digits you see when the calculator is set to SCI 4 display mode. The "5" following the "E" is the exponent of 10: 1.2346×10^5 .

Engineering Format ({ENG})

ENG format displays a number in a manner similar to scientific notation, except that the exponent is a multiple of three (there can be up to three digits before the "." or "E" radix mark). This format is most useful for scientific and engineering calculations that use units specified in multiples of 10^3 (such as micro-, milli-, and kilo-units.)

After the prompt, ENG_, type in the number of digits you want after the first significant digit. For 10 or 11 places, press $\boxed{\cdot}$ 0 or $\boxed{\cdot}$ 1.

For example, in the number 123.46E3, the "2", "3", "4", and "6" are the significant digits after the first significant digit you see when the calculator is set to ENG 4 display mode. The "3" following the "E" is the (multiple of 3) exponent of 10: 123.46×10^3 .

Pressing $\boxed{\text{ENG}}$ or $\boxed{\rightarrow} \boxed{\leftarrow \text{ENG}}$ will cause the exponent display for the number being displayed to change in multiples of 3.

For example, key in the number 12.346E4 and pressing $\boxed{\text{ENG}}$ will convert the displayed value to 123.46E3, which the mantissa n satisfies $1 \leq n < 1000$ and the exponent is a multiple of 3. When you press $\boxed{\text{ENG}}$ again, the displayed value is converted to 123.460E0 by shifting the decimal point three places to the right and converting the exponent to the next lower multiple of 3.

Key in the number 12.346E4 and pressing $\boxed{\rightarrow} \boxed{\leftarrow \text{ENG}}$ will convert the displayed value to 0.12346E6, which the mantissa n satisfies $0.01 \leq n < 10$ and the exponent is a multiple of 3. When you press $\boxed{\rightarrow} \boxed{\leftarrow \text{ENG}}$ again, the displayed value is converted to 0.00012346E9 by shifting the decimal point three places to the left and converting the exponent to the next higher multiple of 3.



ALL Format ({ALL})











ALL format displays a number as precisely as possible (12 digits maximum). If all the digits don't fit in the display, the number is automatically displayed in scientific format.

SHOWing Full 12-Digit Precision

Changing the number of displayed decimal places affects what you see, but it does not affect the internal representation of numbers. Any number stored internally always has 12 digits.

For example, in the number 14.8745632019, you see only "14.8746" when the display mode is set to FIX 4, but the last six digits ("632019") are present internally in the calculator.

To temporarily display a number in full precision, press  . This shows you the *mantissa* (but no exponent) of the number for as long as you hold down .

	Keys:	Display:	Description:
	 {FIX} 4		Displays four decimal places.
✓	45  1.3 	58.5000	Four decimal places displayed.
	 {SCI} 2	5.85E1	Scientific format: two decimal places and an exponent.
	 {ENG} 2	58.5E0	Engineering format.
	 {ALL}	58.5	All significant digits; trailing zeros dropped.
	 {FIX} 4	58.5000	Four decimal places, no exponent.
		0.0171	Reciprocal of 58.5.
	  (hold)	170940170940	Shows full precision until you release  .

Fractions



The HP 33s allows you to type in and display fractions, and to perform math operations on them. Fractions are *real* numbers of the form

$$a b/c$$

where a , b , and c are integers; $0 \leq b < c$; and the denominator (c) must be in the range 2 through 4095.

Entering Fractions

Fractions can be entered onto the stack at any time:

1. Key in the integer part of the number and press . (The first  separates the integer part of the number from its fractional part.)

- Key in the fraction numerator and press $\frac{\square}{\square}$ again. The second $\frac{\square}{\square}$ separates the numerator from the denominator.
- Key in the denominator, then press **ENTER** or a function key to terminate digit entry. The number or result is formatted according to the current display format.

The $a\ b/c$ symbol under the $\frac{\square}{\square}$ key is a reminder that the $\frac{\square}{\square}$ key is used twice for fraction entry.

For example, to enter the fractional number $12\ \frac{3}{8}$, press these keys:

Keys:	Display:	Description:
12	12_	Enters the integer part of the number.
$\frac{\square}{\square}$	12. _	The $\frac{\square}{\square}$ key is interpreted in the normal manner.
3	12.3_	Enters the numerator of the fraction (the number is still displayed in decimal form).
$\frac{\square}{\square}$	12 3/_	The calculator interprets the second $\frac{\square}{\square}$ as a fraction and separates the numerator from denominator.
8	12 3/8_	Appends the denominator of the fraction.
ENTER	12.3750	Terminates digit entry; displays the number in the current display format.

If the number you enter has no integer part (for example, $\frac{3}{8}$), just start the number without an integer:

Keys:	Display:	Description:
$\frac{\square}{\square}$ 3 $\frac{\square}{\square}$ 8	0 3/8_	Enters no integer part. (3 $\frac{\square}{\square}$ $\frac{\square}{\square}$ 8 also works.)
ENTER	0.3750	Terminates digit entry; displays the number in the current display format (FIX 4).

Displaying Fractions

Press **↵** **FDISP** to switch between Fraction–display mode and the current decimal display mode.

Keys:	Display:	Description:
12 □ 3 □ 8	12 3/8_	Displays characters as you key them in.
ENTER	12.3750	Terminates digit entry; displays the number in the current display format.
↵ FDISP	12 3/8	Displays the number as a fraction.

Now add $\frac{3}{4}$ to the number in the X–register (12 $\frac{3}{8}$):

Keys:	Display:	Description:
□ 3 □ 4	0 3/4_	Displays characters as you key them in.
+	13 1/8	Adds the numbers in the X– and Y–registers; displays the result as a fraction.
↵ FDISP	13.1250	Switches to current decimal display format.

Refer to chapter 5, "Fractions," for more information about using fractions.

Messages

The calculator responds to certain conditions or keystrokes by displaying a message. The **▲** symbol comes on to call your attention to the message.

- To clear a message, press **C** or **↵**.
- To clear a message *and* perform another function, press any other key.

If no message appears but **▲** does, you have pressed an *inactive* key (a key that has no meaning in the current situation, such as **3** in Binary mode).

All displayed messages are explained in appendix F, "Messages".

Calculator Memory

The HP 33s has 31KB of memory in which you can store any combination of data (variables, equations, or program lines).

Checking Available Memory





Pressing   displays the following menu:

```
1VAR 2PGM
31,277
```

Where

31,277 is the number of bytes of memory available.



Pressing the {VAR} menu key displays the catalog of variables (see "Reviewing Variables in the VAR Catalog" in chapter 3). Pressing the {PGM} menu key displays the catalog of programs.

1. To enter the catalog of variables, press {VAR}; to enter the catalog of programs, press {PGM}.
2. To review the catalogs, press  or .
3. To delete a variable or a program, press   while viewing it in its catalog.
4. To exit the catalog, press .

Clearing All of Memory

Clearing all of memory erases all numbers, equations, and programs you've stored. It does not affect mode and format settings. (To clear settings as well as data, see "Clearing Memory" in appendix B.)

To clear all of memory:

1. Press   {ALL}. You will then see the confirmation prompt CLR ALL? {Y} {N}, which safeguards against the unintentional clearing of memory.
2. Press {Y} (yes).

RPN: The Automatic Memory Stack

This chapter explains how calculations take place in the automatic memory stack in RPN mode. *You do not need to read and understand this material to use the calculator*, but understanding the material will greatly enhance your use of the calculator, especially when programming.

In part 2, "Programming", you will learn how the stack can help you to manipulate and organize data for programs.

What the Stack Is

Automatic storage of intermediate results is the reason that the HP 33s easily processes complex calculations, and does so without parentheses. The key to automatic storage is the *automatic, RPN memory stack*.

HP's operating logic is based on an unambiguous, *parentheses-free* mathematical logic known as "Polish Notation," developed by the Polish logician Jan Łukasiewicz (1878–1956).

While conventional algebraic notation places the operators *between* the relevant numbers or variables, Łukasiewicz's notation places them *before* the numbers or variables. For optimal efficiency of the stack, we have modified that notation to specify the operators after the numbers. Hence the term *Reverse Polish Notation*, or RPN.

The stack consists of four storage locations, called *registers*, which are "stacked" on top of each other. These registers — labeled X, Y, Z, and T — store and manipulate four current numbers. The "oldest" number is stored in the T- (*top*) register. The stack is the work area for calculations.

T	0.0000	"Oldest" number
Z	0.0000	
Y	0.0000	Displayed
X	0.0000	Displayed

The most "recent" number is in the X-register: *this is the number you see in the second line of the display.*





In programming, the stack is used to perform calculations, to temporarily store intermediate results, to pass stored data (variables) among programs and subroutines, to accept input, and to deliver output.

The X and Y-Registers are in the Display

The X and Y-Registers are what you see *except* when a menu, a message, or a program line is being displayed. You might have noticed that several function names include an x or y.

This is no coincidence: these letters refer to the X- and Y-registers. For example,  10^x raises ten to the power of the number in the X-register.

Clearing the X-Register

Pressing  $\{x\}$ *always* clears the X-register to zero; it is also used to program this instruction. The  key, in contrast, is context-sensitive. It either clears or cancels the current display, depending on the situation: it acts like  $\{x\}$ only when the X-register is displayed.  also acts like  $\{x\}$ when the X-register is displayed *and* digit entry is terminated (no cursor present). It *cancels* other displays: menus, labeled numbers, messages, equation entry, and program entry.

Reviewing the Stack

R↓ (Roll Down)

The **R↓** (*roll down*) key lets you review the entire contents of the stack by "rolling" the contents downward, one register at a time. You can see each number when it enters the X-register.

Suppose the stack is filled with 1, 2, 3, 4. (press 1 **ENTER** 2 **ENTER** 3 **ENTER** 4) Pressing **R↓** four times rolls the numbers all the way around and back to where they started:

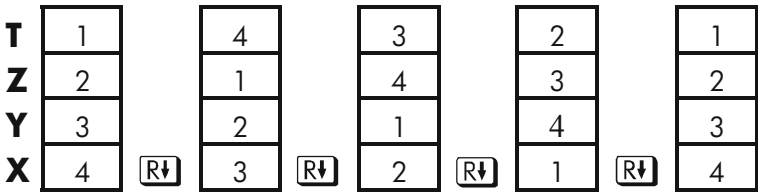

What was in the X-register *rotates* into the T-register, the contents of the T-register rotate into the Z-register, etc. Notice that only the *contents* of the registers are rolled — the registers themselves maintain their positions, and only the X- and Y-register's contents are displayed.

R↑ (Roll Up)

The **R↑** (*roll up*) key has a similar function to **R↓** except that it "rolls" the stack contents upward, one register at a time.

The contents of the X-register rotate into the Y-register; what was in the T-register rotates into the X-register, and so on.

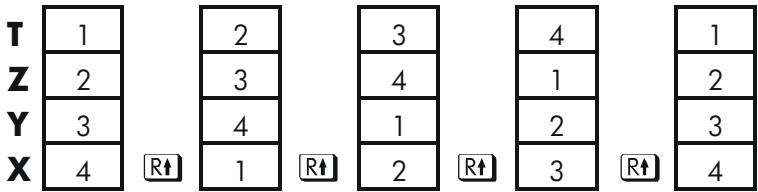

Exchanging the X- and Y-Registers in the Stack

Another key that manipulates the stack contents is $\boxed{x \leftrightarrow y}$ (*x exchange y*). This key swaps the contents of the X- and Y-registers without affecting the rest of the stack. Pressing $\boxed{x \leftrightarrow y}$ twice restores the original order of the X- and Y-register contents.

The $\boxed{x \leftrightarrow y}$ function is used primarily to swap the order of numbers in a calculation. For example, one way to calculate $9 \div (13 \times 8)$:

Press 13 $\boxed{\text{ENTER}}$ 8 $\boxed{\times}$ 9 $\boxed{x \leftrightarrow y}$ $\boxed{\div}$.

The keystrokes to calculate this expression from *left-to-right* are:

9 $\boxed{\text{ENTER}}$ 13 $\boxed{\text{ENTER}}$ 8 $\boxed{\times}$ $\boxed{\div}$.

Note



Always make sure that there are no more than four numbers in the stack at any given time — the contents of the T-register (the top register) will be lost whenever a fifth number is entered.

Arithmetic – How the Stack Does It

The contents of the stack move up and down automatically as new numbers enter the X-register (*lifting the stack*) and as operators combine two numbers in the X- and Y-registers to produce one new number in the X-register (*dropping the stack*).

Suppose the stack is filled with the numbers 1, 2, 3, and 4. See how the stack drops and lifts its contents while calculating

$$3 + 4 - 9$$

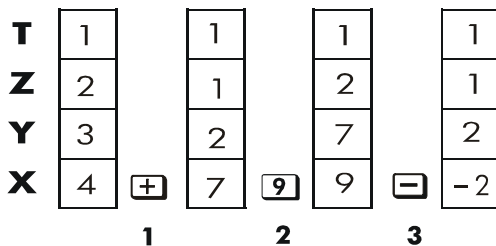

1. The stack "drops" its contents. The T-(top) register *replicates* its contents.
2. The stack "lifts" its contents. The T-register's contents are *lost*.

3. The stack drops.

- Notice that when the stack lifts, it replaces the contents of the T- (top) register with the contents of the Z-register, and that the *former* contents of the T-register are lost. You can see, therefore, that the stack's memory is limited to four numbers.
- Because of the automatic movements of the stack, you do *not* need to clear the X-register before doing a new calculation.
- Most functions prepare the stack to lift its contents *when the next number enters the X-register*. See appendix B for lists of functions that disable stack lift.

How ENTER Works

You know that **ENTER** separates two numbers keyed in one after the other. In terms of the stack, how does it do this? Suppose the stack is again filled with 1, 2, 3, and 4. Now enter and add two new numbers:

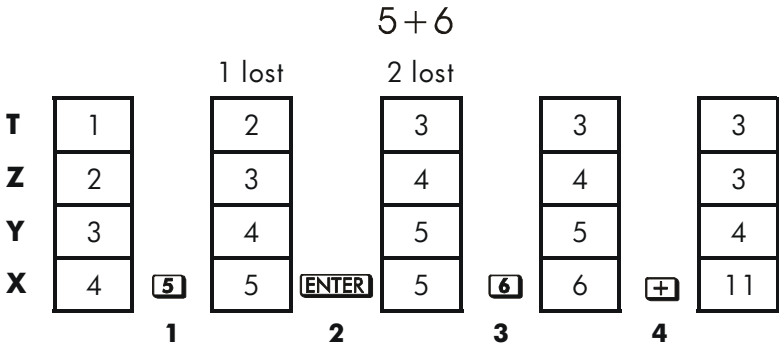

1. Lifts the stack.
2. Lifts the stack and replicates the X-register.
3. Does *not* lift the stack.
4. Drops the stack and replicates the T-register.

ENTER replicates the contents of the X-register into the Y-register. The next number you key in (or recall) *writes over* the copy of the first number left in the X-register. The effect is simply to separate two sequentially entered numbers.

You can use the replicating effect of **ENTER** to clear the stack quickly: press 0 **ENTER** **ENTER** **ENTER**. All stack registers now contain zero. Note, however, that you don't *need* to clear the stack before doing calculations.

Using a Number Twice in a Row

You can use the replicating feature of **[ENTER]** to other advantages. To add a number to itself, press **[ENTER]** **[+]**.

Filling the stack with a constant

The replicating effect of **[ENTER]** together with the replicating effect of stack drop (from T into Z) allows you to fill the stack with a numeric constant for calculations.

Example:

Given bacterial culture with a constant growth rate of 50% per day, how large would a population of 100 be at the end of 3 days?

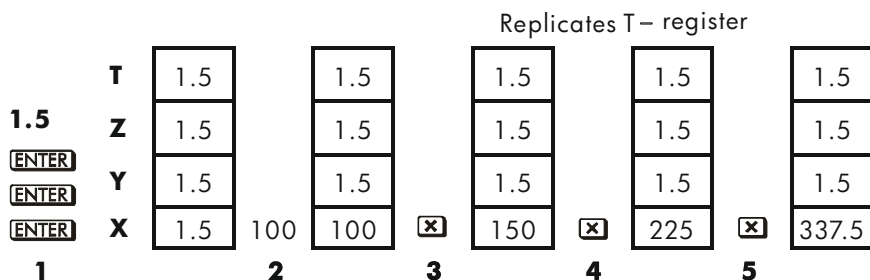

1. Fills the stack with the growth rate.
2. Keys in the initial population.
3. Calculates the population after 1 day.
4. Calculates the population after 2 days.
5. Calculates the population after 3 days.

How CLEAR x Works

Clearing the X-register puts a zero in the X-register. The next number you key in (or recall) *writes over* this zero.

There are three ways to clear the contents of the X-register, that is, to clear x:

1. Press **[C]**
2. Press **[←]**
3. Press **[←] [CLEAR] {x}** (Mainly used during program entry.)

Note these exceptions:

- During program entry, \leftarrow deletes the currently–displayed program line and C cancels program entry.
- During digit entry, \leftarrow backspaces over the displayed number.
- If the display shows a *labeled* number (such as $R=2 \cdot 0000$), pressing C or \leftarrow cancels that display and shows the X–register.
- When viewing an equation, \leftarrow displays the cursor at the end the equation to allow for editing.
- During equation entry, \leftarrow backspaces over the displayed equation, one function at a time.

For example, if you intended to enter 1 and 3 but mistakenly entered 1 and 2, this is what you should do to correct your error:

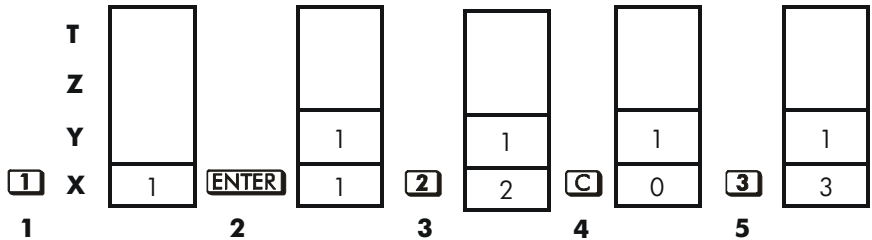

1. Lifts the stack
2. Lifts the stack and replicates the X–register.
3. Overwrites the X–register.
4. Clears x by overwriting it with zero.
5. Overwrites x (replaces the zero.)

The LAST X Register

The LAST X register is a companion to the stack: it holds the number that was in the X–register before the last numeric function was executed. (A numeric function is an operation that produces a result from another number or numbers, such as \sqrt{x} .) Pressing \leftarrow LAST X returns this value into the X–register.

This ability to retrieve the "last x" has two main uses:

1. Correcting errors.

2. Reusing a number in a calculation.

See appendix B for a comprehensive list of the functions that save x in the LAST X register.

Correcting Mistakes with LAST X

Wrong One-Number Function

If you execute the wrong one-number function, use \leftarrow [LAST X] to retrieve the number so you can execute the correct function. (Press [C] first if you want to clear the incorrect result from the stack.)

Since [%] and \leftarrow [%CHG] don't cause the stack to drop, you can recover from these functions in the same manner as from one-number functions.

Example:

Suppose that you had just computed $\ln 4.7839 \times (3.879 \times 10^5)$ and wanted to find its square root, but pressed e^x by mistake. You don't have to start over! To find the correct result, press \leftarrow [LAST X] \sqrt{x} .

Mistakes with Two-number Functions

If you make a mistake with a two-number operation, ([+], [-], [x], [\div], [y^x], \leftarrow [INT \div], \leftarrow [Rmdr], [$\sqrt[y]{x}$], \leftarrow [nCr], \leftarrow [nPr], [%] or \leftarrow [%CHG]), you can correct it by using \leftarrow [LAST X] and the *inverse* of the two-number function.

1. Press \leftarrow [LAST X] to recover the second number (x just before the operation).
2. Execute the inverse operation. This returns the number that was originally first. The second number is still in the LAST X register. Then:
 - If you had used the *wrong function*, press \leftarrow [LAST X] again to restore the original stack contents. Now execute the correct function.
 - If you had used the *wrong second number*, key in the correct one and execute the function.

If you had used the *wrong first number*, key in the correct first number, press \leftarrow [LAST X] to recover the second number, and execute the function again. (Press [C] first if you want to clear the incorrect result from the stack.)

Example:

Suppose you made a mistake while calculating

$$16 \times 19 = 304$$

There are three kinds of mistakes you could have made:

Wrong Calculation:	Mistake:	Correction:
16 ENTER 19 =	Wrong function	↶ LASTx +
15 ENTER 19 ×	Wrong first number	↶ LASTx ×
16 ENTER 18 ×	Wrong second number	↶ LASTx ÷ 19 ×

Reusing Numbers with LAST X

You can use **↶** **LASTx** to reuse a number (such as a constant) in a calculation. Remember to enter the constant second, just before executing the arithmetic operation, so that the constant is the last number in the X-register, and therefore can be saved and retrieved with **↶** **LASTx**.

Example:

Calculate $\frac{96.704 + 52.3947}{52.3947}$

T	t		t		t
Z	z		z		t
96.704 Y	96.7040		96.7040		z
ENTER X	96.7040	52.3947	52.3947	+	149.0987

LAST X	/		/		52.3947
--------	---	--	---	--	---------

T	t		t
Z	z		t
Y	149.0987		z
↶ LAST x X	52.3947	+	2.8457

LAST X	52.3947		52.3947
--------	---------	--	---------

Keys:

Display:

Description:

96.704 **ENTER**

96.7040

Enters first number.

52.3947 **+**

149.0987

Intermediate result.

↶ **LAST x**

52.3947

Brings back display from before **+**.

÷

2.8457

Final result.

Example:

Two close stellar neighbors of Earth are Rigel Centaurus (4.3 light-years away) and Sirius (8.7 light-years away). Use c , the speed of light (9.5×10^{15} meters per year) to convert the distances from the Earth to these stars into meters:

To Rigel Centaurus: $4.3 \text{ yr} \times (9.5 \times 10^{15} \text{ m/yr})$.

To Sirius: $8.7 \text{ yr} \times (9.5 \times 10^{15} \text{ m/yr})$.

Keys:

Display:

Description:

4.3 **ENTER**

4.3000

Light-years to Rigel Centaurus.

9.5	[E]	15	9.5E15_	Speed of light, c.
	[X]		4.0850E16	Meters to R. Centaurus.
8.7	[↵]	[LASTx]	9.5000E15	Retrieves c.
	[X]		8.2650E16	Meters to Sirius.

Chain Calculations in RPN mode

In RPN mode, the automatic lifting and dropping of the stack's contents let you retain intermediate results without storing or reentering them, and without using parentheses.

Work from the Parentheses Out

For example, solve $(12 + 3) \times 7$.

If you were working out this problem on paper, you would first calculate the intermediate result of $(12 + 3)$...

$$(12 + 3) = 15$$

... then you would multiply the intermediate result by 7:

$$(15) \times 7 = 105$$

Solve the problem in the same way on the HP 33s, starting *inside* the parentheses:

Keys:	Display:	Description:
12 [ENTER] 3 [+]	15.0000	Calculates the intermediate result first.

You don't need to press **[ENTER]** to save this intermediate result before proceeding; since it is a *calculated* result, it is saved automatically.

Keys:	Display:	Description:
7 [X]	105.0000	Pressing the function key produces the answer. This result can be used in further calculations.

Now study the following examples. Remember that you need to press **ENTER** only to separate *sequentially-entered* numbers, such as at the beginning of a problem. The operations themselves (**+**, **-**, etc.) separate subsequent numbers and save intermediate results. The last result saved is the first one retrieved as needed to carry out the calculation.

Calculate $2 \div (3 + 10)$:

Keys:	Display:	Description:
3 ENTER 10 +	13.0000	Calculates $(3 + 10)$ first.
2 x\leftrightarrowy \div	0.1538	Puts 2 <i>before</i> 13 so the division is correct: $2 \div 13$.

Calculate $4 \div [14 + (7 \times 3) - 2]$:

Keys:	Display:	Description:
7 ENTER 3 x	21.0000	Calculates (7×3) .
14 + 2 -	33.0000	Calculates denominator.
4 x\leftrightarrowy	33.0000	Puts 4 <i>before</i> 33 in preparation for division.
\div	0.1212	Calculates $4 \div 33$, the answer.

Problems that have multiple parentheses can be solved in the same manner using the automatic storage of intermediate results. For example, to solve $(3 + 4) \times (5 + 6)$ on paper, you would first calculate the quantity $(3 + 4)$. Then you would calculate $(5 + 6)$. Finally, you would multiply the two intermediate results to get the answer.

Work through the problem the same way with the HP 33s, except that you don't have to write down intermediate answers—the calculator remembers them for you.

Keys:	Display:	Description:
3 ENTER 4 +	7.0000	First adds $(3+4)$
5 ENTER 6 +	11.0000	Then adds $(5+6)$
x	77.0000	Then multiplies the intermediate answers together for the final answer.

Exercises

Calculate:

$$\frac{\sqrt{(16.3805 \times 5)}}{0.05} = 181.0000$$

Solution:

$$16.3805 \text{ [ENTER] } 5 \text{ [x] } \sqrt{x} \text{ .05 } \div$$

Calculate:

$$\sqrt{[(2+3) \times (4+5)]} + \sqrt{[(6+7) \times (8+9)]} = 21.5743$$

Solution:

$$2 \text{ [ENTER] } 3 \text{ [+]} 4 \text{ [ENTER] } 5 \text{ [+]} \text{ [x] } \sqrt{x} \text{ 6 [ENTER] } 7 \text{ [+]} 8 \text{ [ENTER] } 9 \text{ [+]} \text{ [x] } \sqrt{x} \text{ [+]}$$

Calculate:

$$(10 - 5) \div [(17 - 12) \times 4] = 0.2500$$

Solution:

$$17 \text{ [ENTER] } 12 \text{ [-]} 4 \text{ [x] } 10 \text{ [ENTER] } 5 \text{ [-]} \text{ [x} \leftrightarrow \text{y]} \div$$

or

$$10 \text{ [ENTER] } 5 \text{ [-]} 17 \text{ [ENTER] } 12 \text{ [-]} 4 \text{ [x] } \div$$

Order of Calculation

We recommend solving chain calculations by working from the innermost parentheses outward. However, you can also choose to work problems in a left-to-right order.

For example, you have already calculated:

$$4 \div [14 + (7 \times 3) - 2]$$

by starting with the innermost parentheses (7×3) and working outward, just as you would with pencil and paper. The keystrokes were 7 [ENTER] 3 [x] 14 [+]
2 [-] 4 [x↔y] ÷.

If you work the problem from left-to-right, press

$$4 \text{ [ENTER] } 14 \text{ [ENTER] } 7 \text{ [ENTER] } 3 \text{ [x] } \text{ [+]} 2 \text{ [-]} \div.$$

This method takes one additional keystroke. Notice that the first intermediate result is still the innermost parentheses (7×3). The advantage to working a problem left-to-right is that you don't have to use $\boxed{x \leftrightarrow y}$ to reposition operands for *noncommutative* functions ($\boxed{-}$ and $\boxed{\div}$).

However, the first method (starting with the innermost parentheses) is often preferred because:

- It takes fewer keystrokes.
- It requires fewer registers in the stack.

Note



When using the *left-to-right* method, be sure that no more than *four* intermediate numbers (or results) will be needed at one time (the stack can hold no more than four numbers).

The above example, when solved *left-to-right*, needed all registers in the stack at one point:

Keys:	Display:	Description:
4 $\boxed{\text{ENTER}}$ 14 $\boxed{\text{ENTER}}$	14.0000	Saves 4 and 14 as intermediate numbers in the stack.
7 $\boxed{\text{ENTER}}$ 3	3_	At this point the stack is full with numbers for this calculation.
$\boxed{\times}$	21.0000	Intermediate result.
$\boxed{+}$	35.0000	Intermediate result.
2 $\boxed{-}$	33.0000	Intermediate result.
$\boxed{\div}$	0.1212	Final result.

More Exercises

Practice using RPN by working through the following problems:

Calculate:

$$(14 + 12) \times (18 - 12) \div (9 - 7) = 78.0000$$

A Solution:

14 [ENTER] 12 [+] 18 [ENTER] 12 [-] [x] 9 [ENTER] 7 [-] [÷]

Calculate:

$$23^2 - (13 \times 9) + 1/7 = 412.1429$$

A Solution:

23 [x²] 13 [ENTER] 9 [x] [-] 7 [1/x] [+]

Calculate:

$$\sqrt{(5.4 \times 0.8) \div (12.5 - 0.7^3)} = 0.5961$$

Solution:

5.4 [ENTER] .8 [x] .7 [ENTER] 3 [yˣ] 12.5 [x↔y] [-] [÷] [√x]

or

5.4 [ENTER] .8 [x] 12.5 [ENTER] .7 [ENTER] 3 [yˣ] [-] [÷] [√x]

Calculate:

$$\sqrt{\frac{8.33 \times (4 - 5.2) \div [(8.33 - 7.46) \times 0.32]}{4.3 \times (3.15 - 2.75) - (1.71 \times 2.01)}} = 4.5728$$

A Solution:

4 [ENTER] 5.2 [-] 8.33 [x] [←] [LASTx] 7.46 [-] 0.32 [x] [÷] 3.15 [ENTER]
2.75 [-] 4.3 [x] 1.71 [ENTER] 2.01 [x] [-] [÷] [√x]

Storing Data into Variables

The HP 33s has 31KB of *user memory*: memory that you can use to store numbers, equations, and program lines. Numbers are stored in locations called *variables*, each named with a letter from A through Z. (You can choose the letter to remind you of what is stored there, such as *B* for *bank balance* and *C* for the speed of light.)

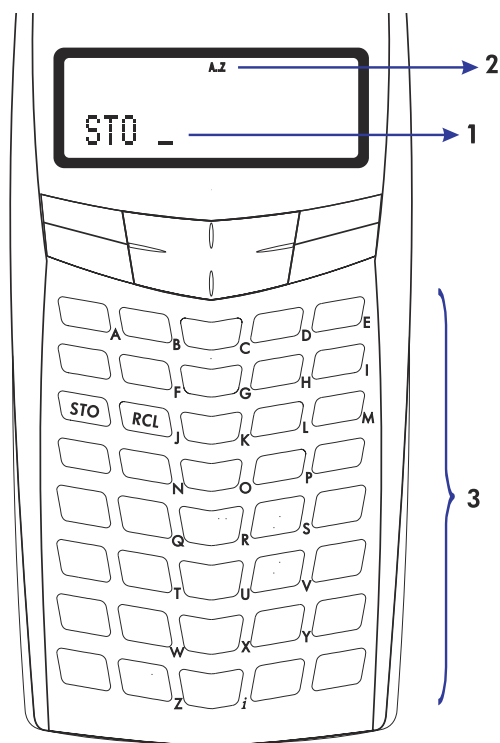

1. Cursor prompts for variable.
2. Indicates letter keys are active.
3. Letter keys.

Each black letter is associated with a key and a unique variable. The letter keys are automatically active when needed. (The **A..Z** annunciator in the display confirms this.)

Note that the variables, *X*, *Y*, *Z* and *T* are *different* storage locations from the X-register, Y-register, Z-register, and T-register in the stack.

Storing and Recalling Numbers

Numbers are stored into and recalled from lettered variables with the **STO** (*store*) and **RCL** (*recall*) functions.

To store a copy of a displayed number (X-register) to a variable:

Press **STO** *letter-key*.

To recall a copy of a number from a variable to the display:

Press **RCL** *letter-key*.

Example: Storing Numbers.

Store Avogadro's number (approximately 6.0221×10^{23}) in A.

Keys:	Display:	Description:
6.0221 E 23	6.0221E23_	Avogadro's number.
STO	STO _	Prompts for variable.
A (hold e^x key)	STO A	Displays function as long as key is held down.
(release)	6.0221E23	Stores a copy of Avogadro's number in A. This also terminates digit entry (no cursor present).
C	0.0000	Clears the number in the display.
RCL	RCL _	Prompts for variable.
A	6.0221E23	Copies Avogadro's number from A the display.

Viewing a Variable without Recalling It

The **VIEW** function shows you the contents of a variable without putting that number in the X-register. The display is labeled for the variable, such as:

```
R=  
1234.5678
```

In Fraction-display mode (**FDISP**), part of the integer may be dropped. This will be indicated by "..." at the left end of the integer.

To see the full mantissa, press **SHOW**. The integer part is the portion to the left of the radix (· or ,).

VIEW is most often used in programming, but it is useful anytime you want to view a variable's value without affecting the contents of the stack.

To cancel the VIEW display, press **←** or **C** once.

Reviewing Variables in the VAR Catalog

The **MEM** (*memory*) function provides information about memory:

```
1VAR 2PGM  
nn.nnn
```

where *nn,nnn* is the number of bytes of available memory.

Pressing the {VAR} menu key displays the catalog of variables.

Pressing the {PGM} menu key displays the catalog of programs.

To review the values at any or all non-zero variables:

1. Press **MEM** {VAR}.
2. Press **↓** or **↑** to move the list and display the desired variable. (Note the **↑↓** annunciators, indicating that the **↓** and **↑** keys are active. If Fraction-display mode is active, **▲▼** indicator will not be turned on to indicate accuracy.)

To see all the significant digits of a number displayed in the {VAR} catalog, press **SHOW**. (If it is a binary number with more than 12 digits, use the **←** and **→** keys to see the rest.)

3. To copy a displayed variable from the catalog to the X-register, press **ENTER**.
4. To clear a variable to zero, press **MEM** **CLEAR** while it is displayed in the catalog.
5. Press **C** to cancel the catalog.

Clearing Variables

Variables' values are retained by Continuous Memory until you replace them or clear them. *Clearing* a variable stores a zero there; a value of zero takes no memory.

To clear a single variable:

Store zero in it: Press 0 **[STO]** variable.

To clear selected variables:

1. Press **[←]** **[MEM]** {VAR:} and use **[↓]** or **[↑]** to display the variable.
2. Press **[←]** **[CLEAR]**.
3. Press **[C]** to cancel the catalog.

To clear all variables at once:

Press **[←]** **[CLEAR]** {VARS}.

Arithmetic with Stored Variables

Storage arithmetic and *recall arithmetic* allow you to do calculations with a number stored in a variable *without recalling the variable into the stack*. A calculation uses one number from the X-register and one number from the specified variable.

Storage Arithmetic

Storage arithmetic uses **[STO]** **[+]**, **[STO]** **[-]**, **[STO]** **[x]**, or **[STO]** **[÷]** to do arithmetic in the variable itself and to store the result there. It uses the value in the X-register and does not affect the stack.

New value of variable = Previous value of variable {+, −, ×, ÷} x.

For example, suppose you want to reduce the value in A(15) by the number in the X-register (3, displayed). Press **[STO]** **[-]** A. Now A = 12, while 3 is still in the display.

A 15

A 12

Result: 15 - 3
that is, A - x

T t
Z z
Y y
X 3

STO - A

T t
Z z
Y y
X 3

Recall Arithmetic

Recall arithmetic uses **RCL** **+**, **RCL** **-**, **RCL** **x**, or **RCL** **÷** to do arithmetic in the X-register using a recalled number and to leave the result in the display. Only the X-register is affected.

New x = Previous x {+, -, x, ÷} Variable

For example, suppose you want to divide the number in the X-register (3, displayed) by the value in A(12). Press **RCL** **÷** A. Now x = 0.25, while 12 is still in A. Recall arithmetic saves memory in programs: using **RCL** **+** A (one instruction) uses half as much memory as **RCL** A, **+** (two instructions).

A 12

A 12

T t
Z z
Y y
X 3

RCL ÷ A

T t
Z z
Y y
X 0.25

Result: 3 ÷ 12
that is, x ÷ 12

Example:

Suppose the variables D, E, and F contain the values 1, 2, and 3. Use storage arithmetic to add 1 to each of those variables.

Keys:	Display:	Description:
1 [STO] D	1.0000	Stores the assumed values into the variable.
2 [STO] E	2.0000	
3 [STO] F	3.0000	
1 [STO] [+] D [STO] [+] E [STO] [+] F	1.0000	Adds 1 to <i>D</i> , <i>E</i> , and <i>F</i> .
[→] [VIEW] D	D= 2.0000	Displays the current value of <i>D</i> .
[→] [VIEW] E	E= 3.0000	
[→] [VIEW] F	F= 4.0000	
[←]	1.0000	

Suppose the variables *D*, *E*, and *F* contain the values 2, 3, and 4 from the last example. Divide 3 by *D*, multiply it by *E*, and add *F* to the result.

Keys:	Display:	Description:
3 [RCL] [÷] D	1.5000	Calculates $3 \div D$.
[RCL] [×] E	4.5000	$3 \div D \times E$.
[RCL] [+] F	8.5000	$3 \div D \times E + F$.

Exchanging x with Any Variable

The **[→]** **[X↔]** key allows you to exchange the contents of *x* (the displayed *X*-register) with the contents of any variable. Executing this function does not affect the *Y*-, *Z*-, or *T*-registers

Example:

Keys:	Display:	Description:
12 [STO] A	12.0000	Stores 12 in variable <i>A</i> .
3	3_	Displays <i>x</i> .

  A 12.0000

Exchanges contents of the X-register and variable A.

  A 3.0000

Exchanges contents of the X-register and variable A.

A

12

A

3

T

<i>t</i>

T

<i>t</i>

Z

<i>z</i>

Z

<i>z</i>

Y

<i>y</i>

Y

<i>y</i>

X

3

X

12

The Variable "i"

There is a 27th variable that you can access directly — the variable *i*. The  key is labeled "i", and it means *i* whenever the **A..Z** annunciator is on. Although it stores numbers as other variables do, *i* is special in that it can be used to refer to *other* variables, including the statistics registers, using the **(i)** function. This is a programming technique called *indirect addressing* that is covered under "Indirectly Addressing Variables and Labels" in chapter 13.

Real-Number Functions

This chapter covers most of the calculator's functions that perform computations on real numbers, including some numeric functions used in programs (such as ABS, the absolute-value function):

- Exponential and logarithmic functions.
- Quotient and Remainder of Divisions.
- Power functions. ($\boxed{x^y}$ and $\boxed{\sqrt[y]{x}}$)
- Trigonometric functions.
- Hyperbolic functions.
- Percentage functions.
- Physics constants
- Conversion functions for coordinates, angles, and units.
- Probability functions.
- Parts of numbers (number-altering functions).

Arithmetic functions and calculations were covered in chapters 1 and 2. Advanced numeric operations (root-finding, integrating, complex numbers, base conversions, and statistics) are described in later chapters.

Exponential and Logarithmic Functions

Put the number in the display, then execute the function — there is no need to press $\boxed{\text{ENTER}}$.

To Calculate:	Press:
Natural logarithm (base e)	$\boxed{\text{LN}}$
Common logarithm (base 10)	$\boxed{\text{LOG}}$
Natural exponential	$\boxed{e^x}$
Common exponential (antilogarithm)	$\boxed{10^x}$

✓ Quotient and Remainder of Division

You can use $\boxed{\text{INT}\div}$ and $\boxed{\text{Rmdr}}$ to produce either the quotient or remainder of division operations involving two integers.

1. Key in the first integer.
2. Press $\boxed{\text{ENTER}}$ to separate the first number from the second.
3. Key in the second number. (Do *not* press $\boxed{\text{ENTER}}$.)
4. Press the function key.

Example:

To display the quotient and remainder produced by $58 \div 9$

Keys:	Display:	Description:
58 $\boxed{\text{ENTER}}$ 9 $\boxed{\text{INT}\div}$	6.0000	Displays the quotient.
58 $\boxed{\text{ENTER}}$ 9 $\boxed{\text{Rmdr}}$	4.0000	Displays the remainder.

Power Functions

To calculate the square of a number x , key in x and press $\boxed{x^2}$.

To calculate the square root of a number x , key in x and press $\boxed{\sqrt{x}}$.

To calculate the cube of a number x , key in x and press $\boxed{x^3}$.

To calculate the cube root of a number x , key in x and press $\boxed{\sqrt[3]{x}}$.

To calculate a power x of 10, key in x and press $\boxed{10^x}$.

- ✓ In RPN mode, to calculate a number y raised to a power x , key in y $\boxed{\text{ENTER}}$ x , then press $\boxed{y^x}$. (For $y > 0$, x can be any number; for $y < 0$, x must be an odd integer; for $y = 0$, x must be positive.)

To Calculate:	Press:	Result:
15 ²	15 $\boxed{x^2}$	225.0000
10 ⁶	6 $\boxed{\leftarrow}$ $\boxed{10^x}$	1,000,000.0000
5 ⁴	5 $\boxed{\text{ENTER}}$ 4 $\boxed{y^x}$	625.0000
2 ^{-1.4}	2 $\boxed{\text{ENTER}}$ 1.4 $\boxed{+/-}$ $\boxed{y^x}$	0.3789
(-1.4) ³	1.4 $\boxed{+/-}$ $\boxed{\text{ENTER}}$ $\boxed{\leftarrow}$ $\boxed{x^3}$	-2.7440
$\sqrt{196}$	196 $\boxed{\sqrt{x}}$	14.0000
$\sqrt[3]{-125}$	125 $\boxed{+/-}$ $\boxed{\leftarrow}$ $\boxed{\sqrt[3]{x}}$	-5.0000

In RPN mode, to calculate a root x of a number y (the x^{th} root of y), key in y $\boxed{\text{ENTER}}$ x , then press $\boxed{\sqrt[y]{x}}$. For $y < 0$, x must be an integer.

To Calculate:	Press:	Result:
$\sqrt[4]{625}$	625 $\boxed{\text{ENTER}}$ 4 $\boxed{\sqrt[y]{x}}$	5.0000
$-1.4\sqrt[3]{.37893}$.37893 $\boxed{\text{ENTER}}$ 1.4 $\boxed{+/-}$ $\boxed{\sqrt[y]{x}}$	2.0000

Trigonometry

Entering π

Press $\boxed{\pi}$ $\boxed{\pi}$ to place the first 12 digits of π into the X-register.

(The number displayed depends on the display format.) Because π is a *function*, it doesn't need to be separated from another number by $\boxed{\text{ENTER}}$.

Note that the calculator cannot *exactly* represent π , since π is an irrational number.

Setting the Angular Mode

The angular mode specifies which unit of measure to assume for angles used in trigonometric functions. The mode does *not* convert numbers already present (see "Conversion Functions" later in this chapter).

$$360 \text{ degrees} = 2\pi \text{ radians} = 400 \text{ grads}$$

To set an angular mode, press **[MODES]**. A menu will be displayed from which you can select an option.

Option	Description	Annunciator
{DEG}	Sets Degrees mode (DEG). Uses decimal degrees, not degrees, minutes, and seconds.	none
{RAD}	Sets Radians mode (RAD).	RAD
{GRAD}	Sets Grads mode (GRAD).	GRAD

Trigonometric Functions

With x in the display:

To Calculate:	Press:
Sine of x .	[SIN]
Cosine of x .	[COS]
Tangent of x .	[TAN]
Arc sine of x .	[\leftarrowASIN]
Arc cosine of x .	[\leftarrowACOS]
Arc tangent of x .	[\leftarrowATAN]

Note



Calculations with the irrational number π cannot be expressed *exactly* by the 12-digit internal precision of the calculator. This is particularly noticeable in trigonometry. For example, the calculated $\sin \pi$ (radians) is not zero but -2.0676×10^{-13} , a very small number close to zero.

Example:

Show that cosine $(5/7)\pi$ radians and cosine 128.57° are equal (to four significant digits).

	Keys:	Display:	Description:
	[MODES] {RAD}		Sets Radians mode; RAD annunciator on.
✓	[.] 5 [.] 7 [ENTER]	0.7143	5/7 in decimal format.
✓	[π] [\times] [COS]	-0.6235	Cos $(5/7)\pi$.
	[MODES] {DEG}	-0.6235	Switches to Degrees mode (no annunciator).
	128.57 [COS]	-0.6235	Calculates $\cos 128.57^\circ$, which is the same as $\cos (5/7)\pi$.

Programming Note:

Equations using inverse trigonometric functions to determine an angle θ , often look something like this:

$$\theta = \arctan (y/x).$$

If $x = 0$, then y/x is undefined, resulting in the error: **DIVIDE BY 0**. For a program, then, it would be more reliable to determine θ by a *rectangular to polar conversion*, which converts (x,y) to (r,θ) . See "Coordinate Conversions" later in this chapter.

Hyperbolic Functions

With x in the display:

To Calculate:	Press:
Hyperbolic sine of x (SINH).	\leftarrow HYP SIN
Hyperbolic cosine of x (COSH).	\leftarrow HYP COS
Hyperbolic tangent of x (TANH).	\leftarrow HYP TAN
Hyperbolic arc sine of x (ASINH).	\leftarrow HYP \leftarrow ASIN
Hyperbolic arc cosine of x (ACOSH).	\leftarrow HYP \leftarrow ACOS
Hyperbolic arc tangent of x (ATANH).	\leftarrow HYP \leftarrow ATAN

Percentage Functions

The percentage functions are special (compared with \times and \div) because they preserve the value of the base number (in the Y-register) when they return the result of the percentage calculation (in the X-register). You can then carry out subsequent calculations using both the base number and the result without reentering the base number.

To Calculate:	Press:
$x\%$ of y	y \leftarrow ENTER \times $\%$
Percentage change from y to x . ($y \neq 0$)	y \leftarrow ENTER \times \leftarrow $\%$ CHG

Example:

Find the sales tax at 6% and the total cost of a \$15.76 item.

Use FIX 2 display format so the costs are rounded appropriately.



Keys:

Display:

Description:

\leftarrow DISPLAY {FIX} 2

Rounds display to two decimal places.

15.76 \leftarrow ENTER

15.76

6 $\%$

0.95

Calculates 6% tax.

$\boxed{+}$

16.71

Total cost (base price + 6% tax).

Suppose that the \$15.76 item cost \$16.12 last year. What is the percentage change from last year's price to this year's?

✓	Keys:	Display:	Description:
	16.12 $\boxed{\text{ENTER}}$	16.12	
	15.76 $\boxed{\rightarrow}$ $\boxed{\%CHG}$	-2.23	This year's price dropped about 2.2% from last year's price.
	$\boxed{\text{DISPLAY}}$ $\boxed{\{FIX\}}$ 4	-2.2333	Restores FIX 4 format.

Note



The order of the two numbers is important for the %CHG function. The order affects whether the percentage change is considered positive or negative.

Physics Constants

There are 40 physics constants in the CONST menu. You can press  **CONST** to view the following items.







CONST Menu

Items	Description	Value
{C}	Speed of light in vacuum	$299792458 \text{ m s}^{-1}$
{g}	Standard acceleration of gravity	9.80665 m s^{-2}
{G}	Newtonian constant of gravitation	$6.673 \times 10^{-11} \text{ m}^3 \text{ kg}^{-1} \text{ s}^{-2}$
{Vm}	Molar volume of ideal gas	$0.022413996 \text{ m}^3 \text{ mol}^{-1}$
{NA}	Avogadro constant	$6.02214199 \times 10^{23} \text{ mol}^{-1}$
{R ∞ }	Rydberg constant	$10973731.5685 \text{ m}^{-1}$
{e}	Elementary charge	$1.602176462 \times 10^{-19} \text{ C}$
{me}	Electron mass	$9.10938188 \times 10^{-31} \text{ kg}$
{mP}	Proton mass	$1.67262158 \times 10^{-27} \text{ kg}$
{mN}	Neutron mass	$1.67492716 \times 10^{-27} \text{ kg}$
{m μ }	Muon mass	$1.88353109 \times 10^{-28} \text{ kg}$
{k}	Boltzmann constant	$1.3806503 \times 10^{-23} \text{ J K}^{-1}$
{h}	Planck constant	$6.62606876 \times 10^{-34} \text{ J s}$
{ \hbar }	Planck constant over 2 pi	$1.054571596 \times 10^{-34} \text{ J s}$
{ ϕ_0 }	Magnetic flux quantum	$2.067833636 \times 10^{-15} \text{ Wb}$
{a $_0$ }	Bohr radius	$5.291772083 \times 10^{-11} \text{ m}$
{ ϵ_0 }	Electric constant	$8.854187817 \times 10^{-12} \text{ F m}^{-1}$
{R}	Molar gas constant	$8.314472 \text{ J mol}^{-1} \text{ K}^{-1}$
{F}	Faraday constant	$96485.3415 \text{ C mol}^{-1}$
{u}	Atomic mass constant	$1.66053873 \times 10^{-27} \text{ kg}$
{ μ_0 }	Magnetic constant	$1.2566370614 \times 10^{-6} \text{ NA}^{-2}$
{ μ_B }	Bohr magneton	$9.27400899 \times 10^{-24} \text{ J T}^{-1}$
{ μ_N }	Nuclear magneton	$5.05078317 \times 10^{-27} \text{ J T}^{-1}$
{ μ_P }	Proton magnetic moment	$1.410606633 \times 10^{-26} \text{ J T}^{-1}$
{ μ_e }	Electron magnetic moment	$-9.28476362 \times 10^{-24} \text{ J T}^{-1}$
{ μ_N }	Neutron magnetic moment	$-9.662364 \times 10^{-27} \text{ J T}^{-1}$
{ μ_μ }	Muon magnetic moment	$-4.49044813 \times 10^{-26} \text{ J T}^{-1}$

Items	Description	Value
{r _e }	Classical electron radius	$2.817940285 \times 10^{-15} \text{ m}$
{Z ₀ }	Characteristic impedance of vacuum	$376.730313461 \ \Omega$
{λ _C }	Compton wavelength	$2.426310215 \times 10^{-12} \text{ m}$
{λ _{Cn} }	Neutron Compton wavelength	$1.319590898 \times 10^{-15} \text{ m}$
{λ _{Cp} }	Proton Compton wavelength	$1.321409847 \times 10^{-15} \text{ m}$
{α}	Fine structure constant	$7.297352533 \times 10^{-3}$
{σ}	Stefan–Boltzmann constant	$5.6704 \times 10^{-8} \text{ W m}^{-2} \text{ K}^{-4}$
{t}	Celsius temperature	273.15
{a t m}	Standard atmosphere	101325 Pa
{γ P}	Proton gyromagnetic ratio	$267522212 \text{ s}^{-1} \text{ T}^{-1}$
{C1}	First radiation constant	$374177107 \times 10^{-16} \text{ W m}^2$
{C2}	Second radiation constant	0.014387752 m K
{G ₀ }	Conductance quantum	$7.748091696 \times 10^{-5} \text{ S}$

Reference: Peter J.Mohr and Barry N.Taylor, CODATA Recommended Values of the Fundamental Physical Constants: 1998, Journal of Physical and Chemical Reference Data, Vol.28, No.6, 1999 and Reviews of Modern Physics, Vol.72, No.2, 2000.

To insert a constant:

1. Position your cursor where you want the constant inserted.
2. Press  **CONST** to display the physics constants menu.
3. Press     (or, you can press  **CONST** to access the next page, one page at a time) to scroll through the menu until the constant you want is underlined, then press **ENTER** to insert the constant.

Conversion Functions

There are four types of conversions: coordinate (polar/rectangular), angular (degrees/radians), time (decimal/minutes–seconds), and unit (cm/in, °C/°F, l/gal, kg/lb).

Coordinate Conversions

The function names for these conversions are $y, x \rightarrow \theta, r$ and $\theta, r \rightarrow y, x$.

Polar coordinates (r, θ) and rectangular coordinates (x, y) are measured as shown in the illustration. The angle θ uses units set by the current angular mode. A calculated result for θ will be between -180° and 180° , between $-\pi$ and π radians, or between -200 and 200 grads.

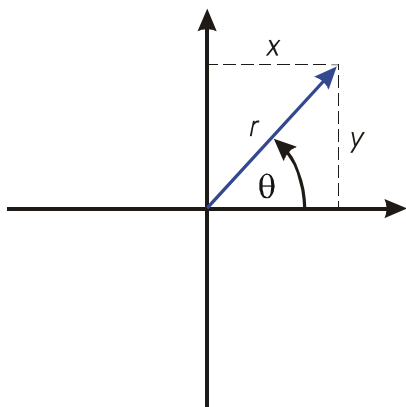

To convert between rectangular and polar coordinates:

1. Enter the coordinates (in rectangular or polar form) that you want to convert. In RPN mode, the order is y **ENTER** x or θ **ENTER** r .
2. Execute the conversion you want: press **↶** **→ θ, r** (rectangular-to-polar) or **↷** **→ y, x** (polar-to-rectangular). The converted coordinates occupy the X- and Y-registers.
3. The resulting display (the X-register) shows either r (polar result) or x (rectangular result). Press **↔** to see θ or y .

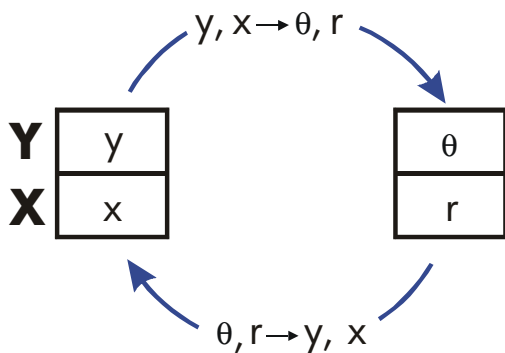

Example: Polar to Rectangular Conversion.

In the following right triangles, find sides x and y in the triangle on the left, and hypotenuse r and angle θ in the triangle on the right.

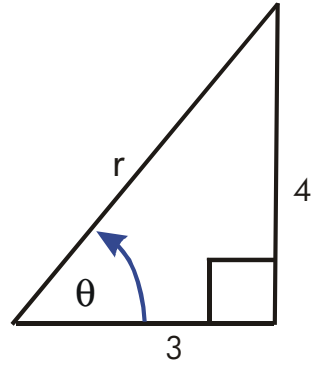
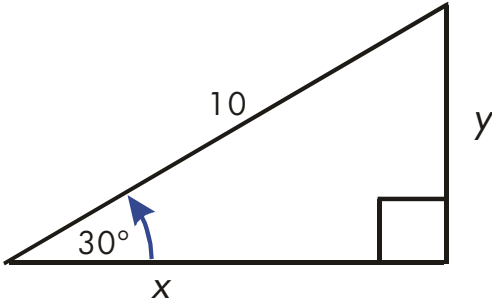

Keys:

Display:

Description:

	<code>MODES</code> {DEG}		Sets Degrees mode.
✓	<code>30</code> <code>ENTER</code> <code>10</code> <code>→y,x</code>	<code>8.6603</code>	Calculates x .
	<code>x→y</code>	<code>5.0000</code>	Displays y .
✓	<code>4</code> <code>ENTER</code> <code>3</code> <code>→θ,r</code>	<code>5.0000</code>	Calculates hypotenuse (r).
	<code>x→y</code>	<code>53.1301</code>	Displays θ .

Example: Conversion with Vectors.

Engineer P.C. Bord has determined that in the RC circuit shown, the total impedance is 77.8 ohms and voltage lags current by 36.5° . What are the values of resistance R and capacitive reactance X_C in the circuit?

Use a vector diagram as shown, with impedance equal to the polar magnitude, r , and voltage lag equal to the angle, θ , in degrees. When the values are converted to rectangular coordinates, the x -value yields R , in ohms; the y -value yields X_C , in ohms.

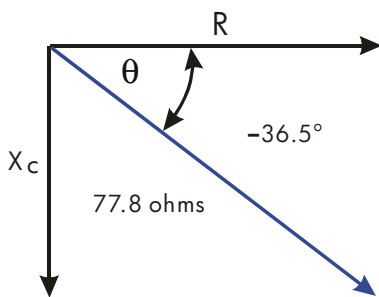
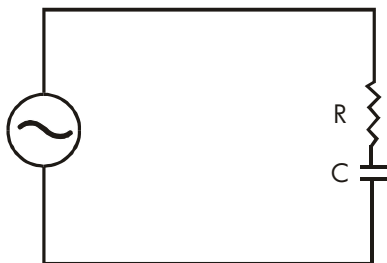

Keys:

Display:

Description:

	[MODES] {DEG}		Sets Degrees mode.
✓	36.5 [+/-] [ENTER]	-36.5000	Enters θ , degrees of voltage lag.
	77.8	77.8_	Enters r , ohms of total impedance.
	[>] [>]x	62.5401	Calculates x , ohms resistance, R .
	[x<]	-46.2772	Displays y , ohms reactance, X_C .

For more sophisticated operations with vectors (addition, subtraction, cross product, and dot product), refer to the "Vector Operations" program in chapter 15, "Mathematics Programs".

Time Conversions

Values for time (in hours, H) or angles (in degrees, D) can be converted between a decimal-fraction form ($H.h$ or $D.d$) and a minutes-seconds form ($H.MMSSss$ or $D.MMSSss$) using the **[>]** **[>]HR** or **[>]** **[>]HMS** keys.

To convert between decimal fractions and minutes-seconds:

1. Key in the time or angle (in decimal form or minutes-seconds form) that you want to convert.
2. Press **[>]** **[>]HMS** or **[>]** **[>]HR**. The result is displayed.

Example: Converting Time Formats.

How many minutes and seconds are there in $1/7$ of an hour? Use FIX 6 display format.

Keys:

Display:

Description:

	[DISPLAY] {FIX} 6		Sets FIX 6 display format.
	[.] 1 [.] 7	0 1/7_	$1/7$ as a decimal fraction.

0.083429

Equals 8 minutes and 34.29 seconds.

 {FIX} 4





0.0834

Restores FIX 4 display format.

Angle Conversions

















When converting to radians, the number in the x-register is assumed to be degrees; when converting to degrees, the number in the x-register is assumed to be radians.

To convert an angle between degrees and radians:

1. Key in the angle (in *decimal* degrees or radians) that you want to convert.
2. Press   or  . The result is displayed.



Unit Conversions

The HP 33s has eight unit-conversion functions on the keyboard: \rightarrow kg, \rightarrow lb, \rightarrow °C, \rightarrow °F, \rightarrow cm, \rightarrow in, \rightarrow l, \rightarrow gal.



To Convert:	To:	Press:	Displayed Results:
1 lb	kg	1  	0.4536 (kilograms)
1 kg	lb	1  	2.2046 (pounds)
32 °F	°C	32  	0.0000 (°C)
100 °C	°F	100  	212.0000 (°F)
1 in	cm	1  	2.5400 (centimeters)
100 cm	in	100  	39.3701 (inches)
1 gal	l	1  	3.7854 (liters)
1 l	gal	1  	0.2642 (gallons)

Probability Functions

Factorial



To calculate the *factorial* of a displayed non-negative integer x ($0 \leq x \leq 253$), press   (the left-shifted  key).

Gamma



To calculate the *gamma function* of a noninteger x , $\Gamma(x)$, key in $(x - 1)$ and press  . The $x!$ function calculates $\Gamma(x + 1)$. The value for x cannot be a negative integer.

Probability



✓ Combinations

To calculate the number of possible sets of n items taken r at a time, enter n first,  , then r (nonnegative integers only). No item occurs more than once in a set, and different orders of the same r items are not counted separately.



✓ Permutations

To calculate the number of possible *arrangements* of n items taken r at a time, enter n first,  , then r (nonnegative integers only). No item occurs more than once in an arrangement, and different orders of the same r items are counted separately.

Seed

To store the number in x as a new seed for the random number generator, press  .



Random number generator

To generate a random number in the range $0 \leq x < 1$, press  . (The number is part of a uniformly-distributed pseudo-random number sequence. It passes the spectral test of D. Knuth, *The Art of Computer Programming*, vol. 2, *Seminumerical Algorithms*, London: Addison Wesley, 1981.)





The RANDOM function uses a seed to generate a random number. Each random number generated becomes the seed for the next random number. Therefore, a sequence of random numbers can be repeated by starting with the same seed. You can store a new seed with the SEED function. If memory is cleared, the seed is reset to zero. A seed of zero will result in the calculator generating its own seed.

Example: Combinations of People.

A company employing 14 women and 10 men is forming a six-person safety committee. How many different combinations of people are possible?

✓	Keys:	Display:	Description:
	24  6	6_	Twenty-four people grouped six at a time.
	 	134,596.0000	Total number of combinations possible.



If employees are chosen at random, what is the probability that the committee will contain six women? To find the *probability* of an event, divide the number of combinations *for that event* by the total number of combinations.

✓	Keys:	Display:	Description:
	14  6	6_	Fourteen women grouped six at a time.
	 	3,003.0000	Number of combinations of six women on the committee.
		134,596.0000	Brings total number of combinations back into the X-register.
		0.0223	Divides combinations of women by total combinations to find probability that any one combination would have all women.



Parts of Numbers

These functions are primarily used in programming.

Integer part

To remove the fractional part of x and replace it with zeros, press  . (For example, the integer part of 14.2300 is 14.0000.)



Fractional part

To remove the integer part of x and replace it with zeros, press  . (For example, the fractional part of 14.2300 is 0.2300)



Absolute value

To replace x with its absolute value, press  .













Sign value



To indicate the sign of x , press  . If the x value is negative, -1.0000 is displayed; if zero, 0.0000 is displayed; if positive, 1.0000 is displayed.

Greatest integer

To obtain the greatest integer equal to or less than given number, press  .

Example:

To calculate:	Press:	Display:
The integer part of 2.47	2.47  	2.0000
The fractional part of 2.47	2.47  	0.4700
The absolute value of -7	7   	7.0000
The sign value of 9	9  	1.0000
The greatest integer equal to or less than -5.3	5.3   	-6.0000

The RND function ( ) rounds x internally to the number of digits specified by the display format. (The internal number is represented by 12 digits.) Refer to chapter 5 for the behavior of RND in Fraction–display mode.

Names of Functions

You might have noticed that the name of a function appears in the display when you press and hold the key to execute it. (The name remains displayed for as long as you hold the key down.) For instance, while pressing $\boxed{\text{SIN}}$, the display shows SIN . "SIN" is the name of the function as it will appear in program lines (and usually in equations also).

Fractions

"Fractions" in chapter 1 introduces the basics about entering, displaying, and calculating with fractions:

- To enter a fraction, press $\frac{\square}{\square}$ *twice* — after the integer part, and between the numerator and denominator. To enter $2\frac{3}{8}$, press 2 $\frac{\square}{\square}$ 3 $\frac{\square}{\square}$ 8. To enter $\frac{5}{8}$, press $\frac{\square}{\square}$ 5 $\frac{\square}{\square}$ 8 or 5 $\frac{\square}{\square}$ $\frac{\square}{\square}$ 8.
- To turn Fraction–display mode on and off, press $\left[\leftarrow\right]$ **[FDISP]**. When you turn off Fraction–display mode, the display goes back to the previous display format. (FIX, SCI, ENG, and ALL also turn off Fraction–display mode.)
- Functions work the same with fractions as with decimal numbers — except for RND, which is discussed later in this chapter.

This chapter gives more information about using and displaying fractions.

Entering Fractions

You can type almost any number as a fraction on the keyboard — including an improper fraction (where the numerator is larger than the denominator). However, the calculator displays \blacktriangle if you disregard these two restrictions:

- The integer and numerator must not contain more than 12 digits total.
- The denominator must not contain more than 4 digits.

Example:

Keys:	Display:	Description:
$\left[\leftarrow\right]$ [FDISP]		Turns on Fraction–display mode.
1.5 [ENTER]	1 1/2	Enters 1.5; shown as a fraction.
1 $\frac{\square}{\square}$ 3 $\frac{\square}{\square}$ 4 [ENTER]	1 3/4	Enters $1\frac{3}{4}$.
$\left[\leftarrow\right]$ [FDISP]	1.7500	Displays x as a decimal number.
$\left[\leftarrow\right]$ [FDISP]	1 3/4	Displays x as a fraction.

If you didn't get the same results as the example, you may have accidentally changed how fractions are displayed. (See "Changing the Fraction Display" later in this chapter.)

The next topic includes more examples of valid and invalid input fractions.

You can type fractions only if the number base is 10 — the normal number base. See chapter 10 for information about changing the number base.

Fractions in the Display

In Fraction–display mode, numbers are evaluated internally as decimal numbers, then they're displayed using the most precise fractions allowed. In addition, accuracy annunciators show the direction of any inaccuracy of the fraction compared to its 12–digit decimal value. (Most statistics registers are exceptions — they're always shown as decimal numbers.)

Display Rules

The fraction you see may differ from the one you enter. In its default condition, the calculator displays a fractional number according to the following rules. (To change the rules, see "Changing the Fraction Display" later in this chapter.)

- The number has an integer part and, if necessary, a proper fraction (the numerator is less than the denominator).
- The denominator is no greater than 4095.
- The fraction is reduced as far as possible.

Examples:

These are examples of entered values and the resulting displays. For comparison, the internal 12–digit values are also shown. The ▲ and ▼ annunciators in the last column are explained below.

Entered Value	Internal Value	Displayed Fraction	
$2 \frac{3}{8}$	2.37500000000	$2 \frac{3}{8}$	
$14 \frac{15}{32}$	14.4687500000	$14 \frac{15}{32}$	
$54/12$	4.50000000000	$4 \frac{1}{2}$	
$6 \frac{18}{5}$	9.60000000000	$9 \frac{3}{5}$	
$34/12$	2.83333333333	$2 \frac{5}{6}$	▼
$15/8192$	0.00183105469	$0 \frac{7}{3823}$	▲
12345678 $12345/3$	(Illegal entry)		▲
$16 \frac{3}{16384}$	(Illegal entry)		▲

Accuracy Indicators

The accuracy of a displayed fraction is indicated by the ▲ and ▼ annunciators at the right of the display. The calculator compares the value of the fractional part of the internal 12-digit number with the value of the displayed fraction:

- If no indicator is lit, the fractional part of the internal 12-digit value exactly matches the value of the displayed fraction.
- If ▼ is lit, the fractional part of the internal 12-digit value is slightly less than the displayed fraction — the *exact* numerator is no more than 0.5 *below* the displayed numerator.
- If ▲ is lit, the fractional part of the internal 12-digit value is slightly greater than the displayed fraction — the *exact* numerator is no more than 0.5 *above* the displayed numerator.

This diagram shows how the displayed fraction relates to nearby values — ▲ means the exact numerator is "a little above" the displayed numerator, and ▼ means the exact numerator is "a little below".

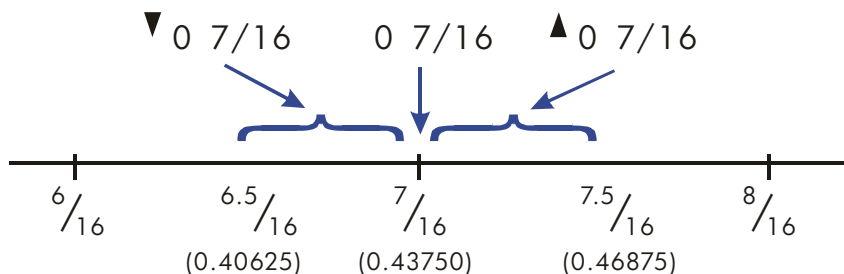



This is especially important if you change the rules about how fractions are displayed. (See "Changing the Fraction Display" later.) For example, if you force all fractions to have 5 as the denominator, then $\frac{2}{3}$ is displayed as $\frac{2}{3} \div 5 \blacktriangle$ because the exact fraction is approximately $\frac{3.3333}{5}$, "a little above" $\frac{3}{5}$. Similarly, $-\frac{2}{3}$ is displayed as $-\frac{2}{3} \div 5 \blacktriangle$ because the true numerator is "a little above" 3.

Sometimes an annunciator is lit when you wouldn't expect it to be. For example, if you enter $2 \frac{2}{3}$, you see $2 \frac{2}{3} \blacktriangle$, even though that's the exact number you entered. The calculator always compares the fractional part of the internal value and the 12-digit value of just the fraction. If the internal value has an integer part, its fractional part contains less than 12 digits — and it can't exactly match a fraction that uses all 12 digits.

Longer Fractions

If the displayed fraction is too long to fit in the display, it's shown with ... at the beginning. The fraction part always fits — the ... means the integer part isn't shown completely. To see the integer part (and the decimal fraction), press and hold  **SHOW**. (You can't scroll a fraction in the display.)

Example:

Keys:	Display:	Description:
14 	...2604 888/3125	Calculates e^{14} .
 SHOW	1202604.28416	Shows all decimal digits.
STO A	...2604 888/3125	Stores value in A.
 VIEW A	A=	Views A.
	...2604 888/3125	
C C	0	Clears x.

Changing the Fraction Display

In its default condition, the calculator displays a fractional number according to certain rules. (See "Display Rules" earlier in this chapter.) However, you can change the rules according to how you want fractions displayed:

- You can set the maximum denominator that's used.







- You can select one of three fraction formats.

The next few topics show how to change the fraction display.

Setting the Maximum Denominator

For any fraction, the denominator is selected based on a value stored in the calculator. If you think of fractions as $a/b/c$, then $/c$ corresponds to the value that controls the denominator.

The $/c$ value defines only the *maximum* denominator used in Fraction–display mode — the specific denominator that's used is determined by the fraction format (discussed in the next topic).

- To set the $/c$ value, press n  , where n is the maximum denominator you want. n can't exceed 4095. This also turns on Fraction–display mode.
- To recall the $/c$ value to the X–register, press 1  .
- To restore the default value or 4095, press 0  . (You also restore the default if you use 4095 or greater.) This also turns on Fraction–display mode.

The $/c$ function uses the absolute value of the integer part of the number in the X–register. It doesn't change the value in the LAST X register.

Choosing a Fraction Format



The calculator has three fraction formats. Regardless of the format, the displayed fractions are always the closest fractions within the rules for that format.

- **Most precise fractions.** Fractions have any denominator up to the $/c$ value, and they're reduced as much as possible. For example, if you're studying math concepts with fractions, you might want any denominator to be possible ($/c$ value is 4095). This is the default fraction format.
- **Factors of denominator.** Fractions have only denominators that are factors of the $/c$ value, and they're reduced as much as possible. For example, if you're calculating stock prices, you might want to see $5\bar{3} \ 1\bar{4}$ and $3\bar{7} \ 7\bar{8}$ ($/c$ value is 8). Or if the $/c$ value is 12, possible denominators are 2, 3, 4, 6, and 12.
- **Fixed denominator.** Fractions always use the $/c$ value as the denominator — they're not reduced. For example, if you're working with time measurements, you might want to see $1 \ 25\bar{60}$ ($/c$ value is 60).

To select a fraction format, you must change the states of two *flags*. Each flag can be "set" or "clear," and in one case the state of flag 9 doesn't matter.

To Get This Fraction Format:	Change These Flags:	
	8	9
Most precise	Clear	—
Factors of denominator	Set	Clear
Fixed denominator	Set	Set

You can change flags 8 and 9 to set the fraction format using the steps listed here. (Because flags are especially useful in programs, their use is covered in detail in chapter 13.)

1. Press  **FLAGS** to get the flag menu.
2. To set a flag, press {**SF**} and type the flag number, such as 8.
To clear a flag, press {**CF**} and type the flag number.
To see if a flag is set, press {**FS?**} and type the flag number. Press  or  to clear the YES or NO response.

Examples of Fraction Displays

The following table shows how the number 2.77 is displayed in the three fraction formats for two */c* values.

Fraction Format	How 2.77 Is Displayed	
	<i>/c</i> = 4095	<i>/c</i> = 16
Most Precise	2 77/100 <small>(2.7700)</small>	2 10/13▲ <small>(2.7692)</small>
Factors of Denominator	2 1051/1365▲ <small>(2.7699)</small>	2 3/4▲ <small>(2.7500)</small>
Fixed Denominator	2 3153/4095▲ <small>(2.7699)</small>	2 12/16▲ <small>(2.7500)</small>

The following table shows how different numbers are displayed in the three fraction formats for a */c* value of 16.

Fraction Format *	Number Entered and Fraction Displayed				
	2	2.5	2 2/3	2.9999	2 ¹⁶ /25
Most precise	2	2 1/2	2 2/3▲	3▼	2 9/14▼
Factors of denominator	2	2 1/2	2 11/16▼	3▼	2 5/8▲
Fixed denominator	2 0/16	2 8/16	2 11/16▼	3 0/16▼	2 10/16▲

* For a /c value of 16.

Example:

Suppose a stock has a current value of $48 \frac{1}{4}$. If it goes down $2 \frac{5}{8}$, what would be its value? What would then be 85 percent of that value?

Keys:

FLAGS {SF} 8

FLAGS {CF} 9

8

48 1 4 **ENTER**

2 5 8

85

Display:

48 1/4

45 5/8

38 3/4 ▲

Description:

Sets flag 8, clears flag 9 for "factors of denominator" format.

Sets up fraction format for $1/8$ increments.

Enters the starting value.

Subtracts the change.

Finds the 85-percent value to the nearest $1/8$.

Rounding Fractions

If Fraction-display mode is active, the RND function converts the number in the X-register to the closest decimal representation of the fraction. The rounding is done according to the current /c value and the states of flags 8 and 9. The accuracy indicator turns off if the fraction matches the decimal representation exactly. Otherwise, the accuracy indicator stays on, (See "Accuracy Indicators" earlier in this chapter.)

In an equation or program, the RND function does fractional rounding if Fraction–display mode is active.

Example:

Suppose you have a $56 \frac{3}{4}$ -inch space that you want to divide into six equal sections. How wide is each section, assuming you can conveniently measure $\frac{1}{16}$ -inch increments? What's the cumulative roundoff error?

	Keys:	Display:	Description:
	16		Sets up fraction format for $\frac{1}{16}$ -inch increments. (Flags 8 and 9 should be the same as for the previous example.)
	56 3 4 D	56 3/4	Stores the distance in <i>D</i> .
✓	6	9 7/16▲	The sections are a bit wider than $9 \frac{7}{16}$ inches.
		9 7/16	Rounds the width to this value.
✓	6	56 5/8	Width of six sections.
✓	D	-0 1/8	The cumulative round off error.
	{CF} 8	-0 1/8	Clears flag 8.
		-0 . 1250	Turns off Fraction–display mode.

Fractions in Equations

When you're typing an equation, you can't type a number as a fraction. When an equation is displayed, all numeric values are shown as decimal values — Fraction–display mode is ignored.

When you're evaluating an equation and you're prompted for variable values, you may enter fractions — values are displayed using the current display format.

See chapter 6 for information about working with equations.

Fractions in Programs

When you're typing a program, you can type a number as a fraction — but it's converted to its decimal value. All numeric values in a program are shown as decimal values — Fraction–display mode is ignored.

When you're running a program, displayed values are shown using Fraction–display mode if it's active. If you're prompted for values by INPUT instructions, you may enter fractions, regardless of the display mode.

A program can control the fraction display using the `/c` function and by setting and clearing flags 7, 8, and 9. Setting flag 7 turns on Fraction–display mode —  `FDISP` isn't programmable. See "Flags" in chapter 13.

See chapters 12 and 13 for information about working with programs.

Entering and Evaluating Equations

How You Can Use Equations

You can use equations on the HP 33s in several ways:

- For specifying an equation to evaluate (this chapter).
- For specifying an equation to solve for unknown values (chapter 7).
- For specifying a function to integrate (chapter 8).

Example: Calculating with an Equation.

Suppose you frequently need to determine the volume of a straight section of pipe. The equation is

$$V = .25 \pi d^2 l$$

where d is the inside diameter of the pipe, and l is its length.

- ✓ You could key in the calculation over and over; for example, $.25$ **ENTER** **π** **×** 2.5 **x²** **×** 16 **×** calculates the volume of 16 inches of 2 1/2-inch diameter pipe (78.5398 cubic inches). However, by storing the *equation*, you get the HP 33s to "remember" the relationship between diameter, length, and volume — so you can use it many times.

Put the calculator in Equation mode and type in the equation using the following keystrokes:

Keys:	Display:	Description:
EQN	EQN LIST TOP or the current equation	Selects Equation mode, shown by the EQN annunciator.

RCL	█	Begins a new equation, turning on the "█" equation-entry cursor. RCL turns on the A..Z annunciator so you can enter a variable name.
V ↵ =	V=█	RCL V types V and moves the cursor to the right.
.25	V= 0.25_	Digit entry uses the "_ " digit-entry cursor.
× ↵ π ×	V=0.25×π×█	× ends the number and restores the "█" cursor.
RCL D y^x 2	V=0.25×π×D ² _	y^x types ^.
× RCL L	V=0.25×π×D ² ×L█	
ENTER	V=0.25×π×D ² ×L	Terminates and displays the equation.
↵ SHOW	CK=49CA LN=14	Shows the checksum and length for the equation, so you can check your keystrokes.

By comparing the checksum and length of your equation with those in the example, you can verify that you've entered the equation properly. (See "Verifying Equations" at the end of this chapter for more information.)

















Evaluate the equation (to calculate V):

Keys:	Display:	Description:
ENTER	D? value	Prompts for variables on the right-hand side of the equation. Prompts for D first; value is the current value of D.
2 □ 1 □ 2	D? 2 1/2_	Enters 2 1/2 inches as a fraction.
R/S	L? value	Stores D, prompts for L; value is current value of L.
16 R/S	V= 78.5398	Stores L; calculates V in cubic inches and stores the result in V.

Summary of Equation Operations

All equations you create are saved in the *equation list*. This list is visible whenever you activate Equation mode.

You use certain keys to perform operations involving equations. They're described in more detail later.

Key	Operation
 EQN	Enters and leaves Equation mode.
	Evaluates the displayed equation. If the equation is an <i>assignment</i> , evaluates the right-hand side and stores the result in the variable on the left-hand side. If the equation is an <i>equality</i> or <i>expression</i> , calculates its value like  . (See "Types of Equations" later in this chapter.)
	Evaluates the displayed equation. Calculates its value, replacing "=" with "-" if an "=" is present.
	Solves the displayed equation for the unknown variable you specify. (See chapter 7.)
 	Integrates the displayed equation with respect to the variable you specify. (See chapter 8.)
	Begins editing the displayed equation; subsequent presses delete the rightmost function or variable.
 CLEAR	Deletes the displayed equation from the equation list.
 or 	Steps up or down through the equation list.
 	Goes to the top line of the equation or program list.
 	Goes to the last line of the equation or program list.
 SHOW	Shows the displayed equation's checksum (verification value) and length (bytes of memory).
	Leaves Equation mode.

You can also use equations in programs — this is discussed in chapter 12.

Entering Equations into the Equation List

The *equation list* is a collection of equations you enter. The list is saved in the calculator's memory. Each equation you enter is automatically saved in the equation list.

To enter an equation:

1. Make sure the calculator is in its normal operating mode, usually with a number in the display. For example, you can't be viewing the catalog of variables or programs.
2. Press $\boxed{\rightarrow}$ $\boxed{\text{EQN}}$. The **EQN** annunciator shows that Equation mode is active, and an entry from the equation list is displayed.
3. Start typing the equation. The previous display is replaced by the equation you're entering — the previous equation isn't affected. If you make a mistake, press $\boxed{\leftarrow}$ as required. You can enter up to 255 characters per equation.
4. Press $\boxed{\text{ENTER}}$ to terminate the equation and see it in the display. The equation is automatically saved in the equation list — right after the entry that was displayed when you started typing. (If you press $\boxed{\text{C}}$ instead, the equation is saved, but Equation mode is turned off.)

Equations can contain variables, numbers, functions, and parentheses — they're described in the following topics. The example that follows illustrates these elements.

Variables in Equations

You can use any of the calculator's 28 variables in an equation: A through Z, *i*, and **(i)**. You can use each variable as many times as you want. (For information about **(i)**, see "Indirectly Addressing Variables and Labels" in chapter 13.)

To enter a variable in an equation, press $\boxed{\text{RCL}}$ *variable* (or $\boxed{\text{STO}}$ *variable*). When you press $\boxed{\text{RCL}}$, the **A..Z** annunciator shows that you can press a variable key to enter its name in the equation.

Numbers in Equations

You can enter any valid number in an equation *except* fractions and numbers that aren't base 10 numbers. Numbers are always shown using ALL display format, which displays up to 12 characters.

To enter a number in an equation, you can use the standard number–entry keys, including \square , \square , and \square . Press \square only after you type one or more digits. Don't use \square for subtraction.

When you start entering the number, the cursor changes from "■" to "_" to show numeric entry. The cursor changes back when you press a nonnumeric key.

Functions in Equations

You can enter many HP 33s functions in an equation. A complete list is given under "Equation Functions" later in this chapter. Appendix G, "Operation Index," also gives this information.

When you enter an equation, you enter functions in about the same way you put them in ordinary algebraic equations:

- In an equation, certain functions are normally shown *between their* arguments, such as "+" and "÷". For such *infix* operators, enter them in an equation in the same order.
- Other functions normally have one or more arguments *after* the function name, such as "COS" and "LN". For such *prefix* functions, enter them in an equation where the function occurs — the key you press puts a left parenthesis after the function name so you can enter its arguments.

If the function has two or more arguments, press \square (on the \square key) to separate them.

If the function is followed by other operations, press \square \square to complete the function arguments.

Parentheses in Equations

You can include parentheses in equations to control the order in which operations are performed. Press $\left[\left(\right) \right]$ and $\left[\left(\right) \right]$ to insert parentheses. (For more information, see "Operator Precedence" later in this chapter.)

Example: Entering an Equation.

Enter the equation $r = 2 \times c \times \cos(t - a) + 25$



Keys:	Display:	Description:
$\left[\left(\right) \right]$ $\left[\text{EQN} \right]$	$V=0.25 \times \pi \times D^2 \times L$	Shows the last equation used in the equation list.
$\left[\text{RCL} \right]$ R $\left[\left(\right) \right]$ $\left[= \right]$	$R=$	Starts a new equation with variable R .
2	$R= 2_$	Enters a number, changing the cursor to " _".
$\left[\times \right]$ $\left[\text{RCL} \right]$ C $\left[\times \right]$	$R=2 \times C \times$	Enters infix operators.
$\left[\text{COS} \right]$	$R=2 \times C \times \text{COS} ($	Enters a prefix function with a left parenthesis.
$\left[\text{RCL} \right]$ T $\left[- \right]$ $\left[\text{RCL} \right]$ A		Enters the argument and right parenthesis.
$\left[\left(\right) \right]$ $\left[+ \right]$ 25	$\times \text{COS} (T - A) + 25_$	Terminates the equation and displays it.
$\left[\text{ENTER} \right]$	$R=2 \times C \times \text{COS} (T - A)$	
$\left[\left(\right) \right]$ $\left[\text{SHOW} \right]$	$CK=1D10$ $LN=17$	Shows its checksum and length.
$\left[\text{C} \right]$		Leaves Equation mode.

Displaying and Selecting Equations





The equation list contains the equations you've entered. You can display the equations and select one to work with.

To display equations:

1. Press $\left[\left(\right) \right]$ $\left[\text{EQN} \right]$. This activates Equation mode and turns on the **EQN** annunciator. The display shows an entry from the equation list:

- EQN LIST TOP if there are no equations in the equation list or if the equation pointer is at the top of the list.
 - The current equation (the last equation you viewed).
2. Press  or  to step through the equation list and view each equation. The list "wraps around" at the top and bottom. EQN LIST TOP marks the "top" of the list.

To view a long equation:







1. Display the equation in the equation list, as described above. If it's more than 14 characters long, only 14 characters are shown. The  annunciator indicates more characters to the right.
2. Press  to scroll the equation one character at a time, showing characters to the right. Press  to show characters to the left.  and  turn off if there are no more characters to the left or right.

To select an equation:

Display the equation in the equation list, as described above. The displayed equation is the one that's used for all equation operations.

Example: Viewing an Equation.

View the last equation you entered.

Keys:	Display:	Description:
 EQN	$R=2xCxCOS(T-A)$	Displays the current equation in the equation list.
  	$xxCxCOS(T-A)+25$	Shows three more characters to the right.
	$2xCxCOS(T-A)+2$	Shows one character to the left.
		Leaves Equation mode.

Editing and Clearing Equations



You can edit or clear an equation that you're typing. You can also edit or clear equations saved in the equation list.

To edit an equation you're typing:





1. Press  repeatedly until you delete the unwanted number or function.

If you're typing a decimal number and the "_" digit-entry cursor is on,  deletes only the rightmost character. If you delete all characters in the number, the calculator switches back to the "■" equation-entry cursor.



If the "■" equation-entry cursor is on, pressing  deletes the *entire* rightmost number or function.

2. Retype the rest of the equation.
3. Press  (or ) to save the equation in the equation list.



To edit a saved equation:



1. Display the desired equation. (See "Displaying and Selecting Equations" above.)
2. Press  (once only) to start editing the equation. The "■" equation-entry cursor appears at the end of the equation. Nothing is deleted from the equation.
3. Use  to edit the equation as described above.
4. Press  (or ) to save the edited equation in the equation list, replacing the previous version.

To clear an equation you're typing:

Press   then press {Y}. The display goes back to the previous entry in the equation list.







To clear a saved equation:

1. Display the desired equation. (See "Displaying and Selecting Equations" above.)
2. Press  . The display shows the previous entry in the equation list.

To clear *all* equations, clear them one at a time: scroll through the equation list until you come to EQN LIST TOP, press , then press   repeatedly as each equation is displayed until you see EQN LIST TOP.

Example: Editing an Equation.

Remove 25 in the equation from the previous example.

Keys:	Display:	Description:
 EQN	$R=2 \times C \times \cos(T-A)$	Shows the current equation in the equation list.
	$C \times \cos(T-A) + 25$ █	Turns on Equation-entry mode and shows the "█" cursor at the end of the equation.
 	$= 2 \times C \times \cos(T-A)$ █	Deletes the number 25.
	$R=2 \times C \times \cos(T-A)$	Shows the end of edited equation in the equation list.
		Leaves Equation mode.

Types of Equations

The HP 33s works with three types of equations:

- **Equalities.** The equation contains an "=", and the left side contains more than just a single variable. For example, $x^2 + y^2 = r^2$ is an *equality*.
- **Assignments.** The equation contains an "=", and the left side contains just a single variable. For example, $A = 0.5 \times b \times h$ is an *assignment*.
- **Expressions.** The equation does *not* contain an "=". For example, $x^3 + 1$ is an *expression*.

When you're calculating *with an* equation, you might use any type of equation — although the type can affect how it's evaluated. When you're solving a problem for an unknown variable, you'll probably use an equality or assignment. When you're integrating a function, you'll probably use an expression.

Evaluating Equations

One of the most useful characteristics of equations is their ability to be *evaluated* — to generate numeric values. This is what enables you to calculate a result from an equation. (It also enables you to solve and integrate equations, as described in chapters 7 and 8).

Because many equations have two sides separated by "=", the basic value of an equation is the *difference* between the values of the two sides. For this calculation, "=" in an equation essentially treated as "-". The value is a measure of how well the equation balances.

The HP 33s has two keys for evaluating equations: **ENTER** and **XEQ**. Their actions differ only in how they evaluate *assignment* equations:

- **XEQ** returns the value of the equation, regardless of the type of equation.
- **ENTER** returns the value of the equation — *unless* it's an *assignment*-type equation. For an assignment equation, **ENTER** returns the value of the right side only, and also "enters" that value into the variable on the left side — it stores the value in the variable.

The following table shows the two ways to evaluate equations.

Type of Equation	Result for ENTER	Result for XEQ
Equality: $g(x) = f(x)$ Example: $x^2 + y^2 = r^2$	$g(x) - f(x)$ $x^2 + y^2 - r^2$	
Assignment: $y = f(x)$ Example: $A = 0.5 \times b \times h$	$f(x)$ * $0.5 \times b \times h$ *	$y - f(x)$ $A - 0.5 \times b \times h$
Expression: $f(x)$ Example: $x^3 + 1$	$f(x)$ $x^3 + 1$	
* Also stores the result in the left-hand variable, A for example.		

To evaluate an equation:

1. Display the desired equation. (See "Displaying and Selecting Equations" above.)
2. Press **ENTER** or **XEQ**. The equation prompts for a value for each variable needed. (If you've changed the number base, it's automatically changed back to base 10.)
3. For each prompt, enter the desired value:
 - If the displayed value is good, press **R/S**.
 - If you want a different value, type the value and press **R/S**. (Also see "Responding to Equation Prompts" later in this chapter.)

The evaluation of an equation takes no values from the stack — it uses only numbers in the equation and variable values. The value of the equation is returned to the X-register. The LAST X register isn't affected.

Using ENTER for Evaluation

If an equation is displayed in the equation list, you can press **ENTER** to evaluate the equation. (If you're in the process of *typing* the equation, pressing **ENTER** only *ends* the equation — it doesn't evaluate it.)

- If the equation is an *assignment*, only the right-hand side is evaluated. The result is returned to the X-register and stored in the left-hand variable, then the variable is VIEWed in the display. Essentially, **ENTER** finds the value of the left-hand variable.
- If the equation is an *equality* or *expression*, the entire equation is evaluated — just as it is for **XEQ**. The result is returned to the X-register.

Example: Evaluating an Equation with ENTER.

Use the equation from the beginning of this chapter to find the volume of a 35-mm diameter pipe that's 20 meters long.

Keys:	Display:	Description:
EQN (↑ as required) ENTER	$V=0.25 \times \pi \times D^2 \times L$ D? 2.5000	Displays the desired equation. Starts evaluating the assignment equation so the value will be stored in V. Prompts for variables on the right-hand side of the equation. The current value for D is 2.5000.
35 R/S	L? 16.0000	Stores D, prompts for L, whose current value is 16.0000.
✓ 20 ENTER 1000 × R/S	V= 19,242,255.0032	Stores L in millimeters; calculates V in cubic millimeters, stores the result in V, and displays V.

✓ **E** 6 **÷**

19.2423

Changes cubic millimeters to liters (but doesn't change V).

Using XEQ for Evaluation

If an equation is displayed in the equation list, you can press **XEQ** to evaluate the equation. The entire equation is evaluated, regardless of the type of equation. The result is returned to the X -register.

Example: Evaluating an Equation with XEQ.

Use the results from the previous example to find out how much the volume of the pipe changes if the diameter is changed to 35.5 millimeters.

Keys:	Display:	Description:
→ EQN	$V=0.25 \times \pi \times D^2 \times L$	Displays the desired equation.
XEQ	$V?$ 19.242,255.0032	Starts evaluating the equation to find its value. Prompts for <i>all</i> variables.
R/S	$D?$ 35.0000	Keeps the same V , prompts for D .
35.5 R/S	$L?$ 20.000,0000	Stores new D , Prompts for L .
R/S	-553,705.7052	Keeps the same L ; calculates the value of the equation — the imbalance between the left and right sides.
✓ E 6 ÷	-0.5537	Changes cubic millimeters to liters.

The value of the equation is the old volume (from V) *minus* the new volume (calculated using the new D value) — so the old volume is smaller by the amount shown.

Responding to Equation Prompts

When you evaluate an equation, you're prompted for a value for each variable that's needed. The prompt gives the variable name and its current value, such as $X?2.5000$.

- **To leave the number unchanged**, just press **R/S**.



- **To change the number**, type the new number and press **R/S**. This new number writes over the old value in the X-register. You can enter a number as a fraction if you want. If you need to calculate a number, use normal keyboard calculations, then press **R/S**. For example, you can press 2 **ENTER** 5 **y^x** **R/S**.
- **To calculate with the displayed number**, press **ENTER** before typing another number.
- **To cancel the prompt**, press **C**. The current value for the variable remains in the X-register. If you press **C** during digit entry, it clears the number to zero. Press **C** again to cancel the prompt.
- **To display digits hidden by the prompt**, press **▶** **SHOW**.

Each prompt puts the variable value in the X-register and disables stack lift. If you type a number at the prompt, it replaces the value in the X-register. When you press **R/S**, stack lift is enabled, so the value is retained on the stack.

The Syntax of Equations

Equations follow certain conventions that determine how they're evaluated:

- How operators interact.
- What functions are valid in equations.
- How equations are checked for syntax errors.

Operator Precedence

Operators in an equation are processed in a certain order that makes the evaluation logical and predictable:

Order	Operation	Example
1	Functions and Parentheses	SIN(X+1), (X+1)
2	Power (y^x)	X^3
3	Unary Minus ($\frac{+}{-}$)	-A
4	Multiply and Divide	X*Y, A÷B
5	Add and Subtract	P+Q, A-B
6	Equality	B=C

So, for example, all operations *inside* parentheses are performed *before* operations *outside* the parentheses.

Examples:

Equations	Meaning
$A \times B^3 = C$	$a \times (b^3) = c$
$(A \times B)^3 = C$	$(a \times b)^3 = c$
$A + B \div C = 12$	$a + (b/c) = 12$
$(A + B) \div C = 12$	$(a + b) / c = 12$
$\%CHG(T+12; A-6)^2$	$[\%CHG((t + 12), (a - 6))]^2$

You can't use parentheses for implied multiplication. For example, the expression $p(1-f)$ must be entered as $P \times (1-F)$, with the "x" operator inserted between P and the left parenthesis.

Equation Functions

The following table lists the functions that are valid in equations. Appendix G, "Operation Index" also gives this information.

LN	LOG	EXP	ALOG	SQ	SQRT
INV	IP	FP	RND	ABS	x!
SGN	INTG	IDIV	RMDR		
SIN	COS	TAN	ASIN	ACOS	ATAN
SINH	COSH	TANH	ASINH	ACOSH	ATANH
→DEG	→RAD	→HR	→HMS	%CHG	XROOT
CB	CBRT	$C_{n,r}$	$P_{n,r}$		
→KG	→LB	→°C	→°F	→CM	→IN
→L	→GAL	RANDOM	π		
+	-	×	÷	^	
sx	sy	σx	σy	\bar{x}	\bar{y}
$\bar{x} w$	\hat{x}	\hat{y}	r	m	b
n	Σx	Σy	Σx^2	Σy^2	Σxy

For convenience, prefix-type functions, which require one or two arguments, display a left parenthesis when you enter them.

The prefix functions that require two arguments are %CHG, RND, XROOT, IDIV, RMDR, $C_{n,r}$ and $P_{n,r}$. Separate the two arguments with a colon.

✓ In an equation, the XROOT function takes its arguments in the opposite order from RPN usage. For example, -8 [ENTER] 3 [√^x] is equivalent to XROOT(3;-8).

✓ All other two-argument functions take their arguments in the Y, X order used for RPN. For example, 28 [ENTER] 4 [↵] [nCr] is equivalent to $C_{n,r}(28;4)$.

For two-argument functions, be careful if the second argument is negative. For a number or variable, use [+/-] or [-]. These are valid equations:

%CHG(-X;-2)

%CHG(X;(-Y))

Eleven of the equation functions have names that differ from their equivalent operations:

Operation	Equation function
x^2	SQ
\sqrt{x}	SQRT
e^x	EXP
10^x	ALOG
$1/x$	INV
$\sqrt[x]{y}$	XROOT
y^x	^
INT÷	IDIV
Rmdr	RMDR
x^3	CB
$\sqrt[3]{x}$	CBRT

Example: Perimeter of a Trapezoid.

The following equation calculates the perimeter of a trapezoid. This is how the equation might appear in a book:

$$\text{Perimeter} = a + b + h \left(\frac{1}{\sin\theta} + \frac{1}{\sin\phi} \right)$$

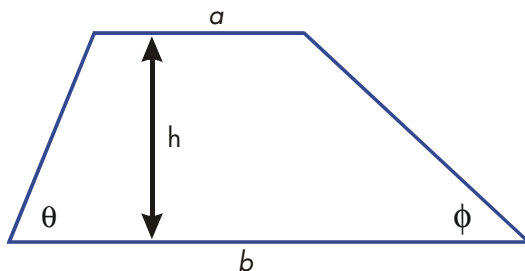

The following equation obeys the syntax rules for HP 33s equations:

6-16 Entering and Evaluating Equations

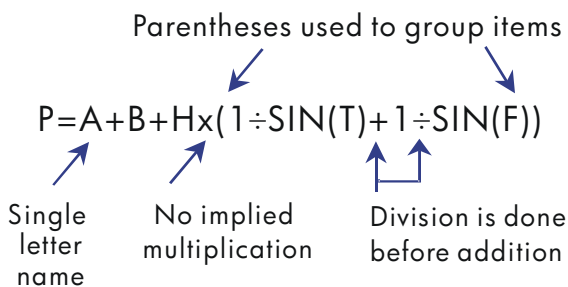

The next equation also obeys the syntax rules. This equation uses the inverse function, $\text{INV}(\text{SIN}(T))$, instead of the fractional form, $1 \div \text{SIN}(T)$. Notice that the SIN function is "nested" inside the INV function. (INV is typed by $\boxed{1/x}$.)

$$P = A + B + H \times (\text{INV}(\text{SIN}(T)) + \text{INV}(\text{SIN}(F)))$$

Example: Area of a Polygon.

The equation for area of a regular polygon with n sides of length d is:

$$\text{Area} = \frac{1}{4} n d^2 \frac{\cos(\pi/n)}{\sin(\pi/n)}$$

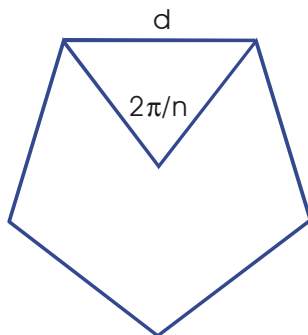

You can specify this equation as

$$A = 0.25 \times N \times D^2 \times \text{COS}(\pi \div N) \div \text{SIN}(\pi \div N)$$

Notice how the operators and functions combine to give the desired equation.

You can enter the equation into the equation list using the following keystrokes:



$\boxed{\rightarrow}$ $\boxed{\text{EQN}}$ $\boxed{\text{RCL}}$ \boxed{A} $\boxed{\rightarrow}$ $\boxed{=}$ $\boxed{.25}$ $\boxed{\times}$ $\boxed{\text{RCL}}$ \boxed{N} $\boxed{\times}$ $\boxed{\text{RCL}}$ \boxed{D} $\boxed{y^x}$ $\boxed{2}$ $\boxed{\times}$ $\boxed{\text{COS}}$ $\boxed{\rightarrow}$
 $\boxed{\pi}$ $\boxed{\div}$ $\boxed{\text{RCL}}$ \boxed{N} $\boxed{\rightarrow}$ $\boxed{)}$ $\boxed{\div}$ $\boxed{\text{SIN}}$ $\boxed{\rightarrow}$ $\boxed{\pi}$ $\boxed{\div}$ $\boxed{\text{RCL}}$ \boxed{N} $\boxed{\rightarrow}$ $\boxed{)}$ $\boxed{\text{ENTER}}$

Syntax Errors

The calculator doesn't check the syntax of an equation until you evaluate the equation and respond to all the prompts — only when a value is actually being calculated. If an error is detected, **INVALID EQN** is displayed. You have to edit the equation to correct the error. (See "Editing and Clearing Equations" earlier in this chapter.)

By not checking equation syntax until evaluation, the HP 33s lets you create "equations" that might actually be messages. This is especially useful in programs, as described in chapter 12.

Verifying Equations







When you're viewing an equation — not while you're typing an equation — you can press   to show you two things about the equation: the equation's checksum and its length. Hold the  key to keep the values in the display.

The checksum is a four-digit hexadecimal value that uniquely identifies this equation. No other equation will have this value. If you enter the equation incorrectly, it will not have this checksum. The length is the number of bytes of calculator memory used by the equation.

The checksum and length allow you to verify that equations you type are correct. The checksum and length of the equation you type in an example should match the values shown in this manual.

Example: Checksum and Length of an Equation.

Find the checksum and length for the pipe-volume equation at the beginning of this chapter.

Keys:	Display:	Description:
  ( as required)	$V=0.25 \times \pi \times D^2 \times L$	Displays the desired equation.
  (hold)	CK=49CA LN=14	Display equation's checksum and length.
(release)	$V=0.25 \times \pi \times D^2 \times L$	Redisplays the equation.
		Leaves Equation mode.

Solving Equations

In chapter 6 you saw how you can use **ENTER** to find the value of the left-hand variable in an *assignment*-type equation. Well, you can use SOLVE to find the value of *any* variable in *any* type of equation.

For example, consider the equation

$$x^2 - 3y = 10$$

If you know the value of y in this equation, then SOLVE can solve for the unknown x . If you know the value of x , then SOLVE can solve for the unknown y . This works for "word problems" just as well:

$$\text{Markup} \times \text{Cost} = \text{Price}$$

If you know any two of these variables, then SOLVE can calculate the value of the third.

When the equation has only one variable, or when known values are supplied for all variables except one, then to solve for x is to find a *root* of the equation. A root of an equation occurs where an *equality* or *assignment* equation balances exactly, or where an *expression* equation equals zero. (This is equivalent to the *value* of the equation being zero.)

Solving an Equation

To solve an equation for an unknown variable:

1. Press **2nd** **EQN** and display the desired equation. If necessary, type the equation as explained in chapter 6 under "Entering Equations into the Equation List."
2. Press **SOLVE** then press the key for the unknown variable. For example, press **SOLVE** X to solve for x . The equation then prompts for a value for every other variable in the equation.
3. For each prompt, enter the desired value:

- If the displayed value is the one you want, press **R/S**.
- If you want a different value, type or calculate the value and press **R/S**.
(For details, see "Responding to Equation Prompts" in chapter 6.)

You can halt a running calculation by pressing **C** or **R/S**.

When the root is found, it's stored in the unknown variable, and the variable value is VIEWed in the display. In addition, the X-register contains the root, the Y-register contains the previous estimate, and the Z-register contains the value of the equation at the root (which should be zero).

For some complicated mathematical conditions, a definitive solution cannot be found — and the calculator displays **NO ROOT FOUND**. See "Verifying the Result" later in this chapter, and "Interpreting Results" and "When SOLVE Cannot Find a Root" in appendix D.

For certain equations it helps to provide one or two *initial guesses* for the unknown variable before solving the equation. This can speed up the calculation, direct the answer toward a realistic solution, and find more than one solution, if appropriate. See "Choosing Initial Guesses for Solve" later in this chapter.

Example: Solving the Equation of Linear Motion.

The equation of motion for a free-falling object is:

$$d = v_0 t + \frac{1}{2} g t^2$$

where d is the distance, v_0 is the initial velocity, t is the time, and g is the acceleration due to gravity.

Type in the equation:

Keys:	Display:	Description:
← CLEAR {ALL} {Y}		Clears memory.
→ EQN	EQN LIST TOP or current equation	Selects Equation mode.
RCL D → = RCL V		Starts the equation.
× RCL T +	$D = V \times T +$	
.5 × RCL G × RCL T		
y^x 2	$V \times T + 0.5 \times G \times T^2$	

ENTER

$$D = V \times T + 0.5 \times G \times T^2$$

Terminates the equation and displays the left end.

SHOW

CK=FB3C

Checksum and length.

LN=15

g (acceleration due to gravity) is included as a variable so you can change it for different units (9.8 m/s^2 or 32.2 ft/s^2).

Calculate how many meters an object falls in 5 seconds, starting from rest. Since Equation mode is turned on and the desired equation is already in the display, you can start solving for D :

Keys:	Display:	Description:
SOLVE	SOLVE_	Prompts for unknown variable.
D	V?	Selects D ; prompts for V .
0 R/S	<i>value</i> T?	Stores 0 in V ; prompts for T .
5 R/S	<i>value</i> G?	Stores 5 in T ; prompts for G .
9.8 R/S	<i>value</i> SOLVING D= 122.5000	Stores 9.8 in G ; solves for D .

Try another calculation using the same equation: how long does it take an object to fall 500 meters from rest?

Keys:	Display:	Description:
EQN	$D = V \times T + 0.5 \times G \times T^2$	Displays the equation.
SOLVE T	D?	Solves for T ; prompts for D .
500 R/S	122.5000 V?	Stores 500 in D ; prompts for V .
R/S	0.0000 G?	Retains 0 in V ; prompts for G .
R/S	9.8000 SOLVING T= 10.1015	Retains 9.8 in G ; solves for T .

Example: Solving the Ideal Gas Law Equation.

The Ideal Gas Law describes the relationship between pressure, volume, temperature, and the amount (moles) of an ideal gas:

$$P \times V = N \times R \times T$$

where P is pressure (in atmospheres or N/m^2), V is volume (in liters), N is the number of moles of gas, R is the universal gas constant ($0.0821 \text{ liter}\cdot\text{atm}/\text{mole}\cdot\text{K}$ or $8.314 \text{ J}/\text{mole}\cdot\text{K}$), and T is temperature (Kelvins: $\text{K} = \text{C} + 273.1$).

Enter the equation:

Keys:	Display:	Description:
EQN P	P×█	Selects Equation mode and starts the equation.
V =		
N		
R T	P×V=N×R×T█	
	P×V=N×R×T	Terminates and displays the equation.
	CK=EDC8 LN=9	Checksum and length.

A 2-liter bottle contains 0.005 moles of carbon dioxide gas at 24°C . Assuming that the gas behaves as an ideal gas, calculate its pressure. Since Equation mode is turned on and the desired equation is already in the display, you can start solving for P :

Keys:	Display:	Description:
P	V?	Solves for P ; prompts for V .
2	value	
	N?	Stores 2 in V ; prompts for N .
.005	value	
	R?	Stores .005 in N ;
	value	prompts for R .
.0821	T?	Stores .0821 in R ;
	value	prompts for T .
✓ 24 273.1	T?	Calculates T (Kelvins).
	297.1000	

R/S	SOLVING	Stores 297.1 in T ; solves
	P=	for P in atmospheres.
	0.0610	

A 5-liter flask contains nitrogen gas. The pressure is 0.05 atmospheres when the temperature is 18°C. Calculate the density of the gas ($N \times 28/V$, where 28 is the molecular weight of nitrogen).

Keys:	Display:	Description:
EQN	$P \times V = N \times R \times T$	Displays the equation.
SOLVE N	P?	Solves for N ; prompts for P .
.05 R/S	V?	Stores .05 in P ; prompts for V .
5 R/S	R?	Stores 5 in V ; prompts for R .
R/S	T?	Retains previous R ;
	297.1000	prompts for T .
✓ 18 ENTER 273.1 +	T?	Calculates T (Kelvins).
	291.1000	
R/S	SOLVING	Stores 291.1 in T ; solves
	N=	for N .
	0.0105	
✓ 28 x	0.2929	Calculates mass in
		grams, $N \times 28$.
✓ RCL V ÷	0.0586	Calculates density in
		grams per liter.

Understanding and Controlling SOLVE

SOLVE first attempts to solve the equation directly for the unknown variable. If the attempt fails, SOLVE changes to an iterative(repetitive) procedure. The procedure starts by evaluating the equation using two initial guesses for the unknown variable. Based on the results with those two guesses, SOLVE generates another, better guess. Through successive iterations, SOLVE finds a value for the unknown that makes the value of the equation equal to zero.

When SOLVE evaluates an equation, it does it the same way $\boxed{\text{XEQ}}$ does — any "=" in the equation is treated as a " - ". For example, the Ideal Gas Law equation is evaluated as $P \times V - (N \times R \times T)$. This ensures that an *equality* or *assignment* equation balances at the root, and that an *expression* equation equals zero at the root.

Some equations are more difficult to solve than others. In some cases, you need to enter initial guesses in order to find a solution. (See "Choosing Initial Guesses for SOLVE," below.) If SOLVE is unable to find a solution, the calculator displays **NO ROOT FND**.

See appendix D for more information about how SOLVE works.

Verifying the Result

After the SOLVE calculation ends, you can verify that the result is indeed a solution of the equation by reviewing the values left in the stack:

- The X-register (press $\boxed{\text{C}}$ to clear the VIEWed variable) contains the solution (root) for the unknown; that is, the value that makes the evaluation of the equation equal to zero.
- ✓ ■ The Y-register (press $\boxed{\text{R}\downarrow}$) contains the previous estimate for the root. This number should be the same as the value in the X-register. If it is not, then the root returned was only an *approximation*, and the values in the X- and Y-registers bracket the root. These bracketing numbers should be close together.
- ✓ ■ The Z-register (press $\boxed{\text{R}\downarrow}$ again) contains this value of the equation at the root. For an exact root, this should be zero. If it is not zero, the root given was only an *approximation*; this number should be close to zero.

If a calculation ends with the **NO ROOT FND**, the calculator could not converge on a root. (You can see the value in the X-register — the final estimate of the root — by pressing $\boxed{\text{C}}$ or $\boxed{\leftarrow}$ to clear the message.) The values in the X- and Y-registers bracket the interval that was last searched to find the root. The Z-register contains the value of the equation at the final estimate of the root.

- If the X- and Y-register values aren't close together, or the Z-register value isn't close to zero, the estimate from the X-register probably isn't a root.
- If the X- and Y-register values *are* close together, and the Z-register value is close to zero, the estimate from the X-register may be an approximation to a root.

Interrupting a SOLVE Calculation

To halt a calculation, press **C** or **R/S**. The current best estimate of the root is in the unknown variable; use **▣** **VIEW** to view it without disturbing the stack.

Choosing Initial Guesses for SOLVE

The two initial guesses come from:

- The number currently stored in the unknown variable.
- The number in the X-register (the display).

These sources are used for guesses *whether you enter guesses or not*. If you enter only one guess and store it in the variable, the second guess will be the same value since the display also holds the number you just stored in the variable. (If such is the case, the calculator changes one guess slightly so that it has two different guesses.)

Entering your own guesses has the following advantages:

- By narrowing the range of search, guesses can reduce the time to find a solution.
- If there is more than one mathematical solution, guesses can direct the SOLVE procedure to the desired answer or range of answers. For example, the equation of linear motion

$$d = v_0 t + \frac{1}{2} g t^2$$

can have two solutions for t . You can direct the answer to the required solution by entering appropriate guesses.

The example using this equation earlier in this chapter didn't require you to enter guesses before solving for T because in the first part of that example you stored a value for T and solved for D . The value that was left in T was a good (realistic) one, so it was used as a guess when solving for T .

- If an equation does not allow certain values for the unknown, guesses can prevent these values from occurring. For example,

$$y = t + \log x$$

results in an error if $x \leq 0$ (message NO ROOT FND).

In the following example, the equation has more than one root, but guesses help find the desired root.

Example: Using Guesses to Find a Root.

Using a rectangular piece of sheet metal 40 cm by 80 cm, form an open-top box having a volume of 7500 cm^3 . You need to find the height of the box (that is, the amount to be folded up along each of the four sides) that gives the specified volume. A taller box is preferred to a shorter one.

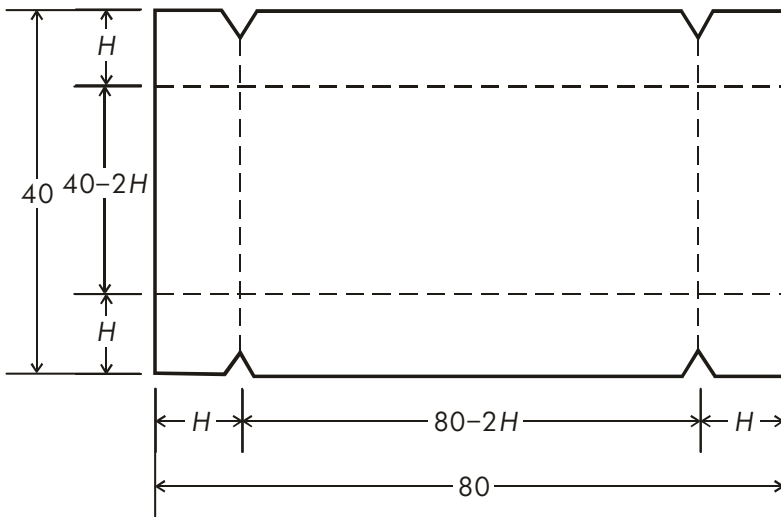

If H is the height, then the length of the box is $(80 - 2H)$ and the width is $(40 - 2H)$. The volume V is:

$$V = (80 - 2H) \times (40 - 2H) \times H$$

which you can simplify and enter as

$$V = (40 - H) \times (20 - H) \times 4 \times H$$

Type in the equation:

Keys:	Display:	Description:
$\boxed{\rightarrow}$ $\boxed{\text{EQN}}$		Selects Equation mode
$\boxed{\text{RCL}}$ V $\boxed{\rightarrow}$ $\boxed{=}$	$V=$	and starts the equation.
$\boxed{\rightarrow}$ $\boxed{[]}$ 40 $\boxed{-}$		
$\boxed{\text{RCL}}$ H $\boxed{\rightarrow}$ $\boxed{[]}$	$V=(40-H)$	
$\boxed{\times}$ $\boxed{\rightarrow}$ $\boxed{[]}$ 20 $\boxed{-}$ $\boxed{\text{RCL}}$ H	$(40-H)\times(20-H)$	
$\boxed{\rightarrow}$ $\boxed{[]}$	$H)\times(20-H)\times 4\times H$	
$\boxed{\times}$ 4 $\boxed{\times}$ $\boxed{\text{RCL}}$ H	$V=(40-H)\times(20-H$	Terminates and displays the equation.
$\boxed{\text{ENTER}}$	$CK=49A4$	Checksum and length.
$\boxed{\rightarrow}$ $\boxed{\text{SHOW}}$	$LN=19$	

It seems reasonable that either a tall, narrow box or a short, flat box could be formed having the desired volume. Because the taller box is preferred, larger initial estimates of the height are reasonable. However, heights greater than 20 cm are not physically possible because the metal sheet is only 40 cm wide. Initial estimates of 10 and 20 cm are therefore appropriate.

Keys:	Display:	Description:
$\boxed{\text{C}}$		Leaves Equation mode.
10 $\boxed{\text{STO}}$ H		Stores lower and upper limit guesses.
20	$20_$	
$\boxed{\rightarrow}$ $\boxed{\text{EQN}}$	$V=(40-H)\times(20-H$	Displays current equation.
$\boxed{\text{SOLVE}}$ H	$V?$	Solves for H ; prompts for V .
	<i>value</i>	
7500 $\boxed{\text{R/S}}$	$H=$	Stores 7500 in V ; solves for H .
	15.0000	

Now check the quality of this solution — that is, whether it returned an exact root — by looking at the value of the previous estimate of the root (in the Y-register) and the value of the equation at the root (in the Z-register).

Keys:

Display:

Description:

✓ $\boxed{R\downarrow}$

15.0000

This value from the Y-register is the estimate made just prior to the final result. Since it is the same as the solution, the solution is an exact root.

✓ $\boxed{R\downarrow}$

0.0000

This value from the Z-register shows the equation equals zero at the root.

The dimensions of the desired box are $50 \times 10 \times 15$ cm. If you ignored the upper limit on the height (20 cm) and used initial estimates of 30 and 40 cm, you would obtain a height of 42.0256 cm — a root that is physically meaningless. If you used small initial estimates such as 0 and 10 cm, you would obtain a height of 2.9774 cm — producing an undesirably short, flat box.

If you don't know what guesses to use, you can use a graph to help understand the behavior of the equation. Evaluate your equation for several values of the unknown. For each point on the graph, display the equation and press \boxed{XEQ} — at the prompt for x enter the x -coordinate, and then obtain the corresponding value of the equation, the y -coordinate. For the problem above, you would always set $V = 7500$ and vary the value of H to produce different values for the equation. Remember that the value for this equation is the *difference* between the left and right sides of the equation. The plot of the value of this equation looks like this.

$$7500 - (40-H)(20-H) - 4H$$

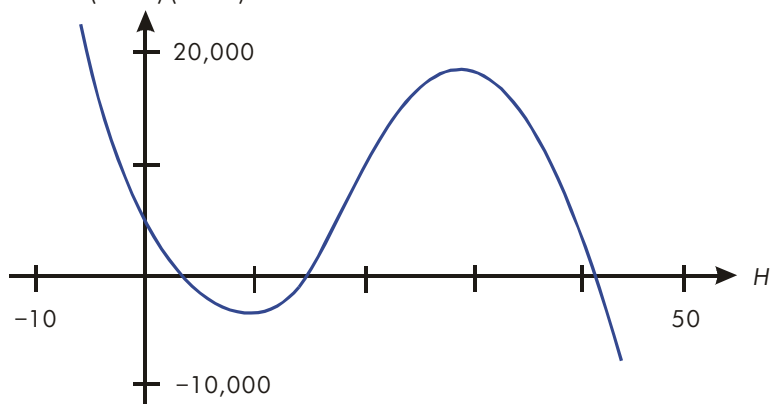

For More Information

This chapter gives you instructions for solving for unknowns or roots over a wide range of applications. Appendix D contains more detailed information about how the algorithm for SOLVE works, how to interpret results, what happens when no solution is found, and conditions that can cause incorrect results.

Integrating Equations

Many problems in mathematics, science, and engineering require calculating the definite integral of a function. If the function is denoted by $f(x)$ and the interval of integration is a to b , then the integral can be expressed mathematically as

$$I = \int_a^b f(x) dx$$

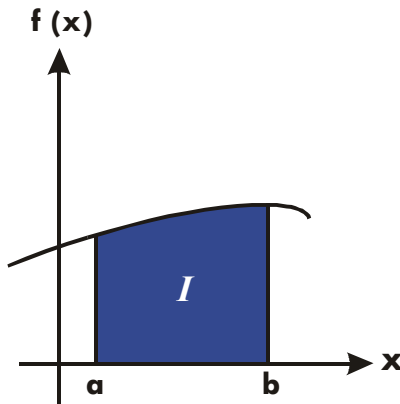

The quantity I can be interpreted geometrically as the area of a region bounded by the graph of the function $f(x)$, the x -axis, and the limits $x = a$ and $x = b$ (provided that $f(x)$ is nonnegative throughout the interval of integration).

The \int operation ($\int FN$) integrates the current equation with respect to a specified variable ($\int FN d_$). The function may have more than one variable.

\int works only with *real* numbers.

Integrating Equations (∫ FN)

To integrate an equation:

1. If the equation that defines the integrand's function isn't stored in the equation list, key it in (see "Entering Equations into the Equation List" in chapter 6) and leave Equation mode. The equation usually contains just an expression.
- ✓ 2. Enter the limits of integration: key in the *lower* limit and press **ENTER**, then key in the upper limit.
3. Display the equation: Press **EQN** and, if necessary, scroll through the equation list (press **↑** or **↓**) to display the desired equation.
4. Select the variable of integration: Press **VAR** **variable**. This starts the calculation.

∫ uses far more memory than any other operation in the calculator. If executing **∫** causes a MEMORY FULL message, refer to appendix B.

You can halt a running integration calculation by pressing **C** or **R/S**. However, no information about the integration is available until the calculation finishes normally.

The display format setting affects the level of accuracy assumed for your function and used for the result. The integration is more precise but takes *much* longer in the {**PL1**} and higher {**FIX**}, {**SCI**}, and {**ENG**} settings. The *uncertainty* of the result ends up in the Y-register, pushing the limits of integration up into the T- and Z-registers. For more information, see "Accuracy of Integration" later in this chapter.

To integrate the same equation with different information:

- ✓ If you use the same limits of integration, press **RT** **RT** move them into the X- and Y-registers. Then start at step 3 in the above list. If you want to use different limits, begin at step 2.

To work another problem using a different equation, start over from step 1 with an equation that defines the integrand.

Example: Bessel Function.

The Bessel function of the first kind of order 0 can be expressed as

$$J_0(x) = \frac{1}{\pi} \int_0^\pi \cos(x \sin t) dt$$

Find the Bessel function for x -values of 2 and 3.

Enter the expression that defines the integrand's function:

$$\cos(x \sin t)$$

Keys:	Display:	Description:
{ALL} {Y}		Clears memory.
EQN	Current equation or EQN LIST TOP	Selects Equation mode.
X	COS(X	Types the equation.
	COS(X×SIN(
T	COS(X×SIN(T	
	COS(X×SIN(T))	
	COS(X×SIN(T))	Terminates the expression and displays its left end.
	CK=E1EC LN=13	Checksum and length.
		Leaves Equation mode.

Now integrate this function with respect to t from zero to π ; $x = 2$.

Keys:	Display:	Description:
{RAD}		Selects Radians mode.
✓ 0	3.1416	Enters the limits of integration (lower limit first).
EQN	COS(X×SIN(T))	Displays the function.
	∫FN d_	Prompts for the variable of integration.
T	X? value	Prompts for value of X .
2	INTEGRATING ∫= 0.7034	$x = 2$. Starts integrating; calculates result for $\int_0^{\pi} f(t)$
✓	0.2239	The final result for $J_0(2)$.

Now calculate $J_0(3)$ with the same limits of integration. You must respecify the limits of integration $(0, \pi)$ since they were pushed off the stack by the subsequent division by π .

	Keys:	Display:	Description:
✓	0 [ENTER] [→] [π]	3.1416	Enters the limits of integration (lower limit first).
	[→] [EQN]	COS(X×SIN(T))	Displays the current equation.
	[→] [∫]	∫FN d_	Prompts for the variable of integration.
	T	X? 2.0000	Prompts for value of X.
	3 [R/S]	INTEGRATING ∫= -0.8170	$x = 3$. Starts integrating and calculates the result for $\int_0^{\pi} f(t) dt$.
✓	[→] [π] [÷]	-0.2601	The final result for $J_0(3)$.

Example: Sine Integral.

Certain problems in communications theory (for example, pulse transmission through idealized networks) require calculating an integral (sometimes called the *sine* integral) of the form

$$S_i(t) = \int_0^t \left(\frac{\sin x}{x}\right) dx$$

Find $S_i(2)$.

Enter the expression that defines the integrand's function:

$$\frac{\sin x}{x}$$

If the calculator attempted to evaluate this function at $x = 0$, the lower limit of integration, an error (DIVIDE BY 0) would result. However, the integration algorithm normally does *not* evaluate functions at either limit of integration, unless the endpoints of the interval of integration are extremely close together or the number of sample points is extremely large.

Keys:	Display:	Description:
EQN	The current equation or EQN LIST TOP	Selects Equation mode.
X	SIN(X)■	Starts the equation.
)	SIN(X)■	The closing right parenthesis is required in this case.
X	SIN(X)÷X■	
	SIN(X)÷X	Terminates the equation.
	CK=0EE0 LN=8	Checksum and length.
		Leaves Equation mode.

Now integrate this function with respect to x (that is, X) from zero to 2 ($t = 2$).

Keys:	Display:	Description:
{RAD}		Selects Radians mode.
0 2	2_	Enters limits of integration (lower first).
	SIN(X)÷X	Displays the current equation.
X	INTEGRATING ∫= 1.6054	Calculates the result for $S_i(2)$.

Accuracy of Integration

Since the calculator cannot compute the value of an integral exactly, it *approximates* it. The accuracy of this approximation depends on the accuracy of the integrand's function itself, as calculated by your equation. This is affected by round-off error in the calculator and the accuracy of the empirical constants.

Integrals of functions with certain characteristics such as spikes or very rapid oscillations *might* be calculated inaccurately, but the likelihood is very small. The general characteristics of functions that can cause problems, as well as techniques for dealing with them, are discussed in appendix E.

Specifying Accuracy

The display format's setting (FIX, SCI, ENG, or ALL) determines the *precision* of the integration calculation: the greater the number of digits displayed, the greater the precision of the calculated integral (and the greater the time required to calculate it). The fewer the number of digits displayed, the faster the calculation, but the calculator will presume that the function is accurate to the only number of digits specified in the display format.

To specify the *accuracy* of the integration, set the display format so that the display shows *no more than* the number of digits that you consider accurate *in the integrand's values*. This same level of accuracy and precision will be reflected in the result of integration.

If Fraction–display mode is on (flag 7 set), the accuracy is specified by the previous display format.

Interpreting Accuracy

After calculating the integral, the calculator places the estimated *uncertainty* of that integral's result in the Y-register. Press $\boxed{x \leftrightarrow y}$ to view the value of the uncertainty.

For example, if the integral $S_i(2)$ is 1.6054 ± 0.0002 , then 0.0002 is its uncertainty.

Example: Specifying Accuracy.

With the display format set to SCI 2, calculate the integral in the expression for $S_i(2)$ (from the previous example).

	Keys:	Display:	Description:
	$\boxed{\text{DISPLAY}}$ {SCI} 2	1.61E0	Sets scientific notation with two decimal places, specifying that the function is accurate to two decimal places.
✓	$\boxed{\text{R}\downarrow}$ $\boxed{\text{R}\downarrow}$	0.00E0 2.00E0	Rolls down the limits of integration from the Z- and T-registers into the X- and Y-registers.
	$\boxed{\text{R}\rightarrow}$ $\boxed{\text{EQN}}$	SIN(X)÷X	Displays the current Equation.

INTEGRATING

The integral approximated to two decimal places.

$\int =$
1.61E0

1.61E-2

The uncertainty of the approximation of the integral.

The integral is 1.61 ± 0.0161 . Since the uncertainty would not affect the approximation until its third decimal place, you can consider all the displayed digits in this approximation to be accurate.

If the uncertainty of an approximation is larger than what you choose to tolerate, you can increase the number of digits in the display format and repeat the integration (provided that $f(x)$ is still calculated accurately to the number of digits shown in the display). In general, the uncertainty of an integration calculation decreases by a factor of ten for each additional digit, specified in the display format.

Example: Changing the Accuracy.

For the integral of $\text{Si}(2)$ just calculated, specify that the result be accurate to four decimal places instead of only two.

Keys:	Display:	Description:
{SCI} 4	1.6079E-2	Specifies accuracy to four decimal places. The uncertainty from the last example is still in the display.
	0.0000E0 2.0000E0	Rolls down the limits of integration from the Z- and T-registers into the X- and Y-registers.
	SIN(X)÷X	Displays the current equation.
	INTEGRATING	Calculates the result.
	$\int =$ 1.6054E0	
	1.6056E-4	Note that the uncertainty is about 1/100 as large as the uncertainty of the SCI 2 result calculated previously.
{FIX} 4	0.0002	Restores FIX 4 format.

MODES {DEG}

0.0002

Restores Degrees mode.

This uncertainty indicates that the result *might* be correct to only three decimal places. In reality, this result is accurate to *seven* decimal places when compared with the actual value of this integral. Since the uncertainty of a result is calculated conservatively, *the calculator's approximation in most cases is more accurate than its uncertainty indicates.*

For More Information

This chapter gives you instructions for using integration in the HP 33s over a wide range of applications. Appendix E contains more detailed information about how the algorithm for integration works, conditions that could cause incorrect results and conditions that prolong calculation time, and obtaining the current approximation to an integral.

Operations with Complex Numbers

The HP 33s can use complex numbers in the form

$$x + iy.$$

It has operations for complex arithmetic (+, −, ×, ÷), complex trigonometry (sin, cos, tan), and the mathematics functions $-z$, $1/z$, $z_1^{z_2}$, $\ln z$, and e^z . (where z_1 and z_2 are complex numbers).

✓ To enter a complex number:

1. Type the *imaginary* part.
2. Press **ENTER**.
3. Type the *real* part.

Complex numbers in the HP 33s are handled by entering each part (imaginary and real) of a complex number as a separate entry. To enter two complex numbers, you enter four separate numbers. To do a complex operation, press **◀** **CMPLEX** before the operator. For example, to do

$$(2 + i 4) + (3 + i 5),$$

press 4 **ENTER** 2 **ENTER** 5 **ENTER** 3 **◀** **CMPLEX** **+**.

The result is $5 + i 9$. (The first line is the *imaginary* and the second is the *real* part.)

The Complex Stack

In RPN mode, the complex stack is really the regular memory stack split into two double registers for holding two complex numbers, $z_1x + i z_1y$ and $z_2x + i z_2y$:

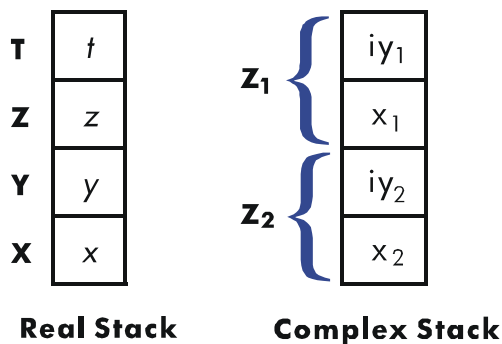

Since the imaginary and real parts of a complex number are entered and stored separately, you can easily work with or alter either part by itself.

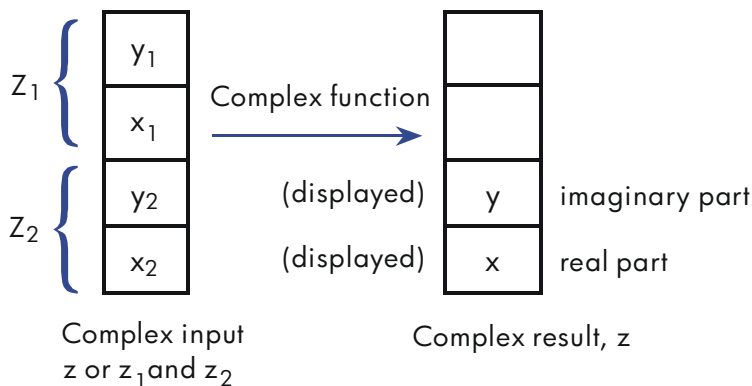

Always enter the imaginary part (the y-part) of a number first. The real portion of the result (z_x) is displayed on the second line; the imaginary portion (z_y) is displayed on the first line. (For two-number operations, the first complex number, z₁, is replicated in the stack's Z and T registers.)

Complex Operations

Use the complex operations as you do real operations, but precede the operator with **CMPLX**.

✓ **To do an operation with one complex number:**

1. Enter the complex number z, composed of x + iy, by keying in y **ENTER** x.
2. Select the complex function.

Functions for One Complex Number, z

To Calculate:	Press:
Change sign, $-z$	C MPL X +/-
Inverse, $1/z$	C MPL X 1/x
Natural log, $\ln z$	C MPL X LN
Natural antilog, e^z	C MPL X e^x
Sin z	C MPL X SIN
Cos z	C MPL X COS
Tan z	C MPL X TAN

✓ To do an arithmetic operation with two complex numbers:

1. Enter the first complex number, z_1 (composed of $x_1 + i y_1$), by keying in y_1 ENTER x_1 ENTER. (For $z_1^{z_2}$, key in the base part, z_1 , first.)
2. Enter the second complex number, z_2 , by keying in y_2 ENTER x_2 . (For $z_1^{z_2}$, key in the exponent, z_2 , second.)
3. Select the arithmetic operation:

Arithmetic With Two Complex Numbers, z_1 and z_2

To Calculate:	Press:
Addition, $z_1 + z_2$	C MPL X +
Subtraction, $z_1 - z_2$	C MPL X -
Multiplication, $z_1 \times z_2$	C MPL X x
Division, $z_1 \div z_2$	C MPL X ÷
Power function, $z_1^{z_2}$	C MPL X y^x

Examples:

Here are some examples of trigonometry and arithmetic with complex numbers:

Evaluate $\sin(2 + i 3)$

Keys:

Display:

Description:

✓ 3 **[ENTER]** 2
[C] **[CPLX]** **[SIN]**

-4.1689
9.1545

Result is $9.1545 - i$
4.1689.

Evaluate the expression

$$z_1 \div (z_2 + z_3),$$

where $z_1 = 23 + i 13$, $z_2 = -2 + i$ $z_3 = 4 - i 3$

Since the stack can retain only two complex numbers at a time, perform the calculation as

$$z_1 \times [1 \div (z_2 + z_3)]$$

Keys:

Display:

Description:

✓ 1 **[ENTER]** 2 **[+/-]** **[ENTER]**
3 **[+/-]** **[ENTER]** 4 **[C]**
[CPLX] **[+]**

-2.0000
2.0000

Add $z_2 + z_3$; displays real part.

[C] **[CPLX]** **[1/x]**

0.2500
0.2500

$1 \div (z_2 + z_3)$.

13 **[ENTER]** 23

[C] **[CPLX]** **[x]**

9.0000
2.5000

$z_1 \div (z_2 + z_3)$. Result is $2.5 + i 9$.

Evaluate $(4 - i 2/5) (3 - i 2/3)$. Do not use complex operations when calculating just one part of a complex number.

Keys:

Display:

Description:

✓ **[.]** 2 **[.]** 5 **[+/-]** **[ENTER]**

-0.4000
-0.4000

Enters imaginary part of first complex number as a fraction.

4 **[ENTER]**

4.0000
4.0000

Enters real part of first complex number.

$\frac{\square}{\square}$ 2 $\frac{\square}{\square}$ 3 $\frac{\square}{\square}$ $\frac{\square}{\square}$ ENTER

-0.6667

-0.6667

Enters imaginary part of second complex number as a fraction.

3 $\frac{\square}{\square}$ Cmplx $\frac{\square}{\square}$

-3.8667

11.7333

Completes entry of second number and then multiplies the two complex numbers. Result is $11.7333 - i$ 3.8667.

Evaluate $e^{z^{-2}}$, where $z = (1 + i)$. Use $\frac{\square}{\square}$ Cmplx $\frac{\square}{\square}$ to evaluate z^{-2} ; enter -2 as $-2 + i0$.



Keys:

Display:

Description:

1 ENTER 1 ENTER

0 ENTER 2 $\frac{\square}{\square}$ $\frac{\square}{\square}$

Cmplx $\frac{\square}{\square}$

-0.5000

0.0000

Intermediate result of $(1 + i)^{-2}$

$\frac{\square}{\square}$ Cmplx $\frac{\square}{\square}$ $\frac{\square}{\square}$

-0.4794

0.8776

Final result is $0.8776 - i0.4794$.

Using Complex Numbers in Polar Notation

Many applications use real numbers in *polar form* or *polar notation*. These forms use pairs of numbers, as do complex numbers, so you can do arithmetic with these numbers by using the complex operations. Since the HP 33s's complex operations work on numbers in *rectangular form*, convert polar form to *rectangular form* (using $\frac{\square}{\square}$ $\frac{\square}{\square}$) before executing the complex operation, then convert the result back to polar form.

$$\begin{aligned} a + i b &= r(\cos \theta + i \sin \theta) = r e^{i\theta} \\ &= r \angle \theta \quad (\text{Polar or phase form}) \end{aligned}$$

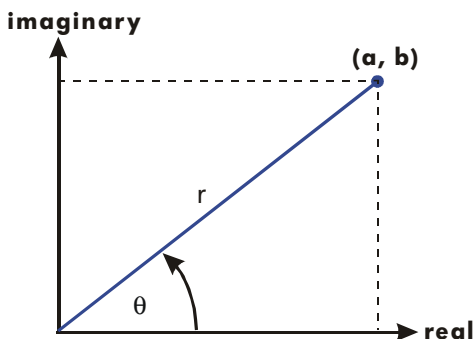

Example: Vector Addition.

Add the following three loads. You will first need to convert the polar coordinates to rectangular coordinates.

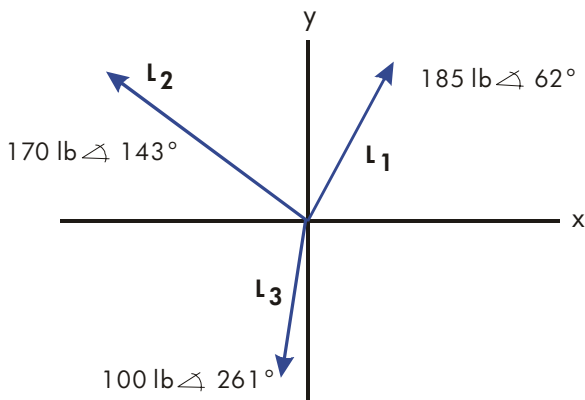

Keys:

Display:

Description:

✓	<code>MODES</code> {DEG}			Sets Degrees mode.
✓	<code>62</code> <code>ENTER</code> <code>185</code> <code>→</code> <code>→y,x</code>	<code>163.3453</code>	<code>86.8522</code>	Enters L_1 and converts it to rectangular form.
✓	<code>143</code> <code>ENTER</code> <code>170</code> <code>→</code> <code>→y,x</code>	<code>102.3086</code>	<code>-135.7680</code>	Enters and converts L_2 .
	<code>↵</code> <code>CMPLEX</code> <code>+</code>	<code>265.6539</code>	<code>-48.9158</code>	Adds vectors.
✓	<code>261</code> <code>ENTER</code> <code>100</code> <code>→</code> <code>→y,x</code>	<code>-98.7688</code>	<code>-15.6434</code>	Enters and converts L_3 .

 **CMPLEX** 

166.8850
-64.5592

Adds $L_1 + L_2 + L_3$.

  θ, r









111.1489
178.9372

Converts vector back to polar form; displays r, θ

Base Conversions and Arithmetic

The BASE menu ( **BASE**) lets you change the number base used for entering numbers and other operations (including programming). Changing bases also converts the *displayed* number to the new base.



BASE Menu



Menu label	Description
{DEC}	<i>Decimal mode.</i> No annunciator. Converts numbers to base 10. Numbers have integer and fractional parts.
{HEX}	<i>Hexadecimal mode.</i> HEX annunciator on. Converts numbers to base 16; uses integers only. The top-row keys become digits  through  .
{OCT}	<i>Octal mode.</i> OCT annunciator on. Converts numbers to base 8; uses integers only. The  ,  , and unshifted top-row keys are inactive.
{BIN}	<i>Binary mode.</i> BIN annunciator on. Converts numbers to base 2; uses integers only. Digit keys other than  and  , and the unshifted top-row functions are inactive. If a number is longer than 12 digits, then the  and  keys are active for viewing windows. (See "Windows for Long Binary Numbers" later in this chapter.)

Examples: Converting the Base of a Number.







The following keystrokes do various base conversions.

Convert 125.99₁₀ to hexadecimal, octal, and binary numbers.











Keys:	Display:	Description:
125.99  BASE {HEX}	7D	Converts just the integer part (125) of the decimal number to base 16 and displays this value.
 BASE {OCT}	175	Base 8.

 BASE {BIN}	1111101	Base 2.
 BASE {DEC}	125.9900	Restores base 10; the original decimal value has been preserved, including its fractional part.

Convert $24FF_{16}$ to binary base. The binary number will be more than 12 digits (the maximum display) long.

Keys:	Display:	Description:
 BASE {HEX}		Use the  key to type "F".
24FF	24FF_	
 BASE {BIN}	010011111111	The entire binary number does not fit. The  annunciator indicates that the number continues to the left.
	10	Displays the rest of the number. The full number is 10010011111111 ₂ .
	010011111111	Displays the first 12 digits again.
 BASE {DEC}	9.471.0000	Restores base 10.

Arithmetic in Bases 2, 8, and 16

You can perform arithmetic operations using , , , and  in any base. The only function keys that are actually deactivated outside of Decimal mode are , , , , , and . However, you should realize that most operations other than arithmetic will not produce meaningful results since the fractional parts of numbers are truncated.

Arithmetic in bases 2, 8, and 16 is in 2's complement form and uses integers only:

- If a number has a fractional part, only the integer part is used for an arithmetic calculation.
- The result of an operation is always an integer (any fractional portion is truncated).

Whereas conversions change only the displayed number and not the number in the X-register, *arithmetic does* alter the number in the X-register.

10-2 Base Conversions and Arithmetic

If the result of an operation cannot be represented in 36 bits, the display shows **OVERFLOW** and then shows the largest positive or negative number possible.

Example:

Here are some examples of arithmetic in Hexadecimal, Octal, and Binary modes:

$$12F_{16} + E9A_{16} = ?$$

Keys:

Display:

Description:

BASE {HEX}

Sets base 16; **HEX** annunciator on.

✓ 12F **ENTER** E9A **+**

FC9 Result.

$$7760_8 - 4326_8 = ?$$

BASE {OCT}

7711 Sets base 8; **OCT** annunciator on. Converts displayed number to octal.

✓ 7760 **ENTER** 4326 **-**

3432 Result.

$$100_8 \div 5_8 = ?$$

✓ 100 **ENTER** 5 **÷**

14 Integer part of result.

$$5A0_{16} + 1001100_2 = ?$$

BASE {HEX} 5A0

5A0_ Set base 16; **HEX** annunciator on.

BASE {BIN} 1001100

1001100_ Changes to base 2; **BIN** annunciator on. This terminates digit entry, so no **ENTER** is needed between the numbers.

✓ **+**

10111101100 Result in binary base.

BASE {HEX}

5EC Result in hexadecimal base.

BASE {DEC}

1,516.0000 Restores decimal base.

The Representation of Numbers

Although the *display* of a number is converted when the base is changed, its stored form is not modified, so decimal numbers are not truncated — until they are used in arithmetic calculations.

When a number appears in hexadecimal, octal, or binary base, it is shown as a right-justified integer with up to 36 bits (12 octal digits or 9 hexadecimal digits). Leading zeros are not displayed, but they are important because they indicate a positive number. For example, the binary representation of 125₁₀ is displayed as:







1111101

which is the same as these 36 digits:

000000000000000000000000000000001111101

Negative Numbers

The leftmost (most significant or "highest") bit of a number's binary representation is the sign bit; it is set (1) for negative numbers. If there are (undisplayed) leading zeros, then the sign bit is 0 (positive). A negative number is the 2's complement of its positive binary number.

Keys:	Display:	Description:
546  {BASE} {HEX}	222	Enters a positive, decimal number; then converts it to hexadecimal.
	FFFFFFDDE	2's complement (sign changed).
 {BASE} {BIN}	110111011110	Binary version;  indicates more digits.
 	111111111111	Displays the leftmost window; the number is negative since the highest bit is 1.
 {BASE} {DEC}	-546.0000	Negative decimal number.

Range of Numbers

The 36-bit word size determines the range of numbers that can be represented in hexadecimal (9 digits), octal (12 digits), and binary bases (36 digits), and the range of decimal numbers (11 digits) that can be converted to these other bases.

Range of Numbers for Base Conversions

Base	Positive Integer of Largest Magnitude	Negative Integer of Largest Magnitude
Hexadecimal	7FFFFFFF	800000000
Octal	377777777777	400000000000
Binary	01111111111111111111111111111111 1111111111111111	10000000000000000000000000000000 0000000000000000
Decimal	34,359,738,367	-34,359,738,368

When you key in numbers, the calculator will not accept more than the maximum number of digits for each base. For example, if you attempt to key in a 10-digit hexadecimal number, digit entry halts and the  annunciator appears.

If a number entered in decimal base is outside the range given above, then it produces the message `TOO BIG` in the other base modes. In RPN mode, the original decimal value of any too-big number is used in calculations. Any operation that results in a number outside the range given above causes `OVERFLOW` to be briefly displayed. The display then shows the largest positive or negative integer representable in the current base. In ALG mode, any operation (except +/- in the entry line but not in a variable prompt) using `TOO BIG` displays the  annunciator.

Windows for Long Binary Numbers

The longest binary number can have 36 digits — three times as many digits as fit in the display. Each 12-digit display of a long number is called a *window*.

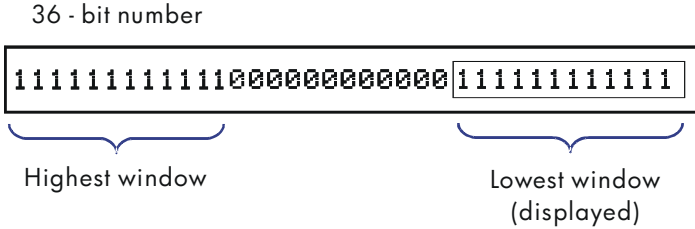

When a binary number is larger than the 12 digits, the ◀ or ▶ annunciator (or both) appears, indicating in which direction the additional digits lie. Press the indicated key (◀ or ▶) to view the obscured window.

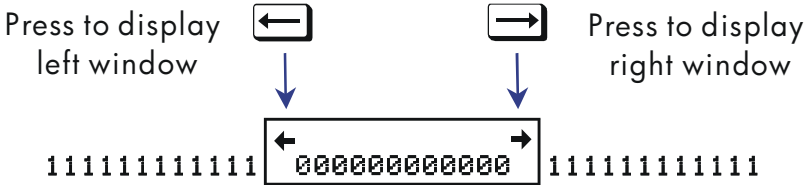

Statistical Operations

The statistics menus in the HP 33s provide functions to statistically analyze a set of one- or two-variable data:

- Mean, sample and population standard deviations.
- Linear regression and linear estimation (\hat{x} and \hat{y}).
- Weighted mean (x weighted by y).
- Summation statistics: n , Σx , Σy , Σx^2 , Σy^2 , and Σxy .

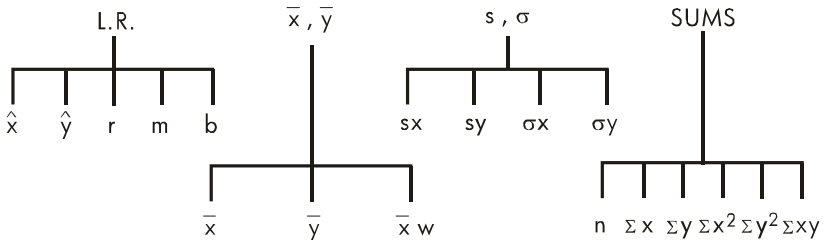

Entering Statistical Data

One- and two-variable statistical data are entered (or deleted) in similar fashion using the $\Sigma+$ (or $\leftarrow \Sigma-$) key. Data values are accumulated as summation statistics in six *statistics registers* (28 through 33), whose names are displayed in the SUMS menu. (Press \rightarrow **SUMS** and see $n \Sigma x \Sigma y \Sigma x^2 \Sigma y^2 \Sigma xy$).

Note

Always clear the statistics registers before entering a new set of statistical data (press \leftarrow **CLEAR** $\{\Sigma\}$).



Entering One-Variable Data

1. Press $\left[\leftarrow \right]$ $\left[\text{CLEAR} \right]$ $\left[\Sigma \right]$ to clear existing statistical data.
2. Key in each x -value and press $\left[\Sigma+ \right]$.
3. The display shows n , the number of statistical data values now accumulated.

Pressing $\left[\Sigma+ \right]$ actually enters two variables into the statistics registers because the value already in the Y -register is accumulated as the y -value. For this reason, the calculator will perform linear regression and show you values based on y even when you have entered only x -data — or even if you have entered an unequal number of x - and y -values. No error occurs, but the results are obviously not meaningful.

To recall a value to the display *immediately after it has been entered*, press $\left[\leftarrow \right]$ $\left[\text{LAST}x \right]$.

✓ Entering Two-Variable Data

In RPN mode, when your data consist of two variables, x is the *independent variable* and y is the *dependent variable*. Remember to enter an (x, y) pair in *reverse order* (y $\left[\text{ENTER} \right]$ x) so that y ends up in the Y -register and X in the X -register.

1. Press $\left[\leftarrow \right]$ $\left[\text{CLEAR} \right]$ $\left[\Sigma \right]$ to clear existing statistical data.
2. Key in the y -value *first* and press $\left[\text{ENTER} \right]$.
3. Key in the corresponding x -value and press $\left[\Sigma+ \right]$.
4. The display shows n , the number of statistical data pairs you have accumulated.
5. Continue entering x, y -pairs. n is updated with each entry.

To recall an x -value to the display immediately after it has been entered, press $\left[\leftarrow \right]$ $\left[\text{LAST}x \right]$.

Correcting Errors in Data Entry

If you make a mistake when entering statistical data, delete the incorrect data and add the correct data. Even if only one value of an x, y -pair is incorrect, you must delete and reenter *both* values.

To correct statistical data:

1. Reenter the incorrect data, but instead of pressing $\Sigma+$, press \leftarrow $\Sigma-$. This deletes the value(s) and decrements n .
2. Enter the correct value(s) using $\Sigma+$.

If the incorrect values were the ones just entered, press \leftarrow $\text{LAST } x$ to retrieve them, then press \leftarrow $\Sigma-$ to delete them. (The incorrect y -value was still in the Y -register, and its x -value was saved in the LAST X register.)

Example:

Key in the x , y -values on the left, then make the corrections shown on the right:





Initial x , y	Corrected x , y
20, 4	20, 5
400, 6	40, 6

Keys:	Display:	Description:
\leftarrow CLEAR $\{\Sigma\}$		Clears existing statistical data.
✓ 4 ENTER 20 $\Sigma+$	4.0000	Enters the first new data pair.
	1.0000	
✓ 6 ENTER 400 $\Sigma+$	6.0000	Display shows n , the number of data pairs you entered.
	2.0000	
\leftarrow LAST x	6.0000	Brings back last x -value.
	400.0000	Last y is still in Y -register.
\leftarrow $\Sigma-$	6.0000	Deletes the last data pair.
	1.0000	
✓ 6 ENTER 40 $\Sigma+$	6.0000	Reenters the last data pair.
	2.0000	
✓ 4 ENTER 20 \leftarrow $\Sigma-$	4.0000	Deletes the first data pair.
	1.0000	
✓ 5 ENTER 20 $\Sigma+$	5.0000	Reenters the first data pair.
	2.0000	There is still a total of two data pairs in the statistics registers.

Statistical Calculations



Once you have entered your data, you can use the functions in the statistics menus.

Statistics Menus

Menu	Key	Description
L.R.	 L.R.	The linear–regression menu: linear estimation $\{\hat{x}\} \{\hat{y}\}$ and curve–fitting $\{r\} \{m\} \{b\}$. See "Linear Regression" later in this chapter.
\bar{x}, \bar{y}	 \bar{x}, \bar{y}	The mean menu: $\{\bar{x}\} \{\bar{y}\} \{\bar{x}\bar{y}\}$. See "Mean" below.
s, σ	 S.O.	The standard–deviation menu: $\{s_x\} \{s_y\} \{\sigma_x\} \{\sigma_y\}$. See "Sample Standard Deviation" and "Population Standard Deviation" later in this chapter.
SUMS	 SUMS	The summation menu: $\{n\} \{\Sigma x\} \{\Sigma y\} \{\Sigma x^2\} \{\Sigma y^2\} \{\Sigma xy\}$. See "Summation Statistics" later in this chapter.

Mean

Mean is the arithmetic average of a group of numbers.

- Press  **\bar{x}, \bar{y}** $\{\bar{x}\}$ for the mean of the x -values.
- Press  **\bar{x}, \bar{y}** $\{\bar{y}\}$ for the mean of the y -values.
- Press  **\bar{x}, \bar{y}** $\{\bar{x}\bar{y}\}$ for the *weighted* mean of the x -values using the y -values as weights or frequencies. The weights can be integers or non-integers.

Example: Mean (One Variable).

Production supervisor May Kitt wants to determine the average time that a certain process takes. She randomly picks six people, observes each one as he or she carries out the process, and records the time required (in minutes):

15.5	9.25	10.0
12.5	12.0	8.5

Calculate the mean of the times. (Treat all data as x -values.)

Keys:	Display:	Description:
CLEAR {Σ}		Clears the statistics registers.
15.5	1.00000	Enters the first time.
9.25 10 12.5		Enters the remaining data; six data points accumulated.
12 8.5	6.00000	
{ \bar{x} }	\bar{x} \bar{y} $\bar{x}\bar{y}$ 11.2917	Calculates the mean time to complete the process.

Example: Weighted Mean (Two Variables).

A manufacturing company purchases a certain part four times a year. Last year's purchases were:

Price per Part (x)	\$4.25	\$4.60	\$4.70	\$4.10
Number of Parts (y)	250	800	900	1000

Find the average price (weighted for the purchase quantity) for this part. Remember to enter y , the weight (frequency), before x , the price.

Keys:	Display:	Description:
CLEAR {Σ}		Clears the statistics registers.
✓ 250 4.25		Enters data; displays n .
✓ 800 4.6		
✓ 900 4.7	900.0000 3.0000	
✓ 1000 4.1	1,000.0000 4.0000	Four data pairs accumulated.
{ $\bar{x}\bar{y}$ }	\bar{x} \bar{y} $\bar{x}\bar{y}$ 4.4314	Calculates the mean price weighted for the quantity purchased.

Sample Standard Deviation

Sample standard deviation is a measure of how dispersed the data values are about the mean. Sample standard deviation assumes the data is a sampling of a larger, complete set of data, and is calculated using $n - 1$ as a divisor.

- Press $\{\sigma_x\}$ for the standard deviation of x -values.
- Press $\{\sigma_y\}$ for the standard deviation of y -values.

The $\{\sigma_x\}$ and $\{\sigma_y\}$ keys in this menu are described in the next section, "Population Standard Deviation."

Example: Sample Standard Deviation.

Using the same process-times as in the above "mean" example, May Kitt now wants to determine the standard deviation time (s_x) of the process:

15.5	9.25	10.0
12.5	12.0	8.5

Calculate the standard deviation of the times. (Treat all the data as x -values.)

Keys:	Display:	Description:
$\{\Sigma\}$		Clears the statistics registers.
15.5	1.0000	Enters the first time.
9.25 10 12.5		Enters the remaining data; six
12 8.5	6.0000	data points entered.
$\{\sigma_x\}$	$\Sigma x \Sigma y \sigma_x \sigma_y$ 2.5808	Calculates the standard deviation time.

Population Standard Deviation

Population standard deviation is a measure of how dispersed the data values are about the mean. Population standard deviation assumes the data constitutes the *complete* set of data, and is calculated using n as a divisor.

- Press $\{\sigma_x\}$ for the population standard deviation of the x -values.
- Press $\{\sigma_y\}$ for the population standard deviation of the y -values.

Example: Population Standard Deviation.

Grandma Hinkle has four grown sons with heights of 170, 173, 174, and 180 cm. Find the population standard deviation of their heights.

Keys:	Display:	Description:
CLEAR {Σ}		Clears the statistics registers.
170 173		Enters data. Four data points accumulated.
174 180	4.0000	
{σx}	Σx Σy σx σy	Calculates the population standard deviation.
	3.6315	

Linear Regression

Linear regression, L.R. (also called *linear estimation*) is a statistical method for finding a straight line that best fits a set of x, y -data.

Note

To avoid a **STAT ERROR** message, enter your data *before* executing any of the functions in the L.R. menu.



L.R. (Linear Regression) Menu

Menu Key	Description
{ \hat{x} }	Estimates (predicts) x for a given hypothetical value of y , based on the line calculated to fit the data.
{ \hat{y} }	Estimates (predicts) y for a given hypothetical value of x , based on the line calculated to fit the data.
{ r }	Correlation coefficient for the (x, y) data. The correlation coefficient is a number in the range -1 through $+1$ that measures how closely the calculated line fits the data.
{ m }	Slope of the calculated line.
{ b }	y -intercept of the calculated line.

- To find an estimated value for x (or y), key in a given hypothetical value for y (or x), then press $\boxed{\rightarrow}$ $\boxed{\text{L.R.}}$ $\boxed{\hat{x}}$ (or $\boxed{\rightarrow}$ $\boxed{\text{L.R.}}$ $\boxed{\hat{y}}$).
- To find the values that define the line that best fits your data, press $\boxed{\rightarrow}$ $\boxed{\text{L.R.}}$ followed by $\boxed{\{r\}}$, $\boxed{\{m\}}$, or $\boxed{\{b\}}$.

Example: Curve Fitting.

The yield of a new variety of rice depends on its rate of fertilization with nitrogen. For the following data, determine the linear relationship: the correlation coefficient, the slope, and the y -intercept.

X, Nitrogen Applied (kg per hectare)	0.00	20.00	40.00	60.00	80.00
Y, Grain Yield (metric tons per hectare)	4.63	5.78	6.61	7.21	7.78

Keys:	Display:	Description:
$\boxed{\leftarrow}$ $\boxed{\text{CLEAR}}$ $\boxed{\Sigma}$		Clears all previous statistical data.
✓ 4.63 $\boxed{\text{ENTER}}$ 0 $\boxed{\Sigma+}$		Enters data; displays n .
✓ 5.78 $\boxed{\text{ENTER}}$ 20 $\boxed{\Sigma+}$		
✓ 6.61 $\boxed{\text{ENTER}}$ 40 $\boxed{\Sigma+}$		
✓ 7.21 $\boxed{\text{ENTER}}$ 60 $\boxed{\Sigma+}$	7.2100 4.0000	
✓ 7.78 $\boxed{\text{ENTER}}$ 80 $\boxed{\Sigma+}$	7.7800 5.0000	Five data pairs entered.
$\boxed{\rightarrow}$ $\boxed{\text{L.R.}}$ $\boxed{\{r\}}$	\hat{x} \hat{y} r m b 0.9880	Displays linear-regression menu. Correlation coefficient; data closely approximate a straight line.
$\boxed{\rightarrow}$	\hat{x} \hat{y} r m b 0.0387	Slope of the line.
$\boxed{\rightarrow}$	\hat{x} \hat{y} r m b 4.8560	y -intercept.

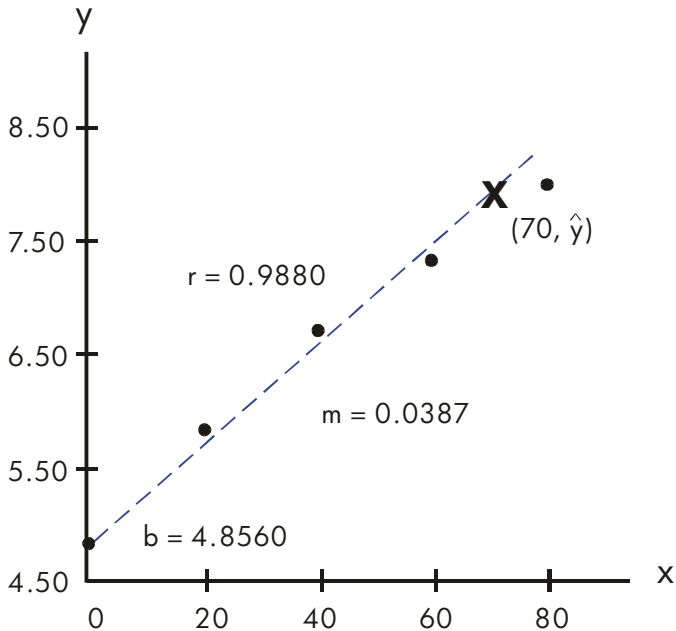

What if 70 kg of nitrogen fertilizer were applied to the rice field? Predict the grain yield based on the above statistics.

Keys:	Display:	Description:
C 70	7.7800	Enters hypothetical x-value.
LR { ŷ }	\hat{y} 7.5615	The predicted yield in tons per hectare.

Limitations on Precision of Data



Since the calculator uses finite precision (12 to 15 digits), it follows that there are limitations to calculations due to rounding. Here are two examples:

Normalizing Close, Large Numbers

The calculator might be unable to correctly calculate the standard deviation and linear regression for a variable whose data values differ by a relatively small amount. To avoid this, normalize the data by entering each value as the difference from one central value (such as the mean). For normalized x -values, this difference must then be added back to the calculation of \bar{x} and \hat{x} , and \hat{y} and b must also be adjusted. For example, if your x -values were 7776999, 7777000, and 7777001, you should enter the data as -1 , 0 , and 1 ; then add 7777000 back to \bar{x} and \hat{x} . For b , add back $7777000 \times m$. To calculate \hat{y} , be sure to supply an x -value that is less 7777000.

Similar inaccuracies can result if your x and y values have greatly different magnitudes. Again, scaling the data can avoid this problem.



Effect of Deleted Data

Executing   does not delete any rounding errors that might have been generated in the statistics registers by the original data values. This difference is not serious unless the incorrect data have a magnitude that is enormous compared with the correct data; in such a case, it would be wise to clear and reenter all the data.

Summation Values and the Statistics Registers

The statistics registers are six unique locations in memory that store the accumulation of the six summation values.

Summation Statistics

Pressing   gives you access to the contents of the statistics registers:

- Press $\{n\}$ to recall the number of accumulated data sets.
- Press $\{x\}$ to recall the sum of the x -values.
- Press $\{y\}$ to recall the sum of the y -values.
- Press $\{\Sigma x^2\}$, $\{\Sigma y^2\}$, and $\{\Sigma xy\}$ to recall the sums of the squares and the sum of the products of the x and y — values that are of interest when performing other statistical calculations in addition to those provided by the calculator.

If you've entered statistical data, you can see the contents of the statistics registers. Press $\boxed{\leftarrow}$ $\boxed{\text{MEM}}$ {VAR}, then use $\boxed{\uparrow}$ and $\boxed{\downarrow}$ to view the statistics registers.

Example: Viewing the Statistics Registers.

Use $\boxed{\Sigma+}$ to store data pairs (1,2) and (3,4) in the statistics registers. Then view the stored statistical values.

Keys:	Display:	Description:
$\boxed{\leftarrow}$ $\boxed{\text{CLEAR}}$ $\boxed{\Sigma}$		Clears the statistics registers.
✓ 2 $\boxed{\text{ENTER}}$ 1 $\boxed{\Sigma+}$	2.0000	Stores the first data pair (1,2).
	1.0000	
✓ 4 $\boxed{\text{ENTER}}$ 3 $\boxed{\Sigma+}$	4.0000	Stores the second data pair (3,4).
	2.0000	
$\boxed{\leftarrow}$ $\boxed{\text{MEM}}$ {VAR}	n=	Displays VAR catalog and views n register.
$\boxed{\uparrow}$	$\Sigma xy =$	Views Σxy register.
$\boxed{\uparrow}$	$\Sigma y^2 =$	Views Σy^2 register.
$\boxed{\uparrow}$	$\Sigma x^2 =$	Views Σx^2 register.
$\boxed{\uparrow}$	$\Sigma y =$	Views Σy register.
$\boxed{\uparrow}$	$\Sigma x =$	Views Σx register.
$\boxed{\text{C}}$	4.0000	Leaves VAR catalog.
	2.0000	

The Statistics Registers in Calculator Memory

The memory space for the statistics registers is automatically allocated when you press $\boxed{\Sigma+}$ or $\boxed{\Sigma-}$. The registers are deleted and the memory deallocated when you execute $\boxed{\leftarrow}$ $\boxed{\text{CLEAR}}$ $\boxed{\Sigma}$.

Access to the Statistics Registers

The statistics register assignments in the HP 33s are shown in the following table.

Statistics Registers

Register	Number	Description
n	28	Number of accumulated data pairs.
Σx	29	Sum of accumulated x -values.
Σy	30	Sum of accumulated y -values.
Σx^2	31	Sum of squares of accumulated x -values.
Σy^2	32	Sum of squares of accumulated y -values.
Σxy	33	Sum of products of accumulated x - and y -values.

You can load a statistics register with a summation by storing the number (28 through 33) of the register you want in i (*number* $\overline{\text{STO}}$ \boxed{i}) and then storing the summation (*value* $\overline{\text{STO}}$ \boxed{i}). Similarly, you can press $\overline{\text{VIEW}}$ \boxed{i} to view a register value — the display is labeled with the register name. The SUMS menu contains functions for recalling the register values. See "Indirectly Addressing Variables and Labels" in chapter 13 for more information.

Part 2

Programming

Simple Programming

Part 1 of this manual introduced you to functions and operations that you can use *manually*, that is, by pressing a key for each individual operation. And you saw how you can use equations to repeat calculations without doing all of the keystrokes each time.

In part 2, you'll learn how you can use *programs* for repetitive calculations — calculations that may involve more input or output control or more intricate logic. A program lets you repeat operations and calculations in the precise manner you want.

In this chapter you will learn how to program a series of operations. In the next chapter, "Programming Techniques," you will learn about subroutines and conditional instructions.

Example: A Simple Program.

To find the area of a circle with a radius of 5, you would use the formula $A = \pi r^2$ and press

RPN mode: 5 x^2 \rightarrow π \times

ALG mode: 5 x^2 \times \rightarrow π ENTER

to get the result for this circle, 78.5398.

But what if you wanted to find the *area* of many different circles?

Rather than repeat the given keystrokes each time (varying only the "5" for the different radii), you can put the repeatable keystrokes into a program:

RPN mode00001 \times^2 00002 π 00003 \times **ALG mode**00001 \times^2 00002 \times 00003 π

00004 ENTER

This very simple program assumes that the value for the radius is in the X-register (the display) when the program starts to run. It computes the area and leaves it in the X-register.

In RPN mode, to enter this program into program memory, do the following:

Keys: (In RPN mode)	Display:	Description:
CLEAR {ALL} {Y}		Clears memory.
PRGM		Activates Program-entry mode (PRGM annunciator on).
GTO	PRGM TOP	Resets program pointer to PRGM TOP.
x^2	00001 \times^2	(Radius) ²
π	00002 π	
\times	00003 \times	Area = πr^2
PRGM		Exits Program-entry mode.

Try running this program to find the area of a circle with a radius of 5:

Keys: (In RPN mode)	Display:	Description:
GTO		This sets the program to its beginning.
5 R/S	78.5398	The answer!

We will continue using the above program for the area of a circle to illustrate programming concepts and methods.

Designing a Program

The following topics show what instructions you can put in a program. What you put in a program affects how it appears when you view it and how it works when you run it.

Selecting a Mode

Programs created and saved in RPN mode can only be edited and executed in RPN mode, and programs or steps created and saved in ALG mode can only be edited and executed in ALG mode. You can ensure that your program executes in the correct mode by making RPN or ALG the first instruction in the program.

Program Boundaries (LBL and RTN)

If you want more than one program stored in program memory, then a program needs a *label* to mark its beginning (such as `R0001 LBL R`) and a *return* to mark its end (such as `R0005 RTN`).

Notice that the line numbers acquire an `R` to match their label.

Program Labels

Programs and segments of programs (called *routines*) should start with a label. To record a label, press:

 `LBL` *letter-key*

The label is a single letter from A through Z. The letter keys are used as they are for variables (as discussed in chapter 3). You cannot assign the same label more than once (this causes the message `DUPLICAT · LBL`), but a label can use the same letter that a variable uses.

It is possible to have one program (the top one) in memory without any label. However, adjacent programs need a label between them to keep them distinct.

Program Returns

Programs and subroutines should end with a return instruction. The keystrokes are:

 `RTN`

When a program finishes running, the last RTN instruction returns the program pointer to PRGM TOP, the top of program memory.

Using RPN, ALG and Equations in Programs

You can calculate in programs the same ways you calculate on the keyboard:

- Using RPN operations (which work with the stack, as explained in chapter 2).
- Using ALG operations (as explained in appendix C).
- Using equations (as explained in chapter 6).

The previous example used a series of *RPN operations* to calculate the area of the circle. Instead, you could have used an *equation* in the program. (An example follows later in this chapter.) Many programs are a combination of RPN and equations, using the strengths of both.

Strengths of RPN Operations

- Use less memory.
- Execute a bit faster.

Strengths of Equations and ALG Operations

- Easier to write and read.
- Can automatically prompt.

When a program executes a line containing an equation, the equation is evaluated in the same way that **XEQ** evaluates an equation in the equation list. For program evaluation, "=" in an equation is essentially treated as "-". (There's no programmable equivalent to **ENTER** for an assignment equation — other than writing the equation as an expression, then using STO to store the value in a variable.)

For both types of calculations, you can include RPN instructions to control input, output, and program flow.

Data Input and Output



For programs that need more than one input or return more than one output, you can decide how you want the program to enter and return information.

For input, you can prompt for a variable with the INPUT instruction, you can get an equation to prompt for its variables, or you can take values entered in advance onto the stack.







For output, you can display a variable with the VIEW instruction, you can display a message derived from an equation, or you can leave unmarked values on the stack.



These are covered later in this chapter under "Entering and Displaying Data."



Entering a Program







Pressing   toggles the calculator into and out of Program-entry mode — turns the **PRGM** annunciator on and off. Keystrokes in Program-entry mode are stored as program lines in memory. Each instruction or number occupies one program line, and there is no limit (other than available memory) on the number of lines in a program.

To enter a program into memory:

1. Press   to activate Program-entry mode.
2. Press     to display PRGM TOP. This sets the *program pointer* to a known spot, before any other programs. As you enter program lines, they are inserted *before* all other program lines.

If you don't need any other programs that might be in memory, clear program memory by pressing   {PGM}. To confirm that you want *all* programs deleted, press {Y} after the message CLR PGMS? Y N.





3. Give the program a *label* — a single letter, A through Z. Press   *letter*. Choose a letter that will remind you of the program, such as "A" for "area."



If the message DUPLICRT·LBL is displayed, use a different letter. You can clear the existing program instead — press   {PGM}, use  or  to find the label, and press   and .

4. To record calculator operations as program instructions, press the same keys you would to do an operation manually. Remember that many functions don't appear on the keyboard but must be accessed using menus.





Programs written for ALG mode should normally have an "=" (ENTER) as the last instruction in the program (before the RTN instruction). This will complete any pending calculations and allow the user to re-use the result of the program in further calculations.



To enter an equation in a program line, see the instructions below.





5. End the program with a *return* instruction, which sets the program pointer back to PRGM TOP after the program runs. Press  .
6. Press  (or  ) to cancel program entry.

Numbers in program lines are stored as precisely as you entered them, and they're displayed using ALL or SCI format. (If a long number is shortened in the display, press   to view all digits.)

To enter an equation in a program line:







1. Press   to activate Equation-entry mode. The **EQN** annunciator turns on.
2. Enter the equation as you would in the equation list. See chapter 6 for details. Use  to correct errors as you type.
3. Press  to terminate the equation and display its left end. (The equation does *not* become part of the equation list.)

After you've entered an equation, you can press   to see its checksum and length. Hold the  key to keep the values in the display.

For a long equation, the  and  annunciators show that scrolling is active for this program line. You can use  and  to scroll the display.

Keys That Clear

Note these special conditions during program entry:



















-  always cancels program entry. It never clears a number to zero.
- If the program line doesn't contain an equation,  deletes the current program line. It backspaces if a digit is being entered ("_" cursor present).
- If the program line contains an equation,  begins editing the equation. It deletes the rightmost function or variable if an equation is being entered ("■" cursor present).
-   {EQN} deletes a program line if it contains an equation.
- To *program* a function to clear the X-register, use   {X}.

Function Names in Programs

The name of a function that is used in a program line is *not* necessarily the same as the function's name on its key, in its menu, or in an equation. The name that is used in a program is usually a fuller abbreviation than that which can fit on a key or in a menu. This fuller name appears briefly in the display whenever you execute a function — as long as you hold down the key, the name is displayed.

Example: Entering a Labeled Program.

The following keystrokes delete the previous program for the area of a circle and enter a new one that includes a label and a return instruction. If you make a mistake during entry, press  to delete the current program line, then reenter the line correctly.

Keys: (In RPN mode)	Display:	Description:
 		Activates Program-entry mode (PRGM on).
  {PGM}		Clears all of program memory.
{Y}	PRGM TOP	
  A	A0001 LBL A	Labels this program routine A (for "area").
	A0002 x ²	Enters the three program lines.
 	A0003 π	
	A0004 x	
 	A0005 RTN	Ends the program.
  {PGM}	LBL A	Displays label A and the length of the program in bytes.
	LN=15	
 	CK=DEFD	Checksum and length of program.
	LN=15	
 		Cancels program entry (PRGM annunciator off).

A different checksum means the program was not entered exactly as given here.

Example: Entering a Program with an Equation.

The following program calculates the area of a circle using an equation, rather than using RPN operations like the previous program.

Keys: (In RPN mode)	Display:	Description:
PRGM . .	PRGM TOP	Activates Program-entry mode; sets pointer to top of memory.
LBL E	E0001 LBL E	Labels this program routine E (for "equation").
R	E0002 STO R	Stores radius in variable R.
EQN π RCL R 2	E0003 $\pi \times R^2$	Selects Equation-entry mode; enters the equation; returns to Program-entry mode.
SHOW	CK=7E5B LN=5	
RTN MEM {PGM}	E0004 RTN LBL E LN=17	Ends the program. Displays label E and the length of the program in bytes.
SHOW	CK=4CDF LN=17	Checksum and length of equation.
		Cancels program entry.

Running a Program

To run or *execute* a program, program entry cannot be active (no program–line numbers displayed; **PRGM** off). Pressing **C** will cancel Program–entry mode.

Executing a Program (XEQ)

Press **XEQ** *label* to execute the program labeled with that letter. If there is only one program in memory, you can also execute it by pressing **◀** **GTO** **•** **•** **R/S** (*run/stop*).

If necessary, enter the data before executing the program.

Example:

Run the programs labeled A and E to find the areas of three different circles with radii of 5, 2.5, and 2π . Remember to enter the radius before executing A or E.

Keys: (In RPN mode)	Display:	Description:
5 XEQ A	RUNNING 78.5398	Enters the radius, then starts program A. The resulting area is displayed.
2.5 XEQ E	19.6350	Calculates area of the second circle using program E.
2 ◀ π × XEQ A	124.0251	Calculates area of the third circle.

Testing a Program

If you know there is an error in a program, but are not sure where the error is, then a good way to test the program is by stepwise execution. It is also a good idea to test a long or complicated program before relying on it. By stepping through its execution, one line at a time, you can see the result after each program line is executed, so you can verify the progress of known data whose correct results are also known.

1. As for regular execution, make sure program entry is not active (**PRGM** annunciator off).

- Press \leftarrow GTO *label* to set the program pointer to the start of the program (that is, at its LBL instruction). The GTO instruction moves the program pointer without starting execution. (If the program is the first or only program, you can press \leftarrow GTO \square \square to move to its beginning.)
- Press and hold \downarrow . This displays the current program line. When you release \downarrow , the line is executed. The result of that execution is then displayed (it is in the X-register).
To move to the *preceding* line, you can press \uparrow . No execution occurs.
- The program pointer moves to the next line. Repeat step 3 until you find an error (an incorrect result occurs) or reach the end of the program.

If Program-entry mode is active, then \downarrow or \uparrow simply changes the program pointer, without executing lines. Holding down a cursor key during program entry makes the lines roll by automatically.

Example: Testing a Program.

Step through the execution of the program labeled A. Use a radius of 5 for the test data. Check that Program-entry mode is *not* active before you start:

Keys: (In RPN mode)	Display:	Description:
5 \leftarrow GTO A	5.0000	Moves program counter to label A.
\downarrow (hold)	R0001 LBL A	
(release)	5.0000	
\downarrow (hold)	R0002 \times^2	Squares input.
(release)	25.0000	
\downarrow (hold)	R0003 π	Value of π .
(release)	3.1416	
\downarrow (hold)	R0004 \times	25π .
(release)	78.5398	
\downarrow (hold)	R0005 RTN	End of program. Result is correct.
(release)	78.5398	

Entering and Displaying Data

The calculator's *variables* are used to store data input, intermediate results, and final results. (Variables, as explained in chapter 3, are identified by a letter from A through Z or *i*, but the variable names have nothing to do with program labels.)

In a program, you can get data in these ways:

- From an INPUT instruction, which prompts for the value of a variable. (This is the most handy technique.)
- From the stack. (You can use STO to store the value in a variable for later use.)
- From variables that already have values stored.
- From automatic equation prompting (if enabled by flag 11 set). (This is also handy if you're using equations.)

In a program, you can display information in these ways:

- With a VIEW instruction, which shows the name and value of a variable. (This is the most handy technique.)
- On the stack — only the value in the X-register is visible. (You can use PSE for a 1-second look at the X-register.)
- In a displayed equation (if enabled by flag 10 set). (The "equation" is usually a message, not a true equation.)

Some of these input and output techniques are described in the following topics.

Using INPUT for Entering Data

The INPUT instruction ( INPUT Variable) stops a running program and displays a prompt for the given variable. This display includes the existing value for the variable, such as

```
R?  
0.0000
```

where

"R" is the variable's name,

"?" is the prompt for information, and

0.0000 is the current value stored in the variable.

Press **R/S** (*run/stop*) to resume the program. The value you keyed in then writes over the contents of the X-register *and* is stored in the given variable. If you have not changed the displayed value, then that value is retained in the X-register.

The area-of-a-circle program with an INPUT instruction looks like this:

RPN mode	ALG mode
A0001 LBL A	A0001 LBL A
A0002 INPUT R	A0002 INPUT R
A0003 \times^2	A0003 \times^2
A0004 π	A0004 \times
A0005 \times	A0005 π
A0006 RTN	A0006 ENTER
	A0007 RTN

To use the INPUT function in a program:

1. Decide which data values you will need, and assign them names.
(In the area-of-a-circle example, the only input needed is the radius, which we can assign to *R*.)
2. In the beginning of the program, insert an INPUT instruction for each variable whose value you will need. Later in the program, when you write the part of the calculation that needs a given value, insert a **RCL** *variable* instruction to bring that value back into the stack.

Since the INPUT instruction also leaves the value you just entered in the X-register, you don't *have* to recall the variable at a later time — you could INPUT it and use it when you need it. You might be able to save some memory space this way. However, in a long program it is simpler to just input all your data up front, and then recall individual variables as you need them.

Remember also that the user of the program can do calculations while the program is stopped, waiting for input. This can alter the contents of the stack, which might affect the next calculation to be done by the program. Thus the program should not assume that the X-, Y-, and Z-registers' contents will be the same before and after the INPUT instruction. If you collect all the data in the beginning and then recall them when needed for calculation, then this prevents the stack's contents from being altered just before a calculation.

For example, see the "Coordinate Transformations" program in chapter 15. Routine *D* collects all the necessary input for the variables *M*, *N*, and *T* (lines D0002 through D0004) that define the *x* and *y* coordinates and angle θ of a new system.

To respond to a prompt:

When you run the program, it will stop at each INPUT and prompt you for that variable, such as $R? \square . \square \square \square \square$. The value displayed (and the contents of the X-register) will be the current contents of R.

- **To leave the number unchanged**, just press **R/S**.
- **To change the number**, type the new number and press **R/S**. This new number writes over the old value in the X-register. You can enter a number as a fraction if you want. If you need to calculate a number, use normal keyboard calculations, then press **R/S**. For example, you can press 2 **ENTER** 5 **y^x** **R/S**.
- **To calculate with the displayed number**, press **ENTER** before typing another number.
- **To cancel the INPUT prompt**, press **C**. The current value for the variable remains in the X-register. If you press **R/S** to resume the program, the canceled INPUT prompt is repeated. If you press **C** during digit entry, it clears the number to zero. Press **C** again to cancel the INPUT prompt.

Using VIEW for Displaying Data

The programmed VIEW instruction (**VIEW** *variable*) stops a running program and displays and identifies the contents of the given variable, such as

```
R=  
78.5398
```

This is a *display only*, and does not copy the number to the X-register. If Fraction-display mode is active, the value is displayed as a fraction.

- Pressing **ENTER** copies this number to the X-register.
- If the number is wider than 14 characters, pressing **VIEW** **SHOW** displays the entire number. (If it is a binary number with more than 12 digits, use the **←** and **→** keys to see the rest.)
- Pressing **C** (or **←**) erases the VIEW display and shows the X-register.



- Pressing  **CLEAR** clears the contents of the displayed variable.

Press  to continue the program,





If you don't want the program to stop, see "Displaying Information without Stopping" below.

For example, see the program for "Normal and Inverse–Normal Distributions" in chapter 16. Lines T0015 and T0016 at the end of the T routine display the result for X . Note also that this VIEW instruction in this program is preceded by a RCL instruction. The RCL instruction is not necessary, but it is convenient because it brings the VIEWed variable to the X-register, making it available for manual calculations. (Pressing  while viewing a VIEW display would have the same effect.) The other application programs in chapters 15 through 17 also ensure that the VIEWed variable is in the X-register as well — except for the "Polynomial Root Finder" program.

Using Equations to Display Messages

Equations aren't checked for valid syntax until they're evaluated. This means you can enter almost *any* sequence of characters into a program as an equation — you enter it just as you enter *any* equation. On any program line, press  **EQN** to start the equation. Press number and math keys to get numbers and symbols. Press  before each letter. Press  to end the equation.

If flag 10 is set, equations are *displayed* instead of being *evaluated*. This means you can display any message you enter as an equation. (Flags are discussed in detail in chapter 13.)

When the message is displayed, the program stops — press  to resume execution. If the displayed message is longer than 14 characters, the  annunciator turns on when the message is displayed. You can then use  and  to scroll the display.

If you don't want the program to stop, see "Displaying Information without Stopping" below.

Example: INPUT, VIEW, and Messages in a Program.

Write an equation to find the surface area and volume of a cylinder given its radius and height. Label the program C (for *cylinder*), and use the variables S (surface area), V (volume), R (radius), and H (height). Use these formulas:

12–14 Simple Programming

$$V = \pi R^2 H$$

$$S = 2\pi R^2 + 2\pi RH = 2\pi R(R + H)$$

Keys: (In RPN mode)	Display:	Description:
PRGM		Program, entry; sets pointer to top of memory.
GTO	PRGM TOP	Labels program.
LBL C	C0001 LBL C	
INPUT R	C0002 INPUT R	Instructions to prompt for radius and height.
INPUT H	C0003 INPUT H	Calculates the volume.
EQN		
π \times RCL R y^x		
2 \times RCL H		
ENTER	C0004 $\pi \times R^2 \times H$	
SHOW	CK=74FE LN=7	Checksum and length of equation.
STO V	C0005 STO V	Store the volume in V.
EQN 2		Calculates the surface area.
\times π		
\times RCL R \times		
() RCL R		
+ RCL H		
) ENTER	C0006 $2 \times \pi \times R \times R$	
SHOW	CK=19B3 LN=11	Checksum and length of equation.
STO S	C0007 STO S	Stores the surface area in S.
FLAGS {SF}		Sets flag 10 to display equations.
\cdot 0	C0008 SF 10	Displays message in equations.
EQN RCL V		
RCL O RCL L		
SPACE + SPACE		
RCL A RCL R		
RCL E RCL A		
ENTER	C0009 VOL + AR	
FLAGS {CF}		Clears flag 10.
\cdot 0	C0010 CF 10	

Keys: (In RPN mode)	Display:	Description:
VIEW V	C0011 VIEW V	Displays volume.
VIEW S	C0012 VIEW S	Displays surface area.
RTN	C0013 RTN	Ends program.
MEM {PGM}	LBL C LN=67	Displays label C and the length of the program in bytes.
SHOW	CK=6182 LN=67	Checksum and length of program.
		Cancels program entry.

Now find the volume and surface area of a cylinder with a radius of $2\frac{1}{2}$ cm and a height of 8 cm.

Keys: (In RPN mode)	Display:	Description:
C	R? <i>value</i>	Starts executing C; prompts for R. (It displays whatever value happens to be in R.)
2 1 2	H? <i>value</i>	Enters $2\frac{1}{2}$ as a fraction. Prompts for H.
8	VOL + AREA	Message displayed.
	V= 157.0796	Volume in cm^3 .
	S= 164.9336	Surface area in cm^2 .

Displaying Information without Stopping

Normally, a program stops when it displays a variable with VIEW or displays an equation message. You normally have to press to resume execution.

If you want, you can make the program continue while the information is displayed. If the *next* program line — after a VIEW instruction or a viewed equation — contains a PSE (*pause*) instruction, the information is displayed *and* execution continues after a 1-second pause. In this case, no scrolling or keyboard input is allowed.



The display is cleared by other display operations, and by the RND operation if flag 7 is set (rounding to a fraction).

Press  **PSE** to enter PSE in a program.



The VIEW and PSE lines — or the equation and PSE lines — are treated as one operation when you execute a program one line at a time.





Stopping or Interrupting a Program

Programming a Stop or Pause (STOP, PSE)

- Pressing  (*run/stop*) during program entry inserts a STOP instruction. This will halt a running program until you resume it by pressing  from the keyboard. You can use STOP rather than RTN in order to end a program without returning the program pointer to the top of memory.
- Pressing  **PSE** during program entry inserts a PSE (*pause*) instruction. This will suspend a running program and display the contents of the X-register for about 1 second — with the following exception. If PSE immediately follows a VIEW instruction or an equation that's displayed (flag 10 set), the variable or equation is displayed instead — and the display remains after the 1-second pause.



Interrupting a Running Program

You can interrupt a running program at any time by pressing  or . The program completes its current instruction before stopping. Press  (*run/stop*) to resume the program.

If you interrupt a program and then press , , or , you *cannot* resume the program with . Reexecute the program instead ( *label*).

Error Stops

















If an error occurs in the course of a running program, program execution halts and an error message appears in the display. (There is a list of messages and conditions in appendix F.)

To see the line in the program containing the error-causing instruction, press  . The program will have stopped at that point. (For instance, it might be a \div instruction, which caused an illegal division by zero.)

Editing a Program

You can modify a program in program memory by inserting, deleting, and editing program lines. If a program line contains an equation, you can edit the equation — if any other program line requires even a minor change, you must delete the old line and insert a new one.

To delete a program line:

1. Select the relevant program or routine (  *label*), activate program entry ( ), and press  or  to locate the program line that must be changed. Hold the cursor key down to continue scrolling. (If you know the line number you want, pressing    *label nnnn* moves the program pointer there.)
2. Delete the line you want to change — if it contains an equation, press   {}; otherwise, press . The pointer then moves to the *preceding* line. (If you are deleting more than one consecutive program line, start with the *last* line in the group.)
3. Key in the new instruction, if any. This replaces the one you deleted.
4. Exit program entry ( or  ).

To insert a program line:

1. Locate and display the program line that is *before* the spot where you would like to insert a line.
2. Key in the new instruction; it is inserted *after* the currently displayed line.

For example, if you wanted to insert a new line between lines A0004 and A0005 of a program, you would first display line A0004, then key in the instruction or instructions. Subsequent program lines, starting with the original line A0005, are moved down and renumbered accordingly.

To edit an equation in a program line:

1. Locate and display the program line containing the equation.

2. Press . This turns on the "█" editing cursor, but does not delete anything in the equation.
3. Press as required to delete the function or number you want to change, then enter the desired corrections.
4. Press to end the equation.

Program Memory

Viewing Program Memory

Pressing toggles the calculator into and out of program entry (**PRGM** annunciator on, program lines displayed). When Program-entry mode is active, the contents of program memory are displayed.

Program memory starts at **PRGM TOP**. The list of program lines is circular, so you can wrap the program pointer from the bottom to the top and reverse. While program entry is active, there are three ways to change the program pointer (the displayed line):

- Use the cursor keys, and . Pressing at the last line moves the pointer to **PRGM TOP**, while pressing at **PRGM TOP** moves the pointer to the last program line.

To move more than one line at a time ("scrolling"), continue to hold the or key.

- Press to move the program pointer to **PRGM TOP**.
- Press *label nnnn* to move to a labeled line number less than 10000.





If Program-entry mode is not active (if no program lines are displayed), you can also move the program pointer by pressing *label*.









Canceling Program-entry mode does *not* change the position of the program pointer.

Memory Usage

If during program entry you encounter the message **MEMORY FULL**, then there is not enough room in program memory for the line you just tried to enter. You can make more room available by clearing programs or other data. See "Clearing One or More Programs" below, or "Managing Calculator Memory" in appendix B.

The Catalog of Programs (MEM)

The catalog of programs is a list of all program labels with the number of bytes of memory used by each label and the lines associated with it. Press   {PGM} to display the catalog, and press  or  to move within the list. You can use this catalog to:

- Review the labels in program memory and the memory cost of each labeled program or routine.
- Execute a labeled program. (Press  or  while the label is displayed.)
- Display a labeled program. (Press   while the label is displayed.)
- Delete specific programs. (Press   while the label is displayed.)
- See the checksum associated with a given program segment. (Press   .)









The catalog shows you how many bytes of memory each labeled program segment uses. The programs are identified by program label:

```
LBL C  
LN=67
```







where 67 is the number of bytes used by the program.

Clearing One or More Programs

To clear a specific program from memory

1. Press   {PGM} and display (using  and ) the label of the program.
2. Press  .
3. Press  to cancel the catalog or  to back out.





To clear all programs from memory:

1. Press   to display program lines (**PRGM** annunciator on).
2. Press   {PGM} to clear program memory.
3. The message CLR PGMS? Y N prompts you for confirmation. Press {Y}.
4. Press   to cancel program entry.





Clearing all of memory (  {ALL}) also clears all programs.

The Checksum

The *checksum* is a unique hexadecimal value given to each program label and its associated lines (until the next label). This number is useful for comparison with a known checksum for an existing program that you have keyed into program memory. If the known checksum and the one shown by your calculator are the same, then you have correctly entered all the lines of the program. To see your checksum:

1. Press   {PGM} for the catalog of program labels.
2. Display the appropriate label by using the cursor keys, if necessary.
3. Press and hold   to display CK=checksum and LN=length.

For example, to see the checksum for the current program (the "cylinder" program):

Keys: (In RPN mode)	Display:	Description:
  {PGM}	LBL C LN=67	Displays label C, which takes 67 bytes.
  (hold)	CK=6182 LN=67	Checksum and length.

If your checksum does *not* match this number, then you have not entered this program correctly.

You will see that all of the application programs provided in chapters 15 through 17 include checksum values with each labeled routine so that you can verify the accuracy of your program entry.

In addition, each equation in a program has a checksum. See "To enter an equation in a program line" earlier in this chapter.

Nonprogrammable Functions

The following functions of the HP 33s are *not* programmable:

CLEAR {PGM}	GTO
CLEAR {ALL}	GTO <i>label nnnn</i>
	MEM
, , ,	SHOW
PRGM	EQN
, ,	FDISP

Programming with BASE

You can program instructions to change the base mode using BASE. These settings work in programs just as they do as functions executed from the keyboard. This allows you to write programs that accept numbers in any of the four bases, do arithmetic in any base, and display results in any base.

When writing programs that use numbers in a base other than 10, set the base mode both as the current setting for the calculator and in the program (as an instruction).

Selecting a Base Mode in a Program

Insert a BIN, OCT, or HEX instruction into the beginning of the program. You should usually include a DEC instruction at the end of the program so that the calculator's setting will revert to Decimal mode when the program is done.

An instruction in a program to change the base mode will determine how input is interpreted and how output looks *during and after program execution*, but it does *not* affect the program lines as you enter them.

Equation evaluation, SOLVE, and \int FN automatically set Decimal mode.

Numbers Entered in Program Lines

Before starting program entry, set the base mode. The current setting for the base mode determines the base of the numbers that are entered into program lines. The display of these numbers changes when you change the base mode.

Program line numbers always appear in base 10.

An annunciator tells you which base is the current setting. Compare the program lines below in the left and right columns. All non-decimal numbers are right-justified in the calculator's display. Notice how the number 13 appears as "D" in Hexadecimal mode.

Decimal mode set:	Hexadecimal mode set:
⋮	⋮
PRGM	PRGM HEX
A0009 HEX	A0009 HEX
PRGM	PRGM HEX
A0010 13	A0010 D
⋮	⋮
⋮	⋮

Polynomial Expressions and Horner's Method

Some expressions, such as polynomials, use the same variable several times for their solution. For example, the expression

$$Ax^4 + Bx^3 + Cx^2 + Dx + E$$

uses the variable x four different times. A program to calculate such an expression using ALG operations could repeatedly recall a stored copy of x from a variable.

Example:

Write a program using ALG operations for $5x^4 + 2x^3$, then evaluate it for $x = 7$.

Keys: (In ALG mode)	Display:	Description:
PRGM	PRGM TOP	
	A0001 LBL A	
LBL A	A0002 INPUT X	
INPUT X	A0003 5	5
5	A0004 x	
X	A0005 RCL X	5x.
RCL X	A0006 y ^x	
y ^x	A0007 4	5x ⁴
4	A0008 +	5x ⁴ +
+	A0009 2	5x ⁴ + 2
2	A0010 x	
X	A0011 RCL X	5x ⁴ + 2x
RCL X	A0012 y ^x	
y ^x	A0013 3	5x ⁴ + 2x ³
3	A0014 ENTER	
ENTER	A0015 RTN	
RTN	LBL A	Displays label A, which takes 93 bytes.
MEM {PGM}	LN=93	
SHOW	CK=6A3F	Checksum and length.
	LN=93	
		Cancels program entry.

Now evaluate this polynomial for $x = 7$.

Keys: (In ALG mode)	Display:	Description:
XEQ A	X?	Prompts for x.
	value	
7 R/S	12.691.0000	Result.

A more general form of this program for any equation $Ax^4 + Bx^3 + Cx^2 + Dx + E$ would be:

```
A0001 LBL A
A0002 INPUT A
A0003 INPUT B
A0004 INPUT C
A0005 INPUT D
A0006 INPUT E
A0007 INPUT X
A0008 RCL X
A0009 RCL× A
A0010 RCL+ B
A0011 RCL× X
A0012 RCL+ C
A0013 RCL× X
A0014 RCL+ D
A0015 RCL× X
A0016 RCL+ E
A0017 ENTER
A0018 RTN
```

Checksum and length: E41A 54

Programming Techniques

Chapter 12 covered the basics of programming. This chapter explores more sophisticated but useful techniques:

- Using subroutines to simplify programs by separating and labeling portions of the program that are dedicated to particular tasks. The use of subroutines also shortens a program that must perform a series of steps more than once.
- Using conditional instructions (comparisons and flags) to determine which instructions or subroutines should be used.
- Using loops with counters to execute a set of instructions a certain number of times.
- Using indirect addressing to access different variables using the same program instruction.

Routines in Programs

A program is composed of one or more *routines*. A routine is a functional unit that accomplishes something specific. Complicated programs need routines to group and separate tasks. This makes a program easier to write, read, understand, and alter.

For example, look at the program for "Normal and Inverse-Normal Distributions" in chapter 16. Routine S "initializes" the program by collecting the input for the mean and standard deviation. Routine D sets a limit of integration, executes routine Q, and displays the result. Routine Q integrates the function defined in routine F and finishes the probability calculation of $Q(x)$.

A routine typically starts with a label (LBL) and ends with an instruction that alters or stops program execution, such as RTN, GTO, or STOP, or perhaps another label.

Calling Subroutines (XEQ, RTN)

A *subroutine* is a routine that is *called from* (executed by) another routine and *returns to* that same routine when the subroutine is finished. The subroutine *must* start with a LBL and end with a RTN. A subroutine is itself a routine, and it can call other subroutines.

- XEQ must branch to a label (LBL) for the subroutine. (It cannot branch to a line number.)
- At the very next RTN encountered, program execution returns to the line after the originating XEQ.

For example, routine Q in the "Normal and Inverse-Normal Distributions" program in chapter 16 is a subroutine (to calculate $Q(x)$) that is called from routine D by line D0003 XEQ Q. Routine Q ends with a RTN instruction that sends program execution back to routine D (to store and display the result) at line D0004. See the flow diagrams below.

The flow diagrams in this chapter use this notation:

- A0005 GTO B → ① Program execution branches from this line to the line marked ← ① ("from 1").
- B0001 LBL B ← ① Program execution branches from a line marked → ① ("to 1") to this line.

D0001 LBL D		Starts here.
D0002 INPUT X		
D0003 XEQ Q	→ ①	Calls subroutine Q.
D0004 STO Q	← ②	Returns here.
D0005 VIEW Q		
D0006 GTO D		Starts D again.
Q0001 LBL Q	← ①	Starts subroutine.
:		
:		
Q0016 RTN	→ ②	Returns to routine D.

Nested Subroutines

A subroutine can call another subroutine, and that subroutine can call yet another subroutine. This "nesting" of subroutines — the calling of a subroutine within another subroutine — is limited to a stack of subroutines seven levels deep (not counting the topmost program level). The operation of nested subroutines is as shown below:

MAIN program (top level)

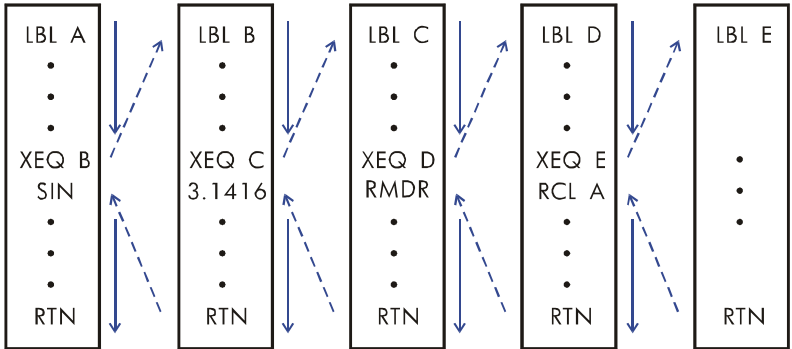

End of program

Attempting to execute a subroutine nested more than seven levels deep causes an XEQ OVERFLOW error.

Example: A Nested Subroutine.

The following subroutine, labeled S, calculates the value of the expression

$$\sqrt{a^2 + b^2 + c^2 + d^2}$$

as part of a larger calculation in a larger program. The subroutine calls upon *another* subroutine (a nested subroutine), labeled Q, to do the repetitive squaring and addition. This saves memory by keeping the program shorter than it would be without the subroutine.

In RPN mode,



S0001	LBL S		Starts subroutine here.
S0002	INPUT A		Enters A.
S0003	INPUT B		Enters B.
S0004	INPUT C		Enters C.
S0005	INPUT D		Enters D.
S0006	RCL D		Recalls the data.
S0007	RCL C		
S0008	RCL B		
S0009	RCL A		
S0010	\times^2		A^2 .
S0011	XEQ Q	→ ①	$A^2 + B^2$.
② → S0012	XEQ Q	→ ③	$A^2 + B^2 + C^2$
④ → S0013	XEQ Q	→ ⑤	$A^2 + B^2 + C^2 + D^2$
⑥ → S0014	$\sqrt{}$ x		$\sqrt{A^2 + B^2 + C^2 + D^2}$
S0015	RTN		Returns to main routine.
Q0001	LBL Q	← ①③⑤	Nested subroutine
Q0002	$\times\langle\rangle y$		
Q0003	\times^2		
Q0004	+		Adds x^2 .
②④⑥ ← Q0005	RTN		Returns to subroutine S.

Branching (GTO)

As we have seen with subroutines, it is often desirable to transfer execution to a part of the program other than the next line. This is called **branching**.

Unconditional branching uses the GTO (*go to*) instruction to branch to a program **label**. It is not possible to branch to a specific line number during a program.



A Programmed GTO Instruction

The GTO *label* instruction (press   *label*) transfers the execution of a running program to the program line containing that label, wherever it may be. The program continues running from the new location, and *never* automatically returns to its point of origination, so GTO is not used for subroutines.

For example, consider the "Curve Fitting" program in chapter 16. The GTO Z instruction branches execution from any one of three independent initializing routines to LBL Z, the routine that is the common entry point into the heart of the program:

S0001 LBL S		Can start here.
.		
.		
S0005 GTO Z	→①	Branches to Z.
L0001 LBL L		Can start here.
.		
.		
L0005 GTO Z	→①	Branches to Z.
E0001 LBL E		Can start here.
.		
.		
E0005 GTO Z	→①	Branches to Z.
Z0001 LBL Z	←①	Branch to here.
.		
.		

Using GTO from the Keyboard

You can use   to move the program pointer to a specified label or line number *without* starting program execution.

- To PRGM TOP: .
- To a line number: *label nnnn* (*nnnn* < 10000). For example, A0005.
- To a label: *label* —but only if program entry is not active (no program lines displayed; **PRGM** off). For example, A.

Conditional Instructions

Another way to alter the sequence of program execution is by a *conditional test*, a true/false test that compares two numbers and skips the next program instruction if the proposition is false.

For instance, if a conditional instruction on line A0005 is $x=0?$ (that is, *is x equal to zero?*), then the program compares the contents of the X-register with zero. If the X-register *does* contain zero, then the program goes on to the next line. If the X-register *does not* contain zero, then the program *skips* the next line, thereby branching to line A0007. This rule is commonly known as "Do if true."

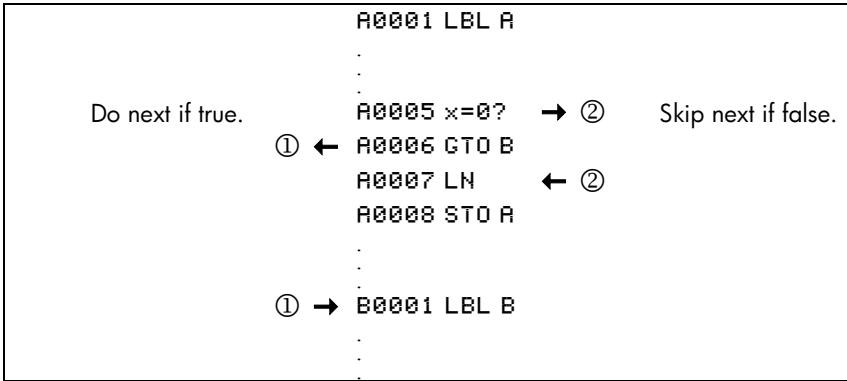





The above example points out a common technique used with conditional tests: the line immediately after the test (which is only executed in the "true" case) is a *branch* to another label. So the net effect of the test is to branch to a different routine under certain circumstances.

There are three categories of conditional instructions:

- Comparison tests. These compare the X- and Y-registers, or the X-register and zero.

- Flag tests. These check the status of flags, which can be either set or clear.
- Loop counters. These are usually used to loop a specified number of times.

Tests of Comparison (x?y, x?0)

There are 12 comparisons available for programming. Pressing   or   displays a menu for one of the two categories of tests:

- x?y for tests comparing x and y.
- x?0 for tests comparing x and 0.

Remember that x refers to the number in the X-register, and y refers to the number in the Y-register. These do *not* compare the variables X and Y.

Select the category of comparison, then press the menu key for the conditional instruction you want.

The Test Menus

x?y	x?0
{≠} for $x \neq y$?	{≠} for $x \neq 0$?
{≤} for $x \leq y$?	{≤} for $x \leq 0$?
{<} for $x < y$?	{<} for $x < 0$?
{>} for $x > y$?	{>} for $x > 0$?
{≥} for $x \geq y$?	{≥} for $x \geq 0$?
{=} for $x = y$?	{=} for $x = 0$?

If you execute a conditional test from the keyboard, the calculator will display YES or NO.



For example, if $x = 2$ and $y = 7$, test $x < y$.

Keys:

Display:

In RPN mode 7  2   {<}

YES

In ALG mode 7  2   {<}

YES

Example:

The "Normal and Inverse–Normal Distributions" program in chapter 16 uses the $x < y?$ conditional in routine T:

Program Lines: (In RPN mode)	Description
⋮	
T0009 ÷	Calculates the correction for X_{guess} .
T0010 STO+ X	Adds the correction to yield a new X_{guess} .
T0011 ABS	
T0012 0.0001	
T0013 x<y?	Tests to see if the correction is significant.
T0014 GTO T	Goes back to start of loop if correction is significant. Continues if correction is not significant.
T0015 RCL X	
T0016 VIEW X	Displays the calculated value of X.
⋮	

Line T0009 calculates the correction for X_{guess} . Line T0013 compares the absolute value of the calculated correction with 0.0001. If the value is less than 0.0001 ("Do If True"), the program executes line T0014; if the value is equal to or greater than 0.0001, the program skips to line T0015.

Flags

A flag is an indicator of status. It is either *set* (*true*) or *clear* (*false*). *Testing a flag* is another conditional test that follows the "Do if true" rule: program execution proceeds directly if the tested flag is set, and skips one line if the flag is clear.

Meanings of Flags

The HP 33s has 12 flags, numbered 0 through 11. All flags can be set, cleared, and tested from the keyboard or by a program instruction. The default state of all 12 flags is *clear*. The three–key memory clearing operation described in appendix B clears all flags. Flags are *not* affected by  **CLEAR** {**ALL**} {**Y**}.

- **Flags 0, 1, 2, 3, and 4** have no preassigned meanings. That is, their states will mean whatever you define them to mean in a given program. (See the example below.)
- **Flag 5**, when set, will interrupt a program when an overflow occurs within the program, displaying `OVERFLOW` and **▲**. An overflow occurs when a result exceeds the largest number that the calculator can handle. The largest possible number is substituted for the overflow result. If flag 5 is clear, a program with an overflow is not interrupted, though `OVERFLOW` is displayed briefly when the program eventually stops.
- **Flag 6** is *automatically* set by the calculator any time an overflow occurs (although you can also set flag 6 yourself). It has no effect, but can be tested.

Flags 5 and 6 allow you to control overflow conditions that occur during a program. Setting flag 5 stops a program at the line just after the line that caused the overflow. By testing flag 6 in a program, you can alter the program's flow or change a result anytime an overflow occurs.

- **Flags 7, 8 and 9** control the display of fractions. Flag 7 can also be controlled from the keyboard. When Fraction–display mode is toggled on or off by pressing  `[FDISP]`, flag 7 is set or cleared as well.

Flag Status	Fraction–Control Flags		
	7	8	9
Clear (Default)	Fraction display off; display real numbers in the current display format.	Fraction denominators not greater than the <code>/c</code> value.	Reduce fractions to smallest form.
Set	Fraction display on; display real numbers as fractions.	Fraction denominators are factors of the <code>/c</code> Value.	No reduction of fractions. (Used only if flag 8 is set.)

- **Flag 10** controls program execution of equations:
When flag 10 is clear (the default state), equations in running programs are evaluated and the result put on the stack.

When flag 10 is set, equations in running programs are displayed as messages, causing them to behave like a VIEW statement:

1. Program execution halts.
2. The program pointer moves to the next program line.
3. The equation is displayed without affecting the stack. You can clear the display by pressing **←** or **C**. Pressing any other key executes that key's function.
4. If the next program line is a PSE instruction, execution continues after a 1-second pause.

The status of flag 10 is controlled only by execution of the SF and CF operations from the keyboard, or by SF and CF statements in programs.

- **Flag 11** controls prompting when executing equations in a program — *it doesn't affect automatic prompting during keyboard execution:*

When flag 11 is clear (the default state), evaluation, SOLVE, and ∫FN of equations in programs proceed without interruption. The current value of each variable in the equation is automatically recalled each time the variable is encountered. INPUT prompting is not affected.



When flag 11 is set, each variable is prompted for when it is first encountered in the equation. A prompt for a variable occurs only once, regardless of the number of times the variable appears in the equation. When solving, no prompt occurs for the unknown; when integrating, no prompt occurs for the variable of integration. Prompts halt execution. Pressing **R/S** resumes the calculation using the value for the variable you keyed in, or the displayed (current) value of the variable if **R/S** is your sole response to the prompt.









Flag 11 is automatically cleared after evaluation, SOLVE, or ∫FN of an equation in a program. The status of flag 11 is also controlled by execution of the SF and CF operations from the keyboard, or by SF and CF statements in programs.

Annunciators for Set Flags

Flags 0, 1, 2, 3 and 4 have annunciators in the display that turn on when the corresponding flag is set. The presence or absence of **0**, **1**, **2**, **3** or **4** lets you know at any time whether any of these five flags is set or not. However, there is no such indication for the status of flags 5 through 11. The statuses of these flags can be determined by executing the FS? instruction from the keyboard. (See "Using Flags" below.)

Using Flags

Pressing   displays the FLAGS menu: {SF} {CF} {FS?}

After selecting the function you want, you will be prompted for the flag number (0–11). For example, press   {SF} 0 to set flag 0; press   {SF}  0 to set flag 10; press   {SF}  1 to set flag 11.

FLAGS Menu

Menu Key	Description
{SF} <i>n</i>	<i>Set flag.</i> Sets flag <i>n</i> .
{CF} <i>n</i>	<i>Clear flag.</i> Clears flag <i>n</i> .
{FS?} <i>n</i>	<i>Is flag set?</i> Tests the status of flag <i>n</i> .

A flag test is a conditional test that affects program execution just as the comparison tests do. The FS? *n* instruction tests whether the given flag is set. If it is, then the next line in the program is executed. If it is not, then the next line is skipped. This is the "Do if True" rule, illustrated under "Conditional Instructions" earlier in this chapter.

If you test a flag from the keyboard, the calculator will display "YES" or "NO".

It is good practice in a program to make sure that any conditions you will be testing start out in a known state. Current flag settings depend on how they have been left by earlier programs that have been run. You should not *assume* that any given flag is clear, for instance, and that it will be set only if something in the program sets it. You should make *sure* of this by clearing the flag before the condition arises that might set it. See the example below.

Example: Using Flags.

The "Curve Fitting" program in chapter 16 uses flags 0 and 1 to determine whether to take the natural logarithm of the X- and Y-inputs:

- Lines S0003 and S0004 clear both of these flags so that lines W0007 and W0011 (in the input loop routine) do not take the natural logarithms of the X- and Y-inputs for a Straight-line model curve.
- Line L0003 sets flag 0 so that line W0007 takes the natural log of the X-input for a Logarithmic-model curve.
- Line E0004 sets flag 1 so that line W0011 takes the natural log of the Y-input for an Exponential-model curve.
- Lines P0003 and P0004 set both flags so that lines W0007 and W0011 take the natural logarithms of both the X- and Y-inputs for a Power-model curve.

Note that lines S0003, S0004, L0004, and E0003 clear flags 0 and 1 to ensure that they will be set only as required for the four curve models.

**Program Lines:
(In RPN mode)**







Description:

.	
.	
S0003 CF 0	Clears flag 0, the indicator for In X.
S0004 CF 1	Clears flag 1, the indicator for In Y.
.	
.	
L0003 SF 0	Sets flag 0, the indicator for In X.
L0004 CF 1	Clears flag 1, the indicator for In Y.
.	
.	
E0003 CF 0	Clears flag 0, the indicator for In X.
E0004 SF 1	Sets flag 1, the indicator for In Y.
.	
.	
P0003 SF 0	Sets flag 0, the indicator for In X.
P0004 SF 1	Sets flag 1, the indicator for In Y.
.	
.	
W0006 FS? 0	If flag 0 is set ...
W0007 LN	... takes the natural log of the X-input.
.	
.	
W0010 FS? 1	If flag 1 is set ...
W0011 LN	... takes the natural log of the Y-input.
.	
.	

Example: Controlling the Fraction Display.

The following program lets you exercise the calculator's fraction-display capability. The program prompts for and uses your inputs for a fractional number and a denominator (the /c value). The program also contains examples of how the three fraction-display flags (7, 8, and 9) and the "message-display" flag (10) are used.

Messages in this program are listed as MESSAGE and are entered as equations:

1. Set Equation-entry mode by pressing   (the **EQN** annunciator turns on).
2. Press  *letter* for each alpha character in the message; press  (the  key) for each space character.
3. Press  to insert the message in the current program line and end Equation-entry mode.

**Program Lines:
(In ALG mode)**

Description:

F0001	LBL F	Begins the fraction program.
F0002	CF 7	Clears three fraction flags.
F0003	CF 8	
F0004	CF 9	
F0005	SF 10	Displays messages.
F0006	DEC	Selects decimal base.
F0007	INPUT V	Prompts for a number.
F0008	INPUT D	Prompts for denominator (2 – 4095).
F0009	RCL V	Displays message, then shows the decimal number.
F0010	DECIMAL	
F0011	PSE	
F0012	STOP	
F0013	RCL D	
F0014	/c	Sets /c value and sets flag 7.
F0015	RCL V	
F0016	MOST PRECISE	Displays message, then shows the fraction.
F0017	PSE	
F0018	STOP	
F0019	SF 8	Sets flag 8.
F0020	FACTOR DENOM	Displays message, then shows the fraction.
F0021	PSE	
F0022	STOP	
F0023	SF 9	Sets flag 9.
F0024	FIXED DENOM	Displays message, then shows the fraction.
F0025	PSE	
F0026	STOP	
F0027	GTO F	Goes to beginning of program.

Checksum and length: 6F14 123

Use the above program to see the different forms of fraction display:

Keys: (In ALG mode)	Display:	Description:
XEQ F	V? <i>value</i>	Executes label <i>F</i> ; prompts for a fractional number (<i>V</i>).
2.53 R/S	D? <i>value</i>	Stores 2.53 in <i>V</i> ; prompts for denominator (<i>D</i>).
16 R/S	DECIMAL 2.5300	Stores 16 as the <i>/c</i> value. Displays message, then the decimal number.
R/S	MOST PRECISE 2 8/15 ▼	Message indicates the fraction format (denominator is no greater than 16), then shows the fraction. ▼ indicates that the numerator is "a little below" 8.
R/S	FACTOR DENOM 2 1/2 ▲	Message indicates the fraction format (denominator is factor of 16), then shows the fraction.
R/S	FIXED DENOM 2 8/16 ▲	Message indicates the fraction format (denominator is 16), then shows the fraction.
R/S C	2.5300	Stops the program and clears flag 10
▶ FLAGS {CF} ◦		
0		

Loops

Branching backwards — that is, to a label in a previous line — makes it possible to execute part of a program more than once. This is called *looping*.

```

D0001 LBL D
D0002 INPUT M
D0003 INPUT N
D0004 INPUT T
D0005 GTO D

```

This routine (taken from the "Coordinate Transformations" program on page 15–32 in chapter 15) is an example of an *infinite loop*. It is used to collect the initial data prior to the coordinate transformation. After entering the three values, it is up to the user to manually interrupt this loop by selecting the transformation to be performed (pressing **XEQ** N for the old-to-new system or **XEQ** O for the new-to-old system).

Conditional Loops (GTO)

When you want to perform an operation until a certain condition is met, but you don't know how many times the loop needs to repeat itself, you can create a loop with a conditional test and a GTO instruction.

For example, the following routine uses a loop to diminish a value *A* by a constant amount *B* until the resulting *A* is less than or equal to *B*.

Program lines: (In RPN mode)

```
A0001 LBL A
A0002 INPUT A
A0003 INPUT B
```





Checksum and length: D548 9



Description:

```
S0001 LBL S
S0002 RCL A      It is easier to recall A than to remember where it is in the
                  stack.
S0003 RCL- B    Calculates A - B.
S0004 STO A     Replaces old A with new result.
S0005 RCL B     Recalls constant for comparison.
S0006 x<y?     Is B < new A?
S0007 GTO S     Yes: loops to repeat subtraction.
S0008 VIEW A   No: displays new A.
S0009 RTN
```

Checksum and length: AC36 27

Loops with Counters (DSE, ISG)

When you want to execute a loop a specific number of times, use the   (increment; skip if greater than) or   (decrement; skip if less than or equal to) conditional function keys. Each time a loop function is executed in a program, it automatically *decrements* or *increments* a counter value stored in a variable. It compares the current counter value to a final counter value, then continues or exits the loop depending on the result.





For a count-down loop, use   *variable*

For a count-up loop, use   *variable*

These functions accomplish the same thing as a FOR-NEXT loop in BASIC:

```
FOR variable = initial-value TO final-value STEP increment
:
:
NEXT variable
```

A DSE instruction is like a FOR-NEXT loop with a negative increment.

After pressing a shifted key for ISG or DSE (  or  ), you will be prompted for a variable that will contain the *loop-control number* (described below).

The Loop-Control Number

The specified variable should contain a loop-control number $\pm\text{cccccc}.fffii$, where:

- $\pm\text{cccccc}$ is the current counter value (1 to 12 digits). This value *changes* with loop execution.
- *fff* is the final counter value (must be three digits). This value does *not* change as the loop runs.
- *ii* is the interval for incrementing and decrementing (must be two digits or unspecified). This value does *not* change. An unspecified value for *ii* is assumed to be 01 (increment/decrement by 1).

Given the loop-control number $\text{cccccc}.fffii$, DSE decrements cccccc to $\text{cccccc} - ii$, compares the new cccccc with *fff*, and makes program execution skip the next program line if this $\text{cccccc} \leq fff$.

Given the loop-control number *cccccc.fffii*, ISG increments *cccccc* to *cccccc + ii*, compares the new *cccccc* with *fff*, and makes program execution skip the next program line if this *cccccc > fff*.

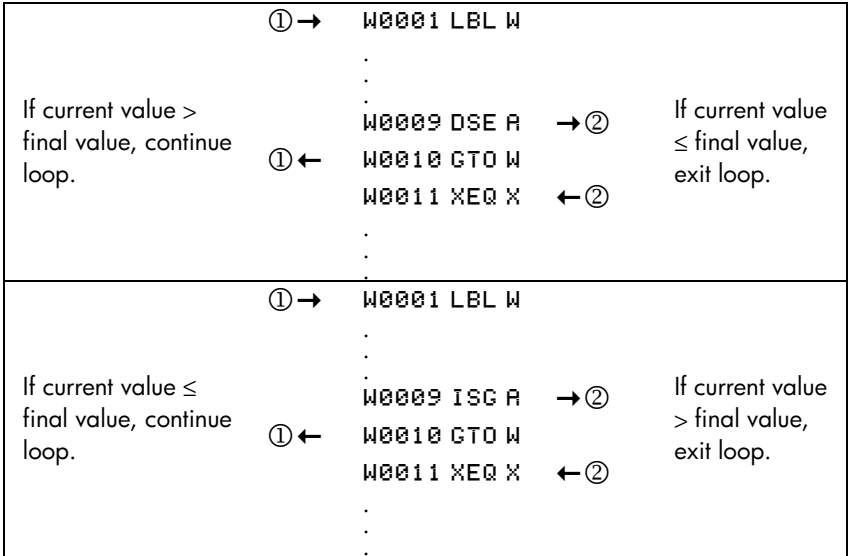

For example, the loop-control number 0.050 for ISG means: start counting at zero, count up to 50, and increase the number by 1 each loop.

The following program uses ISG to loop 10 times. The loop counter (0000001.01000) is stored in the variable Z. Leading and trailing zeros can be left off.

```
L0001 LBL L
L0002 1.01
L0003 ST0 Z
M0001 LBL M
M0002 ISG Z
M0003 GTO M
M0004 RTN
```

Press   Z to see that the loop-control number is now 11.0100.

Indirectly Addressing Variables and Labels

Indirect addressing is a technique used in advanced programming to specify a variable or label *without specifying beforehand exactly which one*. This is determined when the program runs, so it depends on the intermediate results (or input) of the program.

Indirect addressing uses two different keys: \boxed{i} (with \bullet) and $\boxed{\textcircled{i}}$ (with ENTER).

The variable I has nothing to do with $\boxed{\textcircled{i}}$ or the variable i . These keys are active for many functions that take A through Z as variables or labels.

- i is a variable whose contents can refer to another variable or label. It holds a number just like any other variable (A through Z).
- $\boxed{\textcircled{i}}$ is a programming function that directs, "Use the number in i to determine which variable or label to address."
This is an *indirect address*. (A through Z are *direct addresses*.)

Both \boxed{i} and $\boxed{\textcircled{i}}$ are used together to create an indirect address. (See the examples below.)

By itself, i is just another variable.

By itself, $\boxed{\textcircled{i}}$ is either undefined (no number in i) or uncontrolled (using whatever number happens to be left over in i).

The Variable "i"

You can store, recall, and manipulate the contents of i just as you can the contents of other variables. You can even solve for i and integrate using i . The functions listed below can use variable "i".

STO i	INPUT i	DSE i
RCL i	VIEW i	ISG i
STO $+, -, \times, \div, i$	\int FN $d i$	$x < > i$
RCL $+, -, \times, \div, i$	SOLVE i	

The Indirect Address, (i)

Many functions that use A through Z (as variables or labels) can use $\boxed{(i)}$ to refer to A through Z (variables or labels) or statistics registers *indirectly*. The function $\boxed{(i)}$ uses the value in variable i to determine which variable, label, or register to address. The following table shows how.

If i contains:	Then (i) will address:
± 1	variable A or label A
\vdots	\vdots
± 26	variable Z or label Z
± 27	variable i
± 28	n register
± 29	Σx register
± 30	Σy register
± 31	Σx^2 register
± 32	Σy^2 register
± 33	Σxy register
≥ 34 or ≤ -34 or 0	error: INVALID (i)

Only the absolute value of the integer portion of the number in i is used for addressing.

The INPUT(i) and VIEW(i) operations label the display with the name of the indirectly-addressed variable or register.

The SUMS menu enables you to recall values from the statistics registers. However, you must use indirect addressing to do other operations, such as STO, VIEW, and INPUT.

The functions listed below can use (i) as an address. For GTO, XEQ, and FN=, (i) refers to a label; for all other functions (i) refers to a variable or register.

STO(i)	INPUT(i)
RCL(i)	VIEW(i)
STO +, -, ×, ÷, (i)	DSE(i)
RCL +, -, ×, ÷, (i)	ISG(i)
XEQ(i)	SOLVE(i)
GTO(i)	∫ FN d(i)
X<>(i)	FN=(i)

Program Control with (i)

Since the contents of i can change each time a program runs — or even in different parts of the same program — a program instruction such as `GTO(i)` can branch to a different label at different times. This maintains flexibility by leaving open (until the program runs) exactly which variable or program label will be needed. (See the first example below.)

Indirect addressing is very useful for counting and controlling loops. The variable i serves as an *index*, holding the address of the variable that contains the loop-control number for the functions DSE and ISG. (See the second example below.)

Example: Choosing Subroutines With (i).

The "Curve Fitting" program in chapter 16 uses indirect addressing to determine which model to use to compute estimated values for x and y . (Different subroutines compute x and y for the different models.) Notice that i is stored and then indirectly addressed in widely separated parts of the program.

The first four routines (S, L, E, P) of the program specify the curve-fitting model that will be used and assign a number (1, 2, 3, 4) to each of these models. This number is then stored during routine Z, the common entry point for all models:

```
Z0003 STO i
```

Routine Y uses i to call the appropriate subroutine (by model) to calculate the x - and y -estimates. Line Y0003 calls the subroutine to compute \hat{y} :

```
Y0003 XEQ(i)
```

and line Y0008 calls a different subroutine to compute \hat{x} after i has been increased by 6:

```

Y0006 6
Y0007 STO+ i
Y0008 XEQ(i)

```

If <i>i</i> holds:	Then XEQ(<i>i</i>) calls:	To:
1	LBL A	Compute \hat{y} for straight-line model.
2	LBL B	Compute \hat{y} for logarithmic model.
3	LBL C	Compute \hat{y} for exponential model.
4	LBL D	Compute \hat{y} for power model.
7	LBL G	Compute \hat{x} for straight-line model.
8	LBL H	Compute \hat{x} for logarithmic model.
9	LBL I	Compute \hat{x} for exponential model.
10	LBL J	Compute \hat{x} for power model.

Example: Loop Control With (i).

An index value in *i* is used by the program "Solutions of Simultaneous Equations — Matrix Inversion Method" in chapter 15. This program uses the looping instructions ISG *i* and DSE *i* in conjunction with the indirect instructions RCL(i) and STO(i) to fill and manipulate a matrix.

The first part of this program is routine A, which stores the initial loop-control number in *i*.

**Program lines:
(In RPN mode)**

Description:

```

R0001 LBL A      The starting point for data input.
R0002 1.012     Loop-control number: loop from 1 to 12 in intervals of 1.
R0003 STO i     Stores loop-control number in i.

```

The next routine is L, a loop to collect all 12 known values for a 3 × 3 coefficient matrix (variables A – I) and the three constants (J – L) for the equations.

**Program Lines:
(In RPN mode)****Description:**

L0001 LBL L	This routine collects all known values in three equations.
L0002 INPUT (i)	Prompts for and stores a number into the variable addressed by <i>i</i> .
L0003 ISG i	Adds 1 to <i>i</i> and repeats the loop until <i>i</i> reaches 13.012.
L0004 GTO L	
L0005 GTO A	When <i>i</i> exceeds the final counter value, execution branches back to A.

Label J is a loop that completes the inversion of the 3×3 matrix.

**Program Lines:
(In RPN mode)****Description:**

J0001 LBL J	This routine completes inverse by dividing by determinant.
J0002 STO÷(i)	Divides element.
J0003 DSE i	Decrements index value so it points closer to A
J0004 GTO J	Loops for next value.
J0005 RTN	Returns to the calling program or to PRGM TOP.

Equations with (i)

You can use **(i)** in an equation to specify a variable indirectly. Notice that **(i)** means the variable specified by the number in variable *i* (an *indirect* reference), but that *i* or **(i)** means variable *i*.

The following program uses an equation to find the sum of the squares of variables A through Z.

**Program Lines:
(In RPN mode)**

Description:

E0001 LBL E	Begins the program.
E0002 CF 10	Sets equations for execution.
E0003 CF 11	Disables equation prompting.
E0004 1 . 026	Sets counter for 1 to 26.
E0005 STO i	Stores counter.
E0006 0	Initializes sum.

Checksum and length: AEC5 42

F0001 LBL F	Starts summation loop.
F0002 (i) ^2	Equation to evaluate the <i>ith</i> square. (Press  EQN to start the equation.)

Checksum and length of equation: F09C 5

F0003 +	Adds <i>ith</i> square to sum.
F0004 ISG i	Tests for end of loop.
F0005 GTO F	Branches for next variable.
F0006 RTN	Ends program.

Checksum and length of program: E005 23

Solving and Integrating Programs

Solving a Program

In chapter 7 you saw how you can enter an equation — it's added to the equation list — and then solve it for any variable. You can also enter a *program* that calculates a function, and then solve *it* for any variable. This is especially useful if the equation you're solving changes for certain conditions or if it requires repeated calculations.

To solve a programmed function:

1. Enter a program that defines the function. (See "To write a program for SOLVE" below.)
2. Select the program to solve: press **▢** **FN=** *label*. (You can skip this step if you're re-solving the same program.)
3. Solve for the unknown variable: press **SOLVE** *variable*.

Notice that FN= is required if you're solving a programmed function, but not if you're solving an equation from the equation list.

To halt a calculation, press **C** or **R/S**. The current best estimate of the root is in the unknown variable; use **▢** **VIEW** to view it without disturbing the stack. To resume the calculation, press **R/S**.

To write a program for SOLVE:

The program can use equations and ALG or RPN operations — in whatever combination is most convenient.

1. Begin the program with a *label*. This label identifies the function that you want SOLVE to evaluate (**FN=label**).

2. Include an INPUT instruction for each variable, including the unknown. INPUT instructions enable you to solve for any variable in a multi-variable function. INPUT for the *unknown* is ignored by the calculator, so you need to write only one program that contains a *separate* INPUT instruction for every variable (including the unknown).

If you include no INPUT instructions, the program uses the values stored in the variables or entered at equation prompts.

3. Enter the instructions to evaluate the function.
 - A function programmed as a multi-line RPN or ALG sequence must be in the form of an expression that goes to zero at the solution. If your equation is $f(x) = g(x)$, your program should calculate $f(x) - g(x)$. " $=0$ " is implied.
 - A function programmed as an equation can be any type of equation — equality, assignment, or expression. The equation is evaluated by the program, and its value goes to zero at the solution. If you want the equation to prompt for variable values instead of including INPUT instructions, make sure flag 11 is set.
4. End the program with a RTN. Program execution should end with the value of the function in the X-register.

If the program contains a VIEW or STOP instruction, or a message for display (an equation with Flag 10 set), then the instruction is normally executed only once - it is not executed each time the program is called by SOLVE. However, if VIEW or a message is followed by PSE, then the value or message will be displayed for one second each time the program is called. (STOP followed by PSE is ignored.)

SOLVE works only with *real* numbers. However, if you have a complex-valued function that can be written to isolate its real and imaginary parts, SOLVE can solve for the parts separately.

Example: Program Using ALG.

Write a program using ALG operations that solves for any unknown in the equation for the "Ideal Gas Law." The equation is:

$$P \times V = N \times R \times T$$

where

P = Pressure (atmospheres or N/m^2).

V = Volume (liters).

N = Number of moles of gas.

14-2 Solving and Integrating Programs

R = The universal gas constant
(0.0821 liter-atm/mole-K or 8.314 J/mole-K).

T = Temperature (kelvins; $K = ^\circ\text{C} + 273.1$).

To begin, put the calculator in Program mode; if necessary, position the program pointer to the top of program memory.

Keys:
(In ALG mode)



Display:

PRGM TOP

Description:

Sets Program mode.

Type in the program:

Program Lines:
(In ALG mode)

Description:

G0001 LBL G	Identifies the programmed function.
G0002 INPUT P	Stores P .
G0003 INPUT V	Stores V .
G0004 INPUT N	Stores N .
G0005 INPUT R	Stores R .
G0006 INPUT T	Stores T .
G0007 RCL P	Pressure.
G0008 RCL \times V	Pressure \times volume.
G0009 -	Pressure \times volume -
G0010 RCL N	Pressure \times volume - Number of moles of gas.
G0011 RCL \times R	Pressure \times volume - Moles \times gas constant.
G0012 RCL \times T	Pressure \times volume - Moles \times gas constant \times temp.
G0013 ENTER	Gets the result.
G0014 RTN	Ends the program.

Checksum and length: EB2A 42

Press  to cancel Program-entry mode.



Use program "G" to solve for the pressure of 0.005 moles of carbon dioxide in a 2-liter bottle at 24 $^\circ\text{C}$.

Keys: (In ALG mode)	Display:	Description:
G		Selects "G" — the program. SOLVE evaluates to find the value of the unknown variable.
P	V? <i>value</i>	Selects P; prompts for V.
2	N? <i>value</i>	Stores 2 in V; prompts for N.
.005	R? <i>value</i>	Stores .005 in N; prompts for R.
.0821	T? <i>value</i>	Stores .0821 in R; prompts for T.
24 273.1	T? 297.1000	Calculates T.
	SOLVING P= 0.0610	Stores 297.1 in T; solves for P. Pressure is 0.0610 atm.

Example: Program Using Equation.











Write a program that uses an equation to solve the "Ideal Gas Law."

Keys: (In RPN mode)	Display:	Description:
		Selects Program—entry mode.
	PRGM TOP	Moves program pointer to top of the list of programs.
H	H0001 LBL H	Labels the program.
{SF}		Enables equation prompting.
1	H0002 SF 11	
		Evaluates the equation, clearing flag 11. (Checksum and length: EDC8 9).
P		
V		
N		
R		
T	H0003 P×V=N×R×	

 RTN	H0004 RTN	Ends the program.
 C	0.0610	Cancels Program-entry mode.

Checksum and length of program: 36FF 21

Now calculate the change in pressure of the carbon dioxide if its temperature drops by 10 °C from the previous example.

Keys: (In RPN mode)	Display:	Description:
 L	0.0610	Stores previous pressure.
 FN= H	0.0610	Selects program "H."
 P	V? 2.0000	Selects variable <i>P</i> ; prompts for <i>V</i> .
 R/S	N? 0.0050	Retains 2 in <i>V</i> ; prompts for <i>N</i> .
 R/S	R? 0.0821	Retains .005 in <i>N</i> ; prompts for <i>R</i> .
 R/S	T? 297.1000	Retains .0821 in <i>R</i> ; prompts for <i>T</i> .
 10 	T? 287.1000	Calculates new <i>T</i> .
 R/S	SOLVING P= 0.0589	Stores 287.1 in <i>T</i> ; solves for new <i>P</i> .
 L 	-0.0021	Calculates pressure change of the gas when temperature drops from 297.1 K to 287.1 K (negative result indicates drop in pressure).

Using SOLVE in a Program

You can use the SOLVE operation as part of a program.

If appropriate, include or prompt for initial guesses (into the unknown variable and into the X-register) before executing the SOLVE *variable* instruction. The two instructions for solving an equation for an unknown variable appear in programs as:

```
FN= label
```

```
SOLVE variable
```

The *programmed* SOLVE instruction does not produce a labeled display (*variable = value*) since this might not be the significant output for your program (that is, you might want to do further calculations with this number before displaying it). If you *do* want this result displayed, add a VIEW *variable* instruction after the SOLVE instruction.

If no solution is found for the unknown variable, then the next program line is skipped (in accordance with the "Do if True" rule, explained in chapter 13). The program should then handle the case of not finding a root, such as by choosing new initial estimates or changing an input value.

Example: SOLVE in a Program.

The following excerpt is from a program that allows you to solve for x or y by pressing $\boxed{\text{XEQ}}$ X or Y.

**Program Lines:
(In RPN mode)****Description:**

X0001 LBL X	Setup for X.
X0002 24	Index for X.
X0003 GTO L	Branches to main routine.
Checksum and length: 4800	21
Y0001 LBL Y	Setup for Y.
Y0002 25	Index for Y.
Y0003 GTO L	Branches to main routine.
Checksum and length: C5E1	21
L0001 LBL L	Main routine.
L0002 STO i	Stores index in i .
L0003 FN= F	Defines program to solve.
L0004 SOLVE<i>	Solves for appropriate variable.
L0005 VIEW<i>	Displays solution.
L0006 RTN	Ends program.
Checksum and length: D82E	18
F0001 LBL F	Calculates $f(x,y)$. Include INPUT or equation prompting as required.
:	
:	
F0010 RTN	

Integrating a Program

In chapter 8 you saw how you can enter an equation (or expression) — it's added to the list of equations — and then integrate it with respect to any variable. You can also enter a *program* that calculates a function, and then integrate *it* with respect to any variable. This is especially useful if the function you're integrating changes for certain conditions or if it requires repeated calculations.

To integrate a programmed function:

1. Enter a program that defines the integrand's function. (See "To write a program for \int FN" below.)

2. Select the program that defines the function to integrate: press $\boxed{\rightarrow}$ $\boxed{\text{FN=}}$ *label*. (You can skip this step if you're reintegrating the same program.)
- ✓ 3. Enter the limits of integration: key in the *lower limit* and press $\boxed{\text{ENTER}}$, then key in the *upper limit*.
4. Select the variable of integration and start the calculation: press $\boxed{\rightarrow}$ $\boxed{\text{↵}}$ *variable*.

Notice that FN= is required if you're integrating a programmed function, but not if you're integrating an equation from the equation list.

You can halt a running integration calculation by pressing $\boxed{\text{C}}$ or $\boxed{\text{R/S}}$. However, the calculation cannot be resumed.

To write a program for \int FN:

The program can use equations, ALG or RPN operations — in whatever combination is most convenient.

1. Begin the program with a *label*. This label identifies the function that you want to integrate (FN=*label*).
2. Include an INPUT instruction for each variable, including the variable of integration. INPUT instructions enable you to integrate with respect to any variable in a multi-variable function. INPUT for the variable of integration is ignored by the calculator, so you need to write only one program that contains a *separate* INPUT instruction for every variable (including the variable of integration).

If you include no INPUT instructions, the program uses the values stored in the variables or entered at equation prompts.

3. Enter the instructions to evaluate the function.
 - A function programmed as a multi-line RPN or ALG sequence must calculate the function values you want to integrate.
 - A function programmed as an equation is usually included as an expression specifying the integrand — though it can be any type of equation. If you want the equation to prompt for variable values instead of including INPUT instructions, make sure flag 11 is set.
4. End the program with a RTN. Program execution should end with the value of the function in the X-register.

Example: Program Using Equation.

The sine integral function in the example in chapter 8 is

$$Si(t) = \int_0^t \left(\frac{\sin x}{x}\right)dx$$

This function can be evaluated by integrating a program that defines the integrand:

```

S0001 LBL S           Defines the function.
S0002 SIN(X)÷X       The function as an expression. (Checksum and length:
OEE0 8).
S0003 RTN           Ends the subroutine
Checksum and length of program: BDE3 17
    
```

Enter this program and integrate the sine integral function with respect to x from 0 to 2 (t = 2).



Keys: (In RPN mode)	Display:	Description:
MODES {RAD}		Selects Radians mode.
FN= S		Selects label S as the integrand.
0 ENTER 2	2_	Enters lower and upper limits of integration.
INTEGRATE X	INTEGRATING ∫= 1.6054	Integrates function from 0 to 2; displays result.
MODES {DEG}	1.6054	Restores Degrees mode.

Using Integration in a Program

Integration can be executed from a program. Remember to include or prompt for the limits of integration before executing the integration, and remember that accuracy and execution time are controlled by the display format at the time the program runs. The two integration instructions appear in the program as:

```
FN= label
```

∫FN ∇ variable

The *programmed* ∫FN instruction does not produce a labeled display (∫ = *value*) since this might not be the significant output for your program (that is, you might want to do further calculations with this number before displaying it). If you *do* want this result displayed, add a PSE ( PSE) or STOP () instruction to display the result in the X-register after the ∫FN instruction.

If the program contains a VIEW or STOP instruction, or a message for display (an equation with Flag 10 set), then the instruction is normally executed only once — it is not executed each time the program is called by ∫FN. However, if VIEW or a message is followed by PSE, then the value or message will be displayed for one second each time the program is called. (STOP followed by PSE is ignored.)

Example: ∫FN in a Program.

The "Normal and Inverse-Normal Distributions" program in chapter 16 includes an integration of the equation of the normal density function

$$\frac{1}{S\sqrt{2\pi}} \int_M^D e^{-\left(\frac{D-M}{S}\right)^2 / 2} dD.$$

The $e^{-((D-M)+S)^2+2}$ function is calculated by the routine labeled F. Other routines prompt for the known values and do the other calculations to find $Q(D)$, the upper-tail area of a normal curve. The integration itself is set up and executed from routine Q:

```
00001 LBL Q
00002 RCL M      Recalls lower limit of integration.
00003 RCL X      Recalls upper limit of integration. (X = D.)
00004 FN= F      Specifies the function.
00005 ∫FN  $\nabla$  D Integrates the normal function using the dummy variable D.
```

Restrictions on Solving and Integrating

The *SOLVE variable* and *∫FN d variable* instructions cannot call a routine that contains another *SOLVE* or *∫FN* instruction. That is, neither of these instructions can be used recursively. For example, attempting to calculate a multiple integral will result in an $\int \langle \int FN \rangle$ error. Also, *SOLVE* and *∫FN* cannot call a routine that contains an *FN=label* instruction; if attempted, a *SOLVE ACTIVE* or *∫FN ACTIVE* error will be returned. *SOLVE* cannot call a routine that contains an *∫FN* instruction (produces a *SOLVE* $\langle \int FN \rangle$ error), just as *∫FN* cannot call a routine that contains a *SOLVE* instruction (produces an $\int \langle \text{SOLVE} \rangle$ error).

The *SOLVE variable* and *∫FN d variable* instructions in a program use one of the seven pending subroutine returns in the calculator. (Refer to "Nested Subroutines" in chapter 13.)

The *SOLVE* and *∫FN* operations automatically set Decimal display format.

Mathematics Programs

Vector Operations

This program performs the basic vector operations of addition, subtraction, cross product, and dot (or scalar) product. The program uses three-dimensional vectors and provides input and output in rectangular or polar form. Angles between vectors can also be found.

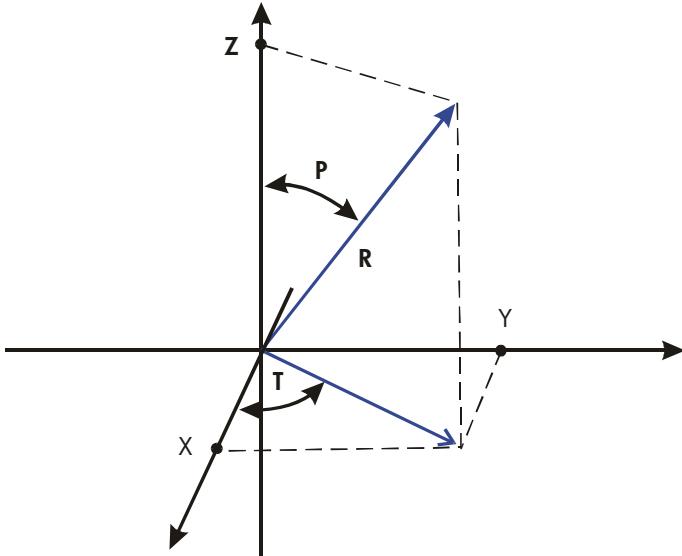

This program uses the following equations. Coordinate conversion:

$$X = R \sin(P) \cos(T)$$

$$Y = R \sin(P) \sin(T)$$

$$Z = R \cos(P)$$

$$R = \sqrt{X^2 + Y^2 + Z^2}$$

$$T = \arctan(Y/X)$$

$$P = \arctan \frac{Z}{\sqrt{X^2 + Y^2}}$$

Vector addition and subtraction:

$$\mathbf{v}_1 + \mathbf{v}_2 = (X + U)\mathbf{i} + (Y + V)\mathbf{j} + (Z + W)\mathbf{k}$$

$$\mathbf{v}_2 - \mathbf{v}_1 = (U - X)\mathbf{i} + (V - Y)\mathbf{j} + (W - Z)\mathbf{k}$$

Cross product:

$$\mathbf{v}_1 \times \mathbf{v}_2 = (YW - ZV)\mathbf{i} + (ZU - XW)\mathbf{j} + (XV - YU)\mathbf{k}$$

Dot Product:

$$D = XU + YV + ZW$$

Angle between vectors (γ):

$$G = \arccos \frac{D}{R_1 \times R_2}$$

where

$$\mathbf{v}_1 = X\mathbf{i} + Y\mathbf{j} + Z\mathbf{k}$$

and

$$\mathbf{v}_2 = U\mathbf{i} + V\mathbf{j} + W\mathbf{k}$$

The vector displayed by the input routines (LBL P and LBL R) is V_1 .

Program Listing:

Program Lines: (In ALG mode)	Description
R0001 LBL R	Defines the beginning of the rectangular input/display routine.
R0002 INPUT X	Displays or accepts input of X.
R0003 INPUT Y	Displays or accepts input of Y.
R0004 INPUT Z	Displays or accepts input of Z.
Checksum and length: 8E7D 12	
Q0001 LBL Q	Defines beginning of rectangular-to-polar conversion process.
Q0002 RCL Y	
Q0003 x<>y	
Q0004 RCL X	
Q0005 y, x → θ, r	Calculates $\sqrt{(X^2 + Y^2)}$ and $\arctan(Y/X)$.
Q0006 x<>y	
Q0007 STO T	Saves $T = \arctan(Y/X)$.
Q0008 RCL Z	
Q0009 y, x → θ, r	Calculates $\sqrt{(X^2 + Y^2 + Z^2)}$ and P.
Q0010 STO R	Saves R.
Q0011 x<>y	
Q0012 STO P	Saves P
Checksum and length: E230 36	
P0001 LBL P	Defines the beginning of the polar input/display routine.
P0002 INPUT R	Displays or accepts input of R.
P0003 INPUT T	Displays or accepts input of T.
P0004 INPUT P	Displays or accepts input of P.
P0005 RCL P	
P0006 x<>y	
P0007 RCL R	
P0008 θ, r → y, x	Calculates $R \cos(P)$ and $R \sin(P)$.

**Program Lines:
(In ALG mode)**

Description

P0009 STO Z Stores $Z = R \cos(P)$.
P0010 RCL T
P0011 x<>y
P0012 $\theta, r \rightarrow y, x$ Calculates $R \sin(P) \cos(T)$ and $R \sin(P) \sin(T)$.
P0013 STO X Saves $X = R \sin(P) \cos(T)$.
P0014 x<>y
P0015 STO Y Saves $Y = R \sin(P) \sin(T)$.
P0016 GTO P Loops back for another display of polar form.
Checksum and length: 5F1D 48

E0001 LBL E Defines the beginning of the vector-enter routine.
E0002 RCL X Copies values in X, Y and Z to U, V and W respectively.

E0003 STO U
E0004 RCL Y
E0005 STO V
E0006 RCL Z
E0007 STO W
E0008 GTO Q Loops back for polar conversion and display/input.
Checksum and length: 1961 24

X0001 LBL X Defines beginning of vector-exchange routine.
X0002 RCL X Exchanges X, Y and Z with U, V and W respectively.
X0003 X<> U
X0004 STO X
X0005 RCL Y
X0006 x<> V
X0007 STO Y
X0008 RCL Z
X0009 x<> W
X0010 STO Z
X0011 GTO Q Loops back for polar conversion and display/input.
Checksum and length: CE3C 33

A0001 LBL A Defines beginning of vector-addition routine.

**Program Lines:
(In ALG mode)**

Description

A0002 RCL X
A0003 RCL+ U
A0004 STO X Saves $X + U$ in X.
A0005 RCL V
A0006 RCL+ Y
A0007 STO Y Saves $V + Y$ in Y.
A0008 RCL Z
A0009 RCL+ W
A0010 STO Z Saves $Z + W$ in Z.
A0011 GTO Q Loops back for polar conversion and display/input.
Checksum and length: 6ED7 33

S0001 LBL S Defines the beginning of the vector-subtraction routine.
S0002 -1 Multiplies X, Y and Z by (-1) to change the sign.
S0003 STO× X
S0004 STO× Y
S0005 STO× Z
S0006 GTO A Goes to the vector-addition routine.
Checksum and length: 5FC1 30

C0001 LBL C Defines the beginning of the cross-product routine.
C0002 RCL Y
C0003 RCL× W
C0004 -
C0005 RCL Z
C0006 RCL× V
C0007 ENTER Calculates $(YW - ZV)$, which is the X component.
C0008 STO A
C0009 RCL Z
C0010 RCL× U
C0011 -
C0012 RCL X
C0013 RCL× W

**Program Lines:
(In ALG mode)**

Description

C0014 ENTER	Calculates $(ZU - WX)$, which is the Y component.	
C0015 STO B		
C0016 RCL X		
C0017 RCL \times V		
C0018 -		
C0019 RCL Y	Stores $(XV - YU)$, which is the Z component.	
C0020 RCL \times U		
C0021 ENTER		
C0022 STO Z		
C0023 RCL R		
C0024 STO X	Stores X component.	
C0025 RCL B	Stores Y component.	
C0026 STO Y		
C0027 GTO Q	Loops back for polar conversion and display/input.	
Checksum and length: 6F95 81		
D0001 LBL D	Defines beginning of dot-product and vector-angle routine.	
D0002 RCL X	Stores the dot product of $XU + YV + ZW$.	
D0003 RCL \times U		
D0004 +		
D0005 RCL Y		
D0006 RCL \times V		
D0007 +		
D0008 RCL Z		
D0009 RCL \times W		
D0010 ENTER		
D0011 STO D		
D0012 VIEW D		Displays the dot product.
D0013 RCL V		
D0014 $\times\langle\rangle\psi$		
D0015 RCL U		
D0016 $\psi, \times \rightarrow \theta, r$		
D0017 $\times\langle\rangle\psi$		

**Program Lines:
(In ALG mode)**

Description

D0018 RCL W	
D0019 $\sqrt{x^2 + y^2 + z^2}$	Calculates the magnitude of the U, V, W vector.
D0020 STO E	
D0021 (
D0022 RCL D	
D0023 RCL ÷ R	Divides the dot product by the magnitude of the X-, Y-, Z-vector.
D0024 ÷	Divides previous result by the magnitude.
D0025 RCL E	
D0026)	
D0027 ACOS	Calculates angle.
D0028 STO G	
D0029 VIEW G	Displays angle.
D0030 GTO P	Loops back for polar display/input.
Checksum and length: 0548 90	

Flags Used:

None.

Remarks:

The terms "polar" and "rectangular," which refer to two-dimensional systems, are used instead of the proper three-dimensional terms of "spherical" and "Cartesian." This stretch of terminology allows the labels to be associated with their function without confusing conflicts. For instance, if LBL C had been associated with Cartesian coordinate input, it would not have been available for cross product.

Program Instructions:

1. Key in the program routines; press **C** when done.
2. If your vector is in rectangular form, press **XEQ** R and go to step 4. If your vector is in polar form, press **XEQ** P and continue with step 3.

3. Key in R and press $\boxed{R/S}$, key in T and press $\boxed{R/S}$, then key in P and press $\boxed{R/S}$. Continue at step 5.
4. Key in X and press $\boxed{R/S}$, key in Y and press $\boxed{R/S}$, and key in Z and press $\boxed{R/S}$.
5. To key in a second vector, press \boxed{XEQ} E (for enter), then go to step 2.
6. Perform desired vector operation:
 - a. Add vectors by pressing \boxed{XEQ} A;
 - b. Subtract vector one from vector two by pressing \boxed{XEQ} S;
 - c. Compute the cross product by pressing \boxed{XEQ} C;
 - d. Compute the dot product by pressing \boxed{XEQ} D and the angle between vectors by pressing $\boxed{R/S}$.
7. Optional: to review v_1 in polar form, press \boxed{XEQ} P, then press $\boxed{R/S}$ repeatedly to see the individual elements.
8. Optional: to review v_1 in rectangular form, press \boxed{XEQ} R, then press $\boxed{R/S}$ repeatedly to see the individual elements.
9. If you added, subtracted, or computed the cross product, v_1 has been replaced by the result, v_2 is not altered. To continue calculations based on the result, remember to press \boxed{XEQ} E before keying in a new vector.
10. Go to step 2 to continue vector calculations.

Variables Used:

X, Y, Z	The rectangular components of v_1 .
U, V, W	The rectangular components of v_2 .
R, T, P	The radius, the angle in the x - y plane (θ), and the angle from the Z axis of v_1 (U).
D	The dot product
G	The angle between vectors (γ)

Example 1:

A microwave antenna is to be pointed at a transmitter which is 15.7 kilometers North, 7.3 kilometers East and 0.76 kilometers below. Use the rectangular to polar conversion capability to find the total distance and the direction to the transmitter.

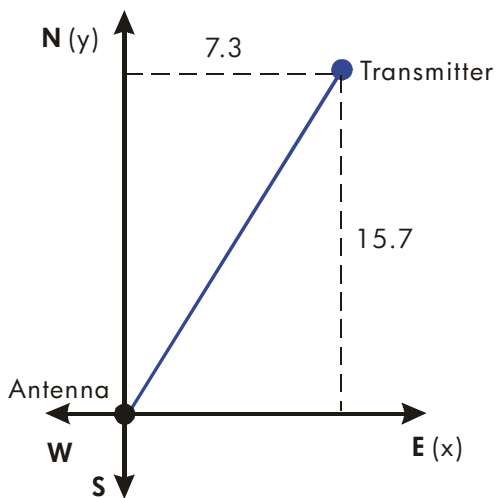

Keys:
(In ALG mode)

Display:

Description:

MODES {DEG}

Sets Degrees mode.

XEQ R

X?
value

Starts rectangular input/display routine.

7.3 **R/S**

Y?
value

Sets X equal to 7.3.

15.7 **R/S**

Z?
value

Sets Y equal to 15.7.

.76 **+/-** **R/S**

R?
17.3308

Sets Z equal to -0.76 and calculates R, the radius.

R/S

T?
65.0631

Calculates T, the angle in the x/y plane.

R/S

P?
92.5134

Calculates P, the angle from the z-axis.

Example 2:

What is the moment at the origin of the lever shown below? What is the component of force along the lever? What is the angle between the resultant of the force vectors and the lever?

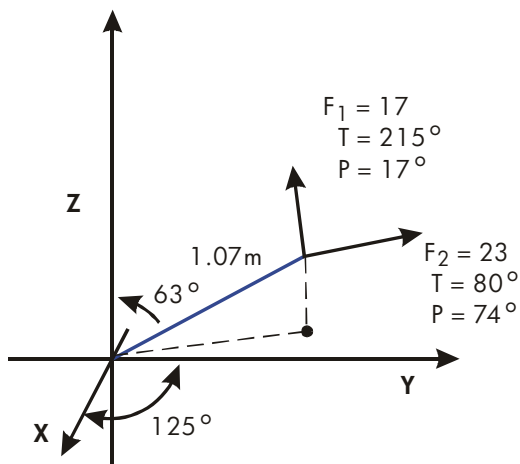

First, add the force vectors.

Keys: (In ALG mode)	Display:	Description:
$\boxed{\text{XEQ}}$ P	R? value	Starts polar input routine.
17 $\boxed{\text{R/S}}$	T? value	Sets radius equal to 17.
215 $\boxed{\text{R/S}}$	P? value	Sets T equal to 215.
17 $\boxed{\text{R/S}}$	R? 17.0000	Sets P equal to 17.
$\boxed{\text{XEQ}}$ E	R? 17.0000	Enters vector by copying it into \mathbf{v}_2 .
23 $\boxed{\text{R/S}}$	T? -145.0000	Sets radius of \mathbf{v}_1 equal to 23.
80 $\boxed{\text{R/S}}$	P? 17.0000	Sets T equal to 80.
74 $\boxed{\text{R/S}}$	R? 23.0000	Sets P equal to 74.
$\boxed{\text{XEQ}}$ A	R? 29.4741	Adds the vectors and displays the resultant R .
$\boxed{\text{R/S}}$	T? 90.7032	Displays T of resultant vector.

R/S	P? 39.9445	Displays P of resultant vector.
XEQ E	R? 29.4741	Enters resultant vector.

Since the moment equals the cross product of the radius vector and the force vector ($\mathbf{r} \times \mathbf{F}$), key in the vector representing the lever and take the cross product.

Keys: (In ALG mode)	Display:	Description:
1.07 R/S	T? 90.7032	Sets R equal to 1.07.
125 R/S	P? 39.9445	Sets T equal to 125.
63 R/S	R? 1.0700	Sets P equal to 63.
XEQ C	R? 18.0209	Calculates cross product and displays R of result.
R/S	T? 55.3719	Displays T of cross product.
R/S	P? 124.3412	Displays P of cross product.
XEQ R	X? 8.4554	Displays rectangular form of cross product.
R/S	Y? 12.2439	
R/S	Z? -10.1660	

The dot product can be used to resolve the force (still in \mathbf{v}_2) along the axis of the lever.

Keys: (In ALG mode)	Display:	Description:
XEQ P	R? 18.0209	Starts polar input routine.
1 R/S	T? 55.3719	Defines the radius as one unit vector.

125	R/S	P?	Sets <i>T</i> equal to 125.
		124.3412	
63	R/S	R?	Sets <i>P</i> equal to 63.
		1.00000	
	XEQ	D=	Calculates dot product.
		24.1882	
	R/S	G=	Calculates angle between resultant force vector and lever.
		34.8490	
	R/S	R?	Gets back to input routine.
		1.00000	

Solutions of Simultaneous Equations

This program solves simultaneous linear equations in two or three unknowns. It does this through matrix inversion and matrix multiplication.

A system of three linear equations

$$AX + DY + GZ = J$$

$$BX + EY + HZ = K$$

$$CX + FY + IZ = L$$

can be represented by the matrix equation below.

$$\begin{bmatrix} A & D & G \\ B & E & H \\ C & F & I \end{bmatrix} \begin{bmatrix} X \\ Y \\ Z \end{bmatrix} = \begin{bmatrix} J \\ K \\ L \end{bmatrix}$$

The matrix equation may be solved for *X*, *Y*, and *Z* by multiplying the result matrix by the inverse of the coefficient matrix.

$$\begin{bmatrix} A' & D' & G' \\ B' & E' & H' \\ C' & F' & I' \end{bmatrix} \begin{bmatrix} J \\ K \\ L \end{bmatrix} = \begin{bmatrix} X \\ Y \\ Z \end{bmatrix}$$

Specifics regarding the inversion process are given in the comments for the inversion routine, *I*.

Program Listing:

Program Lines: (In RPN mode)	Description
A0001 LBL A	Starting point for input of coefficients.
A0002 1 . 012	Loop-control value: loops from 1 to 12, one at a time.
A0003 STO i	Stores control value in index variable.
Checksum and length: 35E7 21	
L0001 LBL L	Starts the input loop.
L0002 INPUT< i >	Prompts for and stores the variable addressed by <i>i</i> .
L0003 ISG i	Adds one to <i>i</i> .
L0004 GTO L	If <i>i</i> is less than 13, goes back to LBL L and gets the next value.
L0005 GTO A	Returns to LBL A to review values.
Checksum and length: 51AB 15	
I0001 LBL I	This routine inverts a 3×3 matrix.
I0002 XEQ D	Calculates determinant and saves value for the division loop, <i>J</i> .
I0003 STO W	
I0004 RCL A	
I0005 RCL× I	
I0006 RCL C	
I0007 RCL× G	
I0008 -	
I0009 STO X	Calculates $E' \times \text{determinant} = AI - CG$.
I0010 RCL C	
I0011 RCL× D	
I0012 RCL A	
I0013 RCL× F	
I0014 -	
I0015 STO Y	Calculates $F' \times \text{determinant} = CD - AF$.
I0016 RCL B	
I0017 RCL× G	
I0018 RCL A	

Program Lines: (In RPN mode)	Description
I0019 RCL× H	
I0020 -	
I0021 STO Z	Calculates $H' \times \text{determinant} = BG - AH$.
I0022 RCL A	
I0023 RCL× E	
I0024 RCL B	
I0025 RCL× D	
I0026 -	
I0027 STO i	Calculates $I' \times \text{determinant} = AE - BD$.
I0028 RCL E	
I0029 RCL× I	
I0030 RCL F	
I0031 RCL× H	
I0032 -	
I0033 STO A	Calculates $A' \times \text{determinant} = EI - FH$,
I0034 RCL C	
I0035 RCL× H	
I0036 RCL B	
I0037 RCL× I	
I0038 -	Calculates $B' \times \text{determinant} = CH - BI$.
I0039 RCL B	
I0040 RCL× F	
I0041 RCL C	
I0042 RCL× E	
I0043 -	
I0044 STO C	Calculates $C' \times \text{determinant} = BF - CE$.
I0045 R↓	
I0046 STO B	Stores B' .
I0047 RCL F	
I0048 RCL× G	
I0049 RCL D	
I0050 RCL× I	
I0051 -	Calculates $D' \times \text{determinant} = FG - DI$.

**Program Lines:
(In RPN mode)**

Description

I0052 RCL D	
I0053 RCL × H	
I0054 RCL E	
I0055 RCL × G	
I0056 -	
I0057 STO G	Calculates $G' \times \text{determinant} = DH - EG$.
I0058 R↓	
I0059 STO D	Stores D' .
I0060 RCL i	
I0061 STO I	Stores I' .
I0062 RCL X	
I0063 STO E	Stores E' .
I0064 RCL Y	
I0065 STO F	Stores F' .
I0066 RCL Z	
I0067 STO H	Stores H' .
I0068 9	
I0069 STO i	Sets index value to point to last element of matrix.
I0070 RCL W	Recalls value of determinant.
Checksum and length: OFFB 222	
J0001 LBL J	This routine completes inverse by dividing by determinant.
J0002 STO ÷ (i)	Divides element.
J0003 DSE i	Decrements index value so it points closer to A.
J0004 GTO J	Loops for next value.
J0005 RTN	Returns to the calling program or to PRGM TOP.
Checksum and length: 1FCF 15	
M0001 LBL M	This routine multiplies a column matrix and a 3×3 matrix.
M0002 7	Sets index value to point, to last element in first row.
M0003 XEQ N	
M0004 8	Sets index value to point to last element in second

**Program Lines:
(In RPN mode)**

Description

row.

M0005 XEQ N

M0006 9

Sets index value to point to last element in third row.

Checksum and length: DA21 54

N0001 LBL N

This routine calculates product of column vector and row pointed to by index value.

N0002 STO i

Saves index value in *i*.

N0003 RCL J

Recalls *J* from column vector.

N0004 RCL K

Recalls *K* from column vector.

N0005 RCL L

Recalls *L* from column vector.

N0006 RCL×(i)

Multiplies by last element in row.

N0007 XEQ P

Multiplies by second element in row and adds.

N0008 XEQ P

Multiplies by first element in row and adds.

N0009 23

Sets index value to display *X*, *Y*, or *Z* based on input row.

N0010 STO+ i

N0011 R↓

Gets result back.

N0012 STO(i)

Stores result.

N0013 VIEW(i)

Displays result.

N0014 RTN

Returns to the calling program or to PRGM TOP.

Checksum and length: DFF4 54

P0001 LBL P

This routine multiplies and adds values within a row.

P0002 x<>y

Gets next column value.

P0003 DSE i

Sets index value to point to next row value.

P0004 DSE i

P0005 DSE i

P0006 RCL×(i)

Multiplies column value by row value.

P0007 +

Adds product to previous sum.

P0008 RTN

Returns to the calling program.

Checksum and length: 7F00 24

D0001 LBL D

This routine calculates the determinant.

D0002 RCL A

Program Lines: (In RPN mode)	Description
D0003 RCL× E	
D0004 RCL× I	Calculates $A \times E \times I$.
D0005 RCL D	
D0006 RCL× H	
D0007 RCL× C	
D0008 +	Calculates $(A \times E \times I) + (D \times H \times C)$.
D0009 RCL G	
D0010 RCL× F	
D0011 RCL× B	
D0012 +	Calculates $(A \times E \times I) + (D \times H \times C) + (G \times F \times B)$.
D0013 RCL G	
D0014 RCL× E	
D0015 RCL× C	
D0016 -	$(A \times E \times I) + (D \times H \times C) + (G \times F \times B) - (G \times E \times C)$.
D0017 RCL A	
D0018 RCL× F	
D0019 RCL× H	
D0020 -	$(A \times E \times I) + (D \times H \times C) + (G \times F \times B) - (G \times E \times C) - (A \times F \times H)$.
D0021 RCL D	
D0022 RCL× B	
D0023 RCL× I	
D0024 -	$(A \times E \times I) + (D \times H \times C) + (G \times F \times B) - (G \times E \times C) - (A \times F \times H) - (D \times B \times I)$.
D0025 RTN	Returns to the calling program or to PRGM TOP.
Checksum and length: 7957 75	

Flags Used:

None.

Program Instructions:

1. Key in the program routines; press **C** when done.
2. Press **XEQ** A to input coefficients of matrix and column vector.
3. Key in coefficient or vector value (A through L) at each prompt and press **R/S**.
4. Optional: press **XEQ** D to compute determinant of 3×3 system.
5. Press **XEQ** I to compute inverse of 3×3 matrix.
6. Optional: press **XEQ** A and repeatedly press **R/S** to review the values of the inverted matrix.
7. Press **XEQ** M to multiply the inverted matrix by the column vector and to see the value of X. Press **R/S** to see the value of Y, then press **R/S** again to see the value of Z.
8. For a new case, go back to step 2.

Variables Used:

A through I	Coefficients of matrix.
J through L	Column vector values.
W	Scratch variable used to store the determinant.
X through Z	Output vector values; also used for scratch.
i	Loop-control value (index variable); also used for scratch.

Remarks:

For 2×2 solutions use zero for coefficients C, F, H, G and for L. Use 1 for coefficient I.

Not all systems of equations have solutions.

Example:

For the system below, compute the inverse and the system solution. Review the inverted matrix. Invert the matrix again and review the result to make sure that the original matrix is returned.

$$23X + 15Y + 17Z = 31$$

$$8X + 11Y - 6Z = 17$$

$$4X + 15Y + 12Z = 14$$

Keys: (In RPN mode)	Display:	Description:
XEQ A	A? <i>value</i>	Starts input routine.
23 R/S	B? <i>value</i>	Sets first coefficient, A, equal to 23.
8 R/S	C? <i>value</i>	Sets B equal to 8.
4 R/S	D? <i>value</i>	Sets C equal to 4.
15 R/S	E? <i>value</i>	Sets D equal to 15.
.	.	Continues entry for E through L.
.	.	
14 R/S	A? 23.0000	Returns to first coefficient entered.
XEQ I	4.598.0000	Calculates the inverse and displays the determinant.
XEQ M	X= 0.9306	Multiplies by column vector to compute X.
R/S	Y= 0.7943	Calculates and displays Y.
R/S	Z= -0.1364	Calculates and displays Z.
XEQ A	A? 0.0483	Begins review of the inverted matrix.
R/S	B? -0.0261	Displays next value.
R/S	C? 0.0165	Displays next value.
R/S	D? 0.0163	Displays next value.
R/S	E? 0.0452	Displays next value.
R/S	F? -0.0620	Displays next value.

R/S	G?	Displays next value.
	-0.0602	
R/S	H?	Displays next value.
	0.0596	
R/S	I?	Displays next value.
	0.0289	
XEQ I	0.0002	Inverts inverse to produce original matrix.
XEQ A	A?	Begins review of inverted matrix.
	23.0000	
R/S	B?	Displays next value, and so on.
	8.0000	
:	:	
:	:	
:	:	

Polynomial Root Finder

This program finds the roots of a polynomial of order 2 through 5 with real coefficients. It calculates both real and complex roots.

For this program, a general polynomial has the form

$$x^n + a_{n-1}x^{n-1} + \dots + a_1x + a_0 = 0$$

where $n = 2, 3, 4,$ or 5 . The coefficient of the highest-order term (a_n) is assumed to be 1. If the leading coefficient is not 1, you should make it 1 by dividing all the coefficients in the equation by the leading coefficient. (See example 2.)

The routines for third- and fifth-order polynomials use SOLVE to find one real root of the equation, since every odd-order polynomial must have at least one real root. After one root is found, synthetic division is performed to reduce the original polynomial to a second- or fourth-order polynomial.

To solve a fourth-order polynomial, it is first necessary to solve the resolvent cubic polynomial:

$$y^3 + b_2y^2 + b_1y + b_0 = 0$$

where $b_2 = -a_2$

$b_1 = a_3a_1 - 4a_0$

$$b_0 = a_0(4a_2 - a_3^2) - a_1^2.$$

Let y_0 be the largest real root of the above cubic. Then the fourth-order polynomial is reduced to two quadratic polynomials:

$$x^2 + (J + L)x + (K + M) = 0$$

$$x^2 + (J - L)x + (K - M) = 0$$

where $J = a_3/2$

$$K = y_0/2$$

$$L = \sqrt{J^2 - a_2 + y_0} \times (\text{the sign of } JK - a_1/2)$$

$$M = \sqrt{K^2 - a_0}$$

Roots of the fourth degree polynomial are found by solving these two quadratic polynomials.

A quadratic equation $x^2 + a_1x + a_0 = 0$ is solved by the formula

$$x_{1,2} = -\frac{a_1}{2} \pm \sqrt{\left(\frac{a_1}{2}\right)^2 - a_0}$$

If the discriminant $d = (a_1/2)^2 - a_0 \geq 0$, the roots are real; if $d < 0$, the roots are complex, being $u \pm iv = -(a_1/2) \pm i\sqrt{-d}$.

Program Listing:

Program Lines: (In RPN mode)	Description
P0001 LBL P	Defines the beginning of the polynomial root finder routine.
P0002 INPUT F	Prompts for and stores the order of the polynomial.
P0003 STO i	Uses order as loop counter.
Checksum and length: 5CC4 9	
I0001 LBL I	Starts prompting routine.
I0002 INPUT (i)	Prompts for a coefficient.
I0003 DSE i	Counts down the input loop.
I0004 GTO I	Repeats until done.
I0005 RCL F	
I0006 STO i	Uses order to select root finding routine.
I0007 GTO (i)	Starts root finding routine.
Checksum and length: 588B 21	
H0001 LBL H	Evaluates polynomials using Horner's method, and synthetically reduces the order of the polynomial using the root.
H0002 RCL H	
H0003 STO i	Uses pointer to polynomial as index.
H0004 1	Starting value for Horner's method.
Checksum and length: 0072 24	
J0001 LBL J	Starts the Horner's method loop.
J0002 ENTER	Saves synthetic division coefficient.
J0003 RCL x X	Multiplies current sum by next power of x.
J0004 RCL + (i)	Adds new coefficient.
J0005 DSE i	Counts down the loop.
J0006 GTO J	Repeats until done.
J0007 RTN	
Checksum and length: 2582 21	
S0001 LBL S	Starts solver setup routine.
S0002 STO H	Stores location of coefficients to use.

**Program Lines:
(In RPN mode)**

Description

S0003 250	
S0004 STO X	First initial guess.
S0005 +/-	Second initial guess.
S0006 FN= H	Specifies routine to solve.
S0007 SOLVE X	Solves for a real root.
S0008 GTO H	Gets synthetic division coefficients for next lower order polynomial.
S0009 0	
S0010 ÷	Generates DIVIDE BY 0 error if no real root found.
Checksum and length: 15FE 54	

Q0001 LBL Q	Starts quadratic solution routine.
Q0002 x<>y	Exchanges a_0 and a_1 .
Q0003 2	
Q0004 ÷	$a_1/2$.
Q0005 +/-	$-a_1/2$.
Q0006 ENTER	
Q0007 ENTER	Saves $-a_1/2$.
Q0008 STO F	Stores real part if complex root.
Q0009 x²	$(a_1/2)^2$.
Q0010 R↑	a_0 .
Q0011 -	$(a_1/2)^2 - a_0$.
Q0012 CF 0	Initializes flag 0.
Q0013 x<0?	Discriminant (d) < 0
Q0014 SF 0	Sets flag 0 if $d < 0$ (complex roots).
Q0015 ABS	$ d $
Q0016 √ x	$\sqrt{ d }$
Q0017 STO G	Stores imaginary part if complex root.
Q0018 FS? 0	Complex roots?
Q0019 RTN	Returns if complex roots.
Q0020 STO- F	Calculates $-a_1/2 - \sqrt{ d }$
Q0021 R↓	
Q0022 STO+ G	Calculates $-a_1/2 + \sqrt{ d }$

**Program Lines:
(In RPN mode)**

Description

00023 RTN

Checksum and length: B9A7 81

B0001 LBL B Starts second-order solution routine.

B0002 RCL B Gets L .

B0003 RCL A Gets M .

B0004 GTO T Calculates and displays two roots.

Checksum and length: DE6F 12

C0001 LBL C Starts third-order solution routine.

C0002 3 Indicates cubic polynomial to be solved.

C0003 XEQ S Solves for one real root and puts a_0 and a_1 for second-order polynomial on stack.

C0004 R↓ Discards polynomial function value.

C0005 XEQ Q Solves remaining second-order polynomial and stores roots.

C0006 VIEW X Displays real root of cubic.

C0007 GTO N Displays remaining roots.

Checksum and length: 7A4B 33

E0001 LBL E Starts fifth-order solution routine.

E0002 5 Indicates fifth-order polynomial to be solved.

E0003 XEQ S Solves for one real root and puts three synthetic division coefficients for fourth-order polynomial on stack.

E0004 R↓ Discards polynomial function value.

E0005 STO A Stores coefficient.

E0006 R↓

E0007 STO B Stores coefficient.

E0008 R↓

E0009 STO C Stores coefficient.

E0010 RCL E

E0011 RCL+ X Calculates a_3 .

E0012 STO D Stores a_3 .

E0013 VIEW X Displays real root of fifth-order polynomial.

**Program Lines:
(In RPN mode)**

Description

Checksum and length: C7A6 51

D0001 LBL D	Starts fourth-order solution routine.
D0002 4	
D0003 RCL × C	$4a^2$.
D0004 RCL D	a_3 .
D0005 \times^2	a_3^2 .
D0006 -	$4a_2 - a_3^2$.
D0007 RCL × A	$a_0(4a_2 - a_3^2)$.
D0008 RCL B	a_1 .
D0009 \times^2	a_1^2 .
D0010 -	$b_0 = a_0(4a_0 - a_3^2) - a_1^2$.
D0011 STO E	Stores b_0 .
D0012 RCL C	a_2 .
D0013 + / -	$b_2 = -a_2$.
D0014 STO G	Stores b_2 .
D0015 RCL D	a_3 .
D0016 RCL × B	$a_3 a_1$.
D0017 4	
D0018 RCL × A	$4a_0$.
D0019 -	$b_1 = a_3 a_1 - 4a_0$.
D0020 STO F	Stores b_1 .
D0021 4	To enter lines D0021 and D0022;
D0022 3	press 4  SHOW 3.
D0023 10^x	
D0024 ÷	
D0025 7	
D0026 +	Creates 7.004 as a pointer to the cubic coefficients.
D0027 XEQ S	Solves for real root and puts a_0 and a_1 for second-order polynomial on stack.
D0028 R ↓	Discards polynomial function value.
D0029 XEQ Q	Solves for remaining roots of cubic and stores roots.
D0030 RCL X	Gets real root of cubic.
D0031 STO E	Stores real root.

**Program Lines:
(In RPN mode)**

Description

D0032 FS? 0	Complex roots?
D0033 GT0 F	Calculate four roots of remaining fourth-order polynomial.
D0034 RCL F	If not complex roots, determine largest real root (y_0)
D0035 x<y?	
D0036 x<>y	
D0037 RCL G	
D0038 x<y?	
D0039 x<>y	
D0040 ST0 E	Stores largest real root of cubic.

Checksum and length: C8B3 180

F0001 LBL F	Starts fourth-order solution routine.
F0002 2	
F0003 ST0÷ D	$J = a_3/2.$
F0004 ST0÷ E	$K = y_0/2.$
F0005 9	
F0006 10×	
F0007 1/×	Creates 10^{-9} as a lower bound for $M^2.$
F0008 RCL E	K
F0009 x ²	$K^2.$
F0010 RCL- A	$M^2 = K^2 - a_0.$
F0011 x<y?	
F0012 CL×	If $M^2 < 10^{-9}$, use 0 for $M^2.$
F0013 √ x	$M = \sqrt{K^2 - a_0}.$
F0014 ST0 A	Stores $M.$
F0015 RCL D	$J.$
F0016 RCL× E	$JK.$
F0017 RCL B	$a_1.$
F0018 2	
F0019 ÷	$a_1/2.$
F0020 -	$JK - a_1/2.$
F0021 x=0?	
F0022 1	Use 1 if $JK - a_1/2 = 0$

**Program Lines:
(In RPN mode)****Description**

F0023 STO B	Stores 1 or $JK - a_1/2$.
F0024 ABS	
F0025 STO ÷ B	Calculates sign of C .
F0026 RCL D	J .
F0027 \times^2	J^2
F0028 RCL - C	$J^2 - a_2$.
F0029 RCL + E	
F0030 RCL + E	$J^2 - a_2 + y_0$.
F0031 $\sqrt{\times}$	$C = \sqrt{J^2 - a_2 + y_0}$.
F0032 STO \times B	Stores C with proper sign.
F0033 RCL D	J .
F0034 RCL + B	$J + L$.
F0035 RCL E	K .
F0036 RCL + A	$K + M$.
F0037 XEQ T	Calculate and display two roots of the fourth-order polynomial.
F0038 RCL D	J .
F0039 RCL - B	$J - L$.
F0040 RCL E	K .
F0041 RCL - A	$K - M$.

Checksum and length: 539D 171

T0001 LBL T	Starts routine to calculate and display two roots.
T0002 XEQ Q	Uses quadratic routine to calculate two roots.

Checksum and length: 410A 6

N0001 LBL N	Starts routine to display two real roots or two complex roots.
N0002 RCL F	Gets the first real root.
N0003 STO X	Stores the first real root.
N0004 VIEW X	Displays real root or real part of complex root.
N0005 RCL G	Gets the second real root or imaginary part of complex root.
N0006 FS? 0	Were there any complex roots?

**Program Lines:
(In RPN mode)****Description**

N0007 GTO U	Displays complex roots if any.
N0008 STO X	Stores second real root.
N0009 VIEW X	Displays second real root.
N0010 RTN	Returns to calling routine.

Checksum and length: 96DA 30

U0001 LBL U	Starts routine to display complex roots.
U0002 STO i	Stores the imaginary part of the first complex root.
U0003 VIEW i	Displays the imaginary part of the first complex root.
U0004 VIEW X	Displays the real part of the second complex root.
U0005 RCL i	Gets the imaginary part of the complex roots.
U0006 +/-	Generates the imaginary part of the second complex root.
U0007 STO i	Stores the imaginary part of the second complex root.
U0008 VIEW i	Displays the imaginary part of the second complex root.

Checksum and length: 748D 24

Flags Used:

Flag 0 is used to remember if the root is real or complex (that is, to remember the sign of d). If d is negative, then flag 0 is set. Flag 0 is tested later in the program to assure that both the real and imaginary parts are displayed if necessary.

Remarks:

The program accommodates polynomials of order 2, 3, 4, and 5. It does not check if the order you enter is valid.

The program requires that the constant term a_0 is nonzero for these polynomials. (If a_0 is 0, then 0 is a real root. Reduce the polynomial by one order by factoring out x .)

The order and the coefficients are *not* preserved by the program.

Because of round-off error in numerical computations, the program may produce values that are not true roots of the polynomial. The only way to confirm the roots is to evaluate the polynomial manually to see if it is zero at the roots.

For a third- or higher-order polynomial, if SOLVE cannot find a real root, the error **DIVIDE BY 0** is displayed.

You can save time and memory by omitting routines you don't need. If you're not solving fifth-order polynomials, you can omit routine E. If you're not solving fourth- or fifth-order polynomials, you can omit routines D, E, and F. If you're not solving third-, fourth-, or fifth-order polynomials, you can omit routines C, D, E, and F.

Program Instructions:

1. Press **☐** **CLEAR** {**ALL**} to clear all programs and variables.
2. Key in the program routines; press **C** when done.
3. Press **XEQ** P to start the polynomial root finder.
4. Key in F, the order of the polynomial, and press **R/S**.
5. At each prompt, key in the coefficient and press **R/S**. You're not prompted for the highest-order coefficient — it's assumed to be 1. You must enter 0 for coefficients that are 0. Coefficient A must not be 0.

Order	Terms and Coefficients					
	x^5	x^4	x^3	x^2	x	Constant
5	1	E	D	C	B	A
4		1	D	C	B	A
3			1	C	B	A
2				1	B	A

6. After you enter the coefficients, the first root is calculated. A real root is displayed as $X=real\ value$. A complex root is displayed as $X=real\ part$, (Complex roots always occur in pairs of the form $u \pm i v$, and are labeled in the output as $X=real\ part$ and $i=imaginary\ part$, which you'll see in the next step.)
7. Press **R/S** repeatedly to see the other roots, or to see $i=imaginary\ part$, the imaginary part of a complex root. The order of the polynomial is same as the number of roots you get.
8. For a new polynomial, go to step 3.

A through E	Coefficients of polynomial; scratch.
F	Order of polynomial; scratch.
G	Scratch.
H	Pointer to polynomial coefficients.
X	The value of a real root, or the real part of complex root
i	The imaginary part of a complex root; also used as an index variable.

Example 1:

Find the roots of $x^5 - x^4 - 101x^3 + 101x^2 + 100x - 100 = 0$.

Keys: (In RPN mode)	Display:	Description:
XEQ P	F? value	Starts the polynomial root finder; prompts for order.
5 R/S	E? value	Stores 5 in F; prompts for E.
1 +/- R/S	D? value	Stores -1 in E; prompts for D.
101 +/- R/S	C? value	Store -101 in D. prompts for C.
101 R/S	B? value	Stores 101 in C; prompts for B.
100 R/S	A? value	Stores 100 in B; prompts for A.
100 +/- R/S	X= 1.0000	Stores -100 in A; calculates the first root.
R/S	X= -10.0000	Calculates the second root.
R/S	X= -1.0000	Displays the third root.
R/S	X= 1.0000	Displays the fourth root.
R/S	X= 10.0000	Displays the fifth root.

Example 2:

Find the roots of $4x^4 - 8x^3 - 13x^2 - 10x + 22 = 0$. Because the coefficient of the highest-order term must be 1, divide that coefficient into each of the other coefficients.

Keys: (In RPN mode)	Display:	Description:
$\boxed{\text{XEQ}}$ P	F? value	Starts the polynomial root finder; prompts for order.
4 $\boxed{\text{R/S}}$	D? value	Stores 4 in F; prompts for D.
8 $\boxed{+/-}$ $\boxed{\text{ENTER}}$ 4 $\boxed{\div}$ $\boxed{\text{R/S}}$	C? value	Stores $-8/4$ in D; prompts for C.
13 $\boxed{+/-}$ $\boxed{\text{ENTER}}$ 4 $\boxed{\div}$ $\boxed{\text{R/S}}$	B? value	Stores $-13/4$ in C. prompts for B.
10 $\boxed{+/-}$ $\boxed{\text{ENTER}}$ 4 $\boxed{\div}$ $\boxed{\text{R/S}}$	A? value	Stores $-10/4$ in B; prompts for A.
22 $\boxed{\text{ENTER}}$ 4 $\boxed{\div}$ $\boxed{\text{R/S}}$	X= 0.8820	Stores $22/4$ in A; calculates the first root.
$\boxed{\text{R/S}}$	X= 3.1180	Calculates the second root.
$\boxed{\text{R/S}}$	X= -1.0000	Displays the real part of the third root.
$\boxed{\text{R/S}}$	i = 1.0000	Displays the imaginary part of the third root.
$\boxed{\text{R/S}}$	X= -1.0000	Displays the real part of the fourth root.
$\boxed{\text{R/S}}$	i = -1.0000	Displays the imaginary part of the fourth root.

The third and fourth roots are $-1.00 \pm 1.00 i$.

Example 3:

Find the roots of the following quadratic polynomial:

$$x^2 + x - 6 = 0$$

Keys: (In RPN mode)	Display:	Description:
$\boxed{\text{XEQ}}$ P	F? <i>value</i>	Starts the polynomial root finder; prompts for order.
2 $\boxed{\text{R/S}}$	B? <i>value</i>	Stores 2 in F; prompts for B.
1 $\boxed{\text{R/S}}$	A? <i>value</i>	Stores 1 in B; prompts for A.
6 $\boxed{+/-}$ $\boxed{\text{R/S}}$	X= -3.0000	Stores -6 in A; calculates the first root.
$\boxed{\text{R/S}}$	X= 2.0000	Calculates the second root.

Coordinate Transformations

This program provides two-dimensional coordinate translation and rotation.

The following formulas are used to convert a point P from the Cartesian coordinate pair (x, y) in the old system to the pair (u, v) in the new, translated, rotated system.

$$u = (x - m) \cos \theta + (y - n) \sin \theta$$

$$v = (y - n) \cos \theta - (x - m) \sin \theta$$

The inverse transformation is accomplished with the formulas below.

$$x = u \cos \theta - v \sin \theta + m$$

$$y = u \sin \theta + v \cos \theta + n$$

The HP 33s complex and polar-to-rectangular functions make these computations straightforward.

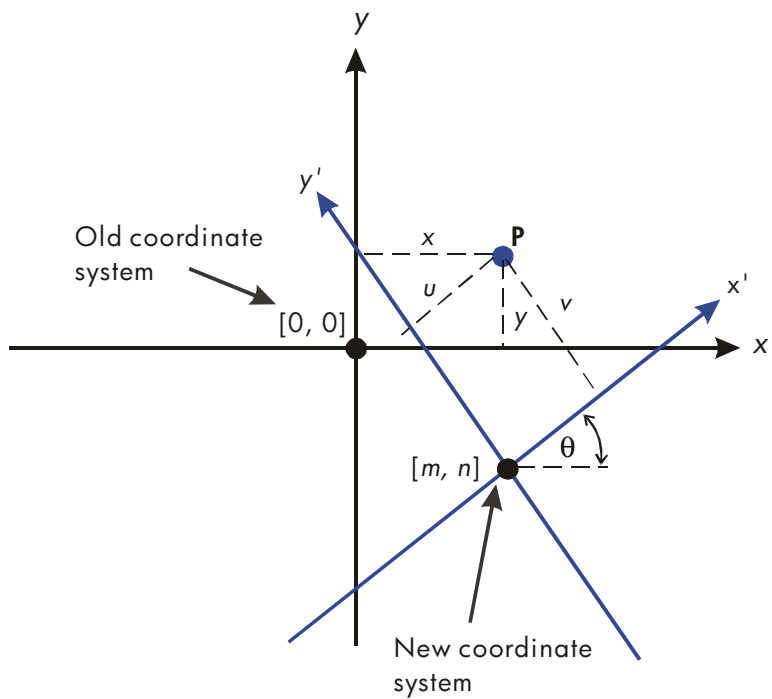

Program Listing:

Program Lines: (In RPN mode)	Description
D0001 LBL D	This routine defines the new coordinate system.
D0002 INPUT M	Prompts for and stores M , the new origin's x -coordinate.
D0003 INPUT N	Prompts for and stores N , the new origin's y -coordinate.
D0004 INPUT T	Prompts for and stores T , the angle θ .
D0005 GTO D	Loops for review of inputs.
Checksum and length: 1EDA 15	
N0001 LBL N	This routine converts from the old system to the new system.
N0002 INPUT X	Prompts for and stores X , the old x -coordinate.
N0003 INPUT Y	Prompts for and stores Y , the old y -coordinate.
N0004 RCL X	Pushes Y up and recalls X to the X -register.
N0005 RCL N	Pushes X and Y up and recalls N to the X -register.
N0006 RCL M	Pushes N , X , and Y up and recalls M .
N0007 CMPLX-	Calculates $(X - M)$ and $(Y - N)$.
N0008 RCL T	Pushes $(X - M)$ and $(Y - N)$ up and recalls T .
N0009 +/-	Changes the sign of T because $\sin(-T)$ equals $-\sin(T)$.
N0010 1	Sets radius to 1 for computation of $\cos(T)$ and $-\sin(T)$.
N0011 $\theta, r \rightarrow y, x$	Calculates $\cos(T)$ and $-\sin(T)$ in X - and Y -registers.
N0012 CMPLXx	Calculates $(X - M) \cos(T) + (Y - N) \sin(T)$ and $(Y - N) \cos(T) - (X - M) \sin(T)$.
N0013 STO U	Stores x -coordinate in variable U .
N0014 $x \leftrightarrow y$	Swaps positions of the coordinates.
N0015 STO V	Stores y -coordinate in variable V .
N0016 $x \leftrightarrow y$	Swaps positions of coordinates back.
N0017 VIEW U	Halts program to display U .
N0018 VIEW V	Halts program to display V .
N0019 GTO N	Goes back for another calculation.
Checksum and length: 921A 69	
00001 LBL O	This routine converts from the new system to the old system.
00002 INPUT U	Prompts for and stores U .

Program Lines: (In RPN mode)

Description

00003 INPUT V	Prompts for and stores V .
00004 RCL U	Pushes V up and recalls U .
00005 RCL T	Pushes U and V up and recalls T .
00006 1	Sets radius to 1 for the computation of $\sin(T)$ and $\cos(T)$.
00007 $\theta, r \rightarrow v, x$	Calculates $\cos(T)$ and $\sin(T)$.
00008 CMPLX \times	Calculates $U \cos(T) - V \sin(T)$ and $U \sin(T) + V \cos(T)$.
00009 RCL N	Pushes up previous results and recalls N .
00010 RCL M	Pushes up results and recalls M .
00011 CMPLX+	Completes calculation by adding M and N to previous results.
00012 STO X	Stores the x -coordinate in variable X .
00013 $x \leftrightarrow y$	Swaps the positions of the coordinates.
00014 STO Y	Stores the y -coordinate in variable Y .
00015 $x \leftrightarrow y$	Swaps the positions of the coordinates back.
00016 VIEW X	Halts the program to display X .
00017 VIEW Y	Halts the program to display Y .
00018 GTO 0	Goes back for another calculation.

Checksum and length: 8C82 66

Flags Used:

None.

Program Instructions:

1. Key in the program routines; press **C** when done.
2. Press **XEQ** D to start the prompt sequence which defines the coordinate transformation.
3. Key in the x -coordinate of the origin of the new system M and press **R/S**.
4. Key in the y -coordinate of the origin of the new system N and press **R/S**.
5. Key in the rotation angle T and press **R/S**.
6. To translate from the old system to the new system, continue with step 7. To translate from the new system to the old system, skip to step 12.

7. Press $\boxed{\text{XEQ}}$ N to start the old-to-new transformation routine.
8. Key in X and press $\boxed{\text{R/S}}$.
9. Key in Y , press $\boxed{\text{R/S}}$, and see the x -coordinate, U , in the new system.
10. Press $\boxed{\text{R/S}}$ and see the y -coordinate, V , in the new system.
11. For another old-to-new transformation, press $\boxed{\text{R/S}}$ and go to step 8. For a new-to-old transformation, continue with step 12.
12. Press $\boxed{\text{XEQ}}$ O to start the new-to-old transformation routine.
13. Key in U (the x -coordinate in the new system) and press $\boxed{\text{R/S}}$.
14. Key in V (the y -coordinate in the new system) and press $\boxed{\text{R/S}}$ to see X .
15. Press $\boxed{\text{R/S}}$ to see Y .
16. For another new-to-old transformation, press $\boxed{\text{R/S}}$ and go to step 13. For an old-to-new transformation, go to step 7.

Variables Used:

M	The x -coordinate of the origin of the new system.
N	The y -coordinate of the origin of the new system.
T	The rotation angle, θ , between the old and new systems.
X	The x -coordinate of a point in the old system.
Y	The y -coordinate of a point in the old system.
U	The x -coordinate of a point in the new system.
V	The y -coordinate of a point in the new system.

Remark:

For translation only, key in zero for T . For rotation only, key in zero for M and N .

Example:

For the coordinate systems shown below, convert points P_1 , P_2 and P_3 , which are currently in the (X, Y) system, to points in the (X', Y') system. Convert point P'_4 , which is in the (X', Y') system, to the (X, Y) system.

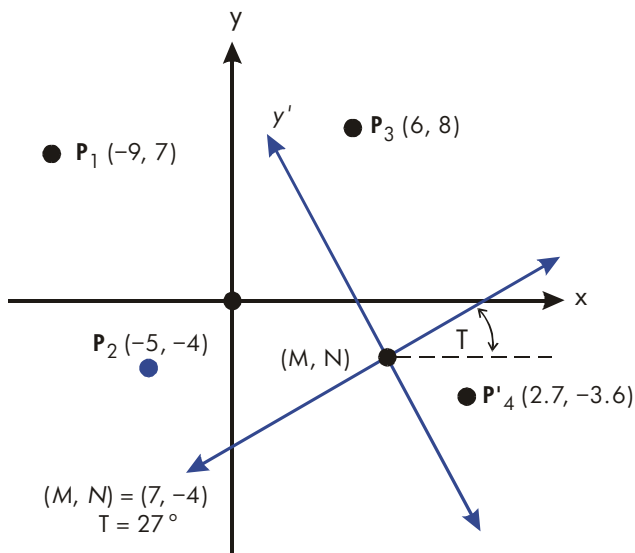

Keys:
(In RPN mode)

Display:

Description:

MODES {DEG}

Sets Degrees mode since T is given in degrees.

XEQ D

M?
value

Starts the routine that defines the transformation.

7 **R/S**

N?
value

Stores 7 in M.

4 **+/-** **R/S**

T?
value

Stores -4 in U.

27 **R/S**

M?
7.0000

Stores 27 in T.

XEQ N

X?
value

Starts the old-to-new routine.

9 **+/-** **R/S**

Y?
value

Stores -9 in X.

7 **R/S**

U=
-9.2622

Stores 7 in Y and calculates U.

R/S

V=
17.0649

Calculates V.

R/S	X?	Resumes the old-to-new routine
	-9.0000	for next problem.
5 +/- R/S	Y?	Stores -5 in X.
	7.0000	
4 +/- R/S	U=	Stores -4 in Y.
	-10.6921	
R/S	V=	Calculates V.
	5.4479	
R/S	X?	Resumes the old-to-new routine
	-5.0000	for next problem.
6 R/S	Y?	Stores 6 in X.
	-4.0000	
8 R/S	U=	Stores 8 in Y and calculates U.
	4.5569	
R/S	V=	Calculates V.
	11.1461	
XEQ ○	U?	Starts the new-to-old routine.
	4.5569	
2.7 R/S	V?	Stores 2.7 in U.
	11.1461	
3.6 +/- R/S	X=	Stores -3.6 in V and calculates
	11.0401	X.
R/S	Y=	Calculates Y.
	-5.9818	

Statistics Programs

Curve Fitting

This program can be used to fit one of four models of equations to your data. These models are the straight line, the logarithmic curve, the exponential curve and the power curve. The program accepts two or more (x, y) data pairs and then calculates the correlation coefficient, r , and the two regression coefficients, m and b . The program includes a routine to calculate the estimates \hat{x} and \hat{y} . (For definitions of these values, see "Linear Regression" in chapter 11.)

Samples of the curves and the relevant equations are shown below. The internal regression functions of the HP 33s are used to compute the regression coefficients.

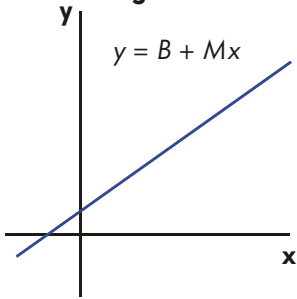
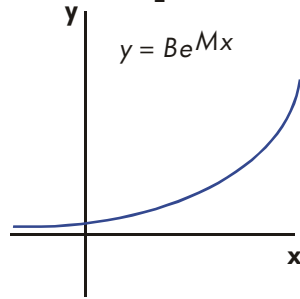
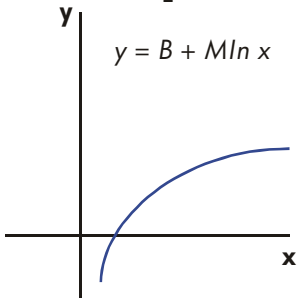
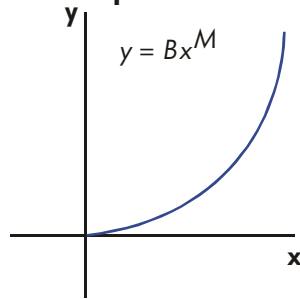
Straight Line Fit**S****Exponential Curve Fit****E****Logarithmic Curve Fit****L****Power Curve Fit****P**

To fit logarithmic curves, values of x must be positive. To fit exponential curves, values of y must be positive. To fit power curves, both x and y must be positive. A LOG<NEG> error will occur if a negative number is entered for these cases.

Data values of large magnitude but relatively small differences can incur problems of precision, as can data values of greatly different magnitudes. Refer to "Limitations in Precision of Data" in chapter 11.

Program Listing:

**Program Lines:
(In RPN mode)**

Description

S0001 LBL S This routine sets, the status for the straight-line model.
S0002 1 Enters index value for later storage in *i* (for indirect
 addressing).
S0003 CF 0 Clears flag 0, the indicator for ln X.
S0004 CF 1 Clears flag 1, the indicator for ln Y.
S0005 GTO Z Branches to common entry point Z.
Checksum and length: E3F5 27

L0001 LBL L This routine sets the status for the logarithmic model.
L0002 2 Enters index value for later storage in *i* (for indirect
 addressing).
L0003 SF 0 Sets flag 0, the indicator for ln X.
L0004 CF 1 Clears flag 1, the indicator for ln Y
L0005 GTO Z Branches to common entry point Z.
Checksum and length: F78E 27

E0001 LBL E This routine sets the status for the exponential model.
E0002 3 Enters index value for later storage in *i* (for indirect
 addressing).
E0003 CF 0 Clears flag 0, the indicator for ln X.
E0004 SF 1 Sets flag 1, the indicator for ln Y.
E0005 GTO Z Branches to common entry point Z.
Checksum and length: 293B 27

P0001 LBL P This routine sets the status for the power model.
P0002 4 Enters index value for later storage in *i* (for indirect
 addressing.)
P0003 SF 0 Sets flag 0, the indicator for ln X.
P0004 SF 1 Sets flag 1, the indicator for ln Y.
Checksum and length: 43AA 24

Z0001 LBL Z Defines common entry point for all models.
Z0002 CLΣ Clears the statistics registers.
Z0003 STO i Stores the index value in *i* for indirect addressing.

**Program Lines:
(In RPN mode)**

Description

Z0004 0	Sets the loop counter to zero for the first input.
Checksum and length: 5AB9 24	
W0001 LBL W	Defines the beginning of the input loop.
W0002 1	Adjusts the loop counter by one to prompt for input.
W0003 +	
W0004 STO X	Stores loop counter in <i>X</i> so that it will appear with the prompt for <i>X</i> .
W0005 INPUT X	Displays counter with prompt and stores <i>X</i> input.
W0006 FS? 0	If flag 0 is set . . .
W0007 LN	. . . takes the natural log of the <i>X</i> -input.
W0008 STO B	Stores that value for the correction routine.
W0009 INPUT Y	Prompts for and stores <i>Y</i> .
W0010 FS? 1	If flag 1 is set . . .
W0011 LN	. . . takes the natural log of the <i>Y</i> -input.
W0012 STO R	
W0013 RCL B	
W0014 $\Sigma+$	Accumulates <i>B</i> and <i>R</i> as <i>x,y</i> -data pair in statistics registers.
W0015 GTO W	Loops for another <i>X, Y</i> pair.
Checksum and length: C95E 57	
U0001 LBL U	Defines the beginning of the "undo" routine.
U0002 RCL R	Recalls the most recent data pair.
U0003 RCL B	
U0004 $\Sigma-$	Deletes this pair from the statistical accumulation.
U0005 GTO W	Loops for another <i>X, Y</i> pair.
Checksum and length: AB71 15	
R0001 LBL R	Defines the start of the output routine
R0002 <i>r</i>	Calculates the correlation coefficient.
R0003 STO R	Stores it in <i>R</i> .
R0004 VIEW R	Displays the correlation coefficient.
R0005 <i>b</i>	Calculates the coefficient <i>b</i> .
R0006 FS? 1	If flag 1 is set takes the natural antilog of <i>b</i> .
R0007 e^X	

**Program Lines:
(In RPN mode)**

Description

R0008 STO B Stores b in B .
R0009 VIEW B Displays value.
R0010 m Calculates coefficient m .
R0011 STO M Stores m in M .
R0012 VIEW M Displays value.

Checksum and length: 9CC9 36

Y0001 LBL Y Defines the beginning of the estimation (projection) loop.
Y0002 INPUT X Displays, prompts for, and, if changed, stores x -value in X .
Y0003 XEQ(i) > Calls subroutine to compute \hat{y} .
Y0004 STO Y Stores \hat{y} -value in Y .
Y0005 INPUT Y Displays, prompts for, and, if changed, stores y -value in Y .
Y0006 6
Y0007 STO+ i Adjusts index value to address the appropriate subroutine.
Y0008 XEQ(i) > Calls subroutine to compute \hat{x} .
Y0009 STO X Stores \hat{x} in X for next loop.
Y0010 GTO Y Loops for another estimate.

Checksum and length: 9B34 42

A0001 LBL A This subroutine calculates \hat{y} for the straight-line model.
A0002 RCL M
A0003 RCL x X
A0004 RCL+ B Calculates $\hat{y} = MX + B$.
A0005 RTN Returns to the calling routine.

Checksum and length: F321 15

G0001 LBL G This subroutine calculates \hat{x} for the straight-line model.
G0002 STO- i Restores index value to its original value.
G0003 RCL Y
G0004 RCL- B
G0005 RCL÷ M Calculates $\hat{x} = (Y - B) \div M$.
G0006 RTN Returns to the calling routine.

Checksum and length: 65AB 18

B0001 LBL B This subroutine calculates \hat{y} for the logarithmic model.

**Program Lines:
(In RPN mode)**

Description

B0002 RCL X

B0003 LN

B0004 RCL× M

B0005 RCL+ B Calculates $\hat{y} = M \ln X + B$.

B0006 RTN Returns to the calling routine.

Checksum and length: A5BB 18

H0001 LBL H This subroutine calculates \hat{x} for the logarithmic model.

H0002 STO- i Restores index value to its original value.

H0003 RCL Y

H0004 RCL- B

H0005 RCL÷ M

H0006 e^X Calculates $\hat{x} = e^{(Y-B) \div M}$

H0007 RTN Returns to the calling routine.

Checksum and length: 5117 21

C0001 LBL C This subroutine calculates \hat{y} for the exponential model.

C0002 RCL M

C0003 RCL× X

C0004 e^X

C0005 RCL× B Calculates $\hat{y} = Be^{MX}$.

C0006 RTN Returns to the calling routine.

Checksum and length: 1F92 18

I0001 LBL I This subroutine calculates \hat{x} for the exponential model.

I0002 STO- i Restores index value to its original value.

I0003 RCL Y

I0004 RCL÷ B

I0005 LN

I0006 RCL÷ M Calculates $\hat{x} = (\ln (Y \div B)) \div M$.

I0007 RTN Returns to the calling routine.

Checksum and length: CC13 21

D0001 LBL D This subroutine calculates \hat{y} for the power model.

D0002 RCL X

Program Lines: (In RPN mode)

Description

D0003 RCL M

D0004 y^x

D0005 RCL \times B Calculates $Y = B(X^M)$.

D0006 RTN Returns to the calling routine.

Checksum and length: 018C 18

J0001 LBL J This subroutine calculates \hat{x} for the power model.

J0002 STO- i Restores index value to its original value.

J0003 RCL Y

J0004 RCL \div B

J0005 RCL M

J0006 $1/x$

J0007 y^x Calculates $\hat{x} = (Y/B)^{1/M}$

J0008 RTN Returns to the calling routine.

Checksum and length: 3040 24

Flags Used:

Flag 0 is set if a natural log is required of the X input. Flag 1 is set if a natural log is required of the Y input.

Program instructions:

1. Key in the program routines; press **C** when done.
2. Press **XEQ** and select the type of curve you wish to fit by pressing:
 - S for a straight line;
 - L for a logarithmic curve;
 - E for an exponential curve; or
 - P for a power curve.
3. Key in x-value and press **R/S**.
4. Key in y-value and press **R/S**.

5. Repeat steps 3 and 4 for each data pair. If you discover that you have made an error after you have pressed **[R/S]** in step 3 (with the $Y?$ value prompt still visible), press **[R/S]** again (displaying the $X?$ value prompt) and press **[XEQ]** U to undo (remove) the last data pair. If you discover that you made an error after step 4, press **[XEQ]** U. In either case, continue at step 3.
6. After all data are keyed in, press **[XEQ]** R to see the correlation coefficient, R .
7. Press **[R/S]** to see the regression coefficient B .
8. Press **[R/S]** to see the regression coefficient M .
9. Press **[R/S]** to see the $X?$ value prompt for the \hat{x} , \hat{y} -estimation routine.
10. If you wish to estimate \hat{y} based on x , key in x at the $X?$ value prompt, then press **[R/S]** to see \hat{y} ($Y?$).
11. If you wish to estimate \hat{x} based on y , press **[R/S]** until you see the $Y?$ value prompt, key in y , then press **[R/S]** to see \hat{x} ($X?$).
12. For more estimations, go to step 10 or 11.
13. For a new case, go to step 2.

Variables Used:

B	Regression coefficient (y -intercept of a straight line); also used for scratch.
M	Regression coefficient (slope of a straight line).
R	Correlation coefficient; also used for scratch.
X	The x -value of a data pair when entering data; the hypothetical x when projecting \hat{y} ; or \hat{x} (x -estimate) when given a hypothetical y .
Y	The y -value of a data pair when entering data; the hypothetical y when projecting \hat{x} ; or \hat{y} (y -estimate) when given a hypothetical x .
i	Index variable used to indirectly address the correct \hat{x} -, \hat{y} -projection equation.
Statistics registers	Statistical accumulation and computation.

Example 1:

Fit a straight line to the data below. Make an intentional error when keying in the third data pair and correct it with the undo routine. Also, estimate y for an x value of 37. Estimate x for a y value of 101.

X	40.5	38.6	37.9	36.2	35.1	34.6
Y	104.5	102	100	97.5	95.5	94

Keys: (In RPN mode)	Display:	Description:
XEQ S	X? 1.0000	Starts straight-line routine.
40.5 R/S	Y? <i>value</i>	Enters x -value of data pair.
104.5 R/S	X? 2.0000	Enters y -value of data pair.
38.6 R/S	Y? 104.5000	Enters x -value of data pair.
102 R/S	X? 3.0000	Enters y -value of data pair.

Now intentionally enter 379 instead of 37.9 so that you can see how to correct incorrect entries.

Keys: (In RPN mode)	Display:	Description:
379 R/S	Y? 102.0000	Enters wrong x -value of data pair.
R/S	X? 4.0000	Retrieves X? prompt.
XEQ U	X? 3.0000	Deletes the last pair. Now proceed with the correct data entry.
37.9 R/S	Y? 102.0000	Enters correct x -value of data pair.

100	R/S	X? 4.0000	Enters y -value of data pair.
36.2	R/S	Y? 100.0000	Enters x -value of data pair.
97.5	R/S	X? 5.0000	Enters y -value of data pair.
35.1	R/S	Y? 97.5000	Enters x -value of data pair.
95.5	R/S	X? 6.0000	Enters y -value of data pair.
34.6	R/S	Y? 95.5000	Enters x -value of data pair.
94	R/S	X? 7.0000	Enters y -value of data pair.
XEQ	R	R= 0.9955	Calculates the correlation coefficient.
R/S		B= 33.5271	Calculates regression coefficient B .
R/S		M= 1.7601	Calculates regression coefficient M .
R/S		X? 7.0000	Prompts for hypothetical x -value.
37	R/S	Y? 98.6526	Stores 37 in X and calculates \hat{y} .
101	R/S	X? 38.3336	Stores 101 in Y and calculates \hat{x} .

Example 2:

Repeat example 1 (using the same data) for logarithmic, exponential, and power curve fits. The table below gives you the starting execution label and the results (the correlation and regression coefficients and the x - and y - estimates) for each type of curve. You will need to reenter the data values each time you run the program for a different curve fit.

	Logarithmic	Exponential	Power
To start:	$\boxed{\text{XEQ}} \text{ L}$	$\boxed{\text{XEQ}} \text{ E}$	$\boxed{\text{XEQ}} \text{ P}$
R	0.9965	0.9945	0.9959
M	-139.0088	51.1312	8.9730
B	65.8446	0.0177	0.6640
$Y(\hat{Y} \text{ when } X=37)$	98.7508	98.5870	98.6845
$X(\hat{X} \text{ when } Y=101)$	38.2857	38.3628	38.3151

Normal and Inverse-Normal Distributions

Normal distribution is frequently used to model the behavior of random variation about a mean. This model assumes that the sample distribution is symmetric about the mean, M , with a standard deviation, S , and approximates the shape of the bell-shaped curve shown below. Given a value x , this program calculates the probability that a random selection from the sample data will have a higher value. This is known as the upper tail area, $Q(x)$. This program also provides the inverse: given a value $Q(x)$, the program calculates the corresponding value x .

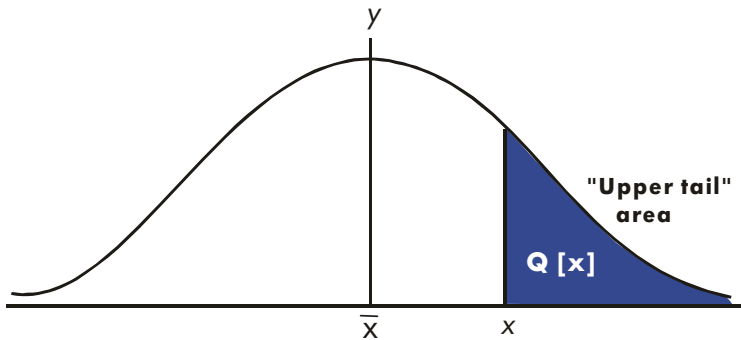

$$Q(x) = 0.5 - \frac{1}{\sigma\sqrt{2\pi}} \int_{\bar{x}}^x e^{-\frac{(x-\bar{x})+\sigma)^2}{2}} dx$$

This program uses the built-in integration feature of the HP 33s to integrate the equation of the normal frequency curve. The inverse is obtained using Newton's method to iteratively search for a value of x which yields the given probability $Q(x)$.

Program Listing:

Program Lines: (In RPN mode)

Description

S0001 LBL S This routine initializes the normal distribution program.
S0002 0 Stores default value for mean.
S0003 STO M
S0004 INPUT M Prompts for and stores mean, M .
S0005 1 Stores default value for standard deviation.
S0006 STO S
S0007 INPUT S Prompts for and stores standard deviation, S .
S0008 RTN Stops displaying value of standard deviation.
Checksum and length: D72F 48

D0001 LBL D This routine calculates $Q(X)$ given X .
D0002 INPUT X Prompts for and stores X .
D0003 XEQ Q Calculates upper tail area.
D0004 STO Q Stores value in Q so VIEW function can display it.
D0005 VIEW Q Displays $Q(X)$.
D0006 GTO D Loops to calculate another $Q(X)$.
Checksum and length: EA54 18

I0001 LBL I This routine calculates X given $Q(X)$.
I0002 INPUT Q Prompts for and stores $Q(X)$.
I0003 RCL M Recalls the mean.
I0004 STO X Stores the mean as the guess for X , called X_{guess} .
Checksum and length: 79B9 12

T0001 LBL T This label defines the start of the iterative loop.
T0002 XEQ Q Calculates $(Q(X_{guess}) - Q(X))$.
T0003 RCL - Q
T0004 RCL X
T0005 STO D
T0006 R↓
T0007 XEQ F Calculates the derivative at X_{guess} .
T0008 RCL ÷ T
T0009 ÷ Calculates the correction for X_{guess} .

**Program Lines:
(In RPN mode)**

Description

T0010 STO+ X Adds the correction to yield a new X_{guess} .
T0011 ABS
T0012 0.0001
T0013 <v? Tests to see if the correction is significant.
T0014 GTO T Goes back to start of loop if correction is significant.
Continues if correction is not significant.
T0015 RCL X
T0016 VIEW X Displays the calculated value of X.
T0017 GTO I Loops to calculate another X.
Checksum and length: 0E12 63

Q0001 LBL Q This subroutine calculates the upper-tail area $Q(x)$.
Q0002 RCL M Recalls the lower limit of integration.
Q0003 RCL X Recalls the upper limit of integration.
Q0004 FN= F Selects the function defined by LBL F for integration.
Q0005 ∫ FN d D Integrates the normal function using the dummy variable D .
Q0006 2
Q0007 π
Q0008 ×
Q0009 √ x
Q0010 RCL× S Calculates $S \times \sqrt{2\pi}$.
Q0011 STO T Stores result temporarily for inverse routine.
Q0012 ÷
Q0013 +/-
Q0014 0.5
Q0015 + Adds half the area under the curve since we integrated using the mean as the lower limit.
Q0016 RTN Returns to the calling routine.
Checksum and length: FA83 72

F0001 LBL F This subroutine calculates the integrand for the normal function $e^{-((X-M)+S)^2+2}$
F0002 RCL D
F0003 RCL- M

Program Lines: (In RPN mode)

Description

F0004 RCL ÷ S

F0005 \times^2

F0006 2

F0007 ÷

F0008 +/-

F0009 e^x

F0010 RTN Returns to the calling routine.

Checksum and length: 1981 42

Flags Used:

None.

Remarks:

The accuracy of this program is dependent on the display setting. For inputs in the area between ± 3 standard deviations, a display of four or more significant figures is adequate for most applications.

At full precision, the input limit becomes ± 5 standard deviations. Computation time is significantly less with a lower number of displayed digits.

In routine Q, the constant 0.5 may be replaced by 2 and $\boxed{1/x}$.

You do not need to key in the inverse routine (in routines I and T) if you are not interested in the inverse capability.

Program Instructions:

1. Key in the program routines; press \boxed{C} when done.
2. Press \boxed{XEQ} S.
3. After the prompt for M, key in the population mean and press $\boxed{R/S}$. (If the mean is zero, just press $\boxed{R/S}$.)
4. After the prompt for S, key in the population standard deviation and press $\boxed{R/S}$. (If the standard deviation is 1, just press $\boxed{R/S}$.)
5. To calculate X given Q(X), skip to step 9 of these instructions.

6. To calculate $Q(X)$ given X , press $\boxed{\text{XEQ}}$ D.
7. After the prompt, key in the value of X and press $\boxed{\text{R/S}}$. The result, $Q(X)$, is displayed.
8. To calculate $Q(X)$ for a new X with the same mean and standard deviation, press $\boxed{\text{R/S}}$ and go to step 7.
9. To calculate X given $Q(X)$, press $\boxed{\text{XEQ}}$ I.
10. After the prompt, key in the value of $Q(X)$ and press $\boxed{\text{R/S}}$. The result, X , is displayed.
11. To calculate X for a new $Q(X)$ with the same mean and standard deviation, press $\boxed{\text{R/S}}$ and go to step 10.

Variables Used:

D	Dummy variable of integration.
M	Population mean, default value zero.
Q	Probability corresponding to the upper-tail area.
S	Population standard deviation, default value of 1.
T	Variable used temporarily to pass the value $S \times \sqrt{2\pi}$ to the inverse program.
X	Input value that defines the left side of the upper-tail area.

Example 1:

Your good friend informs you that your blind date has " 3σ " intelligence. You interpret this to mean that this person is more intelligent than the local population except for people more than three standard deviations above the mean.

Suppose that you intuit that the local population contains 10,000 possible blind dates. How many people fall into the " 3σ " band? Since this problem is stated in terms of standard deviations, use the default value of zero for M and 1 for S .

Keys: (In RPN mode)	Display:	Description:
$\boxed{\text{XEQ}}$ S	M? 0.0000	Starts the initialization routine.
$\boxed{\text{R/S}}$	S? 1.0000	Accepts the default value of zero for M .
$\boxed{\text{R/S}}$	1.0000	Accepts the default value of 1 for S .

XEQ D	X? <i>value</i>	Starts the distribution program and prompts for X .
3 R/S	Q= 0.0013	Enters 3 for X and starts computation of $Q(X)$. Displays the ratio of the population smarter than everyone within three standard deviations of the mean.
10000 X	13.4984	Multiplies by the population. Displays the approximate number of blind dates in the local population that meet the criteria.

Since your friend has been known to exaggerate from time to time, you decide to see how rare a " 2σ " date might be. Note that the program may be rerun simply by pressing **R/S**.

Keys: (In RPN mode)	Display:	Description:
R/S	X? 3.0000	Resumes program.
2 R/S	Q= 0.0228	Enters X -value of 2 and calculates $Q(X)$.
10000 X	227.5012	Multiplies by the population for the revised estimate.

Example 2:

The mean of a set of test scores is 55. The standard deviation is 15.3. Assuming that the standard normal curve adequately models the distribution, what is the probability that a randomly selected student scored at least 90? What is the score that only 10 percent of the students would be expected to have surpassed? What would be the score that only 20 percent of the students would have failed to achieve?

Keys: (In RPN mode)	Display:	Description:
XEQ S	M? 0.0000	Starts the initialization routine.

55	R/S	8? 1.0000	Stores 55 for the mean.
15.3	R/S	15.3000	Stores 15.3 for the standard deviation.
	XEQ D	X? value	Starts the distribution program and prompts for X.
90	R/S	Q= 0.0111	Enters 90 for X and calculates Q(X).

Thus, we would expect that only about 1 percent of the students would do better than score 90.

	Keys: (In RPN mode)	Display:	Description:
	XEQ I	Q? 0.0111	Starts the inverse routine.
0.1	R/S	X= 74.6077	Stores 0.1 (10 percent) in Q(X) and calculates X.
	R/S	Q? 0.1000	Resumes the inverse routine.
0.8	R/S	X= 42.1232	Stores 0.8 (100 percent minus 20 percent) in Q(X) and calculates X.

Grouped Standard Deviation

The standard deviation of grouped data, S_{xy} , is the standard deviation of data points x_1, x_2, \dots, x_n , occurring at positive integer frequencies f_1, f_2, \dots, f_n .

$$S_{xy} = \sqrt{\frac{\sum x_i^2 f_i - (\sum x_i f_i)^2}{(\sum f_i) - 1}}$$

This program allows you to input data, correct entries, and calculate the standard deviation and weighted mean of the grouped data.

Program Listing:

Program Lines: (In ALG mode)	Description
S0001 LBL S	Start grouped standard deviation program.
S0002 CLΣ	Clears statistics registers (28 through 33).
S0003 0	
S0004 STO N	Clears the count N .
Checksum and length: EF85 24	
I0001 LBL I	Input statistical data points.
I0002 INPUT X	Stores data point in X .
I0003 INPUT F	Stores data-point frequency in F .
I0004 1	Enters increment for N .
I0005 STO B	
I0006 RCL F	Recalls data-point frequency f_i .
Checksum and length: 184C 30	
F0001 LBL F	Accumulate summations.
F0002 28	
F0003 STO i	Stores index for register 28.
F0004 RCL F	
F0005 STO+(i)	Updates $\sum f_i$ in register 28.
F0006 RCL× X	$x_i f_i$
F0007 ENTER	
F0008 STO Z	
F0009 29	
F0010 STO i	Stores index for register 29.
F0011 RCL Z	
F0012 STO+(i)	Updates $\sum x_i f_i$ in register 29.
F0013 RCL× X	$x_i^2 f_i$
F0014 ENTER	
F0015 STO Z	Stores index for register 31.
F0016 31	
F0017 STO i	
F0018 RCL Z	

**Program Lines:
(In ALG mode)****Description**

F0019 STO+(i)	Updates $\sum x_i^2 f_i$ in register 31.
F0020 RCL B	
F0021 STO+ N	Increments (or decrements) N.
F0022 RCL N	
F0023 RCL F	
F0024 ABS	
F0025 STO F	
F0026 VIEW N	Displays current number of data pairs.
F0027 GTO I	Goes to label I for next data input.
Checksum and length: 3080 117	

G0001 LBL G	Calculates statistics for grouped data.
G0002 Sx	Grouped standard deviation.
G0003 STO S	
G0004 VIEW S	Displays grouped standard deviation.
G0005 \bar{x}	Weighted mean.
G0006 STO M	
G0007 VIEW M	Displays weighted mean.
G0008 GTO I	Goes back for more points.
Checksum and length: 7246 24	

U0001 LBL U	Undo data-entry error.
U0002 -1	Enters decrement for N.
U0003 STO B	
U0004 RCL F	Recalls last data frequency input.
U0005 +/-	Changes sign of f_i .
U0006 STO F	
U0007 GTO F	Adjusts count and summations.
Checksum and length: E469 33	

Flags Used:

None.

Program Instructions:

1. Key in the program routines; press **C** when done.
2. Press **XEQ** S to start entering new data.
3. Key in x_i -value (data point) and press **R/S**.
4. Key in f_i -value (frequency) and press **R/S**.
5. Press **R/S** after VIEWing the number of points entered.
6. Repeat steps 3 through 5 for each data point.

If you discover that you have made a data-entry error (x_i or f_i) after you have pressed **R/S** in step 4, press **XEQ** U and then press **R/S** again. Then go back to step 3 to enter the correct data.

7. When the last data pair has been input, press **XEQ** G to calculate and display the grouped standard deviation.
8. Press **R/S** to display the weighted mean of the grouped data.
9. To add additional data points, press **R/S** and continue at step 3.
To start a new problem, start at step 2.

Variables Used:

X	Data point.
F	Data-point frequency.
N	Data-pair counter.
S	Grouped standard deviation.
M	Weighted mean.
i	Index variable used to indirectly address the correct statistics register.
Register 28	Summation Σf_i .
Register 29	Summation $\Sigma x_i f_i$.
Register 31	Summation $\Sigma x_i^2 f_i$.

Example:

Enter the following data and calculate the grouped standard deviation.

Group	1	2	3	4	5	6
x_j	5	8	13	15	22	37
f_j	17	26	37	43	73	115

Keys: (In ALG mode)	Display:	Description:
XEQ S	X? <i>value</i>	Prompts for the first x_j .
5 R/S	F? <i>value</i>	Stores 5 in X_j ; prompts for first f_j .
17 R/S	N= 1.0000	Stores 17 in F_j ; displays the counter.
R/S	X? 5.0000	Prompts for the second x_j .
8 R/S	F? 17.0000	Prompts for second f_j .
26 R/S	N= 2.0000	Displays the counter.
R/S	X? 8.0000	Prompts for the third x_j .
14 R/S	F? 26.0000	Prompts for the third f_j .
37 R/S	N= 3.0000	Displays the counter.

You erred by entering 14 instead of 13 for x_3 . Undo your error by executing routine U:

XEQ U	N= 2.0000	Removes the erroneous data; displays the revised counter.
R/S	X? 14.0000	Prompts for new third x_j .
13 R/S	F? 37.0000	Prompts for the new third f_j .
R/S	N= 3.0000	Displays the counter.

R/S	X? 13.0000	Prompts for the fourth x_i .
15 R/S	F? 37.0000	Prompts for the fourth f_i .
43 R/S	N= 4.0000	Displays the counter.
R/S	X? 15.0000	Prompts for the fifth x_i .
22 R/S	F? 43.0000	Prompts for the fifth f_i .
73 R/S	N= 5.0000	Displays the counter.
R/S	X? 22.0000	Prompts for the sixth x_i .
37 R/S	F? 73.0000	Prompts for the sixth f_i .
115 R/S	N= 6.0000	Displays the counter.
XEQ G	S= 11.4118	Calculates and displays the grouped standard deviation (s_x) of the six data points.
R/S	M= 23.4084	Calculates and displays weighted mean (\bar{X}).
C	23.4084	Clears VIEW.

Miscellaneous Programs and Equations

Time Value of Money

Given any four of the five values in the "Time-Value-of-Money equation" (TVM), you can solve for the fifth value. This equation is useful in a wide variety of financial applications such as consumer and home loans and savings accounts.

The TVM equation is:

$$P \left[\frac{1 - (1 + I/100)^{-N}}{I/100} \right] + F(1 + (I/100))^{-N} + B = 0$$

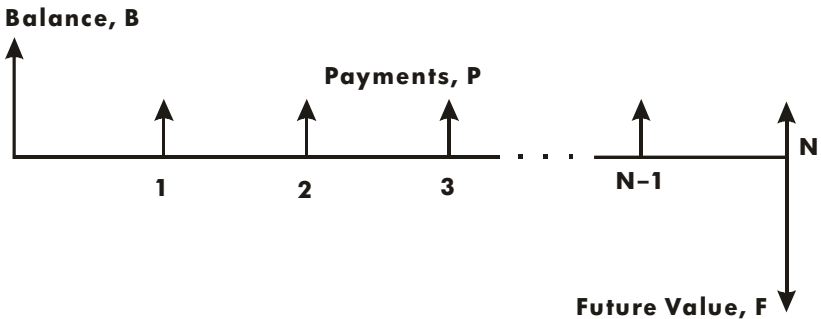

The signs of the cash values (balance, B ; payment, P ; and future balance, F) correspond to the direction of the cash flow. Money that you receive has a positive sign while money that you pay has a negative sign. Note that any problem can be viewed from two perspectives. The lender and the borrower view the same problem with reversed signs.

Equation Entry:

Key in this equation:

$$P \times 100 \times (1 - (1 + I \div 100)^{-N}) \div I + F \times (1 + I \div 100)^{-N} + B$$

Keys: (In RPN mode)

[>] **[EQN]**

[RCL] **P** **[X]** 100

[X] **[>]** **[(]** 1 **[-]**

[>] **[(]** 1 **[+]**

[RCL] **I** **[÷]** 100

[>] **[)]** **[y^x]**

[-] **[RCL]** **N** **[>]** **[)]**

[÷] **[RCL]** **I** **[+]** **[RCL]** **F** **[X]**

[>] **[(]** 1 **[+]** **[RCL]** **I**

[÷] 100 **[>]** **[)]**

[y^x] **[-]** **[RCL]** **N**

[+] **[RCL]** **B**

[ENTER]

[>] **[SHOW]** (hold)

Display:

EQN LIST TOP
or current equation

P× 100_

P×100×(1-█

P×100×(1-(1+█

×(1-(1+I÷ 100_

(1-(1+I÷100)^█

(1+I÷100)^-N)█

100)^-N)÷I+F×█

^-N)÷I+F×(1+I█

I+F×(1+I÷100)█

×(1+I÷100)^-N█

1+I÷100)^-N+B█

P×100×(1-(1+I÷

CK=382E

LN=41

Description:

Selects Equation mode.

Starts entering equation.

Terminates the equation.

Checksum and length.

Remarks:

The TVM equation requires that *I* must be non-zero to avoid a **DIVIDE BY 0** error. If you're solving for *I* and aren't sure of its current value, press 1 **[STO]** 1 before you begin the SOLVE calculation (**[SOLVE]** 1).

The order in which you're prompted for values depends upon the variable you're solving for.

SOLVE instructions:

1. If your *first* TVM calculation is to solve for interest rate, i , press 1 **[STO]** i .
2. Press **[>]** **[EQN]**. If necessary, press **[↑]** or **[↓]** to scroll through the equation list until you come to the TVM equation.
3. Do one of the following five operations:
 - a. Press **[SOLVE]** N to calculate the number of compounding periods.
 - b. Press **[SOLVE]** i to calculate periodic interest.

For monthly payments, the result returned for i is the *monthly* interest rate, i ; press 12 **[X]** to see the annual interest rate.

- c. Press **[SOLVE]** B to calculate initial balance of a loan or savings account.
 - d. Press **[SOLVE]** P to calculate periodic payment.
 - e. Press **[SOLVE]** F to calculate future value or balance of a **loan**.
4. Key in the values of the four known variables as they are prompted for; press **[R/S]** after each value.
 5. When you press the last **[R/S]**, the value of the unknown variable is calculated and displayed.
 6. To calculate a new variable, or recalculate the same variable using different data, go back to step 2.

SOLVE works effectively in this application without initial guesses.

Variables Used:

N	The number of compounding periods.
i	The <i>periodic</i> interest rate as a percentage. (For example, if the <i>annual</i> interest rate is 15% and there are 12 payments per year, the <i>periodic</i> interest rate, i , is $15 \div 12 = 1.25\%$.)
B	The initial balance of loan or savings account.
P	The periodic payment.
F	The future value of a savings account or balance of a loan.

Example:

Part 1. You are financing the purchase of a car with a 3-year (36-month) loan at 10.5% annual interest compounded monthly. The purchase price of the car is \$7,250. Your down payment is \$1,500.

$$B = 7,250 - 1,500$$

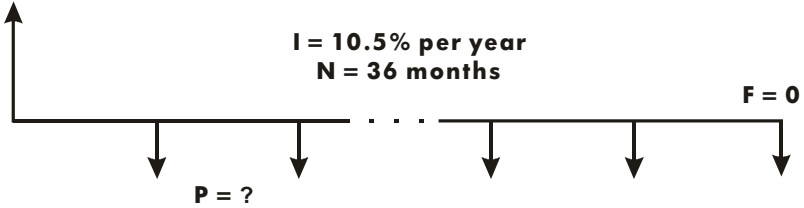

Keys:
(In RPN mode)

Display:

Description:

DISPLAY {FIX} 2

Selects FIX 2 display format.

EQN (↓ as needed)

$P \times 100 \times (1 - (1 + I)^{-N}) \div I$ Displays the leftmost part of the TVM equation.

SOLVE P

I?
value

Selects P; prompts for I.

10.5 **ENTER** 12 **÷**

I?
0.88

Converts your annual interest rate input to the equivalent monthly rate.

R/S

N?
value

Stores 0.88 in I; prompts for N.

36 **R/S**

F?
value

Stores 36 in N; prompts for F.

0 **R/S**

B?
value

Stores 0 in F; prompts for B.

7250 **ENTER** 1500 **-**

B?
5,750.00

Calculates B, the beginning loan balance.





R/S

SOLVING
P=
-186.89

Stores 5750 in B; calculates monthly payment, P.

The answer is negative since the loan has been viewed from the borrower's perspective. Money received by the borrower (the beginning balance) is positive, while money paid out is negative.

Part 2. What interest rate would reduce the monthly payment by \$10?

Keys: (In RPN mode)	Display:	Description:
 EQN	$P \times 100 \times (1 - (1 + I)^{-N}) \div I$	Displays the leftmost part of the TVM equation.
SOLVE I	P? -186.89	Selects I; prompts for P.
 RND	P? -186.89	Rounds the payment to two decimal places.
10 	P? -176.89	Calculates new payment.
R/S	N? 36.00	Stores -176,89 in P; prompts for N.
R/S	F? 0.00	Retains 36 in N; prompts for F.
R/S	B? 5,750.00	Retains 0 in F; prompts for B.
R/S	SOLVING I= 0.56	Retains 5750 in B; calculates monthly interest rate.
12 	6.75	Calculates annual interest rate.

Part 3. Using the calculated interest rate (6.75%), assume that you sell the car after 2 years. What balance will you still owe? In other words, what is the future balance in 2 years?

Note that the interest rate, *I*, from part 2 is *not* zero, so you won't get a **DIVIDE BY 0** error when you calculate the new *I*.

Keys: (In RPN mode)	Display:	Description:
 EQN	$P \times 100 \times (1 - (1 + I)^{-N}) \div I$	Displays leftmost part of the TVM equation.
SOLVE F	P? -176.89	Selects F; prompts for P.

R/S	I?	Retains P ; prompts for I .
	0.56	
R/S	N?	Retains 0.56 in I ; prompts for N .
	36.00	
24 R/S	B?	Stores 24 in N ; prompts for B .
	5,750.00	
R/S	SOLVING	Retains 5750 in B ; calculates F ,
	F=	the future balance. Again, the
	-2,047.05	sign is negative, indicating that
		you must, pay out this money.
DISPLAY {FIX} 4		Sets FIX 4 display format.

Prime Number Generator

This program accepts any positive integer greater than 3. If the number is a prime number (not evenly divisible by integers other than itself and 1), then the program returns the input value. If the input is not a prime number, then the program returns the first prime number larger than the input.

The program identifies non-prime numbers by exhaustively trying all possible factors. If a number is not prime, the program adds 2 (assuring that the value is still odd) and tests to see if it has found a prime. This process continues until a prime number is found.

Note: x is the value in the X-register.

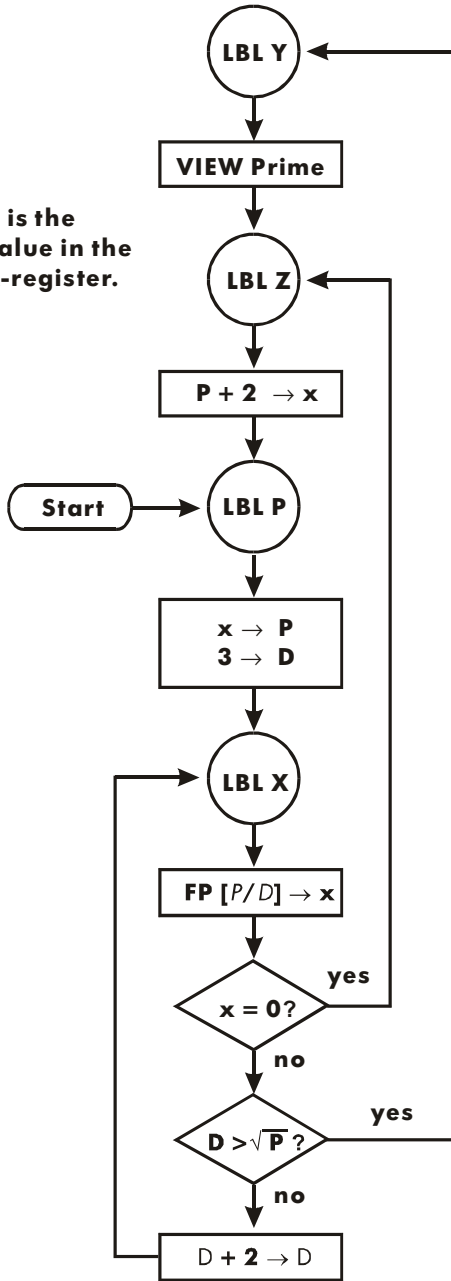

Program Listing:

Program Lines: (In ALG mode)

Description

Y0001 LBL Y This routine displays prime number P .

Y0002 VIEW P

Checksum and length: AA7A 6

Z0001 LBL Z This routine adds 2 to P .

Z0002 2

Z0003 RCL+ P

Checksum and length: 8696 21

P0001 LBL P This routine stores the input value for P .

P0002 STO P

P0003 ÷

P0004 2

P0005 ENTER

P0006 FP

P0007 x<>y

P0008 0

P0009 x=y? Tests for even input.

P0010 1

P0011 STO+ P Increments P if input an even number.

P0012 3 Stores 3 in test divisor, D .

P0013 STO D

Checksum and length: DOB8 87

X0001 LBL X This routine tests P to see if it is prime.

X0002 RCL P

X0003 RCL÷D

X0004 FP Finds the fractional part of $P ÷ D$.

X0005 x=0? Tests for a remainder of zero (*not* prime).

X0006 GTO Z If the number is not prime, tries next possibility.

X0007 RCL P

X0008 \sqrt{x}

X0009 x<>y

Program Lines: (In ALG mode)

Description

X0010 RCL D	
X0011 x>y?	Tests to see whether all possible factors have been tried.
X0012 GTO Y	If all factors have been tried, branches to the display routine.
X0013 2	Calculates the next possible factor, $D + 2$.
X0014 STO+ D	
X0015 GTO X	Branches to test potential prime with new factor.

Checksum and length: 161E 57

Flags Used:

None.

Program Instructions:

1. Key in the program routines; press **C** when done.
2. Key in a positive integer greater than 3.
3. Press **XEQ** P to run program. Prime number, P will be displayed.
4. To see the next prime number, press **R/S**.

Variables Used:

P	Prime value and potential prime values.
D	Divisor used to test the current value of P .

Remarks:

No test is made to ensure that the input is greater than 3.

Example:

What is the first prime number after 789? What is the next prime number?

Keys:
(In ALG mode)

789 **XEQ** P

R/S

Display:

P=
797.0000

P=
809.0000

Description:

Calculates next prime number
after 789.

Calculates next prime number
after 797.

Part 3

Appendixes and Reference

Support, Batteries, and Service

Calculator Support

You can obtain answers to questions about using your calculator from our Calculator Support Department. Our experience shows that many customers have similar questions about our products, so we have provided the following section, "Answers to Common Questions." If you don't find an answer to your question, contact the Calculator Support Department listed on page A-7.

Answers to Common Questions

Q: How can I determine if the calculator is operating properly?

A: Refer to page A-5, which describes the diagnostic self-test.

Q: My numbers contain commas instead of periods as decimal points. How do I restore the periods?

A: Use the **MODES** {·} function (page 1-18).

Q: How do I change the number of decimal places in the display?

A: Use the **DISPLAY** menu (page 1-19).

Q: How do I clear all or portions of memory?

A: **☒** **CLEAR** displays the CLEAR menu, which allows you to clear all variables, all programs (in program entry only), the statistics registers, or all of user memory (not during program entry).

Q: What does an "E" in a number (for example, $2.51E-13$) mean?

A: *Exponent* of ten; that is, 2.51×10^{-13} .

Q: The calculator has displayed the message MEMORY FULL. What should I do?

A: You must clear a portion of memory before proceeding. (See appendix B.)

Q: Why does calculating the sine (or tangent) of π radians display a very small number instead of 0?

A: π cannot be represented *exactly* with the 12-digit precision of the calculator.

Q: Why do I get incorrect answers when I use the trigonometric functions?

A: You must make sure the calculator is using the correct angular mode (**MODES** {DEG}, {RAD}, or {GRAD}).

Q: What does an *annunciator* in the display mean?

A: It indicates something about the status of the calculator. See "Annunciators" in chapter 1.

Q: Numbers show up as fractions. How do I get decimal numbers?

A: Press **1/x** **FDISP**.

Environmental Limits

To maintain product reliability, observe the following temperature and humidity limits:

- Operating temperature: 0 to 45 °C (32 to 113 °F).
- Storage temperature: -20 to 65 °C (-4 to 149 °F).
- Operating and storage humidity: 90% relative humidity at 40 °C (104 °F) maximum.

Changing the Batteries

The calculator is powered by two 3-volt lithium coin batteries, CR2032.

Replace the batteries as soon as possible when the low battery annunciator (**⏏**) appears. If the battery annunciator is on, and the display dims, you may lose data. If data is lost, the MEMORY CLEAR message is displayed.

Once you've removed the batteries, replace them within 2 minutes to avoid losing stored information. (Have the new batteries readily at hand before you open the battery compartment.)

To install batteries:

1. Have two fresh button-cell batteries at hand. Avoid touching the battery terminals — handle batteries only by their edges.
2. Make sure the calculator is OFF. **Do not press ON () again until the entire battery-changing procedure is completed. If the calculator is ON when the batteries are removed, the contents of Continuous Memory will be erased.**
3. Turn the calculator over and slide off the battery cover.

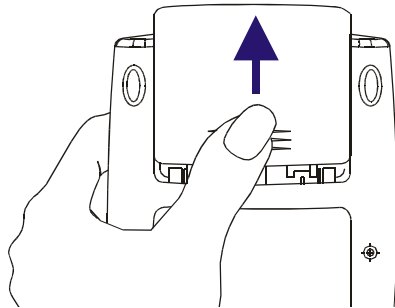

4. **Never remove two old batteries at the same time, to prevent memory lose.** Remove one of the two batteries. Press down the holder. Push the plate in the shown direction and lift it.

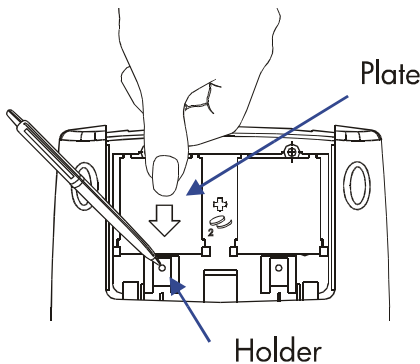

Warning



Do not mutilate, puncture, or dispose of batteries in fire. The batteries can burst or explode, releasing hazardous chemicals.

5. Insert a new CR2032 lithium battery, making sure that the positive sign (+) is facing outward. Replace the plate and push it into its original place.
6. Remove and insert the other battery as in step 4~5. Make sure that the positive sign (+) on each battery is facing outward.
7. Replace the battery compartment cover.
8. Press **C**.

Testing Calculator Operation

Use the following guidelines to determine if the calculator is working properly. Test the calculator after every step to see if its operation has been restored. If your calculator requires service, refer to page A-7.

■ **The calculator won't turn on (steps 1-4) or doesn't respond when you press the keys (steps 1-3):**

1. Reset the calculator. Hold down the **C** key and press **LN**. It may be necessary to repeat these reset keystrokes several times.
2. Erase memory. Press and hold down **C**, then press and hold down both **e^x** and **Σ+**. Memory is cleared and the MEMORY CLEAR message is displayed when you release all three keys.
3. Remove the batteries (see "Changing the Batteries") and lightly press a coin against both battery contacts in the calculator. Replace the batteries and turn on the calculator. It should display MEMORY CLEAR.
4. If the calculator still does not respond to keystrokes, use a thin, pointed object to press the RESET hole. Stored data usually remain intact.

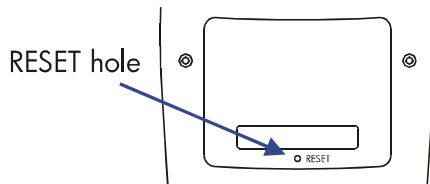

If these steps fail to restore calculator operation, it requires service.

■ **If the calculator responds to keystrokes but you suspect that it is malfunctioning:**

1. Do the self-test described in the next section. If the calculator fails the self test, it requires service.
2. If the calculator passes the self-test, you may have made a mistake operating the calculator. Reread portions of the manual and check "Answers to Common Questions" (page A-1).
3. Contact the Calculator Support Department listed on page A-7.

The Self-Test

If the display can be turned on, but the calculator does not seem to be operating properly, do the following diagnostic self-test.

1. Hold down the \boxed{C} key, then press $\boxed{y^x}$ at the same time.
2. Press any key eight times and watch the various patterns displayed. After you've pressed the key eight times, the calculator displays the copyright message © 2003 HP DEV CO · L · P · and then the message KBD 01.
3. Starting from $\boxed{e^x}$ and moving from left to right, press each key in the top row. Then, moving left to right, press each key in the second row, the third row, and so on, until you've pressed $\boxed{+}$. Then, continue to press these keys in order: \boxed{ENG} $\boxed{\uparrow}$ \boxed{MODES} $\boxed{\leftarrow}$ $\boxed{\rightarrow}$ \boxed{SOLVE} $\boxed{\downarrow}$ $\boxed{DISPLAY}$.
 - If you press the keys in the proper order and they are functioning properly, the calculator displays KBD followed by two-digit numbers. (The calculator is counting the keys using hexadecimal base.)
 - If you press a key out of order, or if a key isn't functioning properly, the next keystroke displays a fail message (see step 4).
4. The self-test produces one of these two results:
 - The calculator displays 33S-OK if it passed the self-test. Go to step 5.
 - The calculator displays 33S-FAIL followed by a one-digit number, if it failed the self-test. If you received the message because you pressed a key out of order, reset the calculator (hold down \boxed{C} , press \boxed{LN}) and do the self test again. If you pressed the keys in order, but got this message, repeat the self-test to verify the results. If the calculator fails again, it requires service (see page A-7). Include a copy of the fail message with the calculator when you ship it for service.
5. To exit the self-test, reset the calculator (hold down \boxed{C} and press \boxed{LN}).

Pressing \boxed{C} and $\boxed{1/x}$ starts a continuous self-test that is used at the factory. You can halt this factory test by pressing any key.

Warranty

HP 33s Scientific Calculator; Warranty period: 12 months

1. HP warrants to you, the end-user customer, that HP hardware, accessories and supplies will be free from defects in materials and workmanship after the date of purchase, for the period specified above. If HP receives notice of such defects during the warranty period, HP will, at its option, either repair or replace products which prove to be defective. Replacement products may be either new or like-new.
2. HP warrants to you that HP software will not fail to execute its programming instructions after the date of purchase, for the period specified above, due to defects in material and workmanship when properly installed and used. If HP receives notice of such defects during the warranty period, HP will replace software media which does not execute its programming instructions due to such defects.
3. HP does not warrant that the operation of HP products will be uninterrupted or error free. If HP is unable, within a reasonable time, to repair or replace any product to a condition as warranted, you will be entitled to a refund of the purchase price upon prompt return of the product.
4. HP products may contain remanufactured parts equivalent to new in performance or may have been subject to incidental use.
5. Warranty does not apply to defects resulting from (a) improper or inadequate maintenance or calibration, (b) software, interfacing, parts or supplies not supplied by HP, (c) unauthorized modification or misuse, (d) operation outside of the published environmental specifications for the product, or (e) improper site preparation or maintenance.
6. HP MAKES NO OTHER EXPRESS WARRANTY OR CONDITION WHETHER WRITTEN OR ORAL. TO THE EXTENT ALLOWED BY LOCAL LAW, ANY IMPLIED WARRANTY OR CONDITION OF MERCHANTABILITY, SATISFACTORY QUALITY, OR FITNESS FOR A PARTICULAR PURPOSE IS LIMITED TO THE DURATION OF THE EXPRESS WARRANTY SET FORTH ABOVE. Some countries, states or provinces do not allow limitations on the duration of an implied warranty, so the above limitation or exclusion might not apply to you. This warranty gives you specific legal rights and you might also have other rights that vary from country to country, state to state, or province to province.

- 7. TO THE EXTENT ALLOWED BY LOCAL LAW, THE REMEDIES IN THIS WARRANTY STATEMENT ARE YOUR SOLE AND EXCLUSIVE REMEDIES. EXCEPT AS INDICATED ABOVE, IN NO EVENT WILL HP OR ITS SUPPLIERS BE LIABLE FOR LOSS OF DATA OR FOR DIRECT, SPECIAL, INCIDENTAL, CONSEQUENTIAL (INCLUDING LOST PROFIT OR DATA), OR OTHER DAMAGE, WHETHER BASED IN CONTRACT, TORT, OR OTHERWISE. Some countries, States or provinces do not allow the exclusion or limitation of incidental or consequential damages, so the above limitation or exclusion may not apply to you.
- 8. The only warranties for HP products and services are set forth in the express warranty statements accompanying such products and services. Nothing herein should be construed as constituting an additional warranty. HP shall not be liable for technical and editorial errors or omissions contained herein.

FOR CONSUMER TRANSACTIONS IN AUSTRALIA AND NEW ZEALAND: THE WARRANTY TERMS CONTAINED IN THIS STATEMENT, EXCEPT TO THE EXTENT LAWFULLY PERMITTED, DO NOT EXCLUDE, RESTRICT OR MODIFY AND ARE IN ADDITION TO THE MANDATORY STATUTORY RIGHTS APPLICABLE TO THE SALE OF THIS PRODUCT TO YOU.

Service

Europe

Country :	Telephone numbers
Austria	+43-1-3602771203
Belgium	+32-2-7126219
Denmark	+45-8-2332844
Eastern Europe countries	+420-5-41422523
Finland	+35-89640009
France	+33-1-49939006
Germany	+49-69-95307103
Greece	+420-5-41422523
Holland	+31-2-06545301
Italy	+39-02-75419782

Norway	+47-63849309
Portugal	+351-229570200
Spain	+34-915-642095
Sweden	+46-851992065
Switzerland	+41-1-4395358 (German) +41-22-8278780 (French) +39-02-75419782 (Italian)
Turkey	+420-5-41422523
UK	+44-207-4580161
Czech Republic	+420-5-41422523
South Africa	+27-11-2376200
Luxembourg	+32-2-7126219
Other European countries	+420-5-41422523

Asia Pacific

Country :	Telephone numbers
Australia	+61-3-9841-5211
Singapore	+61-3-9841-5211

L.America

Country :	Telephone numbers
Argentina	0-810-555-5520
Brazil	Sao Paulo 3747-7799; ROTC 0-800-157751
Mexico	Mx City 5258-9922; ROTC 01-800-472-6684
Venezuela	0800-4746-8368
Chile	800-360999
Columbia	9-800-114726
Peru	0-800-10111
Central America & Caribbean	1-800-711-2884
Guatemala	1-800-999-5105
Puerto Rico	1-877-232-0589
Costa Rica	0-800-011-0524

N.America

Country :	Telephone numbers
USA	1 800-HP INVENT
Canada	(905)206-4663 or 800-HP INVENT

ROTC = Rest of the country

Please logon to <http://www.hp.com> for the latest service and support information.

Regulatory Information

This section contains information that shows how the HP 33s scientific calculator complies with regulations in certain regions. Any modifications to the calculator not expressly approved by Hewlett-Packard could void the authority to operate the 33s in these regions.

USA

This calculator generates, uses, and can radiate radio frequency energy and may interfere with radio and television reception. The calculator complies with the limits for a Class B digital device, pursuant to Part 15 of the FCC Rules. These limits are designed to provide reasonable protection against harmful interference in a residential installation.

However, there is no guarantee that interference will not occur in a particular installation. In the unlikely event that there is interference to radio or television reception(which can be determined by turning the calculator off and on), the user is encouraged to try to correct the interference by one or more of the following measures:

- Reorient or relocate the receiving antenna.
- Relocate the calculator, with respect to the receiver.

Canada

This Class B digital apparatus complies with Canadian ICES-003.

Cet appareil numérique de la classe B est conforme a la norme NMB-003 du Canada.

Japan

この装置は、情報処理装置等電波障害自主規制協議会(VCCI)の基準に基づく第二情報技術装置です。この装置は、家庭環境で使用することを目的としていますが、この装置がラジオやテレビジョン受信機に近接して使用されると、受信障害を引き起こすことがあります。

取扱説明書に従って正しい取り扱いをしてください。

Noise Declaration. In the operator position under normal operation (per ISO 7779): LpA<70dB.

Disposal of Waste Equipment by Users in Private Household in the European Union



This symbol on the product or on its packaging indicates that this product must not be disposed of with your other household waste. Instead, it is your responsibility to dispose of your waste equipment by handing it over to a designated collection point for the recycling of waste electrical and electronic equipment.

The separate collection and recycling of your waste equipment at the time of disposal will help to conserve natural resources and ensure that it is recycled in a manner that protects human health and the environment. For more information about where you can drop off your waste equipment for recycling, please contact your local city office, your household waste disposal service or the shop where you purchased the product.

User Memory and the Stack



This appendix covers



- The allocation and requirements of user memory,
- How to reset the calculator without affecting memory,
- How to clear (purge) all of user memory and reset the system defaults, and
- Which operations affect stack lift.

Managing Calculator Memory



The HP 33s has 31KB of user memory available to you for any combination of stored data (variables, equations, or program lines). SOLVE, ∫FN, and statistical calculations also require user memory. (The ∫FN operation is particularly "expensive" to run.)

All of your stored data is preserved until you explicitly clear it. The message MEMORY FULL means that there is currently not enough memory available for the operation you just attempted. You need to clear some (or all) of user memory. For instance, you can:

- Clear any or all equations (see "Editing and Clearing Equations" in chapter 6).
- Clear any or all programs (see "Clearing One or More Programs" in chapter 12).
- Clear all of user memory (press   {ALL}).

To see how much memory is available, press  . The display shows the number of bytes available.

To see the memory requirements of specific equations in the equation list:

1. Press   to activate Equation mode. (EQN LIST TOP or the left end of the current equation will be displayed.)

2. If necessary, scroll through the equation list (press \uparrow or \downarrow) until you see the desired equation.
3. Press $\left[\text{F2} \right]$ $\left[\text{SHOW} \right]$ to see the checksum (hexadecimal) and length (in bytes) of the equation. For example, CK=382E LN=41.

To see the total memory requirements of specific programs:

1. Press $\left[\text{F1} \right]$ $\left[\text{MEM} \right]$ {PGM} to display the first label in the program list.
2. Scroll through the program list (press \uparrow or \downarrow until you see the desired program label and size). For example, LBL F LN=57.
3. Optional: Press $\left[\text{F2} \right]$ $\left[\text{SHOW} \right]$ to see the checksum (hexadecimal) and length (in bytes) of the program. For example, CK=9CC9 LN=57 for program F.

To see the memory requirements of an equation in a program:

1. Display the program line containing the equation.
2. Press $\left[\text{F2} \right]$ $\left[\text{SHOW} \right]$ to see the checksum and length. For example, CK=AB71 LN=15.

To manually deallocate the memory allocated for a SOLVE or \int FN calculation that has been interrupted, press $\left[\text{F2} \right]$ $\left[\text{RTN} \right]$. This deallocation is done automatically whenever you execute a program or another SOLVE or \int FN calculation.

Resetting the Calculator

If the calculator doesn't respond to keystrokes or if it is otherwise behaving unusually, attempt to reset it. Resetting the calculator halts the current calculation and cancels program entry, digit entry, a running program, a SOLVE calculation, an \int FN calculation, a VIEW display, or an INPUT display. Stored data usually remain intact.

To reset the calculator, hold down the $\left[\text{C} \right]$ key and press $\left[\text{LN} \right]$. If you are unable to reset the calculator, try installing fresh batteries. If the calculator cannot be reset, or if it still fails to operate properly, you should attempt to clear memory using the special procedure described in the next section.

If the calculator still does not respond to keystrokes, use a thin, pointed object to press the RESET hole.

The calculator can reset itself if it is dropped or if power is interrupted.

Clearing Memory

The usual way to clear user memory is to press $\boxed{\leftarrow}$ $\boxed{\text{CLEAR}}$ {ALL}. However, there is also a more powerful clearing procedure that resets additional information and is useful if the keyboard is not functioning properly.

If the calculator fails to respond to keystrokes, and you are unable to restore operation by resetting it or changing the batteries, try the following MEMORY CLEAR procedure. These keystrokes clear all of memory, reset the calculator, and restore all format and modes to their original, *default* settings (shown below):

1. Press and hold down the $\boxed{\text{C}}$ key.
2. Press and hold down $\boxed{e^x}$.
3. Press $\boxed{\Sigma+}$. (You will be pressing three keys simultaneously). When you release all three keys, the display shows MEMORY CLEAR if the operation is successful.

Category	CLEAR ALL	MEMORY CLEAR (Default)
Angular mode	Unchanged	Degrees
Base mode	Unchanged	Decimal
Contrast setting	Unchanged	Medium
Decimal point	Unchanged	", "
Denominator (\sqrt{c} value)	Unchanged	4095
Display format	Unchanged	FIX 4
Flags	Unchanged	Cleared
Fraction–display mode	Unchanged	Off
Random–number seed	Unchanged	Zero
Equation pointer	EQN LIST TOP	EQN LIST TOP
Equation list	Cleared	Cleared
FN = label	Null	Null
Program pointer	PRGM TOP	PRGM TOP
Program memory	Cleared	Cleared
Stack lift	Enabled	Enabled
Stack registers	Cleared to zero	Cleared to zero
Variables	Cleared to zero	Cleared to zero

Memory may inadvertently be cleared if the calculator is dropped or if power is interrupted.



The Status of Stack Lift

The four stack registers are always present, and the stack always has a *stack-lift status*. That is to say, the stack lift is always *enabled* or *disabled* regarding its behavior when the next number is placed in the X-register. (Refer to chapter 2, "The Automatic Memory Stack.")

All functions except those in the following two lists will enable stack lift.

Disabling Operations

The four operations ENTER, $\Sigma+$, $\Sigma-$, and CLx disable stack lift. A number keyed in after one of these disabling operations writes over the number currently in the X-register. The Y-, Z- and T-registers remain unchanged.

In addition, when  and  act like CLx, they also disable stack lift.

The INPUT function *disables* stack lift as it halts a program for prompting (so any number you then enter writes over the X-register), but it *enables* stack lift when the program resumes.

Neutral Operations

The following operations do not affect the status of stack lift:

DEG, RAD, GRAD	FIX, SCI, ENG, ALL	DEC, HEX, OCT, BIN	CLVARS
PSE	SHOW	RADIX . RADIX ,	CLΣ
OFF	R/S and STOP	↑ and ↓	C * and ← *
MEM {VAR}**	MEM {PGM}**	GTO . .	GTO . label nnnn
EQN	FDISP	Errors	PRGM and program entry
Switching binary windows	Digit entry		
<p>* Except when used like CLx.</p> <p>** Including all operations performed while the catalog is displayed except {VAR} ENTER and {PGM} XEQ, which enable stack lift.</p>			

The Status of the LAST X Register

The following operations save x in the LAST X register:

$+, -, \times, \div$	$\sqrt{x}, x^2, \sqrt[3]{x}, x^3$	$e^x, 10^x$
LN, LOG	$y^x, \sqrt[y]{y}$	$1/x, \text{INT}\div, \text{Rmdr}$
SIN, COS, TAN	ASIN, ACOS, ATAN	
SINH, COSH, TANH	ASINH, ACOSH, ATANH	IP, FP, SGN, INTG, RND, ABS
%, %CHG	$\Sigma+, \Sigma-$	RCL+, -, \times, \div
$y, x \rightarrow \theta, r$	$\rightarrow \text{HR}, \rightarrow \text{HMS}$	$\rightarrow \text{DEG}, \rightarrow \text{RAD}$
$\theta, r \rightarrow y, x$		
nCr	$x!$	CMPLX +/-
nPr		
CMPLX $+, -, \times, \div$	CMPLX $e^x, \text{LN}, y^x,$ $1/x$	CMPLX SIN, COS, TAN
$\rightarrow \text{kg}, \rightarrow \text{lb}$	$\rightarrow ^\circ\text{C}, \rightarrow ^\circ\text{F}$	$\rightarrow \text{cm}, \rightarrow \text{in}$
$\rightarrow \text{l}, \rightarrow \text{gal}$		

Notice that $/c$ does not affect the LAST X register.

The recall–arithmetic sequence x **RCL** **+** *variable* stores a different value in the LAST X register than the sequence x **RCL** *variable* **+** does. The former stores x in LAST X; the latter stores the recalled number in LAST X.

ALG: Summary

About ALG

This appendix summarizes some features unique to ALG mode, including,

- Two-number arithmetic
- Chain calculation
- Reviewing the stack
- Coordinate conversions
- Operations with complex numbers
- Integrating an equation
- Arithmetic in bases 2, 8, and 16
- Entering statistical two-variable data

Press  **ALG** to set the calculator to ALG mode. When the calculator is in ALG mode, the ALG annunciator is on.

In ALG mode, operations are performed in the following order.

1. Expression in parenthesis.
2. Function that require inputting values before pressing the function key, for example, COS, SIN, TAN, ACOS, ASIN, ATAN, LOG, LN, x^2 , $1/x$, \sqrt{x} , π , $\sqrt[3]{x}$, $X!$, %, Cmplx, RND, RAND, IP, FP, INTG, SGN, ABS, e^x , 10^x , unit conversion.
3. $\sqrt[x]{y}$ and y^x .
4. nPr, nCr, %CHG.
5. \times , \div , INT \div , Rmdr.
6. +, -.

Doing Two-number Arithmetic in ALG

This discussion of arithmetic using ALG replaces the following parts that are affected by ALG mode. One-number functions (such as \sqrt{x}) work the same in ALG and RPN modes.

Two-number arithmetic operations are affected by ALG mode:

- Simple arithmetic
- Power functions (y^x , $\sqrt[y]{x}$)
- Percentage calculations ($\%$ or $\%$ CHG)
- Permutations and Combinations (nCr , nPr)
- Quotient and Remainder of Division ($\text{INT}\div$, Rmdr)

Simple Arithmetic

Here are some examples of simple arithmetic.

In ALG mode, you enter the first number, press the operator ($+$, $-$, \times , \div), enter the second number, and finally press the ENTER key.

To Calculate:	Press:	Display:
12 + 3	12 $+$ 3 ENTER	12+3= 15.0000
12 - 3	12 $-$ 3 ENTER	12-3= 9.0000
12 \times 3	12 \times 3 ENTER	12 \times 3= 36.0000
12 \div 3	12 \div 3 ENTER	12 \div 3= 4.0000

Power Functions

In ALG mode, to calculate a number y raised to a power x , key in y y^x x , then press ENTER .

To Calculate:12³64^{1/3} (cube root)**Press:**12 $\boxed{y^x}$ 3 $\boxed{\text{ENTER}}$ 3 $\boxed{\sqrt[y]{x}}$ 64 $\boxed{\text{ENTER}}$ **Display:**

12^3=
1,728.0000
3 $\times\sqrt{64}$ =
4.0000

Percentage Calculations

The Percent Function. The $\boxed{\%}$ key divides a number by 100. Combined with $\boxed{+}$ or $\boxed{-}$, it adds or subtracts percentages.

To Calculate:

27% of 200

200 less 27%

12% greater than 25

Press:200 $\boxed{\times}$ 27 $\boxed{\%}$ $\boxed{\text{ENTER}}$ 200 $\boxed{-}$ 27 $\boxed{\%}$ $\boxed{\text{ENTER}}$ 25 $\boxed{+}$ 12 $\boxed{\%}$ $\boxed{\text{ENTER}}$ **Display:**

200 \times 27%=
54.0000
200-27%=
146.0000
25+12%=
28.0000

To Calculate:	Press:
x% of y	y $\boxed{\times}$ x $\boxed{\%}$ $\boxed{\text{ENTER}}$
Percentage change from y to x. (y \neq 0)	y $\boxed{\rightarrow}$ $\boxed{\%CHG}$ x $\boxed{\text{ENTER}}$

Compare these keystrokes in RPN and ALG modes:

27% of 200

RPN Mode200 $\boxed{\text{ENTER}}$ 27 $\boxed{\%}$

200 less 27%

200 $\boxed{\text{ENTER}}$ 27 $\boxed{\%}$ $\boxed{-}$ **ALG Mode**200 $\boxed{\times}$ 27 $\boxed{\%}$
 $\boxed{\text{ENTER}}$ 200 $\boxed{-}$ 27 $\boxed{\%}$
 $\boxed{\text{ENTER}}$

Example:

Suppose that the \$15.76 item cost \$16.12 last year. What is the percentage change from last year's price to this year's?

Keys:	Display:	Description:
16.12 %CHG		
15.76	16.12%CHG15.76= -2.2333	This year's price dropped about 2.2% from last year's price.

Permutations and Combinations

Example: Combinations of People.

A company employing 14 women and 10 men is forming a six-person safety committee. How many different combinations of people are possible?

Keys:	Display:	Description:
24 nCr 6	24nCr6= 134,596,0000	Total number of combinations possible.

Quotient and Remainder Of Division

You can use and to produce either the quotient or remainder of division operations involving two integers.

Integer 1 Integer 2.

Integer 1 Integer 2.

Example:

To display the quotient and remainder produced by $58 \div 9$

Keys:	Display:	Description:
58 9	58INT÷9= 6.0000	Displays the quotient.
58 9	58RMDR9= 4.0000	Displays the remainder.

Parentheses Calculations

In ALG mode, you can use parentheses up to 13 levels. For example, suppose you want to calculate:

$$\frac{30}{85-12} \times 9$$

If you were to key in $30 \div 85 -$, the calculator would calculate the intermediate result, 0.3529. However, that's not what you want. To delay the division until you've subtracted 12 from 85, use parentheses:

Keys:	Display:	Description:
$30 \div$ $($ $85 -$	$30 \div (85 -$ 85.0000	No calculation is done.
$12)$	$30 \div (85 - 12)$ 73.0000	Calculates $85 - 12$.
$\times 9$	$30 \div (85 - 12) \times$ 9 $_$	Calculates $30/73$.
ENTER	$30 \div (85 - 12) \times 9 =$ 3.6986	Calculates $30/(85 - 12) \times 9$.

You can omit the multiplication sign (\times) before a left parenthesis. Implied multiplication is not available in Equation mode. For example, the expression $2 \times (5 - 4)$ can be entered as $2 (5 - 4)$, without the \times key inserted between 2 and the left parenthesis.

Chain Calculations

To do a chain calculation, you don't need to press ENTER after each operation, but only at the very end.

For instance, to calculate $\frac{750 \times 12}{360}$ you can enter either:

750 **×** 12 **ENTER** **÷** 360 **ENTER**

or

750 **×** 12 **÷** 360 **ENTER**

In the second case, the **÷** key acts like the **ENTER** key by displaying the result of 750×12 .

Here's a longer chain calculation: $\frac{456 - 75}{18.5} \times \frac{68}{1.9}$

This calculation can be written as: 456 **-** 75 **ENTER** **÷** 18.5 **×** 68 **÷** 1.9 **ENTER**. Watch what happens in the display as you key it in:

Keys:

Display:

456 **-** 75 **ENTER**

456-75=

381.0000

÷ 18.5 **×**

381÷18.5×

20.5946

68 **÷**

381÷18.5×68÷

1.400.4324

1.9 **ENTER**

381÷18.5×68÷1.9=

737.0697

Reviewing the Stack

The **R↓** or **R↑** **R↓** key produces a menu in the display— X1–, X2–, X3–, X4–registers, to let you review the entire contents of the stack. The difference between the **R↓** and the **R↑** **R↓** key is the location of the underline in the display. Pressing the **R↑** **R↓** displays the underline on the X4 register; pressing the **R↓** displays the underline on the X2 register.

Pressing **R↓** displays the following menu:

X1 X2 X3 X4

value

Pressing **R↑** **R↓** displays the following menu:

X1 X2 X3 X4

value

You can press \leftarrow or \rightarrow (or $\overline{\text{RL}}$ and $\overline{\text{RL}}$) to review the entire contents of the stack and recall them.

However, in normal operation in ALG mode, the stack in ALG mode differs from the one in RPN mode. (Because when you press $\overline{\text{ENTER}}$, the result is not placed into X1, X2 etc.) *Only after evaluating equations, programs, or integrating equations*, the values of the four registers will be the same as in RPN mode.

Coordinate Conversions

To convert between rectangular and polar coordinates:

1. Enter the coordinates (in rectangular or polar form) that you want to convert. In ALG mode, the order is $y \leftarrow y$ or $x \leftarrow x$ or $\theta \leftarrow \theta$ or $r \leftarrow r$.
2. Execute the conversion you want: press $\overline{\text{RPN}} \rightarrow \theta, r$ (rectangular-to-polar) or $\overline{\text{RPN}} \rightarrow y, x$ (polar-to-rectangular). The converted coordinates occupy the X- and Y-registers.
3. The resulting display (the X-register) shows either r (polar result) or x (rectangular result). Press \downarrow to see θ or y .

Example:

If $x = 5$, $y = 30$, what are r , θ ?

Keys:	Display:	Description:
$\overline{\text{MODES}} \{ \text{DEG} \}$		Sets Degrees mode.
30 $\leftarrow y$ 5 $\overline{\text{RPN}} \rightarrow \theta, r$	30.5 $\rightarrow \theta, r$ $r = 30.4138$	Calculates hypotenuse (r).
\downarrow	30.5 $\rightarrow \theta, r$ $\theta = 80.5377$	Displays θ .

If $r = 25$, $\theta = 56$, what are x , y ?

Keys:	Display:	Description:
$\overline{\text{MODES}} \{ \text{DEG} \}$		Sets Degrees mode.
56 $\leftarrow \theta$ 25 $\overline{\text{RPN}} \rightarrow y, x$	56.25 $\rightarrow y, x$ $x = 13.9798$	Calculates x .



56.25 → y, x Displays y.
 Y=20.7259

If you want to perform a coordinate conversion as part of a chain calculation, you need to use parentheses to impose the required order of operations.

Example:

If $r = 4.5$, $\theta = \frac{2}{3}\pi$, what are x , y ?

Keys:

Display:

Description:

{RAD}

Sets Radians mode.

()

Use parentheses to impose the required order of operations.

)

$(2 \div 3 \times \pi)$

2.0944

4.5

2.09439510239, 4.

Calculates x .

X=-2.2500



2.09439510239, 4.

Displays y .

Y=3.8971

Integrating an Equation



1. Key in an equation. (see "Entering Equations into the Equation List" in chapter 6) and leave Equation mode.
2. Enter the limits of integration: key in the *lower* limit and press , then key in the upper limit.
3. Display the equation: Press and, if necessary, scroll through the equation list (press or) to display the desired equation.
4. Select the variable of integration: Press *variable*. This starts the calculation.

Operations with Complex Numbers

To enter a complex number :

$$x + iy.$$

1. Type the real part, x , then the function key.
2. Type the imaginary part, y , then press  **CMPLX**.

For example, to do $2 + i4$, press 2  4  **CMPLX**.

To view the result of complex operations :

After keying in the complex number, press **ENTER** to calculate. Then the real portion of the result is displayed; press  to view the imaginary portion.

Complex Operations

Use the complex operations as you do real operations, but follow the imaginary part with  **CMPLX**.

To do an operation with one complex number:

1. Enter the complex number z . (Use parentheses for z if the real part exists).
2. Select the complex function.
3. Press **ENTER** to calculate.

To do an arithmetic operation with two complex numbers:

1. Enter the first complex number, z_1 . (Use parentheses for z if the real part exists).
2. Select the arithmetic operation.
3. Enter the second complex number, z_2 . (Use parentheses for z if the real part exists).
4. Press **ENTER** to calculate.

Here are some examples with complex numbers:

Examples:

Evaluate $\sin(2 + 3i)$

Keys:	Display:	Description:
\rightarrow () 2 + 3 \leftarrow	(2+3i)	
CMPLEX \rightarrow ()	RE=2.0000	
SIN	SIN(2+3i)	
	RE=9.1545	
\downarrow	SIN(2+3i)	Result is 9.1545 - i 4.1689
	IM=-4.1689	

Examples:

Evaluate the expression

$$z_1 \div (z_2 + z_3),$$

where $z_1 = 23 + i 13$, $z_2 = -2 + i$ $z_3 = 4 - i 3$

Keys:	Display:	Description:
\rightarrow () 23 + 13		
\leftarrow CMPLEX \rightarrow ()		Real part of result.
\div \rightarrow () 2 + Δ +		
1 \leftarrow CMPLEX + 4		
- 3 \leftarrow CMPLEX		
\rightarrow () ENTER	(23+13i)÷(-2+1	
	RE=2.5000	
\downarrow	(23+13i)÷(-2+1	Result is
	IM=9.0000	2.5000 + i 9.0000

Examples:

Evaluate $(4 - i 2/5)(3 - i 2/3)$

Keys:	Display:	Description:
\leftarrow () 4 \ominus () 2		
() 5 \leftarrow [CPLX] \rightarrow		Real part of result.
() \rightarrow () 3 \ominus ()		
2 () 3 \leftarrow [CPLX]		
\rightarrow () [ENTER]	$(4 - 0.2/5i) \times (3 -$	
	$RE = 11.7333$	
\downarrow	$(4 - 0.2/5i) \times (3 -$	Result is
	$IM = -3.8667$	$11.7333 - i 3.8667$

Arithmetic in Bases 2, 8, and 16

In ALG mode, if the current expression in the first line does not fit in the display, the *rightmost* digits are replaced with an ellipsis (. . .) to indicate it is too long to be displayed.

Here are some examples of arithmetic in Hexadecimal, Octal, and Binary modes:

Example:

	$12F_{16} + E9A_{16} = ?$	
Keys:	Display:	Description:
\leftarrow [BASE] {HEX}		Sets base 16; HEX annunciator on.
12F [+] E9A [ENTER]	h12F+hE9A=	Result.
	FC9	
	$7760_8 - 4326_8 = ?$	
\leftarrow [BASE] {OCT}	h12F+hE9A=	Sets base 8: OCT annunciator on.
	7711	
7760 [-] 4326 [ENTER]	o7760-o4326=	Converts displayed number to octal.
	3432	

$$100_8 \div 5_8 = ?$$

100 $\boxed{\div}$ 5 $\boxed{\text{ENTER}}$

o100÷o5=

Integer part of result.

14

$$5A0_{16} + 10011000_2 = ?$$

$\boxed{\leftarrow}$ $\boxed{\text{BASE}}$ {HEX} 5A0

Set base 16; **HEX** annunciator on.

$\boxed{+}$

h5A0+

5A0

$\boxed{\leftarrow}$ $\boxed{\text{BASE}}$ {BIN}

Changes to base 2; **BIN** annunciator on.

10011000

h5A0+

10011000_

$\boxed{\text{ENTER}}$

h5A0+b1001100...

Result in binary base.

11000111000

$\boxed{\leftarrow}$ $\boxed{\text{BASE}}$ {HEX}

h5A0+b1001100...

Result in hexadecimal base.

638

$\boxed{\leftarrow}$ $\boxed{\text{BASE}}$ {DEC}

h5A0+b10011000

Restores decimal base.

1,592.0000

Entering Statistical Two-Variable Data

In ALG mode, remember to enter an (x, y) pair in *reverse order* ($y \boxed{x \leftrightarrow y} x$) so that y ends up in the Y-register and X in the X-register.

1. Press $\boxed{\leftarrow}$ $\boxed{\text{CLEAR}}$ $\{\Sigma\}$ to clear existing statistical data.
2. Key in the y -value *first* and press $\boxed{x \leftrightarrow y}$.
3. Key in the corresponding x -value and press $\boxed{\Sigma+}$.
4. The display shows n , the number of statistical data pairs you have accumulated.
5. Continue entering x, y -pairs. n is updated with each entry.

Example:

Key in the x, y -values on the left, these make the corrections shown on the right:

Initial x, y	Corrected x, y
20, 4	20, 5
400, 6	40, 6

Keys:	Display:	Description:
\leftarrow CLEAR $\{\Sigma\}$		Clears existing statistical data.
4 $x \leftrightarrow y$ 20 $\Sigma+$	20,4 n=1.0000	Enters the first new data pair.
6 $x \leftrightarrow y$ 400 $\Sigma+$	400,6 n=2.0000	Display shows n , the number of data pairs you entered.
\leftarrow LASTx	LASTx 400.0000	Brings back last x -value. Last y is still in Y-register.
\leftarrow $\Sigma-$	400,6 n=1.0000	Deletes the last data pair.
6 $x \leftrightarrow y$ 40 $\Sigma+$	40,6 n=2.0000	Reenters the last data pair.
4 $x \leftrightarrow y$ 20 \leftarrow $\Sigma-$	20,4 n=1.0000	Deletes the first data pair.
5 $x \leftrightarrow y$ 20 $\Sigma+$	20,5 n=2.0000	Reenters the first data pair. There is still a total of two data pairs in the statistics registers.

More about Solving

This appendix provides information about the SOLVE operation beyond that given in chapter 7.

How SOLVE Finds a Root

SOLVE first attempts to solve the equation directly for the unknown variable. If the attempt fails, SOLVE changes to an iterative(repetitive) procedure. The *iterative* operation is to execute repetitively the specified equation. The value returned by the equation is a function $f(x)$ of the unknown variable x . ($f(x)$ is mathematical shorthand for a function defined in terms of the unknown variable x .) SOLVE starts with an estimate for the unknown variable, x , and refines that estimate with each successive execution of the function, $f(x)$.

If any two successive estimates of the function $f(x)$ have opposite signs, then SOLVE presumes that the function $f(x)$ crosses the x -axis in at least one place between the two estimates. This interval is systematically narrowed until a root is found.

For SOLVE to find a root, the root has to exist within the range of numbers of the calculator, and the function must be mathematically defined where the iterative search occurs. SOLVE always finds a root, provided one exists (within the overflow bounds), if one or more of these conditions are met:

- Two estimates yield $f(x)$ values with opposite signs, and the function's graph crosses the x -axis in at least one place between those estimates (figure a, below).
- $f(x)$ always increases or always decreases as x increases (figure b, below).
- The graph of $f(x)$ is either concave everywhere or convex everywhere (figure c, below).
- If $f(x)$ has one or more local minima or maxima, each occurs singly between adjacent roots of $f(x)$ (figure d, below).

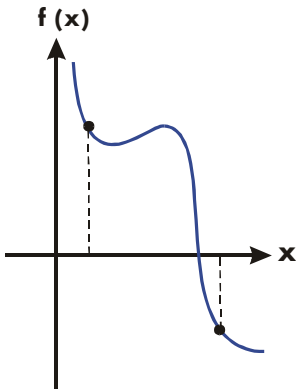

a

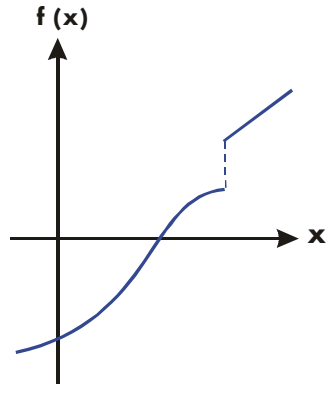

b

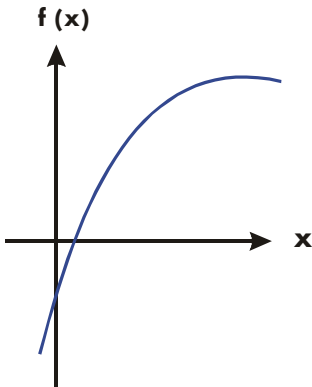

c

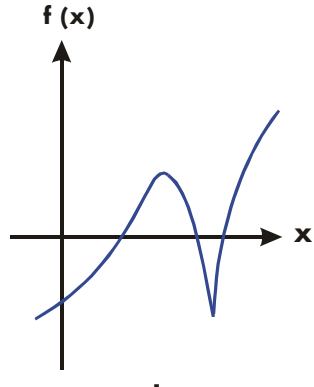

d

Function Whose Roots Can Be Found

In most situations, the calculated root is an accurate estimate of the theoretical, infinitely precise root of the equation. An "ideal" solution is one for which $f(x) = 0$. However, a very small non-zero value for $f(x)$ is often acceptable because it might result from approximating numbers with limited (12-digit) precision.

Interpreting Results

The SOLVE operation will produce a solution under either of the following conditions:

- If it finds an estimate for which $f(x)$ equals zero. (See figure a, below.)
- If it finds an estimate where $f(x)$ is not equal to zero, but the calculated root is a 12-digit number adjacent to the place where the function's graph crosses the x -axis (see figure b, below). This occurs when the two final estimates are neighbors (that is, they differ by 1 in the 12th digit), and the function's value is positive for one estimate and negative for the other. Or they are $(0, 10^{-499})$ or $(0, -10^{-499})$. In *most* cases, $f(x)$ will be relatively close to zero.

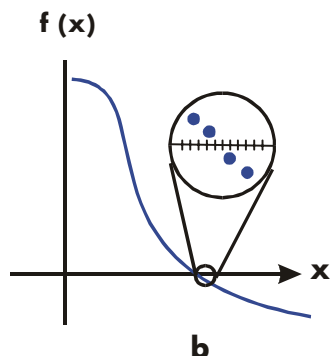
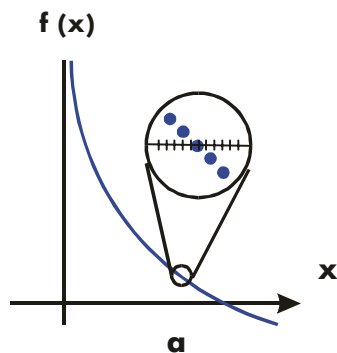

Cases Where a Root Is Found

- ✓ To obtain additional information about the result, press **[R↓]** see the previous estimate of the root (x), which was left in the Y-register. Press **[R↓]** again to see the value of $f(x)$, which was left in the Z-register. If $f(x)$ equals zero or is relatively small, it is very likely that a solution has been found. However, if $f(x)$ is relatively large, you must use caution in interpreting the results.

Example: An Equation With One Root.

Find the root of the equation:

$$-2x^3 + 4x^2 - 6x + 8 = 0$$

Enter the equation as an expression:

Keys:	Display:	Description:
\rightarrow EQN		Select Equation mode.
2 $\frac{\square}{\square}$ \times		Enters the equation.
RCL X y^x 3		
+ 4 \times		
RCL X y^x 2		
\square 6 \times RCL X		
+ 8 ENTER	$-2 \times X^3 + 4 \times X^2 - 6 \times$	
\rightarrow SHOW	CK=B9AD LN=18	Checksum and length.
C		Cancels Equation mode.

Now, solve the equation to find the root:

Keys:	Display:	Description:
0 STO X 10	10_	Initial guesses for the root.
\rightarrow EQN	$-2 \times X^3 + 4 \times X^2 - 6 \times$	Selects Equation mode; displays the left end of the equation.
SOLVE X	SOLVING X= 1.6506	Solves for X; displays the result.
\checkmark \uparrow	1.6506	Final two estimates are the same to four decimal places.
\checkmark \uparrow	$-4.0000E-11$	$f(x)$ is very small, so the approximation is a good root.

Example: An Equation with Two Roots.

Find the two roots of the parabolic equation:

$$x^2 + x - 6 = 0.$$

Enter the equation as an expression:

Keys:	Display:	Description:
\rightarrow EQN		Selects Equation mode.
RCL X y^x 2 +		Enters the equation.
RCL X \square 6 ENTER	$X^2 + X - 6$	

SHOW

CK=3971

Checksum and length.

LN=7

C

Cancels Equation mode.

Now, solve the equation to find its positive and negative roots:

Keys:	Display:	Description:
0 X 10	10_	Your initial guesses for the positive root.
EQN	X^2+X-6	Selects Equation mode; displays the equation.
SOLVE X	SOLVING X= 2.0000	Calculates the positive root using guesses 0 and 10.
✓	2.0000	Final two estimates are the same.
✓ SHOW	0.0000000000	$f(x) = 0$.
0 X 10	-10_	Your initial guesses for the negative root.
EQN	X^2+X-6	Redisplays the equation.
SOLVE X	SOLVING X= -3.0000	Calculates negative root using guesses 0 and -10.
✓ SHOW	0.0000000000	$f(x) = 0$.

Certain cases require special consideration:

- If the function's graph has a discontinuity that crosses the x -axis, then the SOLVE operation returns a value adjacent to the discontinuity (see figure a, below). In this case, $f(x)$ may be relatively large.
- Values of $f(x)$ may be approaching infinity at the location where the graph changes sign (see figure b, below). This situation is called a *pole*. Since the SOLVE operation determines that there is a sign change between two neighboring values of x , it returns the possible root. However, the value for $f(x)$ will be relatively large. If the pole occurs at a value of x that is exactly represented with 12 digits, then that value would cause the calculation to halt with an error message.

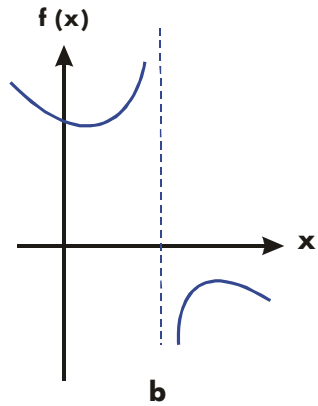
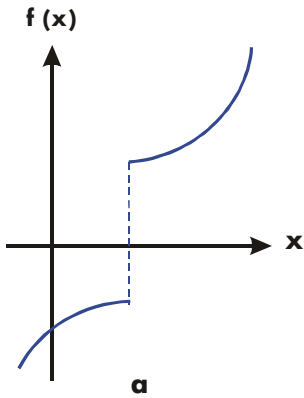

Special Case: A Discontinuity and a Pole

Example: Discontinuous Function.

Find the root of the equation:

$$IP(x) = 1.5$$

Enter the equation:

Keys:	Display:	Description:
$\boxed{\rightarrow}$ \boxed{EQN}		Selects Equation mode.
$\boxed{\rightarrow}$ \boxed{IP} \boxed{RCL} \boxed{X} $\boxed{\rightarrow}$		Enter the equation.
$\boxed{)} \boxed{\rightarrow} \boxed{=}$ 1.5		
\boxed{ENTER}	IP(X)=1.5	
$\boxed{\rightarrow}$ \boxed{SHOW}	CK=D2C1 LN=9	Checksum and length.
\boxed{C}		Cancels Equation mode.

Now, solve to find the root:

Keys:	Display:	Description:
0 \boxed{STO} X		Your initial guesses for the root.
5	5_	
$\boxed{\rightarrow}$ \boxed{EQN}	IP(X)=1.5	Selects Equation mode; displays the equation.

X	SOLVING	Finds a root with guesses 0 and 5.
	X=	
	2.0000	
	1.99999999999	Shows root, to 11 decimal places.
✓	2.00000000000	The previous estimate is slightly bigger.
✓	-0.5000	$f(x)$ is relatively large.

Note the difference between the last two estimates, as well as the relatively large value for $f(x)$. The problem is that there is no value of x for which $f(x)$ equals zero. However, at $x = 1.99999999999$, there is a neighboring value of x that yields an opposite sign for $f(x)$.

Example:

Find the root of the equation

$$\frac{x}{x^2 - 6} - 1 = 0$$

As x approaches $\sqrt{6}$, $f(x)$ becomes a very large positive or negative number.

Enter the equation as an expression.

Keys:	Display:	Description:
		Selects Equation mode.
X		Enters the equation.
(X		
2 6		
) 1		
	X÷(X^2-6)-1	
	CK=7358	Checksum and length.
	LN=11	
		Cancels Equation mode.

Now, solve to find the root.

Keys:	Display:	Description:
2.3 X		Your initial guesses for the root.
2.7	2.7_	
	$X \div (X^2 - 6) - 1$	Selects Equation mode; displays the equation.
X	NO ROOT FND	No root found for $f(x)$.
	81.649,658,092.0	$f(x)$ is relatively large.

When SOLVE Cannot Find a Root

Sometimes SOLVE fails to find a root. The following conditions cause the message NO ROOT FND:

- The search terminates near a local minimum or maximum (see figure a, below). If the ending value of $f(x)$ (stored in the Z-register) is relatively close to zero, it is possible that a root has been found; the number stored in the unknown variable might be a 12-digit number very close to a theoretical root.
- The search halts because SOLVE is working on a horizontal asymptote—an area where $f(x)$ is essentially constant for a wide range of x (see figure b, below). The ending value of $f(x)$ is the value of the potential asymptote.
- The search is concentrated in a local "flat" region of the function (see figure c, below). The ending value of $f(x)$ is the value of the function in this region.

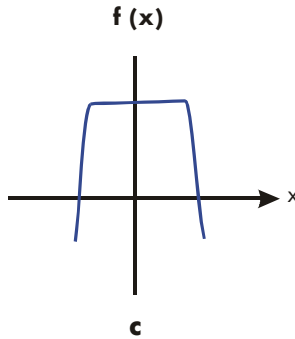
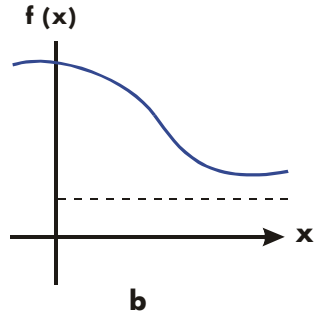
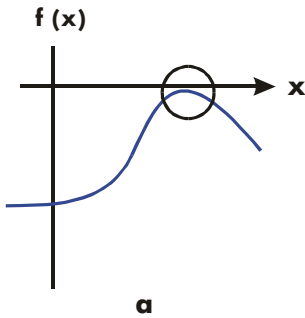

Case Where No Root Is Found

Example: A Relative Minimum.

Calculate the root of this parabolic equation:

$$x^2 - 6x + 13 = 0.$$

It has a minimum at $x = 3$.

Enter the equation as an expression:

Keys:	Display:	Description:
EQN		Selects Equation mode.
X 2		Enters the equation.
6 X		
13	$X^2-6 \times X+13$	
SHOW	CK=EC74 LN=10	Checksum and length.

C

Cancels Equation mode.

Now, solve to find the root:

Keys:

Display:

Description:

0 **STO** X

Your initial guesses for the root.

10

10_

EQN

$X^2 - 6X + 13$

Selects Equation mode; displays the equation.

SOLVE X

NO ROOT FND

Search fails with guesses 0 and 10

← **→** **SHOW**

2.99999984596

Displays the final estimate of x.

✓

↵ **→** **SHOW**

2.99999984594

Previous estimate was not the same.

✓

↵

4.0000

Final value for $f(x)$ is relatively large.

Example: An Asymptote.

Find the root of the equation

$$10 - \frac{1}{X} = 0$$

Enter the equation as an expression.

Keys:

Display:

Description:

EQN

Selects Equation mode.

10 **-** **1/x** **RCL** X

Enters the equation.

→ **)** **ENTER**

10-INV(X)

→ **SHOW**

CK=6ERB

Checksum and length.

LN=9

C

Cancels Equation mode.

.005 **STO** X

Your positive guesses for the root.

5

5_

EQN

10-INV(X)

Selects Equation mode; displays the equation.

SOLVE X

X=

Solves for x using guesses

0.1000

0.005 and 5.

✓	$\boxed{R\downarrow}$	0.1000	Previous estimate is the same.
✓	$\boxed{R\downarrow}$ $\boxed{\rightarrow}$ $\boxed{\text{SHOW}}$	0.000000000000	$f(x) = 0$

Watch what happens when you use negative values for guesses:

Keys:	Display:	Description:
1 $\boxed{+/-}$ $\boxed{\text{STO}}$ X	-1.0000	Your negative guesses for the root.
2 $\boxed{+/-}$ $\boxed{\rightarrow}$ $\boxed{\text{EQN}}$	10-INV(X)	Selects Equation mode; displays the equation.
$\boxed{\text{SOLVE}}$ X	X= 0.1000	Solves for X; displays the result.

Example: Find the root of the equation.

$$\sqrt{[x \div (x + 0.3)]} - 0.5 = 0$$

Enter the equation as an expression:

Keys:	Display:	Description:
$\boxed{\rightarrow}$ $\boxed{\text{EQN}}$		Selects Equation mode.
$\boxed{\sqrt{x}}$ $\boxed{\text{RCL}}$ X $\boxed{\div}$ $\boxed{\rightarrow}$		Enters the equation.
$\boxed{(}$ $\boxed{\text{RCL}}$ X $\boxed{+}$ $\boxed{\cdot}$ 3		
$\boxed{\rightarrow}$ $\boxed{)}$ $\boxed{\rightarrow}$ $\boxed{)}$ $\boxed{-}$		
$\boxed{\cdot}$ 5 $\boxed{\text{ENTER}}$	SQRT(X÷(X+0.3))	
$\boxed{\rightarrow}$ $\boxed{\text{SHOW}}$	CK=9F3B LN=19	Checksum and length.
$\boxed{\text{C}}$		Cancels Equation mode.

First attempt to find a positive root:

Keys:	Display:	Description:
0 $\boxed{\text{STO}}$ X		Your positive guesses for the root.
10	10_	
$\boxed{\rightarrow}$ $\boxed{\text{EQN}}$	SQRT(X÷(X+0.3))	Selects Equation mode; displays the left end of the equation.
$\boxed{\text{SOLVE}}$ X	X= 0.1000	Calculates the root using guesses 0 and 10.

Now attempt to find a negative root by entering guesses 0 and -10. Notice that the function is undefined for values of x between 0 and -0.3 since those values produce a positive denominator but a negative numerator, causing a negative square root.

Keys:	Display:	Description:
0 STO X 10 +/- → EQN	-10_ SQRT(X÷(X+0.3))	Selects Equation mode; displays the left end of the equation.
SOLVE X C	NO ROOT FND	No root found for $f(x)$. Clears error message; cancels Equation mode.
→ VIEW X	X= 0.0000	Displays the final estimate of x .

Example: A Local "Flat" Region.

Find the root of the function

$$f(x) = x + 2 \text{ if } x < -1,$$

$$f(x) = 1 \text{ for } -1 \leq x \leq 1 \text{ (a local flat region),}$$

$$f(x) = -x + 2 \text{ if } x > 1.$$

In RPN mode, enter the function as the program:

```
J0001 LBL J
J0002 1
J0003 ENTER
J0004 2
J0005 RCL+ X
J0006 x<y?
J0007 RTN
J0008 4
J0009 -
J0010 +/-
J0011 x>y?
```

J0012 R↓
J0013 RTH

Checksum and length: B956 75

You can subsequently delete line J0003 to save memory.

Solve for X using initial guesses of 10^{-8} and -10^{-8} .

Keys: (In RPN mode)	Display:	Description:
\boxed{E} 8 $\boxed{+/-}$ \boxed{STO} X		Enters guesses.
1 $\boxed{+/-}$ \boxed{E} 8 $\boxed{+/-}$	$-1E-8$	
$\boxed{\rightarrow}$ $\boxed{FN=}$ J	$-1.0000E-8$	Selects program "J" as the function.
\boxed{SOLVE} X	X= -2.0000	Solves for X; displays the result.

Round-Off Error

The limited (12-digit) precision of the calculator can cause errors due to rounding off, which adversely affect the iterative solutions of SOLVE and integration. For example,

$$[(|x| + 1) + 10^{15}]^2 - 10^{30} = 0$$

has no roots because $f(x)$ is always greater than zero. However, given initial guesses of 1 and 2, SOLVE returns the answer 1.0000 due to round-off error.

Round-off error can also cause SOLVE to fail to find a root. The equation

$$|x^2 - 7| = 0$$

has a root at $\sqrt{7}$. However, no 12-digit number *exactly* equals $\sqrt{7}$, so the calculator can never make the function equal to zero. Furthermore, the function never changes sign SOLVE returns the message **NO ROOT FND**. However, the final estimate of x (press $\boxed{\leftarrow}$ to see it) is the best possible 12-digit approximation of the root when the routine quits.

Underflow

Underflow occurs when the magnitude of a number is smaller than the calculator can represent, so it substitutes zero. This can affect SOLVE results. For example, consider the equation

$$\frac{1}{x^2}$$

whose root is infinite in value. Because of underflow, SOLVE returns a very large value as a root. (The calculator cannot represent infinity, anyway.)

More about Integration

This appendix provides information about integration beyond that given in chapter 8.

How the Integral Is Evaluated

The algorithm used by the integration operation, $\int f(x) dx$, calculates the integral of a function $f(x)$ by computing a weighted average of the function's values at many values of x (known as sample points) within the interval of integration. The accuracy of the result of any such sampling process depends on the number of sample points considered: generally, the more sample points, the greater the accuracy. If $f(x)$ could be evaluated at an infinite number of sample points, the algorithm could — neglecting the limitation imposed by the inaccuracy in the calculated function $f(x)$ — always provide an exact answer.

Evaluating the function at an infinite number of sample points would take forever. However, this is not necessary since the maximum accuracy of the calculated integral is limited by the accuracy of the calculated function values. Using only a finite number of sample points, the algorithm can calculate an integral that is as accurate as is justified considering the inherent uncertainty in $f(x)$.

The integration algorithm at first considers only a few sample points, yielding relatively inaccurate approximations. If these approximations are not yet as accurate as the accuracy of $f(x)$ would permit, the algorithm is iterated (repeated) with a larger number of sample points. These iterations continue, using about twice as many sample points each time, until the resulting approximation is as accurate as is justified considering the inherent uncertainty in $f(x)$.

As explained in chapter 8, the uncertainty of the final approximation is a number derived from the display format, which specifies the uncertainty for the function. At the end of each iteration, the algorithm compares the approximation calculated during that iteration with the approximations calculated during two previous iterations. If the difference between any of these three approximations and the other two is less than the uncertainty tolerable in the final approximation, the calculation ends, leaving the current approximation in the X-register and its uncertainty in the Y-register.

It is extremely unlikely that the errors in each of three successive approximations — that is, the differences between the actual integral and the approximations — would all be larger than the disparity among the approximations themselves. Consequently, the error in the final approximation will be less than its uncertainty (provided that $f(x)$ does not vary rapidly). Although we can't know the error in the final approximation, the error is extremely unlikely to exceed the displayed uncertainty of the approximation. In other words, the uncertainty estimate in the Y-register is an almost certain "upper bound" on the difference between the approximation and the actual integral.

Conditions That Could Cause Incorrect Results

Although the integration algorithm in the HP 33s is one of the best available, in certain situations it — like all other algorithms for numerical integration — might give you an incorrect answer. *The possibility of this occurring is extremely remote.* The algorithm has been designed to give accurate results with almost any *smooth* function. Only for functions that exhibit *extremely* erratic behavior is there any substantial risk of obtaining an inaccurate answer. Such functions rarely occur in problems related to actual physical situations; when they do, they usually can be recognized and dealt with in a straightforward manner.

Unfortunately, since all that the algorithm knows about $f(x)$ are its values at the sample points, it cannot distinguish between $f(x)$ and any other function that agrees with $f(x)$ at all the sample points. This situation is depicted below, showing (over a portion of the interval of integration) three functions *whose* graphs include the many sample points in common.

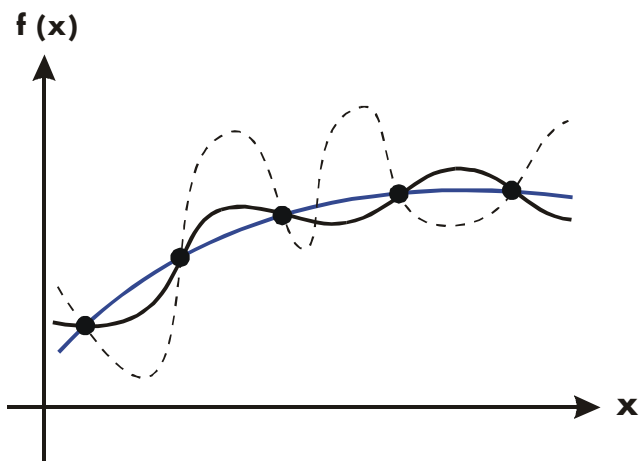

With this number of sample points, the algorithm will calculate the same approximation for the integral of any of the functions shown. The actual integrals of the functions shown with solid blue and black lines are about the same, so the approximation will be fairly accurate if $f(x)$ is one of these functions. However, the actual integral of the function shown with a dashed line is quite different from those of the others, so the current approximation will be rather inaccurate if $f(x)$ is this function.

The algorithm comes to know the general behavior of the function by sampling the function at more and more points. If a fluctuation of the function in one region is not unlike the behavior over the rest of the interval of integration, at some iteration the algorithm will likely detect the fluctuation. When this happens, the number of sample points is increased until successive iterations yield approximations that take into account the presence of the most rapid, *but characteristic*, fluctuations.

For example, consider the approximation of

$$\int_0^{\infty} xe^{-x} dx.$$

Since you're evaluating this integral numerically, you might think that you should represent the upper limit of integration as 10^{499} , which is virtually the largest number you can key into the calculator.

Try it and see what happens. Enter the function $f(x) = xe^{-x}$.

Keys:

$\boxed{\rightarrow}$ $\boxed{\text{EQN}}$
 $\boxed{\text{RCL}}$ $\boxed{\times}$ $\boxed{\times}$ $\boxed{e^x}$
 $\boxed{-}$ $\boxed{\text{RCL}}$ $\boxed{\times}$ $\boxed{\rightarrow}$ $\boxed{\square}$
 $\boxed{\text{ENTER}}$
 $\boxed{\rightarrow}$ $\boxed{\text{SHOW}}$
 $\boxed{\text{C}}$

Display:

$\times \times \text{EXP} < \blacksquare$
 $\times \times \text{EXP} < -\times >$
 $\text{CK} = \text{DF} 17$
 $\text{LN} = 9$

Description:

Select equation mode.
 Enter the equation.
 End of the equation.
 Checksum and length.
 Cancels Equation mode.

Set the display format to SCI 3, specify the lower and upper limits of integration as zero and 10^{499} , then start the integration.

Keys:

\checkmark $\boxed{\text{DISPLAY}}$ $\boxed{\{\text{SCI}\}}$ $\boxed{3}$
 $\boxed{0}$ $\boxed{\text{ENTER}}$ $\boxed{\text{E}}$ $\boxed{499}$
 $\boxed{\rightarrow}$ $\boxed{\text{EQN}}$
 $\boxed{\rightarrow}$ $\boxed{\int}$ $\boxed{\times}$

Display:

$1\text{E}499\text{_}$
 $\times \times \text{EXP} < -\times >$

 INTEGRATING
 $\int =$
 0.00000

Description:

Specifies accuracy level and limits of integration.
 Selects Equation mode; displays the equation.
 Approximation of the integral.

The answer returned by the calculator is clearly incorrect, since the actual integral of $f(x) = xe^{-x}$ from zero to ∞ is exactly 1. But the problem is *not* that ∞ was represented by 10^{499} , since the actual integral of this function from zero to 10^{499} is very close to 1. The reason for the incorrect answer becomes apparent from the graph of $f(x)$ over the interval of integration.

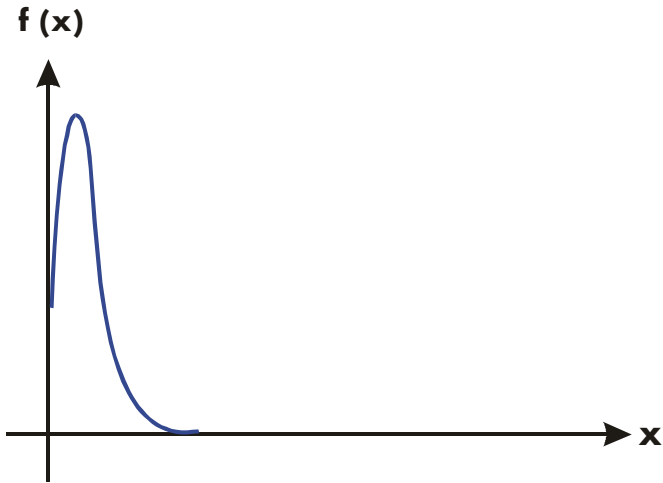

The graph is a spike very close to the origin. Because no sample point happened to discover the spike, the algorithm assumed that $f(x)$ was identically equal to zero throughout the interval of integration. Even if you increased the number of sample points by calculating the integral in SCI 11 or ALL format, none of the additional sample points would discover the spike when this particular function is integrated over this particular interval. (For better approaches to problems such as this, see the next topic, "Conditions That Prolong Calculation Time.")

Fortunately, functions exhibiting such aberrations (a fluctuation that is uncharacteristic of the behavior of the function elsewhere) are unusual enough that you are unlikely to have to integrate one unknowingly. A function that could lead to incorrect results can be identified in simple terms by how rapidly it and its low-order derivatives vary across the interval of integration. Basically, the more rapid the variation in the function or its derivatives, and the lower the order of such rapidly varying derivatives, the less quickly will the calculation finish, and the less reliable will be the resulting approximation.

Note that the rapidity of variation in the function (or its low-order derivatives) must be determined with respect to the width of the interval of integration. With a given number of sample points, a function $f(x)$ that has three fluctuations can be better characterized by its samples when these variations are spread out over most of the interval of integration than if they are confined to only a small fraction of the interval. (These two situations are shown in the following two illustrations.) Considering the variations or fluctuation as a type of oscillation in the function, the criterion of interest is the ratio of the period of the oscillations to the width of the interval of integration: the larger this ratio, the more quickly the calculation will finish, and the more reliable will be the resulting approximation.

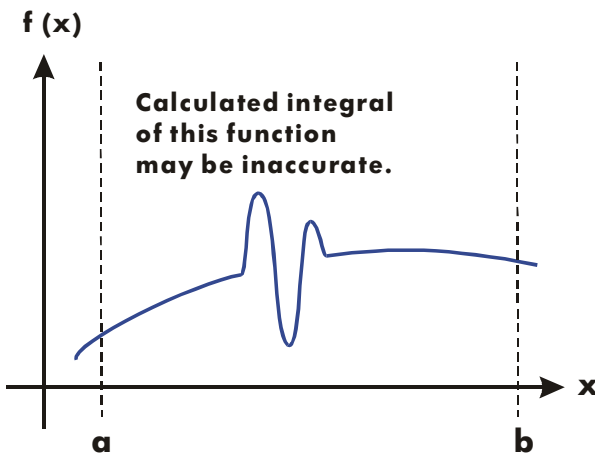
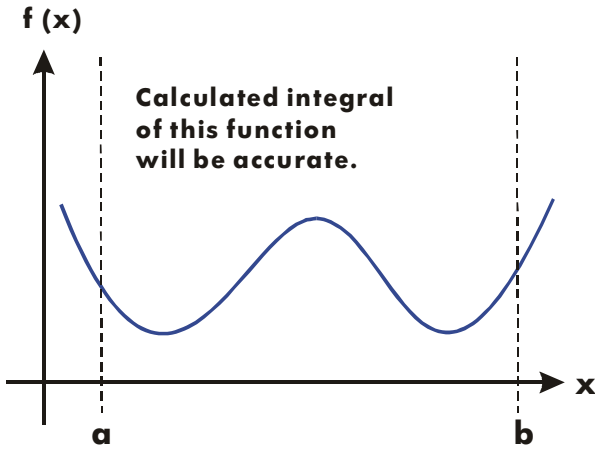

In many cases you will be familiar enough with the function you want to integrate that you will know whether the function has any quick wiggles relative to the interval of integration. If you're not familiar with the function, and you suspect that it may cause problems, you can quickly plot a few points by evaluating the function using the equation or program you wrote for that purpose.







If, for any reason, after obtaining an approximation to an integral, you suspect its validity, there's a simple procedure to verify it: subdivide the interval of integration into two or more adjacent subintervals, integrate the function over each subinterval, then add the resulting approximations. This causes the function to be sampled at a brand new set of sample points, thereby more likely revealing any previously hidden spikes. If the initial approximation was valid, it will equal the sum of the approximations over the subintervals.

Conditions That Prolong Calculation Time

In the preceding example, the algorithm gave an incorrect answer because it never detected the spike in the function. This happened because the variation in the function was too quick relative to the width of the interval of integration. If the width of the interval were smaller, you would get the correct answer; but it would take a very long time if the interval were still too wide.

Consider an integral where the interval of integration is wide enough to require excessive calculation time, but not so wide that it would be calculated incorrectly. Note that because $f(x) = xe^{-x}$ approaches zero very quickly as x approaches ∞ , the contribution to the integral of the function at large values of x is negligible. Therefore, you can evaluate the integral by replacing ∞ , the upper limit of integration, by a number not so large as 10^{499} — say 10^3 .

Rerun the previous integration problem with this new limit of integration:

Keys:	Display:	Description:
0   3	1E3_	New upper limit.
 	X×EXP(-X)	Selects Equation mode; displays the equation.
  X	INTEGRATING ∫= 1.000E0	Integral. (The calculation takes a minute or two.)

This is the correct answer, but it took a very long time. To understand why, compare the graph of the function between $x = 0$ and $x = 10^3$, which looks about the same as that shown in the previous example, with the graph of the function between $x = 0$ and $x = 10$:

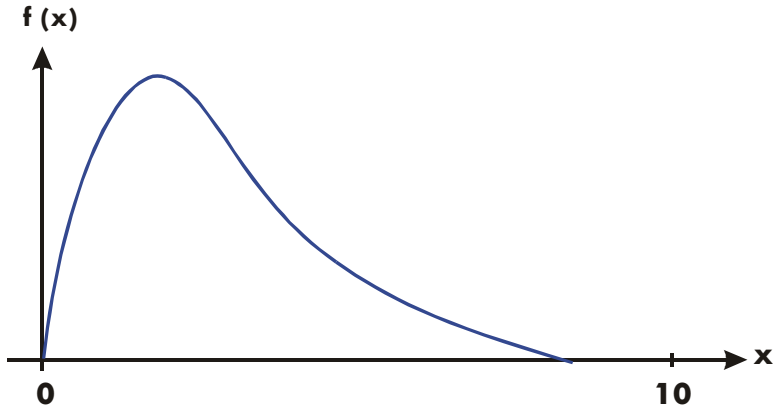

You can see that this function is "interesting" only at small values of x . At greater values of x , the function is not interesting, since it decreases smoothly and gradually in a predictable manner.

The algorithm samples the function with higher densities of sample points until the disparity between successive approximations becomes sufficiently small. For a narrow interval in an area where the function is interesting, it takes less time to reach this critical density.

To achieve the same density of sample points, the total number of sample points required over the larger interval is much greater than the number required over the smaller interval. Consequently, several more iterations are required over the larger interval to achieve an approximation with the same accuracy, and therefore calculating the integral requires considerably more time.

Because the calculation time depends on how soon a certain density of sample points is achieved in the region where the function is interesting, the calculation of the integral of any function will be prolonged if the interval of integration includes mostly regions where the function is not interesting. Fortunately, if you must calculate such an integral, you can modify the problem so that the calculation time is considerably reduced. Two such techniques are subdividing the interval of integration and transformation of variables. These methods enable you to change the function or the limits of integration so that the integrand is better behaved over the interval(s) of integration.

Messages

The calculator responds to certain conditions or keystrokes by displaying a message. The **▲** symbol comes on to call your attention to the message. For significant conditions, the message remains until you clear it. Pressing **C** or **←** clears the message; pressing any other key clears the message and executes that key's function.

∫FN ACTIVE	A running program attempted to select a program label (FN= <i>label</i>) while an integration calculation was running.
∫(∫FN)	A running program attempted to integrate a program (∫FN <i>≠</i> <i>variable</i>) while another integration calculation was running.
∫(SOLVE)	A running program attempted to solve a program while an integration calculation was running.
ALL VARS=0	The catalog of variables (← MEM {VAR}) indicates no values stored.
CALCULATING	The calculator is executing a function that might take a while.
CLR EQN? Y N	Allows you to verify clearing the equation you are editing. (Occurs only in Equation-entry mode.)
CLR PGMS? Y N	Allows you to verify clearing <i>all programs</i> in memory. (Occurs only in Program-entry mode.)
DIVIDE BY 0	Attempted to divide by zero. (Includes %CHG if Y-register contains zero.)
DUPLICAT . LBL	Attempted to enter a program label that already exists for another program routine.
EQN LIST TOP	Indicates the "top" of equation memory. The memory scheme is circular, so EQN LIST TOP is also the "equation" after the last equation in equation memory.

INTEGRATING	The calculator is calculating the integral of an equation or program. <i>This might take a while.</i>
INTERRUPTED	A running SOLVE or \int FN operation was interrupted by pressing C or R/S .
INVALID DATA	Data error: <ul style="list-style-type: none"> ■ Attempted to calculate combinations or permutations with $r > n$, with non-integer r or n, or with $n \geq 10^{16}$. ■ Attempted to use a trigonometric or hyperbolic function with an illegal argument: <ul style="list-style-type: none"> ■ TAN with x an odd multiple of 90°. ■ ACOS or ASIN with $x < -1$ or $x > 1$. ■ HYP ATAN with $x \leq -1$; or $x \geq 1$. ■ HYP ACOS with $x < 1$.
INVALID EQN	A syntax error in the equation was detected during equation evaluation, SOLVE, or \int FN.
INVALID VAR	Attempted to enter an invalid variable name when solving an equation.
INVALID $x!$	Attempted a factorial or gamma operation with x as a negative integer.
INVALID y^x	Exponentiation error: <ul style="list-style-type: none"> ■ Attempted to raise 0 to the 0th power or to a negative power. ■ Attempted to raise a negative number to a non-integer power. ■ Attempted to raise complex number $(0 + i 0)$ to a number with a negative real part.
INVALID (i)	Attempted an operation with an indirect address, but the number in the index register is invalid ($ i \geq 34$ or $0 \leq i < 1$).
LOG(0)	Attempted to take a logarithm of zero or $(0 + i0)$.
LOG(NEG)	Attempted to take a logarithm of a negative number.
MEMORY CLEAR	All of user memory has been erased (see page B-3).
MEMORY FULL	The calculator has insufficient memory available to do the operation (See appendix B).
NO	The condition checked by a test instruction is not true. (Occurs only when executed from the keyboard.)

SOLVING	The calculator is solving an equation or program for its root. This might take a while.
SQRT(NEG)	Attempted to calculate the square root of a negative number.
STAT ERROR	Statistics error: <ul style="list-style-type: none"> ■ Attempted to do a statistics calculation with $n = 0$. ■ Attempted to calculate s_x, s_y, \hat{x}, \hat{y}, m, r, or b with $n = 1$. ■ Attempted to calculate r, \hat{x} or \bar{XW} with x-data only (all y-values equal to zero). ■ Attempted to calculate \hat{x}, \hat{y}, r, m, or b with all x-values equal.
TOO BIG	The magnitude of the number is too large to be converted to HEX, OCT, or BIN base; the number must be in the range $-34,359,738,368 \leq n \leq 34,359,738,367$.
XEQ OVERFLOW	A running program attempted an eighth nested XEQ <i>label</i> . (Up to seven subroutines can be nested.) Since SOLVE and ∫FN each uses a level, they can also generate this error.
YES	The condition checked by a test instruction is true. (Occurs only when executed from the keyboard.)

Self-Test Messages:

33S-OK	The self-test and the keyboard test passed.
33S-FAIL n	The self-test or the keyboard test failed, and the calculator requires service.
© 2003 HP DEV CO. L.P.	Copyright message displayed after successfully completing the self-test.

Operation Index













This section is a quick reference for all functions and operations and their formulas, where appropriate. The listing is in alphabetical order by the function's name. This name is the one used in program lines. For example, the function named FIX n is executed as $\text{[DISPLAY]} \{F I X\} n$.











Nonprogrammable functions have their names in key boxes. For example, [←] .























Non-letter and Greek characters are alphabetized before all the letters; function names preceded by arrows (for example, \rightarrow DEG) are alphabetized as if the arrow were not there.



























The last column, marked *, refers to notes at the end of the table.

















Name	Keys and Description	Page	*
+/-	[+/-] Changes the sign of a number.	1-14	1
+	[+] <i>Addition</i> . Returns $y + x$.	1-17	1
-	[-] <i>Subtraction</i> . Returns $y - x$.	1-17	1
×	[×] <i>Multiplication</i> . Returns $y \times x$.	1-17	1
÷	[÷] <i>Division</i> . Returns $y \div x$.	1-17	1
^	[yx] <i>Power</i> . Indicates an exponent.	6-15	2
[←]	Deletes the last digit keyed in; clears x ; clears a menu; erases last function keyed in an equation; starts equation editing; deletes a program step.	1-4 1-9 6-3 12-6	















Name	Keys and Description	Page	*
	Displays previous entry in catalog; moves to previous equation in equation list; moves program pointer to previous step.	1-24 6-3 12-9 12-18	
	Displays next entry in catalog; moves to next equation in equation list; moves program pointer to next line (during program entry); executes the current program line (not during program entry).	1-24 6-3 12-9 12-18	
 or 	Scrolls the display to show more digits to the left and right; displays the rest of an equation or binary number; goes the next menu page in the CONST and SUMS menus.	1-11 6-4 10-6	
 	Goes to the top line of the equation or program list.	6-3	
 	Goes to the last line of the equation or program list.	6-3	
:	 Separates the two arguments of a function.	6-5	2
1/x	 <i>Reciprocal.</i>	1-17	1
10 ^x	 <i>Common exponential.</i> Returns 10 raised to the x power.	4-2	1
%	 <i>Percent.</i> Returns $(y \times x) \div 100$.	4-6	1
%CHG	%CHG key icon" data-bbox="348 768 385 783"/> <i>Percent change.</i> Returns $(x - y)(100 \div y)$.	4-6	1
π	 Returns the approximation 3.14159265359 (12 digits).	4-3	1







Name	Keys and Description	Page	*
$\Sigma+$	 Accumulates (y, x) into statistics registers.	11-2	
$\Sigma-$	 Removes (y, x) from statistics registers.	11-2	
Σx	 { Σx } Returns the sum of x-values.	11-10	1
Σx^2	 { Σx^2 } Returns the sum of squares of x-values.	11-10	1
Σxy	 { Σxy } Returns the sum of products of x- and y-values.	11-10	1
Σy	 { Σy } Returns the sum of y-values.	11-10	1
Σy^2	 { Σy^2 } Returns the sum of squares of y-values.	11-10	1
σx	 { σx } Returns population standard deviation of x-values: $\sqrt{\sum (x_i - \bar{x})^2 \div n}$	11-6	1
σy	 { σy } Returns population standard deviation of y-values: $\sqrt{\sum (y_i - \bar{y})^2 \div n}$	11-6	1
$\theta, r \rightarrow y, x$	 { $\theta, r \rightarrow y, x$ } <i>Polar to rectangular coordinates.</i> Converts (r, θ) to (x, y).	4-9	

Name	Keys and Description	Page	*
∫FN d variable	  { ∫FN d _ } variable Integrates the displayed equation or the program selected by FN=, using lower limit of the variable of integration in the Y-register and upper limit of the variable of integration in the X-register.	8-2 14-7	
(  <i>Open parenthesis.</i> Starts a quantity associated with a function in an equation.	6-6	2
)	  <i>Close parenthesis.</i> Ends a quantity associated with a function in an equation.	6-6	2
A through Z	 variable or  variable Value of named variable.	6-4	2
ABS	  <i>Absolute value.</i> Returns $ x $.	4-16	1
ACOS	  <i>Arc cosine.</i> Returns $\cos^{-1}x$.	4-4	1
ACOSH	    <i>Hyperbolic arc cosine.</i> Returns $\cosh^{-1}x$.	4-6	1
 	Activates Algebraic mode.	1-10	
A LOG	  <i>Common exponential.</i> Returns 10 raised to the specified power (antilogarithm).	6-15	2
ALL	 {FLL} Selects display of all significant digits.	1-20	
ASIN	  <i>Arc sine</i> Returns $\sin^{-1}x$.	4-4	1



















Name	Keys and Description	Page	*
ASINH	    <i>Hyperbolic arc sine.</i> Returns $\sinh^{-1} x$.	4-6	1
ATAN	  <i>Arc tangent.</i> Returns $\tan^{-1} x$.	4-4	1
ATANH	    <i>Hyperbolic arc tangent.</i> Returns $\tanh^{-1} x$.	4-6	1
<i>b</i>	  { <i>b</i> } Returns the <i>y</i> -intercept of the regression line: $\bar{Y} - m\bar{X}$.	11-10	1
 	Displays the base-conversion menu.	10-1	
BIN	  { <i>BIN</i> } Selects Binary (base 2) mode.	10-1	
	Turns on calculator; clears <i>x</i> ; clears messages and prompts; cancels menus; cancels catalogs; cancels equation entry; cancels program entry; halts execution of an equation; halts a running program.	1-1 1-4 1-9 1-24 6-3 12-6 12-17	
<i>/c</i>	  <i>Denominator.</i> Sets denominator limit for displayed fractions to <i>x</i> . If $x = 1$, displays current <i>/c</i> value.	5-5	
$\rightarrow^{\circ}\text{C}$	  Converts $^{\circ}\text{F}$ to $^{\circ}\text{C}$.	4-13	1
CB	  <i>Cube of argument.</i>	6-15	2
CBRT	  <i>Cube root of argument.</i>	6-15	2
CF <i>n</i>	  { <i>CF</i> } <i>n</i> Clears flag <i>n</i> ($n = 0$ through 11).	13-11	

Name	Keys and Description	Page	*
 CLEAR	Displays menu to clear numbers or parts of memory; clears indicated variable or program from a MEM catalog; clears displayed equation.	1–6 1–24	
 CLEAR {ALL}	Clears all stored data, equations, and programs.	1–24	
 CLEAR {PGM}	Clears all programs (calculator in Program mode).	12–20	
 CLEAR {EQN}	Clears the displayed equation (calculator in Program mode).	12–6	
CLΣ	 CLEAR {Σ} Clears statistics registers.	11–11	
CLVARS	 CLEAR {VARS} Clears all variables to zero.	3–4	
CLx	 CLEAR {x} Clears x (the X-register) to zero.	2–2 2–6 12–6	
→CM	  Converts inches to centimeters.	4–13	1
 CPLX	Displays the CPLX_ prefix for complex functions.	9–2	
CPLX +/-	 CPLX  Complex change sign. Returns $-(z_x + i z_y)$.	9–2	
CPLX +	 CPLX  Complex addition. Returns $(z_{1x} + i z_{1y}) + (z_{2x} + i z_{2y})$.	9–2	
CPLX –	 CPLX  Complex subtraction. Returns $(z_{1x} + i z_{1y}) - (z_{2x} + i z_{2y})$.	9–2	

















Name	Keys and Description	Page	*
CMLPX ×	 CMLPX  <i>Complex multiplication.</i> Returns $(z_{1x} + i z_{1y}) \times (z_{2x} + i z_{2y})$.	9-2	
CMLPX ÷	 CMLPX  <i>Complex division.</i> Returns $(z_{1x} + i z_{1y}) \div (z_{2x} + i z_{2y})$.	9-2	
CMLPX 1/x	 CMLPX  <i>Complex reciprocal.</i> Returns $1/(z_x + i z_y)$.	9-2	
CMLXCOS	 CMLPX COS <i>Complex cosine.</i> Returns $\cos(z_x + i z_y)$.	9-2	
CMLXe ^x	 CMLPX  <i>Complex natural exponential.</i> Returns $e^{(z_x + iz_y)}$.	9-2	
CMLXLN	 CMLPX LN <i>Complex natural log.</i> Returns $\log_e(z_x + i z_y)$.	9-2	
CMLXSIN	 CMLPX SIN <i>Complex sine.</i> Returns $\sin(z_x + i z_y)$.	9-2	
CMLXTAN	 CMLPX TAN <i>Complex tangent.</i> Returns $\tan(z_x + i z_y)$.	9-2	
CMLY ^x	 CMLPX  <i>Complex power.</i> Returns $(z_{1x} + iz_{1y})^{(z_{2x} + iz_{2y})}$.	9-2	
C _{n,r}	 nCr <i>Combinations of n items taken r at a time.</i> Returns $n! \div (r! (n - r)!)$.	4-14	2
COS	COS <i>Cosine.</i> Returns $\cos x$.	4-3	1









Name	Keys and Description	Page	*
COSH	 HYP  <i>Hyperbolic cosine. Returns cosh x.</i>	4-6	1
 CONST	Functions to use 40 physics constants.	4-8	
DEC	 BASE { DEC }	10-1	
DEG	MODES { DEG }	4-4	
→ DEG	 →DEG <i>Radians to degrees. Returns $(360/2\pi) x$.</i>	4-13	1
DISPLAY	Displays menu to set the display format.	1-19	
DSE <i>variable</i>	 DSE <i>variable</i> <i>Decrement, Skip if Equal or less. For control number cccccc.fffii stored in a variable, subtracts ii (increment value) from cccccc (counter value) and, if the result ≤fff (final value), skips the next program line.</i>	13-18	
E	Begins entry of exponents and adds "E" to the number being entered. Indicates that a power of 10 follows.	1-14	1
ENG <i>n</i>	DISPLAY { ENG } <i>n</i> Selects Engineering display with <i>n</i> digits following the first digit (<i>n</i> = 0 through 11).	1-20	
ENG and  ←ENG	Causes the exponent display for the number being displayed to change in multiple of 3.	1-20	



















Name	Keys and Description	Page	*
ENTER	Separates two numbers keyed in sequentially; completes equation entry; evaluates the displayed equation (and stores result if appropriate).	1–17 6–4 6–11	
ENTER	ENTER Copies x into the Y-register, lifts y into the Z-register, lifts z into the T-register, and loses t .	2–5	
EQN	Activates or cancels (toggles) Equation–entry mode.	6–3 12–6	
e^x	e^x <i>Natural exponential.</i> Returns e raised to the x power.	4–1	1
EXP	e^x <i>Natural exponential.</i> Returns e raised to the specified power.	6–15	2
$\rightarrow^\circ\text{F}$	$\rightarrow^\circ\text{F}$ Converts $^\circ\text{C}$ to $^\circ\text{F}$.	4–13	1
FDISP	Turns on and off Fraction–display mode.	5–1	
FIX n	DISPLAY {F I X} n Selects Fixed display with n decimal places: $0 \leq n \leq 11$.	1–19	
FLAGS	Displays the menu to set, clear, and test flags.	13–11	
FN = <i>label</i>	FN <i>label</i> Selects <i>labeled</i> program as the current function (used by SOLVE and \int FN).	14–1 14–7	
FP	FP <i>Fractional part of x.</i>	4–16	1





















Name	Keys and Description	Page	*
FS? <i>n</i>	 FLAGS {FS?} <i>n</i> If flag <i>n</i> (<i>n</i> = 0 through 11) is set, executes the next program line; if flag <i>n</i> is clear, skips the next program line.	13–11	
→GAL	  Converts liters to gallons.	4–13	1
GRAD	 MODES {GRAD} Sets Grads angular mode.	4–4	
GTO <i>label</i>	 GTO <i>label</i> Sets the program pointer to the beginning of program <i>label</i> in program memory.	13–4 13–17	
 GTO  <i>label</i> <i>nnnn</i>	Sets program pointer to line <i>nnnn</i> of program <i>label</i> .	12–19	
 GTO  	Sets program pointer to PRGM TOP.	12–19	
HEX	 BASE {HEX} Selects Hexadecimal (base 16) mode.	10–1	
 HYP	Displays the HYP_ prefix for hyperbolic functions.	4–6	
→HMS	  <i>Hours to hours, minutes, seconds.</i> Converts <i>x</i> from a decimal fraction to hours–minutes–seconds format.	4–12	1
→HR	  <i>Hours, minutes, seconds to hours.</i> Converts <i>x</i> from hours–minutes–seconds format to a decimal fraction.	4–12	1
i	 RCL <i>i</i> or  STO <i>i</i> Value of variable <i>i</i> .	6–4	2

Name	Keys and Description	Page	*
(i)	 <i>Indirect.</i> Value of variable whose letter corresponds to the numeric value stored in variable i.	6-4 13-21	2
→IN	Converts centimeters to inches.	4-13	1
IDIV	Produces the quotient of a division operation involving two integers.	6-15	2
INT÷	Produces the quotient of a division operation involving two integers.	4-2	1
INTG	Obtains the greatest integer equal to or less than given number.	4-16	1
INPUT <i>variable</i>	<i>variable</i> Recalls the <i>variable</i> to the X-register, displays the variable's name and value, and halts program execution. Pressing (to resume program execution) or (to execute the current program line) stores your input in the variable. (Used only in programs.)	12-11	
INV	Reciprocal of argument.	6-15	2
IP	<i>Integer part of x.</i>	4-16	1
ISG <i>variable</i>	<i>variable</i> <i>Increment, Skip if Greater.</i> For control number <i>cccccc.ffffi</i> stored in variable, adds <i>ii</i> (increment value) to <i>cccccc</i> (counter value) and, if the result > <i>fff</i> (final value), skips the next program line.	13-18	























Name	Keys and Description	Page	*
→KG	  kg Converts pounds to kilograms.	4-13	1
→L	  l Converts gallons to liters.	4-13	1
LASTx	 LASTx Returns number stored in the LAST X register.	2-7	
→LB	  lb Converts kilograms to pounds.	4-13	1
LBL <i>label</i>	 LBL <i>label</i> Labels a program with a single letter for reference by the XEQ, GTO, or FN= operations. (Used only in programs.)	12-3	
LN	 LN <i>Natural logarithm.</i> Returns $\log_e x$.	4-1	1
LOG	 LOG <i>Common logarithm.</i> Returns $\log_{10} x$.	4-1	1
 L.R.	Displays menu for linear regression.	11-4	
m	 L.R. {m} Returns the slope of the regression line: $[\sum(x_i - \bar{x})(y_i - \bar{y})] \div \sum(x_i - \bar{x})^2$	11-7	1
 MEM	Displays the amount of available memory and the catalog menu.	1-24	
 MEM {PGM}	Begins catalog of programs.	12-20	
 MEM {VAR}	Begins catalog of variables.	3-3	
MODES	Displays menu to set angular modes and the radix (° or °).	1-18 4-4	
n	 SUMS {n} Returns the number of sets of data points.	11-10	1





















Name	Keys and Description	Page	*
OCT	 [BASE] {OCT} Selects Octal (base 8) mode.	10-1	
 [OFF]	Turns the calculator off.	1-1	
Pn,r	 [nPr] <i>Permutations of n items taken r at a time. Returns $n!/(n-r)!$.</i>	4-14	2
 [PRGM]	Activates or cancels (toggles) Program-entry mode.	12-5	
PSE	 [PSE] <i>Pause.</i> Halts program execution briefly to display x, variable, or equation, then resumes. (Used only in programs.)	12-16 12-17	
r	 [L.R.] {r} Returns the correlation coefficient between the x- and y-values: $\frac{\sum (x_i - \bar{x})(y_i - \bar{y})}{\sqrt{\sum (x_i - \bar{x})^2 \times \sum (y_i - \bar{y})^2}}$	11-7	1
RAD	[MODES] {RAD} Selects Radians angular mode.	4-4	
→RAD	 [→RAD] <i>Degrees to radians.</i> Returns $(2\pi/360) x$.	4-13	1
RADIX ,	[MODES] {,} Selects the comma as the radix mark (decimal point).	1-18	
RADIX .	[MODES] {. Selects the period as the radix mark (decimal point).	1-18	
RANDOM	 [RAND] Executes the RANDOM function. Returns a random number in the range 0 through 1.	4-14	1



















Name	Keys and Description	Page	*
RCL <i>variable</i>	 <i>variable</i> Recall. Copies <i>variable</i> into the X-register.	3-5	
RCL+ <i>variable</i>	  <i>variable</i> Returns $x + \text{variable}$.	3-5	
RCL- <i>variable</i>	  <i>variable</i> . Returns $x - \text{variable}$.	3-5	
RCLx <i>variable</i>	  <i>variable</i> . Returns $x \times \text{variable}$.	3-5	
RCL÷ <i>variable</i>	  <i>variable</i> . Returns $x \div \text{variable}$.	3-5	
RMDR	  Produces the remainder of a division operation involving two integers.	6-15	2
RND	  Round. Rounds x to n decimal places in FIX n display mode; to $n + 1$ significant digits in SCI n or ENG n display mode; or to decimal number closest to displayed fraction in Fraction-display mode.	4-16 5-7	1
 	Activates Reverse Polish notation.	1-10	
RTN	  Return. Marks the end of a program; the program pointer returns to the top or to the calling routine.	12-3 13-2	
R↓	  Roll down. Moves t to the Z-register, z to the Y-register, y to the X-register, and x to the T-register in RPN mode. Displays the X1~X4 menu to review the stack in ALG mode.	2-3 C-6	

Name	Keys and Description	Page	*
R↑	  <i>Roll up.</i> Moves t to the X-register, z to the T-register, y to the Z-register, and x to the Y-register in RPN mode.	2-3 C-6	
 	Displays the X1-X4 menu to review the stack in ALG mode. Displays the standard-deviation Menu.	11-4	
SCI n	 {  } n Selects Scientific display with n decimal places. ($n = 0$ through 11.)	1-19	
SEED	  Restarts the random-number sequence with the seed $ X $.	4-14	
SF n	  {  } n Sets flag n ($n = 0$ through 11).	13-11	
SGN	  <i>Indicates the sign of x.</i>	4-16	1
 	Shows the full mantissa (all 12 digits) of x (or the number in the current program line); displays hex checksum and decimal byte length for equations and programs.	6-18 12-21	
SIN	 <i>Sine.</i> Returns $\sin x$.	4-3	1
SINH	   <i>Hyperbolic sine.</i> Returns $\sinh x$.	4-6	1
SOLVE <i>variable</i>	 <i>variable</i> Solves the displayed equation or the program selected by FN=, using initial estimates in <i>variable</i> and x .	7-1 14-1	

Name	Keys and Description	Page	*
SPACE	R/S Inserts a blank space character during equation entry.	13-14	2
SQ	x² Square of argument.	6-15	2
SQRT	√x Square root of x.	6-15	2
STO <i>variable</i>	STO <i>variable</i> Store. Copies x into variable.	3-2	
STO + <i>variable</i>	STO + <i>variable</i> Stores variable + x into variable.	3-4	
STO - <i>variable</i>	STO - <i>variable</i> Stores variable - x into variable.	3-4	
STO × <i>variable</i>	STO × <i>variable</i> Stores variable × x into variable.	3-4	
STO ÷ <i>variable</i>	STO ÷ <i>variable</i> Stores variable ÷ x into variable.	3-4	
STOP	R/S Run/stop. Begins program execution at the current program line; stops a running program and displays the X-register.	12-17	
↵ SUMS	Displays the summation menu.	11-4	
sx	↵ S.σ {Σx} Returns sample standard deviation of x-values: $\sqrt{\sum (x_i - \bar{x})^2 \div (n - 1)}$	11-6	1
sy	↵ S.σ {Σy} Returns sample standard deviation of y-values: $\sqrt{\sum (y_i - \bar{y})^2 \div (n - 1)}$	11-6	1

Name	Keys and Description	Page	*
TAN	 <i>Tangent</i> . Returns $\tan x$.	4-3	1
TANH	   <i>Hyperbolic tangent</i> . Returns $\tanh x$.	4-6	1
VIEW <i>variable</i>	  <i>variable</i> Displays the labeled contents of <i>variable</i> without recalling the value to the stack.	3-3 12-13	
	Evaluates the displayed equation.	6-12	
XEQ <i>label</i>	 <i>label</i> Executes the program identified by <i>label</i> .	13-2	
x^2	 <i>Square of x</i> .	4-2	1
x^3	  <i>Cube of x</i> .	4-2	1
\sqrt{x}	 <i>Square root of x</i> .	4-2	1
$\sqrt[3]{x}$	  <i>Cube root of x</i> .	4-2	1
$\sqrt[x]{y}$	 <i>The x^{th} root of y</i> .	4-2	1
\bar{x}	  { \bar{x} } Returns the mean of x values: $\Sigma x_j \div n$.	11-4	1
\hat{x}	  { \hat{x} } Given a y -value in the X -register, returns the x -estimate based on the regression line: $\hat{x} = (y - b) \div m$.	11-10	1
$x!$	  <i>Factorial (or gamma)</i> . Returns $(x)(x-1) \dots (2)(1)$, or $\Gamma(x+1)$.	4-14	1
XROOT	 <i>The argument_1 root of argument_2</i> .	6-15	2

Name	Keys and Description	Page	*
\bar{x} w	Returns weighted mean of x values: $(\sum y_i x_i) \div \sum y_i$.	11-4	1
 	Displays the mean (arithmetic average) menu.	11-4	
$x \leftrightarrow$ variable	  x exchange. Exchanges x with a variable.	3-6	
$x \leftrightarrow y$	 x exchange y . Moves x to the Y-register and y to the X-register.	2-4	
 	Displays the "x?y" comparison tests menu.	13-7	
$x \neq y$	  { \neq } If $x \neq y$, executes next program line; if $x = y$, skips next program line.	13-7	
$x \leq y?$	  { \leq } If $x \leq y$, executes next program line; if $x > y$, skips next program line.	13-7	
$x < y?$	  { $<$ } If $x < y$, executes next program line; if $x \geq y$, skips next program line.	13-7	
$x > y?$	  { $>$ } If $x > y$, executes next program line; if $x \leq y$, skips next program line.	13-7	
$x \geq y?$	  { \geq } If $x \geq y$, executes next program line; if $x < y$, skips next program line.	13-7	
$x = y?$	  { $=$ } If $x = y$, executes next program line; if $x \neq y$, skips next program line.	13-7	
 	Displays the "x?0" comparison tests menu.	13-7	

Name	Keys and Description	Page	*
$x \neq 0?$	  { \neq } If $x \neq 0$, executes next program line; if $x = 0$, skips the next program line.	13–7	
$x \leq 0?$	  { \leq } If $x \leq 0$, executes next program line; if $x > 0$, skips next program line.	13–7	
$x < 0?$	  { $<$ } If $x < 0$, executes next program line; if $x \geq 0$, skips next program line.	13–7	
$x > 0?$	  { $>$ } If $x > 0$, executes next program line; if $x \leq 0$, skips next program line.	13–7	
$x \geq 0?$	  { \geq } If $x \geq 0$, executes next program line; if $x < 0$, skips next program line.	13–7	
$x = 0?$	  { $=$ } If $x = 0$, executes next program line; if $x \neq 0$, skips next program line:	13–7	
\bar{y}	  { \bar{y} } Returns the mean of y values. $\Sigma y_i \div n$.	11–4	1
\hat{y}	  { \hat{y} } Given an x -value in the X -register, returns the y -estimate based on the regression line: $\hat{y} = m x + b$.	11–10	1
$y, x \rightarrow \theta, r$	  <i>Rectangular to polar coordinates.</i> Converts (x, y) to (r, θ) .	4–10	









Name	Keys and Description	Page	*
y^x	 Power. Returns y raised to the x^{th} power.	4-2	1

Notes:

1. Function can be used in equations.
2. Function appears only in equations.

Index

Special Characters

- , 6–5
 - \int FN. See integration
 - % functions, 4–6
 - \blacksquare . See equation–entry cursor
 - . See backspace key
 - . See integration
 - , 1–14
 - \blacktriangle , 1–23
 - π , 4–3, A–2
 - \blackleftarrow \blackrightarrow annunciators
 - binary numbers, 10–6
 - equations, 6–7, 12–6
 -  (in fractions), 1–21, 5–1
 - \blacktriangle \blacktriangledown annunciator
 - in catalogs, 3–3
 - in fractions, 3–3, 5–2, 5–3
 - $_.$ See digit–entry cursor
 -   annunciators, 1–3
 -  annunciator, 1–1, A–2
- ## A
- A..Z** annunciator, 1–3, 3–2, 6–4
 - absolute value (real number), 4–16
 - addressing
 - indirect, 13–20, 13–21, 13–22
 - ALG, 1–10
 - compared to equations, 12–4
 - in programs, 12–4

- Algebraic mode, 1–10
- ALL format. See display format
 - in equations, 6–5
 - in programs, 12–6
 - setting, 1–20
- alpha characters, 1–3
- angles
 - between vectors, 15–1
 - converting format, 4–13
 - converting units, 4–13
 - implied units, 4–4, A–2
- angular mode, 4–4, A–2, B–3
- annunciators
 - alpha, 1–3
 - battery, 1–1, A–2
 - descriptions, 1–11
 - flags, 13–11
 - list of, 1–7
 - low–power, 1–1, A–2
 - shift keys, 1–2
- answers to questions, A–1
- arithmetic
 - binary, 10–2
 - general procedure, 1–16
 - hexadecimal, 10–2
 - intermediate results, 2–11
 - long calculations, 2–11
 - octal, 10–2
 - order of calculation, 2–13
 - stack operation, 2–4, 9–1
- assignment equations, 6–9, 6–10, 6–11, 7–1

asymptotes of functions, D-8

B

backspace key

- canceling VIEW, 3-3
- clearing messages, 1-5, F-1
- clearing X-register, 2-2, 2-6
- deleting program lines, 12-18
- equation entry, 1-5, 6-8
- leaving menus, 1-5, 1-9
- operation, 1-5
- program entry, 12-6
- starts editing, 6-8, 12-6, 12-18

balance (finance), 17-1

base

- affects display, 10-4
- arithmetic, 10-2
- converting, 10-1
- default, B-3
- programs, 12-22
- setting, 10-1, 14-11

base mode

- default, B-3
- equations, 6-5, 6-10, 12-22
- fractions, 5-2
- programming, 12-22
- setting, 12-22, 14-11

batteries, 1-1, A-2

Bessel function, 8-2

best-fit regression, 11-7, 16-1

BIN annunciator, 10-1

binary numbers. *See* numbers

- arithmetic, 10-2
- converting to, 10-1
- range of, 10-5
- scrolling, 10-6
- typing, 10-1

viewing all digits, 3-3, 10-6

borrower (finance), 17-1

branching, 13-2, 13-16, 14-7

C

%CHG arguments, 4-7

C

- adjusting contrast, 1-1
- canceling prompts, 1-5, 6-13, 12-13
- canceling VIEW, 3-3
- clearing messages, 1-5, F-1
- clearing X-register, 2-2, 2-6
- interrupting programs, 12-17
- leaving catalogs, 1-5, 3-3
- leaving Equation mode, 6-3, 6-4
- leaving menus, 1-5, 1-9
- leaving Program mode, 12-6
- on and off, 1-1
- operation, 1-5
- stopping integration, 8-2, 14-8
- stopping SOLVE, 7-7, 14-1

CMPLX, 9-1, 9-2

/c value, 5-5, B-3, B-6

calculator

- adjusting contrast, 1-1
- default settings, B-3
- environmental limits, A-2
- questions about, A-1
- resetting, A-4, B-2
- self-test, A-5
- shorting contacts, A-4
- testing operation, A-4, A-5
- turning on and off, 1-1

cash flows, 17-1

catalogs

- leaving, 1-5

- program, 1–24, 12–20
 - using, 1–24
 - variable, 1–24, 3–3
- chain calculations, 2–11
- change–percentage functions, 4–6
- changing sign of numbers, 1–14, 1–17, 9–3
- checksums
 - equations, 6–18, 12–6, 12–21
 - programs, 12–20
- CLEAR menu, 1–6
- clearing
 - equations, 6–8
 - general information, 1–5
 - memory, 1–24, A–1
 - messages, 1–23
 - numbers, 1–14, 1–16
 - programs, 1–24, 12–20
 - statistics registers, 11–2, 11–11
 - variables, 1–24, 3–3, 3–4
 - X-register, 2–2, 2–6
- clearing memory, A–4, B–3
- combinations, 4–14
- commas (in numbers), 1–18, A–1
- comparison tests, 13–7
- complex numbers
 - coordinate systems, 9–5
 - entering, 9–1
 - on stack, 9–1
 - operations, 9–1, 9–2
 - polynomial roots, 15–20
 - viewing, 9–1
- conditional tests, 13–6, 13–7, 13–8, 13–11, 13–17
- constant (filling stack), 2–6
- Continuous Memory, 1–1
- contrast adjustment, 1–1

- conversion functions, 4–9
- conversions
 - angle format, 4–13
 - angle units, 4–13
 - coordinates, 4–9, 9–5, 15–1
 - length units, 4–13
 - mass units, 4–13
 - number bases, 10–1
 - temperature units, 4–13
 - time format, 4–12
 - volume units, 4–13
- coordinates
 - converting, 4–5, 4–9, 15–1
 - transforming, 15–32
- correlation coefficient, 11–7, 16–1
- cosine (trig), 4–4, 9–3
- cross product, 15–1
- cubic equation, 15–20
- curve fitting, 11–8, 16–1

D

- Decimal mode. See base mode
- decimal point, 1–18, A–1
- degrees
 - angle units, 4–4, A–2
 - converting to radians, 4–13
- denominators
 - controlling, 5–5, 13–9, 13–14
 - range of, 1–22, 5–1, 5–2
 - setting maximum, 5–4
- digit–entry cursor
 - backspacing, 1–5, 6–8, 12–6
 - in equations, 6–5
 - in programs, 12–6
 - meaning, 1–15
- discontinuities of functions, D–5
- display

adjusting contrast, 1-1
annunciators, 1-11
function names in, 4-17
X-register shown, 2-2

display format

- affects integration, 8-2, 8-5, 8-7
- affects numbers, 1-19
- affects rounding, 4-16
- default, B-3
- periods and commas in, 1-18, A-1
- setting, 1-19, A-1

DISPLAY menu, 1-19

do if true, 13-6, 14-6

dot product, 15-1

DSE, 13-18

E

ENTER

clearing stack, 2-5

copying viewed variable, 12-14

duplicating numbers, 2-6

ending equations, 6-4, 6-8, 12-6

evaluating equations, 6-10

separating numbers, 1-16, 1-17, 2-5

stack operation, 2-5

E (exponent), 1-15

E in numbers, 1-14, 1-20, A-1

ENG format, 1-20. *See also* display format

EQN annunciator

- in equation list, 6-4, 6-6
- in Program mode, 12-6

EQN LIST TOP, 6-7, F-1

equality equations, 6-9, 6-10, 7-1

equation list

- adding to, 6-4
- displaying, 6-6
- editing, 6-8
- EQN** annunciator, 6-4
- in Equation mode, 6-3
- operation summary, 6-3

Equation mode

- backspacing, 1-5, 6-8
- during program entry, 12-6
- leaving, 1-5, 6-3
- shows equation list, 6-3
- starting, 6-3, 6-6

equation-entry cursor

- backspacing, 1-5, 6-8, 12-19
- operation, 6-5

equations

- and fractions, 5-8
- as applications, 17-1
- base mode, 6-5, 6-10, 12-22
- checksums, 6-18, 12-6, 12-21
- compared to ALG, 12-4
- compared to RPN, 12-4
- controlling evaluation, 13-10
- deleting, 1-6, 6-8
- deleting in programs, 12-6, 12-18
- displaying, 6-6
- displaying in programs, 12-14, 12-16, 13-10
- editing, 1-5, 6-8
- editing in programs, 12-6, 12-18
- entering, 6-4, 6-8
- entering in programs, 12-6
- evaluating, 6-9, 6-10, 6-12, 7-6, 12-4, 13-10

functions, 6-5, 6-15, G-1
in programs, 12-4, 12-6,
12-21, 13-10
integrating, 8-2
lengths, 6-18, 12-6, B-2
list of. See equation list
long, 6-7
memory in, 12-14
multiple roots, 7-8
no root, 7-6
numbers in, 6-5
numeric value of, 6-9, 6-10, 7-1,
7-5, 12-4
operation summary, 6-3
parentheses, 6-5, 6-6, 6-14
polynomial, 15-20
precedence of operators, 6-13
prompt for values, 6-10, 6-12
prompting in programs, 13-10,
14-1, 14-8
roots, 7-1
scrolling, 6-7, 12-6, 12-14
simultaneous, 15-12
solving, 7-1, D-1
stack usage, 6-11
storing variable value, 6-11
syntax, 6-13, 6-18, 12-14
TVM equation, 17-1
types of, 6-9
uses, 6-1
variables in, 6-3, 7-1
with (i), 13-24
error messages, F-1
errors
clearing, 1-5
correcting, 2-7, F-1
estimation (statistical), 11-7, 16-1
executing programs, 12-9

exponential curve fitting, 16-1
exponential functions, 1-15, 4-1,
9-3
exponents of ten, 1-14, 1-15
expression equations, 6-9, 6-10,
7-1

F

∫FN. See integration

FDISP

not programmable, 5-9
toggles display mode, 1-23, 5-1,
A-2
toggles flag, 13-9
factorial function, 4-14
financial calculations, 17-1
FIX format, 1-19. See also display
format
flags
annunciators, 13-11
clearing, 13-11
default states, 13-8, B-3
equation evaluation, 13-10
equation prompting, 13-10
fraction display, 5-6, 13-9
meanings, 13-8
operations, 13-11
overflow, 13-9
setting, 13-11
testing, 13-8, 13-11
unassigned, 13-9
flow diagrams, 13-2
FN=
in programs, 14-6, 14-9
integrating programs, 14-8
solving programs, 14-1

fractional-part function, 4-16

Fraction-display mode

affects rounding, 5-7

affects VIEW, 12-13

setting, 1-23, 5-1, A-2

fractions

accuracy indicator, 5-2, 5-3

and equations, 5-8

and programs, 5-8, 12-13,

13-9

base 10 only, 5-2

calculating with, 5-1

denominators, 1-22, 5-4, 5-5,

13-9, 13-14

displaying, 1-23, 5-1, 5-2, 5-4,

A-2

flags, 5-6, 13-9

formats, 5-5

not statistics registers, 5-2

reducing, 5-2, 5-5

rounding, 5-7

round-off, 5-7

setting format, 5-5, 13-9,

13-14

showing integer digits, 5-4

typing, 1-21, 5-1

functions

in equations, 6-5, 6-15

in programs, 12-6

list of, G-1

names in display, 4-17, 12-7

nonprogrammable, 12-22

one-number, 1-17, 2-8, 9-2

real-number, 4-1

two-number, 1-17, 2-8, 9-3

future balance (finance), 17-1

G

GTO

finds PRGM TOP, 12-5, 12-19,
13-6

finds program labels, 12-9,
12-19, 13-5

finds program lines, 12-18,
12-19, 13-5

gamma function, 4-14

go to. See GTO

grads (angle units), 4-4, A-2

Grandma Hinkle, 11-7

Greatest integer, 4-16

grouped standard deviation, 16-17

GTO, 13-4, 13-17

guesses (for SOLVE), 7-2, 7-5, 7-7,
7-10, 14-6

H

help about calculator, A-1

HEX annunciator, 10-1

hex numbers. See numbers

arithmetic, 10-2

converting to, 10-1

range of, 10-5

typing, 10-1

hexadecimal numbers. See hex
numbers

Horner's method, 12-23

humidity limits for calculator, A-2

hyperbolic functions, 4-6

I

i, 3-7, 13-20

(i), 3-7, 13-20, 13-21, 13-24

imaginary part (complex numbers),
9-1, 9-2
indirect addressing, 13-20, 13-21,
13-22

INPUT

always prompts, 13-10
entering program data, 12-11
in integration programs, 14-8
in SOLVE programs, 14-2
responding to, 12-13

integer-part function, 4-16

integration

accuracy, 8-2, 8-5, 8-6, E-1
base mode, 12-22, 14-11
difficult functions, E-2, E-7
display format, 8-2, 8-6, 8-7
evaluating programs, 14-7
how it works, E-1
in programs, 14-9
interrupting, B-2
limits of, 8-2, 14-8, C-8, E-7
memory usage, 8-2, B-2
purpose, 8-1
restrictions, 14-11
results on stack, 8-2, 8-6
stopping, 8-2, 14-8
subintervals, E-7
time required, 8-6, E-7
transforming variables, E-9
uncertainty of result, 8-2, 8-5,
8-6, E-2
using, 8-2, C-8
variable of, 8-2, C-8

intercept (curve-fit), 11-7, 16-1

interest (finance), 17-3

intermediate results, 2-11

inverse function, 1-17, 9-3

inverse hyperbolic functions, 4-6

inverse trigonometric functions, 4-4

inverse-normal distribution, 16-11

ISG, 13-18

K

keys

alpha, 1-3
letters, 1-3
shifted, 1-3

L

LAST X register, 2-7, B-6

LASTx function, 2-7

lender (finance), 17-1

length conversions, 4-13

letter keys, 1-3

limits of integration, 8-2, 14-8, C-8

linear regression (estimation), 11-7,
16-1

logarithmic curve fitting, 16-1

logarithmic functions, 4-1, 9-3

loop counter, 13-18, 13-22

looping, 13-16, 13-17

Łukasiewicz, 2-1

M

MEM

program catalog, 1-24, 12-20

reviews memory, 1-24

variable catalog, 1-24, 3-3

mantissa, 1-15, 1-21

mass conversions, 4-13

math

complex-number, 9-1

general procedure, 1-16

intermediate results, 2-11

long calculations, 2-11

- order of calculation, 2-13
 - real-number, 4-1
 - stack operation, 2-4, 9-1
- matrix inversion, 15-12
- maximum of function, D-8
- mean menu, 11-4
- means (statistics)
 - calculating, 11-4
 - normal distribution, 16-11
- memory
 - amount available, 1-24
 - clearing, 1-6, 1-24, A-1, A-4, B-1, B-3
 - clearing equations, 6-8
 - clearing programs, 1-24, 12-5, 12-20
 - clearing statistics registers, 11-2, 11-11
 - clearing variables, 1-24, 3-4
 - deallocating, B-2
 - full, A-1
 - maintained while off, 1-1
 - programs, 12-19, B-2
 - size, 1-24, B-1
 - stack, 2-1
 - statistics registers, 11-11
 - usage, B-1
 - variables, 3-4
- MEMORY CLEAR, A-4, B-3, F-2
- MEMORY FULL, B-1, F-2
- menu keys, 1-7
- menus
 - example of using, 1-9
 - general operation, 1-7
 - leaving, 1-5, 1-9
 - list of, 1-7
- messages

- clearing, 1-5, 1-23
- displaying, 12-14, 12-16
- in equations, 12-14
- responding to, 1-23, F-1
- summary of, F-1
- minimum of function, D-8
- modes. See angular mode, base mode, Equation mode, Fraction-display mode, Program-entry mode
- MODES menu
 - angular mode, 4-4
 - setting radix, 1-18
- money (finance), 17-1

N

- negative numbers, 1-14, 9-3, 10-4
- nested routines, 13-3, 14-11
- normal distribution, 16-11
- numbers. See binary numbers, hex numbers, octal numbers, variables
 - bases, 10-1, 12-22
 - changing sign of, 1-14, 1-17, 9-3
 - clearing, 1-5, 1-6, 1-14, 1-16
 - complex, 9-1
 - decimal places, 1-19
 - display format, 1-19, 10-4
 - doing arithmetic, 1-16
 - E in, 1-14, 1-15, A-1
 - editing, 1-5, 1-14, 1-16
 - exchanging, 2-4
 - finding parts of, 4-16
 - fractions in, 1-21, 5-1
 - in equations, 6-5
 - in programs, 12-6

internal representation, 1-19,
10-4
large and small, 1-14, 1-16
limitations, 1-14
mantissa, 1-15
negative, 1-14, 9-3, 10-4
order in calculations, 1-18
periods and commas in, 1-18,
A-1
precision, 1-19, D-13
prime, 17-6
range of, 1-16, 10-5
real, 4-1, 8-1
recalling, 3-2
reusing, 2-6, 2-9
rounding, 4-16
showing all digits, 1-21
storing, 3-2
truncating, 10-4
typing, 1-14, 1-15, 10-1

O

OFF, 1-1

OCT annunciator, 10-1

octal numbers. *See* numbers

arithmetic, 10-2
converting to, 10-1
range of, 10-5
typing, 10-1

one-variable statistics, 11-2

overflow

flags, 13-9, F-3
result of calculation, 1-16, 10-3,
10-5
setting response, 13-9, F-3
testing occurrence, 13-9

P

π , A-2

parentheses

in arithmetic, 2-11
in equations, 6-5, 6-6, 6-14

pause. *See* PSE

payment (finance), 17-1

percentage functions, 4-6

periods (in numbers), 1-18, A-1

permutations, 4-14

Physics constants, 4-8

polar-to-rectangular coordinate
conversion, 4-10, 9-5, 15-1

poles of functions, D-5

polynomials, 12-23, 15-20

population standard deviations,
11-6

power annunciator, 1-1, A-2

power curve fitting, 16-1

power functions, 1-15, 4-2, 9-3

precedence (equation operators),
6-13

precision (numbers), 1-19, 1-21,
D-13

present value. *See* financial
calculations

PRGM TOP, 12-4, 12-6, 12-19,
F-3

prime number generator, 17-6

probability

functions, 4-14
normal distribution, 16-11

program catalog, 1-24, 12-20

program labels

branching to, 13-2, 13-4,
13-16

- checksums, 12-21
- clearing, 12-5
- duplicate, 12-5
- entering, 12-3, 12-5
- executing, 12-9
- indirect addressing, 13-20,
13-21, 13-22
- moving to, 12-10, 12-19
- purpose, 12-3
- typing name, 1-3
- viewing, 12-20
- program lines. *See* programs
- program names. *See* program labels
- program pointer, 12-5, 12-10,
12-17, 12-19, B-3
- Program-entry mode, 1-5, 12-5
- programs. *See* program labels
 - ALG operations, 12-4
 - base mode, 12-22
 - branching, 13-2, 13-4, 13-6,
13-16
 - calculations in, 12-12
 - calling routines, 13-2, 13-3
 - catalog of, 1-24, 12-20
 - checksums, 12-20, 12-21, B-2
 - clearing, 12-5, 12-20
 - clearing all, 12-5, 12-21
 - comparison tests, 13-7
 - conditional tests, 13-7, 13-8,
13-11, 13-17, 14-6
 - data input, 12-4, 12-11, 12-13
 - data output, 12-4, 12-13,
12-16
 - deleting, 1-24
 - deleting all, 1-6
 - deleting equations, 12-6, 12-18
 - deleting lines, 12-18
 - designing, 12-3, 13-1
 - editing, 1-5, 12-6, 12-18
 - editing equations, 12-6, 12-18
 - entering, 12-5
 - equation evaluation, 13-10
 - equation prompting, 13-10
 - equations in, 12-4, 12-6
 - errors in, 12-17
 - executing, 12-9
 - flags, 13-8, 13-11
 - for integration, 14-7
 - for SOLVE, 14-1, D-1
 - fractions with, 5-8, 12-13, 13-9
 - functions not allowed, 12-22
 - indirect addressing, 13-20,
13-21, 13-22
 - inserting lines, 12-5, 12-18
 - interrupting, 12-17
 - lengths, 12-20, 12-21, B-2
 - line numbers, 12-18, 12-19
 - loop counter, 13-18
 - looping, 13-16, 13-17
 - memory usage, 12-20
 - messages in, 12-14, 12-16
 - moving through, 12-10
 - not stopping, 12-16
 - numbers in, 12-6
 - pausing, 12-17
 - prompting for data, 12-11
 - purpose, 12-1
 - resuming, 12-14
 - return at end, 12-3
 - routines, 13-1
 - RPN operations, 12-4
 - running, 12-9
 - showing long number, 12-6
 - stepping through, 12-9
 - stopping, 12-13, 12-14, 12-17
 - techniques, 13-1

testing, 12–9
using integration, 14–9
using SOLVE, 14–6
variables in, 12–11, 14–1, 14–7

prompts

affect stack, 6–13, 12–12
clearing, 1–5, 6–13, 12–13
equations, 6–12
INPUT, 12–11, 12–13, 14–2,
14–8
programmed equations, 13–10,
14–1, 14–8
responding to, 6–12, 12–13
showing hidden digits, 6–13

PSE

pausing programs, 12–11,
12–17, 14–10
preventing program stops, 13–10

Q

quadratic equations, 15–21
questions, A–1
quotient and remainder of division,
4–2

R

R/S

ending prompts, 6–10, 6–13,
7–2, 12–13
interrupting programs, 12–17
resuming programs, 12–14,
12–17
running programs, 12–20
stopping integration, 8–2, 14–8
stopping SOLVE, 7–7, 14–1
R↓ and R↑, 2–3, C–6
radians

angle unit, 4–4
angle units, A–2
converting to degrees, 4–13
radix mark, 1–18, A–1
random numbers, 4–14, B–3
RCL, 3–2, 12–12
RCL arithmetic, 3–5, B–6
real numbers
integration with, 8–1
operations, 4–1
SOLVE with, 14–2
real part (complex numbers), 9–1,
9–2
recall arithmetic, 3–5, B–6
rectangular-to-polar coordinate
conversion, 4–10, 9–5, 15–1
regression (linear), 11–7, 16–1
resetting the calculator, A–4, B–2
return (program). See programs
Reverse Polish Notation. See RPN
rolling the stack, 2–3, C–6
root functions, 4–3
roots. See SOLVE
checking, 7–6, D–3
in programs, 14–6
multiple, 7–8
none found, 7–6, D–8
of equations, 7–1
of programs, 14–1
polynomial, 15–20
quadratic, 15–21
rounding
fractions, 5–7, 12–17
numbers, 4–16
round-off
fractions, 5–7
integration, 8–5

SOLVE, D-13
statistics, 11-9
trig functions, 4-4

routines
calling, 13-2
nesting, 13-3, 14-11
parts of programs, 13-1

RPN
compared to equations, 12-4
in programs, 12-4
origins, 2-1

running programs, 12-9

S

SHOW

equation checksums, 6-18, B-2
equation lengths, 6-18, B-2
fraction digits, 5-4
number digits, 1-21, 12-6
program checksums, 12-20, B-2
program lengths, 12-20, B-2
prompt digits, 6-13
variable digits, 3-3, 12-13

SPACE

sample standard deviations, 11-6

SCI format. See display format
in programs, 12-6
setting, 1-19

scrolling
binary numbers, 10-6
equations, 6-7, 12-6, 12-14

seed (random number), 4-14

self-test (calculator), A-5

shift keys, 1-3

sign (of numbers), 1-14, 1-17, 9-3,
10-4

sign conventions (finance), 17-1

Sign value, 4-16

simultaneous equations, 15-12

sine (trig), 4-4, 9-3, A-2

single-step execution, 12-9

slope (curve-fit), 11-7, 16-1

SOLVE
asymptotes, D-8
base mode, 12-22, 14-11
checking results, 7-6, D-3
discontinuity, D-5
evaluating equations, 7-1, 7-6
evaluating programs, 14-1
flat regions, D-8
how it works, 7-5, D-1
in programs, 14-6
initial guesses, 7-2, 7-5, 7-7,
7-10, 14-6
interrupting, B-2
memory usage, B-2
minimum or maximum, D-8
multiple roots, 7-8
no restrictions, 14-11
no root found, 7-6, 14-6, D-8
pole, D-5
purpose, 7-1
real numbers, 14-2
results on stack, 7-2, 7-6, D-3
resuming, 14-1
round-off, D-13
stopping, 7-2, 7-7
underflow, D-14
using, 7-1

square function, 1-17, 4-2

square-root function, 1-17

stack. See stack lift
affected by prompts, 6-13,
12-12
complex numbers, 9-1

- effect of **ENTER**, 2–5
 - equation usage, 6–11
 - exchanging with variables, 3–6
 - exchanging X and Y, 2–4
 - filling with constant, 2–6
 - long calculations, 2–11
 - operation, 2–1, 2–4, 9–1
 - program calculations, 12–12
 - program input, 12–11
 - program output, 12–11
 - purpose, 2–1, 2–2
 - registers, 2–1
 - reviewing, 2–3, C–6
 - rolling, 2–3, C–6
 - separate from variables, 3–2
 - size limit, 2–4, 9–1
 - unaffected by **VIEW**, 12–14
 - stack lift. *See* stack
 - default state, B–3
 - disabling, B–4
 - enabling, B–4
 - not affecting, B–4
 - operation, 2–4
 - standard deviations
 - calculating, 11–6, 11–7
 - grouped data, 16–17
 - normal distribution, 16–11
 - standard-deviation menu, 11–6
 - statistical data. *See* statistics
 - registers
 - clearing, 1–6, 11–2
 - correcting, 11–2
 - entering, 11–1
 - initializing, 11–2
 - one-variable, 11–2
 - precision, 11–9
 - sums of variables, 11–10
 - two-variable, 11–2
 - statistics
 - calculating, 11–4
 - curve fitting, 11–8, 16–1
 - distributions, 16–11
 - grouped data, 16–17
 - one-variable data, 11–2
 - operations, 11–1
 - two-variable data, 11–2
 - statistics menus, 11–1, 11–4
 - statistics registers. *See* statistical data
 - accessing, 11–11
 - clearing, 1–6, 11–2, 11–11
 - contain summations, 11–1, 11–10, 11–11
 - correcting data, 11–2
 - initializing, 11–2
 - memory, 11–11
 - no fractions, 5–2
 - viewing, 11–11
 - STO**, 3–2, 12–11
 - STO** arithmetic, 3–4
 - STOP**, 12–17
 - storage arithmetic, 3–4
 - subroutines. *See* routines
 - sums of statistical variables, 11–10
 - syntax (equations), 6–13, 6–18, 12–14
- ## T
- tangent (trig), 4–4, 9–3, A–2
 - temperatures
 - converting units, 4–13
 - limits for calculator, A–2
 - test menus, 13–7
 - testing the calculator, A–4, A–5
 - time formats, 4–12

time value of money, 17-1
transforming coordinates, 15-32
T-register, 2-4
trigonometric functions, 4-4, 9-3
troubleshooting, A-4, A-5
turning on and off, 1-1
TVM, 17-1
twos complement, 10-2, 10-4
two-variable statistics, 11-2

U

uncertainty (integration), 8-2, 8-5,
8-6
underflow, D-14
units conversions, 4-13

V

variable catalog, 1-24, 3-3
variables
 arithmetic inside, 3-4
 catalog of, 1-24, 3-3
 clearing, 1-24, 3-3, 3-4
 clearing all, 1-6, 3-4
 clearing while viewing, 12-13
 default, B-3
 exchanging with X, 3-6
 in equations, 6-3, 7-1
 in programs, 12-11, 14-1,
 14-7
 indirect addressing, 13-20,
 13-21
 names, 3-1
 number storage, 3-1
 of integration, 8-2, 14-7, C-8
 polynomials, 12-23
 program input, 12-12
 program output, 12-13, 12-16

recalling, 3-2, 3-3
separate from stack, 3-2
showing all digits, 3-3, 12-13
solving for, 7-1, 14-1, 14-6,
D-1
storing, 3-2
storing from equation, 6-11
typing name, 1-3
viewing, 3-3, 12-13, 12-16

vectors

application program, 15-1
coordinate conversions, 4-11,
9-6, 15-1
operations, 15-1

VIEW

displaying program data, 12-13,
12-16, 14-6
displaying variables, 3-3
no stack effect, 12-14
stopping programs, 12-13

volume conversions, 4-13

W

weight conversions, 4-13
weighted means, 11-4
windows (binary numbers), 10-6

X

XEQ

evaluating equations, 6-10,
6-12
running programs, 12-9, 12-20

X ROOT arguments, 6-16

X-register

affected by prompts, 6-13
arithmetic with variables, 3-4
clearing, 1-6, 2-2, 2-6

clearing in programs, 12–6
displayed, 2–2
during programs pause, 12–17
exchanging with variables, 3–6
exchanging with Y, 2–4

not clearing, 2–5
part of stack, 2–1
testing, 13–7
unaffected by VIEW, 12–14