

REGULATIONS
GOVERNING LICENSURE
OF
CHILD CARE
FACILITIES

Mississippi State Department of Health

www.HealthyMS.com

1-866-HLTHY4U

1-866-458-4948

Child Care Facilities Licensure Division
Post Office Box 1700
Jackson, MS 39215-1700
Phone: (601) 364-2827 FAX: (601) 364-5058

Amended: October 9, 2019, Effective January 1, 2020

THIS PAGE INTENTIONALLY LEFT BLANK

***IMPORTANT PHONE NUMBERS
&
OTHER INFORMATION****

MISSISSIPPI DEPARTMENT OF CHILD PROTECTION SERVICES (MDCPS)

CHILD ABUSE HOT LINE (TOLL FREE) 1-800-222-8000

**MISSISSIPPI STATE DEPARTMENT OF HEALTH
CHILD CARE FACILITIES LICENSURE DIVISION**

CHILD CARE LICENSURE COMPLAINT HOT LINE (TOLL FREE) 1-866-489-8734

MSDH LICENSING OFFICIALS:

DISTRICT I LICENSING OFFICIAL Senatobia (Tate Co) (O) 662-562-4428 (Fax) 662-562-0654

DISTRICT II LICENSING OFFICIAL Pontotoc (Pontotoc Co) (O) 662-489-8916 (Fax) 662-489-7181
Tupelo (Lee Co) (O) 662-841-7870 (Fax) 662-841-9121
Booneville (Prentiss Co) (O) 662-728-3518 (Fax) 662-728-2005

DISTRICT III LICENSING OFFICIAL Greenwood (Leflore Co) (O) 662-455-9429 (Fax) 662-455-9448
Greenville (Washington Co) (O) 662-332-8177 (Fax) 662-378-2620
Indianola (Sunflower Co) (O) 662-887-4951 (Fax) 662-887-4999

DISTRICT IV LICENSING OFFICIAL Starkville (Oktibbeha Co) (O) 662-323-2024 (Fax) 662-323-6313
Columbus (O) 662-368-2032 (Fax) 662-241-7680

DISTRICT V LICENSING OFFICIAL Jackson (O) 601-364-2827 (Fax) 601-364-5058

DISTRICT VI LICENSING OFFICIAL Meridian (O) 601-693-2451 (Fax) 601-484-5013

DISTRICT VII LICENSING OFFICIAL McComb (Pike Co) (O) 601-684-9411 (Fax) 684-0752
..... Monticello (Lawrence Co) (O) 601-587-2561

DISTRICT VIII LICENSING OFFICIAL Ellisville (Jones Co) (O) 601-426-3258 (Fax) 601-425-1080
..... Columbia (Marion Co) (O) 601-736-2676 (Fax) 601-231-2417

DISTRICT IX LICENSING OFFICIAL Gulfport (Harrison Co) (O) 228-575-4093 (Fax) 228-575-0495
Pascagoula (Jackson Co) (O) 228-762-1117 (Fax) 228-762-5934

Other Important Numbers and Information

MDHS EARLY CHILDHOOD CARE & DEVELOPMENT website	https://www.mdhs.ms.gov/early-childhood-care-development/
CHILD DEVELOPMENT ASSOCIATE CREDENTIAL (CDA) Offered by the Council for Early Childhood Professional Recognition.....	1-800-424-4310
Council for Early Childhood Professional Recognition website.....	https://www.cdacouncil.org/
USDA CHILD & ADULT CARE FOOD PROGRAM.....	601-576-5000
EARLY CHILDHOOD ACADEMY	601-432-6138
EARLY CHILDHOOD ACADEMY website	https://www.mccb.edu/offices/ECA
MSDH CHILD CARE and YOUTH CAMP LICENSURE website	https://msdh.ms.gov/msdhsite/_static/30,0,183.html
MSDH CHILD CARE LICENSURE RESOURCE GUIDE for CHILD CARE PROVIDERS	https://msdh.ms.gov/msdhsite/_static/resources/7800.pdf
MSDH CHILD CARE LICENSURE COURSE CATALOG	https://msdh.ms.gov/msdhsite/_static/resources/7841.pdf
MSDH CHILD CARE LICENSURE TRAINING CALENDAR	http://msdh.ms.gov/WebCalendar/mainCal.cfm?catids=39&CalendarTitle=Childcare+Training

***This contact information is being provided as a public service and is not part of *Regulations Governing the Licensure of Child Care Facilities*. The information provided may be updated from time to time.**

Title 15: Mississippi State Department of Health

Part 11: Bureau of Child Care Facilities

Subpart 55: Child Care Facilities Licensure

CHAPTER 1: REGULATIONS GOVERNING LICENSURE OF CHILD CARE FACILITIES

Table of Contents

Subchapter 1: GENERAL..... 1

Rule 1.1.1 Legal Authority..... 1

Rule 1.1.2 Purpose 1

Rule 1.1.3 Severability 2

Rule 1.1.4 Definitions 2

Subchapter 2: LICENSURE 5

Rule 1.2.1 Requirement for Licensure..... 5

Rule 1.2.2 Types of Licenses..... 5

Rule 1.2.3 Application for License..... 8

Rule 1.2.4 License Fee 9

Rule 1.2.5 Certificate of Inspection by Fire Department..... 10

Rule 1.2.6 Inspection 10

Rule 1.2.7 Record of Inspection..... 10

Rule 1.2.8 Renewal of License 10

Rule 1.2.9 License Not Transferable or Assignable..... 11

Rule 1.2.10 Display of Licenses..... 11

Subchapter 3: RIGHT OF ENTRY AND VIOLATIONS 13

Rule 1.3.1 Right of Entry..... 13

Rule 1.3.2 Violations 13

Subchapter 4:	FACILITY POLICY AND PROCEDURES	15
Rule 1.4.1	Parental Information	15
Rule 1.4.2	Smoking, Tobacco Products, and Prohibited Substances	17
Rule 1.4.3	Parental Access.....	18
Rule 1.4.4	Changes in Facility Operations.....	18
Rule 1.4.5	Notice of Legal Action.....	18
Rule 1.4.6	Posting of Information.....	18
Rule 1.4.7	Weapons Prohibited	19
Subchapter 5:	PERSONNEL REQUIREMENTS	21
Rule 1.5.1	General Requirements For Personnel	21
Rule 1.5.2	Criminal Record (Fingerprinting), Child Abuse Central Registry Checks, and Sex Offender Records Checks.....	21
Rule 1.5.3	Child Care Director Qualifications.....	22
Rule 1.5.4	Caregivers	23
Rule 1.5.5	Caregiver Assistants.....	24
Rule 1.5.6	Students.....	24
Rule 1.5.7	Use of Director Designee.....	25
Rule 1.5.8	Staff Development	25
Rule 1.5.9	Review by Licensing Agency	27
Subchapter 6:	RECORDS	29
Rule 1.6.1	Record	29
Rule 1.6.2	Records Retention	29
Rule 1.6.3	Facility Records	29
Rule 1.6.4	Personnel Records	30
Rule 1.6.5	Volunteer Records (120 or more hours per year)	31
Rule 1.6.6	Volunteer Records (Less than 120 hours per year)	31
Rule 1.6.7	Child Records	32

Subchapter 7: REPORTS	35
Rule 1.7.1 Serious Occurrences Involving Children.....	35
Rule 1.7.2 Child Abuse	35
Rule 1.7.3 Communicable Disease.....	35
Rule 1.7.4 Infants and Toddlers.....	35
Subchapter 8: STAFFING	37
Rule 1.8.1 General.....	37
Rule 1.8.2 Ratio	38
Rule 1.8.3 Grouping.....	39
Subchapter 9: PROGRAM OF ACTIVITIES	41
Rule 1.9.1 General.....	41
Rule 1.9.2 Daily Routines.....	41
Rule 1.9.3 Eating	41
Rule 1.9.4 Rest Periods	41
Rule 1.9.5 Outdoor Activities.....	42
Rule 1.9.6 Infant, Toddler, and Preschool Activities.....	42
Rule 1.9.7 Indoor or Outdoor Physical Activity.....	43
Subchapter 10: EQUIPMENT, TOYS, AND MATERIALS	45
Rule 1.10.1 General.....	45
Rule 1.10.2 Playground Equipment	46
Rule 1.10.3 Paint	47
Rule 1.10.4 Chairs and Tables.....	47
Rule 1.10.5 Hooks and Compartments	47
Rule 1.10.6 Sand Boxes	47
Rule 1.10.7 Cribs	47
Rule 1.10.8 High Chairs	48
Rule 1.10.9 Rest Period Equipment.....	48
Rule 1.10.10 Play Equipment.....	49
Rule 1.10.11 School Age Programs.....	49

Subchapter 11: BUILDINGS AND GROUNDS	51
Rule 1.11.1 Building.....	51
Rule 1.11.2 Indoor Square Footage.....	53
Rule 1.11.3 Openings	55
Rule 1.11.4 Kitchens.....	55
Rule 1.11.5 Toilets and Hand Washing Lavatories	56
Rule 1.11.6 Water	57
Rule 1.11.7 Exits.....	57
Rule 1.11.8 Heating, Cooling, and Ventilation.....	58
Rule 1.11.9 Outdoor Playground Area	59
Rule 1.11.10 Indoor Playground Area.....	60
Rule 1.11.11 Grounds.....	61
Rule 1.11.12 Garbage Removal.....	62
Rule 1.11.13 Environmental Health	62
Rule 1.11.14 Pest Control.....	62
Subchapter 12: HEALTH, HYGIENE, AND SAFETY	63
Rule 1.12.1 Employee Health	63
Rule 1.12.2 Child Health	63
Rule 1.12.3 Child Hygiene	64
Rule 1.12.4 Toys and Equipment.....	64
Rule 1.12.5 First Aid Supply.....	65
Rule 1.12.6 Animals and Pets.....	66
Rule 1.12.7 Fire/Disaster Evacuation Drills.....	67
Subchapter 13: NUTRITION AND MEALS	69
Rule 1.13.1 General.....	69
Rule 1.13.2 Nutritional Standards	69
Rule 1.13.3 Refreshments	69
Rule 1.13.4 Sack Lunches	69
Rule 1.13.5 Snacks.....	70
Rule 1.13.6 Food Safety and Food Manager	71

Subchapter 14: DISCIPLINE AND GUIDANCE	73
Rule 1.14.1 Prohibited Behavior	73
Rule 1.14.2 Restraint of a Child	73
Rule 1.14.3 Time Out.....	73
Rule 1.14.4 Children Shall Not Discipline Other Children	74
 Subchapter 15: TRANSPORTATION.....	 75
Rule 1.15.1 General.....	75
Rule 1.15.2 Requirements	75
Rule 1.15.3 Occupant Restraints	75
Rule 1.15.4 Staff-to-Child Ratio	76
 Subchapter 16: DIAPERING AND TOILETING	 77
Rule 1.16.1 Diaper Changing Area	77
Rule 1.16.2 Non-Disposable Diapers and Training Pants.....	77
Rule 1.16.3 Disposable Diapers.....	77
Rule 1.16.4 Potty Chairs	77
Rule 1.16.5 Hand Washing	77
Rule 1.16.6 Parental Consultation	77
 Subchapter 17: REST PERIODS	 79
Rule 1.17.1 Equipment.....	79
Rule 1.17.2 Cleaning of Linens and Bed Coverings.....	79
Rule 1.17.3 Cleaning of Rest Period Equipment.....	79
Rule 1.17.4 Sharing of Rest Period Equipment.....	79
 Subchapter 18: FEEDING OF INFANTS AND TODDLERS	 81
Rule 1.18.1 Hand Washing	81
Rule 1.18.2 Bottle Feeding.....	81
Rule 1.18.3 Formula Storage	81
Rule 1.18.4 Baby Food	81
Rule 1.18.5 Refrigerator.....	81
Rule 1.18.6 Heating Unit and Microwave Use.....	81

Rule 1.18.7	Breast-Feeding Accommodations and Staff Training.....	81
Subchapter 19: SWIMMING AND WATER ACTIVITIES.....		83
Rule 1.19.1	General.....	83
Rule 1.19.2	Lifeguard Supervision	83
Rule 1.19.3	Health and Safety	84
Subchapter 20: CHILDREN WITH SPECIAL NEEDS.....		87
Rule 1.20.1	Facility Adaptation	87
Rule 1.20.2	Activity Plan	87
Rule 1.20.3	Caregiver Staff Development.....	87
Rule 1.20.4	Staffing.....	87
Subchapter 21: NIGHT CARE.....		89
Rule 1.21.1	General.....	89
Rule 1.21.2	Nutrition	89
Rule 1.21.3	Sleeping.....	89
Rule 1.21.4	Bathroom Facilities	89
Subchapter 22: SCHOOL AGE CARE.....		91
Rule 1.22.1	General.....	91
Rule 1.22.2	Enrollment.....	91
Rule 1.22.3	Indoor Square Footage and Grouping	91
Rule 1.22.4	Nutrition	92
Rule 1.22.5	Transportation.....	92
Rule 1.22.6	Toilets and Hand Washing Lavatories	92
Rule 1.22.7	Playgrounds.....	93
Rule 1.22.8	After School Programs.....	93
Subchapter 23: SUMMER DAY CAMP & SCHOOL AGE PROGRAMS		95
Rule 1.23.1	General.....	95
Rule 1.23.2	Definition.....	95
Rule 1.23.3	Enrollment.....	95
Rule 1.23.4	Maximum Capacity	95
Rule 1.23.5	Summer Day Camp & School Age Program Director Qualifications	95

Rule 1.23.6	Caregiver CPR and First Aid Certification.....	96
Rule 1.23.7	Facility Record Storage	96
Rule 1.23.8	Indoor Square Footage and Grouping	96
Rule 1.23.9	Nutrition	97
Rule 1.23.10	Transportation.....	98
Rule 1.23.11	Toilets and Hand Washing Lavatories	98
Rule 1.23.12	Equipment.....	98
Rule 1.23.13	Immunization Requirements	99
Subchapter 24: HOURLY CHILD CARE		101
Rule 1.24.1	General.....	101
Rule 1.24.2	Definition.....	101
Rule 1.24.3	Facility Policy and Procedures.....	101
Rule 1.24.4	Personnel Requirements	102
Rule 1.24.5	Records and Reports.....	102
Rule 1.24.6	Health Records	102
Rule 1.24.7	Program of Activities.....	102
Rule 1.24.8	Buildings and Grounds	102
Rule 1.24.9	Nutrition	103
Rule 1.24.10	Abuse and Neglect Reports.....	104
Subchapter 25: HEARINGS, EMERGENCY SUSPENSIONS, LEGAL ACTIONS AND PENALTIES.....		105
Rule 1.25.1	Emergency Suspensions of License.....	105
Rule 1.25.2	Denial, Revocation, or Suspension of License.....	105
Rule 1.25.3	Notification	105
Rule 1.25.4	District Level Hearing for Monetary Penalties.....	106
Rule 1.25.5	State Level Hearing	106
Rule 1.25.6	Appeal.....	107
Rule 1.25.7	Injunction	107
Rule 1.25.8	Criminal Penalties.....	107
Rule 1.25.9	Violations and Penalties.....	107

Subchapter 26: RELEASE OF INFORMATION	111
Rule 1.26.1 Release of Information.....	111

APPENDICIES

Appendix A	Child Abuse and Neglect Reporting Statutes
Appendix B	Reportable Diseases
Appendix C	Nutritional Standards
Appendix D	Playground Safety Standards
Appendix E	Dishwashing Procedure
Appendix F	Hand Washing Procedure
Appendix G	Diaper Changing Procedure
Appendix H	Cleaning and Disinfection Procedures
Appendix I	Communicable Diseases/Conditions and Return to Child Care Guidelines
Appendix J	Rules and Procedures for State Level Administrative Hearings

Title 15: Mississippi State Department of Health

Part 11: Bureau of Child Care Facilities

Subpart 55: Child Care Facilities Licensure

CHAPTER 1: REGULATIONS GOVERNING LICENSURE OF CHILD CARE FACILITIES

Subchapter 1: GENERAL

Rule 1.1.1 **Legal Authority:** The "Mississippi Child Care Licensing Law," Section 43-20-1 et seq. of the Mississippi Code of 1972 provides the legal authority under which the Mississippi State Department of Health prescribes minimum regulations for child care facilities defined under the law.

Source: Miss. Code Ann. §43-20-8.

Rule 1.1.2 **Purpose:**

1. The purpose of these regulations is to protect and promote the health and safety of children in this state by providing for the licensing of child care facilities as defined herein to assure that certain minimum standards are maintained in such facilities. This policy is predicated upon the fact that a child is not capable of protecting himself, and when his parents for any reason have relinquished his care to others, there arises the probability of exposure of that child to certain risks to his health and safety that require the offsetting statutory protection of licensing. This document and its appendices constitute the "Regulations Governing the Licensure of Child Care Facilities."
2. A child care facility may exceed the minimum quality standards required in these regulations, but may not operate without meeting the minimum standards set forth in these regulations.
3. The maximum capacity of a child care facility is determined by the indoor square footage, kitchen square footage, outdoor playground area, and the number of toilets, urinals, and hand washing lavatories, with the lowest capacity determination being controlling. The maximum capacity of each room that is utilized by the children in a child care facility is calculated individually and may not be exceeded except when provided in these regulations.
4. A child care facility is subject to inspection at anytime at the discretion of the licensing agency.
5. The Mississippi State Department of Health shall maintain a complaint hotline to accommodate reporting of complaints. The department shall investigate each complaint and maintain a log of such complaints. The identity of the reporting party

shall not be disclosed to any other person than the Child Care Licensing Bureau staff unless upon order of a court of competent jurisdiction.

Source: Miss. Code Ann. §43-20-8.

Rule 1.1.3 Severability: If any provision of these regulations or the application thereof to any persons or circumstances shall be held invalid, such invalidity shall not affect the provisions or application of these regulations that can be given effect without the invalid provision or application, and to this end, the provisions of these regulations are declared severable.

Source: Miss. Code Ann. §43-20-8.

Rule 1.1.4 Definitions:

1. **Act:** The "Mississippi Child Care Licensing Law," Section 43-20-1 et seq. of the Mississippi Code of 1972.
2. **Agency Representative:** An authorized representative of the Mississippi State Department of Health.
3. **Caregiver:** A person who provides direct care, supervision, and guidance to children in a child care facility, regardless of title or occupation.
4. **Child Care Facility (Facility):** A place which provides shelter and personal care for six or more children who are not related within the third degree computed according to the civil law to the operator and who are under 13 years of age, for any part of the twenty-four hour day, whether such place be organized or operated for profit or not. The term "child care facility" includes day nurseries, day care centers, child care centers, preschool programs, and any other facility that fall within the scope of the definition set forth above.

EXEMPTIONS: To the extent provided by law, including those facilities or programs which satisfy one or more of the requirements for exemption provided in Miss. Code Ann. § 43-20-5(a), an exemption from the provisions of the Act shall be recognized by the licensing agency. Facilities or programs claiming exemption shall be required, upon the written request of the licensing agency, to provide documentation of the facts claimed to support the basis for the exemption, which documentation shall be provided within 30 days of the request by the licensing agency and shall be sworn by affidavit to be true and accurate under the penalties of perjury. However, any entity exempt from the requirements to be licensed but voluntarily chooses to obtain a license is subject to all provisions of the licensing law and these regulations.

5. **Children with Special Needs:** A child needing adaptation in a particular child care facility to access programming and the physical environment

6. **Director:** Any individual, designated by the operator, who has met minimum state requirements and who has on-site responsibility for the operation of a child care facility. This person may or may not be the operator.
7. **Director Designee:** Any individual designated to act as the director, having all responsibility and authority of a director, during the director's short-term absence. A director designee shall, at a minimum, be at least 21 years of age, have a high school diploma or GED, and 2 years paid experience in a licensed child care facility. Director Designees shall not retain sole director authority in a facility for more than 24 total hours per calendar week.

EXCEPTION: A facility may have a Director Designee serve for a maximum of 14 consecutive calendar days during a licensure year. This exception may be used once during the licensure year for allowing the director personal leave, i.e., vacation, jury duty, etc.
8. **Group:** The children assigned to a caregiver or team of caregivers, occupying an individual classroom, or well-defined physical space within a larger room.
9. **Hazardous Condition:** A situation or place that presents a possible source of injury or danger.
10. **Health:** The condition of being sound in mind and body and encompassing an individual's physical, mental, and emotional welfare.
11. **Infant:** Any child under the age of 12 months.
12. **Licensing Agency:** The Mississippi State Department of Health.
13. **Operator:** Any person, acting individually or jointly with another person or persons, who shall establish, own, operate, conduct or maintain a child care facility. The child care facility license shall be issued in the name of the operator, or if there is more than one operator, in the name of one of the operators. In the event that there is more than one operator, all statutory and regulatory provisions concerning the background checks of operators shall be equally applied to all operators of a facility, including, but not limited to, a spouse who jointly owns, operates, or maintains the child care facility regardless of which operator is named on the license.
14. **Parent:** As used in these regulations, parent shall mean custodial parent, legal guardian, foster parent, *guardian ad litem*, and other individuals or institutions to which a court of competent jurisdiction has granted legal authority over the child.
15. **Person:** Any person, firm, partnership, corporation, or association.
16. **Personal Care:** Assistance rendered by personnel of the child care facility in performing one or more of the activities of daily living, which includes but is not

limited to the feeding, personal grooming, supervising, and dressing of children placed in the child care facility.

17. **Physical Confines:** The space inside the walls of the child care facility.
18. **Safety:** The condition of being protected from hurt, injury or loss.
19. **School Age Child:** A child 5 years of age or older and eligible to be enrolled in public school.

NOTE: A child that is five (5) years old age must have turned five (5) on or before September 1 to be considered a school age child.

20. **Service Staff:** A person who provides support services such as cooking, cleaning, or driving a vehicle, but is not a caregiver.
21. **Toddler:** Any child the age of 12 months and under the age of 24 months.
22. **Usable Space:** In measuring facilities for square footage per child, usable space shall mean space measured on the inside, wall-to-wall dimensions. These spaces are exclusive of food preparation areas, kitchens, bathrooms, toilets, areas for the care of ill children, offices, staff rooms, corridors, hallways, stairways, closets, lockers, laundries, furnace rooms, fixed or permanent cabinets, fixed or permanent storage shelving spaces, and areas not inhabited and used by children. Usable space shall be areas dedicated to children's activities (play, learning, rest, and eating) and shall be utilized for those purposes on a daily basis. Furnishings shall be equipment that is both size and age appropriate for children receiving care. The space occupied by inappropriate or adult size equipment shall be deducted from the children's usable space.
23. **Volunteer:** Any person who is not an employee who is at the facility or assists with children.

Individuals who volunteer for 120 or more hours in a given licensure year shall meet the requirements of (1) criminal record and child abuse central registry checks to include being fingerprinted, and (2) valid Immunization Compliance Form #121. The facility shall document the time that a volunteer is at the facility.

Further, any individual who has not been fingerprinted, has not had a child abuse central registry check completed, and received the Letter of Suitability for Employment shall never be left alone with children.

Source: Miss. Code Ann. §43-20-8.

Subchapter 2: LICENSURE

Rule 1.2.1 Requirement for Licensure:

1. No person shall establish, own, operate, conduct, or maintain a child care facility in this state without a license issued pursuant to these regulations.
2. The licensing authority will require no entity exempt from the licensure requirement to apply for a license. However, should an exempt entity desire to obtain a license, it will be subject to these regulations.

Source: Miss. Code Ann. §43-20-8.

Rule 1.2.2 Types of Licenses:

1. **Temporary License:** The licensing agency may issue a temporary license to any child care facility. This license will allow the child care facility to operate pending the issuance of a regular license. The temporary license will reflect the date of issuance of the license, the expiration date, and the number of children for which the facility is licensed. The license issue date is the actual date documentation is received and approval for initial temporary license is granted; the expiration date is the last day of the sixth month following the issue date; examples: January 01 through June 30 or January 15 through June 30.

NOTE: Before a Temporary License is issued and the facility allowed to begin operation the following items must be submitted to and/or verified by the licensing authority, i.e., Mississippi State Department of Health:

- a. License Application and \$100.00 application fee.
- b. License fee - the amount of fee is determined by the licensed capacity of the facility.
- c. Documentation that the facility has a qualified director for the child care program that meets the standards set forth in Rule 1.5.3.
- d. “Letter of Suitability for Employment” for every employee or volunteer as appropriate that is to begin work when the facility starts operation. The “Letter of Suitability for Employment” issued by the Mississippi State Department of Health verifies that a criminal records check, sex offender registry, and child abuse central registry check has been conducted on an individual.
- e. An MSDH Immunization Form #121 for every employee or volunteer that is to begin work when the facility starts operation and/or have documentation indicating that they comply with the immunization requirements of the Mississippi State Department of Health.

- f. Valid MSDH Fire Inspection Form #333.
- g. Verification of passing an American National Standards Institute – Conference for Food Protection (ANSI-CFP) Accredited food manager training. Currently the following providers are authorized by the MSDH to provide the required training:
 - i. National Restaurant Association, Inc., i.e., ServSafe®,
 - ii. Environmental Health Testing, Inc., i.e., National Registry of Food Safety Professionals,
 - iii. Prometric, Inc., or
 - iv. Mississippi State University Extension Service, i.e., TummySafe©.

NOTE: For information on ServSafe® or TummySafe© contact the Mississippi State University Extension Service at www.msucares.com. In addition, the Mississippi Restaurant Association (MRA) also provides ServSafe® training. The MRA can be contacted at – www.msra.org. For information on the National Registry of Food Safety Professionals or Prometric, contact the MSDH Office of Environmental Health at 601-576-7690.

- h. Wastewater disposal approval.
- i. Potable water source approval - drinking water.
- j. Zoning approval.
- k. Lead Testing approval.
 - i. Building - if constructed before 1965.
 - ii. Playground.
- l. Adult, Child and Infant CPR and First Aid certification as required for a person or persons who will be present at the facility during all hours of operation.
- m. Approved Menu if applicable.
- n. Floor Plan.
- o. MSDH Maximum Capacity Worksheet (Form #28).
- p. MSDH Child Care Facility Inspection Report (Form #281).
- q. MSDH Child Care Facility Data Sheet (Form #286).

- r. MSDH Food Service Inspection (Form #301-302) - if applicable.
- s. Daily Schedule of Activities - developed by provider.
- t. Arrival and Departure Procedures - developed by provider.
- u. Emergency Policy – developed by provider.
- v. Verification of Two Emergency Relocation Sites – developed by provider.
 - i. One site must be a minimum of one mile distant from the facility.
 - ii. One site must be a minimum of five miles distant from the facility.
- w. Transportation Policy – not required if facility does not transport children.

NOTE: An emergency transportation policy is required even if the facility does not plan to transport children. An emergency transportation policy shall encompass such events as emergency evacuation of the facility and emergency transporting of a child to receive medical attention.

- x. Proof of Vehicle Insurance – not required if facility does not transport children.
- y. Verification, in writing, that the operator has or does not have accident/liability insurance covering the business.
- z. Verification, in writing, that the operator has or does not have accident/liability insurance covering the children enrolled at the facility.
- aa. Discipline Policy – developed by the provider.

NOTE: The discipline policy developed by the provider shall not allow any of the prohibited behaviors listed in Subchapter 14 of these regulations.

- bb. Verification that the owner/operator and director have completed mandatory training on:
 - i. *Regulations Governing Licensure of Child Care Facilities.*
 - ii. Directors Orientation.
 - iii. Playground Safety.

NOTE: Contact the Mississippi State Department of Health, Child Care Facilities Licensure Division at 601-364-2827 for more information on the availability and location of the above referenced training. Information on available training classes and approved training providers is listed on the MSDH

website at www.HealthyMS.com. Training classes provided by the Child Care Licensing Division are listed under the heading “MSDH Child Care Provider Training Calendar.” Other approved providers of training for child care facility operators and staff are listed under the headings “MSDH Approved Staff Development Trainers” and “Approved Child Care Staff Development Providers.”

2. **Regular License:** The licensing agency may issue a regular license when all conditions and requirements for licensure have met compliance. The duration of a regular license shall not exceed one year.
3. **Probational License:** The licensing agency may issue a probational license, at its discretion, where violations may endanger the health or safety of the children, but only when such violations may be corrected within a specified period. There shall be a written corrective action plan agreed upon between the operator and the licensing agency. The period of time for which a probational license is issued shall be at the discretion of the licensing agency but in no instance shall exceed six months.
4. **Restricted License:** The licensing agency may issue any type of license with conditions/restrictions when, at its discretion, the health or safety of the children require such a conditional/restrictive statement on the license. Such conditions/restrictions shall include but not be limited to certain individuals to be barred from the premises or any other situations that may endanger children and that should be so recorded on the license. Any violation of any such condition/restriction shall result in immediate emergency suspension of the license. When such conditions/restrictions no longer pose a threat to the children, the conditional/restrictive statement may be removed.

Source: Miss. Code Ann. §43-20-8.

Rule 1.2.3 Application for License: An application for a license under these regulations shall be made to the licensing agency upon forms provided by it and shall contain such information as the licensing agency may reasonably require.

Source: Miss. Code Ann. §43-20-8.

Rule 1.2.4 License Fee: All application fees, licensure fees, renewal fees, and administrative charges shall be paid by certified check or money order payable to the Mississippi State Department of Health, and are nonrefundable. Checks returned for insufficient funds, closed account, etc., shall be assessed an additional \$50 fee.

- 1. **Application Fee**\$130.00
- 2. **Initial Licensure Fee**
 - a. Maximum capacity 12 or fewer\$ 97.50
 - b. Maximum capacity 13 to 30\$195.00
 - c. Maximum capacity 31 to 50\$260.00
 - d. Maximum capacity 51 to 100\$390.00
 - e. Maximum capacity 101 to 150\$455.00
 - f. Maximum capacity 151 or more\$520.00
- 3. **Renewal Fee**
 - a. Maximum capacity 12 or fewer\$ 97.50
 - b. Maximum capacity 13 to 30\$195.00
 - c. Maximum capacity 31 to 50\$260.00
 - d. Maximum capacity 51 to 100\$390.00
 - e. Maximum capacity 101 to 150\$455.00
 - f. Maximum capacity 151 or more\$520.00
- 4. **Reinstatement Fee**\$260.00
- 5. **Returned Check Fee**\$ 50.00
- 6. **Late Fee**.....\$ 25.00
- 7. **Fingerprinting Fee (Per Fingerprint Card)**.....\$ 50.00

NOTE: Except for the fingerprinting fee, no governmental entity or agency that operates a child care facility shall be required to pay the fees set forth in this section. Third party

providers that contract with a state agency for the provision of child care services are subject to all fees, monetary penalties, etc. Further, should an entity exempt from licensure apply for a license it shall be subject to all fees listed in this section.

Source: Miss. Code Ann. §43-20-8.

Rule 1.2.5 Certificate of Inspection by Fire Department: A certificate of inspection and approval by the fire department of the municipality or other political subdivision in which the child care facility is located shall be submitted to the licensing agency with the application and license fees. Except that if no fire department exists where the facility is located, the State Fire Marshall shall certify as to the inspection for safety from fire hazards.

The inspection form to be used for fire inspections shall be MSDH Form #333 and shall be signed by a signatory authority of the fire inspection authority making the inspection.

Source: Miss. Code Ann. §43-20-8.

Rule 1.2.6 Inspection: An agency representative(s) shall inspect each child care facility prior to issuing or renewing a license to assure compliance with these regulations.

Source: Miss. Code Ann. §43-20-8.

Rule 1.2.7 Record of Inspection: Whenever an inspection is made of a child care facility, the findings shall be recorded on an official inspection form and furnished to the operator, director, and/or their representative, at the time the inspection is made.

Source: Miss. Code Ann. §43-20-8.

Rule 1.2.8 Renewal of License:

1. The licensing agency shall issue licenses that may be renewed annually. The licensing agency shall mail a renewal notice, at least 75 days prior to the expiration date of the license, to the address of the operator registered with the licensing agency. The operator shall:
 - a. Complete the renewal form.
 - b. Submit any and all certificates of inspection and approval required by the licensing agency.
 - c. Enclose the renewal fee.
 - d. File the above with the licensing agency at least 30 days prior to the expiration date on the license.

NOTE: Renewal applications postmarked less than 30 days prior to the expiration date of the license shall be assessed a \$25.00 late fee.

2. An operator who does not file the renewal application prior to the date that the license expires will be deemed to have allowed the license to lapse. Said license may be reinstated by the licensing agency, in its discretion, by payment of both the renewal fee and the reinstatement fee, provided said application for reinstatement is made within one month of the expiration date of the license. After the one month reinstatement period, it shall be required that an application for an initial license be submitted. All licensure requirements in effect at the time the new initial application is filed shall be met.

Source: Miss. Code Ann. §43-20-8.

Rule 1.2.9 License Not Transferable or Assignable: Each license shall be issued only for the premises and operator named in the application and shall not be transferable or assignable. A change of ownership includes, but is not limited to, inter vivo gifts, purchases, transfers, lease arrangements, cash and/or stock transactions or other comparable arrangements whenever any person or entity acquires or controls a majority interest of the child care facility or service. Changes of ownership from partnerships, single proprietorships, or corporations to another form of ownership are specifically included.

Source: Miss. Code Ann. §43-20-8.

Rule 1.2.10 Display of Licenses: The current license issued by the licensing agency to the named child care facility and operator shall be posted and displayed in a conspicuous place and in easy view of all persons who enter the child care facility. The facility operator shall also post next to the license, in plain view, a notice provided by the MSDH that informs the public of where and how they may report a complaint against the facility.

Source: Miss. Code Ann. §43-20-8.

THIS PAGE INTENTIONALLY LEFT BLANK

Subchapter 3: RIGHT OF ENTRY AND VIOLATIONS

Rule 1.3.1 Right of Entry: An agency representative may enter any child care facility for making inspections or investigations to determine compliance with these regulations.

Source: Miss. Code Ann. §43-20-8.

Rule 1.3.2 Violations: If violations noted on the inspection form are not corrected within the period specified by the licensing agency, a license may be denied, suspended, or revoked in accordance with these regulations.

Source: Miss. Code Ann. §43-20-8.

THIS PAGE INTENTIONALLY LEFT BLANK

Subchapter 4: FACILITY POLICY AND PROCEDURES

Rule 1.4.1 Parental Information: Before a child's enrollment, the parent shall be provided with the following:

1. Operating information:

- a. The child care facility's purpose, scope of service provided, philosophy, and any religious affiliation.
- b. Name(s), business phone number, business address, and home phone number of the operator, director or an individual in authority who can be reached after the facility's normal hours of operation.
- c. The phone number of the child care facility.
- d. Organization chart or other description of established lines of authority of persons responsible for the child care facility's management within the organization.
- e. The program and services provided and the ages of children accepted.
- f. The hours and days of operation and holidays or other times closed.
- g. The procedures for admission and registration of children.
- h. Tuition, plans for payment, and policies regarding delinquent payments.
- i. Types of insurance coverage for children, or a statement that accident insurance is not provided or available.
- j. If a facility does not provide liability insurance there shall be a statement in the child's record, signed by the parent indicating that the parent is aware that the facility does not carry liability insurance.
- k. Reasons/circumstances and procedures for removal of children from rolls when parents are requested by facility staff to remove a child.
- l. Procedures to include the amount of notice a parent is required to give the facility before removing a child.
- m. Policy governing the maximum hours per day or week that a child can be left at the child care facility.

2. Arrival and departure procedures for children:

- a. Procedure, approved by the licensing authority, for assuring a child's safe arrival and departure (All children shall be signed in and out of the facility by an authorized individual.).
- b. Procedures for protecting children from traffic and other hazards during arrival and departure and when crossing streets.
- c. Policy for release of children from the child care facility only to responsible persons for whom the child care facility has written authorization.
- d. Policy governing a parent picking up a child after closing hours and procedures if a child is not picked up.

3. Program and activities information:

- a. Policies and procedures about accepting and storing a child's personal belongings.
- b. Discipline policies including acceptable and unacceptable discipline measures.
- c. Transportation and safety policies and procedures.
- d. Policies prohibiting the photographing of a child without parental consent.
- e. Policies regarding a child's participation in extracurricular activities not sponsored by the child care facility, including but not limited to baseball, softball, soccer, ballet, or gymnastics.
- f. Policies regarding water activities and safety procedures. These policies shall include those water activities that take place away from the child care facility property, e.g., taking children to a public swimming pool.
- g. Policies encouraging sun safety practices and activities.

4. Health and emergency procedures:

- a. Procedures for storing and giving a child medication.
- b. Policy for reporting suspected child abuse.
- c. Provision for emergency medical care, treatment of illnesses and accidents, which include:
 - i. A plan to handle a child in a medical crisis.
 - ii. A plan to obtain prompt services of physician and hospitalization, if needed.

- iii. A plan for immediately notifying the parent of any illness, accident, or injury to the child.
- iv. A plan to acquire the services of a certified practitioner for a child exempt from medical care on religious grounds.
- d. Evacuation plan including procedures for notifying the parents of the relocation site.
- e. Policy and procedures for handling dangerous situations, including but not limited to, dealing with violent individuals, individuals entering facility with weapons, bomb threats, or conditions posing an immediate threat to children.

5. State regulations:

- a. A summary of the licensing regulations and any appendices thereto, provided by the licensing agency.
- b. Each child's record shall contain a statement signed by the child's parent, indicating that they have received a summary of licensing standards and other materials designated by the licensing agency for such distribution.
- c. The name and phone number of the MSDH licensing official responsible for the inspection of the facility.
- d. The toll free phone number (1-866-489-8734) of the Child Care Facility Complaint Hot Line.

Source: Miss. Code Ann. §43-20-8.

Rule 1.4.2 Smoking, Tobacco Products, and Prohibited Substances:

- 1. Smoking or the use of tobacco products in any form is prohibited within the physical confines or the campus of a child care facility.
- 2. The use of alcohol, illegal use of prescription drugs, or use of illegal drugs is prohibited within the physical confines or the campus of a child care facility.
- 3. Smoking or the use of tobacco products in any form, use of alcohol, illegal use of prescription drugs, or use of illegal drugs by a caregiver is prohibited anytime a child is under the care of such caregiver regardless of location. A caregiver is defined as a person who provides direct care, supervision, and guidance to children in a child care facility, regardless of title or occupation. This definition includes volunteers and parents.

Source: Miss. Code Ann. §43-20-8.

Rule 1.4.3 Parental Access: Child care facilities shall assure the parent that they have welcome access to the child care facility at all times. Welcome access shall be defined as a parent having access to areas of the facility available to his child and non-disruptive to normal daily activities.

Source: Miss. Code Ann. §43-20-8.

Rule 1.4.4 Changes in Facility Operations: The operator shall immediately notify the licensing agency of any major changes affecting areas of the child care facility's operations. Such major changes include, but are not limited to, operator, director, location, physical plant, or number of children served.

Source: Miss. Code Ann. §43-20-8.

Rule 1.4.5 Notice of Legal Action: The licensing agency shall be notified within seven days, in writing, if notice is received of legal action against the child care facility.

Source: Miss. Code Ann. §43-20-8.

Rule 1.4.6 Posting of Information: The following items shall be posted conspicuously in the child care facility at all times:

1. Accessible to employees and parents:
 - a. License.
 - b. Daily activity schedule posted in each classroom.
 - c. Menus and Food Service Permit, if applicable.
 - d. Evacuation route.
 - e. The facility operator shall also post next to the license, in plain view, a notice provided by the MSDH that informs the public of where and how they may report a complaint against the facility.
2. In kitchens:
 - a. Menus.
 - b. Evacuation route.
3. The evacuation route in all rooms utilized by children.

Source: Miss. Code Ann. §43-20-8.

Rule 1.4.7 Weapons Prohibited:

1. There shall be no firearms or other dangerous weapons allowed in a child care facility.
2. If a facility is located in an occupied dwelling, all firearms shall be equipped with trigger locks and kept in a locked room out of the sight of all children. All other dangerous weapons shall be kept under lock in a room not accessible to children.
3. Other dangerous weapons include, but are not limited to, hunting knives, spears, machetes, archery equipment, etc.

Source: Miss. Code Ann. §43-20-8.

THIS PAGE INTENTIONALLY LEFT BLANK

Subchapter 5: PERSONNEL REQUIREMENTS

Rule 1.5.1 General Requirements For Personnel:

1. Each employee or potential employee of a child care facility, whether full time, part time, temporary, substitute, or volunteer, shall be of good moral character and shall meet the minimum qualifications for the respective job classification, as set forth in these regulations.
2. Any individual who, in the opinion of the licensing authority, appears to be unable to physically or mentally care for children on a daily basis and/or in emergency situations will not be allowed to act as a caregiver or caregiver assistant. Any person whose ability is in question shall, at the request of the licensing authority, be able to demonstrate the ability to perform, at a minimum but not limited to the following:
 - a. Physical ability to exit the children during a fire drill in under two minutes.
 - b. Ability to read medication directions and properly dispense medication to children (required only if the facility dispenses medication).

Source: Miss. Code Ann. §43-20-8.

Rule 1.5.2 Criminal Record (Fingerprinting), Child Abuse Central Registry Checks, and Sex Offender Records Checks: Pursuant to Section 43-20-1 et seq., of the Mississippi Code of 1972, all operators, employees and prospective employees of a child care facility and any individual residing in a residence licensed as a child care facility shall have a criminal history records check (fingerprint), child abuse registry check and a sex offender registry check.

1. **Within ten working days from the date of employment**, the child care facility shall submit the following for processing:
 - a. **A completed fingerprint card and fees**, as appropriate, shall be submitted to the **Mississippi State Department of Health** for processing. A copy of the submitted fingerprint card, fees paid and evidence of mailing shall be maintained in the employee's personnel file until the facility receives notification from the Department (MSDH) verifying the employee's suitability for employment.

If the facility is notified that the fingerprints submitted were incomplete or of such poor quality that prevented processing, the facility shall reprint the individual and/or resubmit the necessary information within ten days of the dated letter on the notification.
 - b. **A Child Abuse Registry Form** shall be submitted to the **Department of Human Services** for processing. A copy of the submitted form and evidence of mailing shall be maintained in the employee's personnel file until the facility receives

notification from the Department (MSDH) of the employee's suitability for employment.

2. Although an individual is allowed to begin employment prior to the receiving confirmation of the employee's status for employment suitability, **at no time shall the facility allow that individual to provide unsupervised care or be left alone with a child until the facility receives notification from the Department (MSDH) verifying that employee's suitability for employment.** Each licensed child care facility with internet capabilities may electronically access, monitor, and verify the suitability status of any submitted employee through a MSDH maintained webpage: <http://www.HealthyMS.com>. (Licensed providers without electronic capabilities will receive hardcopy notification of an employee's suitability status.)
3. Upon receipt of notification, either electronically or hardcopy, that the employee has been deemed suitable for employment in a child care facility, the facility shall provide the employee the original Letter of Suitability and shall maintain a copy of the suitability letter for the facility files.

Unless otherwise voided, the letter confirming an employee's Suitability for Employment is valid for a period of **five** years. However, if there is **no break in service from the submitting licensed provider of origin and/or the same campus**, as specified on the suitability letter, the Letter of Suitability will remain valid for as long as the individual remains employed at the licensed facility of origin. The Letter of Suitability is not transferable to another program licensed by the Child Care Licensure Division after the date of expiration as specified within the suitability letter.

4. Individuals under the age of 18 are not required to be fingerprinted. However, that individual must never be left alone with children.
5. The facility shall maintain the following on any individual who volunteers in a child care facility for 120 or more hours per licensure year:
 - a. Letter of Suitability for Employment that reflects the completion of the criminal records check, child abuse registry check, and sex offender check.
 - b. Immunization Compliance Form 121.

Source: Miss. Code Ann. §43-20-8.

Rule 1.5.3 Child Care Director Qualifications: A child care director shall be least 21 years of age and shall have at a minimum:

1. A bachelor's degree in early childhood education, child development, elementary education, child care, special education, psychology (with emphasis on child

psychology), or family and consumer sciences (with emphasis on child development), or equivalent degree from another child-related field or course of study.

OR

2. A two-year associate degree from an accredited community or junior college in child development technology which must include a minimum of 480 hours of practical training, supervised by college instructors, in a college operated child care learning laboratory.

OR

3. A two-year associate degree from an accredited community or junior college in child development technology or child care and two years paid experience in a licensed child care facility.

OR

4. Two years paid experience as a caregiver in a licensed child care facility, and either (1) a current Child Development Associate (CDA) credential from the Council for Early Childhood Professional Recognition (CECPR), or (2) a Mississippi Department of Human Services (MDHS) Division of Early Childhood Care and Development (DECCD) Child Care Director's Credential or MDHS OCY Child Care Director's Credential, or (3) 24 semester hours credit with a grade of "C" or better from an accredited college or university in courses specific to early childhood.

OR

5. A verified certificate from the licensing agency certifying that the individual was qualified to be the director of a licensed child care facility prior to January 1, 2000 in the State of Mississippi.

Source: Miss. Code Ann. §43-20-8.

Rule 1.5.4 Caregivers: Caregivers shall be at least 18 years of age, and shall have at a minimum:

1. A high school diploma or equivalent (GED).

OR

2. A current CECPR Child Development Associate (CDA) credential, a MDHS DECCD Child Care Director's Credential, or MDHS OCY Director's Child Care Credential.

OR

3. Three years prior documented experience caring for children who are under 13 years of age and who are not related to the caregiver within the third degree computed according to civil law.

Staff failing to meet the requirements of education and/or experience to act as a caregiver shall be designated as caregiver assistants.

Source: Miss. Code Ann. §43-20-8.

Rule 1.5.5 Caregiver Assistants: Caregiver assistants shall be at least 16 years of age. Caregiver assistants shall work under the direct on-site supervision of a director or caregiver at all times. They shall not have the direct responsibility for a group of children as the sole caregiver. Caregiver assistants under the age of 18 shall not be given the authority to discipline children.

Source: Miss. Code Ann. §43-20-8.

Rule 1.5.6 Students:

1. Students in a field study placement, a practicum, or vocational child care training program may assist in the care of the children when the following conditions have been met.
2. Students who are 18 years of age or older and who are in a child care facility for 120 or more hours per licensure year shall have a record on file in the facility which shall contain the following:
 - a. Name, date of birth, address, and phone number.
 - b. Name and phone number of a contact person from the school or university placing the student.
 - c. Date placement began and daily record of the hours a student is present.
 - d. Mississippi State Department of Health Certificate of Immunization Compliance Form 121.
 - e. Documentation that the criminal records check (fingerprinting) and child abuse central registry check have been completed and no records found, i.e., Letter of Suitability for Employment.
 - f. Documentation of a minimum of one hour of orientation, within one week of placement, including but not limited to, the child abuse law and reporting procedures, emergency procedures, and facility discipline and transportation policies.

3. Students who are under 18 years of age and who are in a child care facility for 120 or more hours per licensure year shall have a record on file in the facility that shall contain all of the above listed material with the exception of Item e. The facility shall document the time that a student is at the facility.

No student shall be left alone with children unless an approved Letter of Suitability is on file.

Source: Miss. Code Ann. §43-20-8.

Rule 1.5.7 Use of Director Designee:

1. A director designee is an individual designated to act as the director, having all responsibility and authority of a director, during the director's short-term absence.
2. A director designee shall, at a minimum have a high school diploma or GED and two years paid experience in a licensed child care facility or licensed/accredited kindergarten program. A director designee shall not retain sole director authority in a facility for more than 24 total hours per calendar week.

EXCEPTION: Facility may have a Director Designee serve for a maximum of 14 consecutive days during a licensure year. This exception may be used once during the licensure year for allowing the director personal leave, i.e., vacation, jury duty, etc. In addition, if a Director has a medical condition (illness, recovery from surgery, accident, etc.) that requires more than 14 consecutive day's recovery time, the time a Director Designee may be utilized may be extended. The facility is responsible to notify the Child Care Division of such circumstances and provide documentation supporting the need to extend the time the Director Designee needs to be utilized. Approval of this exception is at the discretion of the Child Care Licensure Division

3. When the director designee is in charge of the facility, they shall have full access to all documents of the facility that are necessary for the licensing agency to conduct an inspection or complaint investigation. These documents shall include, but are not limited to, staff records, children's records, safety inspections, and any other material or documents required by the inspecting official.

Source: Miss. Code Ann. §43-20-8.

Rule 1.5.8 Staff Development:

1. Owners, Directors, and Director Designees - Before a new license to operate is issued, owners, directors and director designees of the child care facility shall complete mandatory training on courses covering Child Care Regulations, Director Orientation, and Playground Safety. If a new director or director designee is appointed by the child care facility after the license issuance, the mandatory training courses shall be

completed by such individual(s) within the first six months of appointment. In the sole discretion of the licensing agency, mandatory training may be waived upon the submission of documentation of the individual's prior completion of relevant training.

2. All child care staff, directors, director designees, and caregivers shall be required to complete 15 contact hours of staff development, accrued during the licensure year, annually. The National Association for the Education of Young Children (NAEYC), a leading organization in child care and early childhood education recommends annual training based on the needs of the program and the pre-service qualifications of the staff. Training should address the following:
 - a. Health and safety.
 - b. Child growth and development.
 - c. Nutrition.
 - d. Planning learning activities.
 - e. Guidance and discipline techniques.
 - f. Linkages with community services.
 - g. Communications and relations with families.
 - h. Detection of child abuse.
 - i. Advocacy for early childhood programs.
 - j. Professional issues.
3. Contact hours for staff development shall be approved by the licensing agency.
4. No more than five contact hours of approved in-service training provided by the child care facility may be counted toward the total number of hours required each year. More than five hours of in-service training may be provided by the child care facility but no more than five hours may be counted toward the required total of 15 hours.
5. All volunteers shall receive, at a minimum, one hour of orientation by the facility director. Such orientation at a minimum shall include a review of the child abuse law and reporting requirements, emergency exit procedures, and the facility transportation policy.

Source: Miss. Code Ann. §43-20-8.

Rule 1.5.9 Review by Licensing Agency:

1. The satisfaction of the personnel requirements applicable to any individual shall be determined by the licensing agency acting pursuant to its authority under applicable statutes and regulations.

2. The licensing agency, in its sole discretion, may accept suitable educational credits, programs, or degrees in lieu of those specified in Subchapter 5 upon the submission of adequate documentation by the individual.

Source: Miss. Code Ann. §43-20-8.

THIS PAGE INTENTIONALLY LEFT BLANK

Subchapter 6: RECORDS

Rule 1.6.1 Records: Records listed in this section shall be kept within the physical confines of the child care facility and shall be made available to the licensing agency on request.

Source: Miss. Code Ann. §43-20-8.

Rule 1.6.2 Records Retention:

1. All records, unless otherwise specified, shall be kept for a period of at least three years.
2. A child's records shall be retained for a period of one year after the child is no longer in attendance at the facility.

Source: Miss. Code Ann. §43-20-8.

Rule 1.6.3 Facility Records:

1. Attendance records for children and employees.
2. A current alphabetical roster of children enrolled in the child care facility, to include the child's full name and date of birth.
3. A current alphabetical roster of staff employed or volunteers in the child care facility.
4. Current license.
5. Records of monthly fire/disaster evacuation drills.
6. A record shall be maintained of any medication administered by the director or caregiver showing date, time, and signature of dispensing employee. A medication record may be destroyed 90 days after administering the medication.
7. A record shall be maintained on each volunteer to document date and number of hours of volunteer service.
8. Each facility shall maintain a notebook containing copies of the MSDH Certificate of Immunization Compliance (MSDH Form #121) for both staff and children at the facility. The notebook shall contain separate current alphabetical rosters of both staff and children. The certificates shall be filed in alphabetical order to match the current staff and child rosters.
9. Each facility shall maintain a notebook containing a copy of the Letter of Suitability for Employment from the licensing agency on all employees and, when applicable, volunteers. The notebook shall contain an alphabetical roster of staff and volunteers. Along with name, date-of-birth, the initial date of hire or volunteering must be given

for cross-reference to individual personnel/volunteer files. The Letter of Suitability for Employment shall be filed in order matching the alphabetical roster.

NOTE: Items required by 8 and 9 above may be placed within the same notebook.

Source: Miss. Code Ann. §43-20-8.

Rule 1.6.4 Personnel Records:

1. **Employee Records:** Each employee's personnel record shall contain the following:
 - a. Name, date of birth, address, and phone number.
 - b. Documentation of education, training, and experience necessary for employment.
 - c. Records of staff development accrued during each licensure year, beginning with date employed.
 - d. Date of employment and date of separation.
 - e. Mississippi State Department of Health Certificate of Immunization Compliance Form 121.
 - f. Documentation that the criminal record checks (fingerprinting), Child Abuse Central Registry checks, and Sex Offender Registry checks, have been conducted (Letter of Suitability for Employment); and the information shall be included in each employee's personnel file.

NOTE: Each person living in a private residence used as a child care facility shall meet the same requirements as employed personnel, relative to health, criminal record, fingerprinting, child abuse central registry checks, and sex offender registry checks.

- g. Documentation of orientation, within one week of being hired, including but not limited to emergency procedures (to include policies for handling dangerous situations), staffing and supervision requirements, daily schedules, physical/emotional/developmental problems of children, discipline policies, and child abuse and neglect.
- h. Upon resignation or termination, personnel records shall be kept on file and be made available to the licensing agency for at least one year after the last day of employment.

Source: Miss. Code Ann. §43-20-8.

Rule 1.6.5 Volunteer Records (120 or more hours per year): For any person who volunteers in a child care facility for 120 or more hours per licensure year, a record shall be kept which contains the following:

1. Name, date of birth, address, and phone number.
2. Documentation of education, training, and experience that may help them in their role as a volunteer.
3. Date individual began volunteering and last date individual volunteered at facility.
4. Mississippi State Department of Health Certificate of Immunization Compliance Form 121.
5. Documentation that the criminal records check (fingerprinting), child abuse central registry check, and sex offender registry check have been conducted (Letter of Suitability for Employment), and the information included in each volunteer's file.
6. Documentation of a minimum of one hour of volunteer orientation, within one week of volunteering, including but not limited to, the child abuse law and reporting requirements, emergency exit procedures, policies for handling dangerous situations, and the facility transportation policy.
7. A volunteer's record shall be retained for a period of one year after they are no longer volunteering at the facility.
8. A record shall be maintained on each volunteer to document date and number of hours of volunteer service.

Source: Miss. Code Ann. §43-20-8.

Rule 1.6.6 Volunteer Records (Less than 120 hours per year): For any person who volunteers in a child care facility for less than 120 hours per licensure year, a record shall be kept which contains the following:

1. Documentation of a minimum of one hour of volunteer orientation within one week of volunteering, including but not limited, to the child abuse law and reporting requirements, emergency exit procedures, policies for handling dangerous situations, and the facility transportation policy and special needs of children.
2. A volunteer's record shall be retained for a period of one year after they are no longer volunteering at the facility.
3. A record shall be maintained on each volunteer to document date and number of hours of volunteer service.

Source: Miss. Code Ann. §43-20-8.

Rule 1.6.7 Child Records: The facility shall maintain an individual file for each child under its current care, and for any withdrawn child who withdrew during the preceding twelve months, containing the following identification and contact information, parental instructions, authorizations and other documents required by its policy manual:

1. Identification and Contact Information:

- a. The name of the child and names of parents/guardians.
- b. Home address and home phone number.
- c. The parent's business name, address and phone number.
- d. The child's date of birth.
- e. Date of acceptance at facility and date of withdrawal, if any, with the parent's stated reason for withdrawal.
- f. Other contact information required to be maintained in accordance with facility's policy manual.

2. Parental Instructions:

- a. If the parent provides written instructions to the facility, those instructions concerning the child's growth and development, medical needs, allergies, toilet training and other information relevant to the child's well-being shall be maintained and updated as provided from time to time.
- b. Written identification of an authorized, responsible person(s) for pick up of the child.
- c. Documentation of any limitation of parental rights of the other parent or stepparent.
- d. Documentation of any limitation or restriction, if any, on activities of child, or other participation by the child in certain events such as holiday celebrations or being photographed or other parental concerns.

3. Authorizations:

- a. Signed written authorization to obtain emergency medical treatment and to administer medication.
- b. Election by parent either (a) to provide written authorization consenting to any and all field trips, excursions, or series of events outside the child care facility, or

- (b) to provide written consent only for those specific field trips, excursions, or series of events for which a date, time and location are specifically approved.
 - c. Signed acknowledgment by parent that the written policies and procedures described in 103.01 has been received.
 - d. Signed acknowledgment by parent that a summary of licensing standards and other materials designated by the licensing agency has been received by the parent.
4. **Documents Required by Policy Manual or Contract:**
- a. If agreed by the facility in its policy manual or caregiver contracts, method in which facility will inform the parent or contact person if a child does not arrive at the facility within a reasonable time after a scheduled drop-off.
 - b. Any other documents or identification records agreed to be maintained by the facility.
5. **Confidentiality of Records and Information:**
- a. Individual child records are confidential and shall not be disclosed or released without prior written authorization by the parent.
 - b. Individual personnel records are confidential and shall not be disclosed or released without prior written authorization by the employee.

Source: Miss. Code Ann. §43-20-8.

THIS PAGE INTENTIONALLY LEFT BLANK

Subchapter 7: REPORTS

Rule 1.7.1 Serious Occurrences Involving Children: The child care facility shall enter into the child's record and immediately report, orally to the child's parent and either orally or in writing, via email or fax, to the licensing agency, any serious occurrences involving children. If the child care facility is unable to contact the parent and the licensing official immediately, it shall document this fact, in writing, in the child's record. Oral reports and/or emailed/faxed reports shall be confirmed in writing and mailed within two days of the occurrence. Serious occurrences include accidents or injuries requiring extensive medical care, e.g., child is taken to the doctor or hospital or hospitalizations, alleged abuse and neglect, fire or other emergencies.

Source: Miss. Code Ann. §43-20-8.

Rule 1.7.2 Child Abuse: Any operator or employee of a child care facility who has suspicion or evidence of child abuse or neglect shall report it immediately to the Mississippi Department of Human Services in accordance with the state's Youth Court Act. (Appendix "A")

Source: Miss. Code Ann. §43-20-8.

Rule 1.7.3 Communicable Disease: The child care facility shall promptly report any known or suspected case or carrier of any reportable disease to the Mississippi State Department of Health, as published in the "List of Reportable Diseases. (Appendix "B")

Source: Miss. Code Ann. §43-20-8.

Rule 1.7.4 Infants and Toddlers: For infants and toddlers, the child care facility shall provide, to the child's parent, daily written reports that include liquid intake, child's disposition, bowel movements, and eating and sleep patterns.

Source: Miss. Code Ann. §43-20-8.

THIS PAGE INTENTIONALLY LEFT BLANK

Subchapter 8: STAFFING

Rule 1.8.1 General:

1. The staff-to-child ratio shall be maintained at all times, to include when children are arriving and departing the facility.
2. Children shall not be left unattended at any time. Video monitors cannot be used as a substitute for the physical presence of a caregiver in a room.
3. During all hours of operation, including arrival and departure of children, a child care facility employee shall be present to whom administrative and supervisory responsibilities have been assigned. This child care facility employee shall meet the minimum qualifications of a director or director designee.

NOTE: Operators of child care facilities shall provide to the local licensing official a list of all individuals who meet the qualifications of a director or director designee and may be assigned administrative and supervisory responsibility for the facility when the director is absent. Documentation that an individual meets the qualifications of a director shall be submitted to and approved by the local licensing official. Director designee qualifications shall be maintained on site and available to the licensing official during site visits.

4. During all hours of operation, including the arrival and departure of children, a child care facility employee shall be present who holds a valid CPR certification, at any location where the children are present. Said certificate shall be issued by an agent recognized by the licensing authority.
5. During all hours of operation, including the arrival and departure of children, a child care facility employee shall be present, at any location where the children are present, who holds a valid first aid certificate. Said certificate shall be issued by an agent recognized by the licensing authority.

NOTE: When initially acquiring or renewing the CPR and First Aid certifications required in items 4 and 5 above, online (internet, etc.) training is not acceptable. Training must be face-to-face and hands on.

Source: Miss. Code Ann. §43-20-8.

Rule 1.8.2 Ratio:

1. The minimum ratio of caregiver staff-to-children present at all times shall be as follows:

Age of Children	Number of Children to Caregiver Staff
Less than 1 year	5
1 year	9
2 years	12
3 years	14
4 years	16
5 through 9 years	20
10 through 12 years	25

2. Staff-to-child ratios shall be met at all times, including during opening/closing, field trips and swimming or water activities whether at the child care premises or off-site.
3. In mixed age groups, the age of the youngest child in the group determines the staff-to-child ratio. Preschool children shall not be grouped with school age children in any single area during normal classroom and playground or water activities.
4. With the exception of children under two years of age, children may be under the direct supervision (staff in the same room) of 50 percent of the staff required by this section during rest period times, provided the required staff-to-child ratio is maintained on the premises.
5. At no time will a single individual be responsible for the supervision of children located in more than one classroom at any given time.
6. Compliance with group sizes is not required during normal arrival and departure time periods, or during special events. However, the age-appropriate staff-to-child ratio shall be maintained at all times.

Source: Miss. Code Ann. §43-20-8.

Rule 1.8.3 Grouping: When children are placed in groups, the maximum group size shall be determined by the following chart.

Age of Children in the Group	MAXIMUM number of children ALLOWED in a group of children this age	MINIMUM number of caregivers REQUIRED for a group of children this age	MINIMUM square footage REQUIRED for a group of children this age
Infant (Under 12 months)	10 infants	2 caregivers	40 square feet per child
Toddler (12 months to under 24 months)	10 toddlers	2 caregivers	45 square feet per child
2 years	14 children	2 caregivers	35 square feet per child
3 years	14 children	1 caregiver	35 square feet per child
4 years	20 children	2 caregivers	35 square feet per child
5-9 years	20 children	1 caregiver	35 square feet per child
10-12 years	25 children	1 caregiver	35 square feet per child

NOTE: Space requirements for groupings in facilities licensed for school age children only are addressed in Rule 122.03 and 123.08.

Source: Miss. Code Ann. §43-20-8

THIS PAGE INTENTIONALLY LEFT BLANK

Subchapter 9: PROGRAM OF ACTIVITIES

Rule 1.9.1 General:

1. The child care facility shall provide a basic program of activities geared to the age levels and developmental needs of the children served.
2. The child care facility shall provide for the reading of age-appropriate materials to children.
3. The child care facility shall incorporate programs to encourage sun safety practices (skin cancer prevention), into activities for all age levels.

Source: Miss. Code Ann. §43-20-8.

Rule 1.9.2 Daily Routines: All daily routines, such as eating and rest periods, shall be scheduled for the same time each day.

Source: Miss. Code Ann. §43-20-8.

Rule 1.9.3 Eating: Meal periods are breakfast, lunch, dinner, and snacks. A minimum of 30 minutes shall be scheduled for each breakfast, lunch, and dinner meal period. A minimum of 15 minutes shall be scheduled for each snack meal period.

Source: Miss. Code Ann. §43-20-8.

Rule 1.9.4 Rest Periods:

1. For preschool children, rest periods shall be scheduled for a minimum period of one hour, and shall not exceed two and one-half (2½) hours. Infant and toddler nap times shall be individualized to meet each child's needs as sleeping patterns can vary greatly. Half-day programs must provide for rest periods as is appropriate when the children/child indicates or is observed to require some rest time.
2. Physical force shall not be used in requiring children to lie down or go to sleep during rest periods.
3. Rest periods are not required for children in attendance for less than six hours.
4. Rest periods are not required for school age children.
5. A safe sleep environment for infants to lower the risk of **Sudden Infant Death Syndrome (SIDS)** is required as follows:
 - a. An infant shall be placed on his/her back for sleeping unless written physician orders to the contrary are in the child's record. Sleeping infants shall be within the view of the staff and visually checked regularly when sleeping. Nothing shall

obstruct the view of the staff or prevent the staff from clearly seeing infants or children.

- b. Infants shall be dressed in clothing appropriate for sleeping that is designed to keep the infant warm without the possible hazard of head covering or entrapment. The room shall be kept at a draft-free seasonally appropriate temperature of 65 degrees Fahrenheit to 78 degrees Fahrenheit. If a child is already asleep and is not dressed in clothing appropriate for sleeping, the caregiver does not need to awaken the infant to change his or her clothes.
- c. Facilities shall use a firm mattress covered by a fitted sheet.
- d. Items such as but not limited to pillows, blankets, sheepskins, bumpers, soft objects, stuffed toys, loose bedding, etc., shall not be in the crib.

Source: Miss. Code Ann. §43-20-8.

Rule 1.9.5 Outdoor Activities:

- 1. Each infant shall have a minimum of 30 minutes of outdoor activities per day, weather permitting.
- 2. Toddler, preschool, and school age children shall have a minimum of two hours of outdoor activities per day, weather permitting. Children who attend at a facility for seven hours per day or less shall have a minimum of 30 minutes of outdoor activity per day, weather permitting.
- 3. Sun safe practices shall be used during outdoor activities scheduled between 10 A.M. and 2 P.M. during the period April 1 to September 15.
- 4. Sun safe practices shall be evident in the planning of all outdoor events.
- 5. Outdoor activities shall be held in areas providing shade or covered spaces.

Source: Miss. Code Ann. §43-20-8.

Rule 1.9.6 Infant, Toddler, and Preschool Activities:

- 1. Infants, toddlers, and preschoolers shall be free to creep, crawl, toddle, and walk as they are physically able.
 - a. Cribs, car seats, and high chairs are to be used only for their primary purpose, i.e., cribs for sleeping, car seats for vehicle travel, and high chairs for eating.
 - b. Providers should limit the use of equipment such as strollers, swings, and bouncer seats/chairs for holding infants while they are awake.

- c. Providers should implement activities for toddlers and preschoolers that limit sitting or standing to no more than 30 minutes at a time.
 - d. Providers should use strollers for toddlers and preschoolers only when necessary.
2. Infants and toddlers shall be taken outdoors every day, weather permitting.
 3. For infants who cannot move about the room, caregivers shall frequently change the place and position of the infant and the selection of toys available, and the child shall be held, rocked, and carried about.
 4. Television viewing, including video tapes and/or electronic media, is not allowed for children under the age of two or for staff in the infant and toddler area. The playing of soothing music in the infant and toddler area is acceptable.
 5. Television viewing, including video tapes and/or other electronic media, cell phone, or other digital media, e.g., computer, iPad®, iTouch®, etc., for children, age two and older, is limited to one hour per day, must be of educational content and a scheduled part of the approved daily plan of activities posted in the facility. The use of an “audio player” to play music is acceptable.
 6. In half-day programs, television viewing, including video tapes and/or other electronic media, cell phone, or other digital media, e.g., computer, iPad®, iTouch®, etc., for children, age two and older, is limited to 30 minutes per day, must be of educational content and a scheduled part of the approved daily plan of activities posted in the facility. The use of an “audio player” to play music is acceptable.
 7. Television viewing by staff is not permitted in areas occupied by children except for the purposes as described in item 5 and 6 above.

Source: Miss. Code Ann. §43-20-8.

Rule 1.9.7 Indoor or Outdoor Physical Activity: Child care providers are to provide infants, toddlers, and preschool children with opportunities to be physically active throughout the day.

1. Toddlers and preschool children will be provided the opportunity for light physical activity for at least 15 minutes per hour when children are not involved in their scheduled rest period.
2. Toddlers should accumulate a minimum of 60 minutes of structured moderate to vigorous physical activity per day.
3. Preschoolers should accumulate a minimum of 60 minutes of structured moderate to vigorous physical activity per day.

4. Caregivers should join in and lead the structured moderate to vigorous physical activities in which the children participate.
5. Structured physical activity should involve the performance of large muscle activities.
6. Half-day programs are only required to provide for physical activity for one-half (½) the time as stated above.

NOTE: Examples of “light physical activity” may be found in the Child Care Licensure section of the MSDH website at www.HealthyMS.com. Examples of “moderate physical activity” are aerobic dancing, light calisthenics, getting up and down from the floor, dancing, playing on school ground equipment, singing while actively moving about, etc. Examples of “vigorous physical activity” are running, jumping rope, performing jumping jacks, playing soccer, skipping, etc. Regardless of the activity, it should be age appropriate and within the physical ability limits of the child. Please, understand the above requirement does not mean 60 minutes vigorous activity at one time. The 60 minutes of vigorous physical activity can and should be spread out in short time intervals, (e.g., 5-15 minute intervals) throughout the day.

Source: Miss. Code Ann. §43-20-8.

Subchapter 10: EQUIPMENT, TOYS, AND MATERIALS

Rule 1.10.1 General:

1. Equipment, toys, and materials for both indoor and outdoor use shall be appropriate to the age and developmental needs of the children served.
2. Developmentally age-appropriate toys shall be available and accessible for infants, and shall include but not be limited to the following:
 - a. Simple, lightweight, open-ended, easily washable toys such as containers, balls, large pop-beads, and nesting cups.
 - b. Rattles, squeak toys, action/reaction toys.
 - c. Cuddly toys.
 - d. Toys to mouth such as teethers and rings.
 - e. Pictures of real objects.
 - f. A crawling area with sturdy, stable furniture for pulling up self.
3. Developmentally age-appropriate toys shall be available and accessible for toddlers, and shall include but not be limited to the following:
 - a. Push and pull toys.
 - b. Stacking toys, large wooden spools/beads/cubes.
 - c. Sturdy picture books, music.
 - d. Pounding bench, simple puzzles.
 - e. Play phone, dolls, and toys to appeal to child's imagination.
 - f. Large paper, crayons.
 - g. Sturdy furniture to hold on to while walking.
 - h. Sand and water toys.
4. Developmentally age-appropriate toys shall be available and accessible for preschoolers, and shall include but not be limited to the following:
 - a. Active play equipment for climbing and balancing.

- b. Unit blocks and accessories.
 - c. Puzzles and manipulative toys.
 - d. Picture books, records, and musical instruments.
 - e. Art materials such as finger and tempera paints, clay, play dough, crayons, collage materials, markers, scissors, and paste.
 - f. Dramatic play materials such as dolls, dress-up clothes and props, child-sized furniture, and puppets.
 - g. Sand and water toys.
5. Children's original work shall be displayed in the child care facility.
 6. Books shall be on shelves and tables for children to look at and read. Every child shall have age-appropriate materials (including picture books) read to and discussed with him or her every day. Where appropriate, the materials should cover topics with which the children are involved.
 7. Television viewing by preschool children shall be limited to one hour per day and shall be educational programming only. Television viewing by staff is not permitted in areas occupied by children except for the purposes as described herein.
 8. The daily activity schedule shall demonstrate that preschoolers are given opportunities to do a variety of activities, including both quiet and active, such as block play, art activities, puzzles, books, and learning games, and that stories are read to and discussed with each child every day.

Source: Miss. Code Ann. §43-20-8.

Rule 1.10.2 Playground Equipment:

1. All playgrounds and playground equipment used by children 2 - 12 years of age shall meet the safety standards set forth in Appendix "D" of these regulations.
2. Playground equipment shall be of safe design and in good repair. Outdoor playground climbing equipment and swings shall be set in concrete footings located at least six inches below ground surface. Indoor playground equipment shall be installed according to the manufacturer's specifications. Swings shall have soft and/or flexible seats. Access to playground equipment shall be limited to age groups for which the equipment is developmentally appropriate.
3. Equipment designed for outdoor use by infants and toddlers shall be accessible to shaded areas to ensure sun safe practices.

Source: Miss. Code Ann. §43-20-8.

Rule 1.10.3 Paint: Paint on toys, equipment, furniture, walls, and other items shall be lead-free and non-poisonous.

Source: Miss. Code Ann. §43-20-8.

Rule 1.10.4 Chairs and Tables: Chairs and tables shall be of a size appropriate to the size and age of the children. There shall be an adequate number of chairs and tables to accommodate the children present at the facility.

Source: Miss. Code Ann. §43-20-8.

Rule 1.10.5 Hooks and Compartments: Individual hooks or compartments shall be provided for each child for hanging or storing outer and/or extra clothing as well as for personal possessions. Hooks shall be spaced well apart so that clothes and belongings do not touch those of another child. Hooks shall also be placed at a height suitable to prevent an injury to a child.

Source: Miss. Code Ann. §43-20-8.

Rule 1.10.6 Sand Boxes:

1. Sand boxes shall be constructed to permit drainage, shall be covered tightly and securely when not in use, and shall be kept free from cat or other animal excrement.
2. Sand contained in sand boxes shall not contain toxic or harmful materials.

Source: Miss. Code Ann. §43-20-8.

Rule 1.10.7 Cribs:

1. The facility shall provide a crib or other similarly commercially purchased bed unit, approved and designated for the purpose of sleeping. Mobile infants, at a minimum of eight months, may be placed on a mat during the transition period of crawling to walking. If such mat is used, it shall be a flame retardant, minimum of two (2) inch commercially purchased sleep mat, especially designated for the purpose of sleeping. All cribs, sleep units, and mats must be maintained clean, in sanitary condition and without chips, holes, fraying, tears, or stains.
2. The use of stackable cribs is prohibited

Source: Miss. Code Ann. §43-20-8.

Rule 1.10.8 High Chairs: High chairs, if used, shall have a wide base and a T-shaped safety strap. They shall be labeled or warranted by the manufacturer in documents provided at the time of purchase or verified thereafter by the manufacturer as meeting the American Society for Testing Materials (ASTM) Standard F-404 (Consumer Safety Specifications for High Chairs).

Source: Miss. Code Ann. §43-20-8.

Rule 1.10.9 Rest Period Equipment:

1. Individual beds, cots, mattresses, pads, or other acceptable equipment shall be used for rest periods, and children shall not be placed directly on the floor for rest periods. Bed linens, such as blankets or sheets, cannot be used in place of a bed, cot, mattress, or pad. These shall be kept in a sanitary condition. Once a sheet or blanket has been used by a child, it shall not be used by another child until it has been laundered
2. Rest period equipment shall be clean and covered with a waterproof cover.
3. Nap pads/cots are designed for use by one child only at a time.
4. Nap pads utilized by more than one child shall be sanitized after each child's use. Nap pads utilized by only one child shall be sanitized immediately when soiled or at least weekly.
5. Nap pads and nap cots without mattresses are not acceptable for use in 24 hour programs. Beds, cribs, or roll away cots are the only acceptable bedding for 24 hour centers.
6. The facility shall provide a crib or other similarly commercially purchased bed unit, approved and designated for the purpose of sleeping. Mobile infants, at a minimum of eight months, may be placed on a mat during the transition period of crawling to walking. If such mat is used, it shall be a flame retardant, minimum of two (2) inch commercially purchased sleep mat, especially designated for the purpose of sleeping. All cribs, sleep units, and mats must be maintained clean, in sanitary condition and without chips, holes, fraying, tears, or stains. Cribs, cots, and mats are to be a minimum of 24" apart or separated by a solid barrier. A minimum of 36 inches is recommended.
7. Children are not allowed to sleep in shared places, such as infant seats, strollers, swings, cozy areas, or on tables. If a child falls asleep in such shared place, he or she should be moved immediately to a sanitary individual sleeping place.

Source: Miss. Code Ann. §43-20-8.

Rule 1.10.10 Play Equipment:

1. Play equipment, toys, and materials shall be provided that meets the standards of the Consumer Product Safety Commission and/or the American Society for Testing and Materials (ASTM) for juvenile products. Play equipment, toys, and materials shall be found to be appropriate to the development needs, individual interests, and ages of the children as identified as age-appropriate by a label provided by the manufacturer on the product package.
2. Projectile toys, i.e., dart guns, toy guns, etc., are prohibited.
3. Water play tables, if used, shall be cleaned and sanitized daily.
4. Tricycles and other riding toys used by the children shall be spokeless, steerable, and of a size appropriate for the child, and shall have low centers of gravity. All such toys shall be in good condition and free of sharp edges or protrusions that may injure the children. When not in use, such toys shall be stored in a location where they will not present a physical obstacle to the children and employees. Riding toys shall be inspected at least monthly for protrusions and rough edges that could lead to injury.

Source: Miss. Code Ann. §43-20-8.

Rule 1.10.11 School Age Programs:

1. The foregoing provisions in Subchapter 10 shall not be applied to any facility licensed solely for School age children unless specifically required in Subchapter 10, Rule 1.10.11.
2. All playgrounds and playground equipment used by children 2 - 12 years of age shall meet the safety standards set forth in Appendix "D" of these regulations.
3. Projectile toys are prohibited. Projectile toys are toys which, when projected, have the ability to penetrate body or eye tissue. Play equipment, toys, and materials shall be provided that meets the standards of the Consumer Product Safety Commission and/or the American Society for Testing and Materials (ASTM) for juvenile products.
4. Possessions, belongings, and extra clothing for each school age child must be stored in such a manner as to not touch those of another child.

Source: Miss. Code Ann. §43-20-8.

THIS PAGE INTENTIONALLY LEFT BLANK

Subchapter 11: BUILDINGS AND GROUNDS

Rule 1.11.1 Building:

1. A child care facility shall be physically separated from any other business or enterprise. Other occupants, visitors, and/or employees of other businesses or enterprises within the same building shall not be allowed within the physical confines of the child care facility for the purpose of entering the building or exiting the building, or passing through the child care facility for the purpose of gaining access to another part of the building.
2. All child care facility buildings shall meet all fire safety standards listed on the MSDH Form #333 and all applicable local fire safety standards and/or ordinances.
3. No house trailers, relocatable classrooms, or portable buildings shall be used to house a child care facility unless such structure was originally designed specifically for educational purposes and meet the Mississippi State Department of Education's current standards for a relocatable classroom. Further, such portable structure shall meet all applicable fire safety codes.
4. Current licensees operating facilities housed in such structures are exempted from this provision. Any change of ownership, need for major renovation, or other significant change in the facility's status shall revoke such exemption.
5. Plans and specifications shall be submitted to the licensing agency for review and approval on all proposed construction and/or major renovations.
6. A separate space shall be provided for the use of an ill or injured child until the child can be picked up by the parent. Space shall be located in an area that is supervised at all times by an employee.
7. Separate space for infants and toddlers shall be provided away from older children except in facilities licensed for 12 or fewer children.
8. The ceiling, floor, and/or floor covering shall be properly installed, kept clean and in good condition, and maintained in good repair. Carpeting is prohibited in kitchen areas.
9. All parts of the child care facility used by children shall be lead-safe, well lighted, ventilated, and free of hazardous or potentially hazardous conditions, such as but not limited to, open stairs and unprotected low windows.
 - a. All buildings intended for use as a child care facility constructed before 1965 shall be tested for lead. It is the responsibility of the facility applicant/operator to have a lead hazard screen or lead-based paint risk assessment of the facility done by an individual or company certified as a risk assessor by the Mississippi

Commission on Environmental Quality. If the facility is found not to be lead-safe, it will not be allowed to operate as a child care facility until all required corrective measures have been taken and the facility is determined to be lead-safe by a certified risk assessor.

- b. All buildings intended for use as a child care facility, constructed prior to 1978, shall utilize MDEQ Lead Safe Certified individuals or companies for all renovation, repair and maintenance activities which disturb painted surfaces unless the paint to be disturbed has been documented to be lead-free by an individual or company that is MDEQ Lead Safe Certified as a risk assessor or inspector.

NOTE: It is recommended that child care facility operators contact the Mississippi Department of Environmental Quality at 601-961-5630 regarding any questions they may have about compliance with the laws and regulations related to lead and lead based paint.

10. All buildings intended for use as a child care facility constructed before 1965 shall be tested for lead. It is the responsibility of the facility applicant/operator to have a lead hazard screen or lead-based paint risk assessment of the facility done by an individual or company certified as a risk assessor by the Mississippi Commission on Environmental Quality. If the facility is found not to be lead-safe, it will not be allowed to operate as a child care facility until all required corrective measures have been taken and the facility is determined to be lead-safe by a certified risk assessor.
11. All glass in doors, windows, mirrors, etc., shall have a protective barrier at least four feet high when measured from the floor. Doors, windows, mirrors, etc., using safety-grade glass or polymer (e.g., Lexan®) are not required to have a protective barrier. Glass windows and glass door panels shall be equipped with a vision strip 36 inches from the floor. Safety glass must be so certified by the installer and the statement kept on file at the child care facility.
12. Walls shall be kept clean and free of torn wall covering, chipped paint, broken plaster, and holes. No paint that contains lead compounds shall be applied to interior walls or woodwork.
13. All ceiling lighting shall be shielded completely and encased in shatterproof materials.
14. A child care facility shall have a working phone available to all staff at all times. Telephones shall also be available for incoming calls and shall not be unplugged or disconnected during business hours.
15. All fire extinguishers, as required in the fire safety plan, shall be serviced on an annual basis by a qualified fire extinguisher technician.
16. Unused electrical outlets shall be protected by a safety plug cover.

17. No extension cords shall be used in areas accessible to children.
18. Every child care facility which uses nonelectric heating and/or cooling systems, cooking stoves, and/or hot water heaters or other nonelectric equipment, shall have sufficient carbon monoxide monitors placed appropriately throughout the child care facility.
19. All child care facilities are to be kept clean and in good repair

Source: Miss. Code Ann. §43-20-8.

Rule 1.11.2 Indoor Square Footage:

1. Every license shall set forth the licensed facility's maximum licensed capacity, which shall be based upon a minimum of thirty-five (35) square feet of usable indoor space per child. Likewise, the capacity for each room where children are kept shall have a minimum of thirty five (35) square feet of usable space per child, measured on the inside, wall-to-wall dimensions, subject to the following exceptions:
 - a. During group activity periods such as film viewing, parties, dining, and sleeping, provided child-to-staff ratio is maintained;
 - b. During periods when child pick-up or delivery is normally done, provided child-to staff ratio is maintained;
 - c. In infant and toddler rooms as required in subsections 2-7 below;
 - d. In school age only and summer day camp programs as outlined in Subchapter 23 and Subchapter 24 of these regulations.

The usable space in determining the facility's maximum licensed capacity is measured exclusive of food preparation areas, kitchens, bathrooms, toilets, areas for the care of ill children, offices, staff room, corridors, hallways, stairways, closets, lockers, laundries, furnace rooms, fixed or permanent cabinets, fixed or permanent storage shelving spaces, and areas not inhabited and used by children.

2. Rooms in which infants both play and sleep shall have a minimum of 40 square feet of usable space per child. There shall be at least 24" between each crib. A minimum of 36" is recommended. Cribs with solid ends may be placed end-to-end.
3. Rooms where infants play but do not sleep shall have a minimum of 15 square feet of usable space per child.

NOTE: No other age group shall use this space nor can it be used for any purpose other than infant play.

4. Rooms where infants sleep but do not play shall have a minimum of 25 square feet of usable space per child. There shall be at least two feet between each crib. Cribs with solid ends may be placed end-to-end.
5. Rooms in which toddlers both play and sleep shall have a minimum of 45 square feet of usable space per child. There shall be at least 24” between each crib. A minimum of 36” is recommended. Cribs with solid ends may be placed end-to-end. However, if stackable cots, mats, or other storable sleeping equipment is utilized for sleeping the room shall be measured using the standard of 35 square feet per child. Should it be determined that the sleeping equipment is not properly stored when not in use the capacity of the room will be determined using 45 square feet per child
6. Rooms where toddlers play but do not sleep shall have a minimum of 25 square feet of usable space per child.

NOTE: No other age group shall use this space nor can it be used for any purpose other than toddler play.

7. Rooms where toddlers sleep but do not play shall have a minimum of 25 square feet of usable space per child. There shall be at least 24” between each crib. A minimum of 36” is recommended. Cribs with solid ends may be placed end-to-end.
8. The licensing agency may re-measure the square footage of licensed operating child care facilities, or such parts impacted by the following circumstances, for purposes of determining licensed facility or classroom capacity only under the following circumstances:
 - (a) Major renovations;
 - (b) Significant change in layout and use of space;
 - (c) A change of ownership of an existing facility should the layout or use of space change.

9. **“Grandfather Provision” for regulatory changes regarding maximum facility capacity or room capacity.** Whenever the Mississippi State Board of Health amends these rules regarding square footage and/or licensed maximum capacity of child care facilities, and such change would result in a reduction in the number of children to be served in a licensed and operating facility or any of its classrooms, any such facility in operation at the time of final adoption of said rule change, and in compliance with all other child care regulations, shall be “grandfathered” in and exempt from application of the new regulation regarding capacity. This exemption shall continue for said facility through changes of ownership so long as the building is used continuously as a licensed child care facility and so long as there is no change in the layout or use of the space, as set out in subsection 8 above. Any break in use of the building as a licensed child care facility shall moot the grandfather exemption, and thereafter, any child facility opened

and operated in said building shall be required to comply with the square footage/capacity regulation in affect at the time of the new license.

Source: Miss. Code Ann. §43-20-8.

Rule 1.11.3 Openings:

1. Each window, exterior door, and basement or cellar hatchway shall be weather tight and watertight.
2. All windows above ground level in areas used by children under five years of age shall be constructed, adapted, or adjusted to limit the exit opening accessible to children to less than six inches, or be otherwise protected with guards that do not block outdoor light.
3. Openable windows shall be of a safety type (not fully openable) that are child proofed and screened when open. When there are no openable windows, or when windows are not kept open, rooms shall be adequately ventilated.
4. All openings used for ventilation shall be screened.
5. The width of doors shall accommodate wheelchairs and the needs of individuals with physical disabilities.
6. Exit doors shall open outward. Boiler room doors shall swing inward.
7. Doorways and exits shall be free of debris and equipment to allow unobstructed traffic to and from the room.
8. The hand contact and splash areas of doors and walls shall be covered with an easily cleanable finish, at least as cleanable as an epoxy finish or enamel paint.

Source: Miss. Code Ann. §43-20-8.

Rule 1.11.4 Kitchens:

1. Children are not allowed in the kitchen area. In School Age/After School programs, children may be allowed in the kitchen but not during times when food is being cooked. Supervision in the kitchen when children are present must meet the staffing requirements as referenced in Subchapter 8 of the regulations.
2. Barriers, approved by the local fire authority, shall be erected and doors shall be closed at all times.

3. The kitchen area shall be designed and constructed to be totally enclosed with walls, doors, and/or barriers. Serving counter openings that conform to local fire codes and MSDH food service regulations are permitted.
4. Kitchens shall have the following minimum square footage, based upon the maximum number of children allowed pursuant to the license:

Licensed Capacity	Minimum Sq. Footage
1-50	90 sq. ft.
51-70	150 sq. ft.
71-100	210 sq. ft.
over 100	300 sq. ft.

5. Child care facilities serving 50 or more children shall have a separate, stand alone freezer for storage of frozen foods.
6. All kitchens providing food for child care facilities with 13 or more children, and all kitchens in child care facilities not located in occupied dwellings, shall comply with the Mississippi State Department of Health's 10.0 Regulation Food Code, with the exception that kitchens in facilities located in an occupied dwelling that are licensed for 13 or more children need not have a separate kitchen to serve the child care facility.
7. All kitchens and/or food/snack preparation areas in a child care facility shall be inspected as part of the child care inspection process.

Source: Miss. Code Ann. §43-20-8.

Rule 1.11.5 Toilets and Hand Washing Lavatories:

1. Toilets and hand washing lavatories shall be located within the physical confines of child care facility and shall be convenient to outside playground areas.
2. The following ratios shall apply: Toilets, urinals, and hand washing lavatories shall be apportioned at a ratio of 1:15. Urinals shall not exceed 33 percent of the total required toilet fixtures. When the number of children in the ratio is exceeded by one, an additional fixture shall be required.
3. The hand washing lavatories located in a diapering area shall not be included in the ratio of hand washing lavatories to children for determining a child care facility's capacity. Diaper changing sinks shall not be used for any other purpose such as, but not limited to, rinsing or washing baby bottles, pacifiers, teething rings, or for food preparation.

4. All hand washing lavatories shall have both hot and cold running water. Hot water temperature shall not exceed 120 degrees Fahrenheit.
5. Toilets, urinals, hand washing lavatories, and sinks shall be clean and operational. Bathrooms, hand washing lavatories, and sinks shall be supplied with soap, and individual towels for drying hands. Each toilet shall be supplied with toilet paper.

Source: Miss. Code Ann. §43-20-8.

Rule 1.11.6 Water: The water supply shall be from a public water system or a private system approved by the Mississippi State Department of Health. Water shall be dispensed by the following:

1. Fountain.
2. Disposable paper cups.
3. Labeled cup for each child, which shall be washed and sanitized daily.

Source: Miss. Code Ann. §43-20-8.

Rule 1.11.7 Exits:

1. At least two separate exit doors shall be provided from every floor level.
2. Exit doors shall be remote from each other.
3. Dead end corridors shall not exceed 20 feet in length.
4. Exit doors necessitating passage through a kitchen shall not be counted as one of the two remote exits.
5. Exit doors shall be a minimum of 32 inches wide and open outward. No single leaf in an exit door shall be less than 28 inches wide or more than 48 inches wide.
6. Any latch or other fastening device on an exit door shall be provided with a knob, handle, panic bar, or other simple type of releasing device. Dual action door fasteners are not permitted.
7. The force required to open fully exit doors shall not exceed 50 pounds applied to the latch stile (panic bar).
8. An exit door shall not reduce the effective width of a landing.

Source: Miss. Code Ann. §43-20-8.

Rule 1.11.8 Heating, Cooling, and Ventilation:

1. A draft-free seasonally appropriate temperature of 65 degrees Fahrenheit to 78 degrees Fahrenheit shall be maintained.
2. All rooms used by children shall be heated, cooled, and adequately ventilated to maintain the required temperatures, and air exchange, and to avoid the accumulation of objectionable odors and harmful fumes.
3. Ventilation may be in the form of openable windows as specified in these regulations.
4. Areas where art and craft activities are conducted shall be well ventilated. In areas where substances are used that create toxic fumes, exhaust hood systems or other devices shall be installed.
5. Electric fans, if used, shall be mounted high on the wall or ceiling or shall be guarded to limit the size of the opening in the blade guard to less than one-half (1/2) inch.
6. When air-cooling is needed, draft-free cooling units shall be used. They shall present no safety hazard to the children.
7. Filters on recirculation systems shall be checked and cleaned or replaced monthly.
8. Window draft deflectors shall be provided if necessary.
9. Thermometers that do not present a hazard to children shall be placed on interior walls in every activity area at children's height.
10. Portable, open flame and kerosene space heaters are prohibited. Portable gas stoves shall not be used for heating.
11. Electric space heaters shall be UL-approved; inaccessible to children; and stable; shall have protective covering; and shall be placed at least three feet from curtains, papers, and furniture.
12. Fireplaces and fireplace inserts shall be screened securely or equipped with protective guards while in use. They shall be properly drafted. The child care facility shall provide evidence of cleaning the chimney at least once a year, or as frequently as necessary to prevent excessive buildup of combustibles in the chimney. Records of chimney cleaning shall be retained in the center files.
13. Heating units that utilize gas shall be installed and maintained in accordance with the manufacturer's instructions, are vented properly to the outside, and be supplied with sufficient combustion air as required by the International Fuel Gas Code.

14. If the area of the state where the facility is located does not utilize the International Fuel Gas Code, the installation and maintenance of any heating units that utilize gas shall be in accordance with the manufacturer's instructions and any local ordinances that apply.
15. It is the responsibility of the licensee to provide to the licensing authority documentation that the heating units meet the above stated standards.
16. Heating units, including water pipes and baseboard heaters hotter than 110 degrees Fahrenheit, shall be made inaccessible to children by barriers such as guards or other devices.

Source: Miss. Code Ann. §43-20-8.

Rule 1.11.9 Outdoor Playground Area: All licensed child care facilities are required to have an adequate outdoor playground area. All playgrounds and playground equipment intended for use by children 2-12 years of age shall meet the standards set forth in the *Handbook for Public Playground Safety*, Publication No. 325, published by the U.S. Consumer Product Safety Commission or its successor as shown in Appendix "D."

1. The child care facility shall be equipped with an outdoor playground area that directly adjoins the indoor facilities or that can be reached by a route free of hazards and is no farther than 1/8 mile (660 feet) from the child care facility. The outdoor playground area shall comprise a minimum of 75 square feet for each child using the outdoor playground area at any one time.
2. The total outdoor playground area shall accommodate at least 33 percent of the licensed capacity at one time.
3. A rooftop used as an outdoor playground area shall be enclosed with a fence not less than six feet high and designed to prevent children from climbing it. An approved fire escape shall lead from the roof to an open space at the ground level that meets safety standards for outdoor playground areas.
4. The outdoor playground area shall be well arranged so that all areas are visible to staff at all times.
5. The outdoor playground area shall be free of hazards and not less than 30 feet (measured horizontally parallel to the ground) from electrical transformers, high-voltage power lines, electrical substations, railroad tracks, or sources of toxic fumes or gases. Hazards, including but not limited to air conditioner units and utility mains, meters, tanks, and/or cabling shall be inaccessible to children. Fencing at least four feet high shall be provided around the outdoor playground area. Fencing higher than four feet but not to exceed eight feet may be required if the licensing authority determines that a hazard exists. Fencing twist wires and bolts shall face away from the playground. As an alternative, exposed bolt ends may be cut to no more than two exposed threads. Then the bolt ends shall be ground/sanded smooth or capped.

6. Outdoor playground areas shall be free from unprotected swimming and wading pools, ditches, quarries, canals, excavations, fishponds, or other bodies of water.
7. Sunlit areas and shaded areas shall be provided by means of open space and tree plantings or other cover in outdoor spaces. Outdoor spaces shall be laid out to ensure ample shaded space for each child.
8. The outdoor playground area shall be enclosed with a fence. The fence shall be at least four feet in height and the bottom edge shall be no more than three and one-half (3½) inches off the ground. There shall be at least two exits from such areas, with at least one remote from the buildings. The gate latch or securing device shall be high enough or of such a type that it cannot be opened by small children. The openings in the fence shall be no greater than three and one-half (3½) inches, e.g., between the building and the fence. The fence shall be constructed to discourage climbing.
9. The soil in outdoor playground areas shall not contain hazardous levels of any toxic chemical or substances. The child care facility shall have soil samples and analyses performed where there is good reason to believe a problem may exist.
10. The soil in outdoor playground areas shall be analyzed for lead content initially. It shall be analyzed at least once every two years where the exteriors of adjacent buildings and structures are painted with lead-containing paint. Lead in soil shall not exceed 400 ppm. Testing and analyses shall be in accordance with procedures specified by the licensing agency.

Source: Miss. Code Ann. §43-20-8.

Rule 1.11.10 Indoor Playground Area: In addition to the required outdoor playground area, a licensed child care facility may also provide an indoor playground area. Child care facilities licensed prior to July 1, 2009 that have been granted permission to have an indoor playground area in lieu of an outdoor playground area shall be not be required to have an outdoor playground. However, it is highly recommended that if possible an outdoor playground area should also be provided. For child care facilities which provide such an indoor playground area the following items apply:

1. The total indoor playground area shall accommodate at least 33 percent of the licensed capacity at one time.
2. The indoor playground area shall be well arranged so that all areas are visible to staff at all times.
3. The indoor playground area shall be free of hazards.
4. Indoor playground areas shall be laid out to ensure ample clearance space for the use of each item: nine feet around fixed items and 15 feet around any moving part.

Equipment shall be situated so that clearance space allocated to one piece of equipment does not encroach on that of another piece of equipment.

5. Swings shall have a clearance area of nine feet in all directions beyond the swing beam.
6. All fixed playground equipment shall have a minimum of nine feet clearance space from walkways and other structures that are not used as part of play activities.
7. All equipment shall be arranged so that children playing on one piece of equipment will not interfere with children playing on or running to another piece of equipment.
8. Moving equipment (e.g., swings, merry-go-rounds) shall be located toward the edge or corner of an indoor playground area or shall be designed in such a way as to discourage children from running into the path of moving equipment.
9. All pieces of indoor playground equipment shall be surrounded by a resilient surface of an acceptable depth or by rubber mats manufactured for such use, consistent with the guidelines of the Consumer Product Safety Commission, and the Standard of the American Society for Testing and Materials, extending beyond the external limits of the piece of equipment for at least four feet beyond the fall zone of the equipment. These resilient surfaces shall conform to the standard stating that the impact from falling from the height of the structure will be less than or equal to peak deceleration 200G. Organic materials that support colonization of molds and bacteria shall not be used.
10. Indoor space designated as playground may be used by other individuals when the area is not in use by children attending the facility. However, children of the child care facility shall have priority use of the indoor playground area and the area may not be used by others when children are using it. The indoor playground space shall not count as additional classroom space when determining the maximum capacity of the facility.

Source: Miss. Code Ann. §43-20-8.

Rule 1.11.11 Grounds:

1. The grounds, including the outdoor playground area, shall be free of hazardous or potentially hazardous objects.
2. In-ground swimming pools are prohibited unless protected by a six-foot fence and a locked gate. All fencing shall be placed at a minimum five feet from the pool edge.
3. Above ground pools, including decking and pool structures, are prohibited unless protected by a six-foot fence and a locked gate. All fencing shall be placed at a minimum ten feet from the pool/deck edge.
4. All paved surfaces shall be well drained to avoid water accumulation and ice formation.

5. All walking surfaces, such as walkways, ramps, and decks, shall have a non-slip finish, and shall be free of holes and sudden irregularities in the surface.

Source: Miss. Code Ann. §43-20-8.

Rule 1.11.12 Garbage Removal: Garbage and trash shall be removed from the child care facility daily and from the grounds at least once a week. Garbage and trash shall be stored inaccessible to the children, and in insect and rodent resistant containers.

Source: Miss. Code Ann. §43-20-8.

Rule 1.11.13 Environmental Health: The child care facility shall comply with all regulations promulgated by the Division of Sanitation of the Mississippi Department of Health for:

1. Food Service.
2. On-site Wastewater Systems.
3. Vector (pest) Control.

Source: Miss. Code Ann. §43-20-8.

Rule 1.11.14 Pest Control: All child care facilities are to use a contractor licensed by the State of Mississippi to control pests, e.g., rats, mice, insects, etc. Before a pest control contractor is used, it is the responsibility of the operator to ensure that the pest control contractor is **properly licensed. Use of agricultural chemicals for pest control is strictly prohibited.**

Source: Miss. Code Ann. §43-20-8.

Subchapter 12: HEALTH, HYGIENE, AND SAFETY

Rule 1.12.1 Employee Health:

1. Employees manifesting symptoms or otherwise suspected of having upper respiratory, gastrointestinal, skin, or other serious contagious conditions shall be excluded from work until either free from symptoms or certified by a physician to be no longer infectious.
2. Staff shall use universal precautions when changing diapers or being exposed to blood, fecal material, or urine. Refer to Appendix “F” for instructions on how to properly wash hands.
3. Staff shall wash their hands upon:
 - a. Immediately before handling food, preparing bottles, or feeding children.
 - b. After using the toilet, assisting a child in using the toilet, or changing diapers.
 - c. After contacting a child’s body fluids, including wet or soiled diapers, runny noses, spit, vomit, etc.
 - d. After handling pets, pet cages, or other pet objects.
 - e. Whenever hands are visibly dirty or after cleaning up a child, the room, bathroom items, or toys.
 - f. After removing gloves used for any purpose.
 - g. Before giving or applying medication or ointment to a child or self.

Refer to Appendix “F” for instructions on how to properly wash hands.

Source: Miss. Code Ann. §43-20-8.

Rule 1.12.2 Child Health:

1. A child who is suspected of having a serious contagious condition shall be isolated and returned to the parent as soon as possible.
2. A child having a serious contagious condition shall not be allowed to return to the child care facility until they have been certified by a physician to be no longer contagious.
3. Parents of all children shall be notified of a contagious illness in the child care facility as soon as possible.

4. A child with a physical injury shall be treated by a staff member with valid first aid certificate issued by an agent recognized by the licensing authority. A child with a serious physical injury shall be treated by a staff member with valid first aid certificate issued by an agent recognized by the licensing authority and transported to a hospital or medical facility as soon as appropriate.

Source: Miss. Code Ann. §43-20-8.

Rule 1.12.3 Child Hygiene:

1. A child's wet or soiled clothing shall be changed immediately.
2. A child's hands shall be washed:
 - a. Immediately before and after eating.
 - b. After using the toilet or having their diapers changed.
 - c. After playing on the playground.
 - d. After handling pets, pet cages, or other pet objects.
 - e. Whenever hands are visibly dirty.
 - f. Before going home.
3. A child shall have a shower, tub, or sponge bath to ensure bodily cleanliness when necessary.
4. Individual toilet articles (e.g., combs, brushes, toothbrushes, towels, and wash cloths) used by children shall be provided by the parent or child care facility and plainly marked and stored individually in a sanitary manner in areas which promote drying. Single use and disposable articles are acceptable. Grooming accessories, including but not limited to brushes, combs, barrettes, or picks, shall not be used jointly by children or on children.

Source: Miss. Code Ann. §43-20-8.

Rule 1.12.4 Toys and Equipment: Toys and equipment used by infants or toddlers shall be cleansed daily with a germicidal solution. Refer to (Appendix – “H” for instructions on cleaning and disinfection procedures. A recommended resource regarding sanitation of equipment and toys can be found in the *National Health and Safety Performance Standards: Guidelines for out of home Child Care, Second Edition* (Standard 3.030) website: www.nrc.uchsc.edu.

Source: Miss. Code Ann. §43-20-8.

Rule 1.12.5 First Aid Supply:

1. A first aid supply shall be kept on-site and easily accessible to employees, but not in reach of the children.
2. A first aid supply shall be taken on all field trips and excursions and shall be easily accessible to employees, but not in reach of the children.
3. Medicine shall be kept out of the reach of the children.
4. All vehicles used by the facility in transporting children shall be equipped with a first aid kit.
5. It is recommended that first aid kits contain the following items, according to American Red Cross guidelines:
 - a. 20 Antiseptic Toweletts
 - b. 50 Plastic Strips (Band Aids)
 - c. 5 Fingertip Bandages
 - d. 5 Knuckle Bandages
 - e. 5 Butterfly Closures
 - f. 5 Non Adherent Pads 2" x 3"
 - g. 2 Sterile Eye Pads
 - h. 1 pressure Bandage 4"
 - i. 1 Bandage Scissors
 - j. 1 Triangular Bandage
 - k. 1 Instant Cold Compress
 - l. 2 Tongue Depressors/Finger Splints
 - m. 1 Elastic Bandage 2" x 5 yards
 - n. 5 3" x 3" Gauze Pads
 - o. 1 Trauma Pad 5" x 9"
 - p. 5 Insect Sting Relief Pads

- q. 10 First Aid Ointment 1 gr.
 - r. 5 Non Adherent Pads 3" x 4"
 - s. 5 Pair of Examination Gloves
 - t. 2 Conforming Bandage 2" x 5 yards
 - u. 1 Tweezers
 - v. 2 Poison Ivy Relief Treatment
 - w. 1 Booklet "Till Help Arrives"
 - x. 1 Emergency Rescue Blanket
 - y. 1 Adhesive Tape ½" x 5 yard
6. Some items in this kit may have expiration dates. All first aid kits should be periodically inspected for contents. Depleted and out of date materials should be replaced.
 7. Special attention should be exercised when utilizing first aid supplies or any medication for children who have allergies or other special medical needs.
 8. For additional information on supplies for first aid kits contact your local office of the American Red Cross.

Source: Miss. Code Ann. §43-20-8.

Rule 1.12.6 Animals and Pets:

1. Any pet or animal present at a child care facility, indoors or outdoors, shall be in good health, show no evidence of carrying any disease, and be a friendly companion for the children.
2. Dogs or cats, where allowed, shall be immunized for any disease that can be transmitted to humans, and shall be maintained on a flea, tick, and worm control program.
3. All pets shall be cared for as recommended by the regulating health agency. When pets are kept at the child care facility, procedures for their care and maintenance shall be written and followed. When immunizations are required, proof of current compliance signed by a veterinarian shall be on file at the child care facility where the pet is kept.
 - a. A caregiver shall always be present when children are exposed to animals (including dogs and cats). Children shall be instructed on safe procedures to

follow when in close proximity to these animals (e.g., not to provoke or startle them or remove their food). Potentially aggressive animals (e.g., pit bulls, boxers, etc.) shall not be in the same physical space with the children.

- b. Each child's hands shall be properly washed after being exposed to animals.

Source: Miss. Code Ann. §43-20-8.

Rule 1.12.7 Fire/Disaster Evacuation Drills:

1. Monthly fire/disaster (e.g., tornados, severe weather, floods, earthquakes, hurricanes, etc.) evacuation drills are required and a record of each drill shall be maintained in the facility records; to include date, time, number of children and staff present, and amount of time required to totally exit the building.
2. During fire/disaster evacuation drills, all staff and children present shall be required to exit the building.

Source: Miss. Code Ann. §43-20-8.

THIS PAGE INTENTIONALLY LEFT BLANK

Subchapter 13: NUTRITION AND MEALS

Rule 1.13.1 General:

1. A child care facility shall provide adequate and nutritious meals prepared in a safe and sanitary manner.
2. Meal periods are breakfast, lunch, dinner, and snacks. A minimum of 30 minutes shall be scheduled for each breakfast, lunch, and dinner meal period. A minimum of 15 minutes shall be scheduled for each snack meal period.
3. Meals shall be served at tables where each child may be seated.
4. Meals shall be served by employees only.
5. Employees shall wash hands prior to preparing or serving food.
6. Children shall not share food.

Source: Miss. Code Ann. §43-20-8.

Rule 1.13.2 Nutritional Standards: Meals shall meet the nutritional standards as prescribed in Appendix “C” Minimum Standards for Nutritional Care in Child Care Facilities.

Source: Miss. Code Ann. §43-20-8.

Rule 1.13.3 Refreshments:

1. Refreshments may be provided by parents only on a child's birthday or other special celebration such as Valentine's Day, Easter, Christmas, Graduation, etc. Food provided to children, including vending machines at the facility, must meet nutritional guidelines as set forth in Appendix “C.”
2. It is recommended that foods for the event that are brought to the facility by parents should be “store bought” and not “home cooked.”
3. Food items for the event may include cake, ice cream, fresh fruit, cheese and crackers, etc. Other items, i.e., party favors such as stickers, books, toothbrushes, and crayons, etc., are encouraged.

Source: Miss. Code Ann. §43-20-8.

Rule 1.13.4 Sack Lunches:

1. In facilities, operating more than six hours per day sack lunches prepared by parents may be permitted as included on approved menu plans but shall not exceed one day per month per child. Exceptions may be made for specific activities such as field trips

outside the child care facility. Measures to assure proper storage and refrigeration of sack lunches are required of the child care facility.

For programs which operate for three or more days a week, but which operate only one full day during the week, sack lunches provided by parents shall be permitted on that day. These programs shall also meet the requirements set forth in item 2 below.

2. Facilities operating six hours or less per day are allowed to have children bring sack lunches provided all of the following requirements are met:
 - a. The facility shall have a written policy about sack lunches and a copy shall be given to parents. The policy shall include the requirements b. – h., in this subsection.
 - b. Each individual child’s lunch brought from home shall be clearly labeled with the child’s name, the date, and the type of food.
 - c. All food shall be stored at an appropriate temperature until eaten.
 - d. The food brought from one child’s home shall not be fed to another child.
 - e. Children shall not share their food.
 - f. Food brought from home shall meet the child’s nutritional requirements and the standards set forth in these regulations.
 - g. If a child’s sack lunch does not meet the minimum nutritional standards for child’s age the facility shall be required to supplement the lunch with items that meet the nutritional requirements.
 - h. Parents shall be notified in writing if a child’s sack lunch does not meet the nutritional requirements or the child. The notice shall contain instructions as to what foods are proper for a sack lunch.

Source: Miss. Code Ann. §43-20-8.

Rule 1.13.5 Snacks: All snacks shall meet acceptable nutritional standards, as prescribed in Appendix “C” Minimum Standards for Nutritional Care in Child Care Facilities. In child care facilities where all the children are present for four hours or less per day during normal hours of operation, snacks may be provided by parents. If any child is present for more than four hours per day on a routine basis the facility shall meet the standard of having snacks prepared by the facility or a permitted catering establishment.

When nutritional standards are not met by snacks provided by parents, it is the child care facility's responsibility to see that children are provided acceptable snacks prepared on-site or by a permitted catering establishment.

Source: Miss. Code Ann. §43-20-8.

Rule 1.13.6 Food Safety and Food Manager:

1. All kitchens and/or food/snack preparation areas in a child care facility must be inspected as part of the child care inspection process.
2. Each child care facility must have a Certified Food Manager meeting the standards set forth in Rule 1.2.2 (1)(g). The only exception would be if two facilities had COMPLETELY different operating hours. If this situation exists then one Certified Food Manager could serve more than one facility. Should such occur, documentation to that affect must be in the each facility's file.
3. A Certified Food Manager shall be present during meal preparation. In the absence of the Certified Food Manager, an individual trained in food service must be present.

Source: Miss. Code Ann. §43-20-8.

THIS PAGE INTENTIONALLY LEFT BLANK

Subchapter 14: DISCIPLINE AND GUIDANCE

Rule 1.14.1 Prohibited Behavior: The following behaviors are prohibited by anyone (i.e., parent, caregiver, or child) in all child care settings:

1. Corporal punishment, including hitting, spanking, beating, shaking, pinching, biting, and other measures that produce physical pain.
2. Withdrawal or the threat of withdrawal of food, rest, or bathroom opportunities.
3. Abusive or profane language to include but not limited to yelling at, and/or using harsh tones toward the children or in close proximity (hearing distance) to children.
4. Any form of public or private humiliation, including threats of physical punishment.
5. Any form of emotional abuse, including rejecting, terrorizing, ignoring, isolating (out of view of a caregiver), or corrupting a child.
6. Use of any food product or medication in any manner or for any purpose other than that for which it was intended.
7. Inappropriate disciplinary behavior includes, but is not limited to, putting soap or pepper in a child's mouth.
8. Any acceptable disciplinary action that is not age-appropriate for the child or is excessive in time or duration.

Source: Miss. Code Ann. §43-20-8.

Rule 1.14.2 Restraint of a Child: Children shall not be physically restrained except as necessary to ensure their own safety or that of others, and then for only as long as is necessary for control of the situation. Children shall not be given medicines or drugs that will affect their behavior except as prescribed by a licensed physician and with specific written instructions from the licensed physician for use of the medicines or drugs.

Source: Miss. Code Ann. §43-20-8.

Rule 1.14.3 Time Out: "Time out" that enables the child to regain self-control and keeps the child in visual contact with a caregiver shall be used selectively, taking into account the child's developmental stage and the usefulness of "time out" for the particular child. "Time out" means that the child is given time away from an activity which involved inappropriate behavior. Isolation from a caregiver is not acceptable. "Time out" is not allowed for children younger than three years of age.

Source: Miss. Code Ann. §43-20-8.

Rule 1.14.4 Children Shall Not Discipline Other Children: Children shall neither be allowed nor be instructed to discipline other children.

Source: Miss. Code Ann. §43-20-8.

Subchapter 15: TRANSPORTATION

Rule 1.15.1 General: Regardless of transportation provisions, the child care facility is responsible for the safety of the children.

Source: Miss. Code Ann. §43-20-8.

Rule 1.15.2 Requirements: It is required that:

1. All drivers are appropriately licensed.
2. All vehicles have current safety inspection stickers, licenses, and registrations.
3. Insurance adequately covers the transportation of children.
4. Children board or leave the vehicle from the curb-side of the street and/or are safely accompanied to their destinations.
5. A parent is present if the child is delivered home.
6. Seat restraints are used.

Source: Miss. Code Ann. §43-20-8.

Rule 1.15.3 Occupant Restraints:

1. All children will be properly restrained whenever they are being transported in a motor vehicle.
 - a. Every person transporting a child under the age of four (4) years in a passenger motor vehicle, and operated on a public roadway, street or highway, shall provide for the protection of the child by properly using a child passenger restraint device or system meeting applicable federal motor vehicle safety standards, e.g., child safety seat.
 - b. Every person transporting a child in a passenger motor vehicle operated on a public roadway, street or highway, shall provide for the protection of the child by properly using a belt positioning booster seat system meeting applicable federal motor vehicle safety standards if the child is at least four (4) years of age, but less than seven (7) years of age and measures less than four (4) feet nine (9) inches in height or weighs less than sixty-five (65) pounds.
 - c. **Any** vehicle equipped with seatbelts is subject to the requirements in items a. and b. above.
2. No vehicle shall be occupied by more individuals than its rated capacity.

3. No children shall be transported in the front seat of vehicles equipped with passenger-side air bags.
4. All vehicles under 10,000 lbs. GVWR (Gross Vehicle Weight Rated) shall be equipped with occupant restraints appropriate for the age and/or weight of the children being transported. A child under the age of four shall be transported only if the child is securely fastened in a child safety seat that meets Federal Motor Vehicle Safety Standards (FMVSS, 49 CFR 571.213), which shall be indicated on the child safety seat. The child safety seat shall be appropriate to the child's weight and be installed and used according to the manufacturer's instructions.
5. Vehicles (e.g., school buses) with a GVWR 10,000 lbs. or more at a minimum shall meet the current Federal Motor Vehicle Safety Standards (FMVSS) for buses of that size. It is the responsibility of the child care facility operator to have documentation verifying that a bus meets the current FMVSS
6. An individual seat restraint must be used for each child. The use of an individual seat restraint for two or more children is not allowed.

NOTE: Federal Motor Vehicle Safety Standards (FMVSS) means the National Highway and Traffic Safety Administration's standards for motor vehicles and motor vehicle equipment established under Section 103 of the Motor Vehicle Safety Act of 1966 (49 CFR Part 571) as they apply to school buses.

Source: Miss. Code Ann. §43-20-8.

Rule 1.15.4 Staff-to-Child Ratio:

1. On vehicles with a GVWR of less than 10,000 lbs., the staff-to-child ratio shall be maintained at all times. The driver of the vehicle shall not be counted as a caregiver while transporting the children.
2. On vehicles with at GVWR of 10,000 lbs. or more, the staff-to-child ratio shall be one caregiver to each 25 children or fraction thereof. The driver of the vehicle shall not be counted as a caregiver while transporting the children. In facilities that are dually licensed, i.e., licensed to provide care for both preschool and school age children, if the vehicle is only transporting school age children (no preschool children, infants, or toddlers are being transported), the driver may be counted as a caregiver while transporting the school age children.

Source: Miss. Code Ann. §43-20-8.

Subchapter 16: DIAPERING AND TOILETING

Rule 1.16.1 Diaper Changing Area: Each room in which diaper-wearing children play shall contain a diapering area. A diapering area shall contain a hand washing lavatory with hot and cold running water, a smooth and easily cleanable surface, a plastic-lined, covered garbage receptacle, and sanitizing solution. The hand washing lavatories located in a diapering area shall not be included in the ratio of hand washing lavatories to children for determining a child care facility's capacity nor shall they be used for any other purpose. Example: The diaper-changing sink may not be used for washing/rinsing cups, baby bottles, food, dishes, utensils, pacifiers, etc. In addition, the diaper changing area is not to be used as a storage area for anything other than those items used when changing diapers, such as but not limited to, gloves, towels, soap, etc. For proper diaper changing procedure, see Appendix G - PROCEDURE FOR DIAPERING A CHILD.

Source: Miss. Code Ann. §43-20-8.

Rule 1.16.2 Non-Disposable Diapers and Training Pants: The fecal contents of non-disposable diapers or training pants shall be disposed of into a toilet. The soiled non-disposable diaper or training pants shall then be placed into a plastic bag, sealed, and placed in the child's individual container.

Source: Miss. Code Ann. §43-20-8.

Rule 1.16.3 Disposable Diapers: Disposable diapers shall be placed into a plastic bag and sealed or shall be rolled up and taped securely, then placed into a plastic-lined covered garbage receptacle.

Source: Miss. Code Ann. §43-20-8.

Rule 1.16.4 Potty Chairs: Potty chairs, if used, shall be placed in the bathroom area and sanitized after each child's use.

Source: Miss. Code Ann. §43-20-8.

Rule 1.16.5 Hand Washing: Employees shall wash their hands with soap and running water before and after each diaper change. Individual or disposable towels shall be used for drying. Hand washing sinks at diaper changing stations shall not be used for any other purpose. Example: The diaper changing sink may not be used for washing cups, baby bottles, food, dishes, utensils, etc.

Source: Miss. Code Ann. §43-20-8.

Rule 1.16.6 Parental Consultation: A parent caregiver consultation is required prior to toilet training.

Source: Miss. Code Ann. §43-20-8.

THIS PAGE INTENTIONALLY LEFT BLANK

Subchapter 17: REST PERIODS

Rule 1.17.1 Equipment: Each child shall be placed on a separate bed, crib, cot, or mat. Cribs shall be labeled so that the child's name is visible.

Source: Miss. Code Ann. §43-20-8.

Rule 1.17.2 Cleaning of Linens and Bed Coverings: Linens and bed coverings shall be changed immediately when soiled. All linens and bed coverings shall be changed, at a minimum, two times per week.

Source: Miss. Code Ann. §43-20-8.

Rule 1.17.3 Cleaning of Rest Period Equipment: All rest period equipment shall be wiped clean immediately when soiled. All rest period equipment shall be cleaned twice a week with a germicidal solution. Additional cleaning may be required by the licensing authority if there is an outbreak of a communicable disease, including but not limited to, rotavirus, giardiasis, etc., or a noninfectious condition such as, but not limited to, an infestation of head lice.

Source: Miss. Code Ann. §43-20-8.

Rule 1.17.4 Sharing of Rest Period Equipment: At no time will two or more children be allowed to share the same bed, crib, cot, or mat during their time of enrollment, unless it is cleaned with a germicidal solution between each child's use.

Source: Miss. Code Ann. §43-20-8.

THIS PAGE INTENTIONALLY LEFT BLANK

Subchapter 18: FEEDING OF INFANTS AND TODDLERS

Rule 1.18.1 Hand Washing: Employees shall wash their hands with soap and water, and dry their hands with individual or disposable towels, before and after each feeding. The infant and toddler's hands shall be washed with soap and water, and dried with individual or disposable towels, before and after each feeding.

Source: Miss. Code Ann. §43-20-8.

Rule 1.18.2 Bottle Feeding: Infants shall be held while being bottle fed. Bottles shall not be propped at any time. With parental consent and when infants are old enough to hold their own bottles, they may feed themselves without being held. The bottle shall be removed at once when empty or when the child has fallen asleep.

Source: Miss. Code Ann. §43-20-8.

Rule 1.18.3 Formula Storage: Formula shall be labeled with the child's name, dated, and placed in the refrigerator upon arrival.

Source: Miss. Code Ann. §43-20-8.

Rule 1.18.4 Baby Food: Foods stored or prepared in jars shall be served from a separate dish for each infant or toddler. Any leftovers from the serving dish shall be discarded. Leftovers in the jar shall be labeled with the child's name, dated, refrigerated, and used within the next 24 hours or discarded.

Source: Miss. Code Ann. §43-20-8.

Rule 1.18.5 Refrigerator: A refrigerator shall be available and easily accessible to the infant or toddler's room(s).

Source: Miss. Code Ann. §43-20-8.

Rule 1.18.6 Heating Unit and Microwave Use:

1. A heating unit for warming bottles and food shall be accessible only to adults.
2. Microwave ovens shall not be used for warming bottles or baby/infant food.

Source: Miss. Code Ann. §43-20-8.

Rule 1.18.7 Breast-Feeding Accommodations and Staff Training: This section applies to all mothers choosing to breast-feed their child regardless of the child's age.

1. Breast-feeding mothers, including employees, shall be provided a sanitary place that is not a toilet stall to breast-feed their child or to express milk. This area shall provide an electrical outlet, comfortable chair, and nearby access to running water.

2. A refrigerator must be available to accommodate storage of expressed breast milk. It is acceptable to store expressed milk in the same refrigerator as other milk/bottles provided each bottle is appropriately labeled with the child's name and the time of expected expiration of the milk. Milk must be stored in accordance with the American Academy of Pediatrics and Centers for Disease Control guidelines. Universal precautions are not required in handling human milk.
3. Child care staff shall be trained in the safe and proper storage and handling of human milk. Although other training materials may be utilized, training materials will be available through MSDH.

Guidelines for Milk Storage and Use for All Infants

Storage Method and Temperature	Maximum Amount of Time For Storage
<i>Room (25 C or 77 F)</i>	4 hours
<i>Refrigerator (4 C or 39 F)</i>	48 hours
<i>Previously thawed – Refrigerated milk</i>	24 hours
<i>Freezer (-20 C or 0 F)</i>	3 months

From the ACOG/AAP publication: Breastfeeding Handbook for Physicians

Source: Miss. Code Ann. §43-20-8.

Subchapter 19: SWIMMING AND WATER ACTIVITIES

Rule 1.19.1 General: This section shall apply to any child care facility that, as part of its program, allows the children to swim, wade, or participate in any water activities whether on site or at any other location during the time staff has responsibility for children enrolled.

Source: Miss. Code Ann. §43-20-8.

Rule 1.19.2 Lifeguard Supervision:

1. Swimming pools, lakes, etc.:

- a. A person having an American Red Cross lifeguard certificate, or the equivalent as recognized by the licensing agency, shall be present at all swimming and water activities.
- b. One lifeguard is required for every 25 children or any portion thereof (i.e., two lifeguards are required for groups of 26 - 50, three for 51 - 75, etc.). This required ratio also includes activities that occur near water such as fishing or beach activities.
- c. Lifeguards are not counted in the staff-to-child ratio.
- d. The staff-to-child ratio shall be maintained at all times.
- e. It is the child care facility operator's responsibility to provide adequate certified lifeguards if the pool or lake operator does not.
- f. Each child will be tested by a certified lifeguard prior to participating in swimming lessons or any pool activities. Children will be assigned to swim groups according to the results of the test.
- g. Staff, as well as lifeguards, shall be responsible for enforcing general safety rules.
- h. Staff is responsible for requiring children to obey all swimming/water rules. These rules shall be explained each day that swimming/water activities occur so that all ages can understand what is expected.

2. Wading pools: For activities taking place in wading pools with a water depth of one foot or less the following is required:

- a. There shall be a person(s) with a valid CPR certificate and a valid first aid certificate present at all times.
- b. The staff-to-child ratio shall be maintained at all times.
- c. Wading pools shall be cleaned after each use.

Source: Miss. Code Ann. §43-20-8.

Rule 1.19.3 Health and Safety:

1. All piers, floats, and platforms shall be in good repair, and where applicable, the water depth shall be indicated by printed numerals on the deck or planking.
2. There shall be a minimum water depth of 10 feet for a one-meter diving board and 13 feet for a three-meter board or diving tower.
3. For outdoor swimming areas in natural bodies of water, the bottom shall be cleared of stumps, rocks, and other obstacles.
4. Diving boards shall be mounted on a firm foundation and never on an insecure base, such as a float that can be affected by shifting weight loads and wave action. The entire length of the top surface of diving boards shall be covered with nonskid material. The diving board shall be level. All diving boards shall be installed in accordance with manufacturer's guidelines for the board by professional swimming pool installers who shall certify in writing to the facility that the diving board is adequately installed in accordance with manufacturer's guidelines for the board, in a commercially reasonable manner, located so as to allow a child to safely enter the water from the diving board, and that the diving board is safe for its intended use. Facilities with existing pools equipped with diving boards that are unable to obtain the required certification within 60 days of the adoption of this regulation shall have the diving boards removed.
5. Swimming pools, when in use, shall be continuously disinfected by a chemical that imparts an easily measured free available residual effect. When chlorine is used, a free chlorine residual of at least 0.4 ppm shall be maintained throughout the pool whenever it is open or in use. If other halogens are used, residuals of equivalent disinfecting strength shall be maintained.
6. A testing kit for measuring the concentration of the disinfectant, accurate within 0.1 ppm, shall be provided at each swimming pool.

7. Swimming pool water shall be maintained in an alkaline condition as indicated by a pH of not less than 7.2 and not over 8.2. A pH testing kit accurate to the nearest 0.2 pH unit shall be provided at each swimming pool. The alkalinity of the water shall be at least 50 ppm, as measured by the methyl-orange test. The following chart may be used for reference:

pH	Minimum Free Available Residual Chlorine-mg/L <i>(not stabilized with cyanuric acid)</i>
7.2.....	0.40
7.3.....	0.40
7.4.....	0.40
7.5.....	0.40
7.6.....	0.50
7.7.....	0.60
7.8.....	0.70
7.9.....	0.80
8.0.....	1.00

8. If cyanuric acid is used to stabilize the free available residual chlorine, or if one of the chlorinated isocyanurate compounds is used as the disinfecting chemical in a swimming pool, the concentration of cyanuric acid in the water shall be at least 30 mg/L but shall not exceed 100 mg/L. The free available residual chlorine, of at least the following concentrations, depending upon the pH of the water, shall be maintained:

pH	Minimum Free Available Residual Chlorine-mg/L <i>(Cyanuric acid is at least equal to 30 mg/L, but not greater than 100 mg/L)</i>
7.2.....	1.00
7.3.....	1.00
7.4.....	1.00
7.5.....	1.00
7.6.....	1.25
7.7.....	1.50
7.8.....	1.75
7.9.....	2.00
8.0.....	2.50

9. The water in a swimming pool shall have sufficient clarity at all times so that a black disk, six inches in diameter, is readily visible when placed on a white field at the deepest point of the pool. The pool shall be closed immediately if this requirement cannot be met.
10. For natural bodies of water (e.g., lakes, rivers, streams, etc.), sewage treatment plants or other discharge lines shall not be within 750 feet of swimming areas.

Source: Miss. Code Ann. §43-20-8.

Subchapter 20: CHILDREN WITH SPECIAL NEEDS

Rule 1.20.1 Facility Adaptation:

1. The child care facility areas to be utilized by a child with special needs shall be adapted as necessary to accommodate special devices that may be required for the child to function independently, as appropriate.
2. A separate area shall be available for providing privacy for diapering, dressing, and other personal care procedures.

Source: Miss. Code Ann. §43-20-8.

Rule 1.20.2 Activity Plan: A child with special needs shall have an individual activity plan. The individual activity plan shall have been developed by a person with a bachelors or advanced degree in a discipline dealing with disabilities, as appropriate. The individual activity plan shall be reviewed, at a minimum, once every 12 months.

Source: Miss. Code Ann. §43-20-8.

Rule 1.20.3 Caregiver Staff Development: Caregivers serving children with special needs shall receive staff development related to the specific needs of the children served.

Source: Miss. Code Ann. §43-20-8.

Rule 1.20.4 Staffing: Caregiver staffing shall be appropriate and adequate to meet the specific physical and/or developmental needs of the special needs children served at the child care facility. Staff-to-child ratio shall be determined by the needs of the child rather than child's chronological age as based upon the child's individual plan (i.e., individual education plan, individual habilitation plan, individual family service plan, etc.). The facility is encouraged to be an active participant in the child's individual plan development.

Source: Miss. Code Ann. §43-20-8.

THIS PAGE INTENTIONALLY LEFT BLANK

Subchapter 21: NIGHT CARE

Rule 1.21.1 General: This section shall apply to any child care facility that is open past 11:30 p.m., as part of their regular hours of operation.

Source: Miss. Code Ann. §43-20-8.

Rule 1.21.2 Nutrition:

1. A child care facility that is open prior to 7:00 p.m. shall provide a dinner meal period.
2. A child care facility that remains open after 5:00 a.m. shall provide a breakfast meal period.
3. A snack period shall be provided to children in attendance for more than two and one-half (2½) hours prior to bedtime.
4. Menu plans for lunch and dinner meals shall be varied. No single menu shall be repeated in a 24 hour period.

Source: Miss. Code Ann. §43-20-8.

Rule 1.21.3 Sleeping:

1. Mats shall not be used for sleeping.
2. Bedtime schedules shall be established in consultation with the child's parent.
3. Provisions shall be made in sleeping areas for the use and storage of clothing and personal belongings and they shall be within easy reach of the child using them.
4. A child shall be provided with a bed or cot equipped with a comfortable mattress (a minimum of three inches thick), sheets, a pillow with a pillowcase, and a blanket.
5. The upper level of double-deck beds shall not be used for children under ten years of age. The upper level of double-deck beds are allowed for children ten years of age or older if a bed rail and safety ladder is provided.
6. Each child shall have clean and comfortable sleeping garments.

Source: Miss. Code Ann. §43-20-8.

Rule 1.21.4 Bathroom Facilities:

1. There shall be a bathtub or shower available for children of toddler age or older.
2. Bathtubs and showers shall be equipped to prevent slipping.

3. If night care is provided for infants, there shall be age appropriate bathing facilities for these children.
4. Bathrooms shall be located near the sleeping areas.
5. No children under six years of age shall be left alone or with another child while in the bathtub or shower.
6. All children shall be bathed separately.
7. All children shall be provided an individual washcloth, towel, and soap for bathing, with fresh water for each child.

Source: Miss. Code Ann. §43-20-8.

Subchapter 22: SCHOOL AGE CARE

Rule 1.22.1 General: For a child care facility operating pursuant to a license for "School Age Care," the regulations for child care facilities shall apply, except when inconsistent with the requirements of this section and then the requirements of this section take precedence. Programs operating in excess of 16 weeks per year shall meet the more stringent requirements of Subchapter 22 and 23.

Source: Miss. Code Ann. §43-20-8.

Rule 1.22.2 Enrollment: A child care facility operating pursuant to a license for "School Age Care" shall only enroll school age children (5-12 years of age). These children may not be placed in the same area of a child care facility as preschool children.

Source: Miss. Code Ann. §43-20-8.

Rule 1.22.3 Indoor Square Footage and Grouping: A minimum of 25 square feet of usable indoor floor space, per child per room, shall be maintained for each child. This shall not include hallways, bathrooms, closets, storage rooms, offices, or kitchens. When a room is used for meals, the minimum square footage per child per room requirement will not apply. This standard is only applicable when the program is licensed as school age only. If the school age children are served in conjunction with preschool children under the same license, the preschool square footage standards will apply.

When children are placed in groups, the maximum group size shall be determined by the following chart.

Age of Children in the Group	MAXIMUM number of children ALLOWED in a group of children this age	MINIMUM number of caregivers REQUIRED for a group of children this age	MINIMUM square footage REQUIRED for a group of children this age
5-9 years	20 children	1 caregiver	25 square feet per child
10-12 years	25 children	1 caregiver	25 square feet per child

Source: Miss. Code Ann. §43-20-8.

Rule 1.22.4 Nutrition:

1. A snack period shall be provided.
2. On holidays, inclement weather days, or when a child must be in school age care for a full day program, snacks and meals may be provided by the parents if the parents are given and adhere to policies regarding acceptable nutritional standards, as prescribed in Appendix “C” Minimum Standards for Nutritional Care in Child Care Facilities. When nutritional standards are not met by snacks and meals provided by parents, it is the child care facility's responsibility to see that children are provided acceptable snacks and meals, prepared on-site or by a permitted catering establishment.

Source: Miss. Code Ann. §43-20-8.

Rule 1.22.5 Transportation:

1. The staff-to-child ratio shall be maintained at all times.
2. The driver of the vehicle may be counted as a caregiver while transporting school age children only.

Source: Miss. Code Ann. §43-20-8.

Rule 1.22.6 Toilets and Hand Washing Lavatories:

1. The following ratios shall apply:

Number of Children	Number of Toilets and Hand Washing Lavatories
1-30	1 of each
31-60	2 of each
60-90	3 of each

2. For each additional 30 children or portion thereof, add one toilet and one hand washing lavatory.
3. Urinals shall count as one-half (½) a toilet not to exceed 33 percent of the total number of toilets required.
4. Separate facilities for boys and girls shall be provided.

5. School age programs serving only school age children that are located in schools accredited by any organization listed in Mississippi Code §43-20-5 (a)(iii) are exempt from the requirements for hot water at hand washing lavatories utilized by the children in attendance.

Source: Miss. Code Ann. §43-20-8.

Rule 1.22.7 Playgrounds: School age programs serving only school age children that are located in schools accredited by any organization listed in Mississippi Code §43-20-5 (a)(iii) are exempt from the requirements of Subchapter 10, Rule 1.10.2 Playground Equipment and Subchapter 10, Rule 1.10.9 Outdoor Playground Area of these regulations except that playground equipment shall be in good repair.

Rule 1.22.8 After School Programs: In after school programs, screen time, i.e., television viewing, including video tapes and/or other electronic media, cell phone, or digital media, e.g., iPod®, iPad®, iTouch®, etc., is limited to one hour per day. Screen or media use or other educational electronic equipment is acceptable provided such is for educational purposes.

Source: Miss. Code Ann. §43-20-8.

THIS PAGE INTENTIONALLY LEFT BLANK

Subchapter 23: SUMMER DAY CAMP & SCHOOL AGE PROGRAMS

Rule 1.23.1 General: For a child care facility operating pursuant to a license for a "Summer Day Camp" or "School Age Program," the regulations for child care facilities shall apply, except when inconsistent with the requirements of this section, and then the requirements of this section take precedence.

Source: Miss. Code Ann. §43-20-8.

Rule 1.23.2 Definition:

1. A summer day camp is defined as a child care facility that operates during May, June, July, and/or August only, for a minimum of 22 days and a maximum of 16 weeks.
2. A school age program is defined as a child care facility that operates during the school year. These programs may also operate 12 months a year. School age programs that operate 12 months a year shall meet "School Age Program" space requirements for determining maximum capacity.

Source: Miss. Code Ann. §43-20-8.

Rule 1.23.3 Enrollment: Summer day camps and school age programs shall not enroll children under five years of age.

Source: Miss. Code Ann. §43-20-8.

Rule 1.23.4 Maximum Capacity: All children enrolled (including those over 13 years of age) shall be included in calculating the maximum capacity of the facility.

Source: Miss. Code Ann. §43-20-8.

Rule 1.23.5 Summer Day Camp & School Age Program Director Qualifications:

1. A summer day camp director shall be at least 21 years of age, and shall have, at a minimum:
 - a. A bachelor's degree with a minimum of 18 semester hours in elementary or secondary education or a field such as recreation, physical education, psychology (with emphasis in child/adolescent psychology), or special education, or one related to day camp or school age program operations.

OR

- b. A two year associate degree in child development technology or related field.

OR

- c. A Mississippi Department of Human Services Office for Children and Youth Director's Child Care Credential, or 15 semester hours credit with a grade of "C" or better from an accredited college or university in courses listed in #1 above with an additional two years of experience as a caregiver or caregiver assistant in a licensed child care facility (Any college course(s) submitted for consideration are subject to approval by the licensing authority).

OR

- d. A high school diploma or equivalent (GED) and four years experience in a school age program or four summers in a day camp program.
2. Transcripts shall be provided for review by the licensing agency.

Source: Miss. Code Ann. §43-20-8.

Rule 1.23.6 Caregiver CPR and First Aid Certification:

1. All caregivers in summer day camps are required to have current CPR and first aid certification, copies of which shall be kept with their personnel records.
2. In school age programs that operate in a central location there shall be at least one caregiver on the premises at all times the facility is in operation that has a current certification in CPR and first aid. When groups of children are away from the central location for field trips etc., there shall be at least one caregiver with the group that holds a current certification in CPR and first aid.

Source: Miss. Code Ann. §43-20-8.

Rule 1.23.7 Facility Record Storage: Facility records may be retained in the administrative office.

Source: Miss. Code Ann. §43-20-8.

Rule 1.23.8 Indoor Square Footage and Grouping:

1. For summer day camps that routinely operate indoors in a permanent structure for two or more hours each day a minimum of 25 square feet of usable indoor floor space, per child per room, shall be maintained for each child. This shall not include hallways, bathrooms, closets, storage rooms, offices, or kitchens. When a room is used for meals, the minimum square footage per child requirement will not apply.

When children are placed in groups, the maximum group size shall be determined by the following chart.

Age of Children in the Group	MAXIMUM number of children ALLOWED in a group of children this age	MINIMUM number of caregivers REQUIRED for a group of children this age	MINIMUM square footage REQUIRED for a group of children this age
5-9 years	20 children	1 caregiver	25 square feet per child
10-12 years	25 Children	1 caregiver	25 square feet per child

2. When activities for children are routinely conducted outdoors or off the premises for six or more hours each day, the following requirements shall apply:
 - a. There shall be a permanent structure that serves as a home base where parents deliver and pick up children.
 - b. There shall be a minimum of ten square feet per child usable indoor space available in the event of inclement weather.
3. School age programs require that a minimum of 25 square feet of usable indoor floor space, per child per room shall be maintained for each child. This shall not include hallways, bathrooms, closets, storage rooms, offices, or kitchens. When a room is used for meals, the minimum square footage per child requirement will not apply.

Source: Miss. Code Ann. §43-20-8.

Rule 1.23.9 Nutrition:

1. For summer day camps or school age programs that routinely operate indoors in a permanent structure, snacks, and meals may be provided by the parents if the parents are given and adhere to policies regarding acceptable nutritional standards, as prescribed in Appendix “C” Minimum Standards for Nutritional Care in Child Care Facilities. When nutritional standards are not met by snacks and meals provided by parents, it is the summer day camp's or school age program’s responsibility to see that children are provided acceptable snacks and meals, prepared on-site or by a permitted catering establishment.
2. For summer day camps operating primarily as an outdoor program away from the home base, the following exceptions shall apply:
3. Milk is not required to be served in programs routinely operating outdoors or off the premises for six or more hours each day.
4. If food is brought from home or catered, there shall be sanitary cold storage available.

- All summer day camps shall have an adequate water supply. Potable water, from a Mississippi State Department of Health approved source, shall be used for drinking. Fresh water shall be provided daily in closed containers.

Source: Miss. Code Ann. §43-20-8.

Rule 1.23.10 Transportation:

- The staff-to-child ratio shall be maintained at all times.
- The driver of the vehicle may be counted as a caregiver while transporting the children.

Source: Miss. Code Ann. §43-20-8.

Rule 1.23.11 Toilets and Hand Washing Lavatories:

- The following ratios shall apply:

Number of Children	Number of Toilets and Hand washing Lavatories
1-30	1 of each
31-60	2 of each
60-90	3 of each

- For each additional 30 children or portion thereof, add one toilet and one hand washing lavatory.
- Urinals (in boys' restrooms) shall count as one-half (1/2) a toilet not to exceed 33 percent of the total number of toilets required.
- Separate facilities for boys and girls shall be provided.
- For summer day camps operating primarily as an outdoor program away from the home base, alternative methods of hand washing may be provided.

Source: Miss. Code Ann. §43-20-8.

Rule 1.23.12 Equipment: Archery equipment, firearms (e.g., skeet shooting, target practice, etc.), power equipment, and other potentially hazardous items shall be stored in a locked area when not in use. These items shall be used by children only under the direction and supervision of an individual certified by a state or national organization recognized by the Mississippi State Department of Health.

Source: Miss. Code Ann. §43-20-8.

Rule 1.23.13 Immunization Requirements: Children properly enrolled in a Summer Day Camp or School Age Program are not required to have a Certificate of Immunization Compliance (MSDH Form 121) in their record.

Source: Miss. Code Ann. §43-20-8.

THIS PAGE INTENTIONALLY LEFT BLANK

Subchapter 24: HOURLY CHILD CARE

Rule 1.24.1 General: For a child care facility operating pursuant to a license for an "Hourly Child Care," the regulations for child care facilities shall apply, except when inconsistent with the requirements of this section, and then the requirements of this section take precedence.

Source: Miss. Code Ann. §43-20-8.

Rule 1.24.2 Definition:

1. An "Hourly Child Care Facility" is defined as a facility that meets the provisions of these regulations for a "Child Care Facility" and:
 - a. Limits the care of a child to no more than eight hours per stay not to exceed a total of 45 hours in any calendar month period.
 - b. Provides supervised, short term, hourly care on a temporary basis in conjunction with a specific facility or business complex such as, but not limited to, hotels; shopping malls; recreational, sporting, or entertainment facilities.
2. Hourly child care facilities are not appropriate for full time child care and will not be allowed to provide that type of service. When it is determined by the licensing agency that a facility provides child care services on a full time basis, the facility shall meet all requirements for a regular child care facility as set forth in the preceding sections of these regulations.

Source: Miss. Code Ann. §43-20-8.

Rule 1.24.3 Facility Policy and Procedures:

1. Parents shall be provided a written statement of policies pertaining to emergencies, meals, snacks, procedures for releasing a child to parent, and any other information regarding hourly child care facility operation. All policies and procedures will be submitted to the licensing agency and reviewed prior to a license being issued. Written guidelines will be provided to applicants as part of the application packet.
2. The care of a child shall be no more than eight hours per stay and shall not exceed a total of 45 hours in any calendar month period.
3. When business hours exceed 12 hours in a 24-hour period, the program will be reviewed on an individual basis for compliance with regulations addressing evening and overnight care.

Source: Miss. Code Ann. §43-20-8.

Rule 1.24.4 Personnel Requirements: Students in a field study placement, a practicum, or vocational child care training program may not assist in the care of the children in hourly child care facilities.

Source: Miss. Code Ann. §43-20-8.

Rule 1.24.5 Records and Reports: In addition to all records and reports required in these regulations, hourly child care facilities shall maintain a log containing the name, address, and home phone number of each child along with the date and time of arrival and departure. The hourly child care facility shall maintain information necessary to contact local law enforcement officials and the Mississippi Department of Human Services when a child is left at the facility past its hours of operation, or for an extended period.

Source: Miss. Code Ann. §43-20-8.

Rule 1.24.6 Health Records: Sample forms for duplication will be provided to operators to ensure adequate health information is taken on the children served. Only forms that substantially comply with the aforementioned sample forms will be acceptable. Registration forms will include a signed statement that will serve as verification that a child has received all age-appropriate immunizations. Other information to be included on the form will be the home or forwarding phone numbers and addresses to be used when the parent must be informed of situations or conditions after the child is no longer at the hourly child care facility.

Source: Miss. Code Ann. §43-20-8.

Rule 1.24.7 Program of Activities: Hourly child care facility programs are exempt from the requirement that a planned written program of activities be submitted as part of the licensing process. However, the facility shall provide adequate space and equipment to allow children to choose between quiet and active play. Appropriate toys and books for quiet play shall be maintained in a physically separate area that is a sufficient distance from active play to reduce noise and to assure a quiet, relaxed environment.

Source: Miss. Code Ann. §43-20-8.

Rule 1.24.8 Buildings and Grounds:

1. A certificate of inspection and approval by the fire department of the municipality or other political subdivision in which the child care facility is located shall be submitted to the licensing agency with the application and license fee. Except that if no fire department exists where the facility is located, the State Fire Marshall shall certify as to the inspection for safety from fire hazards.

The inspection form to be used for fire inspections shall be MSDH Form #333 and shall be signed by a signatory authority of the fire inspection authority making the inspection.

2. In non-land-based facilities, only ground level space with exits directly to the outside will be approved.
3. A written emergency evacuation route shall be posted in a conspicuous location within each room used by children. The plan will be subject to review, evaluation, and approval by the licensing agency.
4. Space requirements shall comply with the standards set forth in these regulations. However, in the absence of adequate outdoor playground area, not less than 25 percent or more than 50 percent of the space allocated for children three to 13 years of age shall be set aside and dedicated to large muscle development activities. Such areas shall contain appropriate play equipment for large muscle development. Such equipment may include but is not limited to indoor gyms specifically designed and approved for children in the three to 13 years of age group. Final approval of the appropriateness of the equipment to be located in the designated area shall be made by the licensing agency.
5. If outdoor playground space is provided, but inadequate for the maximum capacity of the building, a schedule shall be provided to show how outdoor playtime will be made available to all the children. At no time will there be more children on the playground than the maximum number allowed computed at 75 square feet per child. Maximum outdoor playground area capacity shall be posted and adhered to at all times the area is in use.
6. When kitchens are not on-site, the hourly child care facility is required to maintain adequate storage and refrigeration for snacks. In addition, food shall be served in disposable containers unless an acceptable method of dishwashing is available (Appendix "E"). All food served shall come from a permitted kitchen or catering facility. Food service shall comply with the standard set in the current 10.0 Regulation Food Code as published by the Mississippi State Department of Health.
7. The ratio of one hand washing lavatory and one toilet for every 30 children shall be maintained. Separate facilities are required for boys and girls.
8. Facilities must meet the requirements of Rule 1.2.2 (1)(k) and Rule 1.11.1 (8) of these regulations. Referenced Rule 1.2.2 (1)(k) and Rule 1.11.1 (8) refer to required testing for lead in child care facilities.

Source: Miss. Code Ann. §43-20-8.

Rule 1.24.9 Nutrition: Parents of children being cared for in an hourly child care facility shall be informed in writing of the availability of meals and the following requirements:

1. When a child is in a facility for three or more hours, a snack shall be provided.

2. Children under five years of age will be provided snacks on request, regardless of the length of time spent in the facility.
3. At regular meal times, all children present shall be offered a meal. Regular meal times are defined as follows:
 - a. Breakfast - between 7 a.m. and 9 a.m.
 - b. Lunch - between 11 a.m. and 1 p.m.
 - c. Supper - between 5 p.m. and 7 p.m.
4. All meals shall meet the nutritional standards prescribed in Appendix “C” Minimum Standards for Nutritional Care in Child Care Facilities.

Source: Miss. Code Ann. §43-20-8.

Rule 1.24.10 Abuse and Neglect Reports:

1. All employees will be informed by the hourly child care facility director of the individual's responsibility in reporting suspected abuse and neglect. Copies of the child abuse law shall be provided to each employee (Appendix "A").
2. Reports of suspected child abuse or neglect will be made to the Mississippi Department of Human Services and/or local law enforcement officials in accordance with state law. Because abused or neglected children requiring immediate attention are often identified after traditional business hours of the Mississippi Department of Human Services, reports of this nature shall also be made to local law enforcement.
3. Hourly child care facility operators and/or directors are encouraged to establish a working relationship with local law enforcement authorities and the Mississippi Department of Human Services. In extreme situations where local county Department of Human Services staff cannot be reached, operators and/or directors will report to the statewide 24-hour Child Abuse Hotline at 1-800-222-8000.
4. Operators and/or directors will work in conjunction with the local law enforcement and the Mississippi Department of Human Services to establish a workable procedure for reporting cases when a child has been left at the hourly child care facility for an extended period of time after business hours or when allowing a child to leave the hourly child care facility will place that child at risk or in potential danger.

Source: Miss. Code Ann. §43-20-8.

Subchapter 25: HEARINGS, EMERGENCY SUSPENSIONS, LEGAL ACTIONS AND PENALTIES

Rule 1.25.1 Emergency Suspensions of License:

1. Any license issued pursuant to these regulations may be suspended prior to a hearing if the licensing agency has reasonable cause to believe that the operation of the child care facility constitutes a substantial hazard to the health or safety of the children cared for by the child care facility.
2. Whenever a license is to be suspended, the operator or director shall be notified in writing that the license, upon service of the notice, is immediately suspended. The notice shall contain the reason for the emergency suspension, and shall set a date for a hearing, which shall be within 14 days of the service of notice.

Source: Miss. Code Ann. §43-20-8.

Rule 1.25.2 Denial, Revocation, or Suspension of License: The licensing agency may deny, refuse to renew, suspend, revoke, or restrict a license of any child care facility upon one more of the following grounds:

1. Fraud, misrepresentation, or concealment of a material fact by the operator in securing the issuance or renewal of a license.
2. Conviction of an operator of any crime, if the licensing agency finds that the acts of which the operator has been convicted could have a detrimental effect on the children cared for by the child care facility.
3. Violation of any of the provisions of the act or of these rules and regulations.
4. Any conduct or failure to act, which is determined by the licensing agency to threaten the health or safety of a child.
5. Failure by the child care facility to have all criminal records and child abuse central registry checks on file at the facility.
6. Information received by the licensing authority as a result of the criminal records check (fingerprinting) or the child abuse central registry check on an operator.

Source: Miss. Code Ann. §43-20-8.

Rule 1.25.3 Notification:

1. Prior to the denial, refusal to renew, suspension, revocation or restriction of a license, and at the time of the imposition of any monetary penalty, written notice of the contemplated action shall be given to the applicant or person named on the license of

the child care facility, at the address on record with the licensing agency. Such notice shall specify the reasons for the proposed action and shall notify the operator of the right to a district level hearing on the matter.

Source: Miss. Code Ann. §43-20-8.

Rule 1.25.4 District Level Hearing for Monetary Penalties:

1. If requested in writing within ten calendar days of receipt of notice of the imposition of a monetary penalty, a district level hearing shall be provided in which the operator or applicant may show cause why the monetary penalty should not be imposed. The District Health Officer or his/her designee will preside at said hearing.
2. Any hearing requested pursuant to Subchapter 1.25.4(1) shall be held no less than five calendar days and no more than 20 calendar days from the receipt of any request for a hearing, unless both parties agree to an alternate period.
3. The district level hearing shall be informal. There will be no court reporter present and the Department will not be represented by counsel. However, the hearing officer will take notes of the proceedings and will provide the licensee with a written order outlining his decision within ten calendar days of conclusion of the district level hearing.
4. Within ten calendar days of the receipt of the district level decision the licensee may make a written request for a new hearing at the state level.

Source: Miss. Code Ann. §43-20-8.

Rule 1.25.5 State Level Hearing:

1. If requested in writing within ten calendar days of receipt of a notice of revocation, non-renewal, probation, or suspension, or after a district level hearing has been held on a monetary penalty, a hearing shall be held at the state level. At the state level hearing a hearing officer shall be appointed by the State Health Officer. A court reporter shall transcribe the proceeding. The hearing shall be held within 30 calendar days of receipt of the request for such hearing, unless waived in writing by the licensee.
2. Within 30 calendar days of the hearing, or such period as determined during the hearing, written findings of fact, together with a recommendation for action, shall be forwarded to the State Health Officer. The State Health Officer shall decide what, if any, action is to be taken on the recommendation within 14 calendar days of receipt of the recommendation. Written notice of the decision of the State Health Officer shall be provided to the operator.
3. At the state level hearing, the licensee shall be entitled to legal representation at his or her own expense.

4. For the *Rules and Procedures for State Level Administrative Hearings* refer to APPENDIX J of these regulations.

Source: Miss. Code Ann. §43-20-8.

Rule 1.25.6 Appeal: Any operator who disagrees with or is aggrieved by a decision of the licensing agency concerning the suspension, revocation, or restriction of a license may appeal to the Chancery Court of the county in which the child care facility is located. The appeal shall be filed no later than 30 calendar days after the operator receives written notice of the final administrative action by the licensing agency as to the suspension, revocation, or restriction of the license. The operator shall have the burden of proving that the decision of the licensing agency was not in accordance with applicable law and these regulations.

If a facility is allowed to continue to operate during the appeal process, it will remain under the regulation of the licensing agency and will be subject to all current licensure regulations to include, but not limited to, inspection of the facility, review of facility and children's records, submission of all required or requested documents, and payment of all applicable fees and/or monetary penalties.

Source: Miss. Code Ann. §43-20-8.

Rule 1.25.7 Injunction: Notwithstanding the existence of any other remedy, the licensing agency may, in the manner provided by law, in term time or in vacation, upon the advice of the Attorney General who shall represent the licensing agency in the proceedings, maintain an action in the name of the state for injunction or other proper remedy against any person to restrain or prevent the establishment, conduct, management, or operation of a child care facility with or without a license under the act, or otherwise in violation of these regulations.

Source: Miss. Code Ann. §43-20-8.

Rule 1.25.8 Criminal Penalties: Any person establishing, conducting, managing, or operating a child care facility without a license pursuant to these regulations shall be guilty of a misdemeanor, and, upon conviction, shall be fined not more than one hundred dollars (\$100.00) for the first offense, and not more than two hundred dollars (\$200.00) for each subsequent offense.

Source: Miss. Code Ann. §43-20-8.

Rule 1.25.9 Violations and Penalties:

In the event of an emergency occurring at a child care facility which makes it difficult or impossible to comply with any of these Rules, the facility shall not be considered to be in violation of those specific Rules. For purposes of this Rule 1.25.9, the term "emergency" shall include only the following:

- (a) Inclement weather;

- (b) Damage to the facility and/or structure which might require moving, transferring or consolidation of children;
 - (c) Traumatic injury or acute illness of a caregiver or the caregiver's immediate family while the caregiver is on-site resulting in the caregiver having to leave the premises;
 - (d) During any declaration of emergency by local or state officials;
 - (e) An injury or illness of a child at the facility requiring the immediate attention of one or more caregivers, resulting in non-compliance with child-to-staff ratio or room capacity; and
 - (f) During a period when Department inspectors or other government official require facility staff to temporarily not be able to perform their normal supervisory duties.
1. Any Class I violation of these regulations, in the discretion of the licensing agency, is punishable by a monetary penalty of five hundred dollars (\$500.00) for a first occurrence and a monetary penalty of one thousand dollars (\$1000.00) for each subsequent occurrence of the same violation. Each violation is considered a separate offense.

The following are Class I violations:

- a. Failure to prevent the death, dismemberment, or permanent disability of a child.
- b. Allowing a child to be unattended at a licensed child care facility before or after operating hours. This also includes a child being left alone during operating hours when no staff is present at the facility. Further, a child left unattended outside of a child care facility is also considered to be a Class I violation.
- c. Allowing a child to be unattended when not at the licensed facility but under the care of the licensed facility.

Should a facility be cited for Class I violations on two separate occasions, it may be cause for suspension or revocation of the facility license for habitual noncompliance with the Regulations Governing Licensure of Child Care Facilities.

2. Any Class II violation of these regulations, in the discretion of the licensing agency, is punishable by a monetary penalty of fifty dollars (\$50.00) for a first occurrence and a monetary penalty of one hundred dollars (\$100.00) for each subsequent occurrence upon further inspections within the same licensure term. Each violation is considered a separate offense. Example: If a facility is five children over maximum capacity it constitutes five separate Class II violations and would be subject to a two hundred fifty dollar (\$250.00) or five hundred dollar (\$500.00) monetary penalty, whichever is applicable.

The following are Class II violations:

- a. Failure to maintain proper staff-to-child ratio (Rule 1.8.1 (1) and Rule 1.8.1 (2)).

- b. Exceeding licensed maximum capacity (Rule 1.1.2 (3) or Rule 1.11.2, i.e. facility or room capacity).
- c. Failure to have a proper criminal record check in a personnel record, i.e., a Letter of Suitability issued by the MSDH Criminal History Records Check Unit (Rule 1.5.2 or Rule 1.6.4 (1)(f)).
- d. Failure to have a proper child abuse central registry check in a personnel record, i.e., a Letter of Suitability issued by the MSDH Criminal History Records Check Unit (Rule 1.5.2 or Rule 1.6.4 (1)(f)).
- e. Improper discipline of a child (Subchapter 14).
- f. Allowing a child to leave the child care facility with an unauthorized individual (Subchapter 4, Rule 1.4.1 (2)(c)).
- g. Violation of an environmental health regulation (Subchapters 11 and 12).
- h. Failure to report a serious occurrence (Rule 1.7.1).
- i. Failure to report a communicable disease (Rule 1.7.3).
- j. Violation of transportation and safety policies, procedures, and regulations (Rule 1.4.1 (3)(c)) and Subchapter 15.
- k. Unauthorized individual assigned administrative and supervisory responsibility for the facility when the director is absent or violation of Rule 1.5.6 Use of Director Designee or Rule 1.8.1 (3).
- l. Failure to have proper (up-to-date) immunization documentation in each child's record and each employee's record.
- m. Failure to display license and/or complaint notice in accordance with Rule 1.2.9.
- n. Failure to meet conditions or restrictions placed on a license. The monetary penalty will be in addition to the immediate closure of the facility for failure to meet any conditions or restrictions as stated on the restricted license (Rule 1.2.2 (4)).
- o. Failure to comply with the requirements of Rule 113.4 Sack Lunches.
- p. Failure to have adequate staff on site holding a valid CPR certificate (Rule 1.8.1 (4)).
- q. Failure to have adequate staff on site holding a valid First Aid certificate (Rule 1.8.1 (5)).

- r. The presence of any individual who has failed to satisfy the personnel requirements of Subchapter 5.
- s. Violation of Rule 1.4.2 Smoking, Tobacco Products, and Prohibited Substances.
- t. Failure to meet nutritional standards as listed in Appendix “C.”
- u. Altering of documents supporting suitability for employment in a child care facility, i.e., Letter of Suitability for Employment or Child Abuse Central Registry Check. Refer to Subchapter 5, Personnel Requirements.

Should a facility be cited for Class II violations on four separate inspection dates, it may be cause for suspension or revocation of the facility license for habitual noncompliance with the Regulations Governing Licensure of Child Care Facilities.

- 3. A Class III violation of these regulations, in the discretion of the licensing agency, is punishable by a monetary penalty of twenty-five dollars (\$25.00) for each occurrence. A Class III violation is any violation of these regulations not listed as a Class I or Class II violation in Rule 1.25.9 (1) & (2).
- 4. Unless they are appealed, all monetary penalties shall be payable within 30 calendar days of being levied. If monetary penalties are appealed they shall be payable within 30 calendar days of final disposition.
- 5. An operator shall have the right to appeal a monetary penalty imposed pursuant to this section of the regulations, in accordance with the policy of the licensing agency. Any appeal of a monetary penalty must be filed with the licensing agency within ten calendar days of being levied.
- 6. An operator shall not be granted a license, nor shall a license be renewed for any operator with outstanding monetary penalties.
- 7. If a license expires during the appeal process, it shall be administratively extended and documentation of the extension shall be provided to the licensee. A facility given an administrative extension during the appeal process, shall remain under the regulation of the licensing agency and will be subject to all current licensure regulations to include, but not limited to, inspection of the facility, review of facility and children’s records, submission of all required or requested documents, and payment of all applicable fees and/or monetary penalties.

Source: Miss. Code Ann. §43-20-8.

Subchapter 26: RELEASE OF INFORMATION

Rule 1.26.1 Information in the possession of the licensing agency concerning the license of individual child care facilities may be disclosed to the public, except such information shall not be disclosed in such manner as to identify children or families of children cared for at a child care facility. Nothing in this section shall affect the agency's authority to release findings of investigation into allegations of abuse pursuant to either Sections 43-21-353(8) and Section 43-21-257 Mississippi Code of 1972, annotated.

Source: Miss. Code Ann. §43-20-8.

THIS PAGE INTENTIONALLY LEFT BLANK

APPENDIX - A

**CHILD ABUSE
AND
NEGLECT
REPORTING
STATUTES**

THIS PAGE INTENTIONALLY LEFT BLANK

APPENDIX A

Child Abuse and Neglect Reporting Statutes

Miss. Code Ann. § 43-21-353

MISSISSIPPI CODE of 1972

*** Current through the 2014 Regular Session and 1st and 2nd Extraordinary Sessions ***

TITLE 43. PUBLIC WELFARE
CHAPTER 21. YOUTH COURT
INTAKE

Miss. Code Ann. § 43-21-353 (2014)

§ 43-21-353. Duty to inform state agencies and officials; duty to inform individual about whom report has been made of specific allegations

(1) Any attorney, physician, dentist, intern, resident, nurse, psychologist, social worker, family protection worker, family protection specialist, child caregiver, minister, law enforcement officer, public or private school employee or any other person having reasonable cause to suspect that a child is a neglected child or an abused child, shall cause an oral report to be made immediately by telephone or otherwise and followed as soon thereafter as possible by a report in writing to the Department of Human Services, and immediately a referral shall be made by the Department of Human Services to the youth court intake unit, which unit shall promptly comply with Section 43-21-357. In the course of an investigation, at the initial time of contact with the individual(s) about whom a report has been made under this Youth Court Act or with the individual(s) responsible for the health or welfare of a child about whom a report has been made under this chapter, the Department of Human Services shall inform the individual of the specific complaints or allegations made against the individual. Consistent with subsection (4), the identity of the person who reported his or her suspicion shall not be disclosed. Where appropriate, the Department of Human Services shall additionally make a referral to the youth court prosecutor.

Upon receiving a report that a child has been sexually abused, or burned, tortured, mutilated or otherwise physically abused in such a manner as to cause serious bodily harm, or upon receiving any report of abuse that would be a felony under state or federal law, the Department of Human Services shall immediately notify the law enforcement agency in whose jurisdiction the abuse occurred and shall notify the appropriate prosecutor within forty-eight (48) hours, and the Department of Human Services shall have the duty to provide the law enforcement agency all the names and facts known at the time of the report; this duty shall be of a continuing nature. The law enforcement agency and the Department of Human Services shall investigate the reported abuse immediately and shall file a preliminary report with the appropriate prosecutor's office within twenty-four (24) hours and shall make additional reports as new or additional information or evidence becomes available. The Department of Human Services shall advise the clerk of the

youth court and the youth court prosecutor of all cases of abuse reported to the department within seventy-two (72) hours and shall update such report as information becomes available.

(2) Any report to the Department of Human Services shall contain the names and addresses of the child and his parents or other persons responsible for his care, if known, the child's age, the nature and extent of the child's injuries, including any evidence of previous injuries and any other information that might be helpful in establishing the cause of the injury and the identity of the perpetrator.

(3) The Department of Human Services shall maintain a statewide incoming wide-area telephone service or similar service for the purpose of receiving reports of suspected cases of child abuse; provided that any attorney, physician, dentist, intern, resident, nurse, psychologist, social worker, family protection worker, family protection specialist, child caregiver, minister, law enforcement officer or public or private school employee who is required to report under subsection (1) of this section shall report in the manner required in subsection (1).

(4) Reports of abuse and neglect made under this chapter and the identity of the reporter are confidential except when the court in which the investigation report is filed, in its discretion, determines the testimony of the person reporting to be material to a judicial proceeding or when the identity of the reporter is released to law enforcement agencies and the appropriate prosecutor pursuant to subsection (1). Reports made under this section to any law enforcement agency or prosecutorial officer are for the purpose of criminal investigation and prosecution only and no information from these reports may be released to the public except as provided by Section 43-21-261. Disclosure of any information by the prosecutor shall be according to the Mississippi Uniform Rules of Circuit and County Court Procedure. The identity of the reporting party shall not be disclosed to anyone other than law enforcement officers or prosecutors without an order from the appropriate youth court. Any person disclosing any reports made under this section in a manner not expressly provided for in this section or Section 43-21-261, shall be guilty of a misdemeanor and subject to the penalties prescribed by Section 43-21-267.

(5) All final dispositions of law enforcement investigations described in subsection (1) of this section shall be determined only by the appropriate prosecutor or court. All final dispositions of investigations by the Department of Human Services as described in subsection (1) of this section shall be determined only by the youth court. Reports made under subsection (1) of this section by the Department of Human Services to the law enforcement agency and to the district attorney's office shall include the following, if known to the department:

- (a) The name and address of the child;
- (b) The names and addresses of the parents;
- (c) The name and address of the suspected perpetrator;
- (d) The names and addresses of all witnesses, including the reporting party if a material witness to the abuse;

(e) A brief statement of the facts indicating that the child has been abused and any other information from the agency files or known to the family protection worker or family protection specialist making the investigation, including medical records or other records, which may assist law enforcement or the district attorney in investigating and/or prosecuting the case; and

(f) What, if any, action is being taken by the Department of Human Services.

(6) In any investigation of a report made under this chapter of the abuse or neglect of a child as defined in Section 43-21-105(m), the Department of Human Services may request the appropriate law enforcement officer with jurisdiction to accompany the department in its investigation, and in such cases the law enforcement officer shall comply with such request.

(7) Anyone who willfully violates any provision of this section shall be, upon being found guilty, punished by a fine not to exceed Five Thousand Dollars (\$ 5,000.00), or by imprisonment in jail not to exceed one (1) year, or both.

(8) If a report is made directly to the Department of Human Services that a child has been abused or neglected in an out-of-home setting, a referral shall be made immediately to the law enforcement agency in whose jurisdiction the abuse occurred and the department shall notify the district attorney's office within forty-eight (48) hours of such report. The Department of Human Services shall investigate the out-of-home setting report of abuse or neglect to determine whether the child who is the subject of the report, or other children in the same environment, comes within the jurisdiction of the youth court and shall report to the youth court the department's findings and recommendation as to whether the child who is the subject of the report or other children in the same environment require the protection of the youth court. The law enforcement agency shall investigate the reported abuse immediately and shall file a preliminary report with the district attorney's office within forty-eight (48) hours and shall make additional reports as new information or evidence becomes available. If the out-of-home setting is a licensed facility, an additional referral shall be made by the Department of Human Services to the licensing agency. The licensing agency shall investigate the report and shall provide the Department of Human Services, the law enforcement agency and the district attorney's office with their written findings from such investigation as well as that licensing agency's recommendations and actions taken.

HISTORY: SOURCES: Laws, 1979, ch. 506, § 41; Laws, 1980, ch. 550, § 17; Laws, 1984, ch. 342; Laws, 1985, ch. 360; Laws, 1993, ch. 522, § 1; Laws, 1994, ch. 387, § 1; Laws, 1994, ch. 591, § 3; Laws, 1995, ch. 335, § 1; Laws, 1996, ch. 323, § 2; Laws, 1997, ch. 440, § 10; Laws, 1998, ch. 340, § 1; Laws, 1998, ch. 557, § 1; Laws, 2004, ch. 489, § 3; Laws, 2006, ch. 600, § 4; Laws, 2007, ch. 337, § 3, eff from and after July 1, 2007.

THIS PAGE INTENTIONALLY LEFT BLANK

APPENDIX - B

REPORTABLE DISEASES

THIS PAGE INTENTIONALLY LEFT BLANK

APPENDIX B

**Mississippi State Department of Health
List of Reportable Diseases and Conditions**

**Reporting Hotline: 1-800-556-0003
Monday - Friday, 8:00 am - 5:00 pm**

**To report inside Jackson telephone area or for consultative services
Monday - Friday, 8:00 am - 5:00 pm: (601) 576-7725**

	Phone	Fax
Epidemiology	(601) 576-7725	(601) 576-7497
STD/HIV	(601) 576-7723	(601) 576-7909
TB	(601) 576-7700	(601) 576-7520

Class 1 Conditions may be reported nights, weekends, and holidays by calling: (601) 576-7400

Class 1: Diseases of major public health importance which shall be reported directly to the Mississippi State Department of Health (MSDH) by telephone within 24 hours of first knowledge or suspicion. Class 1 diseases and conditions are dictated by requiring an immediate public health response. Laboratory directors have an obligation to report laboratory findings for selected diseases (refer to Appendix B of the Rules and Regulations Governing Reportable Diseases and Conditions).

Any Suspected Outbreak (including food borne and waterborne outbreaks)
(Possible biological weapon agents appear in *bold italics*)

<i>Anthrax</i>	Encephalitis (human)	<i>Ricin intoxication (castor beans)</i>
Arboviral infections including but not limited to those due to:	<i>Glanders</i>	<i>Smallpox</i>
California encephalitis virus	<i>Haemophilus influenzae</i> Invasive Disease ^{†‡}	<i>Staphylococcus aureus</i> ,
Eastern equine encephalitis virus	Hemolytic uremic syndrome (HUS), post-diarrheal	vancomycin resistant (VRSA) or
LaCrosse virus	Hepatitis A	vancomycin intermediate (VISA)
Western equine encephalitis virus	HIV infection, including AIDS	Syphilis (including congenital)
St. Louis encephalitis virus	Influenza-associated pediatric mortality (<18 years of age)	Tuberculosis
West Nile virus	Measles	<i>Tularemia</i>
<i>Botulism</i> (including foodborne, infant or wound)	<i>Melioidosis</i>	Typhoid fever
<i>Brucellosis</i>	<i>Neisseria meningitidis</i> Invasive Disease ^{†‡}	<i>Typhus fever</i>
	Pertussis	Varicella infection,

Chancroid	<i>Plague</i>	primary, in patients >15 years of age
Cholera	Poliomyelitis	Viral hemorrhagic fevers (filoviruses [e.g., Ebola, Marburg] and arenaviruses [e.g., Lassa, Machupo])
Creutzfeldt-Jakob disease, including new variant	<i>Psittacosis</i>	Yellow fever
Diphtheria	<i>Q fever</i>	
<i>Escherichia coli</i> O157:H7 and any shiga toxin-producing <i>E. coli</i> (STEC)	Rabies (human or animal)	

Any unusual disease or manifestation of illness, including but not limited to the appearance of a novel or previously controlled or eradicated infectious agent, or biological or chemical toxin.

Class 2: Diseases or conditions of public health importance of which individual cases shall be reported by mail, telephone, fax or electronically, within 1 week of diagnosis. In outbreaks or other unusual circumstances they shall be reported the same as Class 1. Class 2 diseases and conditions are those for which an immediate public health response is not needed for individual cases.

<i>Chlamydia trachomatis</i> , genital infection	Lyme disease	Rubella (including congenital)
Dengue	Malaria	Salmonellosis
Ehrlichiosis	Meningitis other than meningococcal or <i>H. influenzae</i>	Shigellosis
<i>Enterococcus</i> , invasive infection [†] , vancomycin resistant	Mumps	Spinal cord injuries
Gonorrhea	<i>M. tuberculosis</i> infection (positive TST or positive IGRA ^{***}) in children < 15 years of age	<i>Streptococcus pneumoniae</i> , invasive infection [‡]
Hepatitis (acute, viral only) Note - Hepatitis A requires Class 1 Report	Noncholera vibrio disease	Tetanus
Legionellosis	Poisonings* (including elevated blood lead levels ^{**})	Trichinosis
Listeriosis	Rocky Mountain spotted fever	Viral encephalitis in horses and ratites

[†] Usually presents as meningitis or septicemia, or less commonly as cellulitis, epiglottitis, osteomyelitis, pericarditis or septic arthritis.

[‡] Specimen obtained from a normally sterile site.

*Reports for poisonings shall be made to Mississippi Poison Control Center, UMMC 1-800-222-1222.

**Elevated blood lead levels (as designated below) should be reported to the MSDH Lead Program at (601) 576-7447.

Blood lead levels (venous) of >10 µg/dL in children less than 16 years of age

Blood lead levels (venous) of >25 µg/dL in those 16 years or older

***TST- tuberculin skin test; IGRA- Interferon-Gamma Release Assay

Except for rabies, equine, and ratite encephalitis, diseases occurring in animals are not required to be reported to the MSDH.

Class 3: Laboratory based surveillance. To be reported by laboratories only. Diseases or conditions of public health importance of which individual laboratory findings shall be reported by mail, telephone, fax or electronically within one week of completion of laboratory tests (refer to Appendix B of the Rules and Regulations Governing Reportable Diseases and Conditions).

All blood lead test results	Chagas Disease (American Trypanosomiasis)	Hepatitis C infection
Blastomycosis	Cryptosporidiosis	Histoplasmosis
Campylobacteriosis	Hansen disease (Leprosy)	Nontuberculous mycobacterial disease

Class 4: Diseases of public health importance for which immediate reporting is not necessary for surveillance or control efforts. Diseases and conditions in this category shall be reported to the Mississippi Cancer Registry within six months of the date of first contact for the reportable condition.

The National Program of Cancer Registries at the Centers for Disease Control and Prevention requires the collection of certain diseases and conditions. A comprehensive reportable list including ICD9CM codes is available on the Mississippi Cancer Registry website, <http://mcr.umc.edu/documents/ReportableCases10-09andlater.pdf>.

Each record shall provide a minimum set of data items which meets the uniform standards required by the National Program of Cancer Registries and documented in the North American Association of Central Cancer Registries (NAACCR).

For further information, please refer to the Mississippi State Department of Health's website at www.healthmys.com.

Revision: November 19, 2010

**Laboratory Results that must be
Reported to the Mississippi State Department of Health**

Laboratories shall report these findings to the MSDH at least **WEEKLY**. Diseases in **bold type** shall be reported immediately by telephone. Isolates of organisms marked with a dagger (†) should be sent to the MSDH Public Health Laboratory (PHL). All referring laboratories should call the PHL at (601) 576-7582 prior to shipping any isolate. Confirmatory tests for some of these results may be obtained by special arrangement through the Epidemiology Program at (601) 576-7725.

Positive Bacterial Cultures or Direct Examinations	
Result	Reportable Disease
Any bacterial agent in CSF	Bacterial meningitis
<i>Bacillus anthracis</i> †	Anthrax
<i>Bordetella pertussis</i>	Pertussis
<i>Borrelia burgdorferi</i> †	Lyme disease
<i>Brucella</i> species †	Brucellosis
<i>Burkholderia mallei</i> †	Glanders
<i>Burkholderia pseudomallei</i> †	Melioidosis
<i>Campylobacter</i> species	Campylobacteriosis
<i>Chlamydia psittaci</i>	Psittacosis
<i>Chlamydia trachomatis</i>	<i>Chlamydia trachomatis</i> genital infection
<i>Clostridium botulinum</i> †**	Botulism
<i>Clostridium tetani</i>	Tetanus
<i>Corynebacterium diphtheriae</i> †	Diphtheria
<i>Coxiella burnetii</i> †	Q fever
<i>Enterococcus</i> species,* vancomycin resistant	<i>Enterococcus</i> infection, invasive vancomycin resistant
<i>Escherichia coli</i> O157:H7 and any shiga toxin-producing <i>E. coli</i> (STEC) †	<i>Escherichia coli</i> O157:H7 and any shiga toxin-producing <i>E. coli</i> (STEC)
<i>Francisella tularensis</i> †	Tularemia
<i>Haemophilus ducreyi</i>	Chancroid
<i>Haemophilus influenzae</i> †*	<i>H. influenzae</i> infection, invasive
<i>Legionella</i> species	Legionellosis
<i>Listeria monocytogenes</i> †	Listeriosis
<i>Mycobacterium</i> species	Nontuberculous mycobacterial disease
<i>Mycobacterium tuberculosis</i> †	Tuberculosis
<i>Neisseria gonorrhoea</i>	Gonorrhea
<i>Neisseria meningitidis</i> †*	Meningococcal infection, invasive
<i>Rickettsia prowazekii</i>	Typhus Fever
<i>Rickettsia rickettsii</i>	Rocky Mountain Spotted Fever
<i>Salmonella</i> species, not <i>S. typhi</i>	Salmonellosis
<i>Salmonella typhi</i> †	Typhoid fever
<i>Shigella</i> species	Shigellosis
<i>Staphylococcus aureus</i> , vancomycin resistant or vancomycin intermediate	<i>Staphylococcus aureus</i> vancomycin resistant (VRSA) or vancomycin intermediate (VISA)

<i>Streptococcus pneumoniae</i> *	<i>Streptococcus pneumoniae</i> , invasive infection
<i>Vibrio cholerae</i> 01†	Cholera
<i>Vibrio</i> species †	<i>Vibrio</i> infection
<i>Yersinia pestis</i> †	Plague

† Isolates of organism should be sent to the MSDH PHL. All referring laboratories should call the PHL at (601) 576-7582 prior to shipping any isolate.

* Specimen obtained from a normally sterile site (usually blood or cerebrospinal fluid, or, less commonly, joint, pleural, or pericardial fluid). **Do not report throat or sputum isolates.**

**Contact the MSDH Epidemiology Program at (601) 576-7725 or the PHL at (601) 576-7582 for appropriate tests when considering a diagnosis of botulism.

Revision: November 19, 2010 Positive Serologic Tests For:		
Arboviral agents including but not limited to those due to:	Dengue	<i>M. tuberculosis</i> infection
California encephalitis virus	Ehrlichiosis	Plague
Eastern equine encephalitis virus	Hepatitis A (anti-HAV IgM)	Poliomyelitis
LaCrosse virus	Hepatitis B (anti-HBc IgM)	Psittacosis
St. Louis encephalitis virus	Hepatitis C	Rocky Mountain Spotted Fever
Western equine encephalitis virus	HIV infection (refer to Section 113)	Rubella
West Nile virus	Legionellosis [§]	Syphilis (refer to Section 116)
Brucellosis	Lyme disease	Smallpox
Chagas Disease (American Trypanosomiasis)	Malaria	Trichinosis
Cholera	Measles	Varicella infection, primary in patients >15 years of age
<i>Chlamydia trachomatis</i> genital infection	Mumps	Yellow fever

[§] Serologic confirmation of an acute case of legionellosis cannot be based on a single titer. There must be a four-fold rise in titer to >1:128 between acute and convalescent specimens.

Positive Parasitic Cultures or Direct Examinations		Blood Chemistries
Result	Reportable Disease	ALL blood lead test results are reportable to the MSDH Lead Program at (601) 576-7447.
Any parasite in CSF	Parasitic meningitis	
<i>Cryptosporidium parvum</i>	Cryptosporidiosis	
<i>Plasmodium</i> species †	Malaria	

† Indicates the positive specimens may be submitted to the MSDH PHL for confirmation.

Positive Fungal Cultures or Direct Examinations		Positive Toxin Identification
Result	Reportable Disease	Ricin toxin from <i>Ricinus communis</i> (castor beans)
Any fungus in CSF	Fungal meningitis	
<i>Blastomyces dermatitidis</i>	Blastomycosis	
<i>Histoplasma capsulatum</i>	Histoplasmosis	

Positive Viral Cultures or Direct Examinations		Surgical Pathology results
Result	Reportable Disease	Creutzfeldt-Jakob Disease, including new variant
Any virus in CSF	Viral meningitis	Hansen disease (<i>Mycobacterium leprae</i>)
Arboviral agents including but not limited to those due to:		Human rabies
California encephalitis virus	California encephalitis	Malignant neoplasms
Eastern equine encephalitis virus	Eastern equine encephalitis (EEE)	Mycobacterial disease including Tuberculosis
LaCrosse virus	LaCrosse encephalitis	Trichinosis
St. Louis encephalitis virus	St. Louis encephalitis (SLE)	
Western equine encephalitis virus	Western equine encephalitis (WEE)	
West Nile virus	West Nile encephalitis (WNV)	
Arenaviruses	Viral hemorrhagic fevers	
Dengue virus, serotype 1, 2, 3 or 4	Dengue	
Filoviruses	Viral hemorrhagic fevers	
Poliovirus, type 1, 2 or 3	Poliomyelitis	
Varicella virus	Varicella in patients >15 years of age	
Variola virus	Smallpox	
Yellow fever virus	Yellow fever	

For further information, please refer to the Mississippi State Department of Health's website at www.healthhms.com.

Revision: November 19, 2010

Source: Miss. Code Ann. §43-20-8.

APPENDIX - C

NUTRITIONAL STANDARDS

THIS PAGE INTENTIONALLY LEFT BLANK

APPENDIX C

Nutritional Standards

Introduction

Meals shall meet the nutritional standards as prescribed in this section. A child care facility shall provide adequate and nutritious meals prepared in a safe and sanitary manner.

Healthy diets help children grow, develop, and perform well in learning environments. Healthy diets contain the amounts of essential nutrients and calories needed to prevent nutritional deficiencies while preventing an excess amount of discretionary calories. Planned meals and snacks provide the right balance of carbohydrate, fat, and protein to reduce risks of chronic diseases, and are part of a full and productive lifestyle. Such diets are obtained from a variety of foods.

Nutrition and feeding practices for children strongly affect the development and long-term health of the child. Proper nutritional care during the early years is essential for intellectual, social, emotional, and physical growth. It is also necessary that an environment be provided which encourages the development of good food habits.

Meals and vending services shall meet the standards from the Offices of Healthy Schools and Child Nutrition for the Mississippi State Department of Education as well as USDA Food and Nutrition Service guidelines.

THE GOALS OF A CHILD CARE FACILITY IN RELATION TO NUTRITION SHALL BE:

1. Menus shall be nutritionally adequate and consistent with the Dietary Guidelines for Americans.
2. Foods shall be provided in quantities and meal patterns that balance energy and nutrients with children's ages, appetites, activity levels, special needs, and cultural and ethnic differences in food habits.
3. Parents shall be involved in the nutrition component of their child-care facility.
4. A variety of fruits, vegetables, and whole-grain products shall be offered to children for meals and snacks. Mealtime should be used as an opportunity to teach nutrition and/or food concepts.
5. The addition of fat, sugar, and sources of sodium shall be minimal in food preparation and service.
6. Food preparation and service shall be consistent with best practices for food safety and sanitation.
7. Furniture and eating utensils shall be age-appropriate and developmentally suitable to encourage children to accept and enjoy mealtime.
8. Child-care personnel shall encourage positive experiences with food and eating.
9. Caregivers shall receive appropriate training in nutrition, food preparation, and food service.

10. Child-care facilities shall obtain assistance as needed from the Child Care Licensure Division and the supportive staff.
11. Nutrition education for children and for their parents shall be encouraged as a component of the child-care program.
12. Child-care programs must comply with local and state regulations related to wholesomeness of food, food preparation facilities, food safety, and sanitation.
13. Family style dining is encouraged.

Based upon the American Dietetic Association Benchmarks for Nutrition Programs in Child-Care Settings

FEEDING SCHEDULE FOR INFANTS AND CHILDREN ONE YEAR AND OLDER

1. Children's food needs are based on the amount of time spent in the child care facility.
2. Any child in a child care facility at the time of service of a meal or snack will be served that meal or snack
3. Child care facilities that are open 24 hours are required to serve three meals and three snacks.

IF YOU ARE OPEN	YOU MUST SERVE		
Nine hours or less	Two snacks and one meal	OR	One snack and two meals
Over nine hours	Two snacks and two meals	OR	Three snacks and one meal
24 hours or during all meals	Three meal and three snacks: one snack should be a late night snack only served to children who are awake.		

I. Meal Time

Meals and snacks shall be served at regularly scheduled times each day.

The same meal or snack shall not be served more than one time in any 24-hour (one-day) period.

No more than four and no less than a two and one-half hour period must elapse between the beginning of a meal and a snack.

If breakfast is not served, then a mid-morning snack shall be provided.

Since not all children arrive at the facility at the same time, certain parental options regarding breakfast will be allowed as follows:

1. Parent can feed the child prior to arrival at the child care facility.
2. The parent may have the meal provided by the child care facility.

Note: Either option above must be documented and included in the child's record.

Outside foods shall not be brought into the facility, with the exception of special dietary needs. Exempt facilities are facilities that operate less than six hours and as noted in the regulations, otherwise noted in other sections of the standards. Any outside foods shall meet the Office of Healthy School and MSDH Nutrition Standard guidelines.

II. Meal Time Environment

Age appropriate utensils, plates, bowls, cups, and dining area shall be provided.

Children shall not wait longer than fifteen minutes at the table for food to be served.

Sufficient time shall be allowed for children to wash their hands and prepare for the meal.

Mealtime shall be used for socialization, and shall be a relaxed, happy time for the children. No media, e.g., televisions, videos, or DVD's may be viewed during meal and snack times. Family style dining is encouraged with serving platters, bowls, and pitchers on the table so that all present can serve him/her self. Children are encouraged to assist with table setting and bowling up fruits for dessert. All foods served must meet the serving guidelines, and be age appropriate. "Seconds" of foods can be served as indicated at the request of the child or by hunger cues.

A caregiver shall sit and join the children while they are eating. When caregivers are allowed to eat with the children, which is encouraged, staff will eat items that meet nutrition standards. It is suggested that the staff eat the same food items that are served to the children. The staff will encourage social interaction, conversation, and use the mealtime for education purposes. Extra assistance and time shall be provided for slow eaters.

Caregivers shall not eat foods outside of the foods served in the facility in front of the children.

Food shall not be used as a reward or punishment. Children will not be encouraged to "clean your plate," but encouraging children to try two bites of each food served is acceptable.

Additional servings shall be provided for the child who requests more food at a meal or snack. It is at the discretion of the facility and knowledge of the child's eating pattern to allow seconds on food items. This time to teach children on portion control, monitoring extra intake, and better food selections is higher in nutritional value.

Meals and snacks provided by a parent must not be shared with other children, unless a parent is providing baked goods for a celebration or party being held at the operation. Foods for a party or celebration shall meet the Office of Healthy School guidelines.

Children will be permitted in meal preparation areas when under the direct supervision of a staff person, when there is no danger of injury from equipment, and for instruction/teaching purposes only.

III. **Menus**

A complete two-week cycle of menu plans shall be submitted annually to Child Care Licensure as part of the renewal process. Although a minimum complete, two-week cycle menu is required to be submitted annually, child care facilities at their discretion may submit a 4 to 8 week cycle of menu plans.

Daily menus for all meals and snacks prepared and/or served in the child care facility shall be plainly posted. Any substitution shall be of comparable food value and shall be recorded on the menu and dated.

Menus shall be written at least one week in advance. Menus can be completed on a rotating cycle for 4-12 weeks.

Menus shall be posted in the food preparation area and in a conspicuous place in the child care facility at all times.

Menus shall be planned to include food with variety in texture, color, and shape. Record of dated menus served, and any substitutions made, shall be kept on file for a minimum of one year.

New food shall be introduced to help develop good food habits. Introduce only one new food per meal or snack. Foods used for activities/teaching can be included on the written record of foods served for the day.

It is the facility's responsibility to discuss recurring eating problems with the child's parent.

IV. **Child Requiring a Special Diet**

A child requiring a special diet due to medical reasons, allergic reactions, or religious beliefs, shall be provided meals and snacks in accordance with the child's needs. If medical reasons exist for the special diet, a medical prescription from the child's physician stating that the special diet is medically necessary is required. Information required for dietary modifications include:

- Child's full name and date of instructions, updated annually;
- Any dietary restrictions based on the special needs;
- Any special feeding or eating utensils;
- Any foods to be omitted from the diet and any foods to be substituted;
- Limitations of life activities;
- Any other pertinent special needs information;
- What, if anything, needs to be done if the child is exposed to restricted foods.

Religious or ethnic requests should include the above information as needed, plus a certified statement of request based upon the religious or ethnic beliefs of the family.

The facility shall not serve nutrient concentrates and supplements such as protein powders, liquid protein, vitamins, minerals, and other nonfood substances without written instructions from the child's physician.

The child's parent shall meet with the facility staff and/or director to review the written instructions. Such instructions shall list any dietary restrictions/requirements and shall be signed and dated by the child's physician requesting the special diet.

Parents of children with severe restrictions and dietary needs will be given a copy of the facility's menu to pre-select foods to be served. The parents will be responsible for ensuring the accuracy of foods served based upon the preplanned menu.

The child care facility may request the parent to supplement food served by the child care facility. When food is supplied by the parent, the child care facility shall be responsible for assuring that it is properly stored and served to the child in accordance with the diet instructions on file at the child care facility. Any food item that must be cooked, shall be prepared by the facility, such as a soy patty. Meals and snacks provided by a parent must not be shared with other children, unless a parent is providing baked goods for a celebration or party being held at the operation.

Records of food intake shall be maintained when indicated by the child's physician.

Vegetarian/Vegan Dietary Requests

Request for a vegetarian/vegan diet shall be accommodated with the same information completed as for dietary modifications. Specialty items may be supplied by the parent to meet nutritional needs. Contact with the nutritionist with MSDH is recommended.

To the extent authorized by Federal laws, the facility may determine that the special nutritional needs of a child cannot be met at the facility and the child may be excluded from admission into the facility.

V. Food Preparation

Recipes shall be used and a file of recipes used to prepare the food shall be maintained.

Foods shall be prepared in a form that is easy for children to handle. Bite size pieces and finger foods are suitable. Bones shall be removed from any food served to any child in the child care setting.

Foods shall be prepared as close to serving time as possible to preserve nutrients, flavor, and color.

Food should not be highly seasoned. No extra salt or fats should be added to the foods in cooking. The use of salt free, low fat products is allowed. Children need to learn the flavors of food.

Raw vegetables and foods that may cause choking in young children shall not be served to children less than two years of age.

VI. Choking Prevention

A caregiver shall join the children while they are eating. This is an opportunity to teach socialization skills, nutrition education, and is a safety measure to help prevent choking.

Children should be encouraged to eat slowly, take small bites, and chew well before swallowing.

FOODS THAT MAY CAUSE CHOKING

Sausage shaped meats (hot dogs)*	Pop Corn
Hard Candy*	Chips*
Nuts	Thick Pretzels Rods* Thin pretzel sticks and rounds would be allowed
Grapes	Chunks of peanut butter
Gum*	Marshmallows
Dried Fruits	

*Not allowed to be served

To Reduce Choking Hazards

Cook food until soft and cut into thin slices or small pieces. Remove bones from meat, chicken, and fish, and remove seeds and pits from fruit. With toddlers, cutting foods into “pea” size is recommended.

VII. Feeding of Infants

When a pregnant mother is visiting the facility to consider enrollment, breastfeeding should be encouraged.

Breast milk is the recommended feeding for infants and should be encouraged and supported by child care facility staff. The mother may choose to come to the child care facility to nurse her infant, or may choose to supply bottles of expressed breast milk for the child care facility staff to feed the infant. To help a mother be successful with breastfeeding the faculty may:

1. Encourage the mother to come to the facility to breastfeed and provide a
 - Quiet, comfortable and private place to feed;
 - Place to wash the hands;
 - Pillow to support her infant if desired;
 - A comfortable chair, stool for feet while nursing;
 - The mother may opt to nurse while in the infants room;

2. Encourage the mother to provide a back-up supply of frozen breast milk that is labeled with the infant's name and date of expression. The mother's expressed milk shall be used for her infant only. Note: *Excessive shaking of human milk may damage some components that are valuable to the infant.*

The Centers for Disease Control's (CDC) guidelines for storage of frozen expressed breast milk are as follows:

- Freezer compartment of a refrigerator at a temperature of 5° F or -15° C the expressed breast milk can be safely stored for 2 weeks
- Freezer compartment of refrigerator with separate doors 0° F or -18° C the expressed breast milk can be safely stored for 3-6 months
- Freezer compartment of refrigerator with separate doors -4° F or -20° C the expressed breast milk can be safely stored for 6-12 months

Note: Store milk toward the back of the freezer, where temperature is most constant. Milk stored for longer durations in the ranges listed is safe, but some of the lipids in the milk undergo degradation resulting in lower quality. You can go to the CDC website at http://www.cdc.gov/breastfeeding/recommendations/handling_breastmilk.htm for more information.

3. Note: for the breast fed infant, it is acceptable to introduce iron-fortified cereal earlier, at four months if desired, but preferably at 6 months.

A written schedule for feeding the infant shall be provided by the parent and posted for reference by the child care facility staff.

Feeding should be by hunger cues whenever possible. Hunger cues may include:

- Sucking on his tongue, lips, hands, or fingers while asleep
- Moving his arms and hands toward his mouth
- Restless movements while asleep
- Rapid eye movements under his eyelids
- Opening his mouth when his lips are touched
- "Rooting" or searching for the nipple
- Making small sounds

Late hunger cues include:

- Crying
- Fussiness

Signals when an infant is full and feeding should stop:

- "Falls off" the breast, releasing the nipple;
- Falls asleep; or
- Relaxes his body and opens his fists.

Breast milk or formula shall be brought to the child care facility daily, ready to be warmed and fed. Each bottle shall be labeled with the infant's name and the date. No cereal, juice or other foods may be added to the infant's breast milk/formula without a physician's written request, as done for a child with special needs.

Bottles should be warmed for five minutes in a pan of hot, not boiling water; **never** microwave. Before feeding, test the temperature by squirting a couple of drops on the back of your hand.

At the end of each feeding, discard any milk left in the bottle. Staff will send all used bottles home with the parent for proper cleaning and sanitizing.

Age-appropriate solid foods (complimentary foods) may be introduced no sooner than when the child has reached 4 months of age, but ideally at six months. The first food introduced usually is cereal mixed with breast milk or formula (not in a bottle). Adding juice to dry cereal is not allowed.

Commercially prepared baby foods shall be brought in unopened jars and labeled with the infant's name. Home prepared/blended and home canned infant foods shall not be served. A facility may chose to mash and puree the foods served to older children for the infants 7 months to one year - no additional juice, sauces, or fats may be added to the pureed foods.

Iron-fortified dry infant cereal shall be brought in sealed container premeasured for each feeding and labeled with the infant's name.

Juice shall not be served to infants (children less than 12 months of age).

A small amount of water is encouraged at 8-12 months.

Infants shall be held cradled in the arms during feeding. At no time shall an infant be fed by propping a bottle.

Introduction of solid foods to an infant should be done in consultation with the parent and/or according to the schedule of the Mississippi State Department of Health Infant Feeding Guide.

Solid foods must be spoon-fed. No solid foods shall be fed by bottle or infant feeder without written direction from a physician.

Infants are fed when hungry by noting hunger cues, such as crying, being restless. Feeding is stopped when it is determined that the infant is satisfied. Signs of satiety include, refusing the nurse, turning away from the nipple, falling asleep.

Infants are encouraged to start using a cup at six to nine months, based upon motor skills. When the cup is used, the breast milk or formula may be brought into the center in a

clean closed container that is clearly labeled. By the age of one, all children should be off a bottle.

Older infants are encouraged to hold and drink from cups, to use child appropriate eating and serving utensils. Self-feeding should be encouraged. All food should be served in a manner to prevent choking, such as mashing, cutting in small “pea” size portions.

Breast or formula is served to at least 12 months. Cow's milk is not served until age one, unless provided with a written exception from the infant’s physician. Children ages one to two, shall be served whole cow’s milk, after age two, toddlers should be served fat free/skim milk. *When there are children older than two in the classroom with younger children, all children shall be served the whole milk.*

Guidelines for Milk Storage and Use for All Infants

Storage Method and Temperature	Maximum Amount of Time For Storage
<i>Room (25 C or 77 F)</i>	4 hours
<i>Refrigerator (4 C or 39 F)</i>	48 hours
<i>Previously thawed –</i>	
<i>Refrigerated milk</i>	24 hours
<i>Freezer (-20 C or 0 F)</i>	3 months

From the ACOG/AAP publication: Breastfeeding Handbook for Physicians

When centers are reimbursed for meals and must supply formula for their infants, only ready to use formula may be purchased for use. The center may require the parents to supply clean bottles daily. If the center supplies the bottles, there must be provisions in place for the proper cleaning, sanitizing, and drying of all bottles and supplies outside of the infant room.

FEEDING SCHEDULE FOR INFANTS THROUGH ONE YEAR

INFANT’S FOOD NEEDS ARE BASED ON THE AMOUNT OF TIME SPENT IN THE CHILD CARE FACILITY.

ANY INFANT IN A CHILD CARE FACILITY AT THE TIME OF SERVICE OF A MEAL OR SNACK SHALL BE SERVED FOODS APPROPRIATE TO THE AGE.

MEAL/SNACK	BIRTH THROUGH 5 MONTHS	6 THROUGH 12 MONTHS
Breakfast	4-6 fl. oz. breast milk or formula	6-8 fl. oz. breast milk or formula 2-4 Tbsp. prepared infant cereal (optional) 1-4 Tbsp. fruit and/or vegetable(infant or mashed)
Lunch or Supper	4-6 fl. oz. breast milk or formula	6-8 fl. oz. breast milk or formula 2-4 Tbsp. prepared infant cereal (optional) 1-4 Tbsp. fruit and/or vegetable(infant or mashed) 1-4 Tbsp. infant meat
Supplement/Snack	4-6 fl. oz. breast milk or formula	2-4 fl. oz. breast milk or formula 0-1/2 dry bread or 0-2 crackers (optional)

Infant cereal and formulas shall be iron fortified. Infant feeding is individualized after consultation with the parent and by hunger cues from the infant.

MENU PLANNING

Dietary Guidelines for Americans provide assistance in planning meals for ages two and older, which will promote health and prevent disease.

The guidelines, applied to child care feeding are:

1. Offer a variety of foods.
2. Serve meals and snacks that help maintain a healthy weight.

3. Serve fresh, frozen, canned, or dried vegetables, fruits whenever possible, and whole grain products.
4. Avoid excessive fat, saturated fat, and cholesterol. No fried foods or foods with transfats shall be served.
5. Use and serve sugar only in meal preparation and then in moderation. No concentrated sweets, such as candy, syrup, sweetened drinks sodas, or flavored milks may be served.
6. Limit sodium products and the use of salt.
7. Promote an alcohol, tobacco and drug free lifestyle for children, parents, and caregivers.
8. Promote and encourage daily physical activity.

PARTIES AND SPECIAL OCCASIONS

Parties and special party type events should not be held more than once a month. Food for parties should be prepared at the facility when possible. It is recommended that if foods for the event are brought to the facility by parents it should be “store bought” and not “home cooked.”

It is suggested that a plain “store bought” cake be served. Other items may include ice cream, fresh fruit, cheese and crackers, and party favors such as stickers, books, toothbrushes, crayons, etc., are encouraged.

Meal Pattern Points to Remember

Keep in mind the following points when you plan menus to meet meal pattern requirements for each of the food groups.

- Plan your meats first. Then select fruits and vegetables, making sure that you have a Vitamin C source daily and a Vitamin A source every other day, or three times a week. Refer to the vitamin tables. Limit starchy vegetables to once/day - these include lima beans, butterbeans, white/sweet potatoes, English peas, black-eye peas, field peas, Crowder peas, cream and whole kernel corn, any dried pea/bean(unless counted for a meat substitute).
- Two vegetables or two fruits may be served at the mealtime, but it is recommended to serve a vegetable and a fruit for variety. Including brightly colored fruits and vegetables, such as tomatoes, broccoli, carrots, greens, strawberries, melon, peaches, will help to meet the vitamin requirements.
- The same meal may not be served more than once in a day (i.e. facilities who are open for lunch and supper may not serve the same meal for both meals).
- Snacks are to be served mid-morning (if required), early afternoon, and late afternoon, usually 30-60 minutes before closing. Water can be used as the beverage while foods are served.

Snack time is an excellent time to introduce fruits and vegetables.

- Use only 100-percent-strength juice for snack no more than once a day. Give fruit for breakfast/morning snack instead of juice.
- Juice should not be served as part of the snack when milk is the only other component. It is poor menu planning to offer such a combination since it provides too much liquid for children.
- Fruit-flavored drinks, sport drinks, soft drinks, caffeinated beverages, artificially sweetened beverages shall not be served.
- Avoid serving two forms of the same fruit or vegetable in the same day. Example: an orange and orange juice or an apple and applesauce are combinations that should not be used. Serve a variety of vegetables and fruits to ensure a nutritionally well-balanced meal.
- Dry milk shall not be used as a milk beverage, but may be used for cooking purposes.
- Guidelines from USDA FNS (US Department of Agriculture Food Nutrition Supplement) program are used as the standard for menu planning and guidelines. However, when one set of guidelines are stricter than the stricter guidelines shall be enforced (in comparing MSDH and USDA FNS). Emphasis shall be placed on serving more whole grains and fewer foods high in fat, sugar, and sodium.
- Drinking water shall be freely available to children of all ages and offered at frequent intervals. Extra water served with meals, snacks, and during and after physical activity is encouraged. Facilities may have water fountains in the classroom or dining area. This water source should be encouraged before and after all meals and snacks and takes the place of water served at the table.
- To prevent nutrient and vitamin loss from foods during preparation, cooking, or storage, try to
 - Serve fruits and vegetables raw as appropriate for the age. The risk of choking is greater for the child under the age of two.
 - Steam, boil, or simmer foods in a very small amount of water, or microwave for the shortest time possible.
 - Cook potatoes in their skins. Be sure to wash the dirt off the outside of the potato.
 - Refrigerate prepared juices and store them for no more than two to three days.
 - Store cut raw fruits and vegetables in an airtight container and refrigerate - do not soak or store in water. Nutrients may be diluted from soaking in water. Manufacturer packaged fresh fruits and vegetables are the exception due to packaging processes.

MEAL PATTERNS FOR CHILDREN IN CHILDCARE FACILITIES: BREAKFAST

BREAKFAST	AGES 1 YR – 2 YR	AGES 3 YR - 5 YR	AGES 6 YR - 12 YR
Milk (Must be fluid, skim/fat free), or 1% milk)	½ c.	¾ c.	1 c.
Fruit or Vegetable	¼ c.	½ c.	½ c.
Grains/Breads			
Enriched, Whole Grain Bread OR	½ slice	½ slice	½ slice
Enriched Dry Cereal OR	¼ c. OR 1/3 oz. ¼ c.	1/3 c. OR ½ oz. 1/3 c.	¾ c. OR 1 oz. ½ c.
Enriched Hot Cereal OR	¼ c.	1/3 c.	½ c.
Enriched, Whole Grain Pasta, Noodles, Rice			
Water	½ c.	¾ c.	1 c.

Milk:

Milk shall be served at Breakfast. The milk shall be pasteurized fluid milk, fortified with vitamin A and D. Whole milk is served to infants and toddlers less than 2 years of age. After age two, skim/fat free or 1% milk shall be served

Soy milk may be served when indicated with dietary restrictions.

Bread and Bread Alternates:

Use enriched whole-grain breads and bread alternatives. Dry cereals need to be of high fiber and not sugar coated. Hot cereals cannot be instant. Whole grain pasta, noodles, or brown rice may be used occasionally for the breakfast meal.

Breakfast breads may include muffins, biscuit, toast, breakfast bread, no more than weekly pancake or waffle (with no syrup). Crust used as part of the main dish (i.e., for quiche) is allowed as a bread alternate. These items may not be served: doughnuts, honey buns, breakfast tarts, pastries, packaged snack cakes, and other high fat/sugar foods.

Fruits and Vegetables:

Use fresh, canned, dried, or frozen fruit for breakfast. No sugar may be used in the packaging or preparation of the fruit. Canned or frozen fruit should be packed in juice or water - not syrup or sugar packed.

Vegetables, such as tomatoes, may be used occasionally for the breakfast meal. Cultural differences may also dictate that items such as tomatoes, peppers, onions, or salsas may be served with brown rice for the vegetable and bread component at breakfast.

Water:

Water is to be made available with all meals and snacks. Tap or bottled water may used. Facilities may have water fountains in the classroom or dining area. This water source should be encouraged before and after all meals and snacks and takes the place of water served at the table.

Meat and Meat Alternates:

The Meat component is not required for the breakfast meal. IF the facility desires to serve a meat item with the breakfast, that would be allowed. Meats and meat alternates that would be acceptable include eggs, fat free yogurt, low fat cheese, fat free cottage cheese, lean ham, Canadian bacon, and peanut butter. Bacon is not considered a meat and shall not be served due to the high fat and high sodium content.

**MEAL PATTERNS FOR CHILDREN IN CHILDCARE FACILITIES:
LUNCH/SUPPER/DINNER**

LUNCH/SUPPER/DINNER	AGES 1 YR – 2 YR	AGES 3 YR - 5 YR	AGES 6 YR – 12 YR
Meat/Meat Alternate			
Cooked Meat, No Bone	1 oz.	1 ½ oz.	2 oz.
Cooked Dry Beans/Peas	¼ c.	3/8 c.	½ c.
Low Fat Cheese	1 oz.	1 ½ oz.	2 oz.
Egg	1 small	1 medium	1 medium
Peanut Butter	2 Tbsp.	3 Tbsp.	4 Tbsp.
Fat Free Yogurt/Cottage Cheese	4 oz./1/2 c.	6 oz./3/4 c.	8 oz./1 c.
Fruit or Vegetable: Must include 2 different foods- 1 vegetable/1 fruit OR 2 vegetable OR 2 fruit	¼ c. total 1/8 c. of 2 foods	½ c. total ¼ c. of 2 foods	¾ c. total 3/8 c. of 2 foods
Grains/Breads			
Enriched, Whole Grain Bread OR	½ slice	½ slice	½ slice
Enriched Dry Cereal OR	¼ c. OR 1/3 oz. ¼ c.	1/3 c. OR ½ oz. 1/3 c.	¾ c. OR 1 oz. ½ c.
Enriched Hot Cereal OR	¼ c.	1/3 c.	½ c.
Enriched, Whole Grain Pasta, Noodles, Rice			
Milk (Must be fluid, skim/fat free), or 1% milk)	½ c.	¾ c.	1 c.
Water	½ c.	¾ c.	1 c.

Meat and Meat Alternates:

It is recommended to have at least one meatless meal a week. An alternate for meat could be cooked, dried beans, or peas. Cooked dried beans and peas cannot count for a vegetable and meat alternate in the same meal. Canned beans and peas will include the canned kidney, black bean, garbanzo, etc. Note: Canned beans are much higher in sodium/salt.

Edible portion for meats and meat alternates is used. Bone and skin shall not be counted as servings. No bones may be served. Note: 1 ounce of cooked meat is equal to one medium cooked chicken leg with bone removed.

Processed, pre-fried meats are not allowed due to the sodium/salt and fat content. Meats not allowed include hot dogs, corn dogs, bologna, bacon, sausage, pancake sticks, small chicken nuggets, fish sticks, and steak fingers.

Processed cheese, such as cheese spread, canned cheese sauce, and cheese in packaged snack crackers is not allowed. Low fat or fat free cheese would be a meat alternate that is allowed.

For menu variety, use meat, and low fat cheese in combination to equal a full serving portion.

It is not recommended serving nuts and seeds due to nut/seed allergies prevalent in the youth today.

Bread and Bread Alternates:

Use enriched whole-grain breads and bread alternatives. Whole grain pasta, noodles, brown rice, wheat rolls, and cornbread are encouraged for the lunch/supper/dinner meals.

Bread alternates may include crust used as part of the main dish (i.e. pizza or quiche), Dry oatmeal used in a fruit crisp.

Pre-fried items, such as hash browns, French fries, and tater tots are not recommended due to the fat and sodium content. Any pre-fried item served is limited to once a week.

Cookies, pastries, packaged snack cakes, and other high fat/sugar foods cannot be counted for any bread serving at the lunch/supper/dinner meal.

Fruits and Vegetables:

Must serve a Vitamin C source daily and must serve a Vitamin A source every other day, three times a week – refer to the guidelines. Fruits and vegetables supply these nutrients. More than once vitamin source a day is also encouraged.

Use a different combination of two or more servings for the meal service. Use fresh, canned, dried, or frozen vegetables and fruits for lunch/supper/dinner. No sugar may be used in the

packaging or preparation of the fruit. Canned or frozen fruit should be packed in juice or water - not syrup or sugar packed.

Vegetables and fruits may be served as combination dishes (i.e., beef stew with meat, potatoes, carrots, English peas, OR shredded carrot salad with diced pineapple).

Avoid serving two forms of the same fruit or vegetable in the same day. Example: an orange and orange juice or an apple and applesauce are combinations that should not be used. **Serve a variety of vegetables and fruits to ensure a nutritionally well-balanced meal.**

It is highly recommended to either serve at least one raw vegetable and two raw fruits per week, for a meal or snack

Limit serving starchy vegetables to once per meal. Starchy vegetables include white/sweet potatoes, lima beans, butter beans, English peas, black-eye peas, field peas, Crowder peas, cream and whole kernel corn, any dried bean/pea (unless counted for a meat alternate).

Vegetables shall be seasoned with powders, spices, and herbs. The use of high sodium/salt and high fat seasonings should be restricted as much as possible.

Small amounts (less than 1/8 cup) of lettuce, tomatoes, onions, relish, catsup, salsa, jams, jellies, or other condiments may be added for flavor or garnish as "other foods," but do not count as a fruit or vegetable.

Milk:

Milk shall be served at Lunch/Supper/Dinner. The milk shall be pasteurized fluid milk, fortified with vitamin A and D. Whole milk is served to infants and toddlers less than 2 years of age. After age two, skim/fat free milk or 1% milk shall be served. Flavored milk may be served no more than once a week, using flavoring added to whole/skim/fat free milk or 1% milk.

Soy milk may be served when indicated with dietary restrictions.

Provisions must be made to serve calcium in alternate forms when no milk/substitute may be served to the child due to dietary restrictions.

If a child cannot be served milk for medical reasons or upon parent's instructions, then that child is not to be served high content milk products, e.g., pudding, ice cream, cheese, etc.

All milk equivalent used as a meat alternate must be low in fat.

Water:

Water is to be made available at all meals and snacks. Tap or bottled water may be used. Facilities may have water fountains in the classroom or dining area. This water source should be encouraged before and after all meals and snacks and takes the place of water served at the table.

MEAL PATTERNS FOR CHILDREN IN CHILDCARE FACILITIES: SNACK

SNACK – MUST SELECT TWO OF THE FOUR COMPONENTS, PLUS WATER	AGES 1 YR - 2 YR	AGES 3 YR - 5 YR	AGES 6 YR - 12 YR
Meat/Meat Alternate Cooked Meat, No Bone Cooked Dry Beans/Peas Low Fat Cheese Egg Peanut Butter Fat Free Yogurt/Cottage Cheese	1/2 oz. 1/8 c. 1/2 oz. 1 small 1 Tbsp. 2 oz./1/4 c.	1/2 OZ. 1/8 c. 1/2 oz. 1 medium 1 Tbsp. 2 oz./1/4 c.	1 oz. 1/4 c. 1 oz. 1 medium 2 Tbsp. 4 oz./1/2 c.
Fruit or Vegetable	1/2 c.	1/2 c.	3/4 c.
Grains/Breads Enriched, Whole Grain Bread OR Enriched Dry Cereal OR Enriched Hot Cereal OR Enriched, Whole Grain Pasta, Noodles, Rice	1/2 slice 1/4 c. OR 1/3 oz. 1/4 c. 1/4 c.	1/2 slice 1/3 c. OR 1/2 oz. 1/3 c. 1/3 c.	1/2 slice 3/4 c. OR 1 oz. 1/2 c. 1/2 c.
Milk (Must be fluid, skim/fat free), or 1% milk)	1/2 c.	1/2 c.	1 c.
Water	1/2 c.	1 c.	1 c.

Meat and Meat Alternates:

It is recommended to have at least one meatless meal a week. An alternate for meat could be cooked, dried beans or peas. Cooked dried beans and peas cannot count for a vegetable and meat alternate in the same meal. Canned beans and peas will include the canned kidney, black bean, garbanzo, etc. Note: Canned beans are much higher in sodium/salt.

Edible portion for meats and meat alternates is used. Bone and skin shall not be counted as servings. No bones may be served. Note: 1 ounce of cooked meat is equal to one medium cooked chicken leg with bone removed.

Processed, pre-fried meats are not allowed due to the sodium/salt and fat content. Meats not allowed include hot dogs, corn dogs, bologna, bacon, sausage, pancake sticks, small chicken nuggets, fish sticks, and steak fingers.

Processed cheese, such as cheese spread, canned cheese sauce, and cheese in packaged snack crackers is not allowed. Low fat or fat free cheese would be a meat alternate that is allowed.

For menu variety, use meat, and low fat cheese in combination to equal a full serving portion.

Nuts or seeds *may be used* as a meat alternate for snack time, but is not recommended due to nut/seed allergies prevalent in the youth today.

Bread and Bread Alternates:

Use enriched whole-grain breads and bread alternatives. Whole grain pasta, noodles, brown rice, wheat rolls, and cornbread are encouraged for the lunch/supper/dinner meals.

Bread alternates may include crust used as part of the main dish (i.e. pizza or quiche), dry oatmeal used in a fruit crisp.

Pre-fried items, such as hash browns, French fries, tater tots are not recommended due to the fat and sodium content. Any pre-fried item served is limited to once a week. Fresh, “homemade” oven baked fries or wedges would be allowed.

Plain, low sugar type cookies may be served occasionally for a snack component. These cookies may include animal crackers, graham crackers, vanilla wafers, oatmeal, oatmeal raisin, peanut butter, and ginger snaps. Items that may not be served include chocolate chip, most packaged cookies/cakes.

Low fat granola bars, cereal bars, whole grain fruit bars, rice krispie treats may be used for a snack bread component. Packaged crackers with cheese/peanut butter filling are discouraged due to the fat/sodium content. The cheese/peanut butter filling cannot count as a meat serving.

Baked chips, chips, popcorn, hard pretzels, and other low-moisture, high sodium foods cannot meet the bread requirement for a snack. Crackers, cheese and vegetable flavored crackers are allowed. Trail mix made of various dry, no sugar coated cereals, dried fruits, and small marshmallows are a suggested snack item to meet a bread component.

Fruits and Vegetables:

Use fresh, canned, dried, or frozen vegetables and fruits for snack. No sugar may be used in the packaging or preparation of the fruit. Canned or frozen fruit should be packed in juice or water-not syrup or sugar packed.

Vegetables and fruits may be served as combination dishes (i.e., shredded carrot salad with diced pineapple, fat free yogurt parfait with fresh fruit).

Avoid serving two forms of the same fruit or vegetable in the same day. Example: an orange and orange juice or an apple and applesauce are combinations that should not be used. **Serve a variety of vegetables and fruits to ensure a nutritionally well-balanced meal.**

It is highly recommended to either serve at least one raw vegetable and two raw fruits per week, for a meal or snack. Younger children may have an appropriate substitution due to the choking hazard or the item may be cooked first.

Small amounts (less than 1/8 cup) of lettuce, tomatoes, onions, relish, catsup, salsa, jams, jellies, or other condiments may be added for flavor or garnish as "other foods," but do not count as a fruit or vegetable.

Juice should not be served as part of the snack when milk is the only other component. It is poor menu planning to offer such a combination since it provides too much liquid for children.

100% Fruit juice is allowed once a day. Vitamin fortified fruit juices, such as apple juice, with extra Vitamin C, will not be recognized as a good vitamin source.

The best time to serve this juice would be at the late 4:30/5:30 p.m., snack period.

Milk:

The milk shall be pasteurized fluid milk, fortified with vitamin A and D. Whole milk is served to infants and toddlers less than 2 years or age. After age two, skim/fat free milk, or 1% milk shall be served. Flavored milk may be served no more than once a week, using flavoring added to whole/skim/fat free milk, or 1% milk.

Soy milk may be served when indicated with dietary restrictions.

Provisions must be made to serve calcium in alternate forms when no milk/substitute may be served to the child due to dietary restrictions.

If a child cannot be served milk for medical reasons or upon parent's instructions, then that child is not to be served high content milk products, e.g., pudding, ice cream, cheese, etc.

All milk equivalents used as a meat alternate must be low in fat.

Water:

Water is to be made available with all meals and snacks. Tap or bottled water may be used. Facilities may have water fountains in the classroom or dining area. This water source should be encouraged before and after all meals and snacks and takes the place of water served at the table.

VITAMIN C SOURCES
VITAMIN C SOURCE MUST BE SERVED DAILY

**BEST CHOICE

*GOOD CHOICE

#ACCEPTABLE CHOICE (ONLY COUNT FOR A VITAMIN SOURCE ONCE PER WEEK)

Fruits			Vegetables		
Food	Serving Size		Food	Serving Size	
Blackberries	¼ c.	#	Asparagus	¼ c.	*
Blueberries	¼ c.	#	Artichoke	¼ medium	*
Cantaloupe	¼ c	**	Bok Choy	¼ c.	*
Grapefruit	¼ medium	**	Broccoli	¼ c.	**
Grapefruit Juice	½ c	**	Brussel Sprouts	¼ c.	**
Grapefruit-Orange Juice	½ c.	**	Cabbage	¼ c.	*
Guava	¼ c.	**	Cauliflower	¼ c.	*
Honeydew Melon	½ c.	*	Chicory	¼ c.	*
Kiwi	½ medium	**	Collard Greens	¼ c.	*
Mandarin Orange Sections	¼ c.	*	Kale	¼ c.	#
Mango	¼ medium	*	Kohlrabi	¼ c.	**
Melon balls	¼ c.	*			
Orange	½ medium	**	Mustard Greens	¼ c.	#
Orange Juice	¼ c.	**	Okra, not fried	¼ c.	#
Papaya	¼ c.	*	Peppers, green & red	¼ c.	**
Peach, frozen only	¼ c.	**	Potato, White, or Red Skinned Baked only-no instant/fries/tots	½ medium	*
Pineapple	¼ c.	#	Rutabagas	¼ c.	#
Pineapple Juice	¼ c.	*	Snow Peas	¼ c.	#
Pineapple-grapefruit or orange juice	¼ c.	**	Spinach	¼ c.	#
Raspberries	¼ c.	*	Sweet Potato	½ medium	*
Starfruit	¼ c.	#	Tomato	½ medium	*
Strawberries	¼ c.	**	Tomato or V-8 Juice	¼ c.	**
Tangelo	½ medium	**	Turnip Greens	¼ c.	*
Tangerine	½ medium	**	Miscellaneous		
Tropical fruit mix	¼ c.	*			
Watermelon	½ c.	#	Liver, beef	1 oz.	**

VITAMIN A SOURCES

VITAMIN A SOURCE MUST BE SERVED EVERY OTHER DAY, 3 TIMES PER WEEK

** BEST CHOICE

* GOOD CHOICE

#ACCEPTABLE CHOICE (ONLY COUNT FOR A VITAMIN SOURCE ONCE PER WEEK)

Fruits			Vegetables		
Food	Serving Size		Food	Serving Size	
Avocado	¼ medium	#	Asparagus	¼ c.	#
Apricot	2 halves	*	Artichoke	½ medium	#
Cantaloupe	¼ c.	*	Bok Choy	¼ c.	*
Cherries, red sour	¼ c.	*	Broccoli	¼ c.	*
Mandarin Orange Segments	¼ c.	*	Brussels Sprouts	¼ c.	*
Mango	¼ medium	**	Carrots	¼ c.	**
Melon Balls	¼ c.	*	Collard Greens	¼ c.	**
Nectarine	¼ medium	#			
Papaya	¼ c.	*	Kale	¼ c.	**
Peaches	¼ c.	#	Lettuce, Green, Romaine, or Red - NOT Iceberg	½ c.	#
Plantain	¼ c.	#	Mixed Vegetables	¼ c.	**
Prunes	¼ c.	*	Mustard Greens	¼ c.	**
Tangerine	½ medium	*	Okra, not fried	¼ c.	#
			Peas & Carrots	¼ c.	**
			Peppers, red	¼ c.	**
			Pumpkin	¼ c.	**
Miscellaneous			Rutabagas	¼ c.	#
Egg	1 medium	*	Spinach	¼ c.	**
Liver, beef	1 oz.	**	Sweet Potato	½ medium	**
Liver, chicken	1 oz.	**	Tomato or V-8 Juice	¼ c.	**
			Turnip Greens	¼ c.	**
			Winter Squash, Butternut or Hubbard	¼ c.	**

DENTAL CARE

Dental care is encouraged after each meal service. Parents shall supply toothbrushes and tooth powders or pastes for the child's individual use. Recommendations include replacing the brush every three months or when bristles are bent.

Each toothbrush and powder or paste must be:

- Labeled with the child's full name
- Stored out of children's reach when not in use
- Stored in a manner that prevents the toothbrushes from touching each other during storage

Staff is encouraged to attend trainings on dental care that includes:

- Proper tooth brushing technique as appropriate for the child's age and skills.
- Education to train parents about proper oral healthcare techniques.
- Education for staff and parents to learn the appropriate techniques to feed infants and children that minimize damage to teeth and facial development.

Children must have adult supervision during tooth brushing activities.

GARDENING AND FRESH PRODUCE

Gardening is an excellent opportunity to incorporate physical activity with nutrition education. Facilities are encouraged to have gardening projects with the children. Produce that is grown in the gardens may be washed and handled properly to allow the items to be served for a snack time or education activity.

Purchasing local produce from Mississippi farmers is one way to offer fresh items to the children. This also helps the local economy and raising families' awareness of food sources. The child care center must ensure the safety of foods served. Steps must be taken to demonstrate reasonable care has been taken to ensure the safety of foods purchased. Steps include: Investigating the local farm and production practices, communicating with the local farmer on the needs of the facility including packaging, delivery, and payment procedures, and promoting the use of local produce with families and the community. There are several resources available to use as a safety checklist, such as the Iowa State University Checklist for Retail Purchasing of Local Produce. The checklist is on the www.HealthyMS.com website under Nutrition and Farm to School and Preschool.

REFERENCES

Dietary Guidelines for Americans, 2005.

<http://www.health.gov/dietaryguidelines/dga2005/document/>

United States Department of Agriculture; Food and Nutrition Service; Child and Adult Care Food Program: Nutrition Guidance for Child Care Centers.

http://www.fns.usda.gov/cnd/care/ProgramBasics/Meals/Meal_Patterns.

Dietary Reference Intakes, (DRIs), Food and Nutrition board, Institute of Medicine, National Academies

USDA National Nutrient Database for Standard Reference, Release 18.

Promoting good Nutrition and Physical Activity in Child-Care Settings, A Research Brief, May 2007, Robert Wood Johnson Foundation.

Position of the American Dietetic Association: Benchmarks for Nutrition Programs in Child Care Settings, Journal of the American Dietetic Association, June 2005.

Nemours, Health and Prevention Services, Best Practices for Health Eating: A Guide to Help Children Grow Up Healthy, Version 2, 2008

The Wellness Child Care Assessment Tool: A Measure to Assess the Quality of Written Nutrition and Physical Activity Policies, The American Dietetic Associations, December 2011

Institute of Medicine, Child and Adult Care Food Programs: Aligning Dietary Guidance for All, November 4, 2011

Preventing Childhood Obesity in Early Care and Education Programs, American Academy of Pediatric, American Public Health Association, National Resource Centre for Health and Safety in Child Care and Early Education, 2010

Source: Miss. Code Ann. §43-20-8.

THIS PAGE INTENTIONALLY LEFT BLANK

APPENDIX - D

PLAYGROUND SAFETY STANDARDS

THIS PAGE INTENTIONALLY LEFT BLANK

Public Playground Safety Handbook



U.S. Consumer Product Safety Commission
Saving Lives and Keeping Families Safe



TABLE OF CONTENTS

	Page No.
1. Introduction	1
1.1 Scope	1
1.2 Intended Audience	1
1.3 What is a Public Playground?	1
1.4 Public Playground Safety Voluntary Standards and CPSC Handbook History	1
1.4.1 ASTM playground standards	2
1.5 Significant Revisions for 2008	2
1.5.1 Equipment guidelines	2
1.5.2 Surfacing guidelines	2
1.5.3 General guidelines	2
1.5.4 Other revisions	2
1.6 Background	2
1.7 Playground Injuries	3
1.8 Definitions	3
2 General Playground Considerations	5
2.1 Selecting a Site	5
2.1.1 Shading considerations	5
2.2 Playground Layout	5
2.2.1 Accessibility	6
2.2.2 Age separation	6
2.2.3 Age group	6
2.2.4 Conflicting activities	6
2.2.5 Sight lines	6
2.2.6 Signage and/or labeling	6
2.2.7 Supervision	7
2.3 Selecting Equipment	8
2.3.1 Equipment not recommended	8
2.4 Surfacing	8
2.4.1 Equipment not covered by protective surfacing recommendations	8
2.4.2 Selecting a surfacing material	9
2.5 Equipment Materials	10
2.5.1 Durability and finish	10
2.5.2 Hardware	11
2.5.3 Metals	12
2.5.4 Paints and finishes	12
2.5.5 Wood	12
2.6 Assembly and Installation	13
3 Playground Hazards	14
3.1 Crush and Shearing Points	14
3.2 Entanglement and Impalement	14
3.2.1 Strings and ropes	14
3.3 Entrapment	15
3.3.1 Head entrapment	15
3.3.2 Partially bound openings and angles	16
3.4 Sharp Points, Corners, and Edges	16
3.5 Suspended Hazards	16

3.6	Tripping Hazards	16
3.7	Used Tires	17
4	Maintaining a Playground	18
4.1	Maintenance Inspections	18
4.2	Repairs	18
4.3	Maintaining Loose-Fill Surfacing	18
4.4	Recordkeeping	19
5	Parts of the Playground	20
5.1	Platforms, Guardrails and Protective Barriers	20
5.1.1	Platforms	20
5.1.2	Stepped platforms	20
5.1.3	Guardrails and protective barriers	20
5.2	Access Methods to Play Equipment	22
5.2.1	Ramps, stairways, rung ladders, and step ladders	23
5.2.2	Rungs and other hand gripping components	24
5.2.3	Handrails	24
5.2.4	Transition from access to platform	24
5.3	Major Types of Playground Equipment	24
5.3.1	Balance beams	24
5.3.2	Climbing and upper body equipment	24
5.3.3	Log rolls	30
5.3.4	Merry-go-rounds	30
5.3.5	Seesaws	31
5.3.6	Slides	32
5.3.7	Spring rockers	36
5.3.8	Swings	37
5.3.9	Fall height and use zones for composite structure	41
5.3.10	Fall height and use zones not specified elsewhere	41

APPENDICES

A	Appendix A: Suggested General Maintenance Checklist	43
B	Appendix B: Playground Testing	45
B.1	Templates, Gauges, and Testing Tools	45
B.2	Test Methods	49
B.2.1	Determining whether a projection is a protrusion	49
B.2.2	Projections on suspended members of swing assemblies	49
B.2.3	Projections on slides	49
B.2.4	Entrapment	51
B.2.5	Test fixtures	52

1. INTRODUCTION

In recent years, it is estimated that there were more than 200,000 injuries annually on public playgrounds across the country that required emergency room treatment. By following the recommended guidelines in this handbook, you and your community can create a safer playground environment for all children and contribute to the reduction of playground-related deaths and injuries.

1.1 Scope

This handbook presents safety information for public playground equipment in the form of guidelines. Publication of this handbook is expected to promote greater safety awareness among those who purchase, install, and maintain public playground equipment. Because many factors may affect playground safety, the U.S. Consumer Product Safety Commission (CPSC) staff believes that guidelines, rather than a mandatory rule, are appropriate. These guidelines are not being issued as the sole method to minimize injuries associated with playground equipment. However, the Commission believes that the recommendations in this handbook along with the technical information in the ASTM standards for public playgrounds will contribute to greater playground safety.

Some states and local jurisdictions may require compliance with this handbook and/or ASTM voluntary standards. Additionally, risk managers, insurance companies, or others may require compliance at a particular site; check with state/local jurisdictions and insurance companies for specific requirements.

1.2 Intended Audience

This handbook is intended for use by childcare personnel, school officials, parks and recreation personnel, equipment purchasers and installers, playground designers, and any other members of the general public (e.g., parents and school groups) concerned with public playground safety and interested in evaluating their respective playgrounds. Due to the wide range of possible users, some information provided may be more appropriate for certain users than others. The voluntary standards listed in 1.4.1 contain more technical requirements than this handbook and are primarily intended for use by equipment manufacturers, architects, designers, and any others requiring more technical information.

1.3 What is a Public Playground?

“Public” playground equipment refers to equipment for use by children ages 6 months through 12 years in the playground areas of:

- Commercial (non-residential) child care facilities
- Institutions
- Multiple family dwellings, such as apartment and condominium buildings
- Parks, such as city, state, and community maintained parks
- Restaurants
- Resorts and recreational developments
- Schools
- Other areas of public use

These guidelines are not intended for amusement park equipment, sports or fitness equipment normally intended for users over the age of 12 years, soft contained play equipment, constant air inflatable play devices for home use, art and museum sculptures (not otherwise designed, intended and installed as playground equipment), equipment found in water play facilities, or home playground equipment. Equipment components intended solely for children with disabilities and modified to accommodate such users also are not covered by these guidelines. Child care facilities, especially indoor, should refer to ASTM F2373 — *Standard Consumer Safety Performance Specification for Public Use Play Equipment for Children 6 Months Through 23 Months*, for more guidance on areas unique to their facilities.

1.4 Public Playground Safety Voluntary Standards and CPSC Handbook History

- 1981 – First CPSC *Handbook for Public Playground Safety* was published, a two-volume set.
- 1991 – *Standard Specification for Impact Attenuation of Surface Systems Under and Around Playground Equipment*, ASTM F1292, was first published.
- 1991 – Two-volume set was replaced by a single-volume handbook, which contained recommendations based on a COMSIS Corporation report to the CPSC (*Development of Human Factors Criteria for Playground Equipment Safety*).

- 1993 – First version of voluntary standard for public playground equipment, ASTM F1487 — *Standard Consumer Safety Performance Specification for Playground Equipment for Public Use*, was published (revisions occur every 3 to 4 years).
- 1994 – Minor revisions to the *Handbook*.
- 1997 – *Handbook* was updated based on (1) staff review of ASTM F1487, (2) playground safety roundtable meeting held October 1996, and (3) public comment received to a May 1997 CPSC staff request.
- 2005 – First version of voluntary standard for playground equipment intended for children under two years old, ASTM F2373 — *Standard Consumer Safety Performance Specification for Public Use Play Equipment for Children 6 Months Through 23 Months*, was published.
- 2008 – *Handbook* was updated based on comments received from members of the ASTM F15 Playground Committees in response to a CPSC staff request for suggested revisions. Significant revisions are listed below.

1.4.1 ASTM playground standards

Below is a list of ASTM technical performance standards that relate to playgrounds.

- **F1487** *Standard Consumer Safety Performance Specification for Playground Equipment for Public Use*.
- **F2373** *Standard Consumer Safety Performance Specification for Public Use Play Equipment for Children 6 Months through 23 Months*.
- **F1292** *Standard Specification for Impact Attenuation of Surface Systems Under and Around Playground Equipment*.
- **F2075** *Standard Specification for Engineered Wood Fiber for Use as a Playground Safety Surface Under and Around Playground Equipment*.
- **F2223** *Standard Guide for ASTM Standards on Playground Surfacing*.
- **F2479** *Standard Guide for Specification, Purchase, Installation and Maintenance of Poured-In-Place Playground Surfacing*.
- **F1951** *Standard Specification for Determination of Accessibility of Surface Systems Under and Around Playground Equipment*.
- **F1816** *Standard Safety Specification for Drawstrings on Children's Upper Outerwear*.

- **F2049** *Standard Guide for Fences/Barriers for Public, Commercial, and Multi-Family Residential Use Outdoor Play Areas*.
- **F1148** *Standard Consumer Safety Performance Specification for Home Playground Equipment*.
- **F1918** *Standard Safety Performance Specification for Soft Contained Play Equipment*.

1.5 Significant Revisions for 2008

1.5.1 Equipment guidelines

- Age ranges expanded to include children as young as 6 months based on ASTM F2373
- Guidelines for track rides and log rolls added
- Exit zone requirements for slides harmonized with ASTM F1487

1.5.2 Surfacing guidelines

- Critical height table revised
- Suggestions for surfacing over asphalt added

1.5.3 General guidelines

- Suggestions on sun exposure added

1.5.4 Other revisions

- Editorial changes to make the *Handbook* easier to understand and use

1.6 Background

The safety of each individual piece of playground equipment as well as the layout of the entire play area should be considered when designing or evaluating a playground for safety. Since falls are a very common playground hazard pattern, the installation and maintenance of protective surfacing under and around all equipment is crucial to protect children from severe head injuries.

Because all playgrounds present some challenge and because children can be expected to use equipment in unintended and unanticipated ways, adult supervision is highly recommended. The handbook provides some guidance on supervisory practices that adults should follow. Appropriate equipment design, layout, and maintenance, as discussed in this

handbook, are also essential for increasing public playground safety.

A playground should allow children to develop gradually and test their skills by providing a series of graduated challenges. The challenges presented should be appropriate for age-related abilities and should be ones that children can perceive and choose to undertake. Toddlers, preschool- and school-age children differ dramatically, not only in physical size and ability, but also in their intellectual and social skills. Therefore, age-appropriate playground designs should accommodate these differences with regard to the type, scale, and the layout of equipment. Recommendations throughout this handbook address the different needs of toddlers, preschool-age, and school-age children; “toddlers” refers to children ages 6 months through 2 years of age, “preschool-age” refers to children 2 through 5 years, and “school-age” refers to children 5 through 12 years. The overlap between these groups is anticipated in terms of playground equipment use and provides for a margin of safety.

Playground designers, installers and operators should be aware that the Americans with Disabilities Act of 1990 (ADA) is a comprehensive civil rights law which prohibits discrimination on the basis of disability. Titles II and III of the ADA require, among other things, that newly constructed and altered State and local government facilities, places of public accommodation, and commercial facilities be readily accessible to and usable by individuals with disabilities. Recreation facilities, including play areas, are among the types of facilities covered by titles II and III of the ADA.

The Architectural and Transportation Barriers Compliance Boards – also referred to as the “Access Board” – has developed accessibility guidelines for newly constructed and altered play areas that were published October 2000. The play area guidelines are a supplement to the Americans with Disabilities Act Accessibility Guidelines (ADAAG). Once these guidelines are adopted as enforceable standards by the Department of Justice, all newly constructed and altered play areas covered by the ADA will be required to comply. These guidelines also apply to play areas covered by the Architectural Barriers Act (ABA).

Copies of the play area accessibility guidelines and further technical assistance can be obtained from the U.S. Access Board, 1331 F Street, NW, Suite 1000, Washington, DC 20004-1111; 800-872-2253, 800-993-2822 (TTY), www.access-board.gov.

1.7 Playground Injuries

The U. S. Consumer Product Safety Commission has long recognized the potential hazards that exist with the use of playground equipment, with over 200,000 estimated emergency room-treated injuries annually. The most recent study of 2,691 playground equipment-related incidents reported to the CPSC from 2001-2008 indicated that falls are the most common hazard pattern (44% of injuries) followed by equipment-related hazards, such as breakage, tip over, design, and assembly (23%).¹ Other hazard patterns involved entrapment and colliding other children or stationary equipment. Playground-related deaths reported to the Commission involved entanglement of ropes, leashes, or clothing; falls; and impact from equipment tip over or structural failure.

The recommendations in this handbook have been developed to address the hazards that resulted in playground-related injuries and deaths. The recommendations include those that address:

- The potential for falls from and impact with equipment
- The need for impact attenuating protective surfacing under and around equipment
- Openings with the potential for head entrapment
- The scale of equipment and other design features related to user age and layout of equipment on a playground
- Installation and maintenance procedures
- General hazards presented by protrusions, sharp edges, and crush or shear points

1.8 Definitions

Barrier — An enclosing device around an elevated platform that is intended to prevent both inadvertent and deliberate attempts to pass through the device.

Composite Structure — Two or more play structures attached or functionally linked, to create one integral unit that provides more than one play activity.

Critical Height — The fall height below which a life-threatening head injury would not be expected to occur.

¹O'Brien, Craig W.; Injuries and Investigated Deaths Associated with Playground Equipment, 2001–2008. U.S. Consumer Product Safety Commission: Washington DC, October, 2009.

Designated Play Surface — Any elevated surface for standing, walking, crawling, sitting or climbing, or a flat surface greater than 2 inches wide by 2 inches long having an angle less than 30° from horizontal.

Embankment Slide — A slide that follows the contour of the ground and at no point is the bottom of the chute greater than 12 inches above the surrounding ground.

Entanglement — A condition in which the user's clothes or something around the user's neck becomes caught or entwined on a component of playground equipment.

Entrapment — Any condition that impedes withdrawal of a body or body part that has penetrated an opening.

Fall Height — The vertical distance between the highest designated play surface on a piece of equipment and the protective surfacing beneath it.

Footing — A means for anchoring playground equipment to the ground.

Full Bucket Seat Swing — A swing generally appropriate for children under 4 years of age that provides support on all sides and between the legs of the occupant and cannot be entered or exited without adult assistance.

Geotextile (filter) Cloth — A fabric that retains its relative structure during handling, placement, and long-term service to enhance water movement, retard soil movement, and to add reinforcement and separation between the soil and the surfacing and/or sub-base.

Guardrail — An enclosing device around an elevated platform that is intended to prevent inadvertent falls from the elevated surface.

Infill — Material(s) used in a protective barrier or between decks to prevent a user from passing through the barrier (e.g., vertical bars, lattice, solid panel, etc.).

Loose-Fill Surfacing Material — A material used for protective surfacing in the use zone that consists of loose particles such as sand, gravel, engineered wood fibers, or shredded rubber.

Preschool-Age Children — Children 2 years of age through 5 years of age.

Projection — Anything that extends outward from a surface of the playground equipment and must be tested to determine whether it is a protrusion or entanglement hazard, or both.

Protective Barrier — See Barrier.

Protective Surfacing — Shock absorbing (i.e., impact attenuating) surfacing material in the use zone that conforms to the recommendations in §2.4 of this handbook.

Protrusion — A projection which, when tested, is found to be a hazard having the potential to cause bodily injury to a user who impacts it.

Roller Slide — A slide that has a chute consisting of a series of individual rollers over which the user travels.

School-Age Children — Children 5 years of age through 12 years of age.

Slide Chute — The inclined sliding surface of a slide.

Stationary Play Equipment — Any play structure that has a fixed base and does not move.

Supervisor — Any person tasked with watching children on a playground. Supervisors may be paid professionals (e.g., childcare, elementary school or park and recreation personnel), paid seasonal workers (e.g., college or high school students), volunteers (e.g., PTA members), or unpaid caregivers (e.g., parents) of the children playing in the playground.

Toddlers — Children 6 months through 23 months of age.

Tube Slide — A slide in which the chute consists of a totally enclosed tube or tunnel.

Unitary Surfacing Material — A manufactured material used for protective surfacing in the use zone that may be rubber tiles, mats, or a combination of energy absorbing materials held in place by a binder that may be poured in place at the playground site and cures to form a unitary shock absorbing surface.

Upper Body Equipment — Equipment designed to support a child by the hands only (e.g., horizontal ladder, overhead swinging rings).

Use Zone — The surface under and around a piece of equipment onto which a child falling from or exiting from the equipment would be expected to land. These areas are also designated for unrestricted circulation around the equipment.

2. GENERAL PLAYGROUND CONSIDERATIONS

2.1 Selecting a Site

The following factors are important when selecting a site for a new playground:

Site Factor	Questions to Ask	If yes, then...Mitigation
Travel patterns of children to and from the playground	Are there hazards in the way?	Clear hazards.
Nearby accessible hazards such as roads with traffic, lakes, ponds, streams, drop-offs/cliffs, etc.	<p>Could a child inadvertently run into a nearby hazard?</p> <p>Could younger children easily wander off toward the hazard?</p>	Provide a method to contain children within the playground. For example, a dense hedge or a fence. The method should allow for observation by supervisors. If fences are used, they should conform to local building codes and/or ASTM F-2049.
Sun exposure	Is sun exposure sufficient to heat exposed bare metal slides, platforms, steps, & surfacing enough to burn children?	<p>Bare metal slides, platforms, and steps should be shaded or located out of direct sun.</p> <p>Provide warnings that equipment and surfacing exposed to intense sun can burn.</p>
	Will children be exposed to the sun during the most intense part of the day?	Consider shading the playground or providing shaded areas nearby.
Slope and drainage	Will loose fill materials wash away during periods of heavy rain?	Consider proper drainage re-grading to prevent wash outs.

2.1.1 Shading considerations

According to the American Academy of Dermatology, research indicates that one in five Americans will develop some form of skin cancer during their lifetime, and five or more sunburns double the risk of developing skin cancer. Utilizing existing shade (e.g., trees), designing play structures as a means for providing shading (e.g., elevated platforms with shaded space below), or creating more shade (e.g., man-made structures) are potential ways to design a playground to help protect children's skin from the sun. When trees are used for shade, additional maintenance issues arise, such as the need for cleaning up debris and trimming limbs.

2.2 Playground Layout

There are several key factors to keep in mind when laying out a playground:

- Accessibility
- Age separation
- Conflicting activities
- Sight lines
- Signage and/or labeling
- Supervision

2.2.1 Accessibility

Special consideration should be given to providing accessible surfaces in a play area that meets the ASTM *Standard Specification for Determination of Accessibility of Surface Systems Under and Around Playground Equipment*, ASTM F1951.

Equipment selection and location along with the type of protective surfacing are key components to ensuring the opportunity for children with disabilities to play on the playground.

2.2.2 Age separation

For playgrounds intended to serve children of all ages, the layout of pathways and the landscaping of the playground should show the distinct areas for the different age groups. The areas should be separated at least by a buffer zone, which could be an area with shrubs or benches. This separation and buffer zone will reduce the chance of injury from older, more active children running through areas filled with younger children with generally slower movement and reaction times.

2.2.3 Age group

In areas where access to the playground is unlimited or enforced only by signage, the playground designer should recognize that since child development is fluid, parents and caregivers may select a playground slightly above or slightly below their child's abilities, especially for children at or near a cut-off age (e.g., 2-years old and 5-years old). This could be for ease of supervising multiple children, misperceptions about the hazards a playground may pose to children of a different age, advanced development of a child, or other reasons. For this reason, there is an overlap at age 5.

Developmentally a similar overlap also exists around age 2; however, due to the differences in ASTM standards and entrapment testing tools, this overlap is not reflected in the handbook. Playgrounds used primarily by children under the supervision of paid, trained professionals (e.g., child-care centers and schools) may wish to consider separating playgrounds by the facility's age groupings. For example, a child-care facility may wish to limit a playground to toddlers under 2 exclusively and can draw information from this guide and ASTM F2373. A school, on the other hand, may have no children under 4 attending, and can likewise plan appropriately. Those who inspect playgrounds should use the intended age group of the playground.

2.2.4 Conflicting activities

The play area should be organized into different sections to prevent injuries caused by conflicting activities and children running between activities. Active, physical activities should be separate from more passive or quiet activities. Areas for playground equipment, open fields, and sand boxes should be located in different sections of the playground. In addition, popular, heavy-use pieces of equipment or activities should be dispersed to avoid crowding in any one area.

Different types of equipment have different use zones that must be maintained. The following are general recommendations for locating equipment within the playground site. Specific use zones for equipment are given in §5.3.

- Moving equipment, such as swings and merry-go-rounds, should be located toward a corner, side, or edge of the play area while ensuring that the appropriate use zones around the equipment are maintained.
- Slide exits should be located in an uncongested area of the playground.
- Composite play structures have become increasingly popular on public playgrounds. Adjacent components on composite structures should be complementary. For example, an access component should not be located in a slide exit zone.

2.2.5 Sight lines

Playgrounds that are designed, installed, and maintained in accordance with safety guidelines and standards can still present hazards to children. Playgrounds should be laid out to allow parents or caregivers to keep track of children as they move throughout the playground environment. Visual barriers should be minimized as much as possible. For example, in a park situation, playground equipment should be as visible as possible from park benches. In playgrounds with areas for different ages, the older children's area should be visible from the younger children's area to ensure that caregivers of multiple children can see older children while they are engaged in interactive play with younger ones.

2.2.6 Signage and/or labeling

Although the intended user group should be obvious from the design and scale of equipment, signs and/or labels posted in the playground area or on the equipment should give some guidance to supervisors as to the age appropriateness of the equipment.

2.2.7 Supervision

The quality of the supervision depends on the quality of the supervisor's knowledge of safe play behavior. Playground designers should be



aware of the type of supervision most likely for their given playground. Depending on the location and nature of the playground, the supervisors may be paid professionals (e.g., childcare, elementary school or park and recreation personnel), paid seasonal workers (e.g., college or high school students), volunteers (e.g., PTA members), or unpaid caregivers (e.g., parents) of the children playing in the playground.



Parents and playground supervisors should be aware that not all playground equipment is appropriate for all children who may use the playground. Supervisors should look for posted

signs indicating the appropriate age of the users and direct children to equipment appropriate for their age. Supervisors may also use the information in Table 1 to determine the suitability of the equipment for the children they are supervising. Toddlers and preschool-age children require more attentive supervision than older children; however, one should not rely on supervision alone to prevent injuries.

Supervisors should understand the basics of playground safety such as:

- Checking for broken equipment and making sure children don't play on it.
- Checking for and removing unsafe modifications, especially ropes tied to equipment, before letting children play.
- Checking for properly maintained protective surfacing.
- Making sure children are wearing foot wear.

TABLE 1. EXAMPLES OF AGE APPROPRIATE EQUIPMENT

 <p>Toddler – Ages 6-23 months</p> <ul style="list-style-type: none"> • Climbing equipment under 32" high • Ramps • Single file step ladders • Slides* • Spiral slides less than 360° • Spring rockers • Stairways • Swings with full bucket seats 	 <p>Preschool – Ages 2-5 years</p> <ul style="list-style-type: none"> • Certain climbers** • Horizontal ladders less than or equal to 60" high for ages 4 and 5 • Merry-go-rounds • Ramps • Rung ladders • Single file step ladders • Slides* • Spiral slides up to 360° • Spring rockers • Stairways • Swings – belt, full bucket seats (2-4 years) & rotating tire 	 <p>Grade School – Ages 5-12 years</p> <ul style="list-style-type: none"> • Arch climbers • Chain or cable walks • Free standing climbing events with flexible parts • Fulcrum seesaws • Ladders – Horizontal, Rung, & Step • Overhead rings*** • Merry-go-rounds • Ramps • Ring treks • Slides* • Spiral slides more than one 360° turn • Stairways • Swings – belt & rotating tire • Track rides • Vertical sliding poles
<p>* See §5.3.6</p>	<p>** See §5.3.2</p>	<p>*** See §5.3.2.5</p>

- Watching and stopping dangerous horseplay, such as children throwing protective surfacing materials, jumping from heights, etc.
- Watching for and stopping children from wandering away from the play area.

2.3 Selecting Equipment

When selecting playground equipment, it is important to know the age range of the children who will be using the playground. Children at different ages and stages of development have different needs and abilities. Playgrounds should be designed to stimulate children and encourage them to develop new skills, but should be in scale with their sizes, abilities, and developmental levels. Consideration should also be given to providing play equipment that is accessible to children with disabilities and encourages integration within the playground.

Table 1 shows the appropriate age range for various pieces of playground equipment. This is not an all-comprehensive list and, therefore, should not limit inclusion of current or newly designed equipment that is not specifically mentioned. For equipment listed in more than one group, there may be some modifications or restrictions based on age, so consult the specific recommendations in §5.3.

2.3.1 Equipment not recommended

Some playground equipment is not recommended for use on public playgrounds, including:

- Trampolines
- Swinging gates
- Giant strides
- Climbing ropes that are not secured at both ends.
- Heavy metal swings (e.g., animal figures) – These are not recommended because their heavy rigid metal framework presents a risk of impact injury.
- Multiple occupancy swings – With the exception of tire swings, swings that are intended for more than one user are not recommended because their greater mass, as compared to single occupancy swings, presents a risk of impact injury.
- Rope swings – Free-swinging ropes that may fray or otherwise form a loop are not recommended because they present a potential strangulation hazard.
- Swinging dual exercise rings and trapeze bars – These are rings and trapeze bars on long chains that are generally considered to be items of athletic equipment and are not recommended for public playgrounds. *NOTE: The recommendation against the use of exercise rings does not apply to overhead hanging rings such as those used in a ring trek or ring ladder (see Figure 7).*



2.4 Surfacing

The surfacing under and around playground equipment is one of the most important factors in reducing the likelihood of life-threatening head injuries. A fall onto a shock absorbing surface is less likely to cause a

serious head injury than a fall onto a hard surface. However, some injuries from falls, including broken limbs, may occur no matter what playground surfacing material is used.

The most widely used test method for evaluating the shock absorbing properties of a playground surfacing material is to drop an instrumented metal headform onto a sample of the material and record the acceleration/time pulse during the impact. Field and laboratory test methods are described in ASTM F1292 *Standard Specification for Impact Attenuation of Surface Systems Under and Around Playground Equipment*.

Testing using the methods described in ASTM F1292 will provide a “critical height” rating of the surface. This height can be considered as an approximation of the fall height below which a life-threatening head injury would not be expected to occur. Manufacturers and installers of playground protective surfacing should provide the critical height rating of their materials. This rating should be greater than or equal to the fall height of the highest piece of equipment on the playground. The fall height of a piece of equipment is the distance between the highest designated play surface on a piece of equipment and the protective surface beneath it. Details for determining the highest designated play surface and fall height on some types of equipment are included in §5 Parts of the Playground.

2.4.1 Equipment not covered by protective surfacing recommendations

The recommendations for protective surfacing do not apply to equipment that requires a child to be standing or sitting at *ground level*. Examples of such equipment are:



Appropriate Surfacing

- Any material tested to ASTM F1292, including unitary surfaces, engineered wood fiber, etc.
- Pea gravel
- Sand
- Shredded/recycled rubber mulch
- Wood mulch (not CCA-treated)
- Wood chips



Inappropriate Surfacing

- Asphalt
- Carpet not tested to ASTM F1292
- Concrete
- Dirt
- Grass
- CCA treated wood mulch

- Sand boxes
- Activity walls at ground level
- Play houses
- Any other equipment that children use when their feet remain in contact with the ground surface

2.4.2 Selecting a surfacing material

There are two options available for surfacing public playgrounds: unitary and loose-fill materials. A playground should never be installed without protective surfacing of some type. Concrete, asphalt, or other hard surfaces should never be directly under playground equipment. Grass and dirt are not considered protective surfacing because wear and environmental factors can reduce their shock absorbing effectiveness. Carpeting and mats are also not appropriate unless they are tested to and comply with ASTM F1292. Loose-fill should be avoided for playgrounds intended for toddlers.

2.4.2.1 Unitary surfacing materials

Unitary materials are generally rubber mats and tiles or a combination of energy-absorbing materials held in place by a

binder that may be poured in place at the playground site and then cured to form a unitary shock absorbing surface. Unitary materials are available from a number of different manufacturers, many of whom have a range of materials with differing shock absorbing properties. New surfacing materials, such as bonded wood fiber and combinations of loose-fill and unitary, are being developed that may also be tested to ASTM F1292 and fall into the unitary materials category. When deciding on the best surfacing materials keep in mind that some dark colored surfacing materials exposed to the intense sun have caused blistering on bare feet. Check with the manufacturer if light colored materials are available or provide shading to reduce direct sun exposure.

Persons wishing to install a unitary material as a playground surface should request ASTM F1292 test data from the manufacturer identifying the critical height rating of the desired surface. In addition, site requirements should be obtained from the manufacturer because some unitary materials require installation over a hard surface while others do not. Manufacturer's instructions should be followed closely, as some unitary systems require professional installation. Testing should be conducted in accordance with the ASTM F1292 standard.

2.4.2.2 Loose-fill surfacing materials

Engineered wood fiber (EWF) is a wood product that may look similar in appearance to landscaping mulch, but EWF products are designed specifically for use as a playground safety surface under and around playground equipment. EWF products should meet the specifications in ASTM F2075: *Standard Specification for Engineered Wood Fiber* and be tested to and comply with ASTM F1292.

There are also rubber mulch products that are designed specifically for use as playground surfacing. Make sure they have been tested to and comply with ASTM F1292.

When installing these products, tips 1-9 listed below should be followed. Each manufacturer of engineered wood fiber and rubber mulch should provide maintenance requirements for and test data on:

- Critical height based on ASTM F1292 impact attenuation testing.
- Minimum fill-depth data.
- Toxicity.
- ADA/ABA accessibility guidelines for firmness and stability based on ASTM F1951.

Other loose-fill materials are generally landscaping-type materials that can be layered to a certain depth and resist compacting. Some examples include wood mulch, wood chips, sand, pea gravel, and shredded/recycled rubber mulch.

Important tips when considering loose-fill materials:

1. Loose-fill materials will compress at least 25% over time due to use and weathering. This must be considered when planning the playground. For example, if the playground will require 9 inches of wood chips, then the initial fill level should be 12 inches. See Table 2 below.
2. Loose-fill surfacing requires frequent maintenance to ensure surfacing levels never drop below the minimum depth. Areas under swings and at slide exits are more susceptible to displacement; special attention must be paid to maintenance in these areas. Additionally, wear mats can be installed in these areas to reduce displacement.
3. The perimeter of the playground should provide a method of containing the loose-fill materials.
4. Consider marking equipment supports with a minimum fill level to aid in maintaining the original depth of material.

5. Good drainage is essential to maintaining loose-fill surfacing. Standing water with surfacing material reduces effectiveness and leads to material compaction and decomposition.
6. Critical height may be reduced during winter in areas where the ground freezes.
7. Never use less than 9 inches of loose-fill material except for shredded/recycled rubber (6 inches recommended). Shallower depths are too easily displaced and compacted.
8. Some loose-fill materials may not meet ADA/ABA accessibility guidelines. For more information, contact the Access Board (see §1.6) or refer to ASTM F1951.
9. Wood mulch containing chromated copper arsenate (CCA)-treated wood products should not be used; mulch where the CCA-content is unknown should be avoided (see §2.5.5.1).

Table 2 shows the minimum required depths of loose-fill material needed based on material type and fall height. The depths shown assume the materials have been compressed due to use and weathering and are properly maintained to the given level.

2.4.2.3 Installing loose-fill over hard surface

CPSC staff strongly recommends against installing playgrounds over hard surfaces, such as asphalt, concrete, or hard packed earth, unless the installation adds the following layers of protection. Immediately over the hard surface there should be a 3- to 6-inch base layer of loose-fill (e.g., gravel for drainage). The next layer should be a Geotextile cloth. On top of that should be a loose-fill layer meeting the specifications addressed in §2.4.2.2 and Table 2. Embedded in the loose-fill layer should be impact attenuating mats under high traffic areas, such as under swings, at slide exits, and other places where displacement is likely. Figure 1 provides a visual representation of this information. Older playgrounds that still exist on hard surfacing should be modified to provide appropriate surfacing.

2.5 Equipment Materials

2.5.1 Durability and finish

- Use equipment that is manufactured and constructed only of materials that have a demonstrated record of durability in a playground or similar setting.

Table 2. Minimum compressed loose-fill surfacing depths

Inches	Of	(Loose-Fill Material)	Protects to	Fall Height (feet)
6*		Shredded/recycled rubber		10
9		Sand		4
9		Pea Gravel		5
9		Wood mulch (non-CCA)		7
9		Wood chips		10

* Shredded/recycled rubber loose-fill surfacing does not compress in the same manner as other loose-fill materials. However, care should be taken to maintain a constant depth as displacement may still occur.

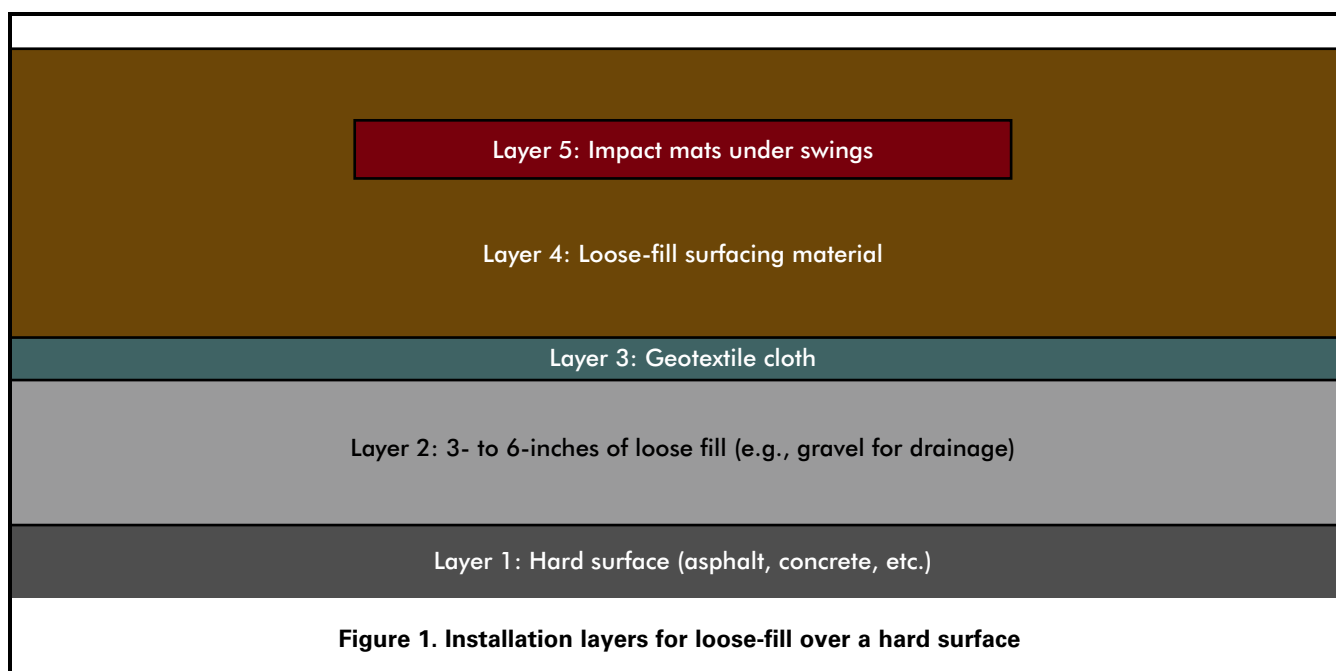
**Figure 1. Installation layers for loose-fill over a hard surface**

- Finishes, treatments, and preservatives should be selected carefully so that they do not present a health hazard to users.
 - All fasteners, connectors, and covering devices that are exposed to the user should be smooth and should not be likely to cause laceration, penetration, or present a clothing entanglement hazard (see also §3.2 and Appendix B).
- ### 2.5.2 Hardware
- When installed and maintained in accordance with the manufacturer's instructions:
- All fasteners, connectors, and covering devices should not loosen or be removable without the use of tools.
 - Lock washers, self-locking nuts, or other locking means should be provided for all nuts and bolts to protect them from detachment.
 - Hardware in moving joints should also be secured against unintentional or unauthorized loosening.

- All fasteners should be corrosion resistant and be selected to minimize corrosion of the materials they connect. This is particularly important when using wood treated with ACQ/CBA/CA-B² as the chemicals in the wood preservative corrode certain metals faster than others.
- Bearings or bushings used in moving joints should be easy to lubricate or be self-lubricating.
- All hooks, such as S-hooks and C-hooks, should be closed (see also §5.3.8.1). A hook is considered closed if there is no gap or space greater than 0.04 inches, about the thickness of a dime.

2.5.3 Metals

- Avoid using bare metal for platforms, slides, or steps. When exposed to direct sunlight they may reach temperatures high enough to cause serious contact burn injuries in a matter of seconds. Use other materials that may reduce the surface temperature, such as but not limited to wood, plastic, or coated metal (see also Slides in §5.3.6).
- If bare or painted metal surfaces are used on platforms, steps, and slide beds, they should be oriented so that the surface is not exposed to direct sun year round.

2.5.4 Paints and finishes

- Metals not inherently corrosion resistant should be painted, galvanized, or otherwise treated to prevent rust.
- The manufacturer should ensure that the users cannot ingest, inhale, or absorb potentially hazardous amounts of preservative chemicals or other treatments applied to the equipment as a result of contact with playground equipment.
- All paints and other similar finishes must meet the current CPSC regulation for lead in paint.
- Painted surfaces should be maintained to prevent corrosion and deterioration.
- Paint and other finishes should be maintained to prevent rusting of exposed metals and to minimize children playing with peeling paint and paint flakes.

- Older playgrounds with lead based paints should be identified and a strategy to control lead paint exposure should be developed. Playground managers should consult the October 1996 report, CPSC Staff Recommendations for Identifying and Controlling Lead Paint on Public Playground Equipment, while ensuring that all paints and other similar finishes meet the current CPSC regulation.³

2.5.5 Wood

- Wood should be either naturally rot- and insect-resistant (e.g., cedar or redwood) or should be treated to avoid such deterioration.
- Creosote-treated wood (e.g., railroad ties, telephone poles, etc) and coatings that contain pesticides should not be used.

2.5.5.1 Pressure-treated wood

A significant amount of older playground wood was pressure-treated with chemicals to prevent damage from insects and fungi. Chromated copper arsenate (CCA) was a chemical used for decades in structures (including playgrounds). Since December 31, 2003, CCA-treated wood is no longer processed for use in playground applications. Other rot- and insect-resistant pressure treatments are available that do not contain arsenic; however, when using any of the new treated wood products, be sure to use hardware that is compatible with the wood treatment chemicals. These chemicals are known to corrode certain materials faster than others.

Existing playgrounds with CCA-treated wood

Various groups have made suggestions concerning the application of surface coatings to CCA-treated wood (e.g., stains and sealants) to reduce a child's potential exposure to arsenic from the wood surface. Data from CPSC staff and EPA studies suggest that regular (at least once a year) use of an oil- or water-based, penetrating sealant or stain can reduce arsenic migration from CCA-treated wood. Installers, builders, and consumers who perform woodworking operations, such as sanding, sawing, or sawdust disposal, on pressure-treated wood should read the consumer information sheet available at the point of sale. This sheet contains important health precautions and disposal information.

² Ammoniacal copper quat (ACQ), copper boron azole (CBA), copper azole type B (CA-B), etc.

³ CPSC Staff Recommendations for Identifying and Controlling Lead Paint on Public Playground Equipment; U.S. Consumer Product Safety Commission: Washington, DC, October 1996.

When selecting wood products and finishes for public playgrounds, CPSC staff recommends:

- Avoid “film-forming” or non-penetrating stains (latex semi-transparent, latex opaque and oil-based opaque stains) on outdoor surfaces because peeling and flaking may occur later, which will ultimately have an impact on durability as well as exposure to the preservatives in the wood.
- Creosote, pentachlorophenol, and tributyl tin oxide are too toxic or irritating and should not be used as preservatives for playground equipment wood.
- Pesticide-containing finishes should not be used.
- CCA-treated wood should not be used as playground mulch.

2.6 Assembly and Installation

- Strictly follow *all* instructions from the manufacturer when assembling and installing equipment.
- After assembly and before its first use, equipment should be thoroughly inspected by a person qualified to inspect playgrounds for safety.
- The manufacturer’s assembly and installation instructions, and all other materials collected concerning the equipment, should be kept in a permanent file.
- Secure anchoring is a key factor to stable installation, and the anchoring process should be completed in *strict* accordance with the manufacturer’s specifications.

3. PLAYGROUND HAZARDS

This section provides a broad overview of general hazards that should be avoided on playgrounds. It is intended to raise awareness of the risks posed by each of these hazards. Many of these hazards have technical specifications and tests for compliance with ASTM F1487 and F2373. Some of these tests are also detailed in Appendix B.

3.1 Crush and Shearing Points

Anything that could crush or shear limbs should not be accessible to children on a playground. Crush and shear points can be caused by parts moving relative to each other or to a fixed part during a normal use cycle, such as a seesaw.

To determine if there is a possible crush or shear point, consider:

- The likelihood a child could get a body part inside the point, and
- The closing force around the point.

Potential crush/shear hazards specific to certain pieces of equipment are identified in §5.3 Major Types of Playground Equipment.

3.2 Entanglement and Impalement

Projections on playground equipment should not be able to entangle children's clothing nor should they be large enough to impale. To avoid this risk:

- The diameter of a projection should not increase in the direction away from the surrounding surface toward the exposed end (see Figure 2).
- Bolts should not expose more than two threads beyond the end of the nut (see Figure 3).
- All hooks, such as S-hooks and C-hooks, should be closed (see also §5.3.8.1). A hook is considered closed if there is no gap or space greater than 0.04 inches, about the thickness of a dime.
 - Any connecting device containing an in-fill that completely fills the interior space preventing entry of clothing items into the interior of the device is exempt from this requirement.

- Swings and slides have additional recommendations for projections detailed in §5.3.
- See Appendix B for testing recommendations.

3.2.1 Strings and ropes

Drawstrings on the hoods of jackets, sweatshirts, and other upper body clothing can become entangled in playground equipment, and can cause death by strangulation. To avoid this risk:

- Children should not wear jewelry, jackets or sweatshirts with drawstring hoods, mittens connected by strings through the arms, or other upper body clothing with drawstrings.
- Remove any ropes, dog leashes, or similar objects that have been attached to playground equipment. Children can become entangled in them and strangle to death.

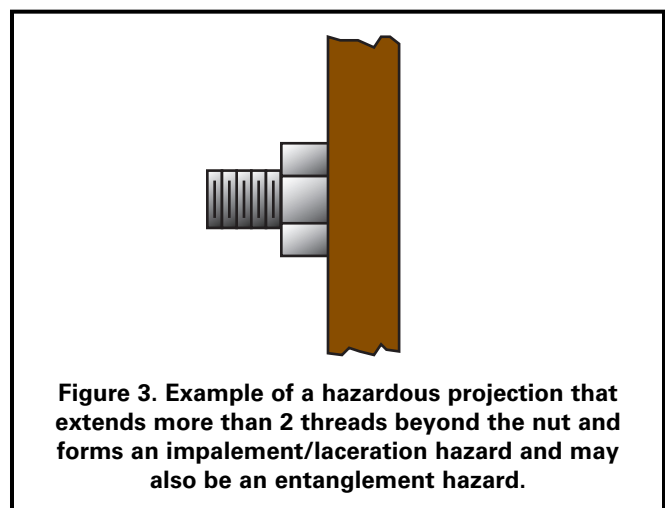
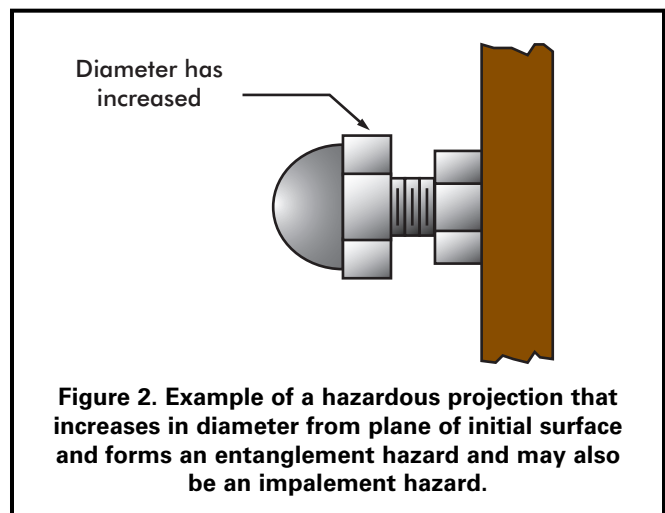

- Avoid equipment with ropes that are not secured at both ends.
- The following label, or a similar sign or label, can be placed on or near slides or other equipment where potential entanglements may occur.

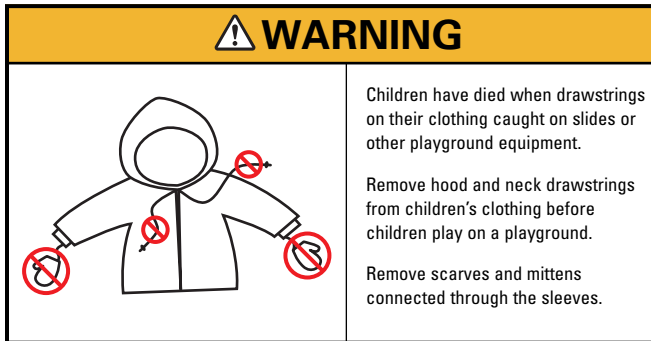

3.3 Entrapment

3.3.1 Head entrapment

Head entrapment is a serious concern on playgrounds, since it could lead to strangulation and death. A child's head may become entrapped if the child enters an opening either feet first or head first. Head entrapment by head-first entry generally occurs when children place their heads through an

opening in one orientation, turn their heads to a different orientation, then are unable to get themselves out. Head entrapment by feet first entry involves children who generally sit or lie down and slide their feet into an opening that is large enough to permit their bodies to go through but is not large enough to permit their heads to go through. A part or a group of parts should not form openings that could trap a child's head. Also, children should not wear their bicycle helmets while on playground equipment. There have been recent head entrapment incidents in which children wearing their bicycle helmets became entrapped in spaces that would not normally be considered a head entrapment.

Certain openings could present an entrapment hazard if the distance between any interior opposing surfaces is greater than 3.5 inches and less than 9 inches. These spaces should be tested as recommended in Appendix B. When one dimension of an opening is within this range, all dimensions of the opening should be considered together to evaluate the possibility of entrapment. Even openings that are low enough for children's feet to touch the ground can present a risk of strangulation for an entrapped child. (See Figure 4). Younger children may not have the necessary intellectual ability or motor skills to reverse the process that caused their heads to become trapped, especially if they become scared or panicked.

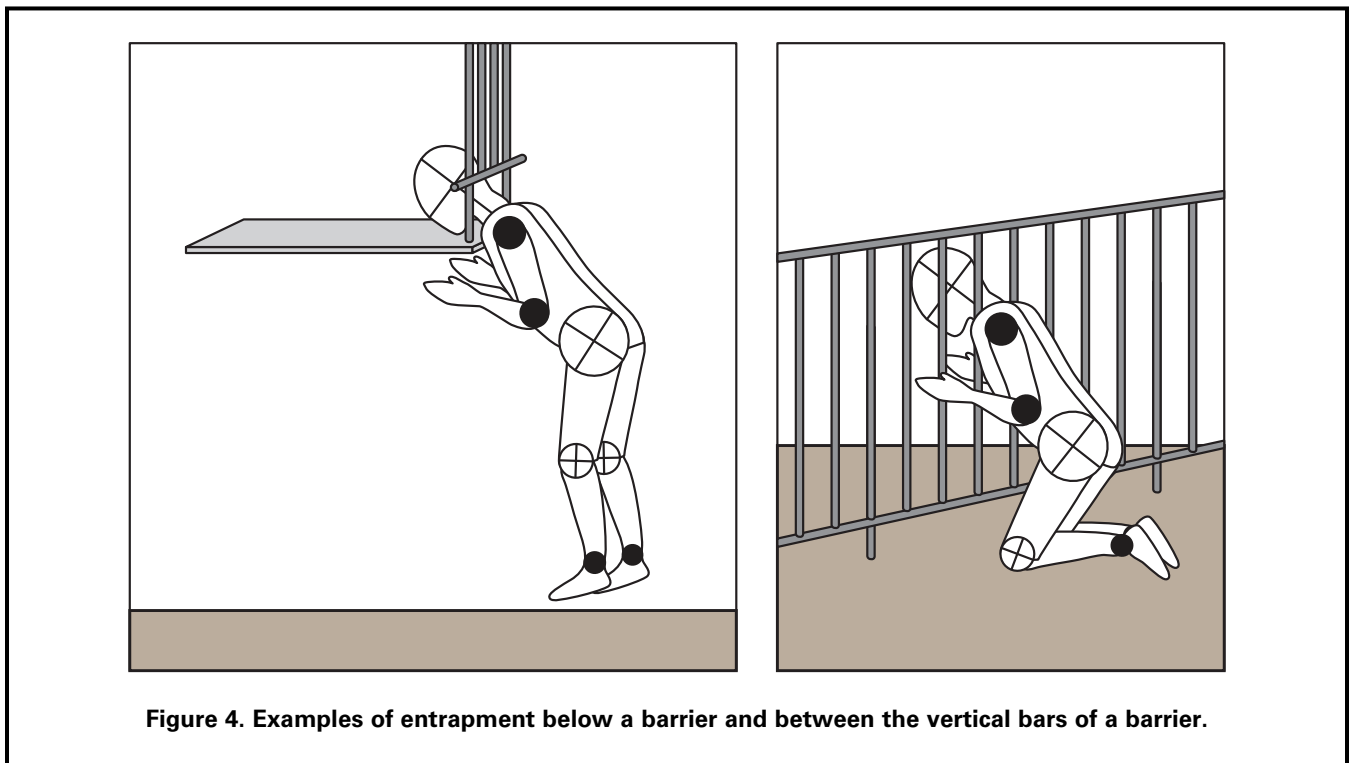

Figure 4. Examples of entrapment below a barrier and between the vertical bars of a barrier.

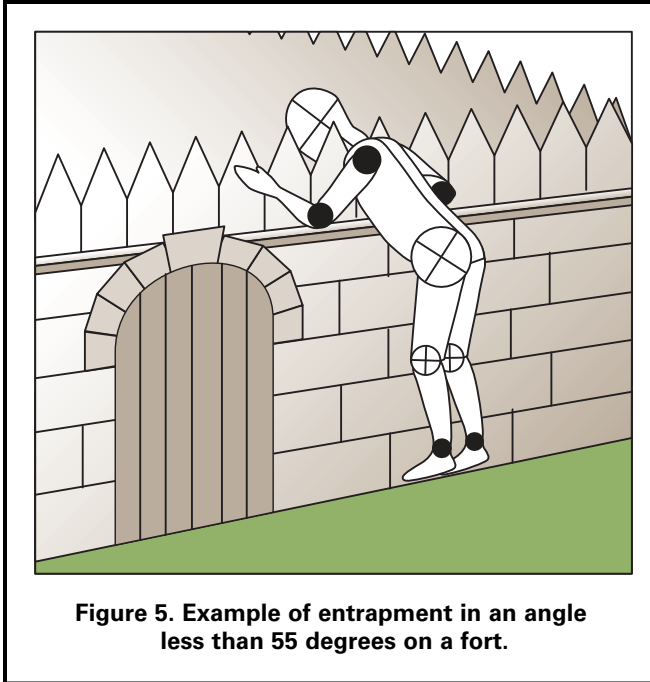

Figure 5. Example of entrapment in an angle less than 55 degrees on a fort.

3.3.2 Partially bound openings and angles

Children can become entrapped by partially bound openings, such as those formed by two or more playground parts.

- Angles formed by two accessible adjacent parts should be greater than 55 degrees unless the lowest leg is horizontal or below horizontal.
- Use the partially-bound opening test in Appendix B to identify hazardous angles and other partially-bound openings.

3.4 Sharp Points, Corners, and Edges

Sharp points, corners, or edges on any part of the playground or playground equipment may cut or puncture a child's skin. Sharp edges can cause serious lacerations if protective measures are not taken. To avoid the risk of injury from sharp points, corners and edges:

- Exposed open ends of all tubing not resting on the ground or otherwise covered should be covered by caps or plugs that cannot be removed without the use of tools.
- Wood parts should be smooth and free from splinters.
- All corners, metal and wood, should be rounded.
- All metal edges should be rolled or have rounded capping.

- There should be no sharp edges on slides. Pay special attention to metal edges of slides along the sides and at the exit (see also §5.3.6.4).
- If steel-belted radials are used as playground equipment, they should be closely examined regularly to ensure that there are no exposed steel belts/wires.
- Conduct frequent inspections to help prevent injuries caused by splintered wood, sharp points, corners, or edges that may develop as a result of wear and tear on the equipment.

3.5 Suspended Hazards

Children using a playground may be injured if they run into or trip over suspended components (such as cables, wires, ropes, or other flexible parts) connected from one piece of the playground equipment to another or hanging to the ground. These suspended components can become hazards when they are within 45 degrees of horizontal and are less than 7 feet above the protective surfacing. To avoid a suspended hazard, suspended components:

- Should be located away from high traffic areas.
- Should either be brightly colored or contrast with the surrounding equipment and surfacing.
- Should not be able to be looped back on themselves or other ropes, cables, or chains to create a circle with a 5 inch or greater perimeter.
- Should be fastened at both ends unless they are 7 inches or less long or attached to a swing seat.

These recommendations do not apply to swings, climbing nets, or if the suspended component is more than 7 feet above the protective surfacing and is a minimum of one inch at its widest cross-section dimension.

3.6 Tripping Hazards

Play areas should be free of tripping hazards (i.e., sudden change in elevations) to children who are using a playground. Two common causes of tripping are anchoring devices for playground equipment and containment walls for loose-fill surfacing materials.

- All anchoring devices for playground equipment, such as concrete footings or horizontal bars at the bottom of flexible climbers, should be installed below ground level

and beneath the base of the protective surfacing material. This will also prevent children from sustaining additional injuries from impact if they fall on exposed footings.

- Contrasting the color of the surfacing with the equipment color can contribute to better visibility.
- Surfacing containment walls should be highly visible.
- Any change of elevation should be obvious.
- Contrasting the color of the containment barrier with the surfacing color can contribute to better visibility.

3.7 Used Tires

Used automobile and truck tires are often recycled as playground equipment, such as tire swings or flexible climbers, or as a safety product such as cushioning under a seesaw or shredded as protective surfacing. When recycling tires for playground use:

- Steel-belted radials should be closely examined regularly to ensure that there are no exposed steel belts/wires.
- Care should be taken so that the tire does not collect water and debris; for example, providing drainage holes on the underside of the tire would reduce water collection.
- Recycled tire rubber mulch products should be inspected before installation to ensure that all metal has been removed.

In some situations, plastic materials can be used as an alternative to simulate actual automobile tires.

4. MAINTAINING A PLAYGROUND

Inadequate maintenance of equipment has resulted in injuries on playgrounds. Because the safety of playground equipment and its suitability for use depend on good inspection and maintenance, the manufacturer’s maintenance instructions and recommended inspection schedules should be strictly followed. If manufacturer’s recommendations are not available, a maintenance schedule should be developed based on actual or anticipated playground use. Frequently used playgrounds will require more frequent inspections and maintenance.

4.1 Maintenance Inspections

A comprehensive maintenance program should be developed for each playground. All playground areas and equipment should be inspected for excessive wear, deterioration, and any potential hazards, such as those shown in Table 3. One possible procedure is the use of checklists. Some manufacturers supply checklists for general or detailed inspections with their maintenance instructions. These can be used to ensure that inspections are in compliance with the manufacturer’s specifications. If manufacturer-provided inspection guidelines are not available, a general checklist that may be used as a guide for frequent routine inspections of public playgrounds is included at Appendix A. This is intended to address only general maintenance concerns. Detailed inspections should give special attention to moving parts and other parts that can be expected to wear. Maintenance inspections should be carried out in a systematic manner by personnel familiar with the playground, such as maintenance workers, playground supervisors, etc.

4.2 Repairs

Inspections alone do not constitute a comprehensive maintenance program. Any problems found during the inspection should be noted and fixed as soon as possible.

- All repairs and replacements of equipment parts should be completed following the manufacturer’s instructions.
- User modifications, such as loose-ended ropes tied to elevated parts, should be removed immediately.
- For each piece of equipment, the frequency of thorough

Table 3. Routine inspection and maintenance issues

- | | |
|--------------------------|--|
| <input type="checkbox"/> | Broken equipment such as loose bolts, missing end caps, cracks, etc. |
| <input type="checkbox"/> | Broken glass & other trash |
| <input type="checkbox"/> | Cracks in plastics |
| <input type="checkbox"/> | Loose anchoring |
| <input type="checkbox"/> | Hazardous or dangerous debris |
| <input type="checkbox"/> | Insect damage |
| <input type="checkbox"/> | Problems with surfacing |
| <input type="checkbox"/> | Displaced loose-fill surfacing (see Section 4.3) |
| <input type="checkbox"/> | Holes, flakes, and/or buckling of unitary surfacing |
| <input type="checkbox"/> | User modifications (such as ropes tied to parts or equipment rearranged) |
| <input type="checkbox"/> | Vandalism |
| <input type="checkbox"/> | Worn, loose, damaged, or missing parts |
| <input type="checkbox"/> | Wood splitting |
| <input type="checkbox"/> | Rusted or corroded metals |
| <input type="checkbox"/> | Rot |

inspections will depend on the type and age of equipment, the amount of use, and the local climate.

- Consult the manufacturer for maintenance schedules for each piece of equipment. Based on these schedules, a maintenance schedule for the entire playground can be created. This routine maintenance schedule should not replace regular inspections.

4.3 Maintaining Loose-Fill Surfacing

Loose-fill surfacing materials require special maintenance. High-use public playgrounds, such as child care centers and schools, should be checked frequently to ensure surfacing has not displaced significantly, particularly in areas of the playground most subject to displacement (e.g., under swings and slide exits). This can be facilitated by marking ideal surfacing depths on equipment posts. Displaced loose-fill

surfacing should be raked back into proper place so that a constant depth is maintained throughout the playground. Impact attenuating mats placed in high traffic areas, such as under swings and at slide exits, can significantly reduce displacement. They should be installed below or level with surfacing so as not to be a tripping hazard.

The following are key points to look for during regular checks of surfacing:

- Areas under swings and at slide exits. Activity in these areas tends to displace surfacing quickly. Rake loose-fill back into place.
- Pooling water on mulch surfacing. For example, wet mulch compacts faster than dry, fluffy mulch. If puddles are noticed regularly, consider addressing larger drainage issues.
- Frozen surfacing. Most loose-fill surfacing that freezes

solid no longer functions as protective surfacing. Even if the first few inches may be loose, the base layer may be frozen and the impact attenuation of the surfacing may be significantly reduced. It is recommended that children not play on the equipment under these conditions.

4.4 Recordkeeping

Records of all maintenance inspections and repairs should be retained, including the manufacturer's maintenance instructions and any checklists used. When any inspection is performed, the person performing it should sign and date the form used. A record of any accident and injury reported to have occurred on the playground should also be retained. This will help identify potential hazards or dangerous design features that should be corrected.

5. PARTS OF THE PLAYGROUND

5.1 Platforms, Guardrails and Protective Barriers

5.1.1 Platforms

- Platforms should be generally flat (i.e., within $\pm 2^\circ$ of horizontal).
- Openings in platforms should be provided to allow for drainage.
- Platforms should minimize the collection of debris.
- Platforms intended for toddlers should be no more than 32 inches from the ground.

5.1.2 Stepped platforms

On some composite structures, platforms are layered or tiered so that a child may access the higher platform without steps or ladders. Unless there is an alternate means of access/egress, the maximum difference in height between stepped platforms should be:

- Toddlers: 7 inches.
- Preschool-age: 12 inches.
- School-age: 18 inches.

An access component (such as a rung) is needed if the difference in height is more than 12 inches for preschool-age and 18 inches for school-age children.

The space between the stepped platforms should follow the recommendations to minimize entrapment hazards in enclosed openings:

- Toddlers: if the space is less than 7 inches, infill should be used to reduce the space to less than 3.0 inches.
- Preschool-age: if the space exceeds 9 inches and the height of the lower platform above the protective surfacing exceeds 30 inches, infill should be used to reduce the space to less than 3.5 inches.
- School-age: if the space exceeds 9 inches and the height of the lower platform above the protective surfacing exceeds 48 inches, infill should be used to reduce the space to less than 3.5 inches.

5.1.2.1 Fall height

- The fall height of a platform is the distance between the top of the platform and the protective surfacing beneath it.

5.1.3 Guardrails and protective barriers

Guardrails and protective barriers are used to minimize the likelihood of accidental falls from elevated platforms. Protective barriers provide greater protection than guardrails and should be designed to discourage children from climbing over or through the barrier. Guardrails and barriers should:

- Completely surround any elevated platform.
- Except for entrance and exit openings, the maximum clearance opening without a top horizontal guardrail should be 15 inches.
- Prevent unintentional falls from the platform.
- Prevent the possibility of entrapment.
- Facilitate supervision.

For example:

- Guardrails may have a horizontal top rail with infill consisting of vertical bars having openings that are greater than 9 inches. These openings do not present an entrapment hazard but do not prevent a child from climbing through the openings.
- A barrier should minimize the likelihood of passage of a child during deliberate attempts to defeat the barrier. Any openings between uprights or between the platform surface and lower edge of a protective barrier should prevent passage of the small torso template (see test in B.2.5).

Guardrails or protective barriers should be provided on elevated platforms, walkways, landings, stairways, and transitional surfaces. In general, the younger the child, the less coordination and balance they have, therefore the more vulnerable they are to unintentional falls. Toddlers are the most vulnerable, and equipment intended for this age should use barriers on all elevated walking surfaces above 18 inches. Physical skills develop further in preschool-age children and then more with school-age children; therefore, minimum elevation recommendations for guardrails and barriers increase with each age group.

Guardrails and barriers should be high enough to prevent the tallest children from falling over the top. For guardrails, the lower edge should be low enough so that the smallest children cannot walk under it. Barriers should be low enough to prevent the smallest child from getting under the barrier in any way. This is generally done by designing the barrier so that the small torso probe (see test methods in Appendix B) cannot pass under or through the barrier. Vertical infill for protective barriers may be preferable for younger children because the vertical components can be grasped at whatever height a child chooses as a handhold.

Guardrail and barrier recommendations are shown in Table 4. However, the recommendations do not apply if the guardrail or barrier would interfere with the intended use of the equipment, such as:

- Climbing equipment
- Platforms layered so that the fall height is:
 - Toddlers: 7 inches or less.
 - Preschool-age: 20 inches or less.
 - School-age: 30 inches or less.

Table 4. Guardrails and Barriers

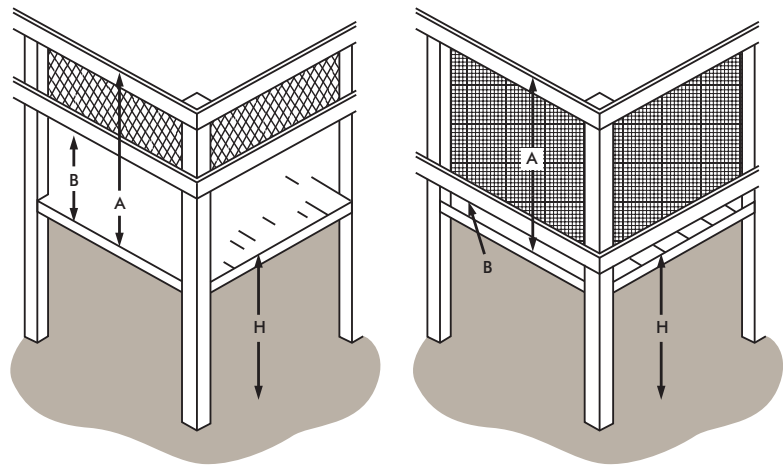

	Guardrail	Barrier
Protects against accidental falls from platform	Yes	Yes
Discourages climbing over	No	Yes
Protects against climbing through	No	Yes
Toddlers		
A Top edge distance from platform	Not recommended	A = 24" or higher
B Bottom edge distance from platform	Not recommended	B < 3"
H Recommended when platform fall height is:	Not recommended	H = 18" or higher
Preschool-age		
A Top edge distance from platform	A = 29" or higher	A = 29" or higher
B Bottom edge distance from platform	9" < B ≤ 23"	B < 3.5"
H Recommended when platform fall height is:	20" < H ≤ 30"	H > 30"
School-age		
A Top edge distance from platform	A = 38" or higher	A = 38" or higher
B Bottom edge distance from platform	9" < B ≤ 28"	B < 3.5"
H Recommended when platform fall height is:	30" < H ≤ 48"	H > 48"

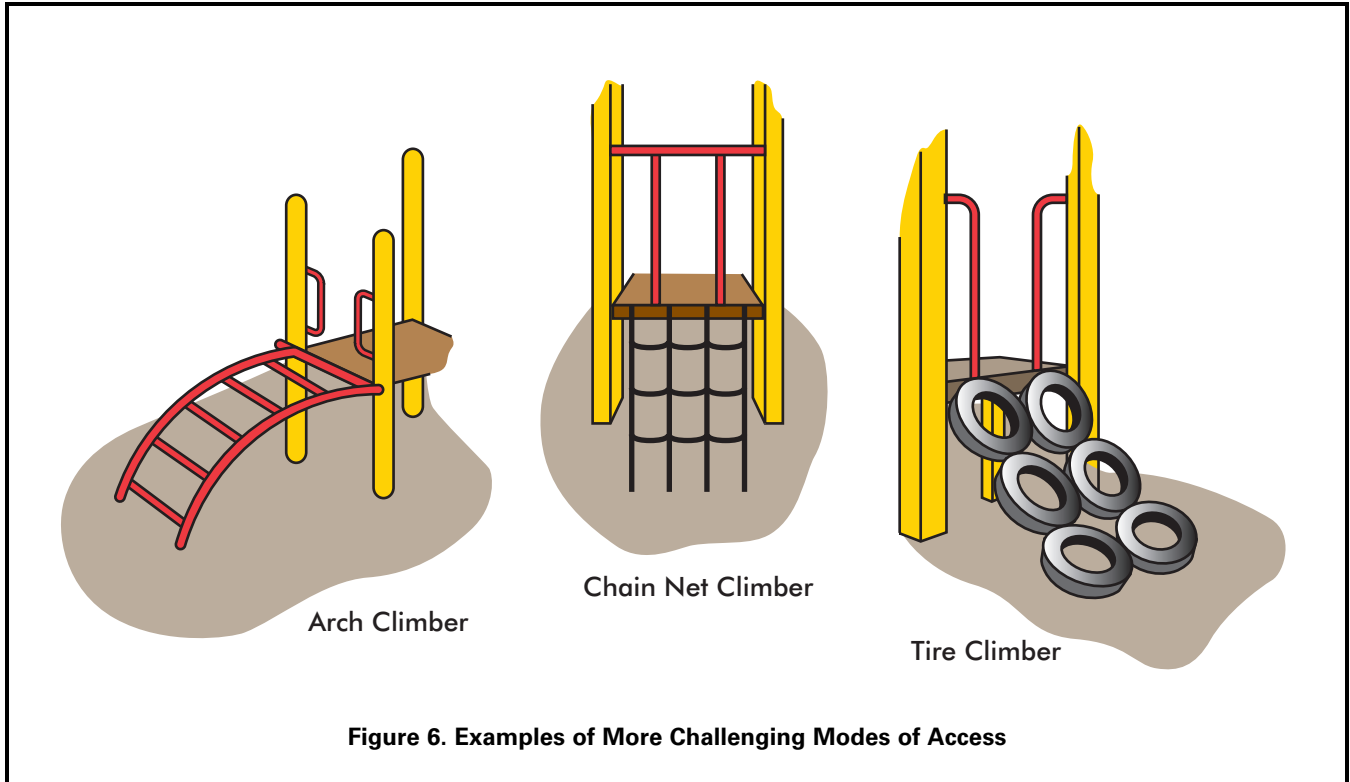

Figure 6. Examples of More Challenging Modes of Access

5.2 Access Methods to Play Equipment

Access to playground equipment can take many forms, such as conventional ramps, stairways with steps, and ladders with steps or rungs. Access may also be by means of climbing components, such as arch climbers, climbing nets, and tire climbers (see Figure 6).

As children develop, they gain better balance and coordination, so it is important to pick appropriate access methods based on the age group. Table 5 shows the most common methods of access and the youngest appropriate age group.

Access to platforms over 6 feet high (except for free-standing slides) should provide an intermediate standing surface so that the child can pause and make a decision to keep going up or find another way down. Children generally master access before egress, that is, they can go up before they can get back down a difficult component. Therefore, if there are more difficult access methods, it is important to have easier components for egress.

Table 5. Methods of access and egress

Method of Access	Challenge Level	Appropriate for
Ramps	Easiest	Toddlers +
Straight stairways	Easy	Toddlers +
Spiral stairways	Moderate	Toddlers* +
Step ladders	Moderate	15 months* +
Rung ladders	Moderate	Preschool* +
Arch climbers	Difficult	Preschool* +
Flexible climbers (nets, tires)	Difficult	Preschool* +
* only if an easy egress method is also provided		

5.2.1 Ramps, stairways, rung ladders, and step ladders

Ramps, stairways, rung ladders, and step ladders each have different recommendations for slope and tread dimension, but the steps or rungs always should be evenly spaced - even the spacing between the top step or rung and the surface of the platform. Table 6 contains recommended dimensions for: access slope; tread or rung width; tread depth; rung diameter; and vertical rise for rung ladders, step ladders, and stairways. Table 6 also contains slope and width recommendations for ramps. However, these recommendations are not intended to address ramps designed for access by wheelchairs.

- Openings between steps or rungs and between the top step or rung and underside of a platform should prevent entrapment.

- When risers are closed, treads on stairways and ladders should prevent the accumulation of sand, water, or other materials on or between steps.
- Climbing equipment should allow children to descend as easily as they ascend. One way of implementing this recommendation is to provide an easier, alternate means of descent, such as another mode of egress, a platform, or another piece of equipment. For example, a stairway can be added to provide a less challenging mode of descent than a vertical rung ladder or flexible climbing device (see Table 5).
- For toddlers and preschool-age children, offering an easy way out is particularly important since their ability to descend climbing components develops later than their ability to climb up the same components.

Table 6. Recommended dimensions for access ladders, stairs, and ramps*			
AGE OF INTENDED USER			
Type of Access	Toddler	Preschool-age	School-age
<i>Ramps (not intended to meet ADA/ABA specifications)</i>			
Slope (vertical:horizontal)	< 1:8	≤ 1:8	≤ 1:8
Width (single)	≥ 19"	≥ 12"	≥ 16"
Width (double)	≥ 30"	≥ 30"	≥ 36"
<i>Stairways</i>			
Slope	≤ 35°	< 50°	< 50°
Tread width (single)	12-21"	≥ 12"	≥ 16"
Tread width (double)	≥ 30"	≥ 30"	≥ 36"
Tread depth (open riser)	Not appropriate	≥ 7"	≥ 8"
Tread depth (closed riser)	≥ 8"	≥ 7"	≥ 8"
Vertical rise	≤ 7"	≤ 9"	≤ 12"
<i>Step ladders</i>			
Slope	35≤65°	50-75°	50-75°
Tread width (single)	12-21"	12-21"	≥ 16"
Tread width (double)	Not appropriate	Not appropriate	≥ 36"
Tread depth (open riser)	Not appropriate	≥ 7"	≥ 3"
Tread depth (closed riser)	8"	≥ 7"	≥ 6"
Vertical rise	> 5" and ≤ 7"	≤ 9"	≤ 12"
<i>Rung ladders</i>			
Slope	Not appropriate	75-90°	75-90°
Rung width	Not appropriate	≥ 12"	≥ 16"
Vertical rise	Not appropriate	≤ 12"	≤ 12"
Rung diameter	Not appropriate	0.95-1.55"	0.95-1.55"
* entrapment recommendations apply to all openings in access components			

5.2.2 Rungs and other hand gripping components

Unlike steps of stairways and step ladders that are primarily for foot support, rungs can be used for both foot and hand support.

- Rungs with round shapes are easiest for children to grip.
- All hand grips should be secured in a manner that prevents them from turning.
- Toddlers:
 - Handrails or other means of hand support should have a diameter or maximum cross-section between 0.60 and 1.20 inches.
 - A diameter or maximum cross-section of 0.90 inches is preferred to achieve maximal grip strength and benefit the weakest children.
- Preschool- and school-age:
 - Rungs, handrails, climbing bars, or other means of hand support intended for holding should have a diameter or maximum cross-section between 0.95 and 1.55 inches.
 - A diameter or maximum cross-section of 1.25 inches is preferred to achieve maximal grip strength and benefit the weakest children.

5.2.3 Handrails

Handrails on stairways and step ladders are intended to provide hand support and to steady the user. Continuous handrails extending over the full length of the access should be provided on both sides of all stairways and step ladders, regardless of the height of the access. Rung ladders do not require handrails since rungs or side supports provide hand support on these more steeply inclined accesses.

5.2.3.1 Handrail height

Handrails should be available for use at the appropriate height, beginning with the first step. The vertical distance between the top front edge of a step or ramp surface and the top surface of the handrail above it should be as follows:

- Toddlers: between 15 and 20 inches.
- Preschool-age: between 22 and 26 inches.
- School-age: between 22 and 38 inches.

5.2.4 Transition from access to platform

Handrails or handholds are recommended at all transition points (the point where the child must move from the access component to the play structure platform).

- The handhold should provide support from the access component until the child has fully achieved the desired posture on the platform.
- Any opening between a handrail and an adjacent vertical structure (e.g., vertical support post for a platform or vertical slat of a protective barrier) should not pose an entrapment hazard.
- Access methods that do not have handrails, such as rung ladders, flexible climbers, arch climbers, and tire climbers, should provide hand supports for the transition between the top of the access and the platform.

5.3 Major Types of Playground Equipment

5.3.1 Balance beams

- Balance beams should be no higher than:
 - Toddlers: not recommended.
 - Preschool-age: 12 inches.
 - School-age: 16 inches.

5.3.1.1 Fall height

The fall height of a balance beam is the distance between the top of the walking surface and the protective surfacing beneath it.

5.3.2 Climbing and upper body equipment

Climbing equipment is generally designed to present a greater degree of physical challenge than other equipment on public playgrounds. This type of equipment requires the use of the hands to navigate up or across the equipment. “Climbers” refers to a wide variety of equipment, such as but not limited to:

- Arch climbers
- Dome climbers
- Flexible climbers (usually chain or net)
- Parallel bars
- Sliding poles



Simple Arch Climber



Geodesic Dome Climber



Overhead Horizontal Ladder



Overhead Loop Ladder

Figure 7. Examples of climbers

- Spiral climbers
- Upper body equipment (horizontal overhead ladders, overhead rings, track ride).

School-age children tend to use climbing and upper body equipment more frequently and more proficiently than preschool children. Young preschool children may have difficulty using some climbers because they have not yet developed some of the physical skills necessary for certain climbing activities (balance, coordination, and upper body strength). Older preschool children (i.e., 4- and 5-year-olds) are beginning to use flexible climbers, arch climbers, and upper body devices.

5.3.2.1 Design considerations

5.3.2.1.1 Layout of climbing components

When climbing components are part of a composite structure, their level of challenge and method of use should be compatible with the traffic flow from nearby components. Upper body devices should be placed so that the swinging movement generated by children on this equipment cannot interfere with the movement of children on adjacent structures, particularly children descending on slides. The design of adjacent play structures should not facilitate climbing to the top support bars of upper body equipment.

5.3.2.1.2 Fall Height

Climbers:

- Unless otherwise specified in this section, the fall height for climbers is the distance between the highest part of the climbing component and the protective surfacing beneath it.
- If the climber is part of a composite structure, the fall height is the distance between the highest part of the climber intended for foot support and the protective surfacing beneath it.
 - Toddlers: The maximum fall height for free standing and composite climbing structures should be 32 inches.

Upper Body Equipment:

- The fall height of upper body equipment is the distance between the highest part of the equipment and the protective surface below.

5.3.2.1.3 Climbing rungs

Some of the access methods discussed in §5.2 are also considered climbing devices; therefore, the recommendations for the size of climbing rungs are similar.

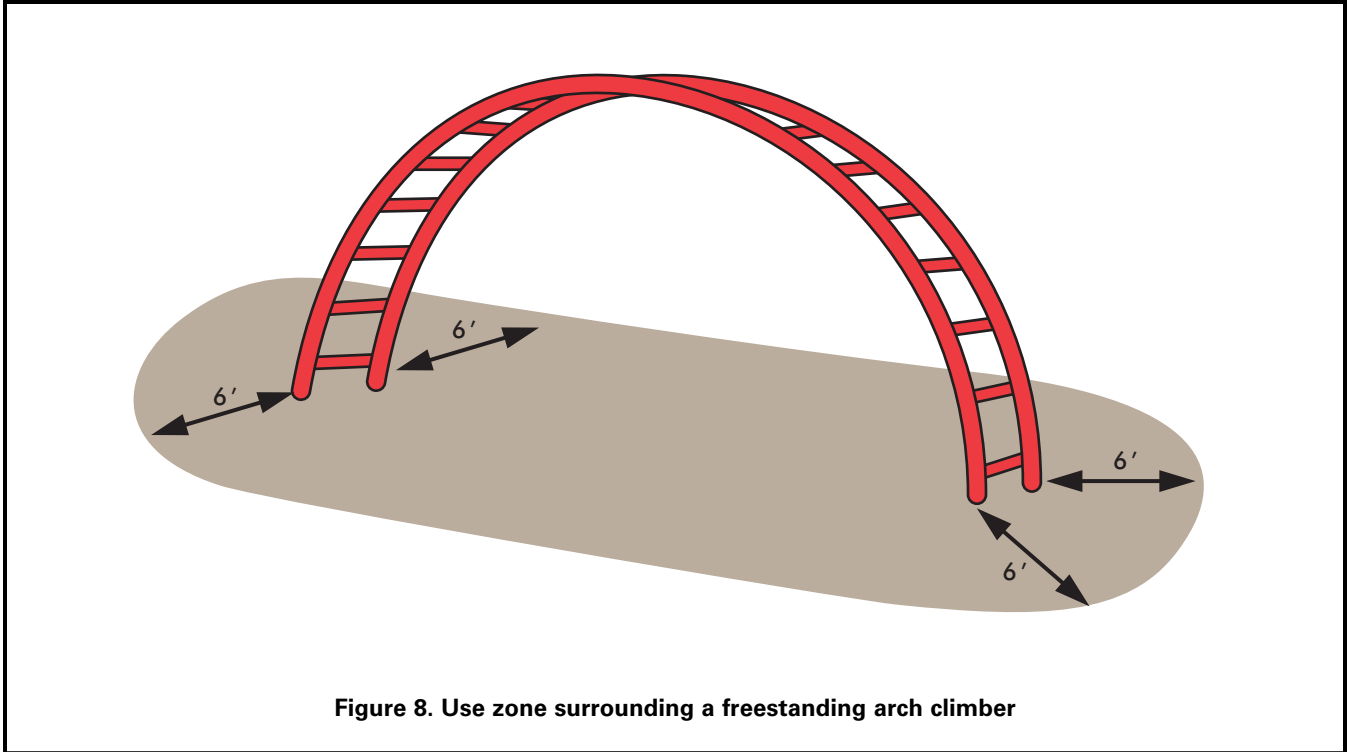

- Rungs should be generally round.
- All rungs should be secured in a manner that prevents them from turning.
- Climbing rungs should follow the same diameter recommendations as in §5.2.2.

5.3.2.1.4 Use zone

- The use zone should extend a minimum of 6 feet in all directions from the perimeter of the stand alone climber. See Figure 8.
- The use zone of a climber may overlap with neighboring equipment if the other piece of equipment allows overlapping use zones and
 - There is at least 6 feet between equipment when adjacent designated play surfaces are no more than 30 inches high; or
 - There is at least 9 feet between equipment when adjacent designated play surfaces are more than 30 inches high.

5.3.2.1.5 Other considerations

- Climbers should not have climbing bars or other rigid structural components in the interior of the climber onto

which a child may fall from a height of greater than 18 inches. See Figure 9 for an example of a climber that **DOES NOT** follow this consideration.

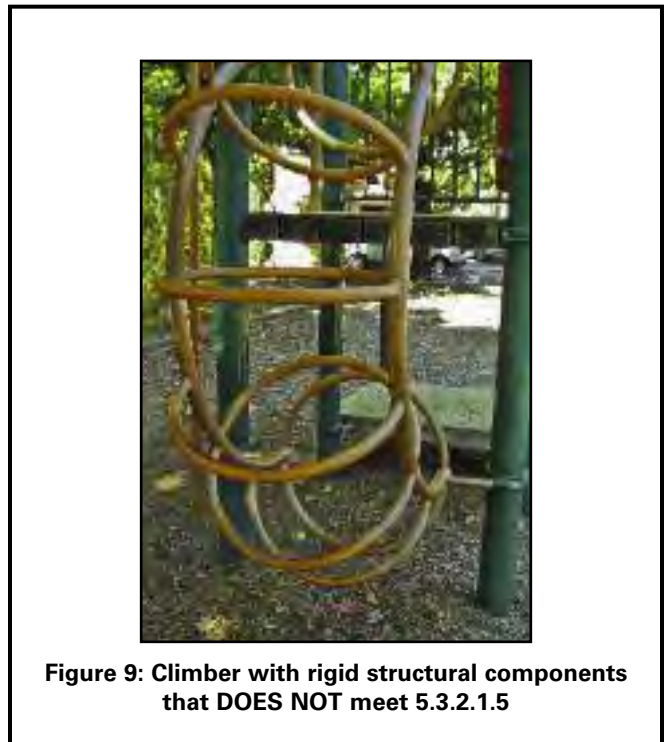

5.3.2.2 Arch climbers

Arch climbers consist of rungs attached to convex side supports. They may be free standing (Figure 10) or be provided as a more challenging means of access to other equipment (Figure 11).

- Arch climbers should not be used as the sole means of access to other equipment for preschoolers.
- Free standing arch climbers are not recommended for toddlers or preschool-age children.
- The rung diameter and spacing of rungs on arch climbers should follow the recommendations for rung ladders in Table 6.

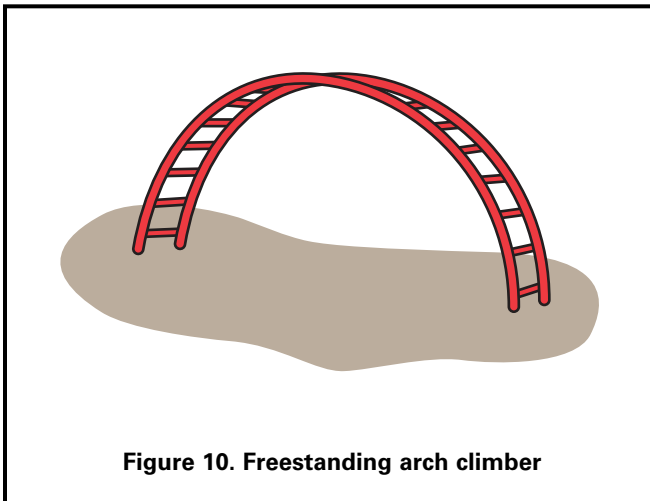

Figure 10. Freestanding arch climber

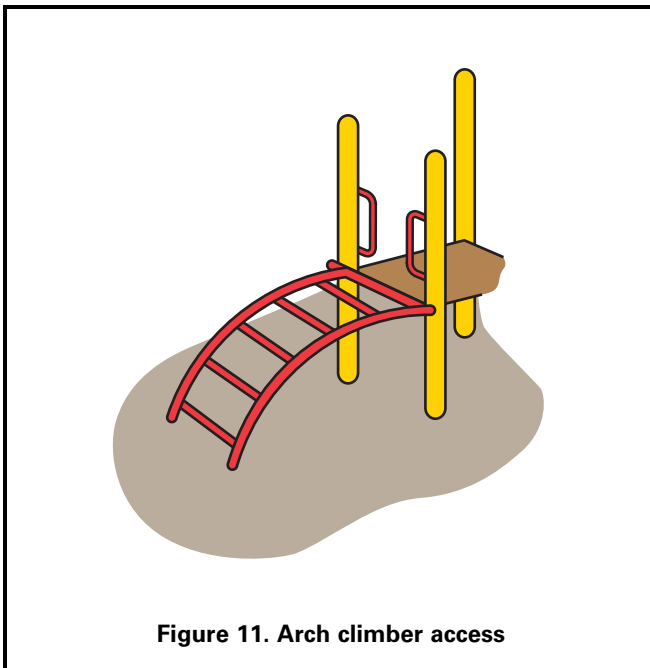

Figure 11. Arch climber access

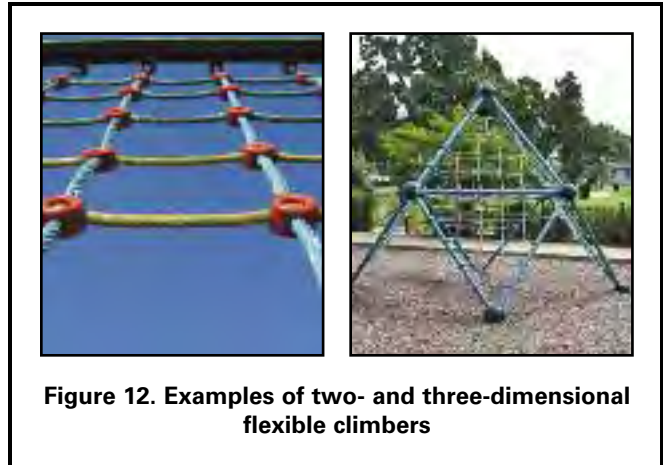

Figure 12. Examples of two- and three-dimensional flexible climbers

5.3.2.3 Flexible climbers

Flexible climbers use a grid of ropes, chains, cables, or tires for climbing. Since the flexible parts do not provide a steady means of support, flexible climbers require more advanced balance abilities than rigid climbers.

Rope, chain, and cable generally form a net-like structure that may be either two or three dimensional. See Figure 12. Tire climbers may have the tires secured tread-to-tread to form a sloping grid, or the tires may be suspended individually by chains or other means.

- Flexible climbers that provide access to platforms should be securely anchored at both ends.
- When connected to the ground, the anchoring devices should be installed below ground level and beneath the base of the protective surfacing material.
- Connections between ropes, cables, chains, or between tires should be securely fixed.
- Flexible climbers are not recommended as the sole means of access to equipment intended for toddlers and preschool-age children.
- Free-standing flexible climbers are not recommended on playgrounds intended for toddlers and preschool children.
- Spacing between the horizontal and vertical components of a climbing grid should not form entrapment hazards.
- The perimeter of any opening in a net structure should be less than 17 inches or greater than 28 inches (see Figure 13).

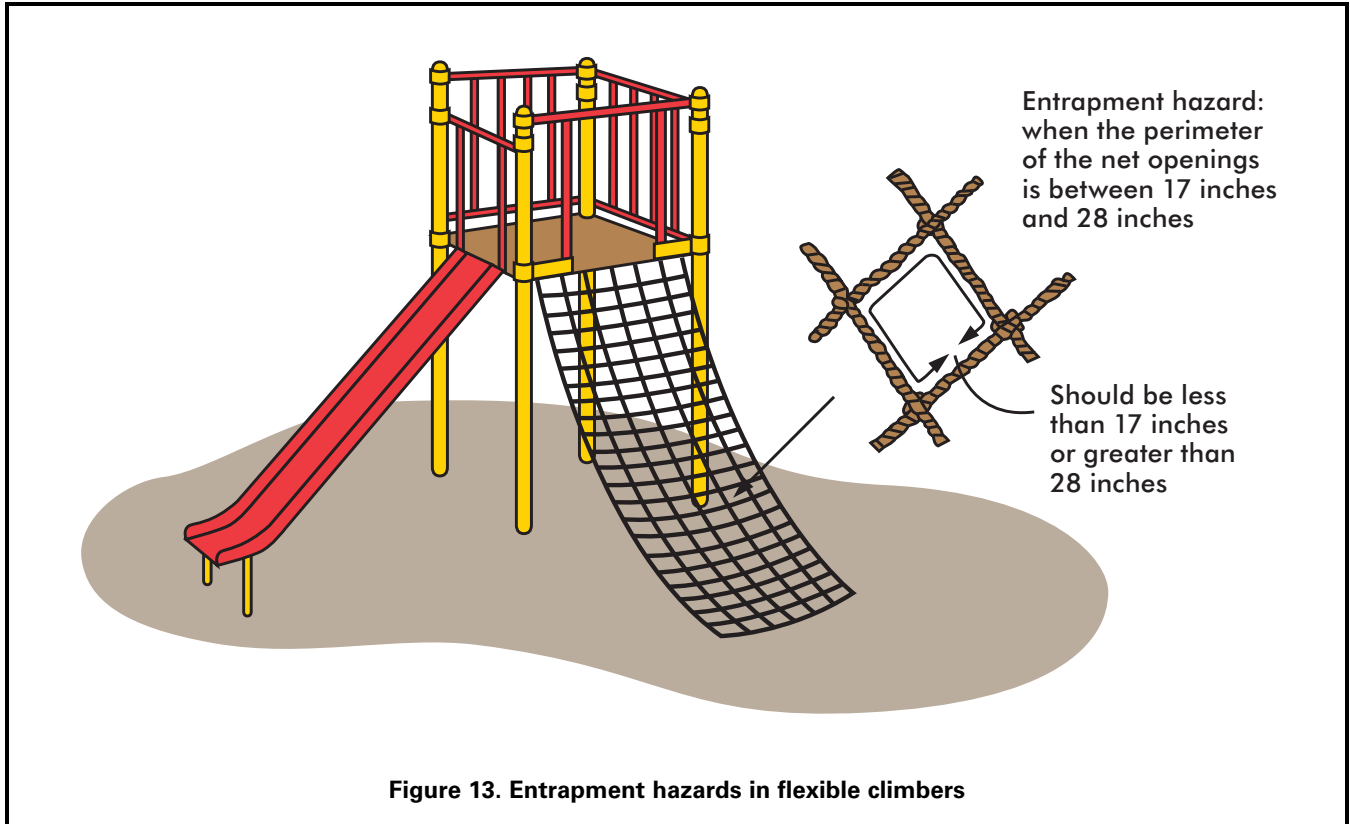

Figure 13. Entrapment hazards in flexible climbers

5.3.2.4 Horizontal (overhead) ladders

Horizontal (overhead) ladders are a type of climber designed to build upper body strength. They are designed to allow children to move across the ladder from end to end using only their hands.

Four-year-olds are generally the youngest children able to use upper body devices like these; therefore, horizontal ladders should not be used on playgrounds intended for toddlers and 3-year-olds. The recommendations below are designed to accommodate children ages 4 through 12 years.

- The first handhold on either end of upper body equipment should not be placed directly above the platform or climbing rung used for mount or dismount. This minimizes the risk of children impacting rigid access structures if they fall from the first handhold during mount or dismount.
- The horizontal distance out to the first handhold should be:
 - No greater than 10 inches but not directly above the platform when access is from a platform.
 - At least 8 inches but no greater than 10 inches when access is from climbing rungs.
- The space between adjacent rungs of overhead ladders should be greater than 9 inches to prevent entrapment.
- Horizontal ladders intended for preschool-age children should have rungs that are parallel to one another and evenly spaced.
- The maximum height of a horizontal ladder (i.e., measured from the center of the grasping device to the top of the protective surfacing below) should be:
 - Preschool-age (4 and 5 years): no more than 60 inches.
 - School-age: no more than 84 inches.
- The center-to-center spacing of horizontal ladder rungs should be as follows:
 - Preschool-age (4 and 5 years): no more than 12 inches.
 - School-age: no more than 15 inches.
- The maximum height of the take-off/landing platform above the protective surfacing should be:
 - Preschool-age (4 and 5 years): no more than 18 inches.
 - School-age: no more than 36 inches.

5.3.2.5 Overhead rings

Overhead rings are similar to horizontal ladders in terms of the complexity of use. Therefore, overhead rings should not be used on playgrounds intended for toddlers and 3-year-olds. The recommendations below are designed to accommodate children 4 through 12 years of age.

Overhead rings differ from horizontal ladders because, during use, the gripped ring swings through an arc and reduces the distance to the gripping surface of the next ring; therefore, the spacing distance recommendations for horizontal ladders do not apply.

- The first handhold on either end of upper body equipment should not be placed directly above the platform or climbing rung used for mount or dismount. This minimizes the risk of children hitting rigid access structures if they fall from the first handhold during mount or dismount.
- The horizontal distance out to the first handhold should be:
 - No greater than 10 inches but not directly above the platform when access is from a platform.
 - At least 8 inches but no greater than 10 inches when access is from climbing rungs.
- The maximum height of overhead rings measured from the center of the grasping device to the protective surfacing should be:
 - Preschool-age (4 and 5 years): 60 inches.
 - School-age: 84 inches.
- If overhead swinging rings are suspended by chains, the maximum length of the chains should be 7 inches.
- The maximum height of the take-off/landing platform above the protective surfacing should be:
 - Preschool-age (4 and 5 years): no more than 18 inches.
 - School-age: no more than 36 inches.

5.3.2.6 Sliding poles

Vertical sliding poles are more challenging than some other types of climbing equipment. They require upper body strength and coordination to successfully slide down the pole. Unlike other egress methods, there is no reverse or stop, so a child cannot change his or her mind. Children who start a sliding pole must have the strength to slide the whole way or they will fall.

- Sliding poles are not recommended for toddlers or preschool-age children since they generally don't have the upper body and/or hand strength to slide.

- Sliding poles should be continuous with no protruding welds or seams along the sliding surface.
- The pole should not change direction along the sliding portion.
- The horizontal distance between a sliding pole and any structure used for access to the sliding pole should be between 18 inches and 20 inches.
- The pole should extend at least 60 inches above the level of the platform or structure used for access to the sliding pole.
- The diameter of sliding poles should be no greater than 1.9 inches.
- Sliding poles and their access structures should be located so that traffic from other events will not interfere with the users during descent.
- Upper access should be on one level only.
- The upper access area through the guardrail or barrier should be 15 inches wide at most.

5.3.2.6.1 Fall height

- For sliding poles accessed from platforms, the fall height is the distance between the platform and the protective surfacing beneath it.
- For sliding poles not accessed from platforms, the fall height is the distance between a point 60 inches below the highest point of the pole and the protective surfacing beneath it.
- The top of the sliding pole's support structure should not be a designated play surface.

5.3.2.7 Track rides

Track rides are a form of upper body equipment where the child holds on to a handle or other device that slides along a track above his or her head. The child then lifts his or her feet and is carried along the length of the track. Track rides require significant upper body strength and the judgment to know when it is safe to let go. These are skills not developed until children are at least school-age; therefore, CPSC staff recommends:

- Track rides should not be used on playgrounds for toddlers and preschool-age children.
- Track rides should not have any obstacles along the path of the ride, including anything that would interfere in the take-off or landing areas.

- Two track rides next to each other should be at least 4 feet apart.
- The handle should be between 64 inches and 78 inches from the surfacing and follow the gripping recommendations in §5.2.2.
- Nothing should ever be tied or attached to any moving part of a track ride.
- Rolling parts should be enclosed to prevent crush hazards.

5.3.2.7.1 Fall height

- The fall height of track ride equipment is the distance between the maximum height of the equipment and the protective surface beneath it.
- Equipment support posts with no designated play surfaces are exempt from this requirement.

5.3.3 Log rolls

Log rolls help older children master balance skills and increase strength. Children must balance on top of the log as they spin it with their feet. See Figure 14.

- Log rolls are not recommended for toddlers and preschool-age children. These children generally do not possess the balance, coordination, and strength to use a log roll safely.
- Log rolls should have handholds to assist with balance.
- The handholds should follow the guidelines in §5.2.2.
- The highest point of the rolling log should be a maximum of 18 inches above the protective surface below.
- When not part of a composite structure, the use zone may overlap with neighboring equipment if the other piece of equipment allows overlapping use zones (see §5.3.9) and
 - There is at least 6 feet between equipment when adjacent designated play surfaces are no more than 30 inches high; or
 - There is at least 9 feet between equipment when adjacent designated play surfaces are more than 30 inches high.

5.3.3.1.1 Fall height

The fall height of a log roll is the distance between the highest portion of the rolling log and the protective surfacing beneath it.



Figure 14. Log roll

5.3.4 Merry-go-rounds

Merry-go-rounds are the most common rotating equipment found on public playgrounds. Children usually sit or stand on the platform while other children or adults push the merry-go-round to make it rotate. In addition, children often get on and off the merry-go-round while it is in motion. Merry-go-rounds may present a physical hazard to preschool-age children who have little or no control over such products once they are in motion. Therefore, children in this age group should always be supervised when using merry-go-rounds.

The following recommendations apply when the merry-go-round is at least 20 inches in diameter.

- Merry-go-rounds should not be used on playgrounds intended for toddlers.
- The standing/sitting surface of the platform should have a maximum height of:
 - Preschool: 14 inches above the protective surface.
 - School-age: 18 inches above the protective surface.
- The rotating platform should be continuous and approximately circular.
- The surface of the platform should not have any openings between the axis and the periphery that permit a rod having a diameter of 5/16 inch to penetrate completely through the surface.

- The difference between the minimum and maximum radii of a non-circular platform should not exceed 2.0 inches (Figure 15).

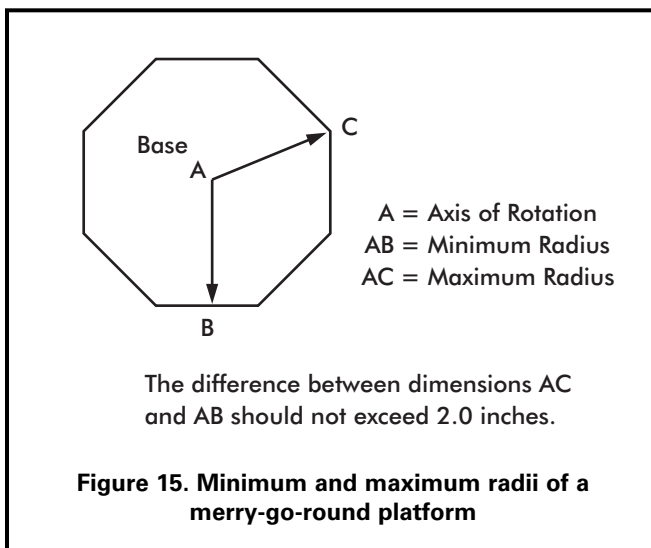

- The underside of the perimeter of the platform should be no less than 9 inches above the level of the protective surfacing beneath it.
- There should not be any accessible shearing or crushing mechanisms in the undercarriage of the equipment.
- Children should be provided with a secure means of holding on. Where handgrips are provided, they should conform to the general recommendations for hand gripping components in §5.2.2.
- No components of the apparatus, including handgrips, should extend beyond the perimeter of the platform.
- The rotating platform of a merry-go-round should not have any sharp edges.
- A means should be provided to limit the peripheral speed of rotation to a maximum of 13 ft/sec.
- Merry-go-round platforms should not have any up and down (oscillatory) motion.

5.3.4.1 Use zone

- The use zone should extend a minimum of 6 feet beyond the perimeter of the platform.
- The use zone may not overlap other use zones, unless the rotating equipment is less than 20 inches in diameter and the adjacent equipment allows overlap.

5.3.4.2 Fall height

The fall height for a merry-go-round is the distance between the perimeter of the platform where a child could sit or stand and the protective surfacing beneath it.

5.3.5 Seesaws

5.3.5.1 Fulcrum seesaws

The typical seesaw (also known as a “teeter totter”) consists of a board or pole with a seat at each end supported at the center by a fulcrum. See Figure 16. Because of the complex way children are required to cooperate and combine their actions, fulcrum seesaws are not recommended for toddlers or preschool-age children.

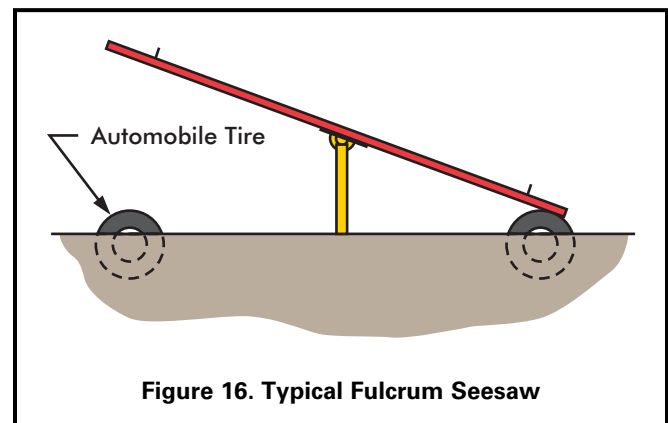

- The fulcrum should not present a crush hazard.
- Partial car tires, or some other shock-absorbing material, should be embedded in the ground underneath the seats, or secured on the underside of the seats. This will help prevent limbs from being crushed between the seat and the ground, as well as cushion the impact.
- The maximum attainable angle between a line connecting the seats and the horizontal is 25°.
- There should not be any footrests.

5.3.5.2 Spring-centered seesaws

Preschool-age children are capable of using spring-centered seesaws because the centering device prevents abrupt contact with the ground if one child dismounts suddenly. Spring-centered seesaws also have the advantage of not requiring two children to coordinate their actions in order to play safely. Spring-centered seesaws should follow the recommendations for spring rockers including the use of footrests (§5.3.7).

5.3.5.3 Use zone for fulcrum and spring-centered seesaws

- The use zone should extend a minimum of 6 feet from each outside edge of the seesaw.
- The use zone may overlap with neighboring equipment if the other piece of equipment allows overlapping use zones and
 - There is at least 6 feet between equipment when adjacent designated play surfaces are no more than 30 inches high; or
 - There is at least 9 feet between equipment when adjacent designated play surfaces are more than 30 inches high.

5.3.5.4 Handholds

- Handholds should be provided at each seating position for gripping with both hands and should not turn when grasped.
- Handholds should not protrude beyond the sides of the seat.

5.3.5.5 Fall height

The fall height for a seesaw is the distance between the highest point any part of the seesaw can reach and the protective surfacing beneath it.

5.3.6 Slides

Children can be expected to descend slide chutes in many different positions, rather than always sitting and facing forward as they slide. These other positions should be discouraged at all times to minimize injuries.



Slides may provide a straight, wavy, or spiral descent either by means of a tube or an open slide chute. They may be either free-standing (Figure 17), part of a composite structure, or built on the grade of a natural or man-made slope (embankment slide). Regardless of the type of slide, avoid using bare metals on the platforms, chutes, and steps. When exposed to direct sunlight the bare metal may reach temperatures high enough to cause serious contact burn injuries in a matter of seconds. Provide shade for bare metal slides or use other materials that may reduce the surface temperature such as, but not limited to, plastic or coated metal.

5.3.6.1 Slide access

Access to a stand-alone slide generally is by means of a ladder with rungs, steps, or a stairway with steps. Slides may also be part of a composite play structure, so children will gain access from other parts of the structure. Embankment slides use the ground for access.

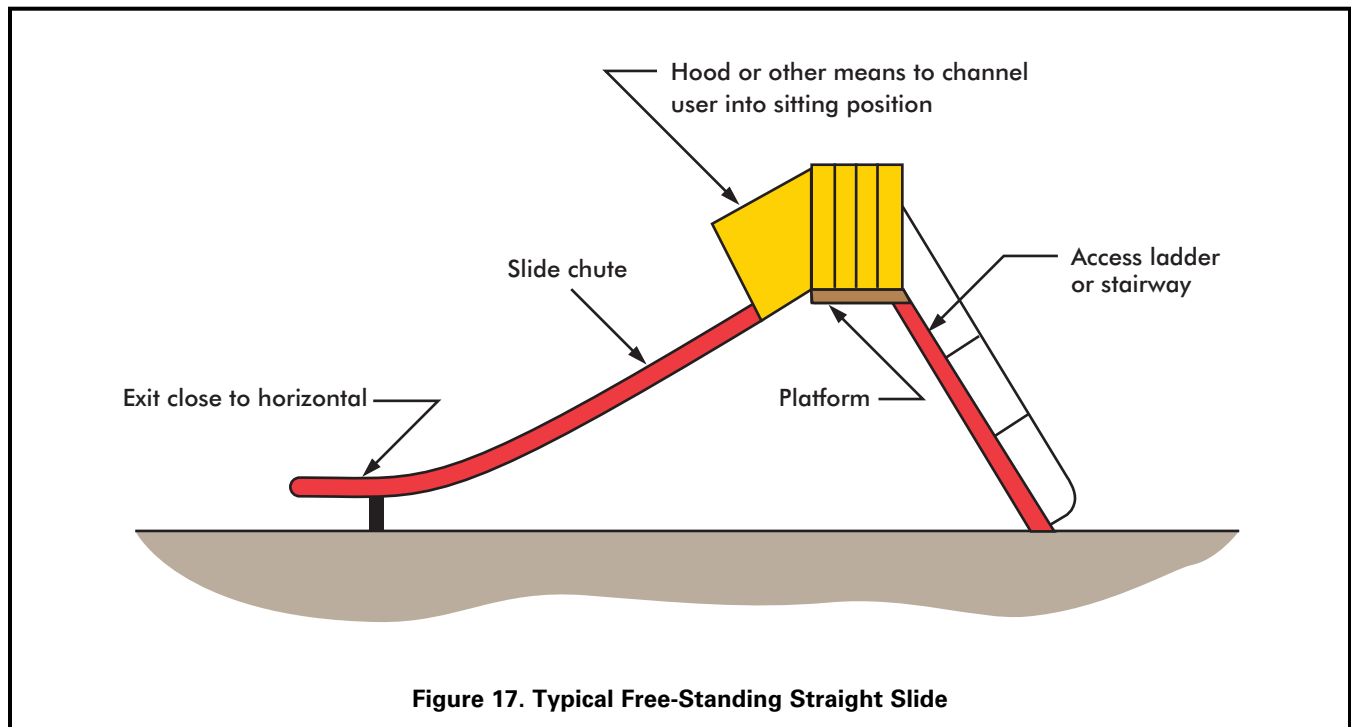

Figure 17. Typical Free-Standing Straight Slide

5.3.6.2 Slide platform

All slides should be provided with a platform with sufficient length to facilitate the transition from standing to sitting at the top of the inclined sliding surface. Embankment slides are exempt from platform requirements because they are on ground level; however, they should not have any spaces or gaps as noted below.

The platform should:

- Be at least 19 inches deep for toddlers.
- Be at least 14 inches deep for preschool-age and school-age children.
- Be horizontal.
- Be at least as wide as the slide chute.
- Be surrounded by guardrails or barriers.
- Conform to the same recommendations as general platforms given in §5.1.1.
- Not have any spaces or gaps that could trap strings, clothing, body parts, etc. between the platform and the start of the slide chute.
- Provide handholds to facilitate the transition from standing to sitting and decrease the risk of falls (except tube slides where the tube perimeter provides hand support). These should extend high enough to provide hand support for the largest child in a standing position, and low enough to provide hand support for the smallest child in a sitting position.
- Provide a means to channel a user into a sitting position at the entrance to the chute, such as a guardrail, hood, or other device that discourages climbing.

5.3.6.3 Slide chutes

5.3.6.3.1 Embankment slides

- The slide chute of an embankment slide should have a maximum height of 12 inches above the underlying ground surface. This design basically eliminates the hazard of falls from elevated heights.
- Embankment slides should follow all of the recommendations given for straight slides where applicable (e.g., side height, slope, use zone at exit, etc.).
- There should be some means provided at the slide chute entrance to minimize the use of embankment slides by children on skates, skateboards, or bicycles.

5.3.6.3.2 Roller slides

- Roller slides should meet applicable recommendations for other slides (e.g., side height, slope, use zone at exit, etc.).
- The space between adjacent rollers and between the ends of the rollers and the stationary structure should be less than 3/16 inch.
- Frequent inspections are recommended to insure that there are no missing rollers or broken bearings and that the rollers roll.

5.3.6.3.3 Spiral slides

- Spiral slides should follow the recommendations for straight slides where applicable (e.g., side height, slope, use zone at exit, etc.).
- Special attention should be given to design features which may present problems unique to spiral slides, such as lateral discharge of the user.
- Toddlers and preschool-age children have less ability to maintain balance and postural control, so only short spiral slides (one 360° turn or less) are recommended for these age groups.

5.3.6.3.4 Straight slides

- Flat open chutes should have sides at least 4 inches high extending along both sides of the chute for the entire length of the inclined sliding surface.
- The sides should be an integral part of the chute, without any gaps between the sides and the sliding surface. (This does not apply to roller slides).
- Slides may have an open chute with a circular, semicircular or curved cross section provided that:
 - A. The vertical height of the sides is no less than 4 inches when measured at right angles to a horizontal line that is 8 inches long when the slide is intended for toddlers, 12 inches long when the slide is intended for preschool-age children, and 16 inches long when the slide is intended for school-age children (Figure 18); or
 - B. For any age group, the vertical height of the sides is no less than 4 inches minus two times the width of the slide chute divided by the radius of the slide chute curvature (Figure 19).

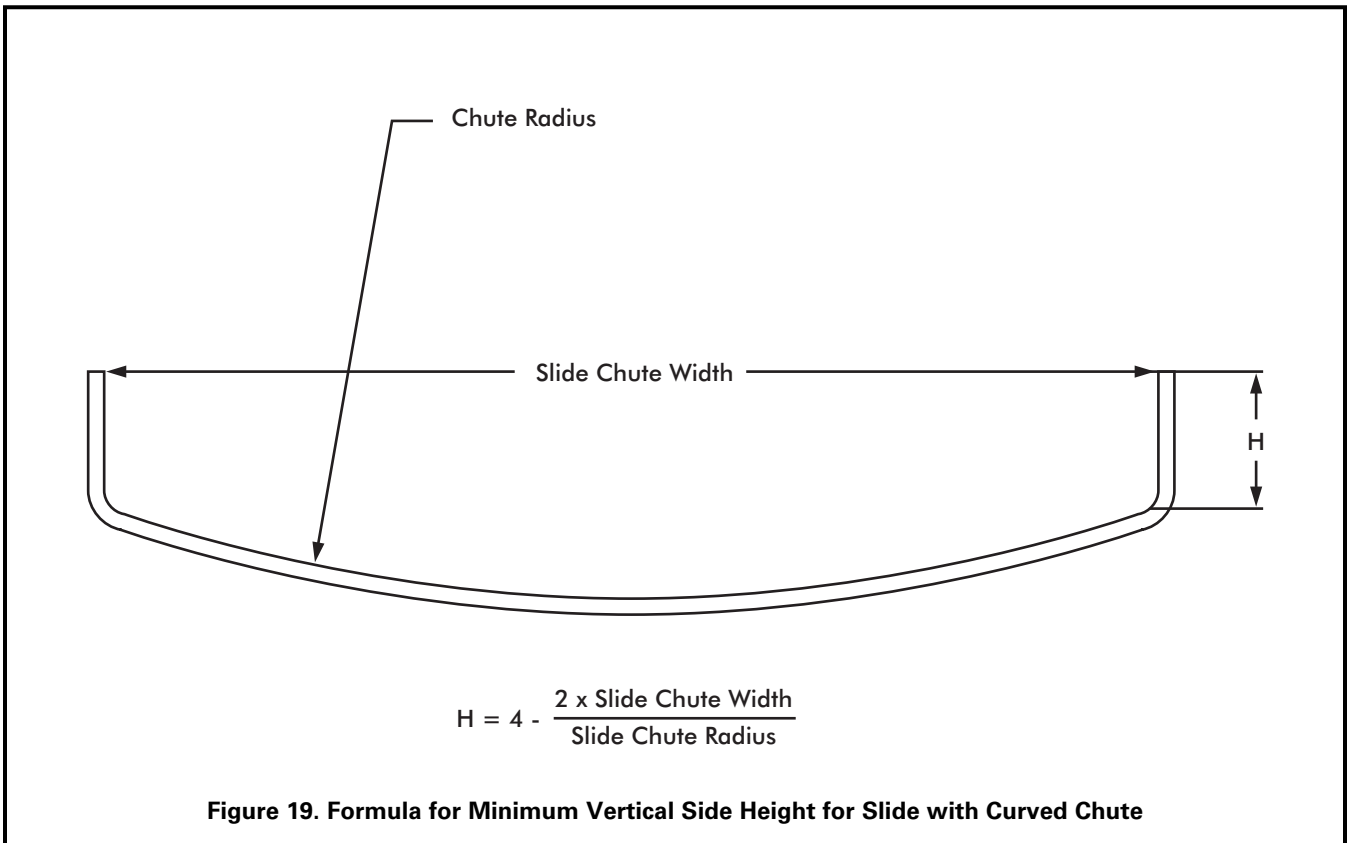
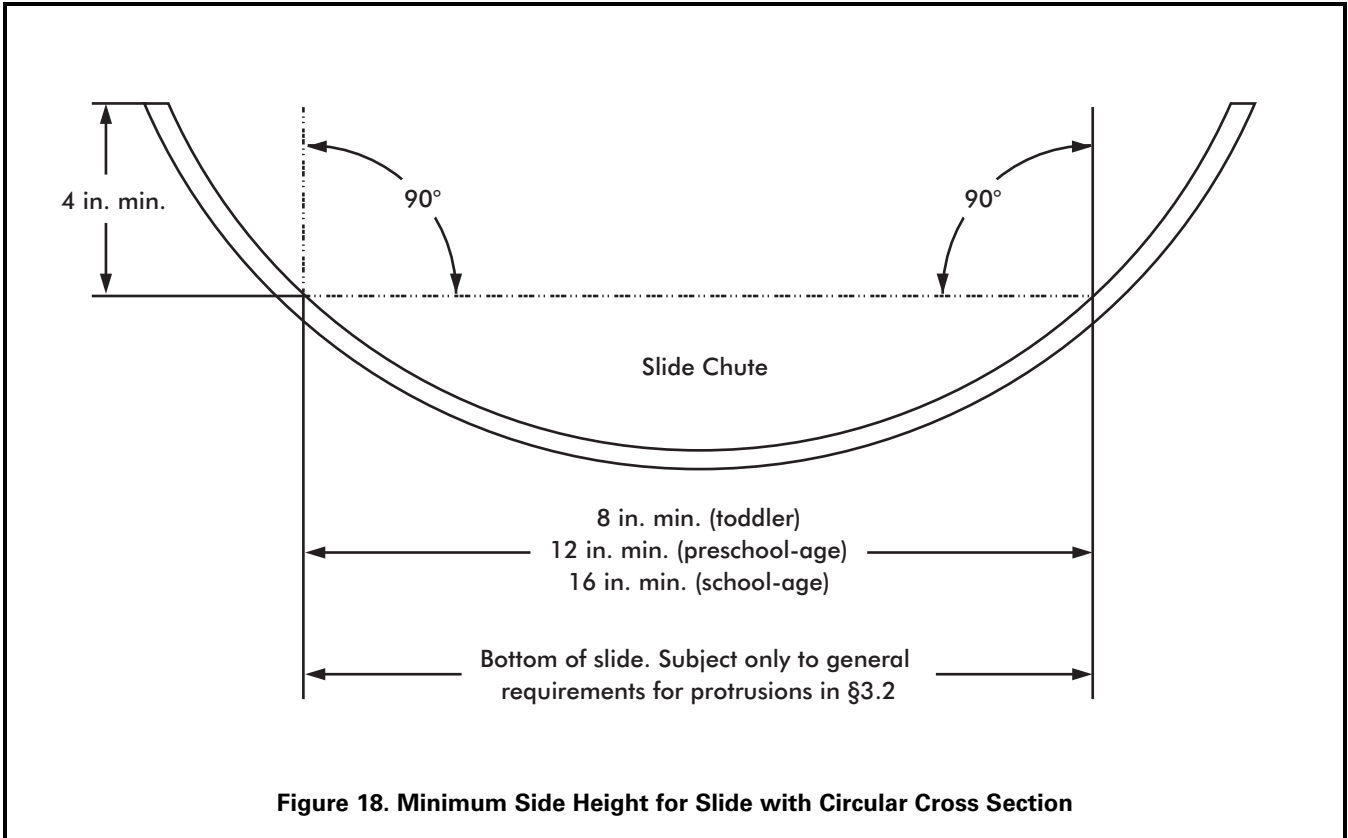

- For toddlers:
 - The average incline of a slide chute should be no more than 24° (that is, the height to horizontal length ratio shown in Figure 20 does not exceed 0.445).
 - No section of the slide chute should have a slope greater than 30° .
 - The slide chute should be between 8 and 12 inches wide.
- For preschool- and school-age children:
 - The average incline of a slide chute should be no more than 30° (that is, the height to horizontal length ratio shown in Figure 20 does not exceed 0.577).
 - No section of the slide chute should have a slope greater than 50° .

5.3.6.3.5 Tube slides

- Tube slides should meet all the applicable recommendations for other slides (e.g., side height, slope, use zone at exit, etc.).
- Means, such as barriers or textured surfaces, should be provided to prevent sliding or climbing on the top (outside) of the tube.
- The minimum internal diameter of the tube should be no less than 23 inches.
- Supervisors should be aware of children using tube slides since the children are not always visible.

5.3.6.4 Chute exit region

All slides should have an exit region to help children maintain their balance and facilitate a smooth transition from sitting to standing when exiting. The chute exit region should:

- Be between 0 and -4° as measured from a plane parallel to the ground.
- Have edges that are rounded or curved to prevent lacerations or other injuries that could result from impact with a sharp or straight edge.
- For toddlers the chute exit region should:
 - Be between 7 and 10 inches long if any portion of the chute exceeds a 24° slope.
 - Be no more than 6 inches above the protective surfacing.
 - Have a transition from the sliding portion to the exit region with a radius of curvature of at least 18 inches.
- For preschool- and school-age the chute exit region should:
 - Be at least 11 inches long.
 - Be no more than 11 inches above the protective surfacing if the slide is no greater than 4 feet high.
 - Be at least 7 inches but not more than 15 inches above the protective surfacing if the slide is over 4 feet high.

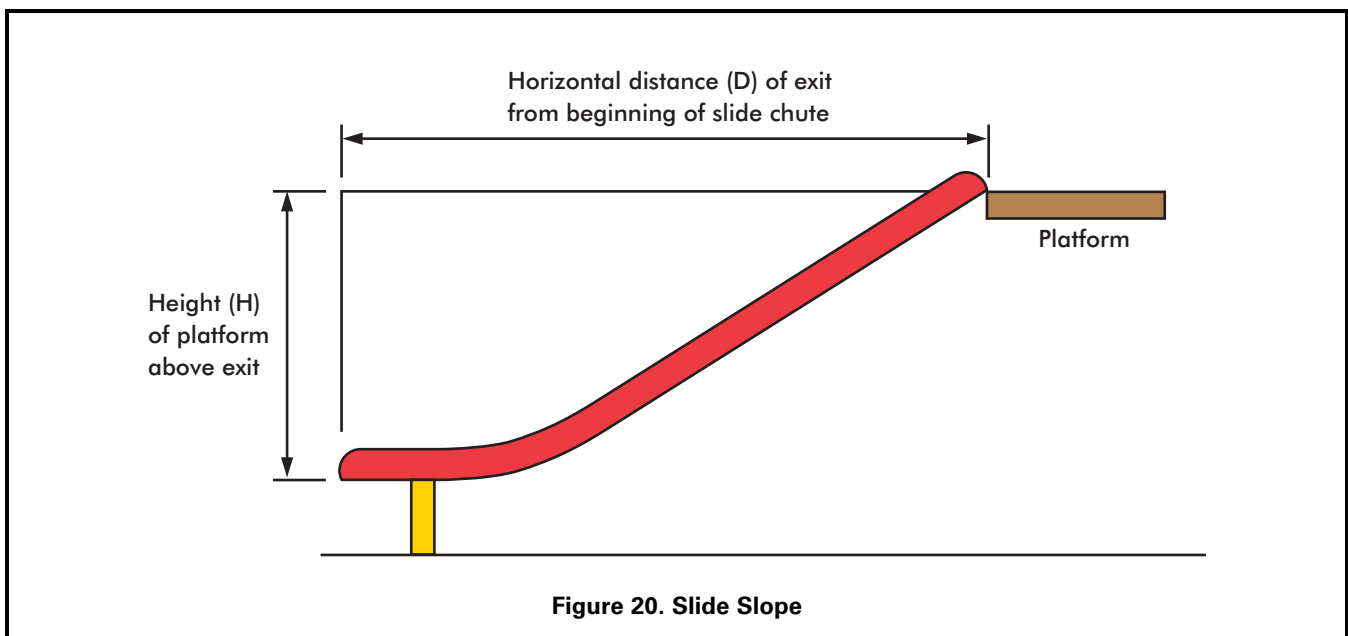

5.3.6.5 Slide use zone

Toddlers:

- In a limited access environment
 - The use zone should be at least 3 feet around the perimeter of the slide.
 - The area at the end of the slide should not overlap with the use zone for any other equipment.
- In public areas with unlimited access
 - For a stand-alone slide, the use zone should be at least 6 feet around the perimeter.
 - For slides that are part of a composite structure, the minimum use zone between the access components and the side of the slide chute should be 3 feet.
 - The use zone at the end of the slide should be at least 6 feet from the end of the slide and not overlap with the use zone for any other equipment.

Preschool- and school-age (see Figure 21):

- The use zone in front of the access and to the sides of a slide should extend a minimum of 6 feet from the perimeter of the equipment. This recommendation does not apply to embankment slides or slides that are part of a composite structure (see §5.3.9).
- The use zone in front of the exit of a slide should never overlap the use zone of any other equipment; however, two or more slide use zones may overlap if their sliding paths are parallel.
- For slides less than or equal to 6 feet high, the use zone in front of the exit should be at least 6 feet.
- For slides greater than 6 feet high, the use zone in front of the exit should be at least as long as the slide is high up to a maximum of 8 feet.

5.3.6.6 Fall height

The fall height for slides is the distance between the transition platform and the protective surfacing beneath it.

5.3.6.7 Entanglement hazard

Children have suffered serious injuries and died by getting parts of their clothing tangled on protrusions or gaps on slides.

To reduce the chance of clothing entanglement:

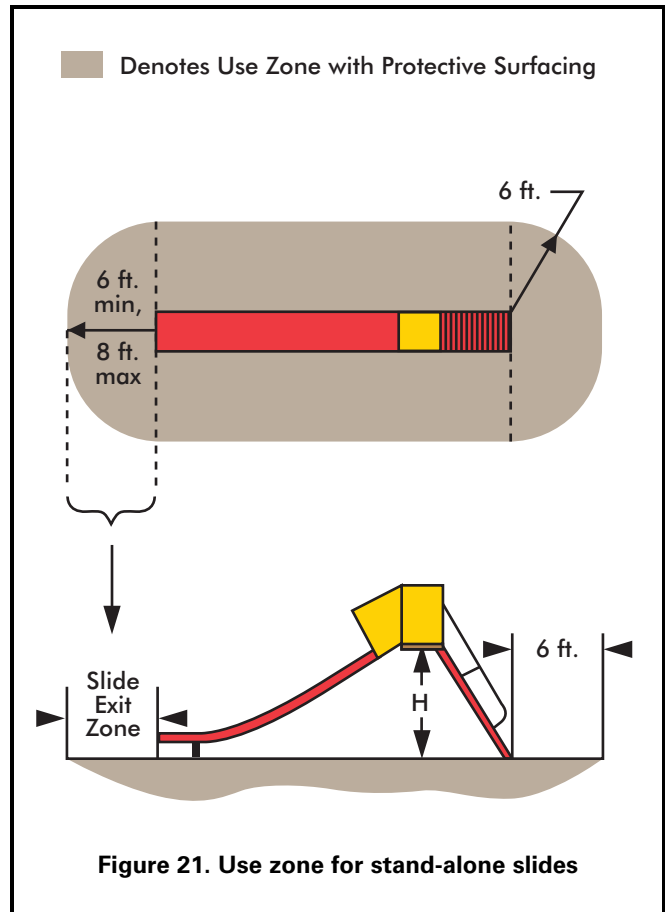

Figure 21. Use zone for stand-alone slides

- Projections up to 3 inches in diameter should not stick up more than 1/8 inch from the slide.
- There should be no gaps at the tops of slides where the slide chute connects with the platform that can entangle clothing or strings.
- See Appendix B for full recommendations and details of the protrusion test procedure.

5.3.6.8 Other sliding equipment

Equipment where it is foreseeable that a primary use of the component is sliding should follow the same guidelines for entanglement that are in 5.3.6.7.

5.3.7 Spring rockers

Toddlers and preschool-age children enjoy the bouncing and rocking activities presented by spring rockers, and they are the primary users of rocking equipment. See Figure 22. Older children may not find it challenging enough.

- Seat design should not allow the rocker to be used by more than the intended number of users.



Figure 22. Example of spring rocker

- For toddlers:
 - The seat should be between 12 and 16 inches high.
 - Spring rockers with opposing seats intended for more than one child should have at least 37 inches between the seat centers.
- For preschoolers:
 - The seat should be between 14 and 28 inches high.
- Each seating position should be equipped with handgrips and footrests. The diameter of handgrips should follow the recommendations for hand gripping components in §5.2.2.
- The springs of rocking equipment should minimize the possibility of children crushing their hands or their feet between coils or between the spring and a part of the rocker.
- The use zone should extend a minimum of 6 feet from the “at rest” perimeter of the equipment.
- The use zone may overlap with neighboring equipment if the other piece of equipment allows overlapping use zones and
 - There is at least 6 feet between equipment when adjacent designated play surfaces are no more than 30 inches high; or

- There is at least 9 feet between equipment when adjacent designated play surfaces are more than 30 inches high; and
- The spring rocker is designed to be used from a seated position.

5.3.7.1 Fall height

The fall height of spring rockers is the distance between either (1) the highest designated playing surface or (2) the seat, whichever is higher, and the protective surfacing beneath it.

5.3.8 Swings

Children of all ages generally enjoy the sensations created while swinging. Mostly they sit on the swings; however, it is common to see children jumping off swings. Younger children also tend to swing on their stomachs, and older children may stand on the seats. To prevent injuries, these behaviors should be discouraged.

Swings may be divided into two distinct types:

- Single axis: Sometimes called a to-fro swing. A single-axis swing is intended to swing back and forth in a single plane and generally consists of a seat supported by at least two suspending members, each of which is connected to a separate pivot on an overhead structure.
- Multi-axis: A multi-axis swing consists of a seat (generally a tire) suspended from a single pivot that permits it to swing in any direction.

5.3.8.1 General swing recommendations

- Hardware used to secure the suspending elements to the swing seat and to the supporting structure should not be removable without the use of tools.
- S-hooks are often part of a swing’s suspension system, either attaching the suspending elements to the overhead support bar or to the swing seat. Open S-hooks can catch a child’s clothing and present a strangulation hazard. S-hooks should be pinched closed. An S-hook is considered closed if there is no gap or space greater than 0.04 inches (about the thickness of a dime).
- Swings should be suspended from support structures that discourage climbing.
- A-frame support structures should not have horizontal cross-bars.

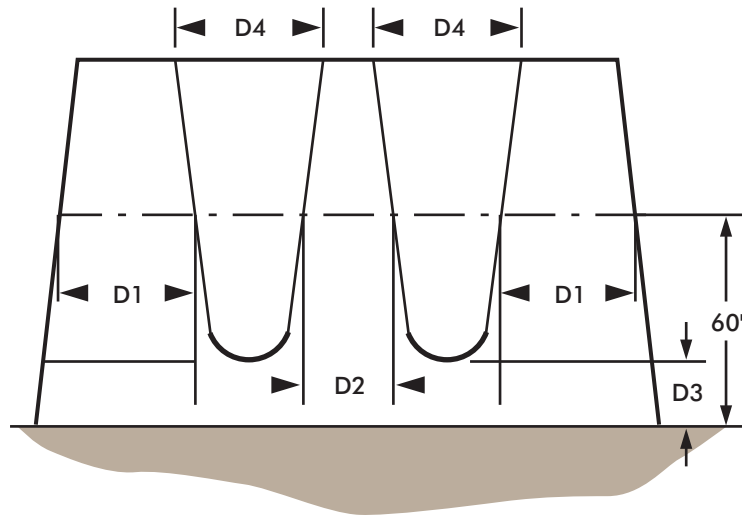

Figure 23. Minimum Clearances for Single-Axis Swings

Table 7. Minimum clearance dimensions for swings

Reason	Dimension	Toddler Full bucket	Preschool-age Belt	School-age Belt
Minimizes collisions between a swing and the supporting structure	D1	20 inches	30 inches	30 inches
Minimizes collisions between swings	D2	20 inches	24 inches	24 inches
Allows access	D3	24 inches	12 inches	12 inches
Reduces side-to-side motion	D4	20 inches	20 inches	20 inches

- Fiber ropes are not recommended as a means of suspending swings since they may degrade over time.
- Swing structures should be located away from other equipment or activities to help prevent young children from inadvertently running into the path of moving swings. Additional protection can be provided by means of a low blockade such as a fence or hedge around the perimeter of the swing area. The blockade should not be an obstacle within the use zone of a swing structure or hamper supervision by blocking visibility.

5.3.8.2 Fall height

The fall height for swings is the vertical distance between the pivot point and the protective surfacing beneath it.

5.3.8.3 Single-axis swings

5.3.8.3.1 Belt seats used without adult assistance

- The use zone to the front and rear of single-axis swings should never overlap the use zone of another piece of equipment.
- To minimize the likelihood of children being struck by a moving swing, it is recommended that no more than two single-axis swings be hung in each bay of the supporting structure.

- Swings should not be attached to composite structures.
- Swing seats should be designed to accommodate no more than one user at any time.
- Lightweight rubber or plastic swing seats are recommended to help reduce the severity of impact injuries. Wood or metal swing seats should be avoided.
- Edges of seats should have smoothly finished or rounded edges and should conform to the protrusion recommendations in 5.3.8.5.
- If loose-fill material is used as a protective surfacing, the height recommendations should be determined after the material has been compressed.

5.3.8.3.2 Full bucket seat swings

Full bucket seat swings are similar to single-axis swings since they move in a to-and-fro direction. However, full bucket seat swings are intended for children under 4 years of age to use with adult assistance.

- The seats and suspension systems of these swings, including the related hardware, should follow all of the criteria for conventional single axis swings.
- Full bucket seats are recommended to provide support on all sides of a child and between the legs of the occupant (see Figure 24).



Figure 24. Example of full bucket seat swings

- The full bucket seat materials should not present a strangulation hazard, such as might be presented with a rope or chain used as part of the seat.
- Openings in swing seats should conform to the entrapment criteria in §3.3.
- Full bucket seat swings should be suspended from structures that are separate from those for other swings, or at least suspended from a separate bay of the same structure.
- Full bucket seat swings should not allow the child to enter and exit alone.
- Pivot points should be more than 47 inches but no more than 96 inches above the protective surfacing.

5.3.8.3.3 Use zone for single-axis swings – belt and full bucket

The use zone in front of and behind the swing should be greater than to the sides of such a swing since children may deliberately attempt to exit from a single-axis swing while it is in motion. See Figure 25.

- The use zone for a belt swing should extend to the front and rear of a single-axis swing a minimum distance of twice the vertical distance from the pivot point and the top of the protective surface beneath it.
- The use zone for a full bucket swing should extend to the front and rear a minimum of twice the vertical distance from the top of the occupant's sitting surface to the pivot point.
- The use zone in front of and behind swings should never overlap with any other use zone.
- The use zone to the sides of a single-axis swing should extend a minimum of 6 feet from the perimeter of the swing. This 6-foot zone may overlap that of an adjacent swing structure or other playground equipment structure.

5.3.8.4 Multi-axis (tire) swings

Tire swings are usually suspended in a horizontal orientation using three suspension chains or cables connected to a single swivel mechanism that permits both rotation and swinging motion in any axis.

- A multi-axis tire swing should not be suspended from a structure having other swings in the same bay.
- Attaching multi-axis swings to composite structures is not recommended.

- To minimize the hazard of impact, heavy truck tires should be avoided. Further, if steel-belted radials are used, they should be closely examined to ensure that there are no exposed steel belts or wires that could be a potential protrusion or laceration hazard. Plastic materials can be used as an alternative to simulate actual automobile tires. Drainage holes should be provided in the underside of the tire.
- Pay special attention to maintenance of the hanger mechanism because the likelihood of failure is higher for tire swings due to the added stress of rotational movement and multiple occupants.
- The hanger mechanisms for multi-axis tire swings should not have any accessible crush points.
- The minimum clearance between the seating surface of a tire swing and the uprights of the supporting structure should be 30 inches when the tire is in a position closest to the support structure (Figure 26).
- The minimum clearance between the bottom of the seat and the protective surface should not be less than 12 inches.

5.3.8.4.1 Multi-axis swing use zones

- The use zone should extend in any direction from a point directly beneath the pivot point for a minimum distance of 6 feet plus the length of the suspending members (see Figure 27). This use zone should never overlap the use zone of any other equipment.

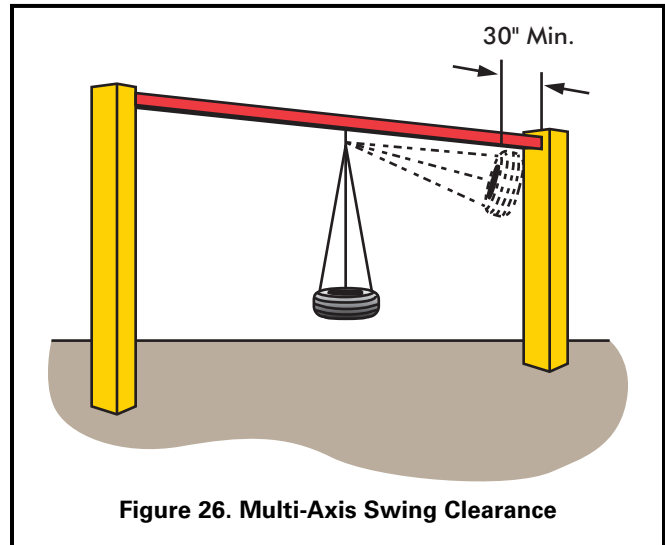

Figure 26. Multi-Axis Swing Clearance

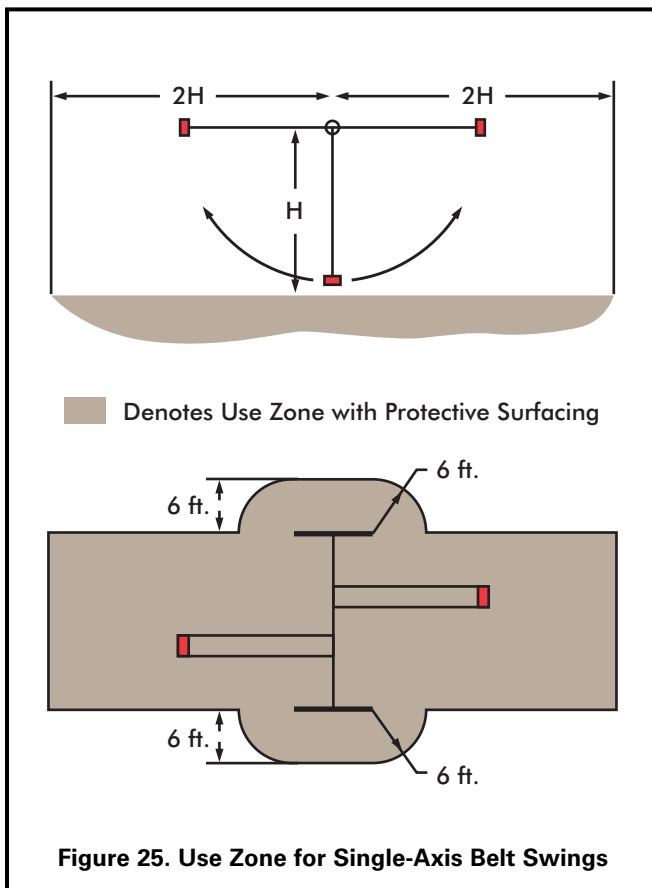

Figure 25. Use Zone for Single-Axis Belt Swings

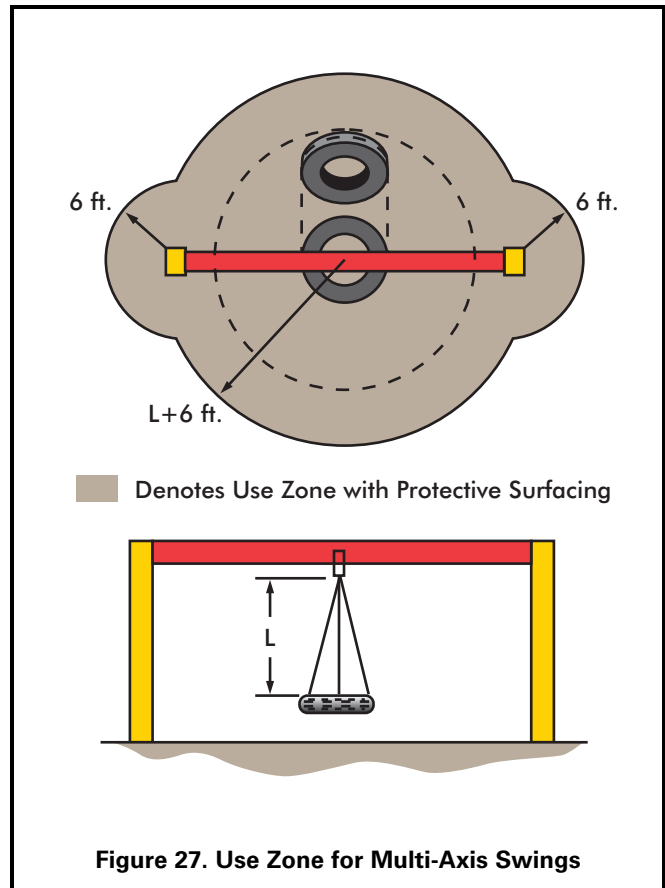

Figure 27. Use Zone for Multi-Axis Swings

- The use zone should extend a minimum of 6 feet from the perimeter of the supporting structure. This 6-foot zone may overlap that of an adjacent swing structure or other playground equipment structure.

5.3.8.5 Protrusions on suspended members of swing assemblies

Protrusions on swings are extremely hazardous because of the potential for impact incidents. Nothing, including bolts or other parts, on the front, back, or underside of a swing should stick out more than 1/8 of an inch. See test procedures in Appendix B.

5.3.9 Fall height and use zones for composite structure

When two or more complementary play components are linked together in a composite structure (e.g., combination climber, slide, and horizontal ladder), the use zone should extend a minimum of 6 feet from the external perimeter of the structure (see Figure 28). Where slides are attached to a platform higher than 6 feet from the protective surfacing, the use zone may need to extend further in front of the slide (see §5.3.6.5).

5.3.10 Fall height and use zones not specified elsewhere

Most playground equipment belongs in one of the categories listed above. If it does not, the following general recommendations should be applied:

- The fall height of a piece of playground equipment is the distance between the highest designated playing surface and the protective surface beneath it.
- The use zone should extend a minimum of 6 feet in all directions from the perimeter of the equipment.
- The use zones of two stationary pieces of playground equipment that are positioned adjacent to one another may overlap if the adjacent designated play surfaces of each structure are no more than 30 inches above the protective surface and the equipment is at least 6 feet apart.
- If adjacent designated play surfaces on either structure exceed a height of 30 inches, the minimum distance between the structures should be 9 feet.
- Use zones should be free of obstacles.

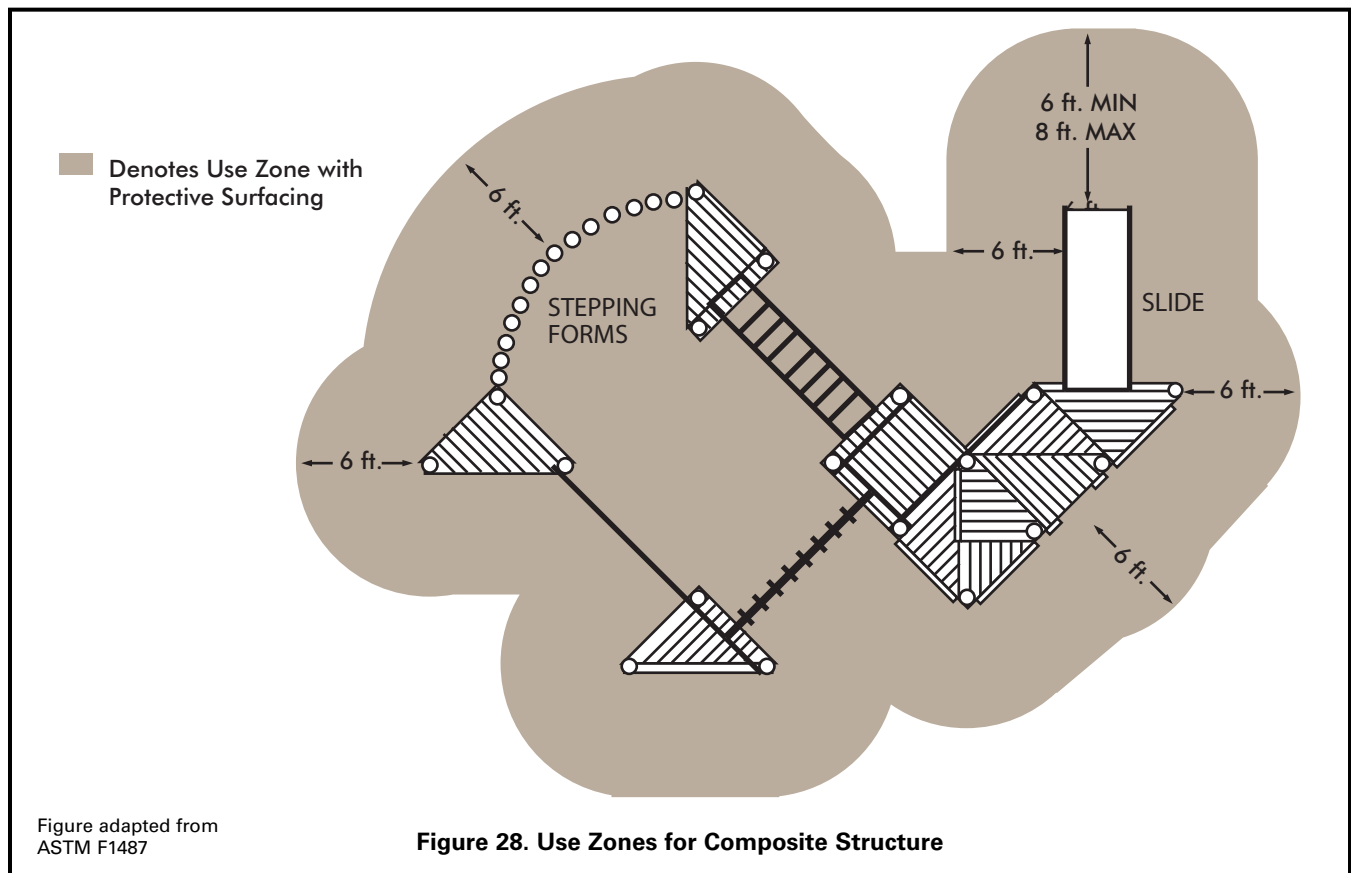

APPENDIX A: SUGGESTED GENERAL MAINTENANCE CHECKLISTS

Surfacing (§2.4)

- Adequate protective surfacing under and around the equipment.
 - Install/replace surfacing
- Surfacing materials have not deteriorated.
 - Replace surfacing
 - Other maintenance: _____
- Loose-fill surfacing materials have no foreign objects or debris.
 - Remove trash and debris
- Loose-fill surfacing materials are not compacted.
 - Rake and fluff surfacing
- Loose-fill surfacing materials have not been displaced under heavy use areas such as under swings or at slide exits.
 - Rake and fluff surfacing

Drainage (§2.4)

- The entire play area has satisfactory drainage, especially in heavy use areas such as under swings and at slide exits.
 - Improve drainage
 - Other maintenance: _____

General Hazards

- There are no sharp points, corners or edges on the equipment (§3.4).
- There are no missing or damaged protective caps or plugs (§3.4).
- There are no hazardous protrusions (§3.2 and Appendix B).
- There are no potential clothing entanglement hazards, such as open S-hooks or protruding bolts (§2.5.2, §3.2, §5.3.8.1 and Appendix B).
- There are no crush and shearing points on exposed moving parts (§3.1).
- There are no trip hazards, such as exposed footings or anchoring devices and rocks, roots, or any other obstacles in a use zone (§3.6).

NOTES:

DATE OF INSPECTION:

Security of Hardware (§2.5)

- There are no loose fastening devices or worn connections.
 - Replace fasteners
 - Other maintenance: _____
- Moving parts, such as swing hangers, merry-go-round bearings, and track rides, are not worn.
 - Replace part
 - Other maintenance: _____

Durability of Equipment (§2.5)

- There are no rust, rot, cracks, or splinters on any equipment (check carefully where it comes in contact with the ground).
- There are no broken or missing components on the equipment (e.g., handrails, guardrails, protective barriers, steps, or rungs).
- There are no damaged fences, benches, or signs on the playground.
- All equipment is securely anchored.

Leaded Paint (§2.5.4)

- Paint (especially lead paint) is not peeling, cracking, chipping, or chalking.
- There are no areas of visible leaded paint chips or accumulation of lead dust.
 - Mitigate lead paint hazards

General Upkeep of Playgrounds (§4)

- There are no user modifications to the equipment, such as strings and ropes tied to equipment, swings looped over top rails, etc.
 - Remove string or rope
 - Correct other modification
- The entire playground is free from debris or litter such as tree branches, soda cans, bottles, glass, etc.
 - Clean playground
- There are no missing trash receptacles.
 - Replace trash receptacle
- Trash receptacles are not full.
 - Empty trash

INSPECTION BY:

Routine Inspection and Maintenance Issues

- Broken equipment such as loose bolts, missing end caps, cracks, etc.
- Broken glass & other trash
- Cracks in plastics
- Loose anchoring
- Hazardous or dangerous debris
- Insect damage
- Problems with surfacing
- Displaced loose-fill surfacing (see Section 4.3)
- Holes, flakes, and/or buckling of unitary surfacing
- User modifications (such as ropes tied to parts or equipment rearranged)
- Vandalism
- Worn, loose, damaged, or missing parts
- Wood splitting
- Rusted or corroded metals
- Rot

APPENDIX B: PLAYGROUND TESTING

B.1 Templates, Gauges, and Testing Tools

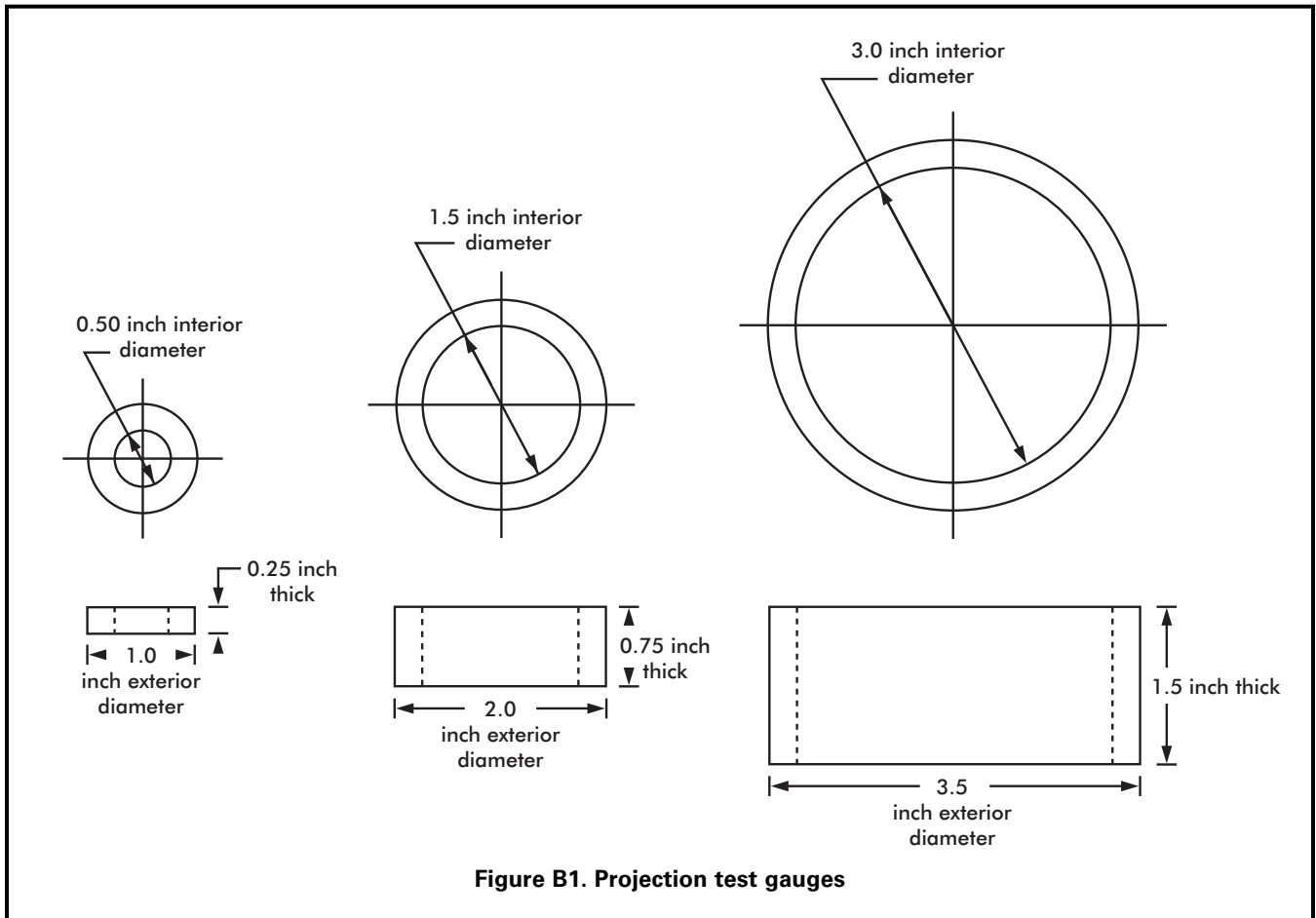

Figure B1. Projection test gauges

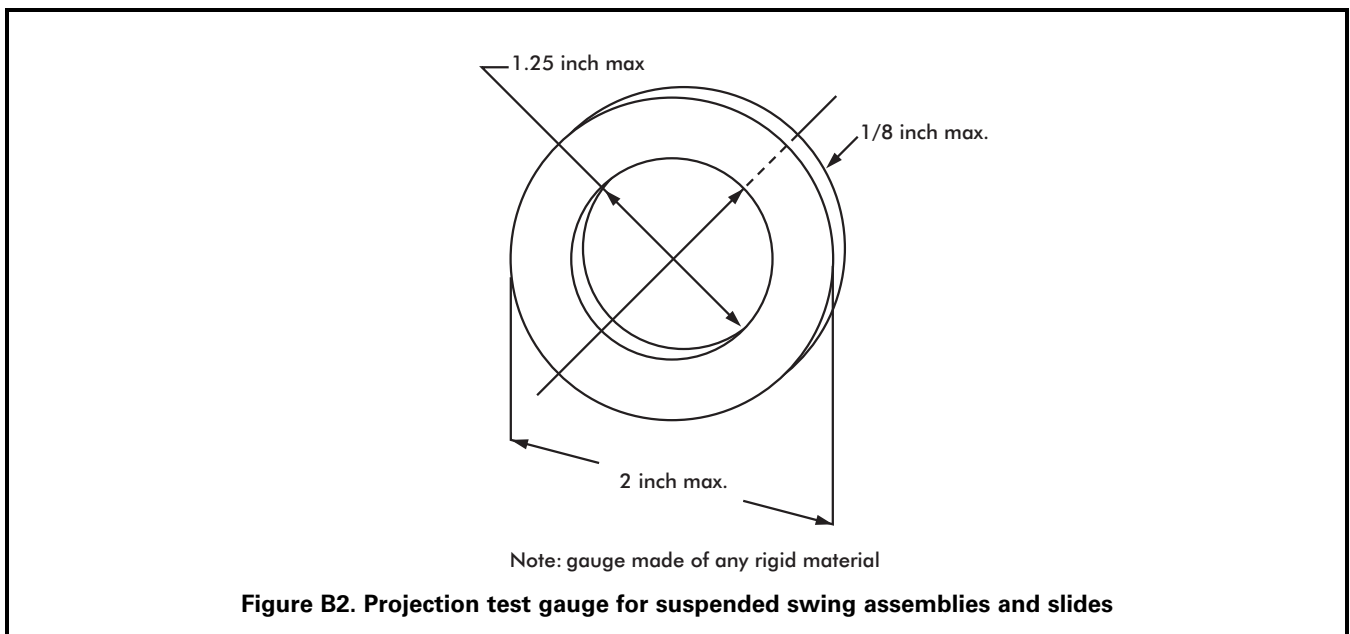

Figure B2. Projection test gauge for suspended swing assemblies and slides

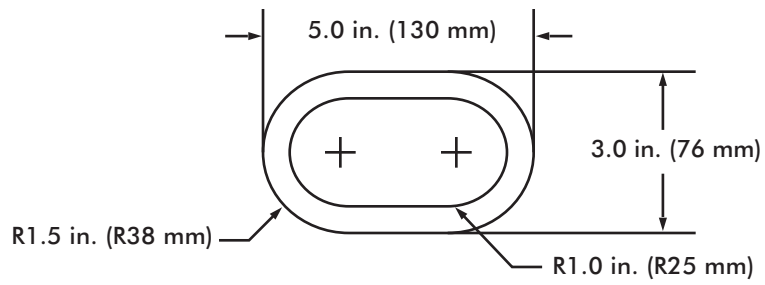

Figure B3. Toddler small torso template

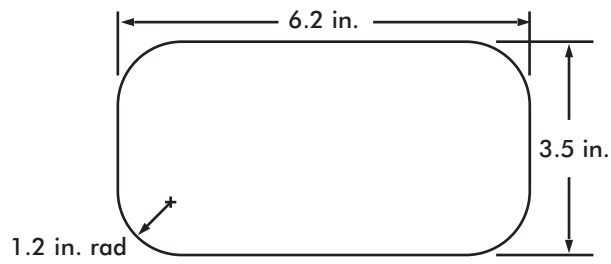

Figure B4. Preschool- and school-age small torso template

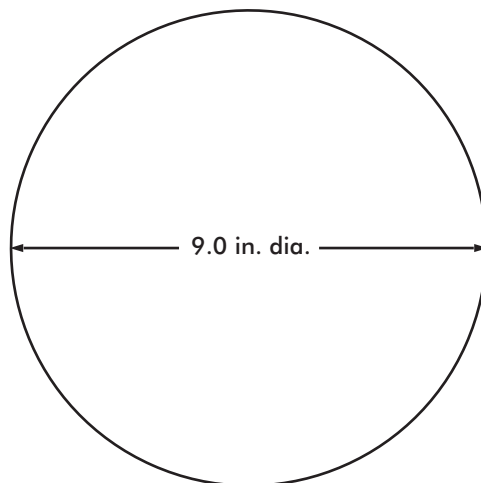
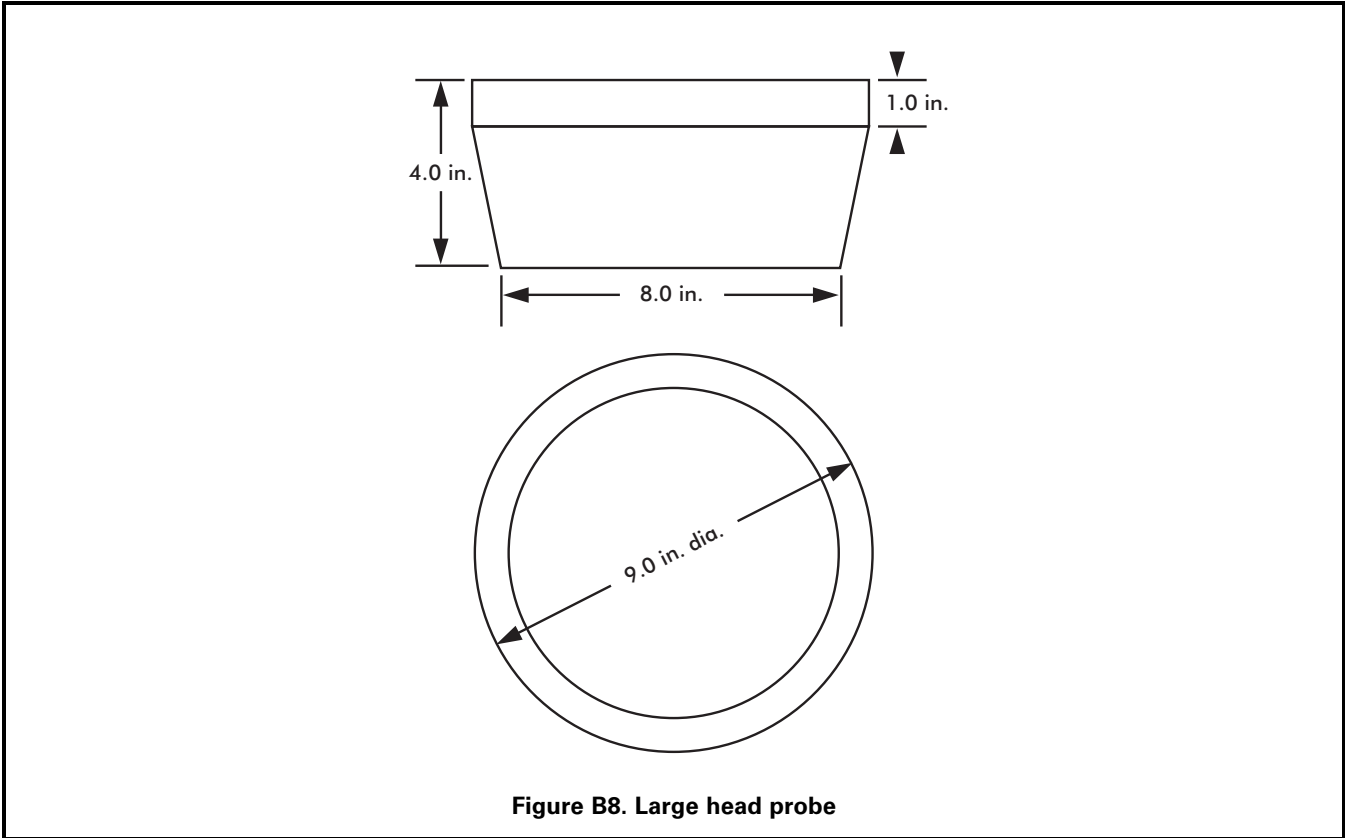
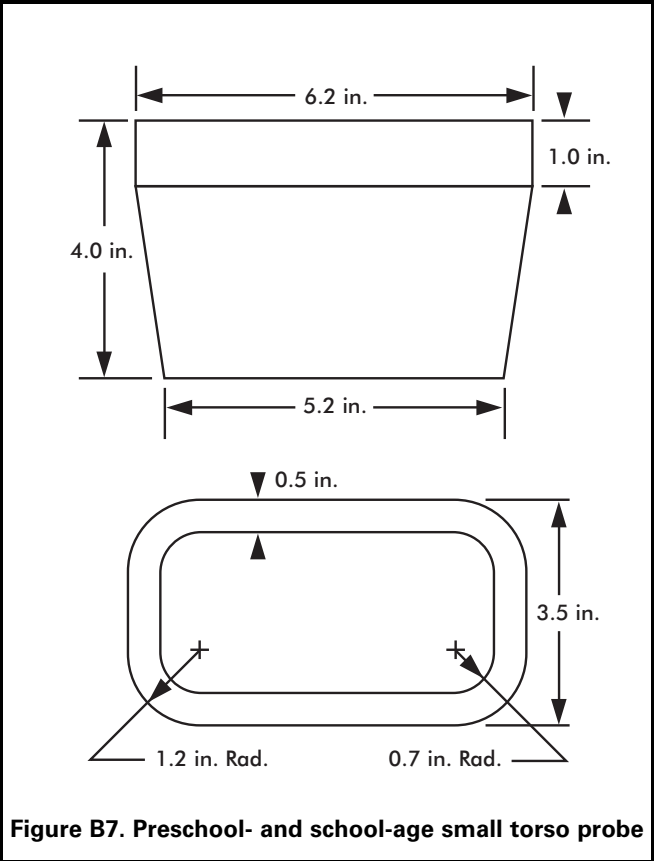
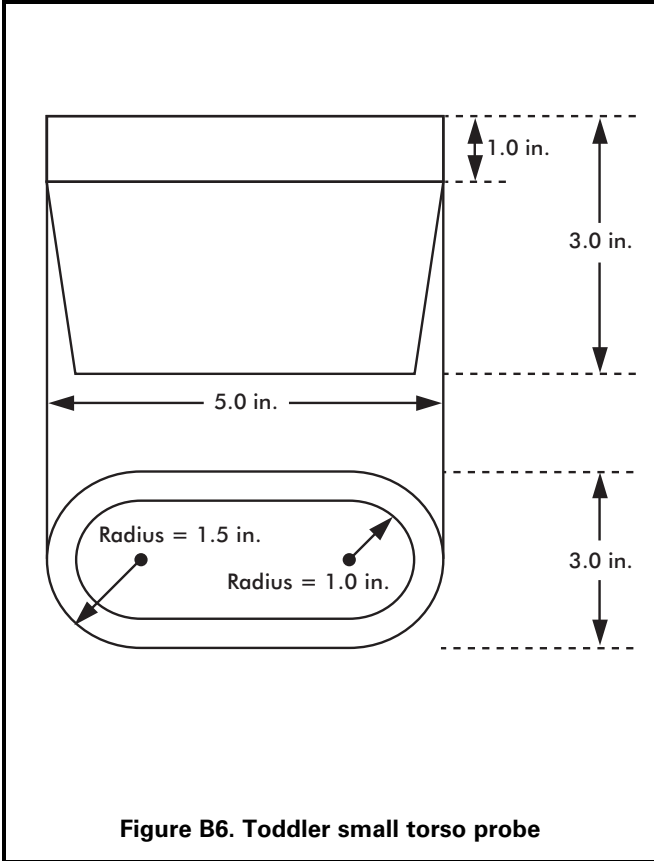

Figure B5. Large head template



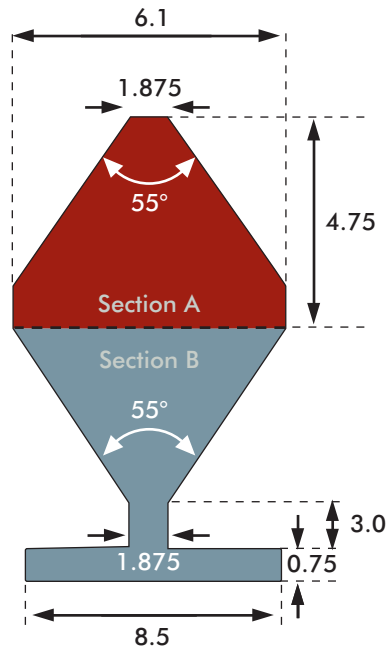

Figure B9. Preschool/School-age partially bound probe (dimensions in inches, template is 0.75 inches thick)

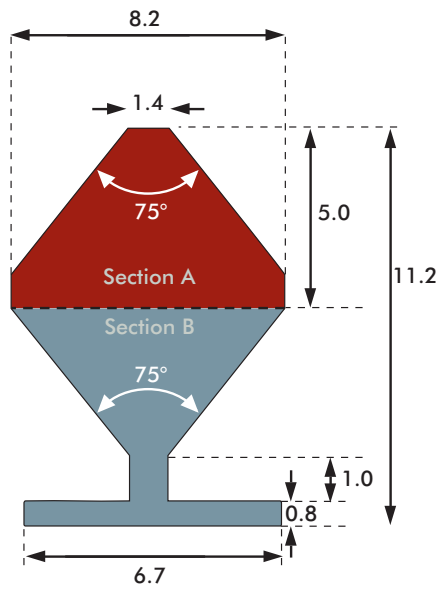

Figure B10. Toddler partially bound probe (dimensions in inches, template is 0.60 inches thick)

APPENDIX B: PLAYGROUND TESTING

B.2 Test Methods

B.2.1 Determining whether a projection is a protrusion

B.2.1.1 Test procedure

Step 1: Successively place each projection test gauge (see Figure B1) over any projection

Step 2: Visually determine if the projection penetrates through the hole and beyond the face of the gauge (see Figure B11 below).

Pass: A projection that does not extend beyond the face of the gauge passes.

Fail: A projection that extends beyond the face of any one of the gauges is considered a hazardous protrusion and should be eliminated.

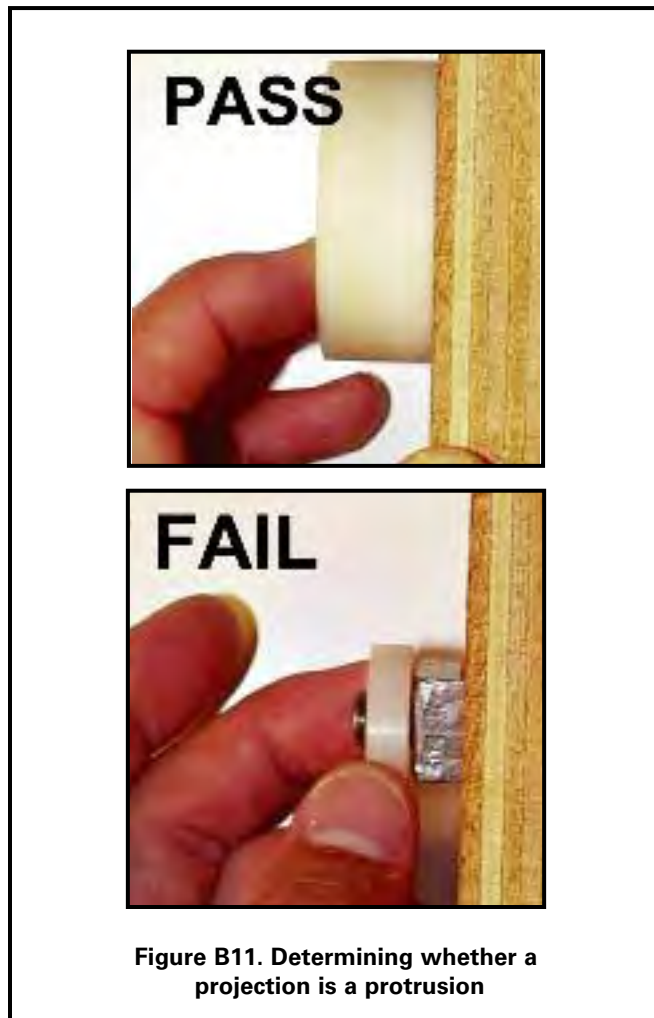

Figure B11. Determining whether a projection is a protrusion

B.2.2 Projections on suspended members of swing assemblies

Given the potential for impact incidents, projections on swings can be extremely hazardous. A special test gauge (see Figure B2) and procedure are recommended. When tested, no bolts or components in the potential impact region on suspended members should extend through the hole beyond the face of the gauge.

B.2.2.1 Test procedure

Step 1: Hold the gauge (Figure B2) vertically with the axis through the hole parallel to the swing's path of travel.

Step 2: Place the gauge over any projections that are exposed during the swing's path of travel.

Step 3: Visually determine if the projection penetrates through the hole and beyond the face of the gauge.

Pass: A projection that does not extend beyond the face of the gauge passes.

Fail: A projection that extends beyond the face of the gauge is considered a hazardous protrusion and should be eliminated.

B.2.3 Projections on slides

To minimize the likelihood of clothing entanglement on slides, projections that (1) fit within any one of the three gauges shown in Figure B1 and (2) have a major axis that projects away from the slide bed should not have projections greater than 1/8 inch perpendicular to the plane of the surrounding surface (Figure B12).

B.2.3.1 Test procedure

Step 1: Identify all projections within the shaded area shown in Figure B13.

Step 2: Determine which, if any, fit inside the projection test gauges (Figure B1).

Step 3: Place the swing and slide projection gauge (Figure B2) next to the projection to check the height of the projection.

Step 4: Visually determine if the projection extends beyond the face of the slide projection gauge.

Pass: A projection that does not extend beyond the face of the gauge passes.

Fail: A projection that extends beyond the face of the gauge is considered a hazardous protrusion and should be eliminated.

NOTE: This test procedure is not applicable to the underside of a slide chute. For a slide chute with a circular cross section, the portion of the underside not subject to this projection recommendation is shown in Figure 18. The general recommendations for projections in §B.2.1 are applicable to the underside of the slide.

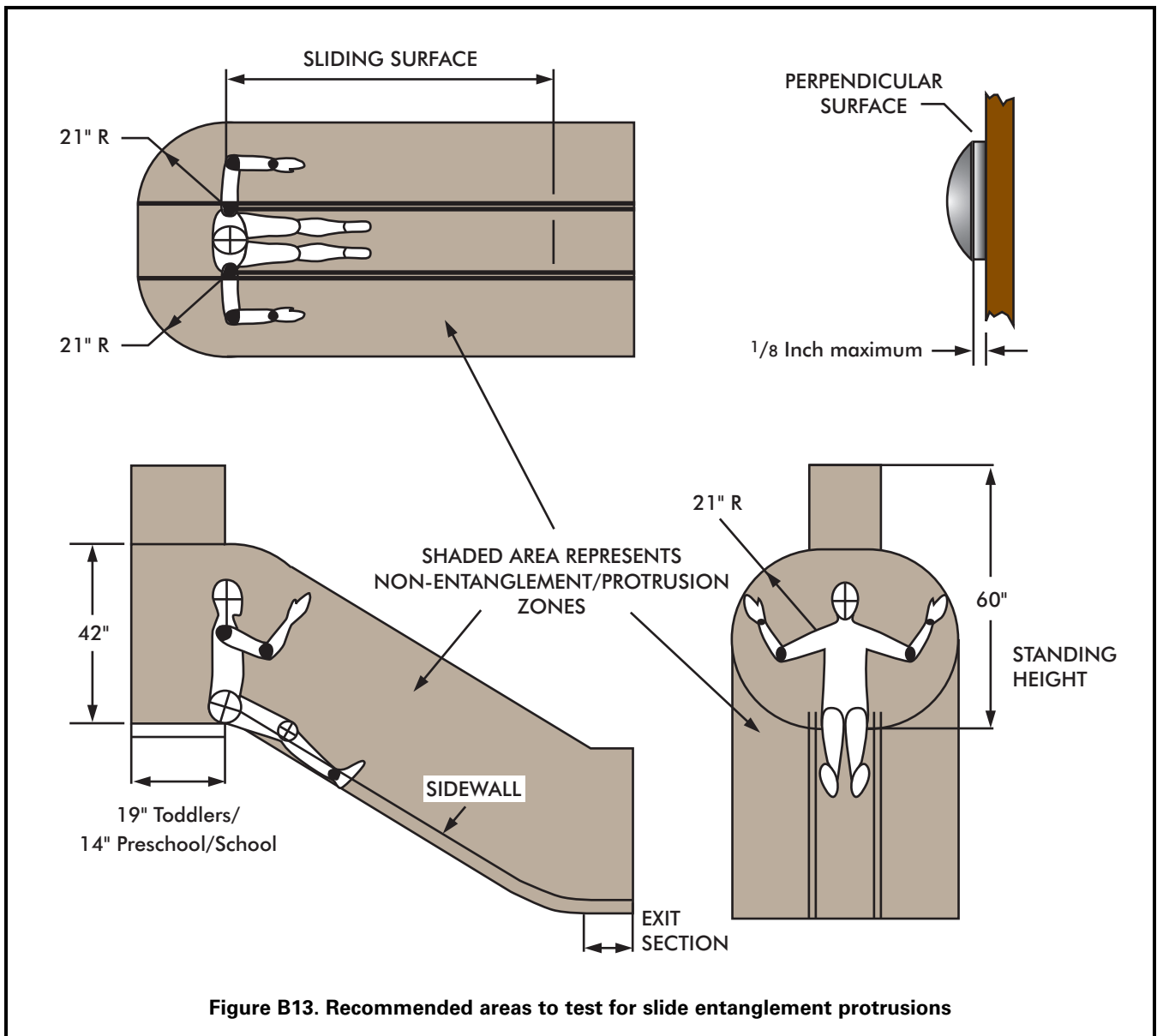
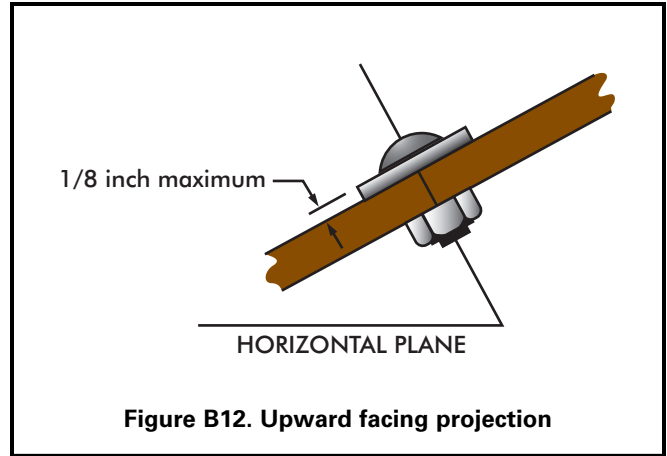

B.2.4 Entrapment

B.2.4.1 General

Any completely-bounded opening (Figure B14) that is not bounded by the ground may be a potential head entrapment hazard. Even those openings which are low enough to permit a child's feet to touch the ground present a risk of strangulation to an entrapped child, because younger children may not have the necessary intellectual ability and motor skills to withdraw their heads, especially if scared or panicked. An opening may present an entrapment hazard if the distance between any interior opposing surfaces is greater than 3.5 inches and less than 9 inches. If one dimension of an opening is within this potentially hazardous range, all dimensions of the opening should be considered together to fully evaluate the possibility of entrapment. The most appropriate method to determine whether an opening is hazardous is to test it using the following fixtures, methods, and performance criteria.

These recommendations apply to all playground equipment, i.e., toddler, preschool-age, and school-age children. Fixed equipment as well as moving equipment (in its stationary position) should be tested for entrapment hazards. There are two special cases for which separate procedures are given: (1) completely-bounded openings where depth of penetration is a critical issue (see Figure B15) and (2) openings formed by flexible climbing components.

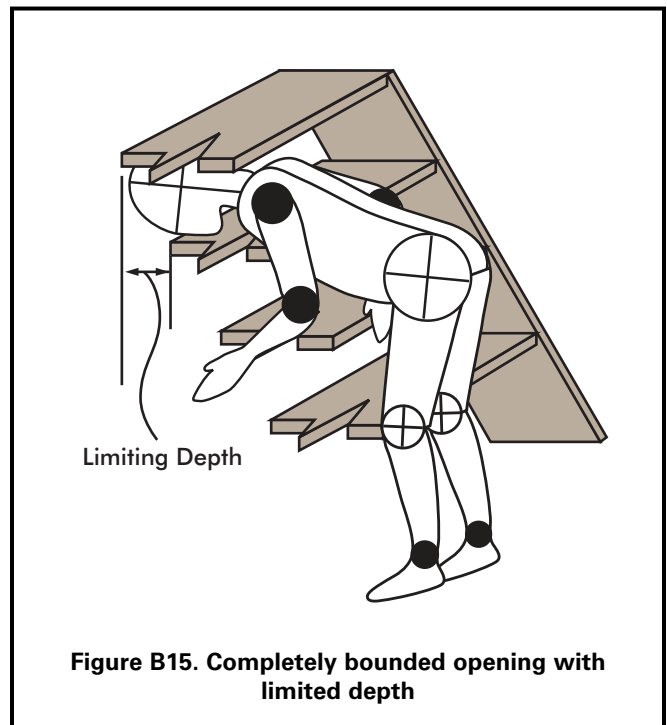
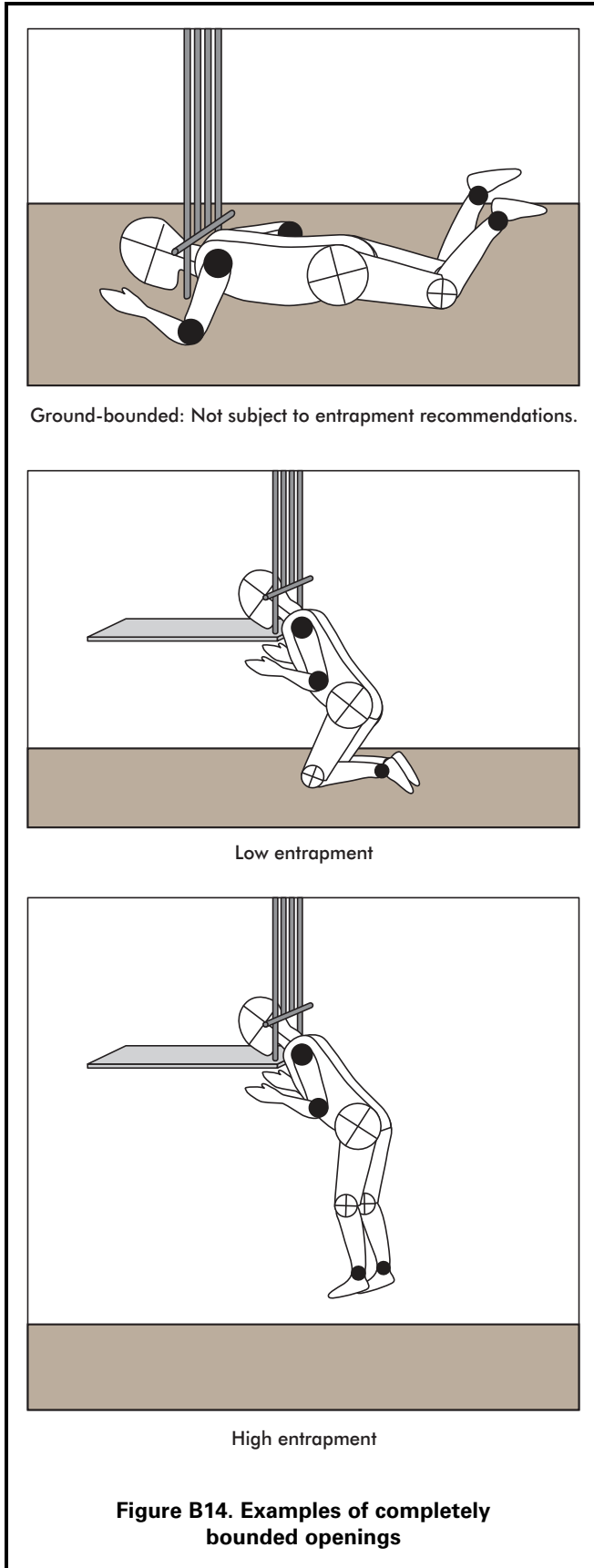

B.2.5 Test fixtures

Two templates are required to determine if completely bounded openings in rigid structures present an entrapment hazard. These templates can easily be fabricated from cardboard, plywood, or sheet metal.

B.2.5.1 Small torso template

The dimensions (see Figure B3 and Figure B4) of this template are based on the size of the torso of the smallest user at risk (5th percentile 6-month-old child for Figure B3 and 2-year-old child for Figure B4). If an opening is too small to admit the template, it is also too small to permit feet first entry by a child. Because children’s heads are larger than their torsos, an opening that does not admit the small torso template will also prevent head first entry into an opening by a child.

B.2.5.2 Large head template

The dimensions (see Figure B5) of this template are based on the largest dimension on the head of the largest child at risk (95th percentile 5-year-old child). If an opening is large enough to permit free passage of the template, it is large enough to permit free passage of the head of the largest child at risk in any orientation. Openings large enough to permit free passage of the large head template will not entrap the chest of the largest child at risk.

B.2.5.3 Completely bounded openings with unlimited depth

B.2.5.3.1 Test procedure

- Step 1: Select the appropriate small torso template based on the intended users of the playground (Figure B3 for toddler playgrounds, Figure B4 for preschool- and school-age playgrounds).
- Step 2: Identify all completely bounded openings.
- Step 3: Attempt to place the small torso template in the opening with the plane of the template parallel to the plane of the opening. While keeping it parallel to the plane of the opening, the template should be rotated to its most adverse orientation (i.e., major axis of template oriented parallel to the major axis of the opening.)

- Step 4: Determine if the small torso template can freely pass through the opening.

No: **Pass.** Stop

Yes: Continue



- Step 5: Place the large head template in the opening, again with the plane of the template parallel to the plane of the opening, and try to insert it through the opening.

Pass: The large head template can be freely inserted through the opening

Fail: The opening admits the small torso template but does not admit the large head template.



B.2.5.4 Completely bounded openings with limited depth of penetration

The configuration of some openings may be such that the depth of penetration is a critical issue for determining the entrapment potential. For example, consider a vertical wall or some other barrier behind a step ladder. The entrapment potential depends not only on the dimensions of the opening between adjacent steps but also on the horizontal space between the lower boundary of the opening and the barrier. A child may enter the opening between adjacent steps feet first and may proceed to pass through the space between the rear of the lower step and the barrier and become entrapped when the child's head is unable to pass through either of these two openings. In effect, there are openings in two different planes, and each has the potential for head entrapment and should be tested.

Figure B16 illustrates these two planes for a step ladder as well as for a generic opening. Plane A is the plane of the completely bounded opening in question, and Plane B is the plane of the opening encompassing the horizontal space between the lower boundary of the opening in Plane A and the barrier that should also be tested for entrapment hazards.

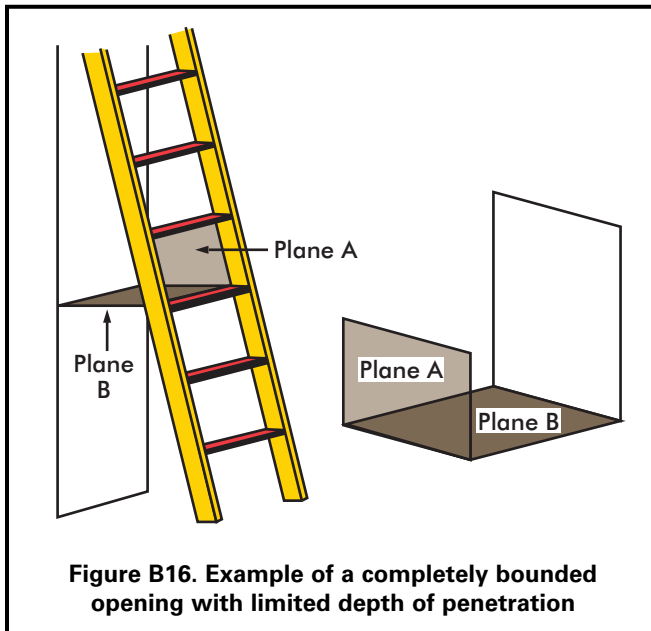

Figure B16. Example of a completely bounded opening with limited depth of penetration

B.2.5.4.1 Test procedure

Step 1: Select the appropriate small torso template based on the intended users of the playground (Figure B3 for toddler playgrounds, Figure B4 for preschool-age and school-age playgrounds).

Step 2: Identify all completely bounded openings with limited depth of penetration.

Step 3: Place the small torso template in the opening in Plane A with its plane parallel to Plane A; rotate the template to its most adverse orientation with respect to the opening while keeping it parallel to Plane A.

Step 4: Determine if the opening in Plane A admits the small torso template in any orientation when rotated about its own axis.

No: Pass. The opening is small enough to prevent either head first or feet first entry by the smallest user at risk and is not an entrapment hazard.

Yes: Continue.

Step 5: Place the small torso template in the opening in Plane B with its plane parallel to Plane B; rotate the template to its most adverse orientation with respect to the opening while keeping it parallel to Plane B.

Step 6: Determine if the opening in Plane B admits the small torso template.

No: Pass. The depth of penetration into the opening in Plane A is insufficient to result in entrapment of the smallest user at risk.

Yes: Continue.

Step 7: Place the large head template (Figure B5) in the opening in Plane A with its plane parallel to Plane A. Determine if the opening in Plane A admits the large head template.

No: Fail. A child, whose torso can enter the opening in Plane A as well as the opening in Plane B, may become entrapped by the head in the opening in Plane A.

Yes: Continue.

Step 8: With the plane of the large head template parallel to the opening in Plane B, determine if the opening in Plane B admits the large head template.

No: Fail. The largest user at risk cannot exit the opening in Plane B.

Yes: Pass. The openings in Plane A and Plane B do not pose an entrapment risk.

B.2.5.5 Flexible openings

Climbing components such as flexible nets are also a special case for the entrapment tests because the size and shape of openings on this equipment can be altered when force is applied, either intentionally or simply when a child climbs on or falls through the openings. Children are then potentially at risk of entrapment in these distorted openings.

The procedure for determining conformance to the entrapment recommendations for flexible openings requires two three-dimensional test probes which are illustrated in Figure B6, Figure B7, and Figure B8 are applied to an opening in a flexible component with a force of up to 50 pounds.

B.2.5.5.1 Test procedure

- Step 1: Select the appropriate small torso template based on the intended users of the playground (Figure B3 for toddler playgrounds, Figure B4 for preschool-age and school-age playgrounds).
- Step 2: Identify all completely bounded openings with flexible sides.
- Step 3: Place the small torso probes (Figures B6 and B7) in the opening, tapered end first, with the plane of its base parallel to the plane of the opening.
- Step 4: Rotate the probe to its most adverse orientation (major axis of probe parallel to major axis of opening) while keeping the base parallel to the plane of the opening.
- Step 5: Determine if the probe can be pushed or pulled completely through the opening by a force no greater than 30 pounds on toddler playgrounds or 50 pounds on preschool-age and school-age playgrounds.

No: Pass. Stop

Yes: Continue.



Step 6: Place the large head probe (Figure B8) in the opening with the plane of its base parallel to the plane of the opening.

Step 7: Determine if the large head probe can be pushed or pulled completely through the opening by a force no greater than 30 pounds on toddler playgrounds or 50 pounds on preschool-age and school-age playgrounds.

Yes: Pass. Stop.



No: Fail.



B.2.5.6 Partially bound openings

A partially bound opening is any opening which has at least one side or portion open, such as a U- or V-shaped opening. These openings can still pose an entrapment hazard by allowing the neck to enter but not allowing the head to slip out. A partially bound opening can be any part of the playground equipment where a child could get his or her neck caught, so it includes not only two- or three-sided openings, but also areas of large openings (large enough for the head template to enter) that have the characteristics that can entrap a child's neck. Several examples outlines of this situation are shown in the figures below. Openings that have an outline similar to these figures are often found when two parts of a playground meet, for example, the top of a slide and the side of a guardrail.

Identifying partially bound openings varies depending on the age range of the playground. Openings that should be tested include any opening where:

For toddlers:

- The perimeter of the opening is not closed
- The lowest leg of the opening is tilted upward (i.e. above horizontal) or 45 degrees below horizontal.

For preschool- and school-age:

- The perimeter of the opening is not closed
- The lowest leg of the opening is tilted upward (i.e. above horizontal)



Examples of partially bound openings. Note, these examples are intended to illustrate the principle of partially bound openings and may or may not require testing.

B.2.5.6.1 Test procedure

Step 1: Select the appropriate Partially Bound Template based on the intended users of the playground (Figure B10 for toddler playgrounds, Figure B9 for preschool and school-age playground).

Step 2: Identify partially bound openings.

Step 3: Align the template so that the face of the template is parallel to the plane of the opening and the narrow tip of the A section is pointing toward the opening.

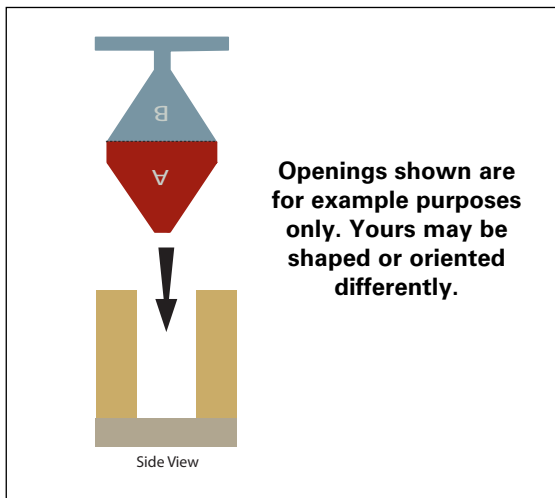

Step 4: Insert the A portion of the template into the opening following the centerline of the opening.

Step 5: Once inserted as far as possible, determine if there is simultaneous contact between the sides of the opening and both of the top corners at the narrow tip of section A.

Yes: Pass. Stop

No: continue

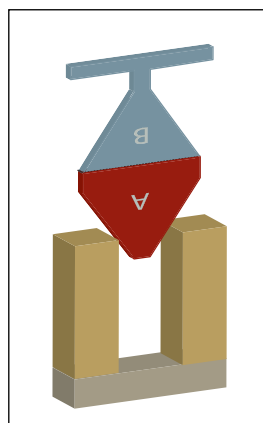
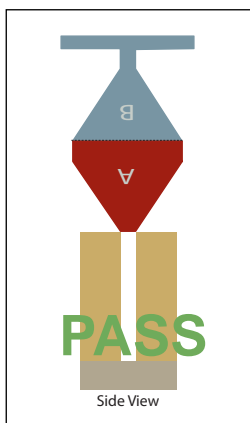

Step 6: While still inserted as far as possible, determine if there is simultaneous contact between both of the angled sides of section A and the sides of the opening.

Yes: Note the points on the sides of opening where contact was made and continue

No: Pass. The narrow tip should be resting on the lower boundary of the opening with no contact with the sides of the opening. Stop

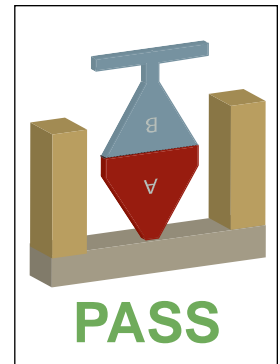
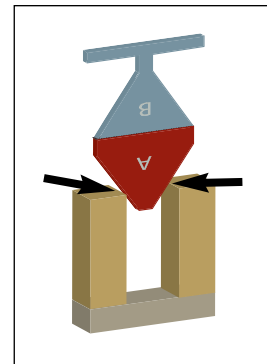

Step 7: Remove the template and turn the template so that the face of the template is perpendicular to the opening.

Step 8: Following the plane of the opening, insert the B portion of the template into the opening so that the narrow part of the B portion is between the sides of the opening.

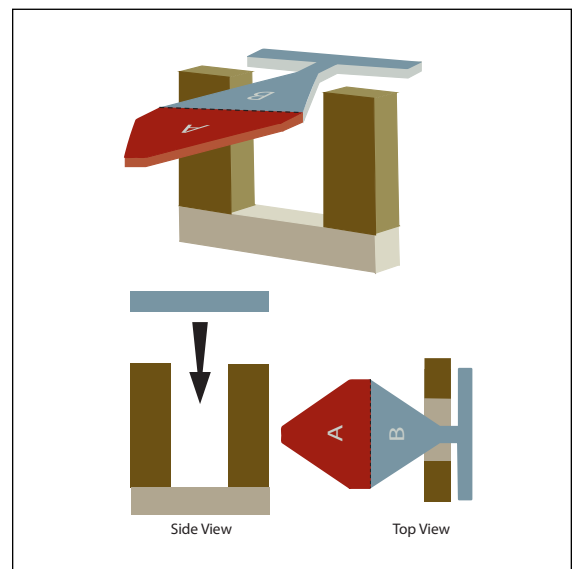

Step 9: Once inserted as far as possible, determine if the B portion is completely past the points where contact was made on the sides of the opening with the A portion.

No: Pass. Stop

Yes: Toddlers:
Fail. Stop

Preschool and
School-age:
Continue

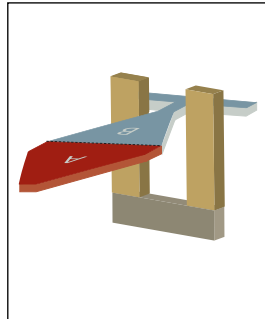
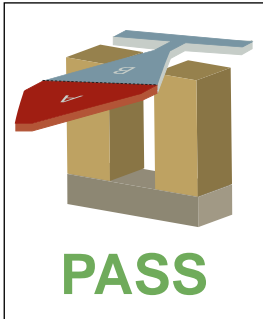

Step 11: Determine if the Large Head Template passes freely through the larger opening.

Yes: Pass

No: Fail

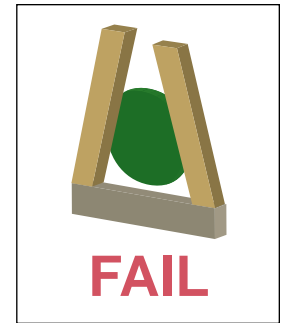
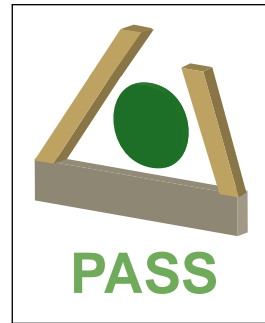

Step 10: Determine if the B portion can reach a point where the opening increases in size.

No: Fail. Stop

Yes: continue

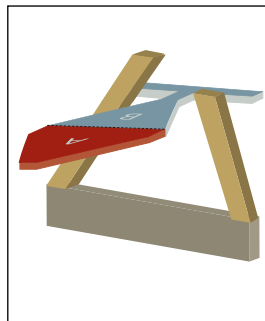
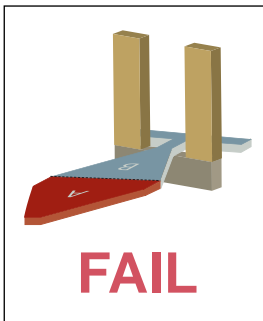

**U.S. CONSUMER PRODUCT
SAFETY COMMISSION**

**4330 EAST WEST HIGHWAY
BETHESDA, MD 20814**

**OFFICIAL BUSINESS
PENALTY FOR PRIVATE USE, \$300**

AN EQUAL OPPORTUNITY EMPLOYER

APPENDIX - E

DISHWASHING PROCEDURE

THIS PAGE INTENTIONALLY LEFT BLANK

APPENDIX E

DISHWASHING PROCEDURE

The best way to wash, rinse, and disinfect dishes and eating utensils is to use a dishwasher with a sanitizing cycle. The final sanitizing rinse of a dishwasher must reach a temperature of 180 degrees. If a dishwasher is not available or cannot be installed, a three-compartment sink will be needed to wash, rinse, and disinfect dishes. A two-compartment or one-compartment sink can be used in child care facilities (located in an occupied residence) licensed for 12 or fewer children by adding one or two dishpans, as needed. In addition to three compartments or dishpans, you will need a dish rack with a drain board to allow dishes and utensils to air dry. To wash, rinse, and disinfect dishes by hand:

- Fill one sink compartment or dishpan with hot tap water and a dishwashing detergent.
- Fill the second compartment or dishpan with hot tap water.
- Fill the third compartment or dishpan with hot tap water and 1-1/2 tablespoons of liquid chlorine bleach for each gallon of water.
- Scrape dishes and utensils and dispose of excess food.
- Immerse scraped dish or utensil in first sink compartment or dishpan and wash thoroughly.
- Rinse dish or utensil in second dishpan of clear water.
- Immerse dish or utensil in third dishpan of chlorinated water for at least 1 minute.
- Place dish or utensil in a rack to air dry.

Note: Food preparation and dishwashing sinks should only be used for these activities and should never be used for routine hand washing or diaper changing activities.

Source: The ABCs of Safe and Healthy Child Care: A Handbook for Child Care Providers, Department of Health and Human Services, U.S. Public Health Service, Centers for Disease Control and Prevention.

Source: Miss. Code Ann. §43-20-8.

THIS PAGE INTENTIONALLY LEFT BLANK

APPENDIX - F

HAND WASHING PROCEDURE

THIS PAGE INTENTIONALLY LEFT BLANK

APPENDIX F

HAND WASHING PROCEDURE

- Always use warm, running water and a mild, preferably liquid, soap. Antibacterial soaps may be used, but are not required. Pre-moistened cleansing towelettes do not effectively clean hands and do not take the place of hand washing.
- Wet the hands and apply a small amount (dime to quarter size) of liquid soap to hands.
- Rub hands together vigorously until a soapy lather appears and continue for at least 15 seconds. Be sure to scrub between fingers, under fingernails, and around the tips and palms of the hands.
- Rinse hands under warm running water. Leave the water running while drying hands.
- Dry hands with a clean, disposable (or single use) towel, being careful to avoid touch the faucet handles or towel holder with clean hands.
- Turn the faucet off using the towel as a barrier between your hands and the faucet handle.
- Discard the used towel in a trash can lined with a fluid-resistant (plastic) bag. Trash cans with foot-pedal operated lids are preferable.
- Consider using hand lotion to prevent chapping of hands. If using lotions, use liquids or tubes that can be squirted so that the hands do not have direct contact with container spout. Direct contact with the spout could contaminate the lotion inside the container.
- When assisting a child in hand washing, either hold the child (if an infant) or have the child stand on a safety step at a height at which the child's hands can hang freely under the running water. Assist the child in performing all of the above steps and then wash your own hands.

Source: The ABCs of Safe and Healthy Child Care: A Handbook for Child Care Providers, Department of Health and Human Services, U.S. Public Health Service, Centers for Disease Control and Prevention.

Source: Miss. Code Ann. §43-20-8.

THIS PAGE INTENTIONALLY LEFT BLANK

APPENDIX - G

DIAPER CHANGING PROCEDURE

THIS PAGE INTENTIONALLY LEFT BLANK

APPENDIX G

PROCEDURE FOR DIAPERING A CHILD

Either of the following two procedures is acceptable in a child care facility for licensing purposes.

Procedure #1

1. Organize needed supplies within reach:
 - a. fresh diaper and clean clothes (if necessary)
 - b. dampened paper towels or premoistened towelettes for Cleaning child's bottom
 - c. child's personal, labeled, ointment (if provided by parents)
 - d. trash disposal bag
2. Place a disposable covering (such as roll paper) on the portion of the diapering table where you will place the child's bottom. Diapering surfaces should be smooth, nonabsorbent, and easy to clean. Don't use areas that come in close contact with children during play such as couches, floor areas where children play, etc.
3. If using gloves, put them on now.
4. Using only your hands, pick up and hold the child away from your body. Don't cradle the child in your arms and risk soiling your cloths.
5. Lay the child on the paper or towel.
6. Remove soiled diaper (and soiled clothes).
7. Put disposable diapers in a plastic-lined trash receptacle.
8. Put soiled reusable diaper and /or soiled clothes **WITHOUT RINSING** in a plastic bag to give to parents.
9. Clean child's bottom with some premoistened disposable towelettes or a dampened, single-use, disposable towel.
10. Place the soiled towelettes or towel in a plastic-lined trash receptacle.
11. If the child needs a more thorough washing, use soap, running water, and paper towels.
12. Remove the disposable covering from beneath the child. Discard it in a plastic-lined receptacle.
13. If you are wearing gloves, remove and dispose of them now in a plastic-lined receptacle.
14. Wash your hands. **NOTE:** The diapering table should be next to a sink with running water so that you can wash your hands without leaving the diapered child unattended.

However, if a sink is not within reach of the diapering table, don't leave the child unattended on the diapering table to go to a sink; wipe your hands with some premoistened toweletts instead. NEVER leave a child alone on the diapering table.

15. Wash the child's hands under running water.
16. Diaper and dress the child.
17. Disinfect the diapering surface immediately after you finish diapering the child.
18. Return the child to the activity area.
19. Clean and disinfect:
 - a. The diapering area,
 - b. all equipment or supplies that were touched, and
 - c. soiled crib or cot, if needed.
20. Wash your hands under running water.

Source: The ABCs of Safe and Healthy Child Care: A Handbook for Child Care Providers, Department of Health and Human Services, U.S. Public Health Service, Centers for Disease Control and Prevention.

Procedure #2

1. Caregiver washes hands
2. Prepare for diapering by gathering wipes, diaper, plastic bag, clean clothes, gloves, and other supplies needed. Bring materials to the diaper changing area but not on the changing table
3. Place child on diapering table. Remove clothing to access diaper. If soiled, place clothes into plastic bag.
4. Remove soiled diaper and place into plastic-lined, hands-free covered trash container. (To limit odor, seal in a plastic bag before placing into trash containers.)
5. Use wipes to clean child's bottom from front to back. Use a fresh wipe for each swipe.
6. If gloves were used, remove at this point.
7. Use a wipe to remove soil from adult's hands.
8. Use another wipe to remove soil from child's hands.
9. Throw soiled wipes into plastic-lined, hands-free covered trash container.

10. Put on clean diaper and redress child.
11. Place child at sink and wash hands using the proper hand washing procedure. Return child to a supervised play area without contaminating any surface
12. Spray the surface of the diapering table with soap-water solution to remove gross soil. Wipe clean using a disposable towel and throw away in a plastic-lined, hands-free covered trash container. Be sure the surface is dried completely.
13. Spray the surface of the diapering table with clear water (recommended). Wipe dry using a disposable towel and throw away in a plastic-lined, hands-free covered trash container.
14. Spray the diapering surface with disinfecting strength bleach-water solution (completely cover table; table should glisten) and wait for 2 minutes before wiping dry with a disposable towel or allow to air dry. Dispose of the towel in a plastic-lined, hands-free covered trash container.
15. Adult washes hands using the proper hand washing procedure.

Source: *Caring for Our Children: National Health and Safety Performance Standards; Guidelines for Early Care and Education Programs, 3rd Edition*, American Academy of Pediatrics, American Public Health Association, National Resource Center for Health and Safety in Child Care and Early Education, 2011.

Source: *Miss. Code Ann. §43-20-8*.

THIS PAGE INTENTIONALLY LEFT BLANK

APPENDIX - H

**CLEANING
AND
DISINFECTION
PROCEDURES**

THIS PAGE INTENTIONALLY LEFT BLANK

APPENDIX H

CLEANING AND DISINFECTION PROCEDURES

Keeping the child care environment clean and orderly is very important for health, safety, and the emotional well-being of both children and providers. One of the most important steps in reducing the number of germs, and therefore the spread of disease, is the thorough cleaning of surfaces that could possibly pose a risk to children or staff. Surfaces considered most likely to be contaminated are those with which children are most likely to have close contact. These include toys that children put in their mouths, crib rails, food preparation areas, and surfaces likely to become very contaminated with germs, such as diaper-changing areas.

Routine cleaning with soap and water is the most useful method for removing germs from surfaces in the child care setting. Good mechanical cleaning (scrubbing with soap and water) physically reduces the numbers of germs from the surface, just as hand washing reduces the numbers of germs from the hands. Removing germs in the child care setting is especially important for soiled surfaces which cannot be treated with chemical disinfectants, such as some upholstery fabrics.

However, some items and surfaces should receive an additional step, **disinfection**, to kill germs after cleaning with soap and rinsing with clear water. Items that can be washed in a dishwasher or hot cycle of a washing machine do not have to be disinfected because these machines use water that is hot enough for a long enough period of time to kill most germs. The disinfection process uses chemicals that are stronger than soap and water. Disinfection also usually requires soaking or drenching the item for several minutes to give the chemical time to kill the remaining germs. Commercial products that meet the Environmental Protection Agency's (EPA's standards for "hospital grade" germicides (solutions that kill germs) may be used for this purpose. One of the most commonly used chemicals for disinfection in child care settings is a homemade solution of household bleach and water. Bleach is cheap and easy to get. The solution of bleach and water is easy to mix, is nontoxic, is safe if handled properly, and kill most infectious agents. (Be aware that some infectious agents are not killed by bleach. For example, cryptosporidia is only killed ammonia or hydrogen peroxide.)

A solution of bleach and water loses its strength very quickly and easily. It is weakened by organic material, evaporation, heat, and sunlight. Therefore, bleach solutions should be mixed fresh each day to make sure it is effective. Any leftover solution should be discarded at the end of the day. NEVER mix bleach with anything but fresh tap water! Other chemicals may react with bleach and create and release a toxic chlorine gas.

Keep the bleach solution you mix each day in a cool place out of direct sunlight and out of the reach of children. (Although a solution of bleach and water mixed as shown in the accompanying box should not be harmful if accidentally swallowed, you should keep all chemicals away from children.)

If a child care facility uses a commercial cleaner, sanitizer, or disinfectant it must be a U.S. Environmental Protection Agency (EPA)-registered product that has an EPA registration number on the label. Such products shall only be used according to the manufacturer's instructions.

NOTE: All EPA-registered products may not be appropriate for use in a child care facility. Therefore, it is the responsibility of the facility to make sure any product use is appropriate for use in a child care facility.

Recipe for Bleach Disinfecting Solution

(For use on non-porous surfaces such as diaper change tables, counter tops, door and cabinet handles toilets, etc.)

1/4 - 3/4 cup bleach
1 gallon of cool water

OR

1 - 3 tablespoon bleach
1 quart of cool water

Apply as a spray or poured fresh solution, not by dipping into a container with a cloth that has been in contact with a contaminated surface.

Add the household bleach (5.25% sodium hypochlorite) to the water.

Recipe for Weaker Bleach Sanitizing Solution

For food contact surfaces sanitizing, e.g., dishes, utensils, cutting boards, highchair trays, and toys, that children may place in their mouths, and pacifiers.

1 tablespoon bleach
1 gallon cool water

Add the bleach to the water

Washing and Disinfecting Toys

- Infants and toddlers should not share toys. Toys that children (particularly infants and toddlers) put in their mouths should be washed and disinfected between uses by individual children. Toys for infants and toddlers should be chosen with this in mind. If you cannot wash a toy, it probably is not appropriate for an infant or toddler.
- When an infant or toddler finishes playing with a toy, you should retrieve it from the play area and put it in a bin reserved for dirty toys. This bin should be out of reach of the

children. Toys can be washed at a later, more convenient time, and then transferred to a bin for clean toys and safely reused by the other children.

- To wash and disinfect a hard plastic toy:
 - Scrub the toy in warm, soapy water. Use a brush to reach into the crevices.
 - Rinse the toy in clean water.
 - Immerse the toy in a mild bleach solution (see above) and allow it to soak in the solution for 10-20 minutes.
 - Remove the toy from the bleach and rinse well in cool water.
 - Air dry.
- Hard plastic toys that are washed in a dishwasher or cloth toys washed in the hot water cycle of the hot water cycle of a washing machine do not need to be additionally disinfected.
- Children in diapers should only have washable toys. Each group of children should have its own toys. Toys should not be shared with other groups.
- Stuffed toys used by only a single child should be cleaned in a washing machine every week or more frequently if heavily soiled.
- Toys and equipment used by older children and not put into their mouths should be cleaned at least weekly and when obviously soiled. A soap and water wash followed by clear water rinsing and air drying should be adequate. No disinfection is required. (These types of toys and equipment include blocks, dolls, tricycles, trucks, and other similar toys.).
- Do not use wading pools for children in diapers.
- Water play tables can spread germs. To prevent this:
 - Disinfect the table with chlorine bleach solution before filling it with water.
 - Disinfect the all toys to be used in the table with chlorine bleach solution. Avoid using sponge toys. They can trap bacteria and are difficult to clean.
 - Have all children wash their hands before and after playing in the water table.
 - Do not allow children with open sores or wounds to play in the water table.
 - Carefully supervise the children to make sure they do not drink the water.
 - Discard water after play is over

Washing and Disinfecting Bathroom and Other Surfaces

Bathroom surfaces, such as faucet handles and toilet seats, should be washed and disinfected several times a day, if possible, but at least once a day or when soiled. The bleach and water solution or chlorine-containing scouring powders or other commercial bathroom surface cleaner/disinfectants can be used in these areas. Surfaces that infants and young toddlers are likely to touch or mouth, such as crib rails, should be washed with soap and water and disinfected with a nontoxic disinfectant, such as bleach solution, at least once every day, more often if visibly soiled. After the surface has been drenched or soaked with the disinfectant for at least 10 minutes, surfaces likely to be mouthed should be thoroughly wiped with a fresh towel

moistened with tap water. Be sure not to use a toxic cleaner on surfaces likely to be mouthed. Floors should be washed and disinfected at least once a day and whenever soiled.

Washing and Disinfecting Diaper Changing Areas

Diaper Changing Areas should:

- Only be used for changing diapers.
- Be smooth and nonporous, such as Formica (NOT wood).
- Have a raised edge or low fence around the area to prevent a child from falling off.
- Be next to a sink with hot and cold running water.
- Not be used to prepare food, mix formula, or rinse pacifiers.
- Be easily accessible to providers.
- Be out of reach of children.

Diaper changing areas should be cleaned and disinfected after each diaper changer as follows:

- Clean the surface with soap and water and rinse with clear water.
- Dry the surface with a paper towel.
- Thoroughly wet the surface with the recommended bleach solution.
- Wipe dry with a clean disposable towel or air dry. If using a commercial disinfectant/sanitizer, follow labeled manufacturer's instructions.

Washing and Disinfecting Clothing, Linen, and Furnishings

Do not wash or rinse clothing soiled with fecal material in the child care setting. You may empty solid stool into the toilet, but be careful not to splash or touch toilet water with your hands. Put the soiled clothes in a plastic bag and seal the bag to await pick up by the child's parent or guardian at the end of the day. Always wash your hands after handling soiled clothing.

Explain to parents that washing or rinsing soiled diapers and clothing increases the chances that you and the children may be exposed to germs that cause diseases. Although receiving soiled clothes is not pleasant, remind parents that this policy protects the health of all children and providers. Each item of sleep equipment, including cribs, cots, mattresses, blankets, sheets, etc., should be cleaned and sanitized before being assigned to a specific child. The bedding items should be labeled with that child's name, and should only be used by that child. Children shall not share bedding. Infants linens (sheets, pillowcases, blankets) shall be cleaned and sanitized daily, and crib mattresses shall be cleaned and sanitized weekly and when soiled or wet. Linens from beds of older children shall be laundered at least weekly and whenever soiled. However, if a child inadvertently used another child's bedding, you shall change the linen and mattress cover before allowing the assigned child to use it again. All blankets shall be changed and laundered routinely at least once a week.

Cleaning up Body Fluid Spills

Spills of body fluids, including blood, feces, nasal and eyed discharges, saliva, urine, and vomit shall be cleaned up immediately. Wear gloves unless the fluid can be easily contained by the material (e.g., paper tissue or cloth) that is being used to clean it up. Be careful not to get any of

the fluid you are cleaning in your eyes, nose, mouth or any open sores you may have. Clean and disinfect any surfaces, such as counter tops and floors, on which body fluids have been spilled. Discard fluid-contaminated material in a plastic bag that has been securely sealed. Mops used to clean up body fluids should be (1) cleaned, (2) rinsed with a disinfecting solution, (3) wrung as dry as possible, and (4) hung to dry completely. Be sure to wash your hands after cleaning up any spill.

Source: The ABCs of Safe and Healthy Child Care: A Handbook for Child Care Providers, Department of Health and Human Services, U.S. Public Health Service, Centers for Disease Control and Prevention (as amended by MSDH).

Source: Miss. Code Ann. §43-20-8.

THIS PAGE INTENTIONALLY LEFT BLANK

APPENDIX - I

**COMMUNICABLE
DISEASES/CONDITIONS
AND
RETURN TO CHILD
CARE
GUIDELINES**

THIS PAGE INTENTIONALLY LEFT BLANK

APPENDIX I

COMMUNICABLE DISEASES/CONDITIONS AND RETURN TO CHILD CARE

TABLE OF CONTENTS

INTRODUCTION3

GENERAL INFORMATION4

IMMUNIZATION REQUIREMENTS5

EXCLUSION CRITERIA7

CHICKENPOX (VARICELLA) & SHINGLES (VARICELLA ZOSTER)8

CYTOMEGALOVIRUS (CMV)9

DIARRHEAL DISEASES9

E. COLI O157:H710

FIFTH DISEASE10

“FLU” (INFLUENZA)11

HAND-FOOT-AND-MOUTH DISEASE11

HEAD LICE.....12

HEPATITIS A12

HEPATITIS B13

HEPATITIS C13

HIV/AIDS13

IMPETIGO14

MEASLES14

MENINGITIS15

MUMPS15

“PINK EYE” (CONJUNCTIVITIS)16

PINWORMS16

RESPIRATORY SYNCYTIAL VIRUS (RSV)16

RINGWORM17

SCABIES17

“STREP THROAT” (STREPTOCOCCAL PHARYNGITIS)
& SCARLET FEVER.....18

TUBERCULOSIS (TB)18

WHOOPING COUGH (PERTUSSIS)18

EXAMPLE PERMISSION SLIP TO COLLECT STOOL SPECIMENS AND
RECEIVE TEST RESULTS FOR OUTBREAKS OF DIARRHEAL DISEASES20

ATTACHMENT A
“RECOMMENDATIONS FOR THE CONTROL OF HEAD LICE IN THE CHILD CARE
SETTING”

INTRODUCTION

COMMUNICABLE DISEASES/CONDITIONS AND RETURN TO CHILD CARE

Childcare providers frequently must make decisions regarding when children with communicable diseases/conditions should be allowed to attend or return to the out-of-home child care setting (a large child care center or where child care is provided in a private residence for more than one child). We hope the information provided in this booklet will help with these decisions. It contains information about the most common or important communicable diseases/conditions and how they are spread. Information is listed about the different times during which infectious agents may be transmitted from one person to another, and when it is usually safe for someone who has one of these conditions to return to the center. The “return to child care times” are based on the usual period of time that a person is considered to be contagious — **not** on the period of time that may be necessary for full clinical recovery from the signs or symptoms of an illness which may vary a great deal from person to person.

While **this booklet will serve as a guide** for child care attendance of children with communicable conditions, the Mississippi State Department of Health (MSDH) welcomes the opportunity to help with your decisions. You may contact your district health department office (see district map on page 18) or the Division of Epidemiology at the MSDH in Jackson to speak with a consultant.

***** THIS booklet is NOT intended to be used to DIAGNOSE an illness or infection. It SHOULD NOT REPLACE a diagnosis by trained MEDICAL personnel.*****

GENERAL INFORMATION

Small children who are cared for in out-of-home group settings are at a greater risk of acquiring and spreading a contagious disease. Small children are highly susceptible to contagious diseases since most of them have not been exposed to many of the most common germs and therefore do not have any immunity to them. Young children also have certain habits (e.g., putting their fingers and other objects in their mouths) that can easily spread germs. Even though contagious diseases/conditions will occur in a child care setting, the child care provider must do everything he or she can to prevent and control the spread of disease. **The use of common sense hygienic practices, especially frequent and thorough hand washing cannot be stressed enough!** Also, making sure that staff and children are up to date on their immunizations helps to lessen the risk of exposure to contagious diseases.

Reportable diseases: There are 4 classes of reportable diseases. Class I diseases are those of major public health importance and are to be reported upon first knowledge or suspicion and are usually reported by the physician, hospital or laboratory. However, the MSDH encourages child care providers who know of a child in their facility who has been diagnosed with a disease such as meningitis or measles to report it to the Health Department. This can sometimes help to expedite the investigation. Class II diseases may require public health intervention also, especially if there are several cases in one room (e.g., diarrheal diseases such as shigella and giardia).

When a Class I reportable disease is reported to the MSDH, there will be an investigation. The immediacy of the response by the MSDH and the extent of the investigation depend on the disease the person has. For example, if a child has been reported to have meningococcal meningitis, an investigation would take place as soon as the report is received. It is the goal of the MSDH to provide preventive medication to those for whom it would be indicated within 24 hours of receiving the report. A current list of the reportable diseases is provided in Appendix B of the Child Care Rules and Regulations.

Outbreaks/parental permission for laboratory tests: During times when there are outbreaks of *Giardia*, *Shigella* infection, etc., large numbers of stool specimens may be requested by the MSDH. The MSDH recommends that child care facilities obtain permission from parents or guardians at the time of enrollment for the child care facility to collect these stool specimens and receive the laboratory results if and when such an outbreak occurs. These laboratory tests would be done by the MSDH Laboratory free of charge. The laboratory test results would be sent to the child care facility and given to the parents/guardians by the child care facility for them to give to the child's physician. (See sample permission slip on page 17)

Handouts: It is good practice to keep parents informed as to what diseases might be occurring in the child care facility so that they can be alert to signs and symptoms of diseases and observe their children for them. We have provided a packet with fact sheets/handouts on certain diseases for you to give to parents.

CHILD CARE IMMUNIZATION REQUIREMENTS (FOR ATTENDEES AND STAFF)

ATTENDEES

The MSDH regulations governing the licensure of child care facilities mandate that each child in a licensed facility have immunizations according to the recommended immunization schedule. These children are to be **age-appropriately immunized** and must have a Certificate of Immunization Compliance (Form 121) or a Certificate of Medical Exemption (Form 122) on file at the child care facility and readily accessible for review by the MSDH. The Form 121 must be signed by the District Health Officer, a physician, nurse, or designee. The medical exemption, Form 122, **MUST** be signed by the District Health Officer. Children enrolled in licensed child care facilities and public and private schools in Mississippi may be exempt for *medical reasons only* and not for religious reasons.

Children usually begin their routine immunizations between 6 weeks and 2 months of age. The immunizations that are currently **required** at the age-appropriate times for child care are: DTaP (diphtheria, tetanus, pertussis), polio, MMR (measles, mumps, rubella), and HIB (*H. Influenzae* type b). Hepatitis B vaccine is a recommended vaccine, and is usually started at birth to 2 months of age. Hepatitis B is **not required for child care** attendance but **is required for entry into 5 year old kindergarten**.

As of August 01, 2002, one (1) dose of Varicella (chicken pox) vaccine is required on or after the 1st birthday and is required for entry into five (5) year-old kindergarten. Varicella is not required if a history of the disease is documented.

Children enrolled in a licensed child care facility or Head Start Center are expected to be age appropriately immunized. All children must have one of the following forms before enrollment in a licensed Child Care/Head Start facility.

1. Certificate of Immunization Compliance (Form 121). This form must be signed by the District Health Officer, a physician, nurse, or designee.
2. Certificate of Medical Exemption (Form 122). This form must be approved and signed by the Mississippi Department of Health District Health Officer from the public health district or the State Epidemiologist.

STAFF

Anyone (whether full or part-time and even if they are the owner/director) who works in a licensed child care facility must have a Certificate of Immunization Compliance (Form 121) or a Certificate of Medical Exemption from Immunization Requirements for Adults (Form 132) on file and readily accessible for review by the MSDH. The requirement for adults is that they must show proof of immunity to **measles** (rubeola or “red” measles) and **rubella** (“German” or “3-day” measles).

Proof of immunity to measles: Persons born prior to 01-01-1957 are assumed to have natural immunity to measles. Persons born on or after 01-01-1957 must show proof of immunity in one of the following ways:

1. A **physician's statement** saying that the person has had measles disease.
2. **Serological (a blood test)** confirmation of measles immunity.
3. A record of **2 doses** of measles-containing vaccine (usually given as MMR) given on or after the first birthday and on or after 01-01-1968. There must be a minimum time interval of 30 days between the 2 doses.

Proof of immunity to rubella: All child care workers, **regardless of age**, must show proof of immunity to rubella in one of the following ways:

1. **Serological (blood test)** confirmation of rubella immunity.
2. A **rubella vaccination** received on or after 12 months of age and on or after 01-01-1969.

The MSDH does not provide serological testing for measles and rubella for the purpose of child care/school attendance or private employment. Those who wish to have a blood test for proof of immunity to measles and/or rubella should see their private physician.

The Child Care Licensure Division of the MSDH checks the immunization records in child care facilities during regular program reviews. District Immunization Representatives also visit child care centers on a random basis to inspect the immunization records of the children and the employees. The purpose of these visits is to verify the presence of the Certificates of Immunization Compliance. These visits also help to ensure adequate immunization of children enrolled in child care facilities.

EXCLUSION CRITERIA

Small children can become ill very quickly. The child care provider should observe each child's health throughout the time the child is in their care. If the child care provider observes signs and symptoms of illness that would require removal from the facility, he/she should contact the parents/guardians to have the child picked up and continue to observe the child for other signs and symptoms. **If the child is not responding to you, is having trouble breathing, or is having a seizure or convulsion, call 911.**

The following conditions require exclusion from child care:

Fever: Defined as 100°F or higher taken under the arm, 101°F taken orally, or 102°F taken rectally. For children 4 months or younger, the lower rectal temperature of 101°F is considered a fever threshold.

Diarrhea: Frequent (3 or more episodes in a 24-hour period) runny, watery, or bloody stools. **According to CDC recommendations, a child who is not toilet trained and has diarrhea should be excluded from child care settings regardless of the cause.**

Vomiting: Two or more times in a 24-hour period

Rash:	Body rash with a fever
Sore throat:	Sore throat with fever and swollen glands
Severe coughing:	The child gets red or blue in the face or makes high-pitched whooping sound after coughing.
Eye discharge:	Thick mucus or pus draining from the eye
Jaundice:	Yellow eyes and skin
Irritability:	Continuous irritability and crying

CHICKENPOX (VARICELLA)

Chickenpox is a highly infectious viral disease that begins with small red bumps that turn into blisters after several hours. The blisters generally last for 3-4 days and then begin to dry up and form scabs. These lesions (bumps/blisters) almost always appear first on the trunk rather than the extremities.

Mode of transmission: Airborne droplets of nose and throat secretions coughed into the air by someone who has chickenpox. Also by direct contact with articles freshly soiled with discharge from the blisters and/or discharge from the nose and mouth (e.g., tissues, handkerchiefs, etc.).

Notification: Notify parents/guardians and staff members that a case of chickenpox has occurred, especially those parents whose child is taking steroid medications, being treated with cancer or leukemia drugs or has a weakened immune system for some reason. Staff members who are pregnant and have never had chickenpox disease or the chickenpox vaccine should consult their physician immediately. A special preventive treatment may be indicated for those with a weakened immune system and non-immune pregnant women. This treatment must be given **within 96 hours** of the exposure to be effective.

Vaccine: As of August 01, 2002, one (1) dose of Varicella (chicken pox) vaccine is required on or after the 1st birthday and is required for entry into five (5) year-old kindergarten. Varicella is not required if a history of the disease is documented.

Return to child care: Once the diagnosis has been made, determine the day that the blisters first appeared. The child may return to child care on the 6th day after the blisters first appeared or earlier if all the lesions are **crusted and dry and no new ones are forming**. Keeping the child home until all the lesions are completely healed is unnecessary and results in excessive absences.

SHINGLES (VARICELLA ZOSTER)

Shingles (varicella zoster) is a reactivation of the chickenpox virus (varicella). After the initial infection with chickenpox, the virus continues to lie dormant (inactive) in a nerve root. We tend to think of the elderly and immunosuppressed individuals as the ones who have shingles; however, it can and does occur sometimes in children. The lesions or blisters of shingles resemble those of chickenpox and usually appear in just one area or on one side (unilateral) of the body and run along a nerve pathway. A mild shingles-like illness has been reported in healthy children who have had the chickenpox vaccine. This is a rare occurrence.

Mode of transmission: It is possible for someone who has never had chickenpox disease or the vaccine to get chickenpox by coming in contact with the fluid from the lesions of someone who has shingles. Shingles itself is not transmissible. A person who has shingles does not transmit chickenpox through the air as does someone who has chickenpox disease.

Return to child care: The child who has shingles may attend child care if the lesions can be covered by clothing. If the lesions cannot be covered, the child should be excluded until the lesions are crusted and dry. Staff members who have shingles pose little risk to others since the lesions would be covered by clothing or a dressing on exposed areas. **Thorough hand washing** is warranted whenever there is contact with the lesions.

NOTE: Staff members, especially those who are pregnant, who have no history of chickenpox disease or chickenpox vaccine, should not take care of children with shingles during the time they have active or fluid-filled lesions.

CYTOMEGALOVIRUS (CMV)

CMV is a viral illness that most people become infected with during childhood. Small children usually have no symptoms when they become infected, but older children may develop an illness similar to mononucleosis with a fever, sore throat, malaise or feeling very tired and an enlarged liver.

Mode of transmission: CMV is spread from person to person by direct contact with body fluids such as urine, saliva, or blood. The virus can also be passed from the mother to the baby before birth.

Pregnancy: Rarely, a woman may contract the disease for the first time during pregnancy which may pose a risk to the fetus causing certain birth defects. CDC recommends that women who are child care providers and who expect to become pregnant should be tested for antibodies to CMV and if the test shows no evidence of previous CMV infection, they should reduce their contact with infected children by working, at least temporarily, with children 2 years of age and older where there is less circulation of the virus. Also, they should avoid kissing an infected child on the lips, and as with any child care situation, **wash hands** thoroughly after each diaper change and contact with a child's saliva. If contact with children does not involve exposure to saliva or urine, there should be no fear of potential infection with CMV.

Return to child care: There is no need to exclude children with CMV from child care as long as they do not have a fever since the virus may be excreted in urine and saliva for many months and may persist or there may be recurring episodes for several years following the initial infection. CMV is a virus that may persist as a latent infection and recur when a person becomes immunosuppressed with conditions such as cancer, AIDS, etc.

DIARRHEAL DISEASES (e.g., campylobacteriosis, cryptosporidiosis, giardiasis, rotavirus, salmonellosis, shigellosis) - See *E. coli* O157:H7 and Hepatitis A sections for specific return-to-child- care recommendations regarding these 2 diseases.

Diarrhea is defined as frequent (3 or more episodes within a 24 hour period), runny, watery stools and can be caused by different types of organisms such as viruses, bacteria and parasites.

Mode of transmission: Diarrheal diseases are generally transmitted or spread by ingesting food or water or by putting something in the mouth such as a toy that has been contaminated with the feces (stool/poop) of an infected person or animal. In some cases such as with *Salmonella* and *E. coli* O157:H7, the disease is transmitted by eating raw or undercooked meats (especially ground beef and poultry) and unpasteurized milk and fruit juices.

Notification: Notify parents/guardians of children in the involved room of the illness. Ask that they have any child with diarrhea, severe cramping, or vomiting evaluated by a physician and that they inform the day care of diarrheal illness in their child and family.

Outbreak situation: Most diarrheal diseases are reportable to the State Department of Health. When there are 2 or more cases of a diarrheal disease in one room, more extensive notification may need to be done as stool specimens may need to be collected. In this case, the director of the child care should consult with the Public Health District Epidemiology Nurse or the Division of Epidemiology at the State Department of Health. (See Public Health District Map on page 18 for addresses and telephone numbers)

Return to child care: In most cases, a child may return to child care after a diarrheal illness once he or she is **free of fever** and the **diarrhea has ceased**.

***E. COLI* O157:H7**

Escherichia (E.) coli bacteria are found in the intestines of most humans and many animals. These infections are usually harmless. However, certain strains of the bacteria such as the O157:H7 can cause severe illness. Some persons who are infected with *E. coli* O157:H7 may have a mild disease while others develop a severe, bloody diarrhea. In some cases, the infection may cause a breakdown of the red blood cells which can lead to HUS or hemolytic uremic syndrome.

Mode of transmission: *E. coli* O157:H7 is usually the result of eating undercooked meat, especially hamburger. There have also been cases reported from drinking **unpasteurized** apple

juice. Person-to-person transmission may occur by contact with the feces or stool of an infected person.

Notification: Notify the staff and parents/guardians that a case of *E. coli* O157:H7 has occurred and ask that they have their child evaluated by a physician if they have diarrhea, especially bloody diarrhea. *E. coli* O157:H7 is a Class I reportable disease and a follow-up investigation will be done by the Health Department.

Return to child care: The infected child should not be in or allowed to return to a child care center until his/her diarrhea has ceased and 2 consecutive negative stool samples are obtained (collected not less than 24 hours apart and not sooner than 48 hours after the last dose of antibiotics).

FIFTH DISEASE (ERYTHEMA INFECTIONOSUM)

This is an infectious disease characterized by a “slapped -face” (redness) appearance of the cheeks followed by a rash on the trunk and extremities.

Mode of transmission: Person-to-person spread by direct contact with nose and throat secretions of an infected person. Transmission of infection can be lessened by routine hygienic practices which include hand washing and the proper disposal of facial tissues containing respiratory secretions.

Notification: Notify parents/guardians and staff members that fifth disease is occurring in the child care facility. Staff members who are pregnant should consult their obstetrician if children in their room have fifth disease.

Return to child care: Children with fifth disease may attend child care if they are **free of fever**, since by the time the rash begins they are no longer contagious. The rash may come and go for several weeks.

“FLU” (INFLUENZA)

Influenza is an acute (sudden onset) viral disease of the respiratory tract characterized by fever, headache, muscle aches, joint pain, malaise, nasal congestion, sore throat, and cough. Influenza in children may be indistinguishable from diseases caused by other respiratory viruses.

Mode of transmission: Direct contact with nose and throat secretions of someone who has influenza - airborne spread by these secretions coughed into the air.

Return to child care: The child may return to child care when **free of fever** and feeling well. The closing of individual schools and child care centers has not proven to be an effective control measure. By the time absenteeism is high enough to warrant closing, it is too late to prevent spread.

HAND-FOOT- AND- MOUTH DISEASE

This is a common childhood disease caused by a strain of coxsackievirus. In some people, the virus causes mild to no symptoms. In others, it may result in painful blisters in the mouth and on the palms of the hands and the soles of the feet.

Mode of transmission: The virus can be spread through saliva from the blisters in the mouth and from the fluid from the blisters on the hands and feet. It is also spread through the feces or stool of an infected person.

Notification: Notify parents/guardians and staff that there are cases of hand-foot-and-mouth disease in the child care facility so that they can be alert to the signs and symptoms.

Return to child care: The virus may be excreted in the stool for weeks after the symptoms have disappeared. **Children who have blisters in their mouths and drool or who have weeping or active lesions/blisters on their hands should be excluded from child care until the lesions are crusted and dry and the child is free of fever.**

HEAD LICE

This is an infestation of the scalp by small “bugs” called lice. They firmly attach egg sacs called “nits” to the hairs, and these nits are difficult to remove. Treatment may be accomplished with prescription or over-the-counter medicines applied to the scalp.

Mode of transmission: Direct contact with an infested person’s hair (head-to-head) and, to a lesser extent, direct contact with their personal belongings, especially shared clothing and headgear. Head lice do not jump or fly from one person to another, but they can crawl very quickly when heads are touching.

Notification: When a case of head lice occurs in a room, notify the parents/guardians that a case of head lice has occurred. Check the other children in that room for head lice and if found, notify their parents/guardians that the child needs treatment. Ask the parents/guardians to be alert to anyone in their family who may have signs and symptoms of head lice (e.g., excessive itching of the scalp, especially at the nape of the neck and around the ears) so that they may also receive treatment.

Infants and children less than 2 yrs. of age: It is a rare occurrence for children in this age group to have head lice. It is generally not recommended to treat this age group prophylactically or just because someone else in the family has been treated. If a child of this age is found to have head lice, the parent/guardian should consult the child’s physician for treatment recommendations.

Return to child care: The child may return to child care after the first treatment has been given. **(See Attachment A - “Recommendations for the Control of Head Lice in the Child Care Setting”)**

HEPATITIS A

This is an infectious viral disease characterized by jaundice (yellowing of the eyes and skin), loss of appetite, nausea, and general weakness. Child care centers can be a major source of hepatitis A spread in the community. This is because small children usually do not show any specific signs and symptoms of the disease. Symptomatic illness primarily occurs among adult contacts of infected, asymptomatic children.

Mode of transmission: Hepatitis A virus is found in the stool of persons infected with hepatitis A. The virus is usually spread from person to person by putting something in the mouth that has been contaminated with the stool of an infected person; for this reason, the virus is more easily spread under poor sanitary conditions, and when good personal hygiene, **especially good hand washing**, is not observed. Rarely, the virus is contracted by eating raw seafood (e.g., raw oysters) that has been collected from contaminated waters.

Notification: Notify the staff and parents/guardians that a case has occurred. Hepatitis A is a Class I reportable disease. A follow-up investigation will be done by the MSDH to determine who in the center may need to receive preventive treatment.

Return to child care: The child may return to child care one week after the onset of jaundice (yellowing of the eyes and skin) or one week after the onset of other signs and symptoms if no jaundice is present.

HEPATITIS B

Hepatitis B is a viral disease that affects the liver. It is a contagious condition characterized by loss of appetite, abdominal discomfort, jaundice (yellowing of the eyes and skin), joint aches, and fever in some cases. It is different from Hepatitis A. There should not be any risk of exposure to hepatitis B in a normal child care setting unless a child who is infected with hepatitis B is bleeding. Also, since the hepatitis B vaccine is now a part of the routine immunization schedule, more and more children should be immune.

Mode of transmission: The most common mode of transmission is through having sex with someone who has the virus; however, it can be transmitted when infected blood enters the body through cuts, scrapes or other breaks in the skin. Injecting drug users are at risk when they share needles with an infected person. It is also possible for infected pregnant women to transmit the virus to their babies during pregnancy or at delivery.

If an exposure to a person who is infected with hepatitis B has occurred, the person exposed should be referred to his/her physician since hepatitis B vaccine and hepatitis B immune globulin may be indicated. **Since hepatitis B and HIV/AIDS are both transmitted through blood exposure, the precautionary measures for HIV/AIDS would also apply to hepatitis B. (See HIV/AIDS section below)**

HEPATITIS C

Hepatitis C is also a viral disease that affects the liver. Again, hepatitis C should pose no risk of exposure in the normal child care setting unless the infected child is bleeding. There is no vaccine available for hepatitis C at this time. **Since it is also transmitted through blood exposure, the same precautionary measures for hepatitis B and HIV/AIDS would be apply to hepatitis C. (See HIV/AIDS section below)**

HUMAN IMMUNODEFICIENCY VIRUS (HIV) INFECTION/ ACQUIRED IMMUNODEFICIENCY SYNDROME (AIDS)

Mode of transmission: The most common mode of transmission is through having sex with someone who has the virus; however, it can be transmitted when infected blood enters the body through cuts, scrapes or other breaks in the skin. Injecting drug users are at risk when they share needles with an infected person. It is also possible for infected pregnant women to transmit the virus to their babies during pregnancy or at delivery. Although HIV and hepatitis B are transmitted in the same way, HIV is much more difficult to transmit from one person to another than hepatitis B.

HIV infection in children causes a broad spectrum of disease manifestations and a varied clinical course. Children with HIV infection should be monitored closely by their physician. They are more susceptible to infectious diseases than other children. Parents of children known to have HIV infection should be notified when certain infectious diseases occur in the child care facility. There is no vaccine available for HIV at this time. According to CDC, HIV is not likely to be spread from one child to another in the child care setting and no case has ever been reported. Parents or guardians of HIV-positive children should inform the child care director of their child's HIV status. Because of concern over stigmatization, the person aware of a child's HIV infection should be limited to those who need such knowledge to care for the children in the child care setting. In a situation where there is concern of possible exposure of others to the blood or body fluids of an infected person, CDC recommends that a team including the child's parents or guardians, the child's physician, public health personnel, and the proposed child care provider evaluate the situation to determine the most appropriate child care setting. The team should weigh the risks and benefits to both the infected child and to others in the child care setting.

It should always be remembered that there those who are known to be infected with HIV, hepatitis B and C and other blood borne diseases, but on the other hand there are those we do not know about and some people are not even aware themselves that they may have an infectious blood borne disease. Therefore, we must always employ universal precautions (treating everyone's blood as though it is infectious) when dealing with blood and body fluids. There is no evidence that HIV, hepatitis B or hepatitis C is transmitted through tears, perspiration, urine, or saliva unless these body fluids contain visible blood.

Child care providers should be prepared to handle blood and blood-containing body fluids using the principles of universal precautions. Supplies of gloves, disposable towels, and disinfectants should be readily available.

The Mississippi State Department of Health is available for consultation in these situations.

IMPETIGO

This is a contagious skin disease characterized by spreading pustular lesions (sores with pus) and should receive medical treatment. This is quite important to avoid the risk of complications involving the heart and kidneys.

Mode of transmission: Skin-to-skin contact with the sores.

Return to child care: The child may return to child care 24 hours after treatment has been started if free of fever and the lesions are not draining.

MEASLES

Measles is a serious viral infection characterized by a rash (red, flat lesions) starting on the head and neck, which enlarge and coalesce (run together), and spread to the trunk, then to the extremities. Other symptoms include a high fever, conjunctivitis (red, inflamed eyes), cough, and nasal congestion. The Health Department must be notified on first suspicion. With our present immunization laws, measles is a rare occurrence today. It is imperative, however, that immunization records be kept current.

Mode of transmission: Direct contact with nose and throat secretions of an infected person. May be airborne by droplets of these secretions coughed into the air. Tiny droplets can be suspended in the air for two hours or more. Measles is very easily spread.

Notification: Notify staff and parents/guardians that a case has occurred. Measles is a Class I reportable disease and there will be a follow-up investigation by the Health Department. Parents of children with weakened immune systems (those being treated for cancer, leukemia or taking steroid medication, etc.) should consult their child's physician and keep the child out of the center until after the investigation by the Health Department and it is considered safe for them to return.

Return to child care: The child may return to child care when free of fever and the rash is fading (this usually takes 5-7 days).

MENINGITIS

Meningitis is an inflammation or infection of the meninges (the membranes that cover the brain and spinal cord). Meningitis can be caused by a variety of organisms or germs. Most people exposed to these germs do not develop meningitis or serious illness. Some people may carry a particular germ and have no symptoms at all. Anyone exhibiting signs and symptoms of meningitis (e.g., severe headache, fever, vomiting, stiffness and pain in the neck, shoulders and back, drowsiness) should seek medical attention promptly.

Meningitis is a reportable disease. The Department of Health evaluates each case individually to determine what public health intervention, if any, might be required. The two types of meningitis that require public health intervention most often are caused by the organisms *Haemophilus influenzae* type b (HIB) and *Neisseria meningitidis* (meningococcal).

Mode of transmission: These germs are most commonly spread by direct contact with nose and throat secretions from an infected person.

Notification: Notify parents/guardians that a case has occurred and to have their children evaluated by a physician should they have any of the signs or symptoms listed above.

Return to child care: The child may return to the center whenever he or she has been released by his/her personal physician.

MUMPS

Mumps is an infectious disease that is characterized by swelling and pain of the salivary glands.

Mode of transmission: Person- to- person spread by direct contact with the saliva of an infected person.

Return to child care: The child may return to child care 9 days after the beginning of the salivary gland swelling.

“PINK EYE” (CONJUNCTIVITIS)

This is an infectious disease characterized by redness of the eye(s), excessive tearing, itching, and discharge. Some cases may require antibiotics; therefore, the child should see a physician.

Mode of transmission: Contact with discharges from the eye, nose, or throat of an infected person. Also, from contact with fingers, clothing and other articles that have been contaminated with the discharge.

Return to child care: Children may return to child care after they have seen a physician or when the redness/discharge is improving.

PINWORMS

Pinworms are tiny worms that live in the large intestine and can cause anal itching, sleeplessness and irritability. They may also be present without any symptoms. Pinworms occur worldwide and affect all socioeconomic classes. They are the most common worm infection in the United States. Prescription medication must be obtained to treat the infection.

Mode of transmission: Pinworms can be spread when an uninfected person touches the anal area of an infected person and then puts their hands/fingers in their mouth. They can also be spread when an infected person scratches the anal area and then contaminates food or other objects that are touched or eaten. Pinworms can be spread as long as the worms or the eggs are present.

Return to child care: The child may return to child care **24** hours after they have received the first treatment. Employ **thorough hand washing** especially before eating and after toilet use and change and wash any bed linens and towels in hot water that have been used for those children. Ask the parents/guardians to do the same at home. Also, discourage children from scratching the anal area.

RESPIRATORY SYNCYTIAL VIRUS (RSV)

RSV can cause an upper respiratory disease like a cold or a disease of the lower respiratory tract such as pneumonia. It is the most common cause of lower respiratory tract infections and pneumonia in infants and children under the age of 2. Almost 100% of children in child care programs get RSV during the first year of life. This usually occurs during outbreaks in the winter months. RSV can range from a very mild disease to life-threatening.

Mode of transmission: Direct contact with nose and throat secretions of an infected person. A young child can be infectious with RSV 1 to 3 weeks after signs and symptoms have subsided.

Return to child care: Most of the time a child is infectious before signs and symptoms appear. An infected child does not need to be excluded from child care unless he/she has a fever and/or is not well enough to participate in the activities. Make sure that **procedures pertaining to hand washing, proper disposal of tissues and disinfection of toys are followed.**

RINGWORM

Ringworm is a skin infection caused by a fungus that can affect the scalp, skin, fingers, toe nails, and feet. Ringworm anywhere except on the scalp or under the nails can be successfully treated with several over-the-counter medicines. Ringworm of the scalp is characterized by inflammation, redness, and hair loss and does not respond to over-the-counter medicines; therefore, the child should see his/her physician.

Mode of transmission: Direct skin-to-skin contact or indirect contact (e.g., toilet articles such as combs and hair brushes, used towels, clothing and hats contaminated with hair from infected persons or animals).

Notification: When the lesions (red, circular places) are found, notify the parent/guardian that the child needs treatment.

Return to child care: The child may return to child care after the treatment has been started. Treatment for ringworm of the scalp and nails usually lasts for several weeks. Strict infection control measures should be taken (e.g., blankets, towels or anything that is used on the infected child

should not be used on another child, make sure that staff caring for these children **practice good hand washing** and that disinfecting procedures are followed.

SCABIES

Scabies is a disease of the skin caused by a mite. The mite burrows beneath the skin and causes a rash that is usually found around finger webs, wrists, and elbows. The rash may appear on the head, neck, and body on infants. Any child with evidence of severe itching especially in these areas should be referred to his/her physician. Scabies requires treatment by prescription drugs.

Mode of transmission: Direct skin-to-skin contact with an infested person. Transfer of the mites from undergarments and bedclothes can occur, but only if contact takes place immediately after the infested person has been in contact with the undergarments and bedclothes.

Notification: Notify parents/guardians and staff that scabies has occurred in the facility so that they can be alert to signs and symptoms and seek treatment.

Return to child care: The child may return to child care 24 hours after the treatment has been completed. It must be noted that itching may continue for several days, but this does not indicate treatment failure or that the child should be sent home.

“STREP THROAT” (STREPTOCOCCAL PHARYNGITIS) & SCARLET FEVER

Strep throat is a communicable disease characterized by sore throat, fever, and tender, swollen lymph glands in the neck. The child should see a physician to obtain prescription medication; this is quite important to avoid the risk of complications involving the heart and kidneys. **Scarlet fever** is a streptococcal infection with a rash (scarlatinaform rash). It is most commonly associated with strep throat. In addition to the signs and symptoms of strep throat, the person with scarlet fever has an inflamed, sandpaper-like rash and sometimes a very red or “strawberry” tongue. The rash is due to a toxin produced by the infecting strain of bacteria. The treatment and exclusion criteria for scarlet fever would be the same as for strep throat.

Mode of transmission: Direct or indirect contact (e.g., contaminated hands, drinking glasses, straws) with throat secretions of an infected person.

Return to child care: The child may return to child care **24** hours after treatment has been started **if free of fever**.

TUBERCULOSIS (TB)

Mode of transmission: Airborne droplets of respiratory secretions coughed or sneezed into the air by a person with active TB disease.

Notification: TB is a class one reportable disease. If a child or a staff member in a child care facility is diagnosed with active TB, the MSDH will conduct an investigation. The MSDH will notify the facility and the parents/guardians of the type of follow-up that will be necessary.

Return to child care: Persons diagnosed with TB infection are evaluated by the Mississippi State Department of Health on an individual basis. Those who have a positive TB skin test *only* may attend child care since they have no disease process that is contagious. **Persons suspected of or diagnosed with active TB disease will need written permission from the Mississippi State Department of Health Tuberculosis Control Program to return to the center.**

Small children are highly susceptible to contracting TB disease, but do not transmit the disease as easily as an older child or adult. Children who do not have active TB disease, but who have been exposed to an active case in their household are considered high risk contacts and are placed on preventive medication. These children may attend child care since they are not infectious.

WHOOPING COUGH (PERTUSSIS)

Pertussis or whooping cough is a contagious disease characterized by upper respiratory tract symptoms with a cough, often with a characteristic inspiratory (breathing in) whoop.

Mode of transmission: Direct or indirect contact (contaminated articles) with nose and throat secretions of an infected person. Airborne transmission can also occur by droplets of these secretions coughed into the air.

Notification: Notify parents/guardians that a case has occurred. Pertussis is a class one reportable disease. The Health Department will conduct an investigation to determine those who may need preventive treatment.

Return to child care: The child may return to child care 5 days after their treatment has begun.

PERMISSION TO COLLECT STOOL SPECIMENS AND RECEIVE TEST RESULTS

If and when an outbreak of diarrheal diseases such as giardiasis, salmonellosis, shigellosis, etc. occurs in a child care facility, the Mississippi State Department (MSDH) investigates and may request that stool specimens be collected. In an outbreak situation, the stool specimen collection bottles are provided by the MSDH and the tests are done in the MSDH Lab free of charge. The collection bottle, with instructions, would either be given to the parent/guardian to collect the stool specimen or it may need to be collected at the child care facility. The child care facility would receive the test results and recommendations would be made by the MSDH. The test results would be given to the parents/guardians by the child care facility and the parents/guardians should give them to their child’s physician.

I give my permission for (name of child care facility) to collect stool specimens from (name of child) when it is recommended by the MSDH and also for them to receive the test results. I understand that I will receive a copy of the test results and be informed of the recommendations made by the MSDH.

Date: _____

Parent/Guardian

ATTACHMENT - A

RECOMMENDATIONS FOR THE CONTROL OF HEAD LICE IN THE CHILD CARE SETTING

Head lice, *Pediculus humanus capitis*, are a common problem in children who attend child care in Mississippi. Although they do not transmit any human disease, they may be a considerable nuisance, and require conscious effort on the part of the child care staff and parents to control. **It should be understood that head lice can only be controlled in the child care center, not eliminated; they will occur sporadically, and will recur even after control efforts. The goal of control efforts is to reduce the problem and its impact, and minimize spread.**

Head lice are not a product of poor personal hygiene or lack of cleanliness and their presence is not a reflection on the child care center or the family. More harm is probably caused by misconceptions about head lice than by the lice themselves.

1. IDENTIFYING INFESTED CHILDREN

By Screening: It is important to establish a screening program. Children should be screened for head lice upon entry into the child care setting and periodically during the year. Staff members should be instructed in the technique of detecting head lice.

By Individual Case: Any child suspected of having head lice (usually because he/she is scratching his/her head a lot) should be examined by a staff member who has been instructed in the technique. If infested, the child should be handled as described in Section 2, "HANDLING OF INFESTED CHILDREN."

If one child in a room is found to be infested, the whole room should be screened.

2. HANDLING OF INFESTED CHILDREN

Exclusion: An infested child's parent/guardians should be notified that the child has been found to have head lice and must receive the proper treatment before returning to child care. Treatment and removal of nits are described in Section 3, "TREATMENT." Care must be taken not to embarrass or stigmatize the child.

Return to Child Care: The child should return to the child care center as soon as the first treatment has been given. **Nits (eggs) may still be seen even in an adequately treated child. This is not evidence of continuing infestation if the child has been properly treated and no adult lice are present.**

3. TREATMENT

Individual: Several effective pediculicides (lice-killing products) are available such as Nix^{®*} (permethrin) creme rinse (10 minute hair rinse) which is available over the counter and has ovicidal (egg or nit-killing) capability. It is the only over-the-counter pediculicide covered by Medicaid. The pyrethrin/pyrinates products (10 minute shampoos) include such products as Rid^{®*}, A-1000^{®*}, R&C^{®*}, Clear^{®*} and Triple-X^{®*} and are available over the counter at pharmacies. Kwell^{®*} (1%

lindane), a 4 minute shampoo, requires a prescription. Central nervous system toxicity with lindane has been documented with prolonged administration. Ovide^{®*} lotion (Malathion 0.5%) has been re-approved by the Food and Drug Administration (FDA) as a prescription drug for the treatment of head lice infestation in the United States. Treatment with any approved pediculicidal (lice-killing) product should be adequate.

One Treatment vs. Two Treatments: Most products require 2 treatments. An initial treatment will kill adult and larval lice, but will not kill all the eggs. **A second treatment 7 to 10 days later, after the eggs left by the first treatment have all hatched, will kill the newly hatched lice before they mature and reproduce and will complete the treatment process.** Nix^{®*} requires only one treatment since it is an ovicidal (also kills the eggs or nits); however, a second treatment is desirable since the product is not likely to kill 100% of the nits. Ovide^{®*} lotion is also ovicidal and requires a second treatment 7 to 10 days after the first one **only** if crawling lice are seen.

Retreatment: Pediculicides should kill lice soon after application. However, in some situations (e.g., a person is too heavily infested, pediculicide is used incorrectly, reinfestation or possible resistance to the medication), the lice may still be present. Immediate retreatment with a **different class or type** of pediculicide is generally recommended if live lice are detected on the scalp 24 hours or longer after the initial treatment.

Treatment of Infants and Children Less Than 2 Years of Age: It is a rare occurrence for children in this age group to have head lice. It is generally not recommended to treat this age group preventively or just because someone else in the family has been treated. If a child of this age is found to have head lice, the parent/guardian should consult the child's physician for treatment. The safety of head lice medications has not been tested in children 2 years of age and under.

Removal of nits: The need to remove nits is somewhat controversial. However, removing the nits may prevent reinfestation by those nits hatching that may have been missed by the treatment. It may also decrease confusion about infestation when the person who has been treated is being re-examined for the presence of head lice, and it will avoid possible embarrassment to the infested child. Nits may be removed by the use of a nit comb or by manually ("nit-picking") removing them. Most of the nits that are easily seen and more easily removed with the nit comb are those that are grayish-white in color, have grown out one or more inches on the hair shaft and have already hatched. The new, viable nits are closer to the scalp (within about 1/4 inch) and are more of a brownish color. These nits are firmly attached to the hair shaft with a glue-like substance. There are commercial products available to help loosen the glue-like substance for easier removal.

Family: Household members of a child with head lice should be examined for lice (by a family member who knows how or someone else knowledgeable about lice) and any infested persons treated as described above. **The one exception is any person over 2 years of age who shares a bed with the infested child should simply be treated presumptively.** If the child is less than 2 years of age, consult the child's physician for treatment recommendations.

4. ENVIRONMENTAL CONTROL

Child Care Facility/Household: Clothing, cloth toys, and personal linens (such as towels and bedclothes used within the previous 48 hours by an infested person) can be disinfected by washing in hot water and drying in the dryer using hot cycles. Non-washables should be dry cleaned, or stored in airtight plastic bags for 2 weeks. Spraying with insecticides is **NOT** recommended. Fumigants and room sprays can be toxic if inhaled or absorbed through the skin. If there are cloth surfaces, such as furniture or carpet, with which the infested person's hair has had extensive contact, they should be **vacuumed** thoroughly. The head louse will not survive off the human scalp for more than 24 - 48 hours.

Questions about control methods, specific treatments, or special problems can be addressed to the local health department, the district public health office, or to the Office of Community Health Services - Division of Epidemiology, State Department of Health in Jackson.

(*Use of specific product names is for example purposes only, and is not intended as endorsement of specific brands over others.)

SAMPLE LETTER TO PARENTS/GUARDIANS

Dear Parent or Guardian:

Your child _____ has been found to have head lice. Head lice do not transmit disease and they are not a result of lack of cleanliness. Children in child care settings get them commonly, sometimes more than once.

You should consult a pharmacist or your child’s physician for a recommendation as to which of several effective products to use to treat your child. **As soon as you have treated your child with an approved pediculicidal (lice-killing) product, he or she may return to child care.**

There are 3 steps in the successful management of head lice:

1. **Treatment (killing the lice with an approved medical treatment)** - It is very important to follow the instructions given by your physician when using prescription medication. If you use over-the-counter medication, you should follow the package directions. The other members of your family should be checked for head lice and treated if they are found to have them. Persons over 2 years of age who sleep in the same bed with the infested child should be treated regardless. If a child less than 2 years of age is found to have head lice, consult the child’s physician for treatment recommendations.

2. **Removal of the nits** - The Mississippi State Department of Health recommends that you attempt to remove the nits to avoid reinfestation by those nits hatching that may have been missed by the treatment. The nits can be removed by dividing the hair into sections and working each section separately. Look for small grayish-white or yellowish-brown specks that are attached to the hair shaft close to the scalp. Nits are attached to the hair shaft very firmly with a glue-like substance and are not easily brushed out. They must be picked out with the fingernails or combed with the nit comb that usually comes with the lice-killing product. This can be done outdoors under bright sunlight or indoors with a good reading lamp as nits are sometimes hard to see.

3. **Environmental control** - Clothing and personal linens (such as towels and bedclothes used by infested persons) should be machine washed using hot water and dried using the hot cycle. Non-washables can be dry cleaned or stored in an airtight plastic bag for 2 weeks. Cloth-covered furniture and carpet that have been in extensive contact with an infested person’s head should be thoroughly vacuumed. Lice-killing sprays are generally not necessary.

Signature: _____ Date: _____

Source: Miss. Code Ann. §43-20-8.

APPENDIX - J

**RULES AND
PROCEDURES
FOR
STATE LEVEL
ADMINISTRATIVE
HEARINGS**

THIS PAGE INTENTIONALLY LEFT BLANK

APPENDIX J

RULES AND PROCEDURES FOR STATE LEVEL ADMINISTRATIVE HEARINGS

1. **Hearing Officer** - The Hearing Officer shall be appointed by the State Health Officer or his/her designee. The Hearing Officer shall preside at the hearing, shall be charged with maintaining order at the hearing, and shall rule on all questions of evidence and procedure in accordance with the provisions of these rules.
2. **Appearance by Licensee/registrant** - The licensee/registrant shall appear at the date and time set for the hearing, and failure to do so without reasonable notice to the Department may result in admission of the charges and adverse action taken against the licensee/registrant.
3. **Representation by Counsel** - The licensee /registrant may, but is not required to be, represented by counsel at the hearing and shall have the right to cross-examine all witnesses, present evidence, written or oral, on his or her own behalf, and to refute any testimony or evidence presented by the Department. The Department shall be represented by the Office of the Attorney General.
4. **Rules of Evidence and Discovery** - Formal rules of evidence and procedure, including Discovery, do not apply in administrative hearings; however, the rules of evidence may be used as a guide during the hearing. A record of the hearing shall be made by a court reporter.
5. **Attendance of Witnesses** - The licensee/registrant or counsel for the Department may make a written request to the Hearing Officer at least 10 days prior to the hearing to ensure the attendance of a witness or the production of documents through the issuance of an administrative subpoena. The issuance of the subpoena shall be at the discretion of the Hearing Officer.
6. **Order of Proceedings** - The Department shall present its case first, followed by the licensee/registrant, and any rebuttal evidence by either party. At the request of either party, all prospective witnesses shall be excluded from the proceedings except while actually testifying.
7. **Standard of Proof** - In order for the Department's decision to be upheld, the Hearing Officer must find that the regulatory violation has been proved by clear and convincing evidence and that the disciplinary action is supported by substantial evidence.
8. **Recommendation and Final Decision** - At the conclusion of the hearing, or within a reasonable time thereafter, considering the amount of testimony and evidence and the complexity of the issues, the Hearing Officer shall submit his/her "Findings of Fact, Conclusions of Law and Recommendation" to the State Health Officer, outlining the proof

presented and containing his/her recommendation to the State Health Officer as to the appropriate action to be taken. The State Health Officer shall in a reasonable time thereafter issue his/her Final Order adopting, modifying, or rejecting the Recommendation. This Final Order becomes the final appealable order of the Mississippi State Department of Health as to those proceedings.

9. Appeal of the Department's Final Order shall be accomplished as provided by the appropriate statute.

Source: Miss. Code Ann. §43-20-8.