

Skylark & **GS**

A close-up photograph of the front of a blue Buick Skylark GS. The image shows the hood with two black air vents, the front grille with a "GS BY BUICK" badge, and two round headlights. The car is parked on a dark surface, and the lighting highlights the metallic blue paint.

Parts and Accessories



We Rebuild:

Motor Mounts
Transmission Mounts
Camshafts
Rocker Assembly
Clutch Discs
Pressure Plate Assembly
Water Pumps
Oil Pumps
Fuel Pumps
Starters & Solenoids
Generators
Alternators
Distributors
Voltage Regulators
Convertible Top Pumps

Master Cylinders
Brake Boosters
Wheel Cylinders
Brake Shoes
Brake Cables
Shocks
Ball Joints
Centerlinks
Drive Shaft Supports
Power Window Motors
Headlight Motors
Windshield Wiper Motors
Vacuum Advances
Carburetors

We are a full service Company



CARS, Inc.
205 Pearl St.
Neshanic Station, NJ 08853
(908) 369-3666
(908) 369-7595 Fax
www.oldbuickparts.com

BUICK PARTS: GROUP NUMBERS

Engine • Clutch • Decals.....	Group 0
Cooling • Oiling • Grills	Group 1
Electrical • Lamps	Group 2
Fuel • Carburetion • Exhaust.....	Group 3
Transmission • Brakes	Group 4
Wheels • Propeller Shaft • Rear Axle	Group 5
Front Suspension • Steering	Group 6
Frame • Springs • Shocks • Bumpers	Group 7
Hood • Front Fenders • Running Boards.....	Group 8
Heater • Air Conditioner • Firewall • Radio • Antenna	Group 9
Glass • Doors • Cowl • Weatherstrip • Wiper • Dash.....	Group 10
Rear 1/4 Glass • Seats • Door Sills • Dome Lenses	Group 11
Rocker Panels • Rear Sheet Metal • Deck Lid.....	Group 12
Convertible Tops and Parts	Group 13
Door Panels • Misc. Interior • Headlinings	Group 14
Carpet • Floor Mats • Trunk Linings	Group 15
Literature.....	Group 16

-ATTENTION-

This catalog pertains to
**1961 and Up Special, Skylark,
Sportwagon and Gran Sport ONLY**

We also have catalogues and stock Buick parts for:

- **1930's and Up** All models
- **1961 and Up** Riviera
- **1961 and Up** Lesabre, Invicta, Wildcat,
Electra 225, Centurion, Century and Apollo
- **1973 and Up** Regal, Grand National, T-Type and GNX

Please inquire about separate catalogs for the above Buicks

www.oldbuickparts.com

All rights reserved. No part of this publication may be reproduced without prior written permission from CARS, Inc. Illustrations in this catalog are representations only and may not exactly depict any particular part or part number. Prices subject to change without notice.

Typical Buick Engine

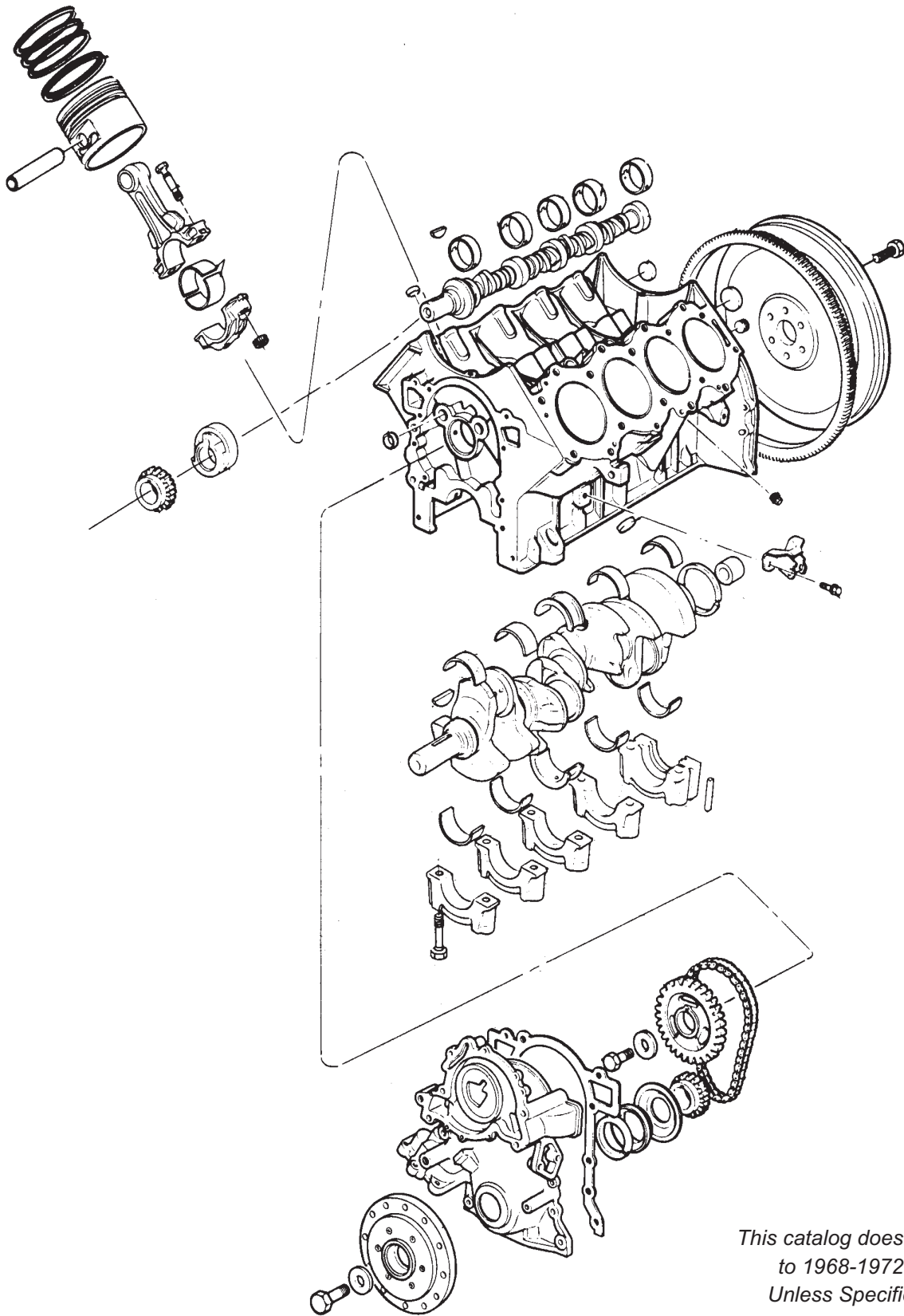

*This catalog does not pertain
to 1968-1972 L6 motors.
Unless Specifically noted.*



Motor Mounts (.027)



1961-1963 198 and 215 engines.
MM613\$65.00 pr.
1965-1967 300 and 340 engines.
MM657\$57.50 pr.
1967-1976 400 and 455 engines. All with four hole flange.
MM676\$52.75 pr.
1968-1972 250 engine.
MM682\$52.75 pr.
1968-1980 350 engine.
MM685\$42.25 pr.

Motor Mount Rebuilding Services

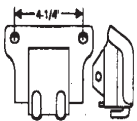

1964 All 225 V-6 and 300 V-8. There are two types. This is not the interlocking type.
MM64\$246.25 pr.

1965-1966 400 engine.
MM656RS\$147.29 pr.

1965-1967 V-6 w/o a.c.
MM657V6\$183.50 pr.

1965-1967 V-6 with a.c.
MM657V6A\$183.50 pr.

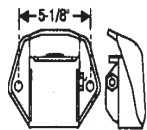

1967 GS There are two types. This is not the interlocking type.
MM670\$191.69 pr.

Big Block Conversion

1968-1972 All. Motor Mount frame pads for conversion from 350 to 400 or 455 engines.
FP455\$90.25 pr.

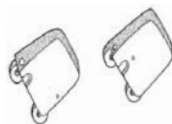

Main Bearing Sets

1961-1963 215 engine.
MBS613\$129.50 set
1962-1963 198 engine.
MBS623\$101.00 set
1964-1967 300 engine.
MBS647\$179.00 set
1964-1967 225 engine.
MBS647S\$60.00 set
1965-1966 400 engine.
MBS596\$179.50 set
1966-1980 340 and 350 engine.
MBS666\$94.00 set
1967-1969 400 engine.
MBS679\$97.50 set
1968-1972 250 engine.
MBS685\$61.00 set
1970-1976 455 engine.
MBS706\$129.00 set

Valves

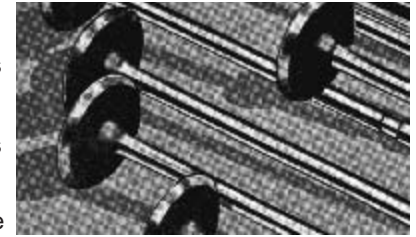

1964 225 and 300 engines (EXHAUST).
EV64\$18.25 ea.
1964 225 and 300 engines (INTAKE).
IV64\$18.25 ea.
1965-1966 400,401 engine (INTAKE).
IV596\$14.25 ea.
1965-1966 400, 401 engine (EXHAUST).
EV596\$16.50 ea.
1965-1967 225, 300 & 340 engines (EXHAUST).
EV657\$18.25 ea.
1967-1976 400 and 455* eng. (INTAKE). Except GS STAGE I.
IV676\$11.50 ea.
1967-1972 400, 455* eng (EXHAUST). * Except GS STAGE I.
EV674\$14.75 ea.
1968-1972 250 engine (INTAKE).
IV686\$14.25 ea.
1968-1970 250 engine (EXHAUST).
EV680\$15.50 ea.
1968-1980 350 engine (EXHAUST).
EV683\$18.25 ea.
1971-1972 250 engine (EXHAUST).
EV716\$15.50 ea.
1968-1980 350 engine (INTAKE).
IV680\$10.00 ea.
1971-1972 455 STAGE 1 (INTAKE).
IV714\$17.00 ea.

Valve Guides

1961-1963 215 engine (INTAKE).
VG880\$3.00 ea.
1961-1963 215 engine (EXHAUST).
VG880\$3.00 ea.
1962-1963 198 engine (INTAKE).
VG7259\$3.00 ea.
1962-1963 198 engine (EXHAUST).
VG7259\$3.00 ea.
1964-1967 225 engine (INTAKE).
VG6105\$3.00 ea.
1964 225 engine (EXHAUST).
VG6105\$3.00 ea.
1965 400 engine (INTAKE).
VG733\$4.00 ea.
1965 400 engine (EXHAUST).
VG733\$4.00 ea.
1965-1967 225 engine (EXHAUST).
VG7460\$2.25 ea.
1965-1967 300 and 400 engines(INTAKE).
VG5607\$3.00 ea.
1965-1967 300 and 340 engines (EXHAUST).
VG7460\$2.25 ea.
1966 400 engine (INTAKE).
VG937\$3.00 ea.
1967-1972 400 and 455 engines (INTAKE).
VG6113\$2.75 ea.
1967-1972 400 and 455 engines (EXHAUST).
VG6114\$2.75 ea.
1968-1972 250 engine (INTAKE).
VG6867\$3.00 ea.
1968-1972 250engine (EXHAUST).
VG5607\$3.00 ea.
1968-1972 350 engine (INTAKE).
VG6108\$3.00 ea.
1968-1972 250 engine (EXHAUST).
VG6113\$2.75 ea.



Engine Parts (Group 0)

Valve Springs and Sets

1961-1964 198, 215, 225 and 300 engine.	
VS614.....	\$5.00 ea.
Set: Sixteen (16) same as above.	
VS614S.....	\$58.00 set
1965-1966 400 engine (INNER).	
VS536.....	\$5.00 ea.
Set: Sixteen (16) same as above.	
VS536S.....	\$58.00 set
1965-1966 400 engine (OUTER).	
VS596.....	\$4.75 ea.
Set: Sixteen (16) same as above.	
VS596S.....	\$52.25 set
1965-1967 225, 300 and 340.	
VS657.....	\$5.00 ea.
Set: Sixteen (16) same as above.	
VS657S.....	\$58.00 set
1967-1972400,455 (Exc. Hvy Duty, & GS STAGE I).	
VS672.....	\$4.50 ea.
Set: Sixteen (16) same as above.	
VS672S.....	\$53.25 set
1968-1974	
1968-1970 350 engine Int. and Exh.;	
1971 350 Int.;	
1972-1974 Int. and Exh.	
VS684.....	\$3.25 ea.
Set: Sixteen (16) same as above.	
VS684S.....	\$44.00 set
1971 350 with Damper (Exhaust).	
VS71D.....	\$5.00 ea.

Valve Spring Retainers (.310)

1965-1966 All 400, 401, 425 engines;	
1967-1975 All V-8 engines. 32 pairs needed per car.	
VR365.....	\$3.75 pr.
VR365S.....(Set of 32).....	\$49.50 set

Valve Lifters (Hydraulic)



1961-1967	
1961-1966: All;	
1967: 300 and 340 engines.	
VL567.....	\$9.50 ea.
VL567S.....(Set of 16).....	\$139.50 set
1967-1969	
1967-1969 400,430 engine;	
1968-1969 350 engine (with hollow push rods).	
VL679.....	\$7.00 ea.
VL679S.....(Set of 16).....	\$102.50 set
1970-1981 All 350 and 455 engines.	
VL680.....	\$4.75 ea.
VL680S.....(Set of 16).....	\$69.50 set

Valve Cover / Intake Manifold Ventilation Grommets

1963-1974	
1963-1967: Valve Cover, All;	
1967-1974: Intake Manifold, All.	
VG634.....	\$7.75 ea.
1970-1974 Valve Cover (Rubber).	
VG704.....	\$6.00 ea.



Valve Seat Inserts and Sets

(Sold in sets of 12 or 16 as needed for your Buick)

1962-1963 198 engine (intake).	
VSI590.....	\$4.75 ea.
1962-1963 198 engine (exhaust).	
VSI623.....	\$3.75 ea.
1961-1963 215 engine (exhaust).	
VSI614.....	\$4.00 ea.
1961-1963 215 engine (intake).	
VSI590.....	\$4.75 ea.
1964-1967 225, 300 engine (intake).	
VSI648.....	\$8.00 ea.
1968-1972 250 engine (intake).	
VSI682.....	\$4.75 ea.
1965-1967 225 engine (exhaust).	
VSI557.....	\$4.50 ea.
1964 225 & 300 engine (exhaust).	
VSI614.....	\$4.00 ea.
1968-1972 250 engine (exhaust).	
VSI572.....	\$4.50 ea.
1965-1966 400 engine (intake).	
VSI592.....	\$4.75 ea.
1965-1966 400 engine (exhaust).	
VSI590.....	\$4.75 ea.
1965-1967 300 and 340 engine (intake).	
VSI657.....	\$5.75 ea.
1965-1967 300 and 340 engine (exhaust).	
VSI557.....	\$4.50 ea.
1967-1969 400 engine (intake).	
VSI674N.....	\$6.75 ea.
1970-1972 455 engine (intake).	
VSI674.....	\$8.00 ea.
1967-1969 400 engine (exhaust).	
VSI648E.....	\$4.25 ea.
1970-1972 455 engine (exhaust).	
VSI704.....	\$5.00 ea.
1968-1972 350 engine (intake).	
VSI592.....	\$4.75 ea.
1968-1972 350 engine (exhaust).	
VSI590.....	\$4.75 ea.

Valve (Stem) Seals

1961-1972	
1961-1963 198 and 215 engine;	
1964-1967 225 and 300 engine;	
1966-1967 340 engine;	
1968-1972 250 engine.	
VSS612.....	\$2.75 ea.
1967-1972	
1967-1969 400 engine;	
1968-1972 350 engine;	
1970-1972 455 engine.	
VSS674.....	\$2.75 ea.
1965-1966 400 engine.	
VSS536.....	\$3.00 ea.

Rocker Cover Plug

1964-1967 Solid plug.	
CP647.....	\$13.50 ea.



Rocker Cover Grommet

1965-1966 GS Rocker cover grommet. 4 needed per car.	
VCG572.....	\$3.75 ea.



Rocker Arm Shafts

- 1961-1967 215, 300 and 340 engines.
- RS617\$65.00 ea.
- 1962-1967 All V-6.
- RS627\$55.00 ea.
- 1965-1966 400 engines.
- RS536\$48.50 ea.
- RS536P.....Pair.....\$95.00 pr.
- 1967 400 engine.
- RS67\$55.00 ea.
- 1968-1969 350 engine.
- RS689S.....\$44.75 ea.
- 1968-1969 400, 430 engine.
- RS689\$55.00 ea.
- 1970-1972 350 engine.
- RS700\$39.50 ea.
- 1970-1972 455 engine.
- RS705\$55.50 ea.



Rocker Arms



- 1961-1966 All 364, 400, 401, 425 engines.
- Fits LH 4 R.....\$17.00 ea.
- 1961-1966 All 364, 400, 401, 425 engines.
- Fits RH 4 Rear and LH 4 Front. Reproduced in steel.
- RA596B.....\$17.00 ea.
- 1961-1967 198, 215, 225, 300 and 340 engines,
- intake 2, 7, exhaust 1,3, 4, 5, 6, 8
- RA617A.....\$17.00 ea.
- 1961-1967 Intake 1, 3, 4, 5, 6, 8 exhaust 2, 7
- RA617B.....\$17.00 ea.
- 1968-1969 350, 400 intake 1, 4, 5, 8, exhaust 2, 3, 6, 7.
- RA689A.....\$17.00 ea.
- 1968-1969 350, 400 intake 2, 3, 6, 7, exhaust 1, 4, 5, 8.
- RA689B.....\$17.00 ea.
- 1968-1969 Complete Set of 16.
- RA689S.....\$259.00 ea.
- 1970-1972 V-8 intake 1, 4, 5, 8 exhaust 2, 3,6 ,7.
- RA705A.....\$8.50 ea.
- 1970-1972 V-8 intake 2, 3, 6, 7 exhaust 1, 4, 5, 8.
- RA705B.....\$8.50 ea.
- 1970-1972 Complete set of 16.
- RA705S.....\$105.25 ea.

Rocker Arm Assembly

- 1962-1967 198, 225 engines.
- RAA627\$95.50 ea.
- 1970-1972 455 engine.
- RAA702\$180.00 pr.

Rocker Assembly Rebuilding

- 1961-1967 All 215, 300, and 340 engines.
- RAA617\$359.00 pr.
- 1961-1966 All 364, 400, 401, and 425 engines.
- RAA596\$379.50 pr.
- 1967-1972 All 400, 430, 455 engines.
- RAA676\$399.00 pr.
- 1968-1972 All 350 engines.
- RAA680\$399.00 pr.

Rocker Arm Retainers

- 1970-1972 All. Rocker arm retainers. For use with aluminum rocker arms. 16 per car. Nylon.
- RR702.....\$1.75 ea.

Chrome Valve Cover Set

- 1970-1976 Buick 455 Engines
- 1967-1969 Buick 455 Engines -(Will Fit But Look Different)
- A beautiful chrome valve cover set.
- VC455C.....\$149.50 pr.



Aluminum Valve Covers



- 1963-1966 All 400,401,425 engines. Grooved with "BUICK" as original. Nice reproduction!
- AVC536.....\$239.00 pr.

- 1963-1966 All with aluminum valve covers. Chrome plated.
- WRS636.....\$34.00 pr.

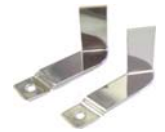

Powder coated so not to flake, peel or chip. Tall valve covers allow use of adjustable roller rockers, large valves, springs and retainers. Thick aluminum construction allows for even gasket compression and proper sealing. Will not bend, dent or distort. Results in reduced engine noise and heat.

- AVC350.....(350 Engines).....\$179.50 pr.
- AVC455....(1967-1976 400, 430, 455 Engines).....\$179.50 pr.



- 1967-1975 Valve cover retaining nut and plate.
- RCS686.....\$3.00 ea.



- 1967-1975 Valve cover retaining nut and plate. Chrome plated.
- RCS686C.....\$4.50 ea.



- 1967-1975 Valve cover retainer with tall stud.
- RCS686T\$4.50 ea.



- 1967-1975 Valve cover retainer with tall stud. Chrome plated.
- RCS686TC.....\$5.00 ea.

Wire Retainers



- 1961-1966: All;
- 1966: 300, 340, 400 engine ign. wire retainer on rocker covers. Two per car.
- WR596.....\$4.75 ea.



- 1967-1972 All. Front "4", ign. wire retainer. Two per car.
- WR683.....\$4.00 ea.



- 1967-1972 All. Rear "3" ign. wire retainer.
- WR673.....\$4.50 ea.

Engine Parts (Group 0)

Push Rods (.426)

1962-1963 All 198 V-6 engines.
 PR573.....\$7.50 ea.
 PR613S6.....(Set of 12).....\$73.50 set

1961-1963 215 engines.
 PR613.....\$5.75 ea.
 PR613S8.....(Set of 16).....\$78.00 set

1964 225 and 300 engines.
 PR64.....\$3.75 ea.
 PR64S6.....(Set of 12).....\$40.25 set
 PR64S8.....(Set of 16).....\$52.00 set

1965-1967
1965-1967: 225 and 300 engines;
1965-1966: 400, 401, 425 engines.
 PR597.....\$5.75 ea.
 PR597S.....(Set of 16).....\$78.00 set
 PR657S.....(Set of 12).....\$59.50 set

1966-1969
1966-1967: 340 engine;
1967-1969: 400, 430 engines except 1969 Stage 1.
 PR669.....\$3.75 ea.
 PR669S.....(Set of 16).....\$58.00 set

1968-1969 350 engine.
 PR689.....\$4.25 ea.
 PR689S.....(Set of 16).....\$58.00 set

1970-1981 350 engine.
 PR701.....\$4.25 ea.
 PR701S.....(Set of 16).....\$58.00 set

1970-1976 455 engine.
 PR706.....\$4.25 ea.
 PR706S.....(Set of 16).....\$58.00 set

Oil Slinger

1961-1972 All.
 OS615.....\$11.50 ea.



Push Rod Cover Gaskets (.443)

1965-1966 400, 401 engines.
 PRG576.....\$11.50 ea.

Freeze Plug Kits

Kits contain necessary plugs for block, cam, oil holes. "B" kits contain brass water jacket plugs.

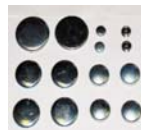

1961-1963 All 196 engines. Steel.
 FPK618.....\$8.75 ea.

1961-1963 All 196 engines. Brass.
 FPK618B.....\$9.75 ea.

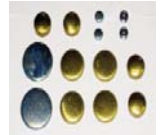

1964-1980 All 225, 300, 340 and 350 engines. Steel.
 FPK640.....\$10.50 ea.



1964-1980 All 225, 300, 340 and 350 engines. Brass.
 FPK640B.....\$11.50 ea.

1965-1966 All 400, 401, 425 engines. Steel.
 FPK536.....\$18.50 ea.



1967-1976 All 400, 430 and 455 engines. Steel.
 FPK670.....\$10.00 ea.



1967-1976 All 400, 430 and 455 engines. Brass.
 FPK670B.....\$15.50 ea.



Camshafts

1961-1963 215 engine.	
CS613	\$169.00 ea.
1964-1967 300 and 340 engines.	
CS649	\$169.00 ea.
1965-1966 400 engine.	
CS576	\$169.50 ea.
1967-1972 *400 and 455 engine.	
*Except GS STAGE I and STAGE II.	
CS676	\$179.50 ea.
1968-1972 250 engine.	
CS686	\$118.75 ea.
1968-1972 350 engine.	
CS680	\$132.00 ea.
All Years. All engines. Cam break-in lube.	
CL300.....	\$7.25 ea.

Cam Bearing Sets

1962-1967 198 and 225 engine.	
CBS627	\$33.00 ea.
1965-1966 340 and 400 engine.	
CBS576	\$47.50 ea.
1968-1972 250 engine.	
CBS685	\$36.75 ea.
1961-1966 215, 300; 1967 340 engine.	
CBS617	\$49.00 ea.
1967 400; 1968-1972 All V-8.	
CBS676	\$54.00 ea.

Connecting Rods

(includes bolts):



1964-1967 225 and 300 engines.	
CR596	\$49.25 ea.
1965-1966 400 engines.	
CR596	\$49.25 ea.
1966-1972 340 and 350 engines.	
CR662	\$43.50 ea.
1967-1972 400 and 455 engines.	
CR672.....	TOS
1968-1972 250 engine.	
CR682	\$39.00 ea.

Rod Bearings

1961-1972 198, 215, 225, 300, 340 and 350 engines.
CRB612.....\$72.00 set

1965-1972 400 and 455 engines.
RBS576.....\$89.50 set

1968-1972 250 engine.
CRB682.....\$59.00 set

Pistons (pins included)

1963-1966 All 400, 401 engines. Piston and pin.
P401S.....(Set of 8).....\$287.00 set

1963-1966 All 425 engines. Piston and pin.
P425.....\$54.50 ea.
P425S.....(Set of 8).....\$325.00 set

1964-1967 225 and 300 engines.
P647.....\$51.00 ea.

1970-1976 All 455 engines. Piston and pin.
P706.....\$25.00 ea.
P706S.....\$530.00 set

ZDDP Oil Supplement - 4 oz. Bottle



ZDDPlus is a oil additive that contains high concentrations of Zinc Diakyl Dithiophosphate, which has been the primary extreme pressure ingredient now missing from modern day motor oils. This is a must in all flat-tappet engines!
ZDDP.....\$14.00 ea.

ZDDP5.....(5 Bottles).....\$39.95



www.oldbuickparts.com

908-369-3666

Engine Parts (Group 0)

Piston Ring Sets

Our piston ring are available in standard and custom sizes such as .030, .040, .060 oversize. Add "030" etc. to part number.

1961-1963 198 V-6 Engine.
 PRS613.....\$161.00 ea.
1961-1963 215 V-8 Engine.
 PRS215C Standard, 30, 40\$70.25 ea.
 PRS215M Street/Strip Premium Moly. Std., 30\$70.25 ea.

1964-1967 225 engine.
 PRS225C Cast Iron. Standard,20,30,40,60.....\$49.00 ea.
 PRS225M Street/Strip Premium Moly. Std.,20,30,40,60..\$70.25 ea.

1964-1967 300, 340 engine.
 PRS647C Cast Iron. Standard, 30, 40, 60.....\$49.00 ea.
 PRS647M Street/Strip Premium Moly. Std., 20,30,40,60 ..\$73.25 ea.

1965-1966 400, 401 engine.
 PRS401M.....(Moly).....\$139.00 set

1967-1969 400 engine.
 PRS400C Cast Iron. Standard,30,40.....\$54.50 ea.
 PRS400M Street/Strip Premium Moly. Std., 30,40,60 ..\$69.75 ea.

1968-1981 350 engine.
 PRS350M..... (Moly).....\$64.50 ea.

1970-1976 455 engine.
 PRS455C Cast Iron. Standard, 30.....\$64.50 ea.
 PRS455M Street/Strip Premium Moly. Std,30,40,60 ...\$95.00 ea.

Flywheels (.666)

For automatic and standard. transmission
 (includes Ring Gear).

1961-1963Please inquire

1964-1980 300, 340 and 350 engines with auto. trans.
 FW645.....\$39.50 ea.

1964-1966 All. 400, 401 and 425 engines with auto transmission.
 FW646.....\$133.75 ea.

1967-1972 All. 400, 455 engines with auto transmission.
 FW676.....\$99.00 ea.

1967-1972 All. 400, 455 engines with std. transmission.
 FW676S\$289.50 ea.



Harmonic Balancers



1967-1976 all 400, 430, 455 engines.
 Sold outright.
 HB676.....\$285.00 ea.

Harmonic Balancer Rebuilding Service (.659)

Balancers are completely disassembled shot peened and inspected. Threaded holes are repaired and new seal saver is installed. (non-rope seal apps.). New silicone rubber is injected, then vulcanized for proper bonding. Please remove any bolted pulleys before sending. For those not listed, please inquire.



1961-1963 All 215 V-8 engines. Riveted type.
 HB215RS.....\$154.00 ea.

1961-1966 All 400, 401 engines. Riveted type.
 HB401RS.....\$199.50 ea.

1963-1966 All 425 engines. Riveted hub seal dia. 2.00 inches, 1.440 id.
 HB425RS.....\$199.50 ea.

1964-1967 All 225 V-6 engines.
 HB225RS.....\$88.25 ea.

1964-1981 All 300, 340, 350 engines. .750 wide ring externally balanced hub and ring.
 HB350RS.....\$88.25 ea.

1967-1976 400, 430, 455 engine. 1.100 wide ring. Externally balanced.
 HB455RS.....\$199.50 ea.

Harmonic Balancer Bolt

1967-1972 All 400, 430, 455 engines.
 HBB676.....\$7.50 ea.



Timing Chain Covers

1965-1966 All 400, 401 and 425 engines.
TC576.....\$379.50 ea.

1967-1976 All 400, 430 and 455 engines. Includes front seal.
TC676.....\$479.00 ea.



Timing Cover Seals



Our modern steel housed, silicon seals replace the OEM "rope" seal and steel retainer. A spring insert keeps pressure against balancer for improved sealing.

1961-1966 All 400, 401, 425 engines.
TCS536L\$12.75 ea.
1961-1967 All 215, 300, 340 engines.
TCS617\$11.75 ea.
1964-1972 All 350 engines.
TCS640\$11.75 ea.
1967-1972 All 400, 430, and 455 engines.
TCS650\$17.00 ea.

Valve Cover Gaskets

1961-1967 215, 300 and 340 engines.
VCG617.....\$15.00 pr.
1962-1967 198 and 225 V-6 engines.
VCG627.....\$12.50 pr.
1967-1972 400 and 455 engines.
VCG676.....\$17.75 pr.
1968-1972 350 engines.
VCG686.....\$11.25 pr.

Rear Main Seals

Replaces OEM "rope" seal.

1964-1972 All 225, 300, 340, and 350 engines.
RMS640\$24.50 ea.
1965-1972 All 400, 430 and 455 engines.
RMS650\$25.25 ea.



Timing Sets With Iron Cam Gear



1961-1972 198, 215, 225, 300, 340 and 350 engine.
TS610\$23.00 ea.
1965-1966 400, 401 engine.
TS576\$108.50 ea.
TC536.....Chain Only.....\$35.50 ea.
1967 400 engine early.
TS67E\$68.75 ea.
1967-1972
1967 400 late;
1968-1972 400 and 455 engine.
TS676\$56.25 ea.

Timing Cover Gasket Sets

(Sets Contain new rubber lip seal)

1961-1963 Special and Skylark.
TCS613\$27.25 set
1965-1966 All 400 engines
TCS536\$20.00 set
1964-1976 All 300, 340, 350 engines
TCS646\$25.25 set
1967-1972 400 and 455 engines.
TCS676\$25.25 set

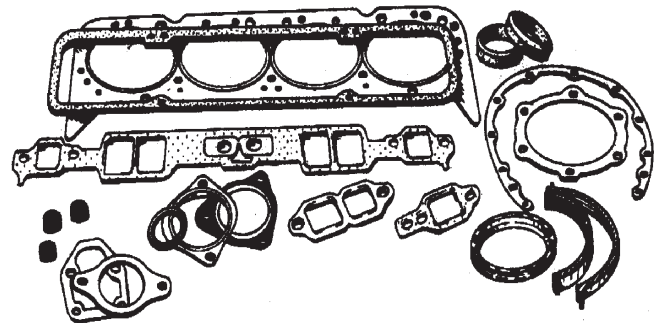

Engine Gaskets (Group 0)

YEAR	APPLICATION	FULL ENGINE OVERHAUL SET	CYLINDER HEAD OVERHAUL SET	CYLINDER HEAD GASKETS
1961-1963	215 V-8 engine.....	FGS613.....\$107.50	HGS613...\$60.00	HG613...\$59.50 pr.
1962-1963	198 V-6 engine.....	FGS623.....\$165.75	HGS623...\$55.00	HG623...\$40.75 pr.
1964-1967	225 V-6 engine.....	FGS647A...\$177.25	HGS647A..\$44.75	HG647A..\$20.75 pr.
1964-1967	300, 340 engine.....	FGS647B....\$92.25	HGS647B..\$69.75	HG647B..\$58.00 pr.
1965-1966	400 engine.....	FGS576.....\$135.00	HGS576....\$112.00	HG576....\$77.50 pr.
1967-1972	400, 455 engine *.....	FGS676.....\$89.50	HGS676....\$112.00	HG676....\$77.50 pr.
1968-1972	350 engine *.....	FGS686.....\$84.25	HGS686....\$41.50	HG686....\$36.75 pr.

* Intake manifold gasket not included. To order, please see Group 3.

Clutch Parts (Group 0)

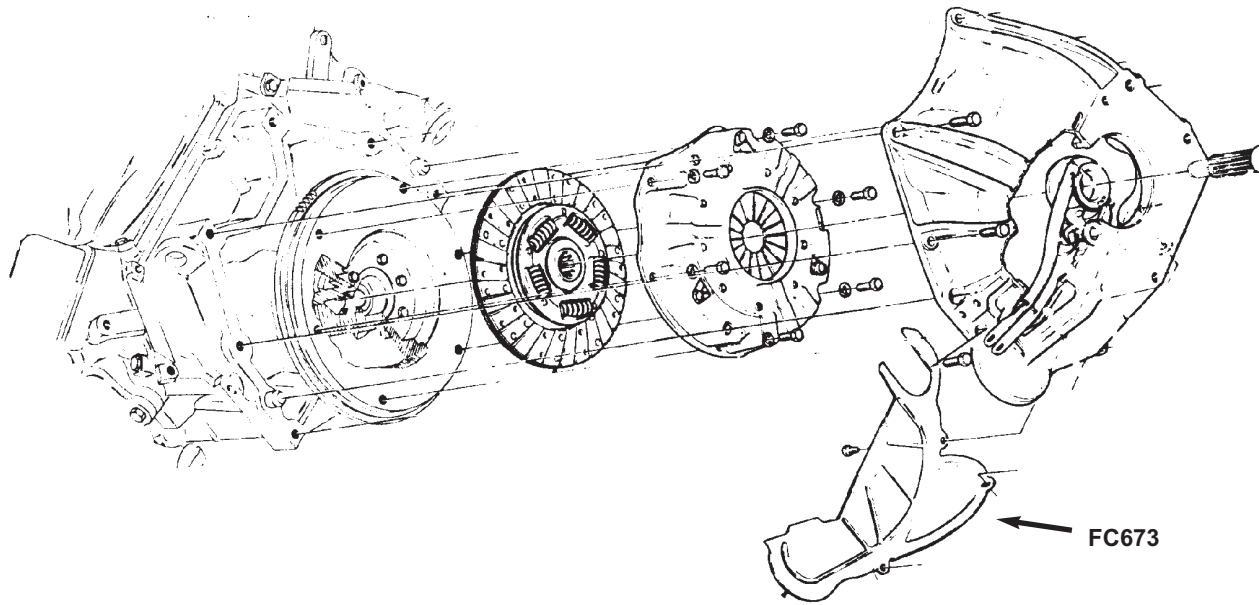

Pressure Plate Assemblies

New - GM

1964-1972 300, 340 and 350 engines.

PP643.....\$202.00 ea.

1967-1972 400 and 455 engines.

PP673.....\$202.00 ea.



Lower Flywheel Cover

1967-1972 300, 340, 350 and 455 engines with standard shift.

FC673.....\$69.75 ea.

Pilot Bearing

1961-1972 All.

PB570.....\$8.25 ea.



Clutch Discs



1961-1972

Please inquire about our Rebuilding Service.

Clutch Fork

1966-1972 340 and 350 engines.

CF662.....\$59.00 ea.



Clutch Release Bearings



1968-1972 350 engines.

TB685.....\$44.75 ea.

1961-1972

1961-1963: All;

1967-1972: 400 and 455 engines.

TB615.....\$51.25 ea.

1964-1967 225, 300 and 340 engines.

TB647.....\$44.75 ea.

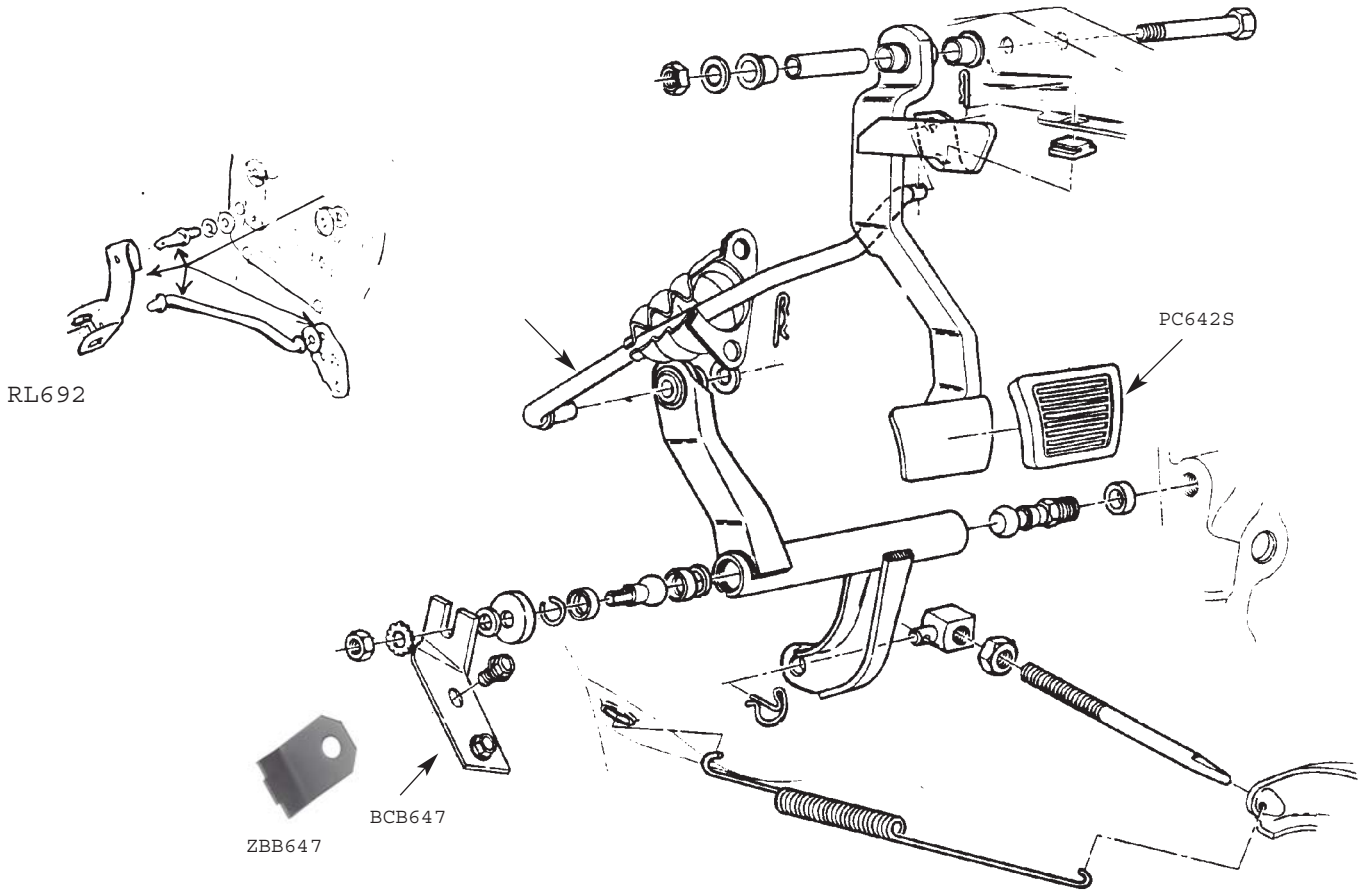

Clutch Adjusting Rods

- 1964-1966 All. Upper Clutch Rod. 14 1/8"
 - CR646\$29.75 ea.
- 1967 All. Upper Clutch Rod. 14 3/8"
 - CR67\$28.50 ea.
- 1968-1972 All 400, 455 engines. Upper clutch rod. 14 7/8".
 - CR685\$29.75 ea.

Clutch Pedal

- 1964-1972 All. (Same Brake Pedal).
 - PC642S\$10.75 ea.

Bell Crank Support Bracket

- 1964-1967 All. Weld on.
 - BCB647\$14.25 ea.
- 1968-1972 All. Bolt on.
 - BCB682\$16.50 ea.
- 1964-1967 Z-Bar return spring bracket.
 - ZBB647\$19.00 ea.



BCB647



BCB682



ZBB647

Clutch Boots

- 1964-1972 Clutch fork to bell housing.
 - CB642\$9.00 ea.
- 1964-1967 Clutch rod to firewall.
 - CB647\$12.75 ea.
- 1968-1972 Clutch rod to firewall.
 - CB682\$21.50 ea.



Clutch Shaft Boot



- 1965-1966 All with Manual Trans.
 - CB636\$45.00 ea.

Reverse Lock-out Linkage

- 1969 -1972 All w/ 4-speed Muncie.
 - RL692\$81.75 ea.

Buick Engine Enamel (Group 0)

Exact Original Colors to Authenticate your Engine.
Our Enamels are the Finest available. Very High Temperature. Can be easily Brushed or Sprayed to obtain a Rich Deep Gloss. Sold in Quart or Spray Cans.

*** Note: Spray cans can not be shipped by Air.**

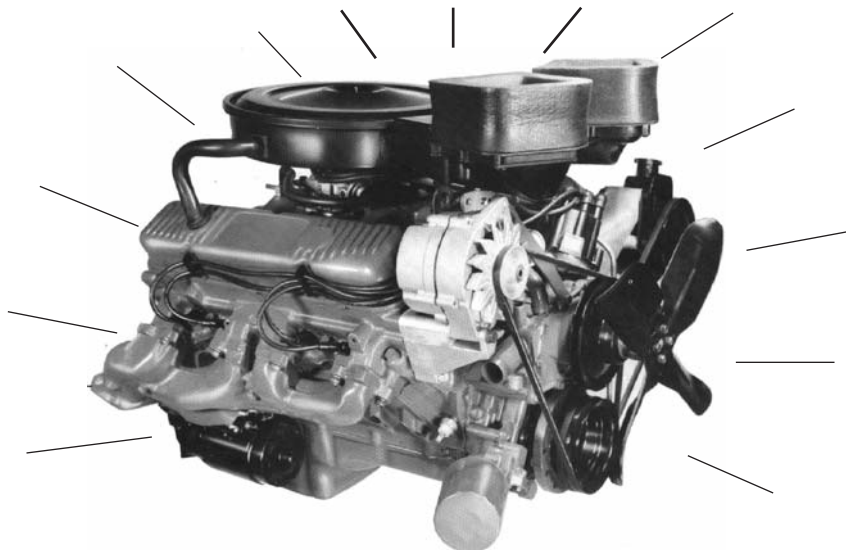

High Heat - High Gloss



Quart Cans



12 oz.
Spray Can

1961-1964	Buick Silver	EP614	\$27.50 ea.	EP614S.....	\$14.00 ea.
1961-1967	Buick Green	EP536	\$27.50 ea.	EP536S.....	\$14.00 ea.
1966-1972	Buick Red	EP644	\$27.50 ea.	EP644S.....	\$14.00 ea.

Cast Iron Paint



Extremely High Temperature - 1800 degrees. Excellent for manifolds and exhaust systems. **Will not burn OFF.**

EP3.....(pint).....\$32.00. ea.
 EP3S.....(spray can).....\$19.50 ea.

Engine Compartment and Chassis Paint

Our Satin Black Enamel contains the correct blend of dulling agents to give that "Authentic New Look". Use it on inner fender wells, under hood, radiator supports brackets, fan, air cleaner, etc. It is also correct for chassis.

All Years and Models

EP2.....(quart).....\$24.50 ea.
 EP2S.....(spray can).....\$14.00 ea.

Spray Gun for Engine Enamels



Self-propelled unit enables you to spray up to 16 oz. of paint. Great for use on engine enamels listed above that are not available in spray cans.

SG220\$8.25 ea.
 Refill cartridge.
 SGR220.....\$6.50 ea.



Air Cleaner Decals

CARS#	YEARS	APPLICATION	PRICE
D257	1961	Special "185" Tri-Shield (On Snorkel).....	\$9.00
D176	1961-1963	"Buick Skylark" (Silver Ltrs. 7" dia.)...	\$14.25
D175	1961-63	Spec. Fireball V8 (On Snorkel)	\$11.00
D272	1962	Special "190" Tri-Shield (On Snorkel).....	\$9.00
D83	1962-1965	"Fireball V6" (Round (Blk, Red & Slvr)	\$11.00
D273	1963	Special "200" Tri-Shiel (On Snorkel).....	\$9.00
D352	1964-1965	300 Engine A96C Air Filter Inst.....	\$8.50
D109	1964-1966	"Wildcat 355" (7"dia. Red).....	\$12.75
D159	1964-1966	"Wildcat 310" (7" dia. Red).....	\$14.25
D243	1964-1966	300 Engine Air Filter Instrut. #6421191...\$8.50	
D126	1964-1966	425 engine, 2 X 4BBL (chrome air cleaner) "Super Wildcat".....	\$8.00
D114	1965-1966	GS "Wildcat 445" (14" dia. Red).....	\$15.25
D90	1965	GS AC-A85C (Filter Instruction).....	\$5.50
D96	1965	A202C decal I.D. #6420861 (Filt. Inst.).....	\$6.25
D354	1966	340-4 Air Cleaner Filter Instr...#6424150	\$8.50
D97	1966	300 Engine Air Filter Instrut. #6421189	\$8.50
D293	1966	"Wildcat 375". 7" diameter.....	\$14.00
D258	1966	SP 310/300 Cu.In. (Air Clnr. Svce.).....	\$9.00
D353	1966	GS A 85C Air Filter Instruction	\$9.50
*D58N	1967-1969	"400-4" (Red & White)	\$12.75
D58	1967-1969	"400-4" (Red & White)	\$9.00
*D59N	1968-1969	"GS-400" (Red & White).....	\$11.75
D59	1968-1969	"GS-400" (Red & White).....	\$9.00
*D47N	1968-1972	"350-2" (Red & White)	\$9.00
D47	1968-1972	"350-2" (Red & White)	\$9.00
D-48	1968-1972	350-4" (7-1/2" across)	\$9.00
*D49N	1968-1972	"350-4" (11" across)	\$11.75
D49	1968-1972	"350-4" (11" across)	\$9.00
D56	1968-74	"Keep your GM car" #6424826	\$9.00
*D56N	1968-74	"Keep your GM car" #6424826	\$8.25
D355	1969	GS350 Air Cleaner Instr #6484022	\$9.00
D52	1969-1974	"Stage 1" (Red & White).....	\$9.00
D52E	1969-1974	"Stage 1" (Embossed as original)	\$8.50
*D53N	1969-1974	"Stage 2" (Red & White).....	\$9.75
D53	1969-1974	"Stage 2" (Red & White).....	\$9.00
D50	1970-1971	"350-4" HI-COMPRESSION.....	\$9.00
*D50N	1970-1971	"350-4" HI-COMPRESSION.....	\$12.75
D60	1970-1972	"GS-350" (Red & White).....	\$9.00
D60E	1970-1972	"GS-350" (Embossed as original)	\$8.25
*D60N	1970-1972	"GS-350" (Embossed as original) ..	\$12.75
D54	1970-1974	"455-4" (Red & White).....	\$9.00
D51E	1970-1974	"GS-455" (Embossed as original)	\$8.50
D51	1970-1974	"GS-455" (Air Cleaner).....	\$9.00

Please Note! Decal numbers preceded by an asterisk (*) are NOS! If you have a serious eye for detail, you will surely appreciate the clarity and construction of these originals. Some feature raised print and correct embossing. Quantities are limited.

Emissions and Tune-up

CARS#	YEARS	APPLICATION	PRICE
D261	1968	Buick 350-2 (Automatic Trans)	\$8.50
D262	1968	Buick 350 (Manual Trans)	\$8.50
D264	1968	Buick 400 (Manual Trans)	\$8.50
D265	1968	Buick 350-4 (Auto.Trans)	\$8.50
D266	1969	Buick 350-2 (Automatic Trans)	\$8.00
D292	1969	350-4 + 400 (Auto Trans).....	\$8.50
D263	1969	Buick 400 (Manual Trans)	\$8.50
D185	1969	400 (Auto Trans).....	\$8.50
D167	1970	Before 1/1/70 350-2BBL Automatic Transmission	\$8.50
D267	1970	Buick 455 STAGE1 (before1/1/70 Manual Transmission)	\$8.50
D62	1970	Buick 455 STAGE1 (after1/1/70 Manual Transmission)	\$8.00
D102	1970	455 Stage 1 (Automatic Transmission) (after 1/1/70)	\$8.50
D168	1970	350-4 BBL (Automatic Trans).	\$8.50
D290	1970	455 Stage 1 (Automatic Transmission) (before 1/1/70)	\$8.50
D291	1970	350 4BBL (Auto Trans) High Comp	\$8.50
D294	1970	All V8 "Evaporative control" decal	\$8.50
D309	1970	455 Automatic Transmission	\$8.50
D186	1971	350-2 Emissions Decal	\$8.50
D268	1971	Buick 350-4 (Automatic Trans)	\$6.00
D269	1971	Buick 455 STAGE1 (Automatic/Manual Transmission)	\$8.50
D270	1971	Buick GS 455 (Automatic Trans)	\$8.50
D278	1972	Buick 350 4BBL (Auto./Manual).....	\$9.00
D120	1972	455 Stage 1 (Auto and Man Trans)	\$8.50
D307	1972	All 455.....	\$8.50
D312	1973	All 455.....	\$9.00
D313	1973	All 455 Stage	\$9.00
D315	1974	455 4BBL Automatic Trans.	\$9.00
D316	1974	455 Stage 1 Automatic Trans.	\$9.00



Valve Cover Decals

CARS#	YEARS	APPLICATION	PRICE
*D87N	1966-1967	"300-2" (Silver & Black)	\$6.75
D87	1966-1967	"300-2" (Silver & Black)	\$8.50
D183	1966-1967	"300 4V" (Silver & Black).....	\$8.50
*D88N	1966-1967	"340-2" (Silver & Black)	\$6.75
D88	1966-1967	"340-2" (Silver & Black)	\$8.50
D89	1966-1967	"340-4" (Silver & Black)	\$8.50
D70	1967-1969	"400-4" (Silver & Black)	\$8.00
D67	1968-1974	"350-4" (Silver & Black)	\$8.00
D66	1968-1974	"350-2" (Silver & Black)	\$8.00
D84	1969	"400-4 Stage 1" (Silver & Black).....	\$10.00

Decals • Stickers (Group 0)

Engine Compartment

CARS#	YEARS	APPLICATION	PRICE
D1	1961-1962	Generator Warning Tag	\$8.00
D72	1961-1974	Harrison Air Cond. (Alum. tag).....	\$9.00
D46	1961-1967	"Optikleen" (Bottle Label).....	\$3.75
D107	1961-1967	"Optikleen" Bottle cap decal.....	\$8.00
D249	1961-68	Buick GM Wind Wash Klear-View.....	\$7.50
D184	1961-1962	Oil Filler Cap Decal (Orange).....	\$3.00
D172	1961-1963	Air Cond. Compr. Warning.....	\$8.50
D171	1961-1963	Alum. Eng. Cooling	\$8.00
D205	1961-1966	"GM" Antifreeze Tag	\$8.00
D179	1962-1964	Cooling System Decal.....	\$7.50
D130	1963-1967	"Positive" Battery Warning	\$8.00
D63	1968-1974	"Positive " Battery Warning	\$4.25
D80	1963-1966	Cooling System Sticker	\$8.50
D100	1963-1972	"GM Antifreeze" Sticker.....	\$7.50
D297	1964	Frigidaire Compressor Decal.....	\$9.00
D190	1965	Harrison Air Conditioner Box.....	\$8.50
D187	1965	Frigidaire Air Cond. Compressor.....	\$9.00
D246	1965-1966	Buick Cooling System (X-Flow).....	\$8.50
D122	1965-1966	Downflow Radiator Cooling.....	\$8.00
D251	1966	Frigidaire Air Cond. Compressor.....	\$9.00
D191	1966	Harrison Air Conditioner Box.....	\$8.50
D357	1966-1967	"Canada" Oil Change Decal.....	\$8.50
D192	1967	Harrison Air Conditioner Box.....	\$8.50
D298	1967-1968	Frigidaire Compressor Decal	\$9.00
D193	1968	Harrison Air Conditioner Box.....	\$8.50
D358	1968-1969	"Canada" Oil Change Decal #734791	\$8.50
D194	1969	Harrison Air Conditioner Box.....	\$8.50
D252	1969	Frigidaire Air Cond. Compressor.....	\$9.00
D77	1969-1972	Windshield Washer Bottle	\$8.00
D195	1970	Harrison Air Conditioner Box.....	\$8.50
D253	1970	Frigidaire Compressor Decal.....	\$9.00
D359	1970-1971	"Canada" Oil Change Decal #733693	\$8.50
D210	1970-1972	Cooling System Decal.....	\$8.25
D188	1971	Frigidaire Air Cond. Compressor.....	\$9.00
D196	1971	Harrison Air Conditioner Box.....	\$8.50
D254	1972	Frigidaire Air Cond. Compressor #5910789	\$9.00
D189	1972	Frigidaire Air Cond. Compressor.....	\$9.00
D197	1972	Harrison Air Conditioner Box.....	\$8.50
D198	1973	Harrison Air Conditioner Box.....	\$8.50
D199	1974	Harrison Air Conditioner Box.....	\$4.25
D200	1975	Harrison Air Conditioner Box.....	\$8.50
D201	1976	Harrison Air Conditioner Box.....	\$4.25



D-55

Interior

CARS#	YEARS	APPLICATION	PRICE
D44	1961	Glove Box Door Sticker.....	\$4.75
D166	1961-1962	Sp/Sky Tire and Oil (Glove Box)	\$8.50
D165	1961-1962	Glove Box Lacquer Paint	\$8.00
D71	1961-1963	Casco Automatic Lighter (tag).....	\$7.50
D379	1961-1963	"Air Conditioned" Window Decal	\$8.50
D386	1961-1964	Delco Battery Certificate	\$7.50
D375	1961-1965	Electric Antenna Tag.....	\$8.00
D371	1964	NEW Car Price Booklet.....	\$8.00
D372	1965	NEW Car Price Booklet.....	\$8.25
D279	1965-1968	Delco Battery Owners Certif.....	\$7.75
D384	1965-1968	Litter Bug Decal.....	\$8.25
D373	1966	NEW Car Price Booklet.....	\$8.25
D95E	1966-1967	"GM mark of Excellence" (Door sticker Aqua/Silver) Embossed	\$10.00
D369	1966-1969	NEW Car Factory Build Sheet.....	\$8.50
D91	1967	All Buick Tire Pressure Sticker	\$8.50
D271	1968	Special /Skylark Tire Pressure	\$8.50
D164	1968	Buick GS 400 Tire Pressure.....	\$8.50
D338	1968	Spec. wagon/Sportwagon Tire Pres.....	\$8.50
D381	1968-1970	Luggage Instruction Tag	\$8.50
D55	1968-1974	"GM Mark of Excellence" (Door Sticker Blue/Sliver).....	\$7.50
D55E	1968-1974	"GM Mark of Excellence" (Door Sticker Blue/Sliver) Embossed	\$10.00
D339	1969	GS-400 Glove Box Tire Pres. Decal.....	\$8.50
D388	1969-1972	Ignition Lock/Start Sleeve 6"	\$8.50
D-389	1969-1972	Ignition Lock/Start Sleeve 7".....	\$8.50
D135	1970	Red Tire Pressure Sticker #1234162.....	\$8.00
D69	1970	Skylark 350 and GS, Green #1234158 Tire Pressure Sticker.....	\$8.00
D300	1970	Skylark 455 and GS 455 Tire Press	\$8.50
D374	1971	NEW Car Price Booklet.....	\$8.25
D105	1971	Except GS455 All Tire Pres. Stkr	\$8.50
D364	1971	GS455 Glove Box Tire Pressure	\$8.50
D380	1971-1973	Starting Instruction Tag	\$8.00
D365	1972	GS Glove Box Tire Pressure	\$8.50
D239	1972	Sky Seat Belt Installation Sleeve	\$8.50
D212	1975-1976	Push Start Warning	\$7.50



D276



Exterior Decals

CARS #	YEARS	DESCRIPTION	PRICE
D276	1970	"GSX" (on 1/4 Panel)	\$15.00
D277	1970	"GSX" (on Rear Spoiler)	\$15.00
D400	1970	Gas Cap Caution Decal (Calif. Cars)	\$8.50
D404	1970-1971	Frame Decal Kit	\$8.50
D163	1973-1974	"gran sport" (Gold 1/4 panel)	\$14.00
D169	1973-1974	"gran sport" (black 1/4 panel)	\$15.00
D303	1973-1974	"gran sport" (white 1/4 panel)	\$15.00
D399		Buick tri-Shield 2 7/8" Wheel Cntr Decal	\$8.50
D405		"Unleaded Fuel Only" 5" Straight-White	\$7.50
D406		"Unleaded Fuel Only" 5" Straight-Black	\$7.50
D407		"Unleaded Fuel Only" 4" Straight-B & W	\$7.50
D408		"Unleaded Fuel Only" 4" Straight-Blk & Slv	\$7.50
D410		"Unleaded Fuel Only" 5" Curved-White	\$7.50
D411		"Unleaded Fuel Only" 5" Curved-Black	\$7.50

gran sport

DECK LID STRIPE KITS

D241	1973	"Gran Sport" Deck Lid Silver	\$102.50
D240	1973	"Gran Sport" Deck Lid Black	\$109.00
D242	1974	"Gran Sport" Deck Lid Black	\$94.50
D244	1974	"Gran Sport" Deck Lid White	\$102.50



D 108



D 112



D 117



D 111



D310



D 118

Garage Wall, Tool Box Decals

D108	Old Style Buick Logo (blue and white)	\$8.50
D111	"Genuine Buick Parts" 2" x 2 1/2" Water Transfer	\$1.50
D112	"Buick 8" 2" x 2 1/2" Water Transfer	\$1.50
D117	"Authorized Service" (10" diameter red, white and blue decal)	\$8.50
D118	"Authorized Service" (5" diameter red, white and blue decal)	\$6.50
D310	Tri-Shield 12" (red, white and blue)	\$9.75

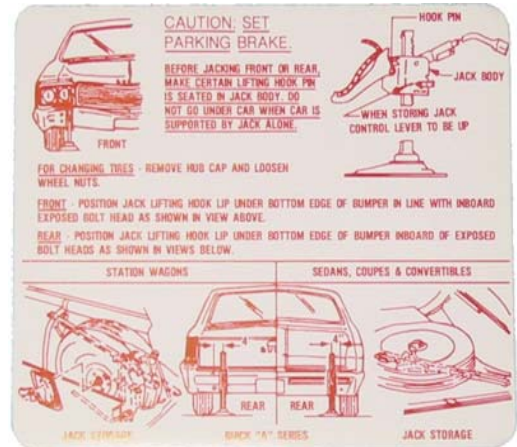

D236

Trunk

CARS#	YEARS	APPLICATION	PRICE
D232	1961	Special/Skylark Jack Instr.	\$8.25
D231	1962	Jack Instructions	\$8.00
D132	1963-1964	Jack Instructions	\$8.50
D275	1965	All Jack Instructions	\$8.50
D234	1966	All Jack Instructions	\$8.00
D235	1967	All Jack Instructions	\$8.00
D236	1968-1969	All Jack Instructions	\$8.00
D237	1970	All Jack Instructions	\$8.00
D395	1970-72	Space Save Tire Inflation decal	\$8.50
D238	1971	All Jack Instructions	\$8.00
D396	1971-1973	Canada Limited Slip Decal	\$8.50
D227	1973-1977	Tire Inflator (On Can)	\$8.50
D304	1972	Skylark/GS Jack Instructions	\$8.25

NEW Car Window Sticker

CARS #	YEARS	DESCRIPTION	PRICE
D127	1963-1964	NEW Car Window Sticker	\$8.50
D129	1965-1966	NEW Car Window Sticker	\$8.50
D131	1967	NEW Car Window Sticker	\$8.00
D344	1968	NEW Car Window Sticker	\$8.50
D133	1969-1970	NEW Car Window Sticker	\$8.50
D140	1971-1974	NEW Car Window Sticker	\$5.50

Please Note! Decal numbers preceded by an asterisk (*) are **NOS!** If you have a serious eye for detail, you will surely appreciate the clarity and construction of these originals. Some feature raised print and correct embossing.
Quantities are limited.

Air Cleaner Identification (Group 0)

1965-1966 Air Cleaner I.D. Plate.

Not just a "decal", but a high quality silk screened impression on a die cut reflective aluminum disc. Add the final touch to your highly detailed engine compartment. Will not fade or wrinkle. Easy to apply. Absolutely Concourse show quality. Approved and licensed by Buick.

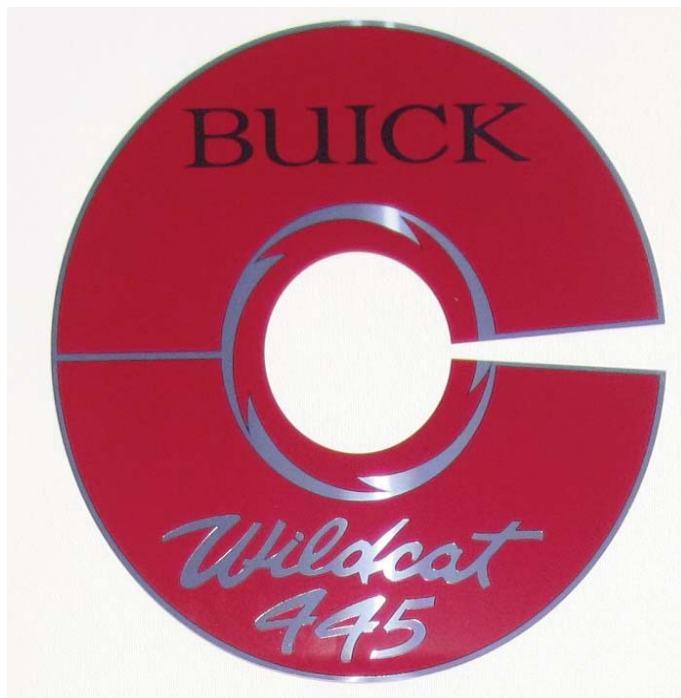

1965-1966 GS-400 Engines "Buick Wildcat 445"
14" Diameter.

D114A.....\$37.50 ea.

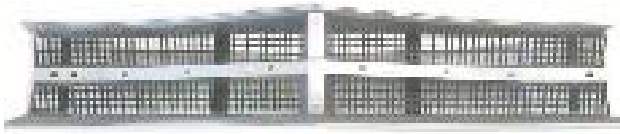

G67GS



G69GS



G70GS



GE70G



GE70X



GM70

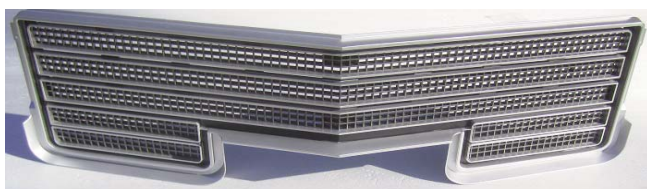

G71GS



GE72G



GEP72

1967 Special and GS Grille

(Includes Mounting Studs)

G67GS\$527.00 ea.

1967 GS Grille Emblem.

GE679G\$32.50 ea.

1968 GS Grille

G68GS\$499.00 ea.

1969 GS Grille

G69GS\$499.00 ea.

1969 GS Grille Emblem.

GEG79G\$32.50 ea.

1970 GS Grille

(Includes Mounting Studs)

G70GS\$494.00 ea.

1970 GS Grille Emblem. "GS by Buick".

GE70G\$49.50 ea.

1970 GSX Grille Emblem. "GSX by Buick".

GE70X.....\$56.50 ea.

1970 Grille Surround Molding Set - 3 pieces.

GM70.....\$159.00 set.

1971 GS Grille

G71GS\$625.00 ea.

1971 GS Grille Emblem. "GS by Buick".

GE71G\$49.50 ea.

1971 GSX Grille Emblem. "GSX by Buick".

GE71X.....\$56.50 ea.

1972 Skylark and GS Grille

G72GS\$499.00 ea.

1972 GS Grille Emblem. "GS by Buick".

GE72G\$44.50 ea.

GEP72.....(Backing Plate).....\$9.75 ea.

1972 GSX Grille Emblem. "GS by Buick".

GE72X.....\$65.00 ea.

GEP72.....(Backing Plate).....\$9.75 ea.

Grilles • Cooling • Oiling (Group 1)

Grille Emblems (1.303)

1965 "Gran Sport" Grille Emblem.
GE65GS.....\$37.50 ea.



1966 "Gran Sport" Grille Emblem.
GE66GS.....\$39.00 ea.



1968 "GS" Grille Emblem.
GE68GS.....\$38.50 ea.



1967, 1969 "GS" Grille Emblem.
GE679G.....\$32.50 ea.



1970 "GS By Buick" Grille Emblem.
GE70G.....\$39.00 ea.



1970 "GSX By Buick" Grille Emblem.
GE70X.....\$49.50 ea.



1971 "Skylark By Buick" Grille Emblem.
GE71S.....\$69.50 ea.



1971 "GS By Buick" Grille Emblem.
GE71G.....\$38.50 ea.



1971 "GSX By Buick" Grille Emblem.
GE71X.....\$77.75 ea.



1972 "GS By Buick" Grille Emblem.
GE72G.....\$43.50 ea.



1970-1972 Hood Release Handle.
HH702.....\$19.50 ea.



1968-1972 Radiator Core Supports, Repair Kits Core Support Mounts and Hardware

**Our 3 piece kit of heavy gauge metal,
repairs rusted box and lower panel area.**

1968-1969 All. Repair for R.H. side.
CSK689R.....\$139.00 ea.

1968-1969 All. Repair for L.H. side.
CSK689L.....\$139.00 ea.

**Our 3 piece kit of heavy gauge metal,
repairs rusted box and lower panel area.**

1970-1972 All. Repair for R.H. side.
CSK702R.....\$139.00 ea.

1970-1972 All. Repair for L.H. side.
CSK702L.....\$139.00 ea.



1970-1972 Complete Core Support

CS702.....\$395.00 ea.



1968-1972 Lower radiator support mount w/ metal core.
3/4" ID. 2 1/2" OD. 1 1/8.
BM644.....\$10.25 ea.

1968-1972 Upper radiator core support mount.
BM644A.....\$8.50 ea.

1964-1967 Core support hardware kit.
CSK647BK.....\$5.00 ea.

1968-1972 Core support hardware kit.
CSK644BK.....\$5.00 ea.

1964-1967 Core support mount kit. Lower mounts, 2 upper mounts and hardware.
CSK647.....\$38.00

1968-1972 Core support mount kit. Lower mounts, 2 upper mounts and hardware.
CSK644.....\$42.00





Fans

Fan Spacer Kit

1969-1972 Fan spacer 2" kit. Includes bolts / washers.
FSK696\$17.00 ea.

Fan Clutches (1.050)



1964-1972
1964-1967 225, 300 and 340 engines;
1968-1972 350 engine.
FC642\$54.50 ea.
1965-1972
1965-1969 400 engine;
1969-1972 250 engine;
1970-1972 455 engine.
FC626\$64.50 ea.

Fan Shrouds (1.277)

Fiberglass Reproductions



1965-1967
1965 300 engine with crossflow radiator;
1966-1967 All 300 and 340 engines.
FS657.....\$157.50 ea.
1965-1966 GS 400
FS656.....\$157.50 ea.
1967 Skylark, GS 400
FS67.....\$157.50 ea.
1968-1969 GS 400
FS689.....\$154.50 ea.
1970 GS and GSX 455.
FS70 (ABS Reproduction).....\$157.50 ea.

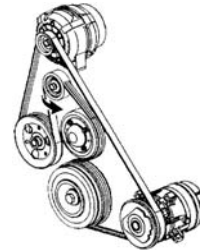

Fan Belts

Don't Rely On Old Belts!

The price of a new belt is a small fraction of the repair costs a broken belt can cause.

We Stock Hundreds of Different Fan Belts.
When Ordering, Please Include:
The Model, The Year, Engine Size, and if you have
Power Steering? or Air Conditioning?

Fan belt - All
FB400.....\$19.75 ea.

ALSO: WHICH BELT (Fan-Alt., Fan-AC Comp.,
Steering Pump-Air Pump, etc.).

Cooling • Oiling (Group 1)

Thermostat (with Gasket) (1.246)



1961-1972 All except 1965-1966 GS.

T330.....(180°)\$9.75 ea.
T330L.....(160°)\$9.75 ea.
T330H.....(195°)\$9.75 ea.
1965-1966 GS	
T536.....(180°)\$9.75 ea.
T536L.....(160°)\$9.75 ea.
T536H.....(195°)\$9.75 ea.

Thermostat By Pass Hoses



1962-1972
1962-1967 V-6 engines;
1964-1972 300, 340 and 350 engines.

BP625.....\$9.75 ea.
1967-1972 400 and 455 engines.	
BP676.....\$9.75 ea.

Water Pump Mounting Gaskets



1961-1972 198, 215, 225, 300, 340 and 350 engines.

WPG615\$3.75 ea.
1965-1972 400 engines.	
WPG626\$3.50 ea.
1967-1972 400 and 455 engines.	
WPG675\$3.25 ea.

Temperature Sending Units



1961-1965 All except 1965 GS - One (1) terminal.

TSU615.....\$14.50 ea.
1965-1968 GS 400 - Two (2) terminals.	
TSU608.....\$19.75 ea.
1966-1972 300, 340, 350 and 455 engines with lights.	
One (1) terminal.	
TSU662.....\$13.50 ea.
1970-1972 All with gauges.	
TSU702.....\$19.50 ea.

Water Pumps (1.069)



1961-1963 198, 215 engine w/o ac;
1962-1963 all V-6.

WP613EI.....(exchange item).....\$69.50 ea.
1964-1970 225, 300, 340 and 350 engines.	
WP640.....\$54.50 ea.
1965-1966 400 engine with A.C. This pump will also fit non - A.C. cars.	
WP626A.....\$79.50 ea.
1967-1970 400, 455 with A. C.	
WP670.....\$80.25 ea.
1971-1972 350 engine.	
WP712S.....\$47.50 ea.
1967-1972 400, 455 without A.C.	
WP672.....\$57.25 ea.
1971-1972 455 engines with A.C.	
WP716.....\$56.75 ea.

Water Outlets



1961-1972
 1961 thru 1972 all except 1965 and 1966 GS.400.

WO615.....\$25.50 ea.
WOB536....Bolts & Washers for Above.....\$3.75 ea.

1965-1966 400 engine.

WO626.....\$29.50 ea.
WOB536....Bolts & Washers for Above.....\$3.75 ea.



Water Manifold Gasket Kit



1961-1966 All 400, 401. Includes 2 gaskets and "O" ring.

WMK536.....\$9.50 ea.
-------------	-----------------

Water Outlet Gasket

1961-1972 All.

WOG615.....\$2.25 ea.
-------------	-----------------



Crankcase Vent Hose (To Carb) (1.746)

1967 400, 430:
1968-1971 All 4BBL engines.

VH671.....\$28.00 ea.
------------	------------------

1971-1975 All 350 and 455 engines with 4BBL carb. (Formed hose).

VH725.....\$24.50 ea.
------------	------------------



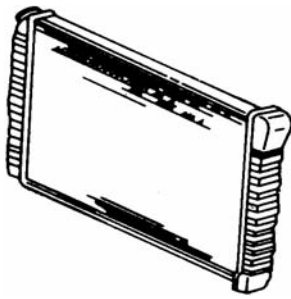

Radiators

- 1968-1972** Skylark and GS with manual transmission. 4 core. Concours correct.
 R682M\$729.00 ea.
- 1968-1972** Skylark and GS with automatic transmission. 4 core. Concours correct.
 R682A\$829.00 ea.

Radiator Insulators

-
- 1962** all 2nd type; Lower.
1963 All. Lower.
 RI623S\$25.99 ea.

- 1962** all 2nd type; Upper. 2 per car.
1963-1964 All. Upper. 1 per car.
1965 All with downflow radiator.
 2 per car.
 RI625S.....\$28.19 ea.

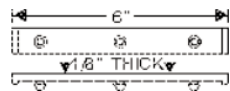

- 1965** All with cross-flow radiator;
1966 All.
 RI656.....\$44.79 pr.

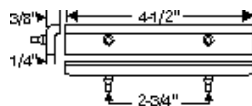

-
- 1965** GS;
1966 All.
 RI656B\$48.19 pr.

-
- 1968-1972** All with 3 core radiators.
 Set of 4. (1970 cars compare with RI690 below).
 RI682S.....\$84.69 set

- 1970** Some with 3 core radiator. 2 pair used per car. Compare with RI682S.
 RI690.....\$48.69 pr.

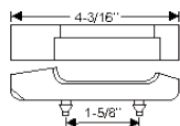

4-Core Radiator Insulators



Correct replacement for 4-core radiators. All years as required.
 RI600\$15.50 pr.

Radiator Caps



Take a good look at these caps. They are identical to the originals. Correct in every detail, they feature the cap number, instructions and of course genuine "AC" identification stamped right into the zinc plated surface. Show quality, approved and licensed by Buick.

- 1961-1964** All. 15 lb.
 RC15D\$32.50 ea.
- 1965-1968** All. 15 lb.
 RC15F.....\$32.50 ea.
- 1969-1970** All w/o coolant recovery sys. 15 lb.
 RC15H\$32.50 ea.
- 1970-1972** All with coolant recovery sys. 15 lb.
 RC29(plate has scalloped edge).....\$29.75 ea.
- 1970-1972** All with coolant recovery sys. 15 lb.
 RC29S(plate has smooth edge).....\$29.75 ea.
- 1961-1969** All. 15 lb.
 RC579.....\$16.50 ea.
- 1970-1972** All.
 RC706.....\$9.75 ea.

Radiator Overflow Hose



Correct "Ribbed" Hose sold in 3 1/2' length. All years as required.
 OH600\$13.50 ea.













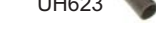

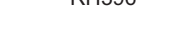

1934-1960 Radiator drain cock. Brass.
 DV344\$5.75 ea.

Cooling (Group 1)

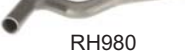
Radiator Hoses

We Can Supply Almost Any Model/Year
Check, NOS Section Also! **Please Inquire.**

	1961 All V8, Lower. RH369.....\$19.50 ea.
	1962 V6 (Radiator 126 or 127), Lower. RH509.....\$19.50 ea.
	1962 V8 (Radiator 121 or 143), Lower. RH369.....\$19.50 ea.
	1962-1963 V6, Upper. UH623.....\$22.50 ea.
	1964-1965 All V6. Upper. RH392.....\$19.50 ea.
	1965 All V8 (Down Flow), Lower. RH396.....\$23.50 ea.
	1965 8 cyl without AC (Down Flow), Upper. RH439.....\$17.75 ea.
	1965 All V 8 w/ Cross Flow, Upper. RH510.....\$17.50 ea.
	1965 8 cyl with AC (Down Flow) Upper. RH755.....\$22.25 ea.
	1965-1968 Lower. 1965: 8 cylinder (X-Flow); 1966: 300, without AC, with AP; 1967-1968 All 300, 340, 400. RH742.....\$22.50 ea.
	1966-1967 Upper. 1966 -1967 All 340 RH485.....\$23.50 ea.
	1966-1967 Lower. 1966: Special, with AC; 1967: 340 (Exc. SP), without AC; RH512.....\$22.50 ea.
	1967 340 (Exc. SP), without AC, Upper. RH533.....\$22.25 ea.
	1968-1970 Upper. 1968 All 350 and 400; 1969-1970: 350 (Special and Skylark); 1969: 400 (GS, Sportwagon); 1970: 455 (GS). RH980.....\$22.25 ea.
	1969-1972 All Skylark/GS, 350, 400 and 455, Lower. RH597.....\$34.75 ea.

	1969-1972 Upper. 1969-1970 All GS350; 1971 All 455; 1972: All GS-350. RH715.....\$22.50 ea.
	1971-1972 Upper. 1971 All 350; 1972 All exc. GS350. RH869.....\$22.50 ea.

Radiator Hose Support



1969-1970 All GS. HS690.....\$ 27.50 ea.
--

Radiator Overflow Reservoir



1970 through 1972 models. Note that 1970 early models came with a clear top. Later 1970 models and all 1971-1972 models had Black tops. This is a fine reproduction with correct embossed letters and numbers, made a bit more sturdy than the original.

OR702B.....Black Top.....\$149.00 ea.
OR702C.....Clear Top.....\$169.00 ea.

Radiator Hose Clamps

ORIGINAL EQUIPMENT
" TOWER TOP " HOSE CLAMP



*Authentic reproduction of "Tower Top"
Hose clamps made by the Wittek
Company for GM.*

They are correct for all 1961-1972 models.

RC134....1 3/4"	\$ 2.75 ea.
RC200....2"	\$ 2.75 ea.
RC216....2 1/16" Diameter fits most upper hoses ..	\$ 2.75 ea.
RC214....2 1/4" Diameter fits most lower hoses...	\$ 2.75 ea.
RC250....2 1/2"	\$ 2.75 ea.
RC2516..2 5/16"	\$ 2.75 ea.
RC400....4"	\$ 4.00 ea.



Heater Hose

3/4" All years.	
HH34	\$1.10 ft.
3/4" All years: 50 ft.	
HH3450	\$43.50
5/8" All years.	
HH58	\$1.10 ft.
5/8" All years: 50 ft.	
HH5850	\$43.50

Breather Tubes (Air Cleaner to Rocker Cover) (1.745)

Breather Tube

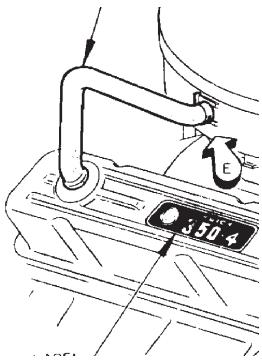

1968-1969 All 350 and 400 4BBL.	
VT689	\$19.50 ea.



1970-1971 all V-8; 1972 all 455 engines	
VT704	\$19.50 ea.



Crankcase Vent Hose (To Carb) (1.746)

1967 400, 430:	
1968-1971 All 4BBL engines.	
VH671	\$28.00 ea.
1971-1975 All 350 and 455 engines with	
4BBL carb. (Formed hose).	
VH725	\$24.50 ea.



**Fax Us
Your Order
Save Time!**

When sending us a long order
it is easier to just fax it.

908-369-7595

Tower Top Heater Hose Clamps



Buick used "Tower Top" hose clamps on all cars from 1961-1972. We supply the identical clamps made by the Wittek Company. They are authentic and correct.

1 1/16" for 5/8" heater hose.

HC580	\$2.75 ea.
1" for use on thin walled 5/8" hose.	
HC580S	\$2.75 ea.
1 1/4" for 3/4" heater hose.	
HC340	\$2.75 ea.
1 3/16" for use on thin walled 3/4" hose.	
HC340S	\$2.75 ea.

Wire Hose Clamps



For 9/16" diameter hose.

HC916W	\$ 1.00 ea.
HC916WP	(5 Pack) \$ 3.25 ea.

For 5/8" diameter hose.

HC580W	\$ 0.75 ea.
--------------	-------------

For 3/4" diameter hose.

HC340W	\$ 0.75 ea.
HC340WP	(5 Pack) \$ 3.25 ea.

For 13/16" diameter hose.

HC1316W	\$ 1.00 ea.
HC1316WP	(5 Pack) \$ 4.25 ea.

For 15/16" diameter hose.

HC1516W	\$ 0.75 ea.
HC1516WP	(5 Pack) \$ 4.25 ea.

For 1" diameter hose.

HC100W	TOS
HC100WP	(5 Pack) \$ 4.25 ea.

For 1-1/4" diameter hose.

HC114W	\$ 1.00 ea.
HC114WP	(5 Pack) \$ 5.00 ea.

For 2" diameter hose.

HC200W	\$ 2.75 ea.
HC200WP	(5 Pack) \$12.25 ea.

Cooling • Oiling (Group 1)

Oil Filters



1961-1966 All. (Also fits thru 1980 where there is room for taller filter). PF-7 type.
OF596\$11.00 ea.

1967-1980 All exc. V-6 and 260 engines.
PF-24 type.
OF670\$11.00 ea.

PF-24 Oil Filters



A brand new quality reproduction on the original 1967-1975 red, white, and blue, AC TYPE PF-24 oil filter with logo and proper coloring. A must for the concours restorer.
OF590AC\$22.25 ea.

Oil Pan



1969-1970 all 400, 430, 455 engines;
1971-1976 all 455 engines.
Not for factory exhaust crossover systems. Powder coated.
OP676\$179.00 ea.

Oil Pan Drain Plug and Gasket Kit

1961-1976 Oil pan drain plug and gasket. 1/2" x 20" thread.
OP595\$5.50 kit

Oil Pick-up Tube and Screen



1964-1968 all 225, 300, 340, 350 engines. Has 5/8" tube. Requires passage drilled to 5/8".
OPU647\$24.50 ea.

1965-1966 GS 400, 401, 425 engine. Stock size.
OPU626\$155.00 ea.

1967-1976 400,455 w/ rear sump. (Increased oil pick-up over stock 1/2" tube. Gives 5-10 psi oil pressure increase. 1967-1970 engines require that pick-up passage drilled to 5/8". Acts as replacement for 1970 Stage 1 and all 1971-1976 455 engines).
OPU676R\$69.75 ea.

1967-1976 400, 430, 455 w. center sump. 5/8" tube. Requires passage to be drilled to 5/8".
OPU676C\$74.50 ea.

1969-1981 350 engine. Stock size.
OPU695\$20.00 ea.

1969-1981 all 350. Has 5/8" tube requiring windage tray to be removed or trimmed.
OPU691\$39.50 ea.

ODG595.....Nylon Gasket Only\$2.50 ea.
ODG595C.....Crushable Copper Gasket.....\$3.00 ea.

Oil Pumps (1.652)

1965-1966 400 engines.
OP626\$189.50 ea.

Oil Pump Kits (1.652)

1961-1963 215 engine.
OPK613\$39.00 kit

1964-1981 All 225, 300, 340, 350 engines.
OPK642\$33.75 kit
OPK642H.....(High Volume Kit)\$49.50 kit

1965-1966 All 400, 401 engines.
OPK626\$69.50 kit



1967-1976 All 400, 430, 455 engines.
OPK676\$39.50 kit
OPK676H....(High Volume Kit).....\$89.75 kit

Oil Pump Thrust Plate Repair Kit

This kit provides a NEW WEARING Surface for badly scored or worn cover housing. Kit contains all necessary screws, gaskets and instructions.

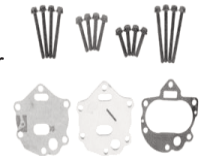

1961-1981 all 215, 225, 300, 340, 350, 455 engines.
OPK685\$32.50 ea.

Distributor Gear Oiler



1967-1976 all 400, 430 and 455. This modification increases the life of the distributor gear and cam gear - a must since the cam gear is not replaceable. Provides constant supply of oil spray to both gears. Modification requires small hole to be drilled and tapped on the inside of timing chain cover. Oil pressure is not affected. Requires 1/8" pipe tap and 2-1/64 drill bit no supplied in kit. Instructions included.
GO676\$19.50 ea.

Oil Pump Covers



1964-1981 All 225, 300, 340, 350, 430, 455 engines.
1967-1969 400 engines.
OPC646\$89.50 ea.
OCG647.....gasket for above.....\$4.75 ea.

1974-2009 All 3.8 (231), 4.1 (252) Metric.
OPC749\$89.50 ea.



OC397A



OC397 and OC647



OC684 and OC694

Oil Filler Breather Caps

- 1961-1967** All exc. chrome jobs. Genuine "AC OIL" exact.
 OC397\$34.50 ea.
1961-1967 All except chrome jobs - replacement.
 OC397A\$9.75 ea.
1965 and 1967 GS models with chrome twist on "AC Oil"
 OC647\$39.50 ea.
1968-1972 All (twist on type) replacement.
 OC684\$4.75 ea.
1969-1972 All stage 1 engines. Chrome. Replacement.
 OC694\$9.75 ea.

Oil Pressure Switches

(1.800)



1961-1966

- 1961** All;
1962-1963 All 8 Cylinder;
1964-1966 225, 300, and 340.



- OPS606\$11.75 ea.
1962-1972
1962-1963 All 6 Cylinder;
1967 All;
1968-1972 All with 1/4" Thread;
 OPS-620\$13.75 ea.
1965-1966GS. 400 engine
 OPS606\$11.75 ea.
1968-1972
1968 1/8 Thread;
1969-1970 1/8 Thread;
1971-1972 1/8 Thread.
 OPS682\$9.75 ea.
1970-1972 All with gauges
 OPS702.....\$ inquire

PCV Valves



- 1963-1967**
1963 All;
1964-1967 V-6.
 PCV637\$ 6.75 ea.
1964-1972 All V8.
 PCV644\$6.75 ea.
 PCV Valve Grommet.
1963-1972 All.
 VG634.....\$7.75 ea.
 PCV Valve hose clamp. All on PCV hose.
 HC660PTOS



Adjustable Oil Pressure Regulator



- 1961-1972** All. Regulate your oil pressure by adjusting tension on relief spring. Allows for safe and easy adjustment externally.
 OPR600\$38.00 ea.

ZDDP Oil Supplement - 4 oz. Bottle



ZDDPlus is a oil additive that contains high concentrations of Zinc Diakyl Dithiophosphate, which has been the primary extreme pressure ingredient now missing from modern day motor oils. This is a must in all flat-tappet engines!

ZDDP.....\$14.00 ea.

ZDDP5.....(5 Bottles).....\$39.95



Oil Gaskets

	1962-63 198 V-6	1961-63 215 V-8	1964-67 225 V-6	1964-72 300, 340, 350	1965-66 400	1967-72 400, 455 engines
Oil Pan	OPG623 \$ 10.75 ea.	OPG613 \$ 12.75 ea.	OPG647 \$ 10.75 ea.	OPG645 \$ 10.75 ea.	OPG576 \$ 14.50 ea.	OPG676 \$ 19.00 ea.
Oil Pan Drain Plug	ODG595 \$ 2.25 ea.	ODG595 \$ 2.25 ea.	ODG595 \$ 2.25 ea.	ODG595 \$ 2.25 ea.	ODG595 \$ 2.25 ea.	ODG595 \$ 2.25 ea.
Rear Main Bearing Set	RMS615 \$ 19.50 set	RMS615 \$ 19.50 set	RMS615 \$ 19.50 set	RMS615 \$ 19.50 set	RMS576* \$ 19.50 set	RMS615 \$ 19.50 set

*RMS576 is the new rubber lip type for easy installation and leak-free seal.

Electrical (Group 2)

Starters and Rebuilding Service

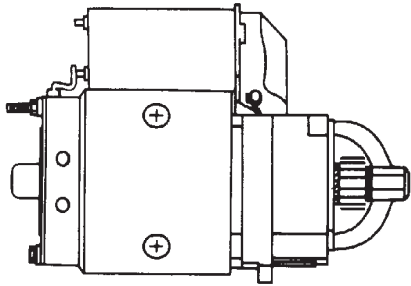

1961-1963 All 215 V-8. Sold outright.
S613.....\$149.50 ea

Heat Shield Starter Motor



1968-1976 All V-8 engines.
SS686.....\$39.00 ea.

Rebuilding Service

1961-1963 All Rebuilding Service.
S613RS.....\$129.50 ea.

1964-1967 225, 300, 340 engines. Rebuilding Service.
S647RS.....\$189.50 ea.

1965-1966 GS 400 engines. Rebuilding Service.
S646RS.....\$189.50 ea.

1967-1972 400 and 455 engines. Exchange or rebuilding service.
S674.....\$129.50 ea.

1968-1972 350 engines.
S684.....\$119.50 ea.

Starter ID Tag



1961-1967 Delco, starter, generator and distributor ID tag. (Red).
ET12.....\$7.00 ea.

Ignition Coils



1961-1972
IC539.....\$26.50 ea.

1961-1972
IC539D.....(Genuine Delco).....\$58.00 ea.



1961-1972 Resistor.
CR533.....\$11.50 ea.



Universal Coil Bracket

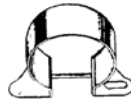

CB350.....\$6.50 ea.
CB350C.....(Chrome).....\$11.50 ea.

Starter Solenoids

1961-1972 All.
SS575.....\$53.00 ea.



Starter Solenoid Repair Kit



1961-1972 All.
SRK570.....\$24.50 ea.

Starter Brush Sets

1961-1972 Brush set.
SBS539.....\$6.50 set

Starter Drives



1961-1972 All.
SD615.....\$24.50 ea.

Wire and Cable Retainers



1964-1972 Engine compartment wiring strap.

WS5.....7" long.....\$1.50 ea.
WS6 2 3/4" Black.....\$0.85 ea.
WS7 4" Black.....\$0.85 ea.
WS8 4 1/2" Black.....\$0.85 ea.
WS9 8 3/4" Black.....\$0.85 ea.



1961-1966 Side frame rail wire retainers.
WR616.....\$5.00 ea.

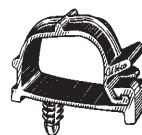



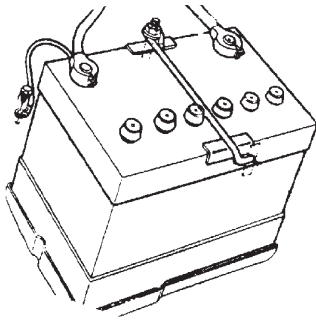

1967-1972 All. Retains positive battery cable to side frame rail.
WR672.....\$3.25 ea.

Battery Hold Down Clamps

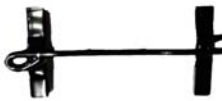

As original, 1961 thru 1967 clamps are rubber coated steel.

-  **1961-1963 All. (Clamp only).**
BC613\$29.50 ea.
-  **1964-1965 All. Except GS.**
BC645\$29.50 ea.
-  **1965 GS.**
BC65GS\$29.50 ea.
-  **1966-1967 All.**
BC657\$29.50 ea.

Battery Hold Down Bolts



1961-1962 All inside. Cut to length if necessary. Includes washer and nut.

BB612.....\$6.25 ea.

1961-1967

1961-1962 All outside;

1963-1967 All. Includes washer and nut.

BB610K\$7.00 ea.



Battery Trays



1964-1965 All. Special, Skylark, GS.
BB645\$55.00 ea.



1968-1972 All. Tray only.
BT682.....\$29.50 ea.



Clamp only.
BC682\$4.00 ea.



Bolt only.
BB682\$2.50 ea.

NOTICE CAR SHOW ATTENDEES

CARS, Inc. will NOT bring the usual "yellow trailer" to the shows.

We will be happy to bring any parts you need.

Please call in advance of the show to place your order.

Look For Us!

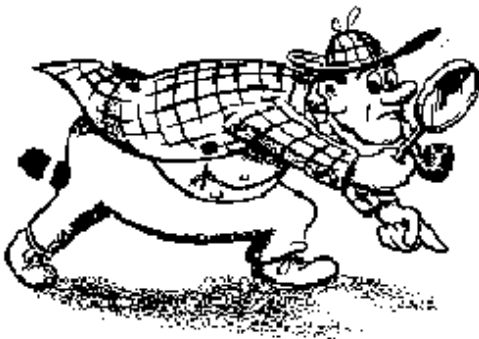

If your thinking of attending any of the shows listed below, be sure to stop by and say "Hello". We will be glad to discuss some of our newest items or simply talk about your **BUICK**.

Plan ahead by calling-in your order weeks ahead of time. We will be able to bring your entire order and save you shipping too.

GS Nationals
Buick Nationals
**Hershey* *GDB 31-34*
near Lamp Post 86

Electrical (Group 2)

Battery Cables

Our **battery cables** listed below for **TOP POST** batteries are made with heavy duty two (2) gauge copper wire, covered with black insulation.



Our reproduction "**Spring Ring**" cables are made from GM blueprints to be identical to the originals in fit and functions. They are sold in pairs. "Spring Ring" cables are also sold individually. **Inquire!**

Years

Replacement Cables

Genuine "Spring Ring" Sets

	(+) Positive	Price	(-) Negative	Price
1961-1962 All.....	BC24	\$19.50 ea.....	BC17	\$16.50 ea.
1963 All V-6	BC24	\$19.50 ea.....	BC19	\$17.50 ea.
1963 All V-8	BC31	\$27.50 ea.....	BC17	\$16.50 ea.
1964-65 300 engines.....	BC38	\$27.25 ea.....	BC31	\$27.50 ea.
1965-66 400 eng. GS.....	BC31	\$27.50 ea.....	BC24	\$19.50 ea.
1966-67 300, 340.....	BC38	\$27.25 ea.....	BC31	\$27.50 ea.
1967-68 350, 400.....	BC48	\$34.50 ea.....	BC31	\$27.50 ea.
1969 350	BC42	\$30.25 ea.....	BC24	\$19.50 ea.
1969 400	BC48	\$34.50 ea.....	BC31	\$27.50 ea.
1970-72 350.....	BC42	\$30.25 ea.....	BC31	\$27.50 ea.
1970-72 455.....	BC48	\$34.50 ea.....	BC31	\$27.50 ea.



BC248.....	\$91.00 pr.
BC258.....	\$91.00 pr.
BC255.....	\$91.00 pr.
BC264.....	\$169.50 pr.
BC285.....	\$169.50 pr.
BC287.....	\$169.50 pr.
BC294.....	\$169.50 pr.
BC300.....	\$169.50 pr.

Side Terminal Cables - Delco Replacements

1972 350 engines.....	BC35S	\$19.75 ea.	BC30S	\$19.25 ea.
1972 455 engines.....	BC45S	\$20.25 ea.	BC30S	\$19.75 ea.

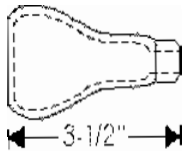
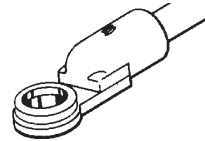

1961-1972 Battery cable cover.
CC315\$6.75 ea.

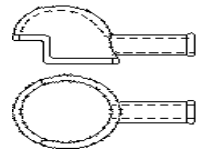

1961-1972 All. Battery cable cover.
Located on switch side and junction
block.
(Two per car).
CC325.....\$6.75 ea.

Wire Loom

Asphalt coated fabric. Wire loom for battery cables, head-lamps, wire etc.



WL180	1/8" ID	\$1.55 ft.
WL316	3/16" ID.	\$1.55 ft.
WL140	1/4" ID	\$1.80 ft.
WL516	5/16" ID	\$1.80 ft.
WL380	3/8" ID.	\$1.80 ft.
WL716	7/16" ID	\$1.80 ft.
WL120	1/2" ID.	\$1.80 ft.
WL916	9/16" ID	\$2.15 ft.
WL580	5/8" ID	\$2.15 ft.
WL340	3/4" ID.	\$2.15 ft.

Battery Terminal Protectors

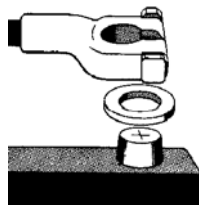

Stops corrosion indefinitely. Two protectors in each kit.
BW300.....\$3.75 kit

Nylon Wire Loom

NWL140	1/4" ID.	\$1.50 ft.
NWL380	3/8" ID.	\$1.50 ft.
NWL120	1/2" ID	\$1.50 ft.
NWL340	3/4" ID.	\$1.75 ft.

Wiring Harness Tape

Non-adhesive vinyl Harness wrap is same as used by GM.
1" wide, 100 foot roll.

WT100	1" wide.....	\$11.25 roll
-------------	--------------	--------------

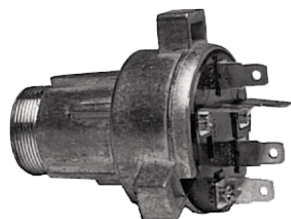

Ignition Switches

(See NOS section-Group 2.188 for models not listed)

Years	Cars #	Price
1964 All.....	IS64S.....	\$28.50 ea.
1965 All.....	IS65S.....	TOS
1966-1967 All.....	IS667.....	\$39.50 ea.
1969-1972(All tilt wheel)	IS699T.....	\$29.50 ea.
1969-1972 (All without tilt).....	IS699.....	\$34.50 ea.



Ignition Lock Cylinder with Keys

Years	Cars #	Price
1961,1962 All	IL414.....	\$22.50 kit
1963 All	IL63S.....	\$22.50 kit
1964 All	IL614.....	\$22.50 kit
1965 All	IL65.....	\$22.50 kit
1966-1967 All	IL667.....	\$22.50 kit
1968 All	IL68.....	\$22.50 kit
1969 and 1972 All	IL695.....	\$22.50 kit



Key Blanks (Genuine GM)
 We can also make keys from your code.
 Please inquire.



1961-1966 Door and Ignition - Octagon. KB10.....	\$3.50 ea.
1961-1966 Glove and Trunk - Rounded. KB11.....	\$4.50 ea.
1967 and 1971 Door and Ignition - Rectangular. KB48.....	\$3.50 ea.
1967 and 1971 Glove and Trunk - Oval. KB49.....	\$3.95 ea.
1968 and 1972 Door and Ignition - Rectangular. KB50.....	\$3.50 ea.
1968 and 1972 Glove and Trunk - Oval. KB51.....	\$3.50 ea.
1969 and 1973 Door and Ignition - Rectangular. KB44.....	\$3.50 ea.
1969 and 1973 Glove and Trunk - Oval. KB45.....	\$3.50 ea.
1970 Door and Ignition - Rectangular. KB46.....	\$3.50 ea.
1970 Glove and Trunk - Oval. KB47.....	\$3.50 ea.

1974 Ignition - Rectangular. KB46.....	\$3.50 ea.
1974 Glove, Door and Trunk - Oval. KB47.....	\$3.50 ea.
1975-1979 and 1983-1985 Ignition - Rectangular. KB48.....	\$3.50 ea.
1975-1979 and 1983-1985 Glove, Door and Trunk - Oval. KB49.....	\$3.50 ea.
1976 and 1980 Ignition - Rectangular. KB50.....	\$3.50 ea.
1976 and 1980 Glove, Door and Trunk - Oval. KB51.....	\$3.50 ea.

Key Caps

1967-1985 All Oval Keys. KC6700.....	\$1.50 ea.
--	------------





www.oldbuickparts.com

Never Change Points Again!

Upgrade to an electronic ignition. Fits entirely inside the distributor.
 Installs as quickly as changing a set of points. No black boxes,
 complicated wiring or special brackets. Only two wires to connect.

IGNITOR ELECTRONIC IGNITION KITS	NO.	PRICE
8 CYLINDER		
1937-1953 All Straight 8, 6 volt, negative ground	PI1183N6	\$125.00
1937-1953 All Straight 8, 12 volt, negative ground (original distributor)	PI1183	\$192.00
1953-1956 All V-8 Mechanical advance under baseplate	PI1185LS	\$99.50
1957-1974 All V-8 Except 215, 300, 340 Engines	PI1181LS	\$95.00
1957-1974 All V-8	PI1181	\$95.00
1957-1974 All V-8 (Ignitor II)	PI91181	\$122.00
6 CYLINDER		
1968-1974 All	PI1162A	\$99.00
1962-1967 V-6 Engine	PI1164	\$99.00
1962-1967 V-6 Engine (Odd Fire)	PI1165	\$99.00
HIGH PERFORMANCE COIL		
1937-1953 All Straight 8, 6 volt, negative ground (Black)	PC45011	\$39.50
1937-1953 All Straight 8, 6 volt, negative ground (Chrome)	PC45001	\$49.50
1953-1974 All (Black)	PC40011	\$39.50
1953-1974 All (Chrome) 12 v	PC40001	\$46.50
1953-1974 All (For Ignitor II applications only - Chrome) 12 v	PC45001	\$49.50
1953-1974 All (For Ignitor II applications only - Black) 12 v	PC45011	\$39.50
Coil Bracket	CB350	\$6.50
Coil Bracket (Chrome)	CB350C	\$11.50
HIGH PERFORMANCE SPARK PLUG WIRES		
Low 500 ohm/ft. resistance with spiral wound alloy to suppress electromagnetic radiation plus redundant current paths.		
V-8 7.0mm Stock-Look Custom Set		
1953-1960 All	PW708103	\$46.50
1960-1967 Special, Skylark, GS (Ex 1967 GS 400)	PW708103	\$46.50
1967-1966 LeSabre, Wildcat, Invicta, Electra, Riviera All 364, 401, 425 Engines	PW708105	\$44.50
1967 GS-400	PW708102	\$44.50
1968-1974 All 350, 400, 430, 455 w/o HEI	PW708102	\$44.50
6 CYLINDER 7.0mm STOCK-LOOK Custom Set		
1968-1974 ALL	PW706101	\$44.50

Tune-ups Kits

Tune-up Parts

Quality Replacement parts for all **1961-1972** Models.

Complete Tune-up kit includes: Points, Plugs, Wires, Cap, Rotor and Condenser.



YEARS	POINT SET	CONDENSER	DIST. CAP	ROTOR	SPARK PLUGS	IGNITION WIRES	COMPLETE TUNE UP KITS	
1961-1963 V-8 2BBL	D106	D203	D308	D409	SP45FFS	IW576	TK613S2	\$94.50
1961-1963 V-8 4BBL								
1964 300 Engine	D106	D203	D308	D409	SPR43FS	IW576	TK614S4	\$94.50
1964-1966 V-6	D106	D203	DC626	D413	SPR43S	IW576	TK626	\$94.50
1965-1966 400, 401, 425								
1965-1967 300, 340 4BBL	D106	D204	D308	D409	SPR43S	IW576	TK617	\$94.50
1967 300, 340 2BBL								
1967-1969 400, 430								
1970 455								
1970-1971 GS350	D106	D204	D308	D409	SP44TS	IW674	TK671	\$94.50
1968-1969 350								
1970-1971 350 EX. GS								
1971-1974 455								
1972-1974 350	D106	D204	D308	D409	SP45TS	IW674	TK684	\$94.50

Spark Plugs

1961-1963 215 V-8 with 2BBL carb.
SP45FFS.....\$2.95 ea.

1961-1964

1961-1963: 215 V-8 with 4BBL carb.;
1964: All 300.

SPR43FS.....\$2.95 ea.

1962-1967 All V-6.

SPR43S.....\$2.95 ea.



1965-1967 300 and 340 engines with 2BBL carb.

SP45R.....\$2.95 ea.

1965-1967

1965-1966: 300, 340 and 400 with 4BBL carb.;

1967: 340 engines with 4BBL carb.

SPR43S\$2.95 ea.

1967-1971

1967-1969: 400 engines;

1970-1971: 350 4BBL GS;

1970-1971: All 455 engines.

SP44TS\$2.95 ea.

1968-1972

1968-1971: All 350 engines exc. GS;

1972: All.

SP45TS\$2.95 ea.



Spark Plug Rubber Boots

Correct for all 1961-1967 Models.

SP577.....\$3.00 ea.



Spark Plug Wire Sets

CARS#	YEARS	APPLICATION	PRICE
IW576	1961-1966	All V-8	\$29.50 ea.
IW629D	1962-1967	All 6 Cyl ...(Delco) ..	\$36.75 ea.
IW674	1967-1972	All V-8.....	\$23.75 set
IW672D	1967-1972	All V-8.....(Delco)...	\$42.50 ea.



1961-1966: All;

1966: 300, 340, 400 engine ign. wire retainer on rocker covers. Two per car.
WR596.....\$4.75 ea.



1967-1972 All. Front "4", ign. wire retainer. Two per car.

WR683.....\$4.00 ea.



1967-1972 All. Rear "3" ign. wire retainer.

WR673.....\$4.50 ea.

Distributor Adjusting Tool

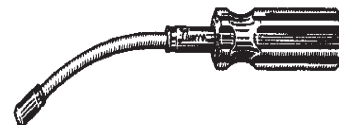

1961-1972 All. If you have ever tried to adjust your points without this tool you know how **NECESSARY** it is.

DT575.....\$10.00 ea.

"Delco Remy" Distributor Cap



1961-1972 All V-8. Identical reproduction.

D308R....("Delco Remy").....\$51.75 ea.



www.oldbuickparts.com

908-369-3666

Electrical (Group 2)

Engine Harnesses

WH4505.....	(1964 All V-6).....	\$179.50
WH4510.....	(1964 All V-8).....	\$179.50
WH5940.....	(1965 All 300 V-8).....	\$179.50
WH6100.....	(1965 All GS 400 V-8).....	\$179.50
WH6180.....	(1965 All V-6).....	\$179.50
WH9470.....	(1966 All V-6).....	\$170.00
WH9475.....	(1966 All 300,340 V-8).....	\$165.00
WH9480.....	(1966 All GS 400 V-8).....	\$164.00
WH10695.....	(1967 All V-6).....	\$170.00
WH19130.....	(1967 All 300,340 V-8).....	\$158.00
WH11325.....	(1967 All GS 400 V-8).....	\$149.50
WH12140.....	(1968 All 350 V-8).....	\$189.00
WH12145.....	(1968 All GS 400 V-8).....	\$189.00
WH13470.....	(1969 All 350 V-8 w/ ac).....	\$189.00
WH12740.....	(1969 All 350 V-8 w/o ac).....	\$189.00
WH13475.....	(1969 All GS 400 V-8 w/ ac).....	\$189.00
WH12745.....	(1969 All GS 400 V-8 w/o ac).....	\$189.00
WH15830.....	(1970 All 350 V-8 man. trans w/ ac).....	\$189.00
WH36250.....	(1970 All 350 V-8 man. trans w/o ac).....	\$189.00
WH13730.....	(1970 All 350 V-8 auto trans w/ ac).....	\$189.00
WH34970.....	(1970 All 350 V-8 auto trans w/o ac).....	\$189.00
WH13735.....	(1970 All 455 V-8 man. trans w/ ac).....	\$189.00
WH36256.....	(1970 All 455 V-8 man. trans w/o ac).....	\$189.00
WH13745.....	(1970 All 455 V-8 auto. trans w/ ac).....	\$189.00
WH13740.....	(1970 All 455 V-8 auto. trans w/o ac).....	\$189.00
WH33015.....	(1971 All 350 V-8 w/ ac).....	\$189.00
WH33010.....	(1971 All 350 V-8 w/o ac).....	\$189.00
WH33005.....	(1971 All 455 V-8 w/ ac).....	\$189.00
WH19135.....	(1971 All 455 V-8 w/o ac).....	\$189.00
WH32105.....	(1972 All 350 V-8 w/ ac).....	\$189.00
WH32100.....	(1972 All 350 V-8 w/o ac).....	\$189.00
WH32115.....	(1972 All 455 V-8 w/ ac).....	\$189.00
WH32110.....	(1972 All 455 V-8 w/o ac).....	\$189.00

Idle Stop Solenoid Harnesses

WH38695.....	(1971 All with auto trans.).....	\$20.35
WH31825.....	(1972 All V-8.).....	\$25.03

Front Lamp Harnesses

WH5760.....	(1964 All with manual trans).....	\$202.65
WH4515.....	(1964 All with auto trans).....	\$197.40
WH5950.....	(1965 All with manual trans exc. GS).....	\$190.05
WH6095.....	(1965 GS with manual trans).....	\$190.05
WH5945.....	(1965 All with auto trans).....	\$197.40
WH9960.....	(1966 All with tach.).....	\$202.65
WH35770.....	(1966 All without tach.).....	\$197.40
WH18488.....	(1966 GS.).....	\$197.40
WH11210.....	(1967 All.).....	\$190.05
WH12150.....	(1968 All.).....	\$197.40
WH12750.....	(1969 All.).....	\$179.50
WH13755.....	(1970 All.).....	\$190.05
WH15905.....	(1971-1972 All.).....	\$190.05

Dash Harnesses

1964-1967 owners - You must supply your old fuse box.

WH4500.....	(1964 All).....	\$477.00
WH6090.....	(1965 console shift, man. trans).....	\$489.00
WH6165.....	(1965 col. shift auto trans or man floor shift).....	\$476.00
*WH6225.....	(1965 console shift, auto. trans).....	\$476.00
WH10225.....	(1966 col. shift auto trans or man floor shift).....	\$489.50
WH10270.....	(1966 console shift, auto. trans).....	\$476.50
WH10275.....	(1966 console shift, man. trans).....	\$476.50
WH11140.....	(1967 col. shift auto trans or man floor shift).....	\$476.00
WH11145.....	(1967 console shift, auto. trans).....	\$489.50
WH11150.....	(1967 console shift, man. trans).....	\$476.00
WH12130.....	(1968 column shift).....	\$512.00
WH12135.....	(1968 console shift).....	\$512.00
WH12725.....	(1969 column shift).....	\$512.00
WH12730.....	(1969 console shift).....	\$512.00
WH13715.....	(1970 column shift with warning lights).....	\$512.00
WH15740.....	(1970 console shift with warning lights).....	\$512.00
WH19170.....	(1970 column shift with gauges).....	\$512.00
WH19175.....	(1970 console shift with gauges).....	\$512.00
WH15945.....	(1971 with gauges).....	\$512.00
WH19180.....	(1971 with warning lights).....	\$512.00
WH15945.....	(1972 with gauges, w/o seat belt warning).....	\$512.00
WH18290.....	(1972 with warning lights & seat belt warning).....	\$488.51
WH19180.....	(1972 with warning lights w/o seat belt warning).....	\$533.14

* requires your old fuse block.

Air Conditioning Harnesses

WH35958.....	(1964-1965 All).....	\$132.00
WH35871.....	(1966-1967 All).....	\$126.50
WH35942.....	(1968 All).....	\$126.50
WH35872.....	(1968 ac jumper wire to blower motor).....	\$12.38
WH32310.....	(1969-1972 All).....	\$127.50

**Fax Us
Your Order**

Save Time!

**When sending us a long order
it is easier to just fax it.**

908-369-7595

Power Window Harnesses

WH6665.....	(1963 Skylark 2-dr. r.h. rear 1/4).....	\$79.80
WH6670.....	(1963 Skylark 2-dr. l.h. rear 1/4).....	\$79.80
WH6685.....	(1963 Skylark convt. r.h. rear 1/4).....	\$77.00
WH6690.....	(1963 Skylark convt. l.h. rear 1/4).....	\$77.00
WH6955.....	(1964 All. r.h. door).....	\$83.74
WH6960.....	(1964 All. l.h. door).....	\$161.80
WH6965.....	(1964 crossover from l.h. to r.h. front windows).....	\$58.80
WH6990.....	(1964 All 2-dr. ht rear 1/4. fits either side).....	\$58.80
WH6995.....	(1964 All convt rear 1/4. fits either side).....	\$59.33
WH7170.....	(1964 2-dr. rear 1/4 exten. to motor. fits either side).....	\$19.80
WH7005.....	(1964 convt. rear 1/4 exten. to motor. fits either side).....	\$19.80
WH36048.....	(1964-1972 All. single switch pigtail).....	\$22.50
WH7605.....	(1965 All. r.h. door).....	\$82.95
WH7610.....	(1965 All. l.h. door).....	\$162.75
WH7640.....	(1965-1966 All. 2-dr. ht rear 1/4. fits either side).....	\$58.80
WH7655.....	(1965-67 2-dr. rear 1/4 exten. to motor. either side).....	\$20.35
WH7660.....	(1965-67 convt. rear 1/4 exten. to motor. either side).....	\$19.80
WH7695.....	(1965-1967 All. convt rear 1/4. fits either side).....	\$59.33
WH8200.....	(1965-66 crossover from l.h. to r.h. front windows).....	\$63.00
WH8260.....	(1966-1967 All. l.h. door).....	\$161.18
WH27310.....	(1966-1967 All. r.h. door).....	\$83.74
WH31135.....	(1968 All. l.h. door).....	\$161.18
WH14165.....	(1968 All. r.h. door).....	\$84.79
WH14405.....	(1968-1969 All. rear 1/4 & intermediate body).....	\$118.65
WH39470.....	(1969 All. 2-dr. l.h. door).....	\$193.20
WH37817.....	(1969 All. 2-dr. l.h. door).....	\$103.95
WH31140.....	(1970-1971 All. 2-dr. l.h. door).....	\$195.30
WH14470.....	(1970-1972 All. 2-dr. r.h. door).....	\$102.90
WH14505.....	(1970-1972 All. 2-dr. rear 1/4. windows).....	\$118.65
WH39471.....	(1972 All. 2-dr. l.h. door).....	\$193.30

Tachometer Harnesses

WH28985.....	(1968-1972 All. extension from coil to dash).....	\$25.03
WH28990.....	(1968-1969 All. extension to tachometer).....	\$42.90
WH702T.....	(1970-1972 All. Hood mounted tachometer).....	\$42.50

Dome Lamp Harnesses

WH6885.....	(1964 All. 2-dr. sedans).....	\$19.25
WH6880.....	(1964 All. 4-dr. sedans).....	\$19.25
WH7580.....	(1965 All. 2-dr. ht models).....	\$19.25
WH7575.....	(1965 All. sedan models).....	\$19.25

Courtesy Lamp Harnesses

WH6890.....	(1964 All. Skylark).....	\$34.00
WH7710.....	(1965-1967 All.).....	\$34.00

Power Seat Harnesses

WH6945.....	(1964 All 4-way bench.).....	\$126.00
WH7600.....	(1965 All 4-way bucket, l.h.).....	\$126.00
WH7595.....	(1965-1967 All 4-way power).....	\$126.00

Rear Body/Tail Lamp Harnesses

WH19070.....	(1964 All except convertibles).....	\$135.45
WH19080.....	(1964 Skylark convertible).....	\$168.00
WH19075.....	(1964 Special convertible).....	\$168.00
WH7730.....	(1965 Special 2-dr. ht).....	\$139.65
WH7930.....	(1965 Skylark 2-dr. ht).....	\$134.40
WH7720.....	(1965 Special convertible).....	\$170.36
WH7725.....	(1965 Skylark convertible).....	\$168.00
WH19085.....	(1966 All hardtops).....	\$159.00
WH19090.....	(1966 Special convertible).....	\$172.20
WH19095.....	(1966 Skylark convertible).....	\$168.00
WH13910.....	(1967 All hardtops).....	\$135.45
WH13915.....	(1967 Special convertible).....	\$172.20
WH13920.....	(1967 Skylark convertible).....	\$168.00
WH19100.....	(1968 All).....	\$135.45
WH19105.....	(1968 All 2-dr. ht. Intermediate).....	\$139.65
WH19110.....	(1968 All convertible. Intermediate).....	\$199.50
WH19115.....	(1969 All).....	\$134.40
WH19120.....	(1969 All ht. models. Intermediate).....	\$135.45
WH19125.....	(1969 All convertible. Intermediate).....	\$199.50
WH18470.....	(1970-1971 All).....	\$134.40
WH18860.....	(1970-1972 All ht. models. Intermediate).....	\$134.40
WH18865.....	(1970-1972 All convertible. Intermediate).....	\$165.90
WH32300.....	(1972 All).....	\$134.40

Wiring Harness Tape



Non-adhesive vinyl Harness wrap is same as used by GM. 1" wide, 100 foot roll.
WT100 1" wide.....\$11.25 roll

DATE CODED SPARK PLUG WIRE SETS

For those requiring the best for their show ready car, these reproduction wire sets are unsurpassed. They are manufactured to original GM blueprint specifications. They include the proper boots, terminals, script and correct factory length. All wires are carbon core for radio suppression. They come correctly identified with "**Packard Radio TVRS**" or "**Radio GM**" along with the proper date code to match your car.

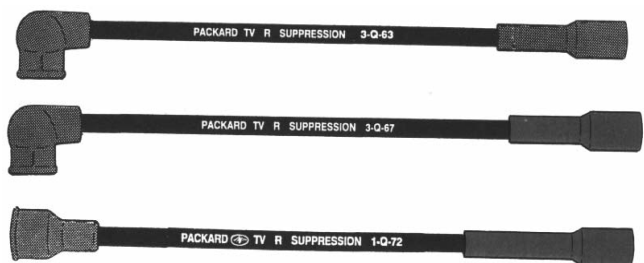

Date codes will read as such: 3 Q 67. The first number, "3" corresponds to the third quarter of the year. "Q" means quarter. The last number, "67", is the year, 1967. Thus, a cable marked 3 Q 67 was produced in the third quarter of 1967. You should order your spark plug wire sets with dates that are 6 to 12 months prior to the manufacturing date of your car. *Note:* wires were not dated on vehicles prior to January 1961.

1964-1966 Special, Skylark and GS.
300, 340 and 400 C.I. V-8 All.

1967-1971 300, 340 and 350 C.I. V-8 All.

1972 350 and 455 C.I. V-8 All.

Year	Application	Date	Part Number	Price
1961	V-8 All 2 Barrel		W3324000.....	\$79.50 ea.
1961	V-8 All 2 Barrel	1-Q-61	W3324611.....	\$79.50 ea.
1961	V-8 All 4 Barrel		W3326000.....	\$79.50 ea.
1961	V-8 All 4 Barrel	1-Q-61	W3326611.....	\$79.50 ea.
1962	V-8 All 2 Barrel	3-Q-61	W3324613.....	\$79.50 ea
1962	V-8 All 2 Barrel	1-Q-62	W3324621.....	\$79.50 ea
1962	V-8 All 4 Barrel	3-Q-61	W3326613.....	\$79.50 ea
1962	V-8 All 4 Barrel	1-Q-62	W3326621.....	\$79.50 ea
1963	V-8 All 2 Barrel	3-Q-62	W3324623.....	\$79.50 ea
1963	V-8 All 2 Barrel	1-Q-63	W3324631.....	\$79.50 ea
1963	V-8 All 4 Barrel	3-Q-62	W3326623.....	\$79.50 ea
1963	V-8 All 4 Barrel	1-Q-63	W3326631.....	\$79.50 ea
1964	V-8 All 300 C.I.	3-Q-63	W3334633.....	\$79.50 ea
1964	V-8 All 300 C.I.	1-Q-64	W3334641.....	\$79.50 ea
1965	V-8 All 300 and 340 C.I.	3-Q-64	W3334643.....	\$79.50 ea
1965	V-8 All 300 and 340 C.I.	1-Q-65	W3334651.....	\$79.50 ea
1966	V-8 All 300 and 340 C.I.	3-Q-65	W3334653.....	\$79.50 ea
1966	V-8 All 300 and 340 C.I.	1-Q-66	W3334661.....	\$79.50 ea
1966	V-8 All 300, 340 and 400 C.I.	3-Q-65	W3332653.....	\$79.50 ea
1966	V-8 All 300, 340 and 400 C.I.	1-Q-66	W3332661.....	\$79.50 ea
1967	V-8 All 300, 340 C.I.	3-Q-66	W3338663.....	\$79.50 ea
1967	V-8 All 300, 340 C.I.	1-Q-67	W3338671.....	\$79.50 ea
1967	V-8 All 400, 430 and 455 C.I.	3-Q-66	W3342663.....	\$79.50 ea
1967	V-8 All 400, 430 and 455 C.I.	1-Q-67	W3342671.....	\$79.50 ea

Year	Application	Date	Part Number	Price
1968	V-8 All 350 C.I.	3-Q-67	W3338673.....	\$79.50 ea
1968	V-8 All 350 C.I.	1-Q-68	W3338681.....	\$79.50 ea
1968	V-8 All 400 C.I.	3-Q-67	W3342673.....	\$79.50 ea
1968	V-8 All 400 C.I.	1-Q-68	W3342681.....	\$79.50 ea
1969	V-8 All 350 C.I.	3-Q-68	W3338683.....	\$79.50 ea
1969	V-8 All 350 C.I.	1-Q-69	W3338691.....	\$79.50 ea
1969	V-8 All 400 C.I.	3-Q-68	W3342683.....	\$79.50 ea
1969	V-8 All 400 C.I.	1-Q-69	W3342691.....	\$79.50 ea
1970	V-8 All 350 C.I.	3-Q-69	W3338693.....	\$79.50 ea
1970	V-8 All 350 C.I.	1-Q-70	W3338701.....	\$82.50 ea
1970	V-8 All 455 C.I.	3-Q-69	W3342693.....	\$79.50 ea
1970	V-8 All 455 C.I.	1-Q-70	W3342701.....	\$79.50 ea
1971	V-8 All 350 C.I.	3-Q-70	W3338703.....	\$79.50 ea
1971	V-8 All 350 C.I.	1-Q-71	W3338711.....	\$79.50 ea
1971	V-8 All 455 C.I.	3-Q-70	W3342703.....	\$79.50 ea
1971	V-8 All 455 C.I.	1-Q-71	W3342711.....	\$79.50 ea
1972	V-8 All 350 C.I.	3-Q-71	W3340713.....	\$79.50 ea
1972	V-8 All 350 C.I.	1-Q-72	W3340721.....	\$79.50 ea
1972	V-8 All 455 C.I. Exc HEI	3-Q-71	W3344713.....	\$79.50 ea
1972	V-8 All 455 C.I. Exc HEI	1-Q-72	W3344721.....	\$79.50 ea
6 Cylinder (V-6)				
1962	V-6 All	3-Q-61	W3210613.....	\$79.50 ea.
1962	V-6 All	1-Q-62	W3210621.....	\$79.50 ea.
1963	V-6 All	3-Q-62	W3210623.....	\$79.50 ea.
1963	V-6 All	1-Q-63	W3210631.....	\$79.50 ea.
1964	V-6 All	3-Q-63	W4012633.....	\$79.50 ea.
1964	V-6 All	1-Q-64	W4012641.....	\$79.50 ea.
1965	V-6 All	3-Q-64	W4012643.....	\$79.50 ea.
1965	V-6 All	1-Q-65	W4012651.....	\$79.50 ea.
1966	V-6 All	3-Q-65	W4012653.....	\$79.50 ea.
1966	V-6 All	1-Q-66	W4012661.....	\$79.50 ea.
1967	V-6 All	3-Q-66	W4012663.....	\$79.50 ea.
1967	V-6 All	1-Q-67	W4012671.....	\$79.50 ea.

Stoplight Switch



1961-1963 All.
SLS563.....\$9.00 ea.



1964-1972
1964-1972: All;
1971-1972: All except cruise control.
SLS645.....\$9.50 ea.



1971-1972 All with cruise control.
SLS715.....\$9.50 ea.



www.oldbuickparts.com

908-369-3666

Electrical (Group 2)

Generators (Rebuilding Service)

- 1961-1962** All.
G612.....\$189.50 ea.
- 1961-1962** Generator brush set.
ABS621.....\$12.75 set.
- 1961-1962** Generator front bearing.
GEB412.....\$8.75 ea.



Alternators

- 1963-1971** All 61 AMP.
A631.....\$69.50 ea.

Alternator Brace/Adjuster (2.317)

- 1969-1970** All 400, 455 engines. (oem # 1387139)
AB680.....\$19.00 ea.
- 1971-1972** All 455 engines. (oem #)
AB715B.....\$19.00 ea.

Voltage Regulators



- 1961-1962** All with generator, without air conditioning.
VR572.....\$69.50 ea.
- 1961-1962** All with generator, with air conditioning.
VR582A.....\$99.50 ea.
- 1962-1972** Delco alternator regulator. All except heavy duty 62, 80 AMP jobs.
VR622.....\$29.50 ea.
VR622D.....Genuine Delco.....\$79.50 ea.
VR622E.....Electronic Replacement.....\$23.75 ea.
- 1965-1972** All with Heavy Duty 62-80 AMP alternators.
VR655.....\$19.75 ea.

Turn Signal Lever And Knob



- 1969-1970** Buick Special, Skylark, Sportwagon, GS. Correct Fluted ChromeLever With Black Knob. All Without Cruise Control .
TSL690.....\$29.00 ea.

- 1969-1970** All With Cruise Control.
TSL670C.....\$109.00 ea.



- 1971-1976** All With Cruise Control. Correct Chrome Lever With Black Knob.
TSL716.....\$109.00 ea.

Alternator Parts



- 1963-1971** All. Alternator front bearing.
GEB581.....\$15.75 ea.
- 1972-1973** All. Alternator front bearing.
GEB723.....\$11.25 ea.

Alternator Contact Rubber Boot



- 1963-1972** All.
AB632.....\$4.57 ea

Distributors (Rebuilding Service)

- 1961-1963** All V-8.
D613.....\$147.50 ea.
- 1962-1965** All V-6.
D625.....\$147.50 ea.
- 1964-1967** 300 engine.
D647.....\$167.75 ea.
- 1965-1966** GS 400.
D596.....\$167.75 ea.
- 1966-1967** All V-6.
D667.....\$167.75 ea.
- 1966-1967** 340 engines.
D667.....\$167.75 ea.
- 1967-1972**
1967 400 engines;
1968-1972 All.
D674.....\$167.75 ea.

Distributor Vacuum Control



- 1961-1974** All. Oem replacement.
VC600.....\$17.50 ea.



ORDER BY PHONE !

908 > 369 > 3666

Genuine Guide T-3 Headlight Bulbs

1961-1967 All.
SB607S.....\$149.00 set of 4
1968-1971 All.
SB681S.....\$149.00 set of 4



Headlight Bulb Retainer

1967-1973 All as required. 3 tabs. For 4 headlight systems.
HR683.....\$9.50 ea.



Headlamp Door Screw Set

Set of 8. Correct chrome plated with small head.
HS702\$5.50 set

Headlamp Switches

1961-1963 All.
HS593.....\$49.50 ea.
1964-1967 All.
HS647\$28.50 ea.
HC645.....(connector plug for above).....\$9.75 ea.
1968-1972 All.
HS685\$25.50 ea.
HC645.....(connector plug for above).....\$9.75 ea.



Headlamp Dimmer Switches

1961-1972 All exc. Guidematic.
HDS615.....\$9.00 ea.

Headlamp Nuts and Pads



1964-1966 All. Headlamp bezel retaining nut.
HBN649\$2.25 ea.



1963-1968 Headlamp body and beam adjusting nut.
HN634.....\$1.25 ea.

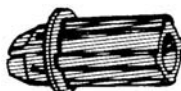

1969-1972 Headlamp bezel retaining nut.
HBN692\$2.75 ea.
HBN692S.....(Set of 8).....\$19.50 set



1969-1972 Headlamp adjusting nut and screw.
HN694.....\$4.00 ea.



1970-1972 Headlamp assembly to core support pads. White nylon. 12 per car.
HP705.....\$2.25 ea.
HP705S.....(Set of 12).....\$20.50 set



Bulbs



Year & Model	Head-light	Parking	Direction Signal		Tail	Stop	License Plate	Instru-ment	Indi-cator	Dome	Back-up	Marker Left	Lamp Right
			Front	Rear									
1961	SB1, SB2	B1034	B1034	B1034	B1034	B1034	B67	B194-1816	B194	B211	B1073	---	---
1962	SB1, SB2	B1034	B1034	B1034	B1034	B1034	B67	B194-1816	B194	B90-211	B1073	---	---
1963	SB1, SB2	B1034	B1034	B1034	B1034	B1034	B67	B194	B194	B90-1004	B1073	---	---
1964	SB1, SB2	B1157	B1034	B1157	B1157	B1157	B97	B194	B194	B90-211	B1156	---	---
1965	SB1, SB2	B1157A	B1157A	B1157	B1157	B1157	B97	B194	B194	B90-211	B1156	---	---
1966	SB1, SB2	B1157A	B1157A	B1157	B1157	B1157	B97	B194	B161	B90-211	B1156	---	---
1967	SB1, SB2	B1157A	B1157A	B1157	B1157	B1157	B97	B194	B161	B211	B1156	---	---
1968	SB1, SB2	B1157A	B1157A	B1157	B1157	B1157	B97	B194-1893	B194	B90-1004	B1157	B194A	B194
1969	SB1, SB2	B1157A	B1157A	B1157	B1157	B1157	B97	B194-1893	B194	B90-1004	B1157	B194A	B194
1970	SB1, SB2	B1157A	B1157A	B1157	B1157	B1157	B97	B194-1893	B194	B90-211	B1157	B194A	B194
1971	SB1, SB2	B1157A	B1157A	B1157	B1157	B1157	B97	B194-1893	B194	B90-211	B1157	B194	B194
1972	SB1, SB2	B1157A	B1157A	B1157	B1157	B1157	B97	B194-1893	B194	B90-211	B1157	B194	B194

Prices: SB1 & SB2-\$11.25, 53-\$1.50, 57-\$1.25, 67-\$1.50, 90-\$2.00, B97-\$2.25, 161,168-\$2.25, 181-\$1.75, 194-\$2.25, 194A-\$3.00, 210-\$5.50, 211-\$2.25, 1004-\$2.75, 1034-\$2.75, 1073-\$2.75, 1156-\$2.50, 1157A-\$3.50, 1157-\$2.50, 1816-\$2.25, 1893-\$2.25.

Electrical (Group 2)

1965 Skylark & GS Park Lamp Lenses



PL65GS.....\$135.00 pr.
 PLG65GS.....Gaskets for above.....\$20.00 pr.

1968-1969 Front Parking Lamp Gaskets



PLG689.....\$9.75 pr.

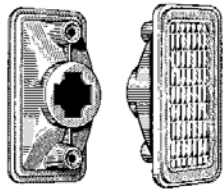

Side Body Marker Lights

1968-1969 left and right front marker lens.

MLF689.....\$16.50 ea.

Marker Lamp Gaskets

1968-1969 Front or rear.

MLG689.....\$4.00 ea.



1970-1972 Front and Rear Marker Lamps and Gaskets

Marker Lamps:

ML702F.....Front Amber.....\$99.00 pr.
 ML702R.....Rear Red.....\$99.00 pr.
 ML702S.....Front and Rear.....\$189.00 st.



Gaskets:

(Manufactured to be identical to originals).

MG702S.....Set of 4.....\$29.75 st.
 MG702F.....Front Only.....\$15.50 pr.
 MG702R.....Rear Only.....\$16.50 pr.

Same as above but flat rubber replacements

MLG702F.....Front Markers.....\$6.25 pr.
 MLG702R.....Rear Markers.....\$6.25 pr.

1965 Tail Lamp Gasket Set

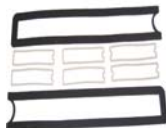

1965 All Skylark and GS. Eight piece set, inner and outer.

TLG65S.....\$37.50 st.

1967 Tail Lamp Gaskets



TLG67S(lens to housing).....\$15.00 pr.

TLM67S(lamp to body).....\$12.75 pr.



Front Marker Lamp Retainer

1970-1972

MLR702F.....\$12.00 ea.

Rear Marker Lamp

1969 Buick Special, Skylark, GS.

Complete Assembly.

MLR69400.....\$54.00 ea.



1968-1969 Tail Lamp Gaskets



TLG689.....\$9.75 pr.

1970-1972 Tail Lamp Lenses & Gaskets



1970 Tail Lamp Lens (Fits either side)

TL70.....\$89.75 ea.

TLG702.....Gaskets for above.....\$10.00 pr.

1971 Tail Lamp Lenses

TL71L.....(Fits L.H. Side).....\$109.00 ea.

TL71R.....(Fits R.H. Side).....\$109.00 ea.

TLG702.....Gaskets for above.....\$10.00 pr.

1972 Tail Lamp Lenses

TL72L.....(Fits L.H. Side).....\$109.00 ea.

TL72R.....(Fits R.H. Side).....\$109.00 ea.

TLG702.....Gaskets for above.....\$10.00 pr.

1972 Rear Tail Lamp Cushions



An excellent reproduction of the Rubber tail lamp cushions used on 1972 Skylark and GS models. (7.831)

TLC72L.....(Left Side).....\$180.00 ea.

TLC72R.....(Right Side).....\$180.00 ea.

TLC72.....(Both Sides).....\$350.00 ea.

1961 Tail Lamp Lenses



1961 Special 4-Door Sedan Models.

TL61SL.....(Fits L.H. Side).....\$24.50 ea.

39 TL61SR.....(Fits R.H. Side).....\$24.00 ea.

1963 Back-up Lens

1963 All. Genuine Guide. Fits either side.
BL63S.....\$17.00 ea.



1967 Back-up Lamp Gasket

1967 All except wagons.
BLG67S.....\$4.75 ea.



Back-up Lamp Switches



1962-1963 Special with 4 speed manual transmission.
BLS623\$59.50 ea.

1964-1966 Special, Skylark, GS with 4 speed manual transmission.
BLS636\$59.50 ea.

1967-1968 Special, Skylark, GS. All manual transmission with floor shift.
BLS678\$59.50 ea.

Directional Signal Switches (2.895)



1964-1966 All with tilt wheel.
DSS646T.....\$80.25 ea.

1965-1966 All w/o tilt wheel. Stamped "guide". Includes wiring.
DSS656\$80.25 ea.



1965-1966 All w/o tilt wheel. Stamped "BPC". Includes wiring.
DSS656BPC\$80.25 ea.



1967-1968 All w/o tilt wheel. Delco color code white or green. Includes wiring.
DSS678\$46.25 ea.

1969-1972 All w/o cornering lamps. Includes wiring.
DSS696.....\$46.25 ea.

Horn Relays (2.815)

1961-1967 All with junction block.
HR617.....\$87.50 ea.



1965-1968:
1965-1967 All except GS with 62 amp. alternator;
1968 All. "Littlefuse"
HR658L.....\$39.50 ea.

1969-1972 All.
HR693.....\$27.50

Signal Flasher

1961-1972 All.
SF615.....\$4.25 ea.



License Lamp Parts

1961-1962 License lamp gasket set.
LG462.....\$11.39 set



1968-1972 License lamp lens assembly.
LLA682\$19.75 ea.



1964-1972 License lamp gasket . (2.707)
LLG643.....\$6.75 ea.



1968-1972 License lamp lens.
LL682.....\$10.25 ea.



Wire Loom

Asphalt coated fabric. Wire loom for battery cables, head-lamps, wire etc.



WL180	1/8" ID	\$1.85 ft.
WL316	3/16" ID	\$1.85 ft.
WL140	1/4" ID	\$2.10 ft.
WL516	5/16" ID	\$2.10 ft.
WL380	3/8" ID	\$2.10 ft.
WL716	7/16" ID	\$2.10 ft.
WL120	1/2" ID	\$2.10 ft.
WL916	9/16" ID	\$2.40 ft.
WL580	5/8" ID	\$2.40 ft.
WL340	3/4" ID	\$2.40 ft.

Lamp Sockets • Pigtails (Group 2)

Headlamp Sockets



For 3 prong beam numbers SB6, 6006, SB12, 6012, SB2, 4000 and 4002.
PT6\$4.75 ea.



For 2 prong beam numbers SB1, 4001.
PT7\$4.25 ea.

Lamp Sockets and Pigtails



Single contact with lead. Fits bulb numbers 51, 53, 55 and 57.
PT1\$2.25 ea.



Single contact with lead. Fits bulb numbers 63, 67, 81, 87, 89, 1073, 1129, 1133, 1141 and 1156.
PT2\$2.25 ea.



Double contact with lead. For ears reversed. Bulbs numbers 82, 88, 90, 210, 1004, 1034, 1154 and 1157.
PT3\$2.75 ea.



Double contact with lead. For ears aligned bulbs.
PT4\$2.50 ea.

Parking and Tail Lamp Sockets

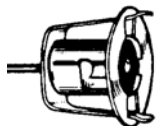

Single contact with lead. For 3/4" to 1 1/8" hole.
LS1\$4.25 ea.

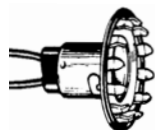

Double contact with lead. For bulb numbers 1034 and 1154. Fits 1 1/8" hole.
LS5\$5.75 ea.

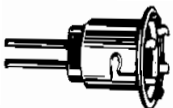

Double contact with leads. Fits 3/4" hole. For bulb numbers 1034, 1154 and 1157.
LS9\$5.75 ea.



Double contact with leads. Fits 3/4" to 1 1/8" hole. For bulb numbers 1034, 1154 and 1157.
LS2\$5.75 ea.



Double contact with leads. Fits 3/4" to 1 1/8" hole. For bulb numbers 82, 88, 90, 210 and 1004.
LS3\$6.85 ea.



Double contact with leads. Fits 1 1/8" hole. For bulb numbers 1034, 1154 and 1157.
LS4\$5.75 ea.

Interior/Dash Sockets



Single contact with lead for dome etc. For bulb numbers 63, 67, 81, 89, 1073, 1129 and 1133.
PT8\$8.75 ea.



Double contact with lead. For dome and map lamps. Reversed ears. Bulb numbers 82, 88, 90, 210 and 1004.
PT9\$7.00 ea.



Double contact with lead for ears aligned bulbs.
PT10\$2.50 ea.

Back-Up and License Lamp Sockets

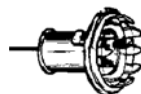

Single contact with lead. Fits 3/4" hole. Bulb numbers 63, 67, 81, 89, 1129 and 1133.
LS6\$5.75 ea.



Single contact with lead. Fits 1 1/8" hole with ground wire. For bulb numbers 63, 67, 81, 89, 1129 and 1133.
LS7TOS



Single contact with lead. Fits 1 1/8" hole. For bulb numbers 63, 67, 81, 89, 1129 and 1133.
LS8\$6.00 ea.

1965 Back-Up Lenses

BL65S.....\$75.00 pr.



BLG65S.....Gaskets for above.....\$15.00 pr.



Carburetor Rebuilding and Restoration Service

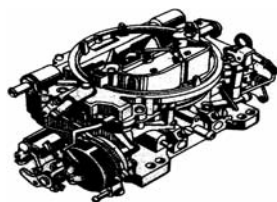

Each carburetor is totally disassembled and cleaned in a hot tank solution. Then, each component is correctly plated, painted and colored to duplicate it's original factory finish. The carburetor is reassembled using all proper gaskets, pumps, needles and seats, etc. and new correct screws. Finally, all bench adjustments are made to factory specs. This includes correct shimming of the start switch. The result, the best rebuilt and restored carburetor available in the Hobby.

NOTE: *This is not an area to skimp on your restoration. Demand the best!*

- 1961-1972** All 2bbl Carburetors w/ Bakelite switch.
CRS390.....\$379.50 ea.
- 1961-1972** 4bbl. Carburetor rebuilding service.
CRS520.....\$389.00 ea.
- 1964-1966** All Carter 2 x 4 sets.
CRS636D.....\$692.00 ea.

Carburetor Mounting Gaskets



- 1961** All Stromberg 2BBL Carbs.
CMG551.....\$4.75 ea.
- 1961-1964** All Carter and Rochester 2BBL Carbs.
CMG554.....\$4.50 ea.
- 1965-1967** All 2BBL.
CMG627.....\$9.75 ea.
- 1961-1965** All 4BBL;
 1966 4BBL w/square bore;
 1967 300, 340 4bbl.
CMG576.....\$4.75 ea.
- 1966** 425 Engine;
1967All 400, 430, 455 with Rochester.
CMG667.....\$6.50 ea.
- 1969-1975** All 400, 430, 455 with Rochester 4BBL.
CMG695.....\$4.75 ea.

Carter Baffle Plate



1965-1966 GS with Carter AFB 4bbl. Stainless steel plate between carb. and intake manifold. This plate is essential for protection against disintegration of aluminum base of carb. It is also necessary for proper idle and smooth running. Recommended is gasket, baffle plate, gasket.
BP576.....\$17.50 ea.

Carburetor Bowl Floats

- 1961-1965** 215, 300 Rochester 2 GC. Brass.
CF615R.....\$24.50 ea.
- 1965-1967** Carter AFB 4BBL. Brass. (2 needed per car)
CF577C.....\$34.50 ea.
- 1966-1967** Rochester 4BBL.
1966 All; **1967** Early.
CF677R.....\$19.50 ea.
- 1967-1974** Rochester 4BBL.
1967 Late; **1968-1974** All.
CF674R.....\$19.50 ea.

Choke Stove Pipe Replacement Kit

1961-1967

All as required.

CSK530.....\$18.25 kit



Carburetor Stud

Made of stainless steel.

1968-1975 All. 350, 400, 430, 455, 4bbl. and 4-1/8" long.

CS685.....\$6.00

Carburetor Kits

Carter

1961-1967 All 4 BBL and 2-4 BBL. Numbers: 3088, 89, 3297, 3503, 79, 3633, 3635, 3665, 3826, 3827, 3921, 22, 23, 4053, 54, 55, 56, 59, 60, 61, 4179, 4180, 81, 4331, 4332, 4344, 4453.
CKC617.....\$49.50 ea.

Rochester

1961-1963 All 215 V8, 4BBL.
Numbers: 7019796, 7020043, 045, 7023044, 045.
CKR613.....\$36.50 ea.

1961-1965 All 215, 300 and 364, 2BBL. Numbers: 7019042, 090, 093, 7020146, 147, 7023046, 047, 142, 7024046, 047, 7025046, 047.
CKR615.....\$39.50 ea.

1964 300 V8, 4BBL. Numbers: 7024044, 7024045.
CKR64.....\$35.00 ea.

1964-1965 All Rochester 1bbl.
CKR645.....\$44.75 ea.

1965-1966 401 V8, 4BBL. Numbers: 7023040, 7023143, 7024040, 7025040, 7025140, 7026040.
CKR636.....\$39.50 ea.

1966 (Early) 400, 401, 425;
1967 400, 430, 4BBL. Numbers: 7026240, 242, 7027146, 147, 148, 149, 7027240,241, 7036240, 7036242.
CKR667.....\$39.50 ea.

1966-1969 300, 340, and 350 V8, 2BBL. Numbers: 7026046, 047, 146, 147, 7027044, 045, 046, 049, 7028140, 7028141, 7029140, 141, 7036046, 048, 146, 248, 7037034, 7037044, 17054649.
CKR669.....\$33.50 ea.

1967 Late; With 400, 430 and 455 engines. 4MV 4BBL.
Numbers: 7027244, 246, 248, 7041304, 305, 306, 307, 308, 309.
1968-1972 Numbers: 7028240, 242, 243, 246, 247, 248, 7029240, 241, 242, 243, 7029246, 7040240, 7040243.
CKR670.....\$35.00 ea.

1968-1974 350, 455, 4BBL. Numbers: 7028244, 245, 7029244, 245, 7040244, 245, 7041245, 7041544, 7042244, 245, 944, 7043244, 245, 246, 7044244, 246, 544, 7044546, 17054900, 901, 902.
CKR684.....\$29.00 ea.

1970-1972 455 HI-PERF, 4BBL. Numbers: 7040246, 247, 7041242, 243, 540, 7042240, 242, 243, 940, 7042942, 7043240, 242, 243, 7044240, 241, 252, 540.
CKR702.....\$27.50 ea.

1970-1974 350 and 455, 2BBL. Numbers: 7040142, 143, 148, 444, 446, 7041142, 143, 442, 7042142, 7042143, 842, 7043142, 143, 7044141, 142, 144, 442, 7044444, 17054651, 17055003, 17057350, 351.
CKR704.....\$26.50 ea.

Stromberg
1961 All. WW 2 BBL #7-14.
CKS61.....\$49.50 ea.

Fuel • Exhaust (Group 3)

Intake Manifold Gaskets (3.270)



- 1961-1963** All V-8. Large metal valley pan.
IMG613\$28.75 ea.
- 1964** All 300 Engines.
IMG64\$19.50 ea.
- 1964-1967** All 225 V-6 Engines.
IMG647\$14.25 ea.
- 1965-1967** All 300 Engines.
IMG657\$17.50 ea.
- 1965-1966** All GS-400.
IMG576\$18.50 ea.
- 1966-1967** All 340 Engines.
IMG667\$16.50 ea.
- 1967-1971** All 400, 455 Engines.
IMG671\$47.50 ea.
- 1968-1972** All 350 Engines.
IMG685\$39.50 ea.
- 1972** All 455 Engines.
IMG726\$39.50 ea.



Accelerator Pedals

1964-1967 All. Correct ribbing and ball sockets, plastic replacement.
GP647.....\$16.50 ea.

- 1968-1972** All.
GP682.....\$16.50 ea.



Pedal Return Spring

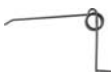

- 1968-1972** All.
PS682\$7.50 ea.

Pedal Rod Pin



- 1968-1972** All.
PR682\$4.50 ea.



CP647

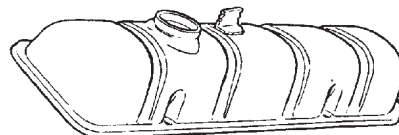

Valve Cover / Intake Manifold Ventilation Grommets

- 1963-1974**
1963-1967: Valve cover, All;
1967-1974: Intake manifold, All.
VG634\$ 7.70 ea.
- 1964-1967** All. Solid rocker cover plug.
CP64713.50 ea.
- 1970-1974** Valve cover (rubber).
VG704.....\$6.00 ea.

Ask About Chrome Plating Your Rocker Covers!



GF636A



GF682



GF636

Gas Filters /Elements

CARS#:	YEARS:	APPLICATION:	PRICE:
GF602	1961	All with AC	~~~~~\$9.50
GF572	1961-1962:	All without AC	~~~~~\$7.50
GF627	1962-1967:	1962-1967 all v-6	
		1966 GS 400 with A.T. without A.C.	
		(this is a "stone" element)-----	\$7.50
GF636A	1962-1966:	All with AC,	~~~~~\$12.50
GF636	1963-1966:	All without AC	~~~~~\$12.50
GF675	1967:	All V8;	
	1968-1972:	All L-6	
	1968-1972:	All V8 w./ 2 Bbl. Carb.	~~~~\$3.50
GF682	1968-1972:	All V8 w./ 4 Bbl. Carb.	~~~~\$3.50



All years replacement. Clear in-line gas filter. Great for near gas tank or frame installation. Important for insuring clean fuel to fuel pump.
GF100.....\$4.50 ea.

In Line Gas Filters



GF140.....For 1/4" ID Hose.....\$9.25 ea.

GF516.....For 5/16" IDHose.....\$9.25 ea.



GF516C...For 5/16" ID Hose(clear)...\$6.50 ea.

GF380.....For 3/8" ID Hose.....\$9.25 ea.



Breather Tubes (Air Cleaner to Rocker Cover)

Breather Tube

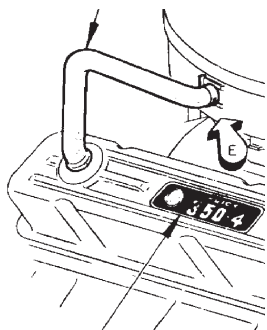

1968-1969 All 350 and 400 4BBL..
VT689.....\$19.50 ea.



1970-1971 all V-8;
1972 all 455 engines.
VT704.....\$19.50 ea.



Pinch Clamps (corbin clamps)

For fuel lines, vacuum lines and PCV hoses

CARS#:	YEARS:	APPLICATION:	PRICE:
PC380	All	3/8" OD hose ~~~~~	\$ 1.00
PC716	All	7/16" OD hose ~~~~~	\$ 1.00
PC150	All	1/2" OD hose ~~~~~	\$ 1.00
PC916	All	9/16" OD hose ~~~~~	\$ 1.00
PC580	All	5/8" OD hose ~~~~~	\$ 1.00
PC1116	All	1 1/16" OD hose ~~~~	\$ 1.25
PC340	All	3/4" OD hose ~~~~~	\$ 1.00
PC100	All	1" OD hose ~~~~~	\$ 1.25

Dash Pots



1961-1963 All with 4 BBL carburetors.
DP613.....TOS

1961-1971

1961-1963: All V-8, 2 BBL;
1962-1963: All V-6 with auto trans.;
1965-1971: All with auto trans.

DP611.....\$29.50 ea.



Ported Vacuum Switch (2.410)

1968-1972 All 8 cylinder except 1972
3 Port 2 terminal switch.
PVS684.....\$49.50 ea.

PCV Valve



CARS#	YEARS	APPLICATION	PRICE
PCV637	1963-1967:	V-6 ~~~~~	\$ 6.75
PCV635	1963-1972:	All V8 ~~~~~	\$ 4.75

PCV Valve Clamp

CARS#	YEARS	APPLICATION	PRICE
HC100W	ALL	on PCV Hose ~~~~~	\$ 1.10

PCV Valve Grommet

CARS#	YEARS	APPLICATION	PRICE
VG634	ALL	~~~~~	\$ 7.75

Choke Pull-Offs (3.755)

(For Rochester 4bbl carburetors)



1968-1974 All 350, 400, 455 engines.
Front or Rear.
CPO684\$19.70 ea.
1971 All 455. Rear.
CPO71\$24.75 ea.

Rod Clips



1961-1966 Carburetor throttle rod clip. 1/4" rod diameter.
RC460.....\$.75 ea.

Wire Hose Clamps



For 9/16" diameter hose.
HC916W\$ 1.00 ea.
HC916WP.....(5 Pack).....\$ 3.25 ea.

For 5/8" diameter hose.
HC580W\$ 0.75 ea.

For 3/4" diameter hose.
HC340W\$ 0.75 ea.
HC340WP.....(5 Pack).....\$ 3.25 ea.

For 13/16" diameter hose.
HC1316W\$ 1.00 ea.
HC1316WP.....(5 Pack).....\$ 4.25 ea.

For 15/16" diameter hose.
HC1516W\$ 0.75 ea.
HC1516WP.....(5 Pack).....\$ 4.25 ea.

For 1" diameter hose.
HC100W\$ 1.05 ea.
HC100WP.....(5 Pack).....\$ 4.25 ea.

For 1-1/4" diameter hose.
HC114W\$ 1.00 ea.
HC114WP.....(5 Pack).....\$ 5.00 ea.

For 2" diameter hose.
HC200W\$ 2.75 ea.
HC200WP.....(5 Pack).....\$12.25 ea.

Fuel • Exhaust (Group 3)

GS Ram Air Foam Seals

Our seals are manufactured just as the originals. They have gray inner foam surrounded by dark gray outer skin.

1969-1971 models use 2 square seals.

1972 models use one square and one triangular seal. Seals for 350 cid. engines are 2 5/8" high. Seals for 455 cid. engines are 2" high.

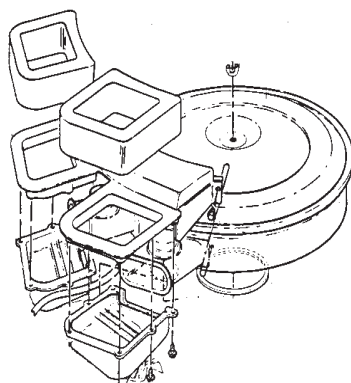

1969-1971 GS350.
RAS691.....\$29.50 pr.

1969-1971 GS400 and GS455.
RAS691B.....\$29.50 pr.

1972 GS-350.
RAS72.....\$29.50 pr.

1972 GS-455.
RAS72B.....\$29.50 pr.



Air Cleaner Vacuum Motor

1968-1972 All as required.
VM694L.....(fits L.H. side of snorkel)..... TOS
VM694.....(fits R.H. side of snorkel).....TOS

Crankcase Ventilation Filter On Side Of Air Cleaner



1968-1972 All.
CVF682.....\$ 4.75 ea.



Air Filters

CARS#	YEARS	APPLICATION	PRICE
6 Cylinder			
AF625	1962-1972:	All ~~~~~	\$ 11.25
8 Cylinder			
AF607	1961-1967	All V-8 exc. 1967 GS~~~~	\$15.00
AF646	1965-1966	GS w/ 2 X 4bbl carbs ~~~~	\$32.50
AF636	1965-1966:	400 (4 Bbl.) ~~~~~	\$17.50
AF67	1967:	GS ~~~~~	\$14.75
AF625	1968:	350 (2 Bbl.) ~~~~~	\$11.25
AF680	1968:	All with (4 Bbl.)	
	1969-1972:	All GS; All 455 ~~~~~	\$12.25
AF698	1969-1972:	350 Eng. Exc. GS ~~~~~	\$11.75

Air Cleaner Wing Nuts

CARS#	YEARS	APPLICATION	PRICE
WN530	1961-1970:	Air cleaner wing nut (1/4" -20 thread) ~~~~~	\$ 1.75
WN710	1971-1972:	Air cleaner wing nut (5/16" -18 thread) ~~~~~	\$ 1.75

Carburetor to Air Cleaner Gaskets

1966-1975 All 400, 430, 455 with Rochester 4BBL.
BG5152.....\$3.75 pr.

Throttle Cables



1968-1971 thru 1971 all 400 and 455 engines.
TC681.....\$39.50 ea.

Throttle Cable Bracket



1968-1972 All 400 and 455 motors with 4 barrel carburetor.
TCB681.....\$20.00 ea.

Fuel Pumps



CARS#	YEARS	APPLICATION	PRICE
FP613RS	1961-1962	All; 1963 all V-6; 1963 V-8 1st type w/ pump # 4827 (Rebuilding Service only)	~~~~~\$89.50
FP635	1963:	215 Engine Pump #40001;	
	1964-1965:	225, 300 Engine	~~~~~\$44.00
FP575	1965:	GS	~~~~~\$39.75
FP66S	1966:	225, 300, 340 Engine	~~~~~\$39.50
FP66	1966:	400 without air conditioning	~~~~~\$49.50
FP67	1967:	225, 300, 340 w/o AC or return fuel line	\$49.50
FP67A	1967:	300, 340 w/ AC or return fuel line	\$39.00
FP685	1968-1972:	350 w/o AC	~~~~~\$39.50
FP682A	1968-1972:	350 with AC	~~~~~\$39.50
FP674	1967-1969:	400 Eng (Except STAGE 1);	
	1970-1972:	455 (Except GS)	~~~~~\$44.25
FP683	1969-1970:	455 GS /STAGE 1;	
	1971-1972:	GS	~~~~~\$75.00

Fuel Pump Block-Off Plates

1961-1972 All as required.

CP300.....\$12.50 ea.



Fuel Pump Cam

Mounts on Camshaft to Operate Fuel Pump



1961-1972 All 225, 300, 340 and 350 engines.
FPC615\$89.50 ea.

Fuel Pump Hardware Kits

1965-1966 all 400, 401, 425 engines. Correct bolts/washers.

FPH406\$4.00 ea

Fuel Pump Rebuilding Kits



1961-1963

1961-1962: All pump #4827;

1963: All V-6.

FPK613.....\$69.50 ea.

1965 GS 400.

FPK575.....\$69.50 ea.

1963-1965

1963: All 215 Engines;

1964-1965: All 225, 300 engines #4001, 1 pump.

FPK635.....\$67.50 ea.

Electric Fuel Pump



1961-1972 All. 12V universal replacement pump.

FP12.....\$49.50 ea.

Fuel Lines

Fuel Pump to Carburetor

CARS#	YEARS	APPLICATION	PRICE
FL350	1968-1972:	All 350-4	~~~~~\$26.50
FL455	1968-1972:	400, All 455-4	~~~~~\$39.50
FL455S	1968-1972:	STAGE 1 455	~~~~~\$26.50
FL70	1970:	All 4 Bbl. carburetors	~~~~~\$26.50

Fuel Line Clip Sets

Correct style in correct colors

(used in conjunction with our brake line clip sets)



1964-1965 all with 5/16" line.

FLC645.....No return.1 pc.....\$2.25 ea.



1964-1967 all with 3/8" line.

FLC647.....No return.1 pc.....\$2.25 ea.

1968-1972 Buick Skylark & GS. All with 3/8"-1/4" fuel lines (3 piece set). OEM Factory Clip Used On Driver's Side Frame. Replaces OEM #1233420

FLC682F.....\$35.00 set



1971-1972 all with 3/8" line.

FLC712.....4 pc.....\$49.50 set



Fuel • Exhaust (Group 3)

Exhaust Headers



Our headers are custom made for their specific applications and legal for off-highway use only. Available in metallic ceramic coating or uncoated. Collector size is 3". All headers come with collector reducers, all mounting hardware, premium gaskets and detailed instructions.

- 1968-1972** All 350 engines
 EH680C.....Ceramic coated\$595.00 set
 EH680.....Uncoated\$395.00 set
- 1964-1972** All 400, 430, 455 engines
 EH648C.....Ceramic coated\$643.00 set
 EH648.....Uncoated\$416.14 set

Exhaust Manifold Gaskets



EMG576



EMG676

- 1961-1963** All 215 V-8 Engines.
 EMG613\$12.75 pr.
- 1962-1967** All. 198 and 225 V-6 Engines.
 EMG627\$14.50 pr.
- 1964-1967** All 300 and 340 Engines.
 EMG647\$13.00 pr.
- 1965-1966** All 400 Engines.
 EMG576\$13.50 pr.
- 1967-1976** All 400 and 455 Engines.
 EMG676\$15.00 pr.
- 1968-1981** All 350 Engines.
 EMG681\$17.00 pr.

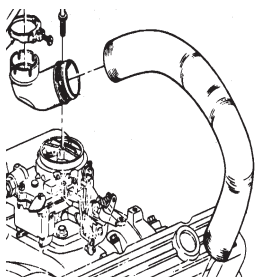

Exhaust Manifold Heat Pipe

(Air Cleaner to Exhaust Manifold)

- 1970-1974** All
 HP704.....(Chrome).....\$14.50 ea.
 HP704B.....(Black).....\$17.25 ea.

Brass Nuts. Tall. All years as required. 3/8-16. Used on manifolds, pipes, exhaust, trim etc. Solid brass.
 N6P.....\$3.75 pr.



Exhaust Manifold French Locks



1964-1966 GS400 (8 per car) Stainless steel.
 FL576\$3.50 ea.



1964-1966 GS400 (4 per car) ; 1966 225, 33, 340 engine as required. Stainless steel.
 FL626\$1.75 ea.

Manifold Anti-Rattle Spring

1965 401, 425;
1965-1967 All;
1968-1969 all V8.
 MS629.....\$7.75 ea.



Rear Muffler Hangers

1964-1972 All models with dual exhaust.
 MH642L.....Left hand Side\$17.50 ea.
 MH642R.....Right hand Side\$17.50 ea.



Tail Pipe Hangers

1964-1972 All models with dual exhaust. Fits either side.
 TPH642TOS

1971-1972 Exhaust Tips

1971-1972 All with N25 exhaust thru the bumper option. Chrome plated steel as original. Approx. 2.25 id to allow room for stock 2" pipes.
 EE712.....\$246.50 pr.





Gas Tanks

(for all cars exc. wagons)

1964-1967 Without vent. Does not come with filler neck. 21.5 gallon.

GT647\$249.00 ea.

1964-1967 With vent. Without filler neck. 20 gal.
GT647V\$197.00 ea.

1968-1969 All. Includes filler neck. 2 vents. 20 gal.
GT689TOS

1970 Without E.E.C. (1 Vent). Does not include filler neck. 20 gallon.
GT70V\$208.75 ea.

1970 Without E.E.C. (2 Vents). Does not include filler neck. 20 gallon.
GT70V2\$187.75 ea.

1970 With E.E.C. (3 Vents). Does not include filler neck. 20 gallon.
GT70V3\$194.00 ea.

1971-1972 All. Filler neck included. 3 vents. 20 gal.
GT712\$207.25 ea.

Gas Tank Straps



1964-1967 All. As original.
GS647\$24.50 pr.
GS647S...Stainless steel...\$69.50 pr.

1968-1972 All. As original.
GS682\$26.75 pr.
GS682S.....Stainless steel...\$69.50 pr.

Gas Tank Caps (3.028)



1961-1963 All;
1964-1970 All Wagons. Vented.
GC575\$9.50 ea.

1964-1970 All Exc. Wagons. Replacement cap. Not vented.
GC640\$7.50 ea.

1971-1972 All.
GC714\$9.75 ea.



Gas Tank Sealer/Liner

Alcohol resistant. Quart can.
TS1\$34.50 ea.

Gas Tank Etch

Removes light rust and will prep for sealer/liner. 16oz.
TE1.....\$16.00 ea.



Lead Additive

All Buick engines needing leaded gas.
LA1\$13.50 ea.

Gas Tank Bolt Kit

1961-1967 All as needed. Two 3/8-16 x 3" bolts and two (2) lock nuts. Brightly zinc plated.
GB610.....\$5.50 kit



Gas Tank Sending Units

(except wagons)



1968-1970 All with dual fuel lines.
SU680.....\$49.50 ea.



1968-1970 All with 350 engines and single fuel lines. Not for wagons.
SU680S.....\$46.50 ea.



1971-1972 All 350 engines with A.C. or dual fuel line;
1971-1972 All 455 engines.
SU712.....\$54.50 ea.



1971-1972 All 350 engines with single fuel line.
SU712S.....\$46.50 ea.

1971-1972 All 350 engines with A.C. or dual fuel line;
1971-1972 All 455 engines.
"GENUINE GM NOS"
SU712NOS.....\$79.50 ea.

Sending Unit Gaskets

1961-1963 All;
GG355.....\$3.75 ea.

1964-1972 All;
GG642.....\$5.00 ea.



Transmission • Brakes (Group 4)

Automatic Transmission Kits

Model	Year	Master Overhaul Kit	Banner Kit	Paper, Rubber, Rings & Seals	External Seal-up Kit
Dualpath.....	1961-1963.....	TOK613S \$329.50 ea.	TKB613S 241.50 ea.	TRK613S \$175.50 ea.	TSK613S \$104.00 ea.
ST300.....	1964-1969.....	TOK300 \$115.50 ea.....	TKB300 \$91.50 ea.....	TRK300..... \$59.50 ea.....	
TH350.....	1969-1979.....	TOK350 \$105.00 ea.....	TKB350 \$93.00 ea.....	TRK350..... \$38.50 ea.....	TSK350 \$49.50 ea.....
TH350C.....	1980-1986.....	TOK350C..... \$126.00 ea.....	TKB350C \$93.50 ea.....	TRK350..... \$38.50 ea.....	
TH400.....	1964.....	TOK400F \$126.00 ea.....	TKB400F \$98.00 ea.....	TRK400F \$87.50 ea.....	
ST400 & TH400...	1965-1998.....	TOK400 \$118.25 ea.....	TKB400 \$89.75 ea.....	TRK400..... \$89.50 ea.....	

Master Overhaul Kit: Gaskets, Friction (lined) Clutches, Lip Seals, Steel Clutches, "O" Rings, Front Pump Seal, Sealing Rings and Extension Housing Seal.

Banner Kit: Same as Master Kit, but without Steel Clutches.

Paper, Rubber, Rings and Seals: All Gaskets, Lipseals, O-Rings, Sealing Rings (Popular Set), Front Pump Seal and Ext. Hsg. Seal.

External Seal-up Kit: Stops any external Leaks. Contains Front Pump Seal, Extension Housing Seal, Selector Lever Seal and External Gaskets (including Pan Gasket and Converter Gasket or O-Ring).

Auto Transmission Oil Pan Gaskets

1961-1963 Dual path, 1 bolt. TPG613	\$19.50 ea.
1964-1969 Super Turbo 300, 14 bolt. TPG649	\$11.50 ea.
1964-1972 Turbo-Hydramatic 400, 13 bolt. TPG645	\$9.50 ea.

Transmission Gaskets

Standard Transmission Envelope Sets

CARS#	YEARS	APPLICATION	PRICE
TGS613	1961-1963:	All	\$19.75
TGS659	1965-1969:	All (Floor Shift)	\$15.00

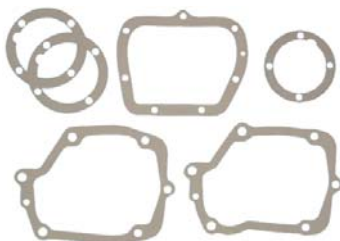

Transmission Filter Change Kits

1964-1969 With S.T. 300 (except early 1964). TFK300	\$36.75 ea.
1964-1966 All TH400; 1967 Early type TH400 with tube. TFK400T.....	\$36.75 ea.
1967 Late TH400 with flat filter; 1968-1972 All TH400. TFK400	\$15.00 ea.
1969-1972 With Turbo 350. TFK350	\$13.00 ea.

Transmission Seals



1964-1972 All front pump oil seal. TS646	\$11.50 ea.
1961-1972 Transmission rear seal. 1961-1963: All; 1964-1972: All ST300, TH350, TH375. TS616	\$10.75 ea.
1964-1968 All TH400, rear. TS640	\$12.25 ea.
1969-1972 All TH400, rear. TS696	\$11.50 ea.

Transmission Mounts

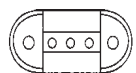

1961-1963 All. Exchange item.
TM613RS\$140.59 ea.



1964-1972 All with standard transmissions;
1964-1972 All ST300 and TH350 transmissions.
TM642\$19.00 ea.

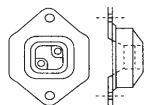

1967-1972 All TH400 transmission.
TM650\$12.50 ea.

Transmission Lines

1968-1972 Radiator to transmission. Cools transmission fluid.
TL682\$53.75 ea.



Console Shift Lever

For Long Console: Chrome Plastic Insert that Clips into Black Plastic. Replaces Worn Chrome Handle.

1970-1975 Auto transmission. Shift lever.
SL705\$28.25 ea.

Transmission Shift Cable

1968-1972 all with long console.
SC682\$65.75 ea.



Transmission Cable Bracket



1968-1972
TCB682\$25.00 ea.

Shift Boots



1964-1965 With console; Lowell.
1965-1967 All 4-speed with console;
1967 All 3-speed with console.
SB647\$32.25 ea.
Retainer for above.
SBR647\$26.50 ea.



1965-1972
1965-1972: GS;
1968-1972: Skylark with consolette (upper).
SB652\$45.25 ea.
1968-1972 All with consolette lower.
SB682\$82.75 ea.

Transmission Governor



All TH350 and TH400. Allows upshift to 5600-5800 rpm range at full throttle instead of stock 4600-5000 range.
TG700\$69.75 ea.

Neutral Safety and Back Up Switch



1964-1966 ST300 exc. long console.
NSS646\$29.50 ea.



1967-1968 All with automatic trans.;
1969-1970 all with long console.
NSS670\$27.75 ea.



1969-1970 All TH400 w/ column shift;
1971-1972 all TH400.
NSS692\$36.50 ea.

Speedometer Cables



1961-1972
SC612\$22.75 ea.
1961-1972 All. Speedometer cable repair kit.
SRK360\$16.00 ea.

Speedometer Cable Lubricant



1961-1972 All.
SCL300\$5.00 ea.

Vacuum Modulator



1964-1969 All V-8 with ST300 except GS;
1964-1972 All TH350 and TH400.
VM642\$35.00 ea.



4-Speed Shift Pattern Plate
All years as required.
SP610\$23.25 ea.

Transmission Lock Linkage



(Also allows reverse lights to function)
For floor shift automatic or manual, or column shift automatic cars. Kit includes rod, swivel and nut.
1969-1972 with auto transmission.
TLL692\$77.50 ea.

Reverse Lockout Kit



1969-1972 4 speed trans. 4 piece.
RLK692\$99.00 ea.

Transmission Gear Selector Lever



This lever mounts onto the transmission and is designed for shifter cables. Uses trunnion block original setup. Sold individually.
TSL682\$19.00 ea.

Brakes (Group 4)



Master Cylinder



1964-1966 Manual brakes.	
MC646.....	\$79.50 ea.
1964-1966 Power brakes.	
MC646P.....	\$78.50 ea.
1967-1972 All regular and power brakes with drums.	
MC672.....	\$89.50 ea.
1971-1978 All Moraine power disc brakes;	
1979 All exc. rear disc brakes;	
1980 All.	
MC680.....	\$59.50 ea.

Master Cylinder Rebuild Kits

1961-1963	
1961-1963: All;	
1964-1966: All with manual brakes.	
MK596.....	\$26.25 ea.
1964-1966 All with Delco Moraine power brakes.	
MK646.....	\$24.75 ea.
1967-1972 All drum brakes.	
MK672.....	\$36.50 ea.
1967-1972 All with Moraine power disc brakes.	
MK675.....	\$30.50 kit

Front Wheel Cylinders and Repair Kits (4.667)

1961-1963 All (1")	
FWC613R.....RH Side.....	\$51.00 ea.
FWC613L.....LH Side.....	\$51.00 ea.
RK370.....Repair Kit.....	\$9.50 ea.
1964-1966 Special, Skylark and Sportwagon (1 1/16")	
FWC646R.....RH Side.....	\$36.75 ea.
FWC646L.....LH Side.....	\$36.75 ea.
FK646.....Repair Kit.....	\$9.50 ea.
1965-1966 GS ;	
1967 All Skylark, GS and Sportwagon (1 1/8")	
FWC657R.....RH Side.....	\$25.00 ea.
FWC657L.....LH Side.....	\$25.00 ea.
FK652.....Repair Kit.....	\$9.75 ea.
1968-1972 All Skylark, GS and Sportwagon (1 1/8")	
FWC682R.....RH Side.....	\$31.50 ea.
FWC682L.....LH Side.....	\$31.50 ea.
FK652.....Repair Kit.....	\$9.75 ea.



Master Cylinder Parts for Moraine Power Disc Brakes

1971-1972 .	
MCC700.....Cover.....	\$9.50 ea.
MCD700.....Diaphragm.....	\$7.50 ea.

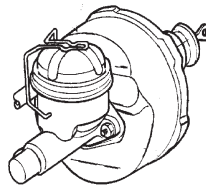

Power Brake Rebuild Service Master Cylinder and Booster with Exchange

1961-1974 All.	
PBR610.....	\$279.50 ea.

Delco Moraine Power Brake Booster

Licensed by GM. Correct in all detail including Gold iridite plating and "DELCO MORaine" stamping.

1964-1966 All	
BB646.....	\$197.50 ea.
1967-1972 All	
BB672.....	\$197.50 ea.



Brake Booster Hose Pinch Clamp

PC1116.....	\$1.25 ea.
-------------	------------

Brake Booster Vacuum Check Valve (4.955)

1968-1972 All.	
CV682.....	\$12.75 ea.



Silicon Brake Fluid

1963-1980 Silicon brake fluid. (one gallon).	
SF360.....	\$63.00 ea.



Rear Wheel Cylinders and Repair Kits

1961-1963 All (7/8")	
RWC613.....RH and LH Side.....	\$49.00 ea.
RK613.....Repair Kit.....	\$8.00 ea.
1964-1966 All Skylark and GS ;	
1967 Skylark (15/16")	
RWC644.....RH and LH Side.....	\$22.25 ea.
RK644.....Repair Kit.....	\$9.50 ea.
1964-1970 Sportwagon (1")	
RWC640R.....RH Side.....	\$58.75 ea.
RWC640L.....LH Side.....	\$58.75 ea.
RK640.....Repair Kit.....	\$8.50 ea.
1967 GS;	
1968-1972 All Skylark and GS except Sportwagon (7/8")	
RWC672.....RH and LH Side.....	\$18.50 ea.
RK672.....Repair Kit.....	\$8.50 ea.

Disc Brake Caliper Repair Kits

1969-1972 All.	
CRK696.....	\$11.50 ea.

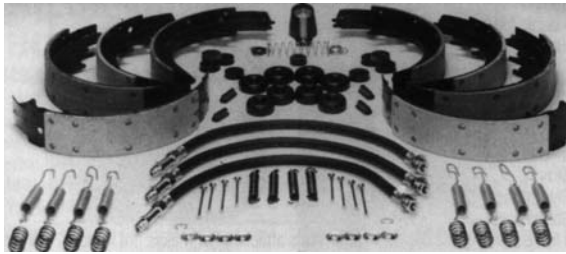

Brake Overhaul Kits

Our complete kits include the following:

- 4 Wheel cylinder kits
- 1 Master cylinder kit
- 4 Brake shoes with linings, or discs
- 3 Hydraulic brake hoses
- Brake spring hardware kit
- Order wheel cylinders separately

- 1961** Special & Skylark. Does not include brake shoes.
 BOK61S.....\$149.00 ea.
1962-1963 Special & Skylark. Does not include brake shoes.
 BOK623S.....\$149.00 ea.
1964-1972 All manual drum brakes.
 BOK642.....\$199.50 ea.
1968-1972 All with power drum brakes.
 BOK682PD.....\$229.75 ea.
1969-1972 All with Moraine power disc brakes.
 BOK692PMD.....\$179.75 ea.

Front Brake Hoses (4.680)



- 1961-1963** All. Front.
 FH613.....\$19.50 ea.
1964-1967 All with drum brakes.
 FH647.....\$18.50 ea.
1967 All with disc brakes.
 FH67.....\$18.50 ea.
1968-1972
 1968: All;
 1969-1972: All drum brakes.
 FH682.....\$16.50 ea.
1969-1972 All with disc brakes.
 FH692.....\$16.50 ea.

Rear Brake Hoses

- 1961** All.
 RH61.....\$24.50 ea.
1962-1963 All.
 RH623.....\$24.50 ea.
1964-1967 All with drum brakes.
 RH626.....\$18.50 ea.
1969-1972 All rear brakes.
 RH682.....\$29.50 ea.

Front Drum to Disc Conversion Kits

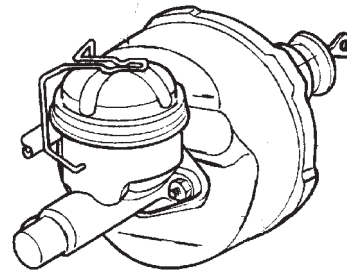

- 1964-1972** All with manual brakes.
 DCK642M.....\$897.50 kit
1964-1972 All with power brakes.
 DCK642P.....\$698.50 kit



Brake Hardware



Brake Shoe Hold Down Spring Kits

- 1961-1963** All.
 BSK613F.....(Front for Drum Brakes).....\$19.50 ea.
 BSK613R.....(Rear).....\$19.50 ea.
1964-1972 All.
 BSK642.....(Front for Drum Brakes).....\$16.50 ea.
 BSK642A.....(Rear).....\$16.50 ea.

Drum Brakes

- 1963-1972** All, rear left.
 BSK632L.....\$19.25 ea.
1963-1972 All, rear right.
 BSK632R.....\$19.25 ea.

- 1936-1980** Brake adjuster hole plug.
 (4 per car).
 BC340.....\$1.00 ea.



Brake Hose Clip

- 1961-1972** All.
 BC360.....\$1.25 ea.

Brakes (Group 4)



Brake Shoes and Pads

- 1961-1963** Special and Skylark. Front, exchange.
 FBS613\$38.50 set
- 1961-1963** Special and Skylark. Sold outright.
 RBS613\$45.75 set
- 1964-1972** All, front shoes;
1964-1969 Sportwagon rear shoes.
 BS642\$45.75 ea.
 BS642D.....(Genuine Delco Rivited)\$50.00 ea.
- 1967-1968** All, front. Discs.
 FDP678\$26.00 ea.
- 1969-1972** All, front. Discs.
 FDP692\$23.50 ea.
- 1964-1972** All, except 1964-1969 Sportwagon. Rear shoes;
 RBS642\$40.75 set

Brake Adjusting Screws

- 1967-1972** All. Fits front and rear.
 BAS674L.....(Fits left hand side).....\$10.75 ea.
 BAS674R.....(Fits right hand side).....\$10.75 ea.

Brake Line Clip Sets Correct Style in Correct Colors

- 1964-1965** All.....BLC645.....9 pc.set.....\$21.00 set
1966-1967 All.....BLC667.....9 pc set.....\$20.75 set

Disc Brake Caliper Repair Kits

- 1967-1968** All with front disc brakes. For 1 wheel.
 CRK678\$19.50 ea.
1969-1972 All with front disc brakes. For 1 wheel.
 CRK696\$16.50 ea.



Brake Drums and Rotors

- 1964-1972** All Front. Cast iron.
 BD642F\$57.50 ea.
1964-1972 All Rear exc. wagons.
 BD642R\$47.50 ea.
1967-1969 Sportwagon. Front and rear.
 BD679W\$87.50 ea.

Rotors

- 1969-1972** All.
 BD692.....\$75.25 ea.

Brake Pedal Pads



- 1964-1972** Auto transmission with drum brakes.
 PC642.....\$8.50 ea.
1964-1972 Standard transmission. For brake and clutch.
 PC642S\$9.50 ea.
- 1967-1972** All w/ disc brakes. (pad only)
 PC672.....\$16.50 ea.
1964-1972 Parking brake.
 PC642E\$4.25 ea.

Stop Light Switches (2.447)



- 1961-1963** All.
 SLS563\$10.75 ea.
1964-1970 All.
1971-1972 All except cruise control.
 SLS645\$9.50 ea.

Brake Junction Blocks



- 1964-1965** With single master cylinder reservoir.
 JB645\$30.25 ea.
1964-1967 With dual master cylinder reservoir.
 JB647\$32.50 ea.
1966 With single master cylinder reservoir.
 JB66\$29.50 ea.

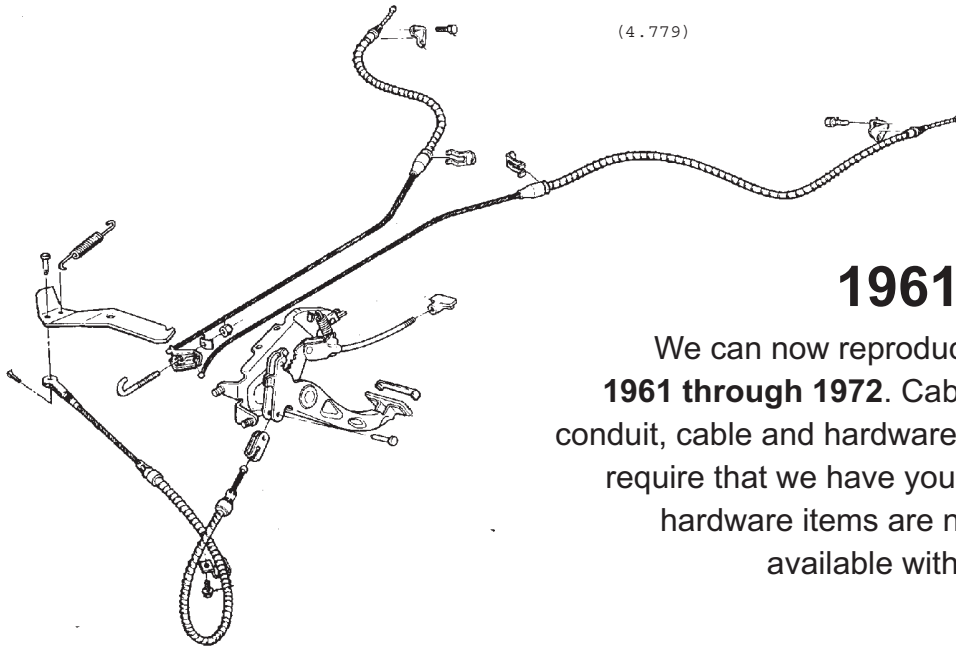

1961-1972

We can now reproduce any cable listed from **1961 through 1972**. Cables are made using correct conduit, cable and hardware. Please note, some cables (*) require that we have your old unit for parts as some hardware items are not available. Some are available with a core charge.

Year & Model	Front	Center	Rear
1961 Special	R579055\$99.75 ea.....	R579062.....\$113.75 ea.....	R579056 (RH)\$113.75 ea.. R579057 (LH).....\$113.75 ea.
1961 Skylark	R579055\$113.75 ea.....	R579062.....\$113.75 ea.....	R1351992.....\$113.75 ea.
1962-1963 Spec & Sky	R1352512\$113.75 ea.....		R583682 (RH)\$113.75 ea.. R583683 (LH).....\$113.75 ea.
1964-1966 All ex. wag.	R1394278\$93.00 ea.....	R1361843.....\$42.25 ea.....	R1367389 (2)\$113.75 ea.
1964-1966 Sportwagon	R1394278\$93.00 ea.....	R1363387.....\$113.75 ea.....	R1367389 (2)\$113.75 ea.
1967 Special & Skylark; 1967 GS w/out TH400	R1394278\$93.00 ea.....	R1361843.....\$42.25 ea.....	R1379642 (2)\$113.75 ea. (without Nylon type)
1967 GS with TH400	R1394997\$113.75 ea.....	R1382066.....\$49.50 ea.....	R1373389 (1)\$78.00 ea. (with Nylon type)
1967 Sportwagon with TH400	R1394353\$113.75 ea.....	R1381418.....\$113.75 ea.....	R1379642 (2)\$113.75 ea. (without Nylon type)
1967 Sportwagon without TH400	R1394278\$93.00 ea.....	R1363387.....\$113.75 ea.....	R1379642 (2)\$113.75 ea. (without Nylon type)
1968-1972 All two door except TH400	R1394278\$93.00 ea.....	R1382395.....\$63.75 ea.....	R1382429 (2)\$78.00 ea.
1968-1972 All four door except wagons	R1394278\$93.00 ea.....	R1361843.....\$42.25 ea.....	R1382429 (2)\$78.00 ea.
1968-1972 GS with TH400	R1394997\$113.75 ea.....	R1374758.....\$63.75 ea.....	R1382429 (2)\$78.00 ea.
1968-1969 Sportwagon with TH400	R1394997\$113.75 ea.....	R1381418.....\$113.75 ea.....	R1382429 (2)\$78.00 ea.
1968-1969 Sportwagon without TH400	R1394278\$93.00 ea.....	R1240298.....\$113.75 ea.....	R1382429 (2)\$78.00 ea.
1971-1972 Sportwagon with TH400	R1394997\$113.75 ea.....	R1374758.....\$63.75 ea.....	R1382429 (2)\$78.00 ea.
1971-1972 Sportwagon without TH400	R1394278\$93.00 ea.....	R1240298.....\$113.75 ea.....	R1382429 (2)\$78.00 ea.

ITEMS NOT PRICED MUST BE QUOTED. PLEASE INQUIRE!

Steel Brake Lines (Group 4)

Front Brake Line Kits				
<u>PART #</u>	<u>YEAR</u>	<u>DESCRIPTION</u>	<u>ORIGINAL MATERIAL</u>	<u>STAINLESS STEEL ("S")</u>
FBL67A	1967	Standard drum, 4 line set.....	\$80.75 ea.	\$112.25 ea.
FBL67B	1967	Power drum, 4 line set.....	\$80.75 ea.	\$112.25 ea.
FBL682A	1968-1972	Standard drum, 4 line set.....	\$80.75 ea.	\$112.25 ea.
FBL682B	1968-1872	Power drum, 4 line set.....	\$80.75 ea.	\$112.25 ea.
FBL689A	1968-1969	Power disc, 5 line set.....	\$80.75 ea.	\$112.25 ea.
FBL70A	1970	Power disc, 5 line set.....	\$80.75 ea.	\$112.25 ea.
FBL712A	1971-1972	Power disc, 4 line set.....	\$80.75 ea.	\$112.25 ea.
Front to Rear Brake Lines				
CBL645A	1964-1965	Front to rear, convertible.....	\$64.25 ea.	\$86.00 ea.
CBL645B	1964-1965	Front to rear, hardtop.....	\$64.25 ea.	\$86.00 ea.
CBL66A	1966	Front to rear, hardtop.....	\$64.25 ea.	\$86.00 ea.
CBL66B	1966	Front to rear, convertible.....	\$64.25 ea.	\$86.00 ea.
CBL67A	1967	Front to rear, hardtop.....	\$64.25 ea.	\$86.00 ea.
CBL67B	1967	Front to rear, convertible.....	\$64.25 ea.	\$86.00 ea.
CBL68A	1968	Front to rear, hardtop.....	\$64.25 ea.	\$86.00 ea.
CBL68B	1968	Front to rear, convertible.....	\$64.25 ea.	\$86.00 ea.
CBL69A	1969	Front to rear, hardtop.....	\$64.25 ea.	\$86.00 ea.
CBL69B	1969	Front to rear, convertible.....	\$64.25 ea.	\$86.00 ea.
CBL70A	1970	Front to rear, hardtop, disc only, 2.....	\$64.25 ea.	\$86.00 ea.
CBL70B	1970	Front to rear, convertible, disc only two piece line.....	\$64.25 ea.	\$86.00 ea.
CBL702A	1970 1971-1972	Front to rear, hardtop, drum Front to rear, hardtop, all.....	\$64.25 ea.	\$86.00 ea.
CBL702B	1970 1971-1972	Front to rear, convertible, drum Front to rear, convertible, all.....	\$64.25 ea.	\$86.00 ea.
Rear Axle Brake Lines				
RBL645	1964-1965	All cars, 2 line set.....	\$39.00 set	\$50.50 set
RBL66	1966	All cars, 2 line set.....	\$39.00 set	\$50.50 set
RBL682	1968-1972	All cars, 2 line set.....	\$39.00 set	\$50.50 set



New Buick Chrome Wheels (5.803)

At last, a source for new 14" and 15" Skylark and GS chrome wheels. These wheels are show and road ready. They come heavily chrome plated with recessed areas already satin black painted. Bolt circle is 5 on 4 3/4". Made in standard or custom sizes. Check your back-spacing requirements before ordering.

- 14 x 6 Chrome Wheel w/ 3 1/2" backspacing.
GSW146.....\$249.50 ea.
- 14 x 7 Chrome Wheel w/ 4" backspacing.
GSW147.....\$249.50 ea.
- 15 x 7 Chrome Wheel w/ 4" backspacing.
GSW157.....\$259.50 ea.
- 15 x 8 Chrome Wheel w/ 4 1/2" backspacing.
GSW158.....\$259.50 ea.

**Please see next page
for Wheel Caps**



Solid Stainless Steel Wheel Nuts



1969-1972 We have reproduced these hard-to-find nuts to look identical to the originals. Of course they are far superior to the originals as they will never rust and feature the durability and strength of stainless steel. 7/16" - 20.

Will also fit 1965-1968.

- WN695\$8.50 ea.
- WN695S.....(Set of 20).....\$150.00 set

Wheel Nuts

Stainless Steel Capped Replacement



These nuts are an inexpensive replacement and do not look authentic.

1964-1972 All. 7/16-20.

- WN691.....\$3.25 ea.
- WN691S.....(Set of 20).....\$44.25 set

Standard Acorn Nut Replacement

1964-1972 All. 7/16- 20.

- WN611.....\$1.75 ea.
- WN611S.....(Set of 20).....\$23.75 set



1961 thru 1963 All. Rear Only

- WN613.....L.H. Thread.....\$1.75 ea.
- WN611.....R.H. Thread\$1.75 ea.

Front Wheel Studs

1967-1970 GS400 and GS455 with drums;
1970-1972 Skylark and GS with disc brakes.
7/16"-20 x 1 1/2". 11/16" deep.

- WS672.....\$1.25 ea.

1965-1970 Chrome Wheel Caps

We have been selling these superior quality cap assemblies since 1991. They come in kit form. You receive chrome plated fluted cap, cap retainer, anti-theft bar, screws, plastic emblem, emblem pad and directions. These caps are guaranteed to be the best available at any price. We are licensed by GM to sell the trademarked medallions below.

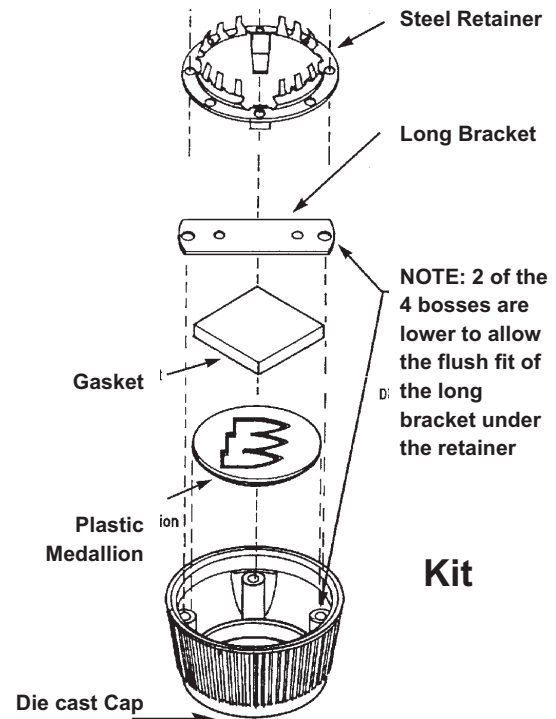

Wheels (Group 5)

1965-1970



Cap assembly without medallion.
WC650.....\$35.00 set

Complete Assemblies.



1965 With "Fat Bird" insert cap assembly with medallion.
WC65.....\$49.50 ea.
Set of Four Kits.
WCS65.....\$189.50 set



1966-1967 Exc GS With "Thin Bird" insert cap assembly with medallion.
WC667.....\$49.50 ea.
Set of Four Kits.
WCS667.....\$189.50 set



1967 GS 1968-1970 With "Tri Shield" insert cap assembly with medallion.
WC680.....\$49.50 ea.
Set of Four Kits.
WCS680.....\$189.50 set

Plastic Emblems.



1965 Wheel Plastic, "Fat Bird".
WP65.....\$21.50 ea.
(will also fit "spinner" wheel covers with 2 1/16" diameter center.)



1966-1967 Wheel Plastic "Thin Bird".
WP667.....\$21.50 ea.



1967-1970 Wheel Plastic, "Tri Shield".
WP660T.....\$19.00 ea.

Retainers.



1965-1970 All.
WCR650.....\$7.00 ea.

1971-1972



Complete cap assembly with medallion.
WC712.....\$49.50 ea.



Cap assembly without medallion.
WC717.....\$30.00 ea.



Wheel Plastic, "Tri Shield".
WP712.....\$18.00 ea.



1971-1972 Wheel Plastic Retainer.
WCR712.....\$9.50 ea.

1977-1987



All with 3" caps. Complete cap assembly with medallion and retainer.
WC777.....\$49.50 ea.



All with 3" caps. Cap assembly without medallion. .
WC717.....\$30.00 ea.



Emblem.
WP777\$15.00 ea.



Retainer.
WCR712\$12.00 ea.

Propeller Shaft Center Bearing Support



1962-1963 All. Steel retainer with rubber collar.
BS623.....\$47.25 ea.

Center Bearing for above.



1961-1963 All. Fits into Driveshaft Center Support.
DSB611\$37.00 ea.

Universal Joints



1961-1963 Front and rear. 4 per car.
UJ613.....\$25.25 ea.



1964-1972 All. Front and rear.
UJ574\$22.50 ea.



1966-1967 All (center).
CVK668\$59.00 ea.

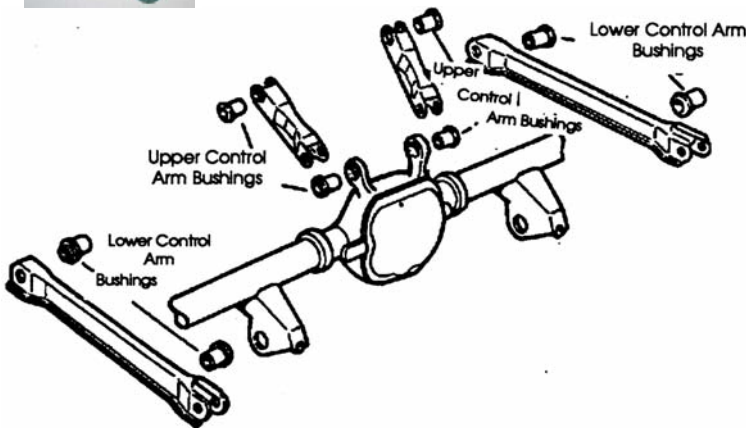

Boxed Lower Control Arms

1964-1972 All. Buick used boxed lower control arms on GS models to improve handling and performance. Our heavy duty boxed control arms upgrade your Skylark or replace the weaker units found on GS models. Available with Rubber or Urethane bushings.

CA642R.....(Rubber Bushings).....\$177.75 pr.
CA642U.....(Urethane Bushings).....\$185.50 pr.



1964-1972 Special, Skylark, GS.
Rear Boxed (Heavy Duty)
Lower Control Arms (2) with Bushings.
LCA642.....\$179.00 pr.

1964-1972 Front Lower Control Arm



Special, Skylark, GS. Front Lower Control Arm LH. Includes bushings and ball joint.
LCA642L.....\$178.50 ea.



Special, Skylark, GS. Front Lower Control Arm RH. Includes bushings and ball joint.
LCA642R.....\$178.50 ea.

1964-1972 Upper Lower Control Arm

Special, Skylark, GS. Upper Control Arm LH. Includes shaft and ball joint.
UCA642L.....\$129.00 ea.



Special, Skylark, GS. Upper Control Arm RH. Includes shaft and ball joint.
UCA642R.....\$129.00 ea.



1965-1967 Traction Bars



Brand new GM A Body cars factory traction bars that came on most all 4-speed manual transmission cars. Eliminates rear wheel hop.

TB647A.....\$79.50 pr.

Rear Axle Control Arm Box Kit



1964-1972 All. Heavy gauge stamped steel inserts are welded into lower control arm for increased strength and better handling. Kit contain 2 inserts for complete job.
BK642.....\$35.50 ea.

Rear Axle Control Arm Bushings

1961-1963 All upper. 2 pair needed per car.
RAB613U.....\$95.75 pr.

1961-1963 All lower, front. 1 pair needed per car.
RAB613LF.....\$74.75 pr.

1961-1963 All lower, rear. 1 pair needed per car.
RAB613LR.....\$143.50 pr.

1964 All upper front. 1 pair needed per car.
RAB64UF.....\$28.25 pr.

1964 All upper rear. 1 pair needed per car.
RAB64UR.....\$90.25 pr.

1965-1972 All upper and lower (4 pair per car).
RAB652.....\$29.50 pr.
RAB652S4.....[Set of 8 (4 pair)].....\$106.50 set

Propeller Shaft • Rear Axle (Group 5)

Rear Axle Control Arm Bolt Kit



1964-1972 All. Premium grade 8 bolts with locking nuts. Enough hardware for both lower control arms.
ABK642.....\$30.25 ea.

Rear Axle Anti-Sway Bar (Complete with Hardware)



1964-1972 All. 1"
SB642R.....\$139.50 ea.



Rear Wheel Bearings (5.855)

1961-1963 All.
RWB613.....\$47.00 ea.
1964-1968 All except Sportwagon and GS.
RWB648.....\$50.50 ea.
1964-1965
1964-1965: Sportwagon;
1965: GS.
RWB645.....\$147.50 ea.
1966-1968 GS and Sportwagon. 2 7/8" diameter bearing.
RWB667.....\$103.50 ea.
1968-1970 All with 12 bolt cover.
RWB689.....\$20.75 ea.
1969-1972 All except Sportwagon and 12 Bolt cover.
RWB692.....\$37.50 ea.
1969 Sportwagon.
RWB696.....\$37.50 ea.



Rear Axle Oil Seals (5.822)

1961-1963 All Special and Skylark.
OS613.....\$15.00 ea.
1964-1965 All; **1966-1968** all exc. GS and Sportwagon.
OS648.....\$18.75 ea.
1966-1968 GS and Sportwagon.
OS668.....\$14.50 ea.
1968-1969 All Canadian built; **1970** w/ 12 bolt rear.
OS681.....\$16.50 ea.
1969 All Special and Skylark except Sportwagon.
OS69.....\$22.50 ea.
1970-1972 Skylark and GS with 9.375 rear gear.
OS709.....\$9.50 ea.

Axle Housing Bumper (5.395)

1964-1972 All.
AB642.....\$15.00 ea.



Rear Axle Pinion Seal (5.445)

1961-1963 All.
PS613.....\$16.50 ea.
1964-1967 All.
PS647.....\$19.00 ea.

Rear Axle Cover

1964-1972 All 10 bolt rears. Bare steel, ready to paint.
AC642.....\$37.50 ea.

Rear Axle Cover Gaskets

1961-1963 All.
RAG613.....TOS



1964-1970 All 10 bolt.
RAG640.....\$9.50 ea.
1968-1970 All 12 bolt.
RAG680.....\$9.50 ea.

Rear Axle Posi-Traction Tag



1961-1972 All "Posi".
PT635 All.....\$5.75 ea.



Rear Axle Posi-Traction Additive

All years as required. For Posi Rears. Reduces chatter and noise. Genuine GM.
AL300.....\$11.75 ea.



www.oldbuickparts.com
908-369-3666

Buick used two types of steering linkages from **1961-1967**, Saginaw and Thompson (Alternate). **Saginaw** original equipment can be identified by having a plastic plate, or a small "s" stamped on the plate. (see *illustration A*) Saginaw Idler arm assemblies will typically be a three-piece unit having a threaded steel bushing (see *illustration B*). The Saginaw Idler Arm Assembly with the metal plug design is an integral unit with the bracket (see *illustration C*). Saginaw centerlinks have ball studs that measure .587 (see *illustration D*). Saginaw linkage has straight joints (see *Illustration E*).



Illustration A

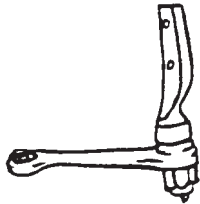

Illustration B



Illustration C

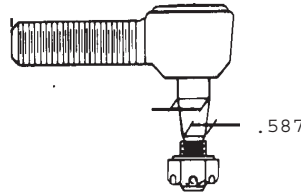

Illustration D

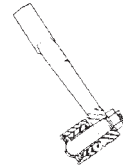

Illustration E

Thompson or **Alternate** original equipment can be identified by a plain metal cover plate under the ball stud of each socket (see *illustration E*). Thompson Idler Arm assemblies are a one piece unit (see *illustration F*). Thompson centerlinks have ball studs that measure .556 (see *illustration G*). Thompson linkage has tapered joints (see *illustration H*).

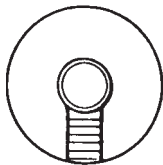

Illustration E

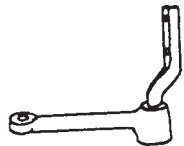

Illustration F

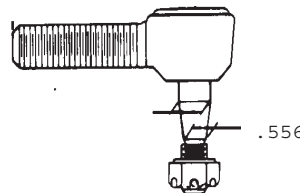

Illustration G

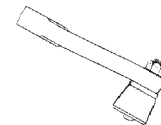
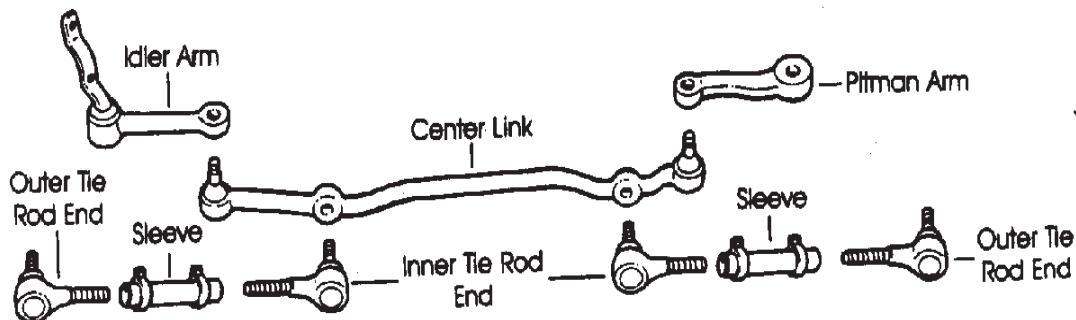
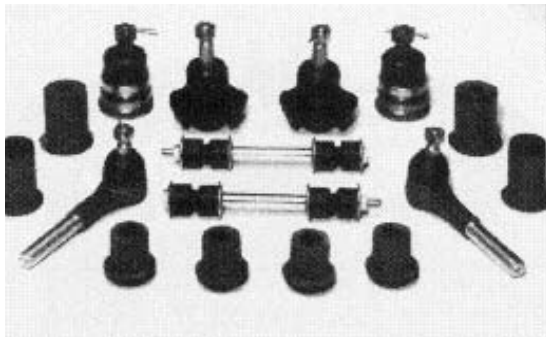

Illustration H



Steering (Group 6)

Standard Front End Rebuilding Kits



1961 through 1972 Standard Kit Contains:

- | | |
|----------------------|--------------------------|
| 2 Upper Ball Joints | 2 Lower Ball Joints |
| 2 Outer Tie Rod Ends | Upper Inner Bushings |
| Lower Inner Bushings | 2 Stabilizer Repair Kits |

1961-1962 All with screw-in lower ball joints.
FEK612S.....\$276.50 ea.

1961-1962 All with press-in lower ball joints.
FEK612P.....\$246.50 ea.

1963 All with screw-in lower ball joints.
FEK63S.....\$246.50 ea.

1963 All with press-in lower ball joints.
FEK63P.....\$246.50 ea.

1964-1965 All.
FEK645S.....\$183.25 ea.

1966-1970 All.
FEK660S.....\$159.00 ea.

1971-1971 All.
FEK712S.....\$183.25 ea.

Deluxe Front End Rebuilding Kits

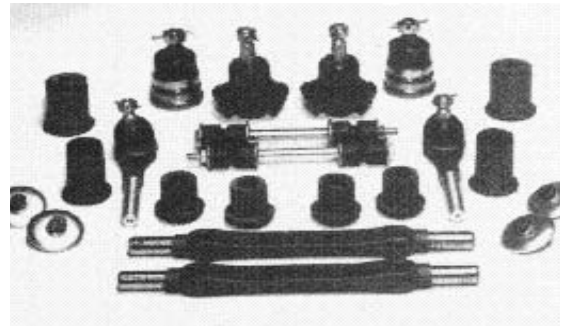

1961 through 1972 Deluxe Kit Contains:

- | | |
|---------------------------------------|--------------------------|
| 2 Upper Ball Joints | 2 Lower Ball Joints |
| Inner Shaft Kits complete w/ Bushings | |
| 2 Outer Tie Rod Ends | 2 Stabilizer Repair Kits |

1961-1962 All with screw-in lower ball joints.
FEK612SD.....\$499.50 ea.

1961-1962 All with press-in lower ball joints.
FEK612PD.....\$649.50 ea.

1963 All with screw-in lower ball joints.
FEK63SD.....\$499.50 ea.

1963 All with press-in lower ball joints.
FEK63PD.....\$499.50 ea.

1964-1965 All. Includes 2 upper shaft kits.
FEK645D.....\$311.75 ea.

1966-1970 All. Includes 2 upper shaft kits.
FEK660D.....\$247.00 ea.

1971-1972 All. Includes 2 upper shaft kits.
FEK712D.....\$247.00 ea.



1969-1972 Steering Wheels

This **BRAND NEW** reproduction wheel is identical to the original with correct diameter and grain detail. Does not include center cap.

SW695\$159.00 ea.

SW695K (Wheel w/ WH695 mounting hub and HC675 Cap)\$246.50 ea.



1967-1972 Steering Wheel Cap



This cap will fit all 1967 thru 1972 3 spoke cushion grip or GSX wheels. It also fits 1967 thru 1969 wood style wheel. Cap includes emblem, black rubber cushion and brushed chrome bezel.

HC675\$69.75 ea.

HE675.....(plastic emblem only).....\$45.75 ea.

Steering Wheel Parts



1969-1972 Wheel Hub. For all cars with rallye wheel.
WH695.....\$59.00 ea.



1964-1966 Cancelling Cam. All except tilt wheel.
CC646\$14.50 ea.



1969-1972 Cancelling Cam for all exc. tilt wheel applications.
CC694\$20.75 ea.



1966-1972 Horn spring and contact kit. For all standard wheels.
HS666\$9.50 kit



1969-1972 Horn contact. For all cars with 3 spoke rallye wheel.
HC695\$28.25 ea.

Power Steering Boxes

1964-1972 All. Standard 4 to 1.
SB648.....\$149.50 ea.

1964-1972 All. Fast ratio 2.5 to 1.
SB648F.....\$197.50 ea.



Power Steering Box Kits

1961-1972 All.
SBK619...(Complete Seal Kit)....\$39.50 ea.

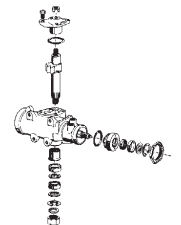

Power Steering Pumps

1970-1972 All w/ 350 engines. Does not include reservoir.
SP702\$90.25 ea.

1970-1972 All Includes reservoir. Rebuilt.
SP704\$125.00 ea.



SP702



SP704

Steering (Group 6)



Power Steering Pump Seal-Kits

- 1961-1963 All.**
 SPK613.....\$28.25 ea.
1964-1966 All 225, 300, 340, 400 engines.
 SPK596.....\$29.25 ea.
1967-1972 All.
 SPK673.....\$20.00 ea.

Steering Pump Rebuilding Kits

- 1967-1972 All.**
 SPK679.....\$20.00 ea.

Power Steering Hoses

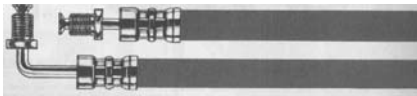

- 1964-1969 All 225, 300, 350;**
1967 GS 400 pressure hose.
 SH649P.....\$40.75 ea.
1964-1969 All. Return line with fitting.
 SH592R.....\$26.75 ea.
1971 w/ 350 engine; 1972 all engines. Pressure hose.
 SH716P.....\$37.50 ea.

Steering Coupling Fiber Disc

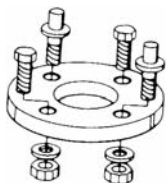

- 1961-1972 All. Kit includes screws and nuts.**
 SD570.....\$22.25 ea.

Steering Column Upper Bearing Kit

- 1969-1972 All.**
 SBK695U.....\$49.50 ea.



Steering Couplers

- 1967-1969 All regular steering.**
 SC679.....\$39.50 ea.
1967-1974 All with power steering.
 SC677.....\$39.50 ea.

Power Steering Pump Pulley



- 1967-1970 All:**
 5 3/8" diameter. Oem # 1386935
 SP670.....\$59.00 ea.

Tilt Lever and Knob



- 1969-1970 Buick Special, Skylark, Sport Wagon, GS.**
 Correct fluted chrome lever with black knob.
 TL690.....\$29.00 ea.



Steering Column Seals



- 1964-1967 All.**
 SS647.....\$6.75 ea.
1968-1972 All.
 SS682.....\$6.75 ea.

Steering Column Jackets (6.578)



- 1964-1967 All.**
 CJ647.....\$29.50 ea.
1968-1972 All.
 CJ692.....\$37.50 ea.



- Column jacket retainer for above.
 IR500.....\$1.00 ea.

Power Steering Pump Cap

- 1964-1966 All.**
 RC596.....\$59.00 ea.



Idler Arms and Brackets

(6.231)



- 1961-1962** Assembly.
IA612.....\$149.50 ea.
- 1963** Frame bracket.
IA63.....\$99.50 ea.
- 1964-1967**
1964: All with 7/8" diameter centerlink;
1965-1967: All.
IA647.....\$53.75 ea.
- 1964** All with 13/16" diameter centerlink;
1968-1972 All. For 13/16" centerlink.
IA682.....\$29.50 ea.

Centerlinks



- 1963** Rebuild only
CL63S.....\$276.25 ea.
- 1964** All with 13/16" diameter rod. Sold outright.
CL64.....\$89.75 ea.
- 1964** Late models with 7/8" diameter rod;
1965-1967 All . Sold outright.
CL647.....\$89.75 ea.
- 1968-1972** All. Sold outright.
CL682.....\$69.50 ea.



Front Wheel Bearings (6.311)

- 1961-1972** All. Inner.
IWB612.....\$13.75 ea.
- 1961-1972** All. Outer.
OWB612.....\$10.25 ea.

Front Wheel Grease Seals (6.326)



- 1961-1963** All.
GS613.....\$11.00 ea.



- 1964-1972** All.
GS642.....\$4.75 ea.

Front Wheel Grease Hub Caps

- 1961-1975** All.
GC610.....\$12.75 ea.

Tie Rods and Ends



- 1961-1962** All outer ends. Two per car.
TE492.....\$31.00 ea.
EC372.....(Dust Cover).....\$3.25 ea.
- 1961-1962** All Inner tie rods.
EC372.....(Dust Cover).....\$3.25 ea.
- 1963** All outer ends. .Two per car.
TE63.....\$29.50 ea.
EC372.....(Dust Cover).....\$3.25 ea.
- 1963** All Inner Tie Rods..
TE63L.....(L.H. Side)\$59.50 ea.
TE63R.....(R.H. Side)\$59.50 ea.
EC372.....(Dust Cover).....\$3.25 ea.
- 1964-1970** All outer ends. Two per car.
TE640.....\$36.25 ea.
- 1964-1970** All inner tie rods. Two per car.
TE640I.....\$29.50 ea.
- 1971-1972** All outer ends. Two per car.
TE712.....\$29.50 ea.
- 1971-1972** All inner tie rods. Two per car.
TE712I.....\$39.50 ea.

Tie Rod Adjusting Sleeves



- 1961-1963** All. Two and four per car.
AS506.....\$14.50 ea.
- 1964-1970** All. Two per car.
AS647.....\$13.00 ea.
- 1971-1972** All. Two per car.
AS506.....\$14.50 ea.

Pitman Arms



- 1964-1972** All with manual steering.
PA642M.....\$83.25 ea.
- 1968-1972** All with power steering.
PA682.....\$83.25 ea.



Pitman Shaft Seal Kit (6.855)

- 1961-1972** All.
PSK577.....\$20.00 ea.

Front Suspension (Group 6)

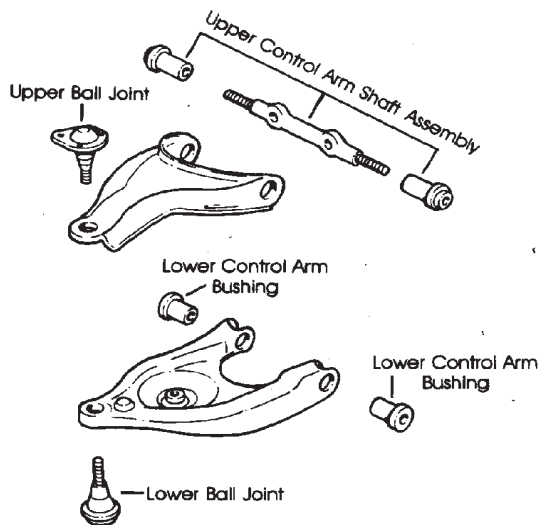

Ball Joints (6.169)

Lower

- 1961-1963 Screw in type.
- LBJ613S.....\$73.75 ea.
- 1961-1963 Press-in type.
- LBJ613P.....\$73.75 ea.
- 1964-1972
- LBJ644.....\$23.75 ea.

Upper (6.178)

- 1961-1962 All.
- UBJ612S.....\$59.50 ea.
- 1963 All.
- UBJ63.....\$49.50 ea.
- 1964-1972 All.
- UBJ642.....\$23.75 ea.

Front Stabilizer Bar Parts (7.240)

- 1961-1963 Stabilizer repair kit.
- SK615.....\$14.25 pr.
- 1964-1972 Stabilizer repair kit.
- SK373.....\$17.00 pr.
- 1967-1970 All. Stabilizer link bushing. (8 needed per car).
- SB376.....\$1.25 ea.

Grease Fittings

- All models as required.
- Sold in packs of 10.
- GF360S....(1/4" diameter)...\$7.75 pk.
- GF360B....(3/8" diameter)...\$8.75 pk.

Upper Control Arm Shaft Kits (6.178)



CARS#	YEARS	APPLICATION	PRICE
UI613S	1961-1963:	All.....	\$99.50 ea.
UI645S	1964-1965:	All.....	\$99.50 ea.
UI662S	1966-1972:	All.....	\$51.00 ea.
*UI642	1964-1972:	All.....	\$49.50 kit

*UI642 is a replacement kit referred to by the manufacturer as a "problem solver" that permits additional positive camber. This is particularly advantageous for cars with worn suspension. Includes shaft and bushings. Two kits needed per car.

Front Control Arm Bushings

Lower (6.169)

- 1961-1963 All Front. Lower Kit. 2 pair needed per car.
- LAB 613.....\$30.25 pr.
- 1964-1965: All Front and Rear Lower Kit. For one side.
- LAB645.....\$17.00 pr.
- 1966-1972 All Front Lower Kit. 2 pair needed per car.
- LAB662.....\$15.25 pr.

Upper (6.178)

- 1961-1963 All Front. Upper Kit. 2 pair needed per car.
- UAB613.....\$30.25 pr.
- 1964-1965 All Front. Upper Kit. 2 pair needed per car.
- BK645S.....\$39.50 pr.
- 1966-1972 All Front. Upper Kit. 2 pair needed per car.
- UAB662.....\$13.75 pr.

Control Arm Bumpers

- 1961-1972 Special Skylark, GS. Upper Control Arm Bumper. All except rally pack. Fits either side.
- UB612.....\$6.75 ea.
- 1961-1972 All lower.
- LB612.....\$9.75 ea.
- 1961-1962 Upper Control Arm Shaft support pin seals.
- SS376.....\$3.25 ea.

Stabilizer Bar To Frame Bushings (7.243)

- 1961-1963 All.
- SB593.....\$15.25 pr.
- 1964-1972 All with 15/16" bar or smaller.
- SB643.....\$11.75 pr.
- 1967-1972 All with 1" bar or larger.
- SB670.....\$8.50 pr.

(Group 7) **Frame • Springs**

Includes Bumpers, Guards and Body Mounts



Body Mount Kits (9.023)
Bushings between Body and Frame

- 1964-1967 All.**
BMK647.....\$99.75 ea.
1968-1972 All. 24 Piece Rubber & Steel Kit
BMK682B.....\$115.00 ea.

Bolt, Nut and Hardware Kits (9.008)

- 1964-1967 All**
BMH647.....\$25.25 ea.
1968-1972 All
BMH682.....\$25.25 ea.

Coil Springs
Available for All Years
Special / Skylark / GS
Replace Your Sagging, Tired Springs;
Correct Ride And Tension
Custom Engineered For Each Individual Application

1961-UP All Front.
CS350F.....\$195.00 ea.
1961-UP All Rear.
CS350R.....\$185.00 ea.

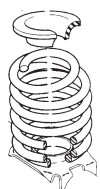

Coil Spring Insulators

(7.420) (7.545)

- 1961-1963 All. Upper Rear**
SI613.....\$69.79 pr.



Tubing and Wiring Clip

- All as required
FC1.....\$2.50 ea.



- 1964-1966 All. Upper Rear**
SI646.....\$22.25 pr.



- 1964-1972 All. Upper Front**
SI641.....\$23.00 pr.



- 1967-1972 All. Upper Rear**
SI655.....\$17.50 pr.



- Rear Spring Lower Retaining Clamp
1964-1966 All.
SC646.....\$17.50 ea.

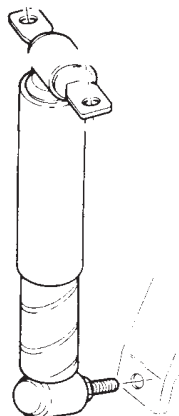

Shock Absorbers

YEARS	GAS SHOCKS
<u>Front</u>	
1961-1963:	FS170G.....\$93.50 pr.
1964-1967:	FS110G.....\$69.50 pr.
1968-1972:	FS198G.....\$69.50 pr.
<u>Rear</u>	
1961-1963:	RS171G.....\$89.50 pr.
1964-1969:Sportwagon.....	RS223G.....\$93.50 pr.
1964-1972:All Except Sportwagon.....	RS199G.....\$72.50 pr.
Also Available	
AS540 1961-1972:	Rear Air Shock System Kit.....\$169.58 Set
CS540 1961-1972:	Rear Coil Booster Shocks.....\$149.00 Set

Frame • Springs (Group 7)

Includes Bumpers, Guards and Body Mounts

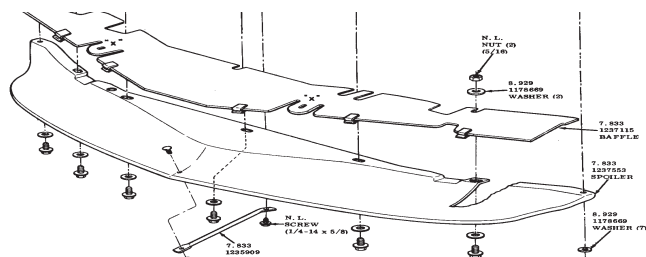

1970-1972 Front Spoiler

Excellent reproduction of the original.
Vacuum formed for superior strength.

- FS702.....(Spoiler)\$158.50 ea.
- SB70.....(1970 Baffle)\$51.00 ea.
- SB712.....(1971-1972 Baffle).....\$62.50 ea.
- FSB702.....(Spoiler Brace)\$36.75 ea.
- FSBK702.....(Spoiler Bolt Kit)\$9.00 ea.

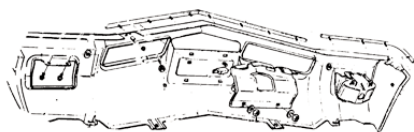

1972 Front Bumper Cushion

A beautiful reproduction of the original. Complete with mounting studs, show quality, and ready to install.

- BC72L.....(left side only)\$76.25 ea.
- BC72R.....(right side only)\$76.25 ea.
- BC72C.....(center only).....\$81.75 ea.
- BC72S.....(complete set of three).....\$188.75 ea.

Bumper Fillers

Rubber Filler "Caps" between end of bumper and fender:

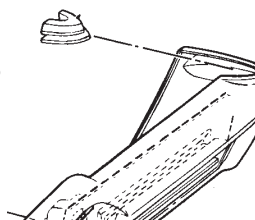

FRONT

- FF65 1965\$29.50 pr.
- FF67 1967 Three per car needed.....\$6.00 ea.
- FF689 1968-1969 Left and Right (Pair Outer) ..\$22.00 pr.
- FF70 1970 Left and Right.....\$22.50 pr.
- FF712 1971-1972 Left and Right (Pair).....\$22.25 pr.
- FF689I 1968-1969 Left and Right (Pair inner) ...\$16.75 pr.

REAR

- RF689 1968-1969 Left and Right (Pair)\$22.00 pr.
- RF70 1970\$22.75 pr.
- RF712 1971-1972 Left and Right (Pair).....\$19.50 pr.
- RF66 1966 Rear - Left and Right.....\$24.25 pr.
- RF67 1967 Rear - Left and Right.....\$18.50 pr.

Bumper Bolts (7.859)

Z1961-1963 All. 3/8" x 1".

- BB616.....\$2.50 ea.

1964-1972 Bumper bolt. 7/16" - 16 x 7/8".

- BB643.....Round Head.....\$2.50 ea.
- BB643F.....Flat Head.....\$2.50 ea.



BB643 BB643F

License Plate Area Parts

1961-1972 All License plate bolt kit.

(two nuts).

- LB300.....\$2.50 kit



1961-1962 All License rubber bumper.

- LB613.....\$6.99 ea.



1963-1972 All License rubber bumper.

- LB552.....\$2.75 pr.



1961-1975 License plate nuts. Correct round head white nylon fits into 5/16" square hole.

- LN642.....\$1.25 ea.



1961-1999 License plate nuts. Nylon fits into 3/8" square hole.

- LN600.....\$1.25 ea.



1961-1999 License plate screw for above nylon nuts.

- S8.....\$.75 ea.



1972 Rear Bumper Guard Cushion

"U" shaped around license plate.

- BGC72R.....\$139.50 ea.



1970 Rear Bumper Filler Rubber Strip Between Body & Bumper

- BF70.....\$26.50 ea.

Chassis Paint



All Years: Satin Black paint: This is the correct enamel for frame and engine compartment, and is authentic for all years;

EP2\$24.50 qt.
EP2S.....(12 oz. spray can).....\$14.00 ea.

"Miracle Paint" Tough stuff!



Hirsch brand, works very well as tested by our personnel. Bonds to rust, will not crack chip or peel. Impervious to gasoline, thinner, salt. Can be applied by brush or spray.

MP300B.....Black (quart)\$35.00 ea.
MP300S.....Silver (quart)\$35.00 ea.
MP300C.....Clear (quart)\$35.00 ea.
MP300BG.....Black (gallon)\$101.00 ea.
MP300SG.....Silver (gallon)\$101.00 ea.
MP300CG.....Clear (gallon)\$101.00 ea.

All Years: Universal gloss black:

(Excellent for chassis and general use).
EP1\$20.50 qt.



Front Anti-Sway Bars (7.241)

1964-1972 All with 1 1/8" Front sway bar.
SB642F\$149.50 ea.
1964-1972 All with 1 1/4" Front sway bar.
SB642FB.....\$158.00 ea.

Look For Us!

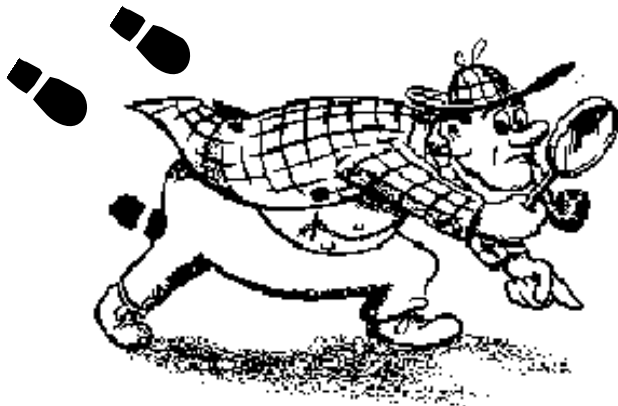

1972 Rear Tail Lamp Cushions



An excellent reproduction of the Rubber tail lamp cushions used on 1972 Skylark and GS models. (7.831)

TLC72L.....(Left Side).....\$180.00 ea.
TLC72R.....(Right Side).....\$180.00 ea.
TLC72.....(Both Sides).....\$350.00 pr.

1970 & 1972 Rear Bumper Name Plate



1970. Top quality reproduction with raised letters on satin black background as original.

BE70\$189.00 ea.



1972. Beautiful reproduction of the brush chrome plated monogram in the center of the rear bumper. (7.831)

BE72\$57.50 ea.



Gas Door

1968-1970 All except wagons. Includes spring.
GD680\$43.75 ea.

If your thinking of attending any of the shows listed below, be sure to stop by and say "Hello". We will be glad to show you some of our newest items or simply talk about your **BUICK**.

Plan ahead by calling-in your order several weeks ahead of time. We will be able to bring your entire order and save you shipping too.

GS Nationals
Buick Nationals
**Hershey* *GDB 31-34*

Hood • Front Fenders (Group 8)

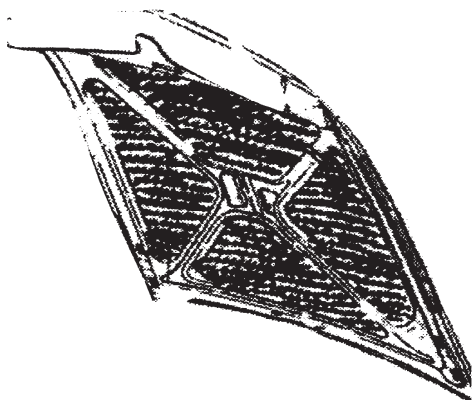

Hood Insulation Kits (Die Cut) 8.021

- 1961-1962 All. Pre-cut, ready to install.
 HI612\$35.00 ea.
 1964-1967 All. 5 piece kit. Pre-cut, ready to install.
 HI647\$35.00 ea.
 1968-1972 All. 5 piece kit. Pre-cut, ready to install.
 HI682\$35.00 ea.

Spray Adhesive for Application of Hood Insulation

- SA360.....(20 oz).....\$18.00 ea.



Hood Bumpers

-  **1961-1972** Adjustable front hood rubber bumper with stainless steel stud.
 HA585.....\$5.75 ea.
 HS585...Stud only. Stainless Steel...\$4.75 ea.
-  Retaining nut for above.
 BN650.....\$6.50 ea.
-  **1961-1972** Front hood rubber bumper cap.
 HB595.....\$2.75 ea.
-  **1961-1962** All. Hood to fender bumper. 4 per car.
 HFB612S\$3.50 ea.
-  **1963-1968** All. Hood to fender bumper. 5/8" wide.
 HFB610\$3.00 ea.
-  **1969-1972** All. Hood to fender bumper. 1 1/4" wide.
 HFB611\$3.00 ea.
-  **1963** All. Special and Skylark. Hood to fender bumper.
 HFB63\$7.49 ea.
-  **1968-1972** All. Hood to cowl bumper.
 HB682.....\$2.25 ea.

Hood Emblems, Letters, Parts

GS Hood Vent Grills



- Die cast chrome as original.
 1970 and 1972 All. Will also fit 1971.
 HG702\$179.00 pr.

Hood Insert Bezels



- 1970-1972
 HB702.....\$139.00 pr.



- 1970 GS. Front hood moulding. Die cast chrome.
 HM70GS\$296.00 ea.

BUICK

- 1964-1965** Hood letters. "BUICK".
 HL645\$79.50 set
1967 All. Hood letters. "BUICK".
 HL67\$69.50 set

-  **1969** GS "400" emblem. Fits either side.
 HE400\$77.50 pr.

-  **1969** GS "350" emblem. Fits either side.
 HE350.....\$39.75 ea.
 HE350P.....(Matched pair).....\$75.75 pr.

- 1969** GS "Stage 1" hood emblem. Fits either side.
 HE69S1\$29.50 ea.
 HE69S1P.....(Matched pair).....\$55.00 pr.



- 1972** Tri-Shield in chrome circle
 HE72\$124.50 ea.

Hood Release Handle

- 1970-1972 All.
 HH702.....\$15.50 ea.

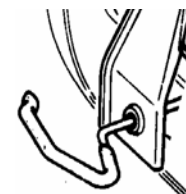

Front Inner Fender Repair Panel



1970-1972 all. Replaces the usually rusted area on the battery side, inner fender.
BP702.....\$145.00 ea.

Fender Splash Aprons



1961-1962 Front inner fender.
FA612\$16.50 set

1964-1965 Front inner fender.
FA645\$16.00 set

1966-1967 Front inner fender.
FA667\$17.50 set



1968-1972 Inner fender.
Includes staples as original.
FA682.....\$17.00 set

Fender Apron Clips

1963-66 All as required.

FSC636.....\$2.25 ea.
FSC636S.....(Set of 15).....\$33.50 ea.



Make Your Own Fender Splash Aprons

Correct composition rubber material is excellent for duplication using your old aprons as a pattern.

MR4812.....(48" x 12").....\$40.75 ea.
MR4824.....(48" x 24").....\$81.50 ea.
MR4836.....(48" x 36").....\$112.25 ea.
MR4848.....(48" x 48").....\$163.00 ea.
MR4860.....(48" x 60").....\$203.75 ea.

Rocker Panel Mouldings (8.304)

1970-1972 All models as required. Sold in pairs. Hardware included.

RM702.....Without Stripes.....\$209.00 pr.
RM702R.....Red Stripes.....\$299.00 pr.
PS1.....Red Pin Stripping Kit.....\$10.00 ea.
PS2.....Black Pin Stripping Kit.....\$10.00 ea.

Rocker Panel Moulding Clips (8.304)

Round discs for retaining mouldings.
Use for any hanging moulding.



MC99\$1.50 ea.
MC99S.....(Pack of 25).....\$36.00 ea.

Front Fender Nameplates



1965 "Special" Front Fender Emblem.
DM64S.....\$36.50 ea.



1965 Skylark Fender Emblem.
FE65B.....\$58.00 set.



1965 "Special" on Front Fender.
FM645S\$36.50 ea.

1968-1972 "GS" Fender monogram. Please note: Mounting studs may be slightly different from some earlier models.
FM682G.....\$25.00 ea.



1970-1972 "Buick Motor Division" Plate.
FM702BMD.....\$24.00 ea.



1970-1972 "455" Plate.
FM455.....\$25.25 ea.



1970-1972 "Stage 1" monogram. Please note: mounting studs are 5 1/4" apart exactly like originals.
FM702.....\$49.50 ea.
FM704.....(replacement pins are 2" apart).....\$46.50 ea.



1970-1972 "Stage 2" monogram.
FM705.....\$49.50 ea.

1969 Skylark Front Fender Louvers

FO69L.....(L.H. side).....\$39.50 ea.
FO69R.....(R.H. side).....\$39.50 ea.



Heater • Air Conditioning • Firewall • Radio • Antenna (Group 9)

Firewall/Cowl Seals and Parts



1964-1967 All. Hood to cowl rubber seal.
CS647\$17.00 ea.



1964-1967 All. cowl grill side seals.
Necessary to keep water out of interior
of car. Don't overlook these. (12.800)
CS647S.....\$9.50 pr.



1968-1972 All. Hood to cowl rubber sealing
strip.
CS682.....\$14.25 ea.



1968-1972 All. Cowl vent screen. Die cut,
dipped and powder coated.
CS682A.....\$30.25 ea.



1968-1972 All. cowl vent screen "H"
Retainers. 5 per car.
CSR682.....\$4.00 ea.
CSR682S.....(set of 5)\$17.00
set.



1968-1972 Hood lace and cowl lace.
Plastic retainer.
LR685.....\$1.00 ea.

Firewall Insulator Pads

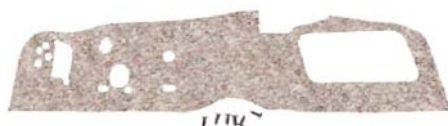

1964-1967 Firewall insulation pad (15.280).
FP647\$39.50 ea.

1968-1972 Firewall insulation pad. For cars w/o a.c.
FP682\$29.50 ea.

1968-1972 Firewall insulation pad. For cars with a.c.
FP682AC\$38.50 ea.

Firewall insulator retainers.

1968 thru 1972 all as required.
IR500.....\$1.75 ea.



1961-1967 firewall grommet for heater
blower wire. Cars w/o a.c.
FWG577\$7.75 ea.



1968-1972 Center firewall grommet. 3 holes
for ac cars.
FWG682A.....\$12.00 ea.

Dash Rallye Pack Gauges

New reproduction includes fuel, temp and oil gauges. This
quality made item fits all 1970 -1972 models. Comes with flat
or convex lens and instructions. Fully tested and calibrated.

RP702.....(Convex Lens).....\$236.50 ea.
RP702F.....(Flat Lens).....\$236.50 ea.



Dash Tachometers (9.750)

T702F.....(Flat Lens).....\$196.50 ea.
T702C.....(Convex Lens).....\$196.50 ea.



Hood Tachometers

T702H...(Lit numbers and pointer)....\$228.50 ea.
WH702T...(wiring harness for above)..\$33.50 ea.

Dash Instrument Lenses

1970 all late;
1971-1972 All. Flat lens.
DL702F\$18.00 ea.

Antenna Chrome Bases (9.618)



1964-1965 All with manual antenna.
AB645.....\$24.50 ea.



1964-1965 All w/ manual antenna.
AN645.....\$16.50 ea.



1966-1967 All w/ manual antenna.
AN667.....\$16.50 ea.

Antenna Lead

1970-1972 Antenna lead in for windshield antennas.
AL708\$20.00 ea.

Radio Bezels



1968-1972 All. Chrome plated so it is correct as is for 1970-
1972 models. 1968-1969 were painted silver so you can
paint or leave as is. Does not come with woodgrain.
RP682.....\$68.50 ea.



1970-1972 All. Plastic Dash Bezel.
DB702.....\$367.50 ea.

(Group 9) **Heater • Air Conditioning**



Heater Blower Motor
 1964-1972 All.
 HBM646\$39.75 ea.



Heater Blower Resistor
 1968-1972 Buick Special, Skylark, GS.
 All Without A/C.
 HBR680\$18.00 ea.



Heater Control Valve
 1965-1972 Heater control valve.
 1965 All;
 1966 All with A.C.;
 1969-1972 All A.C.
 HV652\$41.00 ea.

Heater Control Valve Insulator

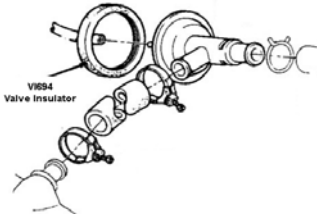

1969-1974 All with A.C.
 V1694\$17.00 ea.

Heater Control Valve Repair

1961-1963 Ranco type. 9.795
 HV420\$153.50 ea.



Heater Cores
 1964-1967 all w/o A.C.
 HC644\$90.25 ea.
 1964-1967 All with A.C.
 HC647A\$96.00 ea.
 1968 thru 1972 all w/o A.C.
 HC682\$79.50 ea.
 1968-1972 all with A.C.
 HC682A\$48.50 ea.

Compressor with Clutch Remanufactured by Delco

1964-1977 All 6cyl type as pictured.
 Delco remanuf.
 AC627 Single pulley\$349.00 ea.
 AC627D Dual pulley\$391.00 ea.



A.C. Evaporator Thermo Expansion Valve

1965-1972 A.C. evaporator thermo expansion valve. (POA)
 EV653\$29.50 ea.



A.C. Refrigerant for R-12 and 134-a



6 oz. standard can. Includes red dye for leak detection. A drop-in replacement for CFC-12 and HFC-134a. No system evacuation needed. Up to 30% more efficient than CFC-12 and far more efficient than HFC-134a.
 ACR360\$10.00 ea.



1971-1977 A.C. Compressor thermal limiter switch.
 TL717\$11.75 ea.

Air Conditioning Blower Relay

1969-1972 All.
 ACR656\$22.25 ea.



GOING TO THE SHOWS?
 Free delivery to:
Buick Nationals
GS Nationals
Hershey
CALL WELL IN ADVANCE.



908-369-3666

Windshield (Group 10)

Windshields

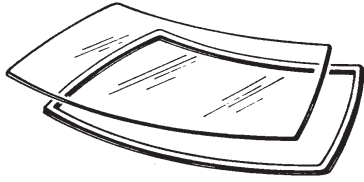

1970-1972 Skylark and GS Convertibles.

- WS702CC.....(Clear w/o antenna).....\$189.00 ea.
- WS702CT.....(Tinted w/o antenna).....\$189.00 ea.
- WS702CTA.....(Tinted w/o antenna).....\$189.00 ea.

Windshield Gaskets and Seals

1961-1963

1961-1962: Special and Skylark;

1963: All Special and Skylark convertibles.

- WS613.....\$161.49 ea.

1961-1972 All "Gasketless" windshield and rear glass.

Glass setting tape. Provides instant and tight seal.

- GS600.....\$12.75 ea.

Butyl dam tape. For use with complete cut-out jobs.

- GS601.....\$12.75 ea.

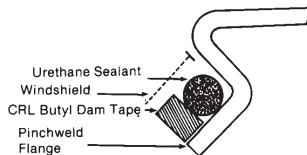

Windshield Reveal Moulding Sets

1964-1965 All Special, Skylark and GS;

1966-1967 Special and Skylark 4-door models. 5 piece kit.

- WRM647S\$167.75 set

1968-1972 Skylark and GS 2 door hardtop models. 3 piece set.

- WRM682S\$129.50 set

1968-1972 Skylark and GS 2 door convertible. 3 piece set.

- WRM682C\$209.00 set

Windshield Clip Kits

1968-1972 all 2-dr. and 4 dr. Hardtop, convertibles and wagons.

22 piece kit.

- WCK682A\$11.75 ea

Windshield Wiper Switch 1965 Skylark

1965 Skylark

All Single Speed Wipers with Washers.

- WS65S.....\$39.50 ea.



Wiper Blades and Refills



1963-1967 All. 15" Replacement blades with inserts.

- WB15.....\$16.50 ea.



1968-1972 all with 16" center pin mounts. Wiper blade.

- WB16.....\$19.50 pr.

1968-1972 Refills 16".

- WBR16\$15.00 pr.

1968-1972 16" Blade w/ pin mounting.

- WB16\$19.50 ea.

Windshield Wiper Motors



1964-1967 All with 2-speed wipers.

- WM647.....\$119.50 ea.

1968-1972 All with hidden wipers.

(Depressed park)

- WM682D.....Delco rebuilt.....\$449.50

Wiper Motor Mounting Kit

1961-1972 All. Includes correct "sems" screws.

- WMK590.....\$14.25 kit



Washer Pumps and Repair Kits

Washer Pump

1963-1968 all 2 and 3 speed;

1968-1972 all w/o depressed park.

- WP634.....\$58.00 ea.

1968-1972 All with depressed park

(hidden) wipers.

- WP683.....\$59.50 ea.



1961-1972 Repair Kit

1961-1968: All with straight hose fittings;

1969-1972: All with depressed wipers.

- WRK614.....\$12.25 ea.

1961-1972 Repair Kit

1961-1967: All with 90 angled hose fittings;

1968-1972: All without depressed wipers.

- WRK594\$12.25 ea.

Windshield Washer Jars



1964-1966. Includes cap.
1964-1965: Special and Skylark;
1966: All first type.
WJ646.....\$44.75 ea.

1968-1970. Has tabs that screw to fender well.
WJ680\$46.25 ea.



Cap for Above Jar
WJC680.....\$4.50 ea.

WH680.....\$18.50 ea.
(Hose for above w/ yellow stripe).



1966 All 2nd type;
1967-1972 All. Type used in bracket.
WJ632\$14.00 ea.



WJC632.....(Cap for above jar)...\$4.50 ea.



WJB632.....(Bracket for jar)\$15.00 ea.

Washer Jar Filter

1961-1972 Washer jar filter.
WF598.....\$4.75 ea.



Windshield Wiper Hose

1961-1975 Windshield wiper hose. (7/64").
VH764.....\$1.50 per foot
1961-1975 Windshield wiper hose. (5/32").
VH532.....\$1.50 per foot
1961-1975 Windshield wiper hose. (7/32").
VH732.....\$1.50 per foot
1961-1975 Windshield wiper hose. (1/4").
VH14.....\$1.50 per foot

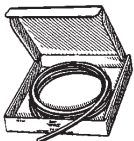

****We have a limited supply of
NOS 1/4" vacuum hose. It features correct outside diameter and "draw" lines for that authentic look.***
VH14OEM.....\$3.50 ft.

Windshield Washer Nozzles



1968-1972 All.
WN682.....\$28.50 pr.

Optikleen Bottles and Caps



1961-1968 all. Bottle assembly. Includes Stainless steel bracket and cap.
OB598.....\$36.50 ea.

1961-1968 All. Includes stenciled writing.
OC598.....(Cap Only).....\$6.75 ea.

1961-1968 Optikleen bottle label for above.
D46.....\$3.75 ea.

1961-1968 Optikleen bottle cap label.
D107.....\$4.00 ea.



Backglass Clip Kits

1968-1972 all 2-dr., 4 dr. Hardtops and sedans. 18 piece kit.

BCK682A.....\$13.25 ea.
For other models see hardware section.



Inside Rear View Mirrors (10.185)



1961-1962 10" wide mirror.
IM572\$79.50 ea.



1963-1972 10" wide mirror.
Stainless steel backed, day-nite with gray rubber bumper.
IM692\$46.00 ea.



1963-1977 12" wide mirror.
Stainless steel backed, day-nite with gray rubber bumper.
IM694\$59.00 ea.

Inside Rear View Mirror Support

1964 Buick Special, Skylark.
1965-1966 Special, Skylark, GS.
All Except Convertibles
MS646.....\$38.50 ea.



1967 Buick Special, Skylark, GS.
All Except Convertibles.
MS67.....\$38.50 ea.



Dash • Interior • Sunvisors (Group 10)

Sunvisor Supports (10.219)



1961-1963 All, except convertibles.

VS613\$49.50 pr.



1964-1972 All, except convertibles.

VS642\$19.75 ea.

Convertible Sunvisor Supports (10.219)



1964-1965 All convertibles. Diecast, very strong, nicely plated.

VS645C\$65.75 pr.

1966-1967 All convertibles. Diecast, very strong, nicely plated.

VS667C\$65.75 pr.



1968 thru 1972 All. Diecast, high strength. Identical to oem.

VS682C\$59.50 pr.

Sunshade Rest Grommet



1963-1972 All as required.

SG632\$5.75 pr.

Sunshade Sleeve



1965-1972 All.

SS642\$5.75 pr.

1968 -1972 Interior Pillar Garnish

Part numbers listed below are for black. For colors, add \$10 with trim code.

PG689.....1968-1969 2 dr. HT.....\$70.25 set

PG689S.....1968-1969 Sedans.....\$70.25 set

PG682C..1968-1972 Convertibles....\$89.75 set



Glove Box Inserts



1961-1963 All w/o ac.

GB613\$24.25 ea.

1964-1965 All.

GB645\$18.50 ea.

1966-1967 All.

GB667\$18.50 ea.

1968-1969 All without A.C.

GB689\$18.50 ea.

1968-1969 All with A.C.

GB689A\$18.50 ea.

1970-1972 All without A.C.

GB702\$29.50 ea.

1970-1972 All with A.C.

GB702A\$29.50 ea.

Glove Box Locks with Two Original Keys (10.266)



1961-1963 Original.

GBL546\$27.75 set

1961-1963 Late style.

GBL613\$25.25 set

*1964 Original.

GBL64\$24.75 set

*1964 Late style.

GBL64L\$21.75 set

1965-1967 Original.

GBL415\$29.25 set

1965-1967 Late style.

GBL657L\$17.00 set

1968 Original.

GBL68\$32.75 set

1968-1972 Late style.

GBL684\$28.25 ea.

CASE NOT INCLUDED

1961-1963 Odometer reset knob.

RK425\$3.75 ea.



Glove Box Light Switch

1964-1972 Special, Skylark, GS. Includes light bulb and new terminal.

GBS644\$14.00

Woodgrain Dash Kits (10.252)

Beautiful woodgrain replaces worn cracked or faded inserts. Precision die cut. Self adhesive backing for easy installation. Our kits are manufactured as original so when dash lights are turned on letters are backlit.



1970-1972 Wood grain dash kit.. For non-AC cars.
DK702.....\$59.50 ea.



1970-1972 Dash wood grain kit. For AC cars.
DK702A\$59.50 ea.

1970-1972 Black dash kit. For non AC cars.
DK702B\$69.00 ea.

1970-1972 Black dash kit. For AC cars.
DK702BA.....\$69.00 ea.



1970-1972 Console woodgrain kit only.
CK702.....\$29.75 ea.

Cigarette Lighter

Show quality with correct black insert.

1970-1972 Skylark, GS, GSX.

CL702.....\$28.75 ea.



Console Parts Lids

1965-1972 Console lid. For Short console with padded lid that has emblem installed. Black or white or paint to match.

CL652B.....(Black)\$149.00 ea.
CL652W.....(White).....\$149.00 ea.



1968-1969 Console lid. Black or paint to match. For cars with long console.

CL689A\$40.25 ea.



Console Lid Emblem

1965-1972 Tri shield emblem for short padded lid.

CE652.....\$39.00 ea.



Console Lid Chrome Trim Plate

1970-1972 Console lid chrome trim plate. Located under lid. For cars with long console.

CLP705.....\$59.50 ea.



Console Locks

1965-1967 All.

GBL657L.....\$17.00 ea.



Shift Handle Lever Chrome Trim Plate

1970 thru 1972 all with long console.

SL705.....\$28.25 ea.

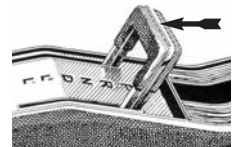

Dash Monograms

1966 "Skylark" with bird.

DM66S.....\$26.50 ea.



1966 "GS" Dash emblem.

DE66GS\$24.00 ea.



1967 "GS 400".

DM67400.....\$33.50 ea.

Interior • Weatherstripping (Group 10)



Roof Rail Weatherstrip

RR623	1962-1963	All 2-Door Hardtops ...\$166.39 pr.
RR645	1964-1965	All 2-Door Hardtops.....\$58.00 pr.
RR667	1966-1967	All 2-Door Hardtops.....\$58.00 pr.
RR667H	1966-1967	All 4-Door Hardtops.....\$79.50 pr.
RR68	1968	All 2-Door Hardtops.....\$58.00 pr.
RR689H	1968-1969	All 4-Door Hardtops...\$240.29 pr.
RR692	1969-1972	All 2-Door Hardtops.....\$58.00 pr.
RR702H	1970-1972	All 4-Door Hardtops...\$210.19 pr.



Roof Rail Window Guides

1969-1972 All two and four door Hardtops.
WG692\$15.00 pr.



1964-1972 Package Shelves (15.024)

This is the Cardboard or Mesh covered area behind the rear seats. Exact Reproduction, Die Cut for Perfect Fit / Easy Installation Replaces Sun Faded or Cracked Shelf. Available in All Colors. Finished in Cardboard or Quality Cloth Mesh. Please State Mesh or Cardboard, and Color.

<u>CARS#</u>	<u>YEARS</u>	<u>TYPE</u>	<u>PRICE</u>
PS645M	1964-1965	2 dr. HT.....MESH.....	\$53.00
PS645C	1964-1965	2 dr. HT.....Cardboard	\$30.75
PS645MS	1964-1965	2 & 4 dr Sedans...MESH.....	\$53.00
PS645CS	1964-1965	2 & 4 dr Sedans...Cardboard ..	\$30.75
PS667M	1966-1967	2 dr. HT.....MESH.....	\$53.00
PS667C	1966-1967	2 dr. HT.....Cardboard	\$30.75
PS667CH	1966-1967	4 dr. HT.....Cardboard	\$30.75
PS667MH	1966-1967	4 dr. HT.....MESH.....	\$53.00
PS667CS	1966-1967	4 dr. Sedans.....Cardboard.....	\$29.95
PS667MS	1966-1967	4 dr. Sedans.....MESH.....	\$53.00
PS682M	1968-1972	Skylark 2 dr. HT MESH.....	\$53.00
PS692M	1969-1972	GS 2 dr. HT.....MESH	\$53.00
PS682C	1968-1972	Skylark 2 dr. HT.Cardboard ...	\$33.50
PS692C	1969-1972	GS2 dr. HT..... Cardboard.....	\$33.50

Package Shelf Jute Underpadding

PJ645A	1964-1965	All	\$10.75
PJ667A	1966-1967	All 2-dr. Hardtop	\$10.75
PJ667AH	1966-1967	All 4-dr. Hardtop	\$14.25
PJ667AS	1966-1967	All 4-dr. Sedans	\$14.25
PJ682A	1968-1972	Skylark	\$10.75
PJ692GS	1969-1972	GS	\$10.75

Rear Glass Moulded Seals

1961-1963	Special 2-door. Model 4027.
BS613\$172.50 ea.
1961-1963	4-door Sedans. Model 4119.
BS613A\$203.19 ea.
1961-1963	Skylark 2-door hardtops.
BS613B\$155.99 ea.

Glass Setting Tape

All "Gasketless" windshield and rear glass.
Provides instant and tight seal. 3/8" round x 15'.
GS600.....\$12.75 ea.

Butyl dam tape. For use with complete window replacement.
1/4" x 3/8" square x 15'.
GS601.....\$12.75 ea.

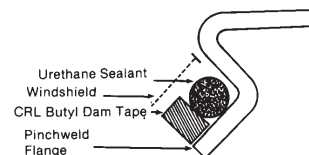

www.oldbuickparts.com
908-369-3666

Outside Rear View Mirror



1961-1967 Non-Remote reproduction fits either side. Identical to the original. Licensed by GM. Includes bracket and hardware. One of our most beautiful reproductions.

MK617F.....(1961 thru 1963 Models).....\$97.50 ea.
 MK617R.....(1964 thru 1967 Models).....\$97.50 ea.

Gasket Only. Will also fit original non-remote mirrors.

MG617F.....(1961 thru 1963 Models).....\$9.75 ea.
 MG617R.....(1964 thru 1967 Models).....\$9.75 ea.

Bracket Kit. Contains metal bracket and screws.
 Fits either side.

MB617\$9.75 ea.
 MS617.....bracket screw\$.65 ea.
 AUV1863.....chrome mirror screw\$1.00 ea.
 Gasket for original Remote Mirror.
 MG617RC.....\$9.75 ea.



1968-1969 All. Non-Remote
 Reproduction Right Side Only. Includes
 gasket and hardware.
 MK689RK.....\$149.00 ea.
Mirror Gasket
 MG689R.....\$10.00 ea.

1968-1969 All. Fits LH side non-remote
 chrome.
 MK689LK.....\$139.00 ea.



1968-1969 All. Fits LH side remote w/
 cable chrome.
 MK689LRK.....\$239.00 ea.



1970 All. Chrome LH remote w/
 tri-shield.
 MK70LR.....\$239.00 ea.

1970 All.
1971-1982 Sky, GS Chrome LH
 side remote.
 MK702LR.....\$229.00 ea.



1970-1972 Sport Mirror Gasket



MG702SL.....(Left Side).....\$4.00 ea.
 MG702SR.....(Right Side).....\$4.00 ea.

1970-1972 Sport Mirror Bracket

MB702SL.....(Left Side)\$14.00 ea.
 MB702SR.....(Right Side)\$14.00 ea.

**Door Lock Pairs
 with Two Keys**



1961 Original style keys.
 DLS608\$39.50 set
1961 Late style keys.
 DLS61\$39.50 set
1962-1966 Original style keys.
 DLS596\$39.50 set
1962-1966 Late style keys.
 DLS683\$24.50 set
1967-1968 Original style keys.
 DLS678\$34.50 set
1967-1968 Late style keys.
 DLS683\$24.50 set
1969-1972 Late style keys.
 DLS683\$11.00 set

Exterior Door Parts (Group 10)



(10.470)

1966-1972 Door Hinges

Our Door Hinges are made from factory blueprints for exact fit and function. They come completely assembled, ready to install.

1964-1965 All

H645LL.....(Lower Left Side).....	\$58.00 ea.
H645LR.....(Lower Right Side).....	\$58.00 ea.
H645U.....(Either Side Upper).....	\$63.50 ea.
H645K.....(Complete Set of 4 Kit).....	\$229.50 ea.

1966-1967 All

H667LL.....(Lower Left Side).....	\$44.75 ea.
H667LR.....(Lower Right Side).....	\$44.75 ea.
H667U.....(Either Side Upper).....	\$44.75 ea.
H667K.....(Complete Set of 4 Kit).....	\$216.50 ea.

1968-1972 All

H682LL.....(Lower Left Side).....	\$58.00 ea.
H682LR.....(Lower Right Side).....	\$58.00 ea.
H682U.....(Either Side Upper).....	\$53.00 ea.
H682K.....(Complete Set of 4 Kit).....	\$216.50 ea.

Door Hinge Bolt Kits

1964-1965 All upper. For 2 hinges

1964-1967 All lower. For 2 hinges.

6 screws, 6 bolts

HH647\$14.25 set

1968-1972

HBK682.....(Complete 24 piece kit).....\$25.25 ea.



Door Hinge Springs

1965-1967 All.

HS657\$9.25 ea.



Door Hinge Repair Kits

Kit will fix two doors and includes 4 hardened shouldered pivot pins and 8 sintered bronze bushings.

1964-1967 All.

DHK647\$30.75 set

1968-1972 All.

DHK682\$20.50 set



Door Hinge Detent Repair Kits



1965-1967 All.

DRP667\$40.75 set

1968-1972 All.

DRP682\$43.25 set



Handle Gasket Sets

1963-1972 Outside Door Handles

1964-1967 All front and rear. Both sides, includes buttons and springs.

DH640S.....(Both Sides).\$ 58.00 set

Door Handle Gasket Set for above handles

HG640\$3.50 set

1968-1969 All models-front or rear. Includes buttons with springs, hardware and gaskets. Left and right hand kit.

DH689S\$58.00 set



1963 All;

1970-1972 All models-front or rear.

Includes buttons with springs, hardware and gaskets. Left and right hand kit.

DH635S\$58.00 set

Door handle gasket set for above handles

HG590\$6.00 set

Door Handle Pushbutton Kit

Includes 2 each: Pushbuttons, Rubber "O"-Rings, Springs, and Retainers.

Note: The Shafts Must Be Trimmed to Length.

1963-1972 All.

HB642\$18.50 pr.

Door Handle Gasket Set

1961-1962 All.

HG612S.....\$17.39 pr.

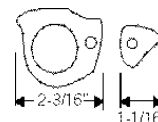

Door Lock Gasket

1961-1972 All.

KLG540\$1.25 ea.

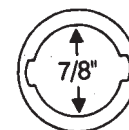

Door Lock Striker

1964-1972 All.

DS645\$12.00 ea.



Door Handle Bolts

1964-1972 All

DHB642.....\$8.25 set



Door Weatherstrip Sets

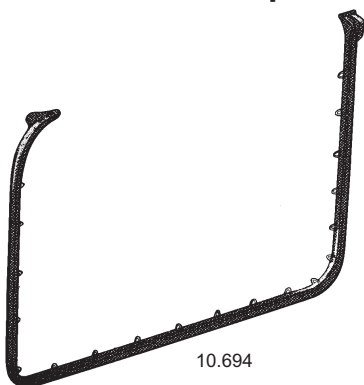

10.694

Our Door Weather-strip-ping is of the Highest Quality, Manufactured to be Identical to the Original. Each Strip Comes With Pre-Inserted Pins and Correctly Fastened Moulded Ends for Authentic Look and Long Lasting Function. SOLD in PAIRS

- DWS613F **1961-1963** Special and Deluxe 4 door Models, Front.....\$169.49 pr.
- DWS613R **1961-1963** Special and Deluxe 4 door Models, Rear.....\$209.49 pr.
- DWS613S **1961-1963** All 2 door Sedans.....\$167.99 pr.
- DWS623 **1962-1963** All 2-dr. HT & Convertible. . \$196.69 pr.
- DWS645 **1964-1965** All 2 Dr. HT & Convertible....\$58.00 pr.
- DWS645P **1964-1965** 2-Dr. Sedans.....\$58.00 pr.
- DWS647 **1964-1967** 4 Door Sedans and Wagons. Front Doors.....\$58.00 pr.
- DWS647B **1964-1967** 4 Door Sedans .Rear Doors.\$58.00 pr.
- DWS647C **1964-1965** All Wagons .Rear Doors; **1966-1967** Special Wagon Rear doors. \$58.00 pr.
- DWS667S **1966-1967** Skylark Wagon. Rear doors.\$58.00 pr.
- DWS667 **1966-1967** 2-dr Hardtop & Convertible. \$58.00 pr.
- DWS667H **1966-1967** 4 Door Hardtop. Front.....\$77.25 pr.
- DWS667R **1966-1967** 4 Door Hardtop. Rear.....\$77.25 pr.
- DWS667P **1966-1967** 2 Door Sedan.....\$58.00 pr.
- DWS68 **1968** 2 Dr. H.T. & Convert.....\$58.00 pr.
- DWS692 **1969-1972** 2-dr Hardtop & Convertible. ..\$58.00 pr.
- DWS682P **1968-1972** 2 Door Sedans.....\$58.00 pr.
- DWS682H **1968-1972** 4-door hardtop. Front.....\$214.69 pr.
- DWS689R **1968-1969** 4-door hardtop. Rear.....\$203.79 pr.
- DWS702R **1970-1972** 4-door hardtop. Rear.....\$173.99 pr.
- DWS682A **1968-1972** 4-dr Sedans & Wagons, front. ..\$58.00 pr.
- DWS682B **1968-1972** 4-dr Sedans & Wagons, rear.\$58.00 pr.

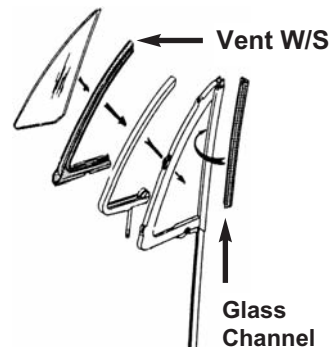

Front Vent Window Weatherstrip

Our Weatherstrips are Pre-Moulded for Correct Fit

- VW613S **1961-1963** All Exc. Convert.....\$159.49 pr.
- VW623S **1962-1963** Convertibles.....\$159.49 pr.
- VW645 **1964-1965** All 2-Door HT & Conv....\$156.89 pr.
- VW647 **1964-1967** All 2 and 4 door Sedans; **1966-1967** all 4 dr. Sedans\$97.50 pr.
- VW667 **1966-67** All 2- Door HT & Convert. ...\$68.00 pr.
- VW68 **1968** All 2-door Hardtop & Convert. ..\$68.00 pr.
- VW682 **1968-1972** Sedan.....\$68.00 pr.

Front Window Glass Channel

(at Window Frame) Includes Moulded End

- VS645 **1964-65** 2-Dr. Hardtops & Convert.....\$ 26.50 pr.
- VS667 **1966-67** 2-Dr. Hardtops & Convert.....\$ 26.50 pr.
- VS68 **1968** 2-Dr. Hardtops & Convert.....\$ 26.50 pr.

1961-1967 Vent Window Handles



- 1961-1965** All models;
- 1966-1967** all 4-door hardtop models.
- VH615L.....(L.H. Side)\$22.25 ea.
- VH615R.....(R.H. Side)\$22.25 ea.
- 1966 thru 1967** all 2-door models.
- VH667L.....(L.H. Side)\$27.75 ea.
- VH667R.....(L.H. Side)\$27.75 ea.

- Hardened Roll Pins for above handles
- VHP617\$2.75 ea.

Division Post Cushions (10.701)

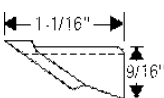
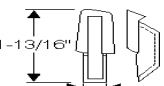
-  **1962-1963** All Skylark hardtops models. Includes metal core.
- VTC623\$53.59 pr.
-  **1962-1963** All convertibles.
- WTC623C\$55.79 ea.



Weatherstripping by the Foot

- 1961-1963** Hardtop and convert. Smooth-skinned extrusion with pre-inserted pins
- DW577.....\$2.75 ft.

Weatherstrip Kits (Group 10)

Weatherstrip Kits for All 1964-1972 Models

Basic Rubber Kit Includes: Door Weatherstrips with Moulded Ends, Roof Rail Seals, Trunk Seal.

Complete Rubber Kit Includes: Roof Rail Seals with Header Seal, Pillar Post Seals, Door Seals, Trunk Seal, OEM Window Sweeper Kit, Quarter Window Seals, Lock Pillar Seals, Cowl Seals (1968-1972), Door Lock Gaskets.

1964-1965 All 2-dr. Hardtops. Basic Rubber Kit.	
BRK645H	\$115.00 ea.
1964 All 2-dr. Hardtops. Complete Rubber Kit.	
CRK64H	\$282.25 ea.
1965 All 2-dr. Hardtops. Complete Rubber Kit.	
CRK65H	\$262.25 ea.
1964-1965 All Convertibles. Basic Rubber Kit.	
BRK645C	\$279.50 ea.
1964 All Convertibles. Complete Rubber Kit.	
CRK64C.....(For 1964 Models).....	\$438.00 ea.
1965 All Convertibles. Complete Rubber Kit.	
CRK65C.....(For 1965 Models).....	\$438.00 ea.
1964-1965 All 2-dr. Sedans. Basic Rubber Kit.	
BRK645S.....	\$86.50 ea.



1966-1967 All 2-dr. Hardtops. Basic Rubber Kit. For cars w/o wide belt mouldings.	
BRK667H	\$158.50 ea.
1966-1967 All 2-dr. Hardtops. Complete Rubber Kit.	
CRK667H	\$262.25 ea.
1966-1967 All Convertibles. Basic Rubber Kit.	
BRK667C	\$296.50 ea.
1966-1967 All Convertibles. Complete Rubber Kit.	
CRK667C	\$524.25 ea.



3M Super weatherstrip adhesive. The best we've found.
WA360.....\$13.50 ea.

1968 All 2-dr. Hardtop. Basic Rubber Kit.	
BRK68H	\$156.25 ea.
1968 All 2-dr. Hardtop. Complete Rubber Kit.	
CRK68H	\$277.50 ea.
1968 All Convertibles. Basic Rubber Kit.	
BRK68C	\$277.25 ea.
1968 All Convertibles. Complete Rubber Kit.	
CRK68C	\$438.00 ea.
1969 Special, Skylark 2-dr. Hardtop. Complete Rubber Kit.	
CRK69H	\$278.00 ea.
1969 GS 2-dr. Hardtop. Complete Rubber Kit.	
CRK69GSH.....	\$278.00 ea.
1969 Skylark Convertibles. Complete Rubber Kit.	
CRK69C	\$438.00 ea.
1969 GS Convertibles. Complete Rubber Kit.	
CRK69GC	\$438.00 ea.

1969-1972 All 2-dr. Hardtops. Basic Rubber Kit.	
BRK692H	\$97.50 ea.
1969-1972 All Convertibles. Basic Rubber Kit.	
BRK692C	\$263.75 ea.

1970-1972 All Skylark 2-dr. Hardtops. Complete Kit.	
CRK702H	\$277.50 ea.
1970-1972 All GS 2-dr. Hardtops. Complete Kit.	
CRK702GH.....	\$277.50 ea.
1970-1972 All Convertibles. Complete Rubber Kit.	
CRK702C	\$438.00 ea.

1964-1972 Door Panel Moisture Shields

Die cut mylar shields installed between the door interior panel and the door body preventing moisture from getting into the interior.

1964-1967 All 2-door hardtop models.	
DPS647H.....	\$22.50 set
1964-1967 All Convertibles.	
DPS647C.....	\$22.50 set
1968-1972 All 2-door hardtop models.	
DPS682H.....	\$22.50 set
1968-1972 All Convertibles.	
DPS682C.....	\$22.50 set

(Group 10) Window Sweeper Kits



(10.710)

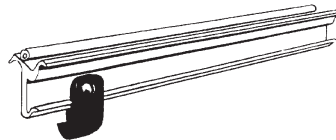

All of the below listed Sweeper kits contain 8 horizontal weatherstrips that seal the bottom of the side doorglass and rear quarter glass. Both inside and outside seals are included in the kits. All pieces come with the correct chrome beads (where necessary) and pre-bent metal backing. All kits come with clips and hardware for easy installation.

Our kits are OEM **"original type"** as they look and function as originals. We understand that there are aftermarket kits available through other vendors that have **"flat"** beads instead of the original **"round"** beads. We have found these kits to be inferior both in function and appearance, therefore, we refuse to sell them. Instead you will find that we sell the best "original" style kits at a fraction of the cost of those found elsewhere. Don't be fooled or settle for less.

1964 All 2-dr. Hardtops.	
WK64H	\$117.50 ea.
1964 All Convertibles.	
WK64C	\$117.50 ea.
1965 All 2-dr. Hardtops.	
WK65H	\$117.50 ea.
1965 All Convertibles.	
WK65C	\$117.50 ea.
1965 All 2-dr. Sedans.	
WK65D	\$117.50 ea.
1966-1967 Skylark 2-dr. H.T., w/o wide aluminum moldings.	
WK667H	\$117.50 ea.
1966-1967 GS 2-dr. H.T.	
WK667GSH.....	\$117.50 ea.
1966-1967 All Converts, w/o wide aluminum moldings.	
WK667C	\$117.50 ea.
1966-1967 All Converts, w/ wide aluminum moldings.	
WK667D	\$117.50 ea.
1966-1967 All 2-dr. Sedans. Clip position may differ.	
WK667S	\$129.50 ea.
1966-1967 All 4-dr. Hardtops.	
WK667A	\$117.50 ea.
1966-1967 All 2-dr. Hardtops, with wide aluminum moldings.	
WK667HW.....	\$117.50 ea.

1968 All 2-dr. Hardtops.	
WK68H	\$117.50 ea.
1968 All Convertibles without belt moldings.	
WK68C	\$117.50 ea.
1968 All Convertibles with belt moldings.	
WK68CB	\$117.50 ea.
1968 2-dr. Sedan.	
WK68S	\$117.50 ea.
1969 All Skylark 2-dr. Hardtops.	
WK69SH	\$117.50 ea.
1969 All GS 2-dr. Hardtops.	
WK69H	\$117.50 ea.
1969 All Skylark Convertibles.	
WK69C	\$117.50 ea.
1969 All GS Convertibles.	
WK69GC	\$117.50 ea.
1970-1972 All Skylark 2-dr. Hardtops.	
WK702H	\$119.50 ea.
1970-1972 All GS 2-dr. Hardtops.	
WK702GH	\$125.00 ea.
1970-1972 All Convertibles.	
WK702C	\$117.50 ea.
1970-1972 All 2-dr. Sedans.	
WK702S.....	\$117.50 ea.



www.oldbuickparts.com
908-369-3666



3M Super weatherstrip Adhesive. The best we've found.
 WA360.....\$13.50 ea.

Door • Windows • Weatherstripping (Group 10)

Flexible Window Channel

Used around perimeter of front and rear windows. Flexible rubber with flocking. Trimming to exact length is required. Sold in 6' lengths only.

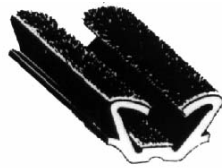

1961-1963 All Closed Models.

WC613\$22.25 ea.

1964-1972 All Closed Models.

WC642\$22.25 ea.

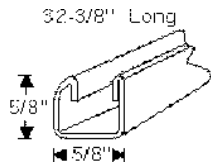

Side Window Sash Channels

1961-1964 Channel, front window lower sash. Formed steel channel. Ready for attaching to your old brackets. Cut and use as required. 32 3/8" in length.

WC614.....\$105.69 pr.

1961-1963 Special 4-dr. models front door lower sash channels.

WC613A\$127.29 pr.

1961-1963 Special 4-dr. models rear door lower sash channels.

WC613B\$97.39 pr.

1962-1963 Special Convertible door lower sash channels.

WC623A.....\$113.99 pr.

1962-1963 Special and Skylark hardtop lower sash channels.

WC623B.....\$127.29 pr.

Inner Window Sweepers

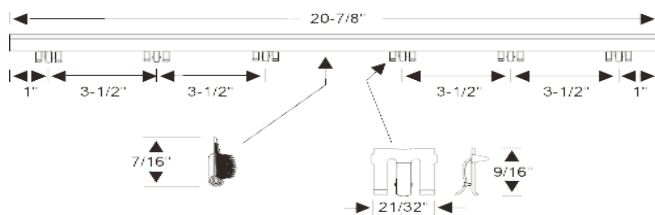

1961-1962 Special 4-dr. models. Includes correct installed clips.

WS612E.....(Front)\$57.99 pr.

WS612F.....(Rear)\$57.99 pr.

1961-1963 All 2-dr. models. Includes correct installed clips.

WS613D.....(Front)\$59.89 pr.

1962-1963 Skylark hardtop. Includes correct installed clips.

WS623F.....(Rear)\$57.99 pr.

1962-1963 All Convertibles. Includes correct installed clips.

WS623G.....(Rear)\$59.89 pr.

Outer Window Sweepers

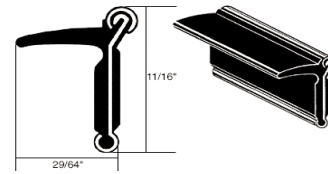

1961-1968 Outer window sweeper with round chrome bead. For use on front, rear and quarter windows without chrome reveal mouldings. Stainless steel bead with rubber lip.

WS618.....64" length\$26.00 ea.

WS618A.....(2) 32" lengths.....\$25.00 pr.

WS618B.....(2) 48" lengths.....\$27.25 pr.

1961-1962 Special 4-dr. models w/ chrome reveal molding.

WS612A.....(Front)\$57.89 pr.

WS612B.....(Rear)\$65.29 pr.

1961-1963 Special 4-dr. sedans and wagons. Made with chrome bead and proper attaching clips as original.

1961 2nd type;

1962 All 4-dr. sedans and wagons;

1963 1st. type

WS613B.....(Front)\$71.59 pr.

WS613C.....(Rear)\$71.59 pr.

1962-1963 Special convertibles and All Skylark models.

For models with chrome reveal molding. Does not have chrome bead. See WG623A for plastic guide.

WS623C.....(Front)\$60.89 pr.

1962-1963 All Skylark hardtop models. Does not have chrome bead. See WG623B for plastic guide.

WS623D.....(Rear)\$63.99 pr.

1962-1963 All Convertibles. Rubber lipped seal as original.

WS623E.....(Rear)\$60.99 pr.

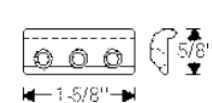

1962-1963 Plastic guide plate. Attaches to various outer window sweepers.

WG623A.....\$10.00 ea.

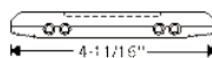

1962-1963 Plastic guide plate. Attaches to various outer window sweepers.

WG623B\$13.25 ea.



1961-1972 All as required. Glass setting tape. Sold by the foot.

ST330.....\$0.85 ft.

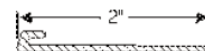

1965 Lower door sash channel filler weatherstrip. All as required for windows with bolt on channels.

SF65.....\$6.89 ft.

(Group 10) Interior Door Handles

Door Handles

For handles not listed NOS Section Group 10.512.

1961 Special 4 dr. Sedan door handles.

DH591.....\$16.00 ea.



1961-1962 All. "Drumstick" type door handles.

DH542.....\$27.25 ea.



1965-1967 All without "Paddle Type" door handles.

DH657.....\$10.00 ea.

1961-1967 All two door Hardtop and Convertibles with "Paddle Type" handles.

DH607\$51.00 pr.



1968-1972 All. Beautifully chrome plated.

DH682L.....(Left Hand).....\$16.50 ea.

DH682R.....(Right Hand).....\$16.50 ea.

Vent Window Cranks

1961-1964 All as required.

Chrome handle with elongated open slot.

VC594.....\$16.50 ea.



1961-1972 All tension spring.

HS395.....\$1.50 ea.



1961-1972 All. Window crank spring washer.

HW552.....\$3.00 ea.

Window Rollers (see more in group 17)

1963-1966 All as required.

Window regulator roller and Rivet.

WR576\$3.25 ea.



1968-1990 All as required. .68 OD, .017 ID. nylon

WR727\$2.25 ea.

1974-1987 All as required. .94 OD nylon with brass threaded stud.

WR747TOS

Window Cranks



1964 All as required. Chrome handle with chrome knob. Elongated open slot.

WH594.....\$16.50 ea.



1965-1966 All as required. Chrome handle with chrome knob.

WH656.....\$12.50 ea.

1967 With correct black knob.

WH67\$12.50 ea.



1968-1972 All with black knob.

WH680B\$6.00 ea.



1968-1972 All a clear knob.

WH680C\$6.00 ea.

Knob Replacement Kit

Will fit from 1961.

1968-1972 Black.

KK680B\$3.00 ea.

1968-1972 Clear.

KK680C\$3.00 ea.



Handle Removal Tool

Remove window and door handle retaining clips without damaging door panels.

1961-1972 All.

HT360.....\$7.75 ea.

KK680B\$3.00 ea.



Handle Retaining Clip

1961-1972 All as required. Door handle retaining clip (10 pack).

HRC318.....\$2.25 set



Doors Floor Panels (Group 10)



Door Sill Step Plates

1964-1967 All two door models.

DS647.....\$54.50 pr.

1968-1972 All two door models.

DS682.....\$49.00 pr.

1961-1972 Door sill screws.

TS634\$0.25 ea.

Door Bumpers (10.587)



1961-1963

DB570.....\$2.75 ea.



1964-1965 As required.

DB646.....\$2.75 ea.



1964-1967 All (4 per car).

1964 all Special 2-dr. models and All Skylark models;

1965-1967 All Special, Skylark and GS 2-dr. models.

DB667.....\$2.75 ea.



1968-1972 All.

DB500C.....\$2.75 ea.



Power Window Motors

1961-1972 Power window motor. State left hand or right hand. Plug may differ. Hard wire if necessary.

WM600L.....Left Hand\$127.25 ea.

WM600R.....Right Hand\$127.25 ea.

Conduit for Front Door Power Lines



DC647..... 1964-1967 All.....\$46.50 pr.

DC68..... 1968 All.....\$51.00 pr.

DC692..... 1969-1972 All.....\$40.75 pr.



Power Window Switches and Bezels

1964-1970 All "4 in a row" type assembly and bezel.

PWS640\$67.50 ea.



1964-1970 All single switch with bezel.

PWS640S\$36.50 ea.

1971-1977 All "4 in a row" type with bezel.

PWS717\$75.75 ea.

1971-1972 All single switch with bezel.

PWS717S.....\$34.50 ea.



1982-1986 Buick Skylark

Power Window Switch (includes escutcheon)

Drivers Door, 2 Button Chrome, 2 Door

Models Only

PWS827.....\$19.50 ea.

Power Door Locks and Bezels



1968-1970 All square switch. "LOCK" .

DLS680\$69.75 ea.



1971-1972 All square switch. "LOCK" .

DLS717\$59.50 ea.

Coat Hooks

1961-1972 All.

CH396.....\$11.25 ea.



Door Lock Buttons

1968-1970 Chrome door lock buttons.

LB680.....\$4.25 ea.



1968-1970 Black door lock buttons.

LB680B.....\$4.25 ea.



Dome Lamp Lenses



1971-1972 All closed models.
DL827\$7.75 ea.



1971-1972 All closed models.
DLH717\$9.75 ea.

Courtesy Lamp Lenses



1961-1972 All convertibles.
CL544\$6.00 ea.



1961-1972 All convertibles. Courtesy lamp housing. Chrome plated.
CLH542\$27.75 ea.



1961-1965 All with three circular rings.
CL615\$7.75 ea.



1966-1968 All with smooth surface.
CL618\$6.25 ea.



CB618...(Chrome bezel for above)...\$28.50 ea.



1968-1969. Correct rectangular lens with tri-shield
1968-1969: Wagons;
1969: All with long rectangular lens.
CL69\$12.00 ea.



1969 Wildcat and Electra. Round courtesy lens with tri shield. Compare to CL695.
CL69R.....\$12.75 ea.



1969-1972 All with seven (7) circular rings. Correct coloring as original.
CL695\$9.00 ea.



1969-1972 All courtesy lamp housing.
CLH692\$17.00 ea.

Air Duct Hose

Sturdy, wire reinforced defroster and air duct made like the original with rubber impregnated cloth covering. Specify inner diameter and length. Sold in one foot increments only.



AD150..... 1 1/2".....\$ 9.00 ft.
AD200.....2".....\$ 9.50 ft.
AD250..... 2 1/2".....\$11.75 ft.
AD300.....3".....\$13.00 ft.
AD350.....3 1/2".....\$12.25 ft.
AD375..... 3 3/4".....\$13.00 ft.
AD400..... 4".....\$13.00 ft.
AD500..... 5".....\$14.50 ft.
AD538..... 5 3/8".....\$15.50 ft.

Door Sill Plates (11.175)



1961-1963 All 2-door models. Pair. Custom made 10 mo. delivery.
DS613S.....\$242.50 pr.

1964-1967 All 2-door models. Pair. In stock. Includes "Fisher" emblem sticker.
DS647\$48.50 pr.

1964-1967 All 2-door models. Pair. In stock. Also, includes "Fisher" emblem already riveted to sill as original. Show Ready.
DS647R.....\$68.50 pr.

1968-1972 All 2-door models. Pair. In stock.
DS682\$59.50 ea.

Door Jamb Switches



1961-1963 Special, Skylark (front).
DJS613.....\$19.50 ea.

1964-1972
1964-1967: Special (front);
1968-1970: All, right front;
1969: Skylark, Sportwagon (rear);
1971-1972: Custom, GS and Sportwagon.
DJS642.....\$ 6.75 ea.



1968-1972
1968-1970: Left front;
1971-1972: Skylark, except custom, GS and Sportwagon.
DJS665.....\$ 8.75 ea.



Rear 1/4 Window • Rocker Panel (Group 11)

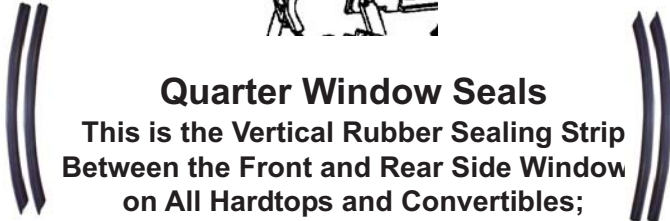
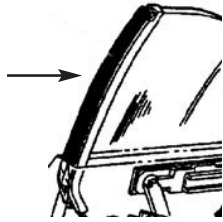

Quarter Window Seals

This is the Vertical Rubber Sealing Strip Between the Front and Rear Side Window on All Hardtops and Convertibles;

SOLD IN PAIRS

- 1961-1963 All.
QS550\$19.50 pr.
- 1964-1965 Convertibles.
QS645C\$22.75 pr.
- 1964-1965 Hardtops.
QS645H\$24.50 pr.
- 1966-1967 All.
QS667\$18.50 pr.
- 1968-1972 All.
QS682\$18.50 pr.

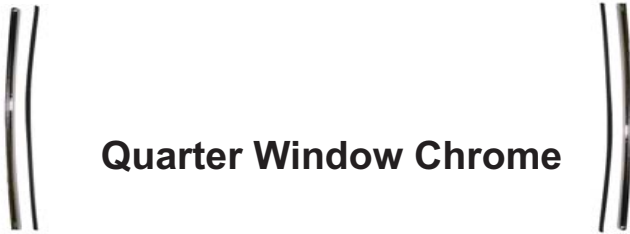

Quarter Window Chrome

1964-1972 All two door hardtop and convertible models. Our formed chrome channels come complete with correct seal to adhere to glass.

1964-1965 Hardtop Models Only

- QC645L.....Left Side.....\$42.00 ea.
- QC645R.....Right Side\$42.00 ea.

1966-1967 Models

- QC667L.....Left Side.....\$42.00 ea.
- QC667R.....Right Side\$42.00 ea.

1968 Models

- QC68L.....Left Side.....\$42.00 ea.
- QC68R.....Right Side\$42.00 ea.

1969-1972 Models

- QC692L.....Left Side.....\$42.00 ea.
- QC692R.....Right Side\$42.00 ea.

Quarter Window Lock Pillar Seals

- 1962-1963 All two door hardtops.
LPS623.....\$73.59 pr.

- 1962-1963 All convertibles.
LPS623C\$60.39 pr.



- 1964-1965 All two door hardtops and convertibles.
LPS645\$18.50 pr.

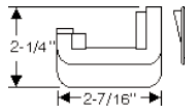

- 1964-1965 All convertibles. Filler at rear on inner panel. Found at bottom rear side of window when window is rolled up.
LPS645C.....\$85.99 pr.

- 1966-1967 All two door hardtops and convertibles.
LPS667\$14.50 pr.



- 1966-1967 All 4-door hardtops. For rear doors.
LPS667H.....\$39.50 pr.



- 1968-1972 All two door hardtops, convertibles and Sport Wagons.
LPS682\$18.50 pr.

Quarter Window Auxillary Seals (11.015)

- 1968-1972 all 2-door hardtop and convertible. Located at rear base of quarter window at bottom.
QS682A.....\$

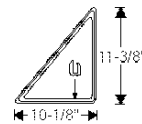

- 1961-1963 Special 4-door sedans. Weatherstrip, rear quarter fixed window.
RQS613\$138.99 pr.



- 1968-1972 All 2-door models. Lower window guide roller. Use as required.
WR682.....\$6.50 ea.

Lock Pillar Vents



PV69 PV702

- 1969 All 2-dr. Models.
PV69\$19.50 ea.
- 1970-1972 All 2-dr. Models.
PV702\$16.00 ea.

Floorpans. 19 gauge

Full Side Floor Pans are made of heavy 20 gauge steel measuring approximately 24-1/2" at the top and about 27-1/2" at the rear. Length is approximately 61" long.
Sent by UPS.

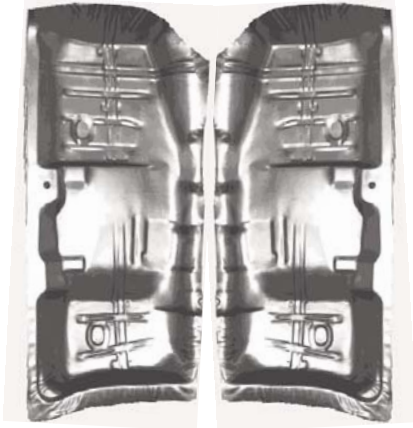

(12.980)

- 1964-1967 Left side.**
FF647L.....\$105.00 ea.
- 1964-1967 Right side.**
FF647R.....\$105.00 ea.
- 1964-1967 Left and right sides.**
FF647P.....\$191.50 ea.
- 1964-1967 Complete 1 piece unit.** Sent truck freight collect.
FF647.....\$191.50 ea.
- 1968-1972 Left side.**
FF682L.....\$107.00 ea.
- 1968-1972 Right side.**
FF682R.....\$107.00 ea.
- 1968-1972 Left and right sides.**
FF682P.....\$197.50 ea.
- 1968-1972 Complete 1 piece unit.** Sent trunk freight collect.
FF682.....\$191.50 ea.

4-Speed Shift Hump Plate

- 1964-1967**
 1964-1966: All with console;
 1967: Non console.
HP647.....\$42.50 ea.
- 1967 All with console.**
HP67.....\$42.50 ea.
- 1968-1972 All.** Some trimming/fabricating required.
HP682.....\$42.50 ea.

Front/Rear Floor Pans

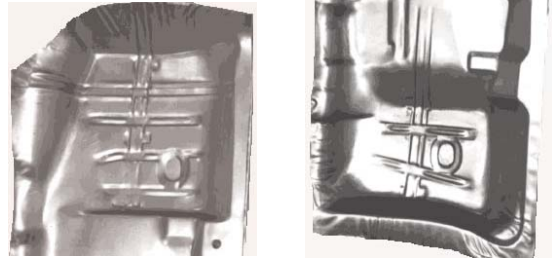

- 1964-1967 Front left.**
FP647L.....\$60.00 ea.
- 1964-1967 Front right.**
FP647R.....\$60.00 ea.
- 1964-1967 Rear left.**
RP647L.....\$60.00 ea.
- 1964-1967 Rear right.**
RP647R.....\$60.00 ea.
- 1964-1967 All 4 sections.**
FP647S.....\$269.75 ea.
- 1968-1972 Front left.**
FP682L.....\$60.00 ea.
- 1968-1972 Front right.**
FP682R.....\$60.00 ea.
- 1968-1972 Rear left.**
RP682L.....\$60.00 ea.
- 1968-1972 Rear right.**
RP682R.....\$60.00 ea.
- 1968-1972 All 4 sections.**
FP682S.....\$211.25 ea.



Floor Braces

- 1964-1972 Front brace.** Under front of front seat.
FB642F.....\$117.00 ea.
- 1964-1972 Middle brace.** Under rear of front seat.
FB642M.....\$117.00 ea.
- 1964-1967 Rear brace.**
FB647R.....\$131.50 ea.
- 1968-1972 Rear brace.**
FB-682R.....\$113.00 ea.

Floor Pan Plugs



- 1964-1966 All.**
FP646.....\$3.75 ea.
- 1967-1972 All.**
FP672.....\$3.75 ea.

Floor Pans (Group 12)

Floor Pan Sound Deadener Kits



Our superior sound deadener floor kits are pre-cut heavy tar like material with paper backing just like Buick made them. They come ready to install and look factory original.

- 1964-1967 All.**
 SD647\$65.00 ea.
- 1968-1972 All.**
 SD682\$65.00 ea.

Body Plugs



- | | | |
|-------|-------------------------|------------|
| BP120 | 1/2" Hole Diameter..... | \$1.75 ea. |
| BP580 | 5/8" Hole Diameter..... | \$1.75 ea. |
| BP340 | 3/4" Hole Diameter..... | \$2.25 ea. |
| BP780 | 7/8" Hole Diameter..... | \$2.25 ea. |
| BP100 | 1" Hole Diameter..... | \$1.75 ea. |
| BP114 | 1 1/4" Hole Dia. | \$1.75 ea. |
| BP112 | 1 1/2" Hole Dia. | \$2.25 ea. |
| BP118 | 1 1/8" Hole Dia. | \$2.50 ea. |

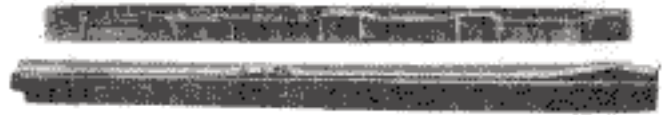

Rocker Panels

- 1964-1967 All 2-door models. Fits outer L.H. side.**
 RP647SL.....\$40.75 ea.
- 1964-1967 All 2-door models. Fits outer R.H. side.**
 RP647SR.....\$40.75 ea.
- 1968-1972 All 2-door models. Fits outer L.H. side.**
 RP682SL.....\$40.75 ea.
- 1968-1972 All 2-door models. Fits outer R.H. side.**
 RP682SR.....\$40.75 ea.



www.oldbuickparts.com

908-369-3666

Pillar Drip Mouldings



1968-1972 All 2-door hardtops. Polished stainless steel.
PM682\$30.25 pr.

1968-1972 All 2-door hardtops.
Drip rail connectors.
Polished stainless steel.
DRC682.....\$14.00 pr.



Drip Rail Moulding Set



1970-1972 All 2-door hardtops. Complete set of 6 polished stainless steel mouldings.
DRM702.....\$80.75 set



Rear Deck Filler Panel
1970-1972 All Hardtop models.

RD702\$249.50

Deck Lid (Trunk)
1970-1972 All Hardtop models.

DL702\$259.75

1970-1972 Deck Lid (Trunk) Moulding

DLM702.....(includes clips)\$59.50



1970-1972 Quarter Panels
Available For Coupes, Hardtops.
(Convertibles with minor trimming)

QP702L.....(L.H. Side)\$659.75 ea.
QP702R.....(R.H. Side)\$659.75 ea.

Quarter Panel Outer Wheel House

1970-1972 All Hardtop models. Can work on convertible models with minor modification.



WH702L.....(L.H. Side)\$197.00 ea.
WH702R.....(R.H. Side)\$197.00 ea.

Quarter Panel Inner Wheel House
1964-1972 All



WH647LI.....(1964-1967 L.H. Side)\$129.50
WH647RI.....(1964-1967 R.H. Side)\$129.50
WH682LI.....(1968-1972 L.H. Side)\$87.50
WH682RI.....(1968-1972 R.H. Side)\$87.50

1970-1972 Quarter Panel Extension Mouldings



EM702L.....(L.H. Side)\$39.75 ea.
EM702R.....(R.H. Side)\$39.75 ea.
EM702P.....(Both Sides)\$75.75 pr.

Rear Quarter Panels • Nameplates (Group 12)

1964 Skylark "Bird" emblem. Used on rear 1/4 panel and trunk. Die cast chrome, beautifully reproduced.
QE64B\$25.00 pr.



1964-1966 "Skylark" quarter panel monogram. Chrome.
QM646S\$17.25 ea.



1965 "Gran Sport" monogram. Used on rear 1/4 and sail panel. Die cast chrome with black & red painted sections.
DM65GS2\$39.50 ea.

1966 Skylark "Bird" emblem. Used on rear 1/4 panel. Die cast chrome, beautifully reproduced.
QE66B\$27.50 pr.



1966 "Gran Sport" monogram. Used on rear 1/4 and trunk lid. Die cast chrome with black and red painted sections.
DM66GS\$39.00 ea.



1966 Skylark "GS" monogram. Used on rear 1/4 and trunk lid.
QM66GS\$34.50 ea.



1967 "Skylark" quarter panel monogram. Chrome.
QM67S\$22.00 ea.



1967-1969 "GS" Monogram. Please note: Mounting studs may be slightly different.
QM679G\$39.50 ea.



1967 "340" Nameplate. Used on Rear 1/4.
QM340\$29.25 ea.



1967 Only "350" Nameplate. Used on Rear 1/4 and trunk lid.
QM350\$29.25 ea.



1967-1969 "400" Nameplate. Used on Rear 1/4 and trunk lid.
QM400\$35.00 ea.



1968-1969 "California" monogram.
QM689C\$39.75 ea.
QM689CP(Matched pair).....\$67.25 pr.



1968-1972 "Skylark" quarter panel monogram. Chrome.
QM682S\$20.00 ea.

1968-1969 Skylark sail panel emblem.
SE689\$32.25 ea.



1970 Skylark "Tri-Shield" sail panel emblem.
SE70\$32.25 ea.



1970-1972 "Custom" 1/4 panel plate.
QM702C\$32.50 ea.

1971-1972 Skylark "Tri-Shield" sail panel emblem.
SE712\$40.75 ea.



1972 "Sun Coupe" sail panel.
SE72C\$39.50 ea.

(Group 12) Deck Lid • Spoilers • Nameplates

1964-1965 "BUICK" trunk letters.
Die cast chrome.
TL645.....\$59.50 set

1966-1967 "BUICK" trunk letters.
DL667..... \$62.75 set



1964 "Special" decklid monogram.
DM64S.....\$30.25 ea.

1965 "Skylark" decklid monogram.
DM65S.....\$31.00 ea.



1965 "Gran Sport" trunk emblem.
DM65GS2\$39.50 ea.

1967 "340" rear panel monogram.
QM340R\$29.25 ea.



1967 "400" decklid nameplate.
DM67\$29.25 ea.

1967-1968 "GS" decklid nameplate.
DM67G.....(1967).....\$29.50 ea.
FM682G.....(1968).....\$25.00 ea.



1968 "350" rear 1/4 + decklid nameplate.
QM350\$24.00 ea.



1969 "GS" Trunk lock cover monogram and base assembly. Includes spring.
LA69.....\$81.75 ea.
LA69B.(Base only, "By Buick"). \$40.75 ea.
LA69S.....(Spring only).....\$4.75 ea.

1968-1969 Skylark "Custom".
Die cast Chrome
DM689C.....\$24.00 ea.



1970-1972 "GS" decklid monogram.
DM702G.....\$35.00 ea.



1971 "BY BUICK" nameplate.
DM71B.....\$14.75 ea.



1970 Skylark, models 3327, 3369;
1971 All; "Buick" decklid nameplate.
DM71\$39.00 ea.



1970-1972 "Custom" decklid plate.
DM702C.....\$27.25 ea.



1970-1972 "Skylark" decklid monogram.
DM702S.....\$36.50 ea.

Rear Spoiler

1970-1972 Rear spoiler.
RS702\$229.00 ea.

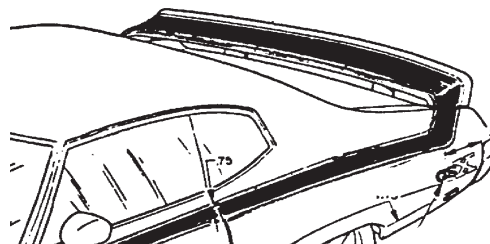

Rear Spoiler Inner Brackets

SB702\$32.00 pr.



Trunk Lock and Keys

1963-1972
1963-1965;
1967-1972 All with lock on lid.
TL609\$16.50 ea.
LR689.....(1968-1969 trunk lock retainer)\$19.50 ea.
1961, 1962 and 1966 All with lock on lid.
TL609B.....\$19.75 ea.



Trunk Lock Gasket



1961-1972 All as required.
KLG540\$1.25 ea.

Trunk (Group 12)

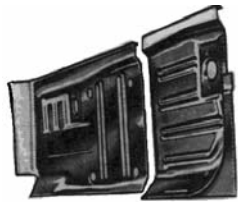

Trunk Floor

*Finest Reproduction Available.
7 piece Kit.*

*Includes Trunk Braces
Available From 1964-1972*

CARS#	YEARS	APPLICATION	PRICE
TF647	1964-1967	\$383.00
TF682	1968-1972	\$383.00

Trunk Weatherstripping

1961-1972 All. Best Quality at any price.

TW54215	\$25.50
---------	-------	---------

Trunk Paint

*Correct Speckles in Paint
Finishes Trunk Correctly
Spray Can Allows Easy Access
to Hard to Reach Spaces*



TP642(Black and aqua).....	\$14.00 ea.
TP642G(White and gray).....	\$14.00 ea.

Trunk Bumpers

1961-1972 All.

TB495	\$2.75 ea.
-------	-------	------------

1961-1964 All Wagons. Bumper and tailgate latch striker.

TB598	\$4.25 ea.
-------	-------	------------

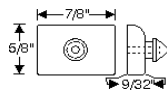
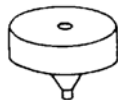

1961-1975 Accessory Trunk Mats



Reproduction of Genuine buick accessory. Features black or saddle with white Tri-Shield logo. Show quality. Licensed and approved by GM. Fits all models.

TM615(Black and White).....	\$139.00 ea.
TM615S(Saddle and White).....	\$79.50 ea.

Trunk Lid Lock Mechanism

1961-1972 Special, Skylark, GS.

TL562	\$39.75
-------	-------	---------



Tire Covers

*Available in Houndstooth Pattern
Hides Spare Tire
Matches Trunk Mat and Material*



CARS#	YEARS	APPLICATION	PRICE
STC647S	1964-1972	Aqua/Black 14".....	\$ 39.00
STC647L	1964-1972	Aqua/Black 15".....	\$ 39.00
STC642S	1964-1972	Gray/Black 14".....	\$ 39.00
STC642L	1964-1972	Gray/Black 15".....	\$ 39.00

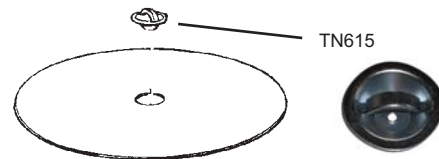

Hardboard Spare Tire Lid

CARS#	YEARS	APPLICATION	PRICE
STL612A	1961-1972	Aqua/Hounds Tooth.....	\$ 20.00
STL612G	1961-1972	Aqua/Speckled.....	\$ 27.75
Spare Tire hold down bolt 5/16"-18 x 9 1/2"			
STB611	1961-1972	\$11.75
Spare Tire hold down wing nut			
TN615	1961-1972	\$18.00

Trunk Mats

*Precision Die Cut Rubber for Perfect Fit
Correct Houndstooth Pattern and Color
Needed for Show Points and Authenticity*

CARS#	YEARS	APPLICATION	PRICE
Gray / Black			
TM645	1964-1965	\$46.50
TM667	1966-1967	\$46.50
TM682	1968-1972	\$46.50
Aqua / Black			
TM645A	1964-1965	\$46.50
TM667A	1966-1967	\$46.50
TM682A	1968-1972	\$46.50

Trunk Tote Bag

Matching Tote Bag 8" x 18".
Custom sewn and fully zippered.



Aqua/Black	TOTEAQUA	\$29.50
Gray/Black	TOTEGRAY	\$29.50

(Group 13) Convertible Tops and Parts

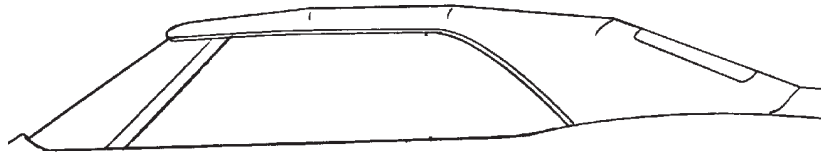

Convertible Tops (13.347)

Our convertible tops are designed and manufactured by a large company responsible for thousands of trophy winning classic cars in the past 20 years. *Each top is custom made for perfect appearance and fit.* All seams are sewn with matching bond thread, dielectrically or latex sealed for long lasting water protection. Tops are guaranteed against defects for a full 54 months. All tops come with heavy duty clear vinyl window. A solid rear panel can also be ordered for installation of your framed glass window. Hardware also included. **When ordering**, keep in mind, the second color listed is the color inside the car. Please, Sorry, no COD's.

HEAVY DUTY VINYL: Quality Sateen Back **32** ounce durable vinyl. Available Colors: Black/Black, Tan/Tan, White/Black, White/Tan, Brown/Black, Beige/Sliver Tan, Red/Black, Maroon/Black, Green/Green, Dark Green/Black, Buckskin/Black, Pale Blue/Black, Medium Blue/Black, Dark Blue/Black.
CT360V32.....\$289.50 kit

DELUXE HEAVY DUTY VINYL: Superior Sateen Back **38** ounce durable vinyl. Available Colors: Black over Black, White over Black.
CT360V38\$389.50 kit

CONVERTIBLE TOP PAD KIT: For all tops.
TP360B.....(Black).....\$ 95.00 kit
TP360T.....(Tan).....\$ 95.00 kit

Convertible Well Liners (13.450)

Gives that finished look in the well behind rear seat superior quality

WL613.....	\$67.50 pr.
WL645.....	\$67.50 pr.
WL667.....	\$67.50 pr.
WL682.....	\$67.50 pr.



Tacking Strips (14.060)

(Price = Per Foot)

CARS#	YEARS	APPLICATION	PRICE
TSF360	1961-1972:	Front (5/8"x1/8")	~~~~~\$2.25
TSR360	1961-1972:	Rear (1/2' x 3/16")	~~~~~\$2.25

Vinyl Roofs - Landau Tops

We can supply Vinyl Roofs and Landau tops for any Special, Skylark or GS from 1962 through 1972. Please state year, model and color.

VR623S.....	1962-1963 Black or White	\$149.50 ea.
VR623SC.....	1962-1963 Colors	\$199.50 ea.
VR645S.....	1964-1965 Black or White	\$118.50 ea.
VR645SC.....	1964-1965 Colors	\$149.50 ea.
VR667S.....	1966-1967 Black or White	\$118.50 ea.
VR667SC.....	1966-1967 Colors	\$149.50 ea.
VR682S.....	1968-1972 Black or White	\$209.50 ea.
VR682SC.....	1968-1972 Colors	\$209.50 ea.

Convertible Tops and Parts (Group 13)



Convertible Top Header Bows

- 1964-1965 All.
 HB645.....\$355.00 ea.
 1966-1967 All.
 HB667.....\$356.00 ea.
 1968-1972 All. Replaces the rusted and worn-out front bow.
 HB682S.....\$356.00 ea.



Convertible Top Latches (14.080)

- 1961-1963 All. Complete assy.
 TL614A.....\$269.50 pr.



- 1964-1972 All. Latch hook knuckles.
 LK642.....\$39.00 pr.

- 1964-1972 Top Latch Chrome hook.
 TH642.....\$5.00 ea. 

- 1964-1965 All. .
 TL645L.....LH.....\$107.50 ea.
 TL645R.....RH.....\$107.50 ea.
 1966-1967 All. .
 TL667L.....LH.....\$107.50 ea.
 TL667R.....RH.....\$107.50 ea.
 1968-1972 All. .
 TL682L.....LH.....\$107.50 ea.
 TL682R.....RH.....\$107.50 ea.

Chrome Header Caps (10.093)



- 1966-1967 All.
 HC667.....\$104.50 pr.

Convertible Top Receptacles (10.219)



- 1968-1972 All. Brushed finish as original.
 CTR682.....\$59.50 pr.

Convertible Top Rain Gutter

Assure your floor pans and trunk pans will not get wet when it rains or you wash your car. Plastic as original. Installs in well area behind rear seat.

- 1968-1972
 RG682.....\$177.25 pr.

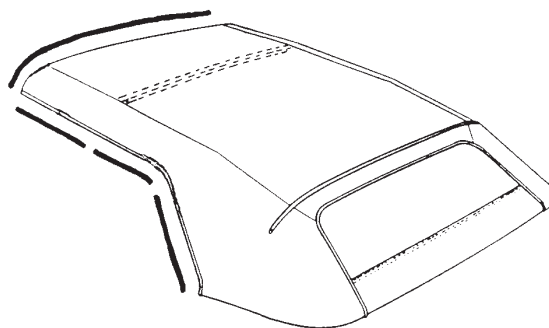

Convertible Top Roof Rail Weatherstripping (14.190)

Seals Convertible Top to Windows and Windshield Available from 1962-1972. Complete 7 Piece Set.

CARS#	YEARS	APPLICATION	PRICE
RR623C	1962-1963:	Full Set ~~~~~	\$ 470.99
RR645C	1964-1965:	Full Set ~~~~~	\$ 198.50
RR667C	1966-1967:	Full Set ~~~~~	\$ 179.00
RR682	1968-1972:	Full Set ~~~~~	\$ 198.50

Convertible Top Bow Seal Weatherstrips



Seals Top Windshield Frame to the Front of Convertible Top Includes Moulded Ends and All Necessary

- 1964-1967 All. Does not have molded ends.
 BS647.....\$25.00 ea.
 1966-1967 All. Includes molded ends.
 BS667.....\$37.50 ea.
 1968-1972 All. Includes molded ends.
 BS682.....\$37.50 ea.

Convertible Top Pillar Seals

Seals Windshield Pillar to the Front of Side Windows. Finest Quality. Replaces Tired Worn or Missing Seals. Available from 1964-1972.

CARS#	YEARS	PRICE
PS645	1964-1965:	\$ 48.50 pr.
PS667	1966-1967:	\$ 48.50 pr.
PS68	1968:	\$ 48.50 pr.
PS692	1969-1972:	\$ 48.50 pr.
PS623	1962-1963:	\$ 135.49 pr.

(Group 13) Convertible Tops and Parts



Convertible Top Motor/Pump (14.481)

- 1961-1963 All.**
 TP572.....\$279.00 ea.
1964-1966 All.
1967 with 4 mount base.
 TP647.....\$279.00 ea.
1967 with 3 mount base.
1968-1972 All.
 TP672.....\$279.00 ea.

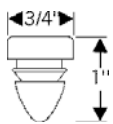

- 1961-1972 All Pump Mounts**
 PM531.....\$2.75 ea.

Convertible Top Hose Sets (14.472)

- 1962-1972 All.** Correct white tube with fittings.
 CHS620.....\$107.00 set

- Silicone hydraulic fluid.
 SF360.....\$63.00 gallon



Convertible Pinchweld Moldings



- 1964-1965 All.** Polished stainless steel with correct features. Open ends for cars with reveal moldings.
 PM645C\$177.50 set
 Clips for above.
 PWC645.....\$4.50 ea.
 PWC645S.....Set of 16\$39.95 set



- 1966-1967 All** with open-ended moulding design.
 PM667CO.....\$177.50 set
1966-1967 All with closed-ended moulding design.
 PM667CC.....\$177.50 set
 Clips above.
 PWC667.....\$4.50 ea.
 PWC667S.....Set of 16\$39.95 set



- 1968-1972 All.**
 PM682C\$177.50 set
 Clips for above.
 PWC682.....\$4.50 ea.
 PWC682S.....Set of 12\$39.95 set



(14.475)

Convertible Top Cylinders

1961-1972 Convertible top cylinders. Absolutely the best obtainable. Five (5) year warranty. Always in ATF. TIP! Always lubricate the shafts and seals with ATF after winter storage.

- 1962-1963 All.**.....TC623.....\$157.50 ea.
1964-1967 All......TC647.....\$157.50 ea.
1968-1972 All......TC682A.....\$157.50 ea.



Convertible Top Cables (13.347)

Replace Broken, Missing, or Stretched out Cables Exact Replacement Cable

- 1964-1965 All.**
 TC645\$29.50 pr.
1966-1967 All.
 TC667\$29.50 pr.
1968-1972 All.
 TC682\$29.50 pr.

Convertible Top Boots (13.450)

(13.450)

For All Years High Quality Vinyl

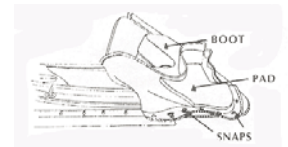

- 1962-1963 Special & Skylark.**
 TB623.....\$199.50 set
1964-1965 Special, Skylark & GS.
 TB645.....\$169.00 set
1966-1967 Special, Skylark & GS.
 TB667\$199.50 set
 TB68.....(Clips on to Pinchweld Mldg.).....\$199.50 set
 TB682.....(Slides in Pinchweld Mldg.).....\$199.50 set

Top Boot Clips (13.384)



- 1964-1965 All.**
 TBC645(1).....\$4.50 ea.
1964-1965 All.
 TBC645S.....(16).....\$49.50 set
1966-1967 Special, Skylark, GS.
 TBC667.....(1).....\$3.50 ea.
1966-1967 All.
 TBC667S.....(12).....\$39.50 set
1968-1972 Special, Skylark, GS.
 TBC682.....(1).....\$3.50 ea.
1968-1972 All.
 TBC682S.....(12).....\$42.50 set

Headliners (Group 14)

Headliners (14.640)



Our Headliners are the finest quality custom made from original patterns to guarantee perfect fit and easy installation. All kits include instructions and contain enough extra material to cover sun visors. Please see our color samples on line. You may also call or write for color samples as these items are custom made and not returnable due to color. See matching trim kits on following pages.

- 1961-1963 Special, Skylark 2-door models.**
 HL613\$249.50 ea.
- 1961-1963 Special, Skylark 4-door models.**
 HL6134\$249.50 ea.
- 1961-1963 Special and Skylark Wagons.**
 HL613W\$249.50 ea.
- 1964-1967 Special, Skylark and GS 2-door models.**
 HL647\$109.75 ea.
- 1964-1967 Special, Skylark 4-door models.**
 HL6474\$70.25 ea.
- 1964-1967 Special and Skylark Wagons.**
 HL647W\$109.50 ea.
- 1968-1969 Special, Skylark and GS 2-door models.**
 HL689\$119.00 ea.
- 1968-1969 Special, Skylark 4-door models.**
 HL6894\$80.25 ea.
- 1968-1969 Special and Skylark Wagons.**
 HL689W\$109.50 ea.
- 1970-1972 Skylark and GS 2-door models.**
 HL702\$82.25 ea.
- 1970-1972 Skylark 4-door models.**
 HL7024\$100.50 ea.
- 1970-1972 Skylark Wagons.**
 HL702W\$129.50 ea.

Colors and Styles

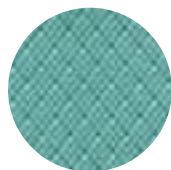

Tier Grain



Basketweave

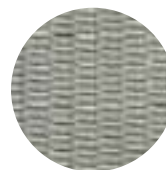

Ribbed

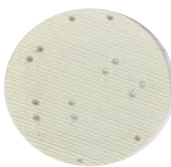

Perforated



Non-Perforated

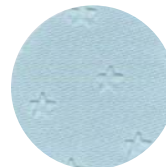

Star

Tier Grain-----

Black	TB	White	TW
Buckskin	TBS	Bright Red	TBR
Dark Red	TDR	Maroon	TM
Light Blue	TLB	Medium Blue	TMB
Dark Blue	TDB	Aqua	TA

Basketweave-----

Black	BB	White	BW
Dark Red	BDR	Light Blue	BLB
Medium Blue	BMB	Aqua	BA

Ribbed-----

Black	RB	White	RW
Dark Red	RDR	Medium Blue	RMB
Dark Blue	RDB	Green	RG

Perforated-----

Black	PB	White	PW
Buckskin	PBS	Saddle	PS
Sandalwood	PSW	Bright Red	PBR
Dark Red	PDR	Maroon	PM
Light Blue	PLB	Medium Blue	PMB
Dark Blue	PDB	Dark Green	PDG

Non-Perforated-----

Black	NB	White	NW
Buckskin	NBS	Bright Red	NBR
Dark Red	NDR	Maroon	NM
Light Blue	NLB	Medium Blue	NMB
Dark Blue	NDB	Saddle	NS
Sandalwood	NSW	Green	NG

Star-----

Black	SB	White	SW
Dark Red	SDR	Parchment	SP
Light Blue	SLB	Aqua	SA
Brown	SBW	Gray	SGY

Headliner Trim Kits

Our Trim Kits Come Complete with the Proper amount of Windlace, Wire-on, Cement, Tacks etc. as Needed. When Ordering Headliner or Headliner Trim Kits, Please Give all Information about your Buick; Including Model and Style Number (This Number is Stamped on the I.D. Plate on the Firewall).

1964-1967 Door Jamb/Headliner Windlace



Correct grain vinyl with steel insert as original. Available colors: Black (B), Lt. Blue (LB), Dk. Blue (DB), Fawn (F), Saddle (S), 64 Red (4R), 1965-1967 Red (R), White (W).

- 1964-1967** All 2 door hardtops and convertibles
- DJW647HB.....(black)\$29.50 set
- DJW647H.....(add color code).....\$29.50 set
- 1964-1967** All sedans.
- DJW647SB.....(black)\$29.50 set
- DJW647S.....(add color code)\$29.50 set

Front Headliner Windlace

- 1968-1972** All 2 door hardtops
- Available colors: Black (B), 68 Lt. Blue (LB), 68 Med. Blue (MB), Dk. Blue (DB), Lt. Saddle (LS), Dk. Saddle (DS), Red (R), Brt. Blue (BB), Parchment (PM), Dk. Green (DG), White (W), Sandalwood (SW), Pearl (P).
- FHW682B.....(black)\$39.75 set
- FHW682.....(add color code).....\$39.75 set



Headliner Insulation



- 1964-1967** All. 4 piece die cut, ready to install.
- HIK64723.25 set
- 1968-1972** All. 4 piece die cut, ready to install.
- HIK68223.25 set

Headliner Bows

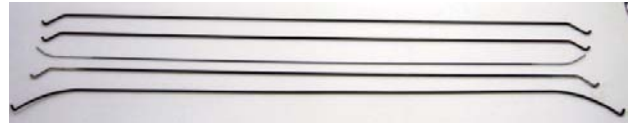

- Bows are color coded and labeled for correct positioning.
- 1964-1965** All 2-door Hardtop models. 5 bow set.
- HBS645\$40.00 kit
- 1966-1967** All 2-door Hardtop models. 5 bow set.
- HBS667\$40.00 kit
- 1968-1972** All 2-door Hardtop models. 5 bow set.
- HBS692\$40.00 kit

Headliner Bow Clips



- 1968-1972** All.
- HBC682A\$7.75 ea.



- 1968-1972** All.
- HBC682B\$7.75 ea.



- 1964-1972** Coat hooks.
- CH645.....\$12.75 ea.

Rear Headliner Windlace

- 1968-1972** All 2 door hardtops.
- Available colors: Black (B), 68 Lt. Blue (LB), 68 Med. Blue (MB), Dk. Blue (DB), Lt. Saddle (LS), Dk. Saddle (DS), Red (R), Brt. Blue (BB), Parchment (PM), Dk. Green (DG), White (W), Sandalwood (SW), Pearl (P).
- RHW682B.....(black)\$69.25 set
- RHW682.....(add color code)\$69.25 set

New for 1970 through 1972 models is our Dash Pad covers. They are meant to be glued right over your existing dash pad (glue is included). Colors are available by your style number.

- 1970-1972** models with AC.
- DC702A ~~~~~~\$129.00 each
- 1970-1972** models without AC and without any vents.
- DC702 ~~~~~~\$129.00 each
- 1970-1972** models without AC and with one vent.
- DC702V ~~~~~~\$99.00 each

Seats • Seat Covers (Groups 14 & 15)

We now offer **quality** seat and door panel sets for Skylark and GS models.

Correct grain vinyls and original sewn designs. Available in most colors.

*** Ordering Note: Please indicate year, model, trim and color code. Add "A" for Bench Seats with Armrest.**



Front Only \$295.00 Front and Rear \$495.00

SC64FB	1964 Skylark Front Buckets Only.
SC64FBR	1964 Skylark Front Buckets and Rear Seat.
SC64FN	1964 Skylark Front Bench.
SC64FNR	1964 Skylark Front Bench and Rear.
SC65FB	1965 Skylark Front Buckets Only.
SC65FBR	1965 Skylark Front Buckets and Rear Seat.
SC65FN	1965 Skylark Front Bench.
SC65FNR	1965 Skylark Front Bench and Rear.
SC66FB	1966 Skylark and GS Front Buckets.
SC66FBR	1966 Skylark and GS Front Buckets and Rear.
SC66FN	1966 Skylark and GS Front Bench.
SC66FNR	1966 Skylark and GS Front Bench and Rear.
SC67FB	1967 Skylark and GS Buckets.
SC67FBR	1967 Skylark and GS Front Buckets and Rear.
SC67FN	1967 Skylark and GS Front Bench.
SC67FNR	1967 Skylark and GS Front Bench and Rear.
SC68FB	1968 Skylark and GS Buckets.
SC68FBR	1968 Skylark and GS Front Buckets and Rear.
SC68FN	1968 Skylark and GS Front Bench.
SC68FNR	1968 Skylark and GS Front Bench and Rear.
SC69FB	1969 Skylark and GS Buckets.
SC69FBR	1969 Skylark and GS Front Buckets and Rear.
SC69FN	1969 Skylark and GS Front Bench.
SC69FNR	1969 Skylark and GS Front Bench and Rear.
SC70FB	1970 Skylark and GS Front Buckets.
SC70FBR	1970 Skylark and GS Front Buckets and Rear.
SC70FN	1970 Skylark and GS Front Bench.
SC70FNR	1970 Skylark and GS Front Bench and Rear.
SC71FB	1971 Skylark and GS Front Buckets.
SC71FBR	1971 Skylark and GS Front Buckets and Rear.
SC71FN	1971 Skylark and GS Front Bench.
SC71FNR	1971 Skylark and GS Front Bench and Rear.
SC72FB	1972 Skylark and GS Front Buckets.
SC72FBR	1972 Skylark and GS Front Buckets and Rear.
SC72FN	1972 Skylark and GS Front Bench.
SC72FNR	1972 Skylark and GS Front Bench and Rear.



www.oldbuickparts.com

908-369-3666

Pre-Assembled Bucket Seats

Our pre-assembled seats feature all new parts, new frames, new seat tracks, new seat foam, new upholstery, new plastic seat back and lowers, new seat release mechanisms with buttons, new headrest post guides with escutcheons. Headrests are not included. More colors soon!

1969 Skylark/Custom/GS



- BS69B.....(black)\$2650.00 set
- BS69F.....(fawn)\$2650.00 set
- BS69P.....(parchment).....\$2650.00 set
- BS69R.....(red)\$2650.00 set

1970 Skylark/Custom/GS



- BS70B.....(black)\$2650.00 set
- BS70MB.....(dark metallic blue).....\$2650.00 set
- BS70MG.....(dark metallic green).....\$2650.00 set
- BS70P.....(pearl)\$2650.00 set
- BS70BS.....(burnished saddle)\$2650.00 set

1971-1972 Skylark/Custom/GS



- BS712B.....(black)\$2650.00 set
- BS712DG.....(dark green)\$2650.00 set
- BS712P.....(pearl).....\$2650.00 set
- BS712W.....(white)\$2650.00 set
- BS712DS.....(dark saddle)\$2650.00 set

Seat Belts (Group 14)

GM Logo Seat Belts



1964-1966 lap seat belt with correct "carriage" logo buckle.
 SB646B.....(Non-retractable)\$77.00 ea.



SB646RB.....(Retractable)\$289.00 set



1968-1972 lap seat belt with matching color, textured buckle and black GM logo.

SB682B.....(Black)\$39.00 ea.
 SB682BR.....(Black Retractable)\$219.00 set
 SB682N.....(Navy Blue)\$39.00 ea.
 SB682NR.....(Navy Blue Retractable).....\$229.00 set
 SB682R.....(Red)\$39.00 ea.
 SB682RR.....(Red Retractable)\$229.00 set
 SB682U.....(Black with Blue GM logo).....\$39.00 ea.
 SB682UR..(Blk w/ Blue GM logo Retractable)...\$229.00 set

Seat Belts

Quality made aftermarket seat belts come in various colors and styles. Colored belts: add \$5 and code, are custom made and not returnable. Please see our website for colors. 74" recommended for fronts, 60" for rears. Per person.

Chrome Lift Lever Style



Lap Belts come standard with authentic style chrome buckle. Black (B), tan (T), rust (R), dark brown (DB), orange (O), glove red (GR), maroon (M), charcoal (C), navy blue (NB), powder blue (PB), turquoise (TQ), ivory (I), white (W), gray (G), silver (S), dark green (DG).
 SB20074B.....(74" Black).....\$39.50 ea.
 SB20060B.....(60" Black).....\$39.50 ea.
 SBH200.....(Hardware Kit).....\$5.25 ea.

Plastic Push Button Style



Lap belts with push-button plastic buckle. Black (B), Taupe (T), Maroon (M), Light Gray (LG), Blue (U). Sizes available are 60" and 74" for the black, light gray and taupe. The blue and maroon are available in 74" only. Colored belts, (add \$3 and code), are custom made and not returnable.
 SB200P74B.....(74" Black).....\$39.50 ea.
 SB200P60B.....(60" Black).....\$39.50 ea.
 SBH200.....(Hardware Kit).....\$5.25 ea.

Metal Push Button Style



Lap belts with push-button metal buckle. Black (B), Taupe (T), Gray (G), Colored belts, (add \$3 and code), are custom made and not returnable.
 SB200M74B.....(74" Black).....\$39.50 ea.
 SB200M60B.....(60" Black).....\$39.50 ea.
 SBH200.....(Hardware Kit).....\$5.25 ea.

Seatbelt Hardware Kit



SBH200\$5.25 ea.

Dress-up Your Seat Belts



Old style Buick coat of arms. Fits well on our lift lever seat belts.
 TBE550\$7.50 ea.



GM Mark of Excellence. Fits well on our lift lever seat belts.
 D55\$3.75 ea.



GM Mark of excellence. Embossed. Fits well on our lift lever seat belts.
 D55E\$6.50 ea.



1967-1972 GM Mark of Excellence. Seat belt emblem.
 SBE672\$6.50 ea.

Bucket Seat Springs

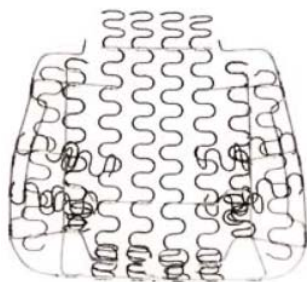

1964-1965

- 1964-1965 All. Bottom.**
 SS645BBO\$88.25 ea.
1964-1965 All. Back.
 SS645BBK\$88.25 ea.

1966-1967

- 1966-1967 All. Bottom.**
 SS667BBO\$116.50 ea.
1966-1967 All. Back.
 SS667BBK\$116.50 ea.

1968-1972

- 1968-1972 All. Bottom.**
 SS682BBO\$90.75 ea.
1968-1972 All. Back.
 SS682BBK\$90.75 ea.

Hog Rings

- For attaching seat covers to frame.
 HR360.....Bag of 100.....\$8.75 ea.



Hog Ring Pliers

- For attaching Hog Rings to seat covers.
 HRP360\$30.25 ea.

Seat Track Knob

- 1967-1972 All.**
 SK672\$8.00 ea.



Bucket Seat Extenders

- GM Factory Accessory allows about 2" more leg room.
1966-1972 All. For drivers side.
 SE662\$79.75 ea.

Bucket Seat Bracket



- Bucket seat mounting bracket 4-piece set.
1966-1970 Special, Skylark, GS.
 BSB660\$39.75 ea.

Bucket Seat Foam Inserts (Seat Buns)



High quality padding matches the original contour. Some trimming may be required. Includes one top and one bottom.

- 1962-1965 All.**
 SI625\$89.50 ea.
 SI625B...(Bottom only)....\$25.75 ea.

- 1966-1970**
 SI660.....\$70.50 ea.

- 1971-1972**
 SI712.....\$79.75 ea.

Seat Components Bucket Seat Chrome Piping and Bullet Ends



- Enough piping for 2 bucket seats
 SP682 (22')\$26.00 set
 Enough bullet ends for 2 bucket seats
 SPC662 (12)\$14.50 set

Seat Back Bumpers

- 1961-1972 All as required.**
 SB612.....(Oval type).....\$6.00 ea.
 SB612R.....(Round type).....\$3.75 ea.



1969-1972 Bucket Seat Headrest Locks



- HL692.....\$16.50 ea.

1969-1972 Bucket Seat Back Release

- Bright chrome bezel and button. Retainer is not included.
 SB692.....\$18.00 ea.



Bucket Seat Hinge Cap



- 1962-1965 Buick Special, Skylark**
 Stamped stainless steel reproduction.
 HC625.....\$12.00 ea.

Seats • Seat Covers (Groups 14 and 15)



1968-1972 Bucket Seat Backs

Top quality seat backs come complete with chrome piping and bullets already installed. Sold in pairs.

1968 Models

SB68.....(Black).....	\$79.50 pair
SB68R.....(Red).....	\$89.50 pair
SB68P.....(Pearl).....	\$89.50 pair
SB68LB.....(Light Blue).....	\$89.50 pair
SB68MB.....(Medium Blue).....	\$89.50 pair

1969-1972 Models

SB692B.....(1969-1972 Black).....	\$89.50 pair
SB692R.....(1969-1970 Red).....	\$99.50 pair
SB692DB.....(1969-1972 Dk. Blue).....	\$99.50 pair
SB692BB.....(1969-1972 Bright Blue).....	\$99.50 pair
SB692PM.....(1969 Parchment).....	\$99.50 pair
SB692DG.....(1969-1972 Dk. Green).....	\$99.50 pair
SB692LS.....(1969 Lt. Saddle).....	\$99.50 pair
SB692DS.....(1971-1972 Dk. Saddle).....	\$99.50 pair
SB692S.....(1971 Sandalwood).....	\$99.50 pair
SB692W.....(1972 White).....	\$99.50 pair
SB692P.....(1972 Pearl).....	\$99.50 pair



1968-1972 Bucket Seat Aprons

Quality aprons match our seat backs. Chrome piping and bullet ends already installed. 1 pair enough for 1 seat.

1968 Models

SA68.....(Black).....	\$59.00 pair
SA68R.....(Red).....	\$99.00 pair
SA68P.....(Pearl).....	\$69.00 pair
SA68LB.....(Light Blue).....	\$69.00 pair
SA68MB.....(Medium Blue).....	\$69.00 pair

1969-1972 Models

SA692B.....(1969-1972 Black).....	\$59.50 pair
SA692R.....(1969-1970 Red).....	\$69.50 pair
SA692DB.....(1969-1972 Dk. Blue).....	\$69.50 pair
SA692BB.....(1969-1972 Bright Blue).....	\$69.50 pair
SA692PM.....(1969 Parchment).....	\$69.50 pair
SA692DG.....(1969-1972 Dk. Green).....	\$69.50 pair
SA692LS.....(1969 Lt. Saddle).....	\$69.50 pair
SA692DS.....(1971-1972 Dk. Saddle).....	\$69.50 pair
SA692S.....(1971 Sandalwood).....	\$69.50 pair
SA692W.....(1972 White).....	\$69.50 pair
SA692P.....(1972 Pearl).....	\$69.50 pair

1968-1972 Bucket Seat Back and Apron Sets

All 6 pieces for 2 bucket seats



1968 Models

SS68.....(Black).....	\$175.00 pair
SS68R.....(Red).....	\$189.00 pair
SS68P.....(Pearl).....	\$189.00 pair
SS68LB.....(Light Blue).....	\$189.00 pair
SS68MB.....(Medium Blue).....	\$189.00 pair

1969-1972 Models

SS692B.....(1969-1972 Black).....	\$168.50 pair
SS692R.....(1969-1970 Red).....	\$188.50 pair
SS692DB.....(1969-1972 Dk. Blue).....	\$188.50 pair
SS692BB.....(1969-1972 Bright Blue).....	\$188.50 pair
SS692PM.....(1969 Parchment).....	\$188.50 pair
SS692DG.....(1969-1972 Dk. Green).....	\$188.50 pair
SS692LS.....(1969 Lt. Saddle).....	\$188.50 pair
SS692DS.....(1971-1972 Dk. Saddle).....	\$188.50 pair
SS692S.....(1971 Sandalwood).....	\$188.50 pair
SS692W.....(1972 White).....	\$188.50 pair
SS692P.....(1972 Pearl).....	\$188.50 pair

1964-1972 2-door Hardtops and Convertibles

Our reproduction door panels are identical to original and feature authentically sewn or embossed designs. Panels are covered in dielectrically sealed correct Seville or Madrid grain vinyl and include carpet and buttons as required. A waterproof backing board is applied with pre-marked locations for window cranks and door handles. Existing trim must be reused. 1968-1972 are assembled with ABS plastic top rails, chrome lock button ferrules and window felts already installed. Please state color and trim number when ordering.



1964 Models

- DPK64F.....(Front Door Panels)\$247.00 pair
- RPK64H.....(Rear Panels, Hardtop).....\$139.50 pair
- RPK64C.....(Rear Panels, Convertible)\$139.50 pair



1965 Models

- DPK65F.....(Front Door Panels)\$247.00 pair
- RPK65H.....(Rear Panels, Hardtop).....\$139.50 pair
- RPK65C.....(Rear Panels, Convertible)\$139.50 pair



1966 Models

- DPK66F.....(Front Door Panels)\$247.00 pair
- RPK66H.....(Rear Panels, Hardtop).....\$139.50 pair
- RPK66C.....(Rear Panels, Convertible)\$139.50 pair



1967 Models

- DPK67F.....(Front Door Panels)\$249.50 pair
- RPK67H.....(Rear Panels, Hardtop).....\$139.50 pair
- RPK67C.....(Rear Panels, Convertible)\$139.50 pair



1968 Models

- DPK68F.....(Front Door Panels)\$306.50 pair
- RPK68H.....(Rear Panels, Hardtop).....\$217.25 pair
- RPK68C.....(Rear Panels, Convertible)\$197.50 pair



1969 Models

- DPK69F.....(Front Door Panels)\$306.50 pair
- RPK69H.....(Rear Panels, Hardtop).....\$217.25 pair
- RPK69C.....(Rear Panels, Convertible)\$197.50 pair



1970 Models

- DPK70F.....(Front Door Panels)\$306.50 pair
- RPK70H.....(Rear Panels, Hardtop).....\$217.25 pair
- RPK70C.....(Rear Panels, Convertible)\$197.50 pair



1971 Models

- DPK71F.....(Front Door Panels)\$306.50 pair
- RPK71H.....(Rear Panels, Hardtop).....\$217.25 pair
- RPK71C.....(Rear Panels, Convertible)\$197.50 pair



1972 Models

- DPK72F.....(Front Door Panels)\$306.50 pair
- RPK72H.....(Rear Panels, Hardtop).....\$217.25 pair
- RPK72C.....(Rear Panels, Convertible)\$197.50 pair

Door Panel Parts (Groups 14)

Door Panel Retainers



1961-1972 All as required.
DPR598.....\$1.00 ea.



1961-1972 All as required. Pack of 25
DPR600.....\$10.25 ea.



1961-1972 All as required. Head width 7/16"
DPF6\$1.00 ea..



1961-1972 All as required. Head width 5/8"
DPF7\$1.00 ea.

See Group 17 in back of catalog for other door panel retainers.

Lock Buttons and Ferrules



1961-1967 Black. Use as required.
LB67B\$4.25 ea.



1961-1967 Chrome. Use as required.
LB67C\$4.25 ea.



1961-1967 All. As Required
LB616 (Chrome)\$4.25 ea.
LB616B (Black)\$4.25 ea.



1968-1970 All.
LB680.....Chrome\$4.25 ea.
LB680B.....Black\$4.00 ea.



1971-1972 All.
LB710\$4.25 ea.

1964-1967 Lock button ferrule.
BF647\$2.00 ea.



1968 up Lock button ferrule. All.
BF685\$0.75 ea.



1968-1972 Lock button ferrule.
BF682\$4.50 pr.

Door Panel Moisture Shields

Die cut mylar shields installed between the door interior panel and the door body preventing moisture from getting into the interior.

1964-1967 All 2-door hardtop models.
DPS647H.....\$19.00 set

1964-1967 All Convertibles.
DPS647C.....\$19.00 set

1968-1972 All 2-door hardtop models.
DPS682H.....\$19.00 set

1968-1972 All Convertibles.
DPS682C.....\$19.00 set

Door Panel Emblems (14.691)



1969 "GS" Nameplate.
DE69G\$29.50 pr.



1970-1972 "GS" Nameplate.
DE702.....\$21.00 ea.

1971 "GS" Emblem.
DE71G.....\$36.00 ea.



1971-1972 GS Door Panel Emblem

4 colors with satin and bright chrome finish.
DE712GS.....\$25.25 ea.

(Group 14) Front Door Arm Rest Parts

Front Arm Rest Pads (14.686)

Arm Rest Pads feature original appearance and correct vinyls. These pads are 11" long.



1964 All. Two door Sedans, Front Pads. Specify Black, White, Saddle, Fawn, Red, Dk. Blue, Light Blue, Fawn, Aqua, Dk. Aqua.

AP64F\$21.50 ea.



1965-1967 All. Two door Sedans, Front Pads, 11". Specify Black (B), White (W), Fawn (F), Red (R), Lt. Blue (LB), Bright Blue (BB), Turquoise (TQ), Gold (G), Aqua (A).

AP657F\$42.00 pr.



1964-1967 Two door Sedans. Front Arm Rest **Bases**. For 11" long pads above.

ARB647\$33.50 pr.

1964-1967 Two door hardtop and convertible Arm Rest Pads. 14" long for use with paddle type door handles. Black only.

AP647\$107.00



1969-1972 Chrome Arm Rest Backing Plates. For use with 12" bases and pads above. Two pair needed for four door models. These plates will fit 1968, but do not have "ribs".

AB692\$48.00 pr.



1968-1970 Hardtop and Convertible Front Arm Rest Pads. Correct vinyl pattern. Black. Paint to match for 16" arm rest bases.

AP680\$96.00 pr.



1969-1970 Chrome arm rest backing plates. For use with 16" pads above. These plates will fit 1968, but do not have "ribs".

AB690\$79.75 pr.

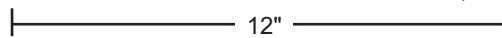

Front Arm Rest Pads

1968-1970 All Sedans;

1971-1972 All with 12" Front arm rest pads.

Correct grain. Pads in colors are vinyl covered.

AP682B.....(Black).....	\$50.50 pr.
AP682W.....(White).....	\$54.50 pr.
AP682P.....(Pearl).....	\$54.50 pr.
AP682RD.....(Red).....	\$54.50 pr.
AP682PM.....(Parchment).....	\$54.50 pr.
AP682LS.....(Lt. Saddle).....	\$54.50 pr.
AP682DB.....(Dark Blue).....	\$54.50 pr.
AP682BB.....(Bright Blue).....	\$54.50 pr.
AP682DG.....(Dark Green).....	\$54.50 pr.
AP682S.....(Sandalwood).....	\$54.50 pr.



Front Arm Rest Bases. For 12" pads listed above.

AB682B.....(Black).....	\$24.50 pr.
AB682W.....(White).....	\$29.75 pr.
AB682P.....(Pearl).....	\$29.75 pr.
AB682RD.....(Red).....	\$29.75 pr.
AB682PM.....(Parchment).....	\$29.75 pr.
AB682LS.....(Lt. Saddle).....	\$54.50 pr.
AB682DB.....(Dark Blue).....	\$29.75 pr.
AB682BB.....(Bright Blue).....	\$29.75 pr.
AB682DG.....(Dark Green).....	\$29.75 pr.
AB682S.....(Sandalwood).....	\$54.50 pr.

For Arm Rest bases with Pads already installed, add "A" to part number above.....\$96.00 pair.



Front Arm Rest Base Moldings (For Arm Rest Bases Above) 12" stainless steel arm rest base molding.

ABM682\$36.00 pr.

Rear Arm Rest Parts (Group 14)

Rear Arm Rest Parts (14.762)



1964

All. Two door Sedans, Rear Pads. Specify Black, White, Saddle, Fawn, Red, Light Blue, Dk. Blue, Dk. Aqua.

AP64R\$20.25 pr.

1965-1967 All. Two door Sedans, Rear Pads. Specify Black, White, Fawn, Red, Lt. Blue, Aqua, Turquoise, Gold.

AP657R\$42.00 pr.

1968 All. Two door Sedans, Rear Pads. Specify Black, Lt. Blue, Md. Blue, Ivy Gold.

AP68R\$29.50 pr.

1968-1969 All. Two door Sedans, Rear Pads. Specify Red, Lt. Green, Dk. Green, Dk. Blue, Dk. Aqua, Lt. Saddle.

AP689R\$29.50 pr.

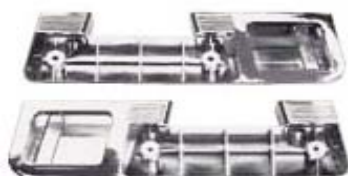

1964-1967 Two door Sedans. Rear arm rest bases.

For 11" pads. "Chrome" plated plastic as original.

ARB647R\$48.00 pr.

Lock Pillar Windlace (14.735)

Our windlace is made with correct Madrid grain vinyl sewn around rubber cord as original.

Black (B), Buckskin (BS), Lt. Blue (LB), Fawn (F), Light Green (LG), Parchment (PM), Pearl (P), Red (R), Off White (OW).



1968-1969 All 2 door hardtops.

LPW689HB.....(Black).....\$33.50 ea.

LPW689H.....(add color code)\$33.50 ea.

1968-1969 All Convertibles.

LPW689CB.....(Black).....\$33.50 ea.

LPW689C.....(add color code)\$33.50 ea.

1970-1972 All 2 door hardtops and convertibles.

LPW702B.....(Black)\$33.50 ea.

LPW702W.....(White or paint to match)\$33.50 ea.

Rear Armrest Panels (15.108)



1970-1972 All 2-door hardtops. Rear armrest panels. Plastic reproduction. Madrid grain texture to look like factory originals. Filler panels are included.

AP702RB.....(Black)\$99.75 pr.

AP702RDU.....(Dk. Blue).....\$99.75 pr.

AP702RDG.....(Dk. Green)\$99.75 pr.

AP702RR.....(Red)\$99.75 pr.

1964-1967 Skylark and GS convt. models. Bare metal.

APU647CL.....(Upper Left)\$69.75 ea.

APU647CR.....(Upper Right)\$69.75 ea.

APL647CL.....(Lower Left)\$90.75 ea.

APL647CR.....(Lower Right)\$90.75 ea.

1968-1972 Skylark and GS convt. models. Bare metal.

APU682CL.....(Upper Left)\$69.75 ea.

APU682CR.....(Upper Right)\$69.75 ea.

APL682CL.....(Lower Left)\$90.75 ea.

APL682CR.....(Lower Right)\$90.75 ea.

Rear Armrest Covers

1968-1972 Skylark and GS. Specify color.

ACR682C.....Convertibles.....\$63.25 set

ACR682.....Coupe Models.....\$63.25 set

Rear Ash Trays (12.045)

1962-1967

1962-1963 All convertibles;

1964-1965 Skylark 2-dr. HT and all convertibles;

1966 All 2-dr. HT and convertibles;

1967 All 2-dr HT models with deluxe arm rests.

AT597\$22.25 ea.



1964-1967 Hardtop

Rear quarter ash trays. Highly polished chrome. An excellent reproduction.

AT617.....\$40.75 pr.



1968-1972 Rear quarter ash trays;

1968-1969 Special, Skylark, GS 2-dr. Hardtop and convertible;

1969-1972 All 4-dr models;

1970-1972 Skylark and GS convertibles.

AT687\$35.00 ea.

1970-1972 Rear quarter ash trays:

Fits all 2-dr. Hardtops.

AT702.....\$51.00 ea.



(15.286) **1961-1972** (15.306)

Custom Form Molded Carpet Sets



Our carpets are Form Press Molded to manufacturers specifications for correct fit and easy installation. All sets include matching vinyl heel pad on drivers side, molded foot wells and jute underpadding. Our carpets are made from Dorsett roll goods, the highest quality automotive carpet available today.

When ordering, please specify color number, year, model and style of car. Colors listed are "names" only and do not imply any exact shade, color or trim code that may have been originally offered. FREE samples are available by sending S.A.S.E. We strongly suggest that you receive a sample before you purchase any carpet. You may also visit our website www.oldbuickparts.com and see group 15 for a color sampling of our carpets. Sorry, no returns on custom made items.

**500 Series 80/20 Nylon Loop
\$209.50**

COLORS AVAILABLE:

- C501 - Black
- C506 - GM Blue
- C508 - Turquoise
- C509 - Olive Green
- C510 - Brown
- C511 - Light Saddle
- C512 - Sky Blue
- C515 - Red
- C521 - Medium Saddle
- C522 - Lt. Blue
- C523 - Gold

COLORS AVAILABLE:

- C525 - Maroon
- C527 - Gray
- C540 - Midnight Blue
- C543 - Ford Tan
- C544 - Emberglow
- C546 - Lt. Oxblood
- C557 - Gun Metal Gray
- C559 - Ivy Gold
- C565 - Red
- C570 - Gold
- C571 - Fawn

Carpet for Door Panel Bottoms

All years and models. 8" wide. State carpet number.
DPC610\$59.00 pair

**800 Series 100% Nylon
CUT PILE \$209.50**

COLORS AVAILABLE:

- C801 - Black
- C8019 - Medium Opal
- C802 - Blue
- C807 - Dark Gray
- C8075 - Medium Gray
- C8078 - Medium Quartz
- C810 - Brown
- C812 - Royal Blue
- C815 - Dark Red
- C8170 - Lapis Blue
- C818 - Ocean Blue
- C820 - Saddle
- C825 - Maroon
- C826 - Titanium
- C8275 - Agate
- C830 - Buckskin
- C832 - Dark Sapphire
- C8335 - Med. Neutral
- C834 - Sand
- C835 - Firethorn
- C840 - Navy Blue
- C8405 - Dark Navy
- C849 - Jade Green
- C851 - Biscuit
- C853 - Silver
- C854 - Caramel
- C865 - Mocha
- C8655 - Med. Mocha
- C868 - Med. Dark Gray
- C871 - Taupe
- C875 - Oxblood
- C8835 - Med. Beige
- C8935 - Adriatic Blue
- C8945 - Dk. Graphite
- C897 - Charcoal

**For carpet by the yard -
add "Y" to the part
number (i.e. C810Y)**

**Essex Premium Plush Pile
\$249.50**

COLORS AVAILABLE:

- C1001 - Black
- C1024 - Med. Dark Graphite
- C1033 - Blue
- C1038 - Charcoal
- C1054 - Caramel
- C1062 - Med. Dark Flint
- C1067 - Dark Taupe
- C1076 - Prairie Tan
- C1079 - Dark Slate
- C1060 - Brown

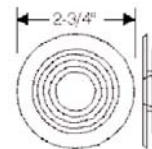

**1936-1960 Grommet for
dimmer Switch on carpet
floor. 1" hole.
SG360.....\$9.50 ea.**

Carpet • Floor Mats • Trunk Linings (Group 15)

Under Carpet Sound Deadener



Die cut from original style tar-based material.

1964-1967 All.

SD647\$65.00 set

1968-1972 All.

SD682\$65.00 set

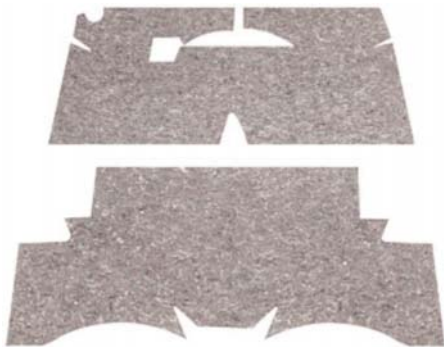

Under Carpet Jute Padding Set

1964-1972 All.

JP642\$38.50 set

Sound Deadening Material

Used under floor matting, on inside of outer sheet metal panels, between trunk inner panels etc. Waffle pattern.

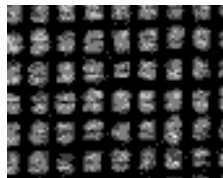

Heavy, black, tar type material.

SD300.....39" X 72".....\$44.75 ea.

Lighter, dark brown, more paper type.

SD301.....27" X 36".....\$25.25 ea.

Kick Panel Insulation (14.630)



Excellent noise reduction and insulation of passenger compartment. Sold in pairs.

1964-1967 All.

KPI647\$12.75 pr.



1968-1972 All.

KPI682\$12.75 pr.



Rear Seat Dividers

Die cut Fiberboard provides insulation of heat, noise, moisture and fumes. Sent UPS oversize.

1961-1962 All.

TD612A\$33.50 each

1964-1967 All.

TD647A\$25.25 each

1968-1972 All except convertibles.

TD682A\$18.75 each

1968-1972 All convertibles.

TD682AC\$18.75 each

Rear Seat Divider Insulation

1964-1967 All.

TDI647A\$17.00 each

1968-1972 All except convertibles.

TDI682A\$17.00 each

1968-1972 All convertibles.

TDI682AC\$17.00 each

Trunk Mats (15.294)

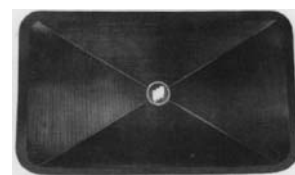

TM615.....**Black** w/ white logo.....\$139.00 ea.

TM615S.....**Saddle** w/ white logo.....\$139.00 ea.

**Free Delivery to
Spring and Fall Carlisle
GS Nationals
Buick Nationals
Call NOW!
908-369-3666**

(Group 15) **1961-1975 Buick Accessory Floor Mats**



(15.292)



Our floor mats are made from original GM blueprints and design. They represent over 20 different part numbers and manufactured to apply to the following applications.

1961 thru 1972 Special, Skylark, GS.

1961 thru 1975 LeSabre, Wildcat, Invicta, Apollo, Centurion, Electra.

1963 thru 1975 Riviera.

Coverage may exceed these applications.

Mats are black with white tri-shield logo. They are show quality in appearance and quality, and approved by G.M.

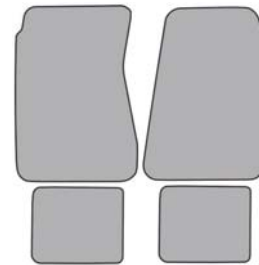

Floor Mats 1968 - 1972 Skylark, GS
Set of 4 with logo

\$139.50

With Skylark
embroidered script logo.

With Tri-Shield
embroidered logo.

COLORS AVAILABLE:

COLORS AVAILABLE:

FM682S - Black

FM682T - GS Black

FM682SG - Grey

FM682TG - GS Grey

FM682SM - Maroon

FM682TM - GS Maroon

FM682ST - Tan

FM682TT - GS Tan

FM382SU - Dark Blue

FM382TU - GS Dark Blue

- 1961-1975 Floor mats. Black with white logo.**
FM615.....Front and Rear.....\$229.50 set
- 1961-1975 Floor mats. Saddle with white logo.**
FM615S.....Front and Rear.....\$249.50 set
- 1961-1975 Floor mats. Red with White Logo**
FM615R.....Front and Rear.....\$239.50 set
- 1961-1975 Floor mats. Blue with white logo.**
FM615U.....Front and Rear.....\$239.50 set
- 1961-1975 Floor mats. Green with white logo.**
FM615G.....Front and Rear.....\$239.50 set
- 1961-1975 Floor mats. Brown with white logo.**
FM615N.....Front and Rear.....\$239.50 set

Floor Mat Set - Universal 4 Piece Set

These are a high quality carpeted floor mat set. Made of high quality carpet. Available in Cutpile or Loop. Finished With A Seamed Binding. A complete set of 4 mats. Front Mat Measures 25-3/4" High by 16-3/4" Wide. Available in Many Colors. Quality Nibbed Backing Prevents Mat Creep. These Mats Stay In Place!

Select Carpet Type And Color Below

FM300.....\$89.50 yd.

NYLON LOOP

- Black
- Red
- Aqua
- Ford Blue
- Dark Blue
- Dark Green
- Medium Blue
- Medium Saddle
- Marroon
- Fawn
- Gold
- Genmetal Gray

NYLON CUT PILE

- Black
- Dark Gray
- Red
- Oxblood
- Sandstone
- Graphite
- Desert Tan
- Flame Red
- Medium Gray



Literature (Group 16)

SHOP MANUALS: A Shop Manual is *ESSENTIAL*. This should be your very first purchase after buying your car. These fully illustrated books were originally developed by **BUICK** for trained **BUICK** mechanics. They offer in detail, description and analysis as well as maintenance and step by step overhaul procedures. All of our Shop Manuals are *Full Size* as originals and feature the clearest print and pictures available in a "xerox" type copy. The covers are "in color" and protected by a heavy clear plastic to keep them clean. As an additional feature, each manual is spiral bound in plastic for long lasting use.

OWNERS MANUALS: Originally placed in the glove compartment of each car. They contain a wealth of information on awareness, instruction and maintenance of your newly purchased car.

Wiring Diagram Manuals

WD66A.....	1966 All	\$7.25 ea.
WD67A.....	1967 All	\$7.25 ea.
WD68A.....	1968 All	\$7.25 ea.
WD69A.....	1969 All	\$7.25 ea.

FISHER BODY MANUALS: These books are "Shop Manuals" for the Body of the car. Topics include Doors, Panels, Weatherstripping, Glass, Glass Channels and all interior.

CHASSIS AND BODY PARTS BOOKS: These books were sent to **BUICK** dealership for their Parts Department Staff to recognize and identify parts. The illustrations within, enable you to find the "group" and "part number" of each part - then identify. In many way they can also serve as assembly manuals.

All items listed below are quality copied from genuine Buick originals. They are provided as informative tools for restoration purposes.

Assembly Manuals

AM63.....	1963 All	\$29.50 ea.
AM64.....	1964 All	\$29.50 ea.
AM68.....	1968 All	\$29.50 ea.
AM69.....	1969 All	\$29.50 ea.
AM70.....	1970 All	\$29.50 ea.
AM71.....	1971 All	\$29.50 ea.
AM72.....	1972 All	\$29.50 ea.

Shop Manuals		Fisher Manuals	Owners Manuals	Chassis & Body Parts Books				
1961 ALL	SM61S	\$47.50	BM61.....	\$35.00	OM-61S.....	\$18.00	PB61.....	\$35.50
1962 ALL	SM62S	\$47.50	BM62.....	\$35.00	OM-62	\$14.75	See NOS section	
1963 ALL	SM63S	\$47.50	BM63.....	\$35.00	See NOS section		PB63.....	\$51.00
1964 ALL	SM64S	\$49.50	BM64.....	\$35.00	See NOS section		PB64.....	\$51.00
1965 Special & Skylark	SM65S	\$45.00	BM65.....	\$35.00	See NOS section		PB65.....	\$51.00
1965 GS	SM65GS.....	\$28.25	BM65.....	\$35.00	See NOS section		PB65.....	\$51.00
1966 ALL	SM66	\$62.50	BM66.....	\$35.00	See NOS section		PB40.....	\$90.25
1967 ALL	SM67	\$62.50	BM67.....	\$35.00	See NOS section		PB67.....	\$58.00
1968 ALL	SM68	\$62.50	BM68.....	\$35.00	See NOS section		PB68.....	\$58.00
1969 ALL	SM69	\$62.50	BM69.....	\$35.00	See NOS section		PB69.....	\$58.00
1970 ALL	SM70	\$62.50	BM70.....	\$35.00	See NOS section		PB40.....	\$90.25
1971 ALL	SM71	\$62.50	BM71.....	\$35.00	See NOS section		PB40.....	\$90.25
1972 ALL	SM72	\$62.50	BM72.....	\$34.00	See NOS section		PB40.....	\$90.25
1973 ALL	SM73	\$79.50	See NOS section		See NOS section		PB40.....	\$90.25
1974 ALL	SM74	\$79.50	See NOS section		See NOS section		PB40.....	\$90.25
1975 ALL	See NOS section		See NOS section		See NOS section		PB40.....	\$90.25
1976 ALL	See NOS section		See NOS section		See NOS section		PB41.....	\$90.25
1977 ALL	See NOS section		See NOS section		See NOS section		PB41.....	\$90.25

Misc. Literature

1962 "Engineer Approved Accessories" pamphlet.	1970 "Engineer Approved Accessories" pamphlet.
AL62.....	AL70.....
\$11.00 ea.	\$11.00 ea.

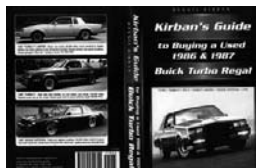

Dennis Kirban's Guide

To Buying a Used 1986 and 1987
Buick Turbo Regal, Grand National,
GNX

KG1.....\$16.00 ea.



Dennis Kirban's Guide

To 1986 and 1987 Buick Turbo
Regal, Grand National, GNX.

KG2.....\$25.00 ea.

Hardware - Push-In Wire Clips (Group 17)



1/4" - 3/16" Hole size.
1/2" x 1/2".
MC3\$0.50 ea.
MC3B Box 100\$25.00 ea.



A11/16" x 9/16" Head.
5/16" Hole size.
MC20\$0.50 ea.
MC20B Box 100.....\$25.00 ea.



1/2" Head diameter.
5/16" Hole size.
MC5\$0.50 ea.
MC5B Box 100\$25.00 ea.



1" x 7/8" Head.
5/16" - 3/8" Hole size.
MC21\$0.50 ea.
MC21B Box 50\$25.00 ea.



1/2" Head diameter.
1/4" Hole size.
MC12\$0.50 ea.
MC12B Box 100\$25.00 ea.



7/8" x 7/8" Head.
5/16" - 3/8" Hole size.
MC22\$0.50 ea.
MC22B Box 50\$25.00 ea.



5/8" x 5/8" Head.
5/16" Hole size.
MC13\$0.50 ea.
MC13B Box 50\$14.00 ea.



1" x 1 1/8" Head.
5/16" - 3/8" Hole size.
MC24\$0.50 ea.
MC24B Box 50\$12.50 ea.



3/4" Head diameter.
5/16" - 3/8" Hole size.
MC16\$0.50 ea.
MC16B Box 100\$25.00 ea.



5/8" x 5/8" Head.
1/4" to 5/16" Hole size.
Tabs can be bent or cut to fit
smaller moldings.
MC54\$0.50 ea.
MC54B Box 25\$7.75 ea.



3/4" x 15/16" Head.
5/16" Hole size.
MC17\$0.50 ea.
MC17B Box 100\$25.00 ea.

Moulding Clips Threaded Type, (Nuts Included)

Door Panel Fasteners

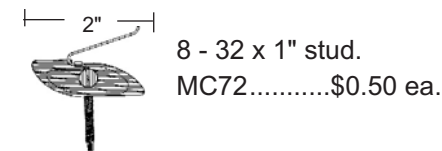
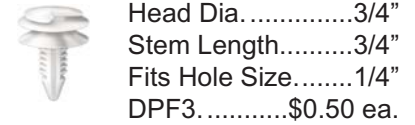
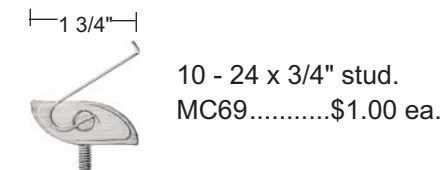
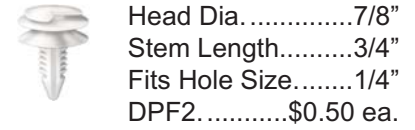
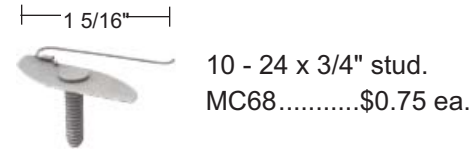
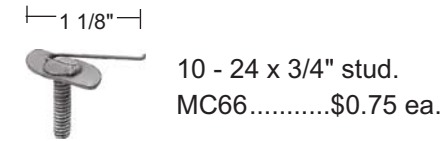
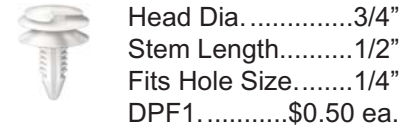
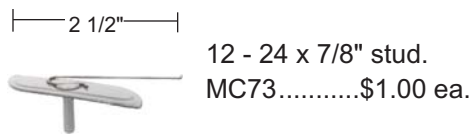
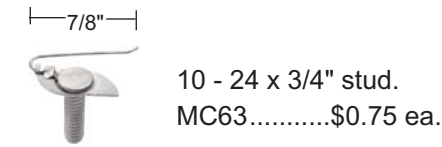

Universal Break-Off Type

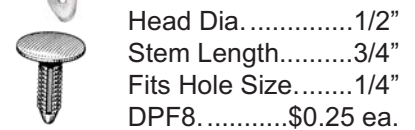
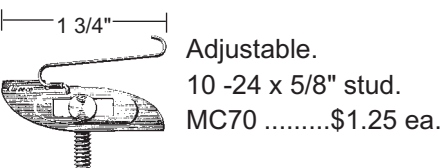
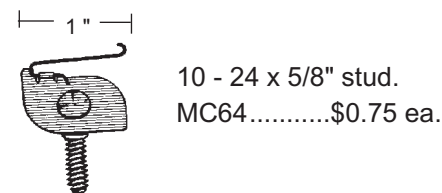
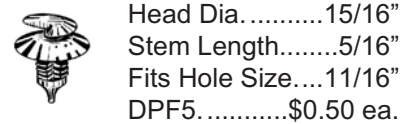
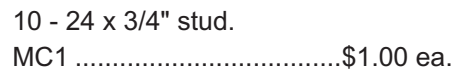
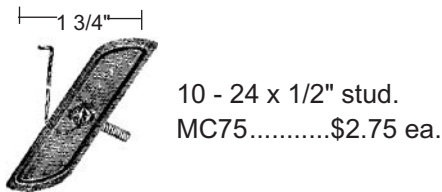
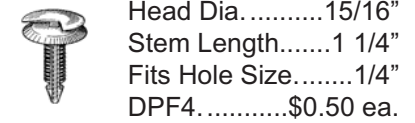

Misc. Retainers

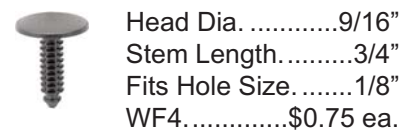
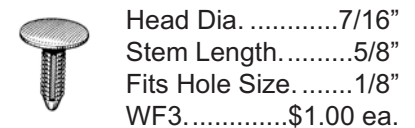
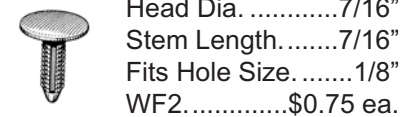

Hardware Section (Group 17)

Push-In Clips



For 5/16" - 3/8" hole.
MC47.....\$0.75 ea.

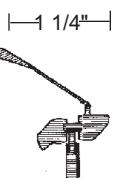

5/16" hole.
MC49.....\$0.75 ea.

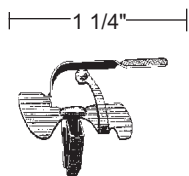

For 3/8" hole.
MC50.....\$0.75 ea.

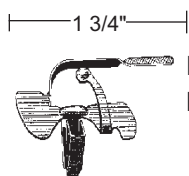

For 3/8" hole.
MC51.....\$2.25 ea.

Universal Wire Moulding Clips Push-in Type



5/16" - 1/2" Moulding.
3/8" Hole size.
MC29.....\$0.50 ea.
MC29B..Box 50...\$12.00 ea.

Nylon Clips

Push into oval holes in panels, then moulding snap over them.



MC84.....\$2.25 ea.



MC85.....\$2.25 ea.



MC86.....\$2.25 ea.



MC600.....\$1.00 ea.

Chrome Trim Screws



#6 Chrome Plated Phillips Oval Head

TS612.....	6x1/2"	\$0.25
TS658.....	6x5/8"	\$0.25
TS634.....	6x3/4"	\$0.25
TS678.....	6x7/8"	\$0.25
TS6100.....	6x1"	\$0.50
TS6114.....	6x1 1/4"	\$0.50

#8 Chrome Plated Phillips Oval Head

TS8386.....	8x3/8" w/ #6 Head	\$0.25
TS812.....	8x1/2"	\$0.25
TS8126.....	8x1/2" w/ #6 Head	\$0.50
TS858.....	8x5/8"	\$0.25
TS8586.....	8x5/8" w/ #6 Head	\$0.25
TS834.....	8x3/4"	\$0.50
TS8346.....	8x3/4" w/ #6 Head	\$0.50
TS83410.....	8x3/4" w/ #10 Head	\$0.50
TS878.....	8x7/8"	\$0.50
TS8786.....	8x7/8" w/ #6 Head	\$0.50
TS8100.....	8x1"	\$0.50
TS81006.....	8x1" w/ #6 Head	\$0.50
TS8118.....	8x1 1/8"	\$0.50
TS81186.....	8x1 1/8" w/ #6 Head	\$0.50
TS8114.....	8x1 1/4"	\$0.50
TS81146.....	8x1 1/4" w/ #6 Head	\$0.50
TS8112.....	8x1 1/2"	\$0.50
TS81126.....	8x1 1/2" w/ #6 Head	\$0.50
TS81346.....	8x1 3/4" w/ #6 Head	\$0.75

#10 Chrome Plated Phillips Oval Head

TS1012.....	10x1/2"	\$0.50
TS10128.....	10x1/2" w/ #8 Head	\$0.50
TS1058.....	10x5/8"	\$0.50
TS1034.....	10x3/4"	\$0.50
TS1000.....	10x1"	\$0.50
TS10008.....	10x1" w/ #8 Head	\$0.50
TS10114.....	10x1 1/4"	\$0.50
TS101126.....	10x1 1/2" w/ #6 Head	\$0.50
TS10134.....	10x1 3/4" w/ #6 Head	\$0.75

Windshield and Backglass Moulding Clips



1969-1975
1969-1970: Lesabre and Wildcat two door models. Backglass. 22 per car;
1971-1972: All Electra, Lesabre and Wildcat four door hardtops. Backglass. As required;
1971-1972: All Electra. Backglass. As required;
1973-1975: All windshield. Backglass and 1/4" glass. As required.
 MC32.....\$0.75 ea.



1963-1965 Windshield & back glass. 26 needed per car.
1963-1966
 MC91.....\$1.00 ea.



1968-1971
1968: All with soft roof trim. Windshield upper and side. Backglass. As required;
1969-1971: All windshield and backglass. As required.
 MC33.....\$0.75 ea.



1968-1973 All windshield and Backglass (Emergency) As required.
 MC35.....\$1.00 ea.



1965-1968
 All windshield and Backglass. As required.
 MC34.....\$1.00 ea.



1966-1975
 All as required. Windshield and Backglass. (Emergency - screw-on type).
 MC37.....\$1.75 ea.



1974-2015
 All as required.
 MC101....\$1.00 ea.

Other Windshield - Backglass Clips (Use as required)



Windshield & backglass clips. Use as required.
 MC41.....\$0.75 ea.



Windshield & backglass clips. Use as required.
 MC43.....\$0.75 ea.



Windshield & backglass clips. Use as required.
 MC44.....\$0.75 ea.



Windshield & backglass clips. Use as required.
 MC42.....\$0.75 ea.



Windshield & backglass clips. Use as required.
 MC39.....\$1.00 ea.

Window Rollers (see also window bearings on next page)



1957 thru 1972
 all as required.
 WR576....\$3.25 ea.



1968 thru 1978 all as required. 7/16" wide.
 WR682.....\$6.50 ea.



1972 thru 1999 all as required. 11/64" id.
 WR727.....\$2.25 ea.



1978 thru 1995 all as required. 5/16" wide.
 WR785....\$6.50 ea.



1968-1975 as required. 5/16" wide.
 WR685...\$16.00 ea.



1979-2004 as req. With metal insert.
 WR790....\$3.75 ea.

Hardware Section (Group 17)



Tubular Nuts (8.921)



For attaching monograms, emblems, etc. with studs. Measure your pin diameter and the size of the hole. Consider nylon tubular nuts. Although not original, they will not rust or chip paint.

Stud size 1/16" Hole size 9/64"
 TN1.....Nylon\$0.50 ea.
 TN1P.....Pack of 25\$7.75

Stud size 3/32" Hole size 1/8"
 TN2.....Steel\$0.25 ea.
 TN2P.....Pack of 25\$6.75

Stud size 1/8" Hole size 5/32"
 TN3.....Steel\$0.25 ea.
 TN3P.....Pack of 25\$6.75

Stud size 5/64" Hole size 5/32"
 TN4.....Nylon\$0.50 ea.
 TN4P.....Pack of 25\$7.75

Stud size 1/8" Hole size 11/64"
 TN5.....Nylon\$0.50 ea.
 TN5P.....Pack of 25\$9.75

Stud size 1/8" Hole size 3/16"
 TN6.....Steel\$0.50 ea.
 TN6P.....Pack of 25\$9.75

Stud size 1/8" Hole size 1/4"
 TN7.....Steel\$0.50 ea.
 TN7P.....Pack of 25\$8.75

Stud size 5/32" Hole size 7/32"
 TN8.....Steel\$0.50 ea.
 TN8P.....Pack of 25\$12.75

Stud size 5/32" Hole size 3/16"
 TN9.....Nylon\$0.50 ea.
 TN9P.....Pack of 25\$7.75

Stud size 3/16" Hole size 7/32"
 TN10.....Steel\$0.50 ea.
 TN10P.....Pack of 25\$8.75

Stud size 3/16" Hole size 13/64"
 TN11.....Steel\$0.50 ea.
 TN11P.....Pack of 25\$8.75

Stud size 1/4" Hole size 5/16"
 TN12.....Steel\$0.50 ea.
 TN12P.....Pack of 25\$9.75



Flat Nuts (8.921)

For attaching monograms, emblems, etc. with studs.

Measure your stud diameter.

FN1.....1/16"\$0.25 ea.
 FN1P.....Pack of 25\$4.75

FN2.....3/32"\$0.25 ea.
 FN2P.....Pack of 25\$4.75

FN3.....1/8"\$0.25 ea.
 FN3P.....Pack of 25\$4.75

FN4.....5/32"\$0.25 ea.
 FN4P.....Pack of 25\$4.75

FN5.....3/16"\$0.25 ea.
 FN5P.....Pack of 25\$4.75

FN6.....1/4"\$0.25 ea.
 FN6P.....Pack of 25\$5.75

FN7.....5/16"\$0.25 ea.
 FN7P.....Pack of 25\$5.75

Round Flat Nuts (8.921)



FN8.....1/8"\$0.25 ea.
 FN8P.....Pack of 25\$5.75

FN9.....3/16"\$0.25 ea.
 FN9P.....Pack of 25\$5.75

Cage Nuts /"U" Nuts

(8.155)



1935-1960 All as required. Cage nut.
 CN363\$3.25 ea.



For 5/16"-18 Screw.
 Range - .025" - .060"
 Center of hole to edge - 9/16"

UN1\$0.50 ea.
 UN1B.....Box of 50\$17.00 ea.



For 3/8"-16 Screw.
 Range - .050" - .200"
 Center of hole to edge - 3/4"

UN2\$0.75 ea.
 UN2B.....Box of 25\$15.00 ea.

Thread Cutting Nuts



Sold in packs of 25 pieces (8.921)

For 1/8" stud. 5/16" Hex.
 7/16" washer OD. Zinc plated.
 TCN18516\$4.25 pack

For 1/8" stud. 1/4" Hex. Zinc plated.
 TCN1814\$4.25 pack

For 5/16" stud. 1/2" Hex.
 7/8" washer OD. Zinc plated.
 TCN51612\$4.25 pack

For 5/32" stud. 11/32" Hex.
 9/16" washer OD. Zinc plated.
 TCN53238\$4.50 pack

For 3/16" stud. 3/8" Hex.
 1/2" washer OD. Zinc plated.
 TCN31638\$4.25 pack

For 1/4" stud. 7/16" Hex.
 9/16" washer OD. Zinc plated.
 TCN14716\$4.25 pack

Window Bearings



1968-1974 as required.
 Low profile. 1 7/32" dia.
 WB684A\$3.75



1968-1974 as required.
 1" dia.
 WB684B\$3.75



1968-1974 as required.
 1" dia. high cap.
 WB684C\$3.75

Buick License Plates

Laser Cut License Plates

These beautiful license plates are made of durable high impact acrylic and are approximately 3/16" thick. Hand inlaid design.

1913 Buick Logo



Black acrylic with bright red square. The "Buick" is shiny mirror like. LP1\$25.75

Buick Tri-Shield - Gold



Black acrylic with gold mirror lettering. Tri-Shield is red, white and blue inlay. LP9\$25.75

Buick Tri-Shield - Silver



Black acrylic with silver mirror lettering. Tri-Shield is red, white and blue inlay. LP8\$25.75

T-Type Turbo 6



Black acrylic with bright yellow/red laser cut and inlaid insignia. LP7\$25.75

Silk Screened License Plates

Heavy gauge embossed aluminum plate.

Buick Tri-Shield



Black with white shield and white "BUICK" lettering. LP2\$9.75

Buick Gold Hawk



Black with gold BUICK Hawk. Sharp! LP3\$9.75

GS by Buick



Black with red "GS" and white "Fast with Class" LP4\$9.75

Grand National



Black plate, red and yellow "6" with gold lettering. LP6\$9.75

Buick License Plates - Frames and Accessories

License Plate Frame Solid Brass



These heavy, **solid brass** frames have "BUICK" stamped in the center flanked by the buick tri-shield. Gold & Chrome (pictured) available.

- Gold - LP13\$25.75
- Chrome - LP12\$25.75

License Plate Grand National



Bad to the bone.

- LP19\$7.25

License Plate Cover Bubble Cover

Protect your License plate with this clear see-thru bubble cover.

- LP14\$15.50

"GO BUICK"



These were found recently in the back room of an old Buick Dealership in Bayonne, NJ. Estimates are that these were from the 1970's.

- LP18\$6.25

Stainless Steel License Plates



Shiny **Stainless Steel** license plate with clear lettering. Tri-Shield is red, white and blue.

- LP10 (Clear Letters)\$25.75
- LP11 (GOLD Letters)\$25.75
- LP20 (BLACK Letters)\$25.75

Fender Covers

GSX Beats You in Stages



Heavy gauge with tool ridge

- FC5.....\$27.25

GS by Buick



A Quality fender cover with tool ridge

- FC3.....\$16.50



BUICK LICENSE PLATES



Laser Cut License Plates

These beautiful license plates are made of durable high impact acrylic and are approximately 3/16" thick. Hand inlaid design.

1913 Buick Logo



Black acrylic with bright red square. The "Buick" is shiny mirror like LP-1\$25.00

Buick Tri-Shield - Gold



Black acrylic with gold mirror lettering. Tri-Shield is red, white and blue inlay LP-9\$25.00

Buick Tri-Shield - Silver



Black acrylic with silver mirror lettering. Tri-Shield is red, white and blue inlay LP-8 . . \$25.00

T-Type Turbo 6



Black acrylic with bright yellow/red laser cut & inlaid insignia. LP-7\$25.00

Silk Screened License Plates

Heavy gauge embossed aluminum plate

Buick Tri-Shield



White with Blue Shield & Red "BUICK" Lettering LP-2\$7.00

Buick Gold Hawk



Black with gold BUICK Hawk. Sharp! LP-3\$7.00

GS by Buick



Black with Red "GS" and white "Fast with Class" LP-4\$7.00

GSX by Buick



Black with Red "GS" and white "X" & "Beats you in stages" LP-5\$7.00

Grand National



Black plate, Red & Yellow "6" with Gold Lettering LP-6\$7.00



BUICK LICENSE PLATES

FRAMES AND ACCESSORIES



LICENSE PLATE FRAME SOLID BRASS



These heavy, **solid brass** frames have "BUICK" stamped in the center flanked by the buick tri-shield. Gold & Chrome (pictured) available

Gold - LP13\$25.00
 Chrome - LP12\$25.00

LICENSE PLATE GRAND NATIONAL



Bad to the bone.

LP19\$7.00

LICENSE PLATE COVER BUBBLE COVER

Protect your License plate with this clear see-thru bubble cover.

LP14\$15.00

COFFEE CUP T-Type - A Boost of BUICK Performance



Dishwasher Safe - GM Licensed

CCTTY1\$10.95

LICENSE PLATE FRAME & COVER



An inexpensive but effective license plate shield. Available in Chrome & Gold (metal frame) and in Black (plastic frame). Each comes with a clear acrylic protector sheet.

Gold Metal Frame- LP17\$5.00
 Chrome Metal Frame - LP16\$5.00
 Black Plastic Frame - LP15\$5.00

"GO BUICK"



These were found recently in the backroom of an old Buick Dealership in Bayonne, NJ. Estimates are that these were from the 1970's

LP18\$6.00

Stainless Steel License Plates



Shiny **Stainless Steel** license plate with clear lettering. Tri-Shield is red, white and blue.

LP-10 (Clear Letters)\$25.00
 LP-11 (GOLD Letters)\$25.00
 LP-20 (BLACK Letters)\$25.00



BUICK STUFF
Fender Covers



Buick Motorsports



GS Fast with class



FC7 Heavy gauge with tool ridge\$18.50

FC4 Heavy gauge with tool ridge\$18.50

GSX Beats you in stages



GS by Buick

FC5 Heavy gauge with tool ridge\$18.50

FC3 A Quality fender cover with tool ridge\$16.00

Old Buick Crest Logo



CARS Logo

FC2 A Quality fender cover with tool ridge\$16.00

FC6 A Quality fender cover with tool ridge\$12.00



www.oldbuickparts.com

NEVER CHANGE POINTS AGAIN!

UPGRADE TO AN ELECTRONIC IGNITION. FITS ENTIRELY INSIDE THE DISTRIBUTOR.
 INSTALLS AS QUICKLY AS CHANGING A SET OF POINTS. NO BLACK BOXES,
 COMPLICATED WIRING OR SPECIAL BRACKETS. ONLY TWO WIRES TO CONNECT.

IGNITOR ELECTRONIC IGNITION KITS

NO.

PRICE

8 CYLINDER

1937-1953 ALL Straight 8, 6 volt, negative ground.....	PI1183N6	\$82.25
1937-1953 ALL Straight 8, 12 volt, negative ground (original distributor)	PI1183	\$74.75
1953-1956 ALL V-8 Mechanical advance under baseplate	<i>New Design - No Magnet Ring</i> PI1185LSC	\$69.50
1957-1974 ALL V-8 Except 215, 300, 340 Engines	<i>New Design - No Magnet Ring</i> PI1181LSC	\$69.50
1957-1974 ALL V-8	PI1181	\$67.50
1957-1974 ALL V-8 (IGNITOR II)	PI91181	NEW \$95.25

6 CYLINDER

1968-1974 All	PI1162A	\$67.50
1962-1967 V-6 Engine.....	PI1164	\$67.50
1962-1967 V-6 Engine (Odd Fire)	PI1165	\$67.50

HIGH PERFORMANCE COILS (40,000 VOLT WITH STOCK APPEARANCE)



1937-1953 ALL Straight 8, 6 volt, negative ground (BLACK).....	PC45011	\$35.75
1937-1953 ALL Straight 8, 6 volt, negative ground (CHROME)	PC45001	\$44.00
1953-1974 ALL (BLACK)	PC40011	\$29.50
1953-1974 ALL (CHROME) 12 v.....	PC40001	\$37.50
1953-1974 ALL (FOR IGNITOR II APPLICATIONS ONLY)(CHROME) 12 v.....	PC45001	NEW \$44.00
1953-1974 ALL (FOR IGNITOR II APPLICATIONS ONLY)(BLACK) 12 v.	PC45011	NEW \$35.75
Coil Bracket	CB350	\$6.75
Coil Bracket (CHROME).....	CB350C	\$9.50

HIGH PERFORMANCE SPARK PLUG WIRES

Low 500 ohm/ft. resistance with spiral wound alloy to suppress electromagnetic radiation plus redundant current paths.

V-8 7.0MM STOCK-LOOK CUSTOM SET

1960-1967 Special, Skylark, GS (Ex 1967 GS 400)	PW708103	\$39.50
1953-1960 All	PW708103	\$39.50
1967-1966 Lesabre, Wildcat, Invicta, Electra, Riviera All 364,401,425 Engines.....	PW708105	\$39.50
1967 GS -400.....	PW708102	\$39.50
1968-1974 All 350, 400, 430, 455 w/o HEI	PW708102	\$39.50

6 CYLINDER 7.0MM STOCK-LOOK CUSTOM SET

1968-1974 ALL.....	PW706101	\$39.50
--------------------	----------	---------

Telephone Number: 908-369-3666 Fax: 908-369-7595

Catalog Order Form

YEAR _____ CARB. _____

NAME _____ TRANS. _____

SUPER, ROADMASTER

SERIES _____ POWER BRAKES _____

40,50,70,4800,ETC.

BODY STYLE _____ POWER STEERING _____

ENGINE, CU. IN. _____ AIR CONDITIONING _____

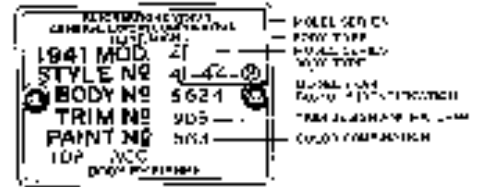

CREDIT CARD BILLING ADDRESS

SHIPPING ADDRESS (if different)

COMPANY _____

COMPANY _____

NAME _____

NAME _____

ADDRESS _____

ADDRESS _____

CITY _____ STATE _____ ZIP _____

CITY _____ STATE _____ ZIP _____

DAYTIME TELEPHONE _____

EVENING TELEPHONE _____

NOTE: ALWAYS GIVE STREET ADDRESS: UPS AND TRUCK LINES CANNOT DELIVER TO POST OFFICE BOXES.

QTY	GROUP NUMBER	PART NUMBER	DESCRIPTION	PRICE EACH	TOTAL PRICE OF ITEMS

Credit Card Information

Visa Mastercard Discover

IMPORTANT: COPY ACCOUNT NUMBER FROM YOUR CREDIT CARD

□□□□ □□□□ □□□□ □□□□

EXPIRATION DATE MONTH □□ YEAR □□ CVV2 □□□

3 Digits on Back

SIGNATURE _____

NOTE: ADDRESS ABOVE MUST BE EXACTLY AS IT APPEARS ON YOUR STATEMENT

SUB TOTAL	
US Shipping Add 10% (\$9.50 Min.)	
US Residential Delivery (\$1.50/\$2.50)*	
NJ Addresses Add 7% Sales Tax	
TOTAL AMOUNT	

*Note: UPS charges extra for residential type delivery (\$1.10) as well as an extended rural area delivery fee (\$1.50). These charges are not well defined by UPS and may affect your order total. We suggest you include these charges if you are unsure. We will gladly refund your money if not required.



1150 W. Fifth St. P.O. Box 614, Marysville, OH 43040

Name: _____

BPG BBS Username: _____

Address: _____

City: _____ **State:** _____ **Zip:** _____

Home Phone: (____) _____ - _____ **Other Phone:** (____) _____ - _____

Email Address: _____ @ _____

Car Interests: V6 ____ V8 ____

Your Buicks: _____

What would you like to see in a Buick Club? _____

Member Signature: _____ **Date:** ____/____/____

Membership Dues: *Please choose a membership plan!*

1 Year \$35.00 ____ **2 Year \$65.00** ____ **3 Year \$90.00** ____ **Lifetime \$500.00** ____

For Office Use Only

Method Of Payment: Cash ____ Check Number ____ PayPal Trans ID _____

Materials: Member Pack ____ Membership Card ____ Member Roster ____ Forum Member ____

Initials: _____ **Code:** BPG Web

Ordering Instructions

ORDER BY TELEPHONE or FAX. Monday through Friday, 8:30AM to 5:00PM. Other hours by chance.

Telephone: 908-369-3666

Fax: 908-369-7595.

ORDER BY MAIL. Please use Catalog Item Order Form, giving complete information requested. Order by Group and Part numbers where applicable. If you do not have enough space use back of the form or a plain piece of paper.

Shipping and Handling Charges

Shipping and Handling charges are estimated at 10% for most orders but not less than our \$9.90 minimum. We pay shipping on in stock orders over \$750.00 within the 48 states (Not included are custom made items, rebuilt or special orders, large items. Large items (fenders, hood, etc.) are shipped freight collect by common carrier and must be pre-paid by check. Foreign Customers please add 20% to order for shipping and handling. Additional shipping charges will apply to large or heavy items. (All Air Shipments, Blue Label, etc. are additional). We ship UPS & USPS unless specified.

Means of Payment



Personal Checks: We gladly accept your personal check. Returned checks will be subject to a \$35.00 retransmission fee.

Visa-Mastercard-Discover:

Foreign: All orders are payable in U.S. funds only. Any extra charges applied such as foreign interchange, duties, customs fees etc. are the responsibility of the customer and will be passed on accordingly.

Damages in Shipment

Damage in transit is the responsibility of the delivering carrier. Retain all packing materials and immediately contact the carrier to file your claim. Do not return damaged items to us as further shipping will result in the loss of claim settlement.

Guarantee - Returns

Your satisfaction is very important to us. If you are not satisfied with an item please phone and tell us why. We will accept any returnable item **within 30 days of the sale** (call first for authorization) provided it is in good unused condition and is returned prepaid with a copy of our receipt. We will then replace the item or refund the original cost. **Parts returned through no fault of CARS, Inc. will be subject to a restocking charge.** Not included in this policy are custom made items such as yard goods, carpets etc., electrical items, and some used parts. Custom items, if made incorrectly with be repaired, not refunded. Labor charges are not refundable. Returns will effect discount and free shipping programs. Expedited delivery charges are not returnable under any circumstances.

Back Orders

In the event an item is not in stock at the time of the order, we will back order until the item comes in or for 30 days at which time you may request a refund.

Subject to Change

All prices, part numbers, specifications, policies and terms are subject to change without notice. All parts subject to prior sale. Always double-check when ordering. Availability is not guaranteed.

Quantity Discount

We will extend a quantity discount of 10% on orders of new parts totalling over \$1,000.00 paid for by cash, check, or postal money order. Excluded are custom made items and all services. Friends and club members should find this advantageous by combining their orders to meet the quantity discount. All items, however, will be shipped to one address. Actual shipping charges will apply.

DEALER INQUIRIES WELCOME

Come visit our Showroom

Appointments recommended

CARS, LLC

205 Pearl Street

Neshanic Station, NJ 08853

Phone: 908-369-3666

Fax: 908-369-7595

Website: www.oldbuickparts.com



TM



CARS, Inc.

205 Pearl St.

Neshanic Station, NJ 08853

(908) 369-3666 Phone

(908) 369-7595 Fax



www.oldbuickparts.com

